



FCC PART 15 SUBPART C TEST REPORT

FCC PART 15.247

Report Reference No......: **TRE1307004502 R/C:89404**

FCC ID.....: **BBP-PRSP201NW1**

Compiled by

(position+printed name+signature)..: File administrators Eric Wang

Eric Wang

Supervised by

(position+printed name+signature)..: Test Engineer Yuchao Wang

yuchao.wang

Approved by

(position+printed name+signature)..: Manager Wenliang Li

Wenliang Li

Date of issue.....: Sep 29, 2013

Testing Laboratory Name: **Shenzhen Huatongwei International Inspection Co., Ltd**

Address: Keji Nan No.12 Road, Hi-tech Park, Shenzhen, China

Applicant's name.....: **RICOH Co., LTD.**

Address: 810 Shimoimaizumi, Ebina City, Kanagawa-Pref., 243-0460 Japan

Test specification:

Standard: **FCC Part 15.247: Operation within the bands 902-928 MHz, 2400-2483.5 MHz and 5725-5850 MHz**

TRF Originator.....: Shenzhen Huatongwei International Inspection CO., Ltd

Master TRF.....: Dated 2006-06

Shenzhen Huatongwei International Inspection Co., Ltd. All rights reserved.

This publication may be reproduced in whole or in part for non-commercial purposes as long as the Shenzhen Huatongwei International Inspection Co., Ltd is acknowledged as copyright owner and source of the material. Shenzhen Huatongwei International Inspection Co., Ltd takes no responsibility for and will not assume liability for damages resulting from the reader's interpretation of the reproduced material due to its placement and context.

Test item description: Printer

Trade Mark: RICOH

Model/Type reference.....: SP 201Nw

Listed Models: /

Manufacturer: **RICOH Co., LTD.**

Modulation Type.....: CCK,OFDM

Operation Frequency.....: From 2412MHz to 2462MHz

Rating: AC 120V/60Hz 8A 900W

Result.....: **Positive**

TEST REPORT

Test Report No. :	TRE1307004502	Sep 29, 2013 Date of issue
--------------------------	----------------------	-------------------------------

Equipment under Test : Printer

Model /Type : SP 201Nw

Listed Models : /

Applicant : **RICOH Co., LTD.**

Address : 810 Shimoimaizumi,Ebina City, Kanagawa-Pref., 243-0460 Japan

Manufacturer : **RICOH Co., LTD.**

Address : 3-6, Naka-magome 1-Chome Ohta-ku,Tokyo 143-8555 Japan

Test Result according to the standards on page 4:	Positive
--	-----------------

The test report merely corresponds to the test sample.
It is not permitted to copy extracts of these test result without the written permission of the test laboratory.

Contents

1.	<u>TEST STANDARDS</u>	4
2.	<u>SUMMARY</u>	5
2.1.	General Remarks	5
2.2.	Product Description	5
2.3.	Equipment Under Test	5
2.4.	Description of the test mode	5
2.5.	Short description of the Equipment under Test (EUT)	5
2.6.	EUT operation mode	5
2.7.	EUT configuration	6
2.8.	Related Submittal(s) / Grant (s)	6
2.9.	Modifications	6
2.10.	NOTE	6
3.	<u>TEST ENVIRONMENT</u>	7
3.1.	Address of the test laboratory	7
3.2.	Test Facility	7
3.3.	Environmental conditions	8
3.4.	Configuration of Tested System	8
3.5.	Test Description	8
3.6.	Statement of the measurement uncertainty	9
3.7.	Equipments Used during the Test	9
4.	<u>TEST CONDITIONS AND RESULTS</u>	11
4.1.	AC Power Conducted Emission	11
4.2.	Radiated Emission	14
4.3.	Maximum Peak Output Power	23
4.4.	Power Spectral Density	32
4.5.	Band Edge Compliance of RF Emission	41
4.6.	Spurious RF Conducted Emission	52
4.7.	6dB Bandwidth	83
4.8.	Antenna Requirement	92
5.	<u>TEST SETUP PHOTOS OF THE EUT</u>	93

1. TEST STANDARDS

The tests were performed according to following standards:

[FCC Rules Part 15.247](#): Frequency Hopping, Direct Spread Spectrum and Hybrid Systems that are in operation within the bands of 902-928 MHz, 2400-2483.5 MHz, and 5725-5850 MHz.

[ANSI C63.10](#): American National Standard for Testing Unlicensed Wireless Devices

[KDB558074 D01 V03](#): Guidance for Performing Compliance Measurements on Digital Transmission Systems (DTS) Operating Under §15.247

2. SUMMARY

2.1. General Remarks

Date of receipt of test sample	:	Sep 25, 2013
Testing commenced on	:	Sep 25, 2013
Testing concluded on	:	Sep 29,2013

2.2. Product Description

The **RICOH Co., LTD.**'s Model: SP 201Nw or the "EUT" as referred to in this report; more general information as follows, for more details, refer to the user's manual of the EUT.

Name of EUT	Printer
Model Number	SP 201Nw
FCC ID	BBP-PRSP201NW1
Modulation Type	CCK,OFDM
Antenna Type	PCB Antenna

2.3. Equipment Under Test

Power supply system utilised

Power supply voltage	:	<input type="radio"/> 120V / 60 Hz	<input type="radio"/> 115V / 60Hz
		<input type="radio"/> 12 V DC	<input type="radio"/> 24 V DC
		<input checked="" type="radio"/> Other (specified in blank below)	

120V/60Hz 8A 900W

2.4. Description of the test mode

IEEE 802.11b/g/n: The product can supported 13 channels while only 11channels are provided to use in USA.

Channel	Frequency(MHz)	Channel	Frequency(MHz)
1	2412	8	2447
2	2417	9	2452
3	2422	10	2457
4	2427	11	2462
5	2432	12	2467
6	2437	13	2472
7	2442		

2.5. Short description of the Equipment under Test (EUT)

2.4GHz (Printer (M/N:SP 201Nw))

For more details, refer to the user's manual of the EUT.

Serial number: Prototype

2.6. EUT operation mode

The EUT has been tested under typical operating condition. The Applicant provides command to control the EUT for staying in continuous transmitting and receiving mode for testing.

2.7. EUT configuration

The following peripheral devices and interface cables were connected during the measurement:

● - supplied by the manufacturer

○ - supplied by the lab

<input type="radio"/>	Power Cable	Length (m) :	/
		Shield :	/
		Detachable :	/
<input type="radio"/>	Multimeter	Manufacturer :	/
		Model No. :	/

2.8. Related Submittal(s) / Grant (s)

This submittal(s) (test report) is intended for **FCC ID: BBP-PRSP201NW1** filing to comply with Section 15.247 of the FCC Part 15, Subpart C Rules.

2.9. Modifications

No modifications were implemented to meet testing criteria.

2.10. NOTE

1. The EUT is a Printer with WLAN function, The functions of the EUT listed as below:

	Test Standards	Reference Report
	FCC Part 15 Subpart B	TRE1307004501
WLAN 802.11b/g/n	FCC Part 15 Subpart C	TRE1307004502
MPE REPORT	FCC Per 47 CFR 2.1091(b)	TRE1307004503

2. The frequency bands used in this EUT are listed as follows:

Frequency Band(MHz)	2400-2483.5	5150-5350	5470-5725	5725-5850
802.11b	√	—	—	—
802.11g	√	—	—	—
802.11n(20MHz)	√	—	—	—
802.11n(40MHz)	√	—	—	—

3. The EUT incorporates a SISO function, Physically, the EUT provides one completed transmitter and one completed receiver.

Modulation Mode	TX Function
802.11b	1TX
802.11g	1TX
802.11n (20MHz)	1TX
802.11n (40MHz)	1TX

3. TEST ENVIRONMENT

3.1. Address of the test laboratory

Shenzhen Huatongwei International Inspection Co., Ltd
Keji Nan No.12 Road, Hi-tech Park, Shenzhen, China
Phone: 86-755-26715686 Fax: 86-755-26748089

The sites are constructed in conformance with the requirements of ANSI C63.7, ANSI C63.4 (2009) and CISPR Publication 22.

3.2. Test Facility

The test facility is recognized, certified, or accredited by the following organizations:

CNAS-Lab Code: L1225

Shenzhen Huatongwei International Inspection Co., Ltd. has been assessed and proved to be in compliance with CNAS-CL01 Accreditation Criteria for Testing and Calibration Laboratories (identical to ISO/IEC 17025: 2005 General Requirements) for the Competence of Testing and Calibration Laboratories, Date of Registration: Mar. 29, 2012. Valid time is until Feb. 28, 2015.

A2LA-Lab Cert. No. 2243.01

Shenzhen Huatongwei International Inspection Co., Ltd. EMC Laboratory has been accredited by A2LA for technical competence in the field of electrical testing, and proved to be in compliance with ISO/IEC 17025: 2005 General Requirements for the Competence of Testing and Calibration Laboratories and any additional program requirements in the identified field of testing. Valid time is until Dec. 30, 2013.

FCC-Registration No.: 662850

Shenzhen Huatongwei International Inspection Co., Ltd. EMC Laboratory has been registered and fully described in a report filed with the FCC (Federal Communications Commission). The acceptance letter from the FCC is maintained in our files. Registration 662850, Renewal date Jun. 01, 2012, valid time is until Jun. 01, 2015.

IC-Registration No.: 5377A

The 3m Alternate Test Site of Shenzhen Huatongwei International Inspection Co., Ltd. has been registered by Certification and Engineering Bureau of Industry Canada for the performance of radiated measurements with Registration No. 5377A on Jan. 25, 2011, valid time is until Jan. 24, 2014.

ACA

Shenzhen Huatongwei International Inspection Co., Ltd. EMC Laboratory can also perform testing for the Australian C-Tick mark as a result of our A2LA accreditation.

VCCI

The 3m Semi-anechoic chamber (12.2m×7.95m×6.7m) and Shielded Room (8m×4m×3m) of Shenzhen Huatongwei International Inspection Co., Ltd. has been registered in accordance with the Regulations for Voluntary Control Measures with Registration No.: G-292. Date of Registration: Dec. 24, 2010. Valid time is until Dec. 23, 2013.

Main Ports Conducted Interference Measurement of Shenzhen Huatongwei International Inspection Co., Ltd. has been registered in accordance with the Regulations for Voluntary Control Measures with Registration No.: C-2726. Date of Registration: Dec. 20, 2012. Valid time is until Dec. 19, 2015.

Telecommunication Ports Conducted Interference Measurement of Shenzhen Huatongwei International Inspection Co., Ltd. has been registered in accordance with the Regulations for Voluntary Control Measures with Registration No.: T-1837. Date of Registration: May 07, 2013. Valid time is until May 06, 2016.

DNV

Shenzhen Huatongwei International Inspection Co., Ltd. has been found to comply with the requirements of DNV towards subcontractor of EMC and safety testing services in conjunction with the EMC and Low voltage Directives and in the voluntary field. The acceptance is based on a formal quality Audit and follow-ups

according to relevant parts of ISO/IEC Guide 17025 (2005), in accordance with the requirements of the DNV Laboratory Quality Manual towards subcontractors. Valid time is until Aug. 24, 2016.

3.3. Environmental conditions

During the measurement the environmental conditions were within the listed ranges:

Temperature:	<u>15-35 ° C</u>
Humidity:	<u>30-60 %</u>
Atmospheric pressure:	<u>950-1050mbar</u>

3.4. Configuration of Tested System

Fig. 2-1 Configuration of Tested System

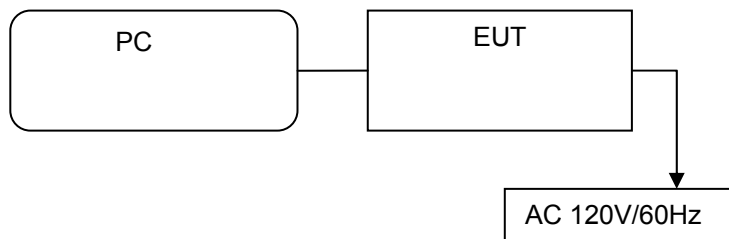

Equipment Used in Tested System

No.	Equipment	Manufacturer	Model No.	Serial No.	Length	shielded/unshielded	Notes
1	Notebook 1	LENOVO	ThinkPad X201i	R8-7DYTX 10/11	/	/	DOC
2	Power line (Printer)	/	/	N/A	1.00m	unshielded	N/A

3.5. Test Description

FCC PART 15 15.247		
FCC Part 15.207	AC Power Conducted Emission	PASS
FCC Part 15.247(a)(2)	6dB Bandwidth	PASS
FCC Part 15.247(d)	Spurious RF Conducted Emission	PASS
FCC Part 15.247(b)	Maximum Peak Output Power	PASS
FCC Part 15.247(e)	Power Spectral Density	PASS
FCC Part 15.109/ 15.205/ 15.209	Radiated Emissions	PASS
FCC Part 15.247(d)	Band Edge	PASS
FCC Part 15.203/15.247 (b)	Antenna Requirement	PASS

Remark: The measurement uncertainty is not included in the test result.

Preliminary tests were performed in different data rate to find the worst radiated emission. The data rate shown in the table below is the worst-case rate with respect to the specific test item. Investigation has been done on all the possible configurations for searching the worst cases. The following table is a list of the test modes shown in this test report.

Test Items	Mode	Data Rate	Channel
Maximum Peak Conducted Output Power	11b/DSSS	1 Mbps	1/6/11
Power Spectral Density	11g/OFDM	6 Mbps	1/6/11
6dB Bandwidth	11g/OFDM	6 Mbps	1/6/11
Spurious RF conducted emission	11n(20MHz)/OFDM	6.5Mbps	1/6/11
Radiated Emission 9kHz~1GHz& Radiated Emission 1GHz~10th Harmonic	11n(40MHz)/OFDM	13.5 Mbps	3/6/9
Band Edge	11b/DSSS	1 Mbps	1/11

	11g/OFDM	6 Mbps	1/11
	11n(20MHz)/OFDM	6.5Mbps	1/11
	11n(40MHz)/OFDM	13.5 Mbps	3/9

3.6. Statement of the measurement uncertainty

The data and results referenced in this document are true and accurate. The reader is cautioned that there may be errors within the calibration limits of the equipment and facilities. The measurement uncertainty was calculated for all measurements listed in this test report acc. to CISPR 16 - 4 „Specification for radio disturbance and immunity measuring apparatus and methods – Part 4: Uncertainty in EMC Measurements“ and is documented in the Shenzhen Huatongwei International Inspection Co., Ltd quality system acc. to DIN EN ISO/IEC 17025. Furthermore, component and process variability of devices similar to that tested may result in additional deviation. The manufacturer has the sole responsibility of continued compliance of the device.

Hereafter the best measurement capability for Shenzhen Huatongwei laboratory is reported:

Test Items	Measurement Uncertainty	Notes
Frequency stability	25 Hz	(1)
Transmitter power conducted	0.57 dB	(1)
Transmitter power Radiated	2.20 dB	(1)
Conducted spurious emission 9KHz-12.75 GHz	1.60 dB	(1)
Radiated spurious emission 9KHz-12.75 GHz	2.20 dB	(1)
Conducted Emission 9KHz-30MHz	3.39 dB	(1)
Radiated Emission 30~1000MHz	4.24 dB	(1)
Radiated Emission 1~18GHz	5.16 dB	(1)
Radiated Emission 18-40GHz	5.54 dB	(1)
Occupied Bandwidth	-----	(1)
Emission Mask	-----	(1)
Modulation Characteristic	-----	(1)
Transmitter Frequency Behavior	-----	(1)

- (1) This uncertainty represents an expanded uncertainty expressed at approximately the 95% confidence level using a coverage factor of k=1.96.

3.7. Equipments Used during the Test

AC Power Conducted Emission					
Item	Test Equipment	Manufacturer	Model No.	Serial No.	Last Cal.
1	Artificial Mains	Rohde&Schwarz	ESH2-Z5	100028	2012/10/27
2	EMI Test Receiver	Rohde&Schwarz	ESCI	100106	2012/10/27
3	Pulse Limiter	Rohde&Schwarz	ESHSZ2	100044	2012/10/27
4	EMI Test Software	Rohde&Schwarz	ES-K1 V1.71	N/A	N/A

Radiated Emission					
Item	Test Equipment	Manufacturer	Model No.	Serial No.	Last Cal.
1	Ultra-Broadband Antenna	ShwarzBeck	VULB9163	538	2012/10/27
2	EMI TEST RECEIVER	Rohde&Schwarz	ESI 26	100009	2012/10/27
3	EMI TEST SOFTWARE	Audix	E3	N/A	2012/10/27
4	TURNTABLE	ETS	2088	2149	N/A
5	ANTENNA MAST	ETS	2075	2346	N/A
6	EMI TEST SOFTWARE	Rohde&Schwarz	ESK1	N/A	N/A
7	HORN ANTENNA	ShwarzBeck	9120D	1011	2012/10/27
8	Amplifer	Sonoma	310N	E009-13	2012/10/27
9	JS amplifer	Rohde&Schwarz	JS4-00101800-28-5A	F201504	2012/10/27
10	High pass filter	Compliance Direction systems	BSU-6	34202	2012/10/27
11	HORN ANTENNA	ShwarzBeck	9120D	1012	2012/10/27
12	Amplifer	Compliance Direction systems	PAP1-4060	120	2012/10/27
13	Loop Antenna	Rohde&Schwarz	HFH2-Z2	100020	2012/10/27

14	TURNTABLE	MATURO	TT2.0	----	N/A
15	ANTENNA MAST	MATURO	TAM-4.0-P	----	N/A
16	Horn Antenna	SCHWARZBECK	BBHA9170	25841	2012/10/27
17	EMI TEST SOFTWARE	Audix	E3	N/A	N/A

Maximum Peak Output Power / Power Spectral Density / 6dB Bandwidth / Band Edge Compliance of RF Emission / Spurious RF Conducted Emission

Item	Test Equipment	Manufacturer	Model No.	Serial No.	Last Cal.
1	Spectrum Analyzer	Rohde&Schwarz	FSP	1164.4391.40	2012/10/27

The Cal.Interval was one year

4. TEST CONDITIONS AND RESULTS

4.1. AC Power Conducted Emission

TEST CONFIGURATION

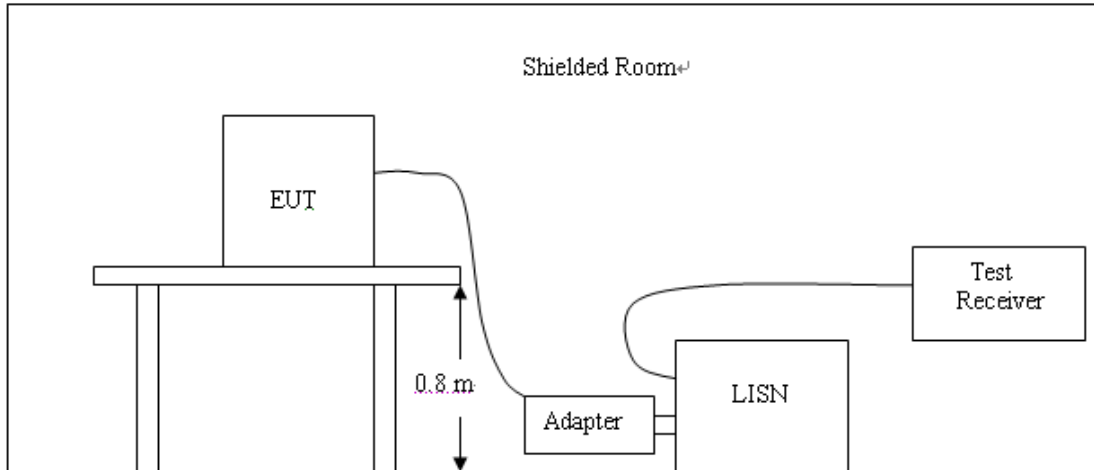

TEST PROCEDURE

- 1 The equipment was set up as per the test configuration to simulate typical actual usage per the user's manual. The EUT is a tabletop system, a wooden table with a height of 0.8 meters is used and is placed on the ground plane as per ANSI C63.4-2009.
- 2 Support equipment, if needed, was placed as per ANSI C63.4-2009
- 3 All I/O cables were positioned to simulate typical actual usage as per ANSI C63.4-2009
- 4 The EUT received DC5V power from the adapter, the adapter received AC120V/60Hz power through a Line Impedance Stabilization Network (LISN) which supplied power source and was grounded to the ground plane.
- 5 All support equipments received AC power from a second LISN, if any.
- 6 The EUT test program was started. Emissions were measured on each current carrying line of the EUT using a spectrum Analyzer / Receiver connected to the LISN powering the EUT. The LISN has two monitoring points: Line 1 (Hot Side) and Line 2 (Neutral Side). Two scans were taken: one with Line 1 connected to Analyzer / Receiver and Line 2 connected to a 50 ohm load; the second scan had Line 1 connected to a 50 ohm load and Line 2 connected to the Analyzer / Receiver.
- 7 Analyzer / Receiver scanned from 150 KHz to 30MHz for emissions in each of the test modes.
- 8 During the above scans, the emissions were maximized by cable manipulation.

AC Power Conducted Emission Limit

For intentional device, according to § 15.207(a) AC Power Conducted Emission Limits is as following :

Frequency (MHz)	Maximum RF Line Voltage (dBµV)			
	CLASS A		CLASS B	
	Q.P.	Ave.	Q.P.	Ave.
0.15 - 0.50	79	66	66-56*	56-46*
0.50 - 5.00	73	60	56	46
5.00 - 30.0	73	60	60	50

* Decreasing linearly with the logarithm of the frequency

TEST RESULTS

The AC Power Conducted Emission measurement are performed the each test mode (b/g/n) and channel (low/mid/high), the datum recorded below (802.11b mode,the middle channel) is the worst case for all the test modes and channels.

SCAN TABLE: "Voltage (9K-30M)FIN"

Short Description: 150K-30M Voltage

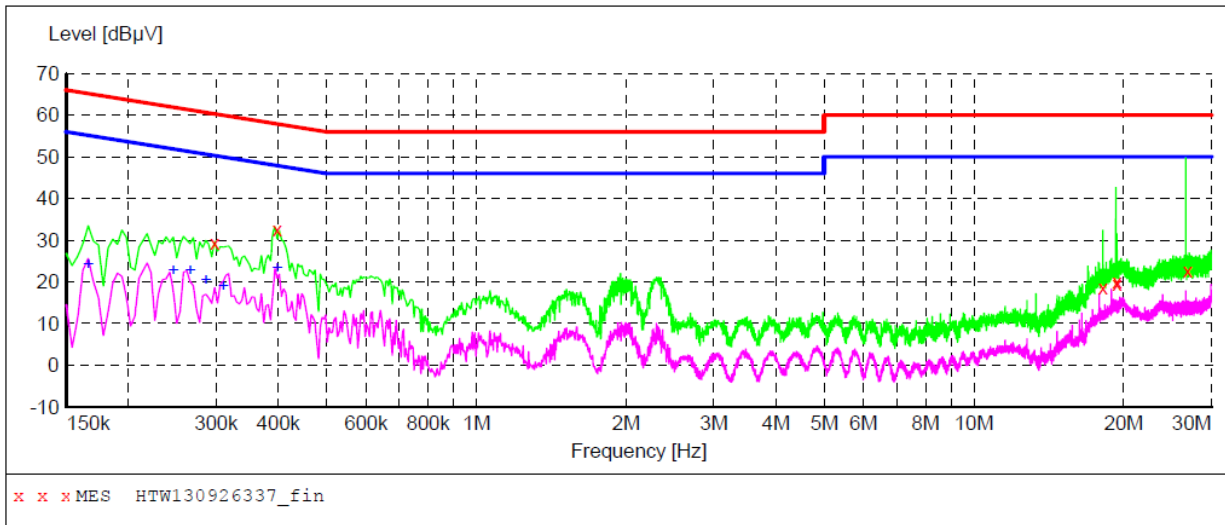

MEASUREMENT RESULT: "HTW130926337_fin"

9/26/2013 6:19PM

Frequency MHz	Level dBµV	Transd dB	Limit dBµV	Margin dB	Detector	Line	PE
0.298000	29.40	10.8	60	30.9	QP	N	GND
0.398000	32.60	10.6	58	25.3	QP	N	GND
18.182000	18.50	10.9	60	41.5	QP	N	GND
19.394000	19.50	10.9	60	40.5	QP	N	GND
19.402000	20.00	10.9	60	40.0	QP	N	GND
26.874000	22.50	11.2	60	37.5	QP	N	GND

MEASUREMENT RESULT: "HTW130926337_fin2"

9/26/2013 6:19PM

Frequency MHz	Level dBµV	Transd dB	Limit dBµV	Margin dB	Detector	Line	PE
0.166000	24.00	12.7	55	31.2	AV	N	GND
0.246000	22.70	11.3	52	29.2	AV	N	GND
0.266000	22.70	11.1	51	28.5	AV	N	GND
0.286000	20.30	10.9	51	30.3	AV	N	GND
0.310000	18.80	10.8	50	31.2	AV	N	GND
0.398000	23.10	10.6	48	24.8	AV	N	GND

SCAN TABLE: "Voltage (9K-30M) FIN"
 Short Description: 150K-30M Voltage

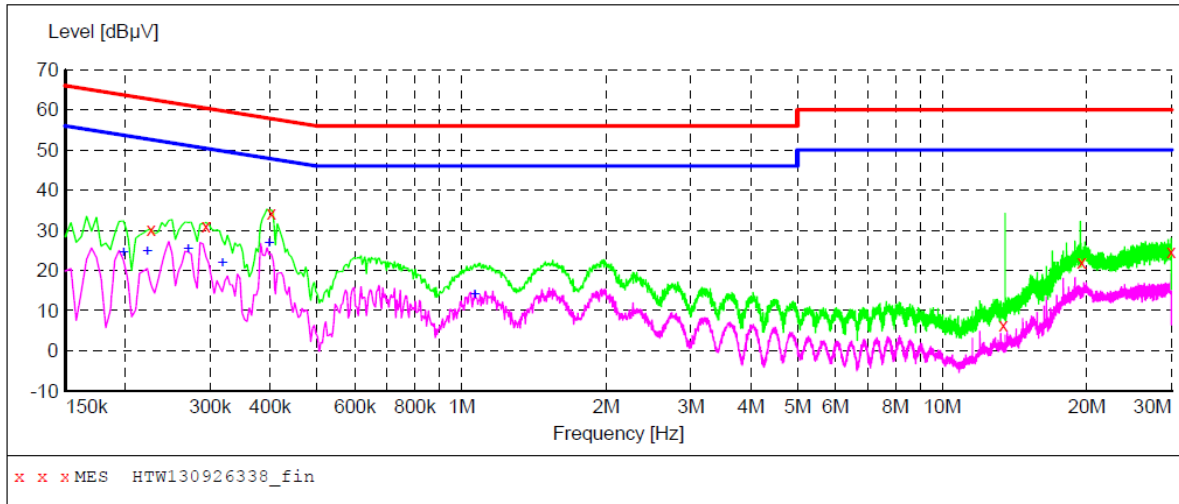

MEASUREMENT RESULT: "HTW130926338_fin"

9/26/2013 6:26PM

Frequency MHz	Level dBµV	Transd dB	Limit dBµV	Margin dB	Detector	Line	PE
0.226000	30.20	11.5	63	32.4	QP	L1	GND
0.294000	31.00	10.8	60	29.4	QP	L1	GND
0.402000	34.30	10.6	58	23.5	QP	L1	GND
13.394000	6.30	10.8	60	53.7	QP	L1	GND
19.514000	22.20	10.9	60	37.8	QP	L1	GND
29.962000	24.60	11.3	60	35.4	QP	L1	GND

MEASUREMENT RESULT: "HTW130926338_fin2"

9/26/2013 6:26PM

Frequency MHz	Level dBµV	Transd dB	Limit dBµV	Margin dB	Detector	Line	PE
0.198000	24.40	11.9	54	29.3	AV	L1	GND
0.222000	24.60	11.6	53	28.1	AV	L1	GND
0.270000	25.40	11.1	51	25.7	AV	L1	GND
0.318000	21.80	10.7	50	28.0	AV	L1	GND
0.398000	26.70	10.6	48	21.2	AV	L1	GND
1.066000	13.80	10.6	46	32.2	AV	L1	GND

4.2. Radiated Emission

TEST CONFIGURATION

Frequency range 9KHz – 30MHz

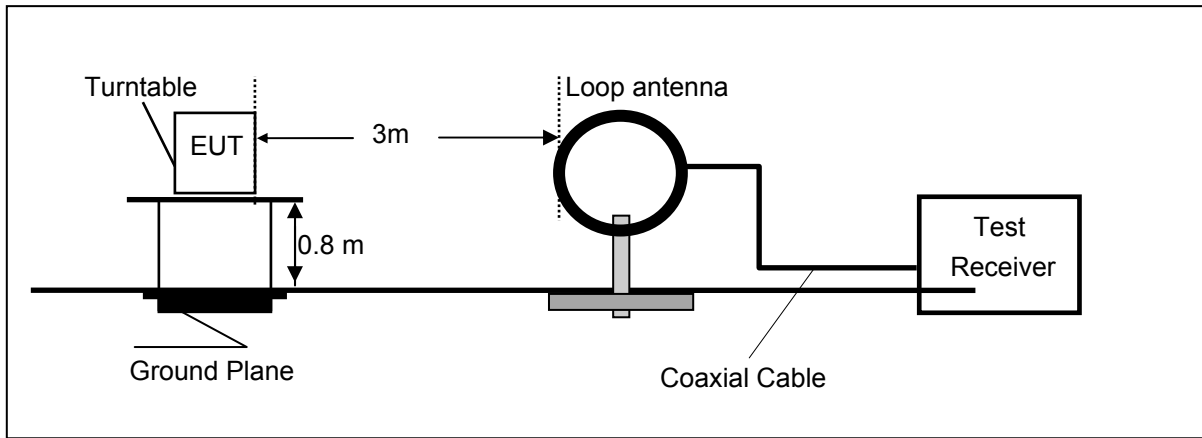

Frequency range 30MHz – 1000MHz

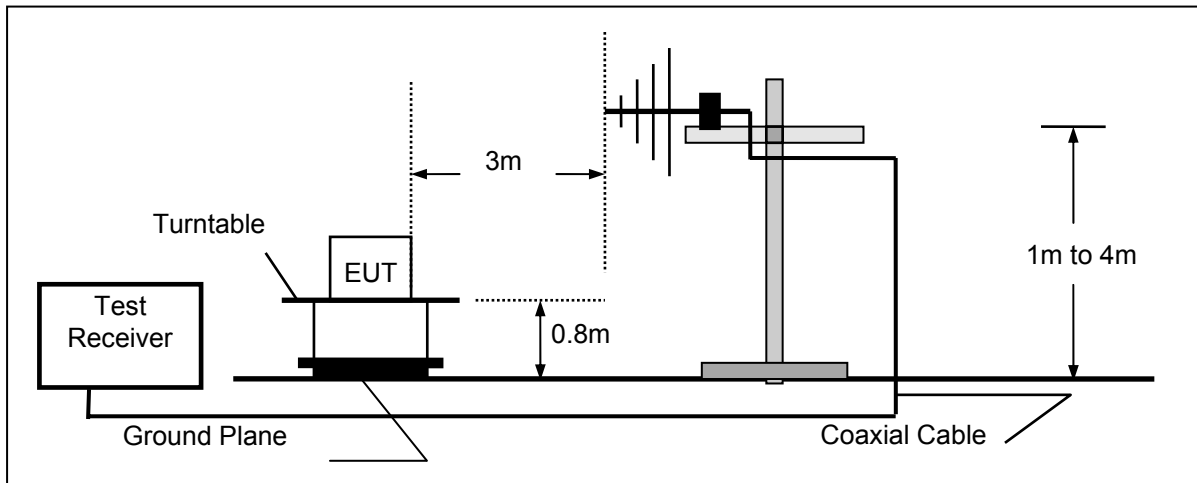

Frequency range above 1GHz-25GHz

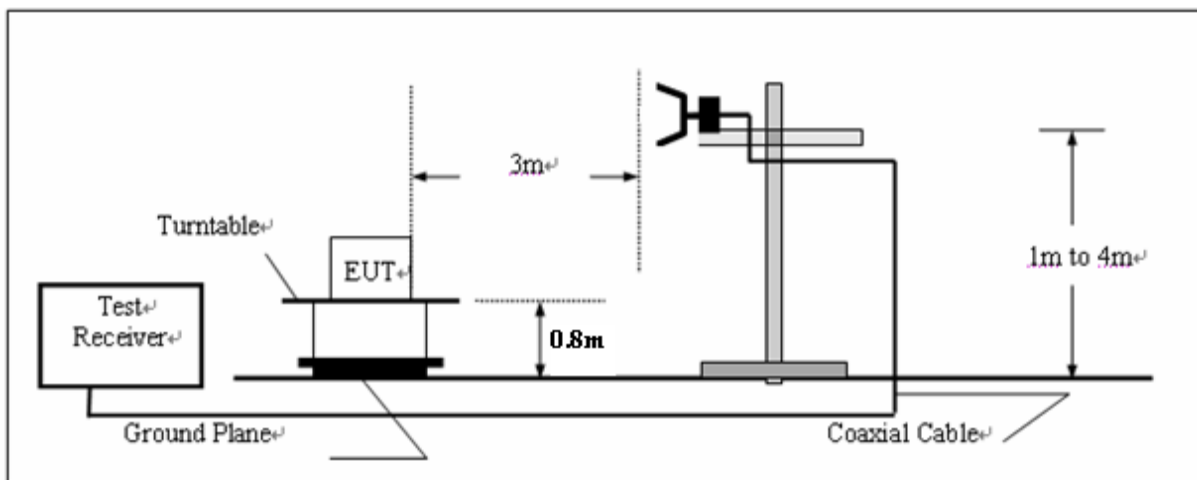

TEST PROCEDURE

1. The EUT was placed on a turn table which is 0.8m above ground plane.
2. Maximum procedure was performed by raising the receiving antenna from 1m to 4m and rotating the turn table from 0° to 360° to acquire the highest emissions from EUT

3. And also, each emission was to be maximized by changing the polarization of receiving antenna both horizontal and vertical.
4. Repeat above procedures until all frequency measurements have been completed.
5. The EUT minimum operation frequency was 26MHz and maximum operation frequency was 2462MHz.so radiated emission test frequency band from 9KHz to 25GHz.

Field Strength Calculation

The field strength is calculated by adding the Antenna Factor and Cable Factor and subtracting the Amplifier Gain and Duty Cycle Correction Factor(if any) from the measured reading. The basic equation with a sample calculation is as follows:

$$FS = RA + AF + CL - AG$$

Where FS = Field Strength	CL = Cable Attenuation Factor (Cable Loss)
RA = Reading Amplitude	AG = Amplifier Gain
AF = Antenna Factor	

RADIATION LIMIT

For intentional device, according to § 15.209(a), the general requirement of field strength of radiated emission from intentional radiators at a distance of 3 meters shall not exceed the following table. According to § 15.247(d), in any 100kHz bandwidth outside the frequency band in which the EUT is operating, the radio frequency power that is produced by the intentional radiator shall be at least 20dB below that in the 100kHz bandwidth within the band that contains the highest level of desired power.

The frequency spectrum above 1 GHz for Transmitter was investigated. All emission not reported are much lower than the prescribed limits. Set the RBW=1MHz,VBW=3MHz for Peak Detector while the RBW=1MHz,VBW=10Hz for Average Detector,Readings are both peak and average values.

Frequency (MHz)	Distance (Meters)	Radiated (dBμV/m)	Radiated (μV/m)
0.009-0.49	300	20log(2400/F(KHz))+80	2400/F(KHz)
0.49-1.705	30	20log(24000/F(KHz))+40	24000/F(KHz)
1.705-30	30	20log(30)+40	30
30-88	3	40.0	100
88-216	3	43.5	150
216-960	3	46.0	200
Above 960	3	54.0	500

TEST RESULTS

Remark:

1. The radiated measurement are performed the each test mode (b/g/n) and channel (low/mid/high), the datum recorded below (802.11b mode,the middle channel) is the worst case for all the test mode and channel.
2. ULTRA-BROADBAND ANTENNA for the radiation emission test below 1G.
3. HORN ANTENNA for the radiation emission test above 1G.
4. We tested both battery powered and charging mode at three orientations,recored woest case at charging mode.

For 9KHz to 30MHz

Frequency (MHz)	Corrected Reading (dBμV/m)@3m	FCC Limit (dBμV/m) @3m	Margin (dB)	Detector	Result
12.00	41.56	69.54	27.98	QP	PASS
24.00	39.78	69.54	29.76	QP	PASS

For 30MHz to 1000MHz

SCAN TABLE: "test Field(30M-1G)QP"

Short Description:		Field Strength(30M-1G)					
Start	Stop	Step	Detector	Meas. Time	IF Bandw.	Transducer	
30.0 MHz	1.1 GHz	60.0 kHz	QuasiPeak	1.0 s	120 kHz	VULB9163	

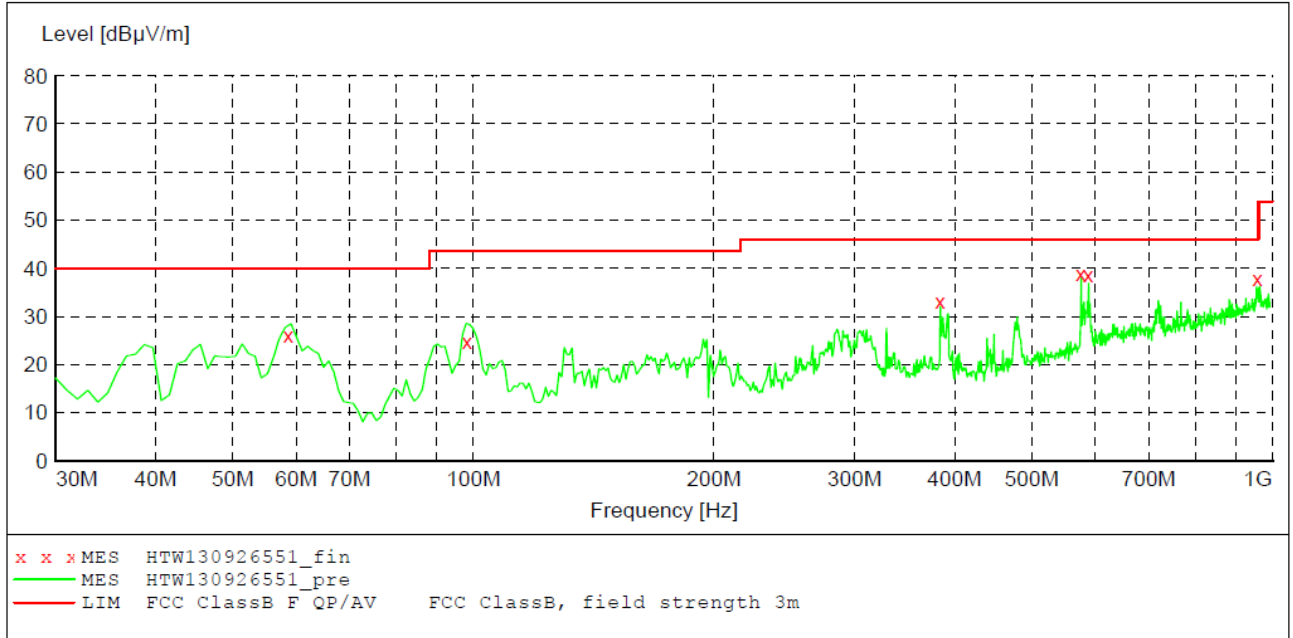

MEASUREMENT RESULT: "HTW130926551_fin"

9/26/2013 4:32PM

Frequency MHz	Level dBµV/m	Transd dB	Limit dBµV/m	Margin dB	Det.	Height cm	Azimuth deg	Polarization
58.620000	26.20	-15.6	40.0	13.8	QP	100.0	355.00	VERTICAL
98.220000	24.90	-13.9	43.5	18.6	QP	100.0	109.00	VERTICAL
383.940000	33.00	-11.4	46.0	13.0	QP	100.0	118.00	VERTICAL
575.940000	38.90	-4.3	46.0	7.1	QP	100.0	141.00	VERTICAL
588.000000	38.70	-3.6	46.0	7.3	QP	100.0	139.00	VERTICAL
957.780000	37.90	3.5	46.0	8.1	QP	100.0	320.00	VERTICAL

SCAN TABLE: "test Field(30M-1G)QP"

Short Description: Field Strength(30M-1G)
 Start Stop Step Detector Meas. IF Transducer
 Frequency Frequency Width Time Bandw.
 30.0 MHz 1.1 GHz 60.0 kHz QuasiPeak 1.0 s 120 kHz VULB9163

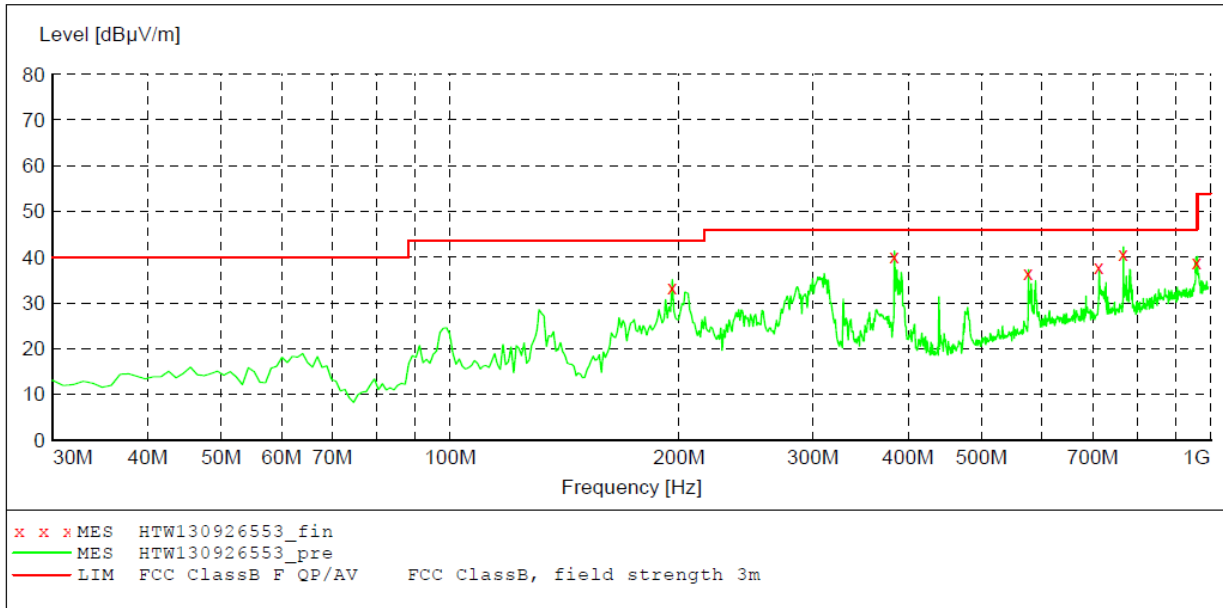

MEASUREMENT RESULT: "HTW130926553_fin"

9/26/2013 4:52PM

Frequency MHz	Level dBµV/m	Transd dB	Limit dBµV/m	Margin dB	Det.	Height cm	Azimuth deg	Polarization
196.020000	33.30	-14.6	43.5	10.2	QP	100.0	153.00	HORIZONTAL
383.940000	40.20	-11.4	46.0	5.8	QP	100.0	348.00	HORIZONTAL
575.940000	36.60	-4.3	46.0	9.4	QP	100.0	33.00	HORIZONTAL
713.100000	37.90	-1.4	46.0	8.1	QP	100.0	242.00	HORIZONTAL
767.880000	40.60	-0.1	46.0	5.4	QP	100.0	208.00	HORIZONTAL
959.280000	39.00	3.5	46.0	7.0	QP	100.0	288.00	HORIZONTAL

For 1GHz to 25GHz

802.11b Mode(above 1GHz)

ANTENNA POLARITY & TEST DISTANCE: HORIZONTAL AT 3 M (802.11b--2412MHz)

No.	Frequency (MHz)	Emission Level (dBuV/m)		Limit (dBuV/m)	Margin (dB)	Antenna Height (m)	Table Angle (Degree)	Raw Value (dBuV)	Antenna Factor (dB/m)	Cable Factor (dB)	Pre-amplifier	Correction Factor (dB/m)
1	4824.00	46.99	PK	74	27.01	1.00 H	26	44.89	31.60	7.00	36.5	2.10
1	4824.00	38.40	AV	54	15.60	1.00 H	26	36.30	31.60	7.00	36.5	2.10
2	7236.00	50.55	PK	74	23.45	1.00 H	175	39.62	37.33	8.90	35.3	10.93
2	7236.00	44.33	AV	54	9.67	1.00 H	175	33.40	37.33	8.90	35.3	10.93

ANTENNA POLARITY & TEST DISTANCE: VERTICAL AT 3 M (802.11b--2412MHz)

No.	Frequency (MHz)	Emission Level (dBuV/m)		Limit (dBuV/m)	Margin (dB)	Antenna Height (m)	Table Angle (Degree)	Raw Value (dBuV)	Antenna Factor (dB/m)	Cable Factor (dB)	Pre-amplifier	Correction Factor (dB/m)
1	4824.00	54.99	PK	74	19.01	1.00 V	335	52.89	31.60	7.00	36.5	2.10
1	4824.00	42.80	AV	54	11.20	1.00 V	335	40.70	31.60	7.00	36.5	2.10
2	7236.00	52.71	PK	74	21.29	1.00 V	179	41.78	37.33	8.90	35.3	10.93
2	7236.00	42.73	AV	54	11.27	1.00 V	179	31.80	37.33	8.90	35.3	10.93

ANTENNA POLARITY & TEST DISTANCE: HORIZONTAL AT 3 M (802.11b--2437MHz)

No.	Frequency (MHz)	Emission Level (dBuV/m)		Limit (dBuV/m)	Margin (dB)	Antenna Height (m)	Table Angle (Degree)	Raw Value (dBuV)	Antenna Factor (dB/m)	Cable Factor (dB)	Pre-amplifier	Correction Factor (dB/m)
1	4874.00	46.34	PK	74	27.66	1.00 H	258	44.22	31.02	7.60	36.5	2.12
1	4874.00	35.24	AV	54	18.76	1.00 H	258	33.12	31.02	7.60	36.5	2.12
2	7311.00	54.21	PK	74	19.79	1.00 H	261	43.13	37.28	8.60	34.8	11.08
2	7311.00	43.30	AV	54	10.70	1.00 H	261	32.22	37.28	8.60	34.8	11.08

ANTENNA POLARITY & TEST DISTANCE: VERTICAL AT 3 M (802.11b--2437MHz)

No.	Frequency (MHz)	Emission Level (dBuV/m)		Limit (dBuV/m)	Margin (dB)	Antenna Height (m)	Table Angle (Degree)	Raw Value (dBuV)	Antenna Factor (dB/m)	Cable Factor (dB)	Pre-amplifier	Correction Factor (dB/m)
1	4874.00	47.34	PK	74	26.66	1.00 V	179	45.22	31.02	7.60	36.5	2.12
1	4874.00	36.25	AV	54	17.75	1.00 V	179	34.13	31.02	7.60	36.5	2.12
2	7311.00	50.30	PK	74	23.70	1.00 V	33	39.22	37.28	8.60	34.8	11.08
2	7311.00	39.21	AV	54	14.79	1.00 V	33	28.13	37.28	8.60	34.8	11.08

ANTENNA POLARITY & TEST DISTANCE: HORIZONTAL AT 3 M (802.11b--2462MHz)

No.	Frequency (MHz)	Emission Level (dBuV/m)		Limit (dBuV/m)	Margin (dB)	Antenna Height (m)	Table Angle (Degree)	Raw Value (dBuV)	Antenna Factor (dB/m)	Cable Factor (dB)	Pre-amplifier	Correction Factor (dB/m)
1	4924.00	50.69	PK	74	23.31	1.00 H	300	48.31	31.58	7.00	36.2	2.38
1	4924.00	34.78	AV	54	19.22	1.00 H	300	32.40	31.58	7.00	36.2	2.38
2	7386.00	58.03	PK	74	15.97	1.00 H	196	46.32	38.51	8.50	35.3	11.71
2	7386.00	44.03	AV	54	9.97	1.00 H	196	32.32	38.51	8.50	35.3	11.71

ANTENNA POLARITY & TEST DISTANCE: VERTICAL AT 3 M (802.11b--2462MHz)

No.	Frequency (MHz)	Emission Level (dBuV/m)		Limit (dBuV/m)	Margin (dB)	Antenna Height (m)	Table Angle (Degree)	Raw Value (dBuV)	Antenna Factor (dB/m)	Cable Factor (dB)	Pre-amplifier	Correction Factor (dB/m)
1	4924.00	54.88	PK	74	19.12	1.00 V	336	52.50	31.58	7.00	36.2	2.38
1	4924.00	48.31	AV	54	5.69	1.00 V	336	45.93	31.58	7.00	36.2	2.38
2	7386.00	66.08	PK	74	7.92	1.00 V	289	54.37	38.51	8.50	35.3	11.71
2	7386.00	44.02	AV	54	9.98	1.00 V	289	32.31	38.51	8.50	35.3	11.71

- REMARKS:**
1. Emission level (dBuV/m)=Raw Value(dBuV) + Correction Factor(dB/m)
 2. Correction Factor (dB/m) = Antenna Factor (dB/m) + Cable Factor (dB) - Pre-amplifier Factor
 3. The other emission levels were very low against the limit.
 4. Margin value = Limit value- Emission level.
 5. For Wireless 802.11b mode at 1Mbps.

802.11g Mode(above 1GHz)

ANTENNA POLARITY & TEST DISTANCE: HORIZONTAL AT 3 M (802.11g--2412MHz)

No.	Frequency (MHz)	Emission Level (dBuV/m)		Limit (dBuV/m)	Margin (dB)	Antenna Height (m)	Table Angle (Degree)	Raw Value (dBuV)	Antenna Factor (dB/m)	Cable Factor (dB)	Pre-amplifier	Correction Factor (dB/m)
1	4824.00	49.42	PK	74	24.58	1.00 H	10	47.32	31.6	7.00	36.5	2.10
1	4824.00	41.52	AV	54	12.48	1.00 H	10	39.42	31.6	7.00	36.5	2.10
2	7236.00	56.99	PK	74	17.01	1.00 H	193	46.06	37.33	8.90	35.3	10.93
2	7236.00	43.21	AV	54	10.79	1.00 H	193	32.28	37.33	8.90	35.3	10.93

ANTENNA POLARITY & TEST DISTANCE: VERTICAL AT 3 M (802.11g--2412MHz)

No.	Frequency (MHz)	Emission Level (dBuV/m)		Limit (dBuV/m)	Margin (dB)	Antenna Height (m)	Table Angle (Degree)	Raw Value (dBuV)	Antenna Factor (dB/m)	Cable Factor (dB)	Pre-amplifier	Correction Factor (dB/m)
1	4824.00	57.41	PK	74	16.59	1.00 V	39	55.31	31.60	7.00	36.5	2.10
1	4824.00	45.52	AV	54	8.48	1.00 V	39	43.42	31.60	7.00	36.5	2.10
2	7236.00	63.17	PK	74	10.83	1.00 V	287	52.24	37.33	8.90	35.3	10.93
2	7236.00	49.43	AV	54	4.57	1.00 V	287	38.50	37.33	8.90	35.3	10.93

ANTENNA POLARITY & TEST DISTANCE: HORIZONTAL AT 3 M (802.11g--2437MHz)

No.	Frequency (MHz)	Emission Level (dBuV/m)		Limit (dBuV/m)	Margin (dB)	Antenna Height (m)	Table Angle (Degree)	Raw Value (dBuV)	Antenna Factor (dB/m)	Cable Factor (dB)	Pre-amplifier	Correction Factor (dB/m)
1	4874.00	64.68	PK	74	9.32	1.00 H	115	62.56	31.02	7.60	36.5	2.12
1	4874.00	47.35	AV	54	6.65	1.00 H	115	45.23	31.02	7.60	36.5	2.12
2	7311.00	59.42	PK	74	14.58	1.00 H	90	48.34	37.28	8.60	34.8	11.08
2	7311.00	47.29	AV	54	6.71	1.00 H	90	36.21	37.28	8.60	34.8	11.08

ANTENNA POLARITY & TEST DISTANCE: VERTICAL AT 3 M (802.11g--2437MHz)

No.	Frequency (MHz)	Emission Level (dBuV/m)		Limit (dBuV/m)	Margin (dB)	Antenna Height (m)	Table Angle (Degree)	Raw Value (dBuV)	Antenna Factor (dB/m)	Cable Factor (dB)	Pre-amplifier	Correction Factor (dB/m)
1	4874.00	59.75	PK	74	14.25	1.00 V	132	57.63	31.02	7.60	36.5	2.12
1	4874.00	43.72	AV	54	10.28	1.00 V	132	41.60	31.02	7.60	36.5	2.12
2	7311.00	54.44	PK	74	19.56	1.00 V	271	43.36	37.28	8.60	34.8	11.08
2	7311.00	43.70	AV	54	10.30	1.00	271	32.62	37.28	8.60	34.8	11.08

ANTENNA POLARITY & TEST DISTANCE: HORIZONTAL AT 3 M (802.11g--2462MHz)

No.	Frequency (MHz)	Emission Level (dBuV/m)		Limit (dBuV/m)	Margin (dB)	Antenna Height (m)	Table Angle (Degree)	Raw Value (dBuV)	Antenna Factor (dB/m)	Cable Factor (dB)	Pre-amplifier	Correction Factor (dB/m)
1	4924.00	51.93	PK	74	22.07	1.00 H	315	49.55	31.58	7.00	36.2	2.38
1	4924.00	39.79	AV	54	14.21	1.00 H	315	37.41	31.58	7.00	36.2	2.38
2	7311.00	54.42	PK	74	19.58	1.00 H	260	42.71	38.51	8.50	35.3	11.71
2	7311.00	47.13	AV	54	6.87	1.00 H	260	35.42	38.51	8.50	35.3	11.71

ANTENNA POLARITY & TEST DISTANCE: VERTICAL AT 3 M (802.11g--2462MHz)

No.	Frequency (MHz)	Emission Level (dBuV/m)		Limit (dBuV/m)	Margin (dB)	Antenna Height (m)	Table Angle (Degree)	Raw Value (dBuV)	Antenna Factor (dB/m)	Cable Factor (dB)	Pre-amplifier	Correction Factor (dB/m)
1	4924.00	47.66	PK	74	26.34	1.00 V	152	45.28	31.58	7.00	36.2	2.38
1	4924.00	36.70	AV	54	17.30	1.00 V	152	34.32	31.58	7.00	36.2	2.38
2	7386.00	56.02	PK	74	17.98	1.00 V	27	44.31	38.51	8.50	35.3	11.71
2	7386.00	44.03	AV	54	9.97	1.00 V	27	32.32	38.51	8.50	35.3	11.71

- REMARKS:**
1. Emission level (dBuV/m) = Raw Value (dBuV) + Correction Factor (dB/m)
 2. Correction Factor (dB/m) = Antenna Factor (dB/m) + Cable Factor (dB) - Pre-amplifier Factor
 3. The other emission levels were very low against the limit.
 4. Margin value = Limit value - Emission level.
 5. For Wireless 802.11g mode at 6Mbps.

802.11n(20MHz) Mode(above 1GHz)**ANTENNA POLARITY & TEST DISTANCE: HORIZONTAL AT 3 M (802.11n20--2412MHz)**

No.	Frequency (MHz)	Emission Level (dBuV/m)		Limit (dBuV/m)	Margin (dB)	Antenna Height (m)	Table Angle (Degree)	Raw Value (dBuV)	Antenna Factor (dB/m)	Cable Factor (dB)	Pre-amplifier	Correction Factor (dB/m)
1	4824.00	56.88	PK	74	17.12	1.00 H	71	54.78	31.60	7.00	36.5	2.10
1	4824.00	43.52	AV	54	10.48	1.00 H	71	41.42	31.60	7.00	36.5	2.10
2	7236.00	58.24	PK	74	15.76	1.00 H	182	47.31	37.33	8.90	35.3	10.93
2	7236.00	42.55	AV	54	11.45	1.00 H	182	31.62	37.33	8.90	35.3	10.93

ANTENNA POLARITY & TEST DISTANCE: VERTICAL AT 3 M (802.11n20--2412MHz)

No.	Frequency (MHz)	Emission Level (dBuV/m)		Limit (dBuV/m)	Margin (dB)	Antenna Height (m)	Table Angle (Degree)	Raw Value (dBuV)	Antenna Factor (dB/m)	Cable Factor (dB)	Pre-amplifier	Correction Factor (dB/m)
1	4824.00	58.74	PK	74	15.26	1.00 V	357	56.64	31.60	7.00	36.5	2.10
1	4824.00	44.42	AV	54	9.58	1.00 V	357	42.32	31.60	7.00	36.5	2.10
2	7236.00	60.35	PK	74	13.65	1.00 V	183	49.42	37.33	8.90	35.3	10.93
2	7236.00	47.68	AV	54	6.32	1.00 V	183	36.75	37.33	8.90	35.3	10.93

ANTENNA POLARITY & TEST DISTANCE: HORIZONTAL AT 3 M (802.11n20--2437MHz)

No.	Frequency (MHz)	Emission Level (dBuV/m)		Limit (dBuV/m)	Margin (dB)	Antenna Height (m)	Table Angle (Degree)	Raw Value (dBuV)	Antenna Factor (dB/m)	Cable Factor (dB)	Pre-amplifier	Correction Factor (dB/m)
1	4874.00	51.82	PK	74	22.18	1.00 H	215	49.70	31.02	7.60	36.5	2.12
1	4874.00	41.44	AV	54	12.56	1.00 H	215	39.32	31.02	7.60	36.5	2.12
2	7311.00	54.51	PK	74	19.49	1.00 H	188	43.43	37.28	8.60	34.8	11.08
2	7311.00	45.43	AV	54	8.57	1.00 H	188	34.35	37.28	8.60	34.8	11.08

ANTENNA POLARITY & TEST DISTANCE: VERTICAL AT 3 M (802.11n20--2437MHz)

No.	Frequency (MHz)	Emission Level (dBuV/m)		Limit (dBuV/m)	Margin (dB)	Antenna Height (m)	Table Angle (Degree)	Raw Value (dBuV)	Antenna Factor (dB/m)	Cable Factor (dB)	Pre-amplifier	Correction Factor (dB/m)
1	4874.00	52.44	PK	74	21.56	1.00 V	241	50.32	31.02	7.60	36.5	2.12
1	4874.00	42.55	AV	54	11.45	1.00 V	241	40.43	31.02	7.60	36.5	2.12
2	7311.00	53.78	PK	74	20.22	1.00 V	204	42.70	37.28	8.60	34.8	11.08
2	7311.00	48.81	AV	54	5.19	1.00 V	204	37.73	37.28	8.60	34.8	11.08

ANTENNA POLARITY & TEST DISTANCE: HORIZONTAL AT 3 M (802.11n20--2462MHz)

No.	Frequency (MHz)	Emission Level (dBuV/m)		Limit (dBuV/m)	Margin (dB)	Antenna Height (m)	Table Angle (Degree)	Raw Value (dBuV)	Antenna Factor (dB/m)	Cable Factor (dB)	Pre-amplifier	Correction Factor (dB/m)
1	4924.00	50.89	PK	74	23.11	1.00 H	149	48.51	31.58	7.00	36.2	2.38
1	4924.00	38.00	AV	54	16.00	1.00 H	149	35.62	31.58	7.00	36.2	2.38
2	7386.00	56.03	PK	74	17.97	1.00 H	210	44.32	38.51	8.50	35.3	11.71
2	7386.00	45.15	AV	54	8.85	1.00 H	210	33.44	38.51	8.50	35.3	11.71

ANTENNA POLARITY & TEST DISTANCE: VERTICAL AT 3 M (802.11n20--2462MHz)

No.	Frequency (MHz)	Emission Level (dBuV/m)		Limit (dBuV/m)	Margin (dB)	Antenna Height (m)	Table Angle (Degree)	Raw Value (dBuV)	Antenna Factor (dB/m)	Cable Factor (dB)	Pre-amplifier	Correction Factor (dB/m)
1	4924.00	46.83	PK	74	27.17	1.00 V	190	44.45	31.58	7.00	36.2	2.38
1	4924.00	34.70	AV	54	19.30	1.00 V	190	32.32	31.58	7.00	36.2	2.38
2	7386.00	56.05	PK	74	17.95	1.00 V	274	44.34	38.51	8.50	35.3	11.71
2	7386.00	44.11	AV	54	9.89	1.00 V	274	32.40	38.51	8.50	35.3	11.71

- REMARKS:**
1. Emission level (dBuV/m) = Raw Value (dBuV) + Correction Factor (dB/m)
 2. Correction Factor (dB/m) = Antenna Factor (dB/m) + Cable Factor (dB) - Pre-amplifier Factor
 3. The other emission levels were very low against the limit.
 4. Margin value = Limit value- Emission level.
 5. For Wireless 802.11n (20MHz) mode at 6.5Mbps.

802.11n(40MHz) Mode(above 1GHz)**ANTENNA POLARITY & TEST DISTANCE: HORIZONTAL AT 3 M (802.11n40--2422MHz)**

No.	Frequency (MHz)	Emission Level (dBuV/m)		Limit (dBuV/m)	Margin (dB)	Antenna Height (m)	Table Angle (Degree)	Raw Value (dBuV)	Antenna Factor (dB/m)	Cable Factor (dB)	Pre-amplifier	Correction Factor (dB/m)
1	4844.00	53.46	PK	74	20.54	1.00 H	63	51.35	31.01	7.30	36.2	2.11
1	4844.00	37.85	AV	54	16.15	1.00 H	63	35.74	31.01	7.30	36.2	2.11
2	7266.00	53.38	PK	74	20.62	1.00 H	198	42.58	36.70	8.90	34.8	10.80
2	7266.00	44.71	AV	54	9.29	1.00 H	198	33.91	36.70	8.90	34.8	10.80

ANTENNA POLARITY & TEST DISTANCE: VERTICAL AT 3 M (802.11n40--2422MHz)

No.	Frequency (MHz)	Emission Level (dBuV/m)		Limit (dBuV/m)	Margin (dB)	Antenna Height (m)	Table Angle (Degree)	Raw Value (dBuV)	Antenna Factor (dB/m)	Cable Factor (dB)	Pre-amplifier	Correction Factor (dB/m)
1	4844.00	51.81	PK	74	22.19	1.00 V	365	49.70	31.01	7.30	36.2	2.11
1	4844.00	39.19	AV	54	14.81	1.00 V	365	37.08	31.01	7.30	36.2	2.11
2	7266.00	62.12	PK	74	11.88	1.00 V	171	51.32	36.70	8.90	34.8	10.80
2	7266.00	47.11	AV	54	6.89	1.00 V	171	36.31	36.70	8.90	34.8	10.80

ANTENNA POLARITY & TEST DISTANCE: HORIZONTAL AT 3 M (802.11n40--2437MHz)

No.	Frequency (MHz)	Emission Level (dBuV/m)		Limit (dBuV/m)	Margin (dB)	Antenna Height (m)	Table Angle (Degree)	Raw Value (dBuV)	Antenna Factor (dB/m)	Cable Factor (dB)	Pre-amplifier	Correction Factor (dB/m)
1	4874.00	53.43	PK	74	20.57	1.00 H	250	51.31	31.02	7.60	36.5	2.12
1	4874.00	41.44	AV	54	12.56	1.00 H	250	39.32	31.02	7.60	36.5	2.12
2	7311.00	56.73	PK	74	17.27	1.00 H	106	45.65	37.28	8.60	34.8	11.08
2	7311.00	41.39	AV	54	12.61	1.00 H	106	30.31	37.28	8.60	34.8	11.08

ANTENNA POLARITY & TEST DISTANCE: VERTICAL AT 3 M (802.11n40--2437MHz)

No.	Frequency (MHz)	Emission Level (dBuV/m)		Limit (dBuV/m)	Margin (dB)	Antenna Height (m)	Table Angle (Degree)	Raw Value (dBuV)	Antenna Factor (dB/m)	Cable Factor (dB)	Pre-amplifier	Correction Factor (dB/m)
1	4874.00	51.12	PK	74	22.88	1.00 V	305	49.00	31.02	7.60	36.5	2.12
1	4874.00	43.96	AV	54	10.04	1.00 V	305	41.84	31.02	7.60	36.5	2.12
2	7311.00	56.09	PK	74	17.91	1.00 V	184	45.01	37.28	8.60	34.8	11.08
2	7311.00	43.36	AV	54	10.64	1.00 V	184	32.28	37.28	8.60	34.8	11.08

ANTENNA POLARITY & TEST DISTANCE: HORIZONTAL AT 3 M (802.11n40--2452MHz)

No.	Frequency (MHz)	Emission Level (dBuV/m)		Limit (dBuV/m)	Margin (dB)	Antenna Height (m)	Table Angle (Degree)	Raw Value (dBuV)	Antenna Factor (dB/m)	Cable Factor (dB)	Pre-amplifier	Correction Factor (dB/m)
1	4904.00	50.58	PK	74	23.42	1.00 H	62	48.31	31.47	7.00	36.2	2.27
1	4904.00	37.58	AV	54	16.42	1.00 H	62	35.31	31.47	7.00	36.2	2.27
2	7356.00	57.70	PK	74	16.30	1.00 H	194	46.05	38.45	8.50	35.3	11.65
2	7356.00	43.96	AV	54	10.04	1.00 H	194	32.31	38.45	8.50	35.3	11.65

ANTENNA POLARITY & TEST DISTANCE: VERTICAL AT 3 M (802.11n40--2452MHz)

No.	Frequency (MHz)	Emission Level (dBuV/m)		Limit (dBuV/m)	Margin (dB)	Antenna Height (m)	Table Angle (Degree)	Raw Value (dBuV)	Antenna Factor (dB/m)	Cable Factor (dB)	Pre-amplifier	Correction Factor (dB/m)
1	4904.00	56.48	PK	74	17.52	1.00 V	205	54.21	31.47	7.00	36.2	2.27
1	4904.00	41.58	AV	54	12.42	1.00 V	205	39.31	31.47	7.00	36.2	2.27
2	7356.00	61.86	PK	74	12.14	1.00 V	186	50.21	38.45	8.50	35.3	11.65
2	7356.00	44.89	AV	54	9.11	1.00 V	186	33.24	38.45	8.50	35.3	11.65

- REMARKS:**
1. Emission level (dBuV/m) = Raw Value (dBuV) + Correction Factor (dB/m)
 2. Correction Factor (dB/m) = Antenna Factor (dB/m) + Cable Factor (dB) - Pre-amplifier Factor
 3. The other emission levels were very low against the limit.
 4. Margin value = Limit value - Emission level.
 5. For Wireless 802.11n (40MHz) mode at 13.5Mbps.

4.3. Maximum Peak Output Power

TEST CONFIGURATION

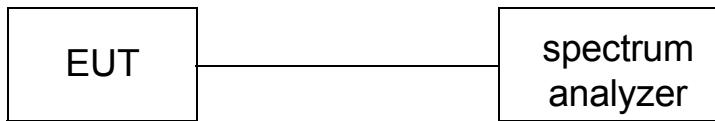

TEST PROCEDURE

The EUT was directly connected to the spectrum analyzer and antenna output port as show in the block diagram as TEST CONFIGURATION shows.

Accoding to KDB558074 D01 V03 Integrated band power method for this procedure may be used when the maximum available RBW of the measurement instrument is less than the DTS bandwidth.

1. Set the RBW = 1 MHz.
2. Set the VBW \geq 3 RBW
3. Set the span \geq 1.5 x DTS bandwidth.
4. Detector = peak.
5. Sweep time = auto couple.
6. Trace mode = max hold.
7. Allow trace to fully stabilize.
8. Use the instrument's band/channel power measurement function with the band limits set equal to the DTS bandwidth edges (for some instruments, this may require a manual override to select peak detector). If the instrument does not have a band power function, sum the spectrum levels (in linear power units) at intervals equal to the RBW extending across the DTS channel bandwidth.

LIMIT

The Maximum Peak Output Power Measurement is 30dBm.

TEST RESULTS

Remark:We measured output power at difference data rate for each mode and recorded woest case for each mode.

4.3.1 802.11b Test Mode

A. Test Verdict

Channel	Frequency (MHz)	Measured Output Peak Power (dBm)	Refer to Plot	Limits (dBm)	Verdict
1	2412	20.31	Plot 4.3.1 A	30	PASS
6	2437	20.54	Plot 4.3.1 B	30	PASS
11	2462	20.64	Plot 4.3.1 C	30	PASS

- Note: 1. For 802.11b mode at finial test to get the worst-case emission at 1Mbps.
2.The test results including the cable lose.

B. Test Plots

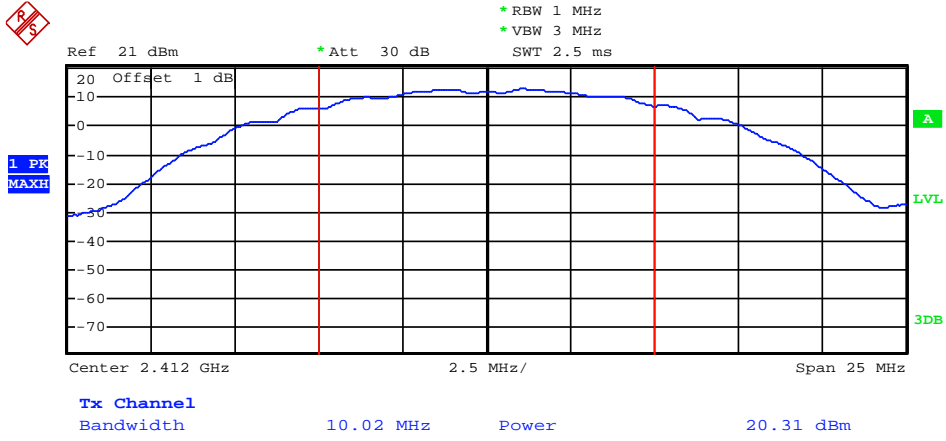

Date: 26.SEP.2013 15:21:48

(Plot 4.3.1 A: Channel 1: 2412MHz @ 802.11b)

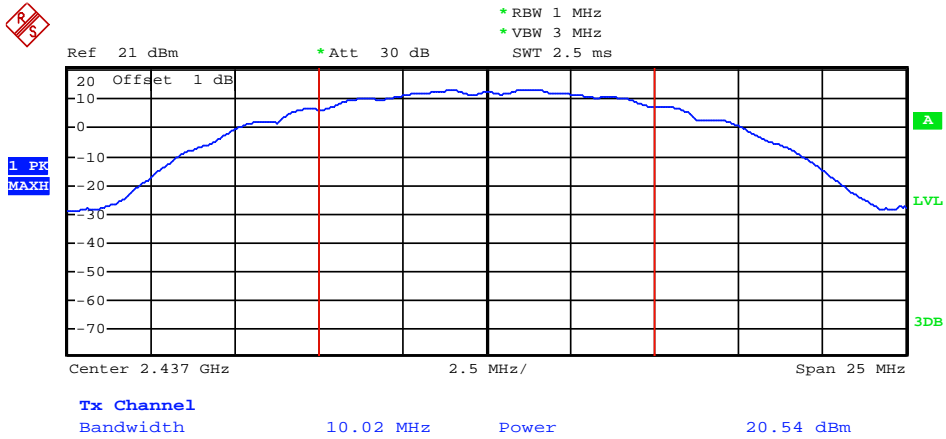

Date: 26.SEP.2013 15:22:43

(Plot 4.3.1 B: Channel 1: 2437MHz @ 802.11b)

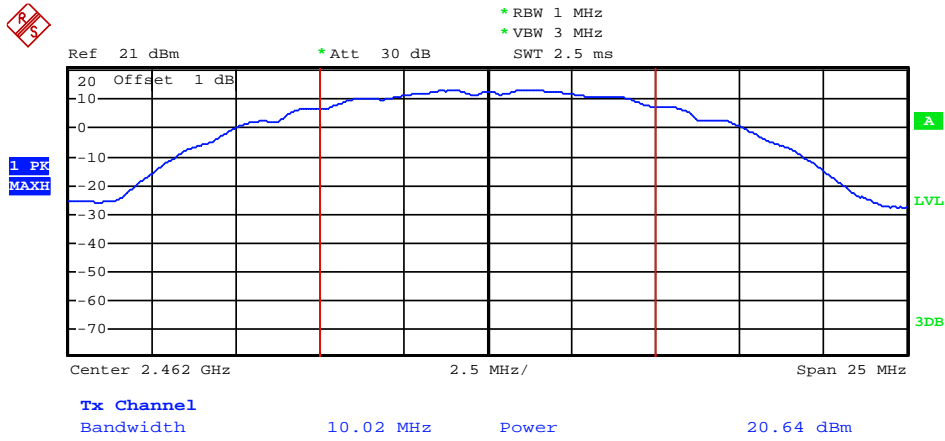

Date: 26.SEP.2013 15:23:41

(Plot 4.3.1 C: Channel 11: 2462MHz @ 802.11b)

4.3.2 802.11g Test Mode

A. Test Verdict

Channel	Frequency (MHz)	Measured Output Peak Power (dBm)	Refer to Plot	Limits (dBm)	Verdict
1	2412	19.92	Plot 4.3.2 A	30	PASS
6	2437	20.06	Plot 4.3.2 B	30	PASS
11	2462	20.20	Plot 4.3.2 C	30	PASS

Note: 1. For 802.11g mode at final test to get the worst-case emission at 6Mbps.
 2. The test results including the cable loss.

B. Test Plots

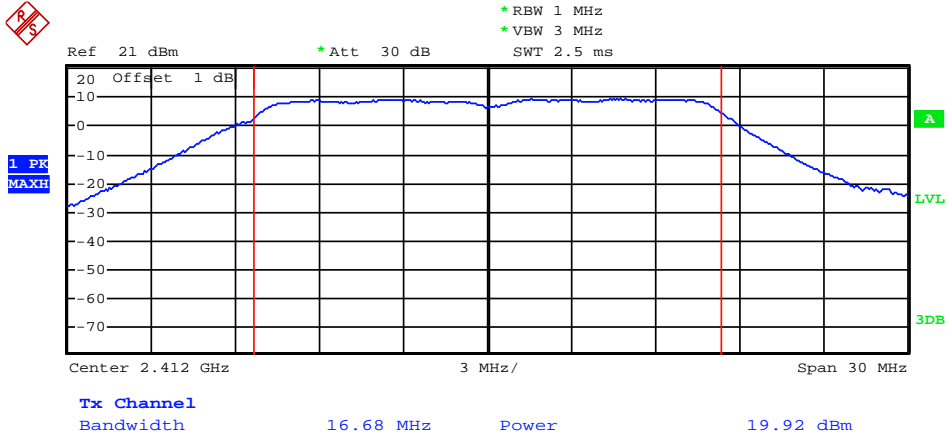

Date: 26.SEP.2013 15:26:00

(Plot 4.3.2 A: Channel 1: 2412MHz @ 802.11g)

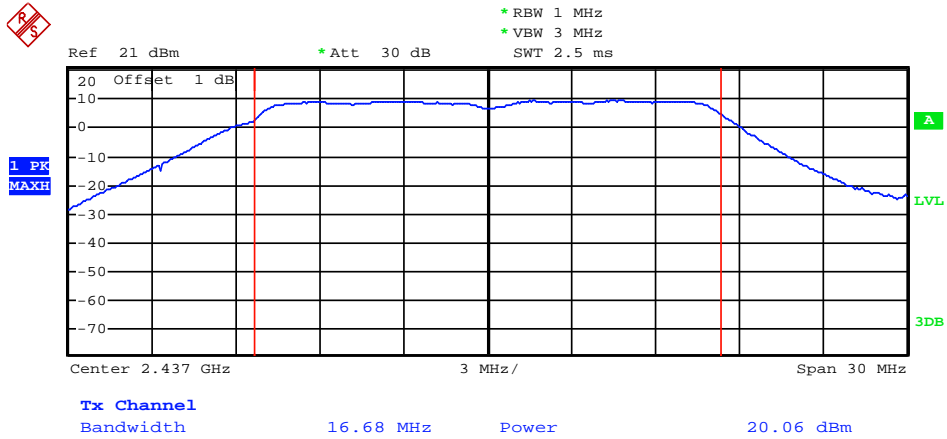

Date: 26.SEP.2013 15:26:52

(Plot 4.3.2 B: Channel 1: 2437MHz @ 802.11g)

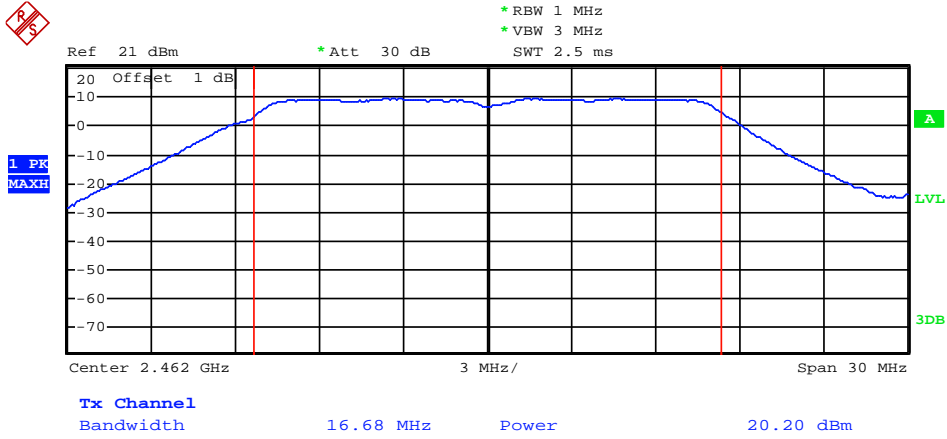

Date: 26.SEP.2013 15:27:38

(Plot 4.3.2 C: Channel 11: 2462MHz @ 802.11g)

4.3.3 802.11n(20MHz) Test Mode

A. Test Verdict

Channel	Frequency (MHz)	Measured Output Peak Power (dBm)	Refer to Plot	Limits (dBm)	Verdict
1	2412	18.63	Plot 4.3.3 A	30	PASS
6	2437	19.23	Plot 4.3.3 B	30	PASS
11	2462	19.85	Plot 4.3.3 C	30	PASS

Note: 1. For 802.11n(20MHz) mode at final test to get the worst-case emission at 6.5Mbps.
 2. The test results including the cable lose.

B. Test Plots

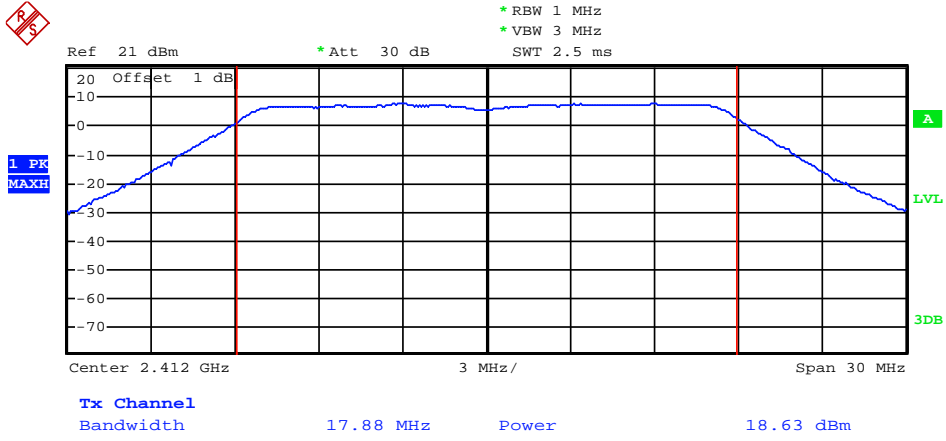

Date: 26.SEP.2013 15:28:57

(Plot 4.3.3 A: Channel 1: 2412MHz @ 802.11n(20MHz))

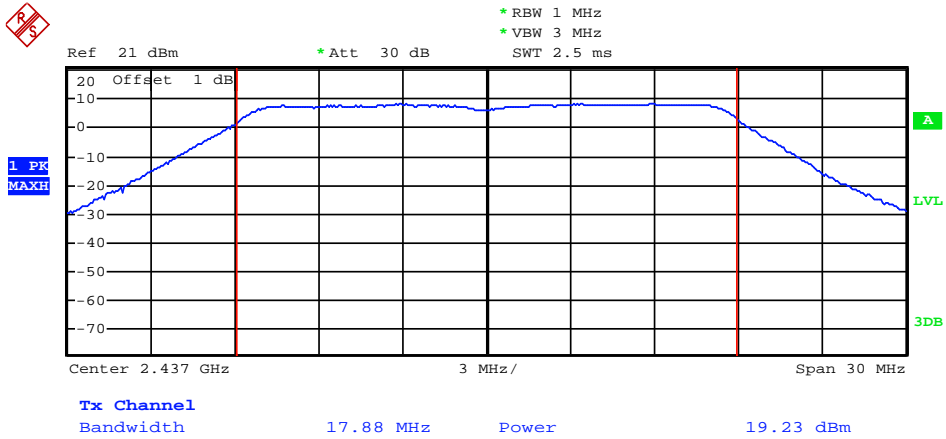

Date: 26.SEP.2013 15:29:36

(Plot 4.3.3 B: Channel 6: 2437MHz @ 802.11n(20MHz))

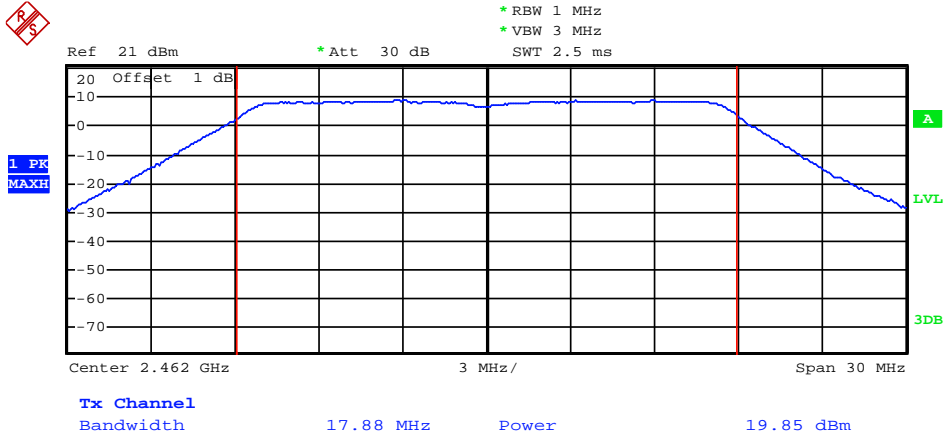

Date: 26.SEP.2013 15:30:14

(Plot 4.3.3 C: Channel 11: 2462MHz @ 802.11n(20MHz))

4.3.4 802.11n(40MHz) Test Mode

A. Test Verdict

Channel	Frequency (MHz)	Measured Output Peak Power (dBm)	Refer to Plot	Limits (dBm)	Verdict
3	2422	18.19	Plot 4.3.4 A	30	PASS
6	2437	18.13	Plot 4.3.4 B	30	PASS
9	2452	18.14	Plot 4.3.4 C	30	PASS

Note: 1. For 802.11n(40MHz) mode at final test to get the worst-case emission at 13.5Mbps.
2. The test results including the cable loss.

B. Test Plots

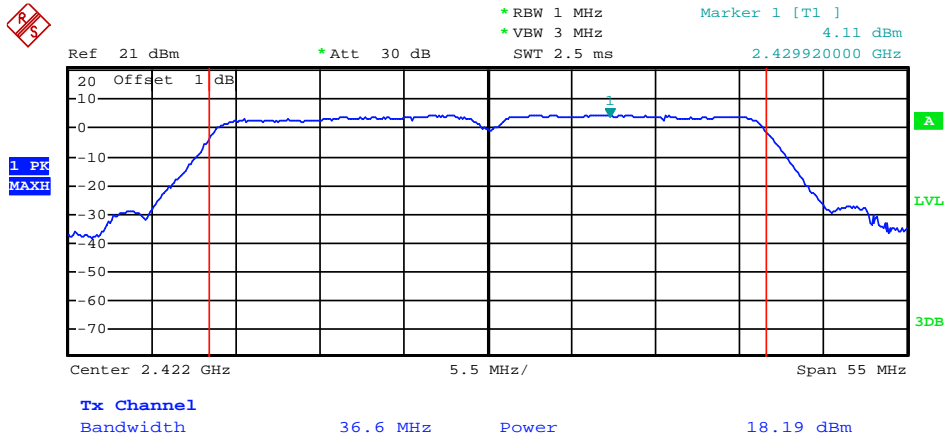

Date: 26.SEP.2013 15:31:52

(Plot 4.3.4 A: Channel 3: 2422MHz @ 802.11n(40MHz))

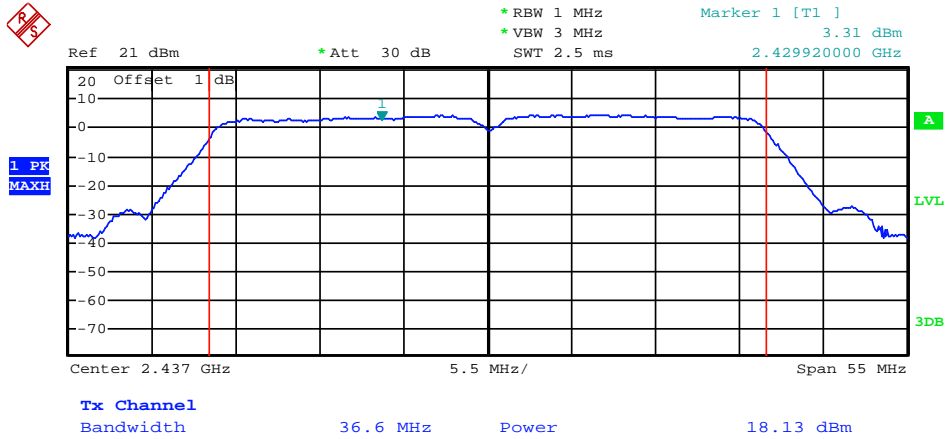

Date: 26.SEP.2013 15:32:35

(Plot 4.3.4 B: Channel 6: 2437MHz @ 802.11n(40MHz))

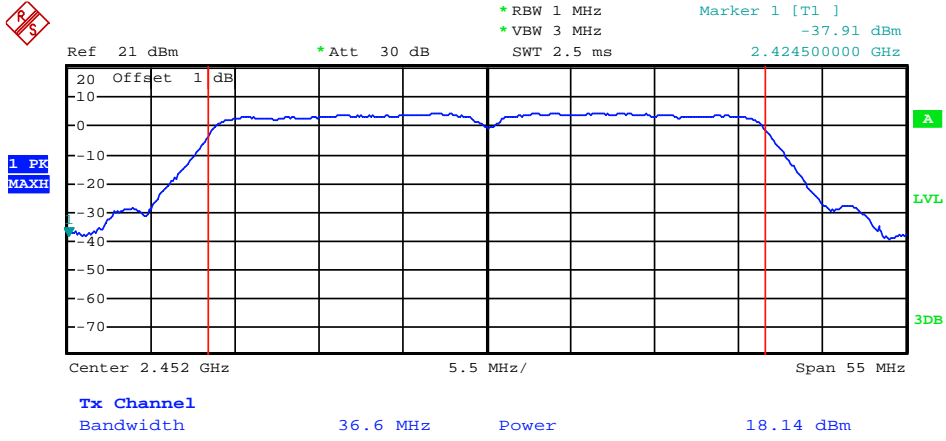

Date: 26.SEP.2013 15:33:36

(Plot 4.3.4 C: Channel 9: 2452MHz @ 802.11n(40MHz))

4.4. Power Spectral Density

TEST CONFIGURATION

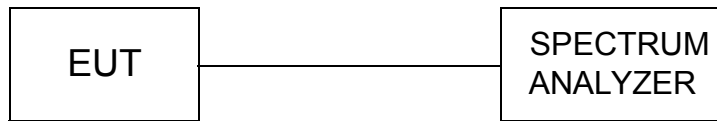

TEST PROCEDURE

According to KDB 558074 D01 V03 Method PKPSD (peak PSD) This procedure shall be used if maximum peak conducted output power was used to demonstrate compliance, and is optional if the maximum conducted (average) output power was used to demonstrate compliance.

1. Set analyzer center frequency to DTS channel center frequency.
2. Set the span to 1.5 times the DTS bandwidth.
3. Set the RBW to: $3 \text{ kHz} \leq \text{RBW} \leq 100 \text{ kHz}$.
4. Set the VBW $\geq 3 \text{ RBW}$.
5. Detector = peak.
6. Sweep time = auto couple.
7. Trace mode = max hold.
8. Allow trace to fully stabilize.
9. Use the peak marker function to determine the maximum amplitude level within the RBW.
10. If measured value exceeds limit, reduce RBW (no less than 3 kHz) and repeat.

LIMIT

For digitally modulated systems, the power spectral density conducted from the intentional radiator to the antenna shall not be greater than 8 dBm in any 3 kHz band during any time interval of continuous transmission.

TEST RESULTS

4.4.1 802.11b Test Mode

A. Test Verdict

Channel	Frequency (MHz)	Report PSD (dBm/3kHz)	Refer to Plot	Limits (dBm/3KHz)	Verdict
1	2412	-12.93	Plot 4.4.1 A	8	PASS
6	2437	-12.05	Plot 4.4.1 B	8	PASS
11	2462	-12.19	Plot 4.4.1 C	8	PASS

Note: 1. For 802.11b mode at final test to get the worst-case emission at 1Mbps.
2. The test results including the cable loss.

B. Test Plots



*RBW 3 kHz Marker 1 [T1]
*VBW 10 kHz -12.93 dBm
SWT 1.75 s 2.412806000 GHz

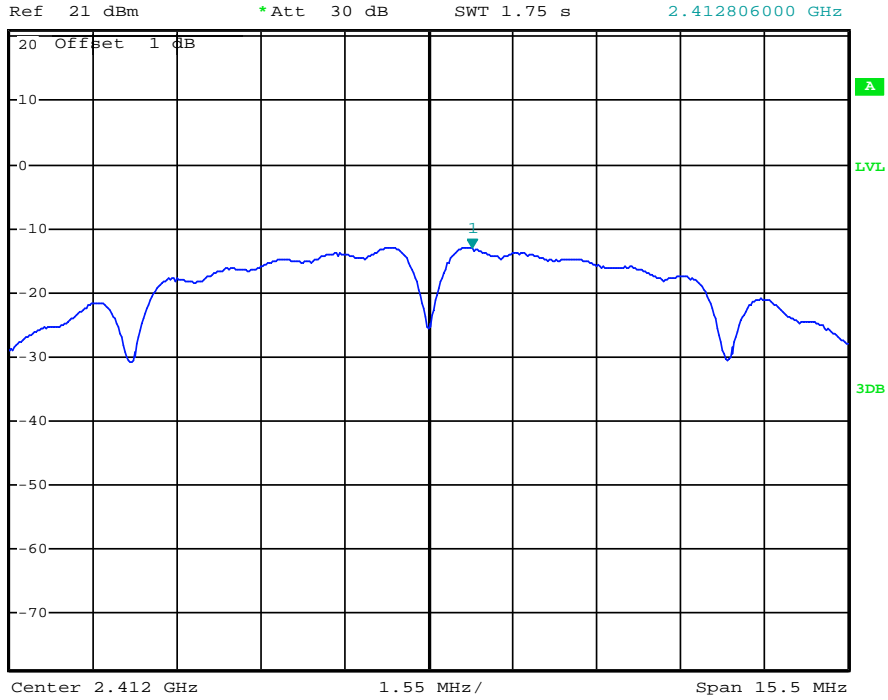

Date: 26.SEP.2013 15:37:54

(Plot 4.4.1 A: Channel 1: 2412MHz @ 802.11b)



*RBW 3 kHz Marker 1 [T1]
*VBW 10 kHz -12.05 dBm
SWT 1.75 s 2.437713000 GHz

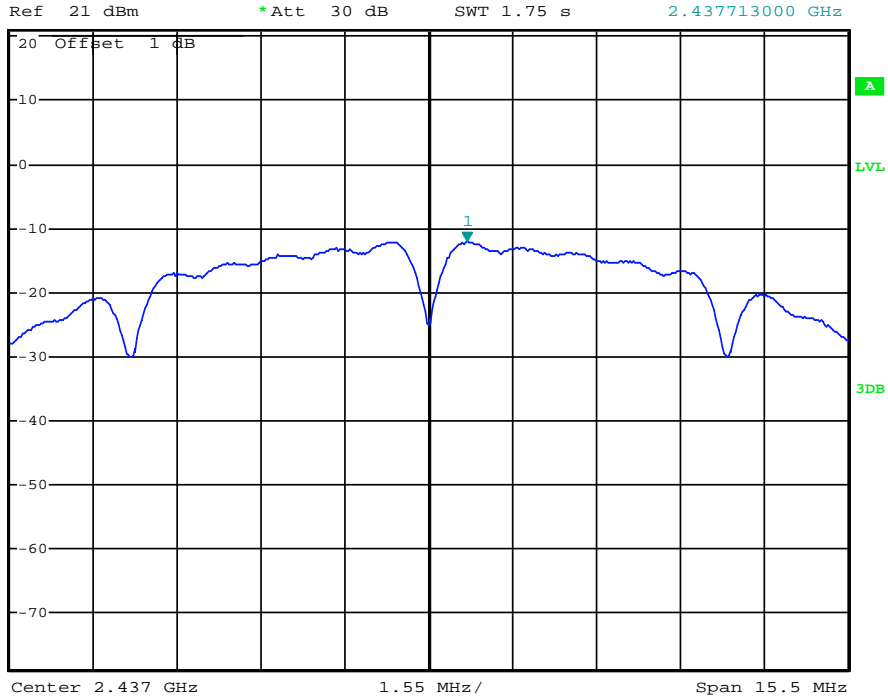

Date: 26.SEP.2013 15:38:53

(Plot 4.4.1 B: Channel 6: 2437MHz @ 802.11b)



*RBW 3 kHz Marker 1 [T1]
 *VBW 10 kHz -12.19 dBm
 Ref 21 dBm *Att 30 dB SWT 1.75 s 2.461287000 GHz

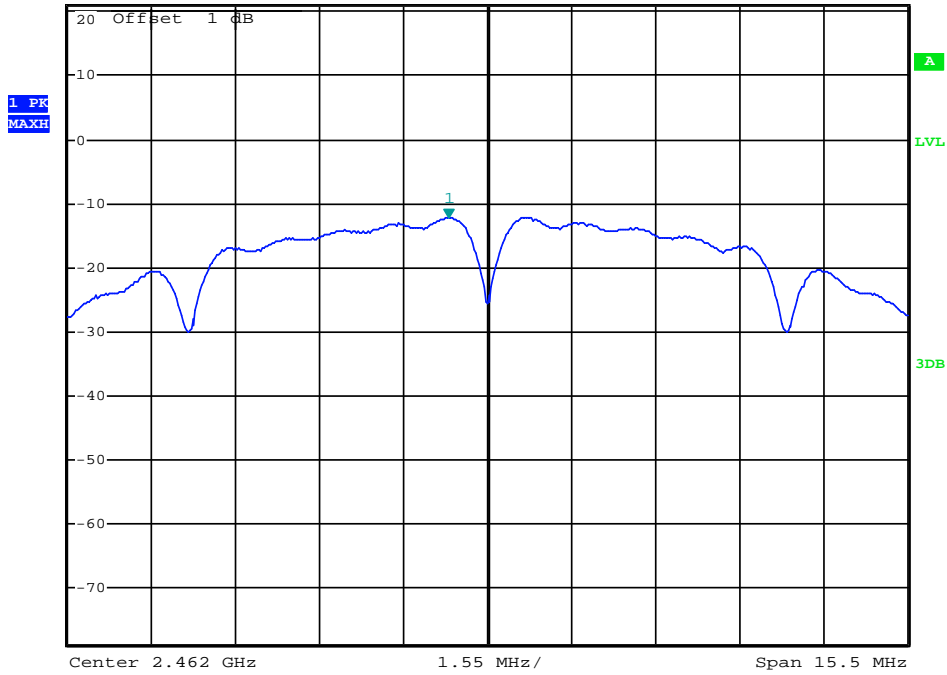

Date: 26.SEP.2013 15:39:33

(Plot 4.4.1 C: Channel 11: 2462MHz @ 802.11b)

4.4.2 802.11g Test Mode

A. Test Verdict

Channel	Frequency (MHz)	Report PSD (dBm/3kHz)	Refer to Plot	Limits (dBm/3KHz)	Verdict
1	2412	-17.20	Plot 4.4.2 A	8	PASS
6	2437	-16.73	Plot 4.4.2 B	8	PASS
11	2462	-16.61	Plot 4.4.2 C	8	PASS

Note: 1. For 802.11g mode at final test to get the worst-case emission at 6Mbps.
 2. The test results including the cable lose.

B. Test Plots



Ref 21 dBm *Att 30 dB *RBW 3 kHz Marker 1 [T1] -17.20 dBm
*VBW 10 kHz SWT 2.9 s 2.411082000 GHz

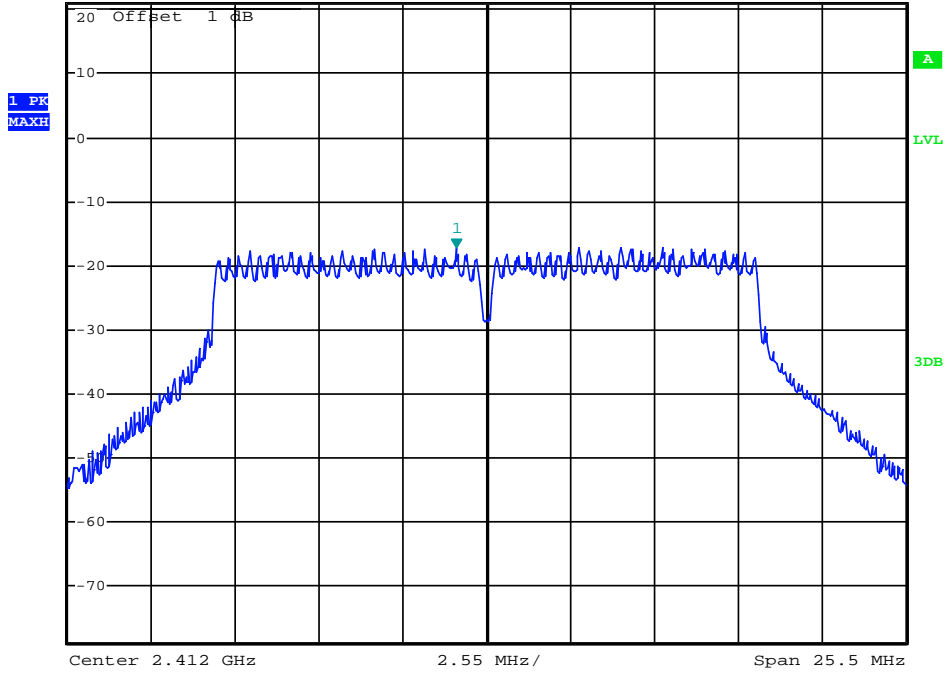

Date: 26.SEP.2013 15:41:34

(Plot 4.4.2 A: Channel 1: 2412MHz @ 802.11g)



Ref 21 dBm *Att 30 dB *RBW 3 kHz Marker 1 [T1] -16.73 dBm
*VBW 10 kHz SWT 2.9 s 2.442355000 GHz

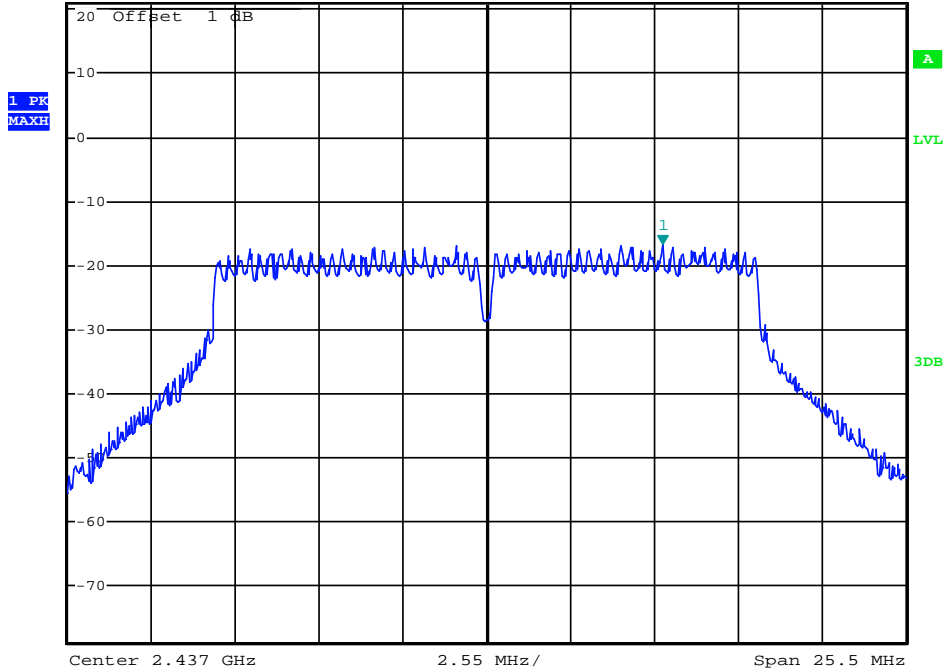

Date: 26.SEP.2013 15:42:16

(Plot 4.4.2 B: Channel 6: 2437MHz @ 802.11g)



*RBW 3 kHz Marker 1 [T1]
 *VBW 10 kHz -16.61 dBm
 SWI 2.9 s 2.467355000 GHz

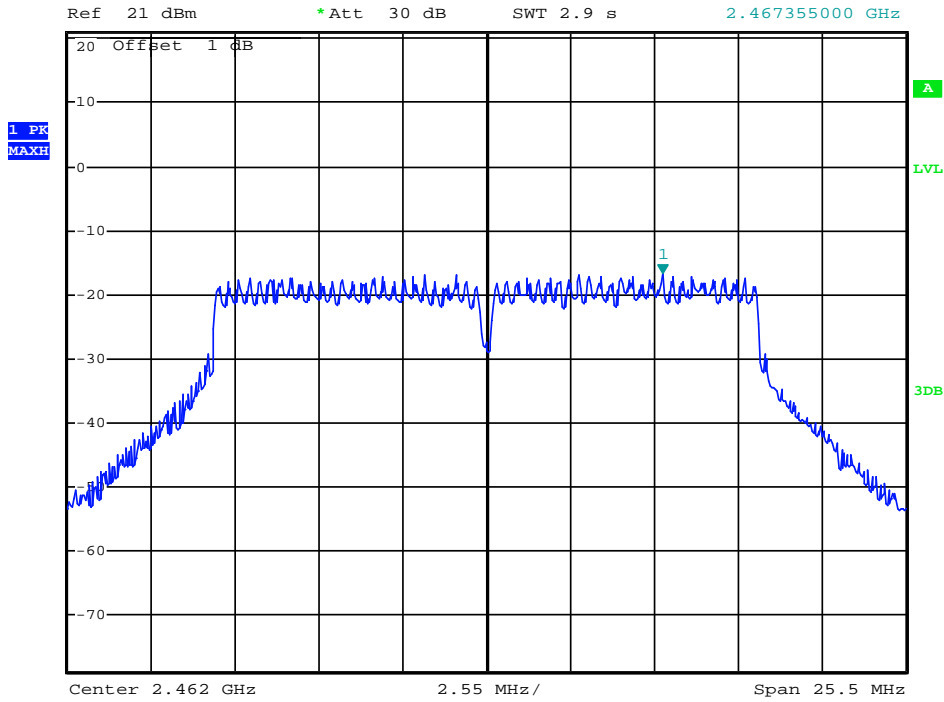

Date: 26.SEP.2013 15:43:14

(Plot 4.4.2 C: Channel 11: 2462MHz @ 802.11g)

4.4.3 802.11n(20MHz) Test Mode

A. Test Verdict

Channel	Frequency (MHz)	Report PSD (dBm/3kHz)	Refer to Plot	Limits (dBm/3KHz)	Verdict
1	2412	-17.23	Plot 4.4.3 A	8	PASS
6	2437	-16.71	Plot 4.4.3 B	8	PASS
11	2462	-16.75	Plot 4.4.3 C	8	PASS

Note: 1. For 802.11n(20MHz) mode at final test to get the worst-case emission at 6.5Mbps.
 2. The test results including the cable loss.

B. Test Plots



Ref 21 dBm *Att 30 dB *RBW 3 kHz Marker 1 [T1] -17.25 dBm
*VBW 10 kHz 2.418579000 GHz
SWT 3 s

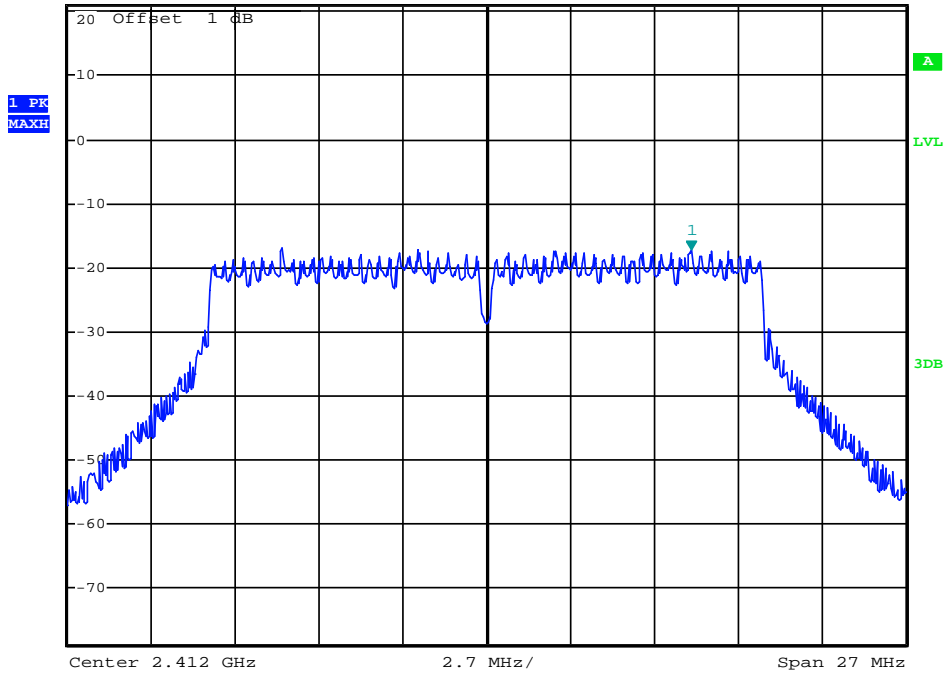

Date: 26.SEP.2013 15:45:28

(Plot 4.4.3 A: Channel 1: 2412MHz @ 802.11n(20MHz))



Ref 21 dBm *Att 30 dB *RBW 3 kHz Marker 1 [T1] -16.71 dBm
*VBW 10 kHz 2.430412000 GHz
SWT 3 s

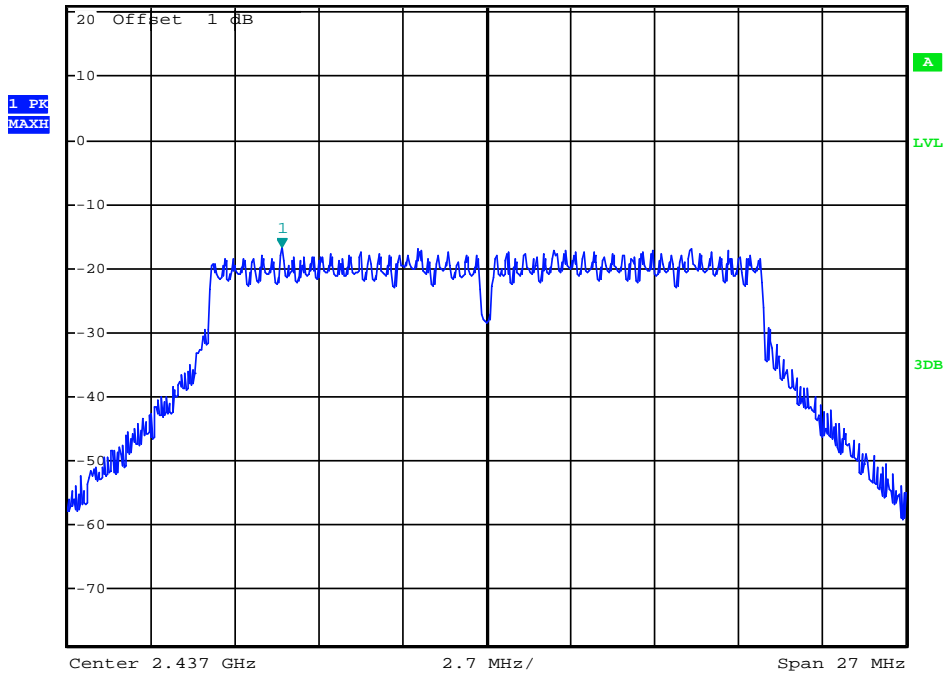

Date: 26.SEP.2013 15:46:05

(Plot 4.4.3 B: Channel 6: 2437MHz @ 802.11n(20MHz))



*RBW 3 kHz Marker 1 [T1]
 *VBW 10 kHz -16.75 dBm
 SWT 3 s 2.459786000 GHz

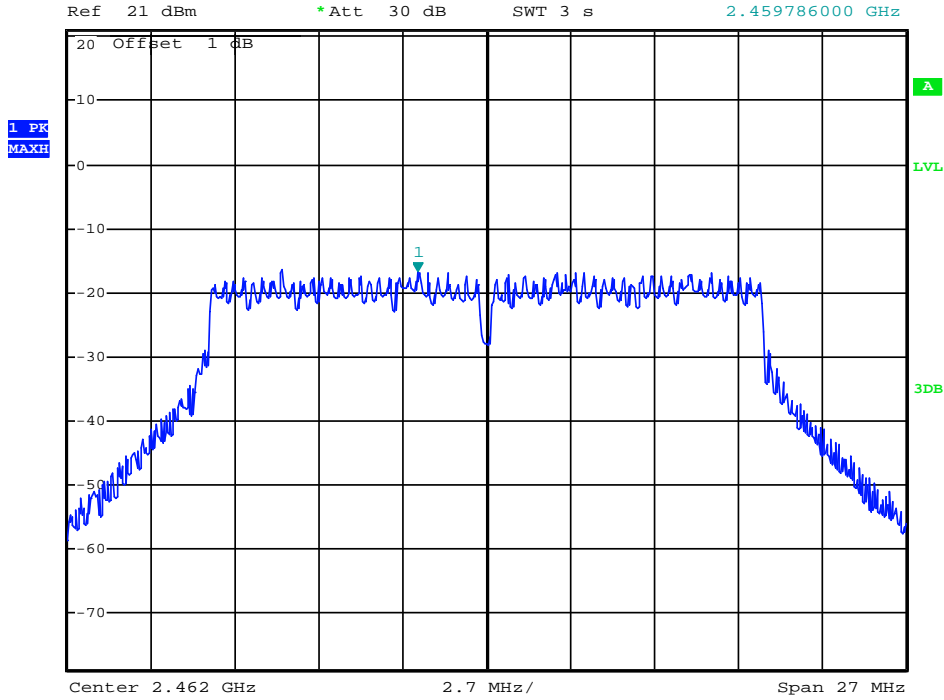

Date: 26.SEP.2013 15:46:45

(Plot 4.4.3 C: Channel 11: 2462MHz @ 802.11n(20MHz))

4.4.4 802.11n(40MHz) Test Mode

A. Test Verdict

Channel	Frequency (MHz)	Report PSD (dBm/3kHz)	Refer to Plot	Limits (dBm/3KHz)	Verdict
3	2422	-18.29	Plot 4.4.4 A	8	PASS
6	2437	-19.12	Plot 4.4.4 B	8	PASS
9	2452	-18.94	Plot 4.4.4 C	8	PASS

Note: 1. For 802.11n(40MHz) mode at final test to get the worst-case emission at 13.5Mbps.
 2.The test results including the cable lose.

B. Test Plots



*RBW 3 kHz Marker 1 [T1]
*VBW 10 kHz -18.29 dBm
Ref 21 dBm *Att 30 dB SWT 6.2 s 2.425410000 GHz

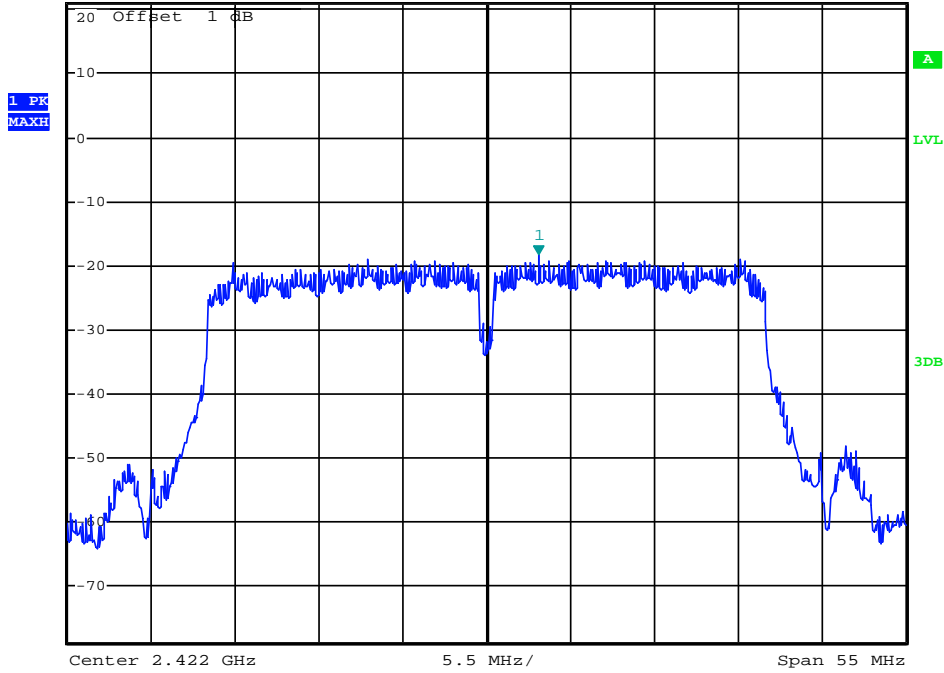

Date: 26.SEP.2013 15:49:18

(Plot 4.4.4 A: Channel 3: 2422MHz @ 802.11n(40MHz))



*RBW 3 kHz Marker 1 [T1]
*VBW 10 kHz -19.12 dBm
Ref 21 dBm *Att 30 dB SWT 6.2 s 2.440410000 GHz

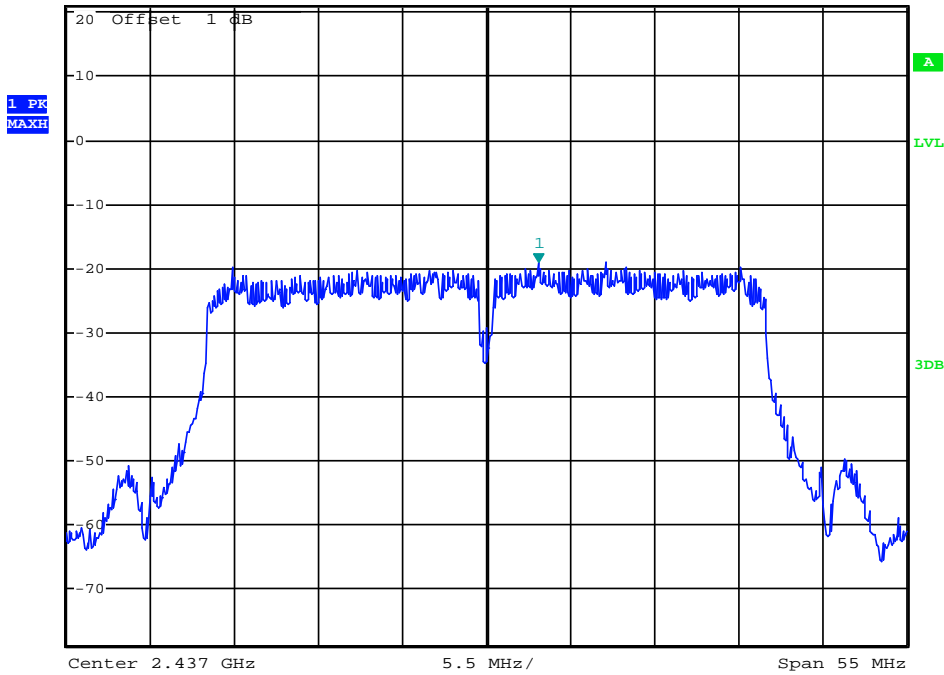

Date: 26.SEP.2013 15:50:20

(Plot 4.4.4 B: Channel 6: 2437MHz @ 802.11n(40MHz))



*RBW 3 kHz Marker 1 [T1]
*VBW 10 kHz -18.94 dBm
SWT 6.2 s 2.459810000 GHz

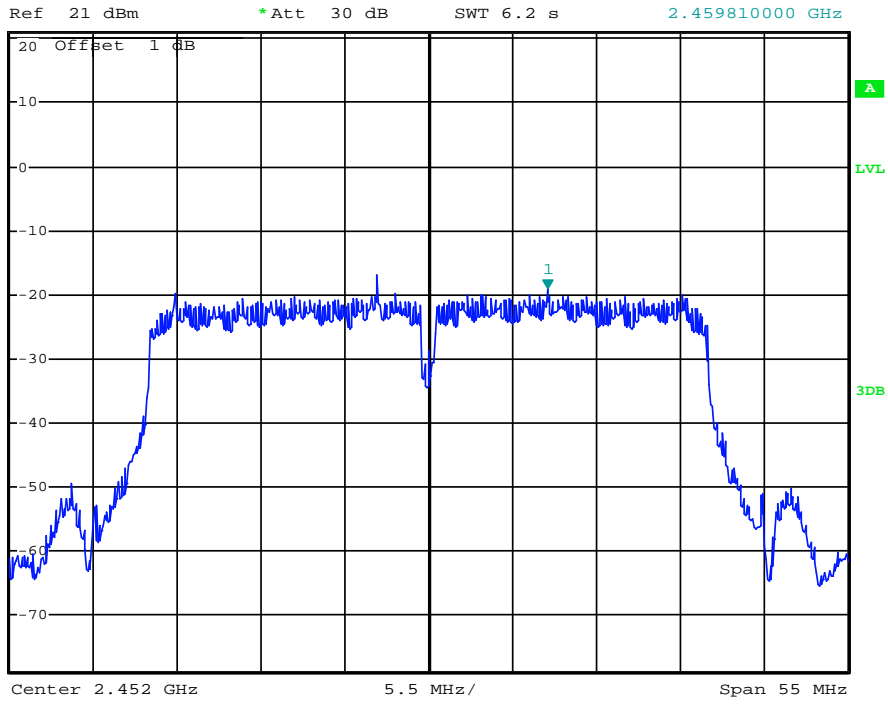

Date: 26.SEP.2013 15:51:24

(Plot 4.4.4 C: Channel 6: 2452MHz @ 802.11n(40MHz))

4.5. Band Edge Compliance of RF Emission

TEST REQUIREMENT

In any 100 kHz bandwidth outside the frequency band in which the spread spectrum or digitally modulated intentional radiator is operating, the radio frequency power that is produced by the intentional radiator shall be at least 20 dB below that in the 100 kHz bandwidth within the band that contains the highest level of the desired power, based on either an RF conducted or a radiated measurement, provided the transmitter demonstrates compliance with the peak conducted power limits. If the transmitter complies with the conducted power limits based on the use of RMS averaging over a time interval, as permitted under paragraph (b)(3) of this section, the attenuation required under this paragraph shall be 30 dB instead of 20 dB. Attenuation below the general limits specified in §15.209(a) is not required. In addition, radiated emissions which fall in the restricted bands, as defined in §15.205(a), must also comply with the radiated emission limits specified in §15.209(a) (see §15.205(c)).

TEST PROCEDURE

According to KDB 558074 D01 V03 for Antenna-port conducted measurement. Antenna-port conducted measurements may also be used as an alternative to radiated measurements for demonstrating compliance in the restricted frequency bands. If conducted measurements are performed, then proper impedance matching must be ensured and an additional radiated test for cabinet/case spurious emissions is required.

1. Check the calibration of the measuring instrument using either an internal calibrator or a known signal from an external generator.
2. Remove the antenna from the EUT and then connect to a low loss RF cable from the antenna port to a EMI test receiver, then turn on the EUT and make it operate in transmitting mode. Then set it to Low Channel and High Channel within its operating range, and make sure the instrument is operated in its linear range.
3. Set both RBW and VBW of spectrum analyzer to 100 kHz with a convenient frequency span including 100kHz bandwidth from band edge, for Radiated emissions restricted band RBW=1MHz, VBW=3MHz for peak detector and RBW=1MHz, VBW=10Hz for average detector.
4. Measure the highest amplitude appearing on spectral display and set it as a reference level. Plot the graph with marking the highest point and edge frequency.
5. Repeat above procedures until all measured frequencies were complete.
6. Measure the conducted output power (in dBm) using the detector specified by the appropriate regulatory agency (see 12.2.2, 12.2.3, and 12.2.4 for guidance regarding measurement procedures for determining quasi-peak, peak, and average conducted output power, respectively).
7. Add the maximum transmit antenna gain (in dBi) to the measured output power level to determine the EIRP level (see 12.2.5 for guidance on determining the applicable antenna gain)
8. Add the appropriate maximum ground reflection factor to the EIRP level (6 dB for frequencies \leq 30 MHz, 4.7 dB for frequencies between 30 MHz and 1000 MHz, inclusive and 0 dB for frequencies $>$ 1000 MHz).
9. For devices with multiple antenna-ports, measure the power of each individual chain and sum the EIRP of all chains in linear terms (e.g., Watts, mW).
10. Convert the resultant EIRP level to an equivalent electric field strength using the following relationship:
$$E = \text{EIRP} - 20\log D + 104.8$$

where:

E = electric field strength in dB μ V/m,

EIRP = equivalent isotropic radiated power in dBm

D = specified measurement distance in meters.

11. Compare the resultant electric field strength level to the applicable regulatory limit.
12. Perform radiated spurious emission test

LIMIT

Below -20dB of the highest emission level in operating band.

Radiated emissions which fall in the restricted bands, as defined in § 15.205(a), must also comply with the radiated emission limits specified in § 15.209(a)

TEST RESULTS

Remark: The Bandedge was measured at difference data rate for each mode and recorded worst case for each mode.

4.5.1 802.11b Test Mode

A. Test Verdict

Frequency (MHz)	Conducted Power (dBm)	Antenna Gain (dBi)	Ground Reflection Factor (dB)	Covert Radiated E Level At 3m (dBuV/m)	Detector	Limit (dBuV/m)	Refer to Plot
2390.00	-42.06	-1.20	0.00	52.00	Peak	74.00	Plot 4.5.1 A1
2390.00	-53.76	-1.20	0.00	40.30	AV	54.00	Plot 4.5.1 A2
2413.20	12.71	-1.20	0.00	106.77	Peak	---	Plot 4.5.1 A1
2411.28	7.82	-1.20	0.00	101.88	AV	---	Plot 4.5.1 A2
2463.10	13.99	-1.20	0.00	108.05	Peak	---	Plot 4.5.1 A3
2461.30	8.54	-1.20	0.00	102.60	AV	---	Plot 4.5.1 A4
2483.50	-38.53	-1.20	0.00	55.53	Peak	74.00	Plot 4.5.1 A3
2483.50	-50.89	-1.20	0.00	43.17	AV	54.00	Plot 4.5.1 A4

- Note: 1. For 802.11b mode at final test to get the worst-case emission at 1Mbps.
 2. The test results including the cable lose.
 3. "----" means that the fundamental frequency not for 15.209 limits requirement.

B. Test Plots

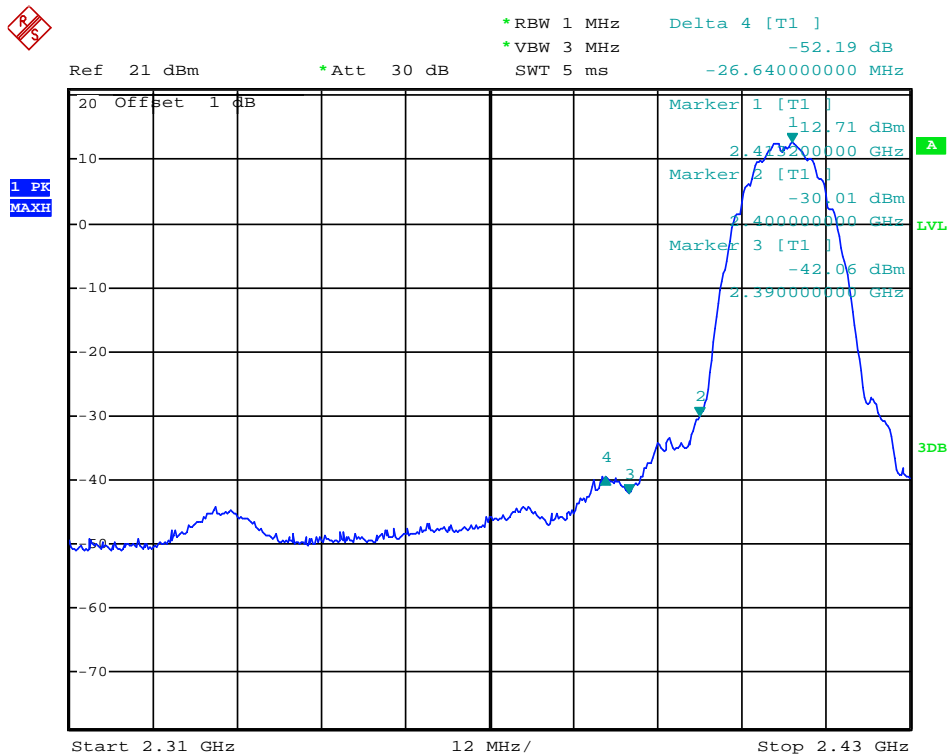

Date: 26.SEP.2013 16:29:01

(Plot 4.5.1 A1: Channel 1: 2412MHz @ 802.11b)

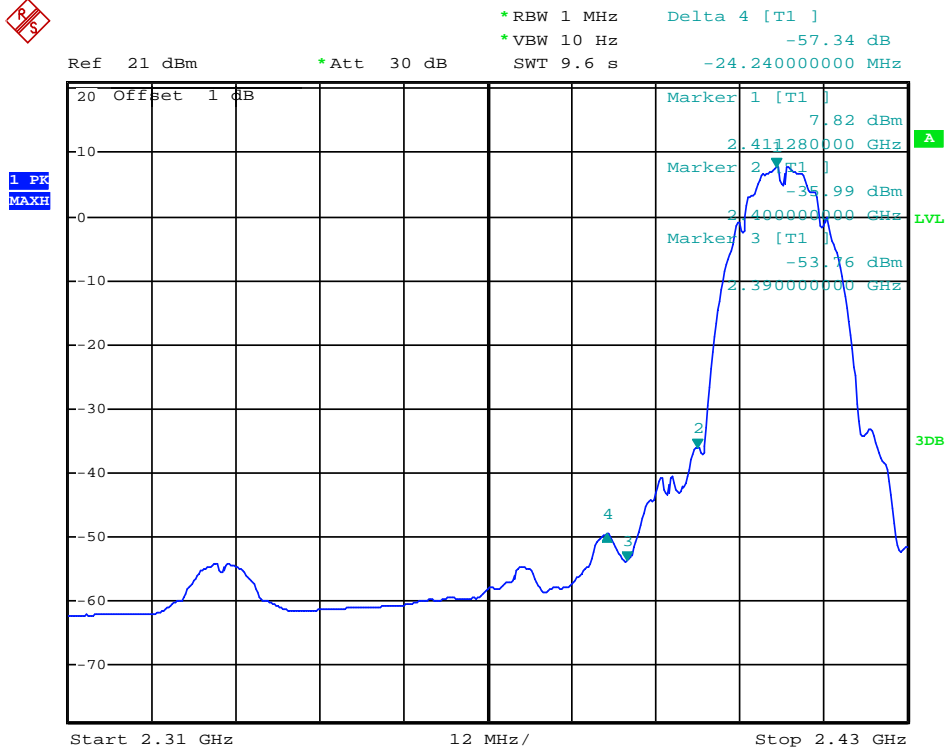

Date: 26.SEP.2013 16:30:21

(Plot 4.5.1 A2: Channel 1: 2412MHz @ 802.11b)

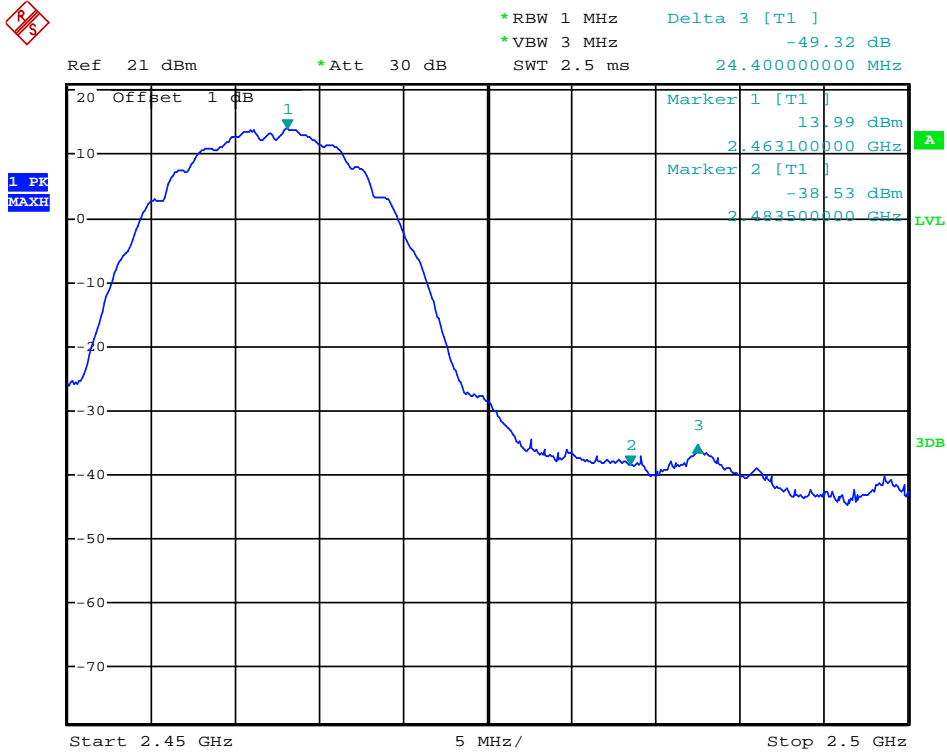

Date: 26.SEP.2013 16:46:50

(Plot 4.5.1 A3: Channel 11: 2462MHz @ 802.11b)

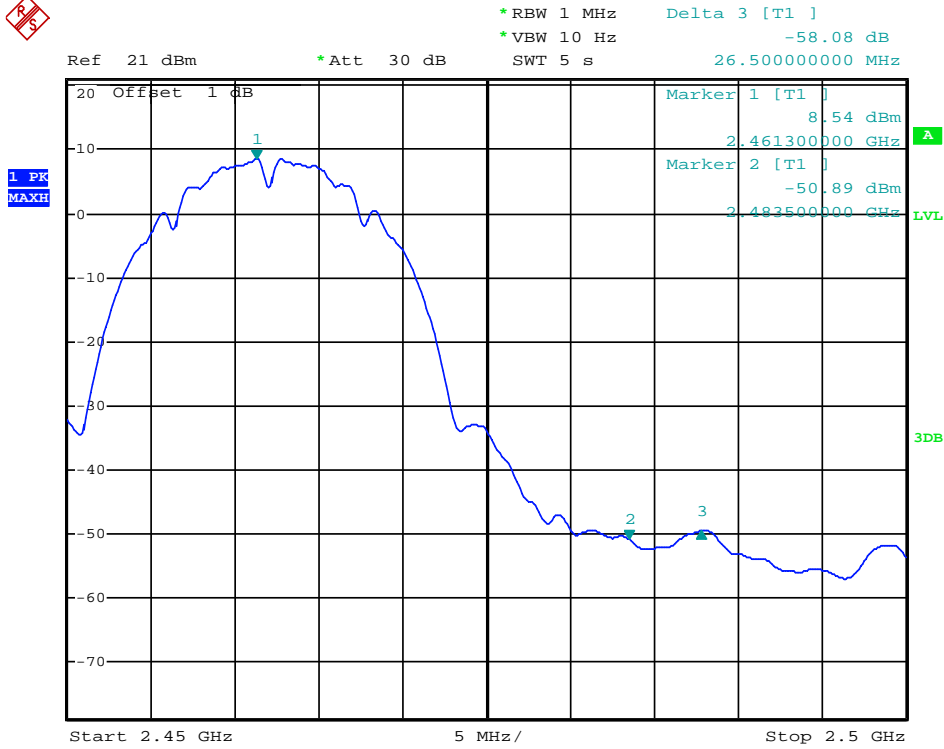

Date: 26.SEP.2013 16:47:33

(Plot 4.5.1 A4: Channel 11: 2462MHz @ 802.11b)

4.5.2 802.11g Test Mode

A. Test Verdict

Frequency (MHz)	Conducted Power (dBm)	Antenna Gain (dBi)	Ground Reflection Factor (dB)	Covert Radiated E Level At 3m (dBuV/m)	Detector	Limit (dBuV/m)	Refer to Plot
2390.00	-31.44	-1.20	0.00	62.62	Peak	74.00	Plot 4.5.2 A1
2390.00	-55.02	-1.20	0.00	39.04	AV	54.00	Plot 4.5.2 A2
2416.80	9.09	-1.20	0.00	103.15	Peak	---	Plot 4.5.2 A1
2416.32	-1.87	-1.20	0.00	92.19	AV	---	Plot 4.5.2 A2
2458.90	9.27	-1.20	0.00	103.33	Peak	---	Plot 4.5.2 A3
2466.00	-1.49	-1.20	0.00	92.57	AV	---	Plot 4.5.2 A4
2483.50	-27.55	-1.20	0.00	66.51	Peak	74.00	Plot 4.5.2 A3
2483.50	-54.56	-1.20	0.00	39.50	AV	54.00	Plot 4.5.2 A4

Note: 1. For 802.11g mode at final test to get the worst-case emission at 6Mbps.
 2. The test results including the cable lose.
 3. “---” means that the fundamental frequency not for 15.209 limits requirement.

B. Test Plots

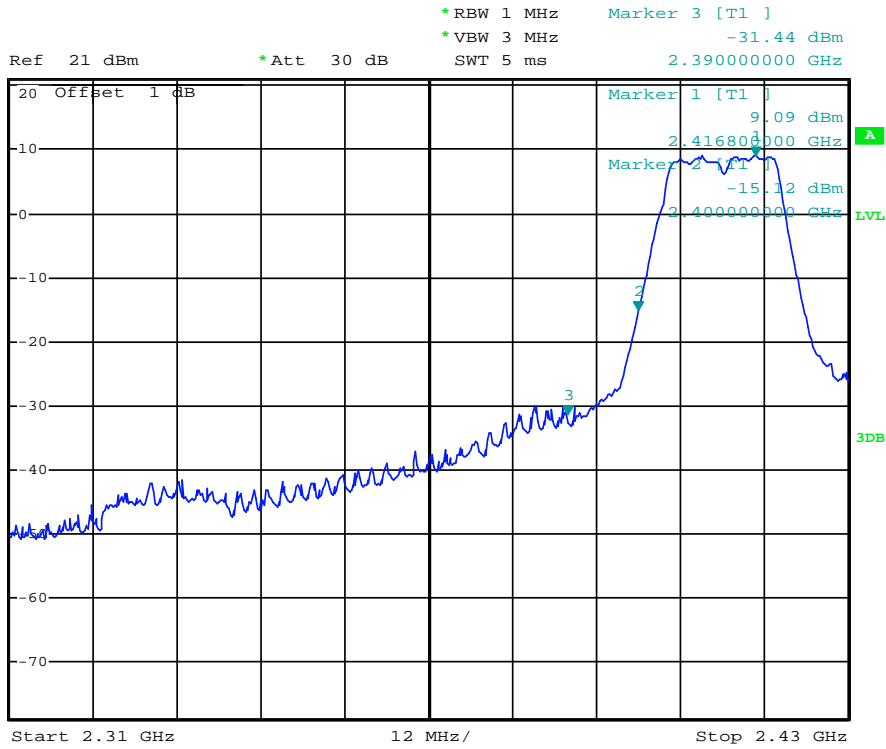

Date: 26.SEP.2013 16:33:31

(Plot 4.5.2 A1: Channel 1: 2412MHz @ 802.11g)

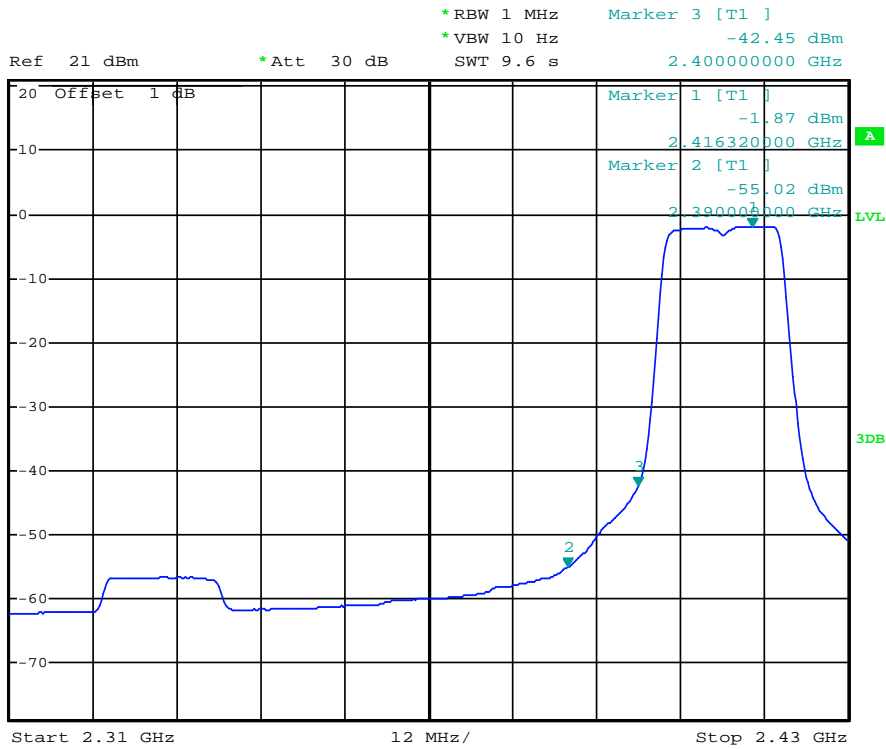

Date: 26.SEP.2013 16:40:25

(Plot 4.5.2 A2: Channel 1: 2412MHz @ 802.11g)



*RBW 1 MHz Marker 2 [T1]
*VBW 3 MHz -27.85 dBm
SWT 2.5 ms 2.48350000 GHz

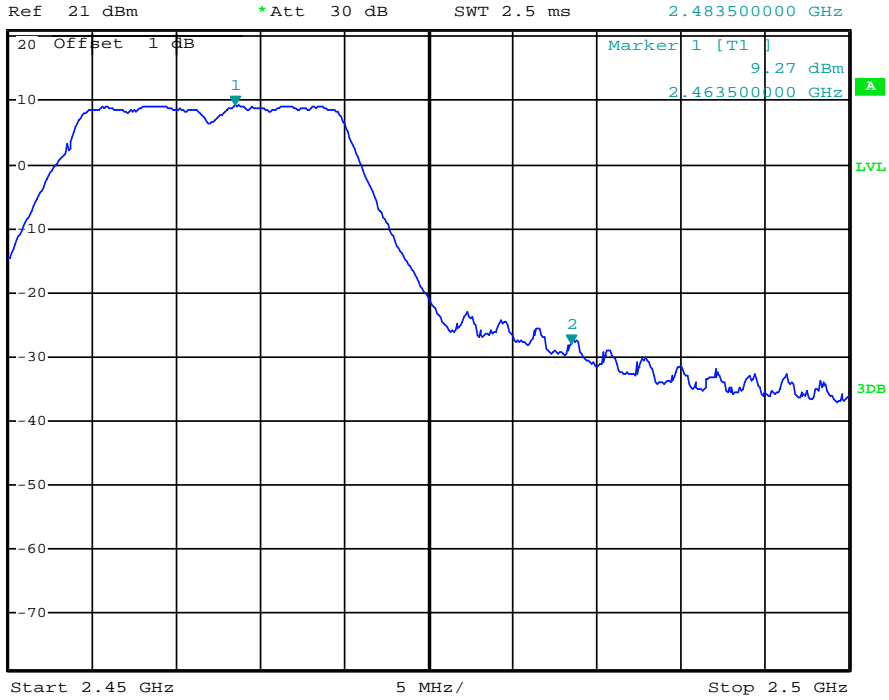

Date: 26.SEP.2013 16:48:29

(Plot 4.5.2 A3: Channel 11: 2462MHz @ 802.11g)



*RBW 1 MHz Marker 2 [T1]
*VBW 10 Hz -54.56 dBm
SWT 5 s 2.48350000 GHz

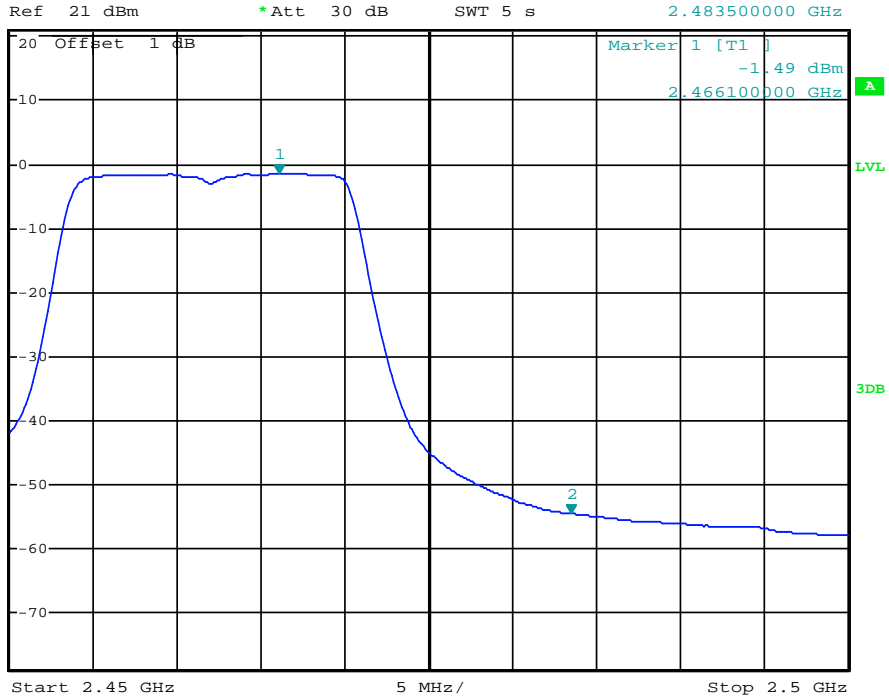

Date: 26.SEP.2013 16:49:02

(Plot 4.5.2 A4: Channel 11: 2462MHz @ 802.11g)

4.5.3 802.11n(20MHz) Test Mode

A. Test Verdict

Frequency (MHz)	Conducted Power (dBm)	Antenna Gain (dBi)	Ground Reflection Factor (dB)	Covert Radiated E Level At 3m (dBuV/m)	Detector	Limit (dBuV/m)	Refer to Plot
2390.00	-35.96	-1.20	0.00	58.10	Peak	74.00	Plot 4.5.3 A1
2390.00	-54.95	-1.20	0.00	39.11	AV	54.00	Plot 4.5.3 A2
2418.00	8.14	-1.20	0.00	102.20	Peak	---	Plot 4.5.3 A1
2417.52	-2.66	-1.20	0.00	91.40	AV	---	Plot 4.5.3 A2
2458.80	9.20	-1.20	0.00	103.26	Peak	---	Plot 4.5.3 A3
2465.20	-2.23	-1.20	0.00	91.83	AV	---	Plot 4.5.3 A4
2483.50	-33.82	-1.20	0.00	60.24	Peak	74.00	Plot 4.5.3 A3
2483.50	-55.07	-1.20	0.00	38.99	AV	54.00	Plot 4.5.3 A4

- Note: 1. For 802.11n(20MHz) mode at final test to get the worst-case emission at 6.5Mbps.
 2. The test results including the cable loss.
 3. "----" means that the fundamental frequency not for 15.209 limits requirement.

B. Test Plots

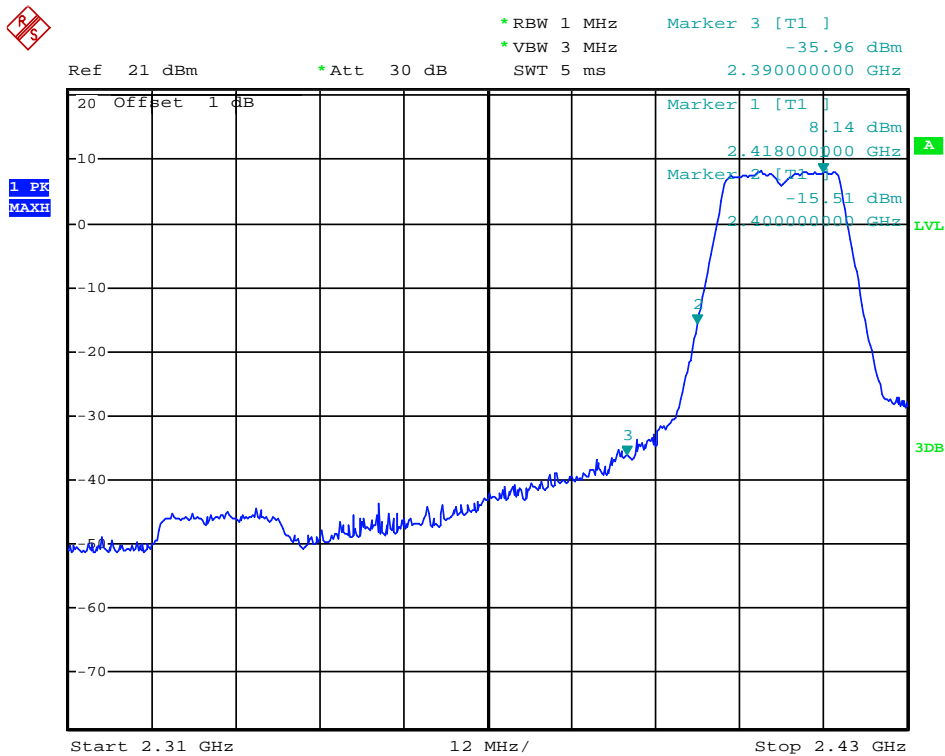

Date: 26.SEP.2013 16:41:34

(Plot 4.5.3 A1: Channel 1: 2412MHz @ 802.11n(20MHz))

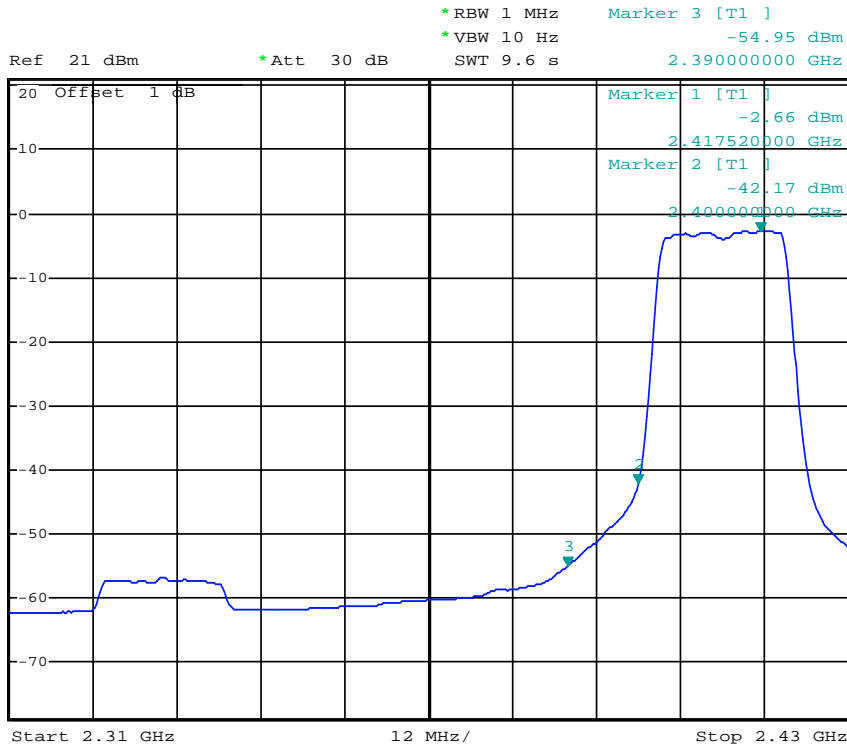

Date: 26.SEP.2013 16:42:37

(Plot 4.5.3 A2: Channel 1: 2412MHz @ 802.11n(20MHz))

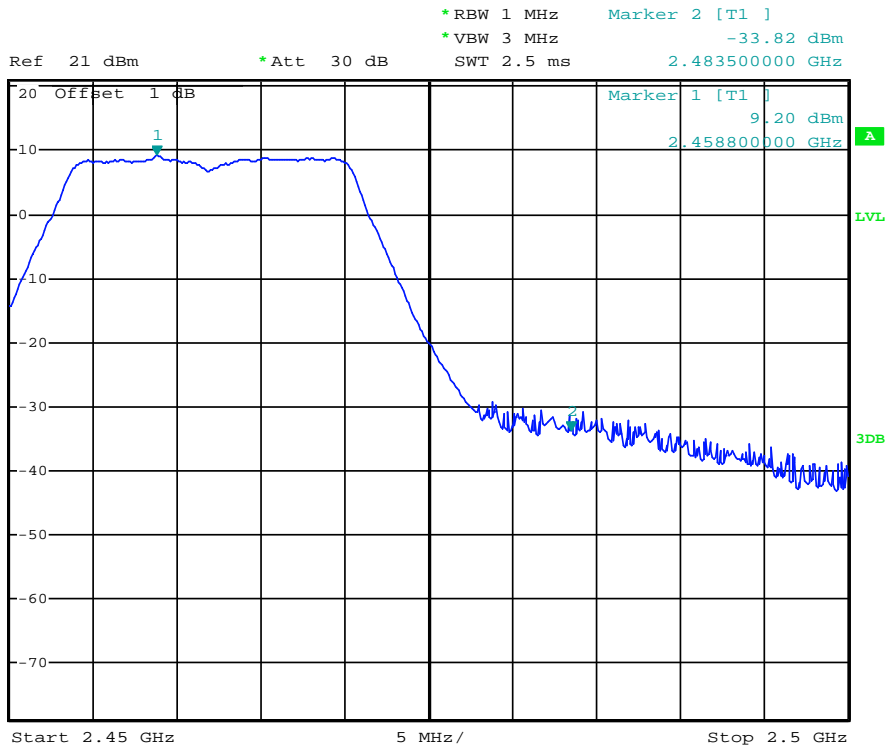

Date: 26.SEP.2013 16:52:01

(Plot 4.5.3 A3: Channel 11: 2462MHz @ 802.11n(20MHz))

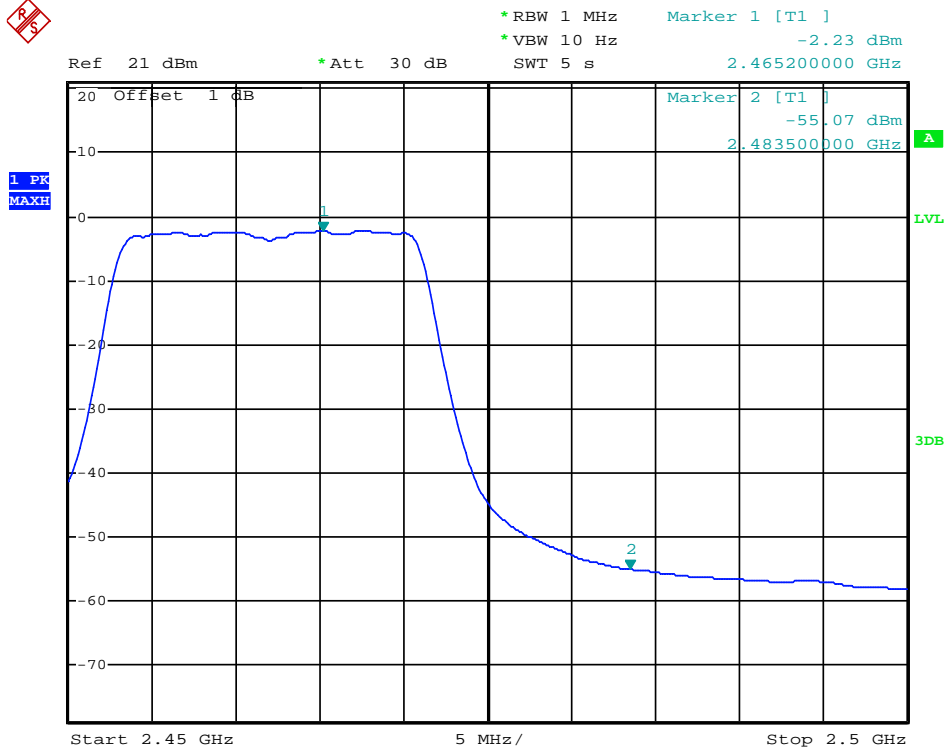

Date: 26.SEP.2013 16:52:27

(Plot 4.5.3 A4: Channel 11: 2462MHz @ 802.11n(20MHz))

4.5.4 802.11n(40MHz) Test Mode

A. Test Verdict

Frequency (MHz)	Conducted Power (dBm)	Antenna Gain (dBi)	Ground Reflection Factor (dB)	Covert Radiated E Level At 3m (dBuV/m)	Detector	Limit (dBuV/m)	Refer to Plot
2390.00	-39.18	-1.20	0.00	54.88	Peak	74.00	Plot 4.5.4 A1
2390.00	-54.67	-1.20	0.00	39.39	AV	54.00	Plot 4.5.4 A2
2430.96	4.54	-1.20	0.00	98.60	Peak	---	Plot 4.5.4 A1
2431.24	-6.02	-1.20	0.00	100.08	AV	---	Plot 4.5.4 A2
2461.08	4.76	-1.20	0.00	98.82	Peak	---	Plot 4.5.4 A3
2461.36	-5.86	-1.20	0.00	88.20	AV	---	Plot 4.5.4 A4
2483.50	-36.63	-1.20	0.00	57.43	Peak	74.00	Plot 4.5.4 A3
2483.50	-55.44	-1.20	0.00	38.62	AV	54.00	Plot 4.5.4 A4

Note: 1. For 802.11n(40MHz) mode at final test to get the worst-case emission at 13.5Mbps.
 2. The test results including the cable loss.
 3. “---” means that the fundamental frequency not for 15.209 limits requirement.

B. Test Plots

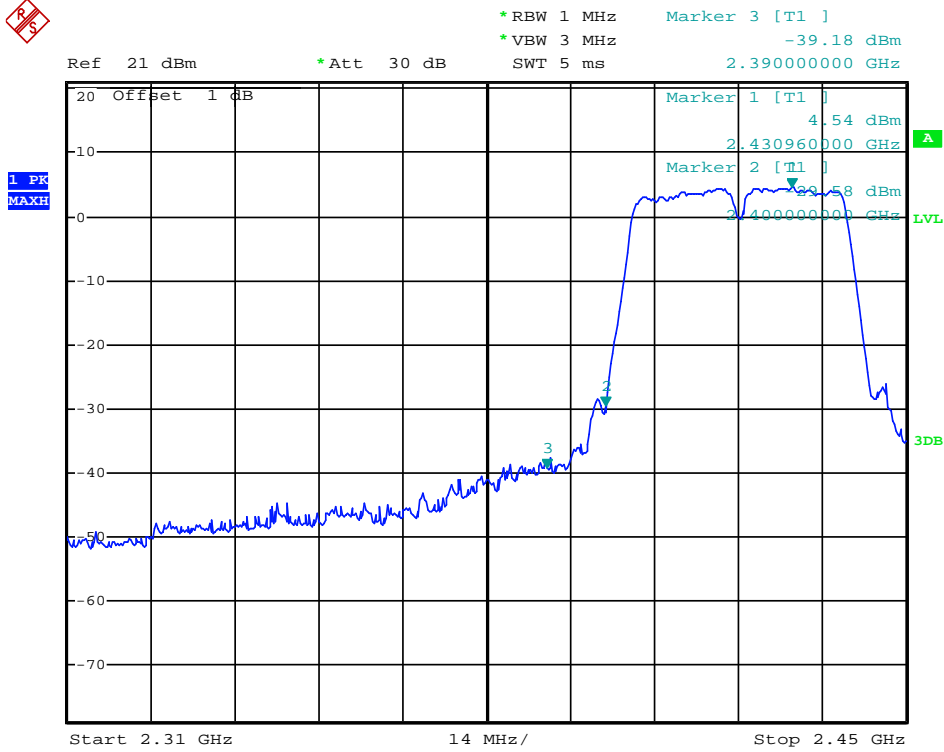

Date: 26.SEP.2013 16:44:00

(Plot 4.5.4 A1: Channel 3: 2422MHz @ 802.11n(40MHz))

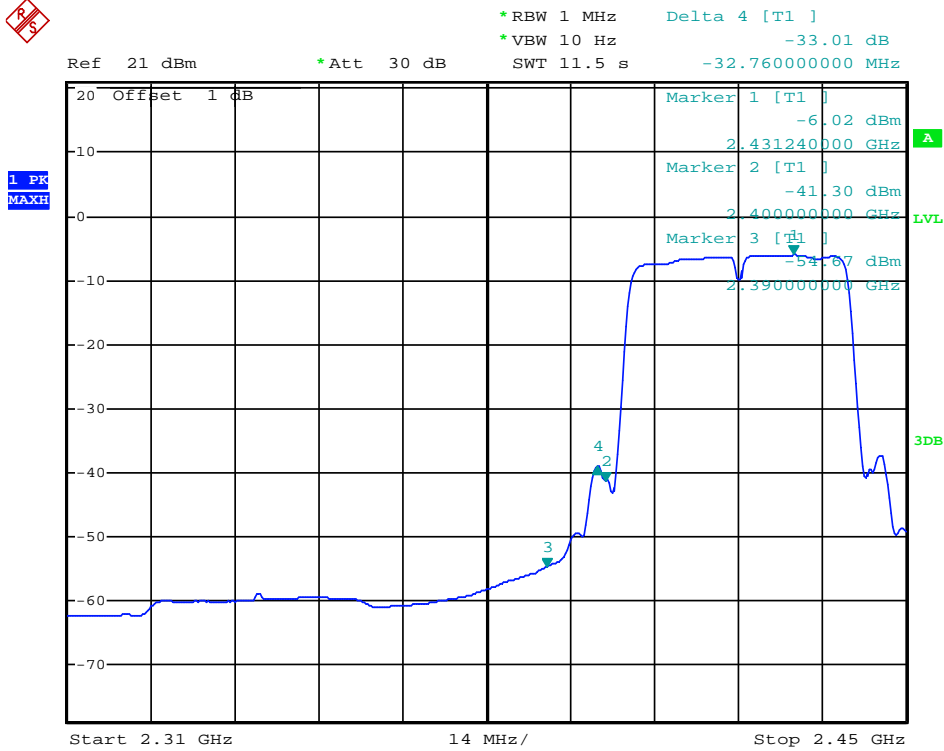

Date: 26.SEP.2013 16:44:54

(Plot 4.5.4 A2: Channel 3: 2422MHz @ 802.11n(40MHz))



Ref 21 dBm *Att 30 dB *RBW 1 MHz Marker 1 [T1] 4.76 dBm
*VBW 3 MHz 2.461080000 GHz
SWT 2.5 ms

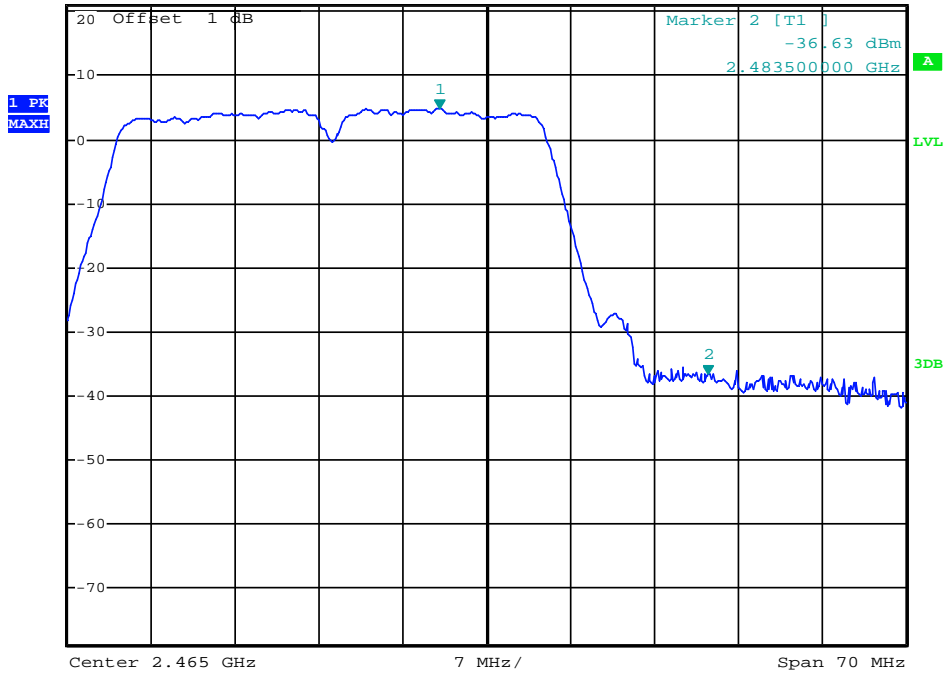

Date: 26.SEP.2013 16:53:33

(Plot 4.5.4 A3: Channel 9: 2452MHz @ 802.11n(40MHz))



Ref 21 dBm *Att 30 dB *RBW 1 MHz Marker 1 [T1] -5.86 dBm
*VBW 10 Hz 2.461360000 GHz
SWT 5.6 s

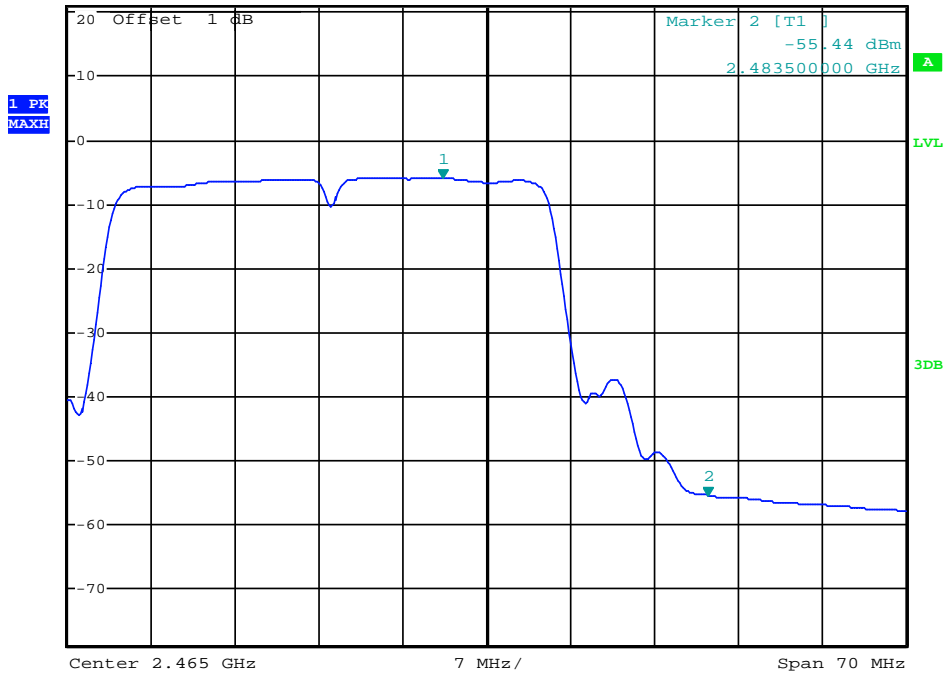

Date: 26.SEP.2013 16:54:09

(Plot 4.5.4 A4: Channel 9: 2452MHz @ 802.11n(40MHz))

4.6. Spurious RF Conducted Emission

TEST CONFIGURATION

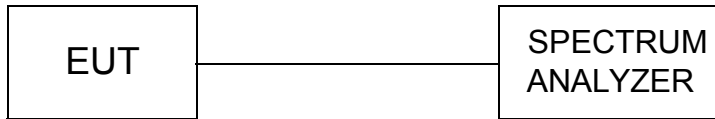

TEST PROCEDURE

The Spurious RF conducted emissions compliance of RF radiated emission should be measured by following the guidance in ANSI C63.10-2009 with respect to maximizing the emission by rotating the EUT, measuring the emission while the EUT is situated in three orthogonal planes (if appropriate), adjusting the measurement antenna height and polarization etc. Set RBW=100kHz and VBM= 300kHz to measure the peak field strength, and measure frequency range from 30MHz to 26.5GHz.

LIMIT

1. Below -20dB of the highest emission level in operating band.
2. Fall in the restricted bands listed in section 15.205. The maximum permitted average field strength is listed in section 15.209.

TEST RESULTS

Remark: The measurement frequency range is from 30MHz to the 10th harmonic of the fundamental frequency. The lowest, middle and highest channels are tested to verify the spurious emissions and bandedge measurement data.

4.6.1 802.11b Test Mode

A. Test Verdict

Channel	Frequency (MHz)	Frequency Range	Refer to Plot	Limit (dBc)	Verdict
1	2412	30MHz-1GHz	Plot 4.6.1 A1	-20	PASS
		1GHz-8GHz	Plot 4.6.1 A2	-20	PASS
		8GHz-16GHz	Plot 4.6.1 A3	-20	PASS
		16GHz-25GHz	Plot 4.6.1 A4	-20	PASS
6	2437	30MHz-1GHz	Plot 4.6.1 B1	-20	PASS
		1GHz-8GHz	Plot 4.6.1 B2	-20	PASS
		8GHz-16GHz	Plot 4.6.1 B3	-20	PASS
		16GHz-25GHz	Plot 4.6.1 B4	-20	PASS
11	2462	30MHz-1GHz	Plot 4.6.1 C1	-20	PASS
		1GHz-8GHz	Plot 4.6.1 C2	-20	PASS
		8GHz-16GHz	Plot 4.6.1 C3	-20	PASS
		16GHz-25GHz	Plot 4.6.1 C4	-20	PASS

Frequency (MHz)	Delta Peak to Band emission (dBc)	Detector	Limit (dBc)	Refer to Plot	Verdict
2400.00	28.74	Peak	-20	Plot 4.6.1 D	PASS
2483.50	37.84	Peak	-20	Plot 4.6.1 E	PASS

- Note: 1. For 802.11b mode at final test to get the worst-case emission at 1Mbps.
2. The test results including the cable loss.

B. Test Plots



*RBW 100 kHz Marker 1 [T1]
*VBW 300 kHz -46.15 dBm
SWT 100 ms 839.95000000 MHz

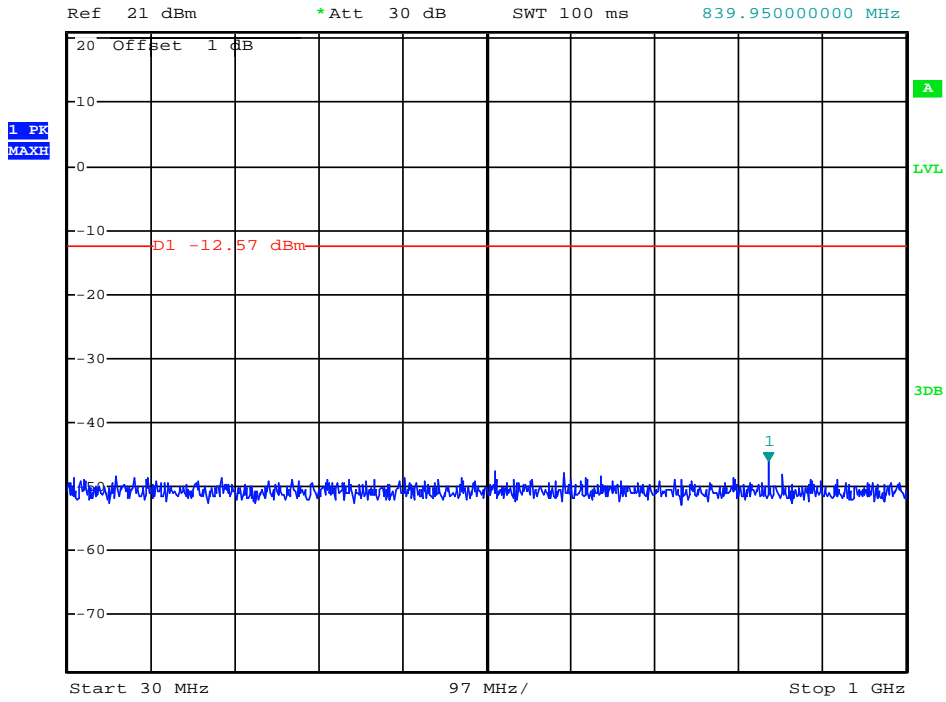

Date: 29.SEP.2013 17:23:39

(Plot 4.6.1 A1: Channel 1: 2412MHz @ 802.11b)



*RBW 100 kHz Marker 1 [T1]
*VBW 300 kHz 7.43 dBm
SWT 700 ms 2.407000000 GHz

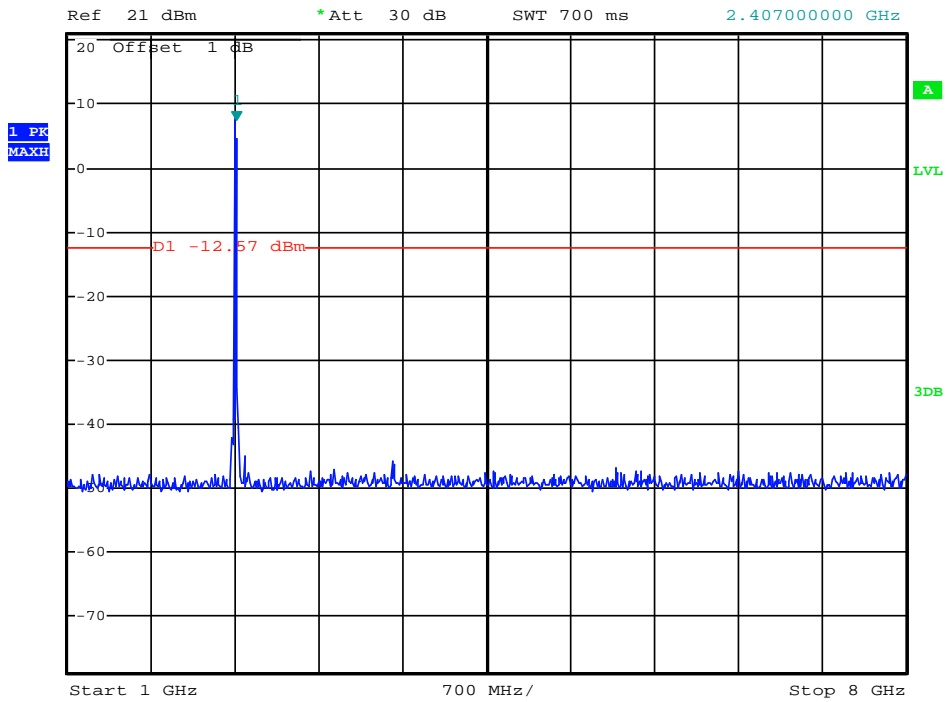

Date: 29.SEP.2013 17:23:17

(Plot 4.6.1 A2: Channel 1: 2412MHz @ 802.11b)



*RBW 100 kHz Marker 1 [T1]
*VBW 300 kHz -44.63 dBm
SWT 800 ms 15.856000000 GHz

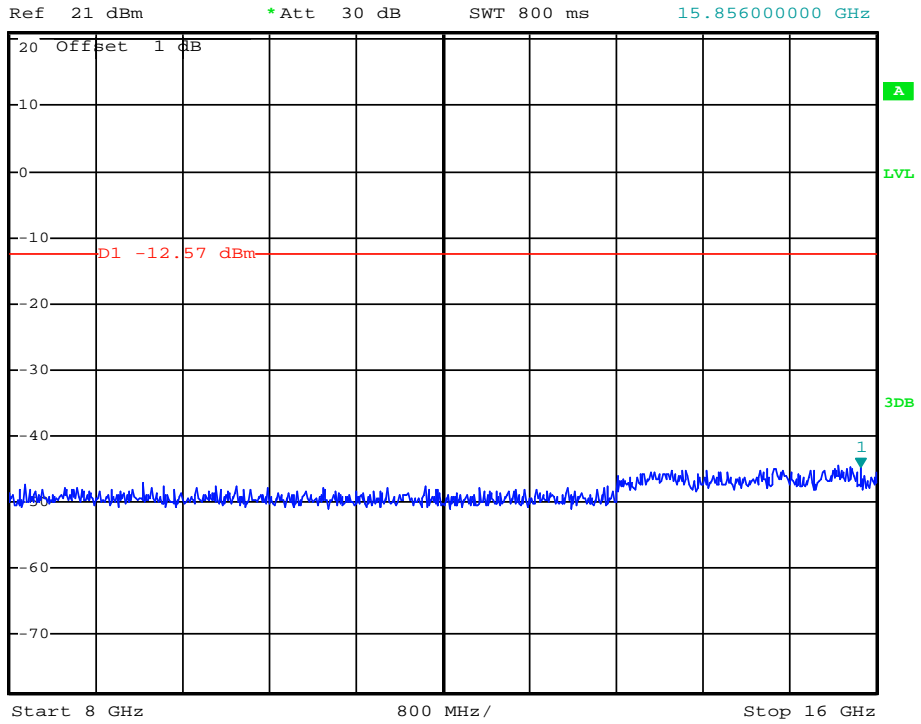

Date: 29.SEP.2013 17:24:14

(Plot 4.6.1 A3: Channel 1: 2412MHz @ 802.11b)



*RBW 100 kHz Marker 1 [T1]
*VBW 300 kHz -43.13 dBm
SWT 900 ms 16.639000000 GHz

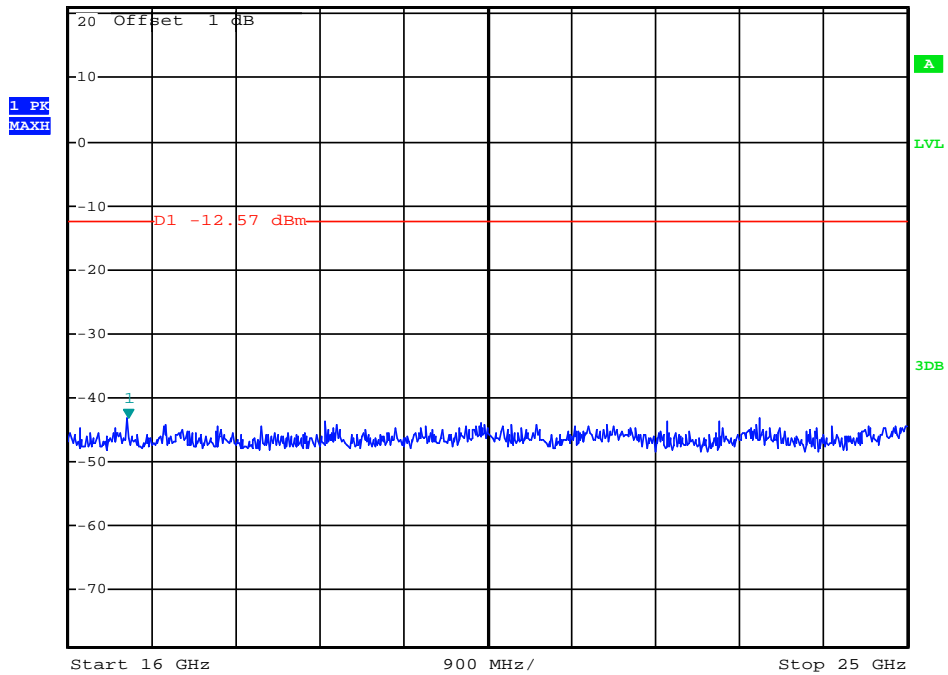

Date: 29.SEP.2013 17:24:28

(Plot 4.6.1 A4: Channel 1: 2412MHz @ 802.11b)

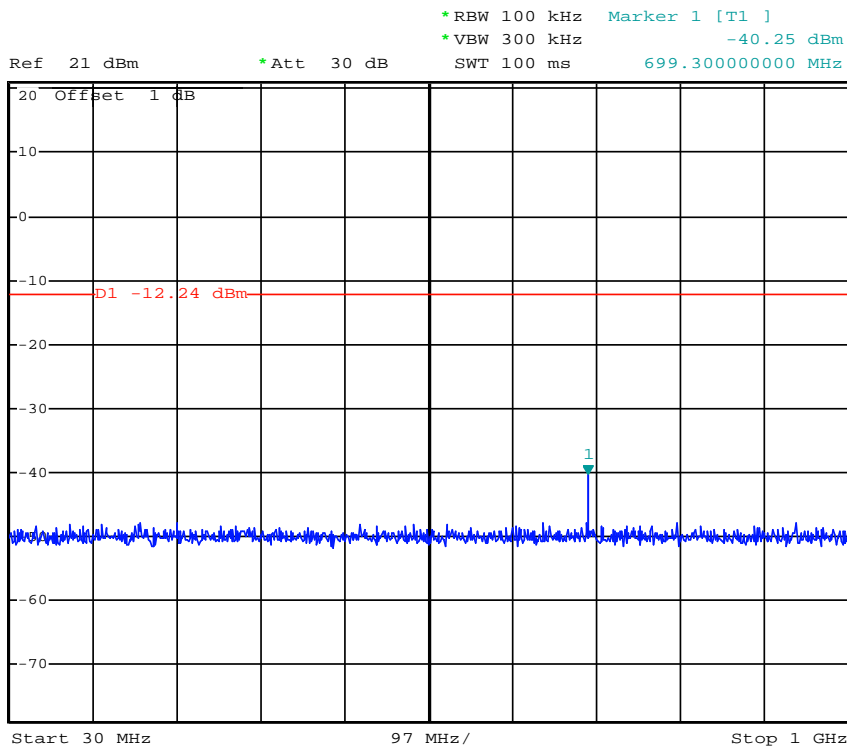

Date: 29.SEP.2013 17:27:45

(Plot 4.6.1 B1: Channel 6: 2437MHz @ 802.11b)

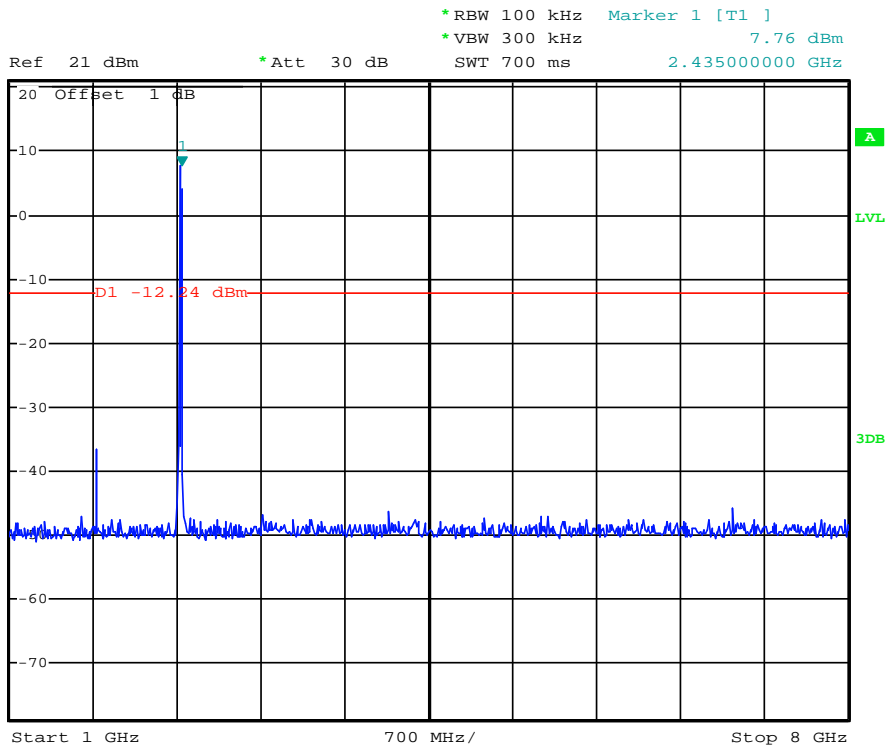

Date: 29.SEP.2013 17:27:09

(Plot 4.6.1 B2: Channel 6: 2437MHz @ 802.11b)



*RBW 100 kHz Marker 1 [T1]
*VBW 300 kHz -44.03 dBm
SWT 800 ms 15.63200000 GHz

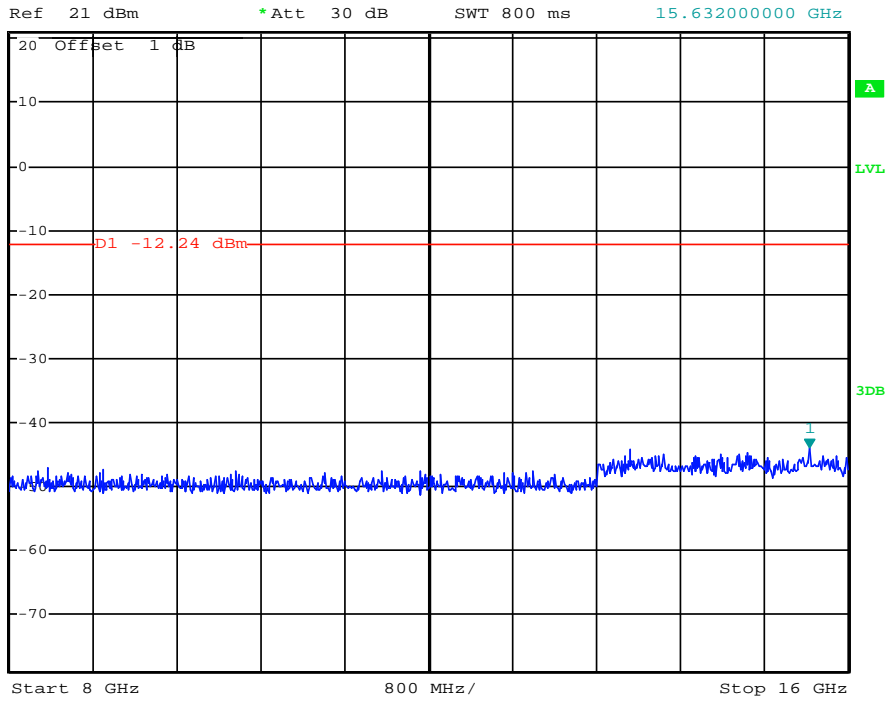

Date: 29.SEP.2013 17:28:07

(Plot 4.6.1 B3: Channel 6: 2437MHz @ 802.11b)



*RBW 100 kHz Marker 1 [T1]
*VBW 300 kHz -43.10 dBm
SWT 900 ms 22.94800000 GHz

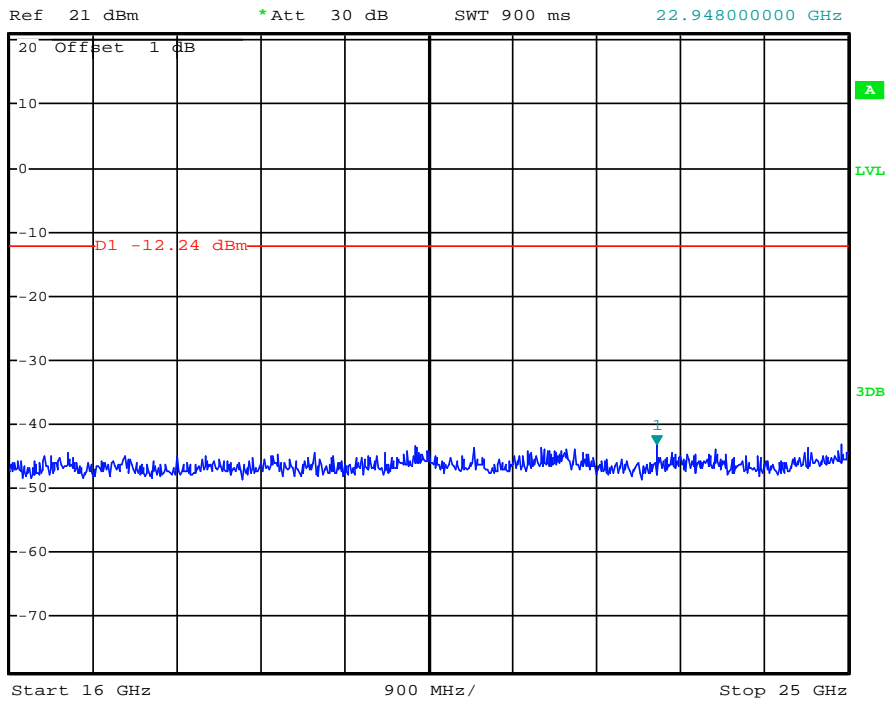

Date: 29.SEP.2013 17:28:19

(Plot 4.6.1 B4: Channel 6: 2437MHz @ 802.11b)



*RBW 100 kHz Marker 1 [T1]
*VBW 300 kHz -40.33 dBm
SWT 100 ms 724.52000000 MHz

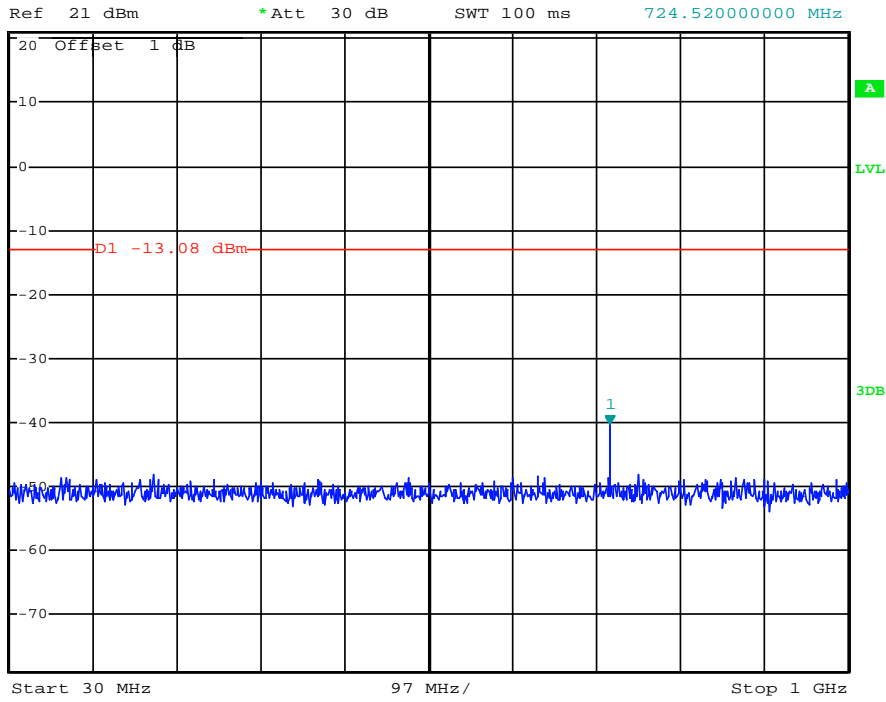

Date: 29.SEP.2013 17:29:10

(Plot 4.6.1 C1: Channel 11: 2462MHz @ 802.11b)



*RBW 100 kHz Marker 1 [T1]
*VBW 300 kHz 6.92 dBm
SWT 700 ms 2.463000000 GHz

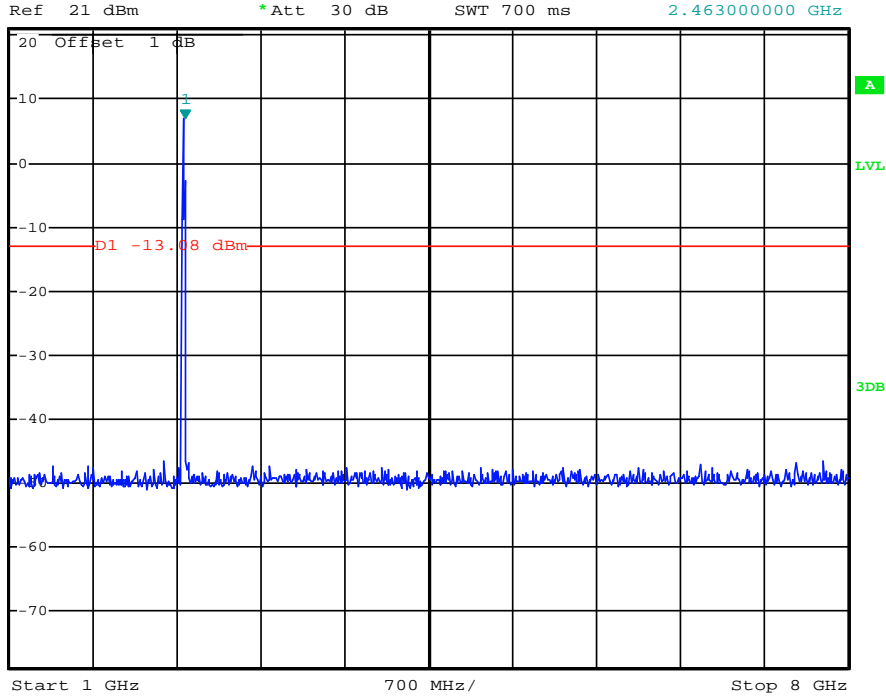

Date: 29.SEP.2013 17:28:55

(Plot 4.6.1 C2: Channel 11: 2462MHz @ 802.11b)



*RBW 100 kHz Marker 1 [T1]
*VBW 300 kHz -44.46 dBm
SWT 800 ms 15.60000000 GHz

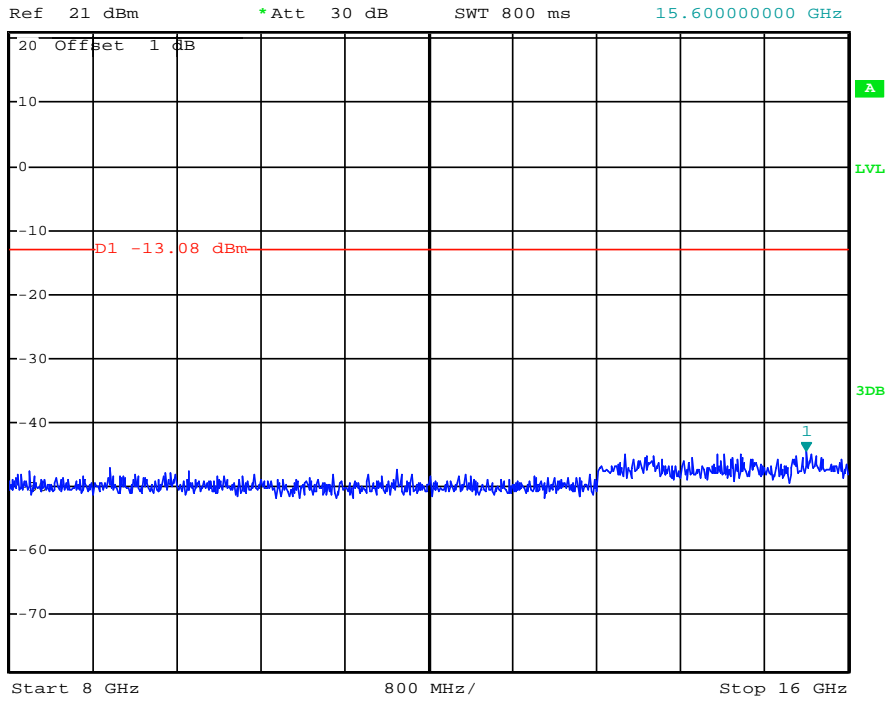

Date: 29.SEP.2013 17:29:24

(Plot 4.6.1 C3: Channel 11: 2462MHz @ 802.11b)



*RBW 100 kHz Marker 1 [T1]
*VBW 300 kHz -43.06 dBm
SWT 900 ms 16.65700000 GHz

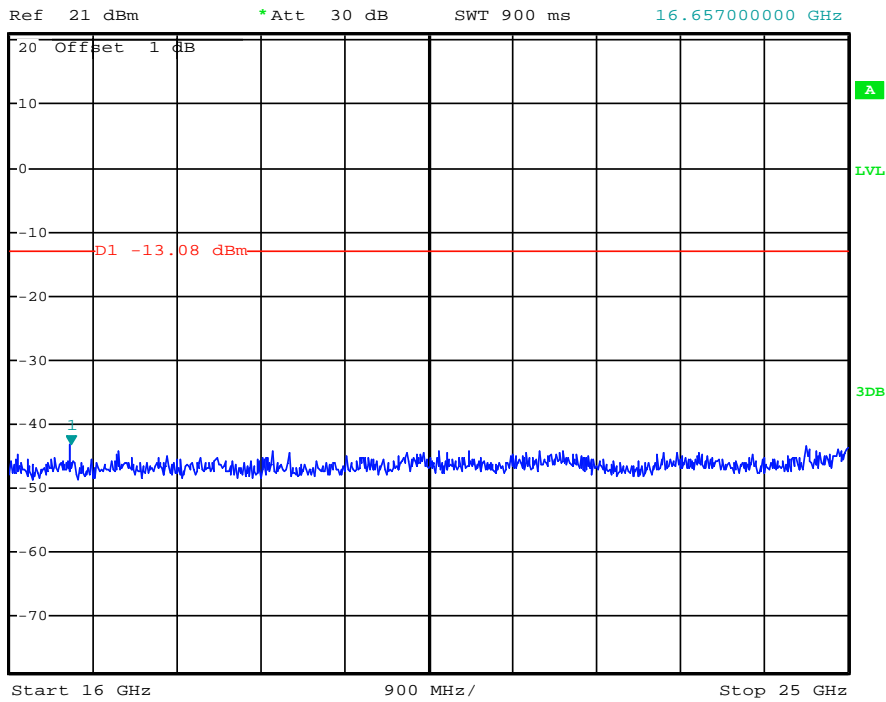

Date: 29.SEP.2013 17:29:38

(Plot 4.6.1 C4: Channel 11: 2462MHz @ 802.11b)



*RBW 100 kHz Delta 4 [T1]
*VBW 300 kHz -43.56 dB
SWT 15 ms -17.760000000 MHz

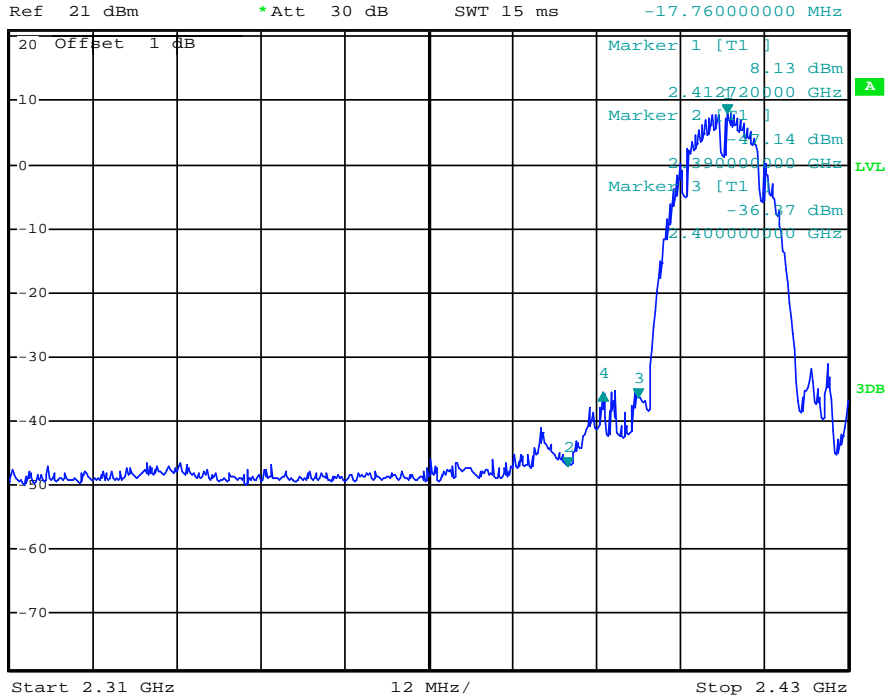

Date: 26.SEP.2013 15:54:26

(Plot 4.6.1 D: Channel 1: 2412MHz @ 802.11b)



*RBW 100 kHz Marker 2 [T1]
*VBW 300 kHz -46.12 dBm
SWT 5 ms 2.483500000 GHz

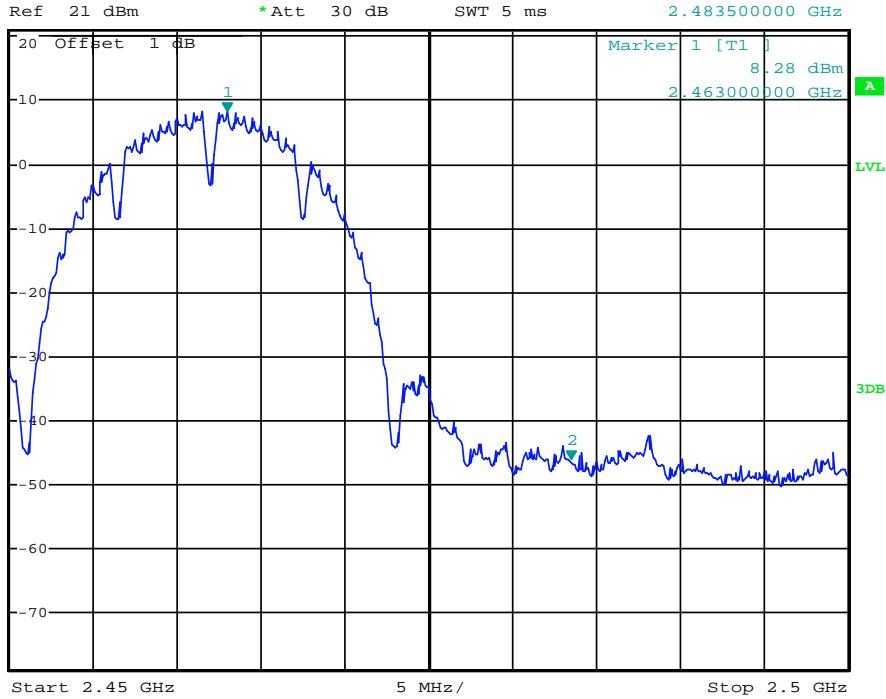

Date: 26.SEP.2013 16:02:23

(Plot 4.6.1 E: Channel 11: 2462MHz @ 802.11b)

4.6.2 802.11g Test Mode

A. Test Verdict

Channel	Frequency (MHz)	Frequency Range	Refer to Plot	Limit (dBc)	Verdict
1	2412	30MHz-1GHz	Plot 4.6.2 A1	-20	PASS
		1GHz-8GHz	Plot 4.6.2 A2	-20	PASS
		8GHz-16GHz	Plot 4.6.2 A3	-20	PASS
		16GHz-25GHz	Plot 4.6.2 A4	-20	PASS
6	2437	30MHz-1GHz	Plot 4.6.2 B1	-20	PASS
		1GHz-8GHz	Plot 4.6.2 B2	-20	PASS
		8GHz-16GHz	Plot 4.6.2 B3	-20	PASS
		16GHz-25GHz	Plot 4.6.2 B4	-20	PASS
11	2462	30MHz-1GHz	Plot 4.6.2 C1	-20	PASS
		1GHz-8GHz	Plot 4.6.2 C2	-20	PASS
		8GHz-16GHz	Plot 4.6.2 C3	-20	PASS
		16GHz-25GHz	Plot 4.6.2 C4	-20	PASS

Frequency (MHz)	Delta Peak to Band emission (dBc)	Detector	Limit (dBc)	Refer to Plot	Verdict
2400.00	32.58	Peak	-20	Plot 4.6.2 D	PASS
2483.50	40.94	Peak	-20	Plot 4.6.2 E	PASS

Note: 1. For 802.11g mode at final test to get the worst-case emission at 6Mbps.
 2. The test results including the cable lose.

B. Test Plots

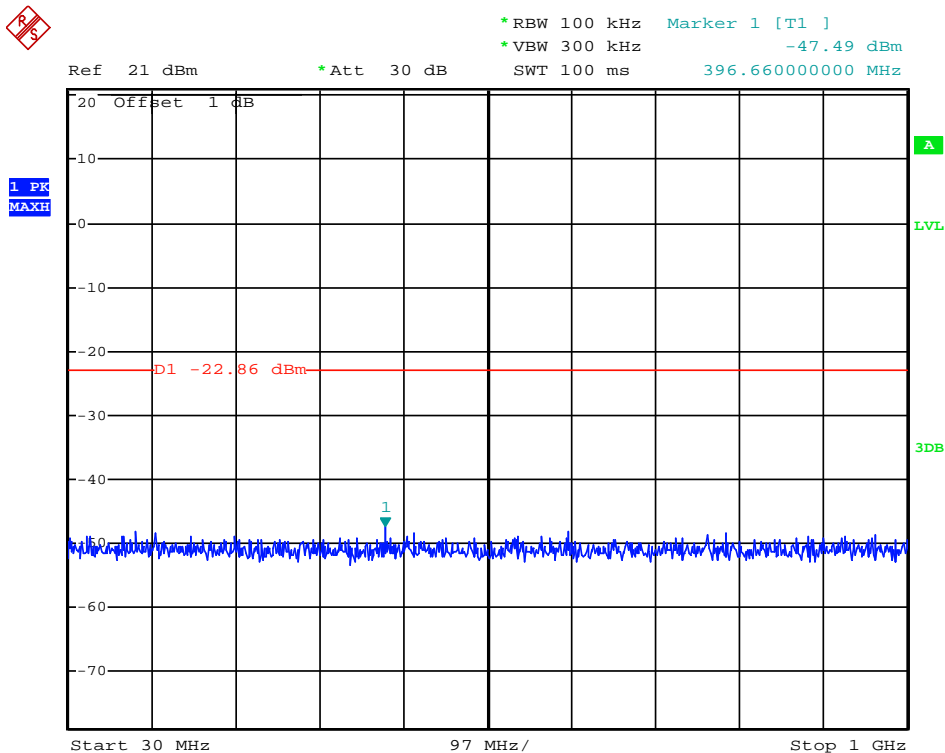

Date: 29.SEP.2013 17:49:53

(Plot 4.6.2 A1: Channel 1: 2412MHz @ 802.11g)



*RBW 100 kHz Marker 1 [T1]
*VBW 300 kHz -2.86 dBm
SWT 700 ms 2.414000000 GHz

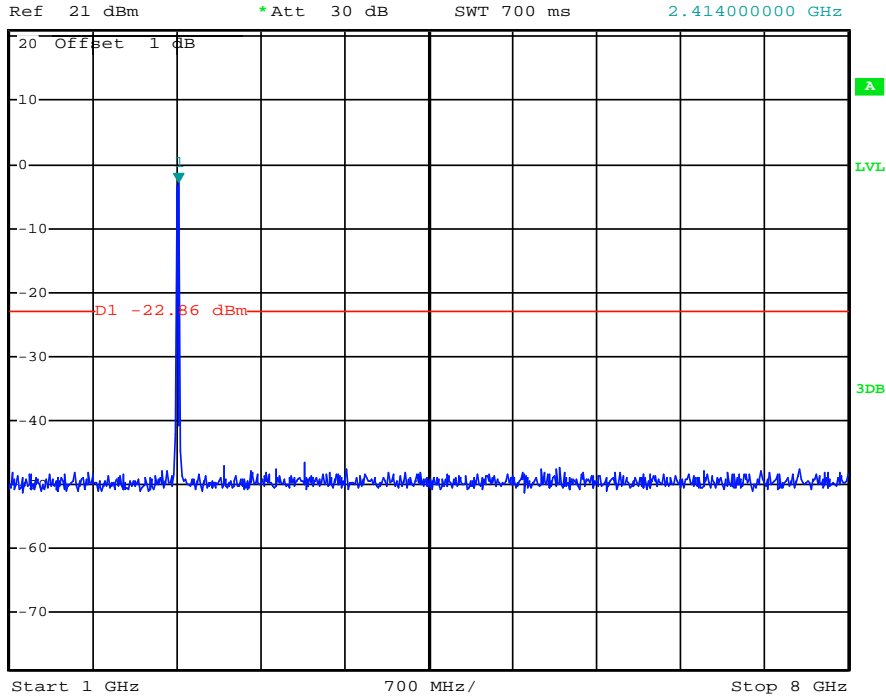

Date: 29.SEP.2013 17:49:41

(Plot 4.6.2 A2: Channel 1: 2412MHz @ 802.11g)



*RBW 100 kHz Marker 1 [T1]
*VBW 300 kHz -44.72 dBm
SWT 800 ms 14.160000000 GHz

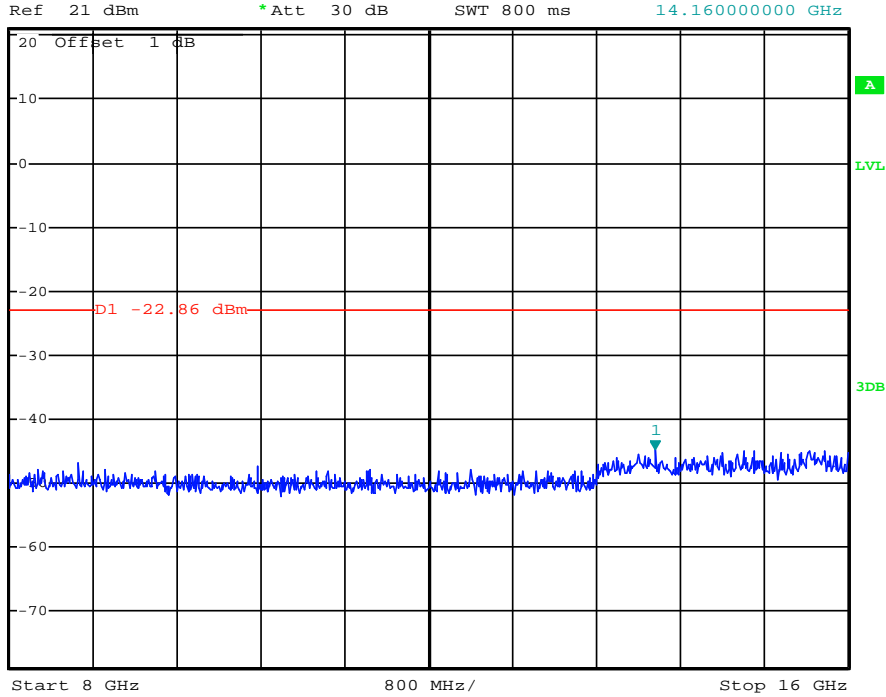

Date: 29.SEP.2013 17:50:02

(Plot 4.6.2 A3: Channel 1: 2412MHz @ 802.11g)



*RBW 100 kHz Marker 1 [T1]
*VBW 300 kHz -43.45 dBm
SWT 900 ms 20.113000000 GHz

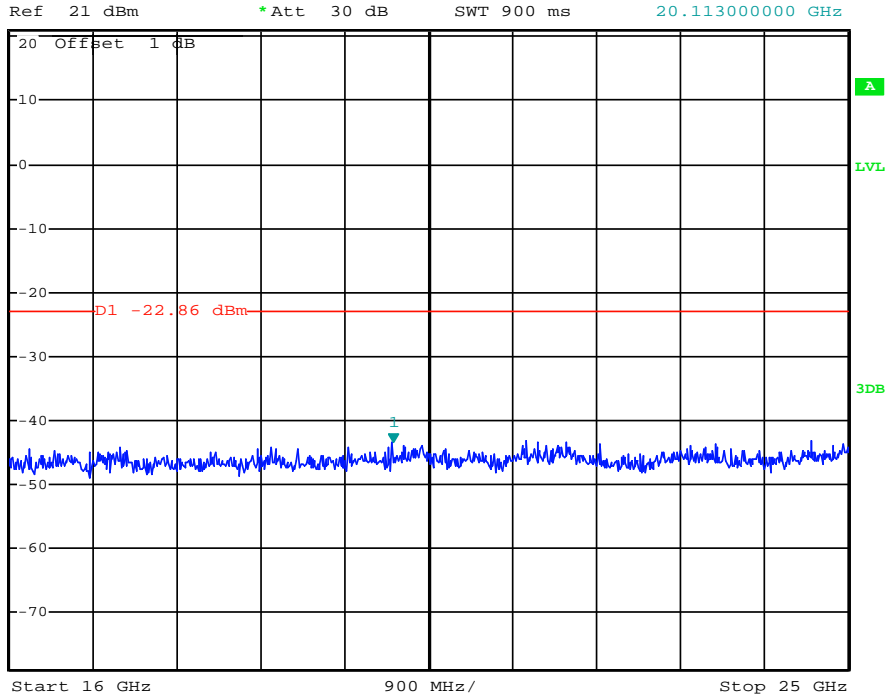

Date: 29.SEP.2013 17:50:21

(Plot 4.6.2 A4: Channel 1: 2412MHz @ 802.11g)



*RBW 100 kHz Marker 1 [T1]
*VBW 300 kHz -47.83 dBm
SWT 100 ms 625.580000000 MHz

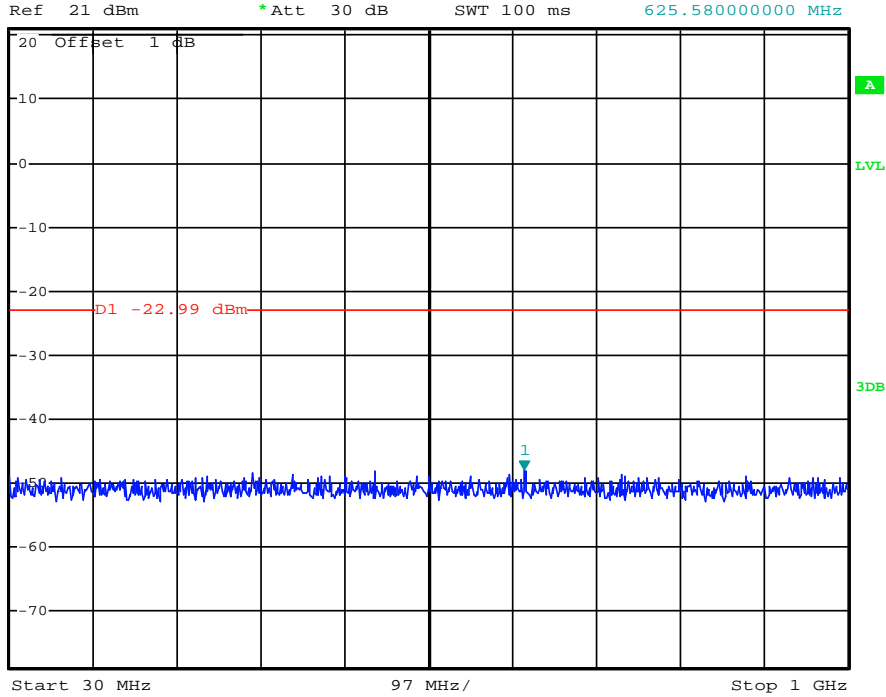

Date: 29.SEP.2013 17:52:20

(Plot 4.6.2 B1: Channel 6: 2437MHz @ 802.11g)

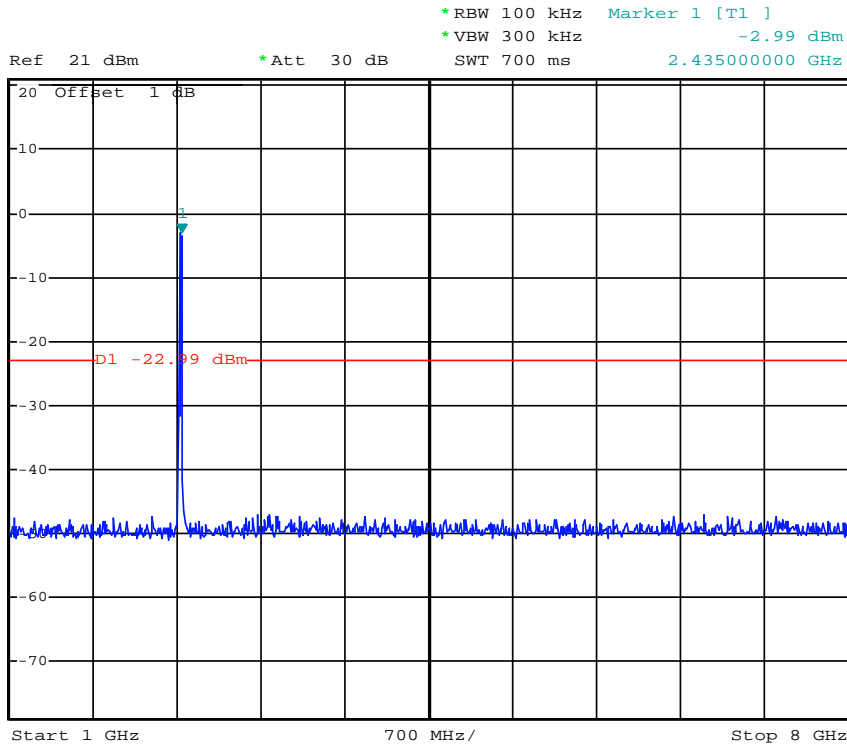

Date: 29.SEP.2013 17:52:09

(Plot 4.6.2 B2: Channel 6: 2437MHz @ 802.11g)

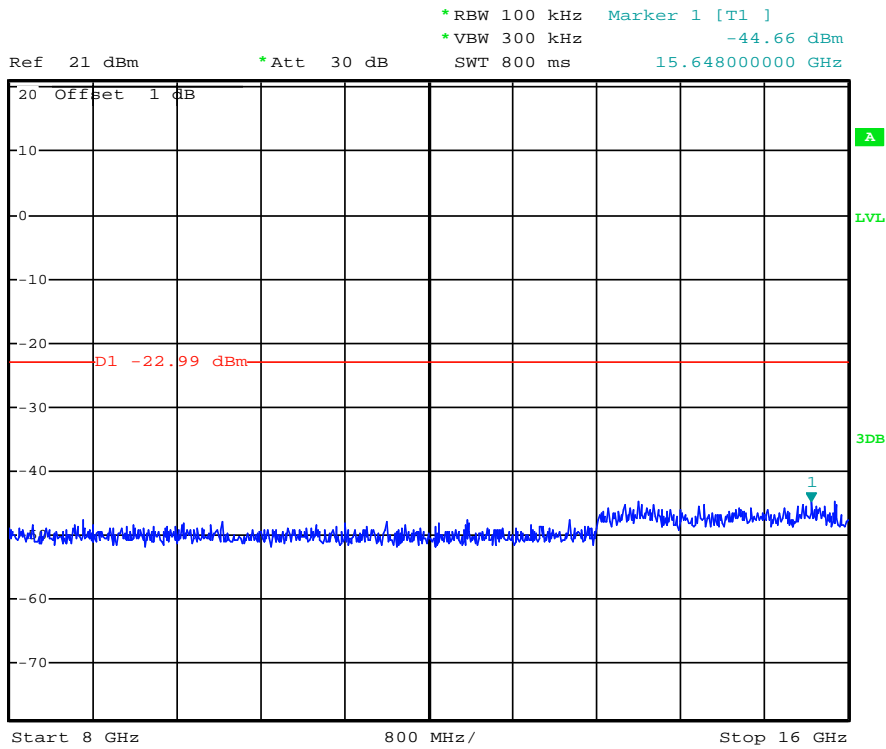

Date: 29.SEP.2013 17:52:31

(Plot 4.6.2 B3: Channel 6: 2437MHz @ 802.11g)



*RBW 100 kHz Marker 1 [T1]
*VBW 300 kHz -43.30 dBm
SWT 900 ms 18.817000000 GHz

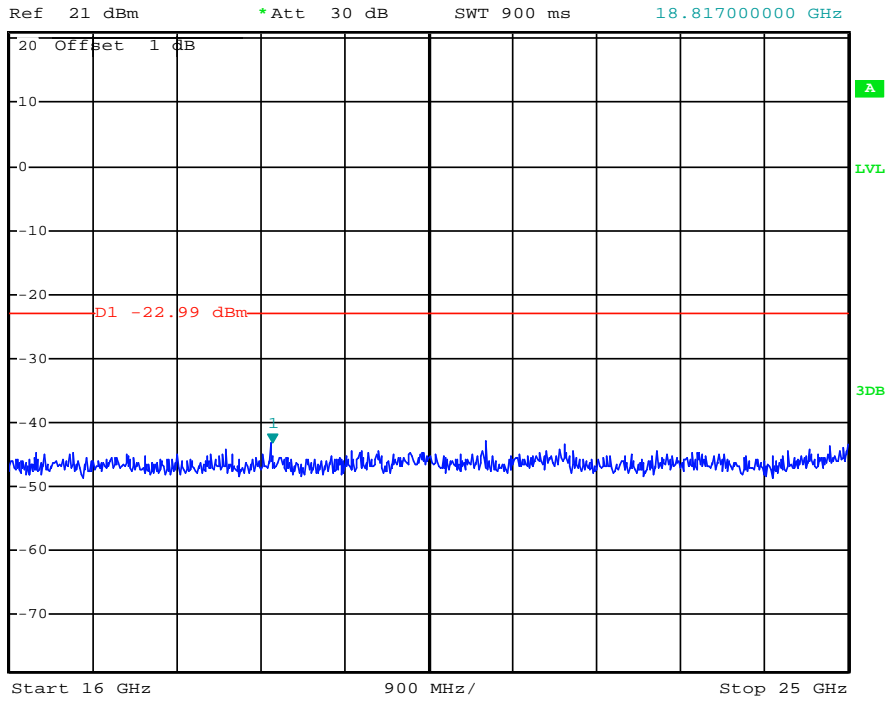

Date: 29.SEP.2013 17:52:43

(Plot 4.6.2 B4: Channel 6: 2437MHz @ 802.11g)



*RBW 100 kHz Marker 1 [T1]
*VBW 300 kHz -47.79 dBm
SWT 100 ms 35.820000000 MHz

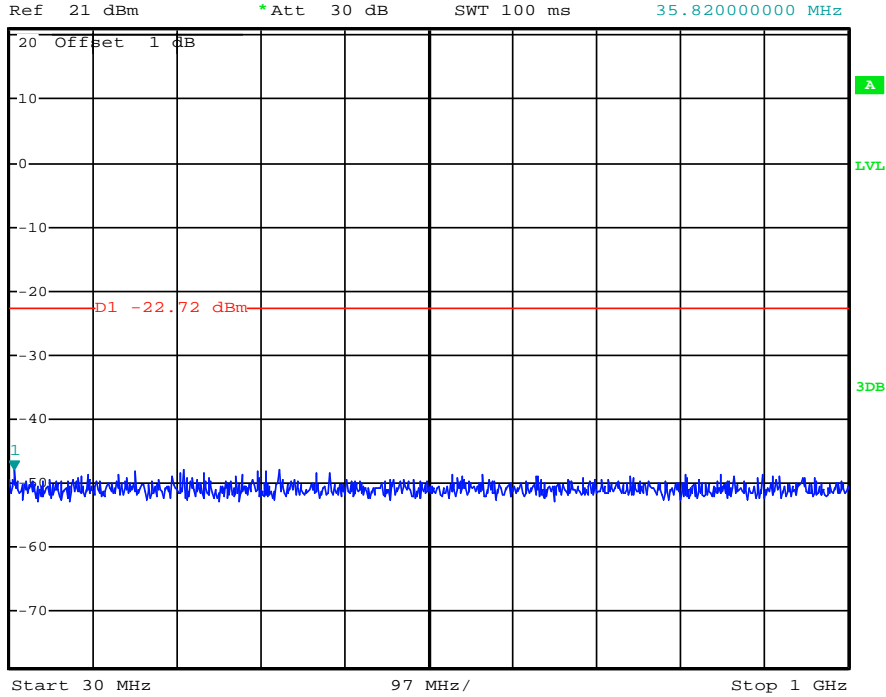

Date: 29.SEP.2013 17:54:00

(Plot 4.6.2 C1: Channel 11: 2462MHz @ 802.11g)

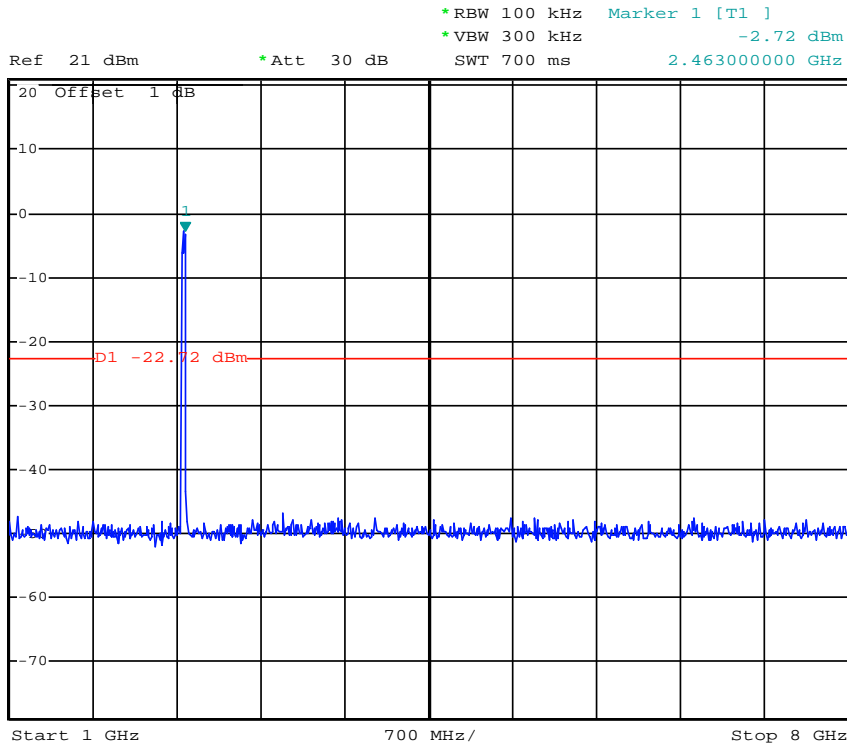

Date: 29.SEP.2013 17:53:49

(Plot 4.6.2 C2: Channel 11: 2462MHz @ 802.11g)

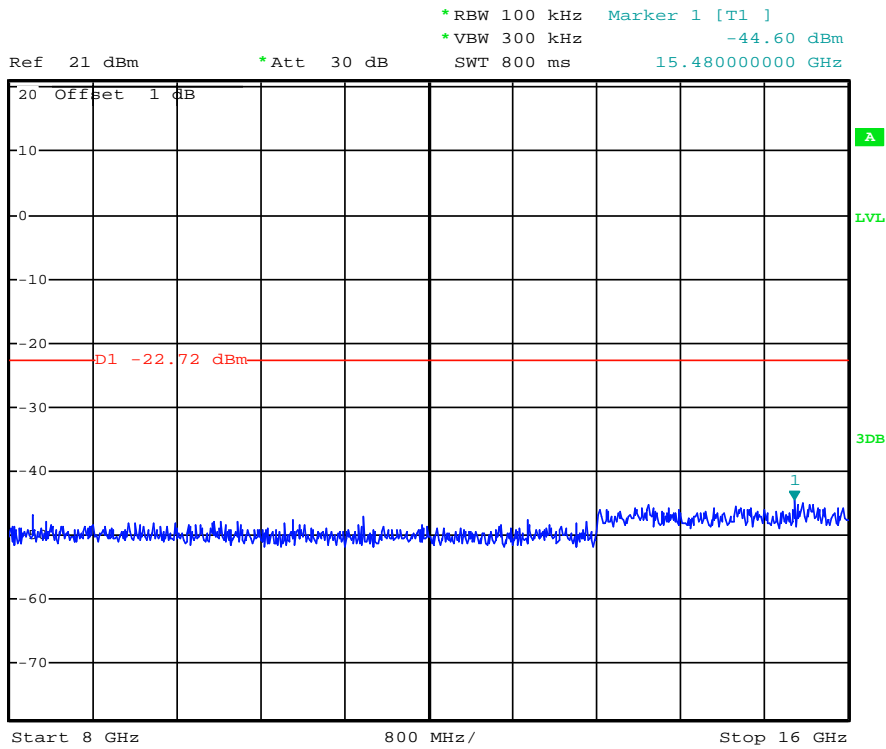

Date: 29.SEP.2013 17:54:10

(Plot 4.6.2 C3: Channel 11: 2462MHz @ 802.11g)

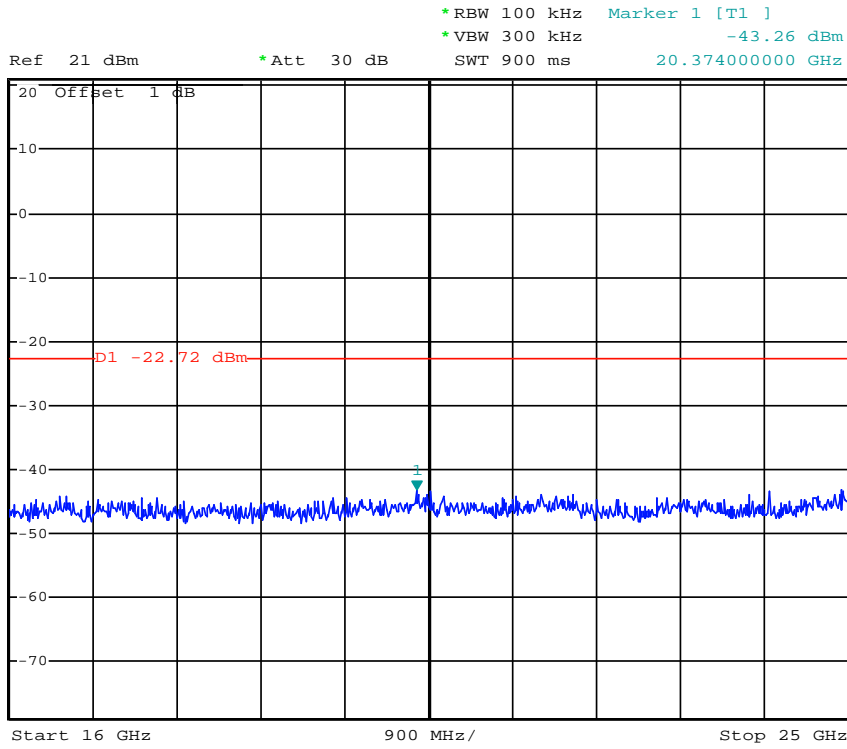

Date: 29.SEP.2013 17:54:24

(Plot 4.6.2 C3: Channel 11: 2462MHz @ 802.11g)

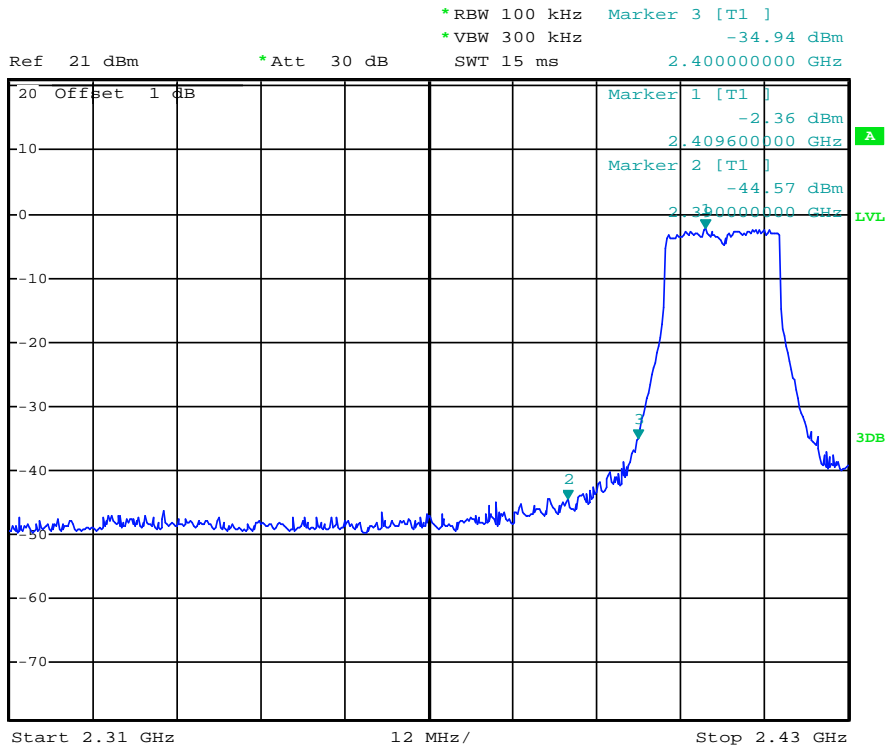

Date: 26.SEP.2013 15:56:55

(Plot 4.6.2 D: Channel 1: 2412MHz @ 802.11g)

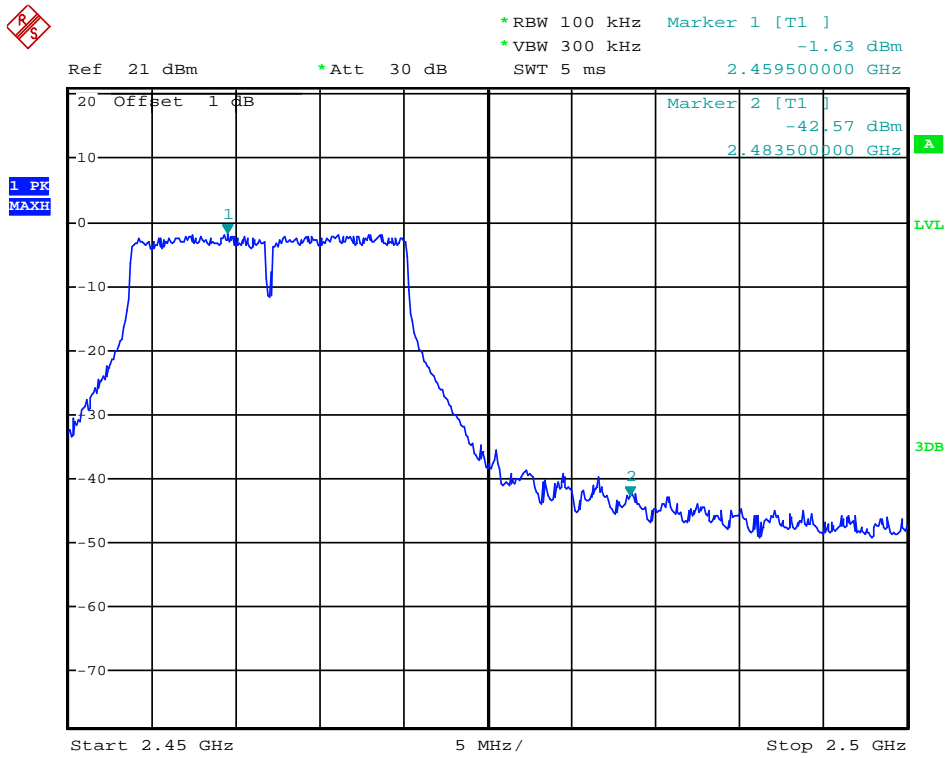

Date: 26.SEP.2013 16:03:48

(Plot 4.6.2 E: Channel 11: 2462MHz @ 802.11g)

4.6.3 802.11n(20MHz) Test Mode

A. Test Verdict

Channel	Frequency (MHz)	Frequency Range	Refer to Plot	Limit (dBc)	Verdict
1	2412	30MHz-1GHz	Plot 4.6.3 A1	-20	PASS
		1GHz-8GHz	Plot 4.6.3 A2	-20	PASS
		8GHz-16GHz	Plot 4.6.3 A3	-20	PASS
		16GHz-25GHz	Plot 4.6.3 A4	-20	PASS
6	2437	30MHz-1GHz	Plot 4.6.3 B1	-20	PASS
		1GHz-8GHz	Plot 4.6.3 B2	-20	PASS
		8GHz-16GHz	Plot 4.6.3 B3	-20	PASS
		16GHz-25GHz	Plot 4.6.3 B4	-20	PASS
11	2462	30MHz-1GHz	Plot 4.6.3 C1	-20	PASS
		1GHz-8GHz	Plot 4.6.3 C2	-20	PASS
		8GHz-16GHz	Plot 4.6.3 C3	-20	PASS
		16GHz-25GHz	Plot 4.6.3 C4	-20	PASS

Frequency (MHz)	Delta Peak to Band emission (dBc)	Detector	Limit (dBc)	Refer to Plot	Verdict
2400.00	32.04	Peak	-20	Plot 4.6.3 D	PASS
2483.50	41.88	Peak	-20	Plot 4.6.3 E	PASS

Note: 1. For 802.11n(20MHz) mode at final test to get the worst-case emission at 6.5Mbps.
 2. The test results including the cable loss.

B. Test Plots



*RBW 100 kHz Marker 1 [T1]
*VBW 300 kHz -48.04 dBm
SWT 100 ms 420.91000000 MHz

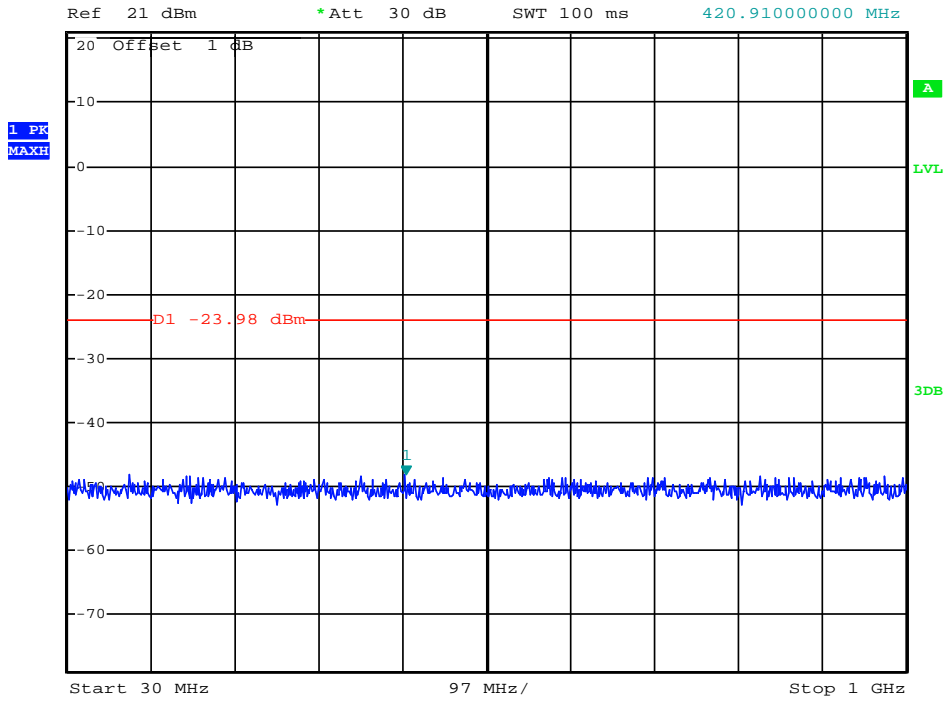

Date: 29.SEP.2013 17:37:44

(Plot 4.6.3 A1: Channel 1: 2412MHz @ 802.11n(20MHz))



*RBW 100 kHz Marker 2 [T1]
*VBW 300 kHz -30.26 dBm
SWT 700 ms 1.721000000 GHz

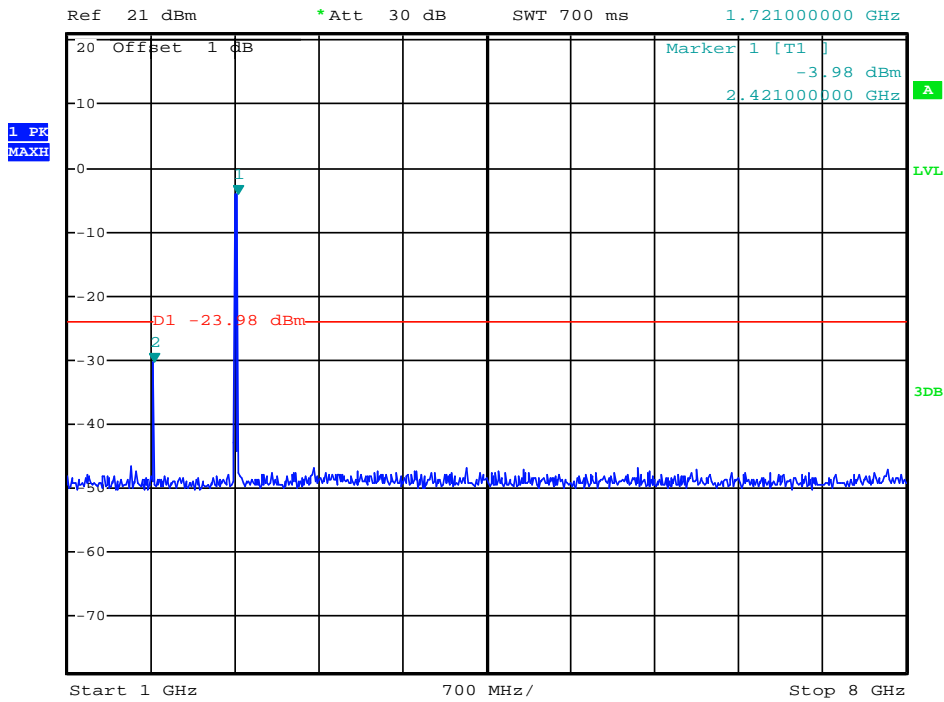

Date: 29.SEP.2013 17:37:29

(Plot 4.6.3 A2: Channel 1: 2412MHz @ 802.11n(20MHz))



*RBW 100 kHz Marker 1 [T1]
*VBW 300 kHz -44.29 dBm
SWT 800 ms 14.39200000 GHz

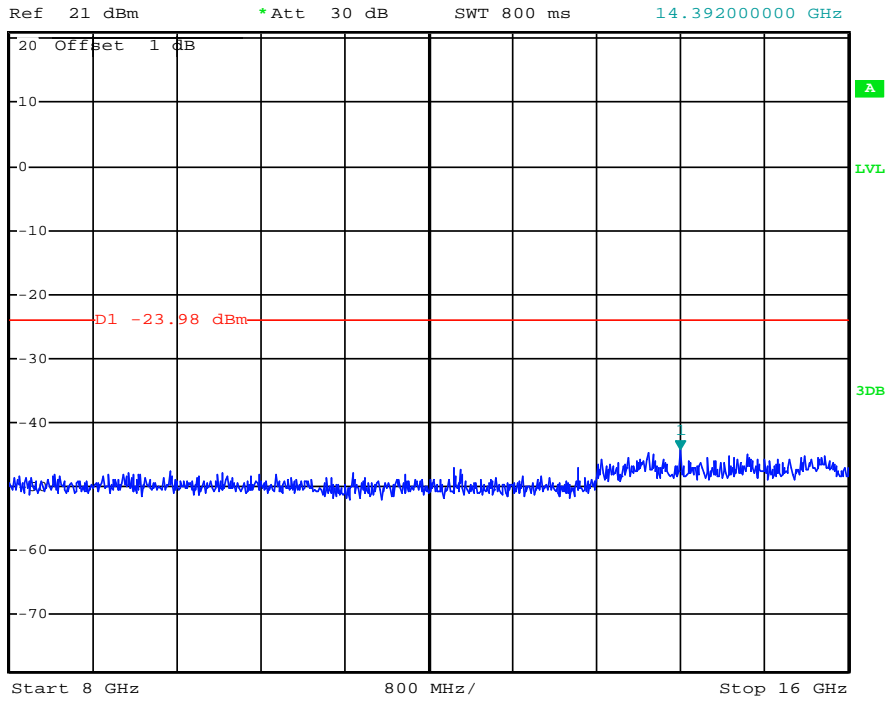

Date: 29.SEP.2013 17:37:55

(Plot 4.6.3 A3: Channel 1: 2412MHz @ 802.11n(20MHz))



*RBW 100 kHz Marker 1 [T1]
*VBW 300 kHz -43.25 dBm
SWT 900 ms 24.97300000 GHz

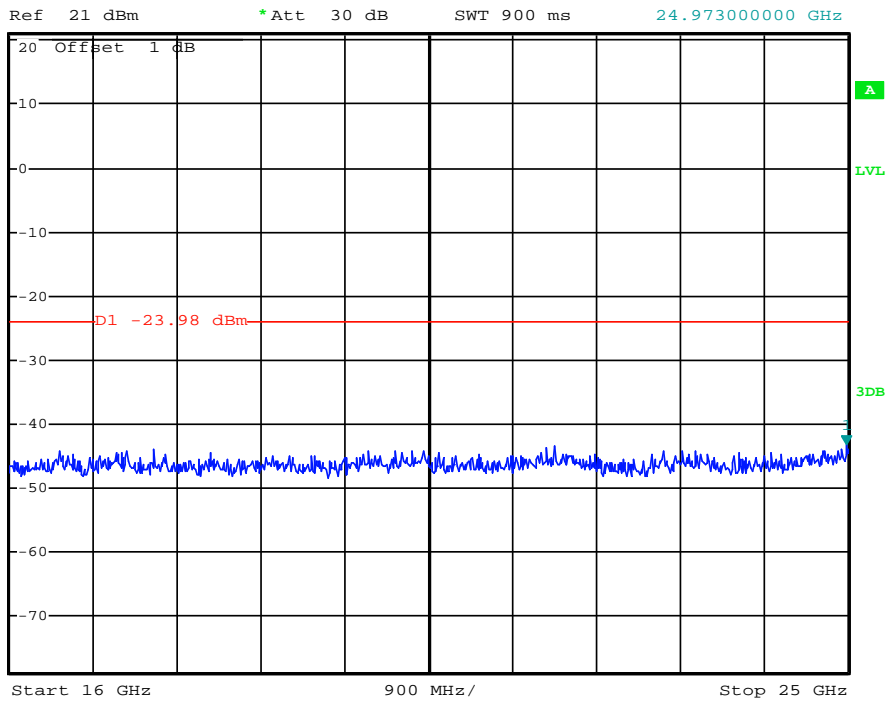

Date: 29.SEP.2013 17:38:07

(Plot 4.6.3 A4: Channel 1: 2412MHz @ 802.11n(20MHz))

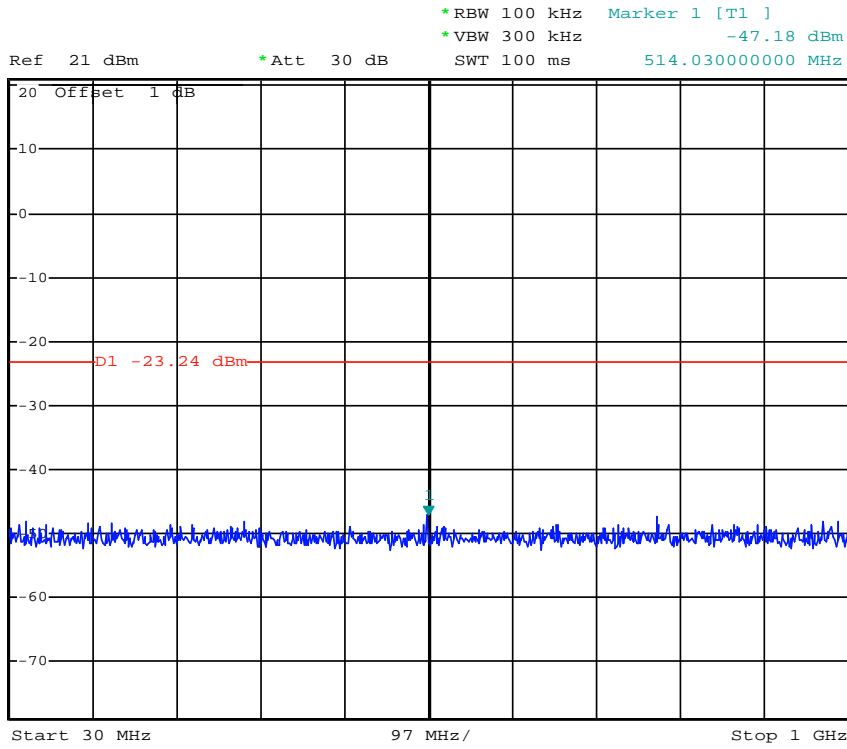

Date: 29.SEP.2013 17:39:15

(Plot 4.6.3 B1: Channel 6: 2437MHz @ 802.11n(20MHz))

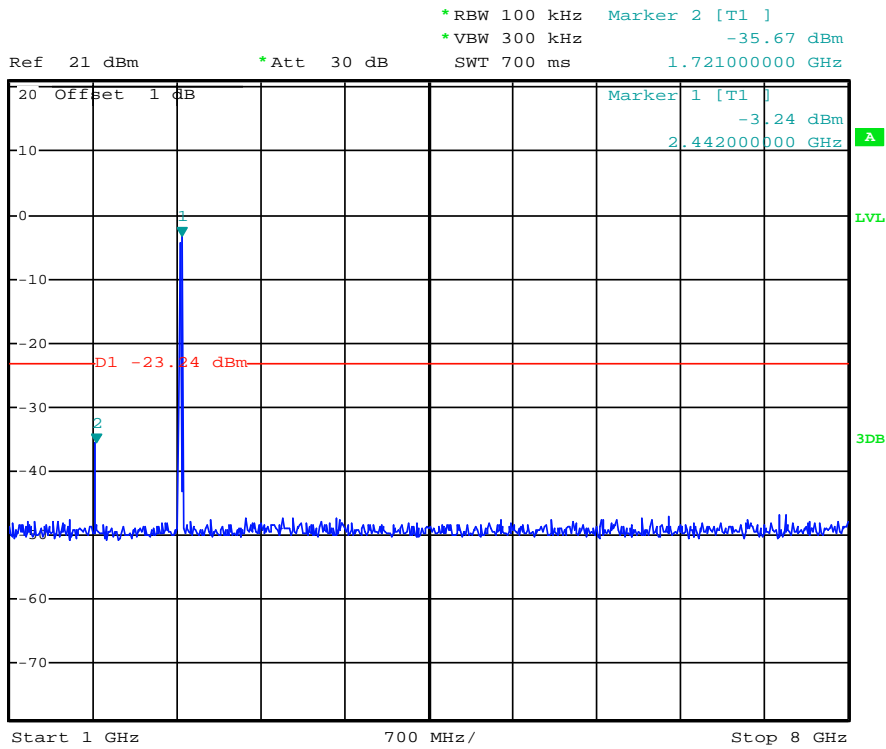

Date: 29.SEP.2013 17:38:59

(Plot 4.6.3 B2: Channel 6: 2437MHz @ 802.11n(20MHz))



*RBW 100 kHz Marker 1 [T1]
*VBW 300 kHz -44.27 dBm
SWT 800 ms 14.08800000 GHz

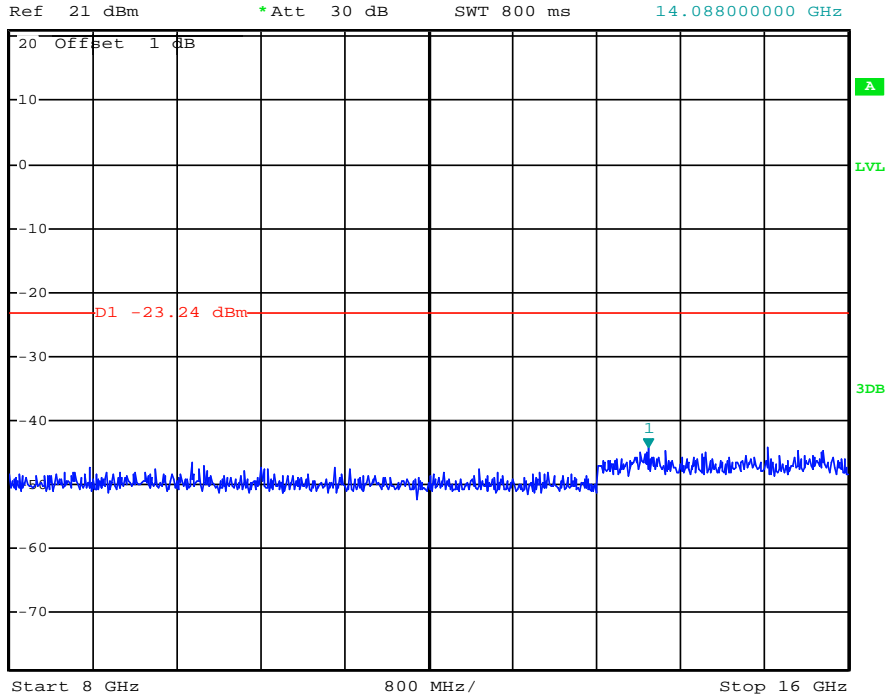

Date: 29.SEP.2013 17:39:29

(Plot 4.6.3 B3: Channel 6: 2437MHz @ 802.11n(20MHz))



*RBW 100 kHz Marker 1 [T1]
*VBW 300 kHz -43.40 dBm
SWT 900 ms 20.22100000 GHz

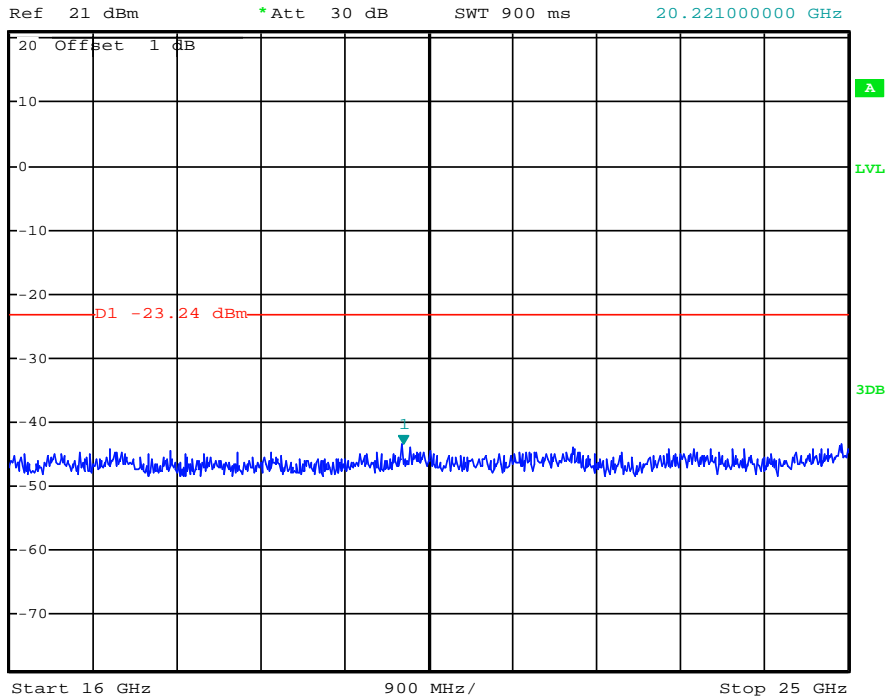

Date: 29.SEP.2013 17:39:41

(Plot 4.6.3 B4: Channel 6: 2437MHz @ 802.11n(20MHz))



*RBW 100 kHz Marker 1 [T1]
*VBW 300 kHz -47.48 dBm
SWT 100 ms 208.48000000 MHz

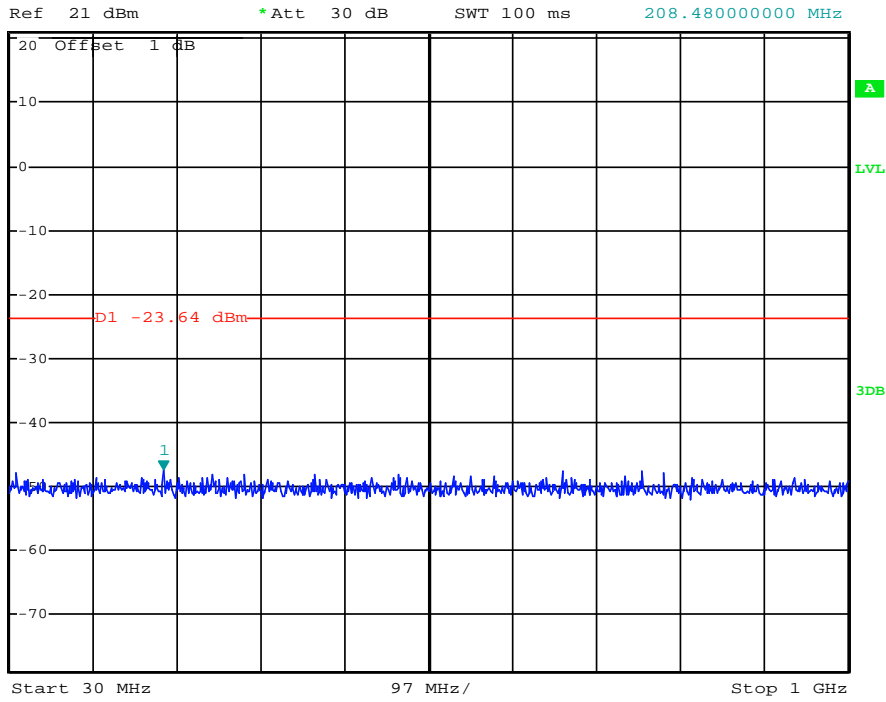

Date: 29.SEP.2013 17:40:41

(Plot 4.6.3 C1: Channel 11: 2462MHz @ 802.11n(20MHz))



*RBW 100 kHz Marker 1 [T1]
*VBW 300 kHz -3.64 dBm
SWT 700 ms 2.470000000 GHz

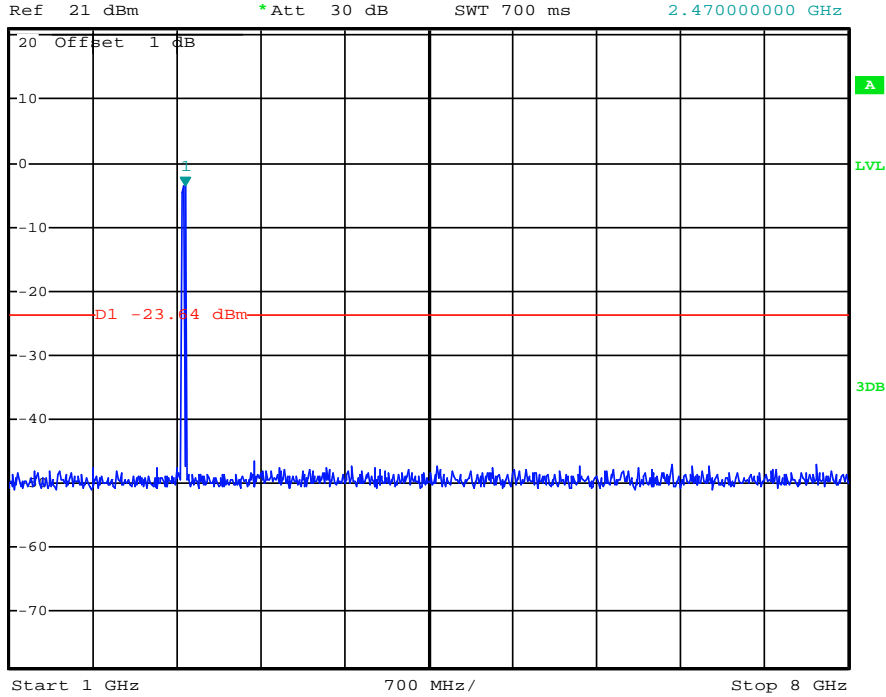

Date: 29.SEP.2013 17:40:14

(Plot 4.6.3 C2: Channel 11: 2462MHz @ 802.11n(20MHz))



*RBW 100 kHz Marker 1 [T1]
*VBW 300 kHz -44.77 dBm
SWT 800 ms 15.72000000 GHz

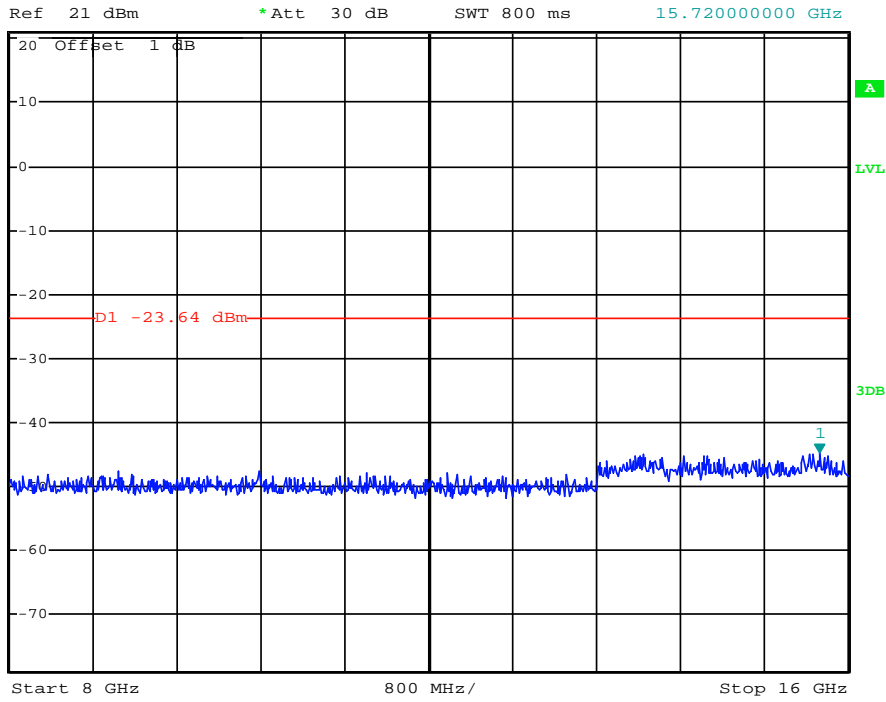

Date: 29.SEP.2013 17:40:57

(Plot 4.6.3 C3: Channel 11: 2462MHz @ 802.11n(20MHz))



*RBW 100 kHz Marker 1 [T1]
*VBW 300 kHz -43.40 dBm
SWT 900 ms 24.87400000 GHz

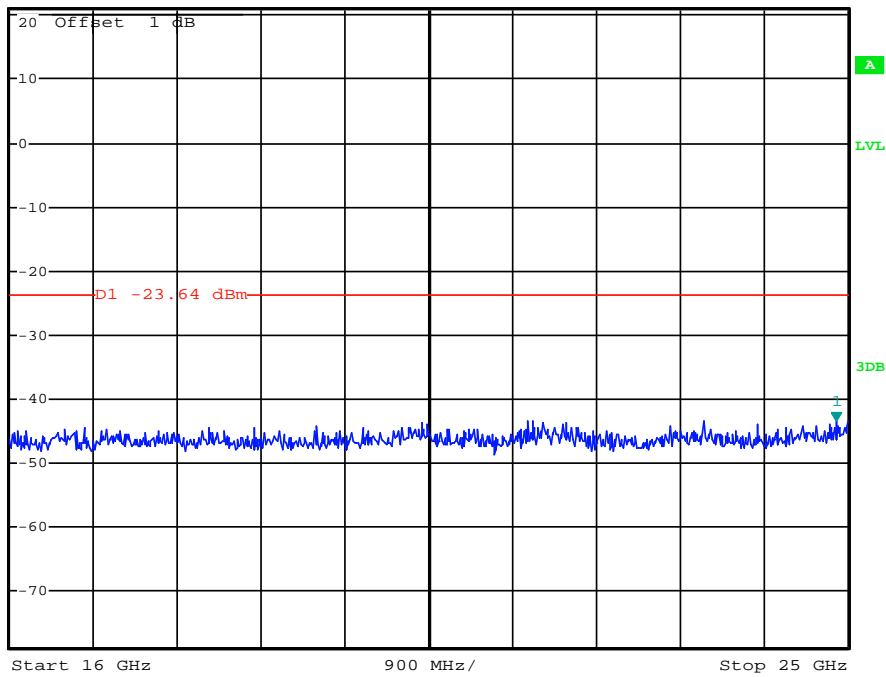

Date: 29.SEP.2013 17:41:10

(Plot 4.6.3 C4: Channel 11: 2462MHz @ 802.11n(20MHz))

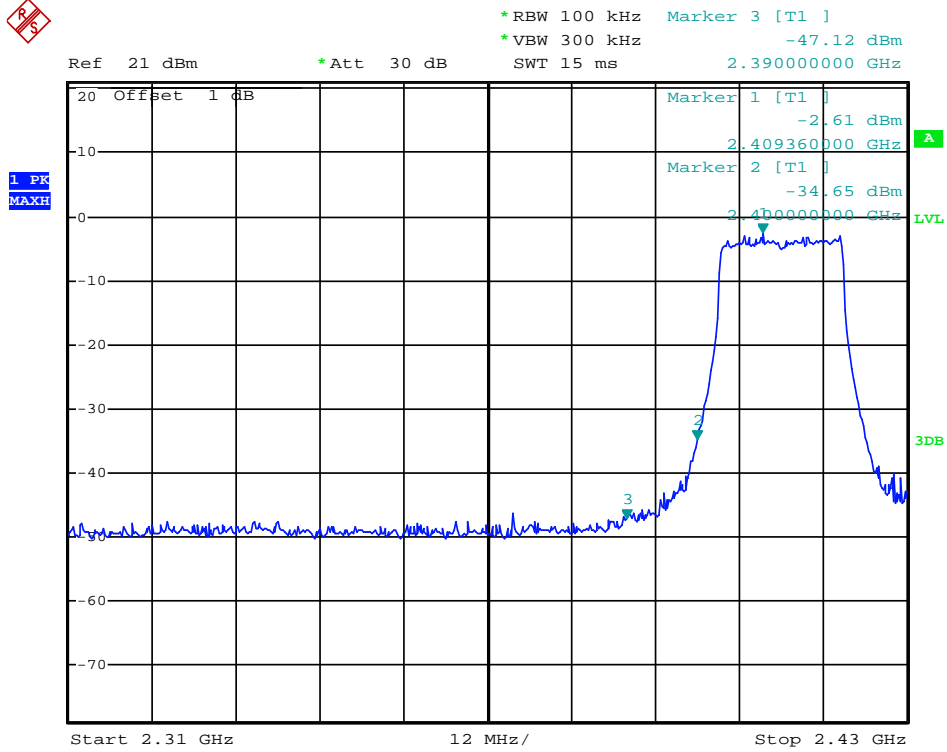

Date: 26.SEP.2013 15:58:07

(Plot 4.6.3 D: Channel 1: 2412MHz @ 802.11n(20MHz))

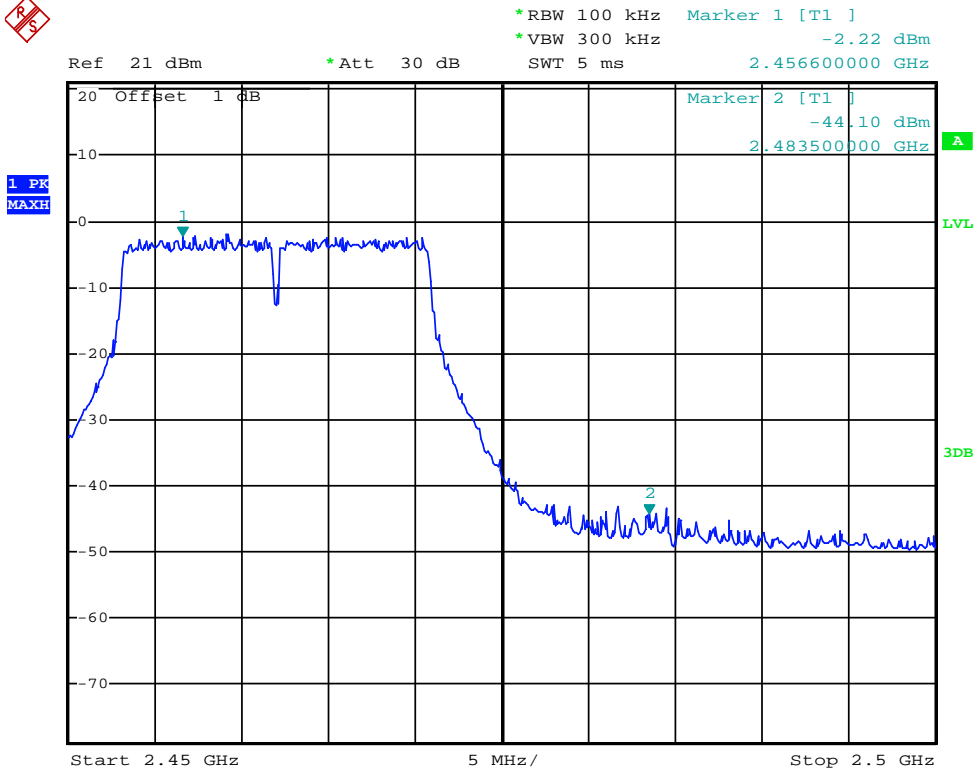

Date: 26.SEP.2013 16:05:04

(Plot 4.6.3 E: Channel 11: 2462MHz @ 802.11n(20MHz))

4.6.4 802.11n(40MHz) Test Mode

A. Test Verdict

Channel	Frequency (MHz)	Frequency Range	Refer to Plot	Limit (dBc)	Verdict
3	2422	30MHz-1GHz	Plot 4.6. A1	-20	PASS
		1GHz-8GHz	Plot 4.6.4 A2	-20	PASS
		8GHz-16GHz	Plot 4.6.4 A3	-20	PASS
		16GHz-25GHz	Plot 4.6.4 A4	-20	PASS
6	2437	30MHz-1GHz	Plot 4.6.4 B1	-20	PASS
		1GHz-8GHz	Plot 4.6.4 B2	-20	PASS
		8GHz-16GHz	Plot 4.6.4 B3	-20	PASS
		16GHz-25GHz	Plot 4.6.4 B4	-20	PASS
9	2452	30MHz-1GHz	Plot 4.6.4 C1	-20	PASS
		1GHz-8GHz	Plot 4.6.4 C2	-20	PASS
		8GHz-16GHz	Plot 4.6.4 C3	-20	PASS
		16GHz-25GHz	Plot 4.6.4 C4	-20	PASS

Frequency (MHz)	Delta Peak to Band emission (dBc)	Detector	Limit (dBc)	Refer to Plot	Verdict
2400.00	38.60	Peak	-20	Plot 4.6.3 D	PASS
2483.50	41.93	Peak	-20	Plot 4.6.3 E	PASS

Note: 1. For 802.11n(40MHz) mode at final test to get the worst-case emission at 13.5Mbps.
 2.The test results including the cable lose.

B. Test Plots

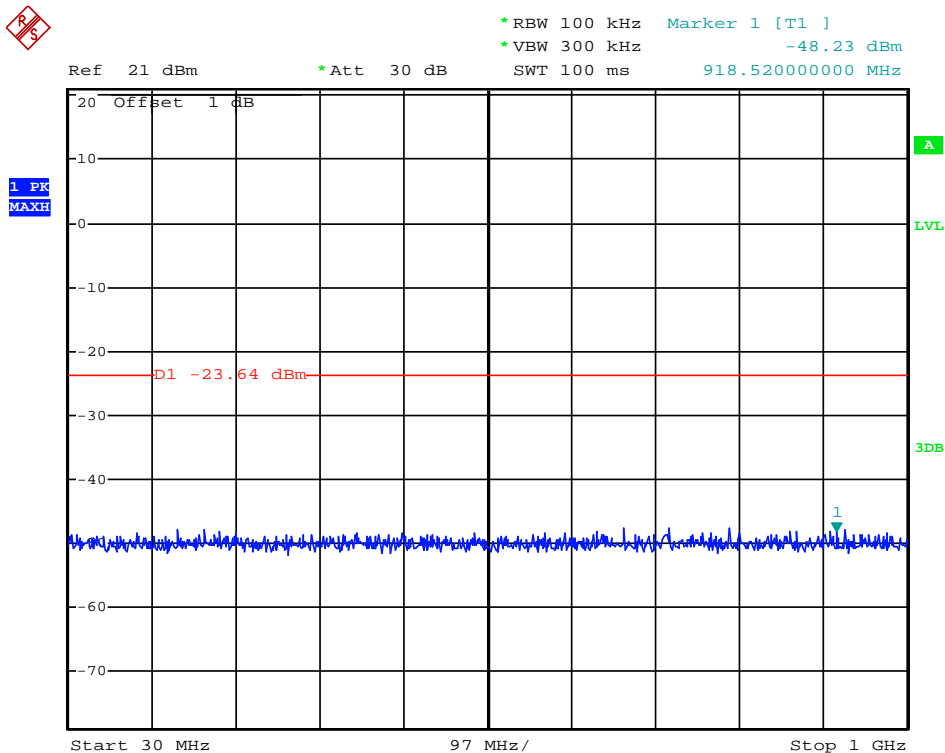

Date: 29.SEP.2013 17:44:30

(Plot 4.6.4 A1: Channel 3: 2422MHz @ 802.11n(40MHz))



*RBW 100 kHz Marker 1 [T1]
*VBW 300 kHz -7.91 dBm
SWT 700 ms 2.414000000 GHz

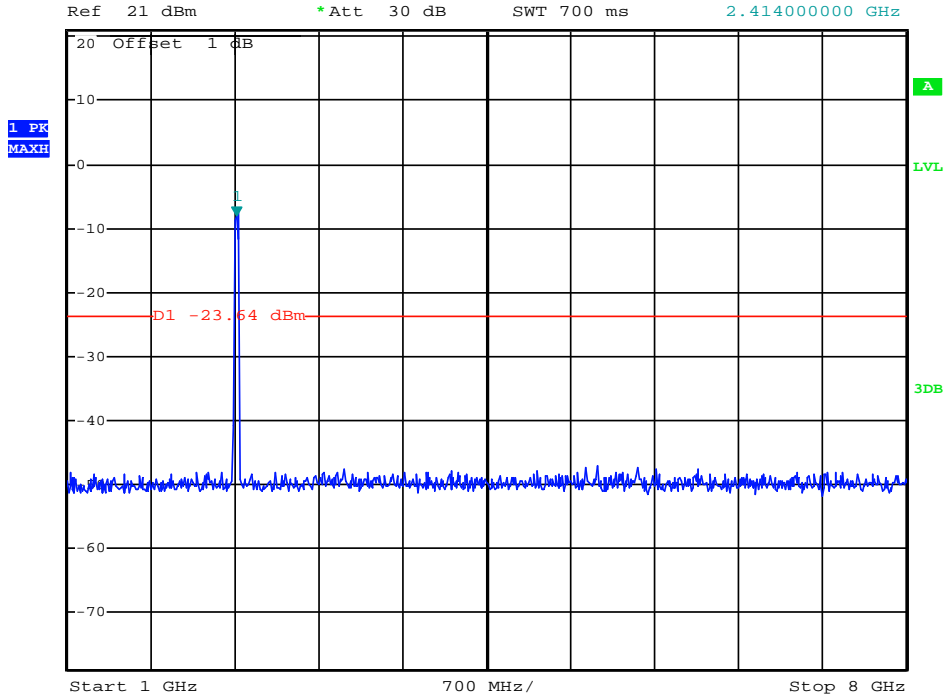

Date: 29.SEP.2013 17:42:30

(Plot 4.6.4 A2: Channel 3: 2422MHz @ 802.11n(40MHz))



*RBW 100 kHz Marker 1 [T1]
*VBW 300 kHz -44.88 dBm
SWT 800 ms 15.600000000 GHz

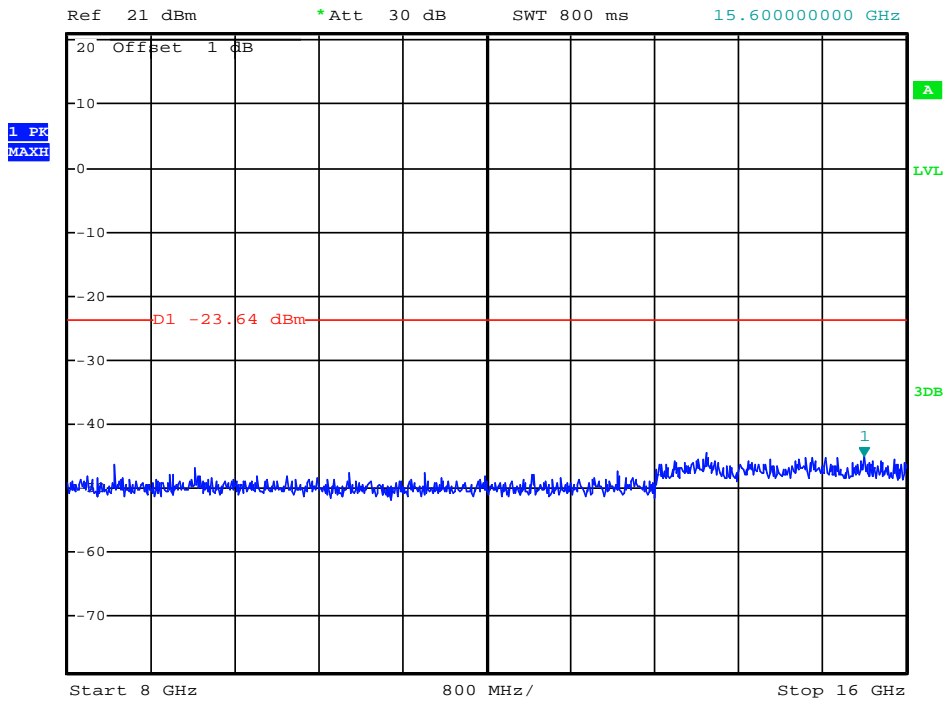

Date: 29.SEP.2013 17:43:03

(Plot 4.6.4 A3: Channel 3: 2422MHz @ 802.11n(40MHz))



*RBW 100 kHz Marker 1 [T1]
*VBW 300 kHz -43.08 dBm
SWT 900 ms 21.994000000 GHz

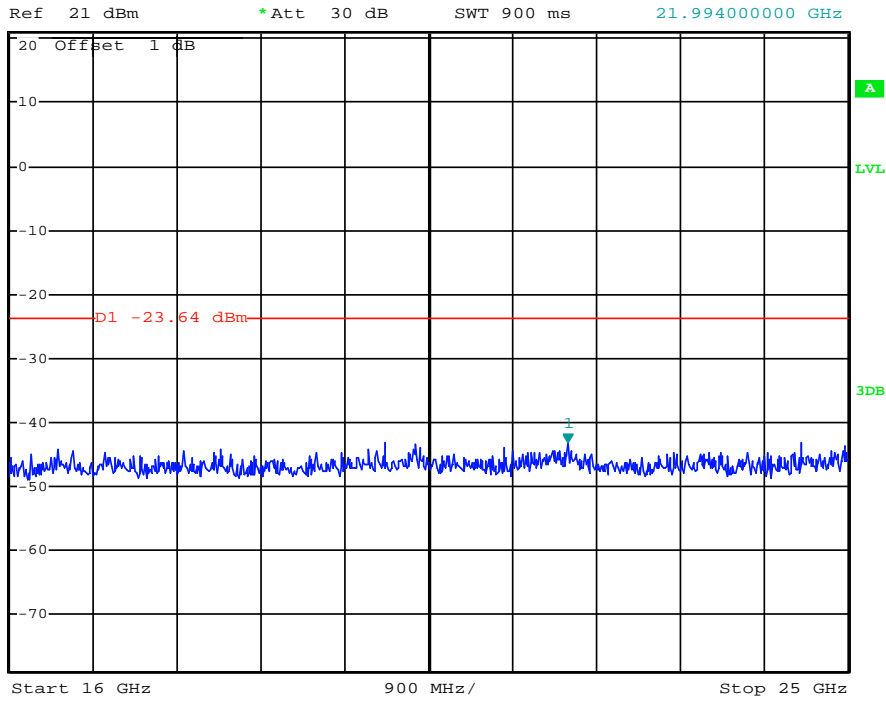

Date: 29.SEP.2013 17:43:15

(Plot 4.6.4 A4: Channel 3: 2422MHz @ 802.11n(40MHz))



*RBW 100 kHz Marker 1 [T1]
*VBW 300 kHz -48.00 dBm
SWT 100 ms 179.380000000 MHz

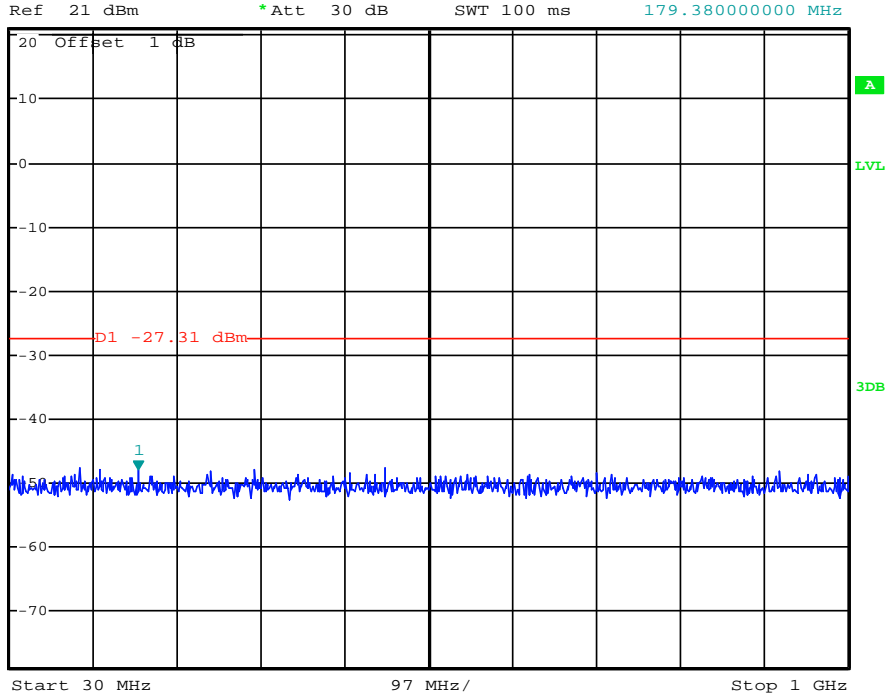

Date: 29.SEP.2013 17:46:31

(Plot 4.6.4 B1: Channel 6: 2437MHz @ 802.11n(40MHz))

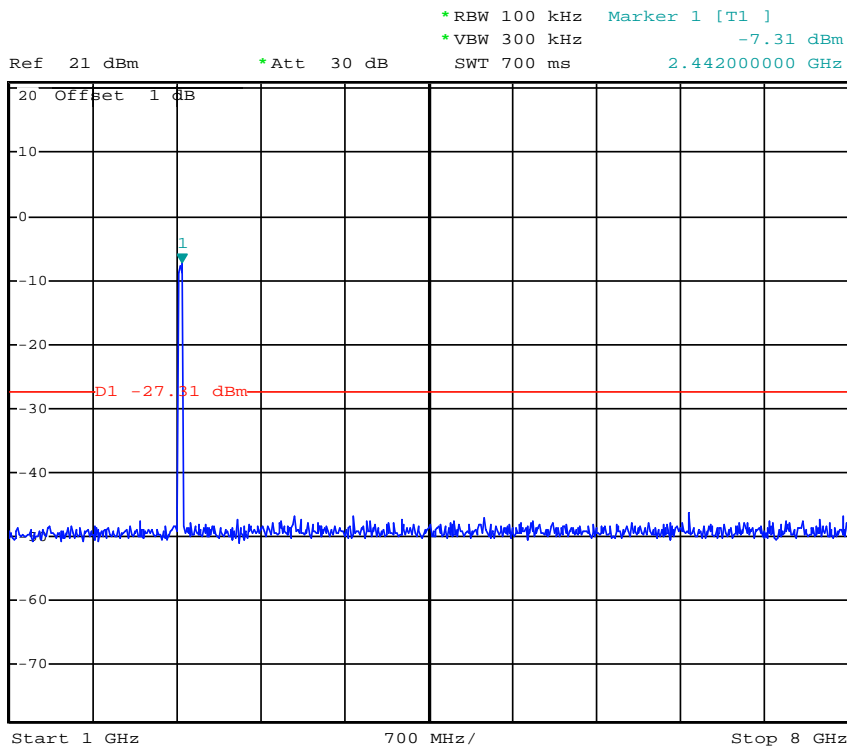

Date: 29.SEP.2013 17:45:47

(Plot 4.6.4 B2: Channel 6: 2437MHz @ 802.11n(40MHz))

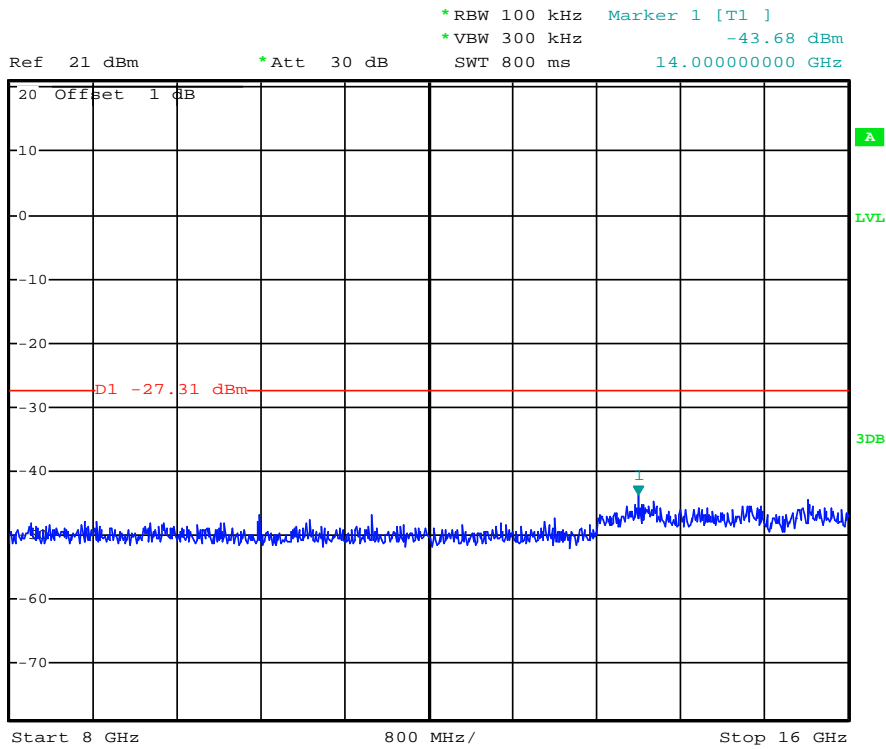

Date: 29.SEP.2013 17:46:45

(Plot 4.6.4 B3: Channel 6: 2437MHz @ 802.11n(40MHz))



*RBW 100 kHz Marker 1 [T1]
*VBW 300 kHz -43.02 dBm
SWT 900 ms 24.874000000 GHz

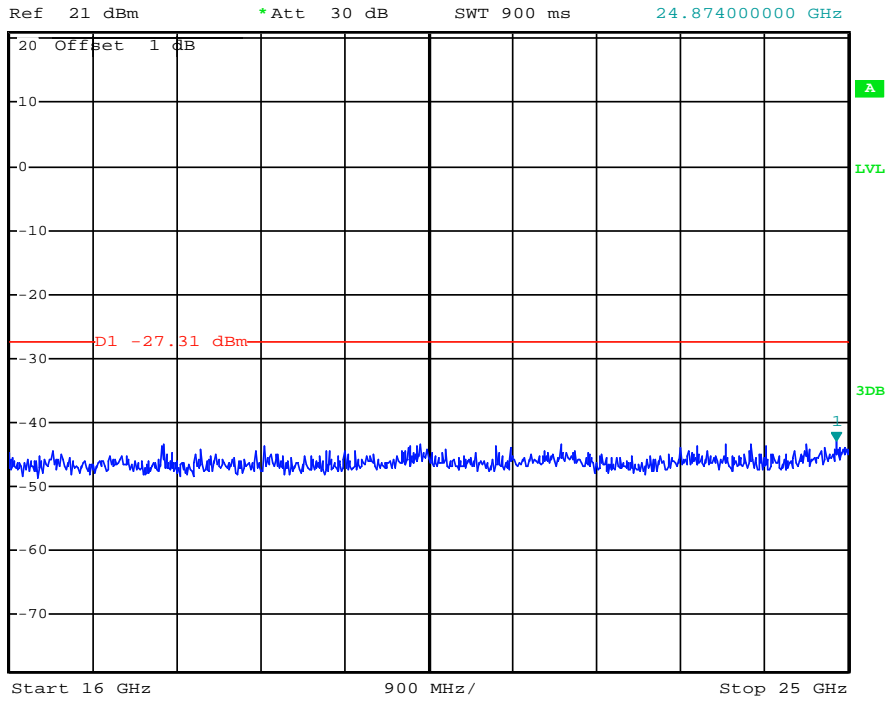

Date: 29.SEP.2013 17:46:59

(Plot 4.6.4 B4: Channel 6: 2437MHz @ 802.11n(40MHz))



*RBW 100 kHz Marker 1 [T1]
*VBW 300 kHz -48.16 dBm
SWT 100 ms 87.230000000 MHz

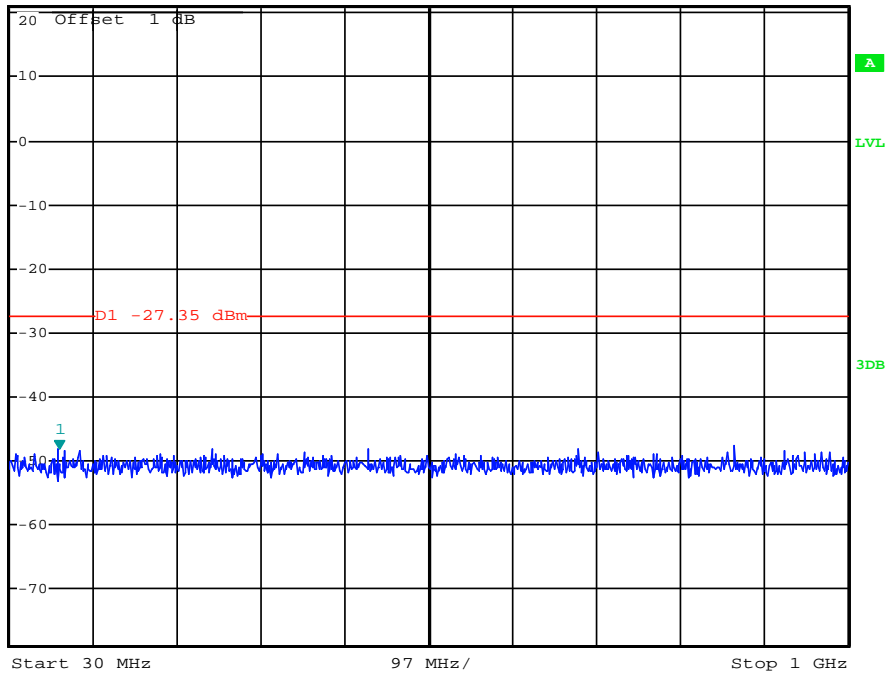

Date: 29.SEP.2013 17:47:43

(Plot 4.6.4 C1: Channel 9: 2452MHz @ 802.11n(40MHz))



*RBW 100 kHz Marker 1 [T1]
*VBW 300 kHz -44.30 dBm
SWT 800 ms 15.64000000 GHz

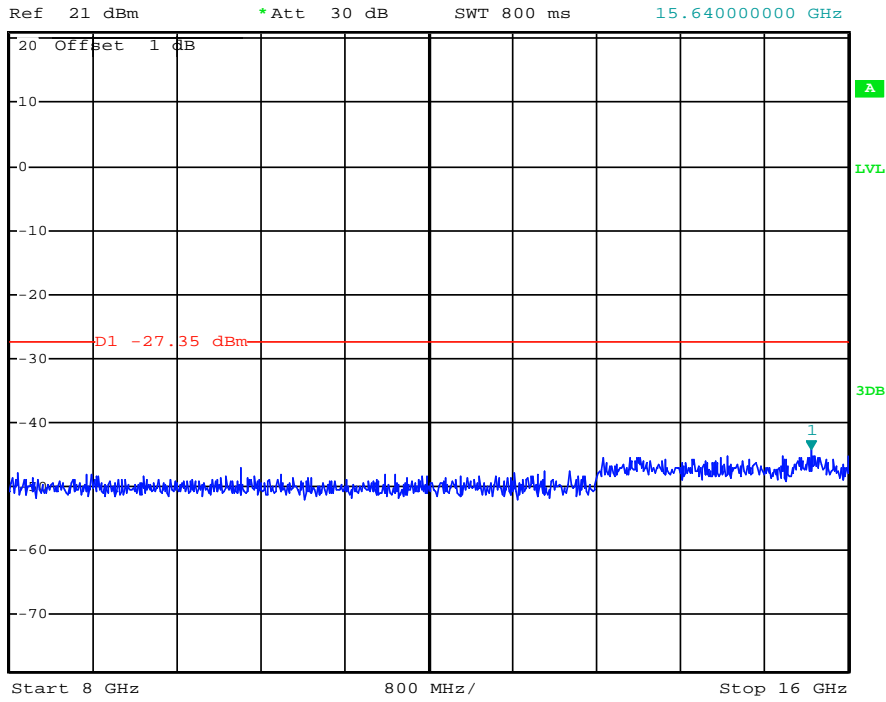

Date: 29.SEP.2013 17:47:55

(Plot 4.6.4 C2: Channel 9: 2452MHz @ 802.11n(40MHz))



*RBW 100 kHz Marker 1 [T1]
*VBW 300 kHz -43.27 dBm
SWT 900 ms 23.47900000 GHz

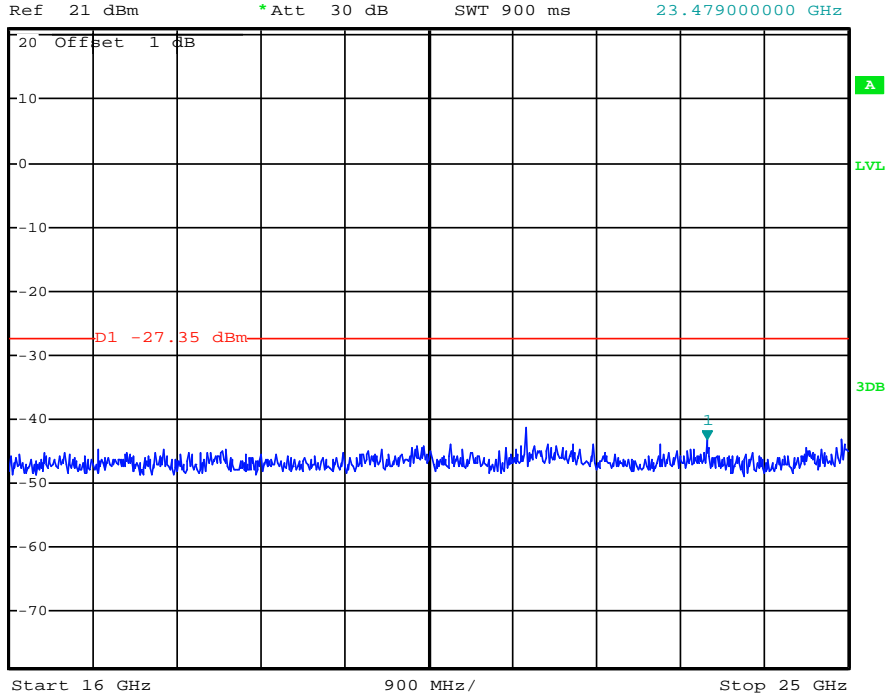

Date: 29.SEP.2013 17:48:07

(Plot 4.6.4 C3: Channel 9: 2452MHz @ 802.11n(40MHz))

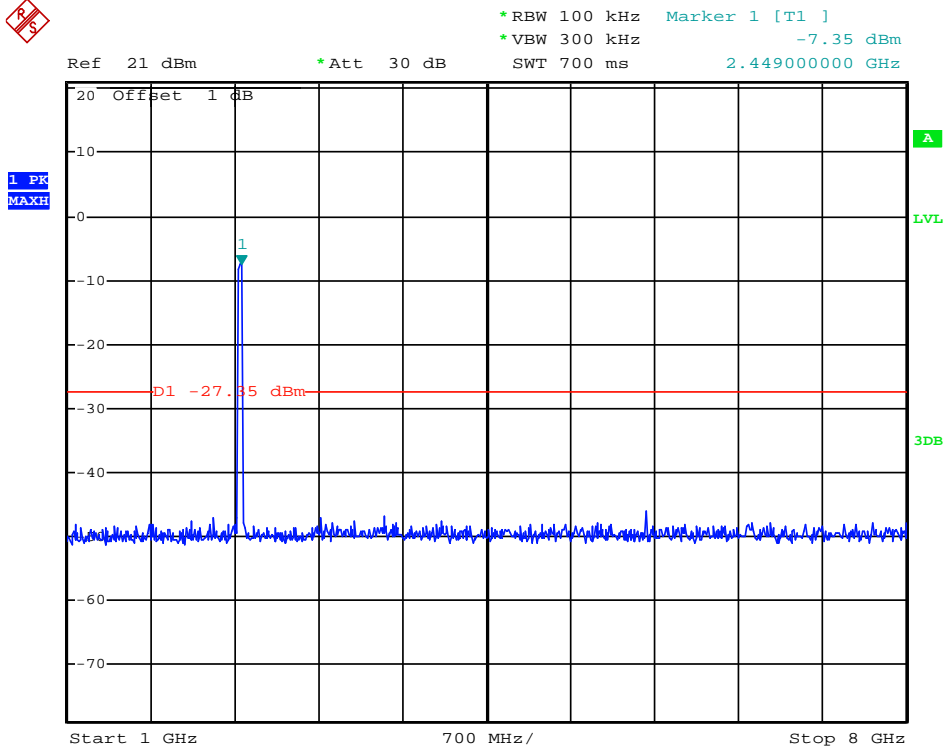

Date: 29.SEP.2013 17:47:33

(Plot 4.6.4 C4: Channel 9: 2452MHz @ 802.11n(40MHz))

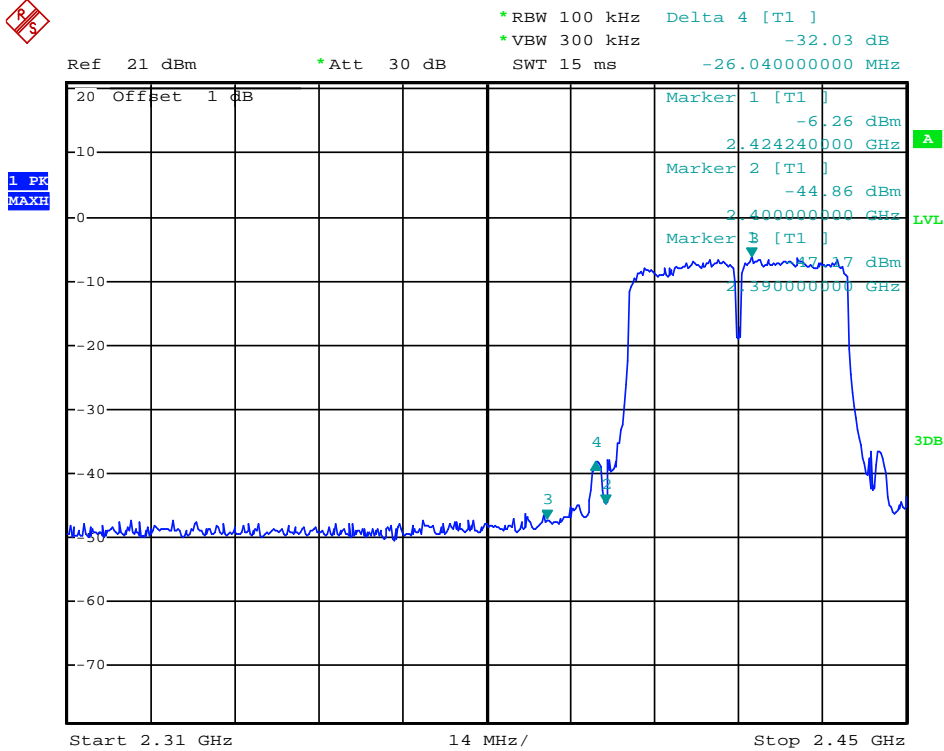

Date: 26.SEP.2013 16:00:52

(Plot 4.6.4 D: Channel 3: 2422MHz @ 802.11n(40MHz))

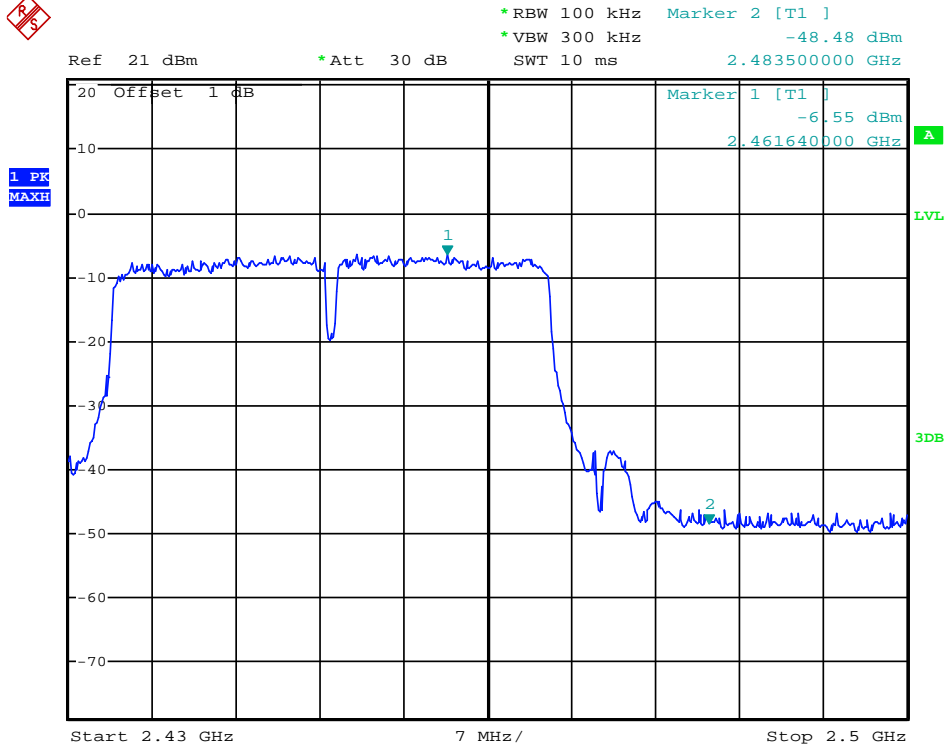

Date: 26.SEP.2013 16:06:27

(Plot 4.6.4 E: Channel 9: 2452MHz @ 802.11n(40MHz))

4.7. 6dB Bandwidth

TEST CONFIGURATION

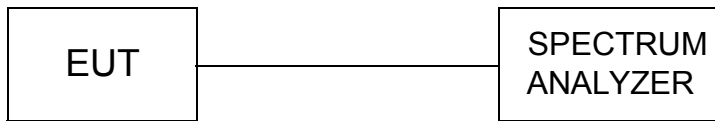

TEST PROCEDURE

The transmitter output was connected to the spectrum analyzer through an attenuator. The bandwidth of the fundamental frequency was measured by spectrum analyzer with 100 KHz RBW and 300KHz VBW. The 6dB bandwidth is defined as the total spectrum the power of which is higher than peak power minus 6dB. According to KDB558074 D01 V03 for one of the following procedures may be used to determine the modulated DTS device signal bandwidth.

1. Set RBW = 100 kHz.
2. Set the video bandwidth (VBW) ≥ 3 RBW.
3. Detector = Peak.
4. Trace mode = max hold.
5. Sweep = auto couple.
6. Allow the trace to stabilize.
7. Measure the maximum width of the emission that is constrained by the frequencies associated with the two outermost amplitude points (upper and lower frequencies) that are attenuated by 6 dB relative to the maximum level measured in the fundamental emission.

LIMIT

For digital modulation systems, the minimum 6 dB bandwidth shall be at least 500 kHz.

TEST RESULTS

4.7.1 801.11b Test Mode

A. Test Verdict

Channel	Frequency (MHz)	6 dB Bandwidth (MHz)	Refer to Plot	Limits (kHz)	Verdict
1	2412	10.02	Plot 4.7.1 A	≥ 500	PASS
6	2437	10.14	Plot 4.7.1 B	≥ 500	PASS
11	2462	10.08	Plot 4.7.1 C	≥ 500	PASS

Note: 1. For 802.11b mode at final test to get the worst-case emission at 1Mbps.
2. The test results including the cable loss.

B. Test Plots

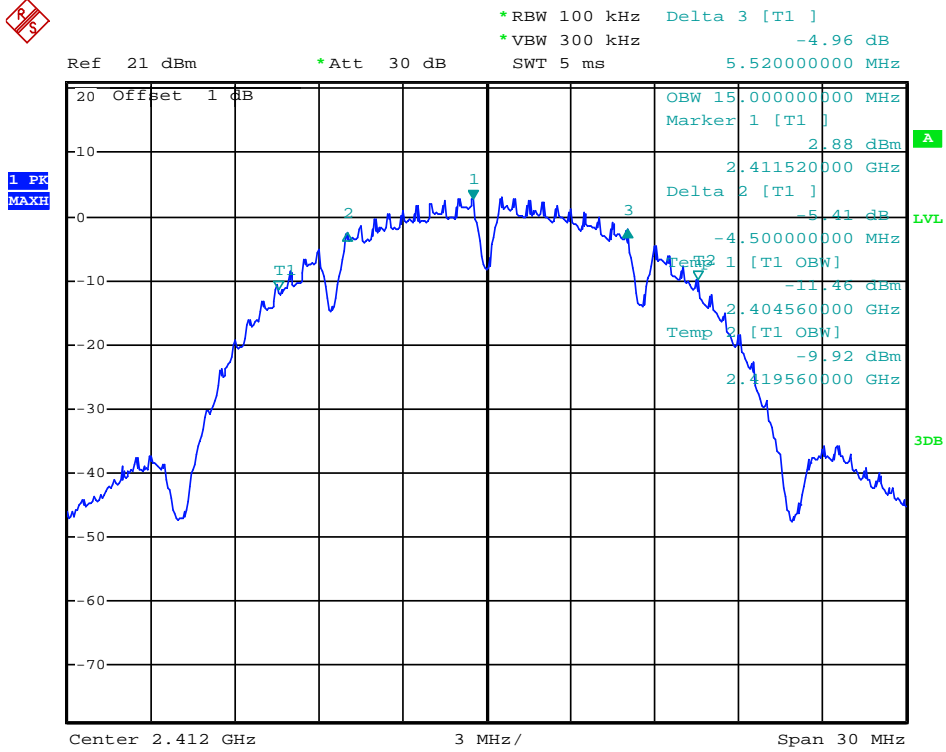

Date: 26.SEP.2013 14:59:40

(Plot 4.7.1 A: Channel 1: 2412MHz @ 802.11b)

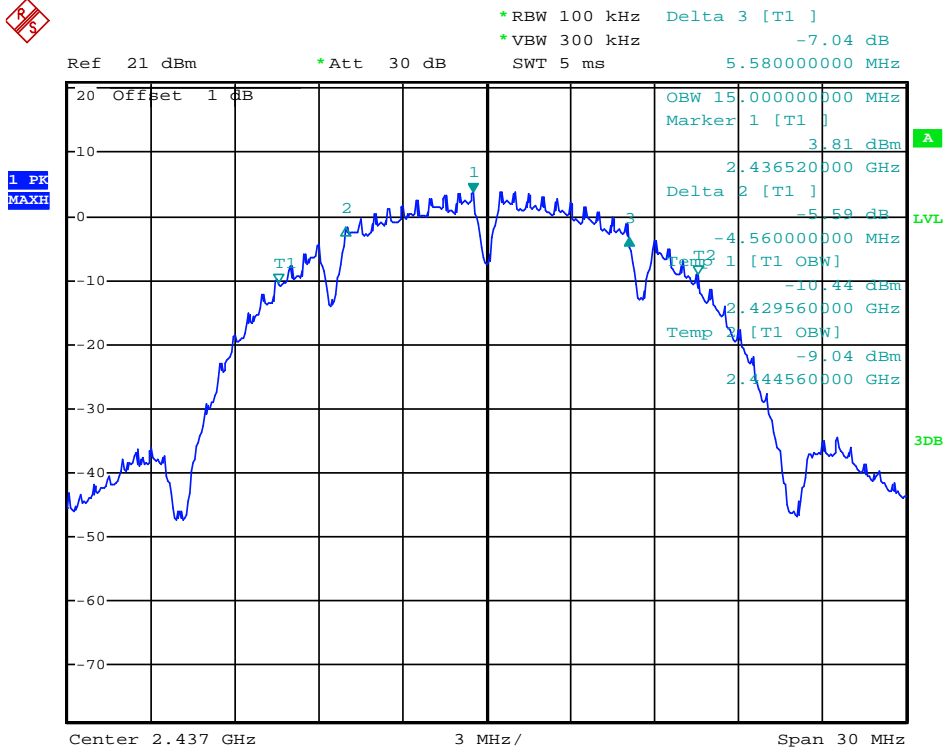

Date: 26.SEP.2013 15:01:39

(Plot 4.7.1 B: Channel 6: 2437MHz @ 802.11b)

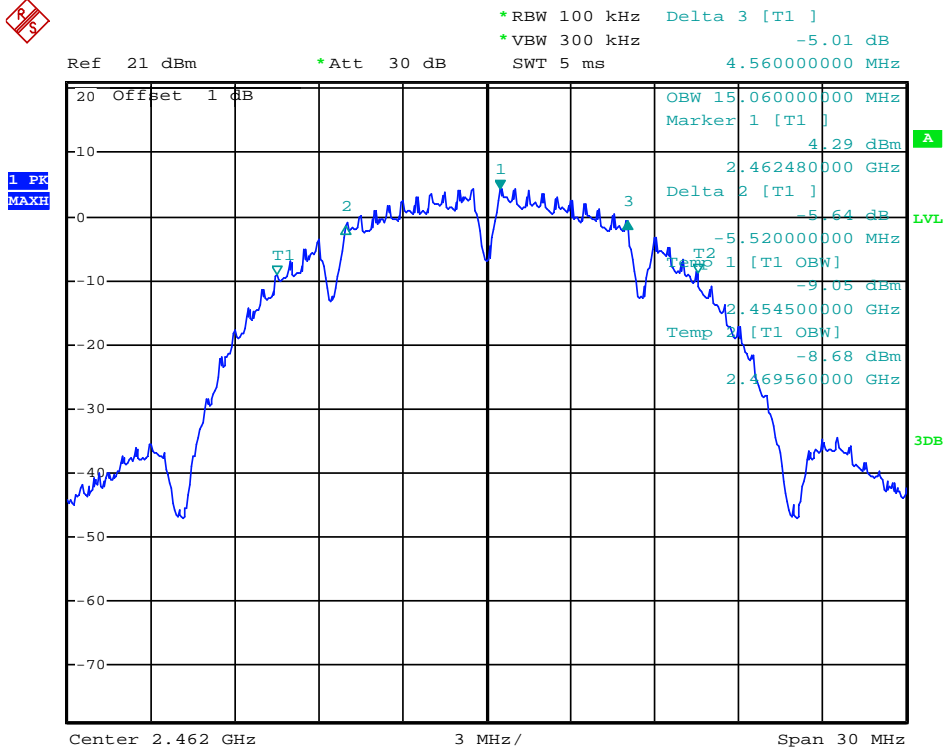

Date: 26.SEP.2013 15:03:02

(Plot 4.7.1 C: Channel 11: 2462MHz @ 802.11b)

4.7.2 801.11g Test Mode

A. Test Verdict

Channel	Frequency (MHz)	6 dB Bandwidth (MHz)	Refer to Plot	Limits (kHz)	Verdict
1	2412	16.68	Plot 4.7.2 A	≥500	PASS
6	2437	16.68	Plot 4.7.2 B	≥500	PASS
11	2462	16.68	Plot 4.7.2 C	≥500	PASS

Note: 1. For 802.11g mode at final test to get the worst-case emission at 6Mbps.
 2. The test results including the cable lose.

B. Test Plots



*RBW 100 kHz Delta 3 [T1]
*VBW 300 kHz -6.58 dB
SWT 5 ms 4.200000000 MHz

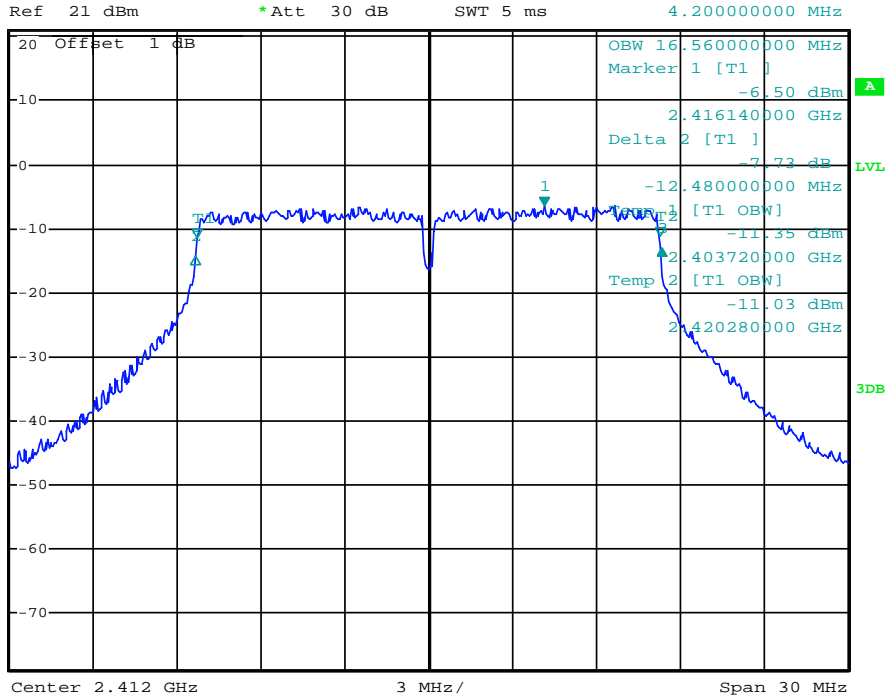

Date: 26.SEP.2013 15:05:04

(Plot 4.7.2 A: Channel 1: 2412MHz @ 802.11g)



*RBW 100 kHz Delta 3 [T1]
*VBW 300 kHz -5.67 dB
SWT 5 ms 4.200000000 MHz

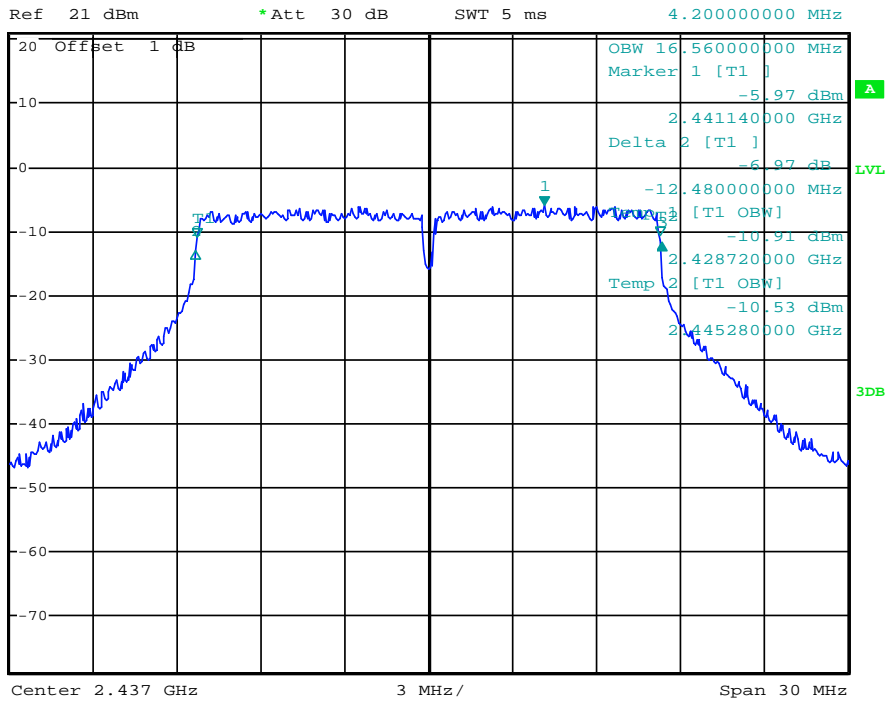

Date: 26.SEP.2013 15:06:24

(Plot 4.7.2 B: Channel 6: 2437MHz @ 802.11g)

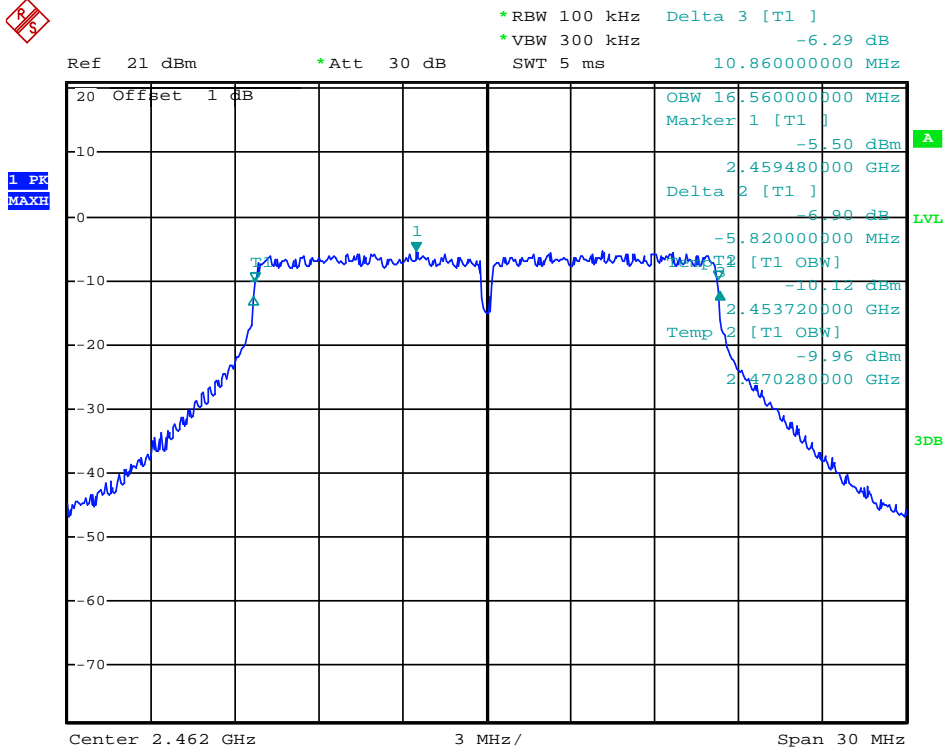

Date: 26.SEP.2013 15:07:30

(Plot 4.7.2 C: Channel 11: 2462MHz @ 802.11g)

4.7.3 801.11n(20MHz) Test Mode

A. Test Verdict

Channel	Frequency (MHz)	6 dB Bandwidth (MHz)	Refer to Plot	Limits (kHz)	Verdict
1	2412	17.88	Plot 4.7.3 A	≥500	PASS
6	2437	17.88	Plot 4.7.3 B	≥500	PASS
11	2462	17.88	Plot 4.7.3 C	≥500	PASS

Note: 1. For 802.11n(20MHz) mode at final test to get the worst-case emission at 6.5Mbps.
 2. The test results including the cable lose.

B. Test Plots



*RBW 100 kHz Delta 3 [T1]
*VBW 300 kHz -7.97 dB
SWT 5 ms 11.880000000 MHz

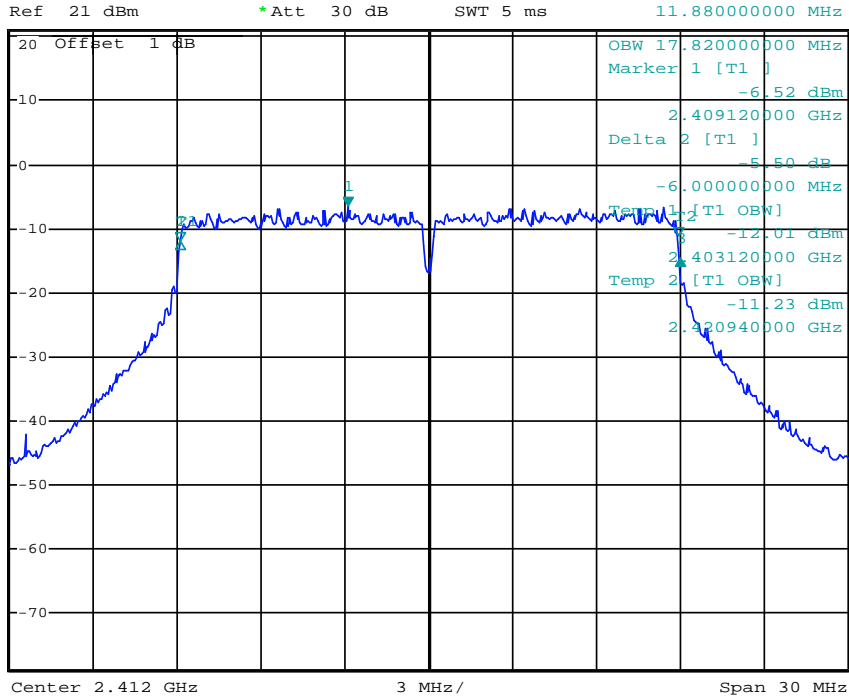

Date: 26.SEP.2013 15:09:31

(Plot 4.7.3 A: Channel 1: 2412MHz @ 802.11n(20MHz))



*RBW 100 kHz Delta 3 [T1]
*VBW 300 kHz -8.76 dB
SWT 5 ms 11.880000000 MHz

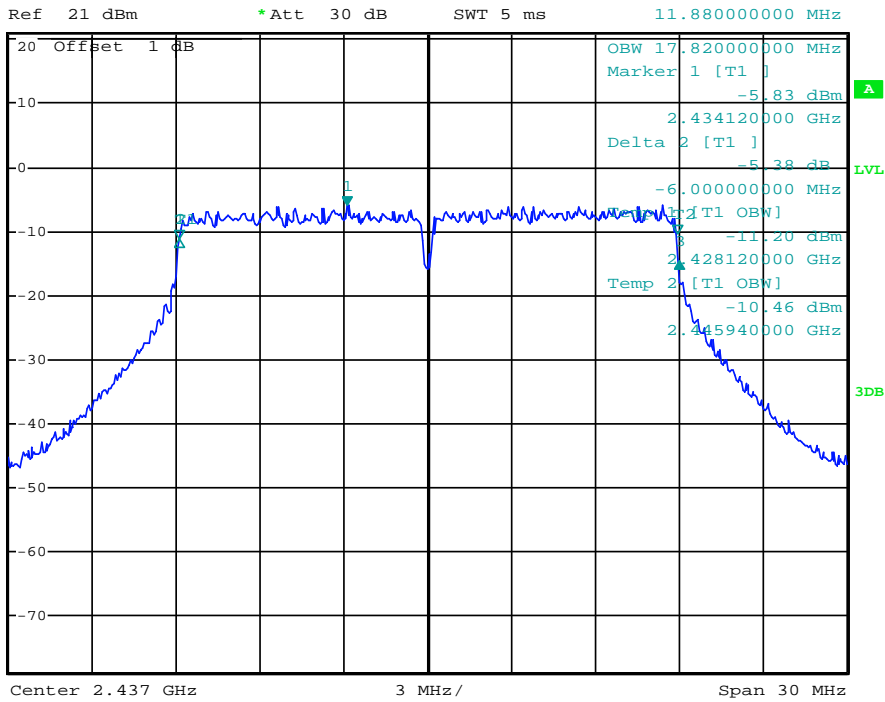

Date: 26.SEP.2013 15:10:44

(Plot 4.7.3 B: Channel 6: 2437MHz @ 802.11n(20MHz))

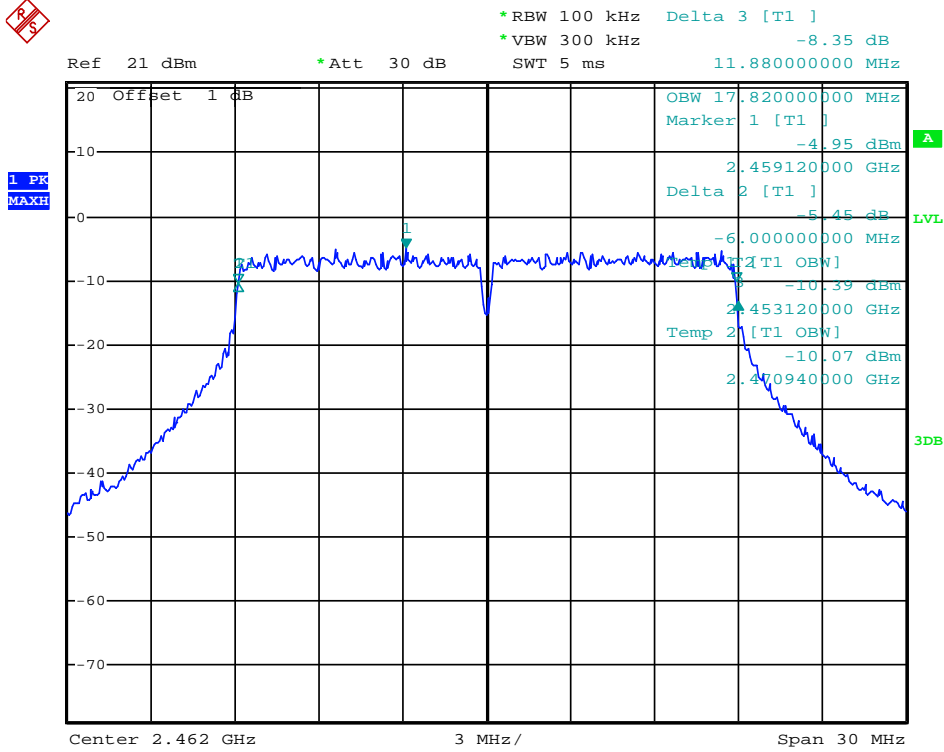

Date: 26.SEP.2013 15:11:49

(Plot 4.7.3 C: Channel 11: 2462MHz @ 802.11n(20MHz))

4.7.4 801.11n(40MHz) Test Mode

A. Test Verdict

Channel	Frequency (MHz)	6 dB Bandwidth (MHz)	Refer to Plot	Limits (kHz)	Verdict
3	2422	36.60	Plot 4.7.4 A	≥500	PASS
6	2437	36.60	Plot 4.7.4 B	≥500	PASS
9	2452	36.70	Plot 4.7.4 C	≥500	PASS

Note: 1. For 802.11n(40MHz) mode at final test to get the worst-case emission at 13.5Mbps.
 2. The test results including the cable lose.

B. Test Plots

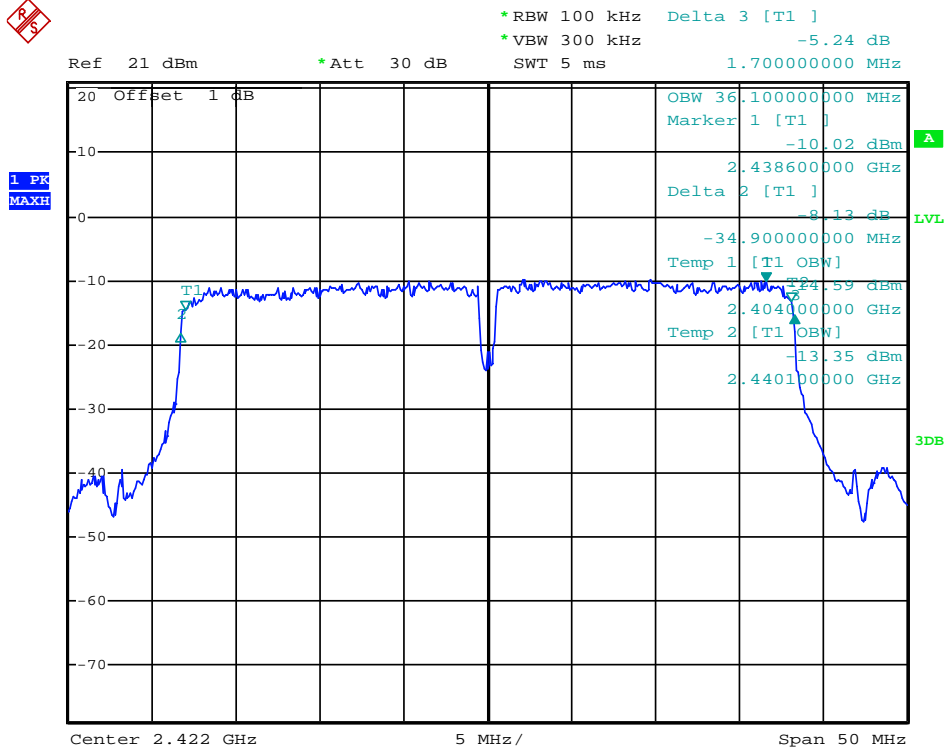

Date: 26.SEP.2013 15:13:17

(Plot 4.7.4 A: Channel 3: 2422MHz @ 802.11n(40MHz))

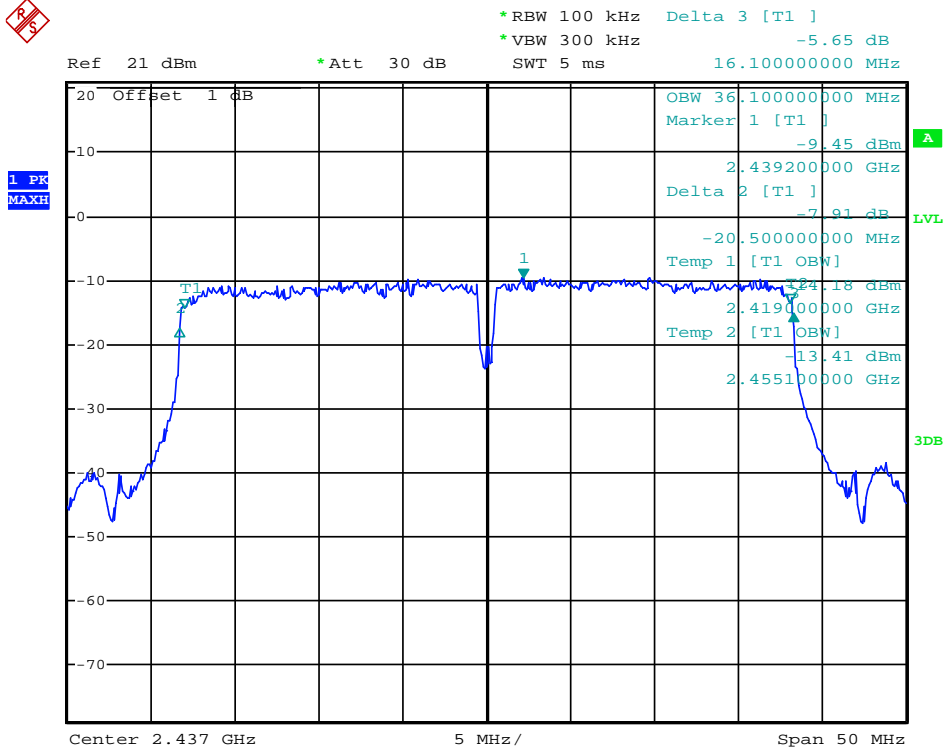

Date: 26.SEP.2013 15:15:12

(Plot 4.7.3 B: Channel 6: 2437MHz @ 802.11n(40MHz))



*RBW 100 kHz Delta 3 [T1]
*VBW 300 kHz -7.65 dB
SWT 5 ms 14.600000000 MHz

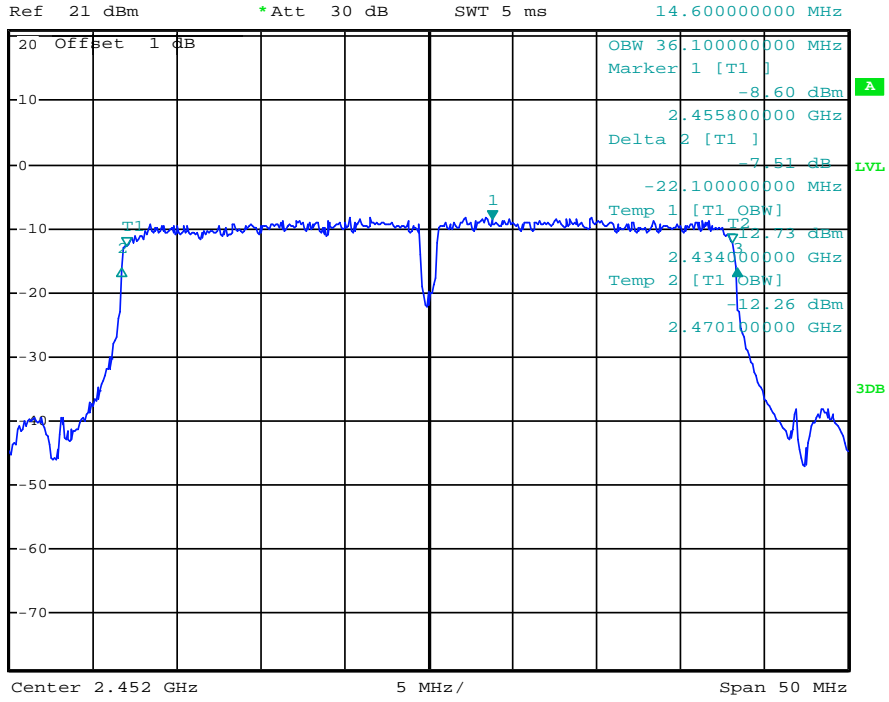

Date: 26.SEP.2013 15:17:51

(Plot 4.7.4 C: Channel 9: 2452MHz @ 802.11n(40MHz))

4.8. Antenna Requirement

Standard Applicable

For intentional device, according to FCC 47 CFR Section 15.203, an intentional radiator shall be designed to ensure that no antenna other than that furnished by the responsible party shall be used with the device.

And according to FCC 47 CFR Section 15.247 (c), if transmitting antennas of directional gain greater than 6dBi are used, the power shall be reduced by the amount in dB that the directional gain of the antenna exceeds 6dBi.

Refer to statement below for compliance

The manufacturer may design the unit so that the user can replace a broken antenna, but the use of a standard antenna jack or electrical connector is prohibited. Further, this requirement does not apply to intentional radiators that must be professionally installed.

Antenna Connected Construction

The maximum antenna gain of WLAN used was -1.20 dBi.

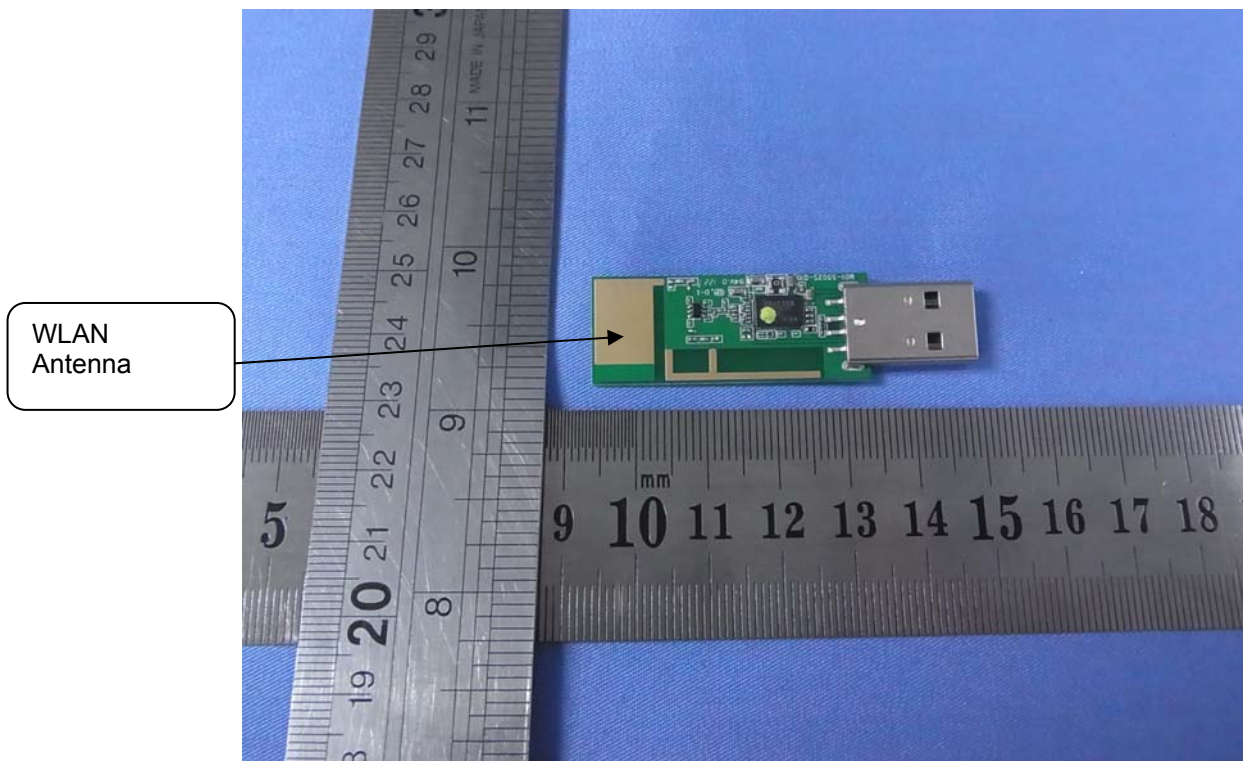

5. Test Setup Photos of the EUT

Radiated Emission (30MHz-1GHz)



Radiated Emission (30MHz-1GHz)

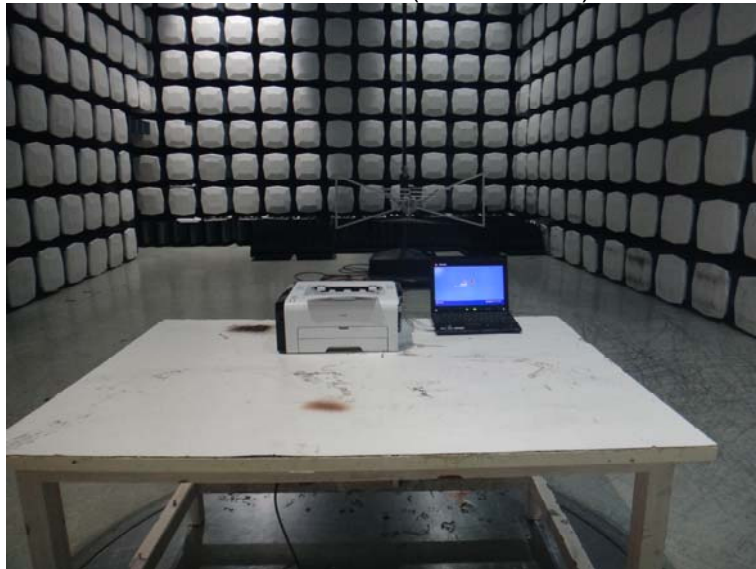

Radiated Emission (above 1GHz)



Radiated Emission (Below 30MHz)



Conducted Emission (AC Mains)



.....End of Report.....