	Test Report Serial No.:	093005BBO-T670-S95U	Report Issue Date:	Oct. 17, 2005
	Date(s) of Evaluation:	October 06-07, 2005	Report Rev. No.:	Revision 0
	Description of Tests:	RF Exposure SAR	FCC §2.1093	IC RSS-102

RF EXPOSURE EVALUATION

SPECIFIC ABSORPTION RATE

SAR TEST REPORT

FOR THE

COBRA ELECTRONICS CORPORATION

PORTABLE FM UHF FRS/GMRS PTT RADIO TRANSCEIVER

MODEL(S): PR255, PR256, PR650, PR656

FCC ID: BBOPR255

IC: 906B-PR255

Test Report Serial Number

**093005BBO-T670-S95U
Revision 0**

Test Report Issue Date

October 17, 2005

Test Lab

**Celltech Compliance Testing & Engineering Lab
(Celltech Labs Inc.)
1955 Moss Court
Kelowna, BC
Canada
V1Y 9L3**

<p>Test Report Prepared By: <i>Cheri Frangiadakis</i> _____ Cheri Frangiadakis Test Report Writer Celltech Labs Inc.</p>	<p>Test Report Approved By:  _____ Jonathan Hughes General Manager Celltech Labs Inc.</p>
--	---

Applicant: Cobra Electronics Corporation	FCC ID: BBOPR255	IC ID: 906B-PR255	
Models: PR255, PR256, PR650, PR656	Portable FRS/GMRS PTT Radio Transceiver	462.5500 - 467.7125 MHz	
2005 Celltech Labs Inc.	This document is not to be reproduced in whole or in part without the prior written permission of Celltech Labs Inc.		Page 1 of 44

	Test Report Serial No.:	093005BBO-T670-S95U	Report Issue Date:	Oct. 17, 2005
	Date(s) of Evaluation:	October 06-07, 2005	Report Rev. No.:	Revision 0
	Description of Tests:	RF Exposure SAR	FCC §2.1093	IC RSS-102



DECLARATION OF COMPLIANCE SAR RF EXPOSURE EVALUATION

<u>Test Lab</u> CELLTECH LABS INC. Testing and Engineering Services 1955 Moss Court Kelowna, B.C. Canada V1Y 9L3 Phone: 250-448-7047 Fax: 250-448-7046 e-mail: info@celltechlabs.com web site: www.celltechlabs.com	<u>Applicant Information</u> COBRA ELECTRONICS CORPORATION 6500 West Cortland Street Chicago, IL 60707 United States
FCC IDENTIFIER: IC IDENTIFIER: Model(s):	BBOPR255 906B-PR255 PR255, PR256, PR650, PR656
Rule Part(s): Test Procedure(s): Device Description: Modulation Type:	FCC 47 CFR §2.1093; IC RSS-102 Issue 1 (Provisional) FCC OET Bulletin 65, Supplement C (Edition 01-01) Portable UHF FRS/GMRS PTT Radio Transceiver FM (UHF)
Tx Frequency Range(s): Max. RF Output Power Tested: Antenna Type(s) Tested: Battery Type(s) Tested:	462.5500 - 462.7250 MHz (GMRS Channels 15-22) 462.5625 - 462.7125 MHz (FRS/GMRS Channels 1-7) 467.5625 - 467.7125 MHz (FRS Channels 8-14) 1.27 Watts (31.04 dBm) ERP (462.7125 MHz) - GMRS Channel 7 Fixed Stubby NiMH AAA x4 (1.2 V, 750 mAh) NiCd AAA x4 (1.2 V, 300 mAh) Alkaline Duracell Procell AAA x4 (1.5 V, 1150 mAh)
Body-Worn Accessories Tested: Audio Accessories Tested:	Plastic Belt-Clip (6 mm thickness) Earbud with Lapel-Microphone (P/N: GA-EBM2)
Max. SAR Level(s) Evaluated:	0.612 W/kg (1g) - Face-held (50% duty cycle) 1.32 W/kg (1g) - Body-worn (50% duty cycle)

Celltech Labs Inc. declares under its sole responsibility that this wireless portable device has demonstrated compliance with the Specific Absorption Rate (SAR) RF exposure requirements specified in FCC 47 CFR §2.1093 and Health Canada's Safety Code 6. The device was tested in accordance with the measurement standards and procedures specified in FCC OET Bulletin 65, Supplement C (Edition 01-01) and Industry Canada RSS-102 Issue 1 (Provisional) for the General Population / Uncontrolled Exposure environment. All measurements were performed in accordance with the SAR system manufacturer recommendations.

I attest to the accuracy of data. All measurements were performed by me or were made under my supervision and are correct to the best of my knowledge and belief. I assume full responsibility for the completeness of these measurements and vouch for the qualifications of all persons taking them.

This test report shall not be reproduced partially, or in full, without the prior written approval of Celltech Labs Inc. The results and statements contained in this report pertain only to the device(s) evaluated.

Tested By:  <hr/> Sean Johnston Compliance Technologist Celltech Labs Inc.	Reviewed By:  <hr/> Spencer Watson Senior Compliance Technologist Celltech Labs Inc.
---	---





Applicant:	Cobra Electronics Corporation	FCC ID:	BBOPR255	IC ID:	906B-PR255	
Models:	PR255, PR256, PR650, PR656	Portable FRS/GMRS PTT Radio Transceiver		462.5500 - 467.7125 MHz		
2005 Celltech Labs Inc.	This document is not to be reproduced in whole or in part without the prior written permission of Celltech Labs Inc.					Page 2 of 44

TABLE OF CONTENTS	
1.0 INTRODUCTION	4
2.0 DESCRIPTION OF DEVICE UNDER TEST (DUT)	4
3.0 SAR MEASUREMENT SYSTEM	5
4.0 MEASUREMENT SUMMARY	6
5.0 DETAILS OF SAR EVALUATION	7
6.0 EVALUATION PROCEDURES	7
7.0 SYSTEM PERFORMANCE CHECK	8
8.0 SIMULATED EQUIVALENT TISSUES	9
9.0 SAR SAFETY LIMITS	9
10.0 ROBOT SYSTEM SPECIFICATIONS	10
11.0 PROBE SPECIFICATION (ET3DV6)	11
12.0 PLANAR PHANTOM	11
13.0 VALIDATION PLANAR PHANTOM	11
14.0 DEVICE HOLDER	11
15.0 TEST EQUIPMENT LIST	12
16.0 MEASUREMENT UNCERTAINTIES	13
17.0 REFERENCES	15
APPENDIX A - SAR MEASUREMENT DATA	16
APPENDIX B - SYSTEM PERFORMANCE CHECK DATA	27
APPENDIX C - MEASURED FLUID DIELECTRIC PARAMETERS	30
APPENDIX D - SAR TEST SETUP & DUT PHOTOGRAPHS	35
APPENDIX E - SYSTEM VALIDATION	43
APPENDIX F - PROBE CALIBRATION	44

	Test Report Serial No.:	093005BBO-T670-S95U	Report Issue Date:	Oct. 17, 2005
	Date(s) of Evaluation:	October 06-07, 2005	Report Rev. No.:	Revision 0
	Description of Tests:	RF Exposure	SAR	FCC §2.1093

1.0 INTRODUCTION

This measurement report demonstrates compliance of the Cobra Electronics Corporation Model(s): PR255, PR256, PR650, PR656 Portable UHF FRS/GMRS PTT Radio Transceiver FCC ID: BBOPR255 with the SAR (Specific Absorption Rate) RF exposure requirements specified in FCC 47 CFR §2.1093 (see reference [1]), and Health Canada's Safety Code 6 (see reference [2]) for the General Population / Uncontrolled Exposure environment. The test procedures described in FCC OET Bulletin 65, Supplement C (Edition 01-01) (see reference [3]) and IC RSS-102 Issue 1 (Provisional) (see reference [4]), were employed. A description of the product and operating configuration, detailed summary of the test results, methodology and procedures used in the evaluation, equipment used, and the provisions of the rules are included within this test report.

2.0 DESCRIPTION OF DEVICE UNDER TEST (DUT)

Rule Part(s)	FCC 47 CFR §2.1093				
	IC RSS-102 Issue 1 (Provisional)				
Test Procedure(s)	FCC OET Bulletin 65, Supplement C (01-01)				
Device Description	Portable FM UHF FRS/GMRS PTT Radio Transceiver				
FCC IDENTIFIER	BBOPR255				
IC IDENTIFIER	906B-PR255				
Model(s)	PR255	PR256	PR650	PR656	
Serial No. of Test Sample	H509000008		Identical Prototype		
Modulation Type	FM (UHF)				
Tx Frequency Range(s)	462.5500 - 462.7250 MHz		GMRS Channels 15-22		
	462.5625 - 462.7125 MHz		FRS/GMRS Channels 1-7		
	467.5625 - 467.7125 MHz		FRS Channels 8-14		
Max. RF Output Power Tested	1.27 Watts	31.04 dBm	ERP	462.7125 MHz	GMRS Channel 7
Antenna Type(s) Tested	External Fixed Stubby				
Battery Type(s) Tested	NiMH AAA (x4)	1.2 V	750 mAh		
	NiCd AAA (x4)	1.2 V	300 mAh		
	Alkaline AAA (x4)	1.5 V	Duracell Procell 1150 mAh		
Body-Worn Accessories Tested	Plastic Belt-Clip		6 mm thickness		
Audio Accessories Tested	Earbud with Lapel-Microphone		P/N: GA-EBM2		

	Test Report Serial No.:	093005BBO-T670-S95U	Report Issue Date:	Oct. 17, 2005
	Date(s) of Evaluation:	October 06-07, 2005	Report Rev. No.:	Revision 0
	Description of Tests:	RF Exposure	SAR	FCC §2.1093

3.0 SAR MEASUREMENT SYSTEM

Celltech Labs Inc. SAR measurement facility utilizes the Dosimetric Assessment System (DASY™) manufactured by Schmid & Partner Engineering AG (SPEAG™) of Zurich, Switzerland. The DASY4 measurement system is comprised of the measurement server, robot controller, computer, near-field probe, probe alignment sensor, specific anthropomorphic mannequin (SAM) phantom, and various planar phantoms for brain and/or body SAR evaluations. The robot is a six-axis industrial robot performing precise movements to position the probe to the location (points) of maximum electromagnetic field (EMF). A cell controller system contains the power supply, robot controller, teach pendant (Joystick), and remote control, is used to drive the robot motors. The Staubli robot is connected to the cell controller to allow software manipulation of the robot. A data acquisition electronic (DAE) circuit performs the signal amplification, signal multiplexing, AD-conversion, offset measurements, mechanical surface detection, collision detection, etc. is connected to the Electro-optical coupler (EOC). The EOC performs the conversion from the optical into digital electric signal of the DAE and transfers data to the DASY4 measurement server. The DAE4 utilizes a highly sensitive electrometer-grade preamplifier with auto-zeroing, a channel and gain-switching multiplexer, a fast 16-bit AD-converter and a command decoder and control logic unit. Transmission to the DASY4 measurement server is accomplished through an optical downlink for data and status information and an optical uplink for commands and clock lines. The mechanical probe-mounting device includes two different sensor systems for frontal and sidewise probe contacts. The sensor systems are also used for mechanical surface detection and probe collision detection. The robot uses its own controller with a built in VME-bus computer.



DASY4 SAR Measurement System with validation phantom



DASY4 SAR Measurement System with Plexiglas planar phantom

Applicant:	Cobra Electronics Corporation	FCC ID:	BBOPR255	IC ID:	906B-PR255	
Models:	PR255, PR256, PR650, PR656	Portable FRS/GMRS PTT Radio Transceiver		462.5500 - 467.7125 MHz		
2005 Celltech Labs Inc.		This document is not to be reproduced in whole or in part without the prior written permission of Celltech Labs Inc.				Page 5 of 44



Test Report Serial No.:	093005BBO-T670-S95U	Report Issue Date:	Oct. 17, 2005
Date(s) of Evaluation:	October 06-07, 2005	Report Rev. No.:	Revision 0
Description of Tests:	RF Exposure	SAR	FCC §2.1093 IC RSS-102

4.0 MEASUREMENT SUMMARY

SAR EVALUATION RESULTS																
Test Type	Test Date	Freq. (MHz)	Channel		Test Mode	Battery Type	Accessories		Separ. Distance to Planar Phantom (cm)	ERP Start Power (Watts)	Measured SAR 1g (W/kg)		SAR Drift During Test (dB)	Scaled SAR with droop 1g (W/kg)		
							Body-worn	Audio			Duty Cycle			Duty Cycle		
											100%	50%		100%	50%	
Face	Oct 7	462.7125	GMRS	7	CW	Alkaline	--	--	2.5	1.27	1.00	0.500	-0.881	1.22	0.612	
Face	Oct 7	462.7125	GMRS	7	CW	NiMH	--	--	2.5	1.27	0.871	0.436	-0.634	1.01	0.504	
Face	Oct 7	462.7125	GMRS	7	CW	NiCd	--	--	2.5	1.27	0.871	0.436	-0.494	0.976	0.488	
Body	Oct 6	462.7125	GMRS	7	CW	Alkaline	Belt-Clip	Ear-Mic	0.6	1.27	1.95	0.975	-1.30	2.63	1.32	
Body	Oct 7	462.7125	GMRS	7	CW	NiMH	Belt-Clip	Ear-Mic	0.6	1.27	2.09	1.05	-0.753	2.49	1.24	
Body	Oct 7	462.7125	GMRS	7	CW	NiCd	Belt-Clip	Ear-Mic	0.6	1.27	2.06	1.03	-0.883	2.52	1.26	
ANSI / IEEE C95.1 1999 - SAFETY LIMIT						Spatial Peak Uncontrolled Exposure / General Population				BRAIN / BODY: 1.6 W/kg (averaged over 1 gram)						
Test Date(s)		October 07, 2005				October 06 & 07, 2005				Measured Fluid Type			Brain Oct 7	Body Oct 6 Oct 7		Unit
Dielectric Constant ϵ_r	450 MHz Brain				450 MHz Body				Atmospheric Pressure			101.3	101.6	101.2	kPa	
	IEEE Target	Meas.	Dev.	IEEE Target	Date	Meas.	Dev.	Relative Humidity			33	34	33	%		
	43.5	$\pm 5\%$	43.2	-0.7%	56.7	$\pm 5\%$	Oct 6 56.7 0.0%	Oct 7 57.3 +1.1%	Ambient Temperature			23.1	23.2	22.1	°C	
Conductivity σ (mho/m)	450 MHz Brain				450 MHz Body				Fluid Temperature			22.7	23.0	22.1	°C	
	IEEE Target	Meas.	Dev.	IEEE Target	Date	Meas.	Dev.	Fluid Depth			≥ 15	≥ 15	≥ 15	cm		
	0.87	$\pm 5\%$	0.83	-4.6%	0.94	$\pm 5\%$	Oct 6 0.94 0.0%	Oct 7 0.95 +1.1%	ρ (Kg/m ³)			1000				

Note(s):

- The measurement results were obtained with the DUT tested in the conditions described in this report. Detailed measurement data and plots showing the maximum SAR location of the DUT are reported in Appendix A.
- The transmission band of the DUT is less than 10 MHz; therefore mid channel data only is reported (per FCC OET Bulletin 65, Supplement C, Edition 01-01 - see reference [3]).
- The power droop measured by the DASY4 system for the duration of the SAR evaluations was added to the measured SAR levels to report scaled SAR results as shown in the above test data table.
- A SAR-versus-Time power drift evaluation was performed in the test configuration that reported the maximum-scaled SAR level (Body-worn, Alkaline battery). See Appendix A (SAR Test Plots) for power drift evaluation plot.
- The ambient and fluid temperatures were measured prior to, and during, the fluid dielectric parameter check and the SAR evaluations. The temperatures reported were consistent for all measurement periods.
- The dielectric parameters of the simulated tissue mixtures were measured prior to the SAR evaluations using an ALS-PR-DIEL Dielectric Probe Kit and an HP 8753ET Network Analyzer (see Appendix C for measured fluid dielectric parameters).
- The SAR evaluations were performed within 24 hours of the system performance check.

	Test Report Serial No.:	093005BBO-T670-S95U	Report Issue Date:	Oct. 17, 2005
	Date(s) of Evaluation:	October 06-07, 2005	Report Rev. No.:	Revision 0
	Description of Tests:	RF Exposure	SAR	FCC §2.1093

5.0 DETAILS OF SAR EVALUATION

The Cobra Electronics Corporation Models: PR255, PR256, PR650, PR656 Portable FM UHF FRS/GMRS PTT Radio Transceiver FCC ID: BBOPR255 was compliant for localized Specific Absorption Rate (General Population / Uncontrolled Exposure) based on the test provisions and conditions described below. The detailed test setup photographs are shown in Appendix D.

1. The DUT was evaluated in a face-held configuration with the front of the radio placed parallel to the outer surface of the planar phantom. A 2.5 cm separation distance was maintained between the front of the DUT and the outer surface of the planar phantom.
2. The DUT was tested in a body-worn configuration with the back of the radio placed parallel to the outer surface of the planar phantom. The attached plastic belt-clip accessory was touching the planar phantom and provided a 0.6 cm separation distance from the back of the DUT to the outer surface of the planar phantom. The DUT was evaluated for body-worn SAR with an ear-bud lapel-microphone audio accessory connected to the audio port.
3. The RF conducted output power of the DUT could not be measured due to a non-detachable antenna. The DUT was evaluated for SAR at the maximum conducted power level preset by the manufacturer.
4. The DUT was evaluated for SAR at the maximum ERP level measured prior to the SAR evaluation at Celltech Labs' 3-meter Open Area Test Site using the signal substitution method in accordance with ANSI/TIA-603-C-2004 (see reference [6]).
5. The power droops measured by the DASY4 system during the SAR evaluations were added to the measured SAR levels to report scaled SAR results as shown in the test data table (page 6).
6. A SAR-versus-Time power drift evaluation was performed in the test configuration that reported the maximum-scaled SAR level. See Appendix A (SAR Test Plots) for SAR-versus-Time power drift evaluation plot.
7. The area scan evaluation was performed with fully charged batteries. After the area scan was completed the radio was cooled down and the batteries were replaced with fully charged batteries prior to the zoom scan evaluation.
8. The DUT was tested in unmodulated continuous transmit operation (Continuous Wave mode at 100% duty cycle) with the transmit key constantly depressed. For a push-to-talk device the 50% duty cycle compensation reported assumes a transmit/receive cycle of equal time base.
9. The SAR evaluations were performed using a Plexiglas planar phantom.
10. The SAR evaluations were performed within 24 hours of the system performance check.

6.0 EVALUATION PROCEDURES

- a. (i) The evaluation was performed in the applicable area of the phantom depending on the type of device being tested. For devices held to the ear during normal operation, both the left and right ear positions were evaluated using the SAM phantom.
(ii) For body-worn and face-held devices a planar phantom was used.
- b. The SAR was determined by a pre-defined procedure within the DASY4 software. Upon completion of a reference and optical surface check, the exposed region of the phantom was scanned near the inner surface with a grid spacing of 15mm x 15mm.
An area scan was determined as follows:
 - c. Based on the defined area scan grid, a more detailed grid is created to increase the points by a factor of 10. The interpolation function then evaluates all field values between corresponding measurement points.
 - d. A linear search is applied to find all the candidate maxima. Subsequently, all maxima are removed that are >2 dB from the global maximum. The remaining maxima are then used to position the cube scans.
A 1g and 10g spatial peak SAR was determined as follows:
 - e. Extrapolation is used to find the points between the dipole center of the probe and the surface of the phantom. This data cannot be measured, since the center of the dipoles is 2.7 mm away from the tip of the probe and the distance between the surface and the lowest measuring point is 1.4 mm (see probe calibration document in Appendix F). The extrapolation was based on trivariate quadratics computed from the previously calculated 3D interpolated points nearest the phantom surface.
 - f. Interpolated data is used to calculate the average SAR over 1g and 10g cubes by spatially discretizing the entire measured cube. The volume used to determine the averaged SAR is a 1mm grid (42875 interpolated points).
 - g. A zoom scan volume of 32 mm x 32 mm x 30 mm (5 x 5 x 7 points) centered at the peak SAR location determined from the area scan is used for all zoom scans for devices with a transmit frequency < 800 MHz. Zoom scans for frequencies ≥ 800 MHz are determined with a scan volume of 30 mm x 30 mm x 30 mm (7 x 7 x 7) to ensure complete capture of the peak spatial-average SAR.

Applicant:	Cobra Electronics Corporation	FCC ID:	BBOPR255	IC ID:	906B-PR255	
Models:	PR255, PR256, PR650, PR656	Portable FRS/GMRS PTT Radio Transceiver		462.5500 - 467.7125 MHz		
2005 Celltech Labs Inc.	This document is not to be reproduced in whole or in part without the prior written permission of Celltech Labs Inc.					Page 7 of 44

	Test Report Serial No.:	093005BBO-T670-S95U	Report Issue Date:	Oct. 17, 2005
	Date(s) of Evaluation:	October 06-07, 2005	Report Rev. No.:	Revision 0
	Description of Tests:	RF Exposure	SAR	FCC §2.1093

7.0 SYSTEM PERFORMANCE CHECK

Prior to the SAR evaluations a system check was performed using a Plexiglas planar phantom and 450MHz dipole (see Appendix E for system validation procedures). The dielectric parameters of the simulated tissue mixture were measured prior to the system performance check using an ALS-PR-DIEL Dielectric Probe Kit and HP 8753ET Network Analyzer (see Appendix C for measured fluid dielectric parameters). A forward power of 250 mW was applied to the dipole and the system was verified to a tolerance of $\pm 10\%$ (see Appendix B for system performance check test plot).

SYSTEM PERFORMANCE CHECK EVALUATION																
Test Date	450MHz Equiv. Tissue	SAR 1g (W/kg)			Dielectric Constant ϵ_r			Conductivity σ (mho/m)			ρ (Kg/m ³)	Amb. Temp. (°C)	Fluid Temp. (°C)	Fluid Depth (cm)	Humid. (%)	Barom. Press. (kPa)
		IEEE Target	Meas.	Dev.	IEEE Target	Meas.	Dev.	IEEE Target	Meas.	Dev.						
10/6/05	Brain	1.23 $\pm 10\%$	1.34	+8.9%	43.5 $\pm 5\%$	42.9	-1.4%	0.87 $\pm 5\%$	0.84	-3.4%	1000	23.3	22.8	≥ 15	32	101.8

Note(s):

1. The ambient and fluid temperatures were measured prior to, and during, the fluid dielectric parameter check and the system performance check. The temperatures listed in the table above were consistent for all measurement periods.

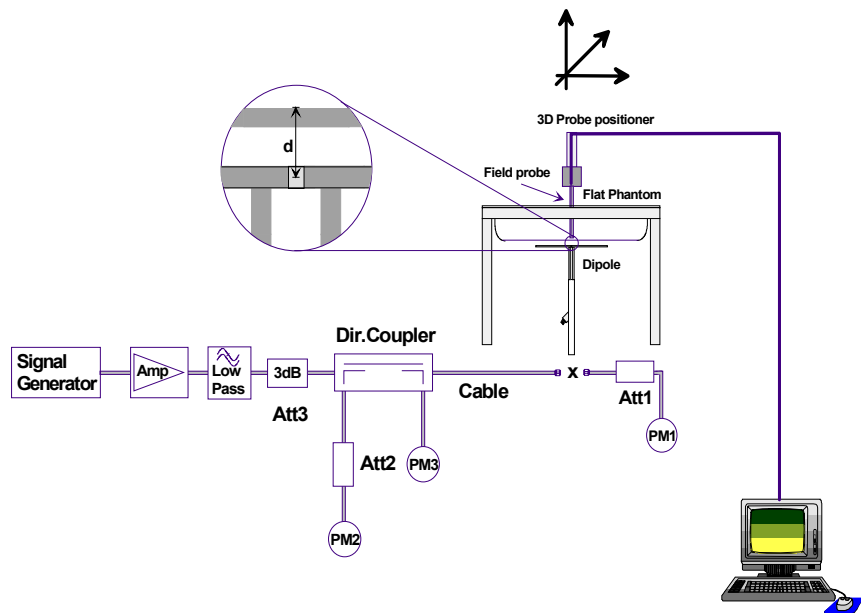



Figure 1. System Performance Check Setup Diagram



450 MHz Dipole Setup

Applicant:	Cobra Electronics Corporation	FCC ID:	BBOPR255	IC ID:	906B-PR255	
Models:	PR255, PR256, PR650, PR656	Portable FRS/GMRS PTT Radio Transceiver		462.5500 - 467.7125 MHz		
2005 Celltech Labs Inc.		This document is not to be reproduced in whole or in part without the prior written permission of Celltech Labs Inc.				Page 8 of 44

	Test Report Serial No.:	093005BBO-T670-S95U	Report Issue Date:	Oct. 17, 2005
	Date(s) of Evaluation:	October 06-07, 2005	Report Rev. No.:	Revision 0
	Description of Tests:	RF Exposure	SAR	FCC §2.1093

8.0 SIMULATED EQUIVALENT TISSUES

The 450MHz brain and body simulated tissue mixtures consist of a viscous gel using hydroxethylcellulose (HEC) gelling agent and saline solution. Preservation with a bactericide is added and visual inspection is made to ensure air bubbles are not trapped during the mixing process. The fluid was prepared according to standardized procedures, and measured for dielectric parameters (permittivity and conductivity).

SIMULATED TISSUE MIXTURES		
INGREDIENT	450 MHz Brain	450 MHz Body
	System Check & DUT Evaluation	DUT Evaluation
Water	38.56 %	52.00 %
Sugar	56.32 %	45.65 %
Salt	3.95 %	1.75 %
HEC	0.98 %	0.50 %
Bactericide	0.19 %	0.10 %

9.0 SAR SAFETY LIMITS

EXPOSURE LIMITS	SAR (W/kg)	
	(General Population / Uncontrolled Exposure Environment)	(Occupational / Controlled Exposure Environment)
Spatial Average (averaged over the whole body)	0.08	0.4
Spatial Peak (averaged over any 1g of tissue)	1.60	8.0
Spatial Peak (hands/wrists/feet/ankles averaged over 10g)	4.0	20.0

Notes:

1. Uncontrolled environments are defined as locations where there is potential exposure of individuals who have no knowledge or control of their potential exposure.
2. Controlled environments are defined as locations where there is potential exposure of individuals who have knowledge of their potential exposure and can exercise control over their exposure.

	Test Report Serial No.:	093005BBO-T670-S95U	Report Issue Date:	Oct. 17, 2005
	Date(s) of Evaluation:	October 06-07, 2005	Report Rev. No.:	Revision 0
	Description of Tests:	RF Exposure SAR	FCC §2.1093	IC RSS-102

10.0 ROBOT SYSTEM SPECIFICATIONS

Specifications

POSITIONER: Stäubli Unimation Corp. Robot Model: RX60L
Repeatability: 0.02 mm
No. of axis: 6

Data Acquisition Electronic (DAE) System

Cell Controller

Processor: AMD Athlon XP 2400+
Clock Speed: 2.0 GHz
Operating System: Windows XP Professional

Data Converter

Features: Signal Amplifier, multiplexer, A/D converter, and control logic
Software: DASY4 software
Connecting Lines: Optical downlink for data and status info.
Optical uplink for commands and clock

DASY4 Measurement Server

Function: Real-time data evaluation for field measurements and surface detection
Hardware: PC/104 166MHz Pentium CPU; 32 MB chipdisk; 64 MB RAM
Connections: COM1, COM2, DAE, Robot, Ethernet, Service Interface

E-Field Probe

Model: ET3DV6
Serial No.: 1387
Construction: Triangular core fiber optic detection system
Frequency: 10 MHz to 6 GHz
Linearity: ±0.2 dB (30 MHz to 3 GHz)

Phantom(s)

Evaluation Phantom

Type: Planar Phantom
Shell Material: Plexiglas
Bottom Thickness: 2.0 mm ± 0.1 mm
Outer Dimensions: 75.0 cm (L) x 22.5 cm (W) x 20.5 cm (H); Back Plane: 25.7 cm (H)

Validation Phantom (≤ 450MHz)

Type: Planar Phantom
Shell Material: Plexiglas
Bottom Thickness: 6.2 mm ± 0.1 mm
Outer Dimensions: 86.0 cm (L) x 39.5 cm (W) x 21.8 cm (H)

Applicant:	Cobra Electronics Corporation	FCC ID:	BBOPR255	IC ID:	906B-PR255	
Models:	PR255, PR256, PR650, PR656	Portable FRS/GMRS PTT Radio Transceiver		462.5500 - 467.7125 MHz		
2005 Celltech Labs Inc.		This document is not to be reproduced in whole or in part without the prior written permission of Celltech Labs Inc.				Page 10 of 44

	Test Report Serial No.:	093005BBO-T670-S95U	Report Issue Date:	Oct. 17, 2005
	Date(s) of Evaluation:	October 06-07, 2005	Report Rev. No.:	Revision 0
	Description of Tests:	RF Exposure SAR	FCC §2.1093	IC RSS-102

11.0 PROBE SPECIFICATION (ET3DV6)

Construction: Symmetrical design with triangular core
 Built-in shielding against static charges
 PEEK enclosure material (resistant to organic solvents, e.g. glycol)

Calibration: In air from 10 MHz to 2.5 GHz
 In brain simulating tissue at frequencies of 900 MHz and 1.8 GHz (accuracy $\pm 8\%$)

Frequency: 10 MHz to > 6 GHz; Linearity: ± 0.2 dB (30 MHz to 3 GHz)

Directivity: ± 0.2 dB in brain tissue (rotation around probe axis)
 ± 0.4 dB in brain tissue (rotation normal to probe axis)

Dynamic Range: $5 \mu\text{W/g}$ to > 100 mW/g; Linearity: ± 0.2 dB

Surface Detection: ± 0.2 mm repeatability in air and clear liquids over diffuse reflecting surfaces

Dimensions: Overall length: 330 mm
 Tip length: 16 mm
 Body diameter: 12 mm
 Tip diameter: 6.8 mm
 Distance from probe tip to dipole centers: 2.7 mm

Application: General dosimetry up to 3 GHz
 Compliance tests of mobile phone



ET3DV6 E-Field Probe

12.0 PLANAR PHANTOM

The planar phantom is constructed of Plexiglas material with a 2.0 mm shell thickness for face-held and body-worn SAR evaluations of portable radio transceivers. The planar phantom is mounted on the side of the DASY4 compact system table.



Plexiglas Planar Phantom

13.0 VALIDATION PLANAR PHANTOM

The validation planar phantom is constructed of Plexiglas material with a 6.0 mm shell thickness for SAR validations at 450MHz and below. The validation planar phantom is mounted in the table of the DASY4 compact system.



Validation Planar Phantom

14.0 DEVICE HOLDER

The DASY4 device holder has two scales for device rotation (with respect to the body axis) and the device inclination (with respect to the line between the ear openings). The plane between the ear openings and the mouth tip has a rotation angle of 65° . The bottom plate contains three pair of bolts for locking the device holder. The device holder positions are adjusted to the standard measurement positions in the three sections.



Device Holder

Applicant:	Cobra Electronics Corporation	FCC ID:	BBOPR255	IC ID:	906B-PR255	
Models:	PR255, PR256, PR650, PR656	Portable FRS/GMRS PTT Radio Transceiver		462.5500 - 467.7125 MHz		
2005 Celltech Labs Inc.		This document is not to be reproduced in whole or in part without the prior written permission of Celltech Labs Inc.				Page 11 of 44



Test Report Serial No.:	093005BBO-T670-S95U	Report Issue Date:	Oct. 17, 2005
Date(s) of Evaluation:	October 06-07, 2005	Report Rev. No.:	Revision 0
Description of Tests:	RF Exposure SAR	FCC §2.1093	IC RSS-102

15.0 TEST EQUIPMENT LIST

USED	TEST EQUIPMENT DESCRIPTION	ASSET NO.	SERIAL NO.	DATE CALIBRATED		CALIBRATION DUE DATE
x	Schmid & Partner DASY4 System	-	-	-	-	-
x	-DASY4 Measurement Server	00158	1078	N/A	N/A	N/A
x	-Robot	00046	599396-01	N/A	N/A	N/A
x	-DAE4	00019	353	15Jun05		15Jun06
	-DAE3	00018	370	25Jan05		25Jan06
x	-ET3DV6 E-Field Probe	00016	1387	18Mar05		18Mar06
	-ET3DV6 E-Field Probe	00017	1590	20May05		20May06
	-EX3DV4 E-Field Probe	00125	3547	21Jan05		21Jan06
	-300 MHz Validation Dipole	00023	135	26Oct04		26Oct05
x	-450 MHz Validation Dipole	00024	136	04Nov04		04Nov05
	-835 MHz Validation Dipole	00022	411	Brain	30Mar05	30Mar06
				Body	12Apr05	12Apr06
	-900 MHz Validation Dipole	00020	054	Brain	10Jun05	10Jun06
				Body	10Jun05	10Jun06
	-1800 MHz Validation Dipole	00021	247	Brain	14Jun05	14Jun06
				Body	14Jun05	14Jun06
	-1900 MHz Validation Dipole	00032	151	Brain	17Jun05	17Jun06
				Body	22Apr05	22Apr06
	-2450 MHz Validation Dipole	00025	150	Brain	20Sep05	20Sep06
				Body	22Apr05	22Apr06
	-5000 MHz Validation Dipole	00126	1031	Brain	11Jan05	11Jan06
				Body	11Jan05	11Jan06
	-SAM Phantom V4.0C	00154	1033	N/A		N/A
	-Barski Planar Phantom	00155	03-01	N/A		N/A
x	-Plexiglas Planar Phantom	00156	161	N/A		N/A
x	-Validation Planar Phantom	00157	137	N/A		N/A
	HP 85070C Dielectric Probe Kit	00033	N/A	N/A		N/A
x	ALS-PR-DIEL Dielectric Probe Kit	00160	260-00953	N/A		N/A
x	Gigatronics 8652A Power Meter	00110	1835801	16Apr05		16Apr06
	Gigatronics 8652A Power Meter	00008	1835267	29Apr05		29Apr06
	Gigatronics 8652A Power Meter	00007	1835272	18Oct04		18Oct05
	Gigatronics 80701A Power Sensor	00013	1833713	11Oct04		11Oct05
x	Gigatronics 80701A Power Sensor	00011	1833542	08Oct04		08Oct05
x	Gigatronics 80701A Power Sensor	00109	1834366	16Apr05		16Apr06
x	HP 8753ET Network Analyzer	00134	US39170292	04May05		04May06
x	HP 8648D Signal Generator	00005	3847A00611	29Apr05		29Apr06
	Rohde & Schwarz SMR40 Signal Generator	00006	100104	12Apr05		12Apr06
x	Amplifier Research 5S1G4 Power Amplifier	00106	26235	N/A		N/A

Applicant:	Cobra Electronics Corporation	FCC ID:	BBOPR255	IC ID:	906B-PR255	
Models:	PR255, PR256, PR650, PR656	Portable FRS/GMRS PTT Radio Transceiver		462.5500 - 467.7125 MHz		
2005 Celltech Labs Inc.	This document is not to be reproduced in whole or in part without the prior written permission of Celltech Labs Inc.					Page 12 of 44

	Test Report Serial No.:	093005BBO-T670-S95U	Report Issue Date:	Oct. 17, 2005
	Date(s) of Evaluation:	October 06-07, 2005	Report Rev. No.:	Revision 0
	Description of Tests:	RF Exposure SAR	FCC §2.1093	IC RSS-102

16.0 MEASUREMENT UNCERTAINTIES

UNCERTAINTY BUDGET FOR DEVICE EVALUATION						
Error Description	Uncertainty Value ±%	Probability Distribution	Divisor	ci 1g	Uncertainty Value ±% (1g)	V _i or V _{off}
Measurement System						
Probe calibration	4.0	Normal	1	1	4.0	∞
Axial isotropy of the probe	4.7	Rectangular	1.732050808	0.7	1.9	∞
Spherical isotropy of the probe	9.6	Rectangular	1.732050808	0.7	3.9	∞
Spatial resolution	0	Rectangular	1.732050808	1	0.0	∞
Boundary effects	1	Rectangular	1.732050808	1	0.6	∞
Probe linearity	4.7	Rectangular	1.732050808	1	2.7	∞
Detection limit	1	Rectangular	1.732050808	1	0.6	∞
Readout electronics	0.3	Normal	1	1	0.3	∞
Response time	0.8	Rectangular	1.732050808	1	0.5	∞
Integration time	2.6	Rectangular	1.732050808	1	1.5	∞
RF ambient conditions	3	Rectangular	1.732050808	1	1.7	∞
Mech. constraints of robot	0.4	Rectangular	1.732050808	1	0.2	∞
Probe positioning	2.9	Rectangular	1.732050808	1	1.7	∞
Extrapolation & integration	1	Rectangular	1.732050808	1	0.6	∞
Test Sample Related						
Device positioning	2.9	Normal	1	1	2.9	12
Device holder uncertainty	3.6	Normal	1	1	3.6	8
Power drift	5	Rectangular	1.732050808	1	2.9	∞
Phantom and Setup						
Phantom uncertainty	4	Rectangular	1.732050808	1	2.3	∞
Liquid conductivity (target)	5	Rectangular	1.732050808	0.64	1.8	∞
Liquid conductivity (measured)	2.5	Normal	1	0.64	1.6	∞
Liquid permittivity (target)	5	Rectangular	1.732050808	0.6	1.7	∞
Liquid permittivity (measured)	2.5	Normal	1	0.6	1.5	∞
Combined Standard Uncertainty					9.88	
Expanded Uncertainty (k=2)					19.77	

Measurement Uncertainty Table in accordance with IEEE Standard 1528-2003 (see reference [5])

Applicant:	Cobra Electronics Corporation	FCC ID:	BBOPR255	IC ID:	906B-PR255	
Models:	PR255, PR256, PR650, PR656	Portable FRS/GMRS PTT Radio Transceiver		462.5500 - 467.7125 MHz		
2005 Celltech Labs Inc.	This document is not to be reproduced in whole or in part without the prior written permission of Celltech Labs Inc.					Page 13 of 44

	Test Report Serial No.:	093005BBO-T670-S95U	Report Issue Date:	Oct. 17, 2005
	Date(s) of Evaluation:	October 06-07, 2005	Report Rev. No.:	Revision 0
	Description of Tests:	RF Exposure SAR	FCC §2.1093	IC RSS-102

MEASUREMENT UNCERTAINTIES (Cont.)

UNCERTAINTY BUDGET FOR SYSTEM VALIDATION						
Error Description	Uncertainty Value ±%	Probability Distribution	Divisor	ci 1g	Uncertainty Value ±% (1g)	V _i or V _{eff}
Measurement System						
Probe calibration	4.0	Normal	1	1	4.0	∞
Axial isotropy of the probe	4.7	Rectangular	1.732050808	1	2.7	∞
Spherical isotropy of the probe	0	Rectangular	1.732050808	1	0.0	∞
Spatial resolution	0	Rectangular	1.732050808	1	0.0	∞
Boundary effects	1	Rectangular	1.732050808	1	0.6	∞
Probe linearity	4.7	Rectangular	1.732050808	1	2.7	∞
Detection limit	1	Rectangular	1.732050808	1	0.6	∞
Readout electronics	0.3	Normal	1	1	0.3	∞
Response time	0	Rectangular	1.732050808	1	0.0	∞
Integration time	0	Rectangular	1.732050808	1	0.0	∞
RF ambient conditions	3	Rectangular	1.732050808	1	1.7	∞
Mech. constraints of robot	0.4	Rectangular	1.732050808	1	0.2	∞
Probe positioning	2.9	Rectangular	1.732050808	1	1.7	∞
Extrapolation & integration	1	Rectangular	1.732050808	1	0.6	∞
Test Sample Related						
Dipole Positioning	2	Normal	1.732050808	1	1.2	∞
Power & Power Drift	4.7	Normal	1.732050808	1	2.7	∞
Phantom and Setup						
Phantom uncertainty	4	Rectangular	1.732050808	1	2.3	∞
Liquid conductivity (target)	5	Rectangular	1.732050808	0.64	1.8	∞
Liquid conductivity (measured)	2.5	Normal	1	0.64	1.6	∞
Liquid permittivity (target)	5	Rectangular	1.732050808	0.6	1.7	∞
Liquid permittivity (measured)	2.5	Normal	1	0.6	1.5	∞
Combined Standard Uncertainty					7.93	
Expanded Uncertainty (k=2)					15.87	

Measurement Uncertainty Table in accordance with IEEE Standard 1528-2003 (see reference [5])

	Test Report Serial No.:	093005BBO-T670-S95U	Report Issue Date:	Oct. 17, 2005
	Date(s) of Evaluation:	October 06-07, 2005	Report Rev. No.:	Revision 0
	Description of Tests:	RF Exposure SAR	FCC §2.1093	IC RSS-102

17.0 REFERENCES

- [1] Federal Communications Commission, "Radiofrequency radiation exposure evaluation: portable devices", Rule Part 47 CFR §2.1093: 1999.
- [2] Health Canada, "Limits of Human Exposure to Radiofrequency Electromagnetic Fields in the Frequency Range from 3 kHz to 300 GHz", Safety Code 6: 1999.
- [3] Federal Communications Commission, "Evaluating Compliance with FCC Guidelines for Human Exposure to Radio frequency Electromagnetic Fields", OET Bulletin 65, Supplement C (Edition 01-01), FCC, Washington, D.C.: June 2001.
- [4] Industry Canada, "Evaluation Procedure for Mobile and Portable Radio Transmitters with respect to Health Canada's Safety Code 6 for Exposure of Humans to Radio Frequency Fields", Radio Standards Specification RSS-102 Issue 1 (Provisional): September 1999.
- [5] IEEE Standard 1528-2003, "Recommended Practice for Determining the Peak Spatial-Average Specific Absorption Rate (SAR) in the Human Head from Wireless Communications Devices: Measurement Techniques": December 2003.
- [6] ANSI/TIA-603-C, "Land Mobile FM or PM Communications Equipment - Measurement and Performance Standards": December 2004.

Applicant:	Cobra Electronics Corporation	FCC ID:	BBOPR255	IC ID:	906B-PR255	
Models:	PR255, PR256, PR650, PR656	Portable FRS/GMRS PTT Radio Transceiver		462.5500 - 467.7125 MHz		
2005 Celltech Labs Inc.	This document is not to be reproduced in whole or in part without the prior written permission of Celltech Labs Inc.					Page 15 of 44

	Test Report Serial No.:	093005BBO-T670-S95U	Report Issue Date:	Oct. 17, 2005
	Date(s) of Evaluation:	October 06-07, 2005	Report Rev. No.:	Revision 0
	Description of Tests:	RF Exposure SAR	FCC §2.1093	IC RSS-102

APPENDIX A - SAR MEASUREMENT DATA

Applicant:	Cobra Electronics Corporation	FCC ID:	BBOPR255	IC ID:	906B-PR255	
Models:	PR255, PR256, PR650, PR656	Portable FRS/GMRS PTT Radio Transceiver		462.5500 - 467.7125 MHz		
2005 Celltech Labs Inc.	This document is not to be reproduced in whole or in part without the prior written permission of Celltech Labs Inc.					Page 16 of 44

	Test Report Serial No.:	093005BBO-T670-S95U	Report Issue Date:	Oct. 17, 2005
	Date(s) of Evaluation:	October 06-07, 2005	Report Rev. No.:	Revision 0
	Description of Tests:	RF Exposure	SAR	FCC §2.1093

Date Tested: 10/07/2005

Face-Held SAR - Alkaline (Duracell Procell) AAA Batteries

DUT: Cobra Model: PR650; Type: Portable UHF FRS/GMRS PTT Radio Transceiver; Serial: H509000008

Ambient Temp: 23.1 °C; Fluid Temp: 22.7 °C; Barometric Pressure: 101.3 kPa; Humidity: 33%

Communication System: FM UHF
 RF Output Power: 1.27 Watts (ERP)
 Frequency: 462.7125 MHz; GMRS Ch. 7; Duty Cycle: 1:1
 1.5V 1150mAh Alkaline (Duracell Procell) AAA Batteries (x4)
 Medium: HSL450 ($\sigma = 0.83 \text{ mho/m}$; $\epsilon_r = 43.2$; $\rho = 1000 \text{ kg/m}^3$)

- Probe: ET3DV6 - SN1387; ConvF(7.5, 7.5, 7.5); Calibrated: 18/03/2005
- Sensor-Surface: 4mm (Mechanical Surface Detection)
- Electronics: DAE4 Sn353; Calibrated: 15/06/2005
- Phantom: Planar; Type: Plexiglas; Serial: 161
- Measurement SW: DASY4, V4.6 Build 19; Postprocessing SW: SEMCAD, V1.8 Build 159

Face-Held SAR - 2.5 cm Separation Distance from Front of DUT to Planar Phantom/Area Scan (7x12x1):

Measurement grid: dx=15mm, dy=15mm

Face-Held SAR - 2.5 cm Separation Distance from Front of DUT to Planar Phantom/Zoom Scan (5x5x7)/Cube 0:

Measurement grid: dx=7.5mm, dy=7.5mm, dz=5mm
 Reference Value = 35.4 V/m; Power Drift = -0.881 dB
 Peak SAR (extrapolated) = 1.59 W/kg
SAR(1 g) = 1.00 mW/g; SAR(10 g) = 0.703 mW/g

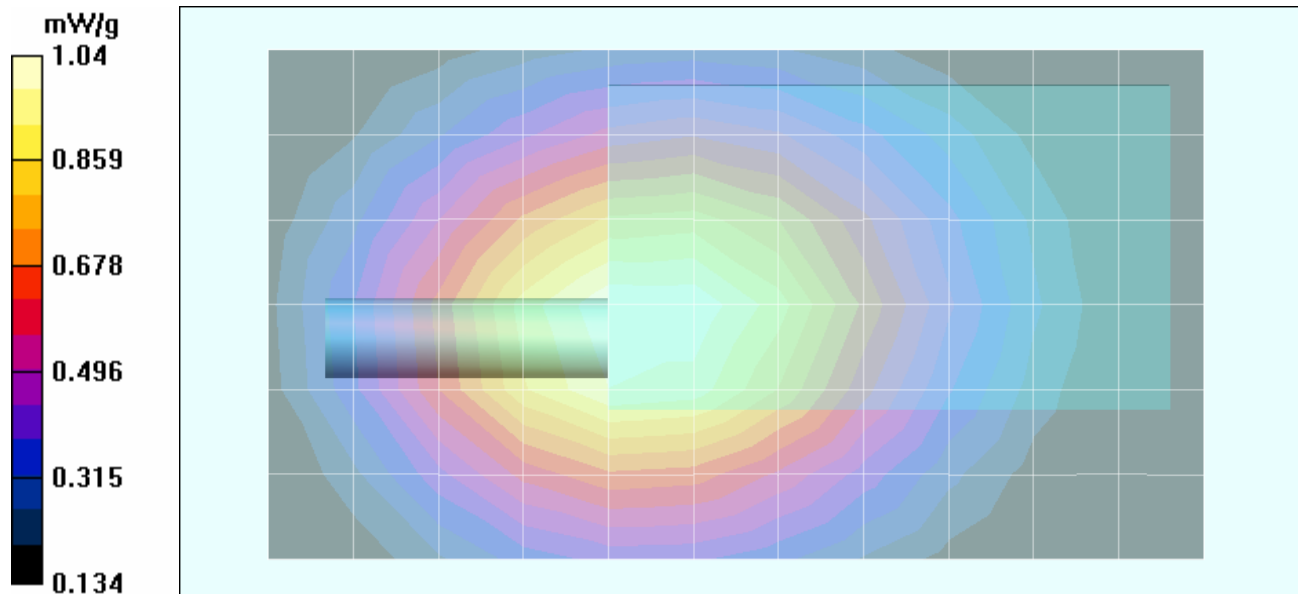

Applicant:	Cobra Electronics Corporation	FCC ID:	BBOPR255	IC ID:	906B-PR255	
Models:	PR255, PR256, PR650, PR656	Portable FRS/GMRS PTT Radio Transceiver		462.5500 - 467.7125 MHz		
2005 Celltech Labs Inc.	This document is not to be reproduced in whole or in part without the prior written permission of Celltech Labs Inc.					Page 17 of 44

Z-Axis Scan

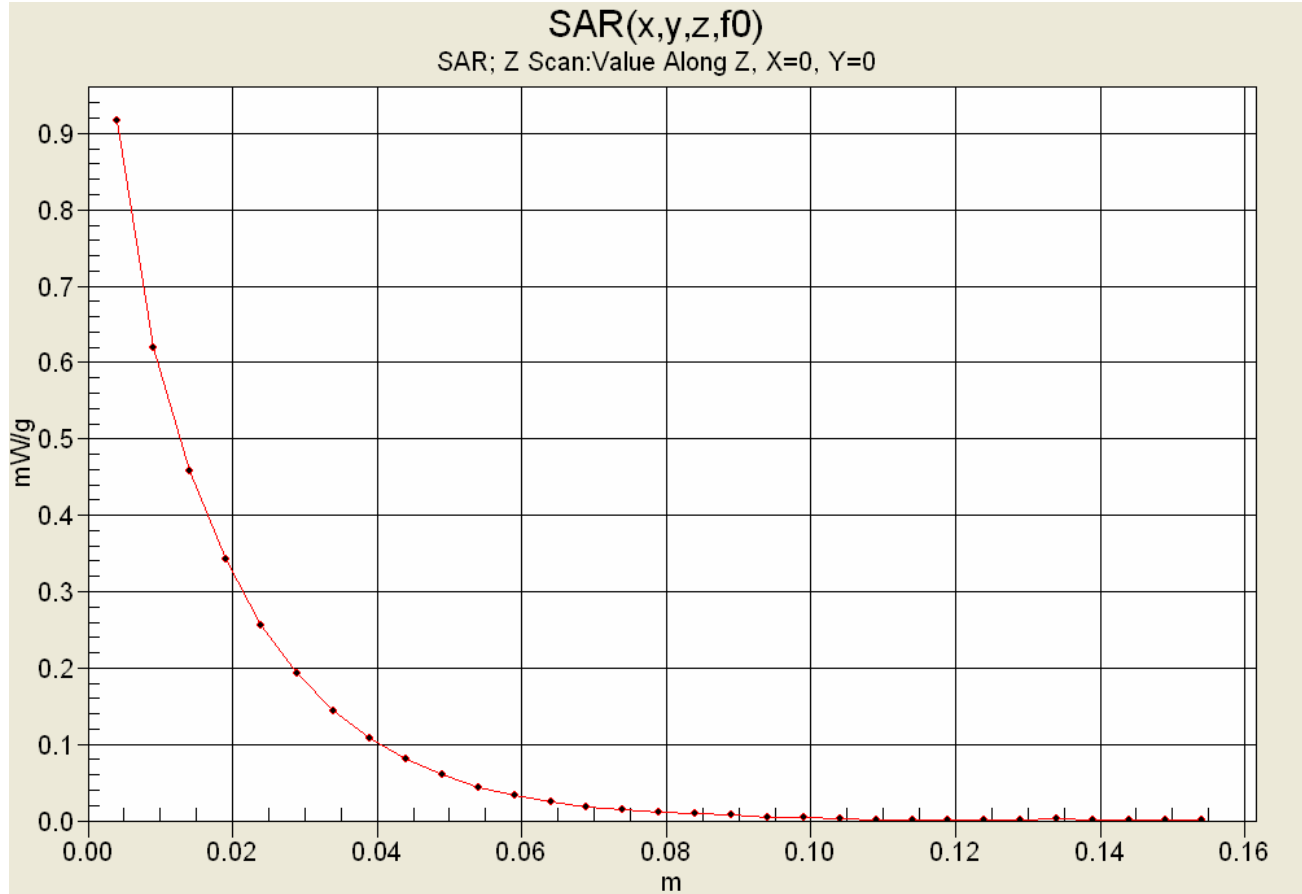

	Test Report Serial No.:	093005BBO-T670-S95U	Report Issue Date:	Oct. 17, 2005
	Date(s) of Evaluation:	October 06-07, 2005	Report Rev. No.:	Revision 0
	Description of Tests:	RF Exposure	SAR	FCC §2.1093

Date Tested: 10/07/2005

Face-Held SAR - NiMH AAA Batteries

DUT: Cobra Model: PR650; Type: Portable UHF FRS/GMRS PTT Radio Transceiver; Serial: H509000008

Ambient Temp: 23.1 °C; Fluid Temp: 22.7 °C; Barometric Pressure: 101.3 kPa; Humidity: 33%

Communication System: FM UHF
 RF Output Power: 1.27 Watts (ERP)
 Frequency: 462.7125 MHz; GMRS Ch. 7; Duty Cycle: 1:1
 1.2V 750mAh NiMH AAA Batteries (x4)
 Medium: HSL450 ($\sigma = 0.83 \text{ mho/m}$; $\epsilon_r = 43.2$; $\rho = 1000 \text{ kg/m}^3$)

- Probe: ET3DV6 - SN1387; ConvF(7.5, 7.5, 7.5); Calibrated: 18/03/2005
- Sensor-Surface: 4mm (Mechanical Surface Detection)
- Electronics: DAE4 Sn353; Calibrated: 15/06/2005
- Phantom: Planar; Type: Plexiglas; Serial: 161
- Measurement SW: DASY4, V4.6 Build 19; Postprocessing SW: SEMCAD, V1.8 Build 159

Face-Held SAR - 2.5 cm Separation Distance from Front of DUT to Planar Phantom/Area Scan (7x12x1):

Measurement grid: dx=15mm, dy=15mm

Face-Held SAR - 2.5 cm Separation Distance from Front of DUT to Planar Phantom/Zoom Scan (5x5x7)/Cube 0:

Measurement grid: dx=7.5mm, dy=7.5mm, dz=5mm
 Reference Value = 32.9 V/m; Power Drift = -0.634 dB
 Peak SAR (extrapolated) = 1.39 W/kg
SAR(1 g) = 0.871 mW/g; SAR(10 g) = 0.609 mW/g

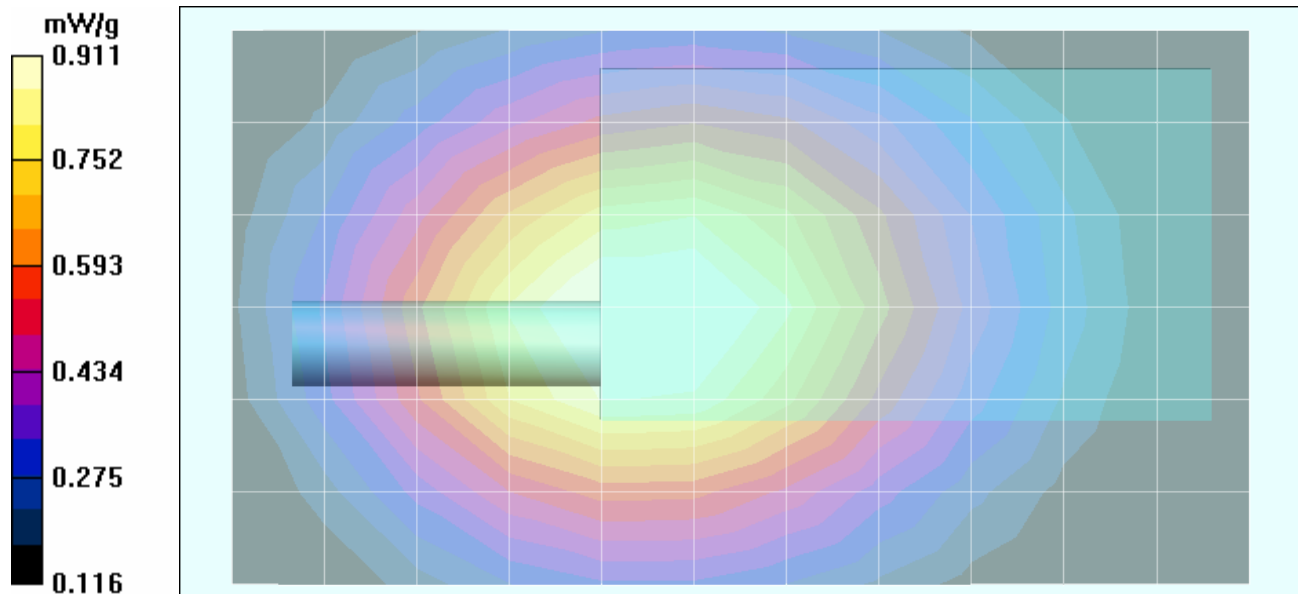

Applicant:	Cobra Electronics Corporation	FCC ID:	BBOPR255	IC ID:	906B-PR255	
Models:	PR255, PR256, PR650, PR656	Portable FRS/GMRS PTT Radio Transceiver		462.5500 - 467.7125 MHz		
2005 Celltech Labs Inc.	This document is not to be reproduced in whole or in part without the prior written permission of Celltech Labs Inc.					Page 19 of 44

	Test Report Serial No.:	093005BBO-T670-S95U	Report Issue Date:	Oct. 17, 2005
	Date(s) of Evaluation:	October 06-07, 2005	Report Rev. No.:	Revision 0
	Description of Tests:	RF Exposure	SAR	FCC §2.1093

Date Tested: 10/07/2005

Face-Held SAR - NiCd AAA Batteries

DUT: Cobra Model: PR650; Type: Portable UHF FRS/GMRS PTT Radio Transceiver; Serial: H509000008

Ambient Temp: 23.1 °C; Fluid Temp: 22.7 °C; Barometric Pressure: 101.3 kPa; Humidity: 33%

Communication System: FM UHF
 RF Output Power: 1.27 Watts (ERP)
 Frequency: 462.7125 MHz; GMRS Ch. 7; Duty Cycle: 1:1
 1.2V 300mAh NiCd AAA Batteries (x4)
 Medium: HSL450 ($\sigma = 0.83$ mho/m; $\epsilon_r = 43.2$; $\rho = 1000$ kg/m³)

- Probe: ET3DV6 - SN1387; ConvF(7.5, 7.5, 7.5); Calibrated: 18/03/2005
- Sensor-Surface: 4mm (Mechanical Surface Detection)
- Electronics: DAE4 Sn353; Calibrated: 15/06/2005
- Phantom: Planar; Type: Plexiglas; Serial: 161
- Measurement SW: DASy4, V4.6 Build 19; Postprocessing SW: SEMCAD, V1.8 Build 159

Face-Held SAR - 2.5 cm Separation Distance from Front of DUT to Planar Phantom/Area Scan (7x12x1):
 Measurement grid: dx=15mm, dy=15mm

Face-Held SAR - 2.5 cm Separation Distance from Front of DUT to Planar Phantom/Zoom Scan (5x5x7)/Cube 0:
 Measurement grid: dx=7.5mm, dy=7.5mm, dz=5mm
 Reference Value = 32.6 V/m; Power Drift = -0.494 dB
 Peak SAR (extrapolated) = 1.38 W/kg
SAR(1 g) = 0.871 mW/g; SAR(10 g) = 0.610 mW/g

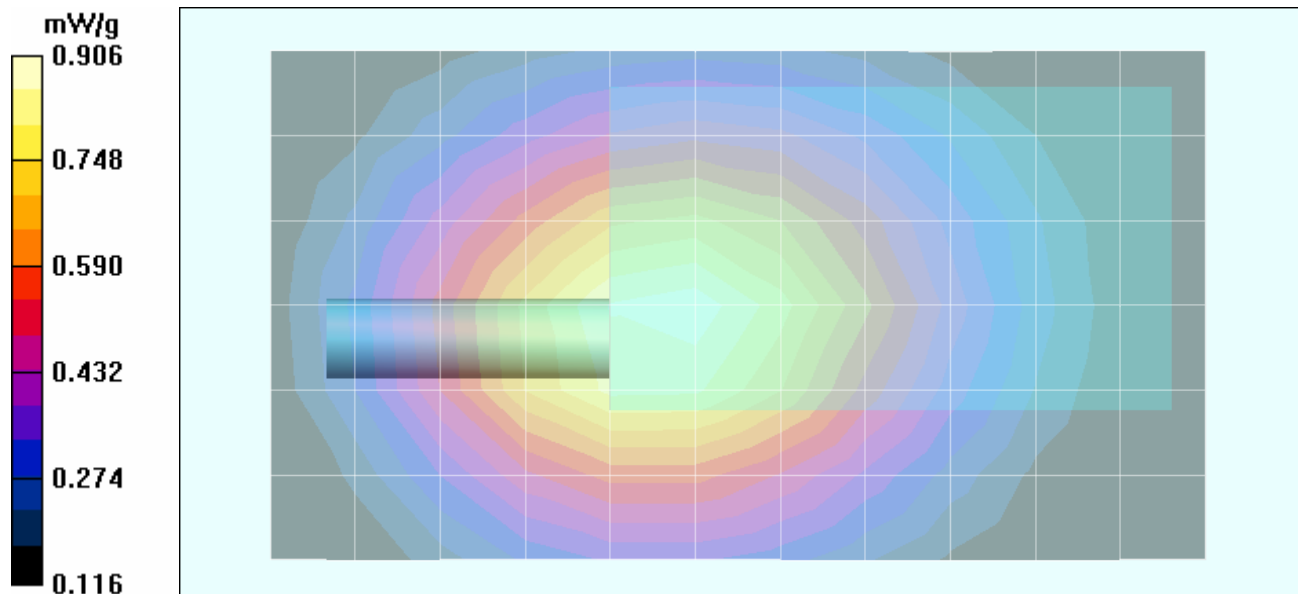

Applicant:	Cobra Electronics Corporation	FCC ID:	BBOPR255	IC ID:	906B-PR255	
Models:	PR255, PR256, PR650, PR656	Portable FRS/GMRS PTT Radio Transceiver		462.5500 - 467.7125 MHz		
2005 Celltech Labs Inc.	This document is not to be reproduced in whole or in part without the prior written permission of Celltech Labs Inc.					Page 20 of 44

	Test Report Serial No.:	093005BBO-T670-S95U	Report Issue Date:	Oct. 17, 2005
	Date(s) of Evaluation:	October 06-07, 2005	Report Rev. No.:	Revision 0
	Description of Tests:	RF Exposure SAR	FCC §2.1093	IC RSS-102

Date Tested: 10/06/2005

Body-Worn SAR - Alkaline (Duracell Procell) AAA Batteries

DUT: Cobra Model: PR650; Type: Portable UHF FRS/GMRS PTT Radio Transceiver; Serial: H509000008

Body-Worn Accessories: Plastic Belt-Clip; Audio Accessories: Earbud with Lapel-Microphone (P/N: GA-EBM2)

Ambient Temp: 23.2 °C; Fluid Temp: 23.0 °C; Barometric Pressure: 101.6 kPa; Humidity: 34%

Communication System: FM UHF
 RF Output Power: 1.27 Watts (ERP)
 Frequency: 462.7125 MHz; GMRS Ch. 7; Duty Cycle: 1:1
 1.5V 1150mAh Alkaline (Duracell Procell) AAA Batteries (x4)
 Medium: M450 ($\sigma = 0.94$ mho/m; $\epsilon_r = 56.7$; $\rho = 1000$ kg/m³)

- Probe: ET3DV6 - SN1387; ConvF(7.5, 7.5, 7.5); Calibrated: 18/03/2005
- Sensor-Surface: 4mm (Mechanical Surface Detection)
- Electronics: DAE4 Sn353; Calibrated: 15/06/2005
- Phantom: Planar; Type: Plexiglas; Serial: 161
- Measurement SW: DASY4, V4.6 Build 19; Postprocessing SW: SEMCAD, V1.8 Build 159

Body-Worn SAR - 0.6 cm Belt-Clip Separation Distance from Back of DUT to Planar Phantom/Area Scan (7x12x1):
 Measurement grid: dx=15mm, dy=15mm

Body-Worn SAR - 0.6 cm Belt-Clip Separation Distance from Back of DUT to Planar Phantom/Zoom Scan (5x5x7)/Cube 0:
 Measurement grid: dx=7.5mm, dy=7.5mm, dz=5mm
 Reference Value = 44.9 V/m; Power Drift = -1.30 dB
 Peak SAR (extrapolated) = 3.19 W/kg
SAR(1 g) = 1.95 mW/g; SAR(10 g) = 1.32 mW/g

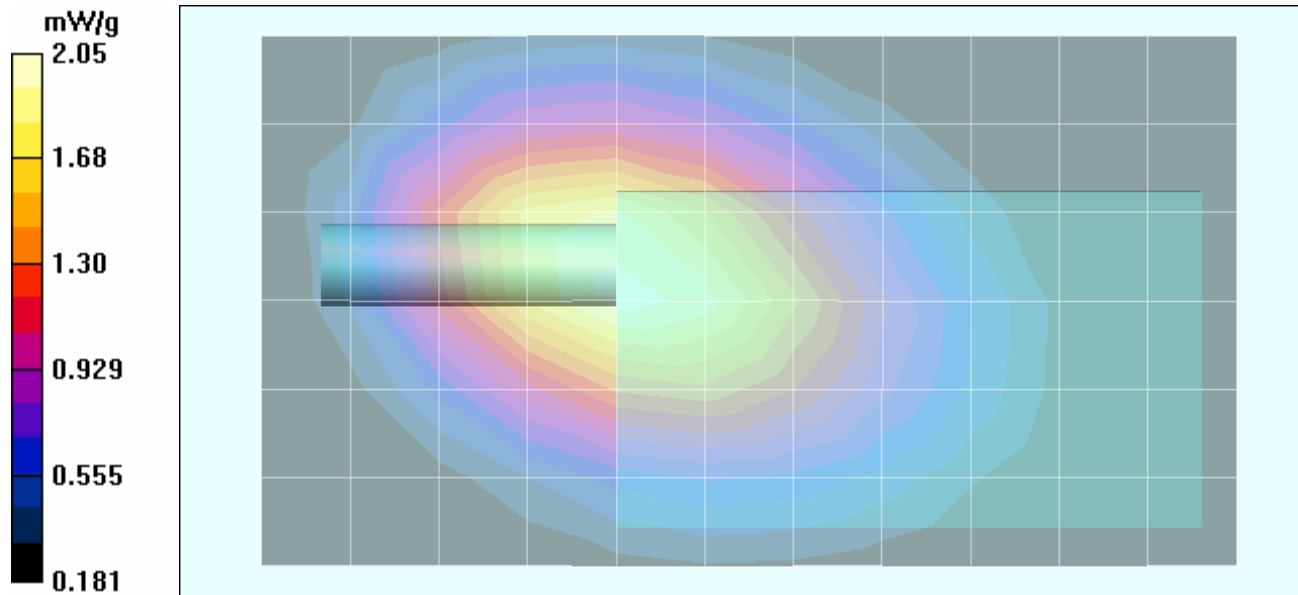

Applicant:	Cobra Electronics Corporation	FCC ID:	BBOPR255	IC ID:	906B-PR255	
Models:	PR255, PR256, PR650, PR656	Portable FRS/GMRS PTT Radio Transceiver		462.5500 - 467.7125 MHz		
2005 Celltech Labs Inc.	This document is not to be reproduced in whole or in part without the prior written permission of Celltech Labs Inc.					Page 21 of 44

Z-Axis Scan

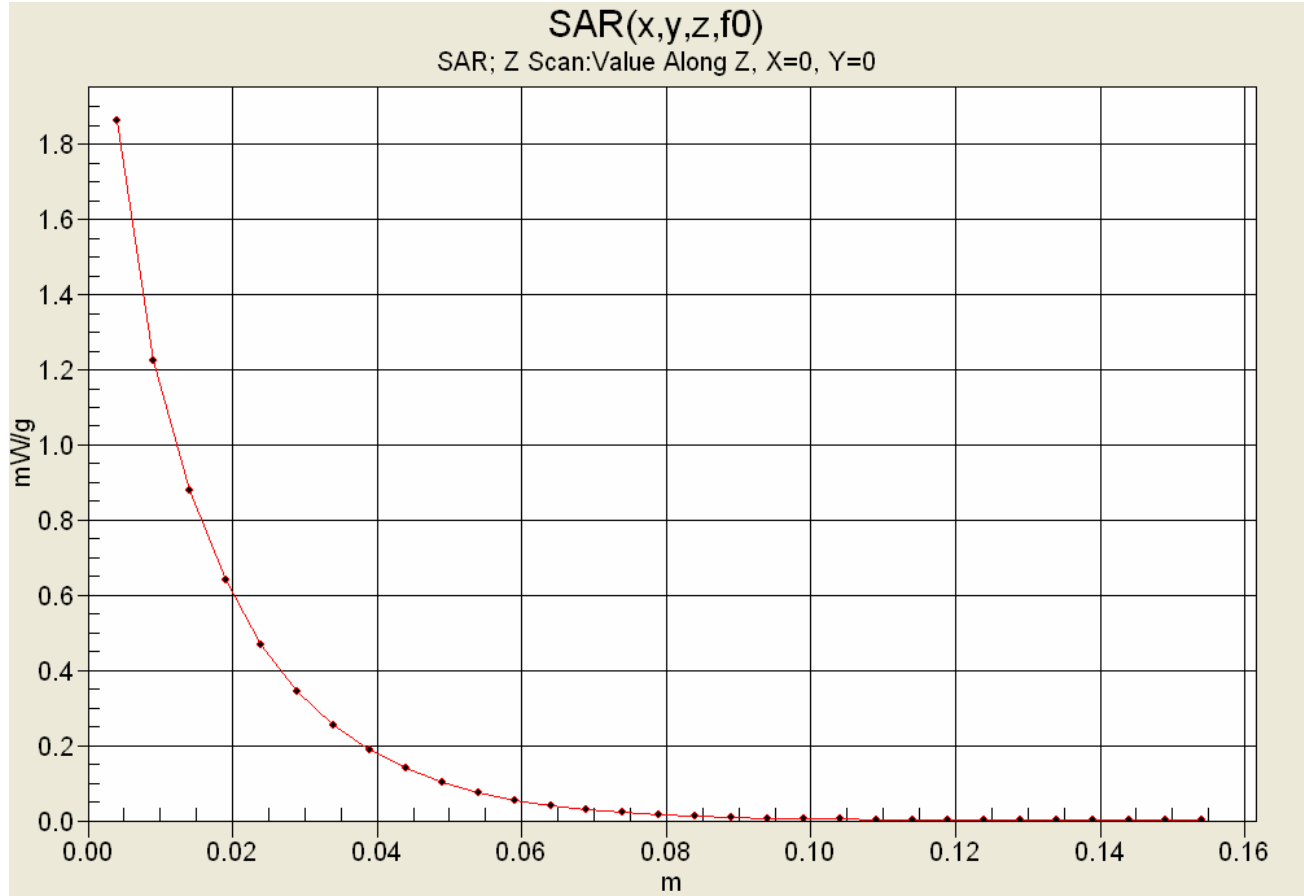

SAR-versus-Time Power Drift Evaluation

Body-Worn Configuration with belt-clip and ear-mic
 DUT with Alkaline AAA Batteries (Duracell Procell)
 GMRS Channel 7 (462.7125 MHz)

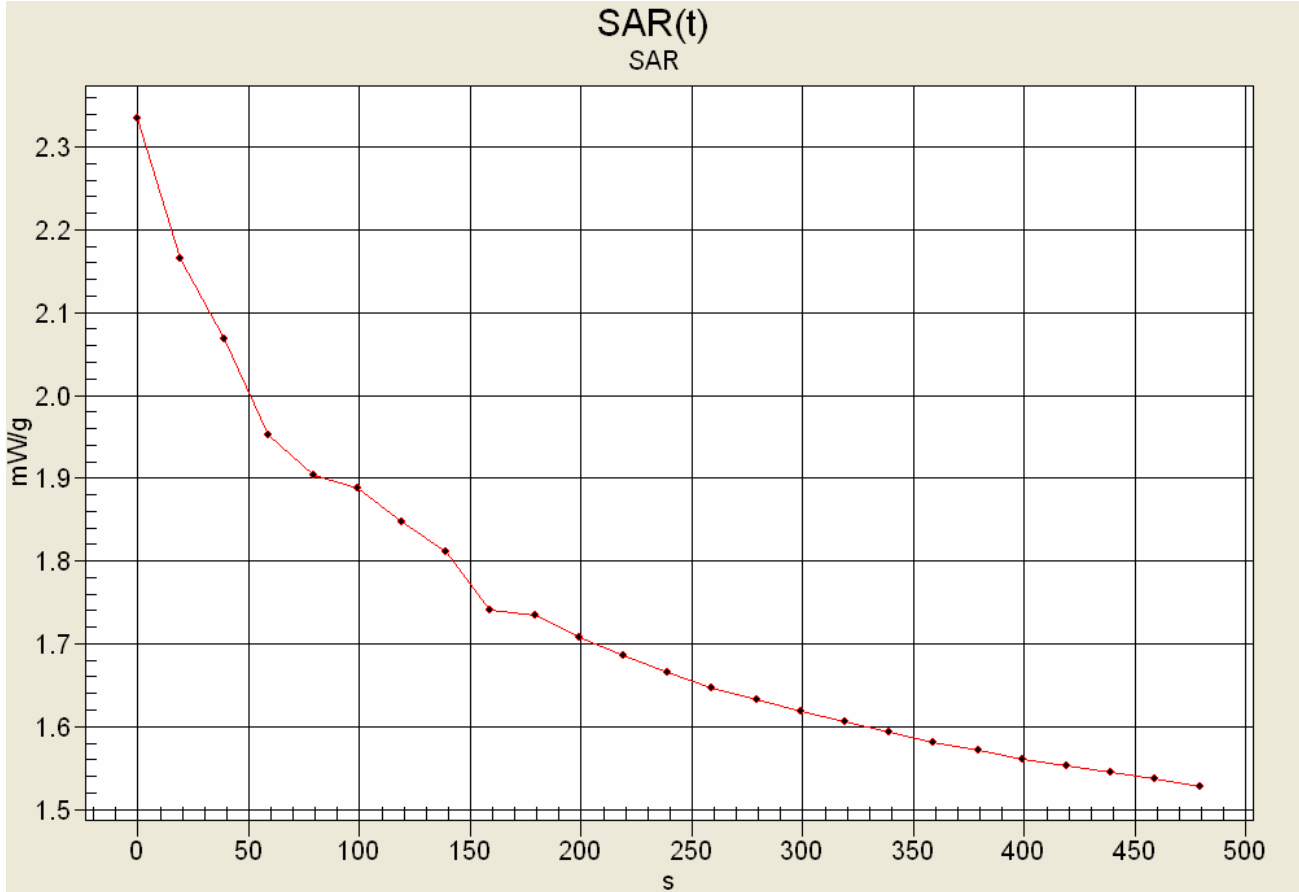

Max SAR: 2.33421 mW/g
 Low SAR: 1.52794 mW/g (-1.840 dB)
 SAR after 340s: 1.59338 mW/g (-1.658 dB)
 (340s = Zoom Scan Duration)
 (480s = Area Scan Duration)

	Test Report Serial No.:	093005BBO-T670-S95U	Report Issue Date:	Oct. 17, 2005
	Date(s) of Evaluation:	October 06-07, 2005	Report Rev. No.:	Revision 0
	Description of Tests:	RF Exposure	SAR	FCC §2.1093

Date Tested: 10/07/2005

Body-Worn SAR - NiMH AAA Batteries

DUT: Cobra Model: PR650; Type: Portable UHF FRS/GMRS PTT Radio Transceiver; Serial: H509000008

Body-Worn Accessories: Plastic Belt-Clip; Audio Accessories: Earbud with Lapel-Microphone (P/N: GA-EBM2)

Ambient Temp: 22.1 °C; Fluid Temp: 22.1 °C; Barometric Pressure: 101.2 kPa; Humidity: 33%

Communication System: FM UHF
 RF Output Power: 1.27 Watts (ERP)
 Frequency: 462.7125 MHz; GMRS Ch. 7; Duty Cycle: 1:1
 1.2V 750mAh NiMH AAA Batteries (x4)
 Medium: M450 ($\sigma = 0.95$ mho/m; $\epsilon_r = 57.3$; $\rho = 1000$ kg/m³)

- Probe: ET3DV6 - SN1387; ConvF(7.5, 7.5, 7.5); Calibrated: 18/03/2005
- Sensor-Surface: 4mm (Mechanical Surface Detection)
- Electronics: DAE4 Sn353; Calibrated: 15/06/2005
- Phantom: Planar; Type: Plexiglas; Serial: 161
- Measurement SW: DASy4, V4.6 Build 19; Postprocessing SW: SEMCAD, V1.8 Build 159

Body-Worn SAR - 0.6 cm Belt-Clip Separation Distance from Back of DUT to Planar Phantom/Area Scan (7x12x1):
 Measurement grid: dx=15mm, dy=15mm

Body-Worn SAR - 0.6 cm Belt-Clip Separation Distance from Back of DUT to Planar Phantom/Zoom Scan (5x5x7)/Cube 0:
 Measurement grid: dx=7.5mm, dy=7.5mm, dz=5mm
 Reference Value = 44.2 V/m; Power Drift = -0.753 dB
 Peak SAR (extrapolated) = 3.46 W/kg
SAR(1 g) = 2.09 mW/g; SAR(10 g) = 1.4 mW/g

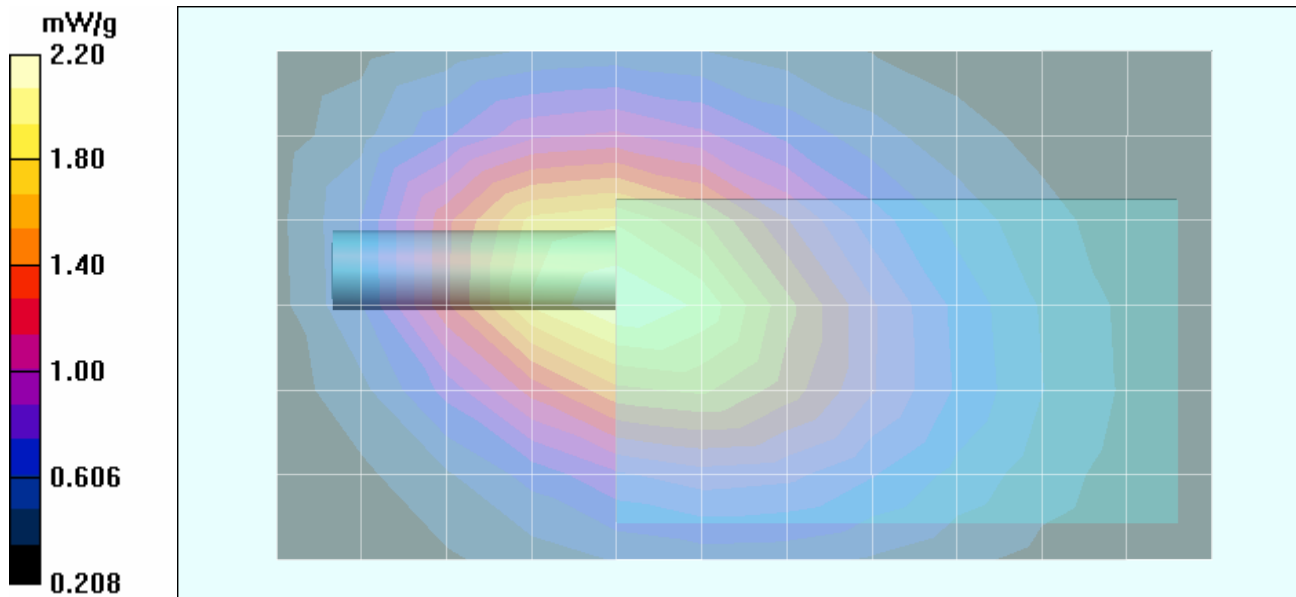

Applicant:	Cobra Electronics Corporation	FCC ID:	BBOPR255	IC ID:	906B-PR255	
Models:	PR255, PR256, PR650, PR656	Portable FRS/GMRS PTT Radio Transceiver		462.5500 - 467.7125 MHz		
2005 Celltech Labs Inc.	This document is not to be reproduced in whole or in part without the prior written permission of Celltech Labs Inc.					Page 24 of 44

Z-Axis Scan

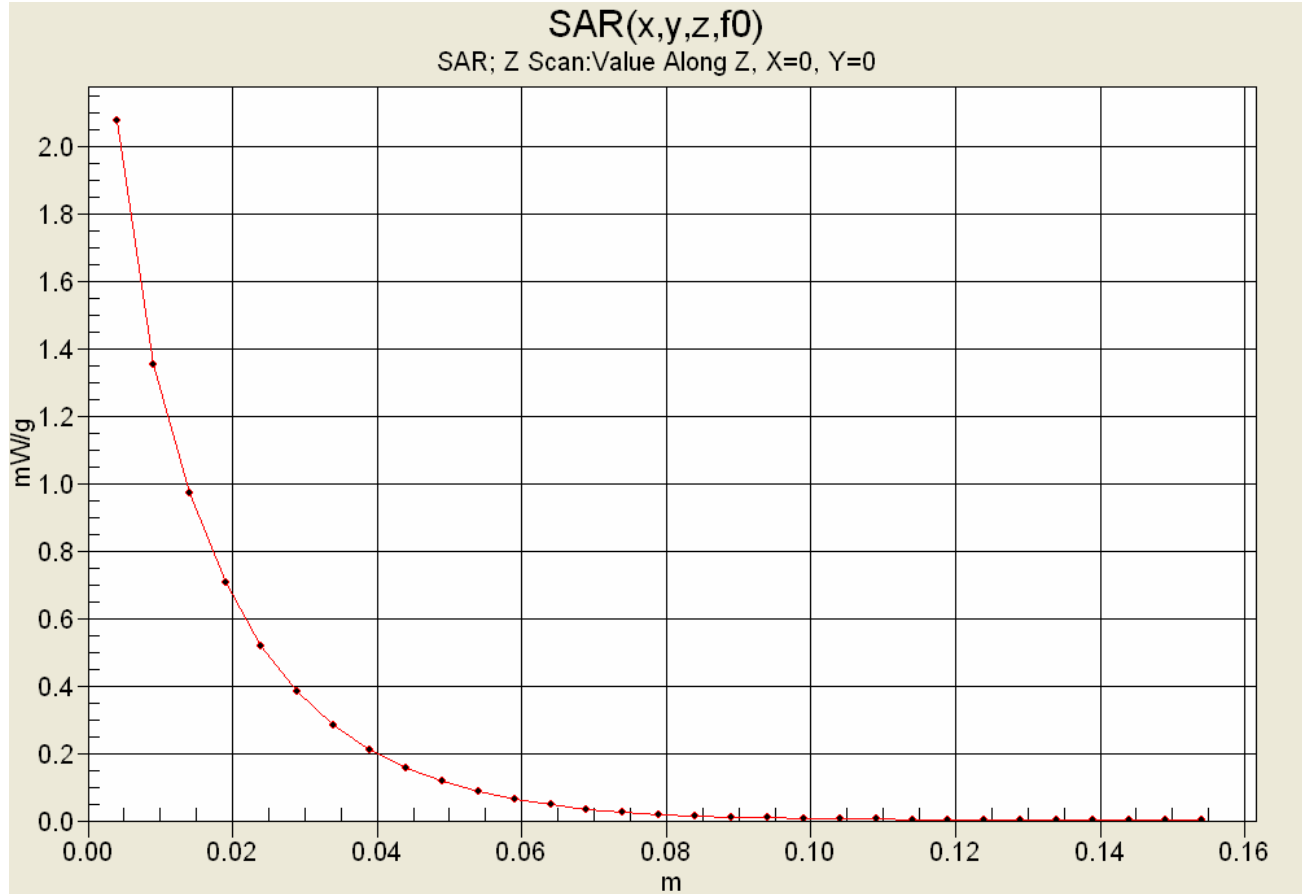

	Test Report Serial No.:	093005BBO-T670-S95U	Report Issue Date:	Oct. 17, 2005
	Date(s) of Evaluation:	October 06-07, 2005	Report Rev. No.:	Revision 0
	Description of Tests:	RF Exposure	SAR	FCC §2.1093

Date Tested: 10/07/2005

Body-Worn SAR - NiCd AAA Batteries

DUT: Cobra Model: PR650; Type: Portable UHF FRS/GMRS PTT Radio Transceiver; Serial: H509000008

Body-Worn Accessories: Plastic Belt-Clip; Audio Accessories: Earbud with Lapel-Microphone (P/N: GA-EBM2)

Ambient Temp: 22.1 °C; Fluid Temp: 22.1 °C; Barometric Pressure: 101.2 kPa; Humidity: 33%

Communication System: FM UHF
 RF Output Power: 1.27 Watts (ERP)
 Frequency: 462.7125 MHz; GMRS Ch. 7; Duty Cycle: 1:1
 1.2V 300mAh NiCd AAA Batteries (x4)
 Medium: M450 ($\sigma = 0.95 \text{ mho/m}$; $\epsilon_r = 57.3$; $\rho = 1000 \text{ kg/m}^3$)

- Probe: ET3DV6 - SN1387; ConvF(7.5, 7.5, 7.5); Calibrated: 18/03/2005
- Sensor-Surface: 4mm (Mechanical Surface Detection)
- Electronics: DAE4 Sn353; Calibrated: 15/06/2005
- Phantom: Planar; Type: Plexiglas; Serial: 161
- Measurement SW: DASY4, V4.6 Build 19; Postprocessing SW: SEMCAD, V1.8 Build 159

Body-Worn SAR - 0.6 cm Belt-Clip Separation Distance from Back of DUT to Planar Phantom/Area Scan (7x12x1):
 Measurement grid: dx=15mm, dy=15mm

Body-Worn SAR - 0.6 cm Belt-Clip Separation Distance from Back of DUT to Planar Phantom/Zoom Scan (5x5x7)/Cube 0:
 Measurement grid: dx=7.5mm, dy=7.5mm, dz=5mm
 Reference Value = 44.9 V/m; Power Drift = -0.883 dB
 Peak SAR (extrapolated) = 3.38 W/kg
SAR(1 g) = 2.06 mW/g; SAR(10 g) = 1.39 mW/g

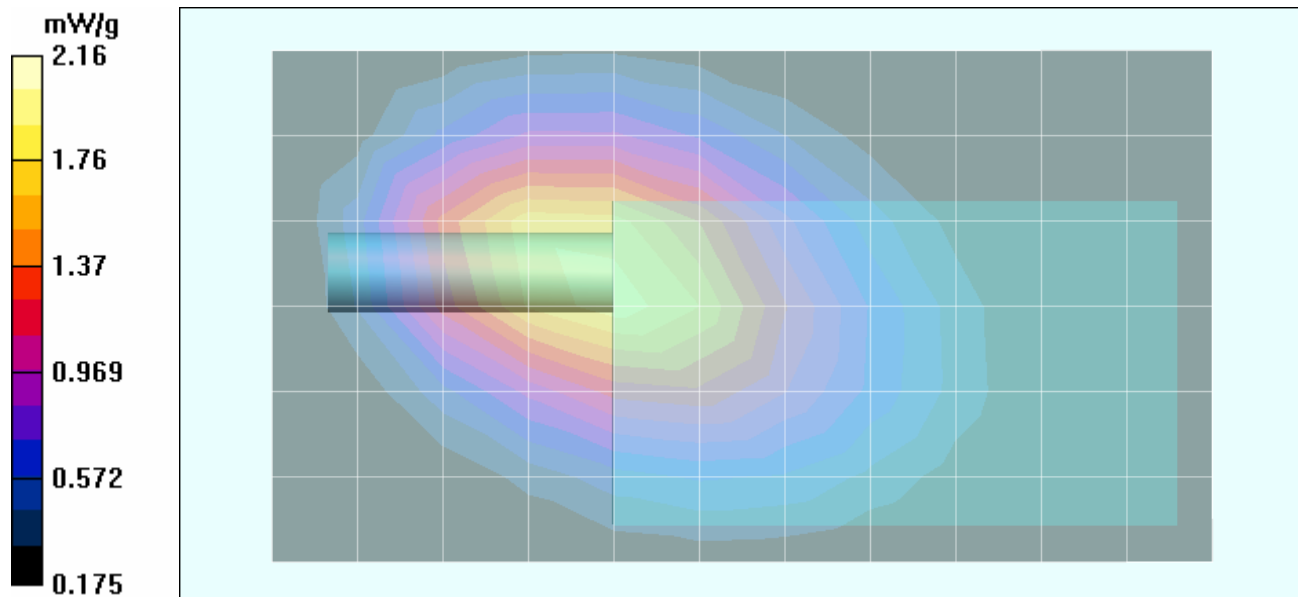

Applicant:	Cobra Electronics Corporation	FCC ID:	BBOPR255	IC ID:	906B-PR255	
Models:	PR255, PR256, PR650, PR656	Portable FRS/GMRS PTT Radio Transceiver		462.5500 - 467.7125 MHz		
2005 Celltech Labs Inc.	This document is not to be reproduced in whole or in part without the prior written permission of Celltech Labs Inc.					Page 26 of 44

	Test Report Serial No.:	093005BBO-T670-S95U	Report Issue Date:	Oct. 17, 2005
	Date(s) of Evaluation:	October 06-07, 2005	Report Rev. No.:	Revision 0
	Description of Tests:	RF Exposure SAR	FCC §2.1093	IC RSS-102

APPENDIX B - SYSTEM PERFORMANCE CHECK DATA

Applicant:	Cobra Electronics Corporation	FCC ID:	BBOPR255	IC ID:	906B-PR255	
Models:	PR255, PR256, PR650, PR656	Portable FRS/GMRS PTT Radio Transceiver		462.5500 - 467.7125 MHz		
2005 Celltech Labs Inc.	This document is not to be reproduced in whole or in part without the prior written permission of Celltech Labs Inc.					Page 27 of 44

	Test Report Serial No.:	093005BBO-T670-S95U	Report Issue Date:	Oct. 17, 2005
	Date(s) of Evaluation:	October 06-07, 2005	Report Rev. No.:	Revision 0
	Description of Tests:	RF Exposure	SAR	FCC §2.1093

Date Tested: 10/06/2005

System Performance Check (Brain) - 450 MHz Dipole

DUT: Dipole 450 MHz; Model: D450V2; Type: System Performance Check; Serial: 136; Calibrated: 11/04/2004

Ambient Temp: 23.3 °C; Fluid Temp: 22.8 °C; Barometric Pressure: 101.8 kPa; Humidity: 32%

Communication System: CW
 Forward Conducted Power: 250 mW
 Frequency: 450 MHz; Duty Cycle: 1:1
 Medium: HSL450 ($\sigma = 0.84$ mho/m; $\epsilon_r = 42.9$; $\rho = 1000$ kg/m³)

- Probe: ET3DV6 - SN1387; ConvF(7.5, 7.5, 7.5); Calibrated: 18/03/2005
- Sensor-Surface: 4mm (Mechanical Surface Detection)
- Electronics: DAE4 Sn353; Calibrated: 15/06/2005
- Phantom: Validation Planar; Type: Plexiglas; Serial: 137
- Measurement SW: DASY4, V4.6 Build 19; Postprocessing SW: SEMCAD, V1.8 Build 159

450 MHz Dipole - System Performance Check/Area Scan (6x11x1):

Measurement grid: dx=15mm, dy=15mm

450 MHz Dipole - System Performance Check/Zoom Scan (7x7x7)/Cube 0:

Measurement grid: dx=5mm, dy=5mm, dz=5mm
 Reference Value = 40.6 V/m; Power Drift = 0.022 dB
 Peak SAR (extrapolated) = 2.35 W/kg
SAR(1 g) = 1.34 mW/g; SAR(10 g) = 0.856 mW/g

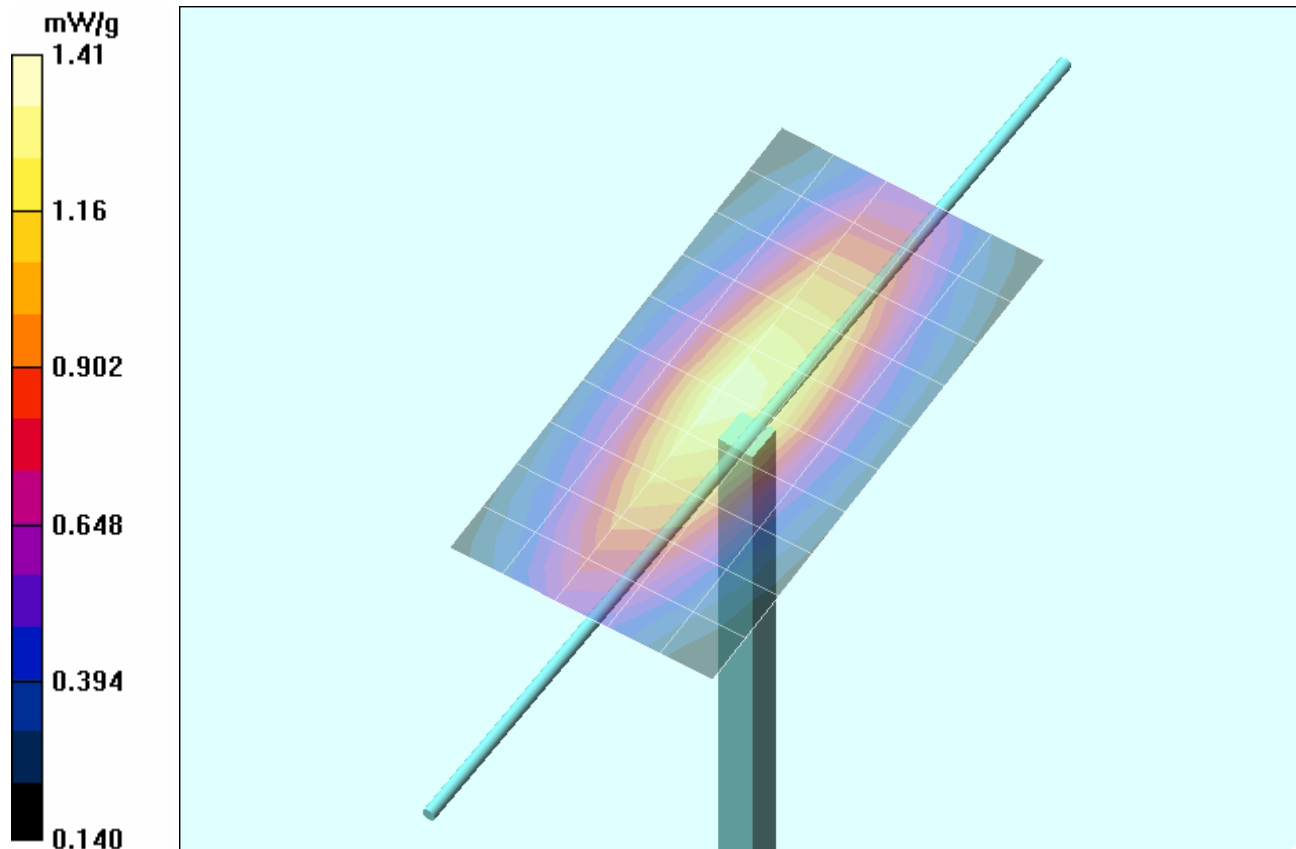

Applicant:	Cobra Electronics Corporation	FCC ID:	BBOPR255	IC ID:	906B-PR255	
Models:	PR255, PR256, PR650, PR656	Portable FRS/GMRS PTT Radio Transceiver		462.5500 - 467.7125 MHz		
2005 Celltech Labs Inc.	This document is not to be reproduced in whole or in part without the prior written permission of Celltech Labs Inc.					Page 28 of 44

Z-Axis Scan

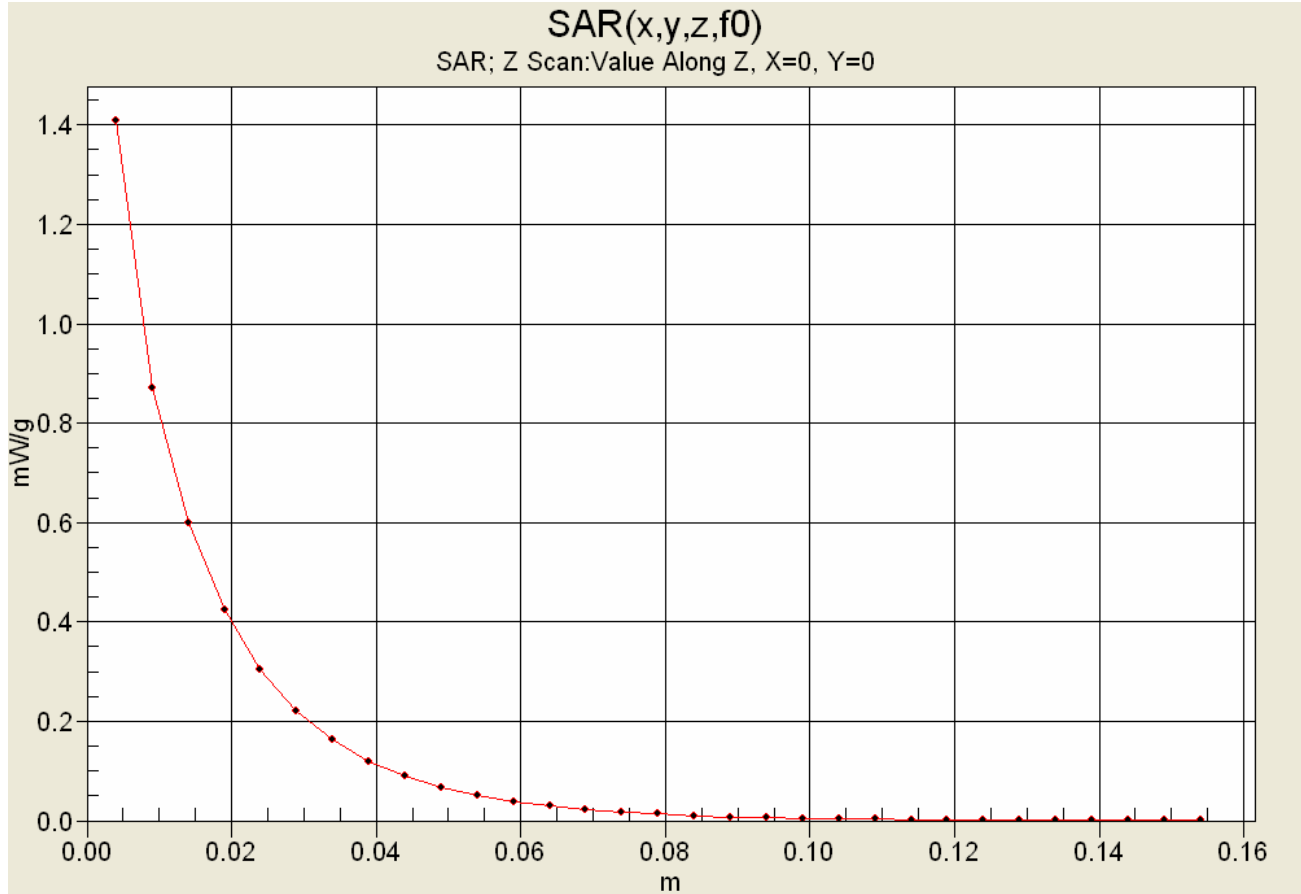

	Test Report Serial No.:	093005BBO-T670-S95U	Report Issue Date:	Oct. 17, 2005
	Date(s) of Evaluation:	October 06-07, 2005	Report Rev. No.:	Revision 0
	Description of Tests:	RF Exposure SAR	FCC §2.1093	IC RSS-102

APPENDIX C - MEASURED FLUID DIELECTRIC PARAMETERS

Applicant:	Cobra Electronics Corporation	FCC ID:	BBOPR255	IC ID:	906B-PR255	
Models:	PR255, PR256, PR650, PR656	Portable FRS/GMRS PTT Radio Transceiver		462.5500 - 467.7125 MHz		
2005 Celltech Labs Inc.	This document is not to be reproduced in whole or in part without the prior written permission of Celltech Labs Inc.					Page 30 of 44

	Test Report Serial No.:	093005BBO-T670-S95U	Report Issue Date:	Oct. 17, 2005
	Date(s) of Evaluation:	October 06-07, 2005	Report Rev. No.:	Revision 0
	Description of Tests:	RF Exposure	SAR	FCC §2.1093

450 MHz System Performance Check (Brain)

Celltech Labs Inc.
 Test Result for UIM Dielectric Parameter
 Thu 06/Oct/2005
 Frequency(GHz)
 FCC_eHFCC OET 65 Supplement C (June 2001) Limits for Head Epsilon
 FCC_sHFCC OET 65 Supplement C (June 2001) Limits for Head Sigma
 Test_e Epsilon of UIM
 Test_s Sigma of UIM

Freq	FCC_eHFCC_sH	Test_e	Test_s
0.3500	44.70	0.87	45.38
0.3600	44.58	0.87	44.74
0.3700	44.46	0.87	44.71
0.3800	44.34	0.87	44.22
0.3900	44.22	0.87	44.23
0.4000	44.10	0.87	44.12
0.4100	43.98	0.87	43.77
0.4200	43.86	0.87	43.47
0.4300	43.74	0.87	43.48
0.4400	43.62	0.87	43.16
0.4500	43.50	0.87	42.93
0.4600	43.45	0.87	42.77
0.4700	43.40	0.87	42.49
0.4800	43.34	0.87	42.28
0.4900	43.29	0.87	42.06
0.5000	43.24	0.87	41.89
0.5100	43.19	0.87	41.56
0.5200	43.14	0.88	41.47
0.5300	43.08	0.88	41.45
0.5400	43.03	0.88	41.19
0.5500	42.98	0.88	41.12

Applicant:	Cobra Electronics Corporation	FCC ID:	BBOPR255	IC ID:	906B-PR255	
Models:	PR255, PR256, PR650, PR656	Portable FRS/GMRS PTT Radio Transceiver		462.5500 - 467.7125 MHz		
2005 Celltech Labs Inc.		This document is not to be reproduced in whole or in part without the prior written permission of Celltech Labs Inc.				Page 31 of 44

	Test Report Serial No.:	093005BBO-T670-S95U	Report Issue Date:	Oct. 17, 2005
	Date(s) of Evaluation:	October 06-07, 2005	Report Rev. No.:	Revision 0
	Description of Tests:	RF Exposure	SAR	FCC §2.1093

450 MHz DUT Evaluation (Body)

Celltech Labs Inc.
 Test Result for UIM Dielectric Parameter
 Thu 06/Oct/2005
 Frequency(GHz)
 FCC_eHFCC Bulletin 65 Supplement C (June 2001) Limits for Head Epsilon
 FCC_sHFCC Bulletin 65 Supplement C (June 2001) Limits for Head Sigma
 FCC_eB FCC Limits for Body Epsilon
 FCC_sB FCC Limits for Body Sigma
 Test_e Epsilon of UIM
 Test_s Sigma of UIM

Freq	FCC_eB	FCC_sB	Test_e	Test_s
0.3500	57.70	0.93	58.29	0.8593
0.3600	57.60	0.93	57.64	0.8656
0.3700	57.50	0.93	57.63	0.8805
0.3800	57.40	0.93	57.55	0.8865
0.3900	57.30	0.93	57.47	0.8976
0.4000	57.20	0.93	57.32	0.8997
0.4100	57.10	0.93	57.31	0.9101
0.4200	57.00	0.94	56.96	0.9180
0.4300	56.90	0.94	56.79	0.9224
0.4400	56.80	0.94	56.74	0.9289
0.4500	56.70	0.94	56.74	0.9420
0.4600	56.66	0.94	56.55	0.9529
0.4700	56.62	0.94	56.25	0.9531
0.4800	56.58	0.94	56.07	0.9687
0.4900	56.54	0.94	56.30	0.9688
0.5000	56.51	0.94	55.92	0.9818
0.5100	56.47	0.94	55.50	0.9928
0.5200	56.43	0.95	55.70	1.000
0.5300	56.39	0.95	55.42	1.007
0.5400	56.35	0.95	55.38	1.014
0.5500	56.31	0.95	55.39	1.024

	Test Report Serial No.:	093005BBO-T670-S95U	Report Issue Date:	Oct. 17, 2005
	Date(s) of Evaluation:	October 06-07, 2005	Report Rev. No.:	Revision 0
	Description of Tests:	RF Exposure SAR	FCC §2.1093	IC RSS-102

450 MHz DUT Evaluation (Face)

Celltech Labs Inc.
Test Result for UIM Dielectric Parameter
Fri 07/Oct/2005
Frequency(GHz)

FCC_eHFCC OET 65 Supplement C (June 2001) Limits for Head Epsilon
FCC_sHFCC OET 65 Supplement C (June 2001) Limits for Head Sigma

Test_e Epsilon of UIM
Test_s Sigma of UIM

Freq	FCC_eHFCC_sH	Test_e	Test_s	
0.3500	44.70	0.87	45.60	0.7515
0.3600	44.58	0.87	45.50	0.7554
0.3700	44.46	0.87	45.26	0.7651
0.3800	44.34	0.87	44.55	0.7733
0.3900	44.22	0.87	44.06	0.7743
0.4000	44.10	0.87	44.01	0.7891
0.4100	43.98	0.87	43.93	0.7926
0.4200	43.86	0.87	43.64	0.7965
0.4300	43.74	0.87	43.56	0.8164
0.4400	43.62	0.87	43.57	0.8219
0.4500	43.50	0.87	43.20	0.8305
0.4600	43.45	0.87	42.81	0.8403
0.4700	43.40	0.87	42.66	0.8433
0.4800	43.34	0.87	42.33	0.8527
0.4900	43.29	0.87	42.15	0.8590
0.5000	43.24	0.87	41.85	0.8699
0.5100	43.19	0.87	41.60	0.8800
0.5200	43.14	0.88	41.51	0.8876
0.5300	43.08	0.88	41.39	0.8994
0.5400	43.03	0.88	41.36	0.9023
0.5500	42.98	0.88	41.23	0.9177

	Test Report Serial No.:	093005BBO-T670-S95U	Report Issue Date:	Oct. 17, 2005
	Date(s) of Evaluation:	October 06-07, 2005	Report Rev. No.:	Revision 0
	Description of Tests:	RF Exposure	SAR	FCC §2.1093

450 MHz DUT Evaluation (Body)

Celltech Labs Inc.
 Test Result for UIM Dielectric Parameter
 Fri 07/Oct/2005
 Frequency(GHz)

FCC_eHFCC Bulletin 65 Supplement C (June 2001) Limits for Head Epsilon
 FCC_sHFCC Bulletin 65 Supplement C (June 2001) Limits for Head Sigma
 FCC_eB FCC Limits for Body Epsilon
 FCC_sB FCC Limits for Body Sigma
 Test_e Epsilon of UIM
 Test_s Sigma of UIM

Freq	FCC_eB	FCC_sB	Test_e	Test_s
0.3500	57.70	0.93	58.80	0.8715
0.3600	57.60	0.93	58.70	0.8732
0.3700	57.50	0.93	58.49	0.8821
0.3800	57.40	0.93	58.26	0.8894
0.3900	57.30	0.93	57.97	0.8950
0.4000	57.20	0.93	57.83	0.9049
0.4100	57.10	0.93	57.62	0.9054
0.4200	57.00	0.94	57.48	0.9181
0.4300	56.90	0.94	57.42	0.9308
0.4400	56.80	0.94	57.37	0.9319
0.4500	56.70	0.94	57.27	0.9495
0.4600	56.66	0.94	56.82	0.9493
0.4700	56.62	0.94	56.85	0.9603
0.4800	56.58	0.94	56.74	0.9648
0.4900	56.54	0.94	56.48	0.9748
0.5000	56.51	0.94	56.30	0.9873
0.5100	56.47	0.94	56.04	0.9941
0.5200	56.43	0.95	55.93	1.004
0.5300	56.39	0.95	55.97	1.009
0.5400	56.35	0.95	55.91	1.011
0.5500	56.31	0.95	55.67	1.032

Applicant:	Cobra Electronics Corporation	FCC ID:	BBOPR255	IC ID:	906B-PR255	
Models:	PR255, PR256, PR650, PR656	Portable FRS/GMRS PTT Radio Transceiver		462.5500 - 467.7125 MHz		
2005 Celltech Labs Inc.		This document is not to be reproduced in whole or in part without the prior written permission of Celltech Labs Inc.				Page 34 of 44

	Test Report Serial No.:	093005BBO-T670-S95U	Report Issue Date:	Oct. 17, 2005
	Date(s) of Evaluation:	October 06-07, 2005	Report Rev. No.:	Revision 0
	Description of Tests:	RF Exposure	SAR	FCC §2.1093

APPENDIX D - SAR TEST SETUP & DUT PHOTOGRAPHS

Applicant:	Cobra Electronics Corporation	FCC ID:	BBOPR255	IC ID:	906B-PR255	
Models:	PR255, PR256, PR650, PR656	Portable FRS/GMRS PTT Radio Transceiver		462.5500 - 467.7125 MHz		
2005 Celltech Labs Inc.	This document is not to be reproduced in whole or in part without the prior written permission of Celltech Labs Inc.					Page 35 of 44

FACE-HELD SAR TEST SETUP PHOTOGRAPHS
2.5 cm Separation Distance from Front of DUT to Planar Phantom

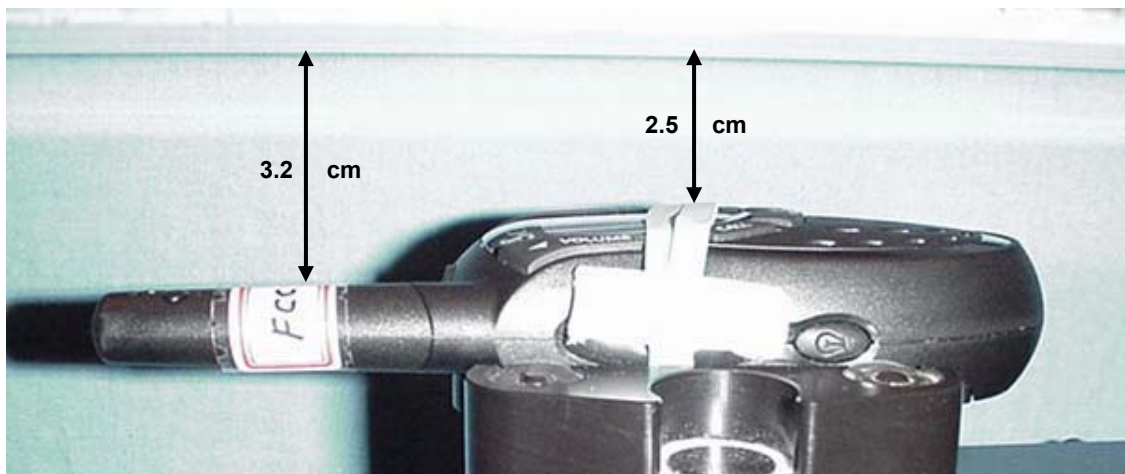

BODY-WORN SAR TEST SETUP PHOTOGRAPHS
0.6 cm Belt-Clip Separation Distance from Back of DUT to Planar Phantom Earbud with Lapel-Microphone Audio Accessory

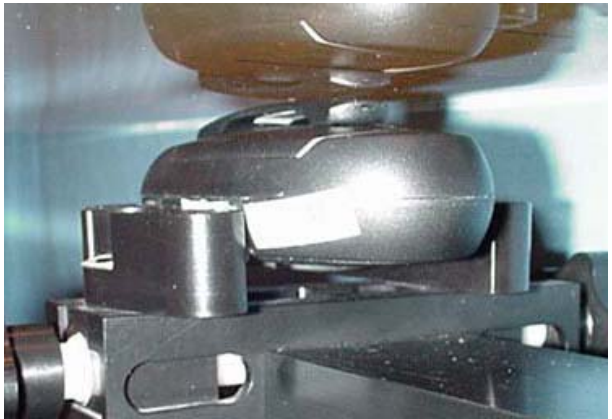
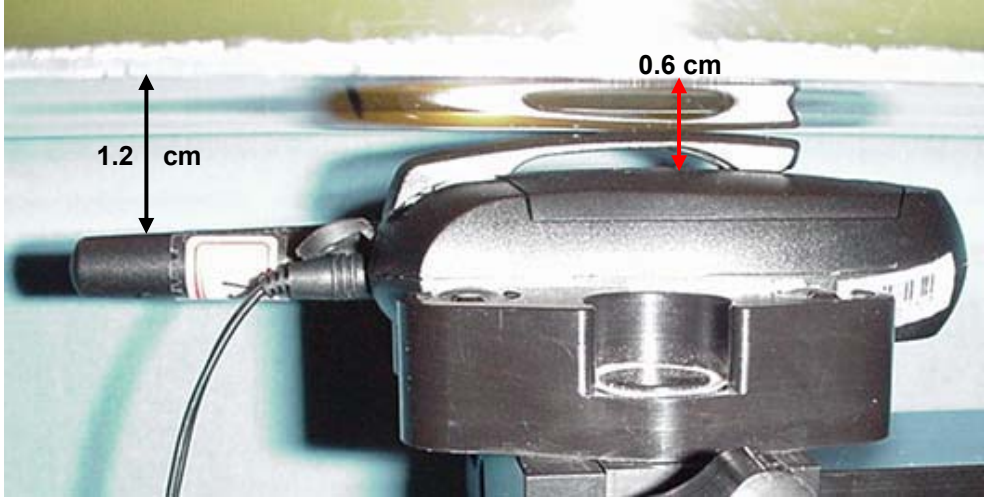

SAR TEST SETUP PHOTOGRAPHS



Face-Held Test Setup Configuration



Body-Worn Test Setup Configuration

DUT PHOTOGRAPHS



Front of DUT



Back of DUT



Back of DUT with Plastic Belt-Clip



Top end of DUT



Bottom end of DUT

	Test Report Serial No.:	093005BBO-T670-S95U	Report Issue Date:	Oct. 17, 2005
	Date(s) of Evaluation:	October 06-07, 2005	Report Rev. No.:	Revision 0
	Description of Tests:	RF Exposure	SAR	FCC §2.1093

DUT PHOTOGRAPHS



Left Side of DUT with Plastic Belt-Clip



Right Side of DUT with Plastic Belt-Clip



Plastic Belt-Clip Accessory (6 mm thickness)

Applicant:	Cobra Electronics Corporation	FCC ID:	BBOPR255	IC ID:	906B-PR255	
Models:	PR255, PR256, PR650, PR656	Portable FRS/GMRS PTT Radio Transceiver		462.5500 - 467.7125 MHz		
2005 Celltech Labs Inc.	This document is not to be reproduced in whole or in part without the prior written permission of Celltech Labs Inc.					Page 40 of 44

DUT PHOTOGRAPHS



DUT with Earbud & Lapel-Microphone Audio Accessory (P/N: GA-EBM2)

DUT PHOTOGRAPHS



DUT Battery Compartment



DUT with Alkaline AAA Batteries



DUT with NiCd AAA Batteries



DUT with NiMH AAA Batteries

	Test Report Serial No.:	093005BBO-T670-S95U	Report Issue Date:	Oct. 17, 2005
	Date(s) of Evaluation:	October 06-07, 2005	Report Rev. No.:	Revision 0
	Description of Tests:	RF Exposure SAR	FCC §2.1093	IC RSS-102

APPENDIX E - SYSTEM VALIDATION

Applicant:	Cobra Electronics Corporation	FCC ID:	BBOPR255	IC ID:	906B-PR255	
Models:	PR255, PR256, PR650, PR656	Portable FRS/GMRS PTT Radio Transceiver		462.5500 - 467.7125 MHz		
2005 Celltech Labs Inc.	This document is not to be reproduced in whole or in part without the prior written permission of Celltech Labs Inc.					Page 43 of 44

450 MHz SYSTEM VALIDATION DIPOLE

Type:

450 MHz Validation Dipole

Serial Number:

136

Place of Calibration:

Celltech Labs Inc.

Date of Calibration:

November 4, 2004

Celltech Labs Inc. hereby certifies that this device has been calibrated on the date indicated above.

Calibrated by:

Spencer Watson

Approved by:

Russell W. Pope

1. Dipole Construction & Electrical Characteristics

The validation dipole was constructed in accordance with the IEEE Std “Recommended Practice for Determining the Spatial-Peak Specific Absorption Rate (SAR) in the Human Body Due to Wireless Communications Devices: Experimental Techniques”. The electrical properties were measured using an HP 8753E Network Analyzer. The network analyzer was calibrated to the validation dipole N-type connector feed point using an HP85032E Type N calibration kit. The dipole was placed parallel to a planar phantom at a separation distance of 15.0mm from the simulating fluid using a loss-less dielectric spacer. The measured input impedance is:

Feed point impedance at 450MHz	$\text{Re}\{Z\} = 54.041\Omega$
	$\text{Im}\{Z\} = 5.5258\Omega$
Return Loss at 450MHz	-23.744dB

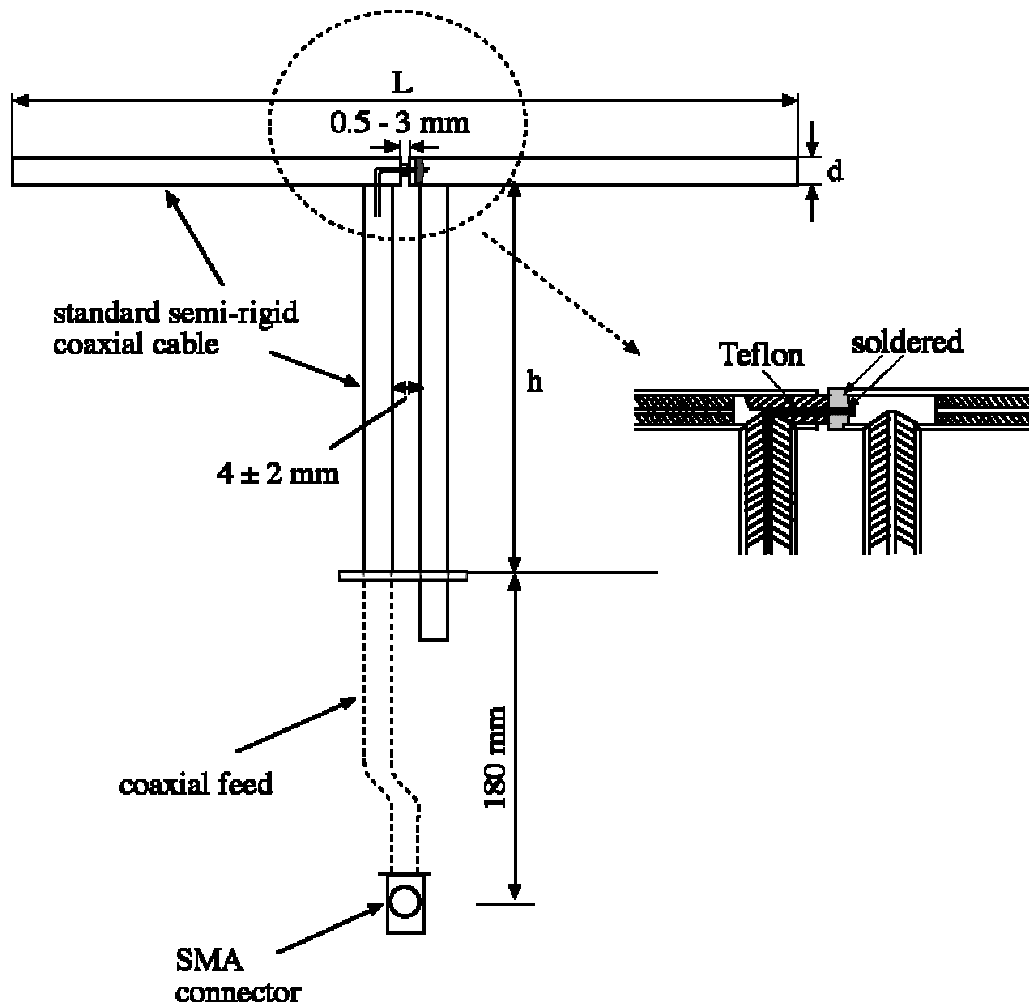

4 Nov 2004 09:03:54

CH1 MEM LOG 10 dB/REF 0 dB

1:-23.744 dB 450.000 000 MHz

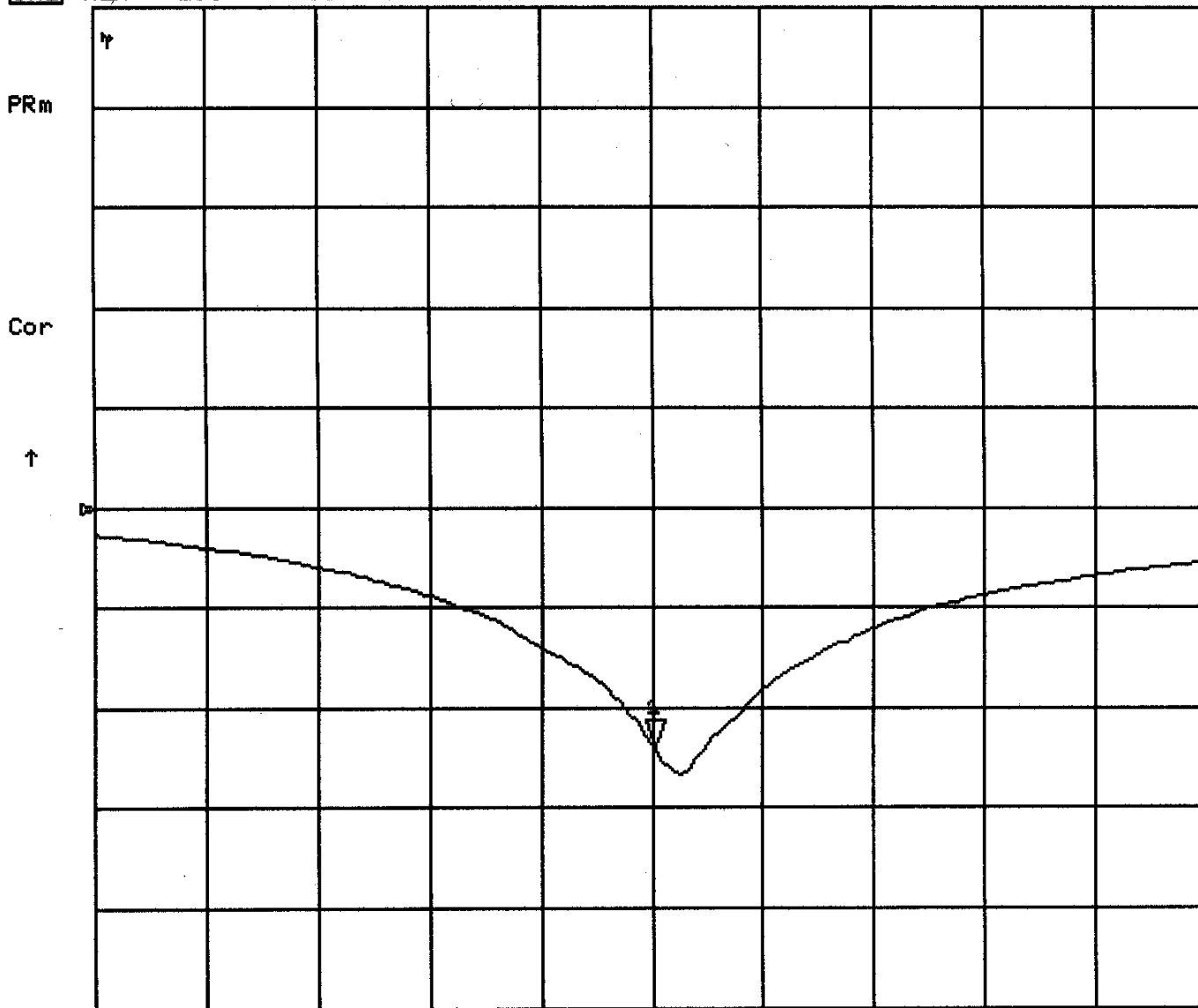

START 350.000 000 MHz

STOP 550.000 000 MHz

4 Nov 2004 09:05:08

CH1 MEM 1 U FS

1: 54.041 Ω 5.4258 Ω 1.9190 nH

450.000 000 MHz

PRm

Cor

↑

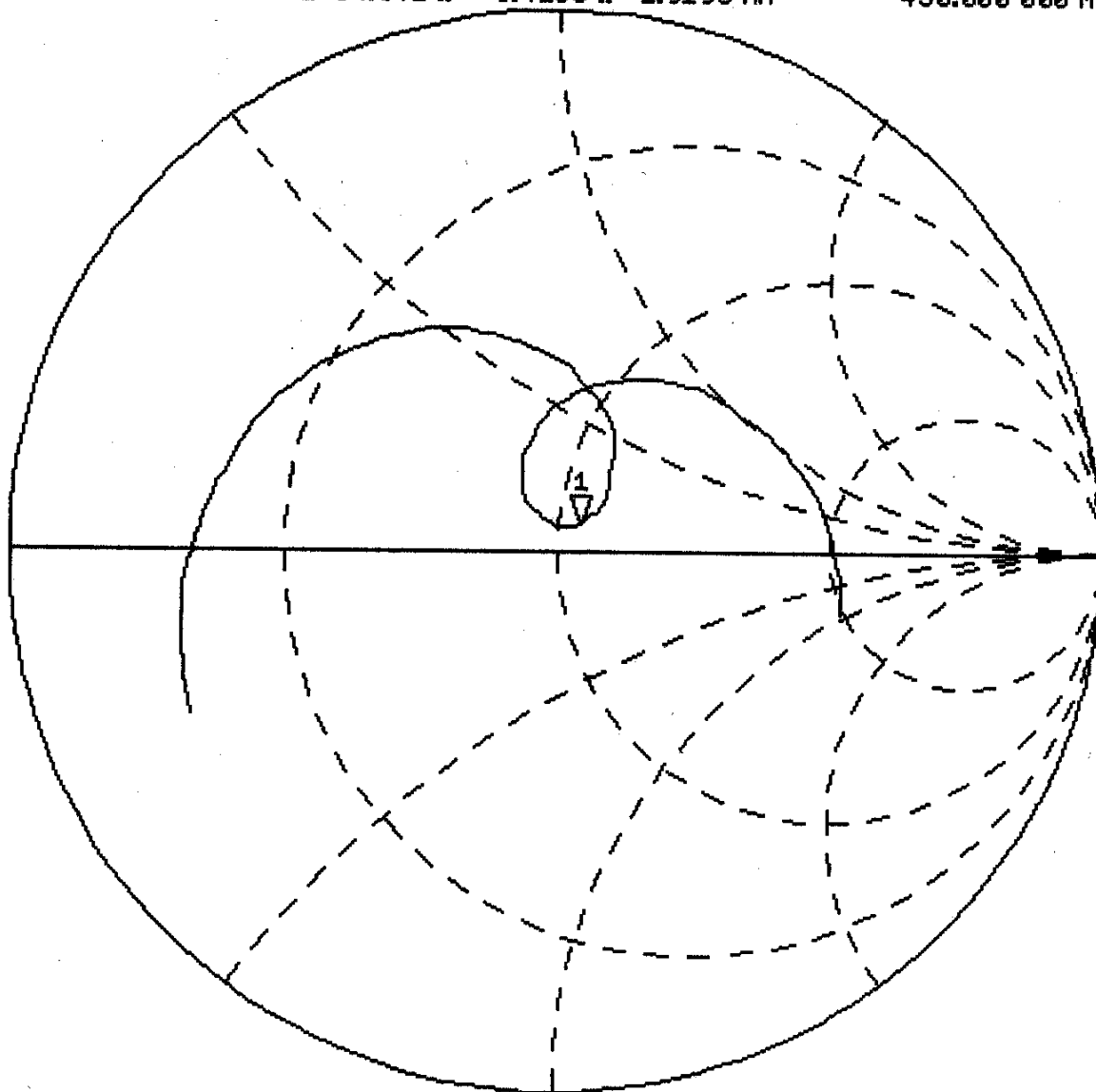

START 350.000 000 MHz

STOP 550.000 000 MHz

2. Validation Dipole Dimensions

Frequency (MHz)	L (mm)	h (mm)	d (mm)
300	420.0	250.0	6.2
450	288.0	167.0	6.2
835	161.0	89.8	3.6
900	149.0	83.3	3.6
1450	89.1	51.7	3.6
1800	72.0	41.7	3.6
1900	68.0	39.5	3.6
2000	64.5	37.5	3.6
2450	51.8	30.6	3.6
3000	41.5	25.0	3.6

3. Validation Phantom

The validation phantom was constructed using relatively low-loss tangent Plexiglas material. The inner dimensions of the phantom are as follows:

Length: 83.5 cm
 Width: 36.9 cm
 Height: 21.8 cm

The bottom section of the validation phantom is constructed of 6.2 ± 0.1 mm Plexiglas.

4. Dimensions of Plexiglas Planar Phantom

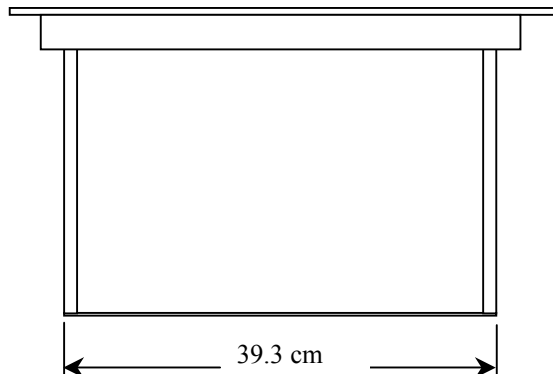
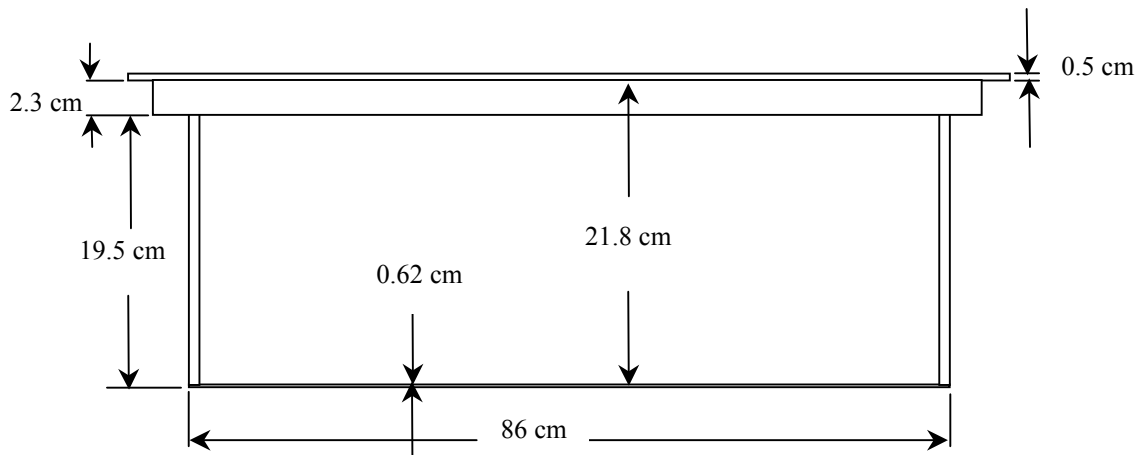
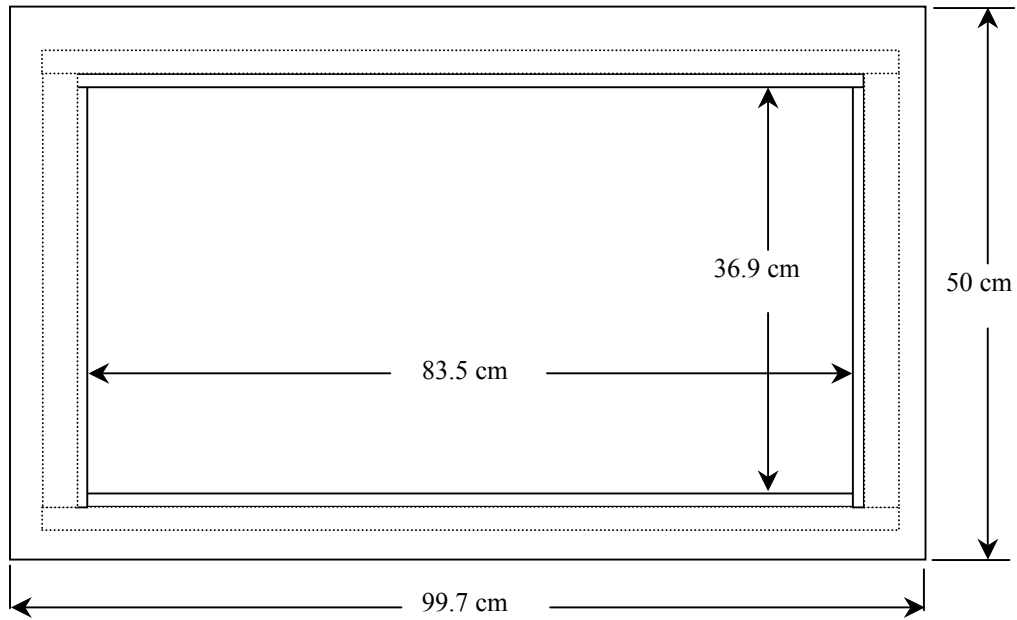

5. 450 MHz System Validation Setup



450 MHz Validation Dipole Setup



6. Measurement Conditions

The planar phantom was filled with brain simulating tissue having the following parameters at 450 MHz:

Relative Permittivity:	42.9
Conductivity:	0.85 mho/m
Fluid Temperature:	21.9 °C
Fluid Depth:	≥ 15.0 cm

Environmental Conditions:

Ambient Temperature:	22.4 °C
Humidity:	31 %
Barometric Pressure:	103.2 kPa

The 450 MHz simulated brain tissue mixture consists of the following ingredients:

Ingredient	Percentage by weight
Water	38.56%
Sugar	56.32%
Salt	3.95%
HEC	0.98%
Dowicil 75	0.19%
450 MHz Target Dielectric Parameters at 22 °C	$\epsilon_r = 43.5$ $\sigma = 0.87 \text{ S/m}$

7. SAR Measurement

The SAR measurement was performed with the E-field probe in mechanical detection mode only. The setup and determination of the forward power into the dipole was performed using the following procedures.

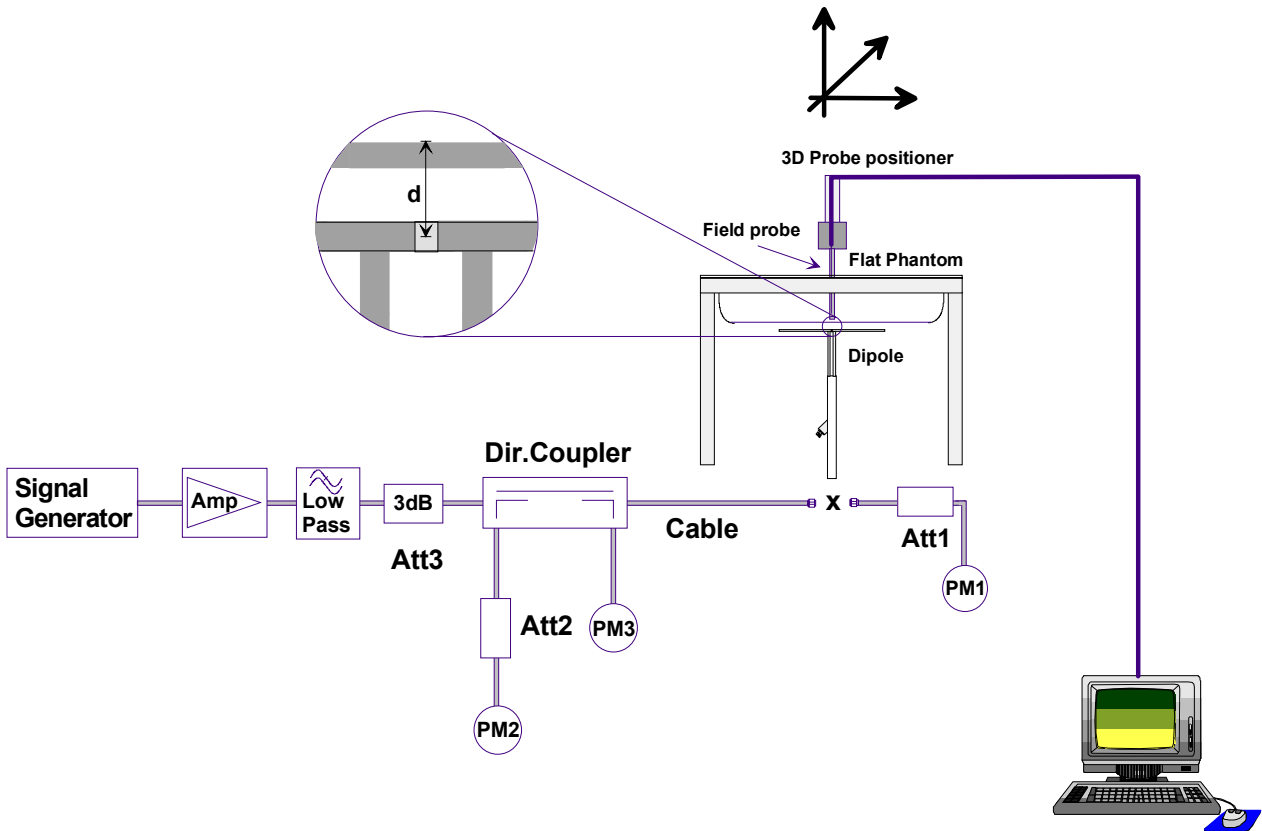

First the power meter PM1 (including attenuator Att1) is connected to the cable to measure the forward power at the location of the dipole connector (X). The signal generator is adjusted for the desired forward power at the dipole connector (taking into account the attenuation of Att1) as read by power meter PM2. After connecting the cable to the dipole, the signal generator is readjusted for the same reading at power meter PM2. If the signal generator does not allow adjustment in 0.01dB steps, the remaining difference at PM2 must be taken into consideration. PM3 records the reflected power from the dipole to ensure that the value is not changed from the previous value. The reflected power should be 20dB below the forward power.

8. Validation Dipole SAR Test Results

Ten SAR measurements were performed in order to achieve repeatability and to establish an average target value.

Validation Measurement	SAR @ 0.25W Input averaged over 1g	SAR @ 1W Input averaged over 1g	SAR @ 0.25W Input averaged over 10g	SAR @ 1W Input averaged over 10g	Peak SAR @ 0.25W Input
Test 1	1.22	4.88	0.782	3.128	1.29
Test 2	1.23	4.92	0.791	3.164	1.30
Test 3	1.23	4.92	0.789	3.156	1.30
Test 4	1.23	4.92	0.790	3.160	1.31
Test 5	1.24	4.96	0.793	3.172	1.31
Test 6	1.24	4.96	0.792	3.168	1.31
Test 7	1.23	4.92	0.791	3.164	1.31
Test 8	1.23	4.92	0.789	3.156	1.30
Test 9	1.24	4.96	0.791	3.164	1.31
Test 10	1.23	4.92	0.789	3.156	1.31
Average Value	1.23	4.93	0.790	3.16	1.31

The results have been normalized to 1W (forward power) into the dipole.

IEEE Target over 1cm³ (1g) of tissue: 4.9 mW/g (+/- 10%)

Averaged over 1cm (1g) of tissue: 4.93 mW/g (deviation +0.6%)

IEEE Target over 10cm³ (10g) of tissue: 3.3 mW/g (+/- 10%)

Averaged over 10cm (10g) of tissue: 3.16 mW/g (deviation -4.2%)

450 MHz System Validation - November 4, 2004

DUT: Dipole 450 MHz; Model: D450V2; Serial: 136; Calibrated: 11/04/2004

Ambient Temp: 22.4 °C; Fluid Temp: 21.9 °C; Barometric Pressure: 103.2 kPa; Humidity: 31%

Communication System: CW

Frequency: 450 MHz; Duty Cycle: 1:1

Medium: HSL450 ($\sigma = 0.85$ mho/m; $\epsilon_r = 42.9$; $\rho = 1000$ kg/m³)

- Probe: ET3DV6 - SN1387; ConvF(7.5, 7.5, 7.5); Calibrated: 18/03/2004

- Sensor-Surface: 4mm (Mechanical Surface Detection)

- Electronics: DAE3 Sn370; Calibrated: 14/05/2004

- Phantom: Validation Planar; Type: Plexiglas; Serial: 137

- Measurement SW: DASY4, V4.3 Build 22; Postprocessing SW: SEMCAD, V1.8 Build 127

450 MHz System Validation/Area Scan (6x11x1): Measurement grid: dx=15mm, dy=15mm

450 MHz System Validation/Zoom Scan (7x7x7)/Cube 0: Measurement grid: dx=5mm, dy=5mm, dz=5mm

Reference Value = 39.3 V/m; Power Drift = -0.1 dB

Peak SAR (extrapolated) = 2.15 W/kg

SAR(1 g) = 1.22 mW/g; SAR(10 g) = 0.782 mW/g

450 MHz System Validation/Zoom Scan 2 (7x7x7)/Cube 0: Measurement grid: dx=5mm, dy=5mm, dz=5mm

Reference Value = 39.2 V/m; Power Drift = -0.0 dB

Peak SAR (extrapolated) = 2.16 W/kg

SAR(1 g) = 1.23 mW/g; SAR(10 g) = 0.791 mW/g

450 MHz System Validation/Zoom Scan 3 (7x7x7)/Cube 0: Measurement grid: dx=5mm, dy=5mm, dz=5mm

Reference Value = 39.1 V/m; Power Drift = -0.004 dB

Peak SAR (extrapolated) = 2.16 W/kg

SAR(1 g) = 1.23 mW/g; SAR(10 g) = 0.789 mW/g

450 MHz System Validation/Zoom Scan 4 (7x7x7)/Cube 0: Measurement grid: dx=5mm, dy=5mm, dz=5mm

Reference Value = 39.2 V/m; Power Drift = -0.0 dB

Peak SAR (extrapolated) = 2.18 W/kg

SAR(1 g) = 1.23 mW/g; SAR(10 g) = 0.790 mW/g

450 MHz System Validation/Zoom Scan 5 (7x7x7)/Cube 0: Measurement grid: dx=5mm, dy=5mm, dz=5mm

Reference Value = 39.2 V/m; Power Drift = 0.009 dB

Peak SAR (extrapolated) = 2.18 W/kg

SAR(1 g) = 1.24 mW/g; SAR(10 g) = 0.793 mW/g

450 MHz System Validation/Zoom Scan 6 (7x7x7)/Cube 0: Measurement grid: dx=5mm, dy=5mm, dz=5mm

Reference Value = 39.1 V/m; Power Drift = 0.007 dB

Peak SAR (extrapolated) = 2.18 W/kg

SAR(1 g) = 1.24 mW/g; SAR(10 g) = 0.792 mW/g

450 MHz System Validation/Zoom Scan 7 (7x7x7)/Cube 0: Measurement grid: dx=5mm, dy=5mm, dz=5mm

Reference Value = 39.2 V/m; Power Drift = 0.004 dB

Peak SAR (extrapolated) = 2.18 W/kg

SAR(1 g) = 1.23 mW/g; SAR(10 g) = 0.791 mW/g

450 MHz System Validation/Zoom Scan 8 (7x7x7)/Cube 0: Measurement grid: dx=5mm, dy=5mm, dz=5mm

Reference Value = 39.2 V/m; Power Drift = 0.0 dB

Peak SAR (extrapolated) = 2.16 W/kg

SAR(1 g) = 1.23 mW/g; SAR(10 g) = 0.789 mW/g

450 MHz System Validation/Zoom Scan 9 (7x7x7)/Cube 0: Measurement grid: dx=5mm, dy=5mm, dz=5mm

Reference Value = 39.4 V/m; Power Drift = 0.0 dB

Peak SAR (extrapolated) = 2.19 W/kg

SAR(1 g) = 1.24 mW/g; SAR(10 g) = 0.791 mW/g

450 MHz System Validation/Zoom Scan 10 (7x7x7)/Cube 0: Measurement grid: dx=5mm, dy=5mm, dz=5mm

Reference Value = 39.1 V/m; Power Drift = 0.007 dB

Peak SAR (extrapolated) = 2.16 W/kg

SAR(1 g) = 1.23 mW/g; SAR(10 g) = 0.789 mW/g

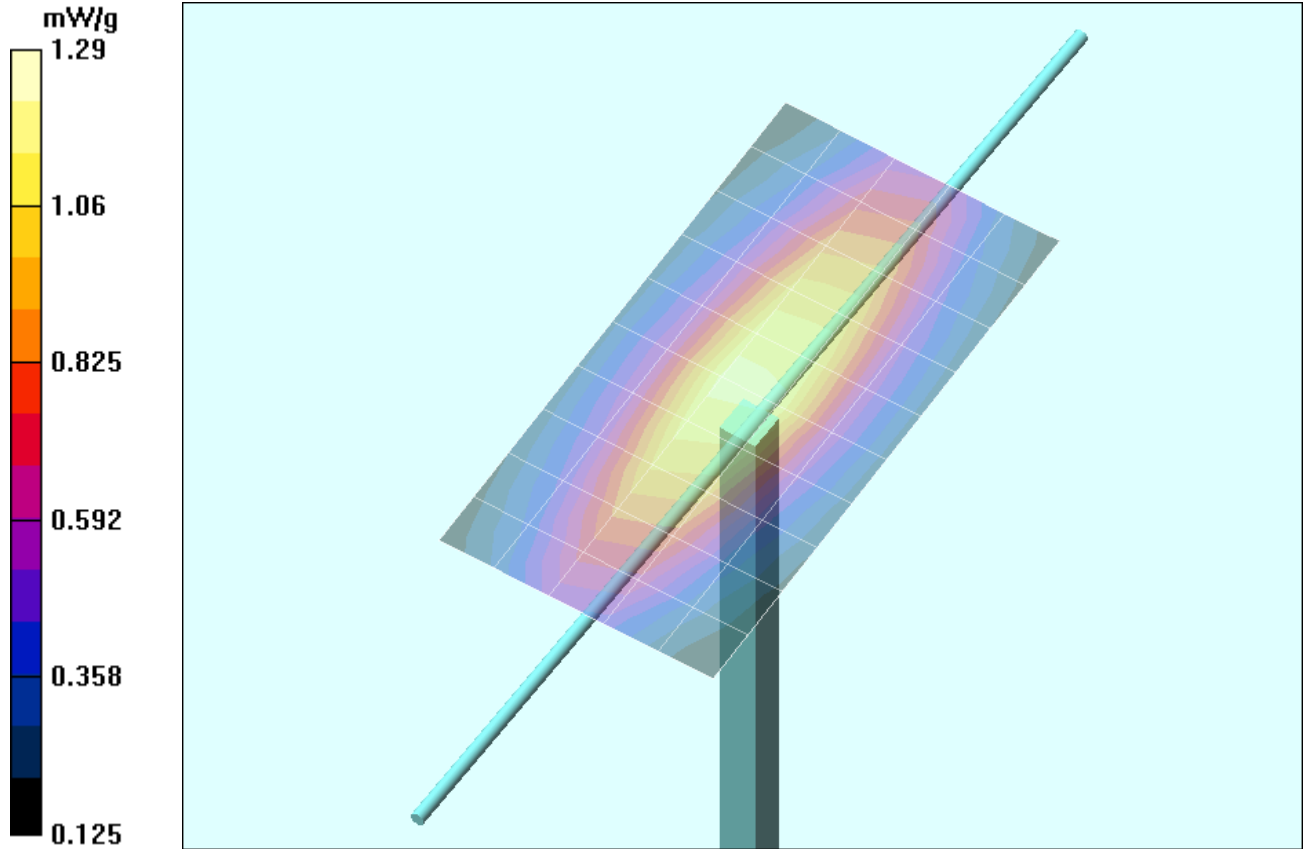

1 g average of 10 measurements: 1.23 mW/g
 10 g average of 10 measurements: 0.790 mW/g

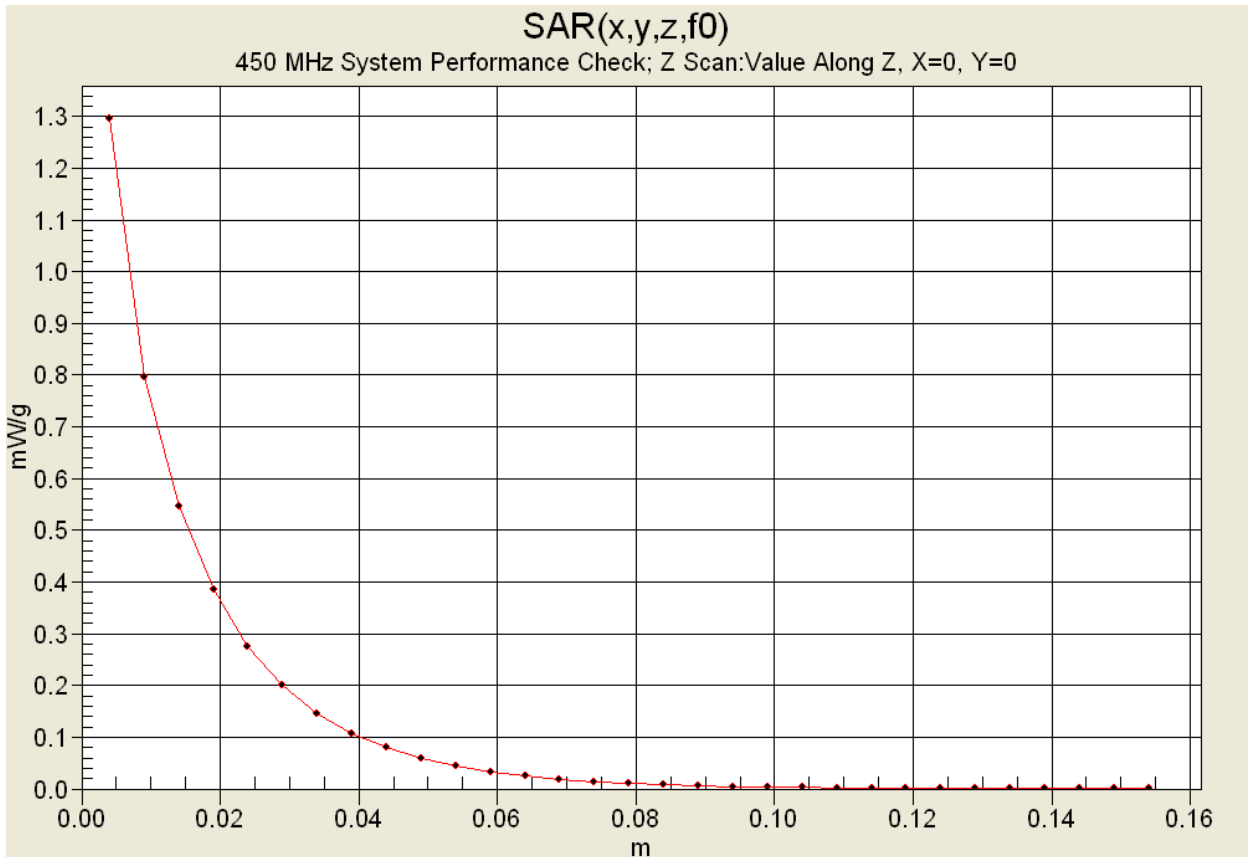

450MHz System Validation

Measured Fluid Dielectric Parameters (Brain)

November 04, 2004

Frequency	ϵ'	ϵ''
350.000000 MHz	45.3974	39.4988
360.000000 MHz	45.0834	38.7858
370.000000 MHz	44.8651	38.1777
380.000000 MHz	44.6622	37.6103
390.000000 MHz	44.3761	37.1472
400.000000 MHz	44.1745	36.5919
410.000000 MHz	43.8392	36.0417
420.000000 MHz	43.6277	35.5608
430.000000 MHz	43.3443	34.9958
440.000000 MHz	43.1200	34.5629
450.000000 MHz	42.8999	34.1583
460.000000 MHz	42.7154	33.7478
470.000000 MHz	42.4773	33.4083
480.000000 MHz	42.2998	33.0563
490.000000 MHz	42.0302	32.7340
500.000000 MHz	41.8641	32.3576
510.000000 MHz	41.6518	31.9703
520.000000 MHz	41.4863	31.6232
530.000000 MHz	41.2685	31.3144
540.000000 MHz	41.1027	30.8977
550.000000 MHz	40.9455	30.6347