

**DECLARATION OF COMPLIANCE
SAR EVALUATION**

Test Lab

CELLTECH RESEARCH INC.
Testing and Engineering Lab
1955 Moss Court
Kelowna, B.C.
Canada V1Y 9L3
Phone: 250-448-7047
Fax: 250-448-7046
e-mail: info@celltechlabs.com
web site: www.celltechlabs.com

Applicant Information

COBRA ELECTRONICS CORPORATION
6500 West Cortland Street
Chicago, IL 60707

Rule Part(s):	FCC 47 CFR §2.1093
Test Procedure(s):	FCC OET Bulletin 65, Supplement C (01-01)
Device Type:	Portable UHF GMRS/FRS PTT Radio Transceiver
FCC ID:	BBOPR135
Model(s):	PR135/PR140
Modulation:	FM (UHF)
Tx Frequency Range(s):	462.5500 - 462.7250 MHz (GMRS Channels 15-22) 462.5625 - 462.7125 MHz (FRS/GMRS Channels 1-7) 467.5625 - 467.7125 MHz (FRS Channels 8-14)
Max. RF Output Power:	0.5 Watts (ERP)
No. of Channels:	22
Antenna Type(s):	Fixed
Battery Type(s):	1.5V AAA Alkaline (x4)
Max. SAR Measured:	0.282 W/kg Face-held / 0.704 W/kg Body-worn

Celltech Research Inc. declares under its sole responsibility that this device was found to be in compliance with the Specific Absorption Rate (SAR) RF exposure requirements specified in FCC §2.1093. The device was tested in accordance with the measurement standards and procedures specified in FCC OET Bulletin 65, Supplement C, Edition 01-01 (General Population / Uncontrolled Exposure).

I attest to the accuracy of data. All measurements were performed by me or were made under my supervision and are correct to the best of my knowledge and belief. I assume full responsibility for the completeness of these measurements and vouch for the qualifications of all persons taking them.

This test report shall not be reproduced partially, or in full, without the prior written approval of Celltech Research Inc. The results and statements contained in this report pertain only to the device(s) evaluated.



Russell W. Pipe
Senior Compliance Technologist
Celltech Research Inc.



TABLE OF CONTENTS		
1.0	INTRODUCTION.....	3
2.0	DESCRIPTION OF DUT.....	3
3.0	SAR MEASUREMENT SYSTEM	4
4.0	MEASUREMENT SUMMARY.....	5
5.0	DETAILS OF SAR EVALUATION.....	6
6.0	EVALUATION PROCEDURES.....	7
7.0	SYSTEM VALIDATION.....	8
8.0	SIMULATED TISSUES.....	9
9.0	SAR LIMITS.....	9
10.0	SYSTEM SPECIFICATIONS.....	10
11.0	PROBE SPECIFICATION.....	11
12.0	SAM PHANTOM.....	11
13.0	LARGE PLANAR PHANTOM.....	11
14.0	DEVICE HOLDER.....	11
15.0	TEST EQUIPMENT LIST.....	12
16.0	MEASUREMENT UNCERTAINTIES.....	13
17.0	REFERENCES.....	14
	APPENDIX A - SAR MEASUREMENT DATA.....	15
	APPENDIX B - SYSTEM VALIDATION.....	16
	APPENDIX C - DIPOLE CALIBRATION.....	17
	APPENDIX D - PROBE CALIBRATION.....	18
	APPENDIX E - MEASURED FLUID DIELECTRIC PARAMETERS.....	19
	APPENDIX F - SAM PHANTOM CERTIFICATE OF CONFORMITY.....	20
	APPENDIX G - SAR TEST SETUP & EUT PHOTOGRAPHS.....	21

1.0 INTRODUCTION

This measurement report demonstrates compliance of the Cobra Electronics Corporation Models: PR135/PR140 Portable UHF GMRS/FRS PTT Radio Transceiver FCC ID: BBOPR135 with FCC 47 CFR §2.1093 (see reference [1]) for the General Population environment. The test procedures described in FCC OET Bulletin 65, Supplement C, Edition 01-01 (see reference [2]) were employed. A description of the product and operating configuration, detailed summary of the test results, methodology and procedures used in the evaluation, equipment used, and the various provisions of the rules are included within this test report.

2.0 DESCRIPTION of Device Under Test (DUT)

FCC Rule Part(s)	47 CFR §2.1093
Test Procedure	FCC OET Bulletin 65, Supplement C (01-01)
Device Type	Portable GMRS/FRS PTT Radio Transceiver
FCC ID	BBOPR135
Model(s)	PR135 (without headset jack) PR140 (with headset jack)
Serial No.	Pre-production
Modulation	FM (UHF)
Tx Frequency Range	462.5500 - 462.7250 MHz (GMRS Channels 15-22) 462.5625 - 462.7125 MHz (FRS/GMRS Channels 1-7) 467.5625 - 467.7125 MHz (FRS Channels 8-14)
Max. RF Output Power	0.5 Watts (ERP)
Battery Type(s)	1.5V AAA Alkaline (x4)
Antenna Type(s)	Fixed

3.0 SAR MEASUREMENT SYSTEM

Celltech Research SAR measurement facility utilizes the Dosimetric Assessment System (DASY™) manufactured by Schmid & Partner Engineering AG (SPEAG™) of Zurich, Switzerland. The DASY system is comprised of the robot controller, computer, near-field probe, probe alignment sensor, specific anthropomorphic mannequin (SAM) phantom, and various planar phantoms for brain and/or body SAR evaluations. The robot is a six-axis industrial robot performing precise movements to position the probe to the location (points) of maximum electromagnetic field (EMF). A cell controller system contains the power supply, robot controller, teach pendant (Joystick), and remote control, is used to drive the robot motors. The Staubli robot is connected to the cell controller to allow software manipulation of the robot. A data acquisition electronic (DAE) circuit performs the signal amplification, signal multiplexing, AD-conversion, offset measurements, mechanical surface detection, collision detection, etc. is connected to the Electro-optical coupler (EOC). The EOC performs the conversion from the optical into digital electric signal of the DAE and transfers data to the PC plug-in card. The DAE3 utilizes a highly sensitive electrometer-grade preamplifier with auto-zeroing, a channel and gain-switching multiplexer, a fast 16-bit AD-converter and a command decoder and control logic unit. Transmission to the PC-card is accomplished through an optical downlink for data and status information and an optical uplink for commands and clock lines. The mechanical probe-mounting device includes two different sensor systems for frontal and sidewise probe contacts. They are also used for mechanical surface detection and probe collision detection. The robot uses its own controller with a built in VME-bus computer.



DASY3 SAR Measurement System with SAM Phantom

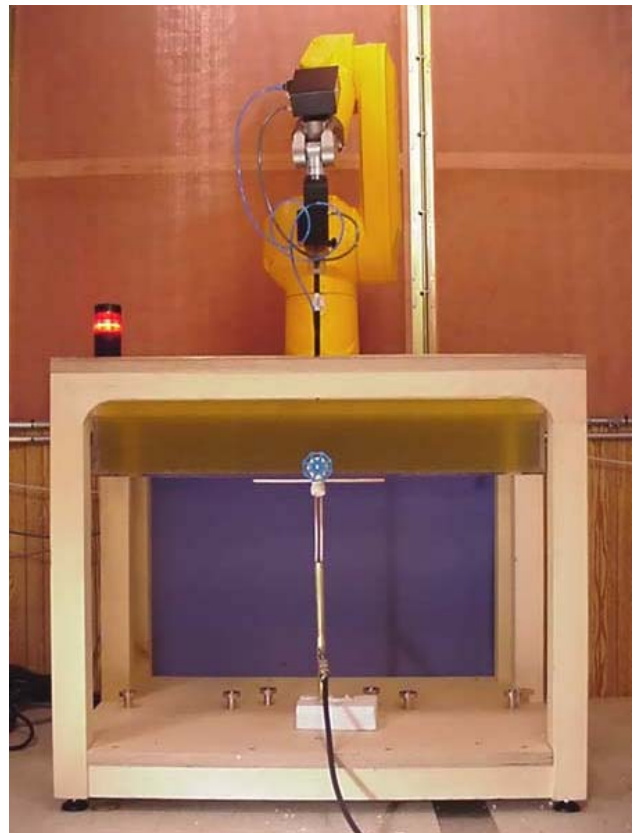

DASY3 SAR Measurement System with validation phantom

4.0 MEASUREMENT SUMMARY

The measurement results were obtained with the DUT tested in the conditions described in this report. Detailed measurement data and plots showing the maximum SAR location of the DUT are reported in Appendix A.

SAR EVALUATION RESULTS										
Freq. (MHz)	Channel	Mode	RF Output Power (ERP)	Power Drift (dB)	Antenna Position	Battery Type	Separation Distance (cm)	Fluid Type	SAR (w/kg)	
									100% Duty Cycle	50% Duty Cycle
462.7125	7 (GMRS)	CW	0.5 W	-0.14	Fixed	Alkaline	2.5	Brain	0.282	0.141
467.5625	8 (FRS)	CW	0.5 W	-0.04	Fixed	Alkaline	2.5	Brain	0.264	0.132
462.7125	7 (GMRS)	CW	0.5 W	-0.15	Fixed	Alkaline	0.7	Muscle	0.704	0.352
467.5625	8 (FRS)	CW	0.5 W	-0.11	Fixed	Alkaline	0.7	Muscle	0.465	0.233
ANSI / IEEE C95.1 1992 - SAFETY LIMIT Spatial Peak - Uncontrolled Exposure / General Population BRAIN & BODY: 1.6 W/kg / (averaged over 1 gram)										
Dielectric Constant		Brain 450MHz		Body 450MHz		Atmospheric Pressure		101.8 kPa		
		Target	Measured	Target	Measured	Relative Humidity		57 %		
		43.5 (+/- 5%)	44.0	56.7 (+/- 5%)	57.8	Ambient Temperature		22.8 °C		
Conductivity		Brain 450MHz		Body 450MHz		Fluid Temperature		21.4 °C		
		Target	Measured	Target	Measured	Fluid Depth		≥ 15 cm		
		0.87 (+/- 5%)	0.86	0.94 (+/- 5%)	0.92	Phantom Section		Planar		

Note(s):

1. The transmission band of the DUT is less than 10 MHz, therefore mid channel data only is reported (per FCC OET Bulletin 65, Supplement C, Edition 01-01 - see reference [2]).

5.0 DETAILS OF SAR EVALUATION

The Cobra Electronics Corporation Model: PR135/PR140 Portable UHF GMRS/FRS PTT Radio Transceiver FCC ID: BBOPR135 was found to be compliant for localized Specific Absorption Rate (Uncontrolled Exposure) based on the test provisions and conditions described below. The detailed test setup photographs are shown in Appendix G.

1. The DUT was evaluated in a face-held configuration with the front of the device placed parallel to the outer surface of the SAM planar phantom. A 2.5 cm separation distance was maintained between the front side of the DUT and the outer surface of the SAM planar phantom for the duration of the tests.
2. The DUT was tested in a body-worn configuration with the back of the device placed parallel to the outer surface of the SAM planar phantom. The attached belt-clip was placed touching the planar phantom and provided a 0.7 cm separation distance between the back of the DUT and the outer surface of the SAM planar phantom. An ear-microphone accessory was connected to the DUT for the duration of the body-worn evaluation.
3. The DUT was operated for an appropriate period prior to the evaluation in order to minimize power drift.
4. The conducted power level could not be measured for the SAR evaluation. The DUT was evaluated for SAR at the maximum conducted power level set by the manufacturer.
5. The DUT was tested in unmodulated continuous transmit operation (Continuous Wave mode at 100% duty cycle) with the transmit key continuously depressed. The 50% duty cycle compensation reported for this push-to-talk device assumes a transmit/receive cycle of equal time base.
6. The location of the maximum spatial SAR distribution (Hot Spot) was determined relative to the device and its antenna.
7. The DUT was tested with fully charged alkaline batteries.



Face-held SAR Test Setup



Body-worn SAR Test Setup

6.0 EVALUATION PROCEDURES

- a. The SAR evaluation was performed using the applicable phantom type depending on the device being tested. For devices held to the ear during normal operation, both the left and right ear positions were evaluated in accordance with FCC OET Bulletin 65, Supplement C (Edition 01-01) using the SAM phantom. For body-worn and face-held devices a planar phantom was used.
- b. The SAR was determined by a pre-defined procedure within the DASY3 software. Upon completion of a reference and optical surface check, the exposed region of the phantom was scanned near the inner surface with a grid spacing of 15mm x 15mm.
- c. A 5x5x7 matrix was performed around the greatest spatial SAR distribution found during the area scan of the applicable exposed region. SAR values were then calculated using a 3-D spline interpolation algorithm and averaged over spatial volumes of 1 and 10 grams.

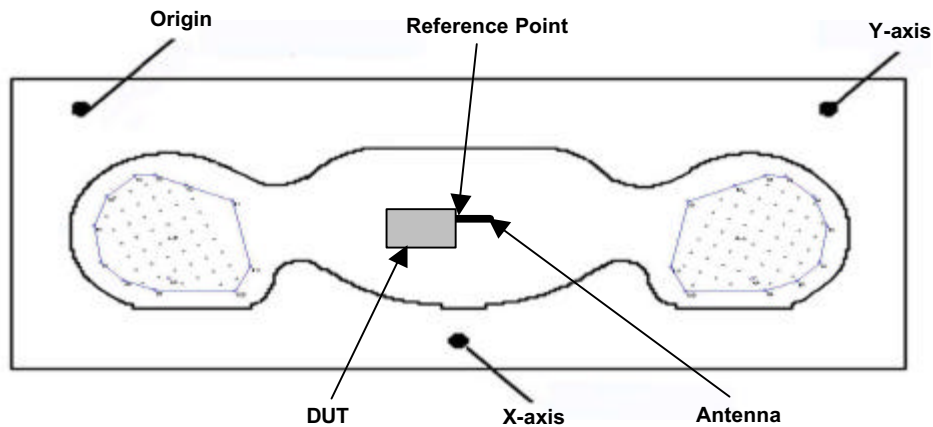

Figure 1. Phantom Reference Point & DUT Positioning (Face-held)

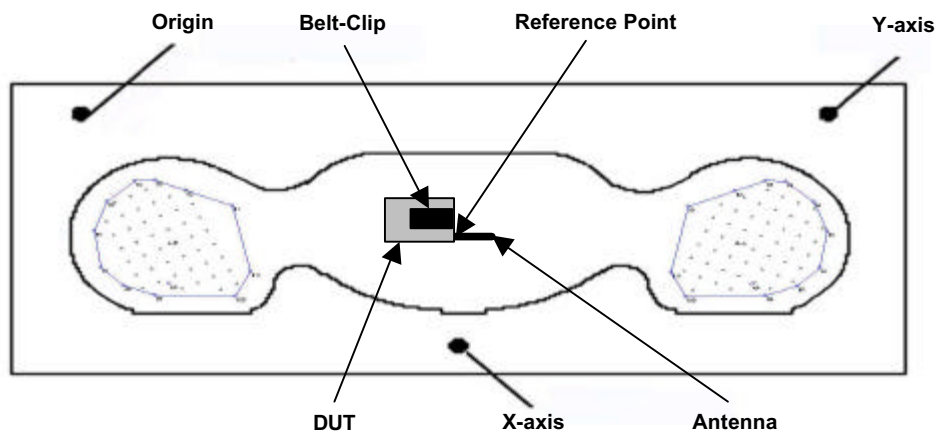

Figure 2. Phantom Reference Point & DUT Positioning (Body-worn)

7.0 SYSTEM VALIDATION

Prior to the evaluation the system was verified using a planar phantom with a 450MHz dipole (see Appendix C for dipole calibration procedure). The simulated tissue fluids were verified prior to the validation using an 85070C Dielectric Probe Kit and an 8753E Network Analyzer (see Appendix E for printout of measured fluid dielectric parameters). A forward power of 250mW was applied to the dipole and system was verified to a tolerance of $\pm 10\%$ (see Appendix B for system validation test plot).

SYSTEM VALIDATION											
Test Date	Equiv. Tissue	SAR 1g (w/kg)		Dielectric Constant ϵ_r		Conductivity σ (mho/m)		ρ (Kg/m ³)	Ambient Temp.	Fluid Temp.	Fluid Depth
		Target	Measured	Target	Measured	Target	Measured				
10/02/02	450MHz (Brain)	1.44 ($\pm 10\%$)	1.33	43.5 ($\pm 5\%$)	44.0	0.87 ($\pm 5\%$)	0.86	1000	22.8 °C	21.4 °C	≥ 15 cm

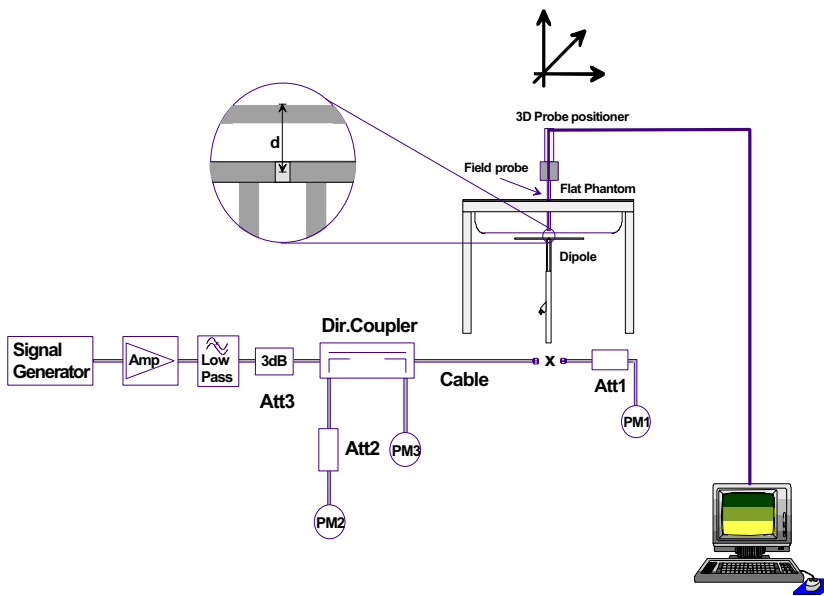

Figure 3. System Validation Setup Diagram



450MHz Dipole Validation Setup

8.0 SIMULATED TISSUES

The 450MHz brain and body tissue mixtures consist of a viscous gel using hydroxethylcellulose (HEC) gelling agent and saline solution. Preservation with a bactericide is added and visual inspection is made to ensure air bubbles are not trapped during the mixing process. The fluid was prepared according to standardized procedures, and measured for dielectric parameters (permittivity and conductivity).

TISSUE MIXTURES		
INGREDIENT	450MHz Brain (System Validation & DUT Evaluation)	450MHz Body (DUT Evaluation)
Water	38.56 %	52.00 %
Sugar	56.32 %	45.65 %
Salt	3.95 %	1.75 %
HEC	0.98 %	0.50 %
Bactericide	0.19 %	0.10 %

9.0 SAR SAFETY LIMITS

EXPOSURE LIMITS	SAR (W/kg)	
	(General Population / Uncontrolled Exposure Environment)	(Occupational / Controlled Exposure Environment)
Spatial Average (averaged over the whole body)	0.08	0.4
Spatial Peak (averaged over any 1g of tissue)	1.60	8.0
Spatial Peak (hands/wrists/feet/ankles averaged over 10g)	4.0	20.0

Notes:

1. Uncontrolled environments are defined as locations where there is potential exposure of individuals who have no knowledge or control of their potential exposure.
2. Controlled environments are defined as locations where there is potential exposure of individuals who have knowledge of their potential exposure and can exercise control over their exposure.

10.0 ROBOT SYSTEM SPECIFICATIONS

Specifications

POSITIONER: Stäubli Unimation Corp. Robot Model: RX60L
Repeatability: 0.02 mm
No. of axis: 6

Data Acquisition Electronic (DAE) System

Cell Controller

Processor: Pentium III
Clock Speed: 450 MHz
Operating System: Windows NT
Data Card: DASY3 PC-Board

Data Converter

Features: Signal Amplifier, multiplexer, A/D converter, and control logic
Software: DASY3 software
Connecting Lines: Optical downlink for data and status info.
Optical uplink for commands and clock

PC Interface Card

Function: 24 bit (64 MHz) DSP for real time processing
Link to DAE3
16-bit A/D converter for surface detection system
serial link to robot
direct emergency stop output for robot

E-Field Probe

Model: ET3DV6
Serial No.: 1387
Construction: Triangular core fiber optic detection system
Frequency: 10 MHz to 6 GHz
Linearity: ± 0.2 dB (30 MHz to 3 GHz)

Evaluation Phantom

Type: SAM V4.0C
Shell Material: Fiberglass
Thickness: 2.0 ± 0.1 mm
Volume: Approx. 20 liters

Validation Phantom (for devices ≤ 450 MHz)

Type: Large Planar Phantom
Shell Material: Plexiglas
Bottom Thickness: 6.2 mm ± 0.1 mm
Dimensions: 83.5 cm (L) x 36.9 cm (W) x 21.8 cm (H)

11.0 PROBE SPECIFICATION (ET3DV6)

Construction:	Symmetrical design with triangular core Built-in shielding against static charges PEEK enclosure material (resistant to organic solvents, e.g. glycol)
Calibration:	In air from 10 MHz to 2.5 GHz In brain simulating tissue at frequencies of 900 MHz and 1.8 GHz (accuracy $\pm 8\%$)
Frequency:	10 MHz to > 6 GHz; Linearity: ± 0.2 dB (30 MHz to 3 GHz)
Directivity:	± 0.2 dB in brain tissue (rotation around probe axis) ± 0.4 dB in brain tissue (rotation normal to probe axis)
Dynam. Rnge:	5 μ W/g to > 100 mW/g; Linearity: ± 0.2 dB
Srfce. Detect.	± 0.2 mm repeatability in air and clear liquids over diffuse reflecting surfaces
Dimensions:	Overall length: 330 mm Tip length: 16 mm Body diameter: 12 mm Tip diameter: 6.8 mm Distance from probe tip to dipole centers: 2.7 mm
Application:	General dosimetry up to 3 GHz Compliance tests of mobile phone



ET3DV6 E-Field Probe

12.0 LARGE PLANAR PHANTOM

The large planar phantom is constructed of Plexiglas material with a 6.0 mm shell thickness for SAR validations at and below 450MHz. The large planar phantom is mounted in the DASY3 compact system in place of the SAM phantom.



Large Planar Phantom

13.0 SAM PHANTOM V4.0C

The SAM phantom V4.0C is a fiberglass shell phantom with a 2.0mm shell thickness for left and right head and flat planar area integrated in a wooden table. The shape of the fiberglass shell corresponds to the phantom defined by SCC34-SC2. The device holder positions are adjusted to the standard measurement positions in the three sections.



SAM Phantom

14.0 DEVICE HOLDER

The DASY3 device holder has two scales for device rotation (with respect to the body axis) and the device inclination (with respect to the line between the ear openings). The plane between the ear openings and the mouth tip has a rotation angle of 65° . The bottom plate contains three pair of bolts for locking the device holder. The device holder positions are adjusted to the standard measurement positions in the three sections.



Device Holder

15.0 TEST EQUIPMENT LIST

SAR MEASUREMENT SYSTEM		
EQUIPMENT	SERIAL NO.	CALIBRATION DATE
DASY3 System -Robot -ET3DV6 E-Field Probe -300MHz Validation Dipole -450MHz Validation Dipole -900MHz Validation Dipole -1800MHz Validation Dipole -2450MHz Validation Dipole -SAM Phantom V4.0C -Small Planar Phantom -Medium Planar Phantom -Large Planar Phantom	599396-01 1387 135 136 054 247 150 N/A N/A N/A N/A	N/A Feb 2002 Oct 2001 Oct 2001 June 2001 June 2001 Oct 2001 N/A N/A N/A N/A
85070C Dielectric Probe Kit	N/A	N/A
Gigatronics 8652A Power Meter -Power Sensor 80701A -Power Sensor 80701A	1835272 1833535 1833542	Feb 2002 Feb 2002 Mar 2002
E4408B Spectrum Analyzer	US39240170	Nov 2001
8594E Spectrum Analyzer	3543A02721	Feb 2002
8753E Network Analyzer	US38433013	Feb 2002
8648D Signal Generator	3847A00611	Feb 2002
5S1G4 Amplifier Research Power Amplifier	26235	N/A

16.0 MEASUREMENT UNCERTAINTIES

Error Description	Uncertainty Value ±%	Probability Distribution	Divisor	C_i 1g	Standard Uncertainty ±% (1g)	V_i or V_{eff}
Measurement System						
Probe calibration	± 4.8	Normal	1	1	± 4.8	∞
Axial isotropy of the probe	± 4.7	Rectangular	√3	(1- c_p)	± 1.9	∞
Spherical isotropy of the probe	± 9.6	Rectangular	√3	(c_p)	± 3.9	∞
Spatial resolution	± 0.0	Rectangular	√3	1	± 0.0	∞
Boundary effects	± 5.5	Rectangular	√3	1	± 3.2	∞
Probe linearity	± 4.7	Rectangular	√3	1	± 2.7	∞
Detection limit	± 1.0	Rectangular	√3	1	± 0.6	∞
Readout electronics	± 1.0	Normal	1	1	± 1.0	∞
Response time	± 0.8	Rectangular	√3	1	± 0.5	∞
Integration time	± 1.4	Rectangular	√3	1	± 0.8	∞
RF ambient conditions	± 3.0	Rectangular	√3	1	± 1.7	∞
Mech. constraints of robot	± 0.4	Rectangular	√3	1	± 0.2	∞
Probe positioning	± 2.9	Rectangular	√3	1	± 1.7	∞
Extrapolation & integration	± 3.9	Rectangular	√3	1	± 2.3	∞
Test Sample Related						
Device positioning	± 6.0	Normal	√3	1	± 6.7	12
Device holder uncertainty	± 5.0	Normal	√3	1	± 5.9	8
Power drift	± 5.0	Rectangular	√3		± 2.9	∞
Phantom and Setup						
Phantom uncertainty	± 4.0	Rectangular	√3	1	± 2.3	∞
Liquid conductivity (target)	± 5.0	Rectangular	√3	0.6	± 1.7	∞
Liquid conductivity (measured)	± 10.0	Rectangular	√3	0.6	± 3.5	∞
Liquid permittivity (target)	± 5.0	Rectangular	√3	0.6	± 1.7	∞
Liquid permittivity (measured)	± 5.0	Rectangular	√3	0.6	± 1.7	∞
Combined Standard Uncertainty					± 13.7	
Expanded Uncertainty (k=2) (95% Confidence Level)					± 27.5	

Measurement Uncertainty Table in accordance with IEEE Std 1528 (Draft - see reference [3])

17.0 REFERENCES

- [1] Federal Communications Commission, "Radiofrequency radiation exposure evaluation: portable devices", Rule Part 47 CFR §2.1093: 1999.
- [2] Federal Communications Commission, "Evaluating Compliance with FCC Guidelines for Human Exposure to Radio frequency Electromagnetic Fields", OET Bulletin 65, Supplement C (Edition 01-01), FCC, Washington, D.C.: June 2001.
- [3] IEEE Standards Coordinating Committee 34, Std 1528-200X, "DRAFT Recommended Practice for Determining the Spatial-Peak Specific Absorption Rate (SAR) in the Human Body Due to Wireless Communications Devices: Experimental Techniques".

APPENDIX A - SAR MEASUREMENT DATA

Cobra Electronics Corporation FCC ID: BBOPR135

SAM Phantom; Flat Section; Position: (90°,90°)
 Probe: ET3DV6 - SN1387; ConvF(7.30,7.30,7.30); Crest factor: 1.0
 450 MHz Brain: $\sigma = 0.86 \text{ mho/m}$ $\epsilon_r = 44.0$ $\rho = 1.00 \text{ g/cm}^3$
 Coarse: Dx = 15.0, Dy = 15.0, Dz = 10.0
 Cube 5x5x7; Powerdrift: -0.14 dB
 SAR (1g): 0.282 mW/g, SAR (10g): 0.197 mW/g

Face-Held SAR at 2.5cm Separation Distance
 Models: PRI35/PRI40 GMRS/FRS PTT Radio Transceiver
 Alkaline Batteries (x4)
 Continuous Wave Mode
 GMRS Mid Channel [462.7125 MHz]
 Power Level: 0.5 Watts (ERP)
 Ambient Temp. 22.8°C; Fluid Temp. 21.4°C
 Date Tested: October 2, 2002

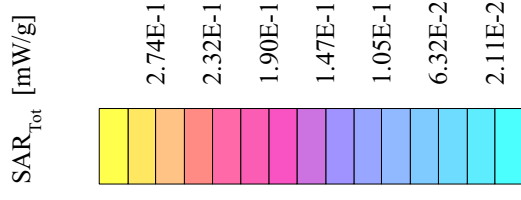
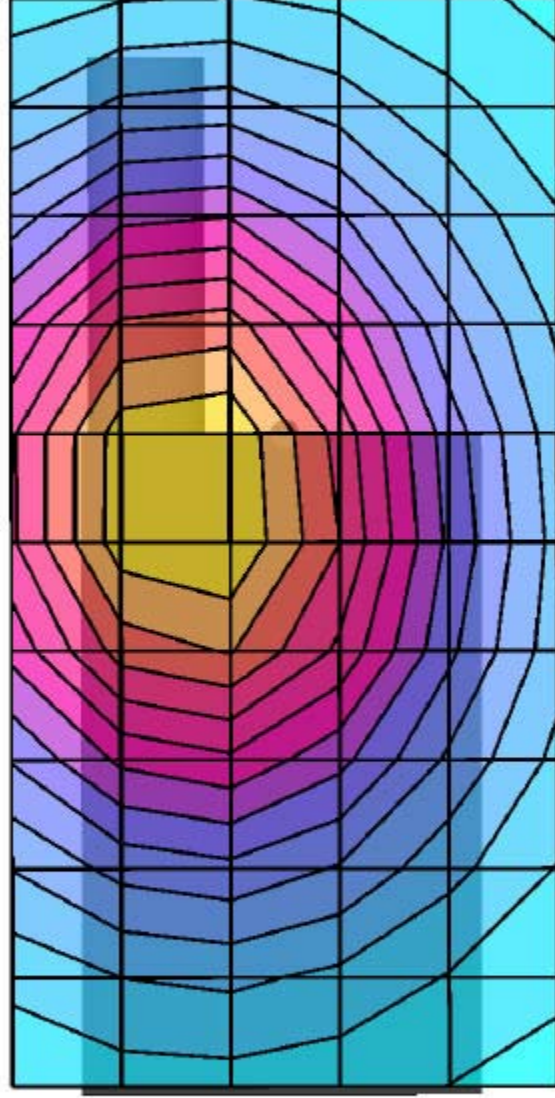

Cobra Electronics Corporation FCC ID: BBOPR135

SAM Phantom; Flat Section

Probe: ET3DV6 - SN1387; ConvF(7.30,7.30,7.30); Crest factor: 1.0

450 MHz Brain: $\sigma = 0.86$ mho/m $\epsilon_r = 44.0$ $\rho = 1.00$ g/cm³

Z-Axis Extrapolation at Peak SAR Location

Face-Held SAR at 2.5cm Separation Distance

Models: PRI35/PRI40 GMRS/FRS PTT Radio Transceiver

Alkaline Batteries (x4)

Continuous Wave Mode

GMRS Mid Channel [462.7125 MHz]

Power Level: 0.5 Watts (ERP)

Ambient Temp. 22.8°C; Fluid Temp. 21.4°C

Date Tested: October 2, 2002

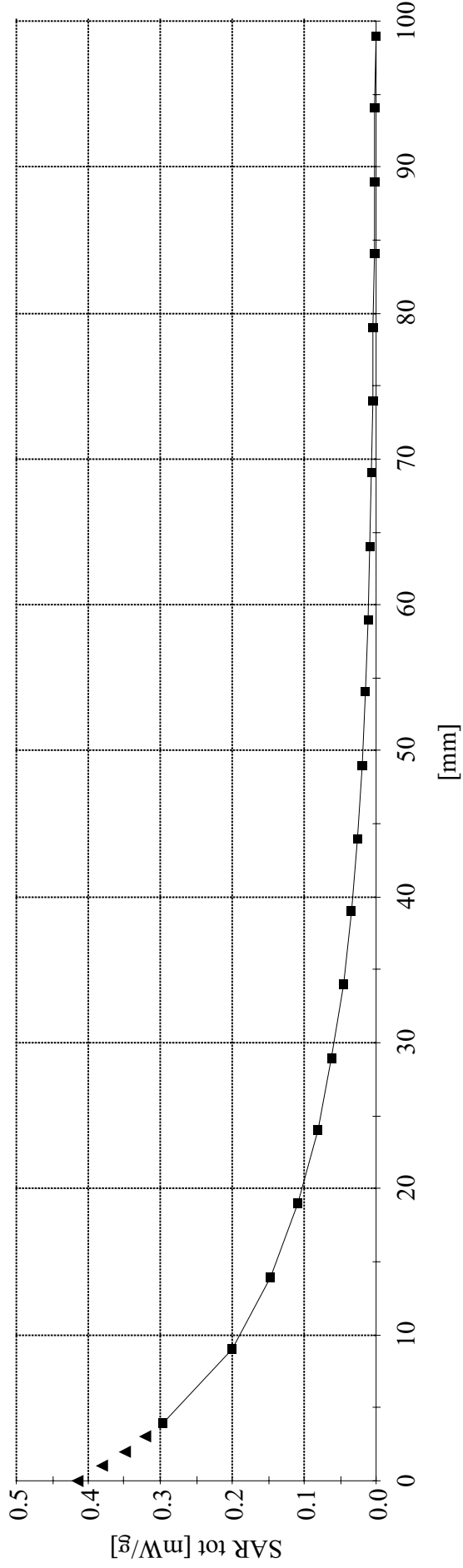

Cobra Electronics Corporation FCC ID: BBOPR135

SAM Phantom; Flat Section; Position: (90°,90°)
Probe: ET3DV6 - SN1387; ConvF(7.30,7.30,7.30); Crest factor: 1.0
450 MHz Brain: $\sigma = 0.86$ mho/m $\epsilon_r = 44.0$ $\rho = 1.00$ g/cm³
Coarse: Dx = 15.0, Dy = 15.0, Dz = 10.0
Cube 5x5x7; Powerdrift: -0.04 dB
SAR (1g): 0.264 mW/g, SAR (10g): 0.185 mW/g

Face-Held SAR at 2.5cm Separation Distance
Models: PRI35/PRI40 GMRS/FRS PTT Radio Transceiver
Alkaline Batteries (x4)
Continuous Wave Mode
FRS Mid Channel [467.5625 MHz]
Power Level: 0.5 Watts (ERP)
Ambient Temp. 22.8°C; Fluid Temp. 21.4°C
Date Tested: October 2, 2002

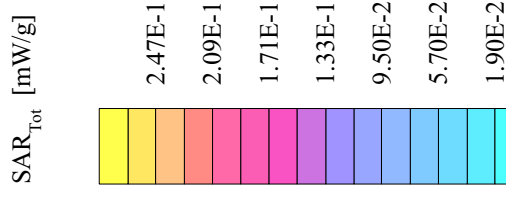
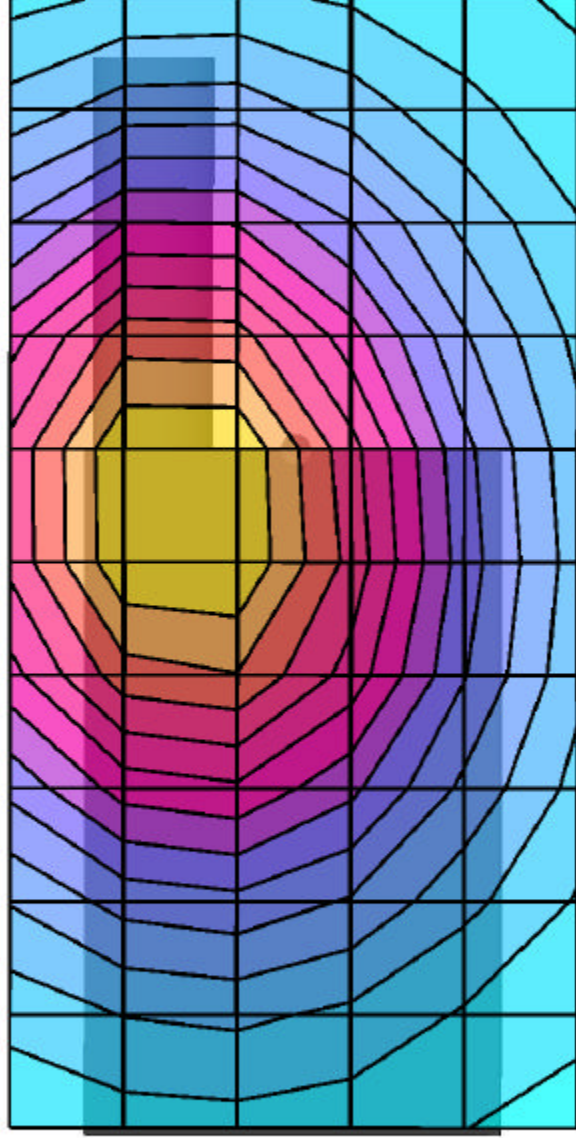

Cobra Electronics Corporation FCC ID: BBOPR135

SAM Phantom; Flat Section; Position: (270°,270°)
Probe: ET3DV6 - SN1387; ConvF(7.70,7.70,7.70); Crest factor: 1.0
450 MHz Muscle: $\sigma = 0.92$ mho/m $\epsilon_r = 57.8$ $\rho = 1.00$ g/cm³
Coarse: Dx = 15.0, Dy = 15.0, Dz = 10.0
Cube 5x5x7; Powerdrift: -0.15 dB
SAR (1g): 0.704 mW/g, SAR (10g): 0.484 mW/g

Body-Worm SAR with 0.7cm Belt-Clip & Ear-Mic Accessory
Models: PRI35/PRI40 GMRS/FRS PTT Radio Transceiver
Alkaline Batteries (x4)
Continuous Wave Mode
GMRS Mid Channel [462.7125 MHz]
Power Level: 0.5 Watts (ERP)
Ambient Temp. 22.8°C; Fluid Temp. 21.4°C
Date Tested: October 2, 2002

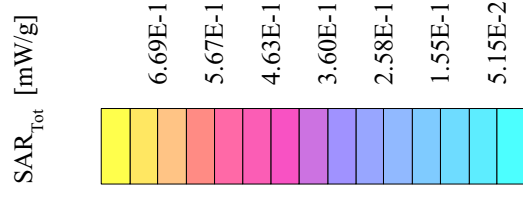
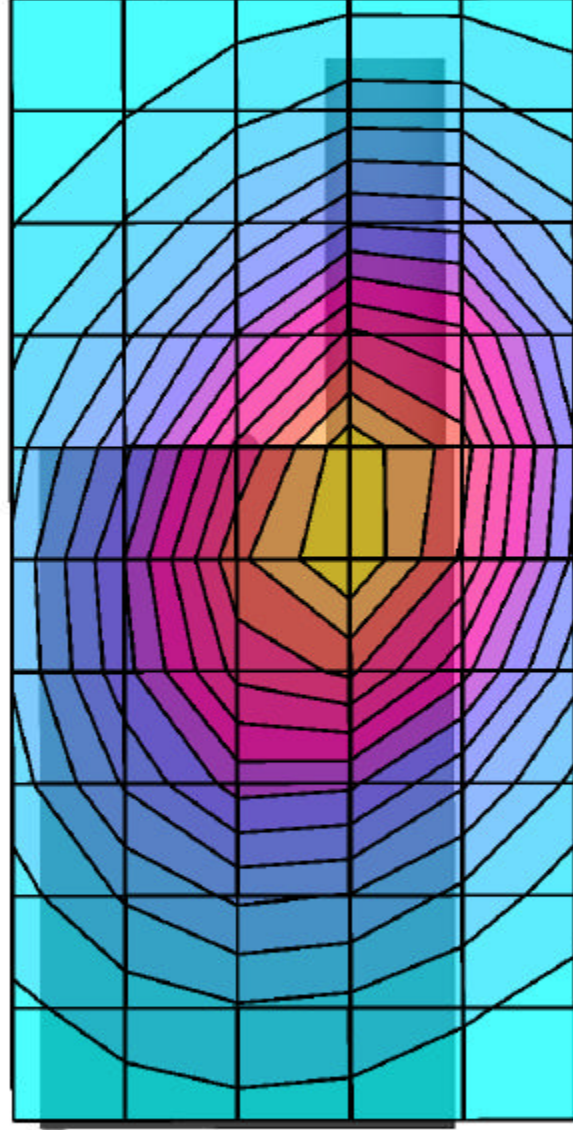

Cobra Electronics Corporation FCC ID: BBOPR135

SAM Phantom; Flat Section

Probe: ET3DV6 - SN1387; ConvF(7.70,7.70,7.70); Crest factor: 1.0
450 MHz Muscle: $\sigma = 0.92$ mho/m $\epsilon_r = 57.8$ $\rho = 1.00$ g/cm³

Z-Axis Extrapolation at Peak SAR Location

Body-Worm SAR with 0.7cm Belt-Clip & Ear-Mic Accessory
Models: PRI35/PRI40 GMRS/FRS PTT Radio Transceiver

Alkaline Batteries (x4)

Continuous Wave Mode

GMRS Mid Channel [462.7125 MHz]

Power Level: 0.5 Watts (ERP)

Ambient Temp. 22.8°C; Fluid Temp. 21.4°C

Date Tested: October 2, 2002

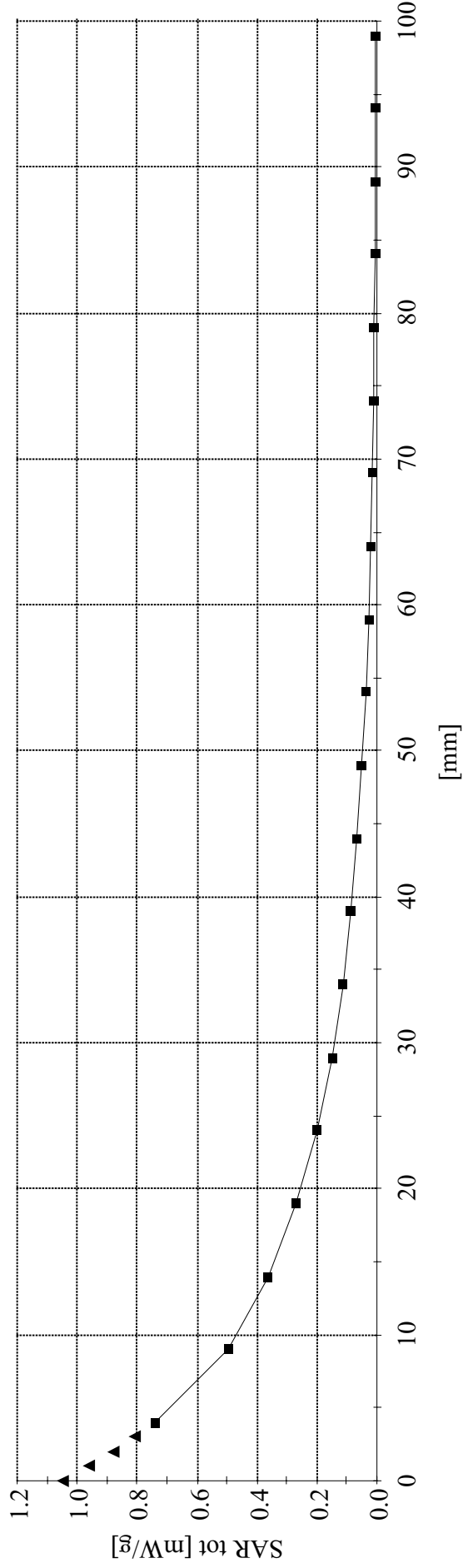

Cobra Electronics Corporation FCC ID: BBOPR135

SAM Phantom; Flat Section; Position: (270°,270°)
Probe: ET3DV6 - SN1387; ConvF(7.70,7.70,7.70); Crest factor: 1.0
450 MHz Muscle: $\sigma = 0.92$ mho/m $\epsilon_r = 57.8$ $\rho = 1.00$ g/cm³
Coarse: Dx = 15.0, Dy = 15.0, Dz = 10.0
Cube 5x5x7; Powerdrift: -0.11 dB
SAR (1g): 0.465 mW/g, SAR (10g): 0.319 mW/g

Body-Worm SAR with 0.7cm Belt-Clip & Ear-Mic Accessory
Models: PR135/PRI40 GMRS/FRS PTT Radio Transceiver
Alkaline Batteries (x4)
Continuous Wave Mode
FRS Mid Channel [467.5625 MHz]
Power Level: 0.5 Watts (ERP)
Ambient Temp. 22.8°C; Fluid Temp. 21.4°C
Date Tested: October 2, 2002

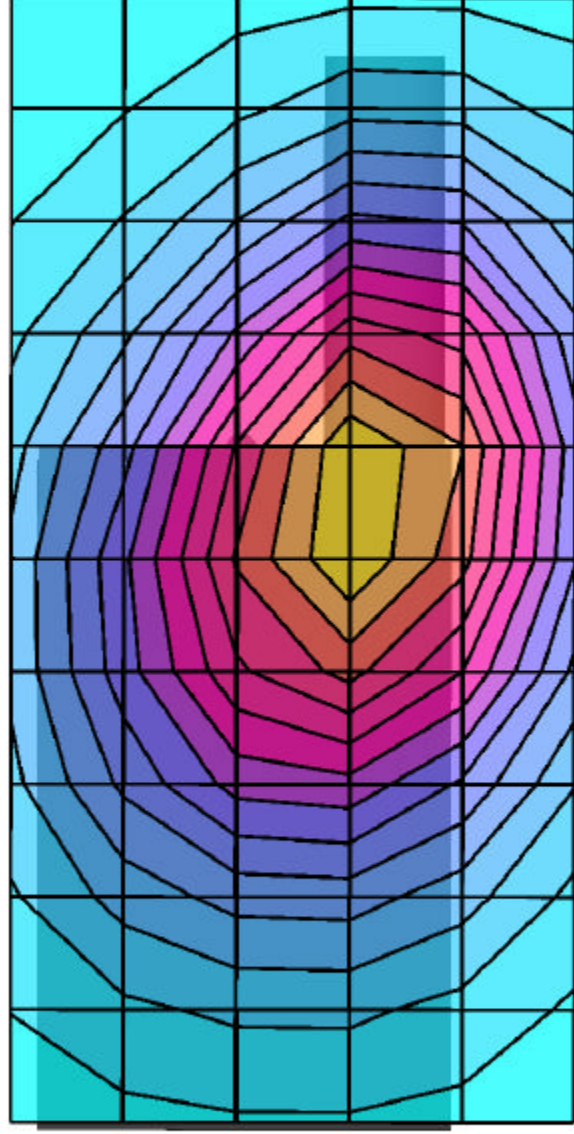

SAR_{tot} [mW/g]

4.51E-1
3.82E-1
3.12E-1
2.43E-1
1.74E-1
1.04E-1
3.47E-2

APPENDIX B - SYSTEM VALIDATION

Dipole 450MHz

Large Planar Phantom; Planar Section

Probe: ET3DV6 - SNI387; ConvF(7.30,7.30,7.30); Crest factor: 1.0; 450 MHz Brain: $\sigma = 0.86$ mho/m $\epsilon_r = 44.0$ $\rho = 1.00$ g/cm³

Cube 5x5x7: Peak: 2.13 mW/g, SAR (1g): 0.868 mW/g, SAR (10g): 0.868 mW/g, (Worst-case extrapolation)

Penetration depth: 12.2 (10.6, 14.4) [mm]; Ambient Temp. 22.8°C; Fluid Temp. 21.4°C

Powerdrift: 0.01 dB

450MHz Validation

Date: October 2, 2002

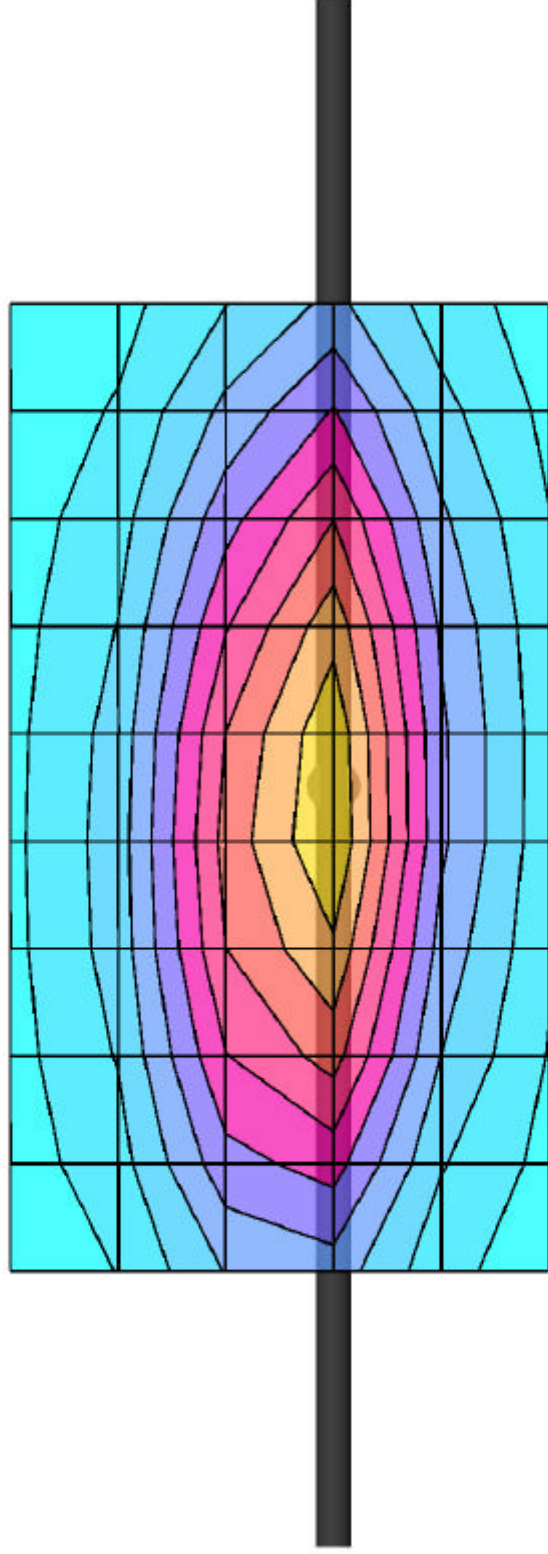
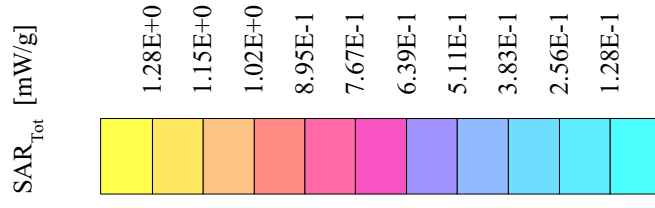

APPENDIX C - DIPOLE CALIBRATION

450MHz SYSTEM VALIDATION DIPOLE

Type:

450MHz Validation Dipole

Serial Number:

136

Place of Calibration:

Celltech Research Inc.

Date of Calibration:

October 17, 2001

Celltech Research Inc. hereby certifies that this device has been calibrated on the date indicated above.

Calibrated by:



Approved by:

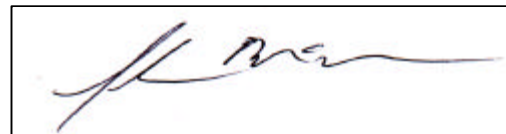

11 Oct 2001 15:34:46

[CH1] S11 LOG 10 dB/REF 0 dB 1*-23.977 dB 450.000 000 MHz

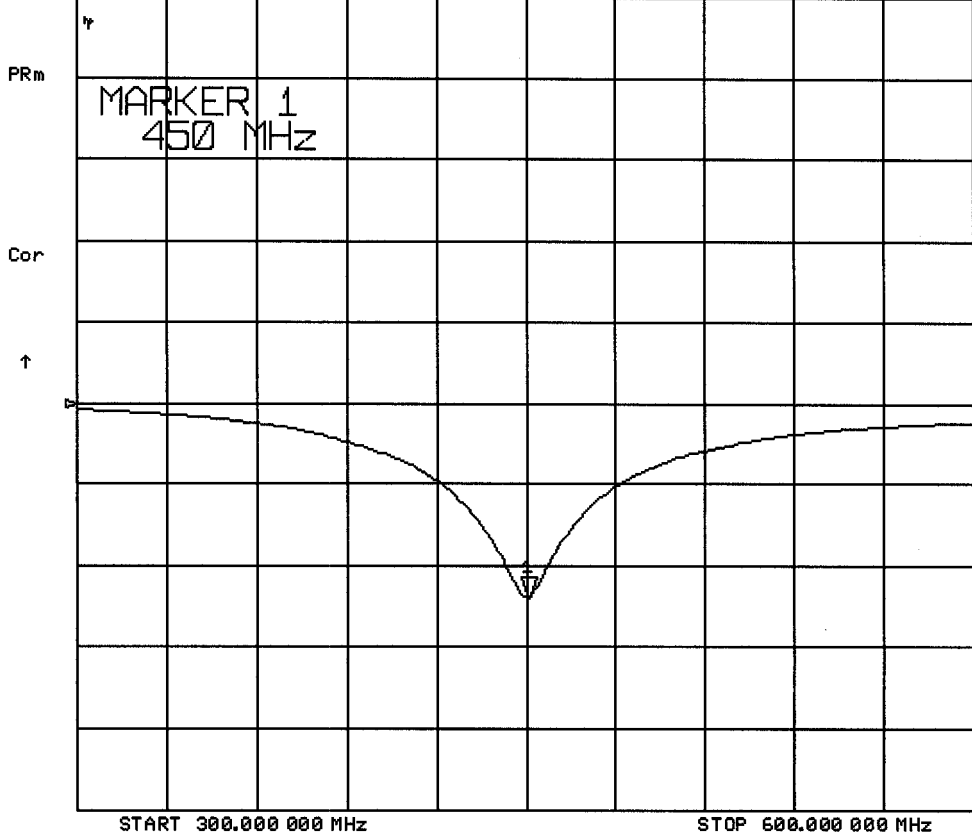

11 Oct 2001 15:34:54

CH1 S11 1 U FS 1: 48.291 Ω 5.9902 Ω 2.1186 nH 450.000 000 MHz

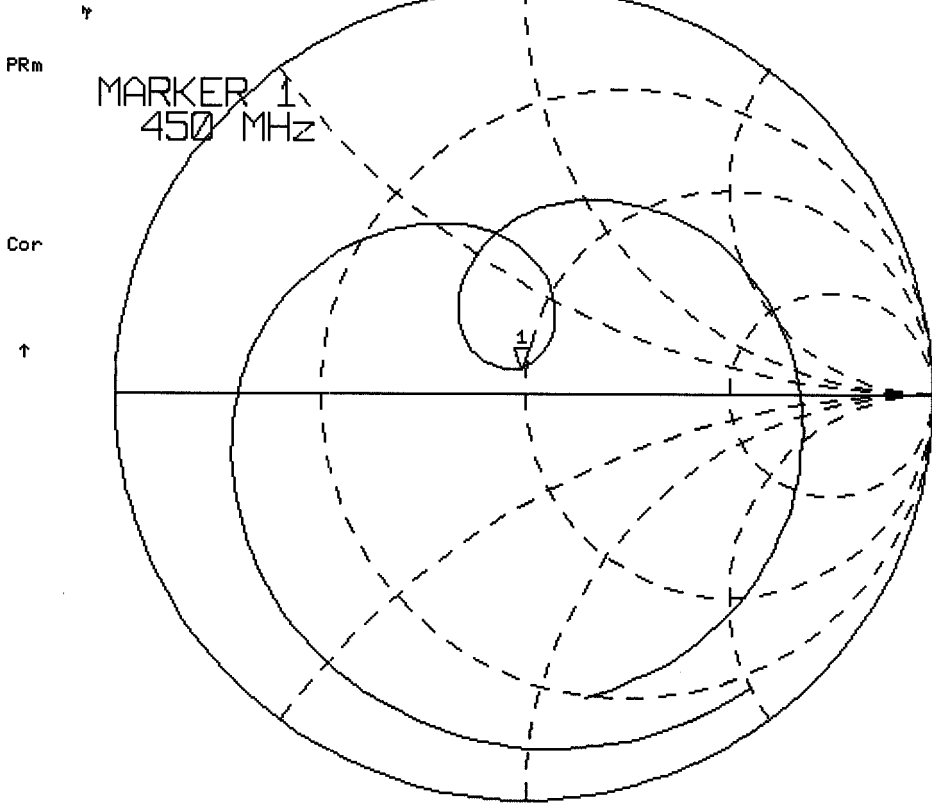

START 300.000 000 MHz

STOP 600.000 000 MHz

Validation Dipole Dimensions

Frequency (MHz)	L (mm)	h (mm)	d (mm)
300	420.0	250.0	6.2
450	288.0	167.0	6.2
835	161.0	89.8	3.6
900	149.0	83.3	3.6
1450	89.1	51.7	3.6
1800	72.0	41.7	3.6
1900	68.0	39.5	3.6
2000	64.5	37.5	3.6
2450	51.8	30.6	3.6
3000	41.5	25.0	3.6

2. Validation Phantom

The validation phantom was constructed using relatively low-loss tangent Plexiglas material. The dimensions of the phantom are as follows:

Length: 83.5 cm
Width: 36.9 cm
Height: 21.8 cm

The bottom of the phantom is constructed of 6.2 ± 0.1 mm Plexiglas.

Dimensions of Plexiglas Planar Phantom

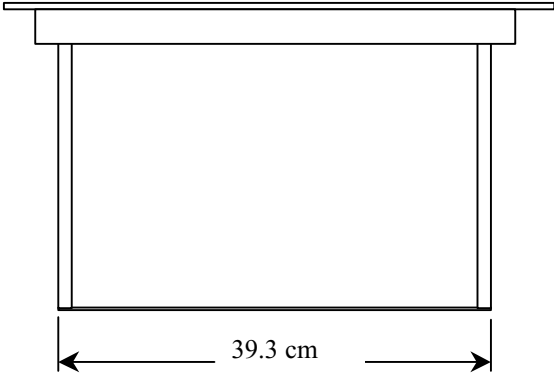
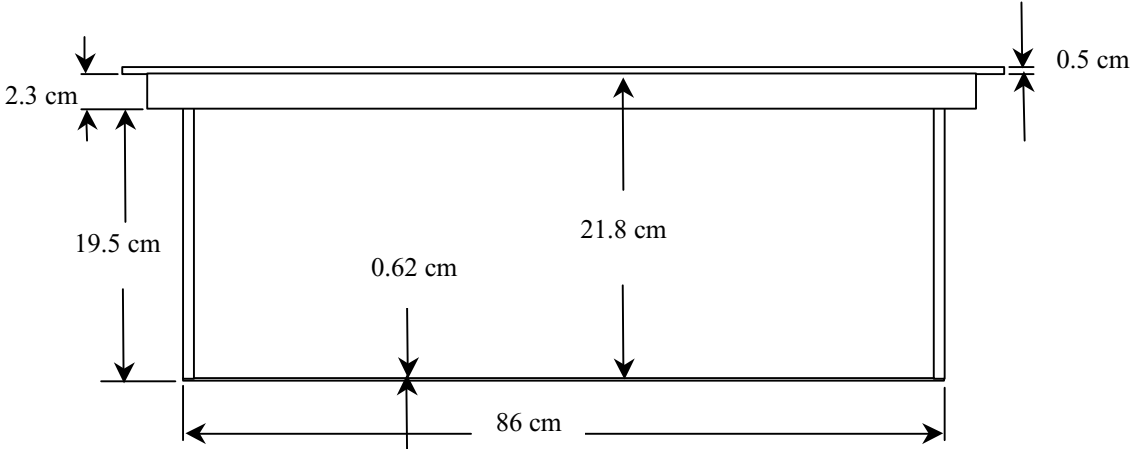
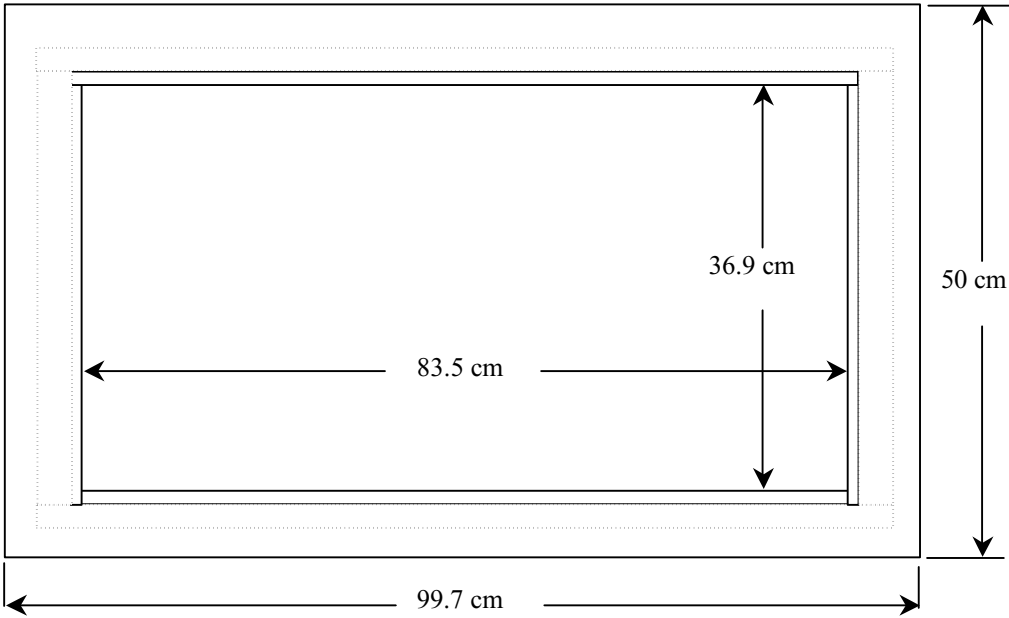

450MHz Dipole Calibration Setup



450MHz Dipole Calibration Setup



3. Measurement Conditions

The planar phantom was filled with brain simulating tissue having the following electrical parameters at 450MHz:

Relative Permittivity: 43.5 \pm 5%
Conductivity: 0.86 mho/m \pm 5%
Temperature: 23.1°C

The 450MHz simulating tissue consists of the following ingredients:

Ingredient	Percentage by weight
Water	38.56%
Sugar	56.32%
Salt	3.95%
HEC	0.98%
Dowicil 75	0.19%
Target Dielectric Parameters at 22°C	$\epsilon_r = 43.5$ $\sigma = 0.87 \text{ S/m}$

4. SAR Measurement

The SAR measurement was performed with the E-field probe in mechanical detection mode only. The setup and determination of the forward power into the dipole was performed using the following procedures.

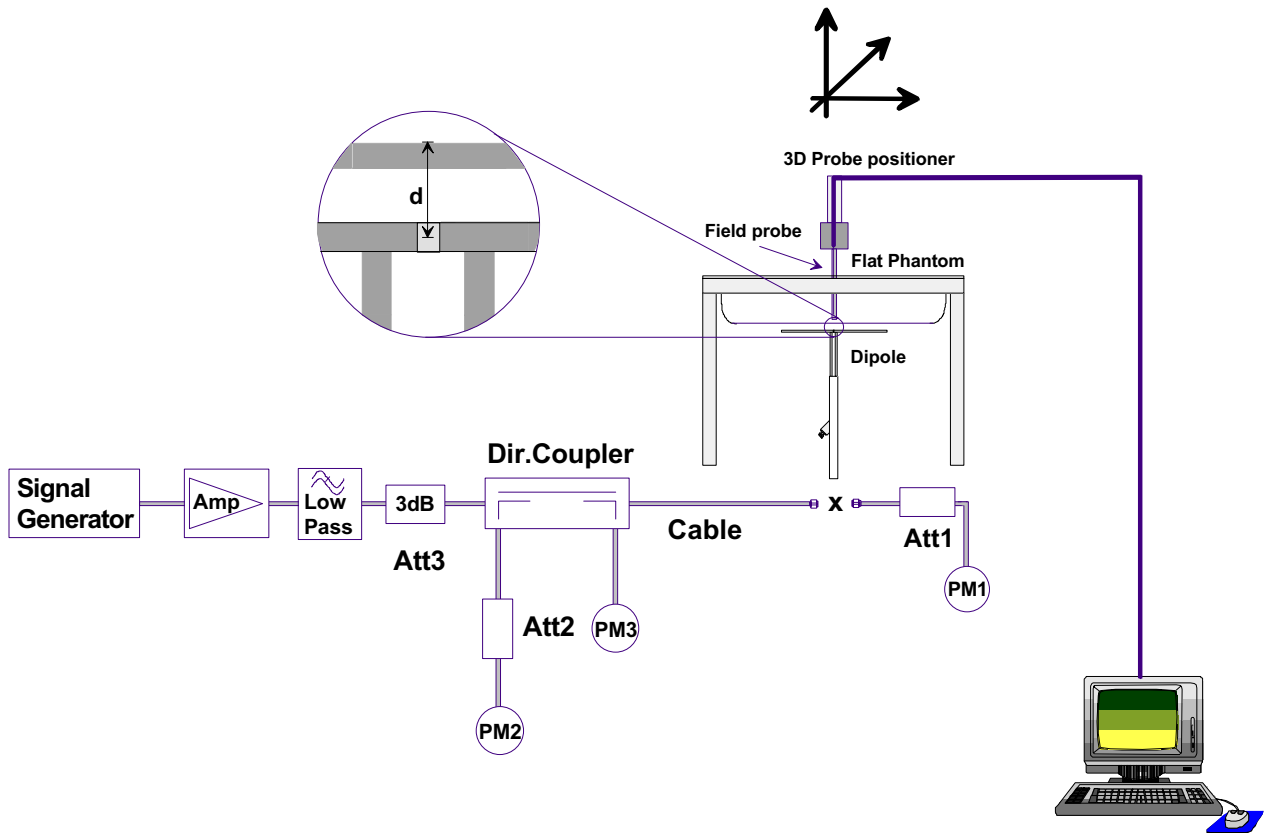

First the power meter **PM1** (including attenuator **Att1**) is connected to the cable to measure the forward power at the location of the dipole connector (**X**). The signal generator is adjusted for the desired forward power at the dipole connector (taking into account the attenuation of **Att1**) as read by power meter **PM2**. After connecting the cable to the dipole, the signal generator is readjusted for the same reading at power meter **PM2**. If the signal generator does not allow adjustment in 0.01dB steps, the remaining difference at **PM2** must be taken into consideration. **PM3** records the reflected power from the dipole to ensure that the value is not changed from the previous value. The reflected power should be 20dB below the forward power.

Ten SAR measurements were performed in order to achieve repeatability and to establish an average target value.

Validation Dipole SAR Test Results

Validation Measurement	SAR @ 0.25W Input averaged over 1g	SAR @ 1W Input averaged over 1g	SAR @ 0.25W Input averaged over 10g	SAR @ 1W Input averaged over 10g	Peak SAR @ 0.25W Input
Test 1	1.47	5.88	0.971	3.88	2.31
Test 2	1.43	5.72	0.949	3.80	2.25
Test 3	1.45	5.80	0.961	3.84	2.27
Test 4	1.44	5.76	0.954	3.82	2.26
Test 5	1.46	5.84	0.969	3.88	2.29
Test 6	1.42	5.68	0.939	3.76	2.23
Test 7	1.45	5.80	0.960	3.84	2.27
Test 8	1.41	5.64	0.928	3.71	2.22
Test 9	1.43	5.72	0.950	3.80	2.25
Test10	1.46	5.84	0.971	3.88	2.29
Average Value	1.44	5.77	0.946	3.82	2.26

The results have been normalized to 1W (forward power) into the dipole.

Averaged over 1cm (1g) of tissue: 5.77 mW/g

Averaged over 10cm (10g) of tissue: 3.82 mW/g

Validation Dipole 450MHz, d = 15 mm

Frequency: 450 MHz; Antenna Input Power: 250 [mW]
Large Planar Phantom; Planar Section
Probe: ET3DV6 - SNI590; ConvF(7.36,7.36,7.36); Crest factor: 1.0
450 MHz Brain: $\sigma = 0.87$ mho/m $\epsilon_r = 43.5$ $\rho = 1.00$ g/cm³
Cube 5x5x7: Peak: 2.34 mW/g, SAR (1g): 1.47 mW/g, SAR (10g): 0.963 mW/g, SAR (Worst-case extrapolation)
Penetration depth: 12.3 (10.7, 14.4) [mm]
Powerdrift: 0.02 dB
Calibration Date: Oct. 17, 2001

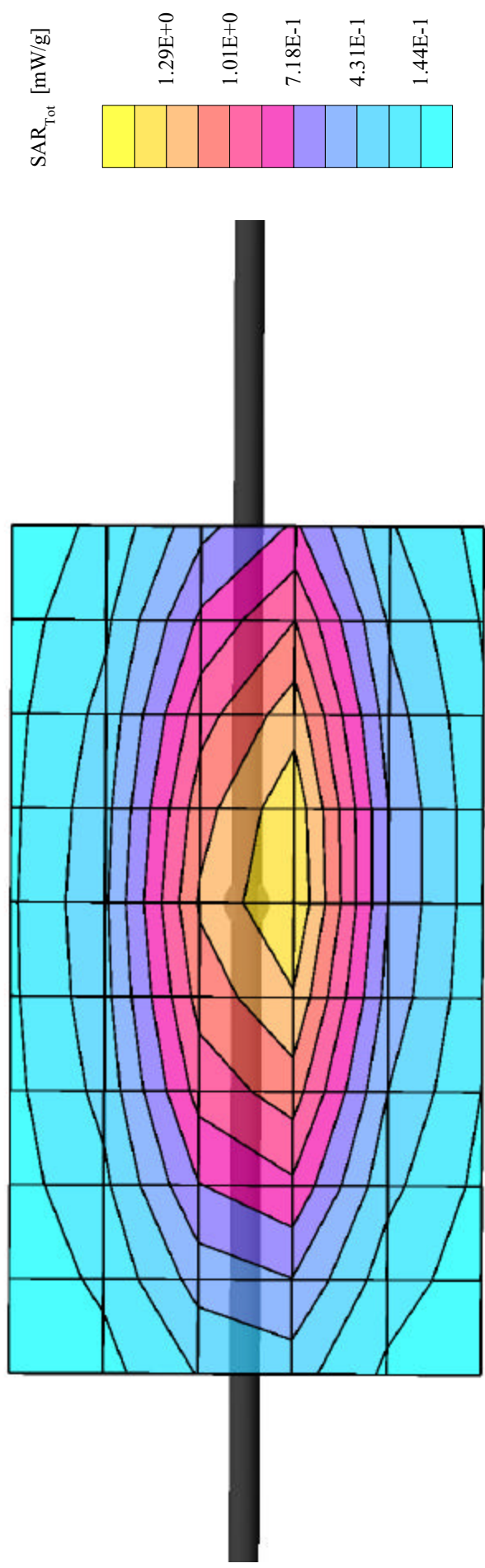

Validation Dipole 450MHz, d = 15 mm

Large Planar Phantom; Planar Section
Probe: ET3DV6 - SNI590; ConvF(7.36,7.36,7.36); Crest factor: 1.0
450 MHz Brain: $\sigma = 0.87$ mho/m $\epsilon_r = 43.5$ $\rho = 1.00$ g/cm³
Z-Axis: Dx = 0.0, Dy = 0.0, Dz = 5.0

Test Date: October 17, 2001
conducted power: 250 mW

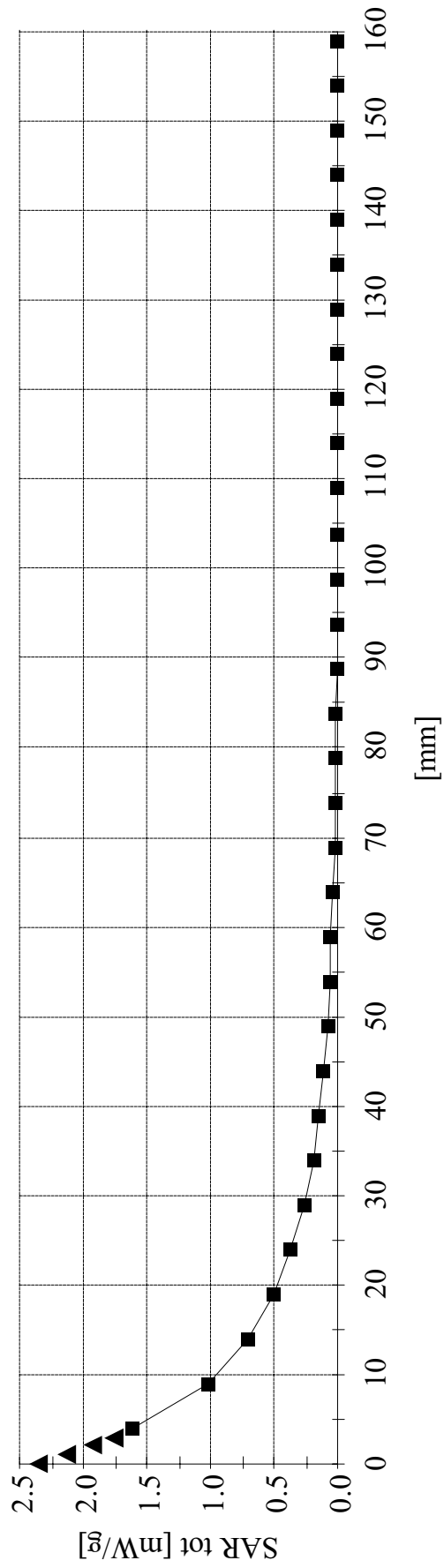

APPENDIX D - PROBE CALIBRATION

Schmid & Partner Engineering AG

Zeughausstrasse 43, 8004 Zurich, Switzerland, Phone +41 1 245 97 00, Fax +41 1 245 97 79

Calibration Certificate

Dosimetric E-Field Probe

Type:

ET3DV6

Serial Number:

1387

Place of Calibration:

Zurich

Date of Calibration:

February 22, 2002

Calibration Interval:

12 months

Schmid & Partner Engineering AG hereby certifies, that this device has been calibrated on the date indicated above. The calibration was performed in accordance with specifications and procedures of Schmid & Partner Engineering AG.

Wherever applicable, the standards used in the calibration process are traceable to international standards. In all other cases the standards of the Laboratory for EMF and Microwave Electronics at the Swiss Federal Institute of Technology (ETH) in Zurich, Switzerland have been applied.

Calibrated by:

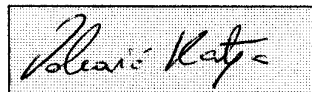

Approved by:



Probe ET3DV6

SN:1387

Manufactured:	September 21, 1999
Last calibration:	September 22, 1999
Recalibrated:	February 22, 2002

Calibrated for System DASY3

DASY3 - Parameters of Probe: ET3DV6 SN:1387

Sensitivity in Free Space

NormX	1.58 $\mu\text{V}/(\text{V}/\text{m})^2$
NormY	1.67 $\mu\text{V}/(\text{V}/\text{m})^2$
NormZ	1.67 $\mu\text{V}/(\text{V}/\text{m})^2$

Diode Compression

DCP X	97	mV
DCP Y	97	mV
DCP Z	97	mV

Sensitivity in Tissue Simulating Liquid

Head	900 MHz	$\epsilon_r = 41.5 \pm 5\%$	$\sigma = 0.97 \pm 5\%$ mho/m
Head	835 MHz	$\epsilon_r = 41.5 \pm 5\%$	$\sigma = 0.90 \pm 5\%$ mho/m
ConvF X	6.6 $\pm 9.5\%$ (k=2)		Boundary effect:
ConvF Y	6.6 $\pm 9.5\%$ (k=2)		Alpha 0.40
ConvF Z	6.6 $\pm 9.5\%$ (k=2)		Depth 2.38
Head	1800 MHz	$\epsilon_r = 40.0 \pm 5\%$	$\sigma = 1.40 \pm 5\%$ mho/m
Head	1900 MHz	$\epsilon_r = 40.0 \pm 5\%$	$\sigma = 1.40 \pm 5\%$ mho/m
ConvF X	5.4 $\pm 9.5\%$ (k=2)		Boundary effect:
ConvF Y	5.4 $\pm 9.5\%$ (k=2)		Alpha 0.57
ConvF Z	5.4 $\pm 9.5\%$ (k=2)		Depth 2.18

Boundary Effect

Head	900 MHz	Typical SAR gradient: 5 % per mm	
	Probe Tip to Boundary	1 mm	2 mm
	SAR _{be} [%] Without Correction Algorithm	9.7	5.4
	SAR _{be} [%] With Correction Algorithm	0.3	0.6
Head	1800 MHz	Typical SAR gradient: 10 % per mm	
	Probe Tip to Boundary	1 mm	2 mm
	SAR _{be} [%] Without Correction Algorithm	11.5	7.3
	SAR _{be} [%] With Correction Algorithm	0.1	0.3

Sensor Offset

Probe Tip to Sensor Center	2.7	mm
Optical Surface Detection	1.3 \pm 0.2	mm

Receiving Pattern (ϕ , $\theta = 0^\circ$)

f = 30 MHz, TEM cell ifi110

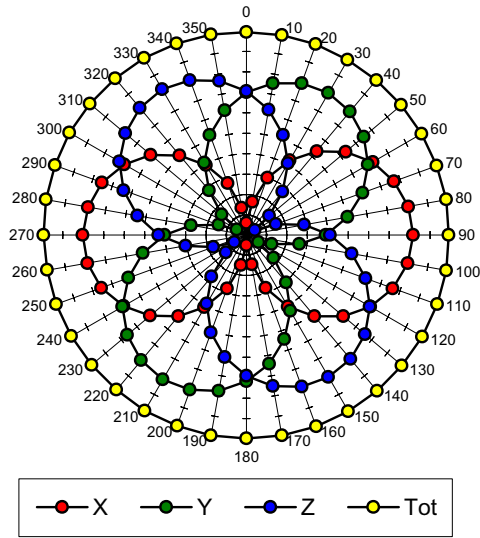

f = 100 MHz, TEM cell ifi110

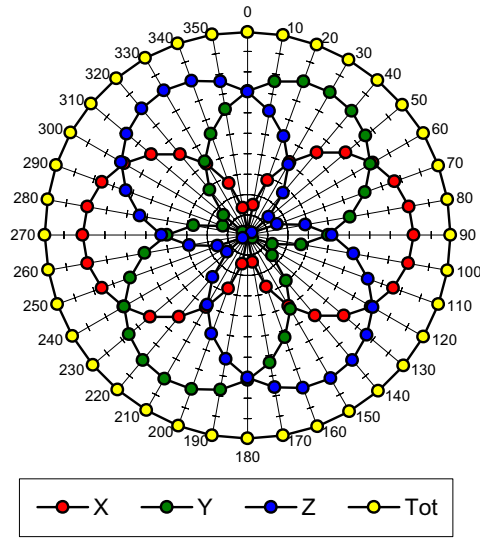

f = 300 MHz, TEM cell ifi110

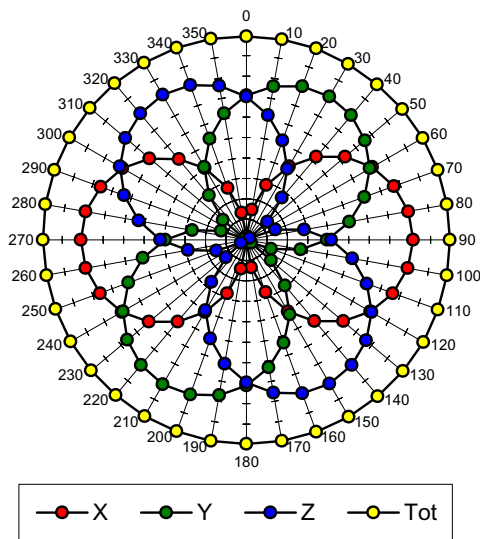

f = 900 MHz, TEM cell ifi110

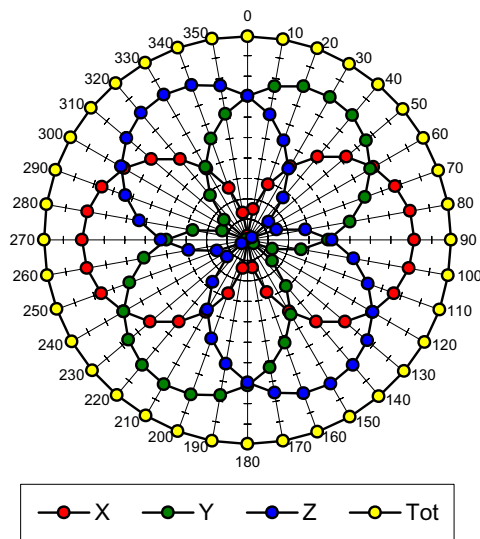

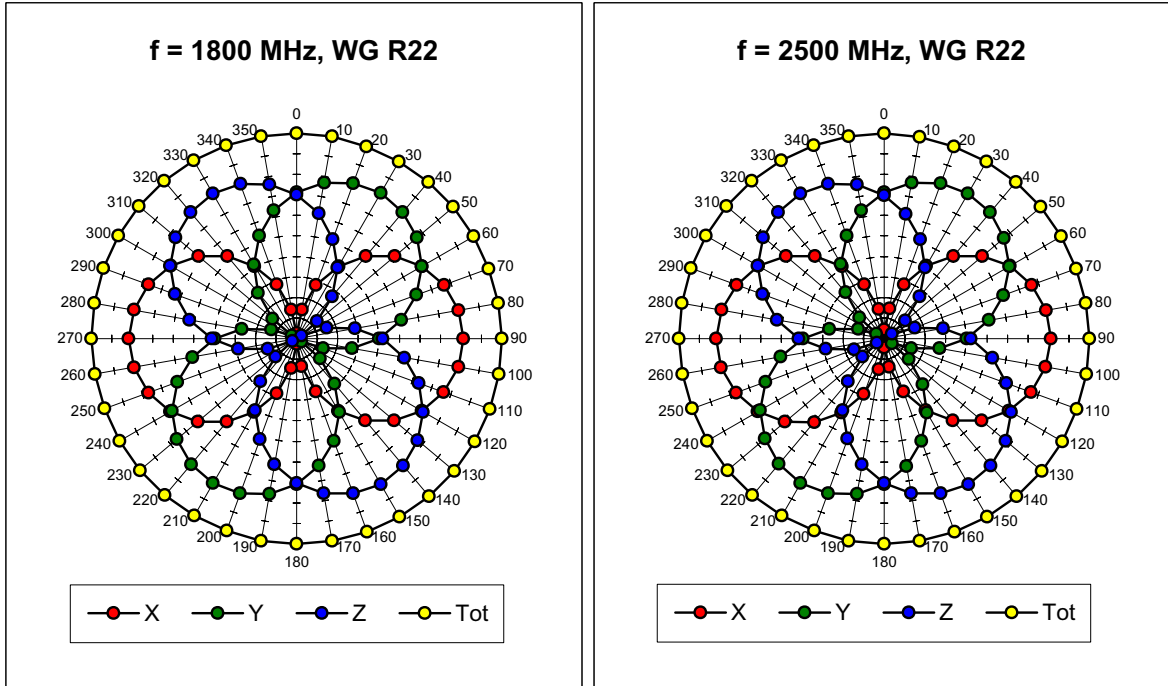

Isotropy Error (ϕ), $\theta = 0^\circ$

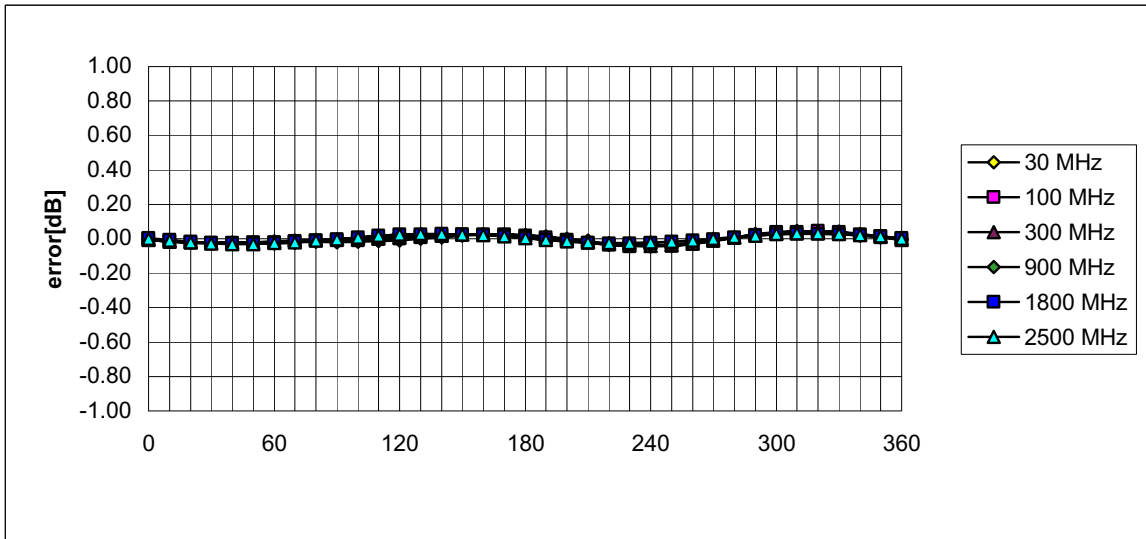

Frequency Response of E-Field

(TEM-Cell:ifi110, Waveguide R22)

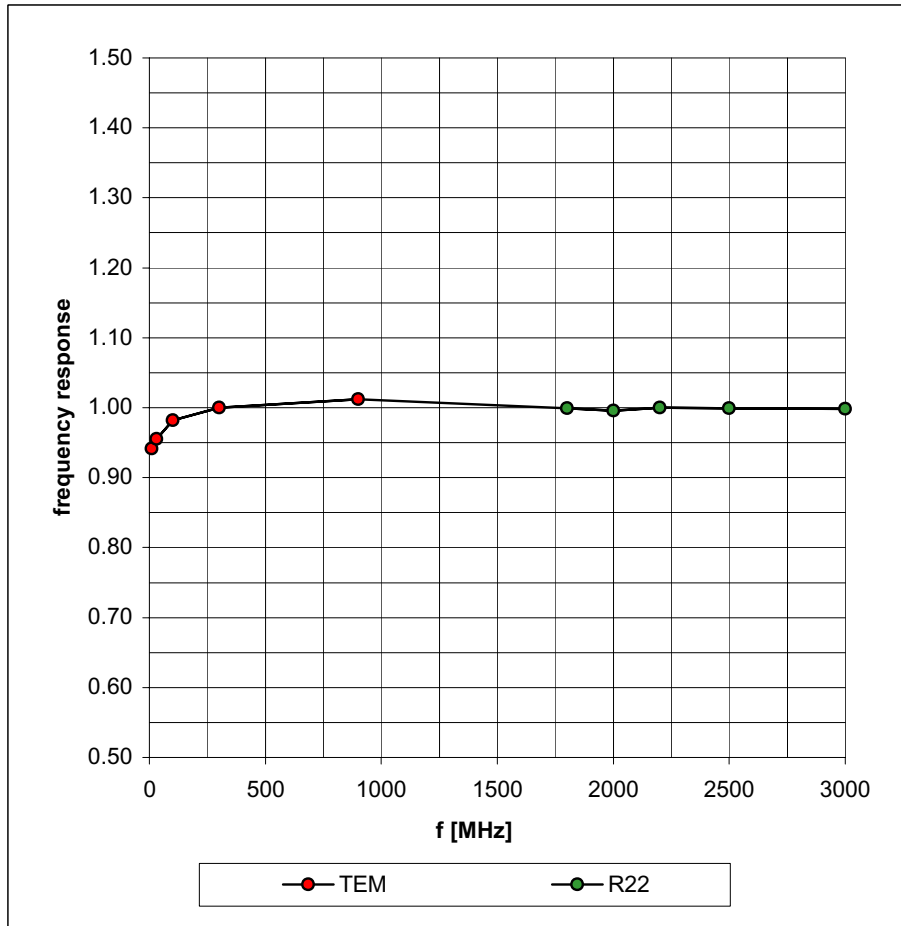

Dynamic Range f(SAR_{brain}) (Waveguide R22)

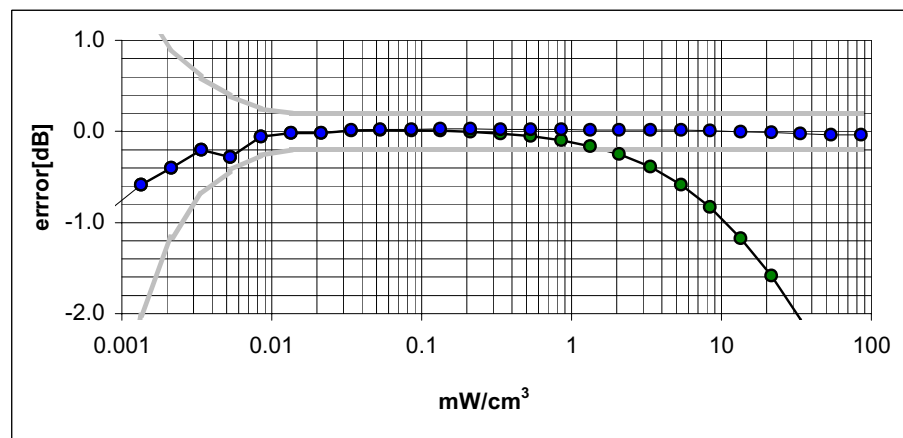
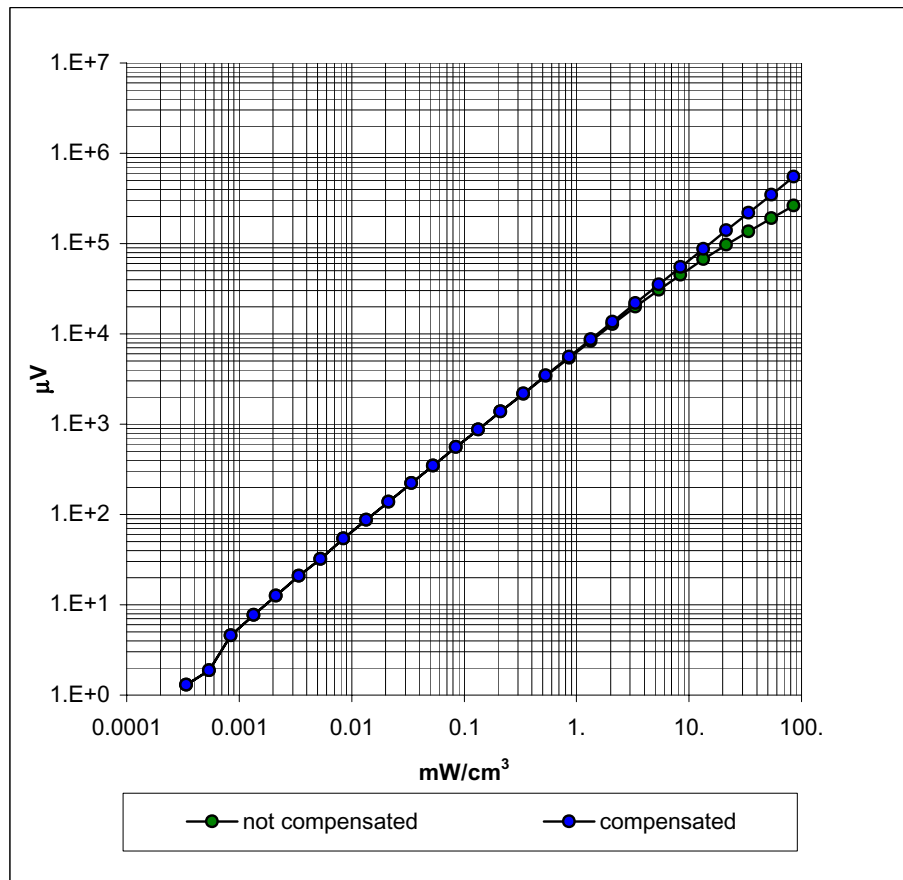

Conversion Factor Assessment

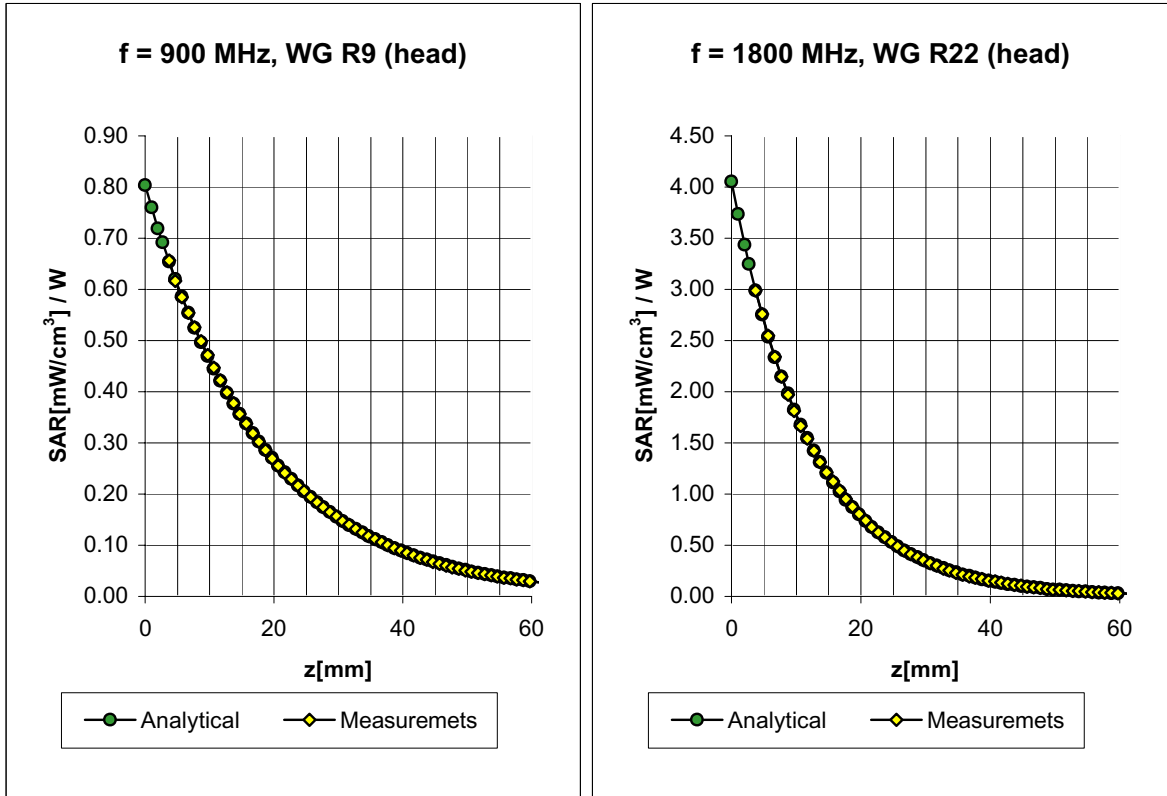

Head	900 MHz	$\epsilon_r = 41.5 \pm 5\%$	$\sigma = 0.97 \pm 5\% \text{ mho/m}$
Head	835 MHz	$\epsilon_r = 41.5 \pm 5\%$	$\sigma = 0.90 \pm 5\% \text{ mho/m}$
	ConvF X	6.6 $\pm 9.5\%$ (k=2)	Boundary effect:
	ConvF Y	6.6 $\pm 9.5\%$ (k=2)	Alpha 0.40
	ConvF Z	6.6 $\pm 9.5\%$ (k=2)	Depth 2.38
Head	1800 MHz	$\epsilon_r = 40.0 \pm 5\%$	$\sigma = 1.40 \pm 5\% \text{ mho/m}$
Head	1900 MHz	$\epsilon_r = 40.0 \pm 5\%$	$\sigma = 1.40 \pm 5\% \text{ mho/m}$
	ConvF X	5.4 $\pm 9.5\%$ (k=2)	Boundary effect:
	ConvF Y	5.4 $\pm 9.5\%$ (k=2)	Alpha 0.57
	ConvF Z	5.4 $\pm 9.5\%$ (k=2)	Depth 2.18

ET3DV6 SN:1387

February 22, 2002

Conversion Factor Assessment

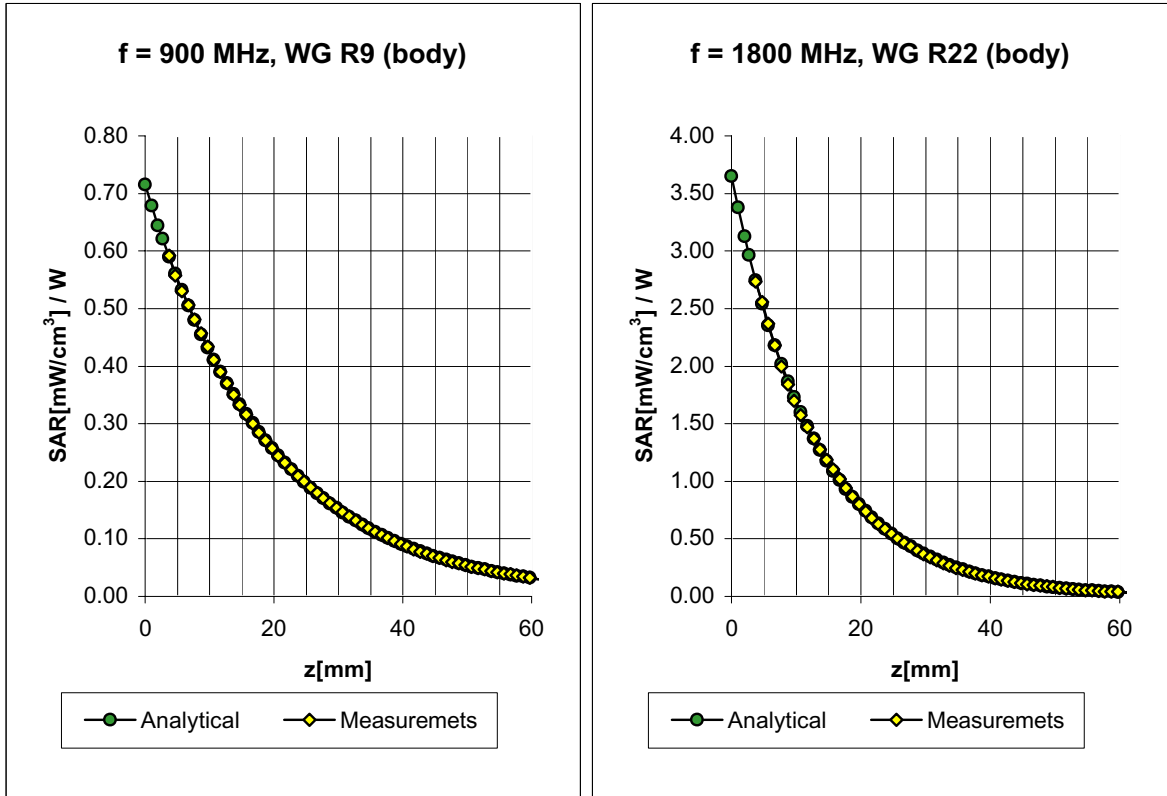

Body	900 MHz	$\epsilon_r = 55.0 \pm 5\%$	$\sigma = 1.05 \pm 5\% \text{ mho/m}$
Body	835 MHz	$\epsilon_r = 55.2 \pm 5\%$	$\sigma = 0.97 \pm 5\% \text{ mho/m}$
	ConvF X	6.3 $\pm 9.5\%$ (k=2)	Boundary effect:
	ConvF Y	6.3 $\pm 9.5\%$ (k=2)	Alpha 0.42
	ConvF Z	6.3 $\pm 9.5\%$ (k=2)	Depth 2.44
Body	1800 MHz	$\epsilon_r = 53.3 \pm 5\%$	$\sigma = 1.52 \pm 5\% \text{ mho/m}$
Body	1900 MHz	$\epsilon_r = 53.3 \pm 5\%$	$\sigma = 1.52 \pm 5\% \text{ mho/m}$
	ConvF X	5.0 $\pm 9.5\%$ (k=2)	Boundary effect:
	ConvF Y	5.0 $\pm 9.5\%$ (k=2)	Alpha 0.76
	ConvF Z	5.0 $\pm 9.5\%$ (k=2)	Depth 2.01

ET3DV6 SN:1387

February 22, 2002

Deviation from Isotropy in HSL

Error (θ, ϕ), $f = 900$ MHz

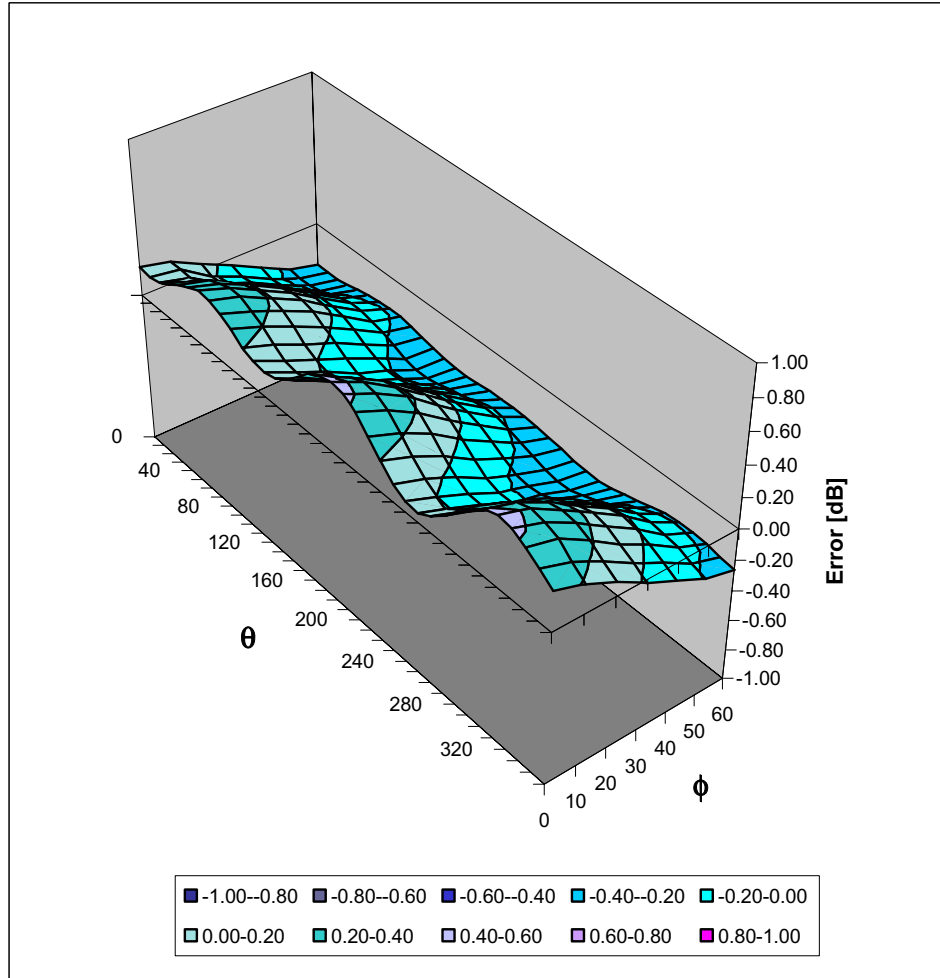

Additional Conversion Factors for Dosimetric E-Field Probe

Type:

ET3DV6

Serial Number:

1387

Place of Assessment:

Zurich

Date of Assessment:

February 25, 2002

Probe Calibration Date:

February 22, 2002

Schmid & Partner Engineering AG hereby certifies that conversion factor(s) of this probe have been evaluated on the date indicated above. The assessment was performed using the FDTD numerical code SEMCAD of Schmid & Partner Engineering AG. Since the evaluation is coupled with measured conversion factors, it has to be recalculated yearly, i.e., following the re-calibration schedule of the probe. The uncertainty of the numerical assessment is based on the extrapolation from measured value at 900 MHz or at 1800 MHz.

Assessed by:



Dosimetric E-Field Probe ET3DV6 SN:1387

Conversion Factor (\pm standard deviation)

150 MHz	ConvF	$9.2 \pm 8\%$	$\epsilon_r = 52.3$ $\sigma = 0.76 \text{ mho/m}$ (head tissue)
300 MHz	ConvF	$8.0 \pm 8\%$	$\epsilon_r = 45.3$ $\sigma = 0.87 \text{ mho/m}$ (head tissue)
450 MHz	ConvF	$7.3 \pm 8\%$	$\epsilon_r = 43.5$ $\sigma = 0.87 \text{ mho/m}$ (head tissue)
2450 MHz	ConvF	$4.7 \pm 8\%$	$\epsilon_r = 39.2$ $\sigma = 1.80 \text{ mho/m}$ (head tissue)
150 MHz	ConvF	$8.8 \pm 8\%$	$\epsilon_r = 61.9$ $\sigma = 0.80 \text{ mho/m}$ (body tissue)
450 MHz	ConvF	$7.7 \pm 8\%$	$\epsilon_r = 56.7$ $\sigma = 0.94 \text{ mho/m}$ (body tissue)
2450 MHz	ConvF	$4.3 \pm 8\%$	$\epsilon_r = 52.7$ $\sigma = 1.95 \text{ mho/m}$ (body tissue)

APPENDIX E - MEASURED FLUID DIELECTRIC PARAMETERS

450MHz System Validation & EUT Evaluation (Face-held)

Measured Fluid Dielectric Parameters (Brain)

October 02, 2002

Frequency	ϵ'	ϵ''
400.000000 MHz	45.366	37.0285
405.000000 MHz	45.269	36.7724
410.000000 MHz	45.133	36.5079
415.000000 MHz	44.951	36.1958
420.000000 MHz	44.865	35.9574
425.000000 MHz	44.698	35.6970
430.000000 MHz	44.580	35.4159
435.000000 MHz	44.455	35.2005
440.000000 MHz	44.345	34.9400
445.000000 MHz	44.166	34.7719
450.000000 MHz	44.048	34.5514
455.000000 MHz	43.939	34.3717
460.000000 MHz	43.848	34.1196
465.000000 MHz	43.785	33.9685
470.000000 MHz	43.615	33.7657
475.000000 MHz	43.520	33.5643
480.000000 MHz	43.411	33.3695
485.000000 MHz	43.309	33.2125
490.000000 MHz	43.138	33.0360
495.000000 MHz	43.061	32.7958
500.000000 MHz	42.935	32.6540

450MHz EUT Evaluation (Body-worn)

Measured Fluid Dielectric Parameters (Muscle)

October 02, 2002

Frequency	ϵ'	ϵ''
400.000000 MHz	58.745	39.7586
405.000000 MHz	58.672	39.3762
410.000000 MHz	58.480	39.1293
415.000000 MHz	58.441	38.7974
420.000000 MHz	58.309	38.5108
425.000000 MHz	58.274	38.1916
430.000000 MHz	58.123	37.8918
435.000000 MHz	58.075	37.5980
440.000000 MHz	57.996	37.3850
445.000000 MHz	57.865	37.1481
450.000000 MHz	57.787	36.9246
455.000000 MHz	57.699	36.6415
460.000000 MHz	57.645	36.4695
465.000000 MHz	57.554	36.2063
470.000000 MHz	57.504	35.9948
475.000000 MHz	57.352	35.7728
480.000000 MHz	57.372	35.4997
485.000000 MHz	57.169	35.3521
490.000000 MHz	57.150	35.0606
495.000000 MHz	57.092	34.9060
500.000000 MHz	56.988	34.6949

APPENDIX F - SAM PHANTOM CERTIFICATE OF CONFORMITY

Schmid & Partner Engineering AG

Zeughausstrasse 43, 8004 Zurich, Switzerland, Phone +41 1 245 97 00, Fax +41 1 245 97 79

Certificate of conformity / First Article Inspection

Item	SAM Twin Phantom V4.0
Type No	QD 000 P40 BA
Series No	TP-1002 and higher
Manufacturer / Origin	Untersee Composites Hauptstr. 69 CH-8559 Fruthwilen Switzerland

Tests

The series production process used allows the limitation to test of first articles. Complete tests were made on the pre-series Type No. QD 000 P40 AA, Serial No. TP-1001 and on the series first article Type No. QD 000 P40 BA, Serial No. TP-1006. Certain parameters have been retested using further series units (called samples).

Test	Requirement	Details	Units tested
Shape	Compliance with the geometry according to the CAD model.	IT'IS CAD File (*)	First article, Samples
Material thickness	Compliant with the requirements according to the standards	2mm +/- 0.2mm in specific areas	First article, Samples
Material parameters	Dielectric parameters for required frequencies	200 MHz – 3 GHz Relative permittivity < 5 Loss tangent < 0.05.	Material sample TP 104-5
Material resistivity	The material has been tested to be compatible with the liquids defined in the standards	Liquid type HSL 1800 and others according to the standard.	Pre-series, First article

Standards

- [1] CENELEC EN 50361
- [2] IEEE P1528-200x draft 6.5
- [3] IEC PT 62209 draft 0.9

(*) The IT'IS CAD file is derived from [2] and is also within the tolerance requirements of the shapes of [1] and [3].

Conformity

Based on the sample tests above, we certify that this item is in compliance with the uncertainty requirements of SAR measurements specified in standard [1] and draft standards [2] and [3].

Date

18.11.2001

Signature / Stamp



**Schmid & Partner
Engineering AG**



Zeughausstrasse 43, CH-8004 Zurich
Tel. +41 1 245 97 00, Fax +41 1 245 97 79

APPENDIX G - SAR TEST SETUP AND DUT PHOTOGRAPHS

FACE-HELD SAR TEST SETUP PHOTOGRAPHS
(2.5cm Separation Distance)

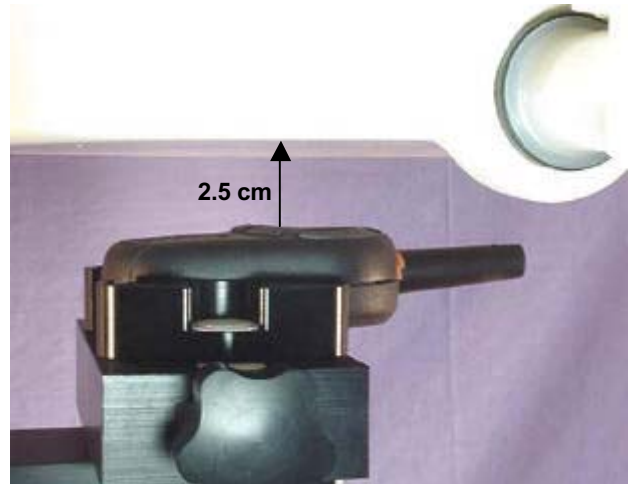

BODY-WORN SAR TEST SETUP PHOTOGRAPHS
(with 0.7cm Belt-Clip & Ear-Microphone Accessory)

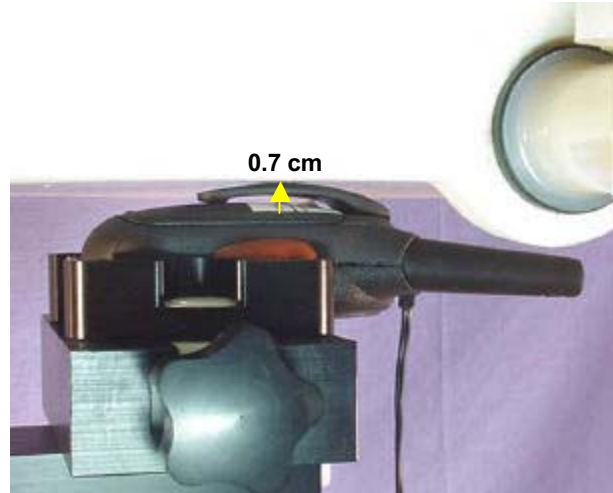

DUT PHOTOGRAPHS

