

**TABLE OF CONTENTS LIST**

**APPLICANT:** COBRA ELECTRONICS CORPORATION

**FCC ID:** BBOMRF75

**TEST REPORT:**

PAGE 1.....GENERAL INFORMATION & TECHNICAL DESCRIPTION  
PAGE 2.....TECHNICAL DESCRIPTION CONTINUED  
                    RF POWER OUTPUT  
PAGE 3.....AUDIO FREQUENCY RESPONSE  
PAGE 4.....AUDIO LOW PASS FILTER  
PAGE 5.....AUDIO INPUT VS MODULATION  
PAGE 6.....OCCUPIED BANDWIDTH  
PAGE 7-9.....OCCUPIED BANDWIDTH PLOT  
PAGE 10.....SPURIOUS EMISSIONS AT ANTENNA TERMINALS  
PAGE 11-12.....FIELD STRENGTH OF SPURIOUS EMISSIONS  
PAGE 13.....METHOD OF MEASURING RADIATED SPURIOUS EMISSIONS  
PAGE 14.....FREQUENCY STABILITY  
PAGE 15.....MPE CALCULATION  
PAGE 16-17.....LIST OF TEST EQUIPMENT

**EXHIBIT CONTAINING:**

EXHIBIT 1.....CONFIDENTIALITY LETTER  
EXHIBIT 2.....FCC ID LABEL SAMPLE  
EXHIBIT 3.....SKETCH OF FCC ID LOCATION  
EXHIBIT 4.....EXTERNAL PHOTOGRAPHS  
EXHIBIT 5.....INTERNAL PHOTOGRAPHS  
EXHIBIT 6.....BLOCK DIAGRAM  
EXHIBIT 7.....SCHEMATICS  
EXHIBIT 8.....PARTS LIST  
EXHIBIT 9.....USER'S MANUAL  
EXHIBIT 10.....OPERATIONAL DESCRIPTION  
EXHIBIT 11.....ALIGNMENT PROCEDURE  
EXHIBIT 12.....TEST SETUP PHOTOGRAPH

APPLICANT: COBRA ELECTRONICS CORPORATION

FCC ID: BBOMRF75

REPORT #: C:\COBRA\1145AUT3\1145AUT3TestReport.doc

TABLE OF CONTENTS

GENERAL INFORMATION REQUIRED  
FOR CERTIFICATION

2.1033(c) COBRA ELECTRONICS CORPORATION will sell the  
FCC ID: BBOMRF75 VHF Marine transmitter in  
quantity, for use under FCC RULES PART 80.

2.1033(c) TECHNICAL DESCRIPTION

(4) Type of Emission: 11K2G3E/11K2F3E For 20 kHz  
For 25KHz

$$B_n = 2M + 2DK$$

$$M = 3000$$

$$D = 2.6 \text{ kHz (Peak Deviation)}$$

$$K = 1$$

$$B_n = 2(3.0K) + 2(2.6K)(1) = 6.0K + 5.2 = 11.2K$$

80.205(A) ALLOWED AUTHORIZED BANDWIDTH = 20.00 kHz.

2.1033(c)(5) Frequency Range: 156.025-157.425 MHz

2.1033(c)(6) Power Range and Controls: There is a user Power switch  
for High/Low Power.

2.1033(c)(8) DC Voltages and Current into Final Amplifier:

POWER INPUT

FINAL AMPLIFIER ONLY

High

$$V_{ce} = 13.8 \text{ VDC}$$

$$I_{ce} = 5.66 \text{ A.}$$

$$P_{in} = 78.11 \text{ Watts}$$

Low

$$V_{ce} = 13.8 \text{ VDC}$$

$$I_{ce} = 1.51$$

$$P_{in} = 20.84 \text{ Watts}$$

Function of each electron tube or semiconductor  
device or other active circuit device: - SEE EXHIBIT# 7

2.1033(c)(10) Complete Circuit Diagrams: The circuit diagram is  
included as EXHIBIT 7. The block diagram is  
included as EXHIBIT 6.

2.1033(c)(3) Instruction book. The instruction manual is included  
as EXHIBIT #9.

2.1033(c) (9) Tune-up procedure. The tune-up procedure is given  
in EXHIBIT #11.

2.1033(c) (13) Digital modulation. This unit does NOT use digital  
modulation.

The data required by 2.1046 through 2.1055 is submitted  
below.

APPLICANT: COBRA ELECTRONICS CORPORATION

FCC ID: BBOMRF75

REPORT #: C:\COBRA\1145AUT3\1145AUT3TestReport.doc

Page 1 of 17

80.911(c) With 13.8 VDC applied and with the radio connected to a 50 ohm resistive wattmeter, the output power was measured at 156.300 MHz and 156.800 MHz with a measured reading of 24 Watts under normal speech modulation.

80.911(d)(2); 80.959 With the power supply set to 13.8 VDC, and the output of the transmitter terminated in a 50 ohm matching artificial load, the transmitter output power was monitored over a 10 minute continuous operational period while in full power. The output power varied from the nominal 44 dBm output power to 43 dBm output power.

80.911(d)(5); 80.959 The primary supply voltage shall be set between 11.5 - 12.6 VDC. For a primary power of 12 volts, the output power shall be equal or greater than the value calculated from the following formula:

$$P = 4.375(12) - 35.313 \text{ or } 17.2 \text{ Watts.}$$

The actual power was measured to be: 23 Watts

2.1046(a) RF\_power\_output.  
80.215(e)(1)

RF power is measured by connecting a 50 ohm, resistive wattmeter to the RF output connector. With a nominal battery voltage of 13.8V, and the transmitter properly adjusted the RF output measures:

POWER OUTPUT

HIGH POWER: 25 WATTS  
LOW POWER: 1 WATT

METHOD OF MEASURING RF POWER OUTPUT

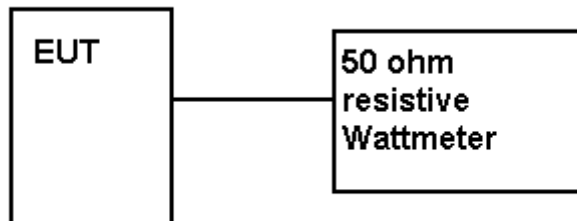

2.1047(a) Voice Modulation characteristics:

(b) AUDIO\_FREQUENCY\_RESPONSE See Below.

### AUDIO FREQUENCY RESPONSE GRAPH

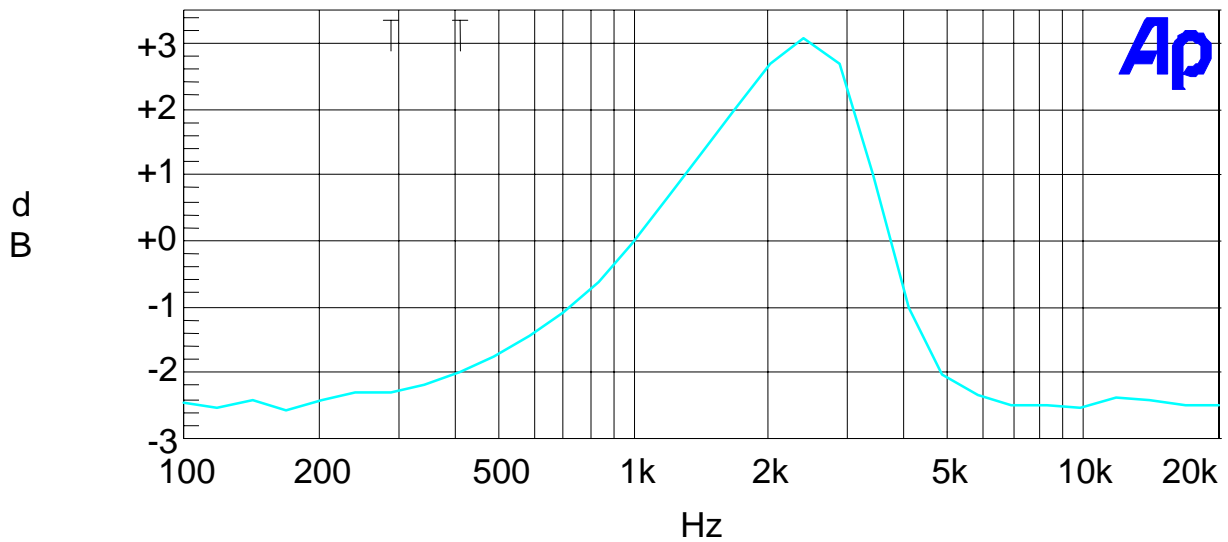

2.1047(a)

AUDIO LOW PASS FILTER

The audio low pass filter is included and the plot is shown below per FCC Rules 80.213(e) for ship stations with a low pass filter.

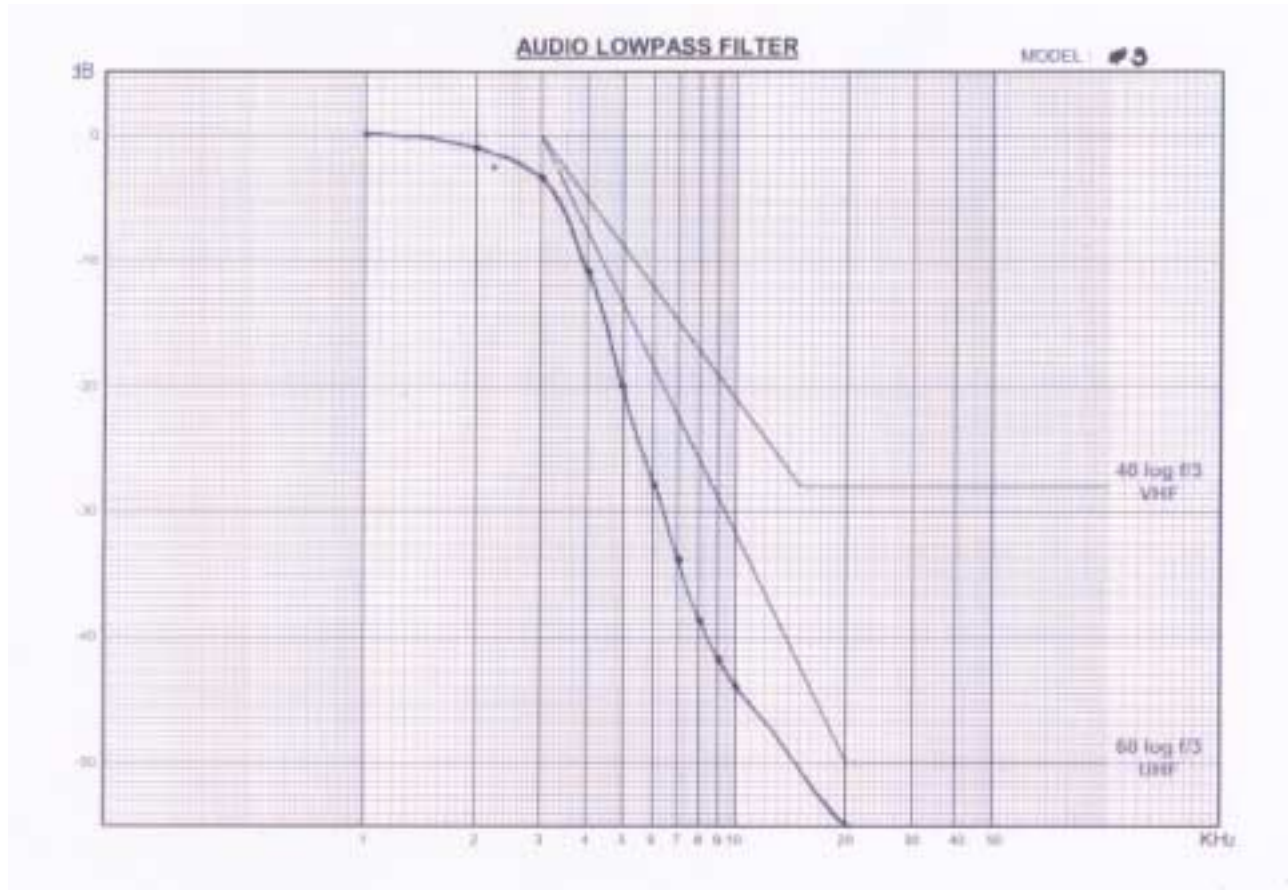

APPLICANT: COBRA ELECTRONICS CORPORATION

FCC ID: BBOMRF75

REPORT #: C\COBRA\1145AUT3\1145AUT3TestReport.doc

2.1047(b)  
80.213(d)

Audio input versus modulation A plot of the  
audio input versus deviation is below.

### MODULATION LIMITING PLOTS

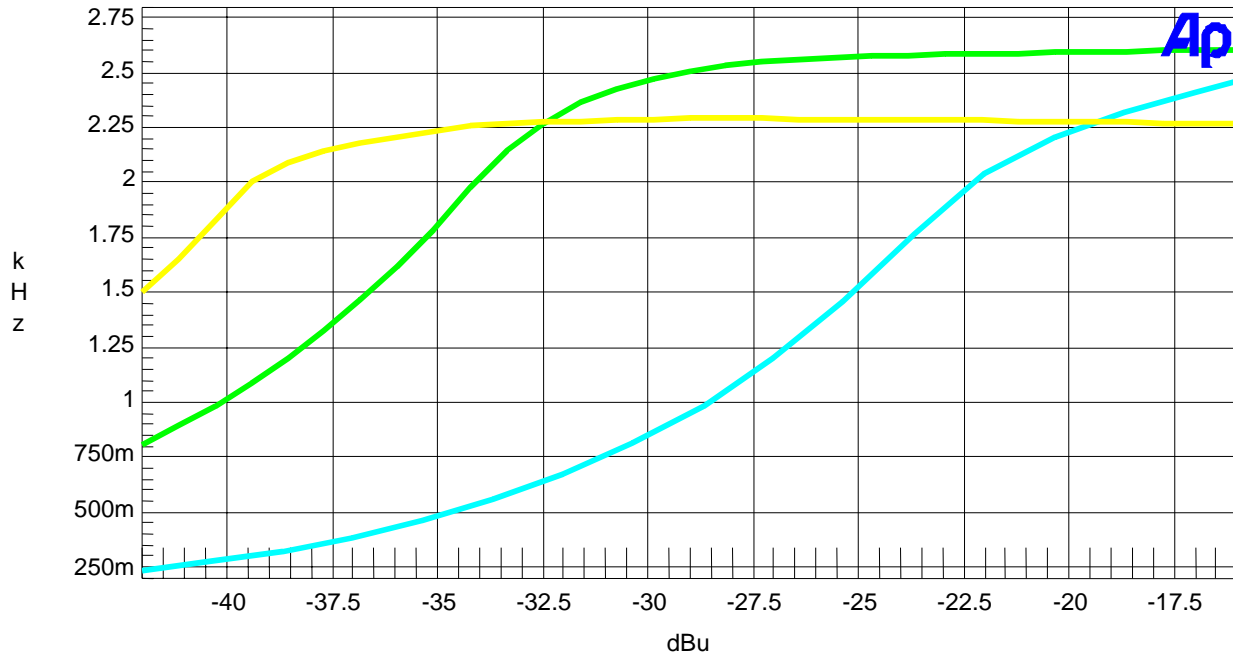

Color	Line Style	Thick	Data	Axis
Cyan	Solid	3	Anlr.Level A	Left
Green	Solid	3	Anlr.Level A	Left
Yellow	Solid	3	Anlr.Level A	Left

modulation limiting.at1

2.1049(c) **Occupied bandwidth:**

80.213(b) Data in the plots shows that on any frequency removed from the assigned frequency by more than 50%, but not more than 100%: At least 25dB. On any frequency removed from the assigned frequency by more than 100%, but not more than 250%: At least 35dB. On any frequency removed from the assigned frequency by more than 250%, of the authorized bandwidth: At least  $43 + \log(P)$  dB.

Radiotelephone transmitter with modulation limiter.

**Test procedure:** TIA/EIA-603 para 2.2.11 , with the exception that various tones were used.

**Test procedure diagram**

**OCCUPIED BANDWIDTH MEASUREMENT**

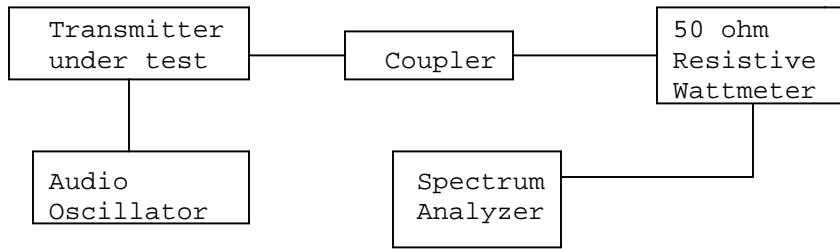

OCCUPIED BANDWIDTH PLOT

NOTES:

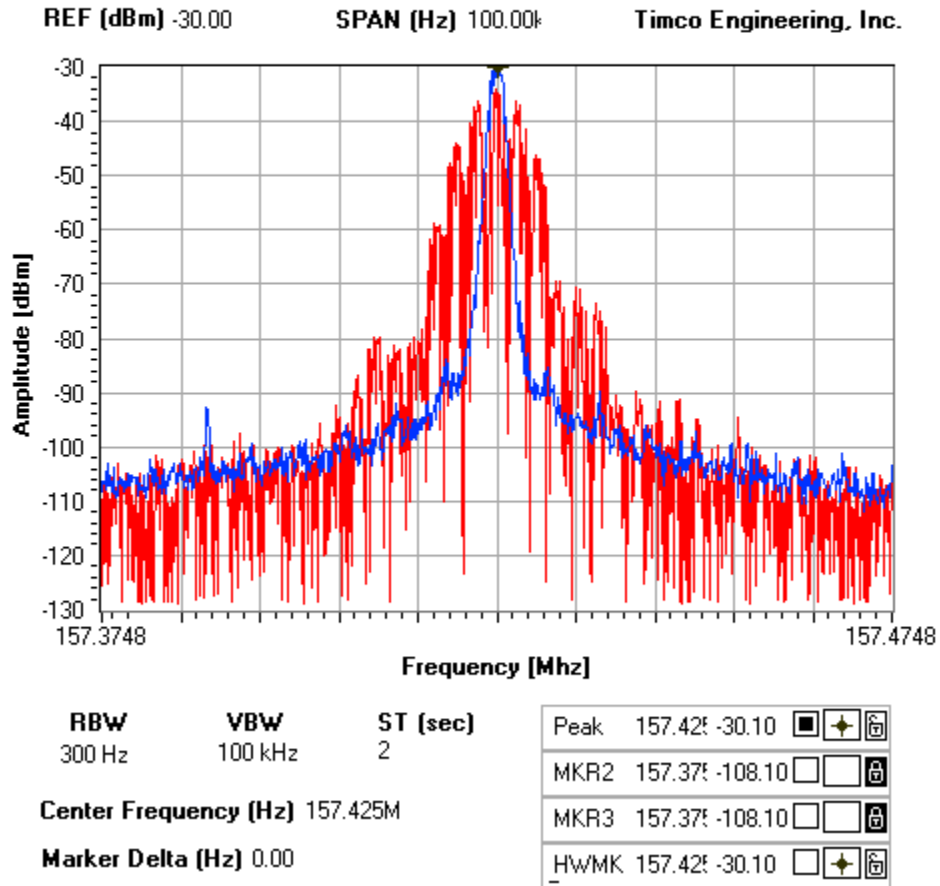



OCCUPIED BANDWIDTH PLOT

NOTES:

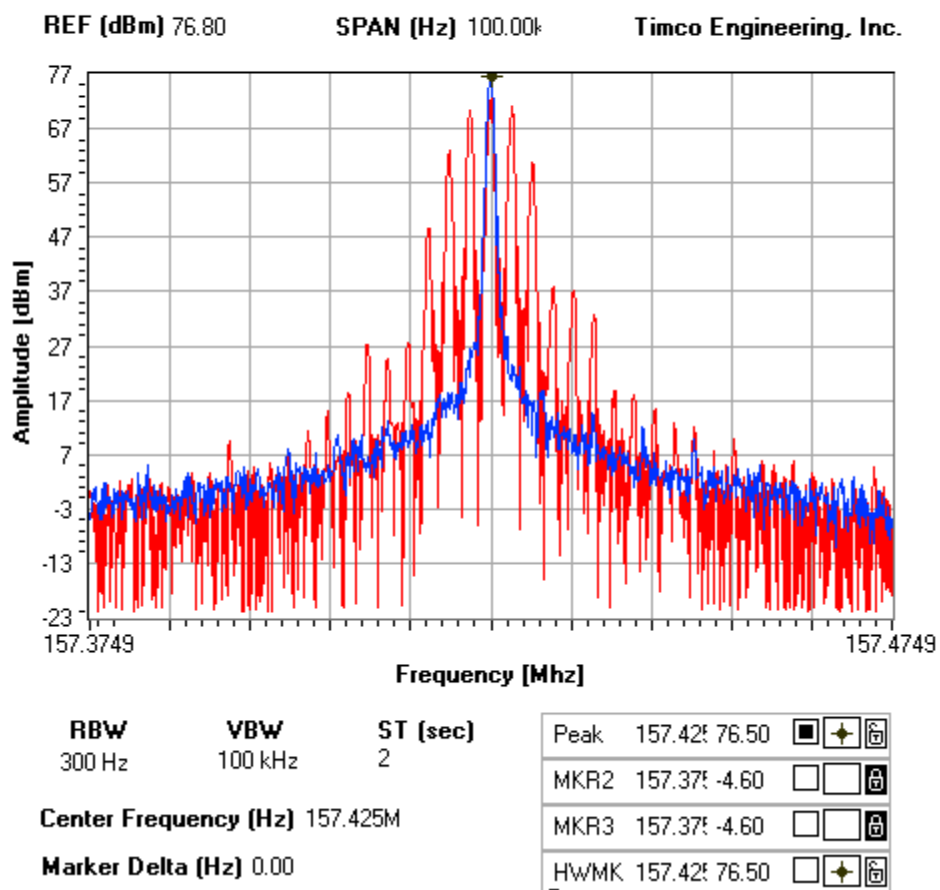

OCCUPIED BANDWIDTH PLOT

NOTES:  
DSC signal

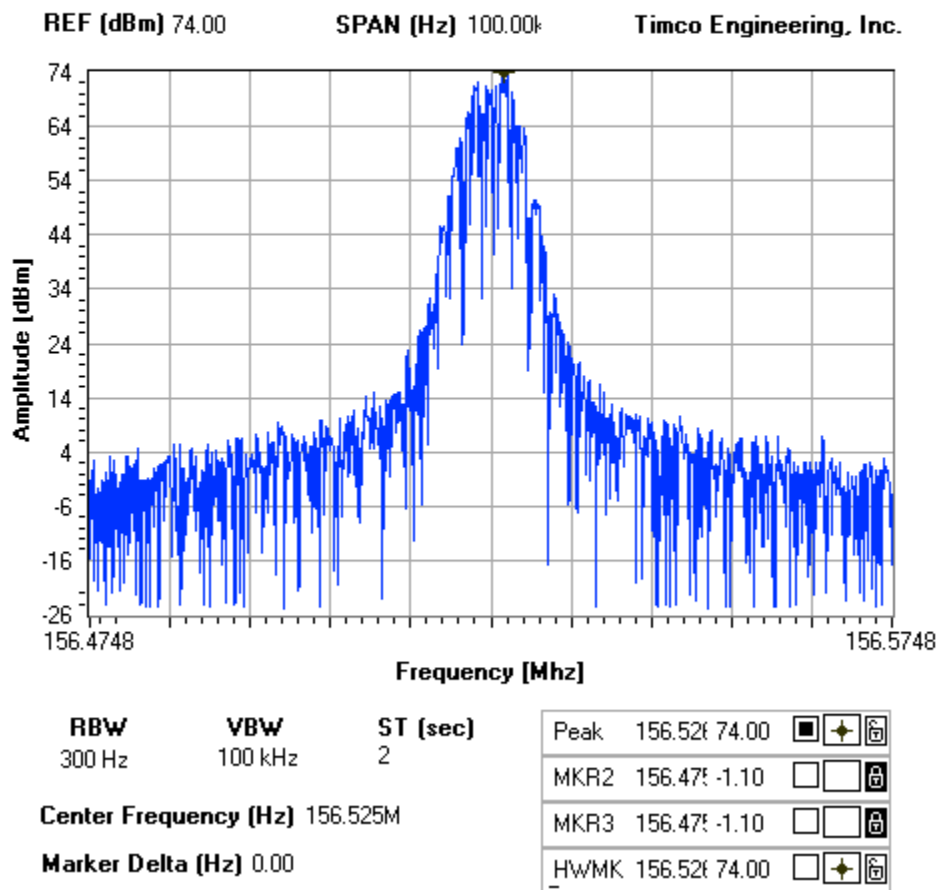

2.1051  
80.211

Spurious emissions at antenna terminals(conducted):  
The data on the following page shows the level of conducted spurious responses. The carrier was modulated 100% using a 2500Hz tone. The spectrum was scanned from 0.4 to at least the 10th harmonic of the fundamental. The measurements were made in accordance with standard TIA/EIA-603.

Method of Measuring Conducted Spurious Emissions

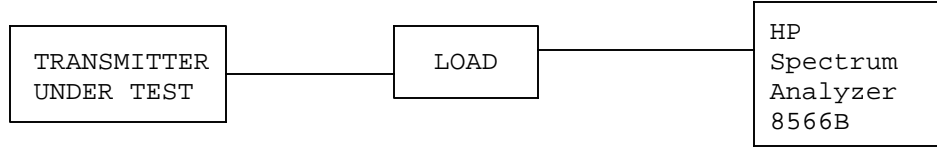

2.1051 Continued Spurious Emissions at the Antenna Terminals:

REQUIREMENTS: Emissions must be 43 +10log(Po) dB below the mean power output of the transmitter.

For 156 MHz HIGH POWER 43 + 10log(24.1) = 56.82dB  
LOW POWER 43 + 10log(0.96) = 42.82dB

For 157.4 MHz HIGH POWER 43 + 10log(24.7) = 56.93dB  
LOW POWER 43 + 10log(.908) = 42.58dB

**TEST DATA:**

156 MHZ - HIGH POWER			157.4 MHZ			LOW POWER		
EF	dB below carrier	dB below carrier	EF	dB below carrier	EF	dB below carrier	dB below carrier	
	156	0		157.4		157.4	0	
	312.1	74.3		314.8		314.8	64.8	
	468.1	70.4		472.2		472.2	78.2	
	624.2	71.7		629.6		629.6	68.8	
	780.2	76.3		787		787	89.9	
	936.3	81.5		944.4		944.5	85.9	
	1092.3	89.7		1101.8		1101.8	93.2	
	1248.4	98.8		1259.2		1259.2	89.3	
	1404.4	100.2		1416.6		1416.6	107.7	
	1560.5	108.8		1574		1574	104.9	

METHOD OF MEASUREMENT: The procedure used was TIA/EIA-603 STANDARD without any exceptions. An audio generator was connected to the UUT through a dummy microphone circuit and the output of the transmitter connected to a standard load and from the standard load through a pre-selector filter of the spectrum analyzer. The spectrum was scanned from 400KHz to at least the tenth harmonic of the fundamental using a HP model 8566B spectrum analyzer. The measurements were made using the shielded room located at TIMCO ENGINEERING INC. 849 STATE ROAD, NEWBERRY FLORIDA 32669.

APPLICANT: COBRA ELECTRONICS CORPORATION  
FCC ID: BBOMRF75

REPORT #: C\COBRA\1145AUT3\1145AUT3TestReport.doc  
Page 10 of 17

2.1053(a) Field strength of spurious emissions:

NAME OF TEST: RADIATED SPURIOUS EMISSIONS

REQUIREMENTS: Emissions must be 43 +10log(Po) dB below the mean power output of the transmitter.

TEST DATA:

**156MHz - HIGH POWER**

$43 + 10\log(24.1) = 56.82\text{dB}$

Emission Frequency MHz	Ant. Polarity	Corrected EUT Signal Reading	Coax Loss (dB)	Substitution Antenna (dBd)	dB Below Carrier (dBc)
156.00	H	43.82	0	0	0
312.00	H	-17.40	0	-1.22	62.44
468.10	H	-13.20	0	-1.46	58.48
624.20	V	-12.40	0	-1.54	57.76
780.20	H	-11.90	0	-1.31	57.03
936.30	H	-26.00	0	-1.33	71.15
1092.30	H	-28.00	1	-3.54	74.36
1248.40	H	-32.00	1	-4.08	78.90
1404.40	H	-36.30	1	-4.63	83.75
1560.50	V	-43.40	1.1	-5.03	91.15

**156MHz - LOW POWER**

$43 + 10\log(0.96) = 42.82\text{dB}$

Emission Frequency MHz	Ant. Polarity	Corrected EUT Signal Reading	Coax Loss (dB)	Substitution Antenna (dBd)	dB Below Carrier (dBc)
156.00	H	29.82	0	0	0
312.00	H	-19.80	0	-1.22	50.84
468.10	H	-11.70	0	-1.46	42.98
624.20	H	-19.70	0	-1.54	51.06
780.20	H	-24.50	0	-1.31	55.63
936.30	H	-29.80	0	-1.33	60.95
1092.30	H	-31.70	1	-3.54	64.06
1248.40	H	-32.80	1	-4.08	65.70
1404.40	H	-38.40	1	-4.63	71.85
1560.50	V	-44.40	1.1	-5.03	78.15

APPLICANT: COBRA ELECTRONICS CORPORATION

FCC ID: BBOMRF75

REPORT #: C\COBRA\1145AUT3\1145AUT3TestReport.doc

**157MHz - HIGH POWER**

$$43 + 10\log(24.7) = 56.93\text{dB}$$

<b>Emission Frequency MHz</b>	<b>Ant. Polarity</b>	<b>Corrected EUT Signal Reading</b>	<b>Coax Loss (dB)</b>	<b>Substitution Antenna (dBd)</b>	<b>dB Below Carrier (dBc)</b>
157.40	H	31.48	0	0	0
314.80	V	-22.80	0	-1.22	67.65
472.20	V	-12.30	0	-1.46	59.59
629.70	H	-20.60	0	-1.54	56.97
787.10	V	-28.80	0	-1.31	57.94
944.50	H	-27.70	0	-1.33	70.16
1102.00	V	-42.00	1	-3.54	74.47
1259.40	H	-34.50	1	-4.08	87.11
1416.80	H	-38.70	1	-4.63	84.86
1574.30	V	-48.20	1.1	-5.03	92.86

**157MHz - LOW POWER**

$$43 + 10\log(.908) = 42.58\text{dB}$$

<b>Emission Frequency MHz</b>	<b>Ant. Polarity</b>	<b>Corrected EUT Signal Reading</b>	<b>Coax Loss (dB)</b>	<b>Substitution Antenna (dBd)</b>	<b>dB Below Carrier (dBc)</b>
157.40	H	43.93	0	0	0
314.80	V	-22.50	0	-1.22	53.6
472.20	H	-14.20	0	-1.46	43.34
629.70	V	-11.50	0	-1.54	51.72
787.10	H	-12.70	0	-1.31	59.69
944.50	H	-24.90	0	-1.33	58.61
1102.00	H	-28.00	1	-3.54	74.12
1259.40	V	-40.10	1	-4.08	67.16
1416.80	H	-37.30	1	-4.63	71.91
1574.30	H	-45.00	1.1	-5.03	81.71

METHOD OF MEASUREMENT: The tabulated data shows the results of the radiated field strength emissions test. The spectrum was scanned from 30 to at least the tenth harmonic of the fundamental. This test was conducted per TIA/EIA STANDARD 603 using the substitution method. Measurements were made at the open field test site of TIMCO ENGINEERING, INC. located at 849 N.W. State Road 45, Newberry, FL 32669.

APPLICANT: COBRA ELECTRONICS CORPORATION

FCC ID: BBOMRF75

REPORT #: C\COBRA\1145AUT3\1145AUT3TestReport.doc

Page 12 of 17

2.1053(a) Continued Field\_strength\_of\_spurious\_emissions:

Method of Measuring Radiated Spurious Emissions

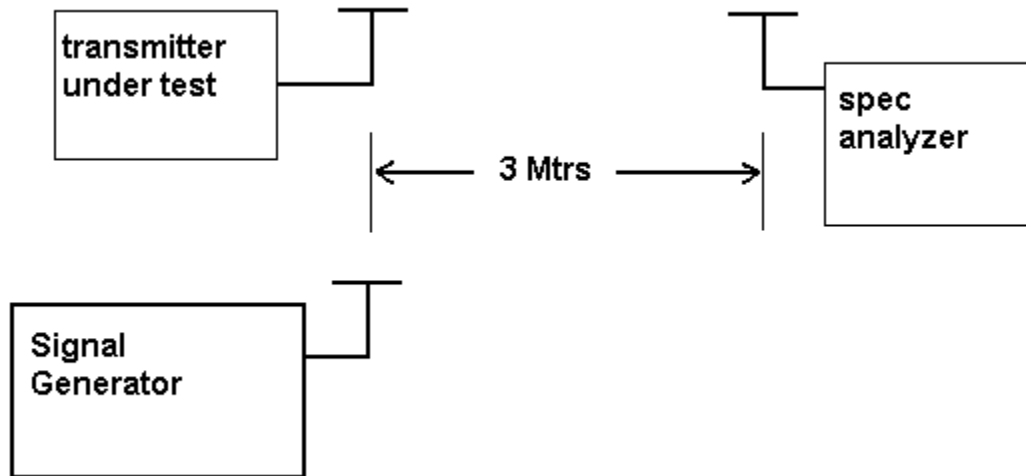

Frequency stability:

2.1055(a)(2)

80.209(a)

Temperature and voltage tests were performed to verify that the frequency remains within the .0005%,5.0 ppm specification limit, for 20kHz spacing. The test was conducted as follows: The transmitter was placed in the temperature chamber at 25 degrees C and allowed to stabilize for one hour. The transmitter was keyed ON for one minute during which four frequency readings were recorded at 15 second intervals. The worse case number was taken for temperature plotting. The assigned channel frequency was considered to be the reference frequency. The temperature was then reduced to -30 degrees C after which the transmitter was again allowed to stabilize for one hour. The transmitter was keyed ON for one minute, and again frequency readings were noted at 15 second intervals. The worst-case number was recorded for temperature plotting. This procedure was repeated in 10 degree increments up to + 50 degrees C.

Readings were also taken at minus 15% of the battery voltage of 13.8 V, which we estimate to be the battery endpoint.

MEASUREMENT DATA:

Assigned Frequency (Ref. Frequency): 157.425 000 MHz

TEMPERATURE_C	FREQUENCY MHz	PPM
REFERENCE_____	157.425 000	
-30_____	157.424 956	-0.28
-20_____	157.425 237	1.51
-10_____	157.425 383	2.43
0_____	157.425 398	2.53
+10_____	157.425 233	1.48
+20_____	157.425 012	0.08
+30_____	157.424 828	-1.09
+40_____	157.424 711	-1.84
+50_____	157.424 725	-1.75

Batt. Volts	Batt. Data	Batt. PPM
-15%	157.424 99	-0.06

RESULTS OF MEASUREMENTS: The test results indicates that the EUT meets the requirements.

## MPE CALCULATION

W := 25.0 power in Watts      D := 1 Duty Factor in decimal % (1=100%)(FM)  
E := 15 exposure time in minutes      U := 30 (use 6 for controlled and 30 for uncontrolled)

$$W_{exp} := W \cdot D \cdot \left( \frac{E}{U} \right)$$

$$W_{exp} = 11.5 \text{ Watts}$$

$$PC := \frac{E}{U}$$

$$PC = 0.5 \text{ percent on time}$$

$$CL := 2.5 \text{ Coax loss in dB}$$

Po := 11500 mWatts      dBd := 3 antenna gain      f := 158 Frequency in MHz

$$G := \text{dBd} + 2.15 - CL \text{ gain in dBi}$$

$$G_n := 10^{\frac{G}{10}} \text{ gain numeric} \quad S := .2 \text{ uncontrolled below 300 MHz}$$

$$G_n = 1.841 \quad S = 0.2$$

$$R := \sqrt{\frac{(P_o \cdot G_n)}{(4 \cdot \pi \cdot S)}}$$

$$R = 91.776 \text{ distance in centimeters required for compliance}$$

$$R_{inches} := \frac{R}{2.54}$$

$$R_{inches} = 36.132$$

### **Conclusion:**

The device complies with the MPE requirements for a typical transceiver with 50 % transmit time by providing a safe separation distance of 91 cm between the antenna, including any radiating structure, and any persons when normally operated .

APPLICANT: COBRA ELECTRONICS CORPORATION

FCC ID: BBOMRF75

REPORT #: C\COBRA\1145AUT3\1145AUT3TestReport.doc

Page 15 of 17



# EMC Equipment List

Device	Manufacturer	Model	Serial Number	Cal/Char Date	Due Date
3/10-Meter OATS	TEI	N/A	N/A	Listed 3/26/01	3/26/04
3-Meter OATS	TEI	N/A	N/A	Listed 1/13/03	1/13/06
Audio Generator	B&K Precision	3010	8739686	CHAR 12/1/02	12/1/04
Audio Oscillator	HP	653A	832-00260	CHAR 12/1/02	12/1/04
Biconnical Antenna	Eaton	94455-1	1057	CAL 3/18/03	3/18/05
Biconnical Antenna	Eaton	94455-1	1096	CAL 10/1/01	10/1/03
Biconnical Antenna	Electro-Metrics	BIA-25	1171	CAL 4/26/01	4/26/03
Blue Tower Quasi-Peak Adapter	HP	85650A	2811A01279	CAL 4/15/03	4/15/05
Blue Tower RF Preselector	HP	85685A	2926A00983	CAL 4/15/03	4/15/05
Blue Tower Spectrum Analyzer	HP	8568B	2928A04729 2848A18049	CAL 4/15/03	4/15/05
Frequency Counter	HP	5352B	2632A00165	CAL 11/28/01	11/28/03
Frequency Counter	HP	5382A	1620A03535	CHAR 3/2/01	3/2/03
Frequency Counter	HP	5385A	2730A03025	CAL 3/7/03	3/7/05
Frequency Counter	HP	5385A	3242A07460	CAL 3/7/03	3/7/05
LISN	Electro-Metrics	ANS-25/2	2604	CAL 10/9/01	10/9/03
LISN	Electro-Metrics	EM-7820	2682	CAL 3/12/03	3/12/05
Log-Periodic Antenna	Eaton	96005	1243	CAL 5/8/03	5/8/05
Log-Periodic Antenna	Electro-Metrics	EM-6950	632	CHAR 10/15/01	10/15/03
Log-Periodic Antenna	Electro-Metrics	LPA-25	1122	CAL 10/2/01	10/2/03
Log-Periodic Antenna	Electro-Metrics	LPA-30	409	CAL 3/4/03	3/4/05
Modulation Analyzer	HP	8901A	3435A06868	CAL 9/5/01	9/5/03
Modulation Meter	Boonton	8220	10901AB	CAL 4/15/03	4/15/05
Peak Power Meter	HP	8900C	2131A00545	CAL 7/2/03	7/2/05

APPLICANT: COBRA ELECTRONICS CORPORATION

FCC ID: BBOMRF75

REPORT #: C:\COBRA\1145AUT3\1145AUT3TestReport.doc

Page 16 of 17

Power Meter And Sensor Signal Generator Tan Tower Preamplifier Tan Tower Quasi-Peak Adapter Tan Tower RF Preselector Tan Tower Spectrum Analyzer Temperature Chamber	Bird HP HP HP HP HP HP Tenney Engineering	4421-107 & 4022 8640B 8449B-H02 85650A 85685A 8566B Opt 462 TTRC	0166 & 0218 2308A21464 3008A00372 3303A01690 3221A01400 3138A07786 3144A20661 11717-7	CAL 4/16/03 CAL 2/15/02 CHAR 3/4/01 CAL 8/31/01 CAL 8/31/01 CAL 8/31/01 CAL 8/31/01 CHAR 1/22/02	4/16/05 2/15/04 3/4/03 8/31/03 8/31/03 8/31/03 8/31/03 1/22/04
---	---	--	--	--	---

APPLICANT: COBRA ELECTRONICS CORPORATION

FCC ID: BBOMRF75

REPORT #: C:\COBRA\1145AUT3\1145AUT3TestReport.doc

Page 17 of 17