



	<u>Date(s) of Evaluation</u> July 25, 2007	<u>Test Report Serial No.</u> 071707BBO-T841-S95U	<u>Test Report Revision No.</u> Revision 1.0	
	<u>Test Report Issue Date</u> August 01, 2007	<u>Description of Test(s)</u> Specific Absorption Rate	<u>RF Exposure Category</u> General Population	

SAR TEST REPORT			
RF EXPOSURE EVALUATION		SPECIFIC ABSORPTION RATE	
APPLICANT	COBRA ELECTRONICS CORPORATION		
PRODUCT	PORTABLE FRS/GMRS PTT RADIO TRANSCEIVER		
MODEL(S)	LI6700	LI6750	
IDENTIFIER(S)	FCC ID: BBOLI6700	IC ID:	906B-LI6700
APPLICATION TYPE	New Certification		
STANDARD(S) APPLIED	47 CFR §2.1093	Health Canada Safety Code 6	
PROCEDURE(S) APPLIED	FCC OET Bulletin 65, Supplement C (01-01)		
	Industry Canada RSS-102 Issue 2		
RF EXPOSURE CATEGORY	General Population / Uncontrolled Exposure		
TEST REPORT SERIAL NO.	071707BBO-T841-S95U		
TEST REPORT REVISION NO.	Revision 1.0 (Initial Release)		
TEST REPORT ISSUE DATE	August 01, 2007		
TEST REPORT SIGNATORIES	Testing and Test Report By	Test Report Reviewed By	
	Cheri Frangiadakis Celltech Labs Inc.	Jonathan Hughes Celltech Labs Inc.	
TEST LAB AND LOCATION	Celltech Compliance Testing & Engineering Lab		
	21-364 Loughheed Road, Kelowna, B.C. V1X 7R8 Canada		
TEST LAB CONTACT INFO.	Tel.: 250-765-7650	Fax: 250-765-7645	
	info@celltechlabs.com	www.celltechlabs.com	
TEST LAB ACCREDITATION(S)	 Certificate No. 2470.01		

Company:	Cobra Electronics Corporation	FCC ID:	BBOLI6700	IC ID:	906B-LI6700	
Model(s):	LI6700 / LI6750	DUT Type:	Portable FM UHF FRS/GMRS PTT Radio Transceiver			
2007 Celltech Labs Inc.	This document is not to be reproduced in whole or in part without the prior written permission of Celltech Labs Inc.					Page 1 of 33

	<u>Date(s) of Evaluation</u> July 25, 2007	<u>Test Report Serial No.</u> 071707BBO-T841-S95U	<u>Test Report Revision No.</u> Revision 1.0	
	<u>Test Report Issue Date</u> August 01, 2007	<u>Description of Test(s)</u> Specific Absorption Rate	<u>RF Exposure Category</u> General Population	

DECLARATION OF COMPLIANCE SAR RF EXPOSURE EVALUATION

<u>Test Lab and Location</u> CELLTECH LABS INCORPORATED Testing and Engineering Services 21-364 Lougheed Road Kelowna, B.C. V1X 7R8 Canada Tel.: 250-765-7650 e-mail: info@celltechlabs.com Fax: 250-765-7645 web site: www.celltechlabs.com		<u>Company Information</u> COBRA ELECTRONICS CORPORATION 6500 West Cortland Street Chicago, IL 60707 United States	
FCC IDENTIFIER:	BBOLI6700	IC IDENTIFIER:	906B-LI6700
Device Model(s):	LI6700 LI6750	Serial No. Tested:	#8 Identical Prototype
Standard(s) Applied:	FCC 47 CFR §2.1093	Health Canada Safety Code 6	
Procedure(s) Applied:	FCC OET Bulletin 65, Supplement C (Edition 01-01) Industry Canada RSS-102 Issue 2		
RF Exposure Category:	General Population / Uncontrolled Environment		
Device Description:	Portable FM UHF FRS/GMRS PTT Radio Transceiver		
Transmit Frequency Range(s):	462.5500 - 462.7250 MHz (GMRS Channels 15-22) 462.5625 - 462.7125 MHz (FRS/GMRS Channels 1-7) 467.5625 - 467.7125 MHz (FRS Channels 8-14)		
Max. RF Output Power Tested:	0.900 Watts	29.54 dBm	ERP 462.6625 MHz GMRS Ch. 5
Antenna Type(s) Tested:	External Fixed Stubby		
Battery Type(s) Tested:	Lithium-ion	7.4 V	950 mAh P/N: MN-0160001
Body-worn Accessories Tested:	Plastic Belt-Clip (4 mm thickness)		
Audio Accessories Connected:	Ear-bud with Lapel-Microphone		
Max. SAR Level(s) Evaluated:	Face-held	0.575 W/kg	1g 50% duty cycle
	Body-worn	1.28 W/kg	1g 50% duty cycle

Celltech Labs Inc. declares under its sole responsibility that this wireless portable device has demonstrated compliance with the Specific Absorption Rate (SAR) RF exposure requirements specified in FCC 47 CFR §2.1093 and Health Canada's Safety Code 6 for the General Population / Uncontrolled Exposure environment. The device was tested in accordance with the measurement standards and procedures specified in FCC OET Bulletin 65, Supplement C (Edition 01-01) and Industry Canada RSS-102 Issue 2. All measurements were performed in accordance with the SAR system manufacturer recommendations.

I attest to the accuracy of data. All measurements were performed by me or were made under my supervision and are correct to the best of my knowledge and belief. I assume full responsibility for the completeness of these measurements and vouch for the qualifications of all persons taking them.

This test report shall not be reproduced partially, or in full, without the prior written approval of Celltech Labs Inc. The results and statements contained in this report pertain only to the device(s) evaluated.

Test Report Approved By:

Sean Johnston
Celltech Labs Inc.



Company:	Cobra Electronics Corporation	FCC ID:	BBOLI6700	IC ID:	906B-LI6700	
Model(s):	LI6700 / LI6750	DUT Type:	Portable FM UHF FRS/GMRS PTT Radio Transceiver			
2007 Celltech Labs Inc.		This document is not to be reproduced in whole or in part without the prior written permission of Celltech Labs Inc.				Page 2 of 33





	<u>Date(s) of Evaluation</u> July 25, 2007	<u>Test Report Serial No.</u> 071707BBO-T841-S95U	<u>Test Report Revision No.</u> Revision 1.0	 Certificate No. 2470.01
	<u>Test Report Issue Date</u> August 01, 2007	<u>Description of Test(s)</u> Specific Absorption Rate	<u>RF Exposure Category</u> General Population	

TABLE OF CONTENTS	
1.0 INTRODUCTION	4
2.0 SAR MEASUREMENT SYSTEM	4
3.0 MEASUREMENT SUMMARY	5
4.0 DETAILS OF SAR EVALUATION	6
5.0 EVALUATION PROCEDURES	6
6.0 SYSTEM PERFORMANCE CHECK	7
7.0 SIMULATED EQUIVALENT TISSUES	8
8.0 SAR SAFETY LIMITS	8
9.0 ROBOT SYSTEM SPECIFICATIONS	9
10.0 PROBE SPECIFICATION (ET3DV6)	10
11.0 SIDE PLANAR PHANTOM	10
12.0 VALIDATION PLANAR PHANTOM	10
13.0 DEVICE HOLDER	10
14.0 TEST EQUIPMENT LIST	11
15.0 MEASUREMENT UNCERTAINTIES	12
MEASUREMENT UNCERTAINTIES (CONT.)	13
16.0 REFERENCES	14
APPENDIX A - SAR MEASUREMENT DATA	15
APPENDIX B - SYSTEM PERFORMANCE CHECK DATA	20
APPENDIX C - MEASURED FLUID DIELECTRIC PARAMETERS	23
APPENDIX D - SAR TEST SETUP & DUT PHOTOGRAPHS	26
APPENDIX E - SYSTEM VALIDATION	32
APPENDIX F - PROBE CALIBRATION	33

	<u>Date(s) of Evaluation</u> July 25, 2007	<u>Test Report Serial No.</u> 071707BBO-T841-S95U	<u>Test Report Revision No.</u> Revision 1.0	
	<u>Test Report Issue Date</u> August 01, 2007	<u>Description of Test(s)</u> Specific Absorption Rate	<u>RF Exposure Category</u> General Population	

1.0 INTRODUCTION

This measurement report demonstrates compliance of the Cobra Electronics Corporation Model(s): LI6700 / LI6750 Portable FM UHF FRS/GMRS PTT Radio Transceiver with the SAR (Specific Absorption Rate) RF exposure requirements specified in FCC 47 CFR §2.1093 (see reference [1]) and Health Canada's Safety Code 6 (see reference [2]) for the General Population / Uncontrolled Exposure environment. The test procedures described in FCC OET Bulletin 65, Supplement C (Edition 01-01) (see reference [3]) and IC RSS-102 Issue 2 (see reference [4]) were employed. A description of the product and operating configuration, detailed summary of the test results, methodology and procedures used in the evaluation, equipment used, and the provisions of the rules are included within this test report.

2.0 SAR MEASUREMENT SYSTEM

Celltech Labs Inc. SAR measurement facility utilizes the Dosimetric Assessment System (DASY™) manufactured by Schmid & Partner Engineering AG (SPEAG™) of Zurich, Switzerland. The DASY4 measurement system is comprised of the measurement server, robot controller, computer, near-field probe, probe alignment sensor, specific anthropomorphic mannequin (SAM) phantom, and various planar phantoms for brain and/or body SAR evaluations. The robot is a six-axis industrial robot performing precise movements to position the probe to the location (points) of maximum electromagnetic field (EMF). A cell controller system contains the power supply, robot controller, teach pendant (Joystick), and remote control, is used to drive the robot motors. The Staubli robot is connected to the cell controller to allow software manipulation of the robot. A data acquisition electronic (DAE) circuit performs the signal amplification, signal multiplexing, AD-conversion, offset measurements, mechanical surface detection, collision detection, etc. is connected to the Electro-optical coupler (EOC). The EOC performs the conversion from the optical into digital electric signal of the DAE and transfers data to the DASY4 measurement server. The DAE4 utilizes a highly sensitive electrometer-grade preamplifier with auto-zeroing, a channel and gain-switching multiplexer, a fast 16-bit AD-converter and a command decoder and control logic unit. Transmission to the DASY4 measurement server is accomplished through an optical downlink for data and status information and an optical uplink for commands and clock lines. The mechanical probe-mounting device includes two different sensor systems for frontal and sidewise probe contacts. The sensor systems are also used for mechanical surface detection and probe collision detection. The robot uses its own controller with a built in VME-bus computer.

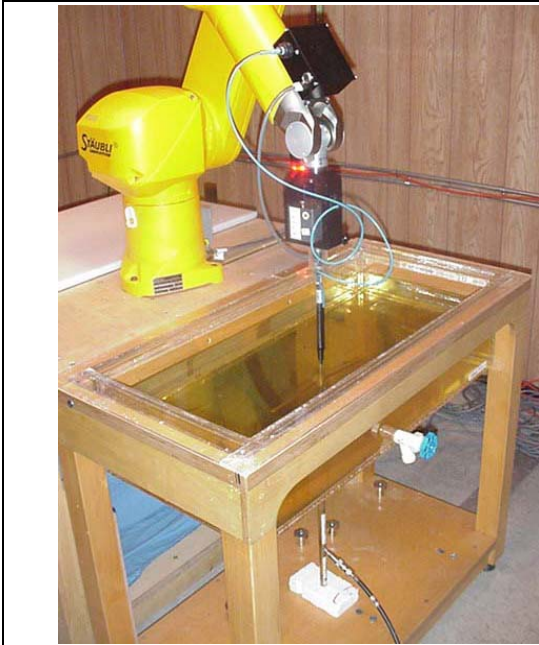



DASY4 SAR System with Plexiglas validation phantom



DASY4 SAR System with Plexiglas side planar phantom



Company:	Cobra Electronics Corporation	FCC ID:	BBOLI6700	IC ID:	906B-LI6700	
Model(s):	LI6700 / LI6750	DUT Type:	Portable FM UHF FRS/GMRS PTT Radio Transceiver			
2007 Celltech Labs Inc.		This document is not to be reproduced in whole or in part without the prior written permission of Celltech Labs Inc.				Page 4 of 33

	<u>Date(s) of Evaluation</u> July 25, 2007	<u>Test Report Serial No.</u> 071707BBO-T841-S95U	<u>Test Report Revision No.</u> Revision 1.0	 Certificate No. 2470.01
	<u>Test Report Issue Date</u> August 01, 2007	<u>Description of Test(s)</u> Specific Absorption Rate	<u>RF Exposure Category</u> General Population	

3.0 MEASUREMENT SUMMARY

SAR EVALUATION RESULTS													
Test Type	Freq. MHz	Channel		Test Mode	Battery Type	Accessories			DUT Position to Planar Phantom	Start Power (ERP) Watts	SAR Drift During Test dB	Measured SAR 1g (W/kg)	
						Body-worn	Spacing	Audio				Duty Cycle	
Face	462.6625	5	GMRS	CW	Li-ion	~	2.5 cm	~	Front Side	0.900	-0.0737	1.15	0.575
Body	462.6625	5	GMRS	CW	Li-ion	Belt-Clip	0.4 cm	Ear-Mic	Back Side	0.900	-0.108	2.55	1.28
ANSI / IEEE C95.1: 2005 - SAFETY LIMIT				BRAIN / BODY: 1.6 W/kg (averaged over 1 gram)					Spatial Peak Uncontrolled Exposure / General Population				
Test Date(s)		July 25, 2007			July 25, 2007			Measured Fluid Type		Brain	Body	Unit	
Dielectric Constant ϵ_r	450 MHz Brain				450 MHz Body			Atmospheric Pressure		101.3	101.3	kPa	
	IEEE Target	Meas.	Dev.	IEEE Target	Meas.	Dev.	Relative Humidity		30	31	%		
	43.5	± 5%	43.3	-0.4%	56.7	± 5%	57.8	+2.0%	Ambient Temperature		25.3	25.5	°C
Conductivity σ (mho/m)	450 MHz Brain				450 MHz Body			Fluid Temperature		23.9	23.9	°C	
	IEEE Target	Meas.	Dev.	IEEE Target	Meas.	Dev.	Fluid Depth		≥ 15	≥ 15	cm		
	0.87	± 5%	0.85	-2.2%	0.94	± 5%	0.97	+3.2%	ρ (Kg/m ³)		1000		
Note(s)	1.	The measurement results were obtained with the DUT tested in the conditions described in this report. Detailed measurement data and plots showing the maximum SAR location of the DUT are reported in Appendix A.											
	2.	The transmission band of the DUT is less than 10 MHz; therefore single channel data only is reported (per FCC OET Bulletin 65, Supplement C, Edition 01-01 - see reference [3]).											
	3.	The area scan evaluation was performed with a fully charged battery. After the area scan was completed the battery was replaced with a fully charged battery prior to the zoom scan evaluation.											
	4.	The power drifts measured by the DASY4 system during the SAR evaluations were <5% from the start power.											
	5.	The fluid temperature was measured prior to and after the SAR evaluations to ensure the temperature remained within +/-2°C of the fluid temperature reported during the dielectric parameter measurements.											
	6.	The dielectric parameters of the simulated tissue mixtures were measured prior to the SAR evaluations using an ALS-PR-DIEL Dielectric Probe Kit and an HP 8753ET Network Analyzer (see Appendix C).											
	7.	The SAR evaluations were performed within 24 hours of the system performance check.											

Company:	Cobra Electronics Corporation	FCC ID:	BBOLI6700	IC ID:	906B-LI6700	
Model(s):	LI6700 / LI6750	DUT Type:	Portable FM UHF FRS/GMRS PTT Radio Transceiver			
2007 Celltech Labs Inc.		This document is not to be reproduced in whole or in part without the prior written permission of Celltech Labs Inc.				Page 5 of 33

	<u>Date(s) of Evaluation</u> July 25, 2007	<u>Test Report Serial No.</u> 071707BBO-T841-S95U	<u>Test Report Revision No.</u> Revision 1.0	  Certificate No. 2470.01
	<u>Test Report Issue Date</u> August 01, 2007	<u>Description of Test(s)</u> Specific Absorption Rate	<u>RF Exposure Category</u> General Population	

4.0 DETAILS OF SAR EVALUATION



The Cobra Electronics Corporation Model(s): LI6700 / LI6750 Portable FRS/GMRS PTT Radio Transceiver was compliant for localized Specific Absorption Rate (General Population / Uncontrolled Exposure) based on the test provisions and conditions described below. The detailed test setup photographs are shown in Appendix D.

1. The DUT was evaluated in a face-held configuration with the front of the radio placed parallel to the outer surface of the planar phantom. A 2.5 cm spacing was maintained between the front of the DUT and the outer surface of the planar phantom.
2. The DUT was tested in a body-worn configuration with the back of the radio placed parallel to the outer surface of the planar phantom. The attached plastic belt-clip accessory was touching the planar phantom and provided a 0.4 cm spacing from the back of the DUT to the outer surface of the planar phantom. The DUT was evaluated for body-worn SAR with the Cobra supplied ear-bud/lapel-microphone audio accessory connected to the audio port.
3. The RF conducted output power of the DUT could not be measured due to a non-detachable antenna. The DUT was evaluated for SAR at the maximum conducted power level preset by the manufacturer.
4. The output power level (ERP) of the DUT referenced in this test report was measured by Timco Engineering Inc. prior to the SAR evaluations.
5. The power drift of the DUT during the SAR evaluations was measured by the DASY4 system.
6. The area scan evaluation was performed with a fully charged battery. After the area scan was completed the battery was replaced with a fully charged battery prior to the zoom scan evaluation.
7. The DUT was tested in unmodulated continuous transmit operation (Continuous Wave mode at 100% duty cycle) with the transmit key constantly depressed. For a push-to-talk device the 50% duty cycle compensation reported assumes a transmit/receive cycle of equal time base.
8. The SAR evaluations were performed using a Plexiglas side planar phantom.
9. The fluid temperature was measured prior to and after the SAR evaluations to ensure the temperature remained within +/-2°C of the fluid temperature reported during the dielectric parameter measurements.
10. The dielectric parameters of the simulated tissue mixtures were measured prior to the SAR evaluations using an ALS-PR-DIEL Dielectric Probe Kit and an HP 8753ET Network Analyzer (see Appendix C).

5.0 EVALUATION PROCEDURES

- a. (i) The evaluation was performed in the applicable area of the phantom depending on the type of device being tested. For devices held to the ear during normal operation, both the left and right ear positions were evaluated using the SAM phantom.
(ii) For body-worn and face-held devices a planar phantom was used.
- b. The SAR was determined by a pre-defined procedure within the DASY4 software. Upon completion of a reference and optical surface check, the exposed region of the phantom was scanned near the inner surface with a grid spacing of 15mm x 15mm.
An area scan was determined as follows:
- c. Based on the defined area scan grid, a more detailed grid is created to increase the points by a factor of 10. The interpolation function then evaluates all field values between corresponding measurement points.
- d. A linear search is applied to find all the candidate maxima. Subsequently, all maxima are removed that are >2 dB from the global maximum. The remaining maxima are then used to position the cube scans.
A 1g and 10g spatial peak SAR was determined as follows:
- e. Extrapolation is used to find the points between the dipole center of the probe and the surface of the phantom. This data cannot be measured, since the center of the dipoles is 2.7 mm away from the tip of the probe and the distance between the surface and the lowest measuring point is 1.4 mm (see probe calibration document in Appendix F). The extrapolation was based on trivariate quadratics computed from the previously calculated 3D interpolated points nearest the phantom surface.
- f. Interpolated data is used to calculate the average SAR over 1g and 10g cubes by spatially discretizing the entire measured cube. The volume used to determine the averaged SAR is a 1mm grid (42875 interpolated points).
- g. A zoom scan volume of 32 mm x 32 mm x 30 mm (5 x 5 x 7 points) centered at the peak SAR location determined from the area scan is used for all zoom scans for devices with a transmit frequency < 800 MHz. Zoom scans for frequencies ≥ 800 MHz are determined with a scan volume of 30 mm x 30 mm x 30 mm (7 x 7 x 7) to ensure complete capture of the peak spatial-average SAR.

Company:	Cobra Electronics Corporation	FCC ID:	BBOLI6700	IC ID:	906B-LI6700	
Model(s):	LI6700 / LI6750	DUT Type:	Portable FM UHF FRS/GMRS PTT Radio Transceiver			
2007 Celltech Labs Inc.	This document is not to be reproduced in whole or in part without the prior written permission of Celltech Labs Inc.					Page 6 of 33

	<u>Date(s) of Evaluation</u> July 25, 2007	<u>Test Report Serial No.</u> 071707BBO-T841-S95U	<u>Test Report Revision No.</u> Revision 1.0	 
	<u>Test Report Issue Date</u> August 01, 2007	<u>Description of Test(s)</u> Specific Absorption Rate	<u>RF Exposure Category</u> General Population	

6.0 SYSTEM PERFORMANCE CHECK

Prior to the SAR evaluations a system check was performed using a Plexiglas planar phantom and 450MHz dipole (see Appendix E for system validation procedures). The dielectric parameters of the simulated tissue mixture were measured prior to the system performance check using an ALS-PR-DIEL Dielectric Probe Kit and HP 8753ET Network Analyzer (see Appendix C). A forward power of 250 mW was applied to the dipole and the system was verified to a tolerance of $\pm 10\%$ (see Appendix B for system performance check test plot).

SYSTEM PERFORMANCE CHECK EVALUATION

Test Date	Equiv. Tissue Freq. MHz	SAR 1g (W/kg)			Dielectric Constant ϵ_r			Conductivity σ (mho/m)			ρ (Kg/m ³)	Amb. Temp. (°C)	Fluid Temp. (°C)	Fluid Depth (cm)	Humid. (%)	Barom. Press. (kPa)
		IEEE Target	Meas.	Dev.	IEEE Target	Meas.	Dev.	IEEE Target	Meas.	Dev.						
Jul 25	Brain 450	1.23 $\pm 10\%$	1.24	+0.9%	43.5 $\pm 5\%$	43.3	-0.4%	0.87 $\pm 5\%$	0.85	-2.2%	1000	25.5	23.8	≥ 15	30	101.3
Note(s)		1. The fluid temperature was measured prior to and after the system performance check to ensure the temperature remained within $\pm 2^\circ\text{C}$ of the fluid temperature reported during the dielectric parameter measurements. 2. The SAR evaluations were performed within 24 hours of the system performance check.														

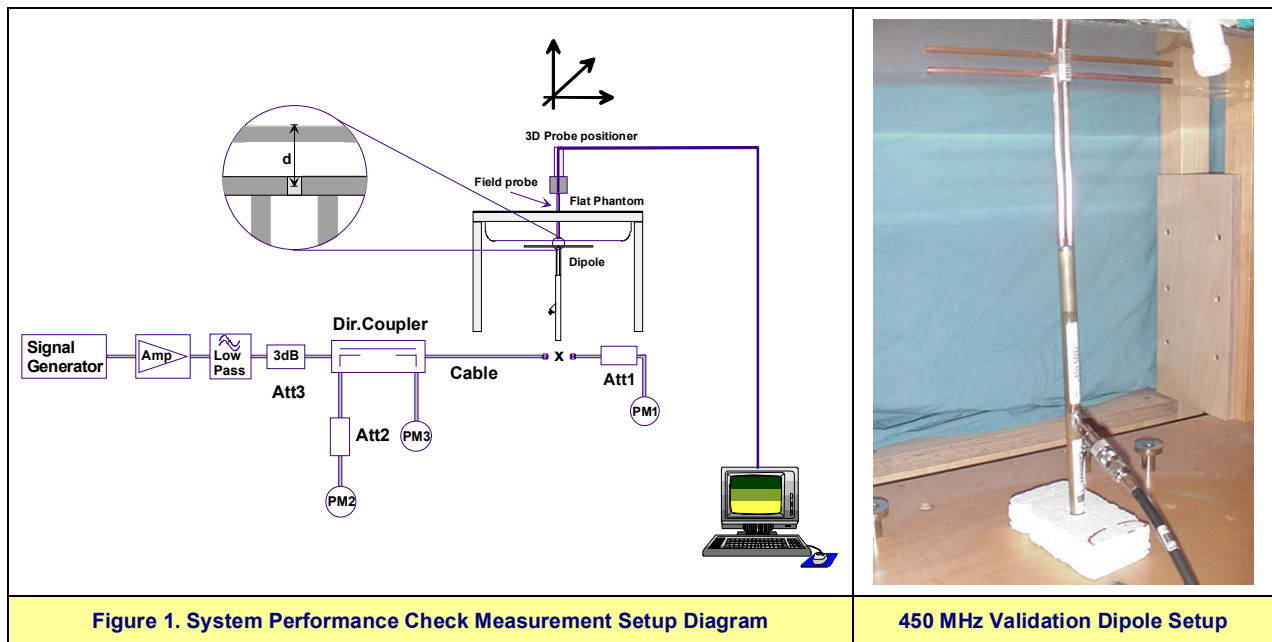





Figure 1. System Performance Check Measurement Setup Diagram

450 MHz Validation Dipole Setup

Company:	Cobra Electronics Corporation	FCC ID:	BBOLI6700	IC ID:	906B-LI6700	
Model(s):	LI6700 / LI6750	DUT Type:	Portable FM UHF FRS/GMRS PTT Radio Transceiver			
2007 Celltech Labs Inc.		This document is not to be reproduced in whole or in part without the prior written permission of Celltech Labs Inc.				Page 7 of 33

	<u>Date(s) of Evaluation</u> July 25, 2007	<u>Test Report Serial No.</u> 071707BBO-T841-S95U	<u>Test Report Revision No.</u> Revision 1.0	 
	<u>Test Report Issue Date</u> August 01, 2007	<u>Description of Test(s)</u> Specific Absorption Rate	<u>RF Exposure Category</u> General Population	

7.0 SIMULATED EQUIVALENT TISSUES



The simulated tissue mixtures consist of a viscous gel using hydroxyethylcellulose (HEC) gelling agent and saline solution. Preservation with a bactericide is added and visual inspection is made to ensure air bubbles are not trapped during the mixing process. The fluid was prepared according to standardized procedures, and measured for dielectric parameters (permittivity and conductivity).

SIMULATED TISSUE MIXTURES		
INGREDIENT	450 MHz Brain	450 MHz Body
	System Check & DUT Evaluation	DUT Evaluation
Water	38.56 %	52.00 %
Sugar	56.32 %	45.65 %
Salt	3.95 %	1.75 %
HEC	0.98 %	0.50 %
Bactericide	0.19 %	0.10 %

8.0 SAR SAFETY LIMITS

EXPOSURE LIMITS	SAR (W/kg)	
	(General Population / Uncontrolled Exposure Environment)	(Occupational / Controlled Exposure Environment)
Spatial Average (averaged over the whole body)	0.08	0.4
Spatial Peak (averaged over any 1 g of tissue)	1.60	8.0
Spatial Peak (hands/wrists/feet/ankles averaged over 10 g)	4.0	20.0
The Spatial Average value of the SAR averaged over the whole body.		
The Spatial Peak value of the SAR averaged over any 1 gram of tissue (defined as a tissue volume in the shape of a cube) and over the appropriate averaging time.		
The Spatial Peak value of the SAR averaged over any 10 grams of tissue (defined as a tissue volume in the shape of a cube) and over the appropriate averaging time.		
Uncontrolled environments are defined as locations where there is potential exposure of individuals who have no knowledge or control of their potential exposure.		
Controlled environments are defined as locations where there is potential exposure of individuals who have knowledge of their potential exposure and can exercise control over their exposure.		



Company:	Cobra Electronics Corporation	FCC ID:	BBOLI6700	IC ID:	906B-LI6700	
Model(s):	LI6700 / LI6750	DUT Type:	Portable FM UHF FRS/GMRS PTT Radio Transceiver			
2007 Celltech Labs Inc.		This document is not to be reproduced in whole or in part without the prior written permission of Celltech Labs Inc.				Page 8 of 33

	<u>Date(s) of Evaluation</u> July 25, 2007	<u>Test Report Serial No.</u> 071707BBO-T841-S95U	<u>Test Report Revision No.</u> Revision 1.0	
	<u>Test Report Issue Date</u> August 01, 2007	<u>Description of Test(s)</u> Specific Absorption Rate	<u>RF Exposure Category</u> General Population	

9.0 ROBOT SYSTEM SPECIFICATIONS

<u>Specifications</u>	
Positioner	Stäubli Unimation Corp. Robot Model: RX60L
Repeatability	0.02 mm
No. of axis	6
<u>Data Acquisition Electronic (DAE) System</u>	
<u>Cell Controller</u>	
Processor	AMD Athlon XP 2400+
Clock Speed	2.0 GHz
Operating System	Windows XP Professional
<u>Data Converter</u>	
Features	Signal Amplifier, multiplexer, A/D converter, and control logic
Software	Measurement Software: DASY4, V4.7 Build 44
	Postprocessing Software: SEMCAD, V1.8 Build 171
Connecting Lines	Optical downlink for data and status info., Optical uplink for commands and clock
<u>DASY4 Measurement Server</u>	
Function	Real-time data evaluation for field measurements and surface detection
Hardware	PC/104 166MHz Pentium CPU; 32 MB chipdisk; 64 MB RAM
Connections	COM1, COM2, DAE, Robot, Ethernet, Service Interface
<u>E-Field Probe</u>	
Model	ET3DV6
Serial No.	1387
Construction	Triangular core fiber optic detection system
Frequency	10 MHz to 6 GHz
Linearity	±0.2 dB (30 MHz to 3 GHz)
<u>Evaluation Phantom</u>	
Type	Side Planar Phantom
Shell Material	Plexiglas
Bottom Thickness	2.0 mm ± 0.1 mm
Outer Dimensions	75.0 cm (L) x 22.5 cm (W) x 20.5 cm (H); Back Plane: 25.7 cm (H)
<u>Validation Phantom (≤ 450MHz)</u>	
Type	Planar Phantom
Shell Material	Plexiglas
Bottom Thickness	6.2 mm ± 0.1 mm
Outer Dimensions	86.0 cm (L) x 39.5 cm (W) x 21.8 cm (H)

Company:	Cobra Electronics Corporation	FCC ID:	BBOLI6700	IC ID:	906B-LI6700	
Model(s):	LI6700 / LI6750	DUT Type:	Portable FM UHF FRS/GMRS PTT Radio Transceiver			
2007 Celltech Labs Inc.		This document is not to be reproduced in whole or in part without the prior written permission of Celltech Labs Inc.				Page 9 of 33

	<u>Date(s) of Evaluation</u> July 25, 2007	<u>Test Report Serial No.</u> 071707BBO-T841-S95U	<u>Test Report Revision No.</u> Revision 1.0	 
	<u>Test Report Issue Date</u> August 01, 2007	<u>Description of Test(s)</u> Specific Absorption Rate	<u>RF Exposure Category</u> General Population	

10.0 PROBE SPECIFICATION (ET3DV6)

Construction:	Symmetrical design with triangular core Built-in shielding against static charges PEEK enclosure material (resistant to organic solvents, glycol)
Calibration:	In air from 10 MHz to 2.5 GHz In brain simulating tissue at frequencies of 900 MHz and 1.8 GHz (accuracy $\pm 8\%$)
Frequency:	10 MHz to > 6 GHz; Linearity: ± 0.2 dB (30 MHz to 3 GHz)
Directivity:	± 0.2 dB in brain tissue (rotation around probe axis) ± 0.4 dB in brain tissue (rotation normal to probe axis)
Dynamic Range:	5 μ W/g to > 100 mW/g; Linearity: ± 0.2 dB
Surface Detect:	± 0.2 mm repeatability in air and clear liquids over diffuse reflecting surfaces
Dimensions:	Overall length: 330 mm Tip length: 16 mm Body diameter: 12 mm Tip diameter: 6.8 mm Distance from probe tip to dipole centers: 2.7 mm
Application:	General dosimetry up to 3 GHz Compliance tests of mobile phone



ET3DV6 E-Field Probe

11.0 SIDE PLANAR PHANTOM

The side planar phantom is constructed of Plexiglas material with a 2.0 mm shell thickness for face-held and body-worn SAR evaluations of portable radio transceivers. The side planar phantom is mounted on the side of the DASY4 compact system table.

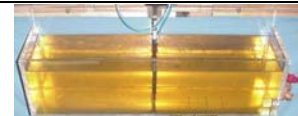

Plexiglas Side Planar Phantom

12.0 VALIDATION PLANAR PHANTOM

The validation planar phantom is constructed of Plexiglas material with a 6.0 mm shell thickness for system validations at 450MHz and below. The validation planar phantom is mounted to the table of the DASY4 compact system.



Plexiglas Validation Planar Phantom



13.0 DEVICE HOLDER

The DASY4 device holder has two scales for device rotation (with respect to the body axis) and the device inclination (with respect to the line between the ear openings). The plane between the ear openings and the mouth tip has a rotation angle of 65°. The bottom plate contains three pair of bolts for locking the device holder. The device holder positions are adjusted to the standard measurement positions in the three sections.



Device Holder



Company:	Cobra Electronics Corporation	FCC ID:	BBOL16700	IC ID:	906B-LI6700	
Model(s):	LI6700 / LI6750	DUT Type:	Portable FM UHF FRS/GMRS PTT Radio Transceiver			
2007 Celltech Labs Inc.		This document is not to be reproduced in whole or in part without the prior written permission of Celltech Labs Inc.				Page 10 of 33

 Celltech <small>Testing and Engineering Services Lab</small>	<u>Date(s) of Evaluation</u> July 25, 2007	<u>Test Report Serial No.</u> 071707BBO-T841-S95U	<u>Test Report Revision No.</u> Revision 1.0	 Certificate No. 2470.01
	<u>Test Report Issue Date</u> August 01, 2007	<u>Description of Test(s)</u> Specific Absorption Rate	<u>RF Exposure Category</u> General Population	

14.0 TEST EQUIPMENT LIST



TEST EQUIPMENT		ASSET NO.	SERIAL NO.	DATE CALIBRATED		CALIBRATION DUE DATE
USED	DESCRIPTION					
x	Schmid & Partner DASY4 System	-	-	-	-	-
x	-DASY4 Measurement Server	00158	1078	N/A	N/A	N/A
x	-Robot	00046	599396-01	N/A	N/A	N/A
x	-DAE4	00019	353	10Jul07		10Jul08
	-DAE3	00018	370	13Mar07		13Mar08
x	-ET3DV6 E-Field Probe	00016	1387	16Mar07		16Mar08
	-EX3DV4 E-Field Probe	00213	3600	24Jan07		24Jan08
	-300 MHz Validation Dipole	00023	135	08Jun07		08Jun08
x	-450 MHz Validation Dipole	00024	136	07Jun07		07Jun08
	-835 MHz Validation Dipole	00022	411	Brain	07Jun07	07Jun08
				Body	07Jun07	07Jun08
	-900 MHz Validation Dipole	00020	054	Brain	07Jun07	07Jun08
				Body	07Jun07	07Jun08
	-1800 MHz Validation Dipole	00021	247	Brain	06Jun07	06Jun08
				Body	06Jun07	06Jun08
	-1900 MHz Validation Dipole	00032	151	Brain	06Jun07	06Jun08
				Body	06Jun07	06Jun08
	-2450 MHz Validation Dipole	00025	150	Brain	08Jun07	08Jun08
				Body	08Jun07	08Jun08
	5GHz Validation Dipole	00126	1031	Body	18May07	18May08
				Body	22May07	22May08
				Brain	09May07	09May08
				Body	10May07	10May08
	-SAM Phantom V4.0C	00154	1033	N/A		N/A
	-Barski Planar Phantom	00155	03-01	N/A		N/A
x	-Plexiglas Side Planar Phantom	00156	161	N/A		N/A
x	-Plexiglas Validation Planar Phantom	00157	137	N/A		N/A
x	ALS-PR-DIEL Dielectric Probe Kit	00160	260-00953	N/A		N/A
x	Gigatronics 8652A Power Meter	00007	1835272	26Mar07		26Mar08
	Gigatronics 8652A Power Meter	00008	1835267	22Jan07		22Jan08
	Gigatronics 80701A Power Sensor	00012	1834350	22Jan07		22Jan08
x	Gigatronics 80701A Power Sensor	00014	1833699	22Jan07		22Jan08
x	Gigatronics 80701A Power Sensor	00109	1834366	26Mar07		26Mar08
x	HP 8753ET Network Analyzer	00134	US39170292	20Apr07		20Apr08
x	HP 8648D Signal Generator	00005	3847A00611	NCR		NCR
	Rohde & Schwarz SMR20 Signal Generator	00006	100104	NCR		NCR
x	Amplifier Research 5S1G4 Power Amplifier	00106	26235	NCR		NCR
	Amplifier Research 10W1000C Power Amplifier	00041	27887	NCR		NCR
	Nextec NB00383 Microwave Amplifier	00151	0535	NCR		NCR
	HP E4408B Spectrum Analyzer	00015	US39240170	05Feb07		05Feb08

Company:	Cobra Electronics Corporation	FCC ID:	BBOLI6700	IC ID:	906B-LI6700	
Model(s):	LI6700 / LI6750	DUT Type:	Portable FM UHF FRS/GMRS PTT Radio Transceiver			
2007 Celltech Labs Inc.		This document is not to be reproduced in whole or in part without the prior written permission of Celltech Labs Inc.				Page 11 of 33

	<u>Date(s) of Evaluation</u> July 25, 2007	<u>Test Report Serial No.</u> 071707BBO-T841-S95U	<u>Test Report Revision No.</u> Revision 1.0	
	<u>Test Report Issue Date</u> August 01, 2007	<u>Description of Test(s)</u> Specific Absorption Rate	<u>RF Exposure Category</u> General Population	

15.0 MEASUREMENT UNCERTAINTIES



UNCERTAINTY BUDGET FOR DEVICE EVALUATION						
Error Description	Uncertainty Value ±%	Probability Distribution	Divisor	ci 1g	Uncertainty Value ±% (1g)	V _i or V _{eff}
Measurement System						
Probe calibration (450 MHz)	8.0	Normal	1	1	8.0	∞
Axial isotropy of the probe	4.7	Rectangular	1.732050808	0.7	1.9	∞
Spherical isotropy of the probe	9.6	Rectangular	1.732050808	0.7	3.9	∞
Spatial resolution	0	Rectangular	1.732050808	1	0.0	∞
Boundary effects	1	Rectangular	1.732050808	1	0.6	∞
Probe linearity	4.7	Rectangular	1.732050808	1	2.7	∞
Detection limit	1	Rectangular	1.732050808	1	0.6	∞
Readout electronics	0.3	Normal	1	1	0.3	∞
Response time	0.8	Rectangular	1.732050808	1	0.5	∞
Integration time	2.6	Rectangular	1.732050808	1	1.5	∞
RF ambient conditions	3	Rectangular	1.732050808	1	1.7	∞
Mech. constraints of robot	0.4	Rectangular	1.732050808	1	0.2	∞
Probe positioning	2.9	Rectangular	1.732050808	1	1.7	∞
Extrapolation & integration	1	Rectangular	1.732050808	1	0.6	∞
Test Sample Related						
Device positioning	2.9	Normal	1	1	2.9	12
Device holder uncertainty	3.6	Normal	1	1	3.6	8
Power drift	5	Rectangular	1.732050808	1	2.9	∞
Phantom and Setup						
Phantom uncertainty	4	Rectangular	1.732050808	1	2.3	∞
Liquid conductivity (target)	5	Rectangular	1.732050808	0.64	1.8	∞
Liquid conductivity (measured)	5	Normal	1	0.64	3.2	∞
Liquid permittivity (target)	5	Rectangular	1.732050808	0.6	1.7	∞
Liquid permittivity (measured)	5	Normal	1	0.6	3.0	∞
Combined Standard Uncertainty					12.65	
Expanded Uncertainty (k=2)					25.31	
Measurement Uncertainty Table in accordance with IEEE Standard 1528-2003 (see reference [5])						

	<u>Date(s) of Evaluation</u> July 25, 2007	<u>Test Report Serial No.</u> 071707BBO-T841-S95U	<u>Test Report Revision No.</u> Revision 1.0	 
	<u>Test Report Issue Date</u> August 01, 2007	<u>Description of Test(s)</u> Specific Absorption Rate	<u>RF Exposure Category</u> General Population	

MEASUREMENT UNCERTAINTIES (Cont.)

UNCERTAINTY BUDGET FOR SYSTEM VALIDATION						
Error Description	Uncertainty Value ±%	Probability Distribution	Divisor	ci 1g	Uncertainty Value ±% (1g)	V _i or V _{eff}
Measurement System						
Probe calibration (450 MHz)	8.0	Normal	1	1	8.0	∞
Axial isotropy of the probe	4.7	Rectangular	1.732050808	1	2.7	∞
Spherical isotropy of the probe	0	Rectangular	1.732050808	1	0.0	∞
Spatial resolution	0	Rectangular	1.732050808	1	0.0	∞
Boundary effects	1	Rectangular	1.732050808	1	0.6	∞
Probe linearity	4.7	Rectangular	1.732050808	1	2.7	∞
Detection limit	1	Rectangular	1.732050808	1	0.6	∞
Readout electronics	0.3	Normal	1	1	0.3	∞
Response time	0	Rectangular	1.732050808	1	0.0	∞
Integration time	0	Rectangular	1.732050808	1	0.0	∞
RF ambient conditions	3	Rectangular	1.732050808	1	1.7	∞
Mech. constraints of robot	0.4	Rectangular	1.732050808	1	0.2	∞
Probe positioning	2.9	Rectangular	1.732050808	1	1.7	∞
Extrapolation & integration	1	Rectangular	1.732050808	1	0.6	∞
Test Sample Related						
Dipole Positioning	2	Normal	1.732050808	1	1.2	∞
Power & Power Drift	4.7	Normal	1.732050808	1	2.7	∞
Phantom and Setup						
Phantom uncertainty	4	Rectangular	1.732050808	1	2.3	∞
Liquid conductivity (target)	5	Rectangular	1.732050808	0.64	1.8	∞
Liquid conductivity (measured)	5	Normal	1	0.64	3.2	∞
Liquid permittivity (target)	5	Rectangular	1.732050808	0.6	1.7	∞
Liquid permittivity (measured)	5	Normal	1	0.6	3.0	∞
Combined Standard Uncertainty					11.20	
Expanded Uncertainty (k=2)					22.39	
Measurement Uncertainty Table in accordance with IEEE Standard 1528-2003 (see reference [5])						



Company:	Cobra Electronics Corporation	FCC ID:	BBOLI6700	IC ID:	906B-LI6700	
Model(s):	LI6700 / LI6750	DUT Type:	Portable FM UHF FRS/GMRS PTT Radio Transceiver			
2007 Celltech Labs Inc.	This document is not to be reproduced in whole or in part without the prior written permission of Celltech Labs Inc.					Page 13 of 33

	<u>Date(s) of Evaluation</u> July 25, 2007	<u>Test Report Serial No.</u> 071707BBO-T841-S95U	<u>Test Report Revision No.</u> Revision 1.0	 Certificate No. 2470.01
	<u>Test Report Issue Date</u> August 01, 2007	<u>Description of Test(s)</u> Specific Absorption Rate	<u>RF Exposure Category</u> General Population	

16.0 REFERENCES



- [1] Federal Communications Commission - "Radiofrequency radiation exposure evaluation: portable devices", Rule Part 47 CFR §2.1093: 1999.
- [2] Health Canada - "Limits of Human Exposure to Radiofrequency Electromagnetic Fields in the Frequency Range from 3 kHz to 300 GHz", Safety Code 6: 1999.
- [3] Federal Communications Commission - "Evaluating Compliance with FCC Guidelines for Human Exposure to Radio frequency Electromagnetic Fields", OET Bulletin 65, Supplement C (Edition 01-01), FCC, Washington, D.C.: June 2001.
- [4] Industry Canada - "Radio Frequency Exposure Compliance of Radiocommunication Apparatus (All Frequency Bands)", Radio Standards Specification RSS-102 Issue 2: November 2005.
- [5] IEEE Standard 1528-2003 - "Recommended Practice for Determining the Peak Spatial-Average Specific Absorption Rate (SAR) in the Human Head from Wireless Communications Devices: Measurement Techniques": December 2003.
- [6] ANSI/IEEE C95.1-2005 - "American National Standard safety levels with respect to human exposure to radio frequency electromagnetic fields, 3 kHz to 300 GHz", New York: IEEE, April 2006.

Company:	Cobra Electronics Corporation	FCC ID:	BBOLI6700	IC ID:	906B-LI6700	
Model(s):	LI6700 / LI6750	DUT Type:	Portable FM UHF FRS/GMRS PTT Radio Transceiver			
2007 Celltech Labs Inc.	This document is not to be reproduced in whole or in part without the prior written permission of Celltech Labs Inc.					Page 14 of 33

	<u>Date(s) of Evaluation</u> July 25, 2007	<u>Test Report Serial No.</u> 071707BBO-T841-S95U	<u>Test Report Revision No.</u> Revision 1.0	 Certificate No. 2470.01
	<u>Test Report Issue Date</u> August 01, 2007	<u>Description of Test(s)</u> Specific Absorption Rate	<u>RF Exposure Category</u> General Population	

APPENDIX A - SAR MEASUREMENT DATA

Company:	Cobra Electronics Corporation	FCC ID:	BBOLI6700	IC ID:	906B-LI6700	
Model(s):	LI6700 / LI6750	DUT Type:	Portable FM UHF FRS/GMRS PTT Radio Transceiver			
2007 Celltech Labs Inc.	This document is not to be reproduced in whole or in part without the prior written permission of Celltech Labs Inc.					Page 15 of 33

	<u>Date(s) of Evaluation</u> July 25, 2007	<u>Test Report Serial No.</u> 071707BBO-T841-S95U	<u>Test Report Revision No.</u> Revision 1.0	 Certificate No. 2470.01
	<u>Test Report Issue Date</u> August 01, 2007	<u>Description of Test(s)</u> Specific Absorption Rate	<u>RF Exposure Category</u> General Population	

Date Tested: 07/25/2007

Face-Held SAR - Channel 5 - 462.6625 MHz (GMRS)

DUT: Cobra Model: LI6700; Type: Portable FRS/GMRS PTT Radio Transceiver; Serial: #8

Ambient Temp: 25.3°C; Fluid Temp: 23.9°C; Barometric Pressure: 101.3 kPa; Humidity: 30%

Communication System: FM UHF
RF Output Power: 0.900 Watts (ERP)
7.4V, 950mAh Lithium-ion Battery Pack
Frequency: 462.663 MHz; Duty Cycle: 1:1
Medium: HSL450 Medium parameters used: $f = 462.663 \text{ MHz}$; $\sigma = 0.85 \text{ mho/m}$; $\epsilon_r = 43.3$; $\rho = 1000 \text{ kg/m}^3$

- Probe: ET3DV6 - SN1387; ConvF(7, 7, 7); Calibrated: 16/03/2007
- Sensor-Surface: 4mm (Mechanical Surface Detection)
- Electronics: DAE4 Sn353; Calibrated: 10/07/2007
- Phantom: Side Planar; Type: Plexiglas; Serial: 161
- Measurement SW: DASY4, V4.7 Build 44; Postprocessing SW: SEMCAD, V1.8 Build 171

Face-Held SAR - 2.5 cm Spacing from Front of DUT to Planar Phantom - Channel 5



Area Scan (8x12x1): Measurement grid: $dx=15\text{mm}$, $dy=15\text{mm}$
Maximum value of SAR (measured) = 1.20 mW/g

Face-Held SAR - 2.5 cm Spacing from Front of DUT to Planar Phantom - Channel 5

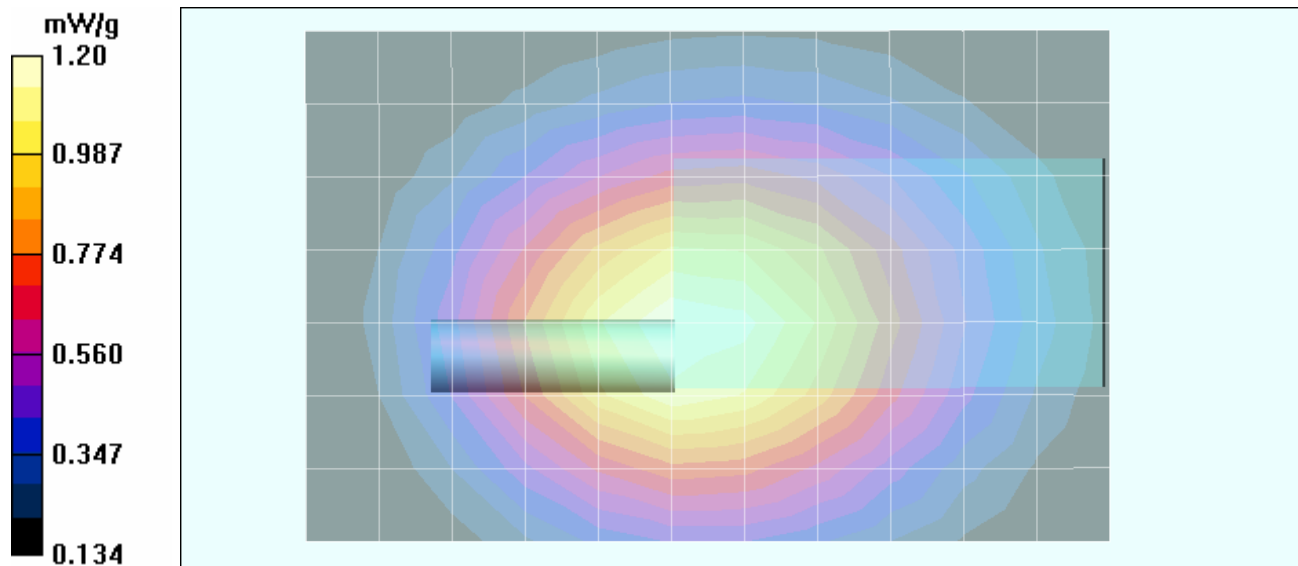
Zoom Scan (5x5x7)/Cube 0: Measurement grid: $dx=7.5\text{mm}$, $dy=7.5\text{mm}$, $dz=5\text{mm}$
Reference Value = 35.6 V/m; Power Drift = -0.0737 dB
Peak SAR (extrapolated) = 1.87 W/kg
SAR(1 g) = 1.15 mW/g; SAR(10 g) = 0.790 mW/g
Maximum value of SAR (measured) = 1.20 mW/g





Company:	Cobra Electronics Corporation	FCC ID:	BBOLI6700	IC ID:	906B-LI6700	
Model(s):	LI6700 / LI6750	DUT Type:	Portable FM UHF FRS/GMRS PTT Radio Transceiver			
2007 Celltech Labs Inc.		This document is not to be reproduced in whole or in part without the prior written permission of Celltech Labs Inc.				Page 16 of 33

	<u>Date(s) of Evaluation</u> July 25, 2007	<u>Test Report Serial No.</u> 071707BBO-T841-S95U	<u>Test Report Revision No.</u> Revision 1.0	 Certificate No. 2470.01
	<u>Test Report Issue Date</u> August 01, 2007	<u>Description of Test(s)</u> Specific Absorption Rate	<u>RF Exposure Category</u> General Population	

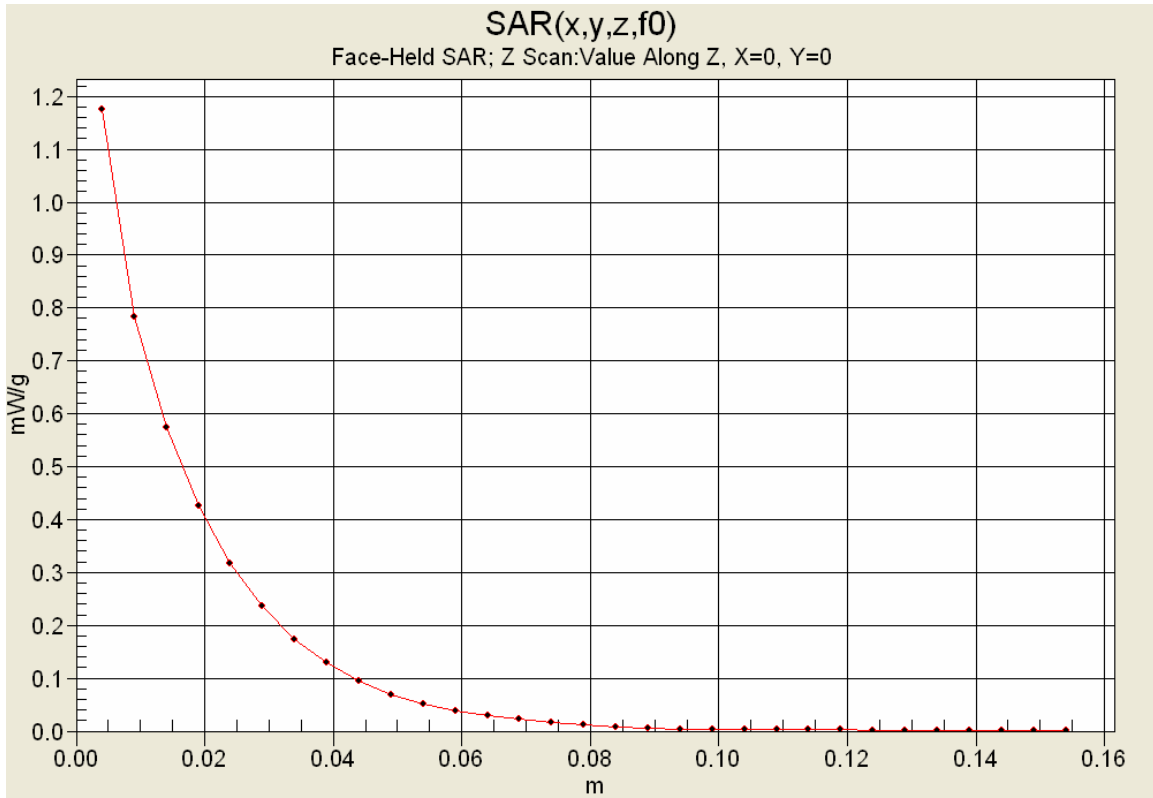
Z-Axis Scan



Company:	Cobra Electronics Corporation	FCC ID:	BBOLI6700	IC ID:	906B-LI6700	
Model(s):	LI6700 / LI6750	DUT Type:	Portable FM UHF FRS/GMRS PTT Radio Transceiver			
2007 Celltech Labs Inc.		This document is not to be reproduced in whole or in part without the prior written permission of Celltech Labs Inc.				Page 17 of 33

	<u>Date(s) of Evaluation</u> July 25, 2007	<u>Test Report Serial No.</u> 071707BBO-T841-S95U	<u>Test Report Revision No.</u> Revision 1.0	 Certificate No. 2470.01
	<u>Test Report Issue Date</u> August 01, 2007	<u>Description of Test(s)</u> Specific Absorption Rate	<u>RF Exposure Category</u> General Population	

Date Tested: 07/25/2007

Body-Worn SAR - Channel 5 - 462.6625 MHz (GMRS)

DUT: Cobra Model: LI6700; Type: Portable FRS/GMRS PTT Radio Transceiver; Serial: #8

Body-Worn Accessory: Plastic Belt-Clip; Audio Accessory: Ear-bud/Lapel-Microphone

Ambient Temp: 25.5°C; Fluid Temp: 23.9°C; Barometric Pressure: 101.3 kPa; Humidity: 31%

Communication System: FM UHF
RF Output Power: 0.900 Watts (ERP)
7.4V, 950mAh Lithium-ion Battery Pack
Frequency: 462.663 MHz; Duty Cycle: 1:1
Medium: M450 Medium parameters used: $f = 462.563 \text{ MHz}$; $\sigma = 0.97 \text{ mho/m}$; $\epsilon_r = 57.8$; $\rho = 1000 \text{ kg/m}^3$

- Probe: ET3DV6 - SN1387; ConvF(6.9, 6.9, 6.9); Calibrated: 16/03/2007
- Sensor-Surface: 4mm (Mechanical Surface Detection)
- Electronics: DAE4 Sn353; Calibrated: 10/07/2007
- Phantom: Side Planar; Type: Plexiglas; Serial: 161
- Measurement SW: DASY4, V4.7 Build 44; Postprocessing SW: SEMCAD, V1.8 Build 171

Body-Worn SAR - 0.4 cm Belt-Clip Spacing from Back of DUT to Planar Phantom - Channel 5



Area Scan (8x12x1): Measurement grid: dx=15mm, dy=15mm
Maximum value of SAR (measured) = 2.65 mW/g

Body-Worn SAR - 0.4 cm Belt-Clip Spacing from Back of DUT to Planar Phantom - Channel 5

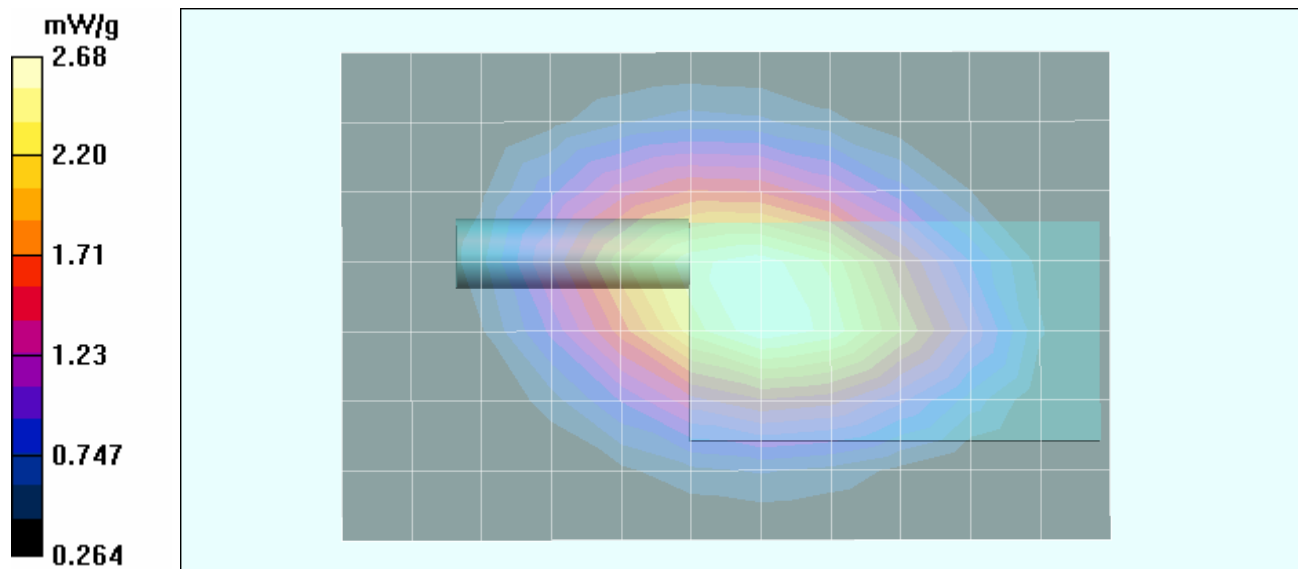
Zoom Scan (5x5x7)/Cube 0: Measurement grid: dx=7.5mm, dy=7.5mm, dz=5mm
Reference Value = 46.0 V/m; Power Drift = -0.108 dB
Peak SAR (extrapolated) = 4.22 W/kg
SAR(1 g) = 2.55 mW/g; SAR(10 g) = 1.69 mW/g
Maximum value of SAR (measured) = 2.68 mW/g





Company:	Cobra Electronics Corporation	FCC ID:	BBOLI6700	IC ID:	906B-LI6700	
Model(s):	LI6700 / LI6750	DUT Type:	Portable FM UHF FRS/GMRS PTT Radio Transceiver			
2007 Celltech Labs Inc.		This document is not to be reproduced in whole or in part without the prior written permission of Celltech Labs Inc.				Page 18 of 33

	<u>Date(s) of Evaluation</u> July 25, 2007	<u>Test Report Serial No.</u> 071707BBO-T841-S95U	<u>Test Report Revision No.</u> Revision 1.0	 Certificate No. 2470.01
	<u>Test Report Issue Date</u> August 01, 2007	<u>Description of Test(s)</u> Specific Absorption Rate	<u>RF Exposure Category</u> General Population	

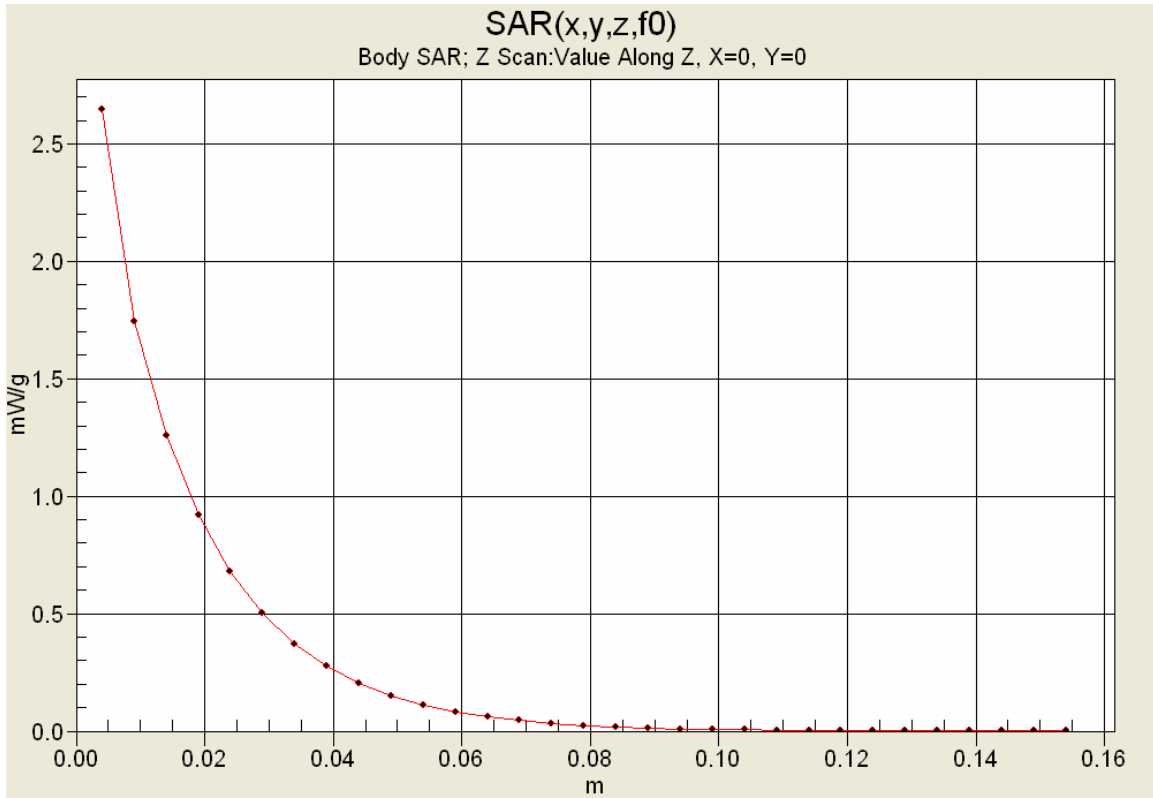
Z-Axis Scan





Company:	Cobra Electronics Corporation	FCC ID:	BBOLI6700	IC ID:	906B-LI6700	
Model(s):	LI6700 / LI6750	DUT Type:	Portable FM UHF FRS/GMRS PTT Radio Transceiver			
2007 Celltech Labs Inc.		This document is not to be reproduced in whole or in part without the prior written permission of Celltech Labs Inc.				Page 19 of 33

	<u>Date(s) of Evaluation</u> July 25, 2007	<u>Test Report Serial No.</u> 071707BBO-T841-S95U	<u>Test Report Revision No.</u> Revision 1.0	 Certificate No. 2470.01
	<u>Test Report Issue Date</u> August 01, 2007	<u>Description of Test(s)</u> Specific Absorption Rate	<u>RF Exposure Category</u> General Population	

APPENDIX B - SYSTEM PERFORMANCE CHECK DATA

Company:	Cobra Electronics Corporation	FCC ID:	BBOLI6700	IC ID:	906B-LI6700	
Model(s):	LI6700 / LI6750	DUT Type:	Portable FM UHF FRS/GMRS PTT Radio Transceiver			
2007 Celltech Labs Inc.	This document is not to be reproduced in whole or in part without the prior written permission of Celltech Labs Inc.					Page 20 of 33

	<u>Date(s) of Evaluation</u> July 25, 2007	<u>Test Report Serial No.</u> 071707BBO-T841-S95U	<u>Test Report Revision No.</u> Revision 1.0	 Certificate No. 2470.01
	<u>Test Report Issue Date</u> August 01, 2007	<u>Description of Test(s)</u> Specific Absorption Rate	<u>RF Exposure Category</u> General Population	

Date Tested: 07/25/2007

System Performance Check - 450 MHz Dipole

DUT: Dipole 450 MHz; Asset: 00024; Serial: 136; Validation: 06/07/2007

Ambient Temp: 25.5°C; Fluid Temp: 23.8°C; Barometric Pressure: 101.3 kPa; Humidity: 30%

Communication System: CW

Forward Conducted Power: 250 mW

Frequency: 450 MHz; Duty Cycle: 1:1

Medium: HSL450 Medium parameters used: $f = 450 \text{ MHz}$; $\sigma = 0.85 \text{ mho/m}$; $\epsilon_r = 43.3$; $\rho = 1000 \text{ kg/m}^3$

- Probe: ET3DV6 - SN1387; ConvF(7, 7, 7); Calibrated: 16/03/2007

- Sensor-Surface: 4mm (Mechanical Surface Detection)

- Electronics: DAE4 Sn353; Calibrated: 10/07/2007

- Phantom: Validation Planar; Type: Plexiglas; Serial: 137

- Measurement SW: DASy4, V4.7 Build 44; Postprocessing SW: SEMCAD, V1.8 Build 171

450 MHz Dipole - System Performance Check/Area Scan (6x11x1):

Measurement grid: $dx=15\text{mm}$, $dy=15\text{mm}$

Maximum value of SAR (measured) = 1.22 mW/g

450 MHz Dipole - System Performance Check/Zoom Scan (5x5x7)/Cube 0:

Measurement grid: $dx=7.5\text{mm}$, $dy=7.5\text{mm}$, $dz=5\text{mm}$

Reference Value = 39.2 V/m; Power Drift = 0.000 dB



Peak SAR (extrapolated) = 2.20 W/kg

SAR(1 g) = 1.24 mW/g; SAR(10 g) = 0.788 mW/g

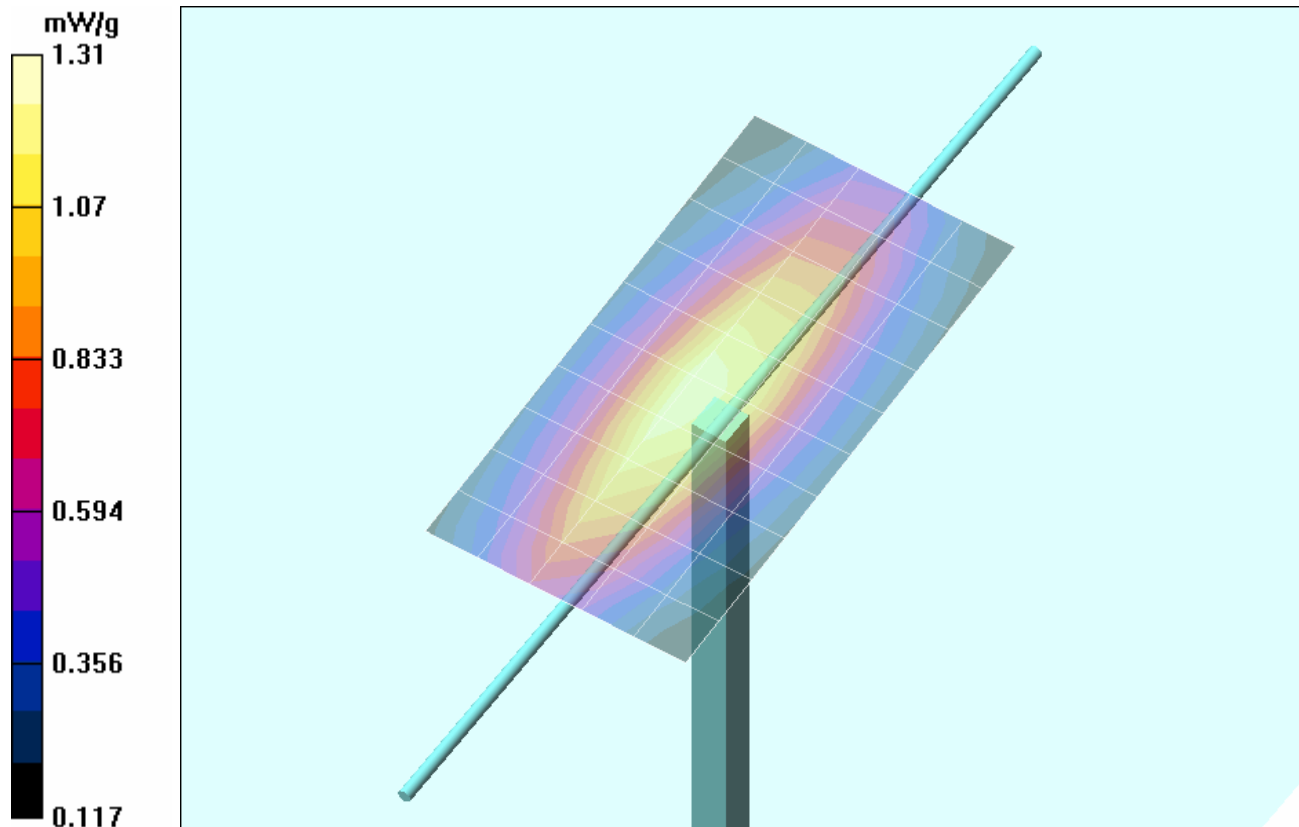
Maximum value of SAR (measured) = 1.31 mW/g





Company:	Cobra Electronics Corporation	FCC ID:	BBOLI6700	IC ID:	906B-LI6700	
Model(s):	LI6700 / LI6750	DUT Type:	Portable FM UHF FRS/GMRS PTT Radio Transceiver			
2007 Celltech Labs Inc.		This document is not to be reproduced in whole or in part without the prior written permission of Celltech Labs Inc.				Page 21 of 33

	<u>Date(s) of Evaluation</u> July 25, 2007	<u>Test Report Serial No.</u> 071707BBO-T841-S95U	<u>Test Report Revision No.</u> Revision 1.0	 Certificate No. 2470.01
	<u>Test Report Issue Date</u> August 01, 2007	<u>Description of Test(s)</u> Specific Absorption Rate	<u>RF Exposure Category</u> General Population	

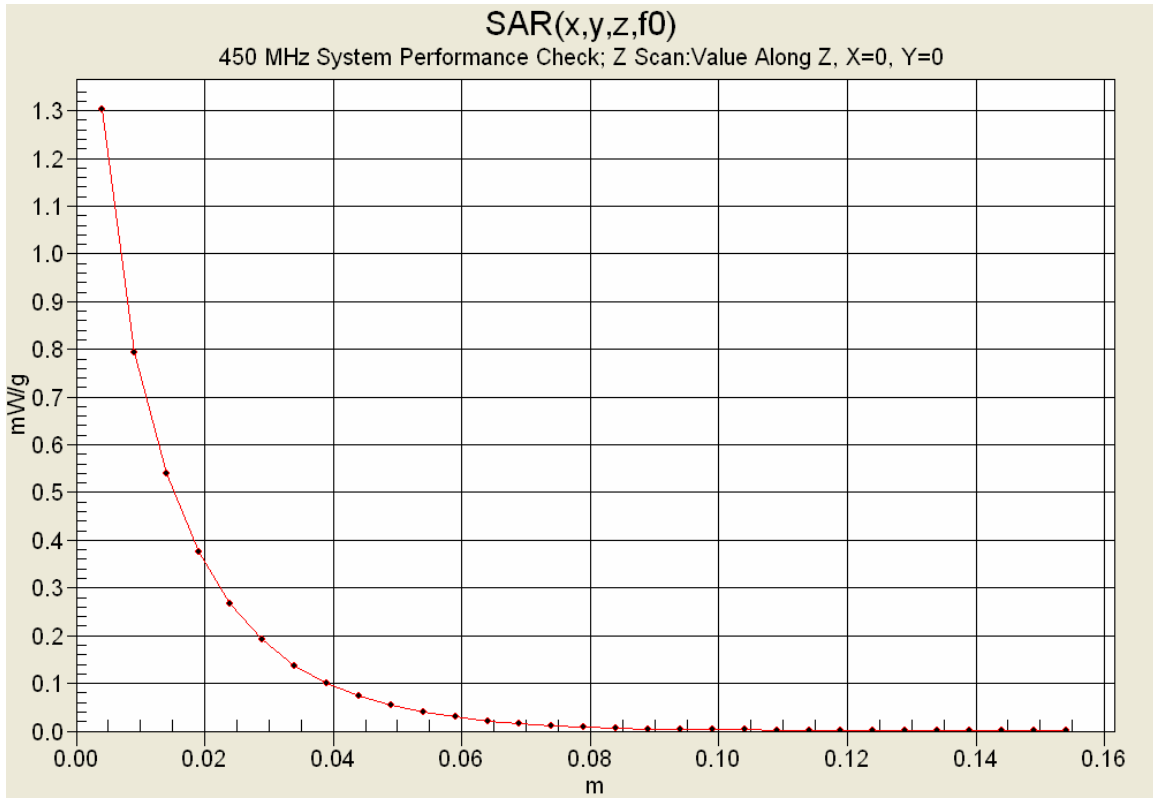
Z-Axis Scan





Company:	Cobra Electronics Corporation	FCC ID:	BBOLI6700	IC ID:	906B-LI6700	
Model(s):	LI6700 / LI6750	DUT Type:	Portable FM UHF FRS/GMRS PTT Radio Transceiver			
2007 Celltech Labs Inc.		This document is not to be reproduced in whole or in part without the prior written permission of Celltech Labs Inc.				Page 22 of 33

	<u>Date(s) of Evaluation</u> July 25, 2007	<u>Test Report Serial No.</u> 071707BBO-T841-S95U	<u>Test Report Revision No.</u> Revision 1.0	 Certificate No. 2470.01
	<u>Test Report Issue Date</u> August 01, 2007	<u>Description of Test(s)</u> Specific Absorption Rate	<u>RF Exposure Category</u> General Population	

APPENDIX C - MEASURED FLUID DIELECTRIC PARAMETERS

Company:	Cobra Electronics Corporation	FCC ID:	BBOLI6700	IC ID:	906B-LI6700	
Model(s):	LI6700 / LI6750	DUT Type:	Portable FM UHF FRS/GMRS PTT Radio Transceiver			
2007 Celltech Labs Inc.	This document is not to be reproduced in whole or in part without the prior written permission of Celltech Labs Inc.					Page 23 of 33

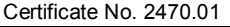

	<u>Date(s) of Evaluation</u> July 25, 2007	<u>Test Report Serial No.</u> 071707BBO-T841-S95U	<u>Test Report Revision No.</u> Revision 1.0	 
	<u>Test Report Issue Date</u> August 01, 2007	<u>Description of Test(s)</u> Specific Absorption Rate	<u>RF Exposure Category</u> General Population	

450 MHz System Performance Check & DUT Evaluation (Brain)

Celltech Labs Inc.
 Test Result for UIM Dielectric Parameter
 Wed 25/Jul/2007
 Frequency (GHz)
 FCC_eHFCC OET 65 Supplement C (June 2001) Limits for Head Epsilon
 FCC_sHFCC OET 65 Supplement C (June 2001) Limits for Head Sigma
 Test_e Epsilon of UIM
 Test_s Sigma of UIM

Freq	FCC_eHFCC	FCC_sHFCC	Test_e	Test_s
0.3500	44.70	0.87	45.75	0.76
0.3600	44.58	0.87	45.46	0.77
0.3700	44.46	0.87	45.34	0.78
0.3800	44.34	0.87	44.99	0.79
0.3900	44.22	0.87	44.71	0.79
0.4000	44.10	0.87	44.47	0.80
0.4100	43.98	0.87	44.26	0.81
0.4200	43.86	0.87	44.06	0.82
0.4300	43.74	0.87	43.72	0.83
0.4400	43.62	0.87	43.63	0.84
0.4500	43.50	0.87	43.25	0.85
0.4600	43.45	0.87	42.90	0.86
0.4700	43.40	0.87	42.80	0.86
0.4800	43.34	0.87	42.65	0.87
0.4900	43.29	0.87	42.48	0.88
0.5000	43.24	0.87	42.45	0.89
0.5100	43.19	0.87	41.88	0.90
0.5200	43.14	0.88	41.81	0.91
0.5300	43.08	0.88	41.73	0.92
0.5400	43.03	0.88	41.59	0.92
0.5500	42.98	0.88	41.25	0.93

Company:	Cobra Electronics Corporation	FCC ID:	BBOL16700	IC ID:	906B-LI6700	
Model(s):	LI6700 / LI6750	DUT Type:	Portable FM UHF FRS/GMRS PTT Radio Transceiver			
2007 Celltech Labs Inc.		This document is not to be reproduced in whole or in part without the prior written permission of Celltech Labs Inc.				Page 24 of 33



	<u>Date(s) of Evaluation</u> July 25, 2007	<u>Test Report Serial No.</u> 071707BBO-T841-S95U	<u>Test Report Revision No.</u> Revision 1.0	
	<u>Test Report Issue Date</u> August 01, 2007	<u>Description of Test(s)</u> Specific Absorption Rate	<u>RF Exposure Category</u> General Population	

450 MHz DUT Evaluation (Body)

Celltech Labs Inc.
 Test Result for UIM Dielectric Parameter
 Wed 25/Jul/2007
 Frequency (GHz)
 FCC_eHFCC Bulletin 65 Supplement C (June 2001) Limits for Head Epsilon
 FCC_sHFCC Bulletin 65 Supplement C (June 2001) Limits for Head Sigma
 FCC_eB FCC Limits for Body Epsilon
 FCC_sB FCC Limits for Body Sigma
 Test_e Epsilon of UIM
 Test_s Sigma of UIM



Freq	FCC_eB	FCC_sB	Test_e	Test_s
0.3500	57.70	0.93	59.20	0.90
0.3600	57.60	0.93	59.01	0.90
0.3700	57.50	0.93	58.97	0.91
0.3800	57.40	0.93	58.81	0.92
0.3900	57.30	0.93	58.55	0.93
0.4000	57.20	0.93	58.57	0.93
0.4100	57.10	0.93	58.15	0.94
0.4200	57.00	0.94	58.29	0.95
0.4300	56.90	0.94	57.90	0.96
0.4400	56.80	0.94	58.01	0.96
0.4500	56.70	0.94	57.78	0.97
0.4600	56.66	0.94	57.55	0.98
0.4700	56.62	0.94	57.31	0.99
0.4800	56.58	0.94	57.36	0.99
0.4900	56.54	0.94	57.14	1.00
0.5000	56.51	0.94	57.17	1.01
0.5100	56.47	0.94	56.82	1.01
0.5200	56.43	0.95	56.80	1.03
0.5300	56.39	0.95	56.60	1.03
0.5400	56.35	0.95	56.50	1.04
0.5500	56.31	0.95	56.37	1.05

Company:	Cobra Electronics Corporation	FCC ID:	BBOLI6700	IC ID:	906B-LI6700	
Model(s):	LI6700 / LI6750	DUT Type:	Portable FM UHF FRS/GMRS PTT Radio Transceiver			
2007 Celltech Labs Inc.		This document is not to be reproduced in whole or in part without the prior written permission of Celltech Labs Inc.				Page 25 of 33

	<u>Date(s) of Evaluation</u> July 25, 2007	<u>Test Report Serial No.</u> 071707BBO-T841-S95U	<u>Test Report Revision No.</u> Revision 1.0	 Certificate No. 2470.01
	<u>Test Report Issue Date</u> August 01, 2007	<u>Description of Test(s)</u> Specific Absorption Rate	<u>RF Exposure Category</u> General Population	

APPENDIX D - SAR TEST SETUP & DUT PHOTOGRAPHS



Company:	Cobra Electronics Corporation	FCC ID:	BBOLI6700	IC ID:	906B-LI6700	
Model(s):	LI6700 / LI6750	DUT Type:	Portable FM UHF FRS/GMRS PTT Radio Transceiver			
2007 Celltech Labs Inc.	This document is not to be reproduced in whole or in part without the prior written permission of Celltech Labs Inc.					Page 26 of 33

	<u>Date(s) of Evaluation</u> July 25, 2007	<u>Test Report Serial No.</u> 071707BBO-T841-S95U	<u>Test Report Revision No.</u> Revision 1.0	 Certificate No. 2470.01
	<u>Test Report Issue Date</u> August 01, 2007	<u>Description of Test(s)</u> Specific Absorption Rate	<u>RF Exposure Category</u> General Population	

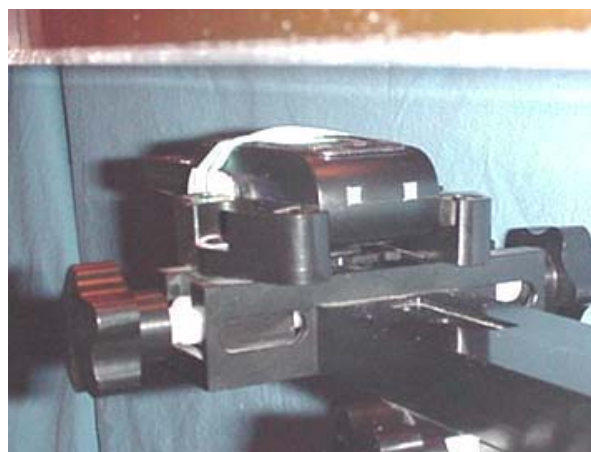
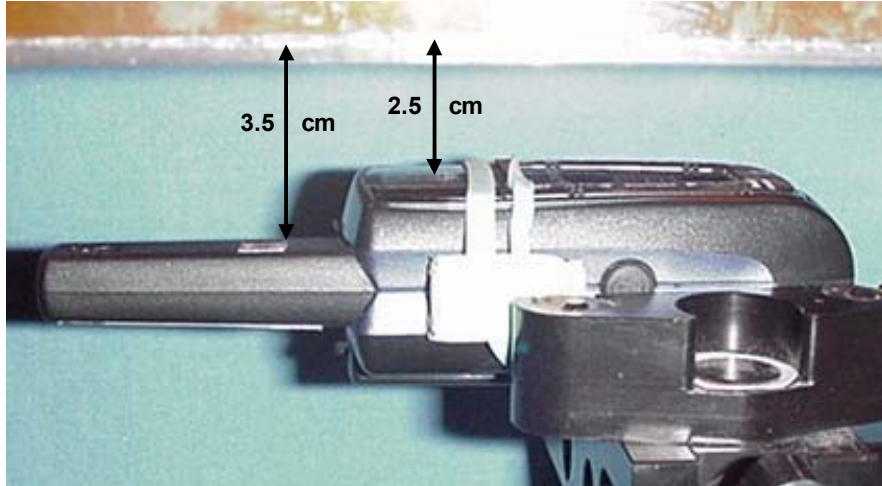
FACE-HELD SAR TEST SETUP PHOTOGRAPHS
2.5 cm Spacing from Front of DUT to Planar Phantom





Company:	Cobra Electronics Corporation	FCC ID:	BBOLI6700	IC ID:	906B-LI6700	
Model(s):	LI6700 / LI6750	DUT Type:	Portable FM UHF FRS/GMRS PTT Radio Transceiver			
2007 Celltech Labs Inc.		This document is not to be reproduced in whole or in part without the prior written permission of Celltech Labs Inc.				Page 27 of 33

	<u>Date(s) of Evaluation</u> July 25, 2007	<u>Test Report Serial No.</u> 071707BBO-T841-S95U	<u>Test Report Revision No.</u> Revision 1.0	 Certificate No. 2470.01
	<u>Test Report Issue Date</u> August 01, 2007	<u>Description of Test(s)</u> Specific Absorption Rate	<u>RF Exposure Category</u> General Population	

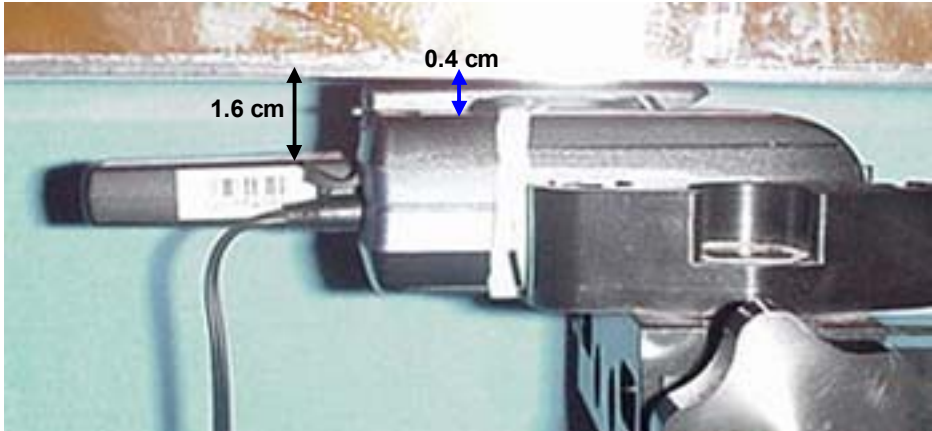
BODY-WORN SAR TEST SETUP PHOTOGRAPHS
0.4 cm Belt-Clip Spacing from Back of DUT to Planar Phantom
With Ear-bud/Lapel-Microphone Audio Accessory



Company:	Cobra Electronics Corporation	FCC ID:	BBOLI6700	IC ID:	906B-LI6700	
Model(s):	LI6700 / LI6750	DUT Type:	Portable FM UHF FRS/GMRS PTT Radio Transceiver			
2007 Celltech Labs Inc.		This document is not to be reproduced in whole or in part without the prior written permission of Celltech Labs Inc.				Page 28 of 33

	<u>Date(s) of Evaluation</u> July 25, 2007	<u>Test Report Serial No.</u> 071707BBO-T841-S95U	<u>Test Report Revision No.</u> Revision 1.0	
	<u>Test Report Issue Date</u> August 01, 2007	<u>Description of Test(s)</u> Specific Absorption Rate	<u>RF Exposure Category</u> General Population	

DUT PHOTOGRAPHS



Front of DUT



Back of DUT



Back of DUT with Plastic Belt-Clip



Top end of DUT



Bottom end of DUT

Company:	Cobra Electronics Corporation	FCC ID:	BBOL16700	IC ID:	906B-LI6700	
Model(s):	LI6700 / LI6750	DUT Type:	Portable FM UHF FRS/GMRS PTT Radio Transceiver			
2007 Celltech Labs Inc.		This document is not to be reproduced in whole or in part without the prior written permission of Celltech Labs Inc.				Page 29 of 33

	<u>Date(s) of Evaluation</u> July 25, 2007	<u>Test Report Serial No.</u> 071707BBO-T841-S95U	<u>Test Report Revision No.</u> Revision 1.0	 Certificate No. 2470.01
	<u>Test Report Issue Date</u> August 01, 2007	<u>Description of Test(s)</u> Specific Absorption Rate	<u>RF Exposure Category</u> General Population	

DUT PHOTOGRAPHS



Left Side of DUT with Plastic Belt-Clip



Right Side of DUT with Plastic Belt-Clip





DUT Battery Compartment



DUT with Li-ion Battery Pack

Company:	Cobra Electronics Corporation	FCC ID:	BBOL16700	IC ID:	906B-LI6700	
Model(s):	LI6700 / LI6750	DUT Type:	Portable FM UHF FRS/GMRS PTT Radio Transceiver			
2007 Celltech Labs Inc.		This document is not to be reproduced in whole or in part without the prior written permission of Celltech Labs Inc.				Page 30 of 33



	<u>Date(s) of Evaluation</u> July 25, 2007	<u>Test Report Serial No.</u> 071707BBO-T841-S95U	<u>Test Report Revision No.</u> Revision 1.0	 Certificate No. 2470.01
	<u>Test Report Issue Date</u> August 01, 2007	<u>Description of Test(s)</u> Specific Absorption Rate	<u>RF Exposure Category</u> General Population	

DUT PHOTOGRAPHS





DUT with Ear-bud/Lapel-Microphone Audio Accessory

Company:	Cobra Electronics Corporation	FCC ID:	BBOL16700	IC ID:	906B-LI6700	
Model(s):	LI6700 / LI6750	DUT Type:	Portable FM UHF FRS/GMRS PTT Radio Transceiver			
2007 Celltech Labs Inc.		This document is not to be reproduced in whole or in part without the prior written permission of Celltech Labs Inc.				Page 31 of 33

	<u>Date(s) of Evaluation</u> July 25, 2007	<u>Test Report Serial No.</u> 071707BBO-T841-S95U	<u>Test Report Revision No.</u> Revision 1.0	 Certificate No. 2470.01
	<u>Test Report Issue Date</u> August 01, 2007	<u>Description of Test(s)</u> Specific Absorption Rate	<u>RF Exposure Category</u> General Population	

APPENDIX E - SYSTEM VALIDATION

Company:	Cobra Electronics Corporation	FCC ID:	BBOLI6700	IC ID:	906B-LI6700	
Model(s):	LI6700 / LI6750	DUT Type:	Portable FM UHF FRS/GMRS PTT Radio Transceiver			
2007 Celltech Labs Inc.	This document is not to be reproduced in whole or in part without the prior written permission of Celltech Labs Inc.					Page 32 of 33

	Date of Evaluation:	June 07, 2007	Document Serial No.:	SV450B-060707-R1.0	
	Evaluation Type:	System Validation	Validation Dipole:	450 MHz	Fluid Type:

450 MHz SYSTEM VALIDATION

Type:

450 MHz Validation Dipole

Asset Number:

00024

Serial Number:

136

Place of Validation:

Celltech Labs Inc.

Date of Validation:

June 07, 2007

Celltech Labs Inc. certifies that the 450 MHz System Validation was performed on the date indicated above.

Validated by:

Cheri Frangiadakis

Approved by:

Jon Hughes

1. Dipole Construction & Electrical Characteristics

The validation dipole was constructed in accordance with the requirements specified in IEEE Standard 1528-2003 and International Standard IEC 62209-1:2005. The electrical properties were measured using an HP 8753ET Network Analyzer. The network analyzer was calibrated to the validation dipole N-type connector feed point using an HP85032E Type N calibration kit. The dipole was placed parallel to a planar phantom at a separation distance of 15.0mm from the simulating fluid using a loss-less dielectric spacer. The measured input impedance is:

Feed point impedance at 450 MHz $Re\{Z\} = 55.109\Omega$
 $Im\{Z\} = 6.2617\Omega$

Return Loss at 450 MHz -22.210dB

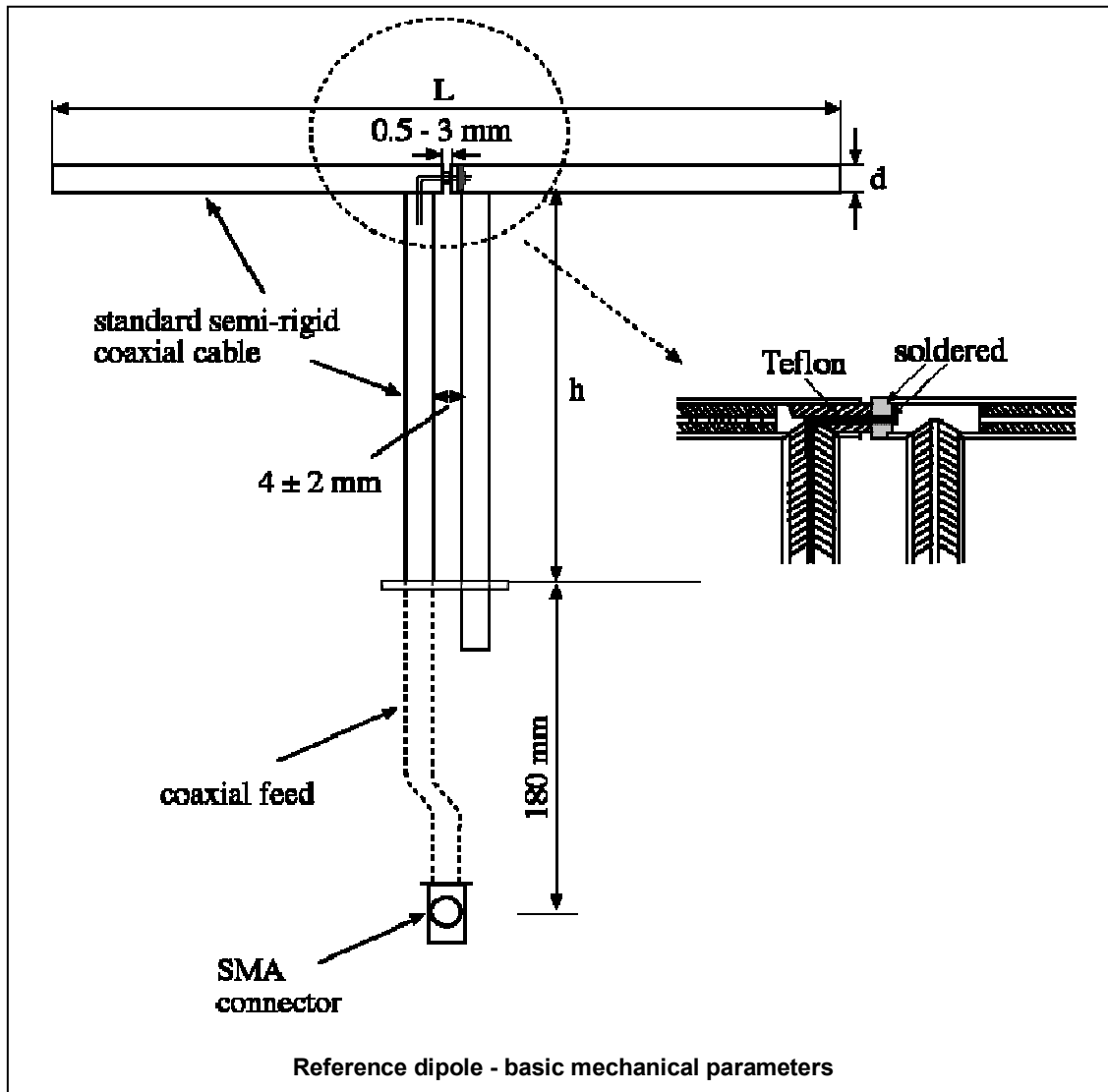

2. Validation Dipole VSWR Data

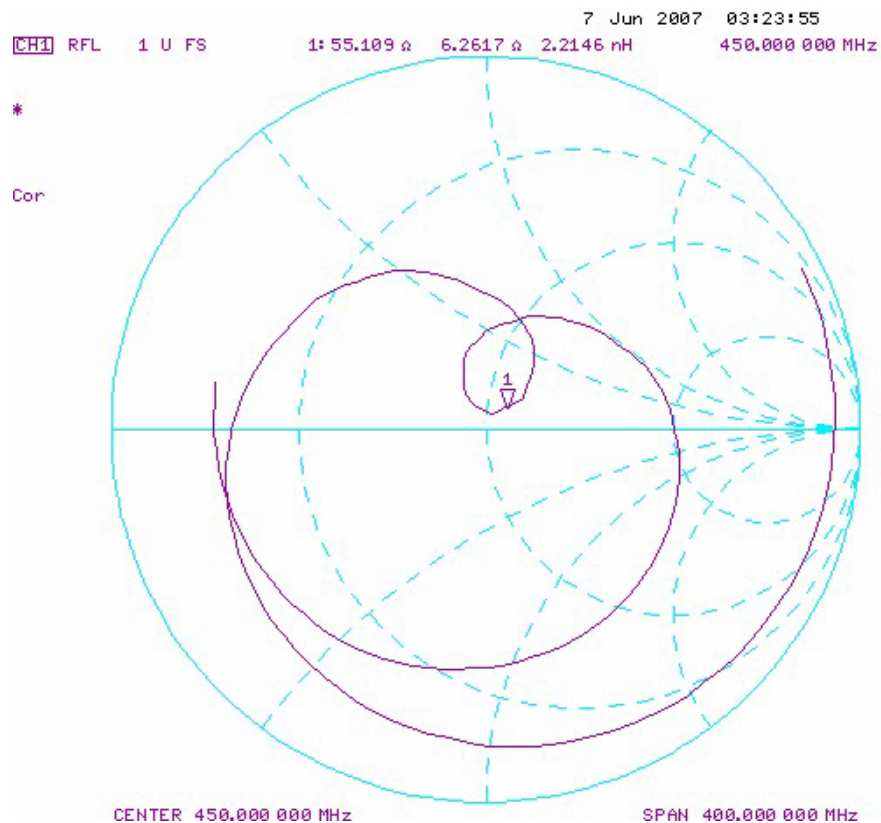
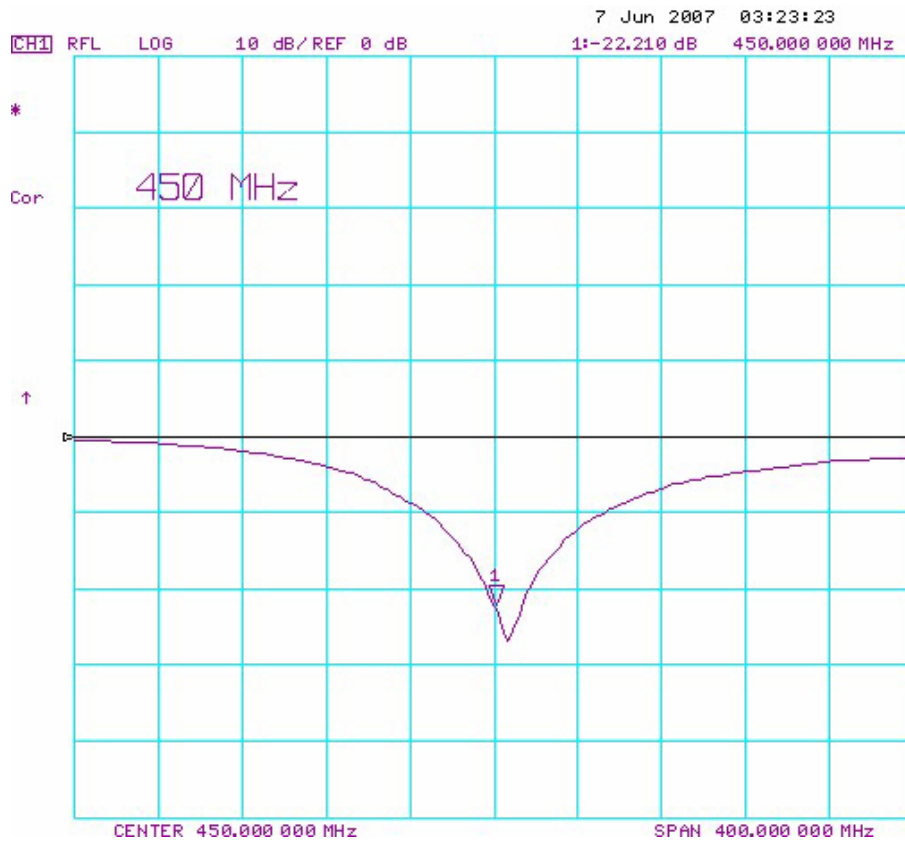

3. Validation Dipole Dimensions

Frequency (MHz)	L (mm)	h (mm)	d (mm)
300	396.0	250.0	6.0
450	270.0	167.0	6.0
835	161.0	89.8	3.6
900	149.0	83.3	3.6
1450	89.1	51.7	3.6
1800	72.0	41.7	3.6
1900	68.0	39.5	3.6
2000	64.5	37.5	3.6
2450	51.5	30.4	3.6
3000	41.5	25.0	3.6

4. Validation Phantom

The validation phantom (planar) was constructed using relatively low-loss tangent Plexiglas material.

The inner dimensions of the validation phantom are as follows:

Length: 83.5 cm
Width: 36.9 cm
Height: 21.8 cm

The bottom section of the validation phantom is constructed of 6.2 ± 0.1 mm Plexiglas.

5. Test Equipment List

TEST EQUIPMENT	ASSET NO.	SERIAL NO.	DATE OF CAL.	CAL. DUE DATE
SPEAG DASY4 Measurement Server	00158	1078	N/A	N/A
SPEAG Robot	00046	599396-01	N/A	N/A
SPEAG DAE4	00019	353	21Jun06	21Jun07
SPEAG ET3DV6 E-Field Probe	00016	1387	16Mar07	16Mar08
450 MHz Validation Dipole	00024	136	07Jun07	07Jun08
Plexiglas Validation Planar Phantom	00157	137	N/A	N/A
ALS-PR-DIEL Dielectric Probe Kit	00160	260-00953	N/A	N/A
Gigatronics 8652A Power Meter	00007	1835272	26Mar07	26Mar08
Gigatronics 80701A Power Sensor	00014	1833699	22Jan07	22Jan08
Gigatronics 80701A Power Sensor	00109	1834366	26Mar07	26Mar08
HP 8753ET Network Analyzer	00134	US39170292	20Apr07	20Apr08
HP 8648D Signal Generator	00005	3847A00611	NCR	NCR
Amplifier Research 5S1G4 Power Amplifier	00106	26235	NCR	NCR

6. Dimensions of Plexiglas Planar Phantom

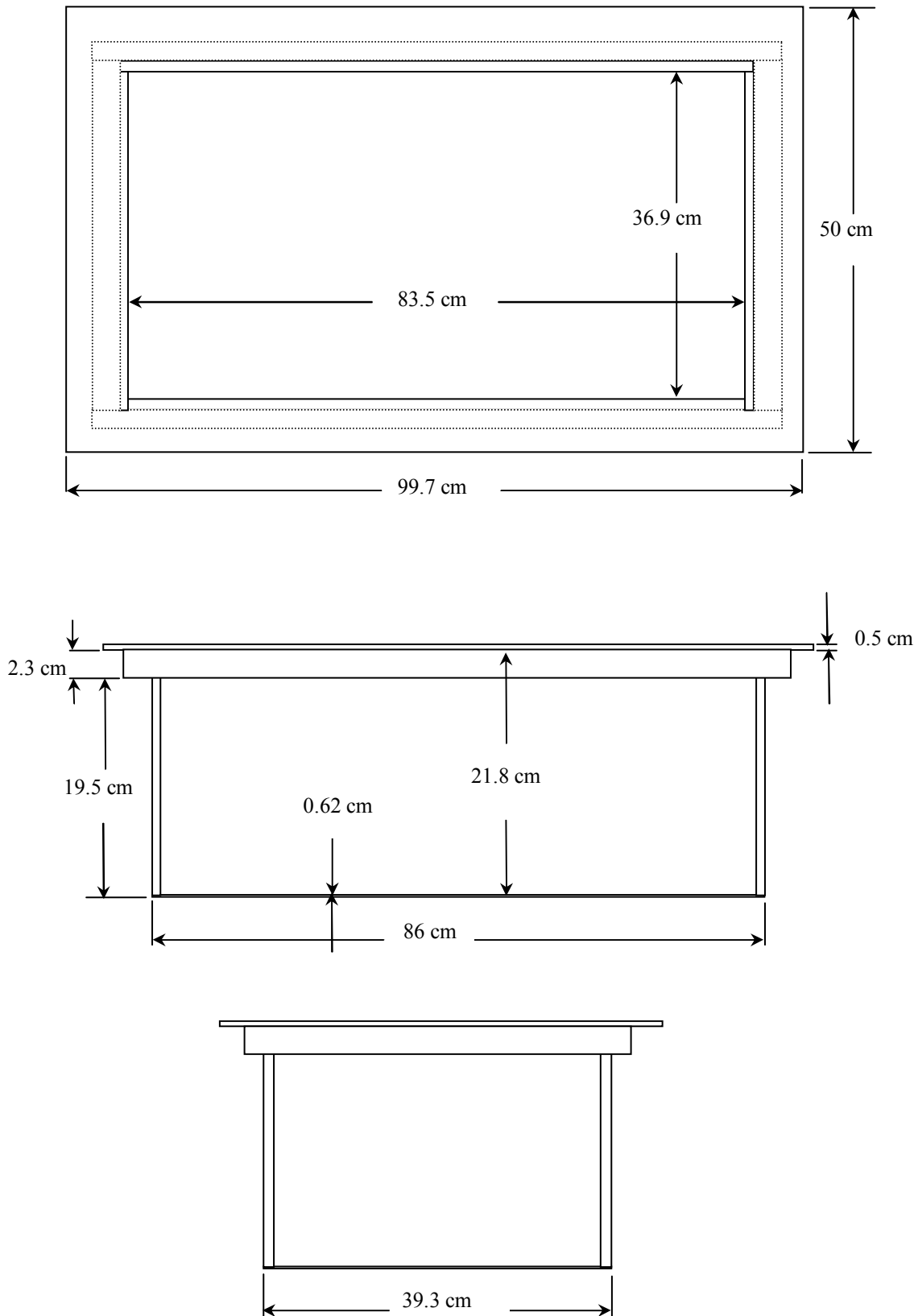

7. 450 MHz System Validation Setup



8. 450 MHz Dipole Setup



9. SAR Measurement

Measurements were made using a dosimetric E-field probe ET3DV6 (S/N: 1387, Conversion Factor 7.0). The SAR measurement was performed with the E-field probe in mechanical detection mode only. The setup and determination of the forward power into the dipole was performed using the procedures described below.

First the power meter PM1 (including attenuator Att1) is connected to the cable to measure the forward power at the location of the dipole connector (X). The signal generator is adjusted for the desired forward power at the dipole connector (taking into account the attenuation of Att1) as read by power meter PM2. After connecting the cable to the dipole, the signal generator is readjusted for the same reading at power meter PM2. If the signal generator does not allow adjustment in 0.01dB steps, the remaining difference at PM2 must be taken into consideration. PM3 records the reflected power from the dipole to ensure that the value is not changed from the previous value. The reflected power should be 20dB below the forward power.

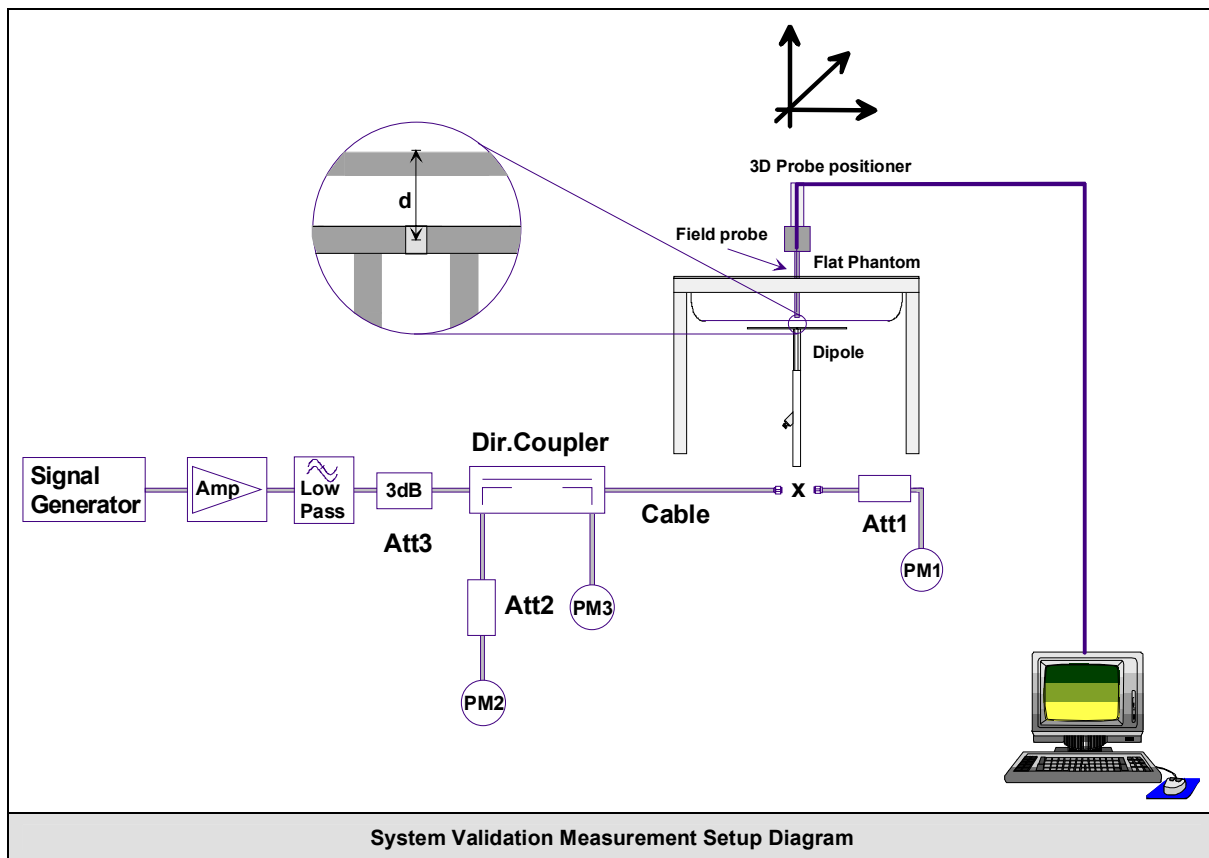

10. Measurement Conditions

The validation phantom was filled with 450 MHz Brain tissue simulant.

Relative Permittivity: 44.9 (+3.3% deviation from target)
 Conductivity: 0.91 mho/m (+4.6% deviation from target)
 Fluid Temperature: 21.4°C (Start of Test) / 21.4 °C (End of Test)
 Fluid Depth: ≥ 15.0 cm

Environmental Conditions:

Ambient Temperature: 24.7°C
 Barometric Pressure: 96.8 kPa
 Humidity: 31%

The 450 MHz Brain tissue simulant consisted of the following ingredients:

Ingredient	Percentage by weight	
Water	38.56%	
Sugar	56.32%	
Salt	3.95%	
HEC	0.98%	
Dowicil 75	0.19%	
Target Dielectric Parameters:	$\epsilon_r = 43.5$ (+/- 5%)	$\sigma = 0.87$ S/m (+/- 5%)

11. System Validation SAR Results

SAR @ 0.25W Input averaged over 1g (W/kg)				SAR @ 1W Input averaged over 1g (W/kg)			
IEEE/IEC Target	Measured	Deviation		IEEE/IEC Target	Measured	Deviation	
1.23	+/- 10%	1.19	-3.2%	4.9	+/- 10%	4.76	-2.8%
SAR @ 0.25W Input averaged over 10g (W/kg)				SAR @ 1W Input averaged over 10g (W/kg)			
IEEE/IEC Target	Measured	Deviation		IEEE/IEC Target	Measured	Deviation	
0.825	+/- 10%	0.769	-6.8%	3.3	+/- 10%	3.08	-6.6%
Frequency (MHz)	1 g SAR	10 g SAR	Local SAR at surface (above feed-point)	Local SAR at surface (y = 2 cm offset from feed-point) [†]			
300	3.0	2.0	4.4	2.1			
450	4.9	3.3	7.2	3.2			
835	9.5	6.2	4.1	4.9			
900	10.8	6.9	16.4	5.4			
1450	29.0	16.0	50.2	6.5			
1800	38.1	19.8	69.5	6.8			
1900	39.7	20.5	72.1	6.6			
2000	41.1	21.1	74.6	6.5			
2450	52.4	24.0	104.2	7.7			
3000	63.8	25.7	140.2	9.5			
Numerical reference SAR values for reference dipole and flat phantom normalized to 1 W (IEEE 1528-2003; IEC 62209-1:2005)							

	Date of Evaluation:	June 07, 2007	Document Serial No.:	SV450B-060707-R1.0
	Evaluation Type:	System Validation	Validation Dipole:	450 MHz
			Fluid Type:	Brain

System Validation - 450 MHz Dipole - June 7, 2007

DUT: Dipole 450 MHz; Asset: 00024; Serial: 136

Ambient Temp: 24.7°C; Fluid Temp: 21.4°C; Barometric Pressure: 96.8 kPa; Humidity: 31%

Communication System: CW

Forward Conducted Power: 250 mW

Frequency: 450 MHz; Duty Cycle: 1:1

Medium: HSL450 Medium parameters used: $f = 450 \text{ MHz}$; $\sigma = 0.91 \text{ mho/m}$; $\epsilon_r = 44.9$; $\rho = 1000 \text{ kg/m}^3$

- Probe: ET3DV6 - SN1387; ConvF(7, 7, 7); Calibrated: 16/03/2007
- Sensor-Surface: 4mm (Mechanical Surface Detection)
- Electronics: DAE4 Sn353; Calibrated: 21/06/2006
- Phantom: Validation Planar; Type: Plexiglas; Serial: 137
- Measurement SW: DASY4, V4.7 Build 44; Postprocessing SW: SEMCAD, V1.8 Build 171

450 MHz System Validation/Area Scan (6x11x1):

Measurement grid: $dx=15\text{mm}$, $dy=15\text{mm}$

Maximum value of SAR (measured) = 1.19 mW/g

450 MHz System Validation/Zoom Scan (5x5x7)/Cube 0:

Measurement grid: $dx=7.5\text{mm}$, $dy=7.5\text{mm}$, $dz=5\text{mm}$

Reference Value = 37.1 V/m; Power Drift = -0.001 dB

Peak SAR (extrapolated) = 2.08 W/kg

SAR(1 g) = 1.19 mW/g; SAR(10 g) = 0.769 mW/g

Maximum value of SAR (measured) = 1.25 mW/g

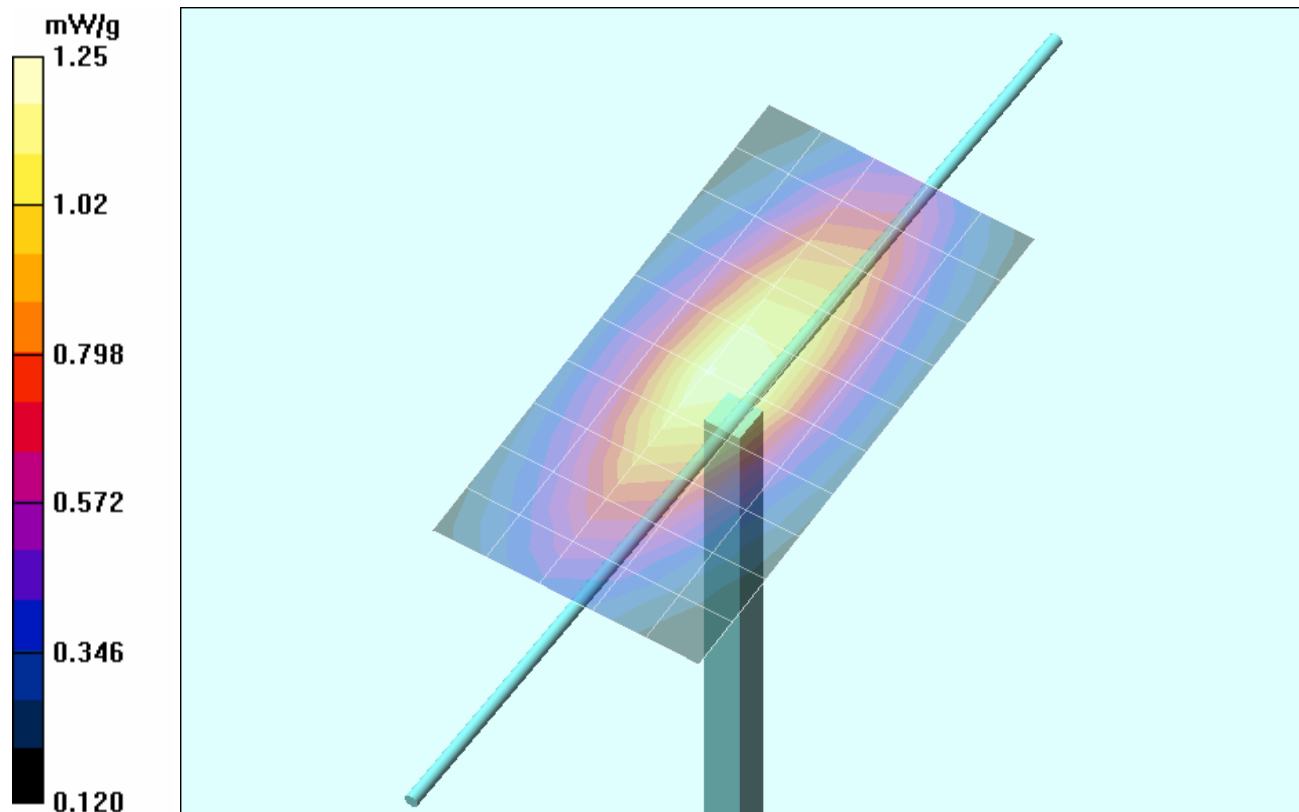

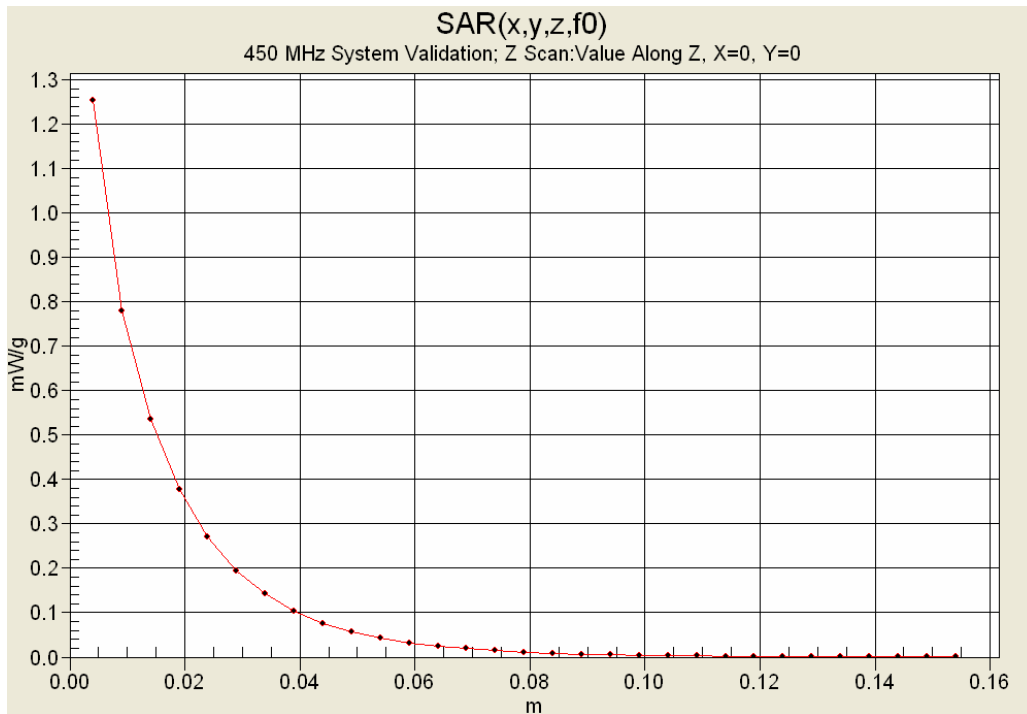

12. Measured Fluid Dielectric Parameters

System Validation - 450 MHz (Brain)

Celltech Labs Inc.

Test Result for UIM Dielectric Parameter

Thu 07/Jun/2007

Frequency (GHz)

FCC_eH FCC OET 65 Supplement C (June 2001) Limits for Head Epsilon

FCC_sH FCC OET 65 Supplement C (June 2001) Limits for Head Sigma

Test_e Epsilon of UIM



Test_s Sigma of UIM

Freq	FCC_eH	FCC_sH	Test_e	Test_s
0.3500	44.70	0.87	47.03	0.83
0.3600	44.58	0.87	46.92	0.83
0.3700	44.46	0.87	46.66	0.84
0.3800	44.34	0.87	46.46	0.86
0.3900	44.22	0.87	45.98	0.86
0.4000	44.10	0.87	45.91	0.87
0.4100	43.98	0.87	45.71	0.88
0.4200	43.86	0.87	45.34	0.89
0.4300	43.74	0.87	45.22	0.90
0.4400	43.62	0.87	44.94	0.90
0.4500	43.50	0.87	44.88	0.91
0.4600	43.45	0.87	44.70	0.92
0.4700	43.40	0.87	44.48	0.93
0.4800	43.34	0.87	44.11	0.94
0.4900	43.29	0.87	43.91	0.95
0.5000	43.24	0.87	43.83	0.95
0.5100	43.19	0.87	43.55	0.96
0.5200	43.14	0.88	43.34	0.97
0.5300	43.08	0.88	42.97	0.98
0.5400	43.03	0.88	42.96	0.98
0.5500	42.98	0.88	43.02	1.00

13. Measurement Uncertainties

UNCERTAINTY BUDGET FOR SYSTEM VALIDATION						
Error Description	Uncertainty Value ±%	Probability Distribution	Divisor	ci 1g	Uncertainty Value ±% (1g)	V _i or V _{eff}
Measurement System						
Probe calibration (450 MHz)	8.0	Normal	1	1.0	8.0	∞
Axial isotropy of the probe	4.7	Rectangular	1.732050808	0.7	1.9	∞
Spherical isotropy of the probe	9.6	Rectangular	1.732050808	0.7	3.9	∞
Spatial resolution	0.0	Rectangular	1.732050808	1	0.0	∞
Boundary effects	1.0	Rectangular	1.732050808	1	0.6	∞
Probe linearity	4.7	Rectangular	1.732050808	1	2.7	∞
Detection limit	1.0	Rectangular	1.732050808	1	0.6	∞
Readout electronics	0.3	Normal	1	1	0.3	∞
Response time	0.8	Rectangular	1.732050808	1	0.5	∞
Integration time	2.6	Rectangular	1.732050808	1	1.5	∞
RF ambient conditions	3.0	Rectangular	1.732050808	1	1.7	∞
Mech. constraints of robot	0.4	Rectangular	1.732050808	1	0.2	∞
Probe positioning	2.9	Rectangular	1.732050808	1	1.7	∞
Extrapolation & integration	1.0	Rectangular	1.732050808	1	0.6	∞
Test Sample Related						
Device positioning	2.0	Normal	1.732050808	1	1.2	∞
Power drift	5.0	Rectangular	1.732050808	1	2.9	∞
Phantom and Setup						
Phantom uncertainty	4.0	Rectangular	1.732050808	1	2.3	∞
Liquid conductivity (target)	5.0	Rectangular	1.732050808	0.7	2.0	∞
Liquid conductivity (measured)	5.0	Rectangular	1.732050808	0.7	2.0	∞
Liquid permittivity (target)	5.0	Rectangular	1.732050808	0.6	1.7	∞
Liquid permittivity (measured)	5.0	Rectangular	1.732050808	0.6	1.7	∞
Combined Standard Uncertainty					11.34	
Expanded Uncertainty (k=2)					22.68	
Note(s)	1. Measurement Uncertainty Table in accordance with IEC 62209-1:2005.					

UNCERTAINTY BUDGET FOR SYSTEM VALIDATION						
Error Description	Uncertainty Value $\pm\%$	Probability Distribution	Divisor	c_i 1g	Uncertainty Value $\pm\%$ (1g)	V_i or V_{eff}
Measurement System						
Probe calibration (450 MHz)	8.0	Normal	1	1.0	8.0	∞
Axial isotropy of the probe	4.7	Rectangular	1.732050808	0.7	1.9	∞
Spherical isotropy of the probe	0.0	Rectangular	1.732050808	0.7	3.9	∞
Spatial resolution	0.0	Rectangular	1.732050808	1	0.0	∞
Boundary effects	1.0	Rectangular	1.732050808	1	0.6	∞
Probe linearity	4.7	Rectangular	1.732050808	1	2.7	∞
Detection limit	1.0	Rectangular	1.732050808	1	0.6	∞
Readout electronics	0.3	Normal	1	1	0.3	∞
Response time	0.0	Rectangular	1.732050808	1	0.5	∞
Integration time	0.0	Rectangular	1.732050808	1	1.5	∞
RF ambient conditions	3.0	Rectangular	1.732050808	1	1.7	∞
Mech. constraints of robot	0.4	Rectangular	1.732050808	1	0.2	∞
Probe positioning	2.9	Rectangular	1.732050808	1	1.7	∞
Extrapolation & integration	1.0	Rectangular	1.732050808	1	0.6	∞
Test Sample Related						
Device positioning	2.0	Normal	1.732050808	1	1.2	∞
Power drift	4.7	Rectangular	1.732050808	1	2.9	∞
Phantom and Setup						
Phantom uncertainty	4.0	Rectangular	1.732050808	1	2.3	∞
Liquid conductivity (target)	5.0	Rectangular	1.732050808	0.7	2.0	∞
Liquid conductivity (measured)	5.0	Rectangular	1.732050808	0.7	2.0	∞
Liquid permittivity (target)	5.0	Rectangular	1.732050808	0.6	1.7	∞
Liquid permittivity (measured)	5.0	Rectangular	1.732050808	0.6	1.7	∞
Combined Standard Uncertainty					11.20	
Expanded Uncertainty (k=2)					22.39	
Note(s)	1. Measurement Uncertainty Table in accordance with IEEE 1528-2003.					

	<u>Date(s) of Evaluation</u> July 25, 2007	<u>Test Report Serial No.</u> 071707BBO-T841-S95U	<u>Test Report Revision No.</u> Revision 1.0	 Certificate No. 2470.01
	<u>Test Report Issue Date</u> August 01, 2007	<u>Description of Test(s)</u> Specific Absorption Rate	<u>RF Exposure Category</u> General Population	

APPENDIX F - PROBE CALIBRATION

Company:	Cobra Electronics Corporation	FCC ID:	BBOLI6700	IC ID:	906B-LI6700	
Model(s):	LI6700 / LI6750	DUT Type:	Portable FM UHF FRS/GMRS PTT Radio Transceiver			
2007 Celltech Labs Inc.	This document is not to be reproduced in whole or in part without the prior written permission of Celltech Labs Inc.					Page 33 of 33



Accredited by the Swiss Federal Office of Metrology and Accreditation
The Swiss Accreditation Service is one of the signatories to the EA
Multilateral Agreement for the recognition of calibration certificates

Accreditation No.: **SCS 108**

Client **Celltech Labs**

Certificate No: **ET3-1387_Mar07**

CALIBRATION CERTIFICATE

Object **ET3DV6 - SN:1387**

Calibration procedure(s) **QA CAL-01.v5
Calibration procedure for dosimetric E-field probes**

Calibration date: **March 16, 2007**

Condition of the calibrated item **In Tolerance**

This calibration certificate documents the traceability to national standards, which realize the physical units of measurements (SI).
The measurements and the uncertainties with confidence probability are given on the following pages and are part of the certificate.

All calibrations have been conducted in the closed laboratory facility: environment temperature (22 ± 3)°C and humidity < 70%.

Calibration Equipment used (M&TE critical for calibration)

Primary Standards	ID #	Cal Date (Calibrated by, Certificate No.)	Scheduled Calibration
Power meter E4419B	GB41293874	5-Apr-06 (METAS, No. 251-00557)	Apr-07
Power sensor E4412A	MY41495277	5-Apr-06 (METAS, No. 251-00557)	Apr-07
Power sensor E4412A	MY41498087	5-Apr-06 (METAS, No. 251-00557)	Apr-07
Reference 3 dB Attenuator	SN: S5054 (3c)	10-Aug-06 (METAS, No. 217-00592)	Aug-07
Reference 20 dB Attenuator	SN: S5086 (20b)	4-Apr-06 (METAS, No. 251-00558)	Apr-07
Reference 30 dB Attenuator	SN: S5129 (30b)	10-Aug-06 (METAS, No. 217-00593)	Aug-07
Reference Probe ES3DV2	SN: 3013	4-Jan-07 (SPEAG, No. ES3-3013_Jan07)	Jan-08
DAE4	SN: 654	21-Jun-06 (SPEAG, No. DAE4-654_Jun06)	Jun-07

Secondary Standards	ID #	Check Date (in house)	Scheduled Check
RF generator HP 8648C	US3642U01700	4-Aug-99 (SPEAG, in house check Nov-05)	In house check: Nov-07
Network Analyzer HP 8753E	US37390585	18-Oct-01 (SPEAG, in house check Oct-06)	In house check: Oct-07

	Name	Function	Signature
Calibrated by:	Katja Pokovic	Technical Manager	
Approved by:	Fin Bomholt	R&D Director	

Issued: March 19, 2007

This calibration certificate shall not be reproduced except in full without written approval of the laboratory.



Accredited by the Swiss Federal Office of Metrology and Accreditation
The Swiss Accreditation Service is one of the signatories to the EA
Multilateral Agreement for the recognition of calibration certificates

Accreditation No.: **SCS 108**

Glossary:

TSL	tissue simulating liquid
NORM _{x,y,z}	sensitivity in free space
ConF	sensitivity in TSL / NORM _{x,y,z}
DCP	diode compression point
Polarization φ	φ rotation around probe axis
Polarization ϑ	ϑ rotation around an axis that is in the plane normal to probe axis (at measurement center), i.e., $\vartheta = 0$ is normal to probe axis

Calibration is Performed According to the Following Standards:

- IEEE Std 1528-2003, "IEEE Recommended Practice for Determining the Peak Spatial-Averaged Specific Absorption Rate (SAR) in the Human Head from Wireless Communications Devices: Measurement Techniques", December 2003
- IEC 62209-1, "Procedure to measure the Specific Absorption Rate (SAR) for hand-held devices used in close proximity to the ear (frequency range of 300 MHz to 3 GHz)", February 2005

Methods Applied and Interpretation of Parameters:

- NORM_{x,y,z}**: Assessed for E-field polarization $\vartheta = 0$ ($f \leq 900$ MHz in TEM-cell; $f > 1800$ MHz: R22 waveguide). NORM_{x,y,z} are only intermediate values, i.e., the uncertainties of NORM_{x,y,z} does not effect the E²-field uncertainty inside TSL (see below *ConvF*).
- NORM(f)_{x,y,z}** = NORM_{x,y,z} * *frequency_response* (see Frequency Response Chart). This linearization is implemented in DASY4 software versions later than 4.2. The uncertainty of the frequency response is included in the stated uncertainty of *ConvF*.
- DCP_{x,y,z}**: DCP are numerical linearization parameters assessed based on the data of power sweep (no uncertainty required). DCP does not depend on frequency nor media.
- ConvF and Boundary Effect Parameters**: Assessed in flat phantom using E-field (or Temperature Transfer Standard for $f \leq 800$ MHz) and inside waveguide using analytical field distributions based on power measurements for $f > 800$ MHz. The same setups are used for assessment of the parameters applied for boundary compensation (alpha, depth) of which typical uncertainty values are given. These parameters are used in DASY4 software to improve probe accuracy close to the boundary. The sensitivity in TSL corresponds to NORM_{x,y,z} * *ConvF* whereby the uncertainty corresponds to that given for *ConvF*. A frequency dependent *ConvF* is used in DASY version 4.4 and higher which allows extending the validity from ± 50 MHz to ± 100 MHz.
- Spherical isotropy (3D deviation from isotropy)**: in a field of low gradients realized using a flat phantom exposed by a patch antenna.
- Sensor Offset**: The sensor offset corresponds to the offset of virtual measurement center from the probe tip (on probe axis). No tolerance required.

Probe ET3DV6

SN:1387

Manufactured:	September 21, 1999
Last calibrated:	March 16, 2006
Recalibrated:	March 16, 2007

Calibrated for DASY Systems

(Note: non-compatible with DASY2 system!)

DASY - Parameters of Probe: ET3DV6 SN:1387

Sensitivity in Free Space ^A			Diode Compression ^B	
NormX	1.68 ± 10.1%	$\mu\text{V}/(\text{V}/\text{m})^2$	DCP X	91 mV
NormY	1.73 ± 10.1%	$\mu\text{V}/(\text{V}/\text{m})^2$	DCP Y	92 mV
NormZ	1.73 ± 10.1%	$\mu\text{V}/(\text{V}/\text{m})^2$	DCP Z	92 mV

Sensitivity in Tissue Simulating Liquid (Conversion Factors)

Please see Page 8.

Boundary Effect

TSL 835 MHz Typical SAR gradient: 5 % per mm

Sensor Center to Phantom Surface Distance		3.7 mm	4.7 mm
SAR _{be} [%]	Without Correction Algorithm	8.2	3.7
SAR _{be} [%]	With Correction Algorithm	0.8	0.9

Sensor Offset

Probe Tip to Sensor Center 2.7 mm

The reported uncertainty of measurement is stated as the standard uncertainty of measurement multiplied by the coverage factor k=2, which for a normal distribution corresponds to a coverage probability of approximately 95%.

^A The uncertainties of NormX,Y,Z do not affect the E²-field uncertainty inside TSL (see Page 8).

^B Numerical linearization parameter: uncertainty not required.

Frequency Response of E-Field

(TEM-Cell:ifi110 EXX, Waveguide: R22)

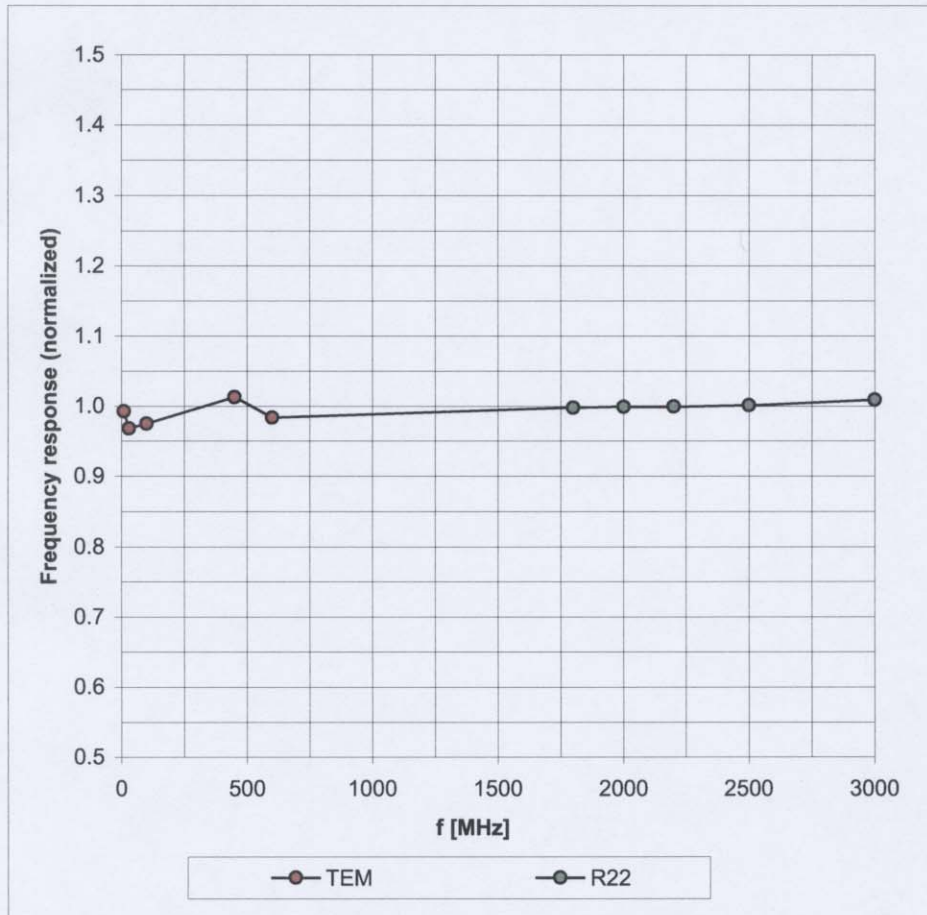

Uncertainty of Frequency Response of E-field: $\pm 6.3\%$ (k=2)

Receiving Pattern (ϕ), $\vartheta = 0^\circ$

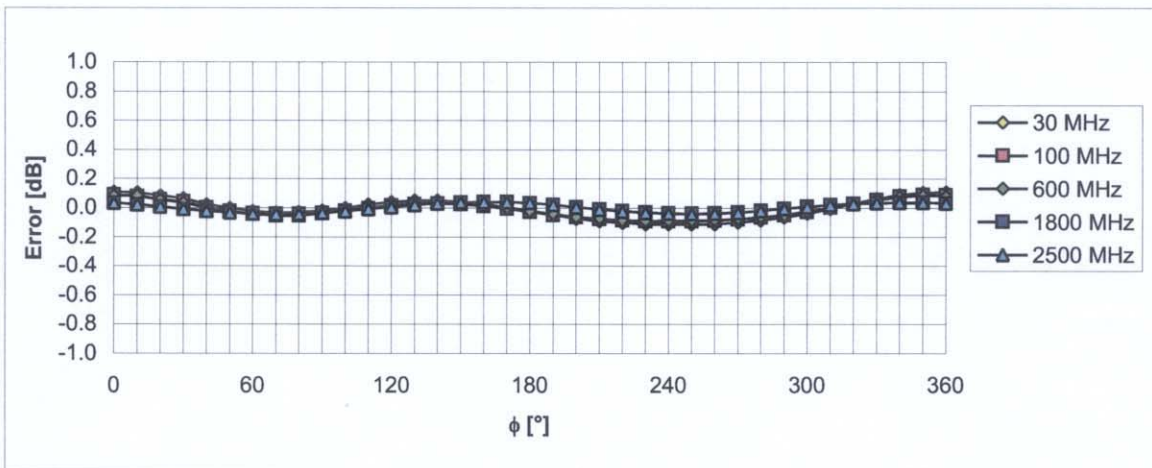
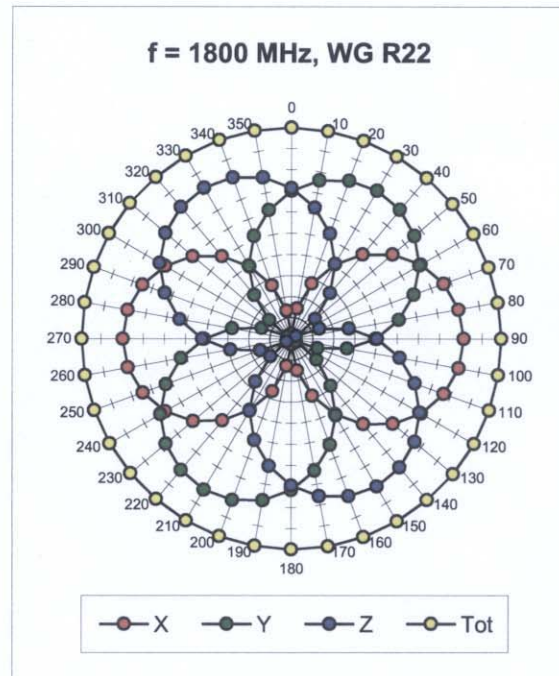
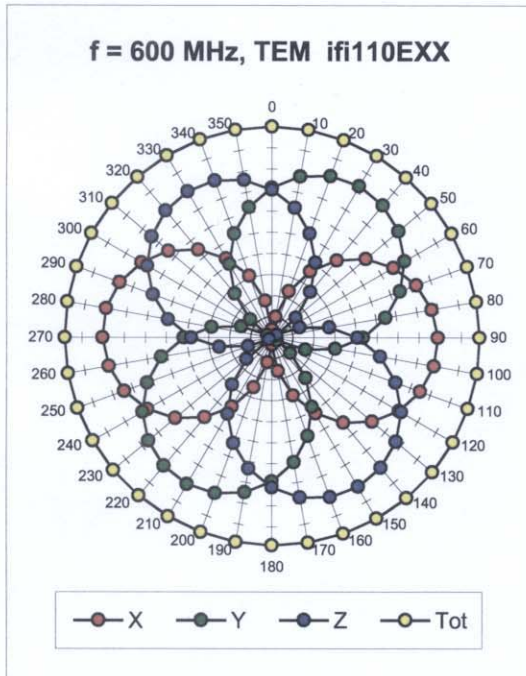

Uncertainty of Axial Isotropy Assessment: $\pm 0.5\%$ ($k=2$)

Dynamic Range $f(SAR_{head})$ (Waveguide R22, $f = 1800$ MHz)

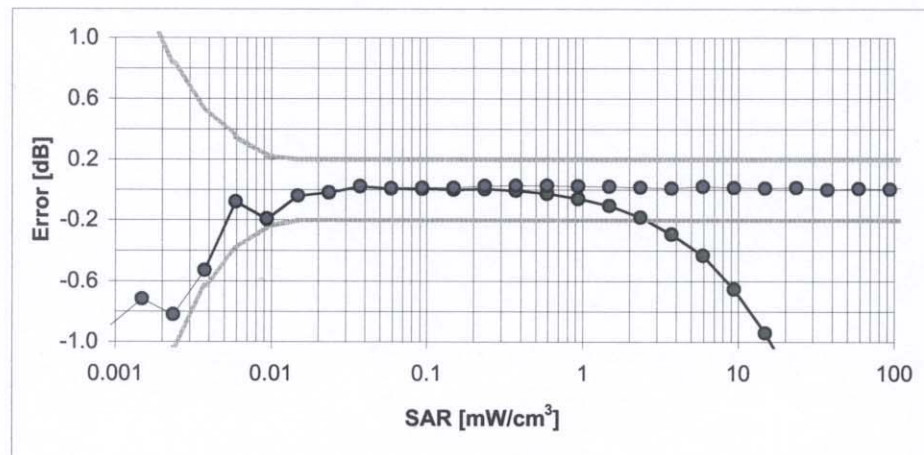
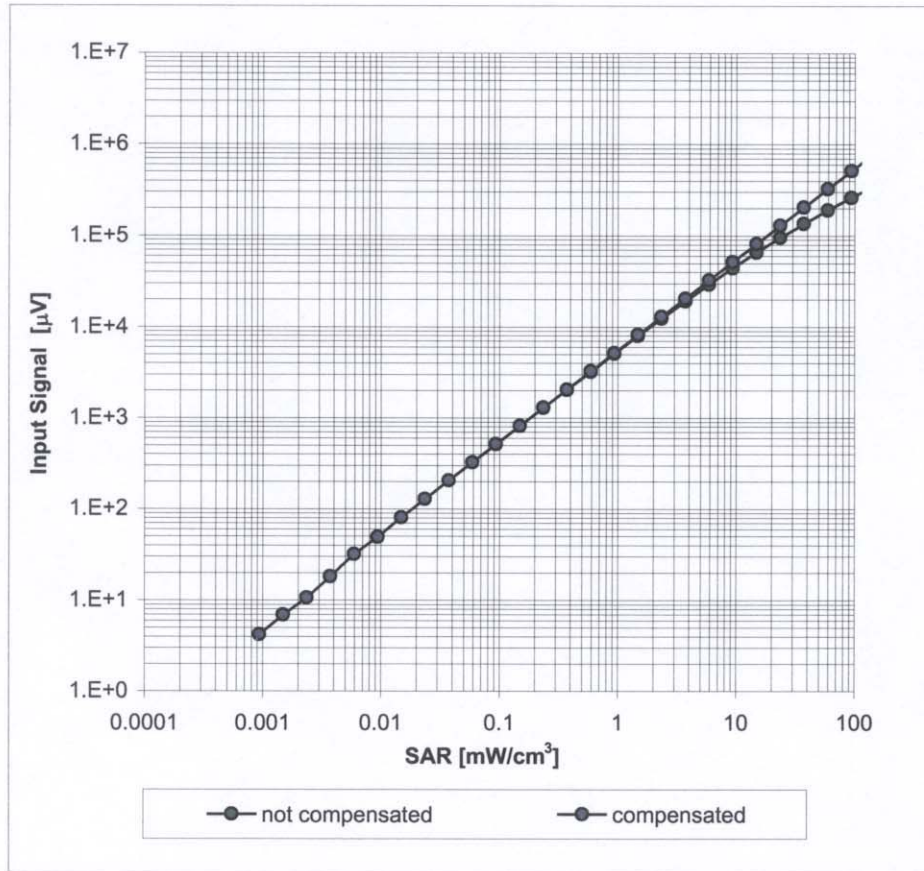

Uncertainty of Linearity Assessment: $\pm 0.6\%$ ($k=2$)

Conversion Factor Assessment

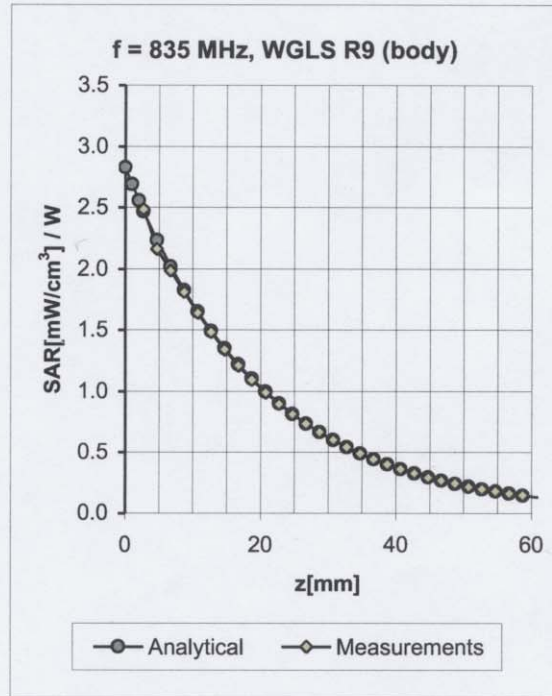
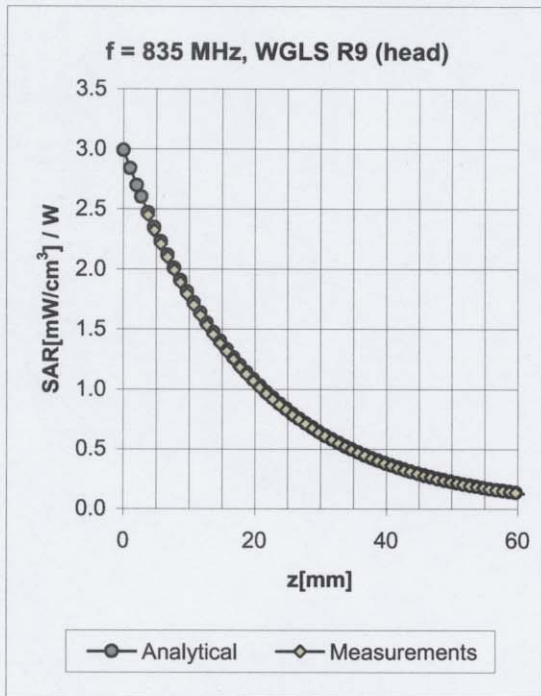

f [MHz]	Validity [MHz] ^c	TSL	Permittivity	Conductivity	Alpha	Depth	ConvF Uncertainty
835	± 50 / ± 100	Head	41.5 ± 5%	0.90 ± 5%	0.36	2.45	6.25 ± 11.0% (k=2)
835	± 50 / ± 100	Body	55.2 ± 5%	0.97 ± 5%	0.34	2.66	6.18 ± 11.0% (k=2)

^c The validity of ± 100 MHz only applies for DASY v4.4 and higher (see Page 2). The uncertainty is the RSS of the ConvF uncertainty at calibration frequency and the uncertainty for the indicated frequency band.

Deviation from Isotropy in HSL

Error (ϕ, ϑ), $f = 900$ MHz

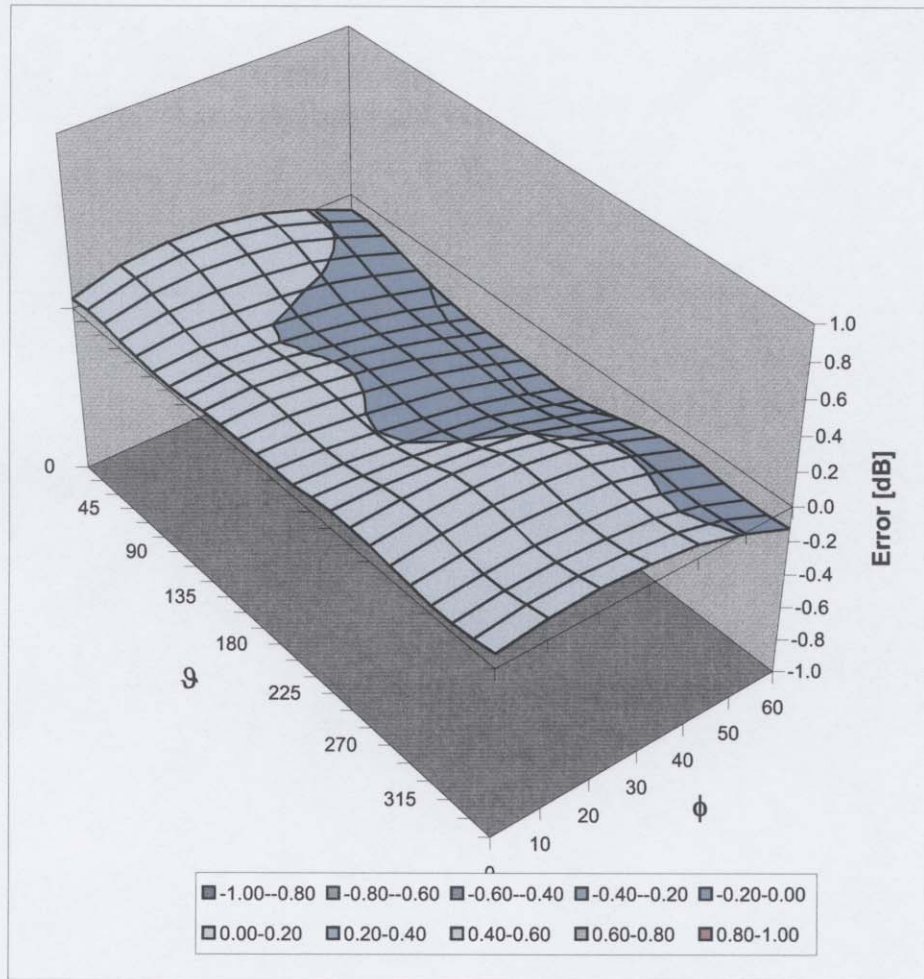

Uncertainty of Spherical Isotropy Assessment: $\pm 2.6\%$ ($k=2$)

Additional Conversion Factors

for Dosimetric E-Field Probe

Type:	ET3DV6
Serial Number:	1387
Place of Assessment:	Zurich
Date of Assessment:	March 20, 2007
Probe Calibration Date:	March 16, 2007

Schmid & Partner Engineering AG hereby certifies that conversion factor(s) of this probe have been evaluated on the date indicated above. The assessment was performed using the FDTD numerical code SEMCAD of Schmid & Partner Engineering AG. Since the evaluation is coupled with measured conversion factors, it has to be recalculated yearly, i.e., following the re-calibration schedule of the probe. The uncertainty of the numerical assessment is based on the extrapolation from measured value at 900 MHz.

Assessed by:

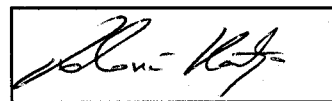

Dosimetric E-Field Probe ET3DV6 SN:1387Conversion factor (\pm standard deviation)

f = 150 MHz	ConvF	7.8 \pm 10 %	$\epsilon_r = 52.3 \pm 5\%$ $\sigma = 0.76 \pm 5\%$ mho/m (head tissue)
f = 300 MHz	ConvF	7.3 \pm 9 %	$\epsilon_r = 45.3 \pm 5\%$ $\sigma = 0.87 \pm 5\%$ mho/m (head tissue)
f = 450 MHz	ConvF	7.0 \pm 8 %	$\epsilon_r = 43.5 \pm 5\%$ $\sigma = 0.87 \pm 5\%$ mho/m (head tissue)
f = 750 MHz	ConvF	6.3 \pm 8 %	$\epsilon_r = 41.8 \pm 5\%$ $\sigma = 0.89 \pm 5\%$ mho/m (head tissue)
f = 150 MHz	ConvF	7.8 \pm 10 %	$\epsilon_r = 61.9 \pm 5\%$ $\sigma = 0.80 \pm 5\%$ mho/m (body tissue)
f = 450 MHz	ConvF	6.9 \pm 8 %	$\epsilon_r = 56.7 \pm 5\%$ $\sigma = 0.94 \pm 5\%$ mho/m (body tissue)
f = 750 MHz	ConvF	6.0 \pm 8 %	$\epsilon_r = 55.4 \pm 5\%$ $\sigma = 0.96 \pm 5\%$ mho/m (body tissue)

Important Note:

For numerically assessed probe conversion factors, parameters Alpha and Delta in the DASY software must have the following entries: Alpha = 0 and Delta = 1.

Please see also Section 4.7 of the DASY4 Manual.