



	<u>Date(s) of Evaluation</u> August 20, 2008	<u>Test Report Serial No.</u> 082008BBO-T923-S95U	<u>Test Report Revision No.</u> Rev. 1.0 (Initial Release)	
	<u>Test Report Issue Date</u> September 04, 2008	<u>Description of Test(s)</u> Specific Absorption Rate	<u>RF Exposure Category</u> General Population	

SAR TEST REPORT (FCC/IC)				
RF EXPOSURE EVALUATION		SPECIFIC ABSORPTION RATE		
APPLICANT	COBRA ELECTRONICS CORPORATION			
DEVICE UNDER TEST (DUT)	PORTABLE GMRS/FRS PUSH-TO-TALK RADIO TRANSCEIVER			
DEVICE FREQUENCY RANGE(S)	462.5500 - 462.7250 MHz		GMRS Channels 15-22	
	462.5625 - 462.7125 MHz		GMRS/FRS Channels 1-7	
	467.5625 - 467.7125 MHz		FRS Channels 8-14	
DEVICE MODEL(S)	CXR800 / CXR820 / CXR825 / CXR850 / CXR855 / CXR856			
DEVICE IDENTIFIER(S)	FCC ID:	BBOCXR800	IC:	906B-CXR800
APPLICATION TYPE	Certification			
STANDARD(S) APPLIED	FCC 47 CFR §2.1093			
	Health Canada Safety Code 6			
PROCEDURE(S) APPLIED	FCC OET Bulletin 65, Supplement C (01-01)			
	Industry Canada RSS-102 Issue 2			
	IEEE 1528-2003			
	IEC 62209-1:2005			
RF EXPOSURE CATEGORY	General Population / Uncontrolled			
RF EXPOSURE EVALUATION(S)	Face-held & Body-worn			
DATE(S) OF EVALUATION(S)	August 20, 2008			
TEST REPORT SERIAL NO.	082008BBO-T923-S95U			
TEST REPORT REVISION NO.	Revision 1.0	Initial Release	September 04, 2008	
TEST REPORT SIGNATORIES	Testing Performed By		Test Report Prepared By	
	Sean Johnston Celltech Labs Inc.		Jonathan Hughes Celltech Labs Inc.	
TEST LAB AND LOCATION	Celltech Compliance Testing and Engineering Lab			
	21-364 Lougheed Road, Kelowna, B.C. V1X 7R8 Canada			
TEST LAB CONTACT INFO.	Tel.: 250-765-7650		Fax: 250-765-7645	
	info@celltechlabs.com		www.celltechlabs.com	
TEST LAB ACCREDITATION(S)	 Test Lab Certificate No. 2470.01			

Applicant:	Cobra Electronics Corporation	FCC ID:	BBOCXR800	IC:	906B-CXR800	
Model(s):	CXR800/CXR820/CXR825/CXR850/CXR855/CXR856		Portable GMRS/FRS PTT Radio Transceiver			
2008 Celltech Labs Inc.		This document is not to be reproduced in whole or in part without the prior written permission of Celltech Labs Inc.				Page 1 of 33

	<u>Date(s) of Evaluation</u> August 20, 2008	<u>Test Report Serial No.</u> 082008BBO-T923-S95U	<u>Test Report Revision No.</u> Rev. 1.0 (Initial Release)	
	<u>Test Report Issue Date</u> September 04, 2008	<u>Description of Test(s)</u> Specific Absorption Rate	<u>RF Exposure Category</u> General Population	

DECLARATION OF COMPLIANCE SAR RF EXPOSURE EVALUATION

Test Lab Information	Name	CELLTECH LABS INC.				
	Address	21-364 Lougheed Road, Kelowna, B.C. V1X 7R8 Canada				
Applicant Information	Name	COBRA ELECTRONICS CORPORATION				
	Address	6500 West Cortland Street, Chicago, IL 60707 United States				
Standard(s) Applied	FCC	47 CFR §2.1093				
	IC	Health Canada Safety Code 6				
Procedure(s) Applied	FCC	OET Bulletin 65, Supplement C (Edition 01-01)				
	IC	RSS-102 Issue 2				
	IEEE	1528-2003				
	IEC	62209-1:2005				
Device RF Exposure Category	Portable	General Population / Uncontrolled Environment				
Device Identifier(s)	FCC ID:	BBOCXR800				
	IC:	906B-CXR800				
	Model(s)	CXR800 / CXR820 / CXR825 / CXR850 / CXR855 / CXR856				
	Serial No.	#1 (Pre-production)				
Device Description	Portable FM UHF GMRS/FRS Push-To-Talk (PTT) Radio Transceiver					
Transmit Frequency Range(s)	462.5500 - 462.7250 MHz (GMRS Channels 15-22)					
	462.5625 - 462.7125 MHz (GMRS/FRS Channels 1-7)					
	467.5625 - 467.7125 MHz (FRS Channels 8-14)					
Max. RF Output Power Tested	1.78 Watts	32.5 dBm	ERP	High Power	462.7250 MHz	GMRS Ch. 22
Antenna Type(s) Tested	External Fixed Stubby (Non-detachable)					
Battery Type(s) Tested	Lithium-ion	7.4 V	950 mAh	P/N: MN-0160001		
Body-worn Accessories Tested	Plastic Belt-Clip (5 mm thickness)					
Audio Accessories Tested	Earbud with Lapel-Microphone (P/N: GA-EBM2)					
Max. SAR Level(s) Evaluated	Face-held	1.49 W/kg	1g	50% duty cycle	General Population / Uncontrolled	
	Body-worn	1.15 W/kg	1g	50% duty cycle	General Population / Uncontrolled	
FCC/IC Spatial Peak SAR Limit	Head/Body	1.6 W/kg	1g	50% duty cycle	General Population / Uncontrolled	
<p>Celltech Labs Inc. declares under its sole responsibility that this wireless portable device has demonstrated compliance with the Specific Absorption Rate (SAR) RF exposure requirements specified in FCC 47 CFR §2.1093 and Health Canada's Safety Code 6 for the General Population / Uncontrolled Exposure environment. The device was tested in accordance with the measurement standards and procedures specified in FCC OET Bulletin 65, Supplement C (Edition 01-01), Industry Canada RSS-102 Issue 2, IEEE 1528-2003 and IEC 62209-1:2005. All measurements were performed in accordance with the SAR system manufacturer recommendations.</p>						
<p>I attest to the accuracy of data. All measurements were performed by me or were made under my supervision and are correct to the best of my knowledge and belief. I assume full responsibility for the completeness of these measurements and vouch for the qualifications of all persons taking them.</p>						
<p>The results and statements contained in this report pertain only to the device(s) evaluated.</p>						
<p>This test report shall not be reproduced partially, or in full, without the prior written approval of Celltech Labs Inc.</p>						
Test Report Approved By			Sean Johnston	Celltech Labs Inc.		



Applicant:	Cobra Electronics Corporation	FCC ID:	BBOCXR800	IC:	906B-CXR800	
Model(s):	CXR800/CXR820/CXR825/CXR850/CXR855/CXR856	Portable GMRS/FRS PTT Radio Transceiver				
2008 Celltech Labs Inc.	This document is not to be reproduced in whole or in part without the prior written permission of Celltech Labs Inc.					Page 2 of 33





	<u>Date(s) of Evaluation</u> August 20, 2008	<u>Test Report Serial No.</u> 082008BBO-T923-S95U	<u>Test Report Revision No.</u> Rev. 1.0 (Initial Release)	
	<u>Test Report Issue Date</u> September 04, 2008	<u>Description of Test(s)</u> Specific Absorption Rate	<u>RF Exposure Category</u> General Population	

TABLE OF CONTENTS	
1.0 INTRODUCTION	4
2.0 SAR MEASUREMENT SYSTEM	4
3.0 MEASUREMENT SUMMARY	5
4.0 DETAILS OF SAR EVALUATION	6
5.0 EVALUATION PROCEDURES	6
6.0 SYSTEM PERFORMANCE CHECK	7
7.0 SIMULATED EQUIVALENT TISSUES	8
8.0 SAR LIMITS	8
9.0 ROBOT SYSTEM SPECIFICATIONS	9
10.0 PROBE SPECIFICATION (ET3DV6)	10
11.0 SIDE PLANAR PHANTOM	10
12.0 VALIDATION PLANAR PHANTOM	10
13.0 DEVICE HOLDER	10
14.0 TEST EQUIPMENT LIST	11
15.0 MEASUREMENT UNCERTAINTIES	12
MEASUREMENT UNCERTAINTIES (CONT.)	13
16.0 REFERENCES	14
APPENDIX A - SAR MEASUREMENT DATA	15
APPENDIX B - SYSTEM PERFORMANCE CHECK DATA	20
APPENDIX C - MEASURED FLUID DIELECTRIC PARAMETERS	23
APPENDIX D - SAR TEST SETUP & DUT PHOTOGRAPHS	26
APPENDIX E - SYSTEM VALIDATION	32
APPENDIX F - PROBE CALIBRATION	33

Applicant:	Cobra Electronics Corporation	FCC ID:	BBOCXR800	IC:	906B-CXR800	
Model(s):	CXR800/CXR820/CXR825/CXR850/CXR855/CXR856	Portable GMRS/FRS PTT Radio Transceiver				
2008 Celltech Labs Inc.	This document is not to be reproduced in whole or in part without the prior written permission of Celltech Labs Inc.					Page 3 of 33

	<u>Date(s) of Evaluation</u> August 20, 2008	<u>Test Report Serial No.</u> 082008BBO-T923-S95U	<u>Test Report Revision No.</u> Rev. 1.0 (Initial Release)	
	<u>Test Report Issue Date</u> September 04, 2008	<u>Description of Test(s)</u> Specific Absorption Rate	<u>RF Exposure Category</u> General Population	

1.0 INTRODUCTION

This measurement report demonstrates compliance of the Cobra Electronics Corporation Model(s): CXR800, CXR820, CXR825, CXR850, CXR855, CXR856 Portable FM UHF GMRS/FRS PTT Radio Transceiver with the SAR (Specific Absorption Rate) RF exposure requirements specified in FCC 47 CFR §2.1093 (see reference [1]) and Health Canada's Safety Code 6 (see reference [2]) for the General Population / Uncontrolled Exposure environment. The test procedures described in FCC OET Bulletin 65, Supplement C (Edition 01-01) (see reference [3]), IC RSS-102 Issue 2 (see reference [4]), IEEE Standard 1528-2003 (see reference [5]) and IEC Standard 62209-1:2005 (see reference [6]) were employed. A description of the product and operating configuration, detailed summary of the test results, methodology and procedures used in the evaluation, equipment used, and the provisions of the rules are included within this test report.

2.0 SAR MEASUREMENT SYSTEM

Celltech Labs Inc. SAR measurement facility utilizes the Dosimetric Assessment System (DASY™) manufactured by Schmid & Partner Engineering AG (SPEAG™) of Zurich, Switzerland. The DASY4 measurement system is comprised of the measurement server, robot controller, computer, near-field probe, probe alignment sensor, specific anthropomorphic mannequin (SAM) phantom, and various planar phantoms for brain and/or body SAR evaluations. The robot is a six-axis industrial robot performing precise movements to position the probe to the location (points) of maximum electromagnetic field (EMF). A cell controller system contains the power supply, robot controller, teach pendant (Joystick), and remote control, is used to drive the robot motors. The Staubli robot is connected to the cell controller to allow software manipulation of the robot. A data acquisition electronic (DAE) circuit performs the signal amplification, signal multiplexing, AD-conversion, offset measurements, mechanical surface detection, collision detection, etc. is connected to the Electro-optical coupler (EOC). The EOC performs the conversion from the optical into digital electric signal of the DAE and transfers data to the DASY4 measurement server. The DAE4 utilizes a highly sensitive electrometer-grade preamplifier with auto-zeroing, a channel and gain-switching multiplexer, a fast 16-bit AD-converter and a command decoder and control logic unit. Transmission to the DASY4 measurement server is accomplished through an optical downlink for data and status information and an optical uplink for commands and clock lines. The mechanical probe-mounting device includes two different sensor systems for frontal and sidewise probe contacts. The sensor systems are also used for mechanical surface detection and probe collision detection. The robot uses its own controller with a built in VME-bus computer.

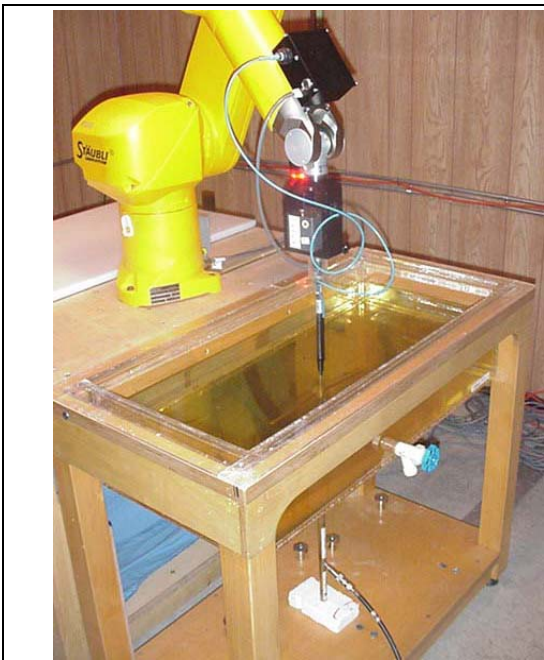



DASY4 SAR System with Plexiglas validation phantom



DASY4 SAR System with Plexiglas side planar phantom



Applicant:	Cobra Electronics Corporation	FCC ID:	BBOCXR800	IC:	906B-CXR800	
Model(s):	CXR800/CXR820/CXR825/CXR850/CXR855/CXR856	Portable GMRS/FRS PTT Radio Transceiver				
2008 Celltech Labs Inc.	This document is not to be reproduced in whole or in part without the prior written permission of Celltech Labs Inc.					Page 4 of 33

	<u>Date(s) of Evaluation</u> August 20, 2008	<u>Test Report Serial No.</u> 082008BBO-T923-S95U	<u>Test Report Revision No.</u> Rev. 1.0 (Initial Release)	
	<u>Test Report Issue Date</u> September 04, 2008	<u>Description of Test(s)</u> Specific Absorption Rate	<u>RF Exposure Category</u> General Population	

3.0 MEASUREMENT SUMMARY

SAR EVALUATION RESULTS														
Test Type	Freq. MHz	Channel		Test Mode	Battery Type	Accessories		DUT Position to Planar Phantom	DUT Start Power (ERP) Watts	Measured SAR 1g (W/kg)		SAR Drift During Test dB	Scaled SAR with droop 1g (W/kg)	
						Body-worn Audio	Spacing cm			Duty Cycle 100% 50%			Duty Cycle 100% 50%	
	Face	462.7250	22	GMRS	CW	Li-ion	--	2.5	Front Side	1.78	2.78	1.39	-0.297	2.98
Body	462.7250	22	GMRS	CW	Li-ion	Belt-Clip	0.5	Back Side	1.78	2.30	1.15	0.011	2.30	1.15
						Earbud-Mic								
SAR LIMIT(S)						BRAIN	BODY	SPATIAL PEAK			RF EXPOSURE CATEGORY			
FCC 47 CFR 2.1093		Health Canada Safety Code 6				1.6 W/kg	1.6 W/kg	averaged over 1 gram			General Population / Uncontrolled			
Test Date(s)	August 20, 2008					August 20, 2008			Measured Fluid Type		Brain	Body	Unit	
Dielectric Constant ϵ_r	450 MHz Brain				450 MHz Body				Atmospheric Pressure		101.1	101.1	kPa	
	IEEE Target		Meas.	Dev.	IEEE Target		Meas.	Dev.	Relative Humidity		34	35	%	
	43.5	$\pm 5\%$	44.3	+1.8%	56.7	$\pm 5\%$	56.2	-0.9%	Ambient Temperature		22.5	22.8	°C	
Conductivity σ (mho/m)	450 MHz Brain				450 MHz Body				Fluid Temperature		21.8	22.0	°C	
	IEEE Target		Meas.	Dev.	IEEE Target		Meas.	Dev.	Fluid Depth		≥ 15	≥ 15	cm	
	0.87	$\pm 5\%$	0.89	+2.3%	0.94	$\pm 5\%$	0.93	-1.0%	ρ (Kg/m ³)		1000			
Notes														
1.	Detailed measurement data and plots showing the maximum SAR location of the DUT are shown in Appendix A.													
2.	The transmission band of the DUT is less than 10 MHz; therefore single channel data only is reported (per FCC OET Bulletin 65, Supplement C, Edition 01-01 - see reference [3]).													
3.	The area scan evaluation was performed with a fully charged battery. After the area scan was completed the battery was replaced with a fully charged battery prior to the zoom scan evaluation.													
4.	The power drift of the DUT was measured by the DASY4 system for the duration of the SAR evaluations. The measured power droop was added to the measured SAR level to report a scaled SAR result as shown in the above test data table. A SAR-versus-Time power droop evaluation was performed and the evaluation plot is shown in Appendix A (SAR Test Plots).													
5.	The fluid temperature was measured prior to and after the SAR evaluations to ensure the temperature remained within +/-2°C of the fluid temperature reported during the dielectric parameter measurements.													
6.	The dielectric parameters of the simulated tissue mixtures were measured prior to the SAR evaluations using a Dielectric Probe Kit and a Network Analyzer (see Appendix C).													
7.	The SAR evaluations were performed within 24 hours of the system performance check.													

Applicant:	Cobra Electronics Corporation	FCC ID:	BBOCX800	IC:	906B-CXR800	
Model(s):	CXR800/CXR820/CXR825/CXR850/CXR855/CXR856	Portable GMRS/FRS PTT Radio Transceiver				
2008 Celltech Labs Inc.		This document is not to be reproduced in whole or in part without the prior written permission of Celltech Labs Inc.				Page 5 of 33

	<u>Date(s) of Evaluation</u> August 20, 2008	<u>Test Report Serial No.</u> 082008BBO-T923-S95U	<u>Test Report Revision No.</u> Rev. 1.0 (Initial Release)	
	<u>Test Report Issue Date</u> September 04, 2008	<u>Description of Test(s)</u> Specific Absorption Rate	<u>RF Exposure Category</u> General Population	

4.0 DETAILS OF SAR EVALUATION

The Cobra Electronics Corporation Models: CXR800/CXR820/CXR825/CXR850/CXR855/CXR856 Portable FM UHF GMRS/FRS PTT Radio Transceiver was compliant for localized Specific Absorption Rate (General Population / Uncontrolled Exposure) based on the test provisions and conditions described below. The detailed test setup photographs are shown in Appendix D.

1. The DUT was evaluated in a face-held configuration with the front of the radio placed parallel to the outer surface of the planar phantom. A 2.5 cm spacing was maintained between the front of the DUT and the outer surface of the planar phantom.
2. The DUT was tested in a body-worn configuration with the back of the radio placed parallel to the outer surface of the planar phantom. The attached plastic belt-clip accessory was touching the planar phantom and provided a 0.5 cm spacing from the back of the DUT to the outer surface of the planar phantom. The DUT was evaluated for body-worn SAR with the Cobra supplied earbud/lapel-microphone audio accessory connected to the audio port.
3. The RF conducted output power of the DUT could not be measured due to a non-detachable antenna. The DUT was evaluated for SAR at the maximum conducted power level preset by the manufacturer.
4. The output power levels (ERP) of the DUT referenced in this report were measured by Celltech Labs Inc. on the Open Area Test Site (FCC Registration No. 714830 and IC Site Number 3874A-1) prior to the SAR evaluations using the signal substitution method in accordance with the measurement standards and procedures described in ANSI TIA/EIA-603-C (2004).
5. The DUT was tested at maximum power setting in unmodulated continuous transmit operation (Continuous Wave mode at 100% duty cycle) with the transmit key constantly depressed. For a push-to-talk device the 50% duty cycle compensation reported assumes a transmit/receive cycle of equal time base.

5.0 EVALUATION PROCEDURES

- a. (i) The evaluation was performed in the applicable area of the phantom depending on the type of device being tested. For devices held to the ear during normal operation, both the left and right ear positions were evaluated using the SAM phantom.
(ii) For body-worn and face-held devices a planar phantom was used.
- b. The SAR was determined by a pre-defined procedure within the DASY4 software. Upon completion of a reference and optical surface check, the exposed region of the phantom was scanned near the inner surface with a grid spacing of 15mm x 15mm.



An area scan was determined as follows:

- c. Based on the defined area scan grid, a more detailed grid is created to increase the points by a factor of 10. The interpolation function then evaluates all field values between corresponding measurement points.
- d. A linear search is applied to find all the candidate maxima. Subsequently, all maxima are removed that are >2 dB from the global maximum. The remaining maxima are then used to position the cube scans.

A 1g and 10g spatial peak SAR was determined as follows:

- e. Extrapolation is used to find the points between the dipole center of the probe and the surface of the phantom. This data cannot be measured, since the center of the dipoles is 2.7 mm away from the tip of the probe and the distance between the surface and the lowest measuring point is 1.4 mm (see probe calibration document in Appendix F). The extrapolation was based on trivariate quadratics computed from the previously calculated 3D interpolated points nearest the phantom surface.
- f. Interpolated data is used to calculate the average SAR over 1g and 10g cubes by spatially discretizing the entire measured cube. The volume used to determine the averaged SAR is a 1mm grid (42875 interpolated points).
- g. A zoom scan volume of 32 mm x 32 mm x 30 mm (5 x 5 x 7 points) centered at the peak SAR location determined from the area scan is used for all zoom scans for devices with a transmit frequency < 800 MHz. Zoom scans for frequencies ≥ 800 MHz are determined with a scan volume of 30 mm x 30 mm x 30 mm (7 x 7 x 7) to ensure complete capture of the peak spatial-average SAR.

Applicant:	Cobra Electronics Corporation	FCC ID:	BBOCXR800	IC:	906B-CXR800	
Model(s):	CXR800/CXR820/CXR825/CXR850/CXR855/CXR856	Portable GMRS/FRS PTT Radio Transceiver				
2008 Celltech Labs Inc.	This document is not to be reproduced in whole or in part without the prior written permission of Celltech Labs Inc.					Page 6 of 33



	<u>Date(s) of Evaluation</u> August 20, 2008	<u>Test Report Serial No.</u> 082008BBO-T923-S95U	<u>Test Report Revision No.</u> Rev. 1.0 (Initial Release)	
	<u>Test Report Issue Date</u> September 04, 2008	<u>Description of Test(s)</u> Specific Absorption Rate	<u>RF Exposure Category</u> General Population	

6.0 SYSTEM PERFORMANCE CHECK

Prior to the SAR evaluations a system check was performed using a Plexiglas planar phantom and 450 MHz dipole (see Appendix B for system performance check test plot). The dielectric parameters of the simulated tissue mixture were measured prior to the system performance check using a Dielectric Probe Kit and a Network Analyzer (see Appendix C for measured fluid dielectric parameters). A forward power of 250 mW was applied to the dipole and the system was verified to a tolerance of $\pm 10\%$ from the system validation target SAR value (see Appendix E for system validation procedures).

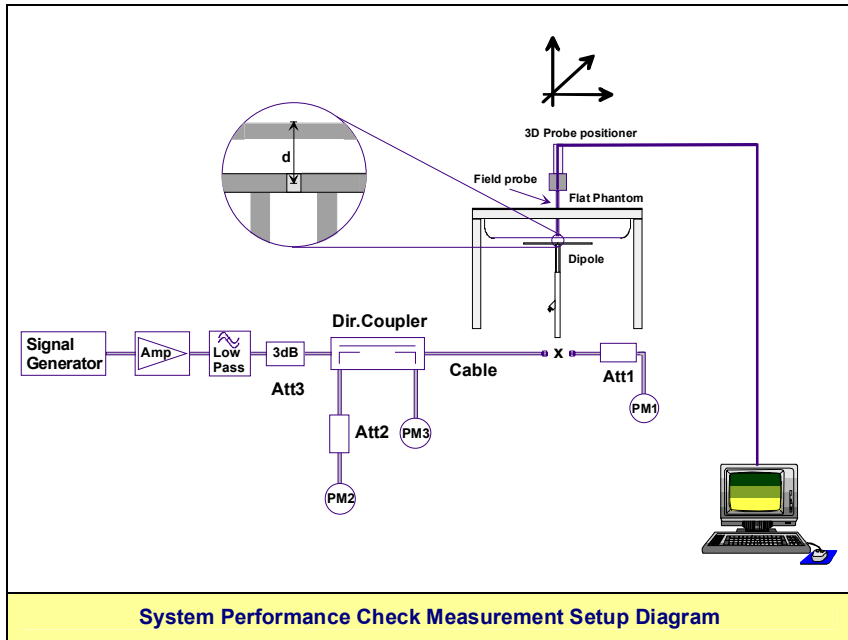
SYSTEM PERFORMANCE CHECK EVALUATION																
Test Date	Equiv. Tissue	SAR 1g (W/kg)			Dielectric Constant ϵ_r			Conductivity σ (mho/m)			ρ (Kg/m ³)	Amb. Temp. (°C)	Fluid Temp. (°C)	Fluid Depth (cm)	Humid. (%)	Barom. Press. (kPa)
		Sys. Val Target	Meas.	Dev.	Sys. Val Target	Meas.	Dev.	Sys. Val Target	Meas.	Dev.						
Aug 20	Brain 450	1.18 \pm 10%	1.29	+9.3%	43.4 \pm 5%	44.3	+2.1%	0.89 \pm 5%	0.89	0.0%	1000	22.5	21.8	\geq 15	101.1	34
Note(s)		1. The target SAR value is referenced from the System Validation procedure performed by Celltech Labs Inc. (see Appendix E). 2. The target dielectric parameters are referenced from the System Validation procedure performed by Celltech Labs Inc. (see Appendix E). 3. The fluid temperature was measured prior to and after the system performance check to ensure the temperature remained within $\pm 2^\circ\text{C}$ of the fluid temperature reported during the dielectric parameter measurements. 4. The SAR evaluations were performed within 24 hours of the system performance check.														



	<u>Date(s) of Evaluation</u> August 20, 2008	<u>Test Report Serial No.</u> 082008BBO-T923-S95U	<u>Test Report Revision No.</u> Rev. 1.0 (Initial Release)	
	<u>Test Report Issue Date</u> September 04, 2008	<u>Description of Test(s)</u> Specific Absorption Rate	<u>RF Exposure Category</u> General Population	

7.0 SIMULATED EQUIVALENT TISSUES



The 450 MHz simulated tissue mixtures consist of a viscous gel using hydroxethylcellulose (HEC) gelling agent and saline solution. Preservation with a bactericide is added and visual inspection is made to ensure air bubbles are not trapped during the mixing process. The fluid was prepared according to standardized procedures, and measured for dielectric parameters (permittivity and conductivity).

SIMULATED TISSUE MIXTURES		
INGREDIENT	450 MHz Brain	450 MHz Body
	System Check & DUT Evaluation	DUT Evaluation
Water	38.56 %	52.00 %
Sugar	56.32 %	45.65 %
Salt	3.95 %	1.75 %
HEC	0.98 %	0.50 %
Bactericide	0.19 %	0.10 %

8.0 SAR LIMITS

SAR RF EXPOSURE LIMITS			
FCC 47 CFR 2.1093	Health Canada Safety Code 6	(General Population / Uncontrolled Exposure)	(Occupational / Controlled Exposure)
Spatial Average (averaged over the whole body)		0.08 W/kg	0.4 W/kg
Spatial Peak (averaged over any 1 g of tissue)		1.6 W/kg	8.0 W/kg
Spatial Peak (hands/wrists/feet/ankles averaged over 10 g)		4.0 W/kg	20.0 W/kg
The Spatial Average value of the SAR averaged over the whole body.			
The Spatial Peak value of the SAR averaged over any 1 gram of tissue (defined as a tissue volume in the shape of a cube) and over the appropriate averaging time.			
The Spatial Peak value of the SAR averaged over any 10 grams of tissue (defined as a tissue volume in the shape of a cube) and over the appropriate averaging time.			
Uncontrolled environments are defined as locations where there is potential exposure of individuals who have no knowledge or control of their potential exposure.			
Controlled environments are defined as locations where there is potential exposure of individuals who have knowledge of their potential exposure and can exercise control over their exposure.			



Applicant:	Cobra Electronics Corporation	FCC ID:	BBOCX800	IC:	906B-CXR800	
Model(s):	CXR800/CXR820/CXR825/CXR850/CXR855/CXR856	Portable GMRS/FRS PTT Radio Transceiver				
2008 Celltech Labs Inc.	This document is not to be reproduced in whole or in part without the prior written permission of Celltech Labs Inc.					Page 8 of 33

	<u>Date(s) of Evaluation</u> August 20, 2008	<u>Test Report Serial No.</u> 082008BBO-T923-S95U	<u>Test Report Revision No.</u> Rev. 1.0 (Initial Release)	 Test Lab Certificate No. 2470.01
	<u>Test Report Issue Date</u> September 04, 2008	<u>Description of Test(s)</u> Specific Absorption Rate	<u>RF Exposure Category</u> General Population	

9.0 ROBOT SYSTEM SPECIFICATIONS

<u>Specifications</u>	
Positioner	Stäubli Unimation Corp. Robot Model: RX60L
Repeatability	0.02 mm
No. of axis	6
<u>Data Acquisition Electronic (DAE) System</u>	
<u>Cell Controller</u>	
Processor	AMD Athlon XP 2400+
Clock Speed	2.0 GHz
Operating System	Windows XP Professional
<u>Data Converter</u>	
Features	Signal Amplifier, multiplexer, A/D converter, and control logic
Software	Measurement Software: DASYS4, V4.7 Build 44
	Postprocessing Software: SEMCAD, V1.8 Build 171
Connecting Lines	Optical downlink for data and status info., Optical uplink for commands and clock
<u>DASY4 Measurement Server</u>	
Function	Real-time data evaluation for field measurements and surface detection
Hardware	PC/104 166MHz Pentium CPU; 32 MB chipdisk; 64 MB RAM
Connections	COM1, COM2, DAE, Robot, Ethernet, Service Interface
<u>E-Field Probe</u>	
Model	ET3DV6
Serial No.	1590
Construction	Triangular core fiber optic detection system
Frequency	10 MHz to 6 GHz
Linearity	±0.2 dB (30 MHz to 3 GHz)
<u>Evaluation Phantom</u>	
Type	Side Planar Phantom
Shell Material	Plexiglas
Bottom Thickness	2.0 mm ± 0.1 mm
Outer Dimensions	75.0 cm (L) x 22.5 cm (W) x 20.5 cm (H); Back Plane: 25.7 cm (H)
<u>Validation Phantom (≤ 450MHz)</u>	
Type	Planar Phantom
Shell Material	Plexiglas
Bottom Thickness	6.2 mm ± 0.1 mm
Outer Dimensions	86.0 cm (L) x 39.5 cm (W) x 21.8 cm (H)

Applicant:	Cobra Electronics Corporation	FCC ID:	BBOCX800	IC:	906B-CXR800	
Model(s):	CXR800/CXR820/CXR825/CXR850/CXR855/CXR856	Portable GMRS/FRS PTT Radio Transceiver				
2008 Celltech Labs Inc.		This document is not to be reproduced in whole or in part without the prior written permission of Celltech Labs Inc.				Page 9 of 33

	<u>Date(s) of Evaluation</u> August 20, 2008	<u>Test Report Serial No.</u> 082008BBO-T923-S95U	<u>Test Report Revision No.</u> Rev. 1.0 (Initial Release)	
	<u>Test Report Issue Date</u> September 04, 2008	<u>Description of Test(s)</u> Specific Absorption Rate	<u>RF Exposure Category</u> General Population	

10.0 PROBE SPECIFICATION (ET3DV6)

<p>Construction: Symmetrical design with triangular core Built-in shielding against static charges PEEK enclosure material (resistant to organic solvents, glycol)</p> <p>Calibration: In air from 10 MHz to 2.5 GHz In brain simulating tissue at frequencies of 900 MHz and 1.8 GHz (accuracy $\pm 8\%$)</p> <p>Frequency: 10 MHz to > 6 GHz; Linearity: ± 0.2 dB (30 MHz to 3 GHz)</p> <p>Directivity: ± 0.2 dB in brain tissue (rotation around probe axis) ± 0.4 dB in brain tissue (rotation normal to probe axis)</p> <p>Dynamic Range: 5 μW/g to > 100 mW/g; Linearity: ± 0.2 dB</p> <p>Surface Detect: ± 0.2 mm repeatability in air and clear liquids over diffuse reflecting surfaces</p> <p>Dimensions: Overall length: 330 mm Tip length: 16 mm Body diameter: 12 mm Tip diameter: 6.8 mm Distance from probe tip to dipole centers: 2.7 mm</p> <p>Application: General dosimetry up to 3 GHz Compliance tests of mobile phone</p>	
	ET3DV6 E-Field Probe

11.0 SIDE PLANAR PHANTOM

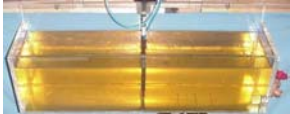
<p>The side planar phantom is constructed of Plexiglas material with a 2.0 mm shell thickness for face-held and body-worn SAR evaluations of portable radio transceivers. The side planar phantom is mounted on the side of the DASY4 compact system table.</p>	
	Plexiglas Side Planar Phantom



12.0 VALIDATION PLANAR PHANTOM

<p>The validation planar phantom is constructed of Plexiglas material with a 6.0 mm shell thickness for system validations at 450MHz and below. The validation planar phantom is mounted to the table of the DASY4 compact system.</p>	
	Plexiglas Validation Planar Phantom

13.0 DEVICE HOLDER

<p>The DASY4 device holder has two scales for device rotation (with respect to the body axis) and the device inclination (with respect to the line between the ear openings). The plane between the ear openings and the mouth tip has a rotation angle of 65°. The bottom plate contains three pair of bolts for locking the device holder. The device holder positions are adjusted to the standard measurement positions in the three sections.</p>	
	Device Holder



Applicant:	Cobra Electronics Corporation	FCC ID:	BBOCX800	IC:	906B-CXR800	
Model(s):	CXR800/CXR820/CXR825/CXR850/CXR855/CXR856	Portable GMRS/FRS PTT Radio Transceiver				
2008 Celltech Labs Inc.	This document is not to be reproduced in whole or in part without the prior written permission of Celltech Labs Inc.					Page 10 of 33

	<u>Date(s) of Evaluation</u> August 20, 2008	<u>Test Report Serial No.</u> 082008BBO-T923-S95U	<u>Test Report Revision No.</u> Rev. 1.0 (Initial Release)	
	<u>Test Report Issue Date</u> September 04, 2008	<u>Description of Test(s)</u> Specific Absorption Rate	<u>RF Exposure Category</u> General Population	

14.0 TEST EQUIPMENT LIST

TEST EQUIPMENT		ASSET NO.	SERIAL NO.	DATE CALIBRATED	CALIBRATION DUE DATE
USED	DESCRIPTION				
x	Schmid & Partner DASY4 System	-	-	-	-
x	-DASY4 Measurement Server	00158	1078	NA	NA
x	-Robot	00046	599396-01	NA	NA
x	-DAE4	00019	353	22Apr08	22Apr09
x	-ET3DV6 E-Field Probe	00017	1590	21Jul08	21Jul09
x	-450 MHz Validation Dipole	00024	136	25Jul08	25Jul09
	-SAM Phantom V4.0C	00154	1033	NA	NA
	-Barski Planar Phantom	00155	03-01	NA	NA
x	-Plexiglas Side Planar Phantom	00156	161	NA	NA
x	-Plexiglas Validation Planar Phantom	00157	137	NA	NA
	ALS-PR-DIEL Dielectric Probe Kit	00160	260-00953	NA	NA
x	HP 85070C Dielectric Probe Kit	00033	US39240170	NA	NA
x	Gigatronics 8652A Power Meter	00007	1835272	23Apr08	23Apr09
x	Gigatronics 80701A Power Sensor	00014	1833699	23Apr08	23Apr09
x	HP 8753ET Network Analyzer	00134	US39170292	28Apr08	28Apr09
x	HP 8648D Signal Generator	00005	3847A00611	NR	NR
	Rohde & Schwarz SMR20 Signal Generator	00006	100104	NR	NR
x	Amplifier Research 5S1G4 Power Amplifier	00106	26235	NR	NR
	Amplifier Research 10W1000C Power Amplifier	00041	27887	NR	NR
	Nextec NB00383 Microwave Amplifier	00151	0535	NR	NR
Abbr.	NA = Not Applicable		NR = Not Required		

Applicant:	Cobra Electronics Corporation	FCC ID:	BBOCX800	IC:	906B-CXR800	
Model(s):	CXR800/CXR820/CXR825/CXR850/CXR855/CXR856	Portable GMRS/FRS PTT Radio Transceiver				
2008 Celltech Labs Inc.	This document is not to be reproduced in whole or in part without the prior written permission of Celltech Labs Inc.					Page 11 of 33



	<u>Date(s) of Evaluation</u> August 20, 2008	<u>Test Report Serial No.</u> 082008BBO-T923-S95U	<u>Test Report Revision No.</u> Rev. 1.0 (Initial Release)	
	<u>Test Report Issue Date</u> September 04, 2008	<u>Description of Test(s)</u> Specific Absorption Rate	<u>RF Exposure Category</u> General Population	

Test Lab Certificate No. 2470.01

15.0 MEASUREMENT UNCERTAINTIES

UNCERTAINTY BUDGET FOR DEVICE EVALUATION						
Error Description	Uncertainty Value ±%	Probability Distribution	Divisor	ci 1g	Uncertainty Value ±% (1g)	V _i or V _{eff}
Measurement System						
Probe calibration (450 MHz)	6.65	Normal	1	1	6.65	∞
Axial isotropy of the probe	4.7	Rectangular	1.732050808	0.7	1.9	∞
Spherical isotropy of the probe	9.6	Rectangular	1.732050808	0.7	3.9	∞
Spatial resolution	0	Rectangular	1.732050808	1	0.0	∞
Boundary effects	0.8	Rectangular	1.732050808	1	0.5	∞
Probe linearity	4.7	Rectangular	1.732050808	1	2.7	∞
Detection limit	1	Rectangular	1.732050808	1	0.6	∞
Readout electronics	0.3	Normal	1	1	0.3	∞
Response time	0.8	Rectangular	1.732050808	1	0.5	∞
Integration time	2.6	Rectangular	1.732050808	1	1.5	∞
RF ambient conditions	3	Rectangular	1.732050808	1	1.7	∞
Mech. constraints of robot	0.4	Rectangular	1.732050808	1	0.2	∞
Probe positioning	2.9	Rectangular	1.732050808	1	1.7	∞
Extrapolation & integration	1	Rectangular	1.732050808	1	0.6	∞
Test Sample Related						
Device positioning	2.9	Normal	1	1	2.9	12
Device holder uncertainty	3.6	Normal	1	1	3.6	8
Power drift	5	Rectangular	1.732050808	1	2.9	∞
Phantom and Setup						
Phantom uncertainty	4	Rectangular	1.732050808	1	2.3	∞
Liquid conductivity (target)	5	Rectangular	1.732050808	0.64	1.8	∞
Liquid conductivity (measured)	2.3	Normal	1	0.64	1.5	∞
Liquid permittivity (target)	5	Rectangular	1.732050808	0.6	1.7	∞
Liquid permittivity (measured)	1.8	Normal	1	0.6	1.1	∞
Combined Standard Uncertainty					11.15	
Expanded Uncertainty (k=2)					22.30	
Measurement Uncertainty Table in accordance with IEEE 1528-2003 and IEC 62209-1:2005						



Applicant:	Cobra Electronics Corporation	FCC ID:	BBOCX800	IC:	906B-CXR800	
Model(s):	CXR800/CXR820/CXR825/CXR850/CXR855/CXR856	Portable GMRS/FRS PTT Radio Transceiver				
2008 Celltech Labs Inc.	This document is not to be reproduced in whole or in part without the prior written permission of Celltech Labs Inc.					Page 12 of 33

	<u>Date(s) of Evaluation</u> August 20, 2008	<u>Test Report Serial No.</u> 082008BBO-T923-S95U	<u>Test Report Revision No.</u> Rev. 1.0 (Initial Release)	
	<u>Test Report Issue Date</u> September 04, 2008	<u>Description of Test(s)</u> Specific Absorption Rate	<u>RF Exposure Category</u> General Population	

MEASUREMENT UNCERTAINTIES (CONT.)

UNCERTAINTY BUDGET FOR SYSTEM VALIDATION						
Error Description	Uncertainty Value ±%	Probability Distribution	Divisor	ci 1g	Uncertainty Value ±% (1g)	V _i or V _{eff}
Measurement System						
Probe calibration (450 MHz)	6.65	Normal	1	1	6.65	∞
Axial isotropy of the probe	4.7	Rectangular	1.732050808	1	2.7	∞
Spherical isotropy of the probe	0	Rectangular	1.732050808	1	0.0	∞
Spatial resolution	0	Rectangular	1.732050808	1	0.0	∞
Boundary effects	0.8	Rectangular	1.732050808	1	0.5	∞
Probe linearity	4.7	Rectangular	1.732050808	1	2.7	∞
Detection limit	1	Rectangular	1.732050808	1	0.6	∞
Readout electronics	0.3	Normal	1	1	0.3	∞
Response time	0	Rectangular	1.732050808	1	0.0	∞
Integration time	0	Rectangular	1.732050808	1	0.0	∞
RF ambient conditions	3	Rectangular	1.732050808	1	1.7	∞
Mech. constraints of robot	0.4	Rectangular	1.732050808	1	0.2	∞
Probe positioning	2.9	Rectangular	1.732050808	1	1.7	∞
Extrapolation & integration	1	Rectangular	1.732050808	1	0.6	∞
Dipole						
Dipole Positioning	2	Normal	1.732050808	1	1.2	∞
Power & Power Drift	4.7	Normal	1.732050808	1	2.7	∞
Phantom and Setup						
Phantom uncertainty	4	Rectangular	1.732050808	1	2.3	∞
Liquid conductivity (target)	5	Rectangular	1.732050808	0.64	1.8	∞
Liquid conductivity (measured)	0	Normal	1	0.64	0.0	∞
Liquid permittivity (target)	5	Rectangular	1.732050808	0.6	1.7	∞
Liquid permittivity (measured)	2.1	Normal	1	0.6	1.3	∞
Combined Standard Uncertainty					9.37	
Expanded Uncertainty (k=2)					18.74	
Measurement Uncertainty Table in accordance with IEEE 1528-2003 and IEC 62209-1:2005						



Applicant:	Cobra Electronics Corporation	FCC ID:	BBOCX800	IC:	906B-CXR800	
Model(s):	CXR800/CXR820/CXR825/CXR850/CXR855/CXR856	Portable GMRS/FRS PTT Radio Transceiver				
2008 Celltech Labs Inc.	This document is not to be reproduced in whole or in part without the prior written permission of Celltech Labs Inc.					Page 13 of 33

	<u>Date(s) of Evaluation</u> August 20, 2008	<u>Test Report Serial No.</u> 082008BBO-T923-S95U	<u>Test Report Revision No.</u> Rev. 1.0 (Initial Release)	 Test Lab Certificate No. 2470.01
	<u>Test Report Issue Date</u> September 04, 2008	<u>Description of Test(s)</u> Specific Absorption Rate	<u>RF Exposure Category</u> General Population	

16.0 REFERENCES



- [1] Federal Communications Commission - "Radiofrequency radiation exposure evaluation: portable devices", Rule Part 47 CFR §2.1093.
- [2] Health Canada - "Limits of Human Exposure to Radiofrequency Electromagnetic Fields in the Frequency Range from 3 kHz to 300 GHz", Safety Code 6: 1999.
- [3] Federal Communications Commission - "Evaluating Compliance with FCC Guidelines for Human Exposure to Radio frequency Electromagnetic Fields", OET Bulletin 65, Supplement C (Edition 01-01), FCC, Washington, D.C.: June 2001.
- [4] Industry Canada - "Radio Frequency Exposure Compliance of Radiocommunication Apparatus (All Frequency Bands)", Radio Standards Specification RSS-102 Issue 2: November 2005.
- [5] IEEE Standard 1528-2003 - "Recommended Practice for Determining the Peak Spatial-Average Specific Absorption Rate (SAR) in the Human Head from Wireless Communications Devices: Measurement Techniques": December 2003.
- [6] IEC International Standard 62209-1:2005 - "Human exposure to radio frequency fields from hand-held and body-mounted wireless communication devices - Human models, instrumentation, and procedures."

Applicant:	Cobra Electronics Corporation	FCC ID:	BBOCXR800	IC:	906B-CXR800	
Model(s):	CXR800/CXR820/CXR825/CXR850/CXR855/CXR856	Portable GMRS/FRS PTT Radio Transceiver				
2008 Celltech Labs Inc.	This document is not to be reproduced in whole or in part without the prior written permission of Celltech Labs Inc.					Page 14 of 33

	<u>Date(s) of Evaluation</u> August 20, 2008	<u>Test Report Serial No.</u> 082008BBO-T923-S95U	<u>Test Report Revision No.</u> Rev. 1.0 (Initial Release)	 Test Lab Certificate No. 2470.01
	<u>Test Report Issue Date</u> September 04, 2008	<u>Description of Test(s)</u> Specific Absorption Rate	<u>RF Exposure Category</u> General Population	

APPENDIX A - SAR MEASUREMENT DATA

Applicant:	Cobra Electronics Corporation	FCC ID:	BBOCXR800	IC:	906B-CXR800	
Model(s):	CXR800/CXR820/CXR825/CXR850/CXR855/CXR856	Portable GMRS/FRS PTT Radio Transceiver				
2008 Celltech Labs Inc.	This document is not to be reproduced in whole or in part without the prior written permission of Celltech Labs Inc.					Page 15 of 33

	<u>Date(s) of Evaluation</u> August 20, 2008	<u>Test Report Serial No.</u> 082008BBO-T923-S95U	<u>Test Report Revision No.</u> Rev. 1.0 (Initial Release)	 Test Lab Certificate No. 2470.01
	<u>Test Report Issue Date</u> September 04, 2008	<u>Description of Test(s)</u> Specific Absorption Rate	<u>RF Exposure Category</u> General Population	

Date Tested: 08/20/2008

Face-held SAR - GMRS - Channel 22 - 462.7250 MHz

DUT: Cobra; Model: CXR800; Type: Portable GMRS/FRS PTT Radio Transceiver; Serial: #1 (Pre-production)

Ambient Temp: 22.5°C; Fluid Temp: 21.8°C; Barometric Pressure: 101.1 kPa; Humidity: 34%

RF Output Power: 1.78 W (ERP)
 7.4V, 950mAh Li-ion Battery Pack
 Communication System: FM UHF (CW)
 Frequency: 462.725 MHz; Duty Cycle: 1:1
 Medium: HSL450 Medium parameters used: $f = 462.725 \text{ MHz}$; $\sigma = 0.89 \text{ mho/m}$; $\epsilon_r = 44.3$; $\rho = 1000 \text{ kg/m}^3$

- Probe: ET3DV6 - SN1590; ConvF(7.66, 7.66, 7.66); Calibrated: 21/07/2008
- Sensor-Surface: 4mm (Mechanical Surface Detection)
- Electronics: DAE4 Sn353; Calibrated: 22/04/2008
- Phantom: Side Planar; Type: Plexiglas; Serial: 161
- Measurement SW: DASy4, V4.7 Build 44; Postprocessing SW: SEMCAD, V1.8 Build 171

Face-held SAR - 2.5 cm Spacing from Front Side of DUT to Planar Phantom

Area Scan (7x14x1): Measurement grid: $dx=15\text{mm}$, $dy=15\text{mm}$
 Maximum value of SAR (measured) = 3.00 mW/g

Face-held SAR - 2.5 cm Spacing from Front Side of DUT to Planar Phantom

Zoom Scan (5x5x7)/Cube 0: Measurement grid: $dx=7.5\text{mm}$, $dy=7.5\text{mm}$, $dz=5\text{mm}$
 Reference Value = 55.1 V/m; Power Drift = -0.297 dB
 Peak SAR (extrapolated) = 4.19 W/kg
SAR(1 g) = 2.78 mW/g; SAR(10 g) = 1.99 mW/g
 Maximum value of SAR (measured) = 2.90 mW/g

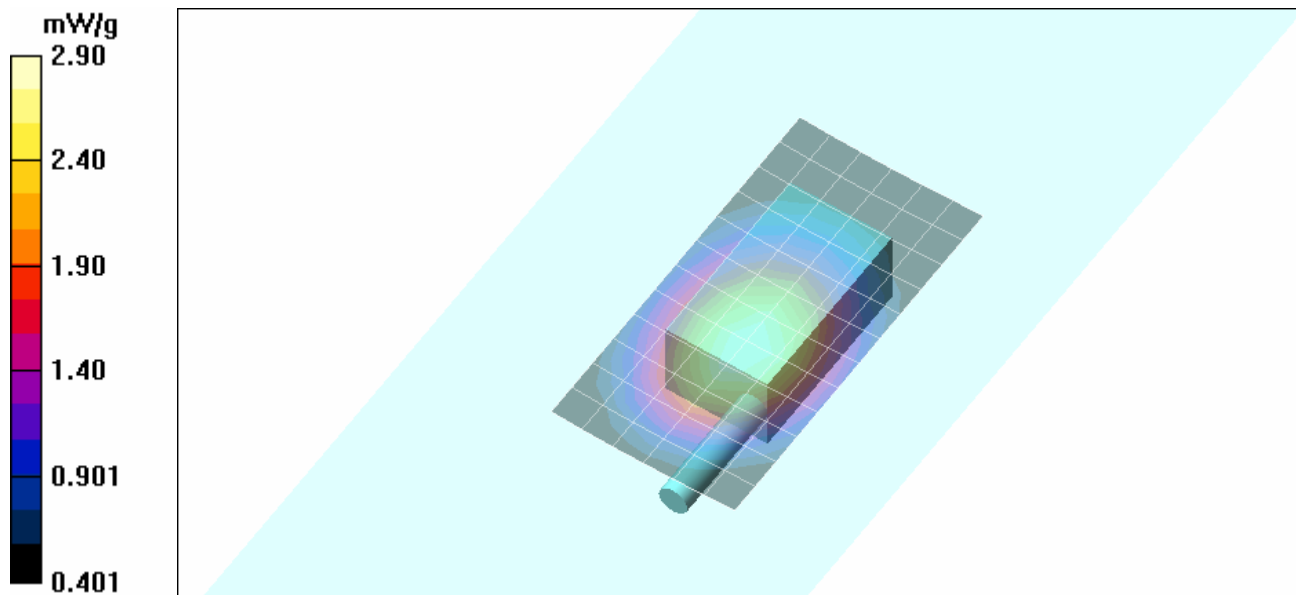

Applicant:	Cobra Electronics Corporation	FCC ID:	BBOCXR800	IC:	906B-CXR800	
Model(s):	CXR800/CXR820/CXR825/CXR850/CXR855/CXR856	Portable GMRS/FRS PTT Radio Transceiver				
2008 Celltech Labs Inc.	This document is not to be reproduced in whole or in part without the prior written permission of Celltech Labs Inc.					Page 16 of 33

Z-Axis Scan

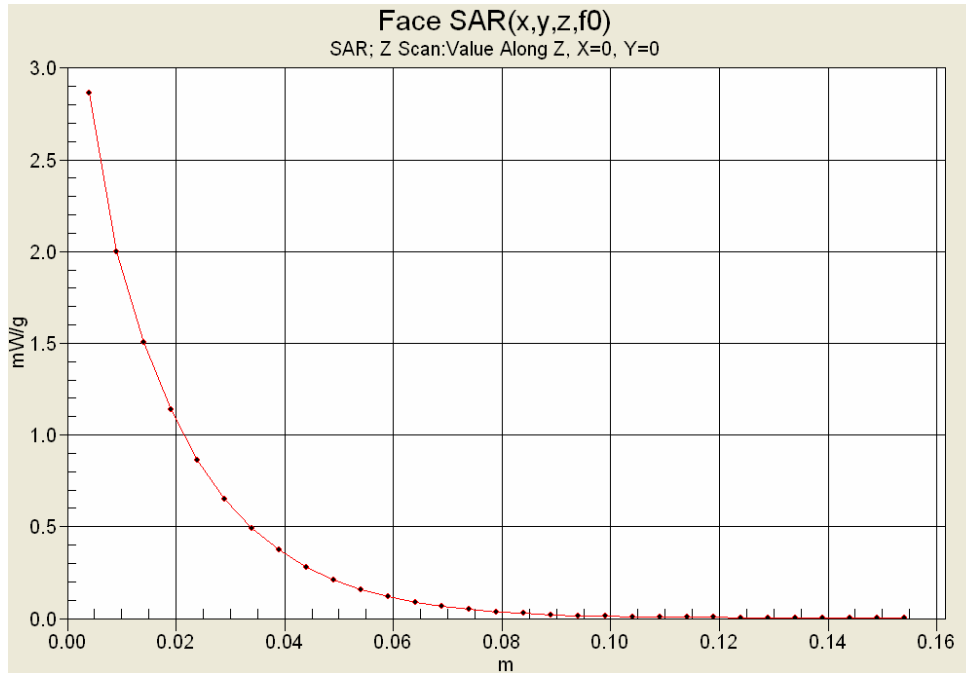

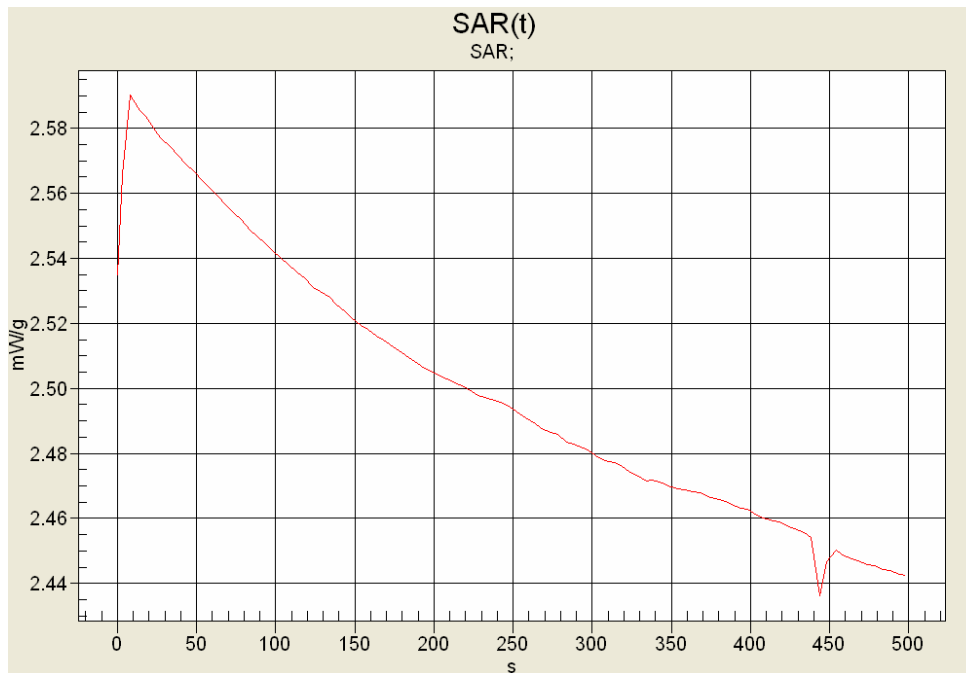

SAR-versus-Time Power Droop Evaluation

Face-held Configuration
Channel 22 (462.725 MHz)



Start SAR: 2.53 mW/g
 End SAR: 2.44 mW/g (-0.157 dB)
 SAR after 340s: 2.47 mW/g (-0.104 dB)
 340s = Zoom Scan Duration
 500s = Area Scan Duration

	<u>Date(s) of Evaluation</u> August 20, 2008	<u>Test Report Serial No.</u> 082008BBO-T923-S95U	<u>Test Report Revision No.</u> Rev. 1.0 (Initial Release)	
	<u>Test Report Issue Date</u> September 04, 2008	<u>Description of Test(s)</u> Specific Absorption Rate	<u>RF Exposure Category</u> General Population	

Date Tested: 08/20/2008

Body-worn SAR - GMRS - Channel 22 - 462.7250 MHz

DUT: Cobra; Model: CXR800; Type: Portable GMRS/FRS PTT Radio Transceiver; Serial: #1 (Pre-production)

Body-worn Accessory: Plastic Belt-Clip; Audio Accessory: Earbud/Lapel-Microphone (P/N: GA-EMB2)

Ambient Temp: 22.8°C; Fluid Temp: 22°C; Barometric Pressure: 101.1 kPa; Humidity: 35%

RF Output Power: 1.78 W (ERP)
 7.4V, 950mAh Li-ion Battery Pack
 Communication System: FM UHF (CW)
 Frequency: 462.725 MHz; Duty Cycle: 1:1
 Medium: M450 Medium parameters used: $f = 462.725 \text{ MHz}$; $\sigma = 0.93 \text{ mho/m}$; $\epsilon_r = 56.2$; $\rho = 1000 \text{ kg/m}^3$

- Probe: ET3DV6 - SN1590; ConvF(8.27, 8.27, 8.27); Calibrated: 21/07/2008
- Sensor-Surface: 4mm (Mechanical Surface Detection)
- Electronics: DAE4 Sn353; Calibrated: 22/04/2008
- Phantom: Side Planar; Type: Plexiglas; Serial: 161
- Measurement SW: DASY4, V4.7 Build 44; Postprocessing SW: SEMCAD, V1.8 Build 171

Body-worn SAR - 0.5 cm Belt-Clip Spacing from Back Side of DUT to Planar Phantom

Area Scan (7x14x1): Measurement grid: dx=15mm, dy=15mm

Maximum value of SAR (measured) = 2.32 mW/g

Body-worn SAR - 0.5 cm Belt-Clip Spacing from Back Side of DUT to Planar Phantom

Zoom Scan (5x5x7)/Cube 0: Measurement grid: dx=7.5mm, dy=7.5mm, dz=5mm

Reference Value = 47.2 V/m; Power Drift = 0.011 dB



Peak SAR (extrapolated) = 3.40 W/kg

SAR(1 g) = 2.3 mW/g; SAR(10 g) = 1.6 mW/g

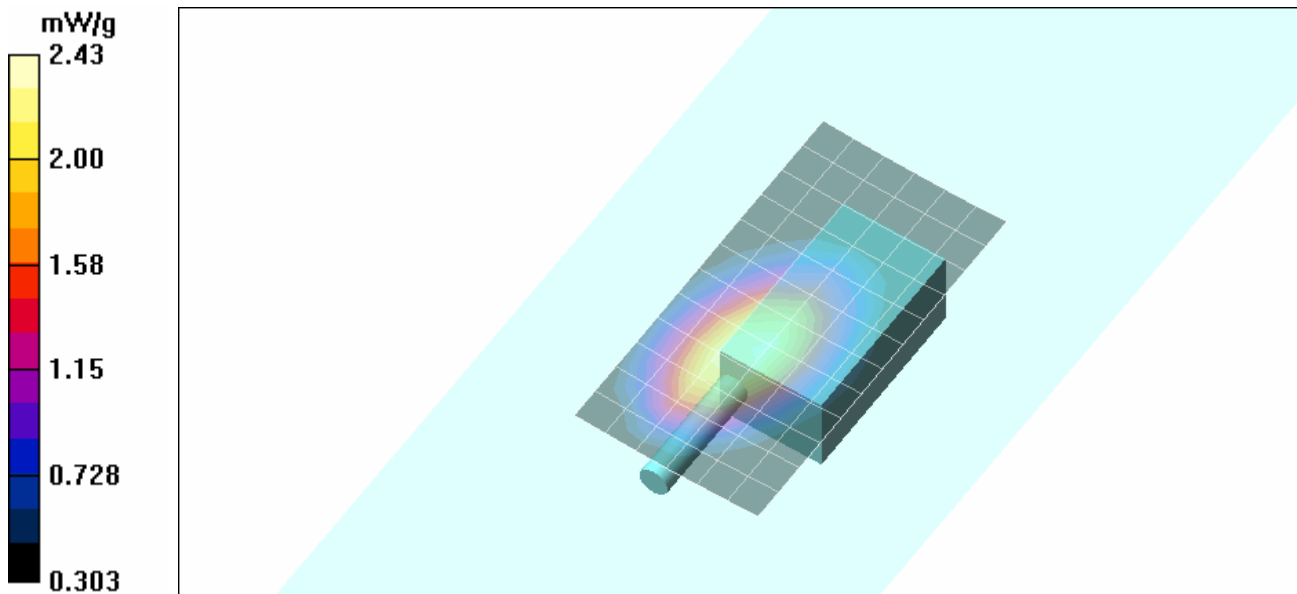
Maximum value of SAR (measured) = 2.43 mW/g





Applicant:	Cobra Electronics Corporation	FCC ID:	BBOCXR800	IC:	906B-CXR800	
Model(s):	CXR800/CXR820/CXR825/CXR850/CXR855/CXR856	Portable GMRS/FRS PTT Radio Transceiver				
2008 Celltech Labs Inc.	This document is not to be reproduced in whole or in part without the prior written permission of Celltech Labs Inc.					Page 18 of 33

	<u>Date(s) of Evaluation</u> August 20, 2008	<u>Test Report Serial No.</u> 082008BBO-T923-S95U	<u>Test Report Revision No.</u> Rev. 1.0 (Initial Release)	 Test Lab Certificate No. 2470.01
	<u>Test Report Issue Date</u> September 04, 2008	<u>Description of Test(s)</u> Specific Absorption Rate	<u>RF Exposure Category</u> General Population	

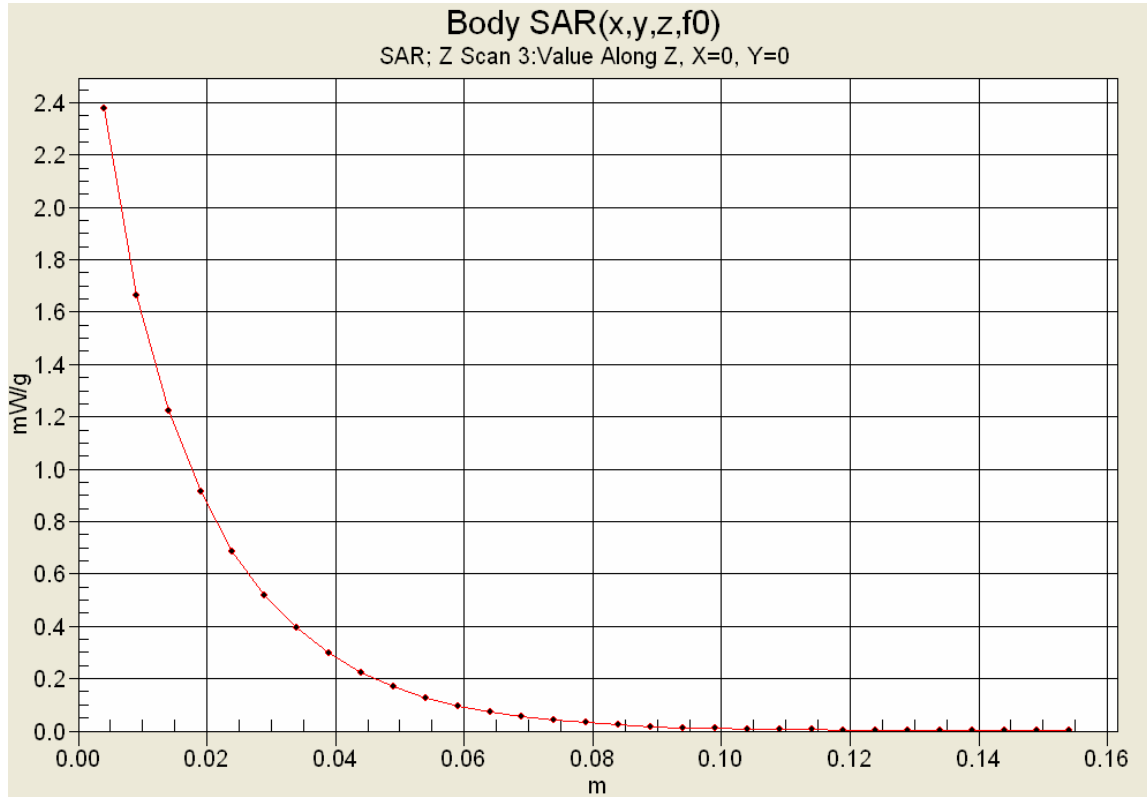
Z-Axis Scan





Applicant:	Cobra Electronics Corporation	FCC ID:	BBOCXR800	IC:	906B-CXR800	
Model(s):	CXR800/CXR820/CXR825/CXR850/CXR855/CXR856	Portable GMRS/FRS PTT Radio Transceiver				
2008 Celltech Labs Inc.	This document is not to be reproduced in whole or in part without the prior written permission of Celltech Labs Inc.					Page 19 of 33

	<u>Date(s) of Evaluation</u> August 20, 2008	<u>Test Report Serial No.</u> 082008BBO-T923-S95U	<u>Test Report Revision No.</u> Rev. 1.0 (Initial Release)	 Test Lab Certificate No. 2470.01
	<u>Test Report Issue Date</u> September 04, 2008	<u>Description of Test(s)</u> Specific Absorption Rate	<u>RF Exposure Category</u> General Population	

APPENDIX B - SYSTEM PERFORMANCE CHECK DATA

Applicant:	Cobra Electronics Corporation	FCC ID:	BBOCXR800	IC:	906B-CXR800	
Model(s):	CXR800/CXR820/CXR825/CXR850/CXR855/CXR856	Portable GMRS/FRS PTT Radio Transceiver				
2008 Celltech Labs Inc.	This document is not to be reproduced in whole or in part without the prior written permission of Celltech Labs Inc.					Page 20 of 33

	<u>Date(s) of Evaluation</u> August 20, 2008	<u>Test Report Serial No.</u> 082008BBO-T923-S95U	<u>Test Report Revision No.</u> Rev. 1.0 (Initial Release)	
	<u>Test Report Issue Date</u> September 04, 2008	<u>Description of Test(s)</u> Specific Absorption Rate	<u>RF Exposure Category</u> General Population	

Date Tested: 08/20/2008

System Performance Check - 450 MHz Dipole - HSL

DUT: Dipole 450 MHz; Asset: 00024; Serial: 136; Validation: 07/25/2008

Ambient Temp: 22.5°C; Fluid Temp: 21.8°C; Barometric Pressure: 101.1 kPa; Humidity: 34%

Communication System: CW

Forward Conducted Power: 250 mW

Frequency: 450 MHz; Duty Cycle: 1:1

Medium: HSL450 Medium parameters used: $f = 450 \text{ MHz}$; $\sigma = 0.89 \text{ mho/m}$; $\epsilon_r = 44.3$; $\rho = 1000 \text{ kg/m}^3$

- Probe: ET3DV6 - SN1590; ConvF(7.66, 7.66, 7.66); Calibrated: 21/07/2008

- Sensor-Surface: 4mm (Mechanical Surface Detection)

- Electronics: DAE4 Sn353; Calibrated: 22/04/2008

- Phantom: Validation Planar; Type: Plexiglas; Serial: TE#137

- Measurement SW: DASY4, V4.7 Build 44; Postprocessing SW: SEMCAD, V1.8 Build 171

System Performance Check - 450 MHz Dipole

Area Scan (6x11x1): Measurement grid: $dx=15\text{mm}$, $dy=15\text{mm}$

Maximum value of SAR (measured) = 1.31 mW/g

System Performance Check - 450 MHz Dipole

Zoom Scan (5x5x7)/Cube 0: Measurement grid: $dx=7.5\text{mm}$, $dy=7.5\text{mm}$, $dz=5\text{mm}$

Reference Value = 40.0 V/m; Power Drift = -0.009 dB



Peak SAR (extrapolated) = 2.07 W/kg

SAR(1 g) = 1.29 mW/g; SAR(10 g) = 0.848 mW/g

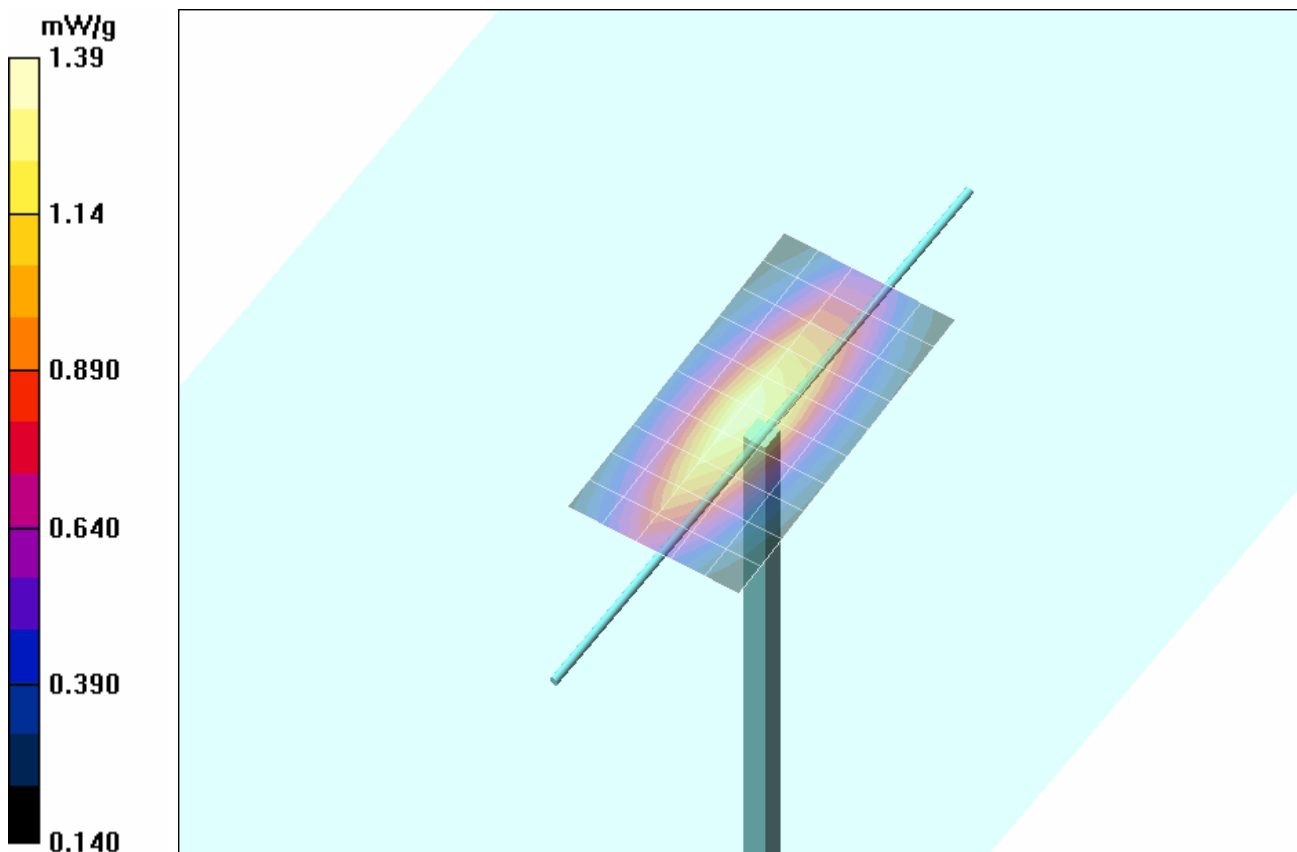
Maximum value of SAR (measured) = 1.39 mW/g





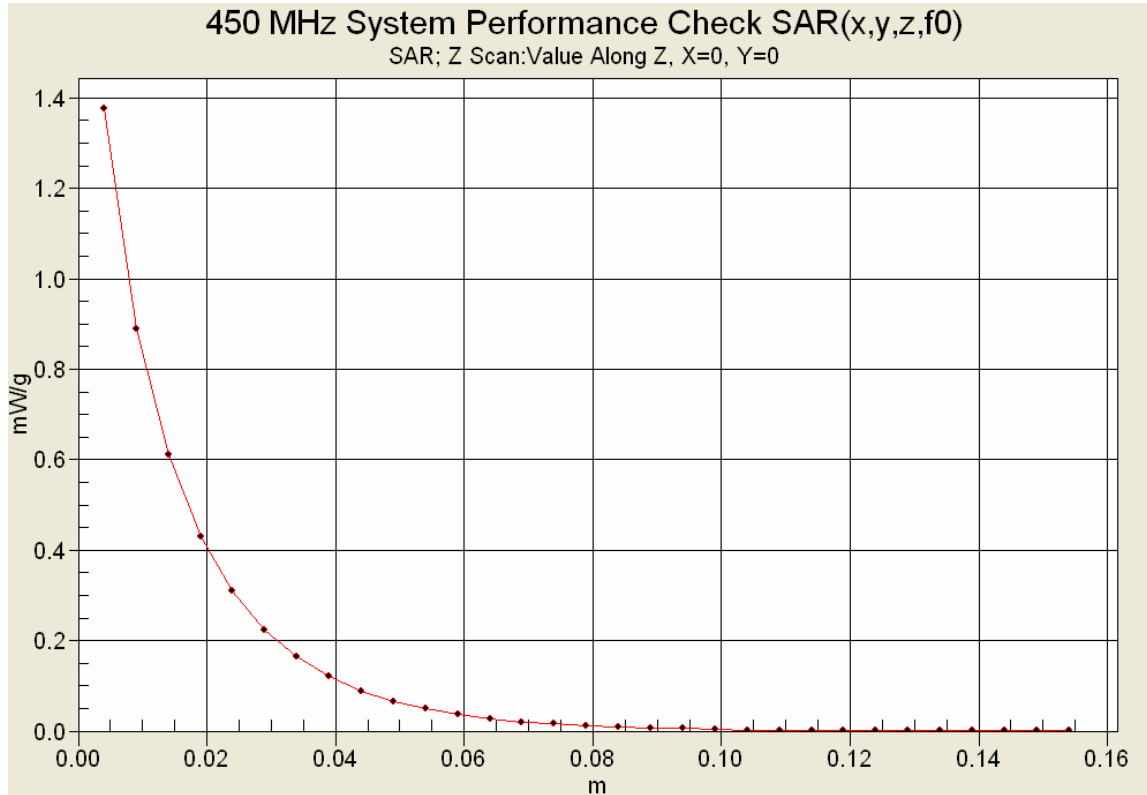

Applicant:	Cobra Electronics Corporation	FCC ID:	BBOCX800	IC:	906B-CXR800	
Model(s):	CXR800/CXR820/CXR825/CXR850/CXR855/CXR856	Portable GMRS/FRS PTT Radio Transceiver				
2008 Celltech Labs Inc.		This document is not to be reproduced in whole or in part without the prior written permission of Celltech Labs Inc.				Page 21 of 33

	<u>Date(s) of Evaluation</u> August 20, 2008	<u>Test Report Serial No.</u> 082008BBO-T923-S95U	<u>Test Report Revision No.</u> Rev. 1.0 (Initial Release)	 Test Lab Certificate No. 2470.01
	<u>Test Report Issue Date</u> September 04, 2008	<u>Description of Test(s)</u> Specific Absorption Rate	<u>RF Exposure Category</u> General Population	

Z-Axis Scan





Applicant:	Cobra Electronics Corporation	FCC ID:	BBOCXR800	IC:	906B-CXR800	
Model(s):	CXR800/CXR820/CXR825/CXR850/CXR855/CXR856	Portable GMRS/FRS PTT Radio Transceiver				
2008 Celltech Labs Inc.		This document is not to be reproduced in whole or in part without the prior written permission of Celltech Labs Inc.				Page 22 of 33

	<u>Date(s) of Evaluation</u> August 20, 2008	<u>Test Report Serial No.</u> 082008BBO-T923-S95U	<u>Test Report Revision No.</u> Rev. 1.0 (Initial Release)	  Test Lab Certificate No. 2470.01
	<u>Test Report Issue Date</u> September 04, 2008	<u>Description of Test(s)</u> Specific Absorption Rate	<u>RF Exposure Category</u> General Population	

APPENDIX C - MEASURED FLUID DIELECTRIC PARAMETERS

Applicant:	Cobra Electronics Corporation	FCC ID:	BBOCXR800	IC:	906B-CXR800	
Model(s):	CXR800/CXR820/CXR825/CXR850/CXR855/CXR856	Portable GMRS/FRS PTT Radio Transceiver				
2008 Celltech Labs Inc.	This document is not to be reproduced in whole or in part without the prior written permission of Celltech Labs Inc.					Page 23 of 33



	<u>Date(s) of Evaluation</u> August 20, 2008	<u>Test Report Serial No.</u> 082008BBO-T923-S95U	<u>Test Report Revision No.</u> Rev. 1.0 (Initial Release)	 Test Lab Certificate No. 2470.01
	<u>Test Report Issue Date</u> September 04, 2008	<u>Description of Test(s)</u> Specific Absorption Rate	<u>RF Exposure Category</u> General Population	

450 MHz System Performance Check & DUT Evaluation (Brain)

Celltech Labs Inc.
 Test Result for UIM Dielectric Parameter
 20/Aug/2008
 Frequency (GHz)
 IEEE_eH 1528-2003 Limits for Head Epsilon
 IEEE_sH 1528-2003 Limits for Head Sigma
 Test_e Epsilon of UIM
 Test_s Sigma of UIM

Freq	IEEE_eH	IEEE_sH	Test_e	Test_s
0.3500	44.70	0.87	47.36	0.79
0.3600	44.58	0.87	46.68	0.80
0.3700	44.46	0.87	45.61	0.82
0.3800	44.34	0.87	46.20	0.83
0.3900	44.22	0.87	45.77	0.82
0.4000	44.10	0.87	46.06	0.83
0.4100	43.98	0.87	45.27	0.83
0.4200	43.86	0.87	45.62	0.85
0.4300	43.74	0.87	45.23	0.85
0.4400	43.62	0.87	44.90	0.87
0.4500	43.50	0.87	44.26	0.89
0.4600	43.45	0.87	44.15	0.89
0.4700	43.40	0.87	44.37	0.90
0.4800	43.34	0.87	44.33	0.91
0.4900	43.29	0.87	43.70	0.92
0.5000	43.24	0.87	43.42	0.91
0.5100	43.19	0.87	43.18	0.93
0.5200	43.14	0.88	43.31	0.93
0.5300	43.08	0.88	42.95	0.94
0.5400	43.03	0.88	43.25	0.96
0.5500	42.98	0.88	43.09	0.97

Applicant:	Cobra Electronics Corporation	FCC ID:	BBOCX800	IC:	906B-CXR800	
Model(s):	CXR800/CXR820/CXR825/CXR850/CXR855/CXR856	Portable GMRS/FRS PTT Radio Transceiver				
2008 Celltech Labs Inc.	This document is not to be reproduced in whole or in part without the prior written permission of Celltech Labs Inc.					Page 24 of 33



	<u>Date(s) of Evaluation</u> August 20, 2008	<u>Test Report Serial No.</u> 082008BBO-T923-S95U	<u>Test Report Revision No.</u> Rev. 1.0 (Initial Release)	 Test Lab Certificate No. 2470.01
	<u>Test Report Issue Date</u> September 04, 2008	<u>Description of Test(s)</u> Specific Absorption Rate	<u>RF Exposure Category</u> General Population	

450 MHz DUT Evaluation (Body)

Celltech Labs Inc.
Test Result for UIM Dielectric Parameter
20/Aug/2008
Frequency (GHz)
IEEE_eB 1528-2003 Limits for Body Epsilon
IEEE_sB 1528-2003 Limits for Body Sigma
Test_e Epsilon of UIM
Test_s Sigma of UIM

Freq	IEEE_eB	IEEE_sB	Test_e	Test_s
0.3500	57.70	0.93	57.76	0.85
0.3600	57.60	0.93	58.22	0.84
0.3700	57.50	0.93	57.73	0.85
0.3800	57.40	0.93	57.79	0.86
0.3900	57.30	0.93	57.34	0.87
0.4000	57.20	0.93	57.08	0.88
0.4100	57.10	0.93	57.66	0.90
0.4200	57.00	0.94	57.43	0.91
0.4300	56.90	0.94	56.67	0.90
0.4400	56.80	0.94	56.80	0.92
0.4500	56.70	0.94	56.21	0.93
0.4600	56.66	0.94	56.54	0.91
0.4700	56.62	0.94	56.18	0.94
0.4800	56.58	0.94	56.37	0.95
0.4900	56.54	0.94	55.46	0.94
0.5000	56.51	0.94	56.19	0.96
0.5100	56.47	0.94	55.97	0.98
0.5200	56.43	0.95	55.19	0.98
0.5300	56.39	0.95	55.88	0.99
0.5400	56.35	0.95	55.43	1.00
0.5500	56.31	0.95	55.46	1.01

Applicant:	Cobra Electronics Corporation	FCC ID:	BBOCX800	IC:	906B-CXR800	
Model(s):	CXR800/CXR820/CXR825/CXR850/CXR855/CXR856	Portable GMRS/FRS PTT Radio Transceiver				
2008 Celltech Labs Inc.	This document is not to be reproduced in whole or in part without the prior written permission of Celltech Labs Inc.					Page 25 of 33

	<u>Date(s) of Evaluation</u> August 20, 2008	<u>Test Report Serial No.</u> 082008BBO-T923-S95U	<u>Test Report Revision No.</u> Rev. 1.0 (Initial Release)	 Test Lab Certificate No. 2470.01
	<u>Test Report Issue Date</u> September 04, 2008	<u>Description of Test(s)</u> Specific Absorption Rate	<u>RF Exposure Category</u> General Population	

APPENDIX D - SAR TEST SETUP & DUT PHOTOGRAPHS

Applicant:	Cobra Electronics Corporation	FCC ID:	BBOCXR800	IC:	906B-CXR800	
Model(s):	CXR800/CXR820/CXR825/CXR850/CXR855/CXR856	Portable GMRS/FRS PTT Radio Transceiver				
2008 Celltech Labs Inc.	This document is not to be reproduced in whole or in part without the prior written permission of Celltech Labs Inc.					Page 26 of 33

	<u>Date(s) of Evaluation</u> August 20, 2008	<u>Test Report Serial No.</u> 082008BBO-T923-S95U	<u>Test Report Revision No.</u> Rev. 1.0 (Initial Release)	 Test Lab Certificate No. 2470.01
	<u>Test Report Issue Date</u> September 04, 2008	<u>Description of Test(s)</u> Specific Absorption Rate	<u>RF Exposure Category</u> General Population	

FACE-HELD SAR TEST SETUP PHOTOGRAPHS
 2.5 cm Spacing from Front of DUT to Planar Phantom



Antenna Distance to Planar Phantom = 3.4 cm



Spacing from Front of DUT to Planar Phantom = 2.5 cm

Applicant:	Cobra Electronics Corporation	FCC ID:	BBOCXR800	IC:	906B-CXR800	
Model(s):	CXR800/CXR820/CXR825/CXR850/CXR855/CXR856	Portable GMRS/FRS PTT Radio Transceiver				
2008 Celltech Labs Inc.	This document is not to be reproduced in whole or in part without the prior written permission of Celltech Labs Inc.					Page 27 of 33



BODY-WORN SAR TEST SETUP PHOTOGRAPHS
0.5 cm Belt-Clip Spacing from Back of DUT to Planar Phantom
DUT with Earbud/Lapel-Microphone Audio Accessory



Antenna Distance to Planar Phantom = 1.5 cm





Belt-Clip Spacing from Back of DUT to Planar Phantom = 0.5 cm

	<u>Date(s) of Evaluation</u> August 20, 2008	<u>Test Report Serial No.</u> 082008BBO-T923-S95U	<u>Test Report Revision No.</u> Rev. 1.0 (Initial Release)	 Test Lab Certificate No. 2470.01
	<u>Test Report Issue Date</u> September 04, 2008	<u>Description of Test(s)</u> Specific Absorption Rate	<u>RF Exposure Category</u> General Population	

DUT PHOTOGRAPHS

			
Front Side of DUT	Back Side with Belt-Clip	Back Side w/out Belt-Clip	DUT with Battery Cover Removed
			
Bottom End of DUT	Top End of DUT	Plastic Belt-Clip body-worn accessory	

Applicant:	Cobra Electronics Corporation	FCC ID:	BBOCX800	IC:	906B-CXR800	
Model(s):	CXR800/CXR820/CXR825/CXR850/CXR855/CXR856	Portable GMRS/FRS PTT Radio Transceiver				
2008 Celltech Labs Inc.		This document is not to be reproduced in whole or in part without the prior written permission of Celltech Labs Inc.				Page 29 of 33

	<u>Date(s) of Evaluation</u> August 20, 2008	<u>Test Report Serial No.</u> 082008BBO-T923-S95U	<u>Test Report Revision No.</u> Rev. 1.0 (Initial Release)	 Test Lab Certificate No. 2470.01
	<u>Test Report Issue Date</u> September 04, 2008	<u>Description of Test(s)</u> Specific Absorption Rate	<u>RF Exposure Category</u> General Population	

DUT PHOTOGRAPHS



Top Side of DUT





Right Side of DUT with Plastic Belt-Clip accessory



Left Side of DUT with Plastic Belt-Clip accessory

Applicant:	Cobra Electronics Corporation	FCC ID:	BBOCX800	IC:	906B-CXR800	
Model(s):	CXR800/CXR820/CXR825/CXR850/CXR855/CXR856	Portable GMRS/FRS PTT Radio Transceiver				
2008 Celltech Labs Inc.	This document is not to be reproduced in whole or in part without the prior written permission of Celltech Labs Inc.					Page 30 of 33

	<u>Date(s) of Evaluation</u> August 20, 2008	<u>Test Report Serial No.</u> 082008BBO-T923-S95U	<u>Test Report Revision No.</u> Rev. 1.0 (Initial Release)	 Test Lab Certificate No. 2470.01
	<u>Test Report Issue Date</u> September 04, 2008	<u>Description of Test(s)</u> Specific Absorption Rate	<u>RF Exposure Category</u> General Population	

DUT PHOTOGRAPHS



Right Side of Belt-Clip accessory attached to DUT



Left Side of Belt-Clip accessory attached to DUT



7.4V 950mAh Lithium-ion Battery

DUT with earbud/lapel-microphone audio accessory

Applicant:	Cobra Electronics Corporation	FCC ID:	BBOCX800	IC:	906B-CXR800	
Model(s):	CXR800/CXR820/CXR825/CXR850/CXR855/CXR856	Portable GMRS/FRS PTT Radio Transceiver				
2008 Celltech Labs Inc.		This document is not to be reproduced in whole or in part without the prior written permission of Celltech Labs Inc.				Page 31 of 33

	<u>Date(s) of Evaluation</u> August 20, 2008	<u>Test Report Serial No.</u> 082008BBO-T923-S95U	<u>Test Report Revision No.</u> Rev. 1.0 (Initial Release)	  Test Lab Certificate No. 2470.01
	<u>Test Report Issue Date</u> September 04, 2008	<u>Description of Test(s)</u> Specific Absorption Rate	<u>RF Exposure Category</u> General Population	

APPENDIX E - SYSTEM VALIDATION

Applicant:	Cobra Electronics Corporation	FCC ID:	BBOCXR800	IC:	906B-CXR800	
Model(s):	CXR800/CXR820/CXR825/CXR850/CXR855/CXR856	Portable GMRS/FRS PTT Radio Transceiver				
2008 Celltech Labs Inc.	This document is not to be reproduced in whole or in part without the prior written permission of Celltech Labs Inc.					Page 32 of 33

	Date of Evaluation:	July 25, 2008	Validation Document Serial No.:	SV450B-072508-R1.0	
	Type of Evaluation:	System Validation	Validation Dipole:	450 MHz	Fluid Type:

450 MHz SYSTEM VALIDATION

Type:

450 MHz Validation Dipole

Asset Number:

00024

Serial Number:

136

Place of Validation:

Celltech Labs Inc.

Date of Validation:

July 25, 2008

Celltech Labs Inc. certifies that the 450 MHz System Validation was performed on the date indicated above.

Validated by:

Sean Johnston

Signature:



1. Dipole Construction & Electrical Characteristics

The validation dipole was constructed in accordance with the requirements specified in IEEE Standard 1528-2003 and International Standard IEC 62209-1:2005. The electrical properties were measured using an HP 8753ET Network Analyzer. The network analyzer was calibrated to the validation dipole N-type connector feed point using an HP85032E Type N calibration kit. The dipole was placed parallel to a planar phantom at a separation distance of 15.0 mm from the simulating fluid using a loss-less dielectric spacer. The measured input impedance is:

Feed point impedance at 450 MHz $\text{Re}\{Z\} = 58.207 \Omega$
 $\text{Im}\{Z\} = 5.6914 \Omega$

Return Loss at 450 MHz -20.703 dB

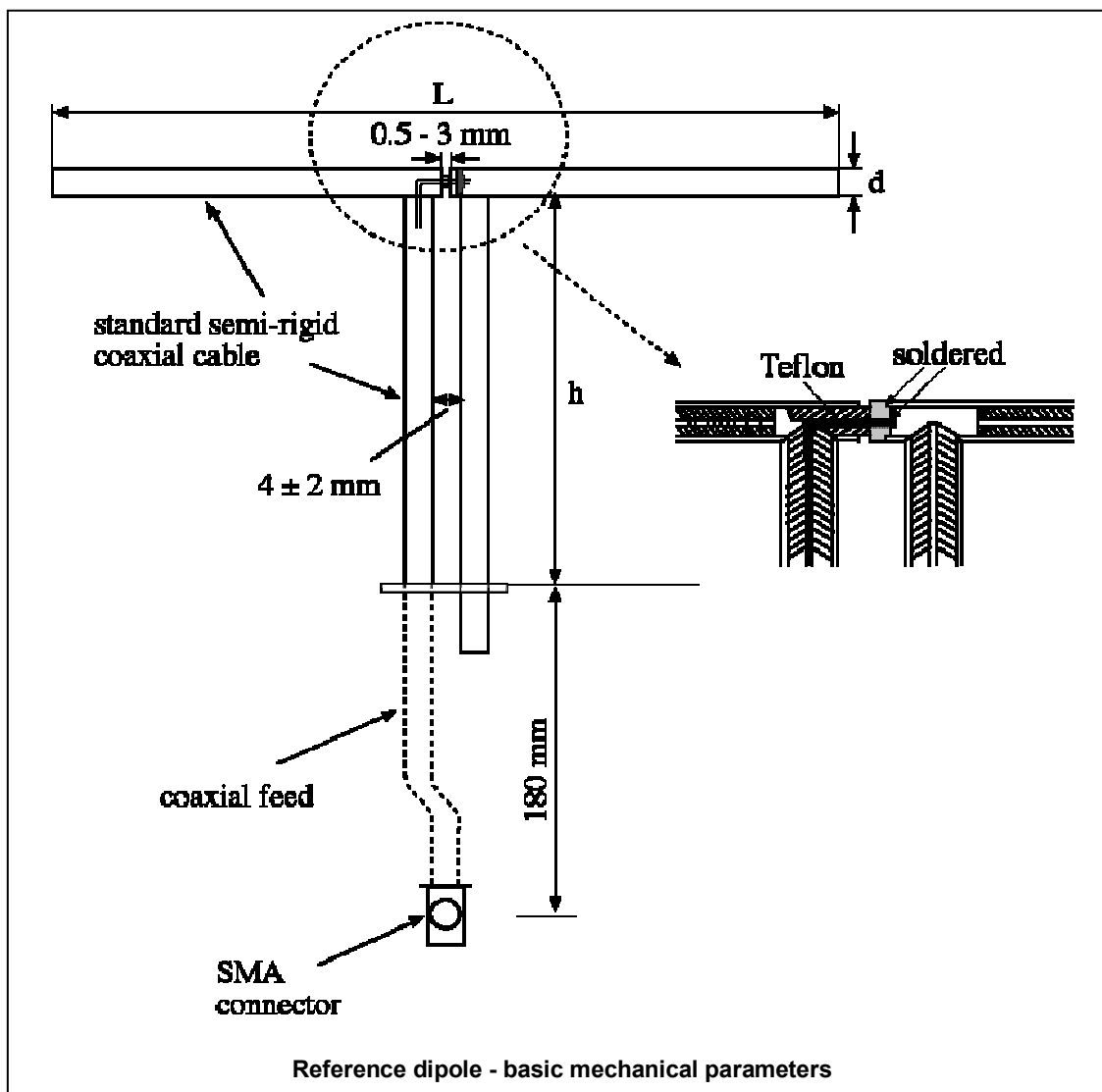

2. Validation Dipole VSWR Data

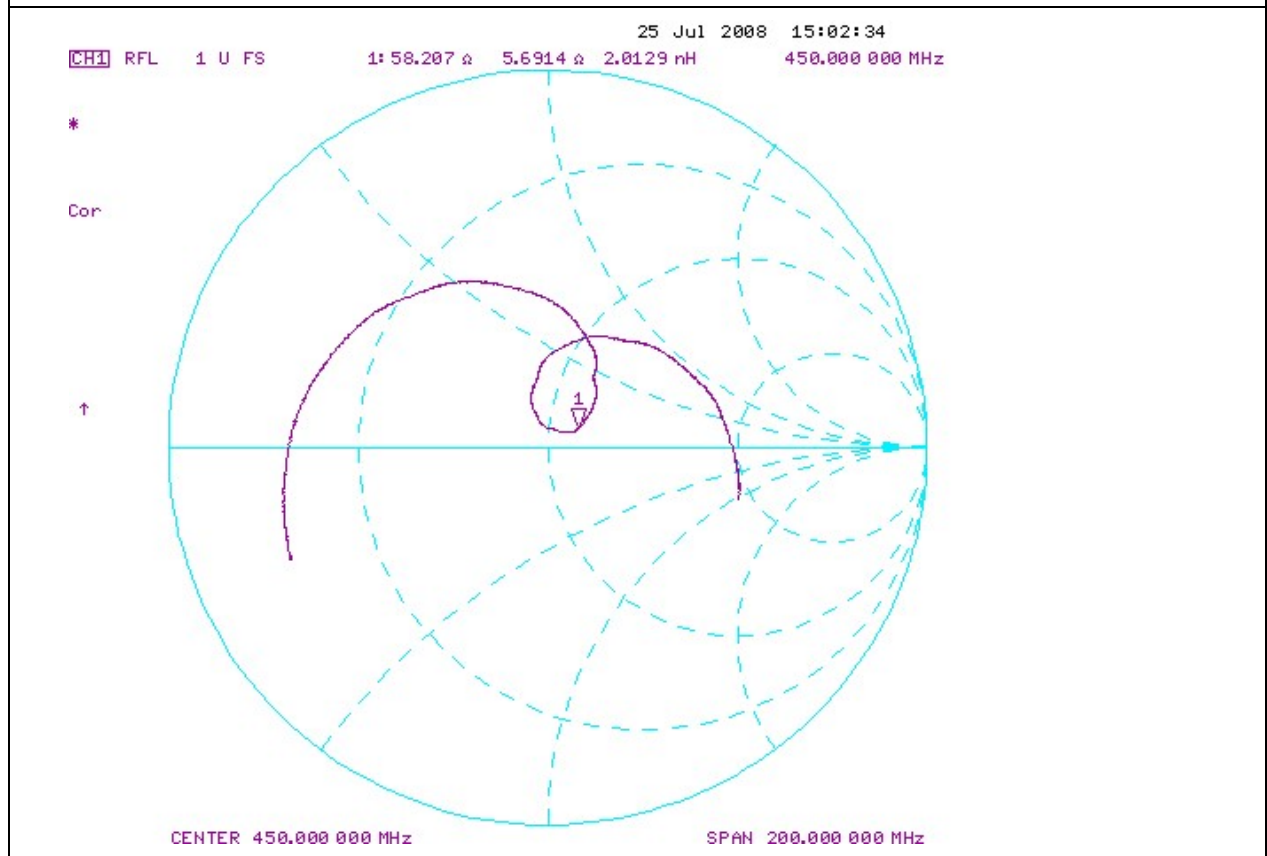
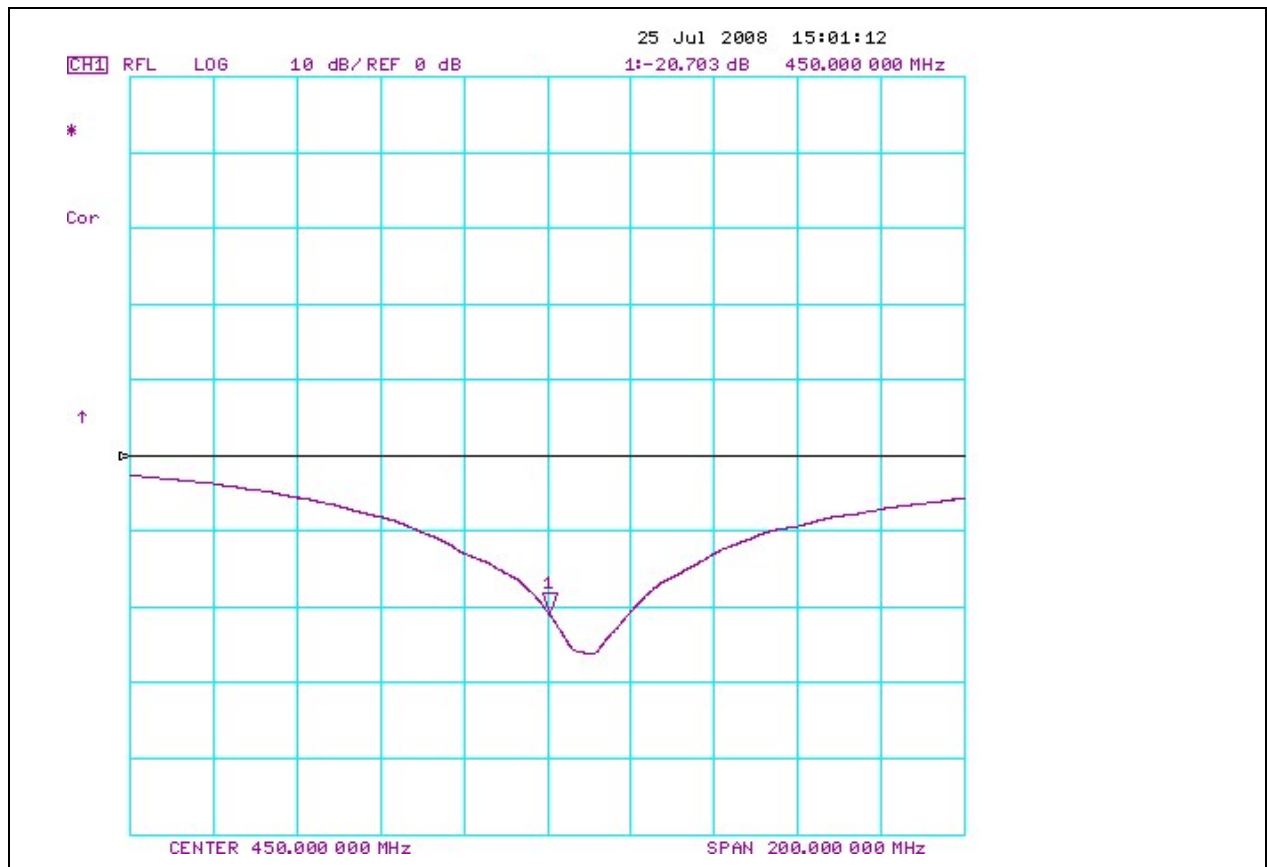

	Date of Evaluation:	July 25, 2008	Validation Document Serial No.:	SV450B-072508-R1.0	
	Type of Evaluation:	System Validation	Validation Dipole:	450 MHz	Fluid Type:

3. Validation Dipole Dimensions

Frequency (MHz)	L (mm)	h (mm)	d (mm)
300	396.0	250.0	6.0
450	270.0	167.0	6.0
835	161.0	89.8	3.6
900	149.0	83.3	3.6
1450	89.1	51.7	3.6
1800	72.0	41.7	3.6
1900	68.0	39.5	3.6
2000	64.5	37.5	3.6
2450	51.5	30.4	3.6
3000	41.5	25.0	3.6

4. Validation Phantom

The validation phantom (planar) was constructed using relatively low-loss tangent Plexiglas material.

The inner dimensions of the validation phantom are as follows:

Length: 83.5 cm
Width: 36.9 cm
Height: 21.8 cm

The bottom section of the validation phantom is constructed of 6.2 ± 0.1 mm Plexiglas.

5. Test Equipment List

TEST EQUIPMENT	ASSET NO.	SERIAL NO.	DATE OF CAL.	CAL. DUE DATE
SPEAG DASY4 Measurement Server	00158	1078	N/A	N/A
SPEAG Robot	00046	599396-01	N/A	N/A
SPEAG DAE4	00019	353	22Apr08	22Apr09
SPEAG ET3DV6 E-Field Probe	00017	1590	21Jul08	21Jul09
450 MHz Validation Dipole	00024	136	25Jul08	25Jul09
Plexiglas Validation Planar Phantom	00157	137	N/A	N/A
HP 85070C Dielectric Probe Kit	00033	US39240170	N/A	N/A
Gigatronics 8652A Power Meter	00007	1835272	23Apr08	23Apr09
Gigatronics 80701A Power Sensor	00014	1833699	23Apr08	23Apr09
HP 8753ET Network Analyzer	00134	US39170292	28Apr08	28Apr09
HP 8648D Signal Generator	00005	3847A00611	NCR	NCR
Amplifier Research 5S1G4 Power Amplifier	00106	26235	NCR	NCR

6. Dimensions of Plexiglas Planar Phantom

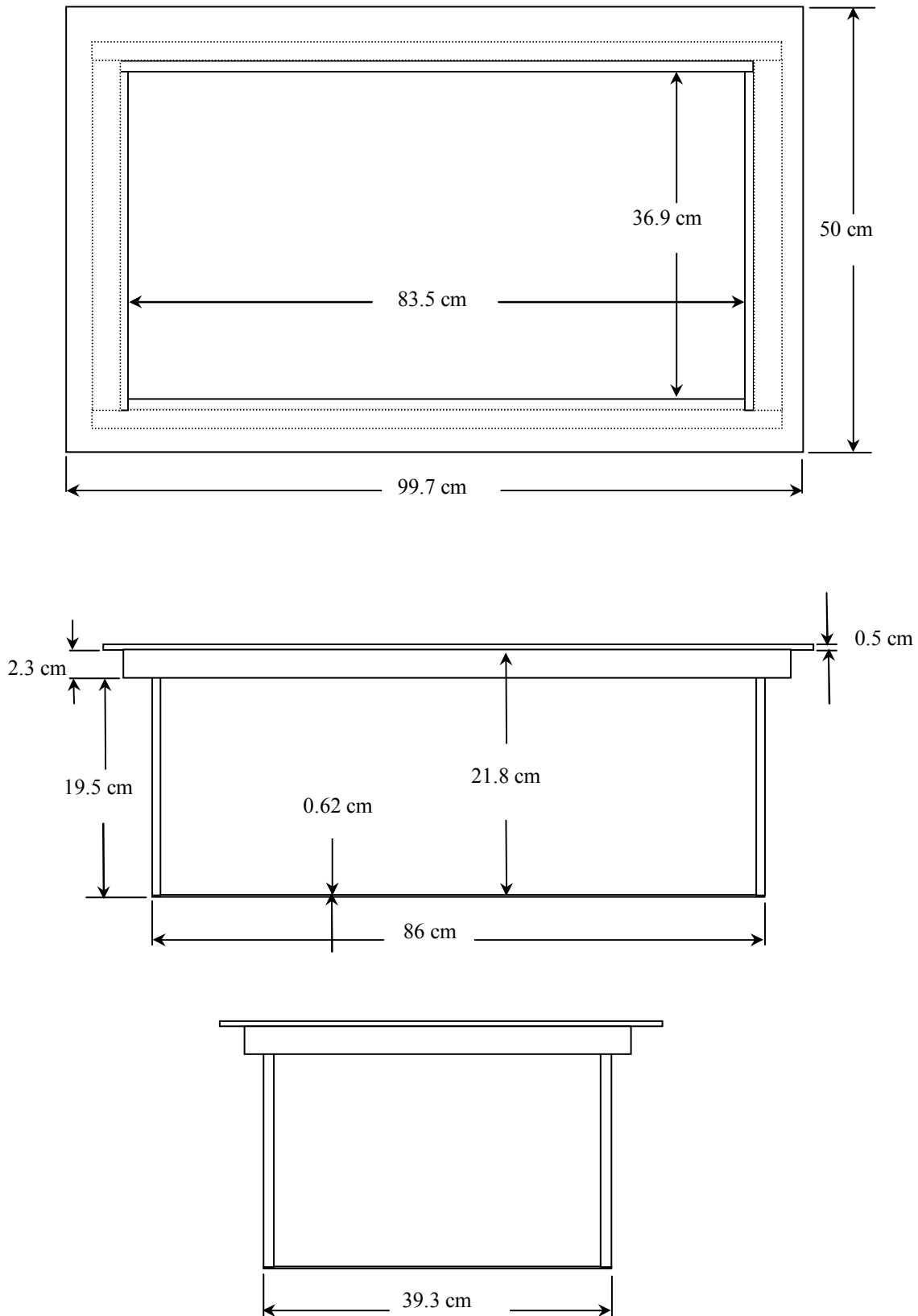

	Date of Evaluation:	July 25, 2008	Validation Document Serial No.:	SV450B-072508-R1.0	
	Type of Evaluation:	System Validation	Validation Dipole:	450 MHz	Fluid Type:

7. 450 MHz System Validation Setup



	Date of Evaluation:	July 25, 2008	Validation Document Serial No.:	SV450B-072508-R1.0	
	Type of Evaluation:	System Validation	Validation Dipole:	450 MHz	Fluid Type:

8. 450 MHz Validation Dipole Setup



9. SAR Measurement

Measurements were made using a dosimetric E-field probe ET3DV6 (S/N: 1590, Conversion Factor 7.66). The SAR measurement was performed with the E-field probe in mechanical detection mode only. The setup and determination of the forward power into the dipole was performed using the procedures described below.

First the power meter PM1 (including attenuator Att1) is connected to the cable to measure the forward power at the location of the dipole connector (X). The signal generator is adjusted for the desired forward power at the dipole connector (taking into account the attenuation of Att1) as read by power meter PM2. After connecting the cable to the dipole, the signal generator is readjusted for the same reading at power meter PM2. If the signal generator does not allow adjustment in 0.01dB steps, the remaining difference at PM2 must be taken into consideration. PM3 records the reflected power from the dipole to ensure that the value is not changed from the previous value. The reflected power should be 20dB below the forward power.

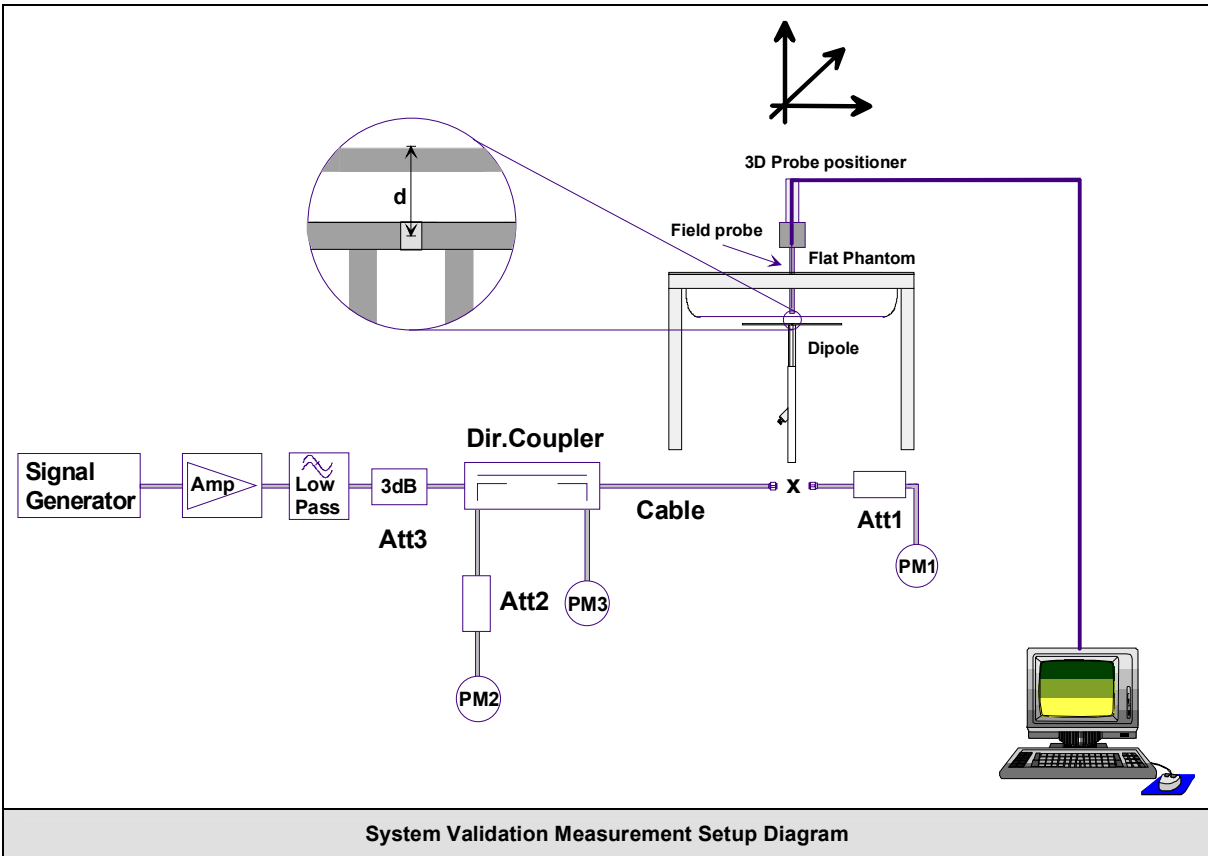

10. Measurement Conditions

The validation phantom was filled with 450 MHz Brain tissue simulant.

Relative Permittivity: 43.4 (-0.2% deviation from target)
 Conductivity: 0.89 mho/m (+2.3% deviation from target)
 Fluid Temperature: 23.1°C (Start of Test) / 23.2°C (End of Test)
 Fluid Depth: ≥ 15.0 cm

Environmental Conditions:

Ambient Temperature: 24.1°C
 Barometric Pressure: 100.9 kPa
 Humidity: 31%

The 450 MHz Brain tissue simulant consisted of the following ingredients:

Ingredient	Percentage by weight	
Water	38.56%	
Sugar	56.32%	
Salt	3.95%	
HEC	0.98%	
Dowicil 75	0.19%	
IEEE/IEC Target Dielectric Parameters (450 MHz):	$\epsilon_r = 43.5$ (+/- 5%)	$\sigma = 0.87$ S/m (+/- 5%)

11. System Validation SAR Results

SAR @ 0.25W Input averaged over 1g (W/kg)				SAR @ 1W Input averaged over 1g (W/kg)			
IEEE/IEC Target		Measured	Deviation	IEEE/IEC Target		Measured	Deviation
1.23	+/- 10%	1.18	-4.0%	4.92	+/- 10%	4.72	-4.0%
SAR @ 0.25W Input averaged over 10g (W/kg)				SAR @ 1W Input averaged over 10g (W/kg)			
IEEE/IEC Target		Measured	Deviation	IEEE/IEC Target		Measured	Deviation
0.825	+/- 10%	0.775	-6.1%	3.30	+/- 10%	3.10	-6.1%
Frequency (MHz)	1 g SAR	10 g SAR	Local SAR at surface (above feed-point)	Local SAR at surface (y = 2 cm offset from feed-point) ²			
300	3.0	2.0	4.4	2.1			
450	4.9	3.3	7.2	3.2			
835	9.5	6.2	4.1	4.9			
900	10.8	6.9	16.4	5.4			
1450	29.0	16.0	50.2	6.5			
1800	38.1	19.8	69.5	6.8			
1900	39.7	20.5	72.1	6.6			
2000	41.1	21.1	74.6	6.5			
2450	52.4	24.0	104.2	7.7			
3000	63.8	25.7	140.2	9.5			
Numerical reference SAR values for reference dipole and flat phantom normalized to 1 W (IEEE 1528-2003; IEC 62209-1:2005)							

	Date of Evaluation:	July 25, 2008	Validation Document Serial No.:	SV450B-072508-R1.0	
	Type of Evaluation:	System Validation	Validation Dipole:	450 MHz	Fluid Type: Brain

Date Tested: 07/25/2008

System Validation - 450 MHz Dipole - HSL

DUT: Dipole 450 MHz; Asset: 00024; Serial: 136; Validation: 07/25/2008

Ambient Temp: 24.1°C; Fluid Temp: 23.1°C; Barometric Pressure: 100.9 kPa; Humidity: 31%

Communication System: CW

Forward Conducted Power: 250 mW

Frequency: 450 MHz; Duty Cycle: 1:1

Medium: HSL450 Medium parameters used: $f = 450 \text{ MHz}$; $\sigma = 0.89 \text{ mho/m}$; $\epsilon_r = 43.4$; $\rho = 1000 \text{ kg/m}^3$

- Probe: ET3DV6 - SN1590; ConvF(7.66, 7.66, 7.66); Calibrated: 21/07/2008
- Sensor-Surface: 4mm (Mechanical Surface Detection)
- Electronics: DAE4 Sn353; Calibrated: 22/04/2008
- Phantom: Validation Planar; Type: Plexiglas; Serial: TE#137
- Measurement SW: DASY4, V4.7 Build 44; Postprocessing SW: SEMCAD, V1.8 Build 171

450 MHz Dipole - System Validation

Area Scan (6x11x1): Measurement grid: $dx=15\text{mm}$, $dy=15\text{mm}$

Maximum value of SAR (measured) = 1.18 mW/g

450 MHz Dipole - System Validation

Zoom Scan (5x5x7)/Cube 0: Measurement grid: $dx=7.5\text{mm}$, $dy=7.5\text{mm}$, $dz=5\text{mm}$

Reference Value = 38.3 V/m; Power Drift = 0.000 dB

Peak SAR (extrapolated) = 1.88 W/kg

SAR(1 g) = 1.18 mW/g; SAR(10 g) = 0.775 mW/g

Maximum value of SAR (measured) = 1.27 mW/g

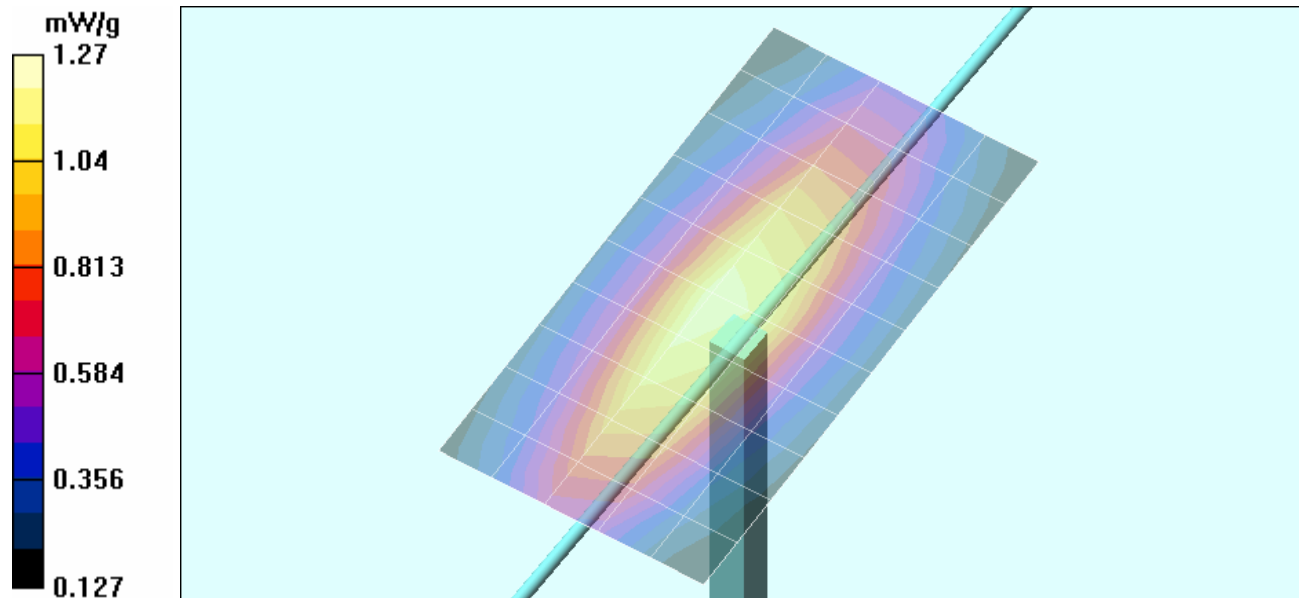

Z-Axis Scan

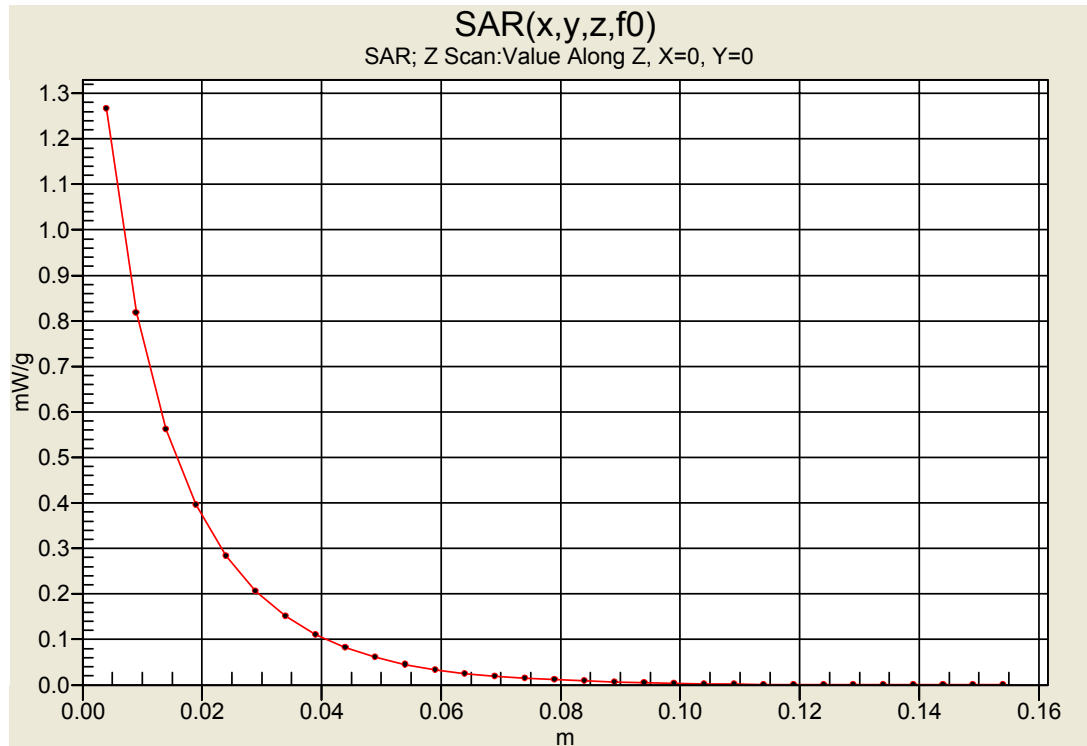

12. Measured Fluid Dielectric Parameters

System Validation - 450 MHz (Brain)

Celltech Labs Inc.
 Test Result for UIM Dielectric Parameter
 Fri 25/Jul/2008
 Frequency (GHz)
 IEEE_eH IEEE 1528-2003 Limits for Head Epsilon
 IEEE_sH IEEE 1528-2003 Limits for Head Sigma
 Test_e Epsilon of UIM
 Test_s Sigma of UIM

Freq	IEEE_eH	IEEE_sH	Test_e	Test_s
0.3500	44.70	0.87	46.31	0.80
0.3600	44.58	0.87	45.65	0.82
0.3700	44.46	0.87	45.27	0.82
0.3800	44.34	0.87	45.47	0.83
0.3900	44.22	0.87	44.76	0.84
0.4000	44.10	0.87	44.57	0.87
0.4100	43.98	0.87	44.63	0.86
0.4200	43.86	0.87	44.66	0.86
0.4300	43.74	0.87	43.79	0.89
0.4400	43.62	0.87	43.68	0.87
0.4500	43.50	0.87	43.44	0.89
0.4600	43.45	0.87	43.27	0.90
0.4700	43.40	0.87	43.17	0.90
0.4800	43.34	0.87	43.66	0.91
0.4900	43.29	0.87	42.68	0.92
0.5000	43.24	0.87	42.39	0.95
0.5100	43.19	0.87	42.24	0.94
0.5200	43.14	0.88	41.96	0.95
0.5300	43.08	0.88	42.42	0.95
0.5400	43.03	0.88	41.99	0.97
0.5500	42.98	0.88	41.92	0.98

	Date of Evaluation:	July 25, 2008	Validation Document Serial No.:		SV450B-072508-R1.0	
	Type of Evaluation:	System Validation	Validation Dipole:	450 MHz	Fluid Type:	Brain

13. Measurement Uncertainties

UNCERTAINTY BUDGET FOR SYSTEM VALIDATION						
Error Description	Uncertainty Value $\pm\%$	Probability Distribution	Divisor	c_i 1g	Uncertainty Value $\pm\%$ (1g)	V_i or V_{eff}
Measurement System						
Probe calibration (450 MHz)	6.65	Normal	1	1	6.65	∞
Axial isotropy of the probe	4.7	Rectangular	1.732050808	1	2.7	∞
Spherical isotropy of the probe	0	Rectangular	1.732050808	1	0.0	∞
Spatial resolution	0	Rectangular	1.732050808	1	0.0	∞
Boundary effects	0.8	Rectangular	1.732050808	1	0.5	∞
Probe linearity	4.7	Rectangular	1.732050808	1	2.7	∞
Detection limit	1	Rectangular	1.732050808	1	0.6	∞
Readout electronics	0.3	Normal	1	1	0.3	∞
Response time	0	Rectangular	1.732050808	1	0.0	∞
Integration time	0	Rectangular	1.732050808	1	0.0	∞
RF ambient conditions	3	Rectangular	1.732050808	1	1.7	∞
Mech. constraints of robot	0.4	Rectangular	1.732050808	1	0.2	∞
Probe positioning	2.9	Rectangular	1.732050808	1	1.7	∞
Extrapolation & integration	1	Rectangular	1.732050808	1	0.6	∞
Dipole						
Dipole Positioning	2	Normal	1.732050808	1	1.2	∞
Power & Power Drift	4.7	Normal	1.732050808	1	2.7	∞
Phantom and Setup						
Phantom uncertainty	4	Rectangular	1.732050808	1	2.3	∞
Liquid conductivity (target)	5	Rectangular	1.732050808	0.64	1.8	∞
Liquid conductivity (measured)	2.3	Normal	1	0.64	1.5	∞
Liquid permittivity (target)	5	Rectangular	1.732050808	0.6	1.7	∞
Liquid permittivity (measured)	0.2	Normal	1	0.6	0.1	∞
Combined Standard Uncertainty					9.40	
Expanded Uncertainty (k=2)					18.80	
Measurement Uncertainty Table in accordance with IEEE Standard 1528-2003 and IEC 62209-1:2005						

	<u>Date(s) of Evaluation</u> August 20, 2008	<u>Test Report Serial No.</u> 082008BBO-T923-S95U	<u>Test Report Revision No.</u> Rev. 1.0 (Initial Release)	
	<u>Test Report Issue Date</u> September 04, 2008	<u>Description of Test(s)</u> Specific Absorption Rate	<u>RF Exposure Category</u> General Population	

APPENDIX F - PROBE CALIBRATION

Applicant:	Cobra Electronics Corporation	FCC ID:	BBOCXR800	IC:	906B-CXR800	
Model(s):	CXR800/CXR820/CXR825/CXR850/CXR855/CXR856	Portable GMRS/FRS PTT Radio Transceiver				
2008 Celltech Labs Inc.	This document is not to be reproduced in whole or in part without the prior written permission of Celltech Labs Inc.					Page 33 of 33



Accredited by the Swiss Accreditation Service (SAS)
The Swiss Accreditation Service is one of the signatories to the EA
Multilateral Agreement for the recognition of calibration certificates

Accreditation No.: **SCS 108**

Client **Calltech**

Certificate No: **ET3-1590_Jul08**

CALIBRATION CERTIFICATE

Object **ET3DV6 - SN:1590**

Calibration procedure(s) **QA CAL-01.v6, QA CAL-12.v5 and QA CAL-23.v3
Calibration procedure for dosimetric E-field probes**

Calibration date: **July 21, 2008**

Condition of the calibrated item **In Tolerance**

This calibration certificate documents the traceability to national standards, which realize the physical units of measurements (SI).
The measurements and the uncertainties with confidence probability are given on the following pages and are part of the certificate.

All calibrations have been conducted in the closed laboratory facility: environment temperature (22 ± 3)°C and humidity < 70%.

Calibration Equipment used (M&TE critical for calibration)

Primary Standards	ID #	Cal Date (Certificate No.)	Scheduled Calibration
Power meter E4419B	GB41293874	1-Apr-08 (No. 217-00788)	Apr-09
Power sensor E4412A	MY41495277	1-Apr-08 (No. 217-00788)	Apr-09
Power sensor E4412A	MY41498087	1-Apr-08 (No. 217-00788)	Apr-09
Reference 3 dB Attenuator	SN: S5054 (3c)	1-Jul-08 (No. 217-00865)	Jul-09
Reference 20 dB Attenuator	SN: S5086 (20b)	31-Mar-08 (No. 217-00787)	Apr-09
Reference 30 dB Attenuator	SN: S5129 (30b)	1-Jul-08 (No. 217-00866)	Jul-09
Reference Probe ES3DV2	SN: 3013	2-Jan-08 (No. ES3-3013_Jan08)	Jan-09
DAE4	SN: 660	3-Sep-07 (No. DAE4-660_Sep07)	Sep-08
Secondary Standards	ID #	Check Date (in house)	Scheduled Check
RF generator HP 8648C	US3642U01700	4-Aug-99 (in house check Oct-07)	In house check: Oct-09
Network Analyzer HP 8753E	US37390585	18-Oct-01 (in house check Oct-07)	In house check: Oct-08

	Name	Function	Signature
Calibrated by:	Katja Pokovic	Technical Manager	
Approved by:	Niels Kuster	Quality Manager	

Issued: July 21, 2008

This calibration certificate shall not be reproduced except in full without written approval of the laboratory.



Accredited by the Swiss Accreditation Service (SAS)
The Swiss Accreditation Service is one of the signatories to the EA
Multilateral Agreement for the recognition of calibration certificates

Accreditation No.: **SCS 108**

Glossary:

TSL	tissue simulating liquid
NORM _{x,y,z}	sensitivity in free space
ConvF	sensitivity in TSL / NORM _{x,y,z}
DCP	diode compression point
Polarization φ	φ rotation around probe axis
Polarization ϑ	ϑ rotation around an axis that is in the plane normal to probe axis (at measurement center), i.e., $\vartheta = 0$ is normal to probe axis

Calibration is Performed According to the Following Standards:

- IEEE Std 1528-2003, "IEEE Recommended Practice for Determining the Peak Spatial-Averaged Specific Absorption Rate (SAR) in the Human Head from Wireless Communications Devices: Measurement Techniques", December 2003
- IEC 62209-1, "Procedure to measure the Specific Absorption Rate (SAR) for hand-held devices used in close proximity to the ear (frequency range of 300 MHz to 3 GHz)", February 2005

Methods Applied and Interpretation of Parameters:

- NORM_{x,y,z}**: Assessed for E-field polarization $\vartheta = 0$ ($f \leq 900$ MHz in TEM-cell; $f > 1800$ MHz: R22 waveguide). NORM_{x,y,z} are only intermediate values, i.e., the uncertainties of NORM_{x,y,z} does not effect the E²-field uncertainty inside TSL (see below *ConvF*).
- NORM(f)_{x,y,z} = NORM_{x,y,z} * frequency_response** (see Frequency Response Chart). This linearization is implemented in DASY4 software versions later than 4.2. The uncertainty of the frequency response is included in the stated uncertainty of *ConvF*.
- DCP_{x,y,z}**: DCP are numerical linearization parameters assessed based on the data of power sweep (no uncertainty required). DCP does not depend on frequency nor media.
- ConvF and Boundary Effect Parameters**: Assessed in flat phantom using E-field (or Temperature Transfer Standard for $f \leq 800$ MHz) and inside waveguide using analytical field distributions based on power measurements for $f > 800$ MHz. The same setups are used for assessment of the parameters applied for boundary compensation (alpha, depth) of which typical uncertainty values are given. These parameters are used in DASY4 software to improve probe accuracy close to the boundary. The sensitivity in TSL corresponds to NORM_{x,y,z} * ConvF whereby the uncertainty corresponds to that given for ConvF. A frequency dependent ConvF is used in DASY version 4.4 and higher which allows extending the validity from ± 50 MHz to ± 100 MHz.
- Spherical isotropy (3D deviation from isotropy)**: in a field of low gradients realized using a flat phantom exposed by a patch antenna.
- Sensor Offset**: The sensor offset corresponds to the offset of virtual measurement center from the probe tip (on probe axis). No tolerance required.

Probe ET3DV6

SN:1590

Manufactured:	March 19, 2001
Last calibrated:	May 20, 2005
Recalibrated:	July 21, 2008

Calibrated for DASY Systems

(Note: non-compatible with DASY2 system!)

DASY - Parameters of Probe: ET3DV6 SN:1590**Sensitivity in Free Space^A**

NormX	1.81 ± 10.1%	$\mu\text{V}/(\text{V}/\text{m})^2$
NormY	2.00 ± 10.1%	$\mu\text{V}/(\text{V}/\text{m})^2$
NormZ	1.72 ± 10.1%	$\mu\text{V}/(\text{V}/\text{m})^2$

Diode Compression^B

DCP X	87 mV
DCP Y	92 mV
DCP Z	85 mV

Sensitivity in Tissue Simulating Liquid (Conversion Factors)

Please see Page 8.

Boundary Effect

TSL **835 MHz** **Typical SAR gradient: 5 % per mm**

Sensor Center to Phantom Surface Distance		3.7 mm	4.7 mm
SAR _{be} [%]	Without Correction Algorithm	10.7	7.2
SAR _{be} [%]	With Correction Algorithm	0.8	0.5

Sensor Offset

Probe Tip to Sensor Center **2.7 mm**

The reported uncertainty of measurement is stated as the standard uncertainty of measurement multiplied by the coverage factor k=2, which for a normal distribution corresponds to a coverage probability of approximately 95%.

^A The uncertainties of NormX,Y,Z do not affect the E²-field uncertainty inside TSL (see Page 8).

^B Numerical linearization parameter: uncertainty not required.

Frequency Response of E-Field

(TEM-Cell:ifi110 EXX, Waveguide: R22)

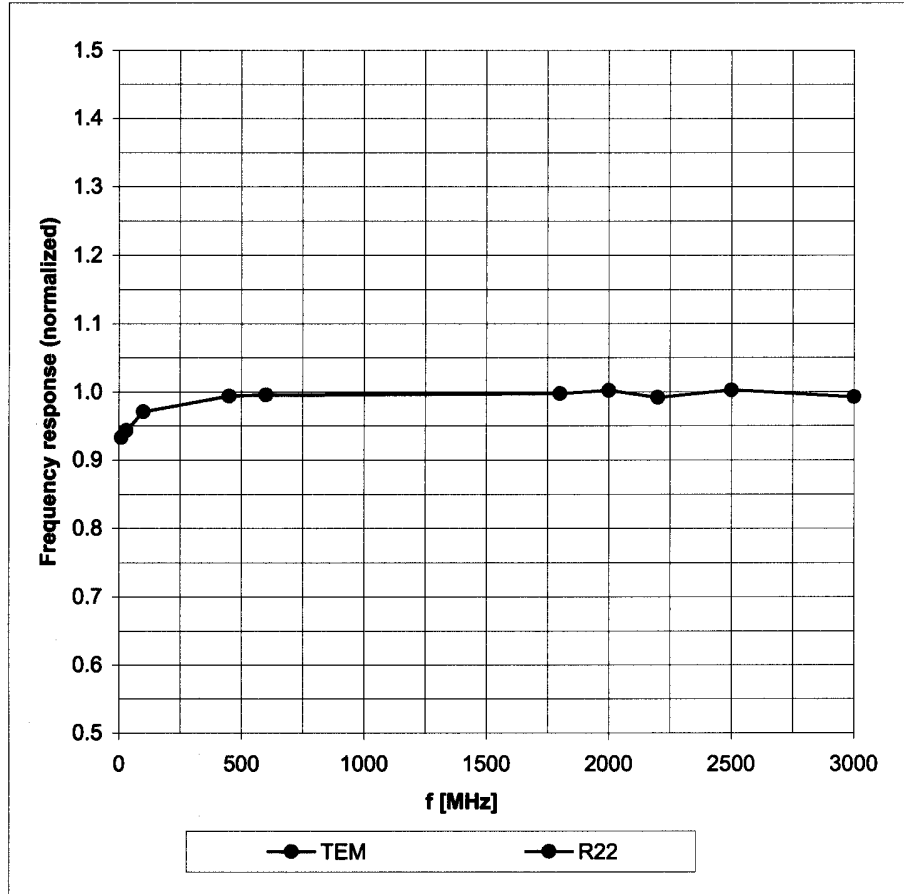

Uncertainty of Frequency Response of E-field: $\pm 6.3\%$ ($k=2$)

Receiving Pattern (ϕ), $\vartheta = 0^\circ$

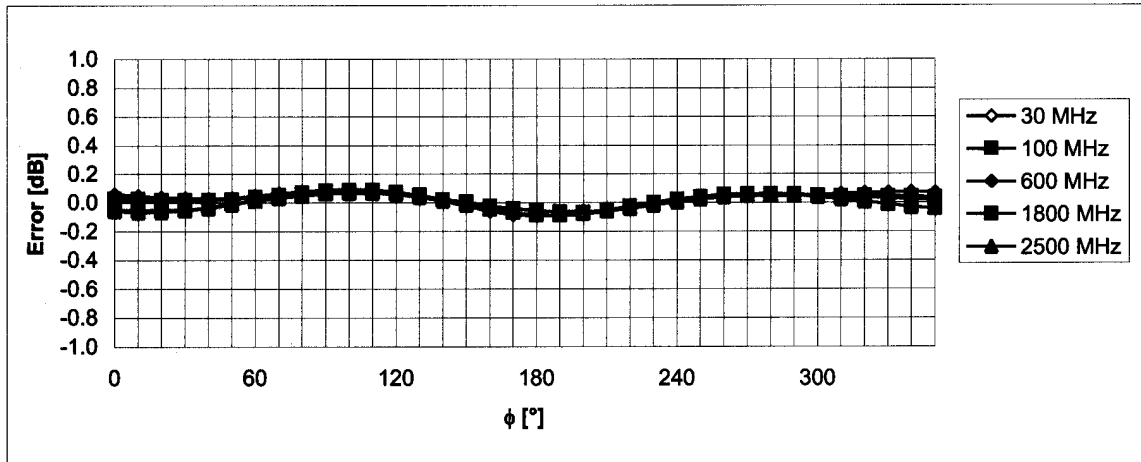
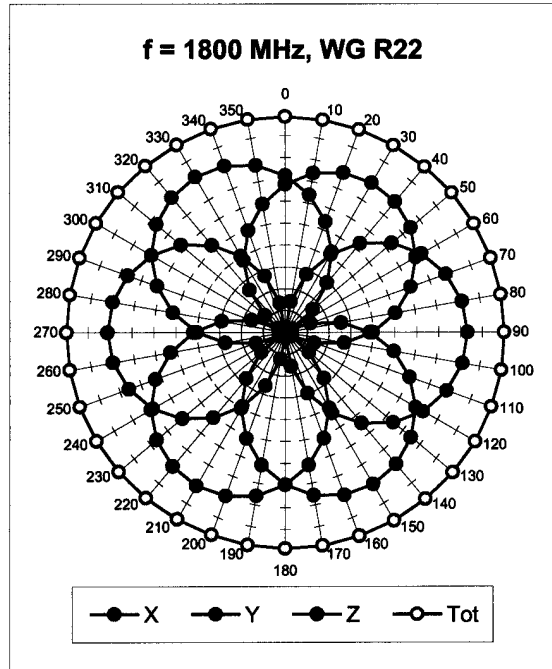
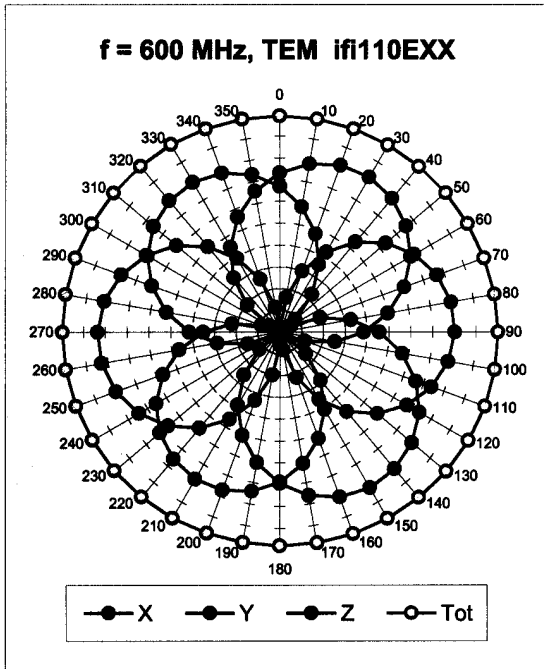

Uncertainty of Axial Isotropy Assessment: $\pm 0.5\%$ ($k=2$)

Dynamic Range $f(\text{SAR}_{\text{head}})$ (Waveguide R22, $f = 1800 \text{ MHz}$)

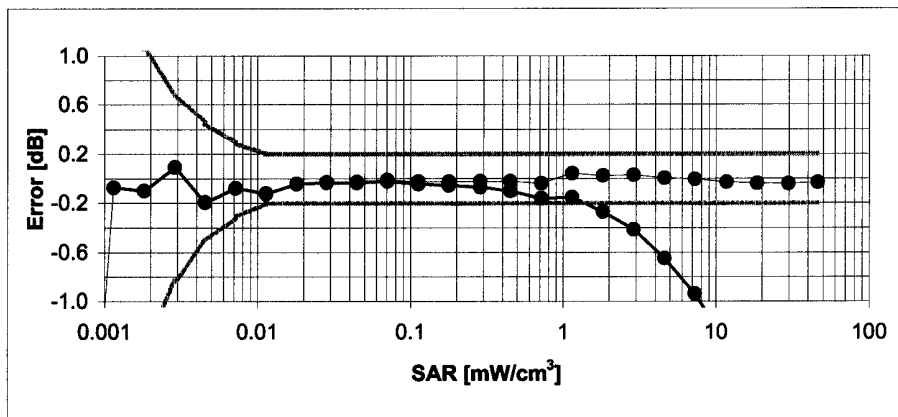
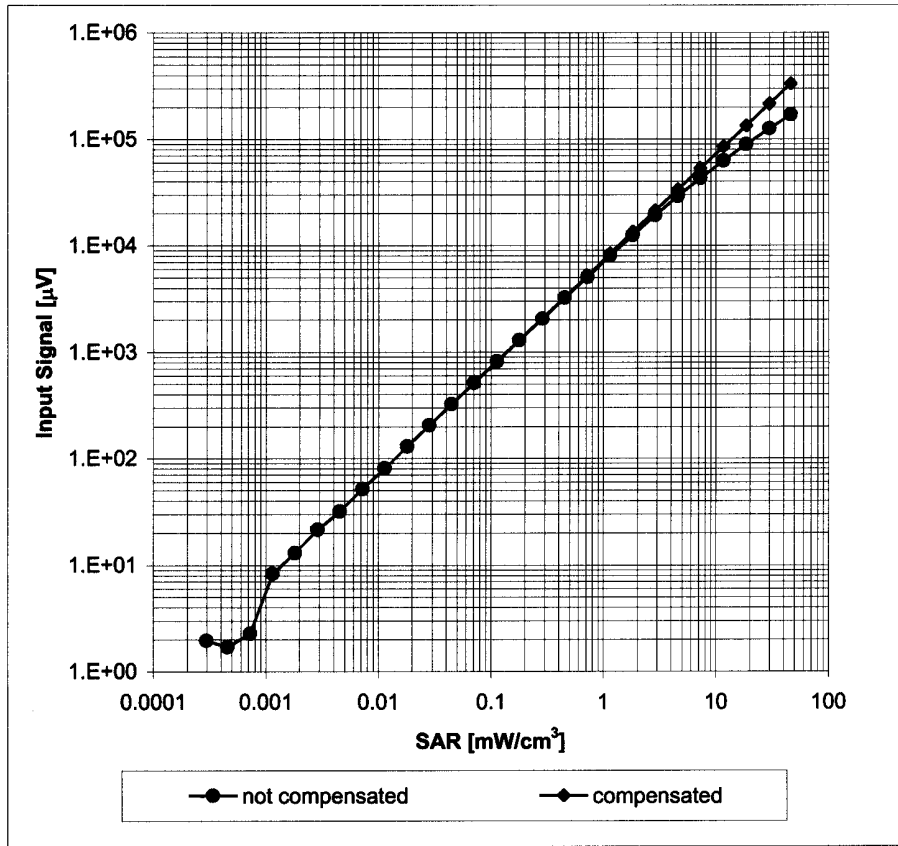

Uncertainty of Linearity Assessment: $\pm 0.6\%$ ($k=2$)

Conversion Factor Assessment

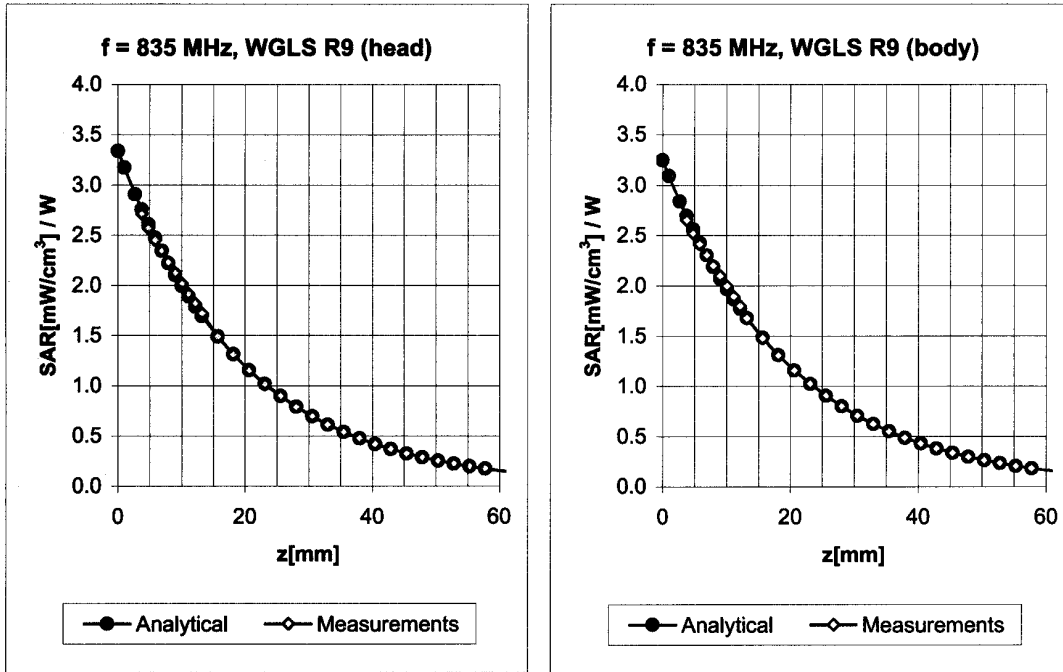

f [MHz]	Validity [MHz] ^c	TSL	Permittivity	Conductivity	Alpha	Depth	ConvF Uncertainty
450	± 50 / ± 100	Head	43.5 ± 5%	0.87 ± 5%	0.34	1.75	7.66 ± 13.3% (k=2)
835	± 50 / ± 100	Head	41.5 ± 5%	0.90 ± 5%	0.32	3.52	6.54 ± 11.0% (k=2)
450	± 50 / ± 100	Body	56.7 ± 5%	0.94 ± 5%	0.28	1.77	8.27 ± 13.3% (k=2)
835	± 50 / ± 100	Body	55.2 ± 5%	0.97 ± 5%	0.36	3.31	6.39 ± 11.0% (k=2)

^c The validity of ± 100 MHz only applies for DASY v4.4 and higher (see Page 2). The uncertainty is the RSS of the ConvF uncertainty at calibration frequency and the uncertainty for the indicated frequency band.

Deviation from Isotropy in HSL

Error (ϕ, ϑ), $f = 900$ MHz

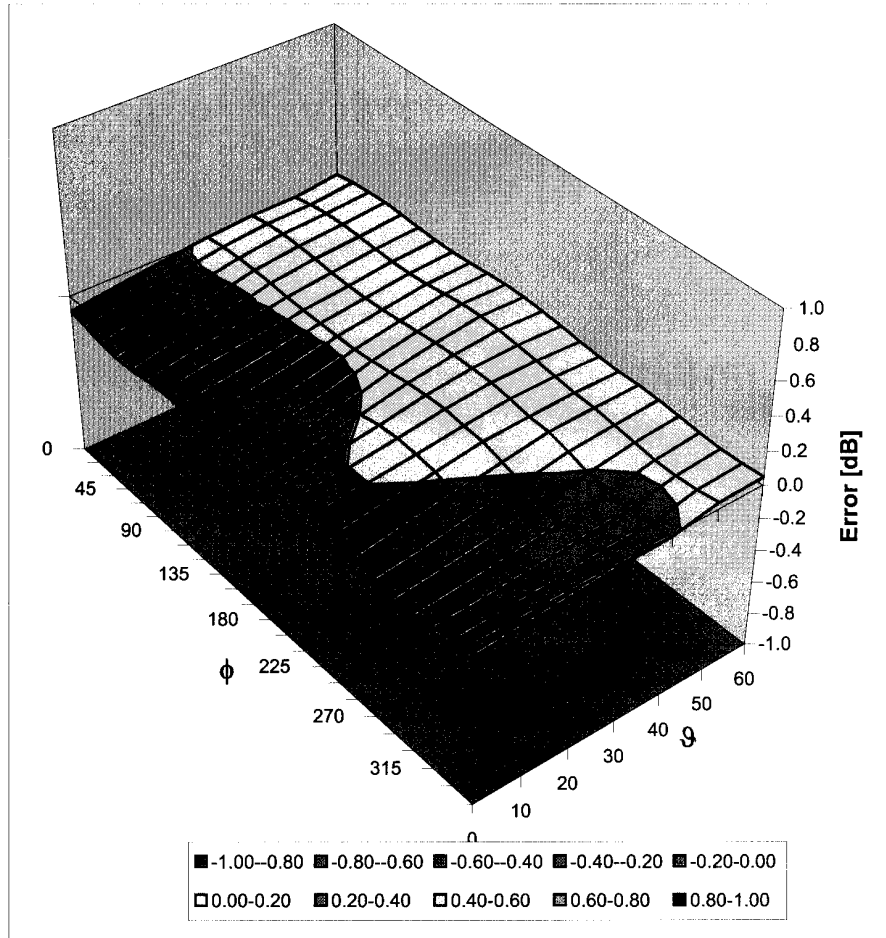

Uncertainty of Spherical Isotropy Assessment: $\pm 2.6\%$ ($k=2$)