

# TEST REPORT

**FCC ID: BBO9941**

**Product: Sports camera**

**Model No.: 9941**

**Additional Model No.: 9942**

**Trade Mark:** 

**Report No.: TCT170522E015**

**Issued Date: Jun. 09, 2017**

Issued for:

**Cobra Electronics Corporation**

**6500 West Cortland Street Chicago, IL 60707 USA**

Issued By:

**Shenzhen Tongce Testing Lab.**

**1F, Leinuo Watch Building, Fuyong Town, Baoan Dist, Shenzhen, China**

**TEL: +86-755-27673339**

**FAX: +86-755-27673332**

**Note:** This report shall not be reproduced except in full, without the written approval of Shenzhen Tongce Testing Lab.

This document may be altered or revised by Shenzhen Tongce Testing Lab. personnel only, and shall be noted in the revision section of the document. The test results in the report only apply to the tested sample.

**TABLE OF CONTENTS**

1. Test Certification..... 3

2. Test Result Summary..... 4

3. EUT Description..... 5

4. Genera Information..... 7

    4.1. Test environment and mode..... 7

    4.2. Description of Support Units..... 7

5. Facilities and Accreditations..... 10

    5.1. Facilities..... 10

    5.2. Location..... 10

    5.3. Measurement Uncertainty..... 10

6. Test Results and Measurement Data..... 11

    6.1. Antenna requirement..... 11

    6.2. Conducted Emission..... 12

    6.3. Emission Bandwidth..... 22

    6.4. Power Spectral Density..... 28

    6.5. Conducted Band Edge and Spurious Emission Measurement..... 34

    6.6. Radiated Spurious Emission Measurement..... 44

Appendix A: Photographs of Test Setup

Appendix B: Photographs of EUT

## 1. Test Certification

<b>Product:</b>	Sports camera
<b>Model No.:</b>	9941
<b>Additional Model No.:</b>	9942
<b>Trade Mark:</b>	
<b>Applicant:</b>	Cobra Electronics Corporation
<b>Address:</b>	6500 West Cortland Street Chicago, IL 60707 USA
<b>Manufacturer:</b>	Guangzhou Yaozhong Electronics Co., Ltd.
<b>Address:</b>	No.2, Shaxing Road, Shajiao, Lanhe, Nansha district, Guangzhou, China
<b>Date of Test:</b>	May 23, 2017 – Jun. 08, 2017
<b>Applicable Standards:</b>	FCC CFR Title 47 Part 15 Subpart C Section 15.247 KDB 558074 D01 DTS Meas Guidance v03r05

The above equipment has been tested by Shenzhen Tongce Testing Lab. and found compliance with the requirements set forth in the technical standards mentioned above. The results of testing in this report apply only to the product/system, which was tested. Other similar equipment will not necessarily produce the same results due to production tolerance and measurement uncertainties.

Tested By:



---

**Brews Xu**

Date:

**Jun. 08, 2017**

---

Reviewed By:



---

**Joe Zhou**

Date:

**Jun. 09, 2017**

---

Approved By:



---

**Tomsin**

Date:

**Jun. 09, 2017**

---

## 2. Test Result Summary

Requirement	CFR 47 Section	Result
Antenna requirement	§15.203/§15.247 (c)	PASS
AC Power Line Conducted Emission	§15.207	PASS
Conducted Peak Output Power	§15.247 (b)(3) §2.1046	PASS
6dB Emission Bandwidth	§15.247 (a)(2) §2.1049	PASS
Power Spectral Density	§15.247 (e)	PASS
Band Edge	§15.247(d) §2.1051, §2.1057	PASS
Spurious Emission	§15.205/§15.209 §2.1053, §2.1057	PASS

**Note:**

1. PASS: Test item meets the requirement.
2. Fail: Test item does not meet the requirement.
3. N/A: Test case does not apply to the test object.
4. The test result judgment is decided by the limit of test standard.

### 3. EUT Description

<b>Product:</b>	Sports camera
<b>Model No.:</b>	9941
<b>Additional Model No.:</b>	9942
<b>Trade Mark:</b>	
<b>Operation Frequency:</b>	2412MHz~2462MHz (802.11b/802.11g/802.11n(HT20)) 2422MHz~2452MHz (802.11n(HT40))
<b>Channel Separation:</b>	5MHz
<b>Number of Channel:</b>	11 for 802.11b/802.11g/802.11n(HT20) 7 for 802.11n(HT40)
<b>Modulation Technology: (IEEE 802.11b)</b>	Direct Sequence Spread Spectrum (DSSS)
<b>Modulation Technology: (IEEE 802.11g/802.11n)</b>	Orthogonal Frequency Division Multiplexing(OFDM)
<b>Data speed (IEEE 802.11b):</b>	1Mbps, 2Mbps, 5.5Mbps, 11Mbps
<b>Data speed (IEEE 802.11g):</b>	6Mbps, 9Mbps, 12Mbps, 18Mbps, 24Mbps, 36Mbps, 48Mbps, 54Mbps
<b>Data speed (IEEE 802.11n):</b>	Up to 135Mbps
<b>Antenna Type:</b>	Internal Antenna
<b>Antenna Gain:</b>	2dBi
<b>Power Supply:</b>	Rechargeable Li-ion battery DC 3.7V
<b>Remark:</b>	All models above are identical in interior structure, electrical circuits and components, and just model names are different for the marketing requirement.

#### Operation Frequency each of channel For 802.11b/g/n(HT20)

Channel	Frequency	Channel	Frequency	Channel	Frequency	Channel	Frequency
1	2412MHz	4	2427MHz	7	2442MHz	10	2457MHz
2	2417MHz	5	2432MHz	8	2447MHz	11	2462MHz
3	2422MHz	6	2437MHz	9	2452MHz		

**Operation Frequency each of channel For 802.11n (HT40)**

Channel	Frequency	Channel	Frequency	Channel	Frequency	Channel	Frequency
--	--	4	2427MHz	7	2442MHz	--	--
--	--	5	2432MHz	8	2447MHz	--	--
3	2422MHz	6	2437MHz	9	2452MHz		

**Note:**

*In section 15.31(m), regards to the operating frequency range over 10 MHz, the Lowest frequency, the middle frequency, and the highest frequency of channel were selected to perform the test, and the selected channel see below:*

**802.11b/802.11g/802.11n (HT20)**

Channel	Frequency
The lowest channel	2412MHz
The middle channel	2437MHz
The Highest channel	2462MHz

**802.11n (HT40)**

Channel	Frequency
The lowest channel	2422MHz
The middle channel	2437MHz
The Highest channel	2452MHz

## 4. Genera Information

### 4.1. Test environment and mode

Operating Environment:	
Temperature:	25.0 °C
Humidity:	56 % RH
Atmospheric Pressure:	1010 mbar
Test Mode:	
Engineering mode:	Keep the EUT in continuous transmitting by select channel and modulations(The value of duty cycle is 98.46%)
<p>The sample was placed (0.8m below 1GHz, 1.5m above 1GHz) above the ground plane of 3m chamber. Measurements in both horizontal and vertical polarities were performed. During the test, each emission was maximized by: having the EUT continuously working, investigated all operating modes, rotated about all 3 axis (X, Y &amp; Z) and considered typical configuration to obtain worst position, manipulating interconnecting cables, rotating the turntable, varying antenna height from 1m to 4m in both horizontal and vertical polarizations. The emissions worst-case are shown in Test Results of the following pages. For the full battery state and The output power to the maximum state.</p>	

We have verified the construction and function in typical operation. All the test modes were carried out with the EUT in transmitting operation, which was shown in this test report and defined as follows:

**Per-scan all kind of data rate in lowest channel, and found the follow list which it was worst case.**

Mode	Data rate
802.11b	1Mbps
802.11g	6Mbps
802.11n(H20)	6.5Mbps
802.11n(H40)	13.5Mbps

#### Final Test Mode:

Operation mode:	Keep the EUT in continuous transmitting with modulation
<p>1. For WIFI function, the engineering test program was provided and enabled to make EUT continuous transmit/receive.</p> <p>2. According to ANSI C63.10 standards, the test results are both the “worst case” and</p>	

“worst setup” 1Mbps for 802.11b, 6Mbps for 802.11g, 6.5Mbps for 802.11n(H20), 13.5Mbps for 802.11(H40). Duty cycle setting during the transmission is 98.5% with maximum power setting for all modulations.



## 4.2. Description of Support Units

The EUT has been tested as an independent unit together with other necessary accessories or support units. The following support units or accessories were used to form a representative test configuration during the tests.

Equipment	Model No.	Serial No.	FCC ID	Trade Name
Adapter	XC-0501000-06-B	/	/	ADAPTER

**Note:**

1. All the equipment/cables were placed in the worst-case configuration to maximize the emission during the test.
2. Grounding was established in accordance with the manufacturer's requirements and conditions for the intended use.
3. For conducted measurements (Output Power, 6dB Emission Bandwidth, Power Spectral Density, Spurious Emissions), the antenna of EUT is connected to the test equipment via temporary antenna connector, the antenna connector is soldered on the antenna port of EUT, and the temporary antenna connector is listed in the Test Instruments.

## 5. Facilities and Accreditations

### 5.1. Facilities

The test facility is recognized, certified, or accredited by the following organizations:

- FCC - Registration No.: 572331

Shenzhen Tongce Testing Lab

The 3m Semi-anechoic chamber has been registered and fully described in a report with the (FCC) Federal Communications Commission. The acceptance letter from the FCC is maintained in our files.

- IC - Registration No.: 10668A-1

The 3m Semi-anechoic chamber of Shenzhen TCT Testing Technology Co., Ltd. has been registered by Certification and Engineering Bureau of Industry Canada for radio equipment testing

### 5.2. Location

Shenzhen Tongce Testing Lab

Address: 1F, Leinuo Watch Building, Fuyong Town, Baoan Dist, Shenzhen, China

TEL: +86-755-27673339

### 5.3. Measurement Uncertainty

The reported uncertainty of measurement  $y \pm U$ , where expanded uncertainty  $U$  is based on a standard uncertainty multiplied by a coverage factor of  $k=2$ , providing a level of confidence of approximately 95 %.

No.	Item	MU
1	Conducted Emission	$\pm 2.56\text{dB}$
2	RF power, conducted	$\pm 0.12\text{dB}$
3	Spurious emissions, conducted	$\pm 0.11\text{dB}$
4	All emissions, radiated(<1G)	$\pm 3.92\text{dB}$
5	All emissions, radiated(>1G)	$\pm 4.28\text{dB}$
6	Temperature	$\pm 0.1^\circ\text{C}$
7	Humidity	$\pm 1.0\%$

## 6. Test Results and Measurement Data

### 6.1. Antenna requirement

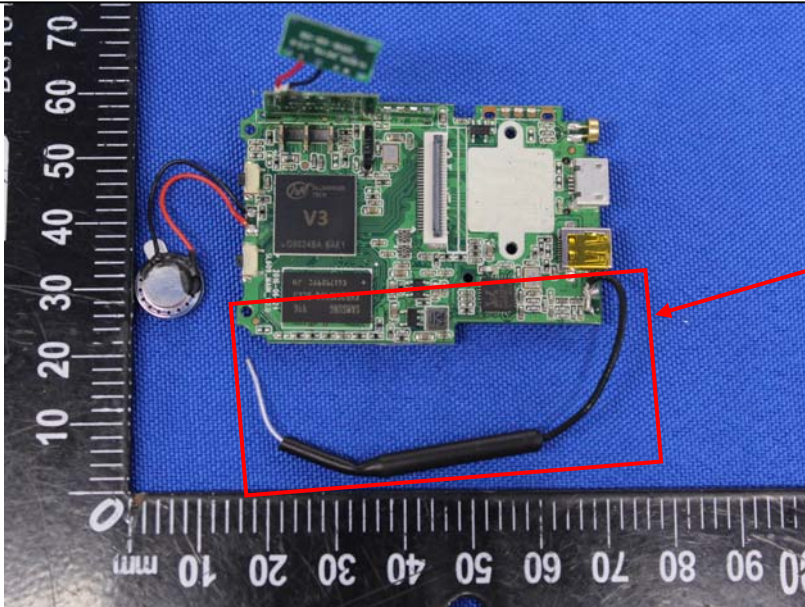
<b>Standard requirement:</b>	FCC Part15 C Section 15.203 /247(c)
<p>15.203 requirement: An intentional radiator shall be designed to ensure that no antenna other than that furnished by the responsible party shall be used with the device. The use of a permanently attached antenna or of an antenna that uses a unique coupling to the intentional radiator, the manufacturer may design the unit so that a broken antenna can be replaced by the user, but the use of a standard antenna jack or electrical connector is prohibited.</p> <p>15.247(c) (1)(i) requirement: (i) Systems operating in the 2400-2483.5 MHz band that is used exclusively for fixed. Point-to-point operations may employ transmitting antennas with directional gain greater than 6dBi provided the maximum conducted output power of the intentional radiator is reduced by 1 dB for every 3 dB that the directional gain of the antenna exceeds 6dBi.</p>	
<b>E.U.T Antenna:</b>	
<p>The WIFI antenna is an internal antenna which permanently attached, and the best case gain of the antenna is 2dBi.</p>	
	

## 6.2. Conducted Emission

### 6.2.1. Test Specification

<b>Test Requirement:</b>	FCC Part15 C Section 15.207														
<b>Test Method:</b>	ANSI C63.10:2013														
<b>Frequency Range:</b>	150 kHz to 30 MHz														
<b>Receiver setup:</b>	RBW=9 kHz, VBW=30 kHz, Sweep time=auto														
<b>Limits:</b>	<table border="1"> <thead> <tr> <th rowspan="2">Frequency range (MHz)</th> <th colspan="2">Limit (dBuV)</th> </tr> <tr> <th>Quasi-peak</th> <th>Average</th> </tr> </thead> <tbody> <tr> <td>0.15-0.5</td> <td>66 to 56*</td> <td>56 to 46*</td> </tr> <tr> <td>0.5-5</td> <td>56</td> <td>46</td> </tr> <tr> <td>5-30</td> <td>60</td> <td>50</td> </tr> </tbody> </table>	Frequency range (MHz)	Limit (dBuV)		Quasi-peak	Average	0.15-0.5	66 to 56*	56 to 46*	0.5-5	56	46	5-30	60	50
	Frequency range (MHz)		Limit (dBuV)												
		Quasi-peak	Average												
	0.15-0.5	66 to 56*	56 to 46*												
0.5-5	56	46													
5-30	60	50													
<b>Test Setup:</b>	<p><i>Remark</i> E.U.T: Equipment Under Test LISN: Line Impedance Stabilization Network Test table height=0.8m</p>														
<b>Test Mode:</b>	Charging + transmitting with modulation														
<b>Test Procedure:</b>	<ol style="list-style-type: none"> <li>The E.U.T is connected to the main power through a line impedance stabilization network (L.I.S.N.). This provides a 50ohm/50uH coupling impedance for the measuring equipment.</li> <li>The peripheral devices are also connected to the main power through a LISN that provides a 50ohm/50uH coupling impedance with 50ohm termination. (Please refer to the block diagram of the test setup and photographs).</li> <li>Both sides of A.C. line are checked for maximum conducted interference. In order to find the maximum emission, the relative positions of equipment and all of the interface cables must be changed according to ANSI C63.10: 2013 on conducted measurement.</li> </ol>														
<b>Test Result:</b>	PASS														

**6.2.2. Test Instruments**

Conducted Emission Shielding Room Test Site (843)				
Equipment	Manufacturer	Model	Serial Number	Calibration Due
EMI Test Receiver	R&S	ESCS30	100139	Aug. 11, 2017
LISN	Schwarzbeck	NSLK 8126	8126453	Aug. 16, 2017
Coax cable (9kHz-40GHz)	TCT	CE-05	N/A	Aug. 11, 2017
EMI Test Software	Shurple Technology	EZ-EMC	N/A	N/A

**Note:** The calibration interval of the above test instruments is 12 months and the calibrations are traceable to international system unit (SI).

6.2.3. Test data

Please refer to following diagram for individual

Conducted Emission on Line Terminal of the power line (150 kHz to 30MHz)

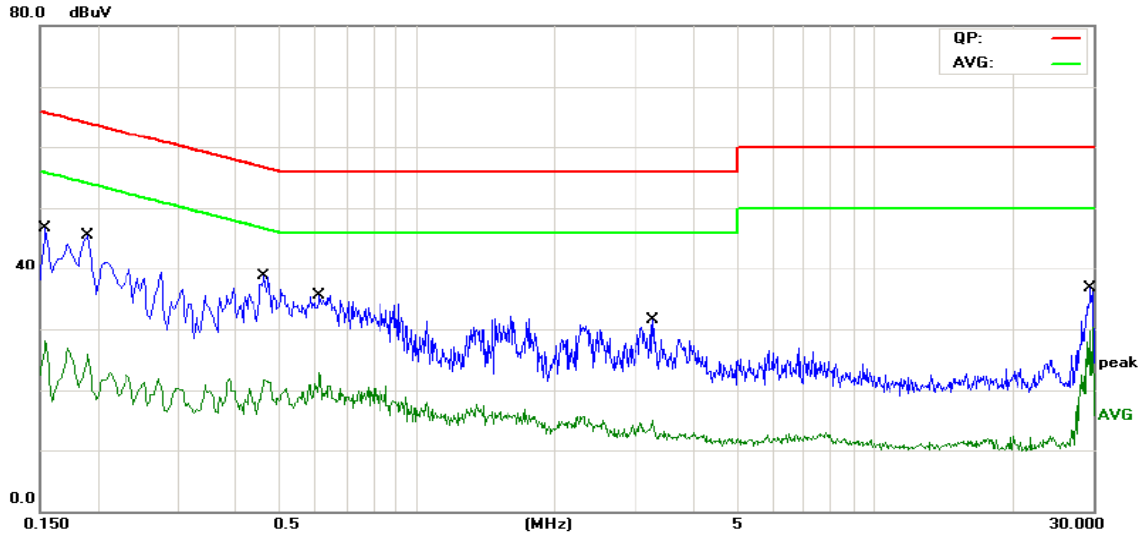

Site Chamber #2 Phase: **L1** Temperature: 25 (C)  
Limit: FCC Part 15B Class B Conduction(QP) Power: AC 120V/60Hz Humidity: 55 %

No.	Mk.	Freq. MHz	Reading Level dBuV	Correct Factor dB	Measure- ment dBuV	Limit dBuV	Over dB	Detector	Comment
1		0.1544	35.19	11.49	46.68	65.75	-19.07	QP	
2		0.1544	16.62	11.49	28.11	55.75	-27.64	AVG	
3		0.1905	34.02	11.47	45.49	64.01	-18.52	QP	
4		0.1905	14.41	11.47	25.88	54.01	-28.13	AVG	
5	*	0.4650	27.41	11.33	38.74	56.60	-17.86	QP	
6		0.4650	10.46	11.33	21.79	46.60	-24.81	AVG	
7		0.6134	24.33	11.26	35.59	56.00	-20.41	QP	
8		0.6134	11.64	11.26	22.90	46.00	-23.10	AVG	
9		3.2775	20.26	11.24	31.50	56.00	-24.50	QP	
10		3.2775	3.58	11.24	14.82	46.00	-31.18	AVG	
11		29.9130	26.05	10.68	36.73	60.00	-23.27	QP	
12		29.9130	19.70	10.68	30.38	50.00	-19.62	AVG	

**Note:**

- Freq. = Emission frequency in MHz
- Reading level (dBuV) = Receiver reading
- Corr. Factor (dB) = Antenna factor + Cable loss
- Measurement (dBuV) = Reading level (dBuV) + Corr. Factor (dB)
- Limit (dBuV) = Limit stated in standard
- Margin (dB) = Measurement (dBuV) – Limits (dBuV)
- Q.P. =Quasi-Peak
- AVG =average
- \* is meaning the worst frequency has been tested in the frequency range 150 kHz to 30MHz.

**Conducted Emission on Neutral Terminal of the power line (150 kHz to 30MHz)**

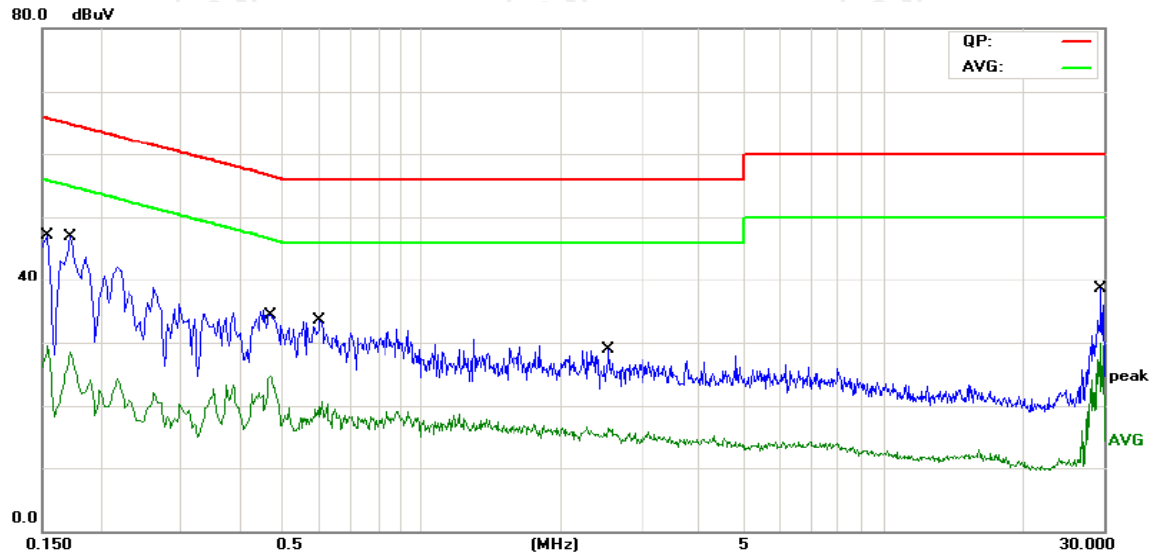

Site Chamber #2 Phase: **N** Temperature: 25 (C)  
Limit: FCC Part 15B Class B Conduction(QP) Power: AC 120V/60Hz Humidity: 55 %

No.	Mk.	Freq. MHz	Reading Level dBuV	Correct Factor dB	Measure- ment dBuV	Limit dBuV	Over dB	Detector	Comment
1		0.1544	35.70	11.49	47.19	65.75	-18.56	QP	
2		0.1544	17.98	11.49	29.47	55.75	-26.28	AVG	
3	*	0.1725	35.51	11.48	46.99	64.83	-17.84	QP	
4		0.1725	16.95	11.48	28.43	54.83	-26.40	AVG	
5		0.4695	23.05	11.32	34.37	56.52	-22.15	QP	
6		0.4695	13.44	11.32	24.76	46.52	-21.76	AVG	
7		0.6000	22.15	11.27	33.42	56.00	-22.58	QP	
8		0.6000	9.34	11.27	20.61	46.00	-25.39	AVG	
9		2.5170	17.38	11.51	28.89	56.00	-27.11	QP	
10		2.5170	4.88	11.51	16.39	46.00	-29.61	AVG	
11		29.6655	27.88	10.69	38.57	60.00	-21.43	QP	
12		29.6655	19.22	10.69	29.91	50.00	-20.09	AVG	

**Note:**

- Freq. = Emission frequency in MHz
- Reading level (dBuV) = Receiver reading
- Corr. Factor (dB) = Antenna factor + Cable loss
- Measurement (dBuV) = Reading level (dBuV) + Corr. Factor (dB)
- Limit (dBuV) = Limit stated in standard
- Margin (dB) = Measurement (dBuV) – Limits (dBuV)
- Q.P. =Quasi-Peak
- AVG =average
- \* is meaning the worst frequency has been tested in the frequency range 150 kHz to 30MHz.



**6.2.4. Maximum Conducted (Average) Output Power**

**6.2.5. Test Specification**

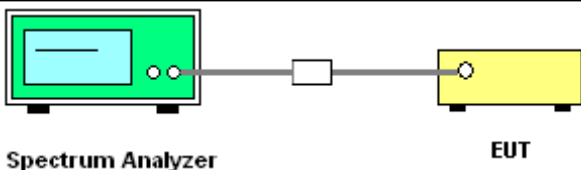
<b>Test Requirement:</b>	FCC Part15 C Section 15.247 (b)(3)
<b>Test Method:</b>	KDB 558074
<b>Limit:</b>	30dBm
<b>Test Setup:</b>	 <p style="text-align: center;">Spectrum Analyzer                      EUT</p>
<b>Test Mode:</b>	Transmitting mode with modulation
<b>Test Procedure:</b>	<ol style="list-style-type: none"> <li>1. The testing follows the Measurement Procedure of FCC KDB No. 558074 DTS D01 Meas. Guidance v03r05.</li> <li>2. The RF output of EUT was connected to the spectrum analyzer by RF cable and attenuator. The path loss was compensated to the results for each measurement.</li> <li>3. Set to the maximum power setting and enable the EUT transmit continuously.</li> <li>4. Measure the conducted output power and record the results in the test report.</li> </ol>
<b>Test Result:</b>	PASS

**6.2.6. Test Instruments**

Equipment	Manufacturer	Model	Serial Number	Calibration Due
Spectrum Analyzer	R&S	FSU	200054	Aug. 11, 2017
RF cable (9kHz-40GHz)	TCT	RE-06	N/A	Aug. 12, 2017
Antenna Connector	TCT	RFC-01	N/A	Aug. 12, 2017

**Note:** The calibration interval of the above test instruments is 12 months and the calibrations are traceable to international system unit (SI).



**6.2.7. Test Data**

802.11b mode			
Test channel	Maximum Conducted Output Power (dBm)	Limit (dBm)	Result
Lowest	16.40	30.00	PASS
Middle	15.51	30.00	PASS
Highest	15.28	30.00	PASS

802.11g mode			
Test channel	Maximum Conducted Output Power (dBm)	Limit (dBm)	Result
Lowest	13.36	30.00	PASS
Middle	14.16	30.00	PASS
Highest	13.91	30.00	PASS

802.11n(H20) mode			
Test channel	Maximum Conducted Output Power (dBm)	Limit (dBm)	Result
Lowest	13.12	30.00	PASS
Middle	14.42	30.00	PASS
Highest	14.21	30.00	PASS

802.11n(H40) mode			
Test channel	Maximum Conducted Output Power (dBm)	Limit (dBm)	Result
Lowest	13.39	30.00	PASS
Middle	13.28	30.00	PASS
Highest	13.22	30.00	PASS

Test plots as follows:  
802.11b Modulation

### Lowest channel

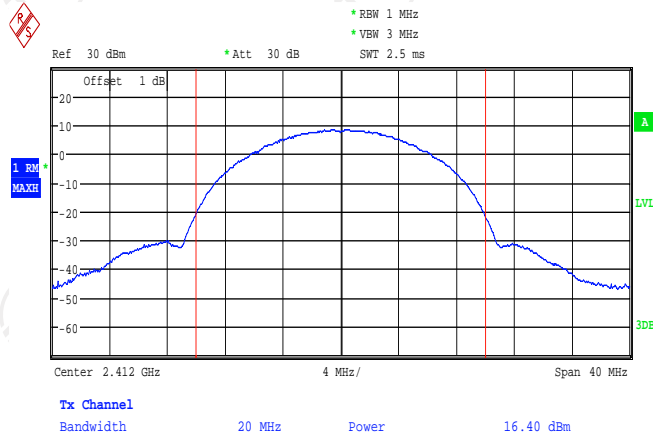

### Middle channel

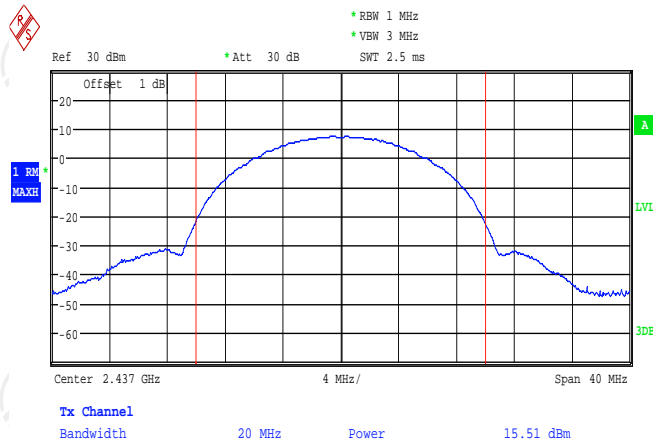

### Highest channel

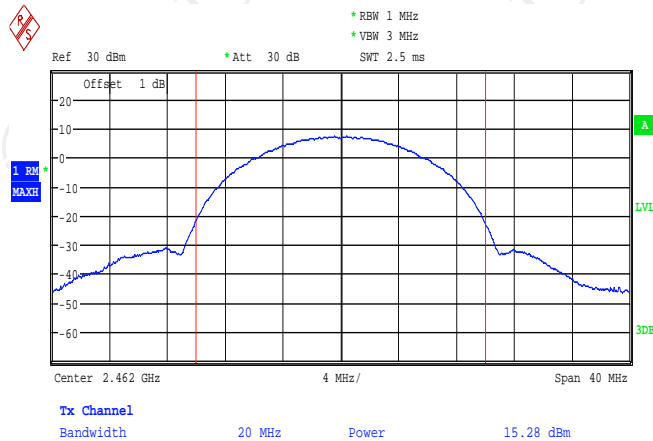

## 802.11g Modulation

### Lowest channel

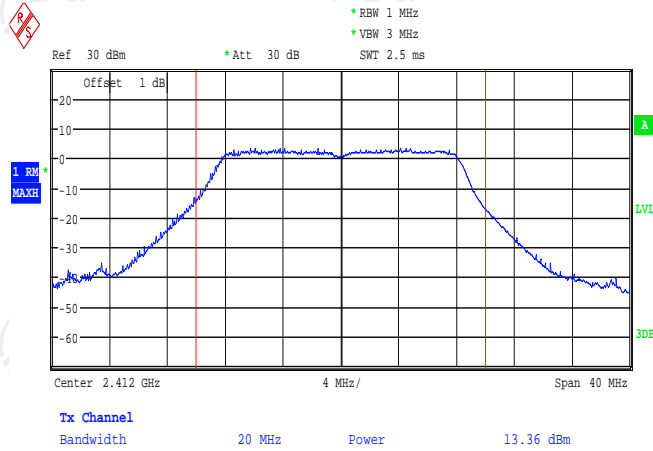

### Middle channel

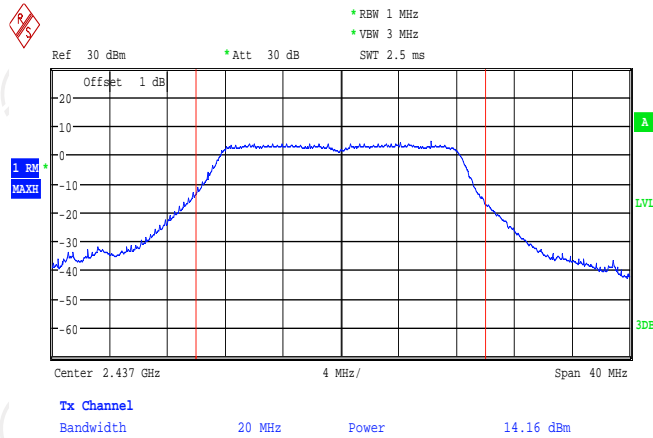

### Highest channel

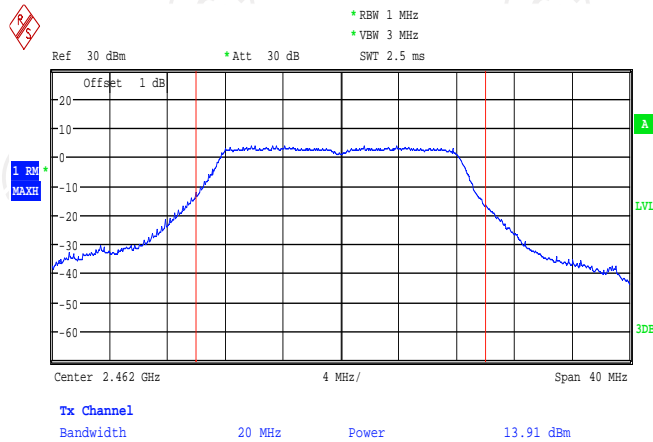

## 802.11n (HT20) Modulation

### Lowest channel

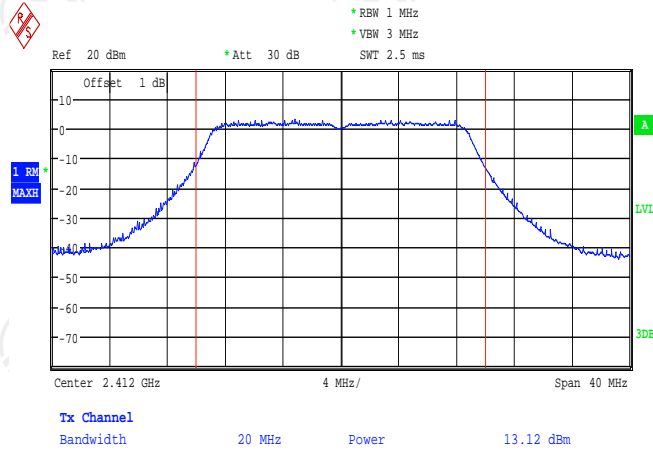

### Middle channel

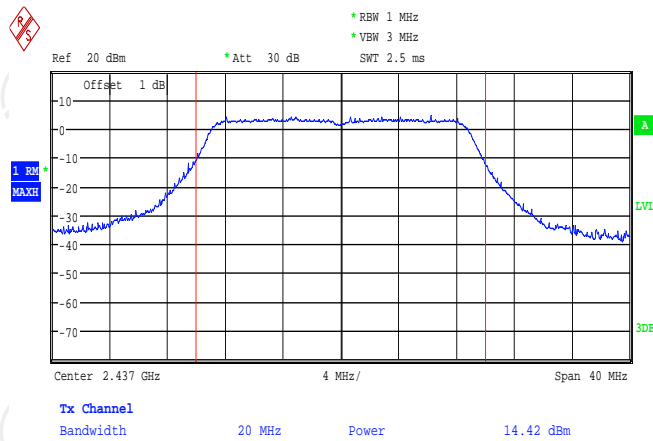

### Highest channel

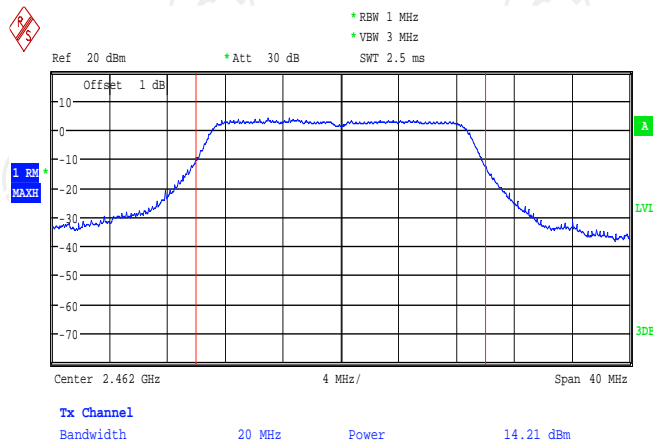

**802.11n (HT40) Modulation**

**Lowest channel**

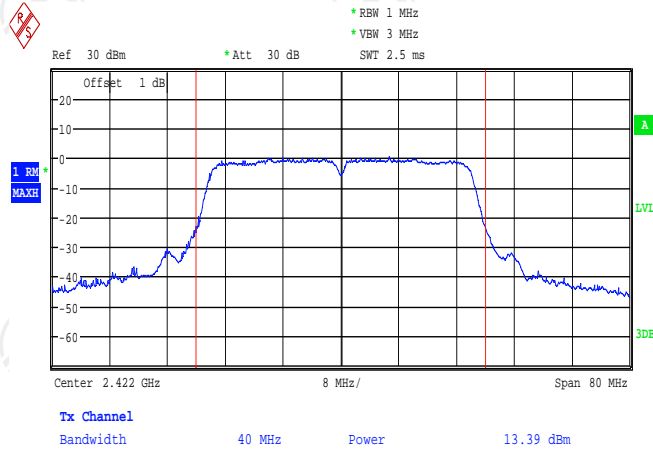

**Middle channel**

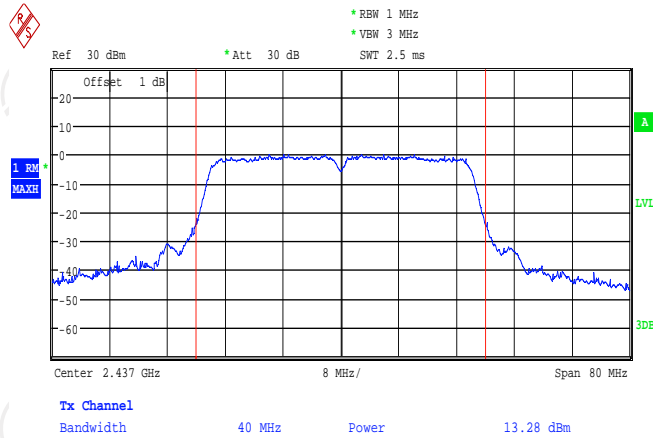

**Highest channel**

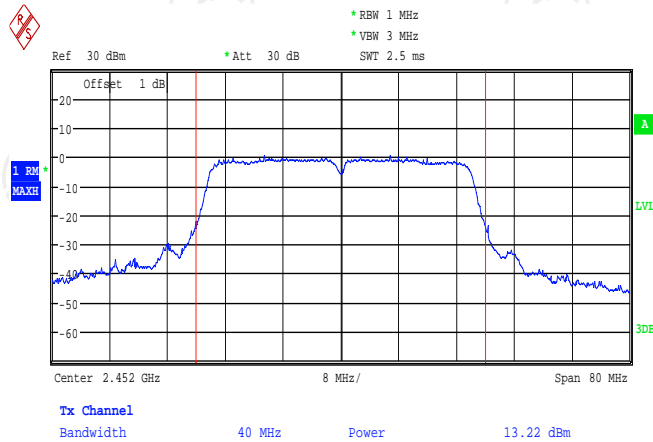

### 6.3. Emission Bandwidth

#### 6.3.1. Test Specification

<b>Test Requirement:</b>	FCC Part15 C Section 15.247 (a)(2)
<b>Test Method:</b>	KDB 558074
<b>Limit:</b>	>500kHz
<b>Test Setup:</b>	 <p style="text-align: center;">Spectrum Analyzer                      EUT</p>
<b>Test Mode:</b>	Transmitting mode with modulation
<b>Test Procedure:</b>	<ol style="list-style-type: none"> <li>1. The testing follows FCC KDB Publication No. 558074 DTS D01 Meas. Guidance v03r05.</li> <li>2. Set to the maximum power setting and enable the EUT transmit continuously.</li> <li>3. Make the measurement with the spectrum analyzer's resolution bandwidth (RBW) = 100 kHz. Set the Video bandwidth (VBW) = 300 kHz. In order to make an accurate measurement. The 6dB bandwidth must be greater than 500 kHz.</li> <li>4. Measure and record the results in the test report.</li> </ol>
<b>Test Result:</b>	PASS

#### 6.3.2. Test Instruments

RF Test Room				
Equipment	Manufacturer	Model	Serial Number	Calibration Due
Spectrum Analyzer	R&S	FSU	200054	Aug. 11, 2017
RF cable (9kHz-40GHz)	TCT	RE-06	N/A	Aug. 12, 2017
Antenna Connector	TCT	RFC-01	N/A	Aug. 12, 2017

**Note:** The calibration interval of the above test instruments is 12 months and the calibrations are traceable to international system unit (SI).

**6.3.3. Test data**

Test channel	6dB Emission Bandwidth (MHz)			
	802.11b	802.11g	802.11n(H20)	802.11n(H40)
Lowest	10.06	16.60	17.82	36.54
Middle	10.06	16.60	17.82	36.41
Highest	10.06	16.60	17.88	36.54
Limit:	>500k			
Test Result:	PASS			

Test plots as follows:

## 802.11b Modulation

### Lowest channel

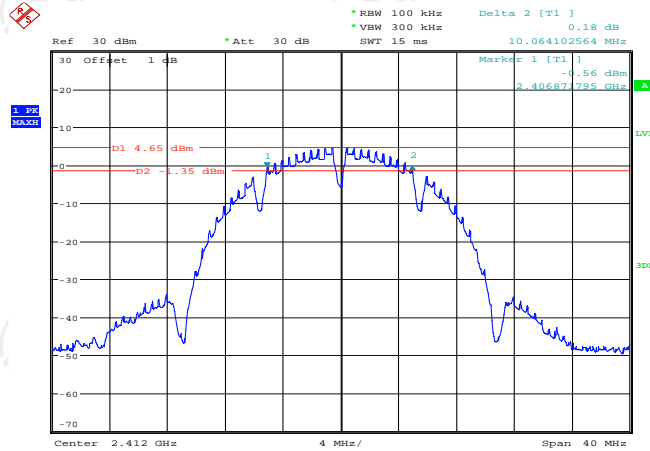

Date: 5 JUN. 2017 17:26:38

### Middle channel

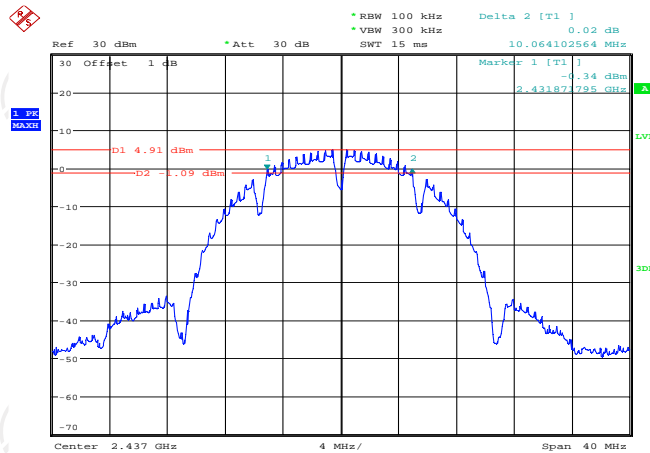

Date: 5 JUN. 2017 17:25:14

### Highest channel

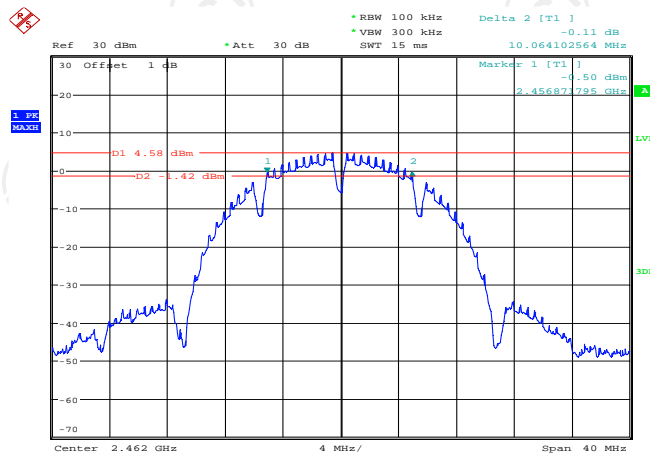

Date: 5 JUN. 2017 17:23:50



## 802.11g Modulation

### Lowest channel

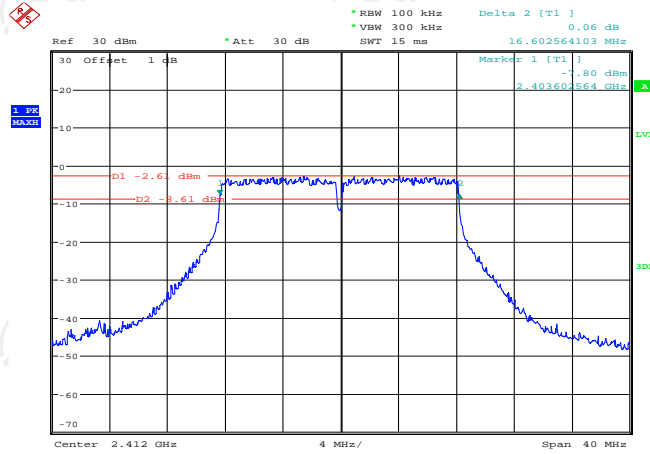

Date: 5 JUN. 2017 18:38:23

### Middle channel

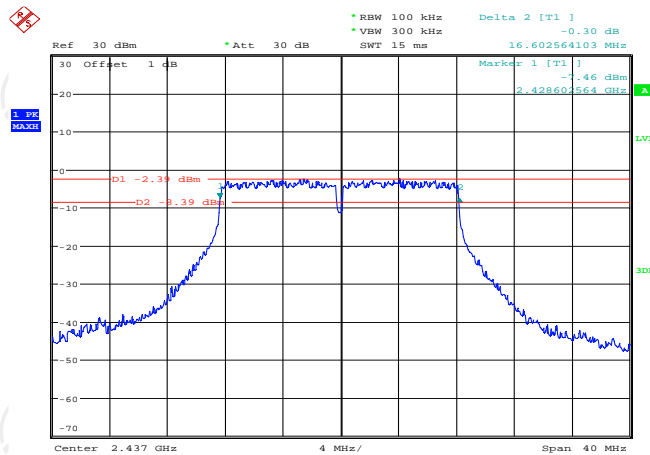

Date: 5 JUN. 2017 18:37:21

### Highest channel

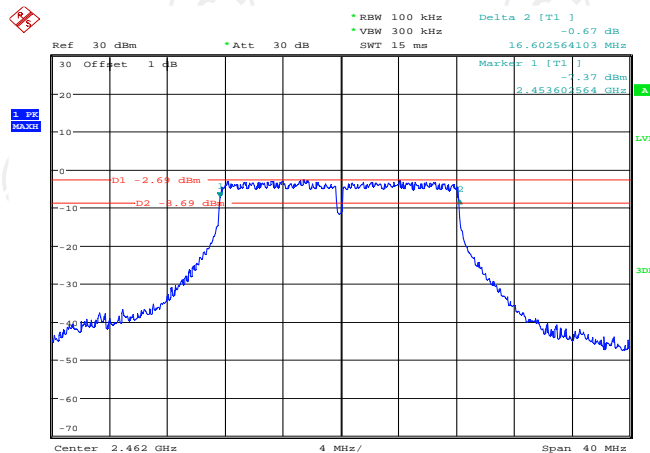

Date: 5 JUN. 2017 18:39:53

## 802.11n (HT20) Modulation

### Lowest channel

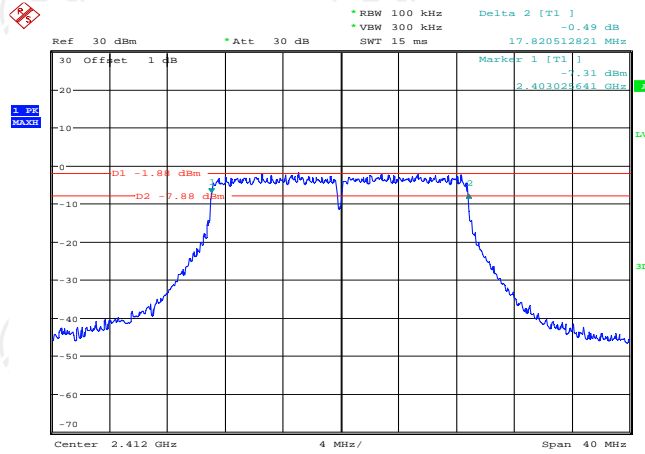

Date: 5.JUN.2017 19:43:25

### Middle channel

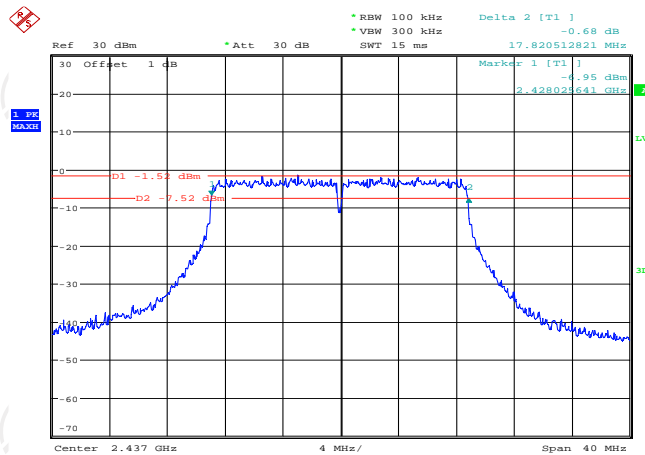

Date: 5.JUN.2017 19:44:36

### Highest channel

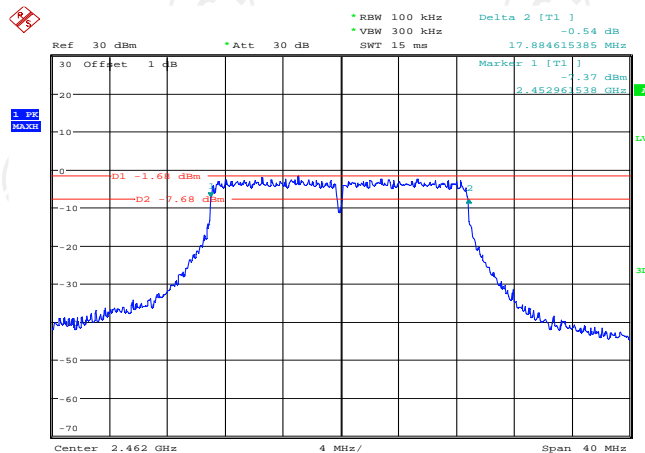

Date: 5.JUN.2017 19:48:38

## 802.11n (HT40) Modulation

### Lowest channel

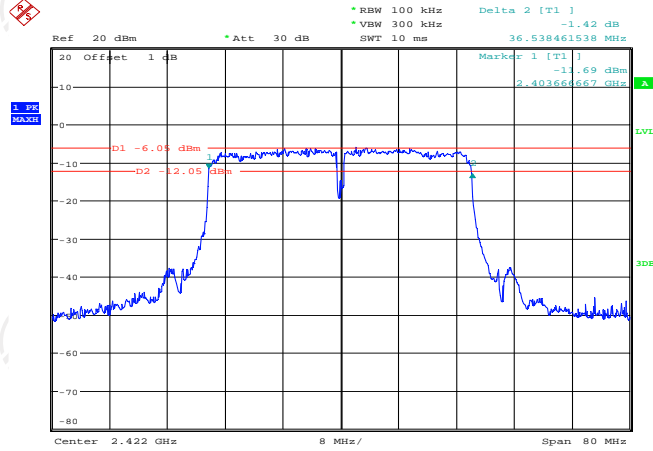

Date: 5 JUN. 2017 20:17:14

### Middle channel

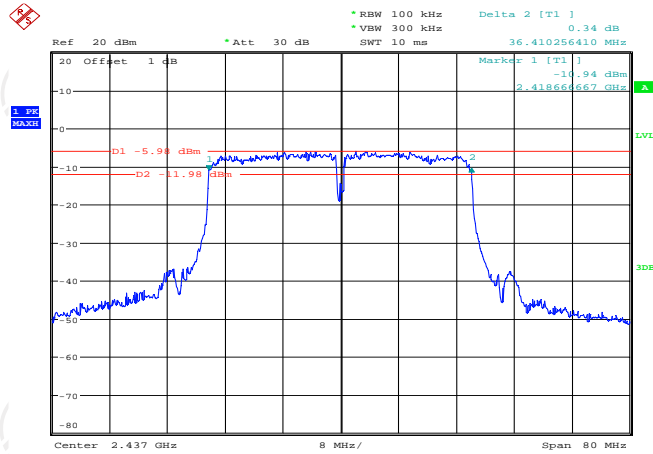

Date: 5 JUN. 2017 20:15:44

### Highest channel

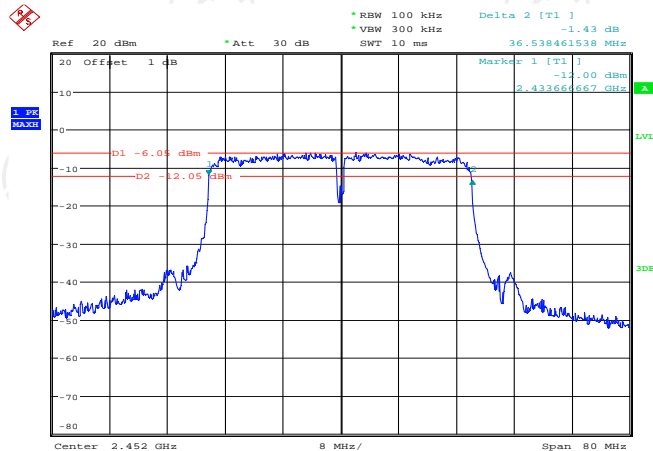

Date: 5 JUN. 2017 20:12:05

## 6.4. Power Spectral Density

### 6.4.1. Test Specification

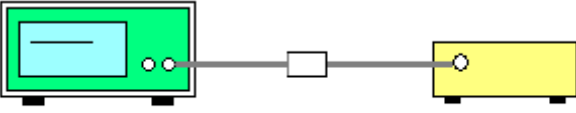
<b>Test Requirement:</b>	FCC Part15 C Section 15.247 (e)
<b>Test Method:</b>	KDB 558074
<b>Limit:</b>	The average power spectral density shall not be greater than 8dBm in any 3kHz band at any time interval of continuous transmission.
<b>Test Setup:</b>	 <p style="text-align: center;">Spectrum Analyzer                      EUT</p>
<b>Test Mode:</b>	Transmitting mode with modulation
<b>Test Procedure:</b>	<ol style="list-style-type: none"> <li>1. The testing follows Measurement Procedure 10.3 Method AVGPSD of FCC KDB Publication No.558074 D01 DTS Meas. Guidance v03r05</li> <li>2. The RF output of EUT was connected to the spectrum analyzer by RF cable and attenuator. The path loss was compensated to the results for each measurement.</li> <li>3. Set to the maximum power setting and enable the EUT transmit continuously.</li> <li>4. Make the measurement with the spectrum analyzer's resolution bandwidth (RBW): <math>3\text{ kHz} \leq \text{RBW} \leq 100\text{ kHz}</math>. Video bandwidth VBW <math>\geq 3 \times \text{RBW}</math>. Set the span to at least 1.5 times the OBW.</li> <li>5. Detector = RMS, Sweep time = auto couple.</li> <li>6. Employ trace averaging (RMS) mode over a minimum of 100 traces. Use the peak marker function to determine the maximum power level.</li> <li>6. Measure and record the results in the test report.</li> </ol>
<b>Test Result:</b>	PASS

### 6.4.2. Test Instruments

RF Test Room				
Equipment	Manufacturer	Model	Serial Number	Calibration Due
Spectrum Analyzer	R&S	FSU	200054	Aug. 11, 2017
RF cable (9kHz-40GHz)	TCT	RE-06	N/A	Aug. 12, 2017
Antenna Connector	TCT	RFC-01	N/A	Aug. 12, 2017

**Note:** The calibration interval of the above test instruments is 12 months and the calibrations are traceable to international system unit (SI).

**6.4.3. Test data**

Test channel	AVG Power Spectral Density (dBm/3kHz)			
	802.11b	802.11g	802.11n(H20)	802.11n(H40)
Lowest	-15.18	-16.86	-15.58	-18.34
Middle	-14.92	-16.73	-15.29	-17.48
Highest	-15.39	-16.95	-15.81	-18.37
Limit:	8dBm/3kHz			
Test Result:	PASS			

Test plots as follows:

## 802.11b Modulation

### Lowest channel

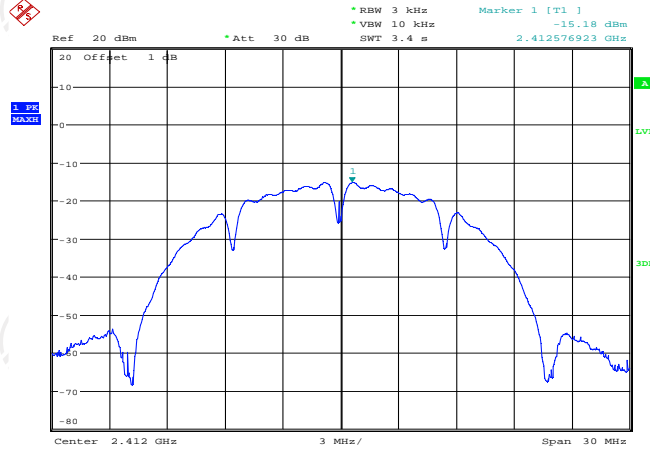

Date: 5.JUN.2017 17:31:34

### Middle channel

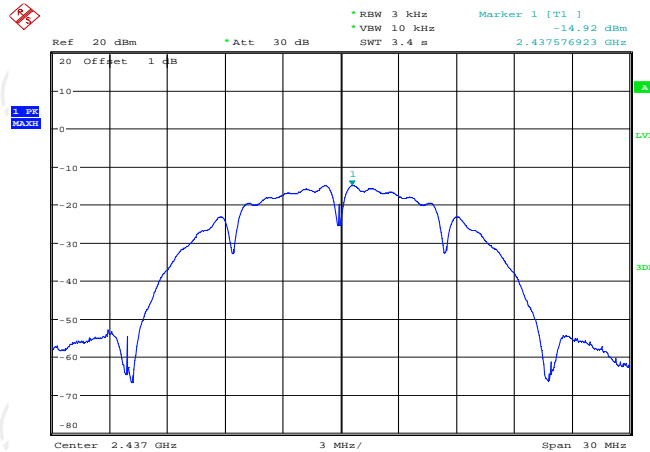

Date: 5.JUN.2017 17:49:12

### Highest channel

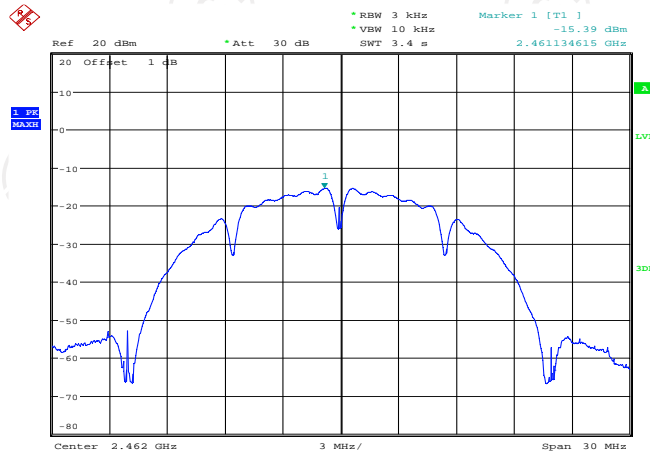

Date: 5.JUN.2017 17:47:53

## 802.11g Modulation

### Lowest channel

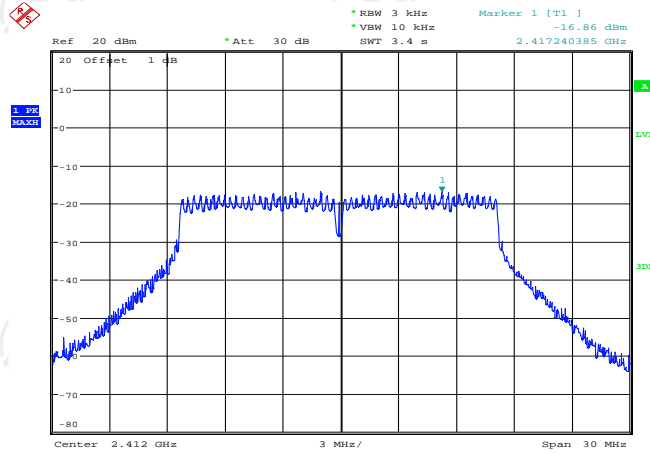

Date: 5 JUN. 2017 19:21:56

### Middle channel

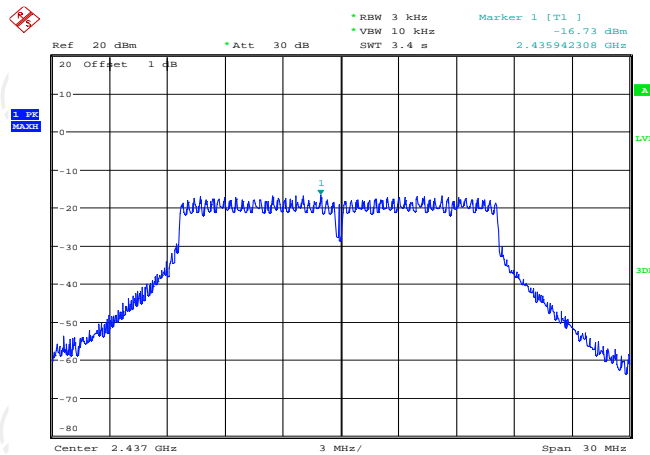

Date: 5 JUN. 2017 19:20:23

### Highest channel

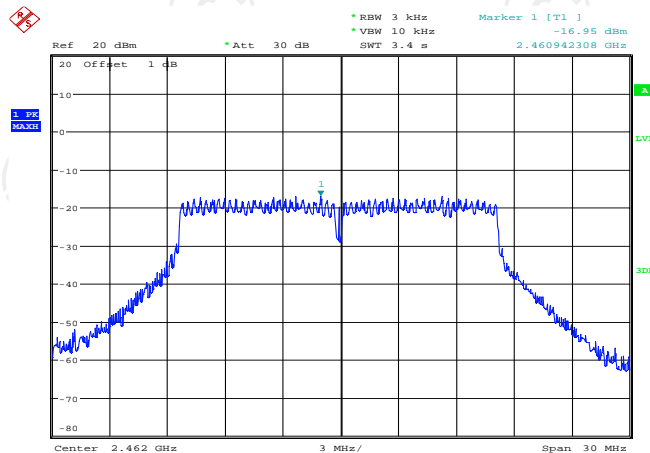

Date: 5 JUN. 2017 19:16:39

## 802.11n (HT20) Modulation

### Lowest channel

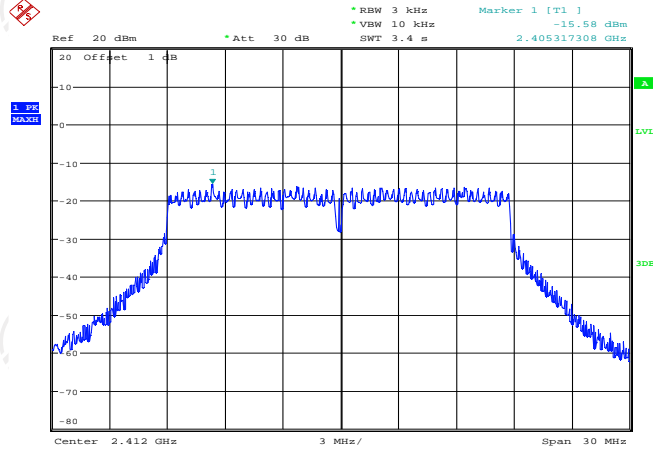

Date: 5 JUN. 2017 19:56:12

### Middle channel

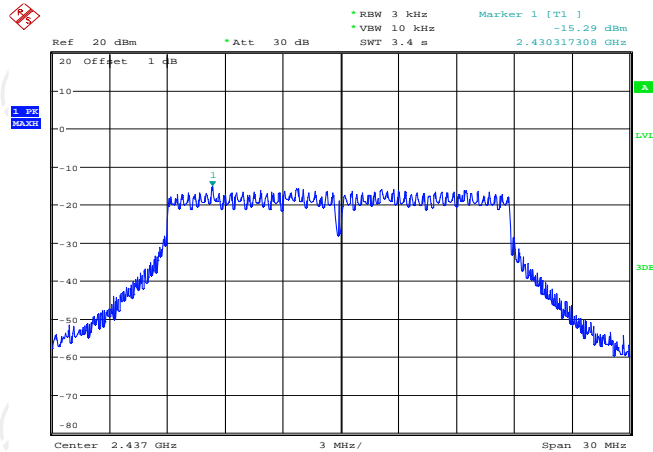

Date: 5 JUN. 2017 19:54:36

### Highest channel

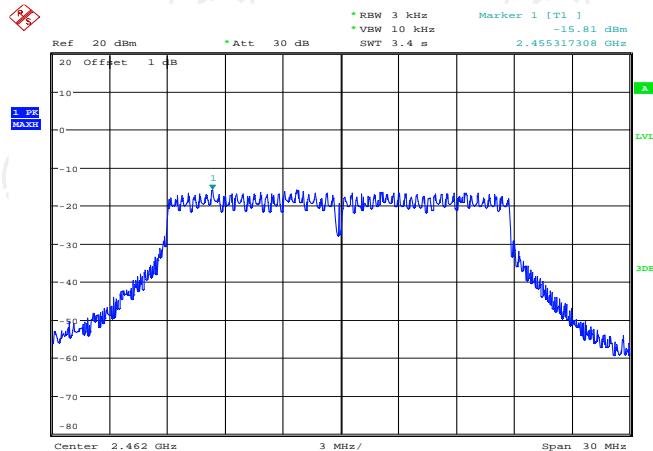

Date: 5 JUN. 2017 19:51:22



## 802.11n (HT40) Modulation

### Lowest channel

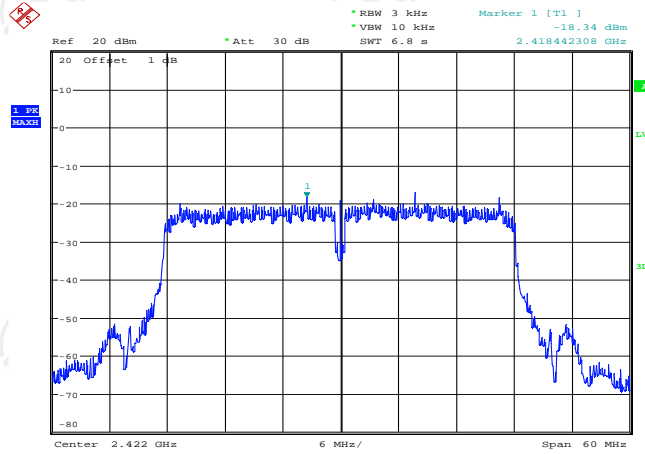

Date: 5 JUN. 2017 20:18:46

### Middle channel

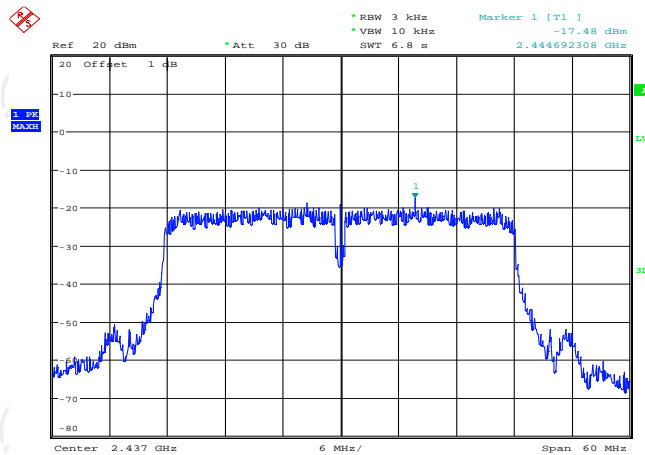

Date: 5 JUN. 2017 20:19:57

### Highest channel

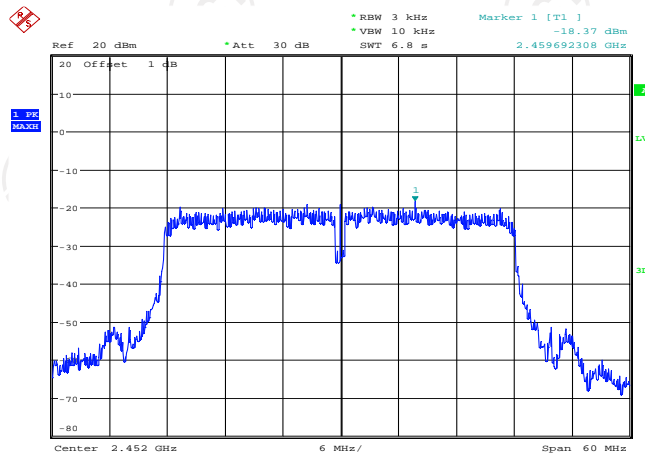

Date: 5 JUN. 2017 20:21:07

### 6.5. Conducted Band Edge and Spurious Emission Measurement

#### 6.5.1. Test Specification

<b>Test Requirement:</b>	FCC Part15 C Section 15.247 (d)
<b>Test Method:</b>	KDB558074
<b>Limit:</b>	In any 100 kHz bandwidth outside of the authorized frequency band, the emissions which fall in the non-restricted bands shall be attenuated at least 20 dB / 30dB relative to the maximum PSD level in 100 kHz by RF conducted measurement and radiated emissions which fall in the restricted bands, as defined in Section 15.205(a), must also comply with the radiated emission limits specified in Section 15.209(a).
<b>Test Setup:</b>	 <p style="text-align: center;">Spectrum Analyzer                                  EUT</p>
<b>Test Mode:</b>	Transmitting mode with modulation
<b>Test Procedure:</b>	<ol style="list-style-type: none"> <li>The testing follows FCC KDB Publication No. 558074 D01 DTS Meas. Guidance v03r05.</li> <li>The RF output of EUT was connected to the spectrum analyzer by RF cable and attenuator. The path loss was compensated to the results for each measurement.</li> <li>Set to the maximum power setting and enable the EUT transmit continuously.</li> <li>Set RBW = 100 kHz, VBW=300 kHz, Peak Detector. Unwanted Emissions measured in any 100 kHz bandwidth outside of the authorized frequency band shall be attenuated by at least 20 dB relative to the maximum in-band peak PSD level in 100 kHz when maximum peak conducted output power procedure is used. If the transmitter complies with the conducted power limits based on the use of RMS averaging over a time interval, the attenuation required under this paragraph shall be 30 dB instead of 20 dB per 15.247(d).</li> <li>Measure and record the results in the test report.</li> <li>The RF fundamental frequency should be excluded against the limit line in the operating frequency band.</li> </ol>
<b>Test Result:</b>	PASS

### 6.5.2. Test Instruments

RF Test Room				
Equipment	Manufacturer	Model	Serial Number	Calibration Due
Spectrum Analyzer	R&S	FSU	200054	Aug. 11, 2017
RF cable (9kHz-40GHz)	TCT	RE-06	N/A	Aug. 12, 2017
Antenna Connector	TCT	RFC-01	N/A	Aug. 12, 2017

**Note:** The calibration interval of the above test instruments is 12 months and the calibrations are traceable to international system unit (SI).

6.5.3. Test Data

802.11b Modulation

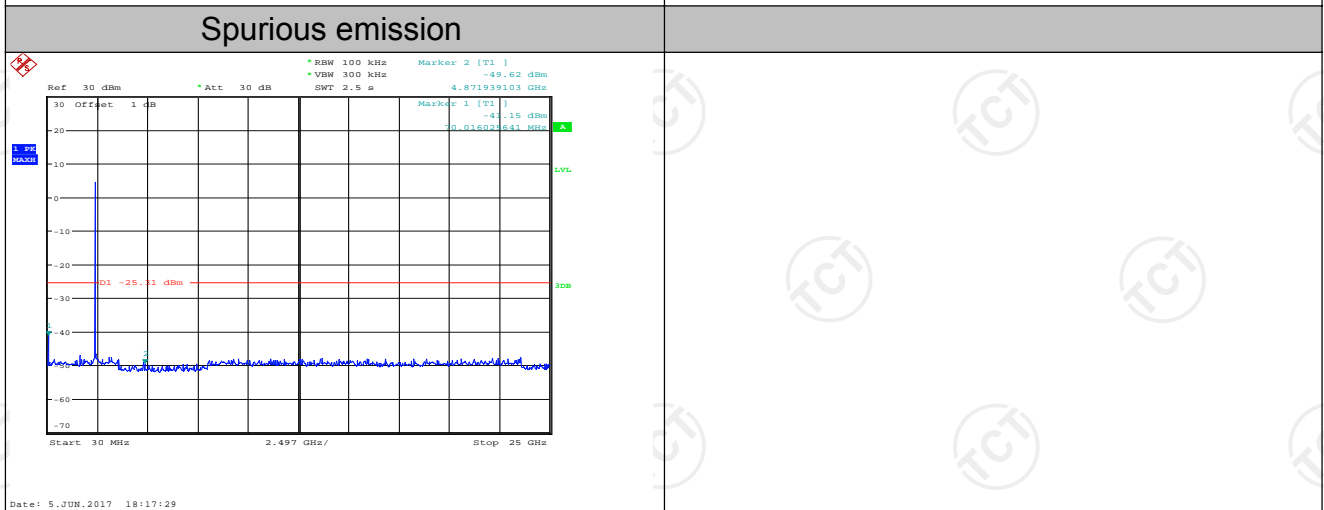
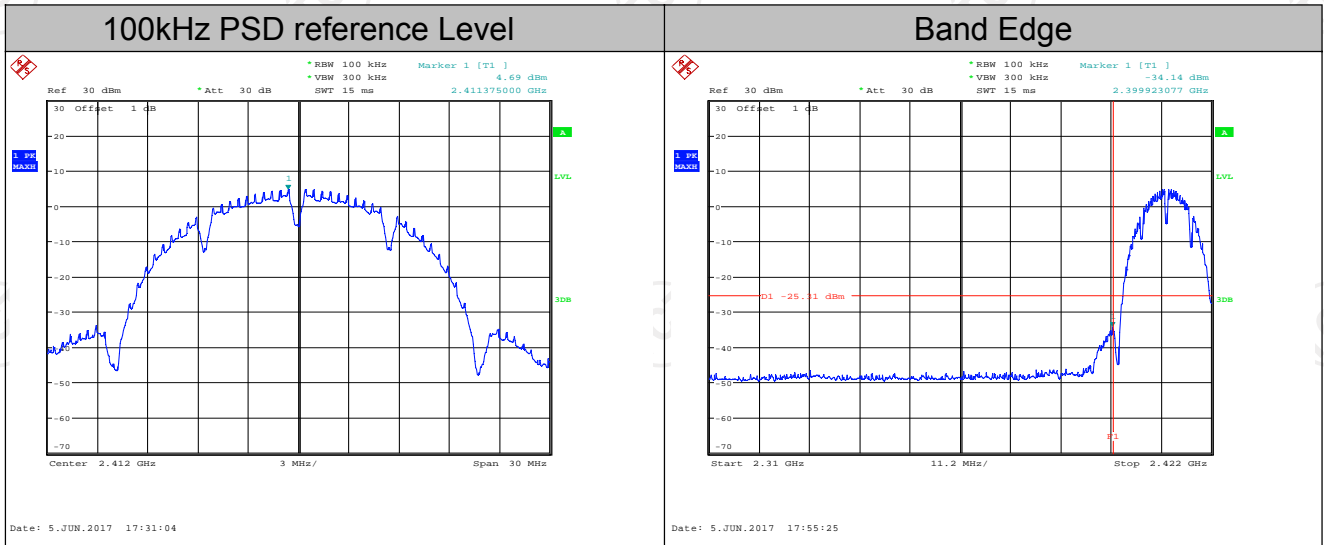

Lowest Channel

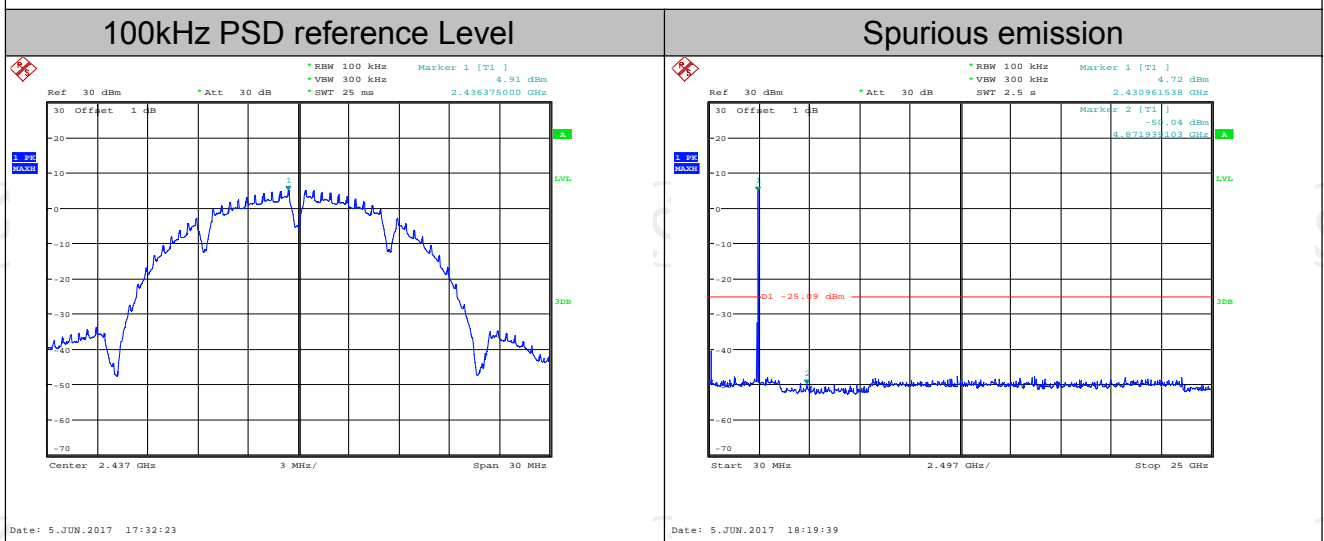

Middle Channel

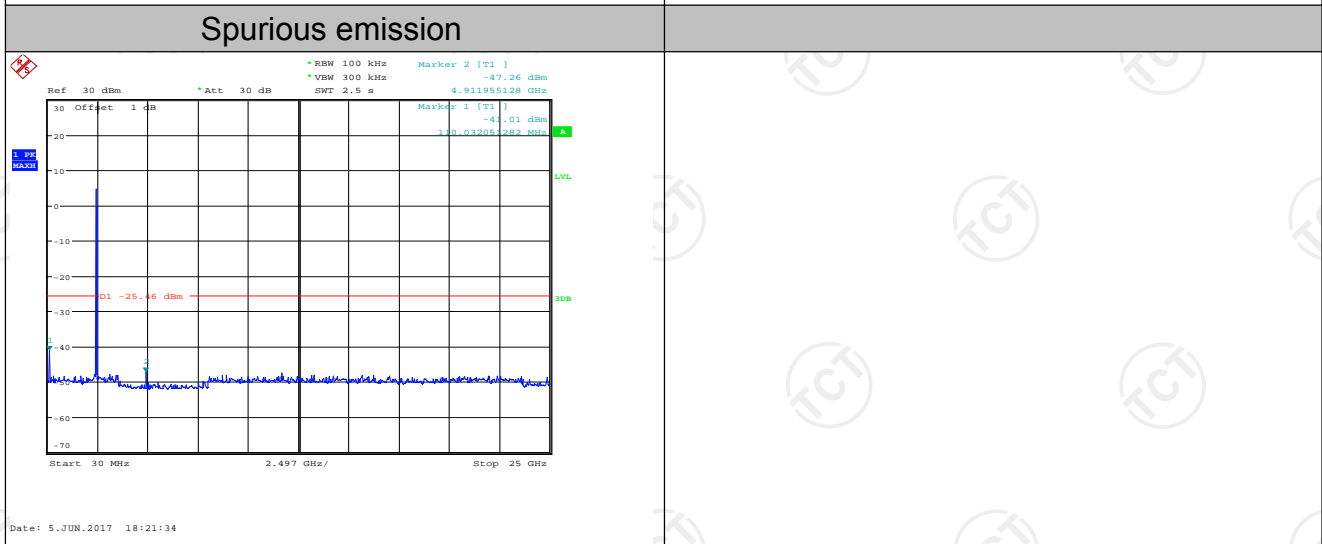
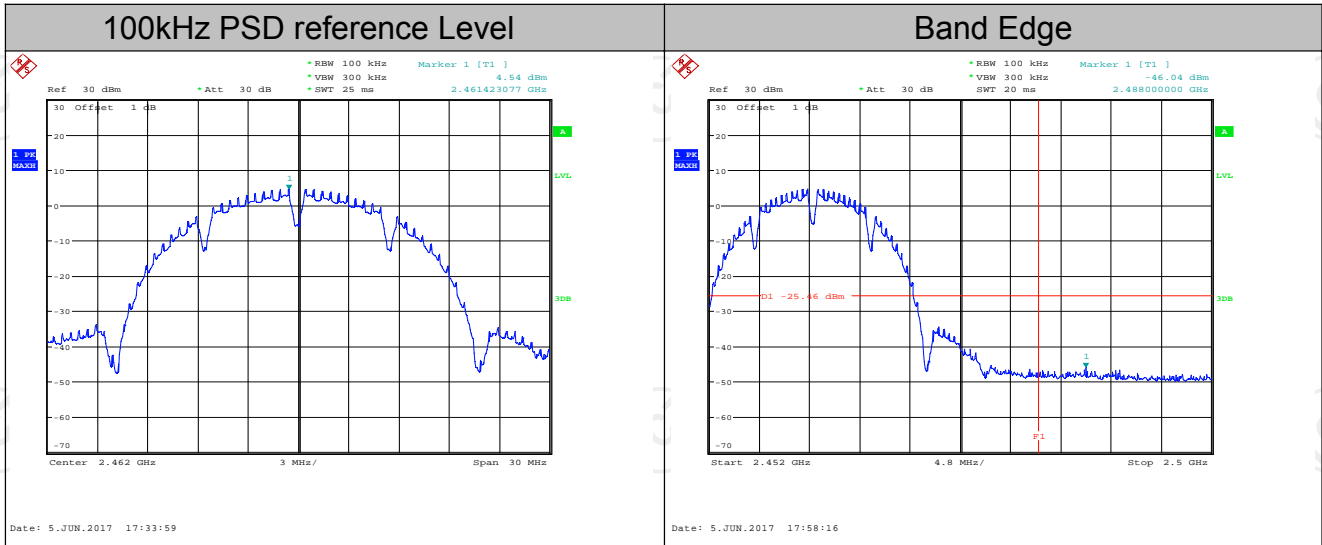

Highest Channel

## 802.11g Modulation

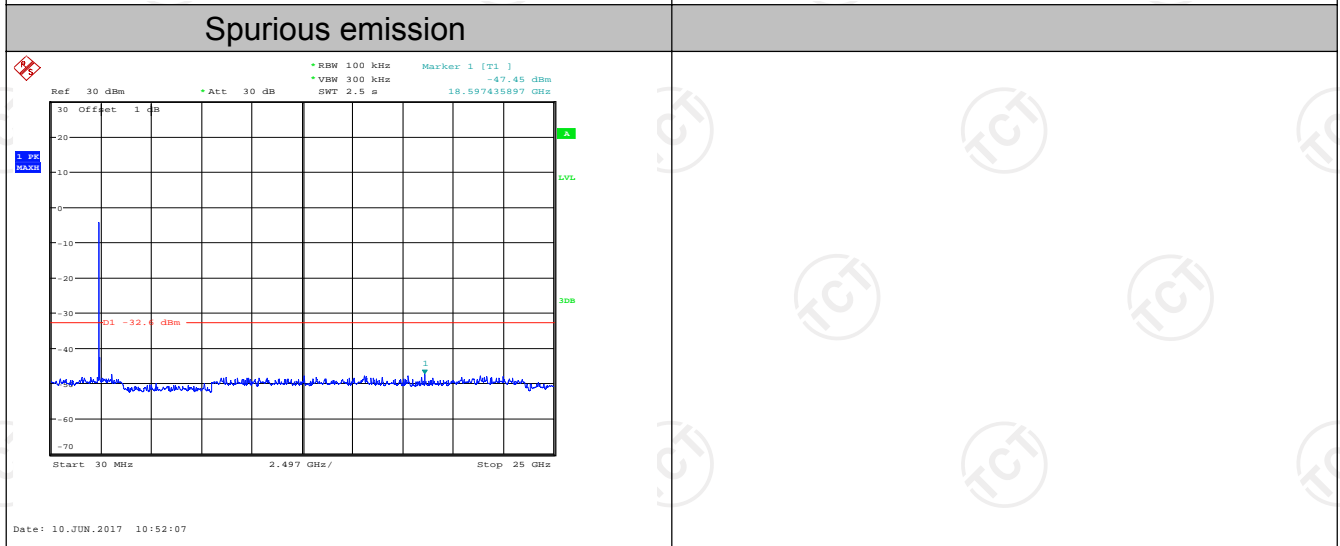
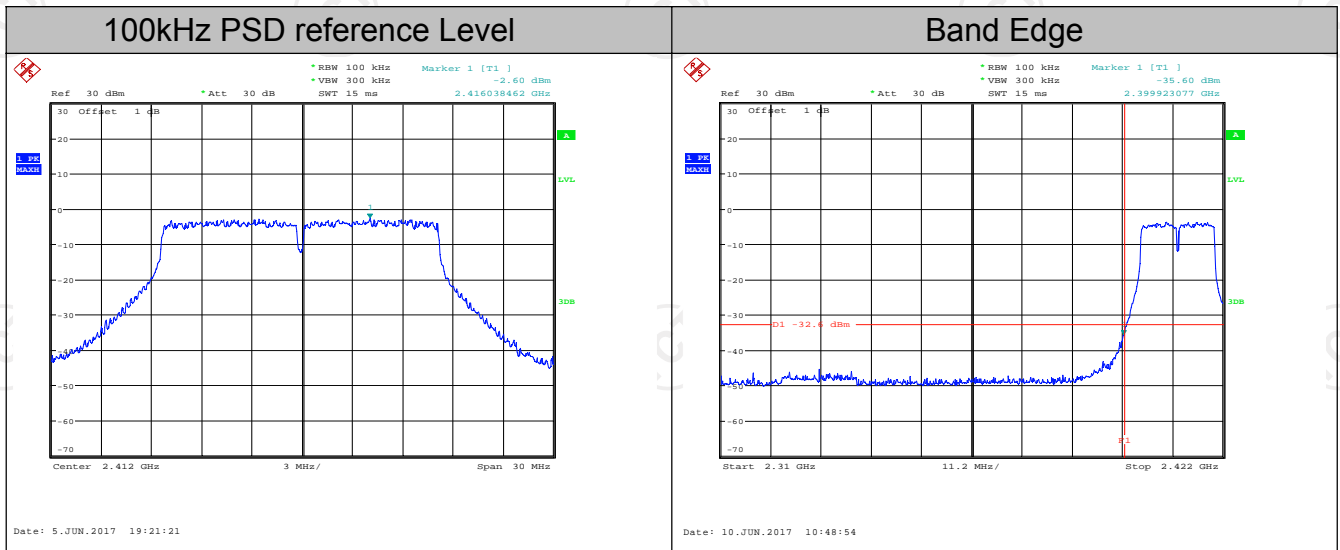

## Lowest Channel

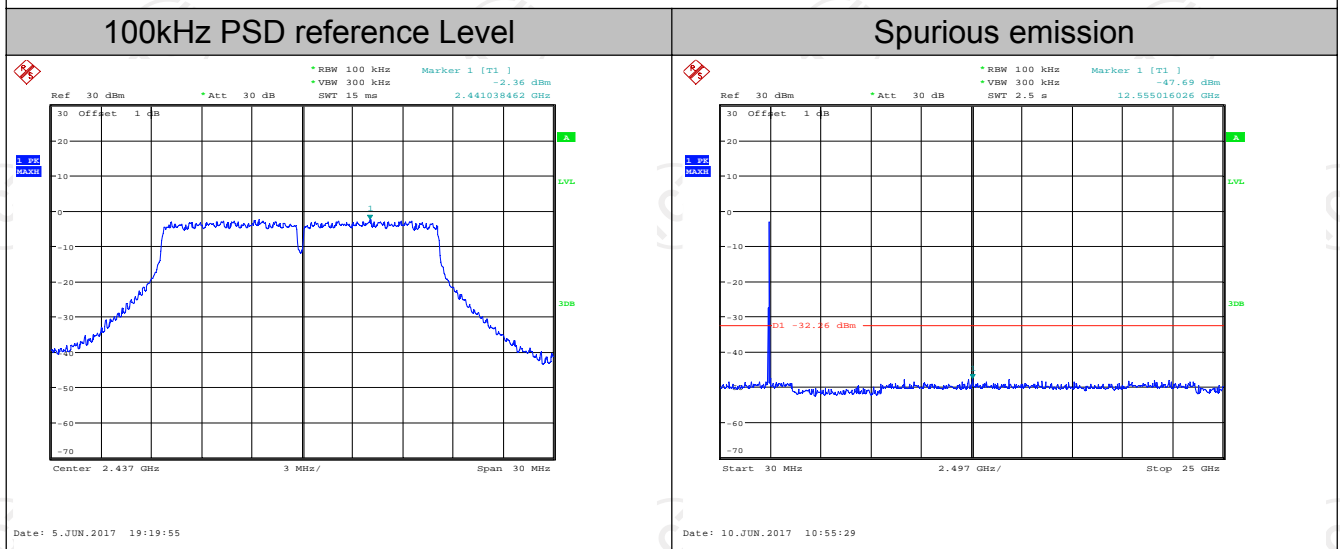

## Middle Channel

## 100kHz PSD reference Level

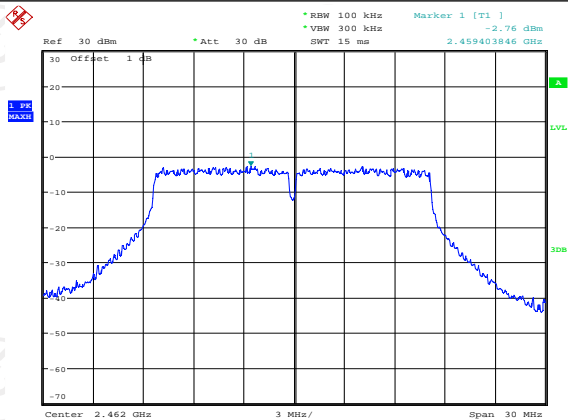

Date: 5 JUN.2017 19:16:07

## Band Edge

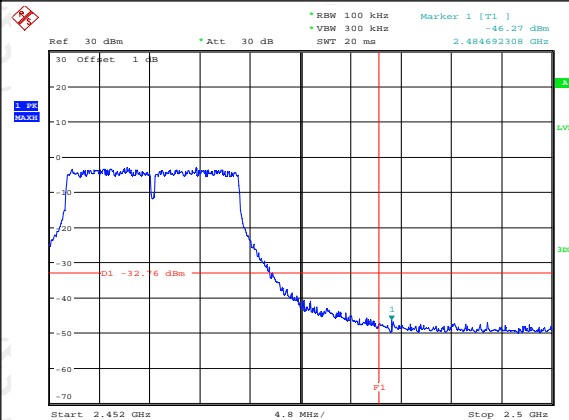

Date: 10 JUN.2017 10:53:53

## Spurious emission

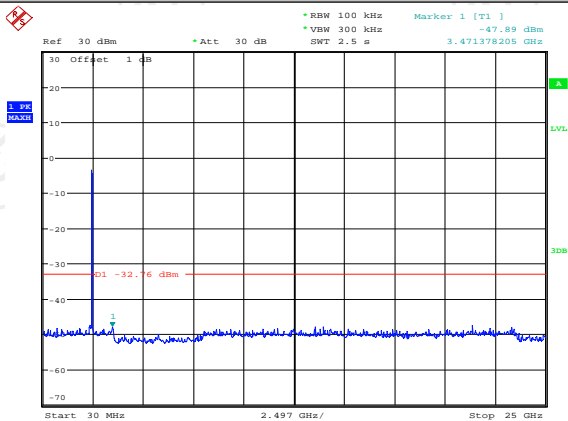

Date: 10 JUN.2017 10:54:39

## Highest Channel

**802.11n (HT20) Modulation**

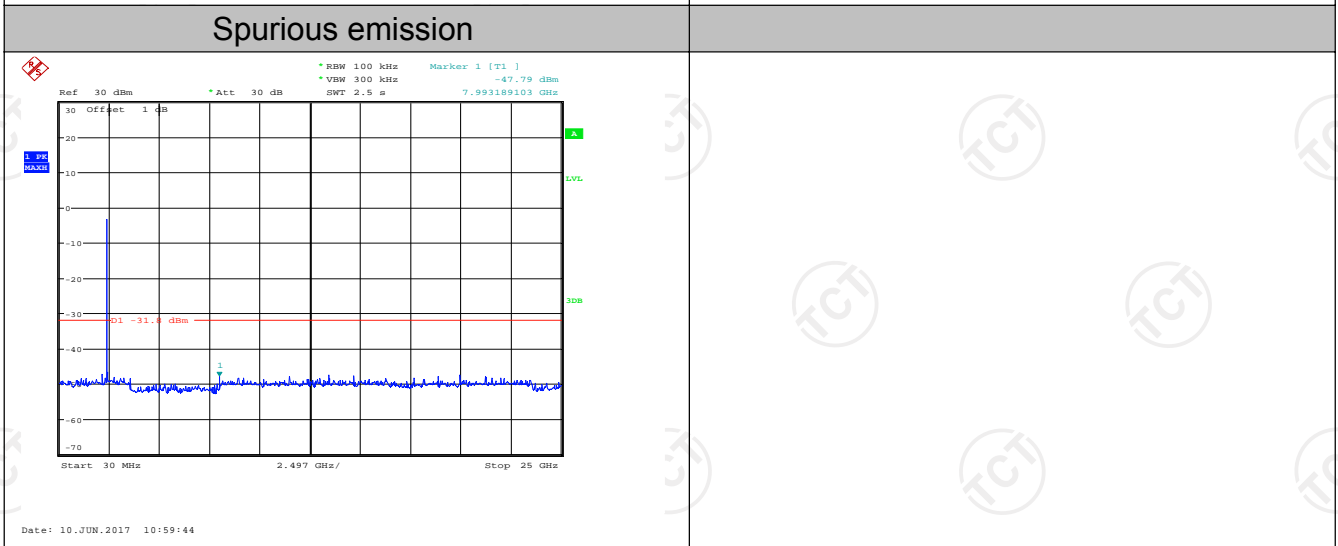
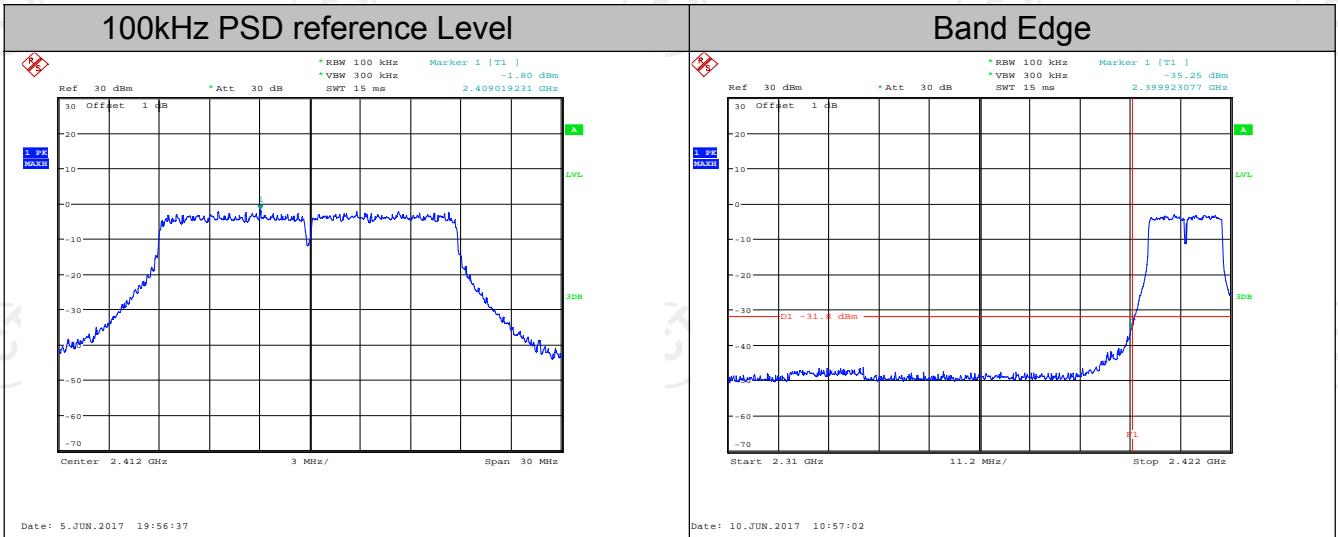

**Lowest Channel**

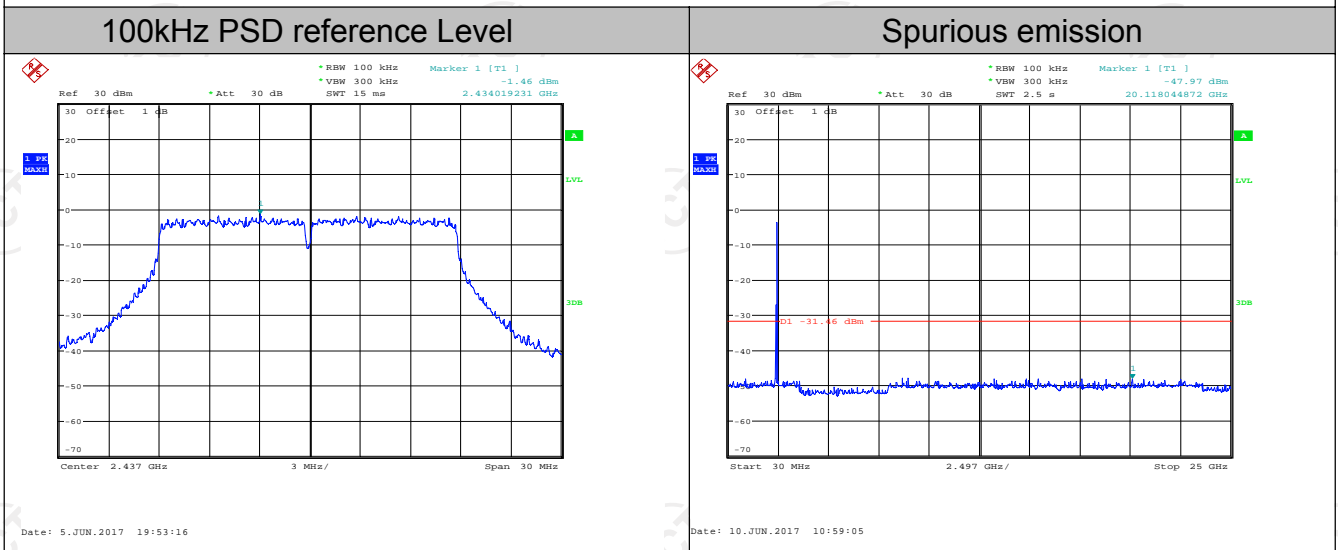

**Middle Channel**



## 100kHz PSD reference Level

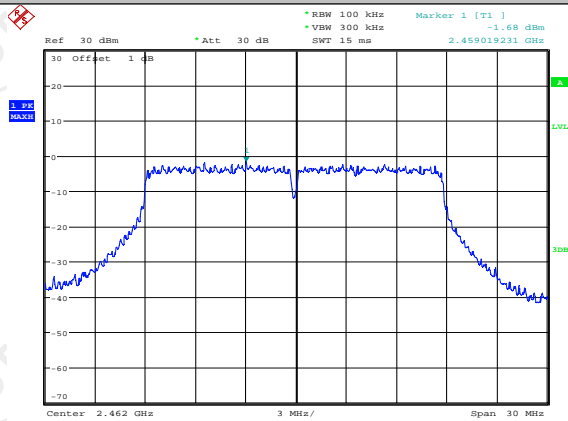

Date: 5 JUN.2017 19:50:00

## Band Edge

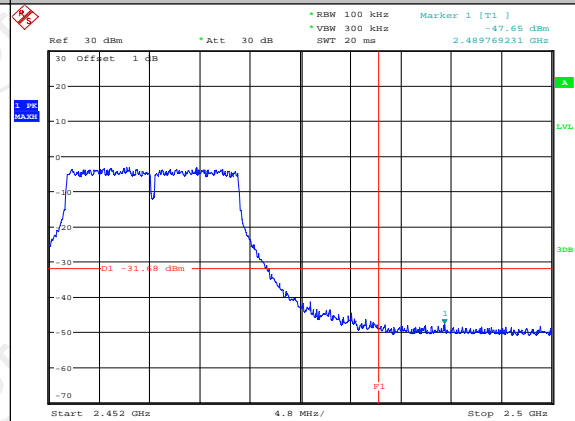

Date: 10 JUN.2017 10:57:53

## Spurious emission

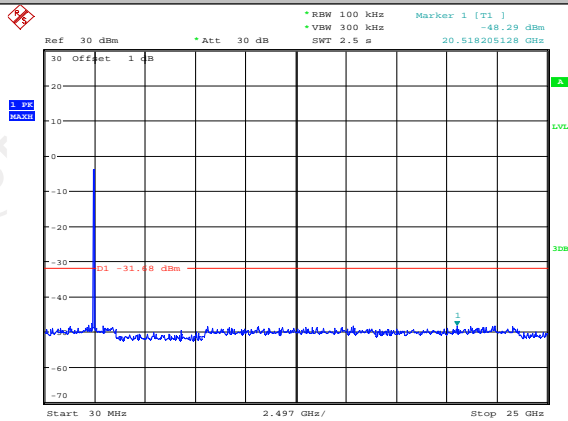

Date: 10 JUN.2017 10:58:31

## Highest Channel

802.11n (HT40) Modulation

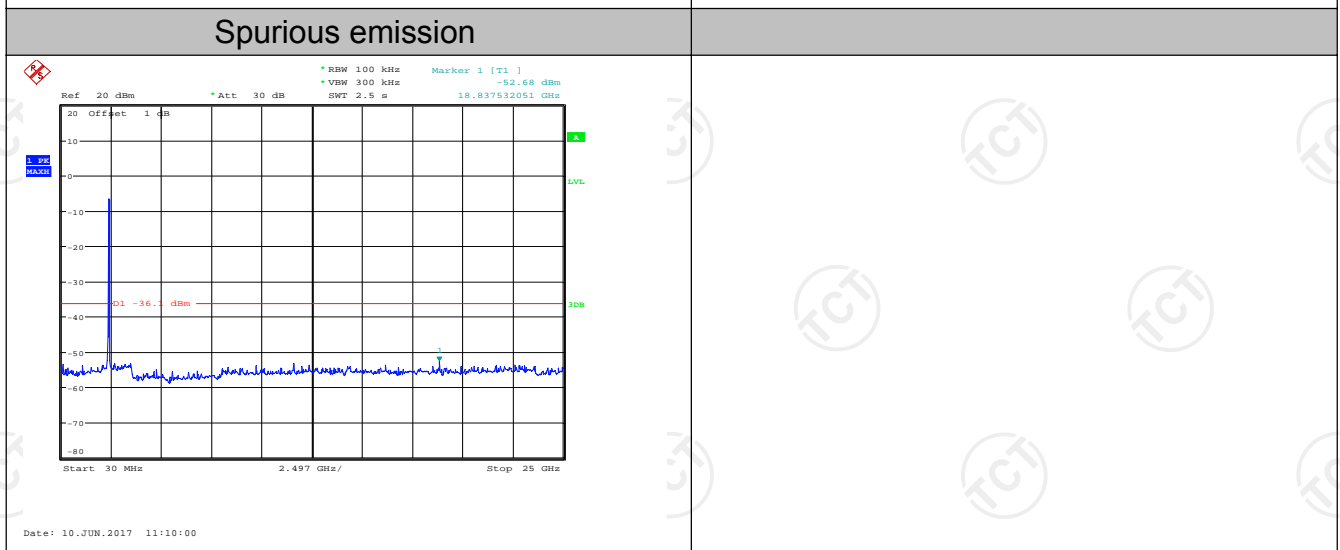
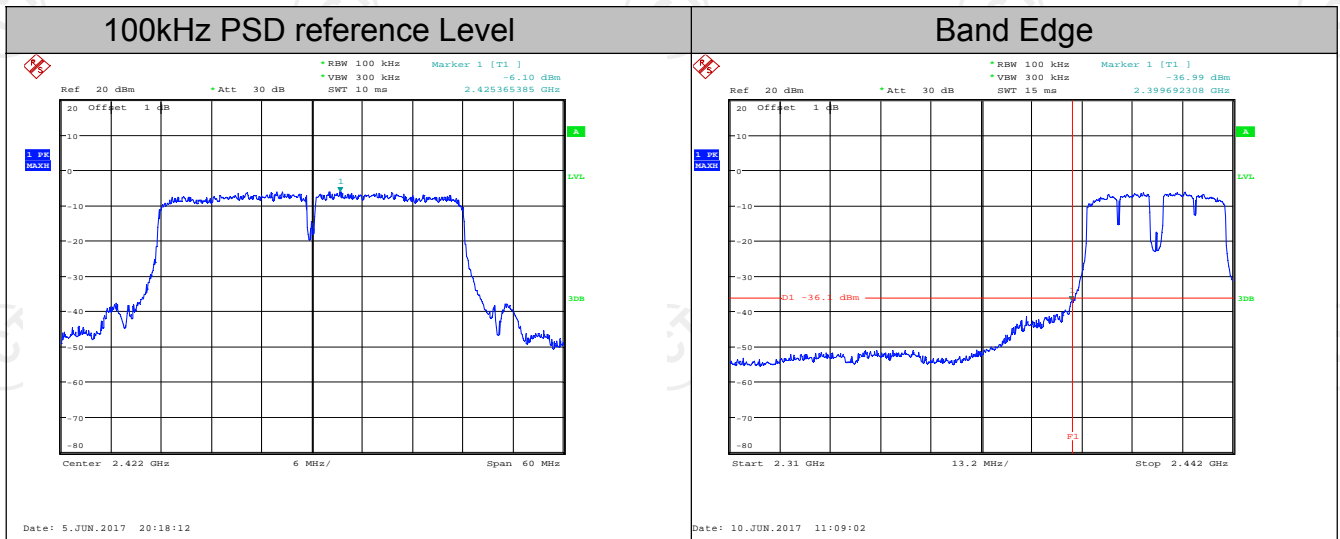

Lowest Channel

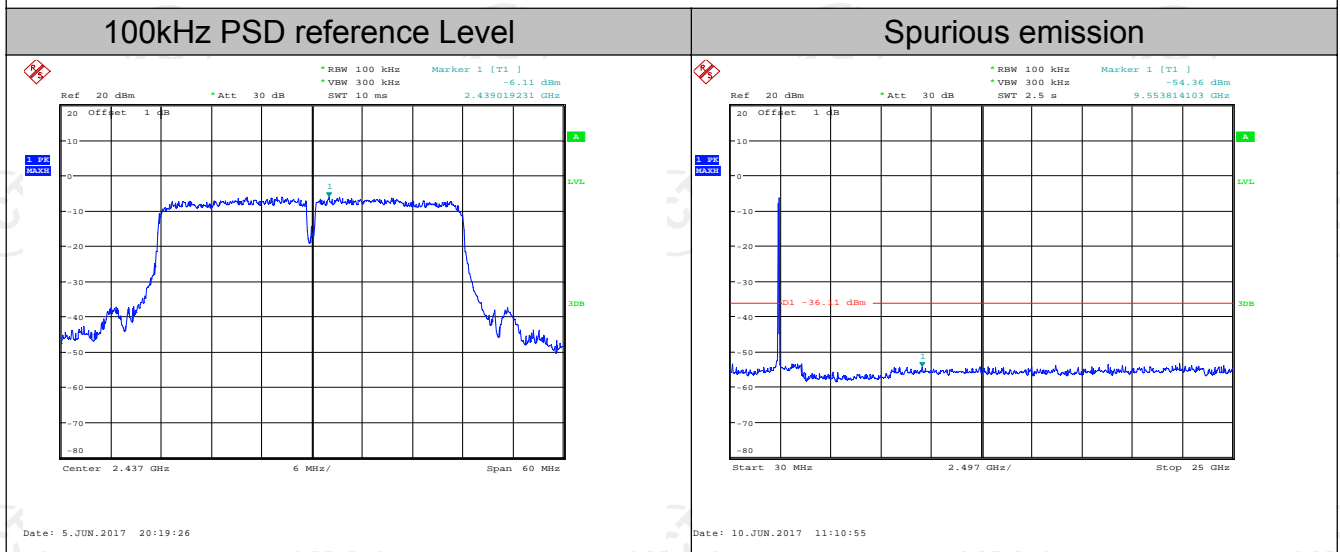

Middle Channel

## 100kHz PSD reference Level

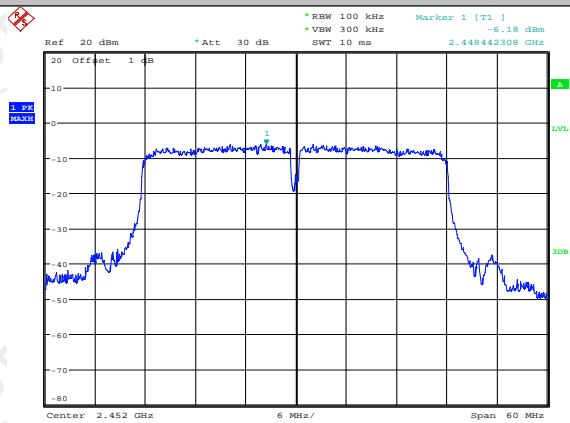

Date: 5 JUN. 2017 20:20:35

## Band Edge

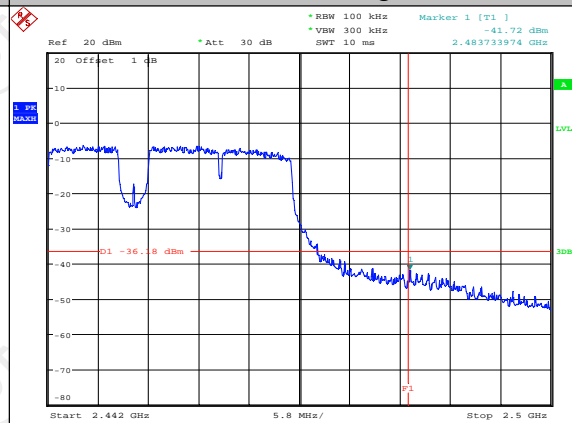

Date: 10 JUN. 2017 11:08:02

## Spurious emission

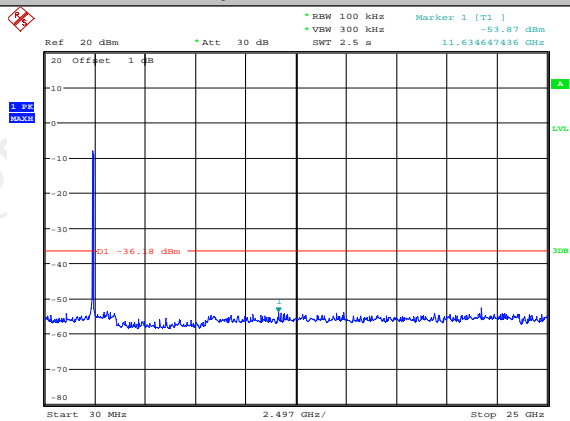

Date: 10 JUN. 2017 11:13:50

## Highest Channel

## 6.6. Radiated Spurious Emission Measurement

### 6.6.1. Test Specification

<b>Test Requirement:</b>	FCC Part15 C Section 15.209					
<b>Test Method:</b>	ANSI C63.10: 2013					
<b>Frequency Range:</b>	9 kHz to 25 GHz					
<b>Measurement Distance:</b>	3 m					
<b>Antenna Polarization:</b>	Horizontal & Vertical					
<b>Operation mode:</b>	Transmitting mode with modulation					
<b>Receiver Setup:</b>	Frequency	Detector	RBW	VBW	Remark	
	9kHz- 150kHz	Quasi-peak	200Hz	1kHz	Quasi-peak Value	
	150kHz- 30MHz	Quasi-peak	9kHz	30kHz	Quasi-peak Value	
	30MHz-1GHz	Quasi-peak	100KHz	300KHz	Quasi-peak Value	
	Above 1GHz	Peak	1MHz	3MHz	Peak Value	
Peak		1MHz	10Hz	Average Value		
<b>Limit:</b>	Frequency	Field Strength (microvolts/meter)		Measurement Distance (meters)		
	0.009-0.490	2400/F(KHz)		300		
	0.490-1.705	24000/F(KHz)		30		
	1.705-30	30		30		
	30-88	100		3		
	88-216	150		3		
	216-960	200		3		
	Above 960	500		3		
	Frequency	Field Strength (microvolts/meter)	Measurement Distance (meters)	Detector		
	Above 1GHz	500	3	Average		
		5000	3	Peak		
	<b>Test setup:</b>	For radiated emissions below 30MHz				
		<p>Distance = 3m</p> <p>0.8m</p> <p>EUT</p> <p>Turn table</p> <p>Ground Plane</p> <p>Computer</p> <p>Pre-Amplifier</p> <p>Receiver</p>				
30MHz to 1GHz						

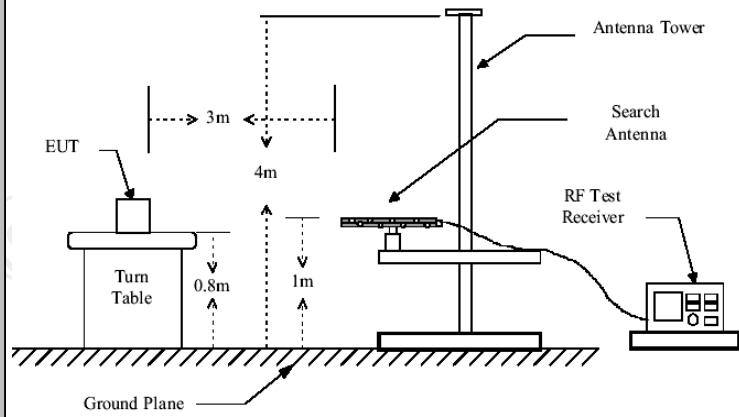

Above 1GHz

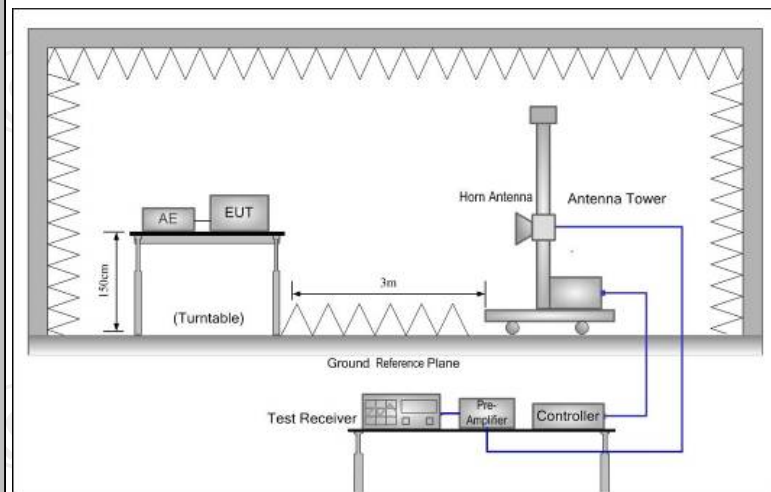

**Test Procedure:**

1. For the radiated emission test below 1GHz:  
The EUT was placed on a turntable with 0.8 meter above ground. The EUT was set 3 meters from the interference receiving antenna, which was mounted on the top of a variable height antenna tower. The EUT was arranged to its worst case and then tune the antenna tower (from 1 m to 4 m) and turntable (from 0 degree to 360 degrees) to find the maximum reading. A pre-amp and a high PASS filter are used for the test in order to get better signal level.
- For the radiated emission test above 1GHz:  
Place the measurement antenna on a turntable with 1.5 meter above ground, which is away from each area of the EUT determined to be a source of emissions at the specified measurement distance, while keeping the measurement antenna aimed at the source of emissions at each frequency of significant emissions, with polarization oriented for maximum response. The measurement antenna may have to be higher or lower than the EUT, depending on the radiation pattern of the emission and staying aimed at the emission source for

	<p>receiving the maximum signal. The final measurement antenna elevation shall be that which maximizes the emissions. The measurement antenna elevation for maximum emissions shall be restricted to a range of heights of from 1 m to 4 m above the ground or reference ground plane.</p> <p>3. Corrected Reading: Antenna Factor + Cable Loss + Read Level - Preamp Factor = Level</p> <p>4. For measurement below 1GHz, If the emission level of the EUT measured by the peak detector is 3 dB lower than the applicable limit, the peak emission level will be reported. Otherwise, the emission measurement will be repeated using the quasi-peak detector and reported.</p> <p>5. Use the following spectrum analyzer settings:</p> <p>(1) Span shall wide enough to fully capture the emission being measured;</p> <p>(2) Set RBW=100 kHz for <math>f &lt; 1</math> GHz; <math>VBW \geq RBW</math>; Sweep = auto; Detector function = peak; Trace = max hold;</p> <p>(3) Set RBW = 1 MHz, <math>VBW = 3</math> MHz for <math>f \geq 1</math> GHz for peak measurement.</p> <p>For average measurement: <math>VBW = 10</math> Hz, when duty cycle is no less than 98 percent. <math>VBW \geq 1/T</math>, when duty cycle is less than 98 percent where T is the minimum transmission duration over which the transmitter is on and is transmitting at its maximum power control level for the tested mode of operation.</p>
<b>Test results:</b>	PASS

**6.6.2. Test Instruments**

Radiated Emission Test Site (966)				
Name of Equipment	Manufacturer	Model	Serial Number	Calibration Due
ESPI Test Receiver	ROHDE&SCHW ARZ	ESVD	100008	Aug. 11, 2017
Spectrum Analyzer	ROHDE&SCHW ARZ	FSEM	848597/001	Aug. 11, 2017
Spectrum Analyzer	Agilent	N9020A	MY49100060	Aug. 12, 2017
Pre-amplifier	EM Electronics Corporation CO.,LTD	EM30265	07032613	Aug. 11, 2017
Pre-amplifier	HP	8447D	2727A05017	Aug. 11, 2017
Loop antenna	ZHINAN	ZN30900A	12024	Aug. 13, 2017
Broadband Antenna	Schwarzbeck	VULB9163	340	Aug. 13, 2017
Horn Antenna	Schwarzbeck	BBHA 9120D	631	Aug. 13, 2017
Horn Antenna	Schwarzbeck	BBHA 9170	373	Aug. 13, 2017
Coax cable (9kHz-40GHz)	TCT	RE-low-01	N/A	Aug. 11, 2017
Coax cable (9kHz-40GHz)	TCT	RE-high-02	N/A	Aug. 11, 2017
Coax cable (9kHz-40GHz)	TCT	RE-low-03	N/A	Aug. 11, 2017
Coax cable (9kHz-40GHz)	TCT	RE-High-04	N/A	Aug. 11, 2017
Antenna Mast	CCS	CC-A-4M	N/A	Aug. 12, 2017
EMI Test Software	Shurple Technology	EZ-EMC	N/A	N/A

**Note:** The calibration interval of the above test instruments is 12 months and the calibrations are traceable to international system unit (SI).

6.6.3. Test Data

Please refer to following diagram for individual  
Below 1GHz

Horizontal:

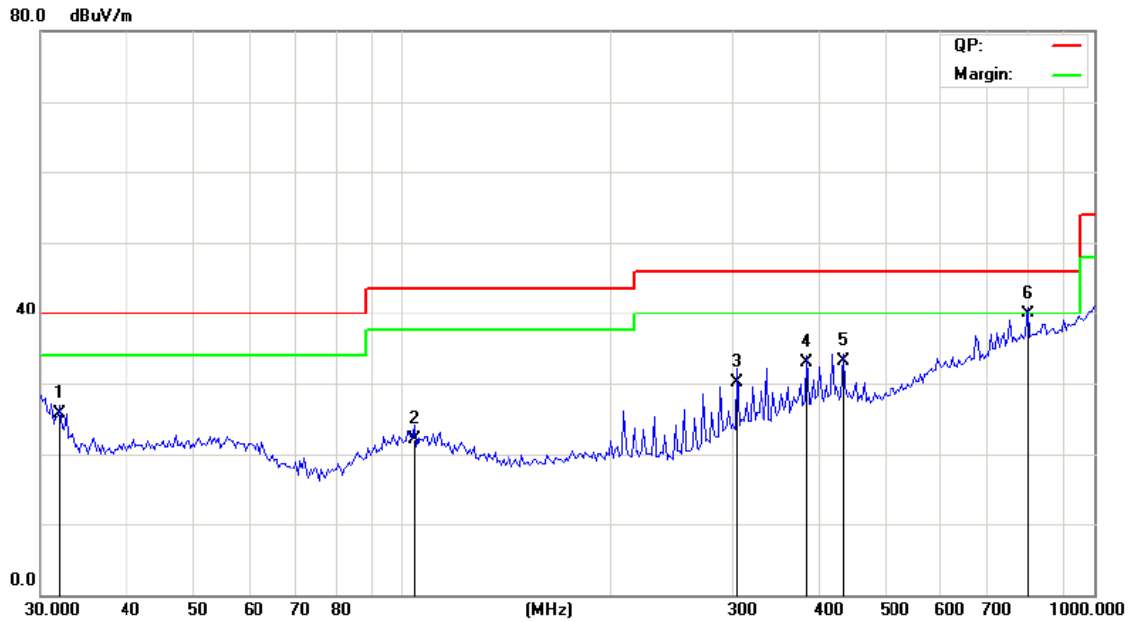

Site Chamber #2 Polarization: **Horizontal** Temperature: 25 (C)  
Limit: FCC Part 15B Class B 3M Radiation Power: DC 3.7V Humidity: 55 %

No.	Mk.	Freq. MHz	Reading Level dBuV	Correct Factor dB	Measure- ment dBuV/m	Limit dBuV/m	Over dB	Detector	Comment
1		31.9586	33.62	-7.82	25.80	40.00	-14.20	QP	
2		104.0639	28.69	-6.67	22.02	43.50	-21.48	QP	
3		304.9548	35.24	-5.05	30.19	46.00	-15.81	QP	
4		384.5446	34.93	-2.05	32.88	46.00	-13.12	QP	
5		433.3397	34.87	-1.69	33.18	46.00	-12.82	QP	
6	*	804.2523	34.15	5.83	39.98	46.00	-6.02	QP	



Vertical:

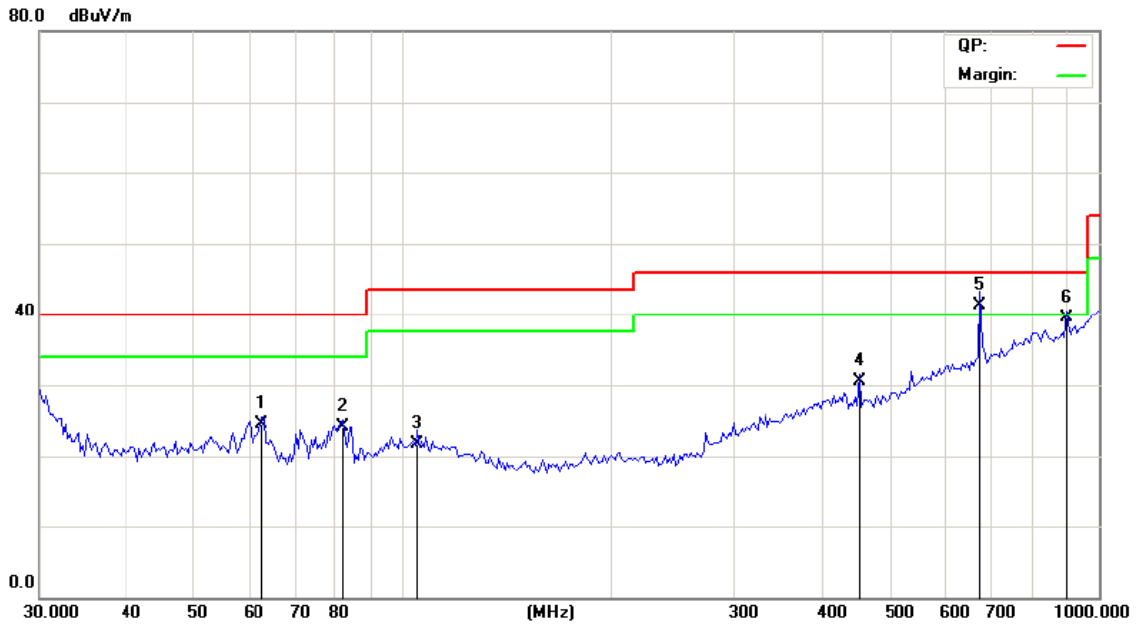

Site Chamber #2

Polarization: **Vertical**

Temperature: 25 (C)

Limit: FCC Part 15B Class B 3M Radiation

Power: DC 3.7V

Humidity: 55 %

No.	Mk.	Freq. MHz	Reading Level dBuV	Correct Factor dB	Measure- ment dBuV/m	Limit dBuV/m	Over dB	Detector	Comment
1		62.7432	32.86	-8.44	24.42	40.00	-15.58	QP	
2		81.9477	34.46	-10.45	24.01	40.00	-15.99	QP	
3		104.7977	28.32	-6.71	21.61	43.50	-21.89	QP	
4		452.0013	32.33	-1.76	30.57	46.00	-15.43	QP	
5	*	674.6766	37.92	3.33	41.25	46.00	-4.75	QP	
6		899.9577	32.51	7.07	39.58	46.00	-6.42	QP	

**Note:** 1. The low frequency, which started from 9KHz~30MHz, was pre-scanned and the result which was 20dB lower than the limit line per 15.31(o) was not reported

2. Measurements were conducted in all three channels (high, middle, low) and all modulation(802.11b, 802.11g, 802.11n(HT20), 802.11n(HT40) ), and the worst case Mode (Lowest channel and 802.11b) was submitted only.

**Test Result of Radiated Spurious at Band edges**

Modulation Type: 802.11b

Low channel: 2412 MHz

Frequency (MHz)	Ant. Pol. H/V	Peak reading (dB $\mu$ V)	Correction Factor (dB/m)	Peak Final Emission Level	Peak limit (dB $\mu$ V/m)	AV limit (dB $\mu$ V/m)
2310	H	44.12	-4.20	39.92	74.00	54.00
2377.38	H	46.23	-4.10	42.13	74.00	54.00
2390	H	50.5	-3.94	46.56	74.00	54.00
2310	V	42.65	-4.20	38.45	74.00	54.00
2377.38	V	53.44	-4.10	49.34	74.00	54.00
2390	V	51.8	-3.94	47.86	74.00	54.00

Modulation Type: 802.11b

Low channel: 2462 MHz

Frequency (MHz)	Ant. Pol. H/V	Peak reading (dB $\mu$ V)	Correction Factor (dB/m)	Peak Final Emission Level	Peak limit (dB $\mu$ V/m)	AV limit (dB $\mu$ V/m)
2483.5	H	52.2	-3.60	48.6	74.00	54.00
2487.09	H	45.87	-3.50	42.37	74.00	54.00
2500	H	43.59	-3.34	40.25	74.00	54.00
2483.5	V	54.25	-3.60	50.65	74.00	54.00
2487.09	V	46.8	-3.50	43.3	74.00	54.00
2500	V	42.66	-3.34	39.32	74.00	54.00

Modulation Type: 802.11g

Low channel: 2412 MHz

Frequency (MHz)	Ant. Pol. H/V	Peak reading (dB $\mu$ V)	Correction Factor (dB/m)	Peak Final Emission Level	Peak limit (dB $\mu$ V/m)	AV limit (dB $\mu$ V/m)
2310	H	45.08	-4.20	40.88	74.00	54.00
2388.96	H	51.34	-4.12	47.22	74.00	54.00
2390	H	52.1	-3.94	48.16	74.00	54.00
2310	V	44.98	-4.20	40.78	74.00	54.00
2388.96	V	48.71	-4.12	44.59	74.00	54.00
2390	V	54.95	-3.94	51.01	74.00	54.00

Modulation Type: 802.11g

Low channel: 2462 MHz

Frequency (MHz)	Ant. Pol. H/V	Peak reading (dB $\mu$ V)	Correction Factor (dB/m)	Peak Final Emission Level	Peak limit (dB $\mu$ V/m)	AV limit (dB $\mu$ V/m)
2483.5	H	53.43	-3.60	49.83	74.00	54.00
2487.59	H	49.36	-3.52	45.84	74.00	54.00
2500	H	46.68	-3.34	43.34	74.00	54.00
2483.5	V	50.61	-3.60	47.01	74.00	54.00
2487.59	V	46.82	-3.52	43.3	74.00	54.00
2500	V	45.5	-3.34	42.16	74.00	54.00

Modulation Type: 802.11n(20MHz)

Low channel: 2412 MHz

Frequency (MHz)	Ant. Pol. H/V	Peak reading (dBμV)	Correction Factor (dB/m)	Peak Final Emission Level	Peak limit (dBμV/m)	AV limit (dBμV/m)
2310	H	45.55	-4.20	41.35	74.00	54.00
2388.01	H	54.68	-4.10	50.58	74.00	54.00
2390	H	52.79	-3.94	48.85	74.00	54.00
2310	V	46.38	-4.20	42.18	74.00	54.00
2388.01	V	54.19	-4.10	50.09	74.00	54.00
2390	V	50.84	-3.94	46.9	74.00	54.00

Modulation Type: 802.11n(20MHz)

Low channel: 2462 MHz

Frequency (MHz)	Ant. Pol. H/V	Peak reading (dBμV)	Correction Factor (dB/m)	Peak Final Emission Level	Peak limit (dBμV/m)	AV limit (dBμV/m)
2483.5	H	55.11	-3.60	51.51	74.00	54.00
2392.55	H	52.61	-3.50	49.11	74.00	54.00
2500	H	46.57	-3.34	43.23	74.00	54.00
2483.5	V	51.91	-3.60	48.31	74.00	54.00
2392.55	V	49.86	-3.50	46.36	74.00	54.00
2500	V	48.99	-3.34	45.65	74.00	54.00

Modulation Type: 802.11n(40MHz)

Low channel: 2422 MHz

Frequency (MHz)	Ant. Pol. H/V	Peak reading (dBμV)	Correction Factor (dB/m)	Peak Final Emission Level	Peak limit (dBμV/m)	AV limit (dBμV/m)
2310	H	50.81	-4.20	46.61	74.00	54.00
2387.85	H	55.02	-4.10	50.92	74.00	54.00
2390	H	52.66	-3.94	48.72	74.00	54.00
2310	V	51.48	-4.20	47.28	74.00	54.00
2389.98	V	50.78	-4.10	46.68	74.00	54.00
2390	V	49.76	-3.94	45.82	74.00	54.00

Modulation Type: 802.11n(40MHz)

Low channel: 2452 MHz

Frequency (MHz)	Ant. Pol. H/V	Peak reading (dBμV)	Correction Factor (dB/m)	Peak Final Emission Level	Peak limit (dBμV/m)	AV limit (dBμV/m)
2483.5	H	52.59	-3.60	48.99	74.00	54.00
2493.51	H	54.38	-3.50	50.88	74.00	54.00
2500	H	49.65	-3.34	46.31	74.00	54.00
2493.51	V	54.19	-3.60	50.59	74.00	54.00
2489.36	V	52.87	-3.46	49.41	74.00	54.00
2500	V	50.9	-3.34	47.56	74.00	54.00

**Note:**

1. Peak Final Emission Level=Peak Reading + Correction Factor;
2. Correction Factor=Antenna Factor + Cable loss – Pre-amplifier

**Above 1GHz**

Modulation Type: 802.11b

Low channel: 2412 MHz

Frequency (MHz)	Ant. Pol. H/V	Peak reading (dBμV)	AV reading (dBμV)	Correction Factor (dB/m)	Emission Level		Peak limit (dBμV/m)	AV limit (dBμV/m)	Margin (dB)
					Peak (dBμV/m)	AV (dBμV/m)			
4824	H	45.98	---	0.66	46.64	---	74	54	-7.36
7236	H	39.52	---	9.5	49.02	---	74	54	-4.98
---	H	---	---	---	---	---	---	---	---
4824	V	46.54	---	0.66	47.2	---	74	54	-6.8
7236	V	37.64	---	9.5	47.14	---	74	54	-6.86
---	V	---	---	---	---	---	---	---	---

Middle channel: 2437MHz

Frequency (MHz)	Ant. Pol. H/V	Peak reading (dBμV)	AV reading (dBμV)	Correction Factor (dB/m)	Emission Level		Peak limit (dBμV/m)	AV limit (dBμV/m)	Margin (dB)
					Peak (dBμV/m)	AV (dBμV/m)			
4874	H	44.9	---	0.99	45.89	---	74	54	-8.11
7311	H	40.67	---	9.85	50.52	---	74	54	-3.48
---	H	---	---	---	---	---	---	---	---
4874	V	47.75	---	0.99	48.74	---	74	54	-5.26
7311	V	38.02	---	9.85	47.87	---	74	54	-6.13
---	V	---	---	---	---	---	---	---	---

High channel: 2462 MHz

Frequency (MHz)	Ant. Pol. H/V	Peak reading (dBμV)	AV reading (dBμV)	Correction Factor (dB/m)	Emission Level		Peak limit (dBμV/m)	AV limit (dBμV/m)	Margin (dB)
					Peak (dBμV/m)	AV (dBμV/m)			
4924	H	46.22	---	1.33	47.55	---	74	54	-6.45
7386	H	39.25	---	10.22	49.47	---	74	54	-4.53
---	H	---	---	---	---	---	---	---	---
4924	V	45.51	---	1.33	46.84	---	74	54	-7.16
7386	V	35.29	---	10.22	45.51	---	74	54	-8.49
---	V	---	---	---	---	---	---	---	---

**Note:**

1. Emission Level=Peak Reading + Correction Factor; Correction Factor=Antenna Factor + Cable loss – Pre-amplifier
2. Margin (dB) = Emission Level (Peak) (dBμV/m)-Average limit (dBμV/m)
3. The emission levels of other frequencies are very lower than the limit and not show in test report.
4. Measurements were conducted from 1 GHz to the 10th harmonic of highest fundamental frequency. The highest test frequency is 25GHz.
5. Data of measurement shown “---“in the above table mean that the reading of emissions is attenuated more than 20 dB below the limits or the field strength is too small to be measured.

Modulation Type: 802.11g

Low channel: 2412 MHz

Frequency (MHz)	Ant. Pol. H/V	Peak reading (dB $\mu$ V)	AV reading (dB $\mu$ V)	Correction Factor (dB/m)	Emission Level		Peak limit (dB $\mu$ V/m)	AV limit (dB $\mu$ V/m)	Margin (dB)
					Peak (dB $\mu$ V/m)	AV (dB $\mu$ V/m)			
4824	H	49.36	---	0.75	50.11	---	74	54	-3.89
7236	H	40.61	---	9.87	50.48	---	74	54	-3.52
---	H	---	---	---	---	---	---	---	---
4824	V	47.57	---	0.75	48.32	---	74	54	-5.68
7236	V	40.68	---	9.87	50.55	---	74	54	-3.45
---	V	---	---	---	---	---	---	---	---

Middle channel: 2437MHz

Frequency (MHz)	Ant. Pol. H/V	Peak reading (dB $\mu$ V)	AV reading (dB $\mu$ V)	Correction Factor (dB/m)	Emission Level		Peak limit (dB $\mu$ V/m)	AV limit (dB $\mu$ V/m)	Margin (dB)
					Peak (dB $\mu$ V/m)	AV (dB $\mu$ V/m)			
4874	H	48.15	---	0.97	49.12	---	74	54	-4.88
7311	H	40.17	---	9.83	50.00	---	74	54	-4.00
---	H	---	---	---	---	---	---	---	---
4874	V	47.32	---	0.97	48.29	---	74	54	-5.71
7311	V	40.58	---	9.83	50.41	---	74	54	-3.59
---	V	---	---	---	---	---	---	---	---

High channel: 2462 MHz

Frequency (MHz)	Ant. Pol. H/V	Peak reading (dB $\mu$ V)	AV reading (dB $\mu$ V)	Correction Factor (dB/m)	Emission Level		Peak limit (dB $\mu$ V/m)	AV limit (dB $\mu$ V/m)	Margin (dB)
					Peak (dB $\mu$ V/m)	AV (dB $\mu$ V/m)			
4924	H	47.76	---	1.18	48.94	---	74	54	-5.06
7386	H	39.94	---	10.07	50.01	---	74	54	-3.99
---	H	---	---	---	---	---	---	---	---
4924	V	46.57	---	1.18	47.75	---	74	54	-6.25
7386	V	40.20	---	10.07	50.27	---	74	54	-3.73
---	V	---	---	---	---	---	---	---	---

**Note:**

1. Emission Level=Peak Reading + Correction Factor; Correction Factor= Antenna Factor + Cable loss – Pre-amplifier
2. Margin (dB) = Emission Level (Peak) (dB $\mu$ V/m)-Average limit (dB $\mu$ V/m)
3. The emission levels of other frequencies are very lower than the limit and not show in test report.
4. Measurements were conducted from 1 GHz to the 10th harmonic of highest fundamental frequency. The highest test frequency is 25GHz.
5. Data of measurement shown "---" in the above table mean that the reading of emissions is attenuated more than 20 dB below the limits or the field strength is too small to be measured.

Modulation Type: 802.11n (HT20)

Low channel: 2412 MHz

Frequency (MHz)	Ant. Pol. H/V	Peak reading (dBμV)	AV reading (dBμV)	Correction Factor (dB/m)	Emission Level		Peak limit (dBμV/m)	AV limit (dBμV/m)	Margin (dB)
					Peak (dBμV/m)	AV (dBμV/m)			
4824	H	47.45	---	1.33	48.78	---	74	54	-5.22
7236	H	37.81	---	10.22	48.03	---	74	54	-5.97
---	H	---	---	---	---	---	---	---	---
4824	V	45.4	---	1.33	46.73	---	74	54	-7.27
7236	V	36.09	---	10.22	46.31	---	74	54	-7.69
---	V	---	---	---	---	---	---	---	---

Middle channel: 2437MHz

Frequency (MHz)	Ant. Pol. H/V	Peak reading (dBμV)	AV reading (dBμV)	Correction Factor (dB/m)	Emission Level		Peak limit (dBμV/m)	AV limit (dBμV/m)	Margin (dB)
					Peak (dBμV/m)	AV (dBμV/m)			
4874	H	45.47	---	0.99	46.46	---	74	54	-7.54
7311	H	39.61	---	9.85	49.46	---	74	54	-4.54
---	H	---	---	---	---	---	---	---	---
4874	V	45.13	---	0.99	46.12	---	74	54	-7.88
7311	V	37.74	---	9.85	47.59	---	74	54	-6.41
---	V	---	---	---	---	---	---	---	---

High channel: 2462 MHz

Frequency (MHz)	Ant. Pol. H/V	Peak reading (dBμV)	AV reading (dBμV)	Correction Factor (dB/m)	Emission Level		Peak limit (dBμV/m)	AV limit (dBμV/m)	Margin (dB)
					Peak (dBμV/m)	AV (dBμV/m)			
4924	H	40.17	---	1.33	41.5	---	74	54	-12.5
7386	H	35.75	---	10.22	45.97	---	74	54	-8.03
---	H	---	---	---	---	---	---	---	---
4924	V	39.81	---	1.33	41.14	---	74	54	-12.86
7386	V	36.4	---	10.22	46.62	---	74	54	-7.38
---	V	---	---	---	---	---	---	---	---

**Note:**

1. Emission Level=Peak Reading + Correction Factor; Correction Factor= Antenna Factor + Cable loss – Pre-amplifier
2. Margin (dB) = Emission Level (Peak) (dBμV/m)-Average limit (dBμV/m)
3. The emission levels of other frequencies are very lower than the limit and not show in test report.
4. Measurements were conducted from 1 GHz to the 10th harmonic of highest fundamental frequency. The highest test frequency is 25GHz.
5. Data of measurement shown "—" in the above table mean that the reading of emissions is attenuated more than 20 dB below the limits or the field strength is too small to be measured.

Modulation Type: 802.11n (HT40)

Low channel: 2422 MHz

Frequency (MHz)	Ant. Pol. H/V	Peak reading (dB $\mu$ V)	AV reading (dB $\mu$ V)	Correction Factor (dB/m)	Emission Level		Peak limit (dB $\mu$ V/m)	AV limit (dB $\mu$ V/m)	Margin (dB)
					Peak (dB $\mu$ V/m)	AV (dB $\mu$ V/m)			
4844	H	45.97	---	0.66	46.63	---	74	54	-7.37
7266	H	38.52	---	9.5	48.02	---	74	54	-5.98
---	H	---	---	---	---	---	---	---	---
4824	V	44.56	---	0.66	45.22	---	74	54	-8.78
7236	V	35.6	---	9.5	45.1	---	74	54	-8.9
---	V	---	---	---	---	---	---	---	---

Middle channel: 2437MHz

Frequency (MHz)	Ant. Pol. H/V	Peak reading (dB $\mu$ V)	AV reading (dB $\mu$ V)	Correction Factor (dB/m)	Emission Level		Peak limit (dB $\mu$ V/m)	AV limit (dB $\mu$ V/m)	Margin (dB)
					Peak (dB $\mu$ V/m)	AV (dB $\mu$ V/m)			
4874	H	42.95	---	0.99	43.94	---	74	54	-10.06
7311	H	34.61	---	9.85	44.46	---	74	54	-9.54
---	H	---	---	---	---	---	---	---	---
4874	V	43.7	---	0.99	44.69	---	74	54	-9.31
7311	V	37.35	---	9.85	47.2	---	74	54	-6.8
---	V	---	---	---	---	---	---	---	---

High channel: 2452 MHz

Frequency (MHz)	Ant. Pol. H/V	Peak reading (dB $\mu$ V)	AV reading (dB $\mu$ V)	Correction Factor (dB/m)	Emission Level		Peak limit (dB $\mu$ V/m)	AV limit (dB $\mu$ V/m)	Margin (dB)
					Peak (dB $\mu$ V/m)	AV (dB $\mu$ V/m)			
4904	H	45.18	---	1.33	46.51	---	74	54	-7.49
7356	H	36.29	---	10.22	46.51	---	74	54	-7.49
---	H	---	---	---	---	---	---	---	---
4904	V	43.5	---	1.33	44.83	---	74	54	-9.17
7356	V	36.81	---	10.22	47.03	---	74	54	-6.97
---	V	---	---	---	---	---	---	---	---

**Note:**

1. Emission Level=Peak Reading + Correction Factor; Correction Factor= Antenna Factor + Cable loss – Pre-amplifier
2. Margin (dB) = Emission Level (Peak) (dB $\mu$ V/m)-Average limit (dB $\mu$ V/m)
3. The emission levels of other frequencies are very lower than the limit and not show in test report.
4. Measurements were conducted from 1 GHz to the 10th harmonic of highest fundamental frequency. The highest test frequency is 25GHz.
5. Data of measurement shown "—" in the above table mean that the reading of emissions is attenuated more than 20 dB below the limits or the field strength is too small to be measured.



### Appendix A: Photographs of Test Setup

Product: Sports camera

Model: 9941

Radiated Emission

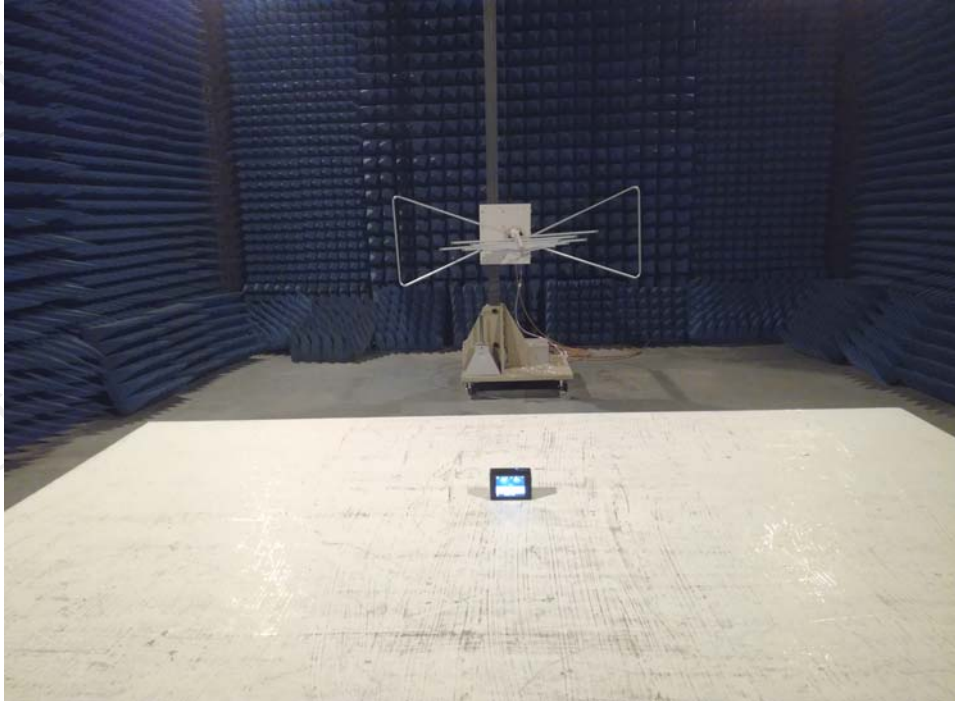



Conducted Emission



**Appendix B: Photographs of EUT**  
**Product: Sports camera**  
**Model: 9941**  
**External Photos**







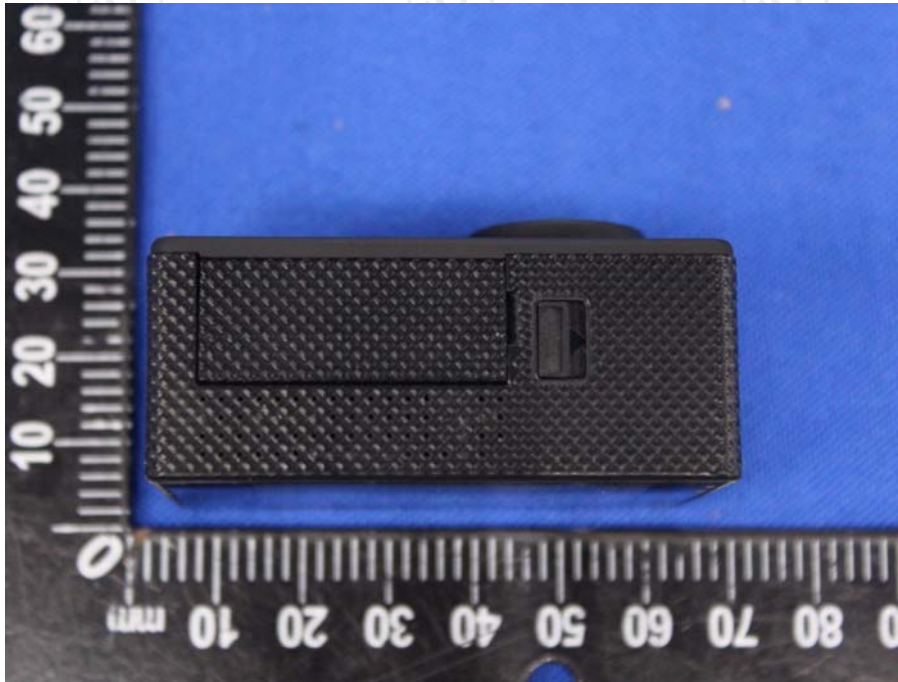

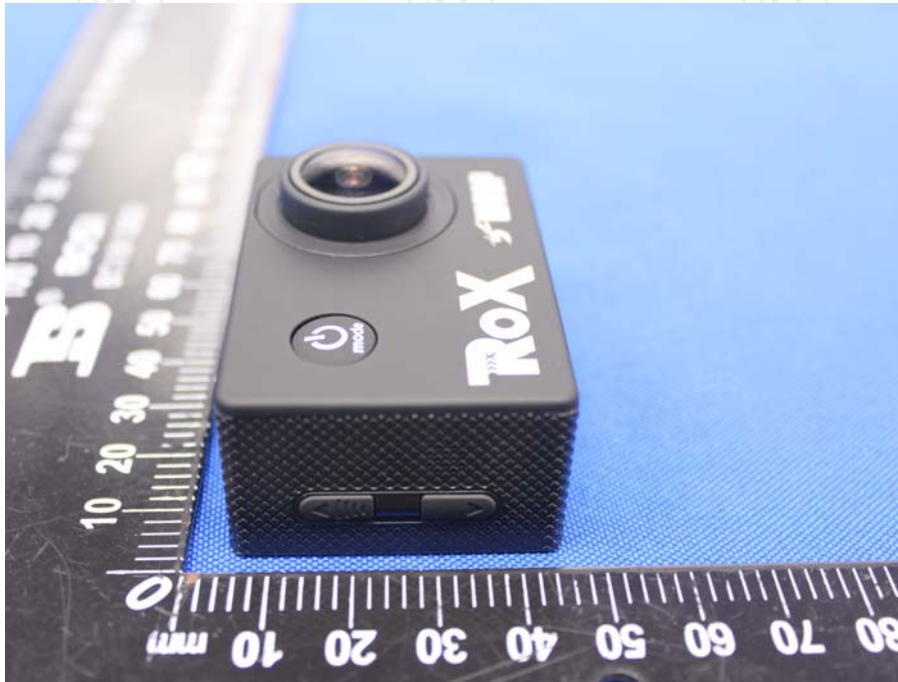

**Product: Sports camera**  
**Model: 9941**  
**Internal Photos**

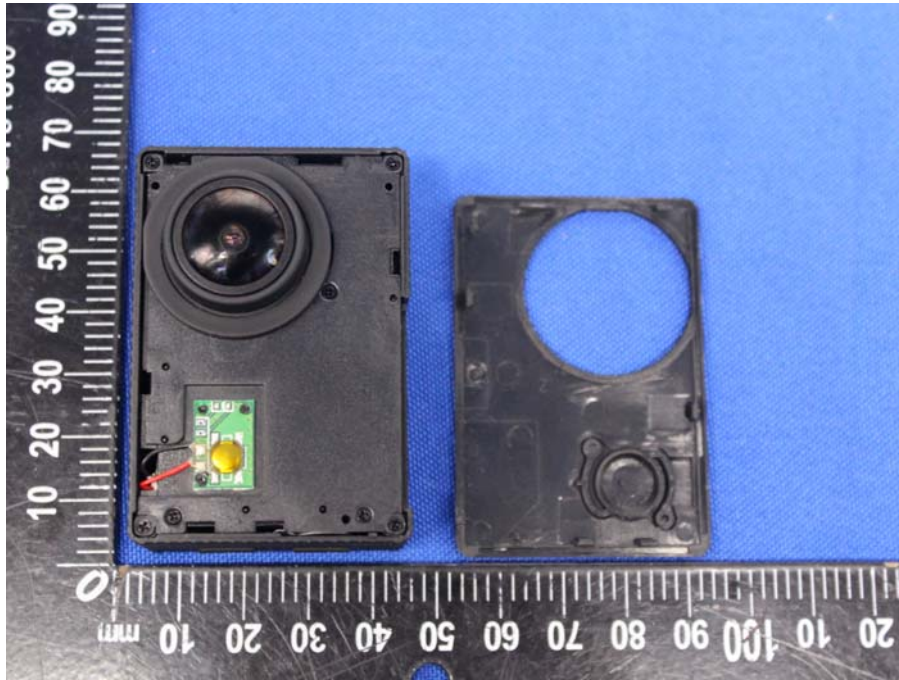



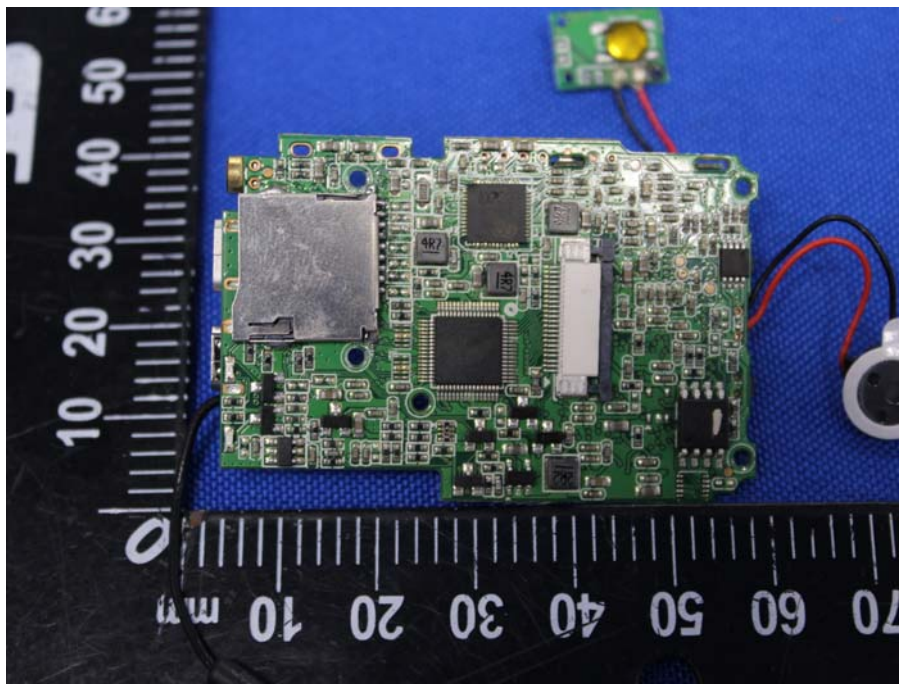
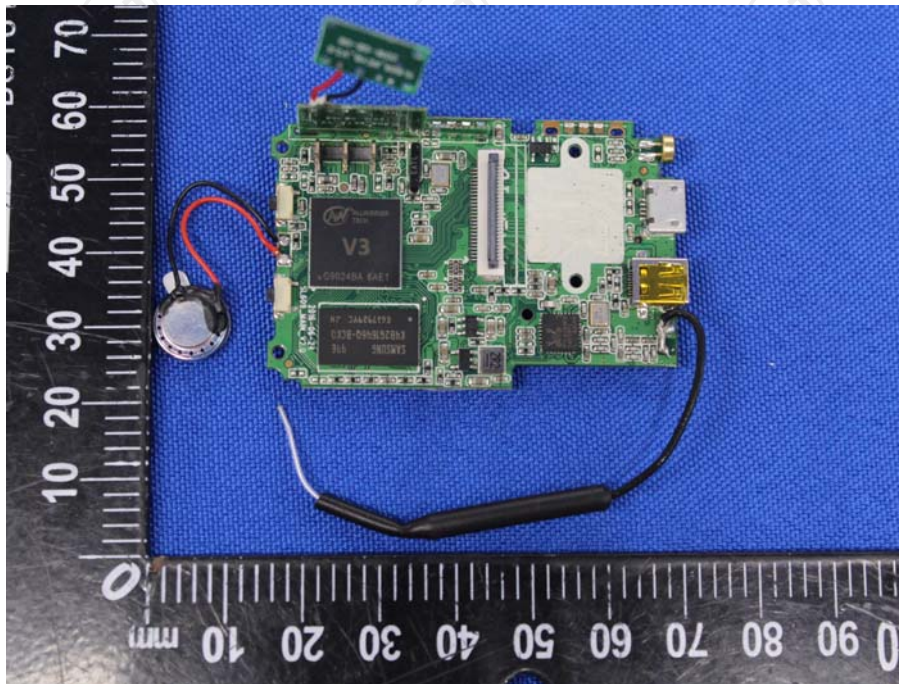

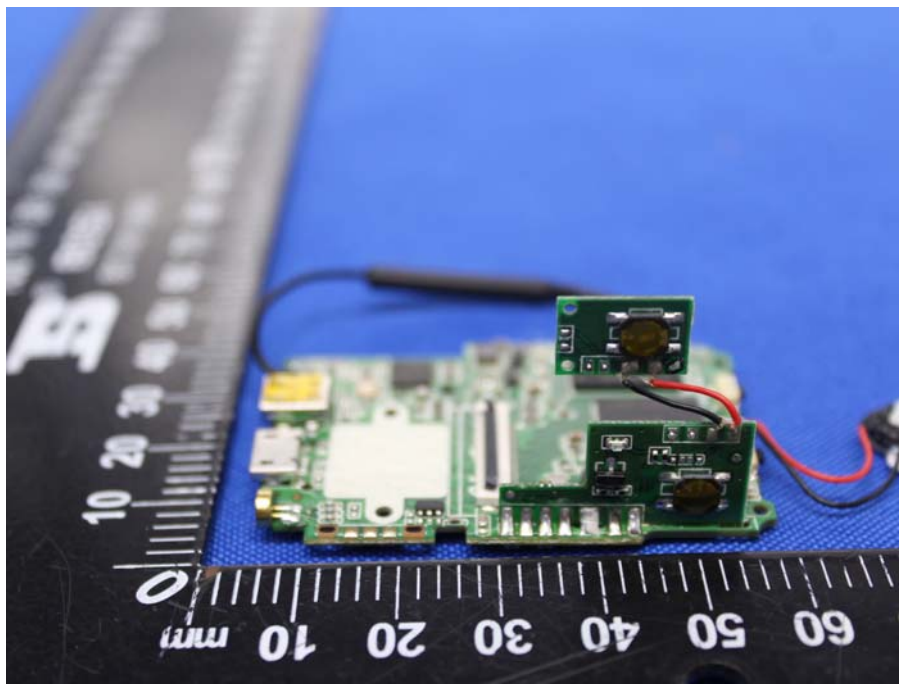
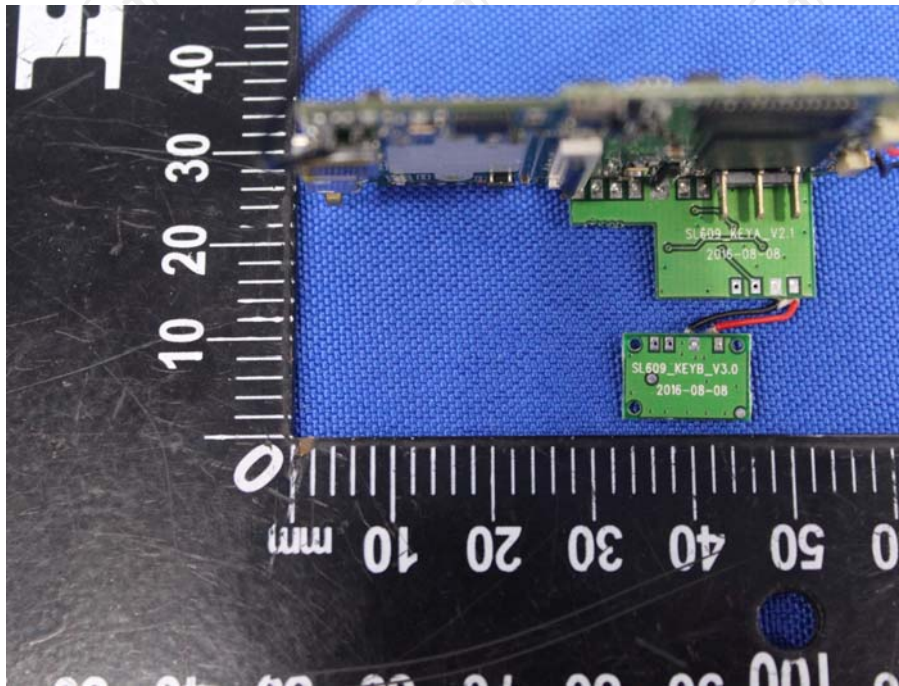



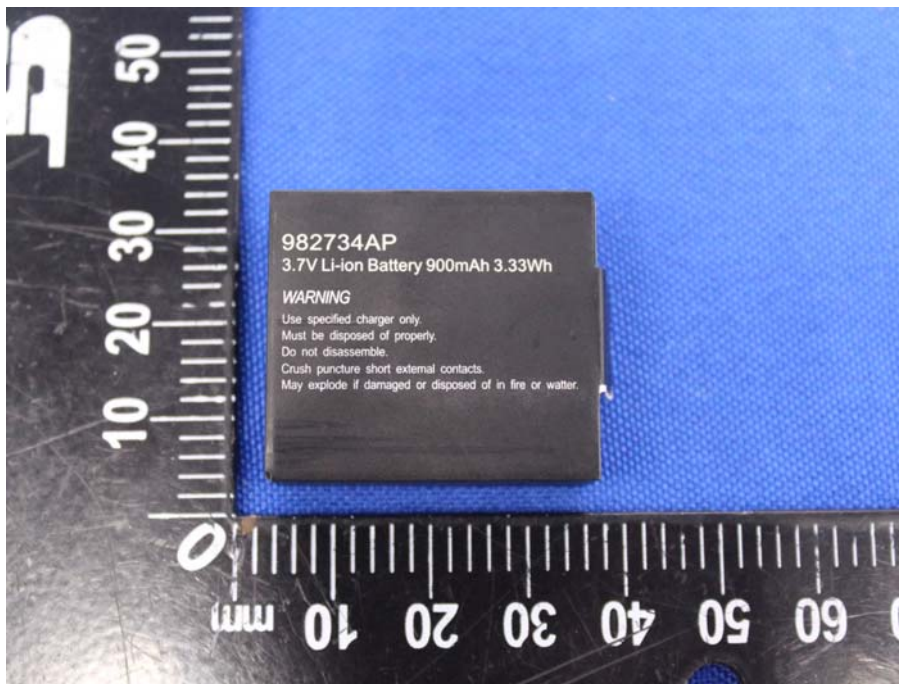
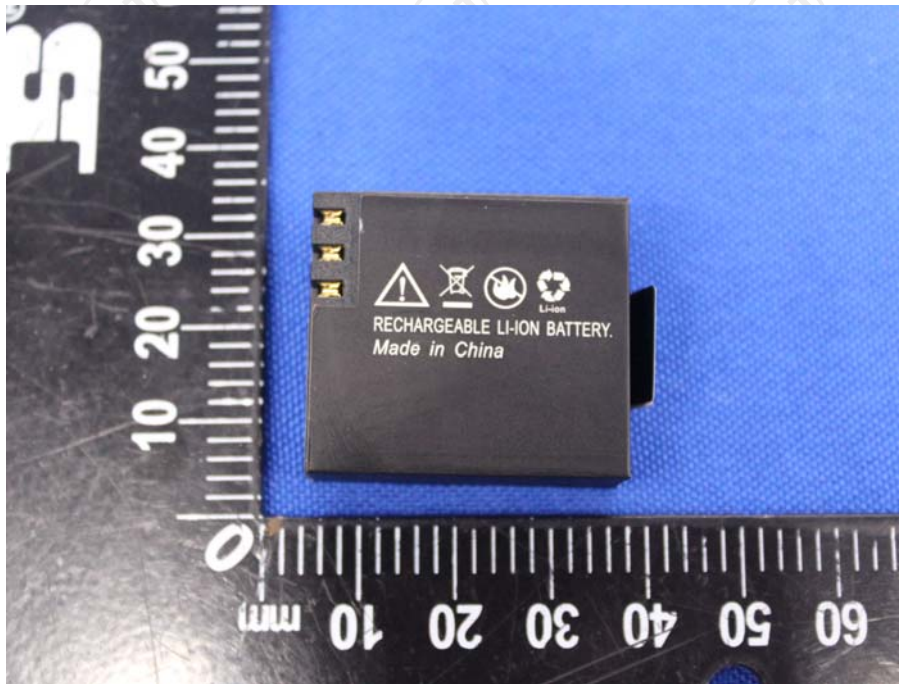

**\*\*\*\*\*END OF REPORT\*\*\*\*\***