

How to Use Your Cobra 29 LX MAX

Features	1
The CB Story.....	A1
FCC Regulations, FCC Warnings & Included Accessories	
Controls & Indicators.....	A2
Our Thanks to You.....	A3
Customer Support	
Installation	
Location & Mounting/Connection.....	2
Antennas	
CB Antenna & Marine Installation.....	6-7
Ignition Noise Interference.....	7
Operating Your 29 LX MAX	
Turning On Your CB.....	8
Setting Channel Selector	9
Calibrate For SWR (Standing Wave Ratio).....	10
To Receive.....	12
Selecting a Channel & S-Meter	13
To Transmit.....	14
Setting Dynamike®.....	15
Setting Talkback.....	15
Menu Mode.....	16
Setting the Clock.....	17
Setting the Alarm.....	17
Setting the Count Down Timer.....	18
Key Tones Mode.....	18
Radio Check Mode.....	19
Setting Display Color Mode	20
Setting Brightness Mode.....	21
Turn NightWatch Illumination On/Off.....	21
Setting Contrast Mode	22
Bluetooth® Pairing	22-23
iRadar Smartphone App.....	24-27
Downloading the App	24
Pairing the Radio to Use with iRadar	24
AURA® Location Based Alerts	25
iRadar® Community, Using Report Button, Radar Threat Alerts...27	
Rewind-Say-Again®.....	28
Playback Last Transmission	28
Record 10 Second Memo	28
Weather Information.....	29
Weather Channels	29
Weather Alert Mode.....	30
Setting Weather Alert Scan and Auto Scan.....	30
Software Version/Factory Settings	31
NB-ANL/Off (Noise Blanker/Automatic Noise Limiter Switch)	32
Setting Delta Tune & RF Gain Control.....	32
Program Memory Channels	33
Scan/Memory Scan, Scan Memory Channels & CB Channels.....	34
Dimmer Control.....	34
Setting Squelch.....	35
S/RF Meter	36
External Speaker, Push-To-Talk & Mic Jack.....	37
Home And Office Set-Up.....	38
Temporary Mobile Set-Up	39
How Your CB Can Serve You.....	40
A Few Rules You Should Know	40
Channel 9 Emergency Messages.....	41
CB 10 Codes.....	42
Frequency Ranges	44
29 LX MAX Specifications.....	45
FCC Statement	46
Warranty Information	48
Product Service.....	49
Ordering Info	50

Features of This Product

- Selectable 4-Color LCD Display
- Advanced Bluetooth® Connectivity
- Rewind-Say-Again®
- Memo Record
- iRadar App Integration
- Report Feature
- NightWatch® Illumination
- 10 Weather Channels
- Weather Scan
- Emergency Weather Alert
- 40 CB Radio Channels
- 40 Channel Scan
- Memory Channels
- Channel Frequency Read-Out
- Radio Check Diagnostic
- Clock/Timer/Alarm
- Multi-Function Heavy-Duty Electret Microphone with Phone, Rewind-Say-Again® & Report Functions
- Full 4 Watts AM RF Power Output
- SWR Calibration Meter
- Instant Channel 19 and 9
- Front Panel 6-Pin Microphone Connector
- Switchable Automatic Noise Limiter & Noise Blanker
- Adjustable Dynamike Boost
- Tactile Controls
- 9 Ft Mic Cord
- Programmable Dimmer Control
- RF Gain
- External Push-To-Talk Jack
- External Microphone Jack

Bluetooth® Features

- Dual Point Bluetooth®
- Caller I.D.
- A2DP Audio Streaming
- Phone Directory

Installation

Installation

Location

Plan a location of the transceiver and microphone bracket before starting the installation.

Select a location that is convenient for operation, yet does not interfere with the driver or the passenger.

The transceiver is usually mounted to the underside of the dash with the microphone bracket beside it.

Mounting and Connection

- 1 Hold the radio with the mounting bracket in the exact desired location. If there is no interference, remove the bracket and use it as a template to mark the location for the mounting screws.

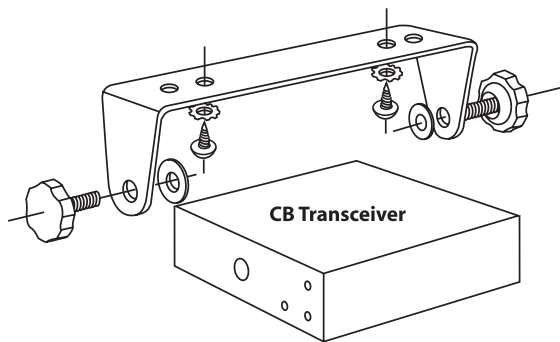

- 2 Drill the pilot and secure the bracket.

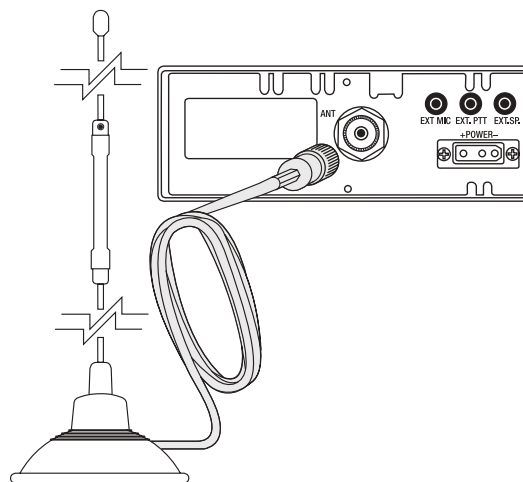

- 3 Connect the antenna cable plug to the receptacle marked "ANT" on the back of the unit.

Note

The transceiver is held in the universal mounting bracket by two thumbscrews which allow for adjustment at a convenient angle.

The bracket includes two self-tapping screws and star washers. The mounting must be mechanically strong and conveniently located.

continued

2

3

Installation

Note
Before installing the CB radio, visually check the vehicle's battery connection to determine which terminal is positive or negative. A negatively grounded vehicle has its negative lead grounded to the chassis.

Note
Connecting to an accessory fuse prevents the unit from being left on accidentally, operating the unit without running the engine when the ignition is set to the accessory position.

Note
The CB must be connected to constant 12V power to use the clock and alarm functions.

Note
When connected to an accessory fuse, unit will self test the emergency weather alert automatically when ignition is turned on. As a result, the CB radio will briefly turn itself on and then off again.

Note
The Clock/Timer feature needs to be reset when connected to a switched accessory fuse.

Note
The radio should be connected to a constant 12V source to maintain the time when the radio is turned off. This should also be considered if using the radio's alarm clock function.

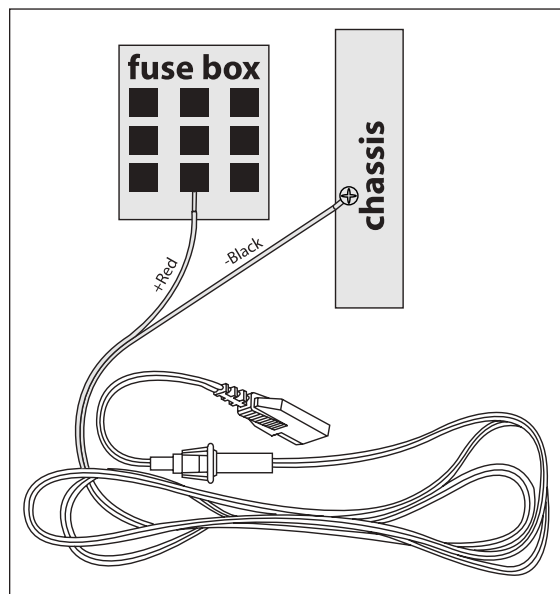

- 4 Connect the red lead of the DC power cord to an accessory 12 volt fuse or directly to the battery.

- 5 Connect the black lead to the negative side of the vehicle electrical system. This is usually the chassis. Any convenient location with a good electrical contact (remove paint) may be used.

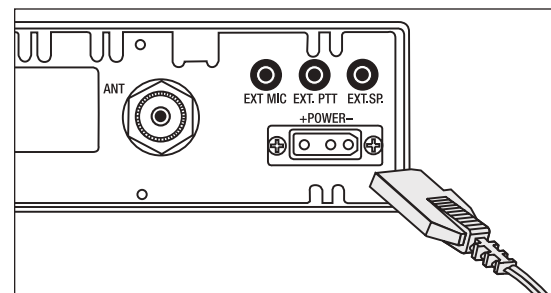

- 6 Plug the power cable into the back of the unit marked "Power". Be sure to observe polarity markings.

- 7 Mount the microphone bracket on either side of the unit using the two screws supplied.

The bracket should be placed under the dash so the microphone is readily accessible.

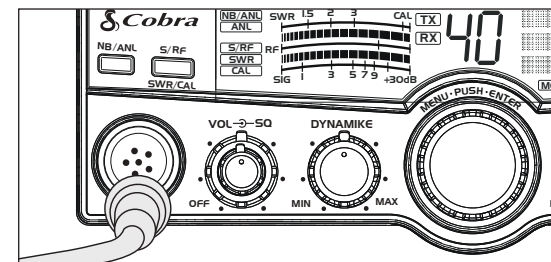
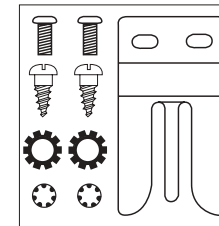

- 8 Attach the microphone cable to the receptacle on the front of the unit and install the unit in the bracket securely.

Installation

Note
If the microphone is not connected, audio will not be heard at the speaker.

Antennas

Note

For optimum performance in passenger cars the ideal antenna location is on the center of the roof. Second choice is on the center of the trunk.

Note

Because many newer trucks feature fiberglass door skins, the outside mirror must be grounded to the chassis via a ground strap, if the antenna is mounted on the mirror bracket.

Note

3-way Combination Antennas are also available which allow operation of all three bands (AM-FM & CB), using a single antenna. However, this type of antenna usually results in less than normal transmit and receive range when compared to a standard-type "Single Band" CB antenna.

CB Antenna

Since the maximum allowable power output of the transmitter is limited by the FCC, the antenna is critical in affecting the transmission distance. Only a properly matched antenna system will allow maximum power output. Loaded type antenna models are highly recommended for most installations. **The 29 LX MAX includes a weather mode (WX), a Dual Band (Center Load/Base Load) antenna is recommended.** Consult your Cobra dealer for further details, or visit our website: www.cobra.com

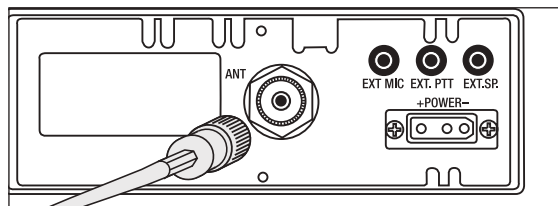

- 1 A standard antenna connector is provided on the transceiver for easy connection.

Ignition Noise Interference

Use of a mobile receiver at low signal levels is normally limited by the presence of electrical noise. The primary source of noise in automobiles is from the alternator and ignition system. Typically, when the signal level is adequate, the background noise does not present a serious problem. Also, when extremely low level signals are being received, the transceiver may be operated with the vehicle's engine turned off. The unit requires very little current and therefore will not significantly discharge the vehicle's battery.

Even though the Cobra 29 LX MAX has an automatic noise limiter, in some installations ignition interference may be high enough to make good communications challenging. Many possibilities exist and variations between vehicles require different solutions. Consult with your Cobra dealer or radio technician for help in locating the source of severe noise.

Marine Installation

The transceiver will not operate at maximum efficiency in a boat without a ground plane, (unless it has a steel hull). Before attempting installation, consult your dealer for information regarding an adequate grounding system and prevention of electrolysis between fittings in the hull and water.

Turning On the Radio

Make sure the power cord, antenna and microphone are connected to their proper connectors before starting.

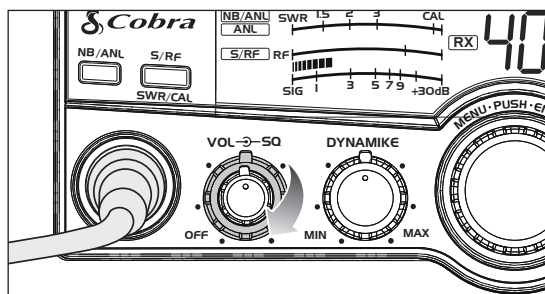

- 1 Rotate the **On/Off Volume** knob *clockwise* to turn the unit on and adjust to a normal listening level.

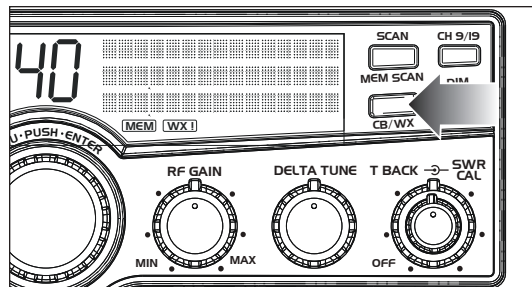

- 2 Press the **CB/WX** button to change between CB and weather modes.

Setting Channel Selector

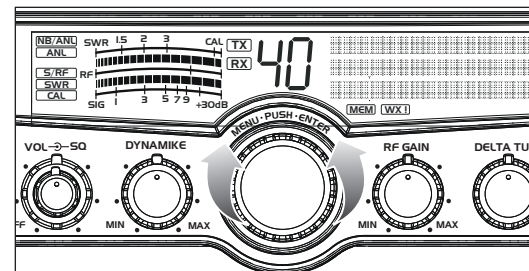

- 3 Select one of forty channels. The selected channel (1 through 40) will be indicated by the readout directly above the channel selector knob

Calibrate for SWR (Standing Wave Ratio)

SWR calibration is done to properly adjust the length of the antenna and to monitor the quality of the coaxial cable and all RF connections. This calibration is critical in order to achieve optimum performance.

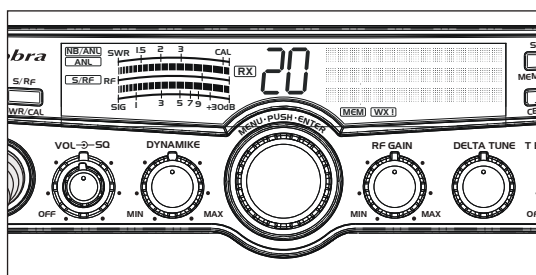

1 Set the radio to channel 20.

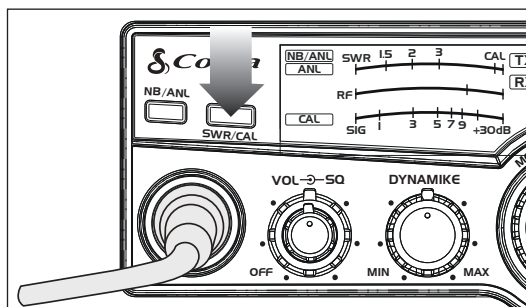

2 Press S/R F-SWR/CAL button to select CAL.

PUSH & HOLD

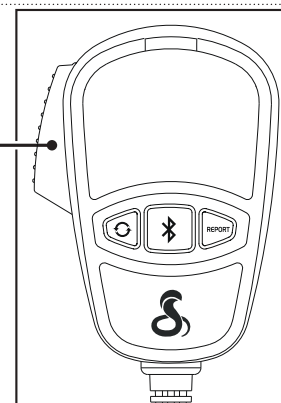

3 Push and hold the Push-to-Talk (PTT) button.

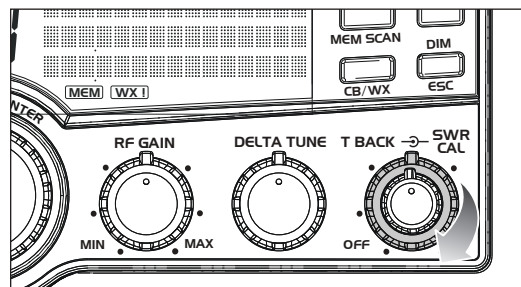

4 While holding the PTT adjust the SWR CAL knob so the meter swings to the CAL mark on the right side of the meter.

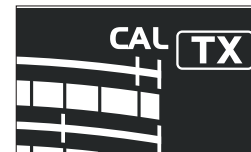

continued

Note

Calibration must be made in an open area (never in a garage). The vehicle's doors must be closed. No one should be standing near the antenna. (See your antenna directions for more complete information).

Note

The reading will be slightly higher on Channels 1 and 40 compared to Channel 20.

Calibrate for SWR *continued*

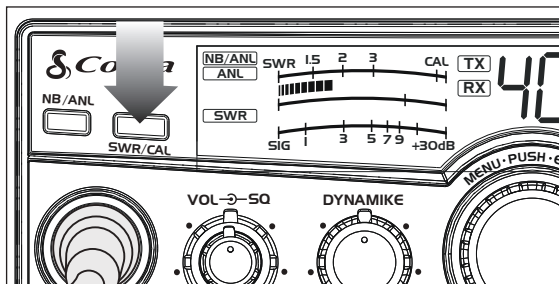

Note

When switched to SWR mode the meter reading should ideally be as far to the left as possible. Anything over 3 is not acceptable. A slight antenna height adjustment (higher or lower) may be required. Repeat recalibration steps.

- 5 Release the Push-to-Talk (PTT) button and press and release the **S/RF-SWR/CAL** button to the SWR position. Then press the PTT button to read the SWR reading.
- 6 Repeat the same steps two through five on Channel 1 and 40. This will check SWR for all channels.

To Receive

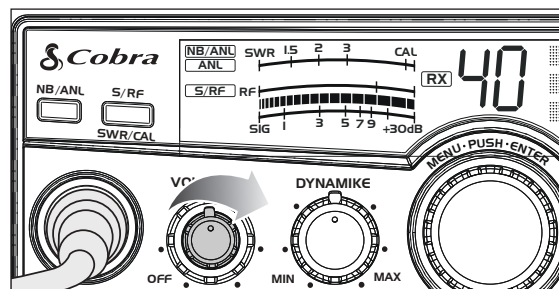

- 1 Rotate the **On/Off Volume** knob *clockwise*. While receiving, the RX icon will be displayed and the lower portion of the meter will show the incoming signal strength.

Selecting A Channel

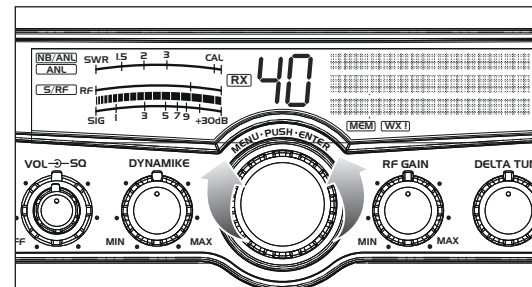

- 1 Rotate the **Channel Selector** *clockwise* or *counter-clockwise* to select the desired channel.

S-Meter

The S-Meter swings proportionately to the strength of the incoming signal when receiving.

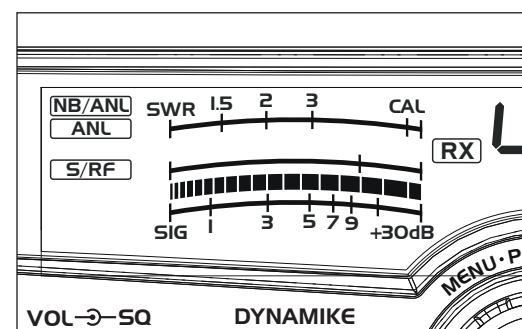

- 1 The **S/RF-SWR/CAL** button must be set in the S/RF setting to read the meter.

Operation

Caution!

STOP

Be sure the antenna is properly connected to the radio before transmitting. Transmitting without an antenna, or a poorly matched antenna, could cause damage to the transmitter.

Be sure to read the F.C.C. Rules and Regulations included with this unit before transmitting.

To Transmit

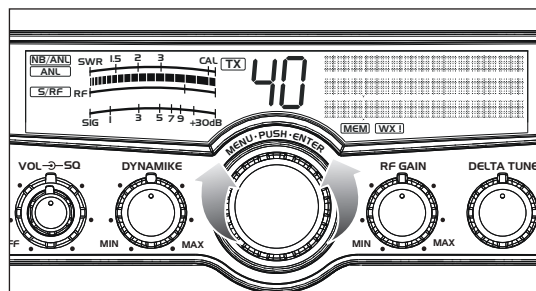

- 1 Select a desired channel.

Transmit

PUSH & HOLD

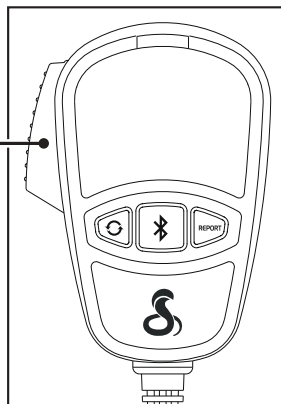

- 2 Push and hold the **PTT** button to transmit. When transmitting, hold the microphone two inches from your mouth and speak in a clear, normal voice. Release **PTT** button to receive.

Operation

Setting Dynamike®

This controls the microphone sensitivity (outgoing audio level).

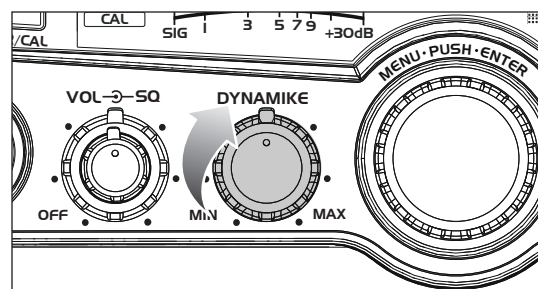

- 3 Initially, set **Dynamike** fully *clockwise* so that maximum voice volume is available. The Dynamike may have to be reduced in some conditions.

Setting TalkBack

This control is used to adjust the desired amount of modulation talk back present at the speaker during transmit.

At the fully *counter-clockwise* position the **TalkBack** is **Off**.

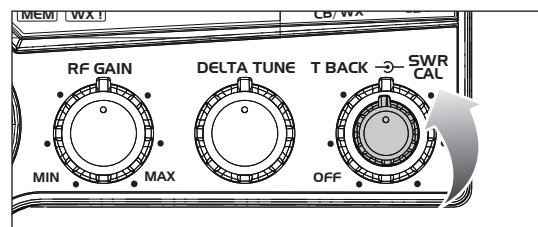

Operation

Note
Use **DIM/ESC** button to exit from any menu back to CB standby mode.

Menu Mode

Pressing the **Menu/Enter** knob is used to enter the menu and to select.

Rotating the **Menu/Enter** knob is used to move the cursor.

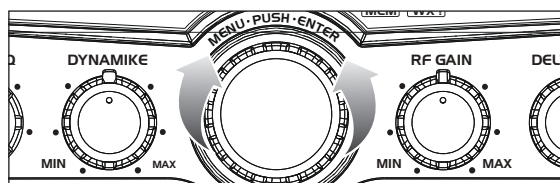

Rotate the **Menu/Enter** knob clockwise and counter-clockwise to navigate the menu levels.

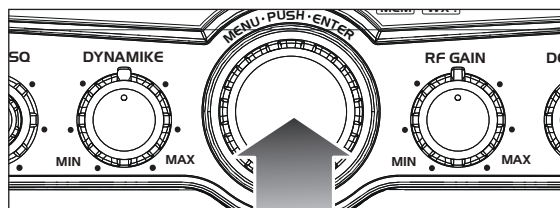

Press the **Menu/Enter** knob to select.

Level 1:

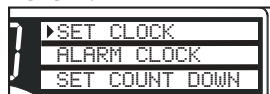

Level 2:

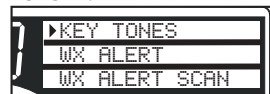

Level 3:

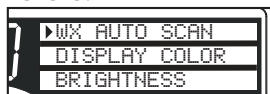

Level 4:

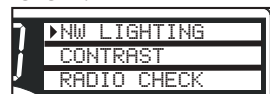

Level 5:

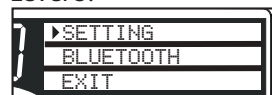

Operation

Setting the Clock

To set the clock, press the **Menu/Enter** knob and select **Set Clock**.

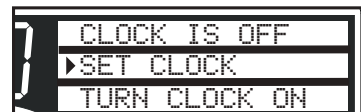

Press again to set the clock.

- Rotate the **Menu/Enter** knob to select the hour, minutes and AM/PM.
- Press the **Menu/Enter** knob to save each value.



Press the **Menu/Enter** knob to **SAVE** and **EXIT**.

Note
The clock will not appear on the display if the time has not yet been set.

Note
The radio should be connected to a constant 12V source to maintain the time when the radio is turned off.

Note
The clock will be displayed in the top right corner of the display

Setting the Alarm

Your 29 LX MAX can be utilized as an alarm clock.

To set the alarm, press the **Menu/Enter** knob and select **Alarm Clock**.

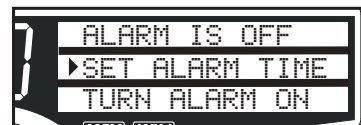

Press **SET ALARM TIME**.

- Rotate the **Menu/Enter** knob to select a value.
- Press the **Menu/Enter** knob to save.

Press the **Menu/Enter** knob to set **AM/PM**. Press **Menu/Enter** knob to **save** and proceed to set the **Set Snooze Length** or **EXIT**.

Operation

d

Note
Default snooze time length is 10 minutes.

Note
Use **DIM/ESC** button to exit from any menu back to CB standby mode.

Note
Default alarm length is 60 seconds and is set in 10 second increments.

Note
Once count down time is complete, there will be audio tones for 5 seconds.

Setting the Alarm *continued*

Once the alarm settings are complete, rotate the **Menu/Enter** knob *clockwise* to **Set Snooze** and press **Menu/Enter** to select.

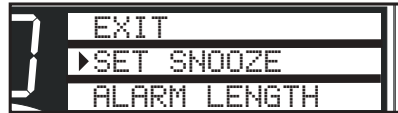

Select the desired snooze time (from 1 to 60 minutes). Press **Enter** to save and exit, return to **Set Snooze** or **Alarm Length**. Select **Alarm Length** to set the alarm duration (from 10 to 300 seconds). Press the **Menu/Enter** knob save and exit.

Setting the Count Down Timer

To set the count down timer, press **Menu/Enter** knob and select **Set Count Down**.



Follow the instructions in **Setting the Clock** section (page 17) to set the count down hour and minutes. Once the desired count down time is selected, press the **Menu/Enter** knob again to save and exit.

Key Tones Mode On and Off

Press the **Menu/Enter** knob and select **Key Tones**. Press the **Menu/Enter** to set Key Tones **On/Off**.

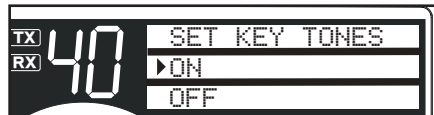

Rotate the **Menu/Enter** knob to select **On/Off** and press the **Menu/Enter** knob to exit to main menu.

Operation

Radio Check Mode

Allows testing of important radio functions. Press **Menu/Enter** knob and select **RADIO CHECK**.

Press **Menu/Enter** to select **1st test**, **2nd test** and **3rd test**.

Test 1- Battery Level: Confirms that battery voltage level is between 10.8 V to 15.8 V. If in that range, it is **PASS**. Outside of that range, either **FAIL LOW** or **FAIL HIGH** will be displayed. Press **Menu/Enter** knob to advance to next test.

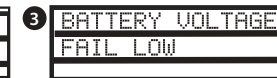

Test 2- RF Power Output: Confirms a 3.3 to 4 Watt output level. Once the **PTT** button is pressed, Pass or Fail will be displayed if the level is outside the limits.



Test 3- Antenna Mismatch Warning: Press the **PTT** button to check for proper matching.

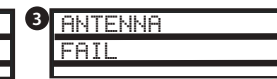

Note
Use **DIM/ESC** button to exit and return to CB standby mode. If 10 seconds pass or if **Enter** button pressed, unit goes to 2nd test.

Note
Press **PTT** within 10 seconds or unit will go to the next test.

Note
Use **DIM/ESC** button to exit and return to CB standby mode. If 10 seconds pass or if **Enter** button pressed, go to 3rd test.

Note
If 10 seconds pass or if **Menu/Enter** knob is pressed, testing is complete. Unit will return to CB Standby mode.

Setting the Display Color Mode

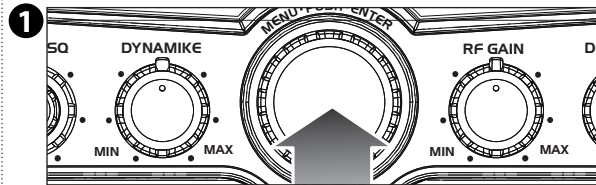

Press the **Menu/Enter** knob and select **Display Color**.



Press and release **Menu/Enter** to set the color.

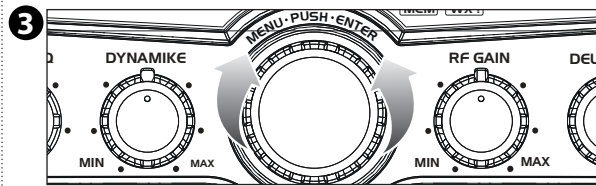

Rotating the **Menu/Enter** knob changes the display color from green to blue to amber to red then back to green.



Press the **Menu/Enter** knob to save and exit and set the **Brightness** mode.

Setting Brightness Mode

Press **Menu/Enter** knob to select **Brightness**



Press the **Menu/Enter** knob to select **Brightness**. Press the **Menu/Enter** knob to select **Day-Bright**. Turn **Menu/Enter** clockwise to increase brightness and turn counter-clockwise to decrease brightness.



To set the **Night-Dim** level, select **Night-Dim** then repeat instructions above.



Press **Menu/Enter** knob to save and exit routine. Press **DIM/ESC** to exit menu without saving.

Turn NightWatch Illumination On-Off-Hi-Low

Press the **Menu/Enter** knob and scroll down to select **NW Lighting**.



Rotate the **Menu/Enter** knob clockwise to change the setting to **HI-LOW** or **OFF**.

Press the **Menu/Enter** knob to save and exit.

Note

Exit will return to the previous menu mode. Use **DIM/ESC** button exit and return to CB Standby.

Note

To select **HI-LOW-OFF**, rotate **Menu/Enter** knob to change the setting. Press and release the **Menu/Enter** knob to set the Nightwatch® illumination level, save and exit.

Setting Contrast Mode

Press the **Menu/Enter** knob and rotate *clockwise* to select **Set Contrast**.



Rotate the **Menu/Enter** knob *clockwise* to increase contrast, *counter-clockwise* to decrease contrast.

Press the **Menu/Enter** knob to save and exit and continue settings or **DIM/ESC** to exit **Menu** mode.



Note Dual Point Bluetooth:

For team drivers, two cell phones can be paired, however; only one phone can be used at a time.

Note

If no further pairing steps are taken, the unit will time-out and return to Standby after 90 seconds. During the pairing process, press and release the **BT Button** or **DIM/ESC** to cancel the pairing process.

Note

For Text-to-Speech conversion, an app should be downloaded to your cell phone.

Bluetooth®

Calls on a Bluetooth® enabled cell phone can be routed through the 29 LX MAX speaker or external speaker accessory.

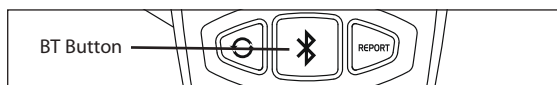
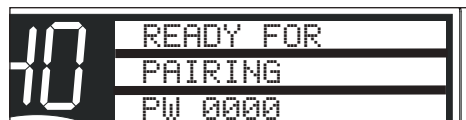

To Pair with a Cell Phone

Press and hold the **BT Button** for six seconds to enter **Ready For Pairing mode**. A tone will sound to confirm entry to pairing mode.

A. First time pairing with a cell phone:

- I. A tone will sound to confirm Pairing mode.
- II. Follow the cell phone manufacturer's instruction to enable its **Bluetooth** function. Select 29 LX MAX from the list of Bluetooth devices. Enter the PIN (Personal Identification Number) 0000 if required. Most smartphones no longer require a PIN entry.

- III. Successful pairing will be indicated by a tone to confirm entry to Connected mode. A pair record will also be established for subsequent connections.

B. Subsequent pairings with a cell phone:

- I. Follow the cell phone manufacturer's instruction, to enable its **Bluetooth**® function.
- II. Successful pairing will be indicated by a tone to confirm entry to Connected mode.

To Answer Calls

- 1 Press and release the **BT Button** when the cell phone ring is heard through the 29 LX MAX speaker.
- 2 Speak into the 29 LX MAX microphone. The CB function of the unit and **PTT** Button will be disabled while a call is in progress.
- 3 Press and release the **BT Button** to end the call. A tone will sound.

To Initiate Calls

- 1 To initiate the phone's voice assistant, if supported, press and release the **BT Button** twice.
- 2 Dial a number according to the cell phone manufacturer's instructions. The key press and other tones will be heard through the 29 LX MAX speaker.
- 3 Press Send on the cell phone, you will hear the ring tone for the number you dialed on the CB speaker. Once connected, speak into the microphone.
- 4 Press and release of the **BT Button** to end the call. A tone will sound.
- 5 Press and hold the **BT Button** for two seconds to redial a number. A tone will sound; and after a few seconds, you will hear the ring tone for the number you dialed.

Note

When cell phone calls are in progress using the **Bluetooth** features, the CB functions of the unit are disabled unless the phone call is put on hold (see page 27).

Note

When dialing a phone number on your phone's keypad, it is recommended that you dial when the vehicle is not in motion.

Note

The external microphone (see accessories on page 35) can be plugged into the rear of the unit and clipped to a pocket or lapel for hands-free speech during calls.

When the external microphone is plugged in, the main microphone will not pick up speech during calls but will be fully functional for CB operation.



Operation

Note

For more information on pairing with **Bluetooth**® devices consult your phone's owners manual.

If you are having trouble initializing or maintaining your **Bluetooth**® connection completely turn off your smartphone and the radio device, wait 30 seconds, and then turn them back on.

Note

The radio will not alert when police are monitoring speed with radar or laser guns.

Downloading the iRadar App

For optimal performance and access to all this radio's advanced features, you should download the iRadar app. To download the app you must enter the iOS App Store or Google Play Store and search for "**Cobra iRadar**". Follow the onscreen instructions to download and install the Cobra iRadar app.

Make sure to check out the Tutorial for a full explanation of app features. The Tutorial can be accessed from the Menu. Information on specific settings and explanations of radar bands can be found by pressing the green info icons in the settings menus. The iRadar app can also be used to change and easily adjust the alert settings.

Pairing/Connecting With Your Radio to Use with the Cobra iRadar App

GPS and iRadar-based features require connection to a **Bluetooth**® device and the Cobra iRadar app. For a full list of compatible **Bluetooth**® devices visit www.bluetooth.com

Please note, this is a newer **Bluetooth**® low-energy technology and pairing is not always done in the same manner and menus as conventional **Bluetooth**®. This radio will NOT APPEAR in the **Bluetooth**® Settings menu of your iPhone®.

- Power on the CB radio.
- Make sure your iPhone **Bluetooth**® is turned On.
- Start the Cobra iRadar application. Press the Menu icon (three horizontal bars) in the upper left corner of the app and select Devices. Select **29 LX MAX** from the devices list. A successful connection shows under the paired devices list as **29 LX MAX CONNECTED**.
- From the main menu, **29 LX MAX - CONNECTED** appears.

Operation

Pairing/Connecting With Your Radio *continued*



For Android™ :

- Power on the CB radio.
- Make sure your Android™ **Bluetooth**® is turned On. Press and hold the **Bluetooth**® button on the microphone to put the radio into Bluetooth pairing mode.
- Select **Bluetooth**® from **SETTINGS** on the Android device. The **Available Devices** list should contain the following:

DEVICES:

 **29 LX MAX** (phone functionality)

 **29 LX MAX** (iRadar app functionality)

- Select **29 LX MAX**  to pair and connect to the 29 LX MAX phone call feature. Select **29 LX MAX**  for pairing to the iRadar app. The phone might show "Paired but not connected" in this menu. That's OK as the connection will be completed after opening the iRadar App.
- Enter the iRadar App to complete the connection.
- From the main menu, **29 LX MAX - CONNECTED** appears.

AURA® Location-Based Alerts (LBAs) and iRadar Community

Your radio is capable of providing you with LBAs and iRadar Community threat sharing data when connected to phone running iRadar. The radio uses the GPS in your smartphone to connect to and obtain the latest LBA's and alert you to them. Vehicle speed uses your phone's GPS as well.

Operation

Note





Caution Areas may include: Car on the side of the road, traffic slowdowns, hazard on road, etc.

AURA and iRadar *continued*

When other iRadar users detect a radar or laser signal the alert information is anonymously sent to Cobra's cloud servers. Within seconds, that information is processed and displayed on your map as part of a Threat Area.

iRadar users can also report live police, red light cameras, caution zones, etc. These are also sent to Cobra's cloud servers and displayed on your map and on the radio as user reported Location-Based Alerts (LBA).

The distance will count down as you approach the Location-Based Alerts (LBA) Area. The alert types are:

- | | | | |
|---|----------------------|---|-------------------------------------|
|  | Photo-Enforced Areas |  | Known Speed Trap Areas |
|  | Red-Light Cameras |  | Caution Areas (High Accident Areas) |
|  | Speed Cameras | | |

As you approach a threat area, the iRadar app and the 29 LX MAX will display the type of threat (laser, radar, radar band, etc), the threat level, and when the threat was reported.

Using the Report Button

You can report to the iRadar Community locations where you see active police enforcement or a caution area by pressing the **REPORT** button on the microphone.

- To report **Live Police**, press and release the **REPORT** button.
- To report a **Caution Area**, press and hold the **REPORT** button for 2 seconds.

A double beep confirmation tone will be heard.

When receiving an alert you can mark the alert **TRUE** or **FALSE** by pressing and releasing the **REPORT** button.

- To mark the alert **TRUE**, press and release the **REPORT** button.
- To mark an alert **FALSE**, press and hold the **REPORT** button for 2 seconds.

A double-beep confirmation tone will be heard.

Operation

Note

If the call is dropped while on hold, you will hear a beep and the CB radio will return to standby.

To Place a call on Hold

During a call the display will show:

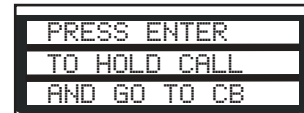

Press **Menu/Enter** knob. This puts the call on hold allowing CB communication.

To Return to Phone Call

While a call is on hold the display will show:

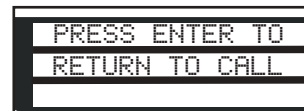

Press **Menu/Enter** knob to resume the call.

To Turn Bluetooth ON/Off on the Radio:

Press **Menu/Enter** and select **Bluetooth**®:

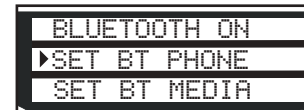

Press **Menu/Enter** again to select **Bluetooth**® **Phone ON** or **OFF**:

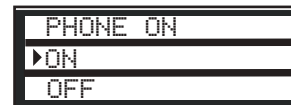

Press **Menu/Enter** again to select **Bluetooth**® **Media ON** or **OFF**:



A2DP Audio Streaming

Allows your phone's audio to be routed through the CB radio. This way third-party apps that output audio (such as music players, text message and email readers, or Caller ID annunciators) will play through the radio.

Note

BT PHONE is for hands-free calling.

BT MEDIA is for routing other audio through the radio.

Operation

Rewind-Say-Again®

Your 29 LX MAX allows you to play back the last transmission received over the airwaves and record a 10 second memo to be played back at any time.

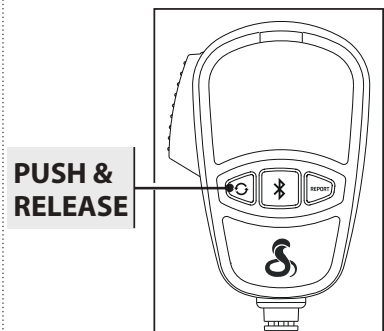

To Playback the Last Transmission

Press and release the **Rewind-Say-Again** button on the mic. The last transmission (up to 10 seconds) that the radio received will be heard over the speaker.

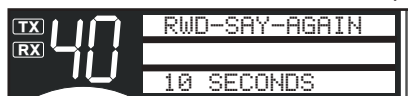

To Record a 10 Second Memo

Press and hold the **Rewind-Say-Again** button on the mic for the duration of the 10 second recording.

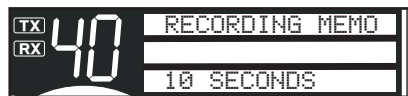

Speak into the microphone to record the Memo.

To play back the recorded memo, double press and release the **Rewind-Say-Again** button. The Memo will be heard over the speaker.

Note
The previous Memo recording will be erased when a new one is recorded.

Operation

Weather Alert

What You Should Know About Weather

If threatening weather is nearby, the National Weather Service may broadcast a 10 second alert tone. This tone will be heard through the CB, even if the CB/WX Control is in the **CB mode** or the unit is turned off.

This enables you to monitor CB frequencies and still be warned by the National Weather Service Emergency Alert. When you hear the alert, press the **CB/WX** button in the **WX mode**. You will then be able to listen to the Weather Warning Broadcast.

Your 29 LX MAX has a special auto squelch circuit for weather transmission which disables your squelch control.

Weather Alert Scan

The unit will continually scan all 10 WX channels for the (1050 Hz) alert tone. If the tone is detected the unit will activate **WX mode** on the channel with the tone. Default is **Off**. Go to **Menu mode** to choose **On/Off** (see page 30):

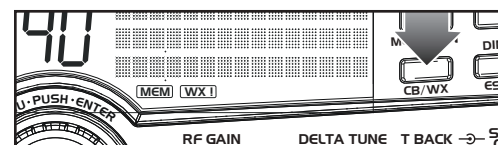

Weather Auto Scan

If active while in **CB mode**, will determine if the present WX channel is active. If the present WX channel is not active, will search for the strongest WX channel and auto change to that channel. Default is **Off**. Go to **Menu mode** to choose on/off (see page 30).

Weather Information

Note

To see a full listing of NOAA Weather Radio stations and locations, please visit: weather.gov/nwr/station_listing
For ideal weather reception use a dual band antenna (center load/baseload).

Weather Channels

What is Weather Radio?

NOAA Weather Radio (NWR) is a service of the National Oceanic and Atmospheric Administration (NOAA), of the U.S. Department of Commerce. 380 NWR stations are in operation by the U.S. Government in addition to several NWR stations that are maintained by private interest groups. The capability is to supplement warnings by sirens and by commercial radio and television. The 10 National Weather Channels provide full coverage to keep you informed of weather conditions, 24 hours a day, 7 days a week.

Operation

Note
Press **DIM/ESC** button to return to CB mode.

Note
If an alert is detected the unit will activate WX mode on the channel with the alert.

Setting Weather Alert Mode

Turns WX Alert On/Off. Default is **Off**. Press the **Menu/Enter** knob to select **Set WX Alert**. If Weather is **On**, WX Alert Icon will be displayed.



Press the **Menu/Enter** knob to select **On/Off** and exit to main menu.

Setting Weather Alert Scan

Press the **Menu/Enter** knob and rotate *clockwise* to **WX Alert Scan**. Press the **Menu/Enter** knob to select **On/Off**.

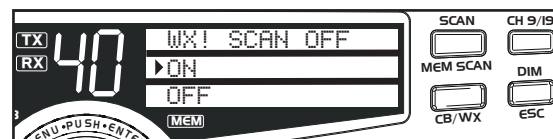

Press **Menu/Enter** knob to select **On/Off** and exit to the main menu.

Setting Weather Auto Scan

Press the **Menu/Enter** knob and rotate *clockwise* to **WX Auto Scan**. Press the **Menu/Enter** knob to select **On/Off**.



Press the **Menu/Enter** knob to select **On/Off** and exit to the main menu.

Operation

Software Version/Factory Settings

Displays current software version and returns unit to original factory settings. To view the software version, press the **Menu/Enter** knob and select **Setting** then **Software Version**.

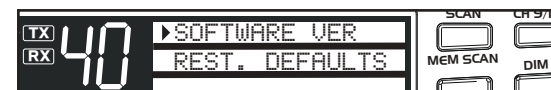
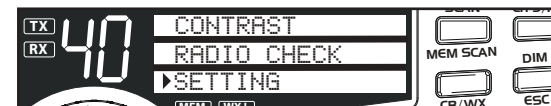

To restore default settings, Press the **Menu/Enter** knob and select **Settings** then select **Go To Rest. Defaults**.



Press the **Menu/Enter** knob to restore default settings. Choose **No** to maintain present settings with no change.

Note
Default display color is blue.

Operation

Note

The RF noise blanker is very effective in reducing repetitive noises such as ignition interference.

NB-ANL/OFF (Noise Blanker/Automatic Noise Limiter) Button

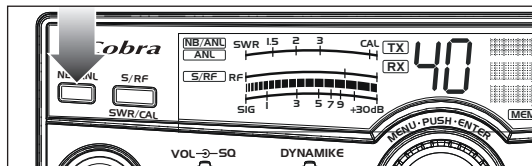

When switched to **ANL mode** the Automatic Noise Limiter is activated. This helps reduce noise created by the vehicle's electronics.

When switched to **NB/ANL mode** the RF Noise Blanker is also activated, providing increased noise filtration.

When switched to **Off**, all noise filtration will be turned off.

Setting Delta Tune

Rotate the **Delta Tune** knob to the center position for optimum tuning.

RF Gain Control

The **RF Gain** is used to optimize reception in strong or weak signal areas.

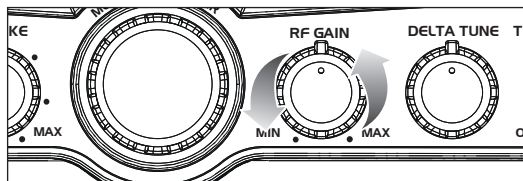

Rotate the **RF Gain** knob *counterclockwise* to reduce gain in strong signal areas. In weak signal areas turn *clockwise* to increase gain.

Operation

Program Memory Channels

Set first channel. Press and hold the **SCAN/MEM-SCAN** button. The **Memory** icon will appear. Select a second channel, press and hold the **SCAN/MEM-SCAN** button again until the Memory icon appears. Repeat above steps to enter up to 10 channels in memory.

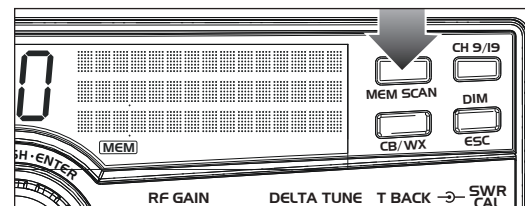
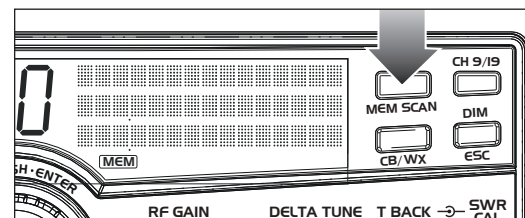

1 Pressing the **SCAN/MEM-SCAN** button toggles from **Off** to **Scan All Channels** to **Memory Channel Only** **Scan** and back to **Off**.

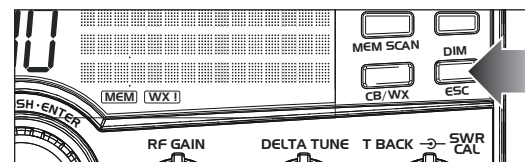

2 Press the **DIM/ESC** button to end Scan and return to **CB mode**.

Note

The radio should be squelched before scan features are activated.

Note

Keying the microphone will stop the scan feature.

Note

If more than 10 channels are attempted to be programmed, 3 error beeps will be heard and "Memory Full" will be displayed for 10 seconds or until any button is pushed.

Note

To remove a channel from memory, go to the unwanted memory channel then press and hold the **SCAN/MEM SCAN** button until the **MEM** icon turns off.

Operation

Note

If in WX mode the unit will scan Weather channels.

Scan CB Channels

To scan all 40 CB channels, the unit must be squelched. Press and release the **SCAN/MEM-SCAN** button once.

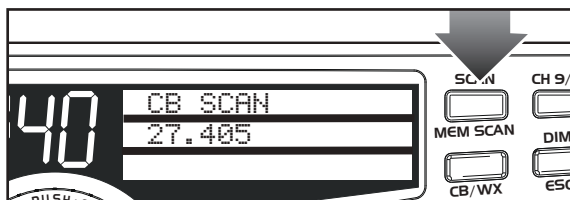

Scan Memory Channels

To scan memory channels, press and release the **SCAN/MEM-SCAN** button twice.



Dimmer Control

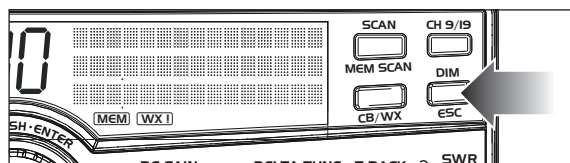

- 1 Press the **DIM/ESC** button to toggle between day and night settings. See setting instructions on page 21.

Operation

Setting Squelch

Squelch is the “control gate” for incoming signals.

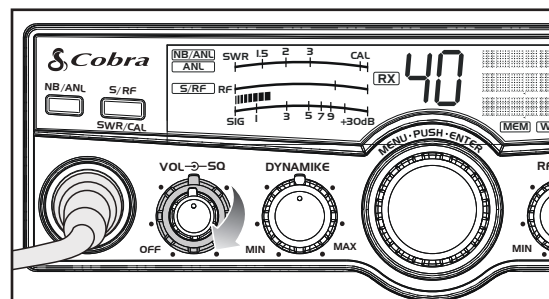

- 1 Full *clockwise* rotation closes the gate allowing only very strong signals to enter.

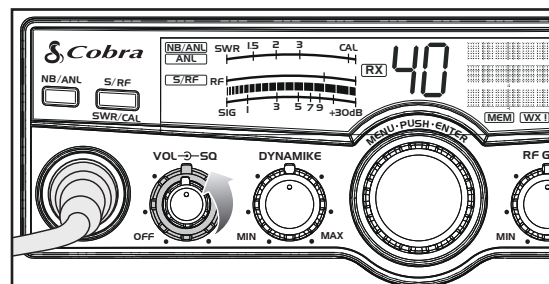

- 2 Full *counterclockwise* rotation opens the “gate” allowing all signals in.

Gate closed

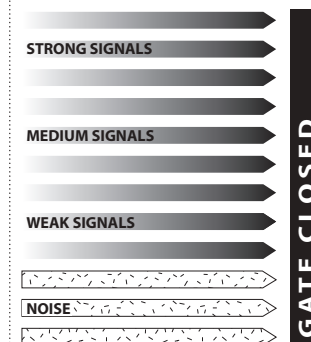

Gate open

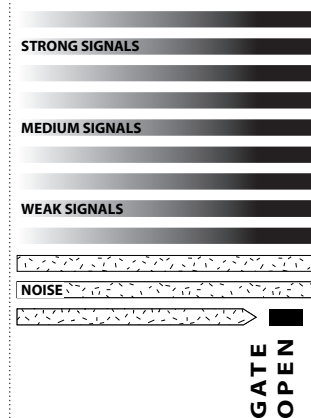

Operation

Continued

Gate set to Desired Squelch Setting (DSS)

STRONG SIGNALS

MEDIUM SIGNALS

WEAK SIGNALS

NOISE

GATE

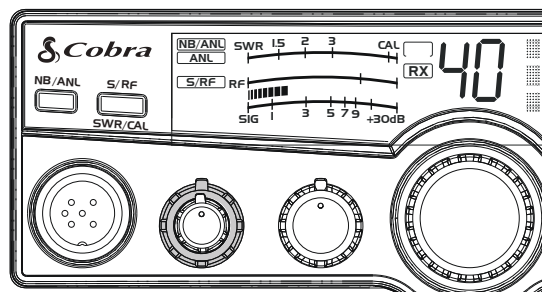

- 3 To achieve the Desired Squelch Setting (DSS), rotate the **Squelch** knob *counterclockwise* until you hear noise. Now rotate the knob *clockwise* just until the noise stops. This is the DSS setting.

S/R/F Meter

This meter swings proportionately to the RF output (outgoing signal) while transmitting.

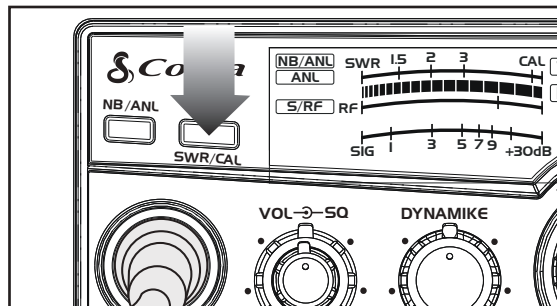

- 1 The **S/R-F-SWR/CAL** button must be in the S/R/F mode.

Operation

External Speaker

The external speaker jack is used for remote receiver monitoring.

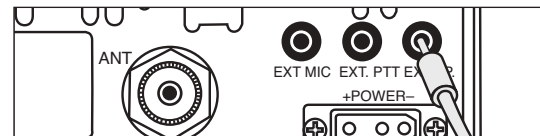

Connect an external speaker to the external speaker jack on the rear panel.

Note

The external speaker should have 8-ohm impedance and be rated to handle at least 4.0 watts. When an external speaker is plugged in, the internal speaker is automatically disconnected.

Note

Cobra external speakers are rated at 10 watts.

Home And Office Set-Up

STOP

Warning!

Do not attempt to operate this transceiver by connecting it directly to 120V AC.

Base Station Operation

To operate your transceiver from home or office you will need a 13.2 volt DC Power Supply rated at a minimum of 2 amps, and a properly installed base station antenna.

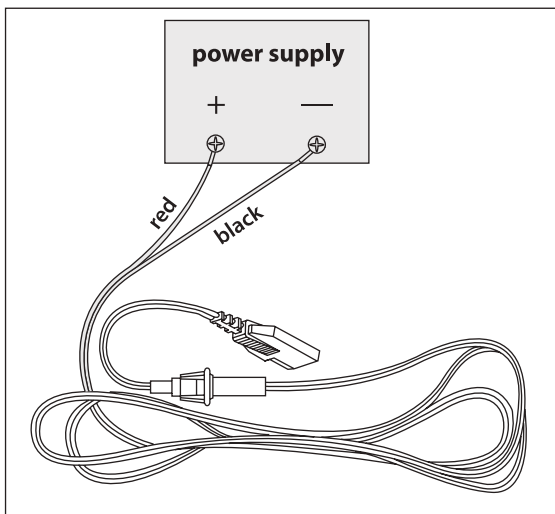

- 1 Simply connect the red (+) and black (-) leads of the transceiver to the corresponding terminals of the power pack.

Temporary Mobile Set-Up

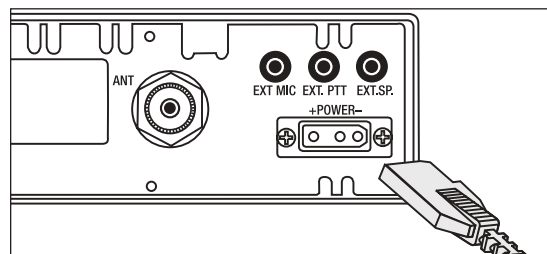

- 2 Plug the power cable into the back of the unit marked "Power". Be sure to observe the polarity markings.
- 3 Connect the properly installed and matched base station antenna.

Temporary Mobile Operation

For temporary mobile operation you may want to purchase an optional cigarette lighter adapter from your COBRA dealer. This adapter and a magnetic mount antenna allow you to quickly "install" your transceiver for temporary use.

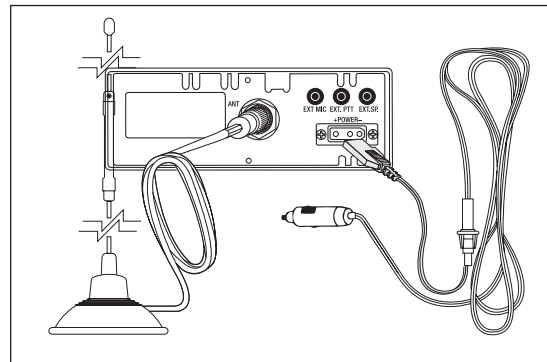

How Your CB Can Serve You

- Warn of traffic problems
- Provide weather and road data
- Provide help in event of an emergency
- Provide direct contact with home or office
- Assist police by reporting erratic drivers
- Get "local information" to find destination
- Communicate with family and friends
- Suggest spots to eat and sleep
- Keep you alert while traveling

A Few Rules You Should Know

- Conversations cannot last more than 5 minutes with another station. A one minute break is required to let others use the channel.
- You cannot blast others off the air by use of illegally amplified transmitters or illegally high antennas.
- You cannot use CB to promote illegal activities.
- Profanity is not allowed.
- You may not transmit music with a CB.
- Selling of merchandise and/or services is prohibited.

1. Set to channel 9 for emergencies

Be sure antenna is properly connected.

2. CB Distress Data

When transmitting an emergency, you should request a "REACT BASE" and provide the CB distress data (called CLIP):

- C** all Sign *Identify yourself.*
- L** ocation *Be exact.*
- I** njuries *Number. Type. Trapped?*
- P** roblem *Give details and help needed.*

Transmit CLIP repeatedly so any monitor can assist.

Note

If no response on channel 9, try channels 19 or 14.

How Your CB Can Serve You

The FCC gives these examples of permitted and prohibited messages for channel 9. These are only guidelines and not all-inclusive:

Permitted	Example Message
Yes	"Tornado sighted six miles north of town."
No	"Post number 10. No tornado sighted."
Yes	"Out of gas on I-95 at mile marker 211."
No	"Out of gas in my driveway."
Yes	"Four car accident on I-94 at Exit 11. Send police and ambulance."
No	"Traffic moving smoothly on I-94."
Yes	"Weather Bureau has issued thunderstorm warning. Bring sailboat into port."
No	"Attention motorists. Weather Bureau advises snow tomorrow will accumulate 4 to 6 inches."
Yes	"Fire in building at 539 Main, Evanston."
No	"Halloween patrol number 3. All quiet."

How Your CB Can Serve You

CB 10-Codes

Citizen Bands have adopted the "10-CODES" for standard questions and answers. These codes provide quick and easy communication, especially in noisy areas. Following are some of the more common codes and meanings:

Code	Meaning
10-1	Receiving poorly
10-2	Receiving well
10-3	Stop transmitting
10-4	OK, message received
10-5	Relay message
10-6	Busy, stand by
10-7	Out of service, leaving
10-8	In service, subject to call
10-9	Repeat message
10-10	Transmission completed standing by
10-11	Talking too rapidly
10-12	Visitors present
10-13	Advise weather/roads
10-16	Make pick up at
10-17	Urgent business
10-18	Anything for us?
10-19	Return to base
10-20	My location is
10-21	Call by phone
10-22	Report in person to
10-23	Stand by
10-24	Completed last assignment
10-25	Can you contact
10-26	Disregard last info
10-27	Moving to channel
10-28	Identify your station

Code	Meaning
10-29	Time is up for contact
10-30	Does not conform to FCC rules
10-33	Emergency traffic
10-34	Trouble at this station
10-35	Confidential information
10-36	Correct time is
10-37	Wrecker needed at
10-38	Ambulance needed
10-39	Message delivered
10-41	Turn to channel
10-42	Traffic accident at
10-43	Traffic tie up at
10-44	Have a message for
10-45	All units within range please report
10-50	Break channel
10-60	What is next message number?
10-62	Unable to copy. Use phone
10-63	Net directed to
10-64	Net clear
10-65	Awaiting your next message/assignment
10-67	All units comply
10-70	Fire at
10-71	Proceed, transmission in sequence
10-77	Negative contact
10-81	Reserve hotel room for
10-82	Reserve room for
10-85	My address is
10-91	Talk closer to mic
10-93	Check my frequency on this channel
10-94	Give me a long count
10-99	Mission completed, all units secure
10-200	Police needed at

Frequency Ranges

The Cobra 29 LX MAX transceiver represents one of the most advanced AM two-way radios used as a Class D station in the Citizens Radio Service. This unit features advanced Phase Lock Loop (PLL) circuitry providing complete coverage of all 40 CB channels.

CB Channel	Channel Freq. In MHz	CB Channel	Channel Freq. In MHz	WX Channel	Freq. In MHz
1	26.965	21	27.215	1	162.550
2	26.975	22	27.225	2	162.400
3	26.985	23	27.255	3	162.475
4	27.005	24	27.235	4	162.425
5	27.015	25	27.245	5	162.450
				6	162.500
6	27.025	26	27.265	7	162.525
7	27.035	27	27.275	8	161.650
8	27.055	28	27.285	9	161.775
9	27.065	29	27.295	10	163.275
10	27.075	30	27.305		
11	27.085	31	27.315		
12	27.105	32	27.325		
13	27.115	33	27.335		
14	27.125	34	27.345		
15	27.135	35	27.355		
16	27.155	36	27.365		
17	27.165	37	27.375		
18	27.175	38	27.385		
19	27.185	39	27.395		
20	27.205	40	27.405		

29 LX MAX Specifications

GENERAL
CHANNELS CB - 40 CH
FREQUENCY RANGE CB - 26.965 TO 27.405 MHZ
 WX - 162.400 TO 162.775 MHZ
FREQUENCY TOLERANCE 0.005 %
FREQUENCY CONTROL PLL (PHASE LOCK LOOP) SYNTHESIZER
OPERATING TEMPERATURE RANGE -30° C TO + 50° C
MICROPHONE Plug-in Electret
INPUT VOLTAGE 13.2VDC nom. negative ground
Current Drain Transmit: AM full mod., 1.5A (maximum)
 Receive: Squelched, 0.3A;
 full audio output, 1.2A (nominal)
Size 8-5/8" D x 7-9/32" W x 2-13/63" H
Weight 4 lbs.
Antenna Connector UHF; SO-239
Meter Indicates relative power output received signal strength, and vswr

TRANSMITTER
Power Output 4 watts
Modulation AM (Amplitude Modulation)
Frequency Response 300 to 3000 Hz
Output Impedance 50 ohms, unbalanced

RECEIVER
Sensitivity Less than 1 µV for 10 dB (S+N) /N
Selectivity 6 dB @ 7 KHz, 60 dB @ 10KHz
Image Rejection 80 dB, typical
Adjacent-Channel Rejection 60 dB, typical
IF Frequencies Double Conversion: 1st: 10.695 MHz
 2nd: 455 KHz
Automatic Gain Control (AGC) Less than 10 dB change in audio output for inputs from 10 to 50,000 microvolts
RF Gain range 40 db
Noise Blanker RF type
Squelch Adjustable; threshold less than 1µV
Audio Output Power 4 watts
Frequency Response 300 to 3000 Hz
Distortion Less than 7% @3 watts @ 1000 Hz
Built-in Speaker 8 ohms, 5w
External Speaker (Not supplied) 8 ohms; disables internal speaker when connected

Maximum antenna gain0dbi

(SPECIFICATIONS SUBJECT TO CHANGE WITHOUT NOTICE)

FCC Statement

FCC Part 15.19 Warning Statement

THIS DEVICE COMPLIES WITH PART 15 OF THE FCC RULES. OPERATION IS SUBJECT TO THE FOLLOWING TWO CONDITIONS: (1) THIS DEVICE MAY NOT CAUSE HARMFUL INTERFERENCE, AND (2) THIS DEVICE MUST ACCEPT ANY INTERFERENCE RECEIVED, INCLUDING INTERFERENCE THAT MAY CAUSE UNDESIRE OPERATION.

FCC Part 15.21 Warning Statement-

NOTE: THE GRANTEE IS NOT RESPONSIBLE FOR ANY CHANGES OR MODIFICATIONS NOT EXPRESSLY APPROVED BY THE PARTY RESPONSIBLE FOR COMPLIANCE. SUCH MODIFICATIONS COULD VOID THE USER'S AUTHORITY TO OPERATE THE EQUIPMENT.

FCC Part 15.105(b) Warning Statement

NOTE: This equipment has been tested and found to comply with the limits for a Class B digital device, pursuant to part 15 of the FCC Rules. These limits are designed to provide reasonable protection against harmful interference in a residential installation. This equipment generates uses and can radiate radio frequency energy and, if not installed and used in accordance with the instructions, may cause harmful interference to radio communications. However, there is no guarantee that interference will not occur in a particular installation. If this equipment does cause harmful interference to radio or television reception, which can be determined by turning the equipment off and on, the user is encouraged to try to correct the interference by one or more of the following measures:

- Reorient or relocate the receiving antenna.
- Increase the separation between the equipment and receiver.
- Connect the equipment into an outlet on a circuit different from that to which the receiver is connected.
- Consult the dealer or an experienced radio/TV technician for help.

IC RSS-GEN, Sec 8.4 Warning Statement

ENGLISH: This device complies with Industry Canada license-exempt RSS standard(s). Operation is subject to the following two conditions: (1) this device may not cause interference, and (2) this device must accept any interference, including interference that may cause undesired operation of the device.

FRENCH: Le présent appareil est conforme aux CNR d'Industrie Canada applicables aux appareils radio exempts de licence. L'exploitation est autorisée aux deux conditions suivantes : (1) l'appareil ne doit pas produire de brouillage, et (2) l'utilisateur de l'appareil doit accepter tout brouillage radioélectrique subi, même si le brouillage est susceptible d'en compromettre le fonctionnement.

IC RSS-GEN, Sec 8.3 Warning Statement

ENGLISH: This radio transmitter (identify the device by certification number, or model number if Category II) has been approved by Industry Canada to operate with the antenna types listed below with the maximum permissible gain and required antenna impedance for each antenna type indicated. Antenna types not included in this list, having a gain greater than the maximum gain indicated for that type, are strictly prohibited for use with this device.

Immediately following the above notice, the manufacturer shall provide a list of all antenna types approved for use with the transmitter, indicating the maximum permissible antenna gain (in dBi) and required impedance for each.

FRENCH: Le présent émetteur radio (identifier le dispositif par son numéro de certification ou son numéro de modèle s'il fait partie du matériel de catégorie I) a été approuvé par Industrie Canada pour fonctionner avec les types d'antenne énumérés ci-dessous et ayant un gain admissible maximal et l'impédance requise pour chaque type d'antenne. Les types d'antenne non inclus dans cette liste, ou dont le gain est supérieur au gain maximal indiqué, sont strictement interdits pour l'exploitation de l'émetteur.

RF Exposure Statement

ENGLISH: This equipment complies with FCC radiation exposure limits set forth for an uncontrolled environment. This equipment should be installed and operated with minimum distance 20cm between the radiator & your body, and CB radio antenna at least 40cm from nearby persons.

The device is in compliance with RF exposure guidelines, users can obtain Canadian information on RF exposure and compliance. The minimum distance from body to use the device is 20cm.

FRENCH: Le présent appareil est conforme

Après examen de ce matériel aux conformités ou aux limites d'intensité de champ RF, les utilisateurs peuvent sur l'exposition aux radiofréquences et compliance d'acquérir les informations correspondantes. La distance minimale du corps à utiliser le dispositif est de 20cm.

Limited Two Year Warranty

Warranty Terms:

Cobra warrants your product against all defects in materials and workmanship for a period of two (2) years from the date of original purchase.

Cobra, at our sole discretion, will repair or replace your product (with the same or comparable product) free of charge.

Cobra will not pay shipping charges that you incur for sending your product to us. Products received COD will be refused.

To make a warranty claim, we will require proof of purchase in the form of an invoice or receipt. No proof of purchase is required for factory direct purchases.

Warranty Exclusions: Warranty does not apply to your product under any of the following conditions: 1. The serial number has been removed or modified. 2. Your product has been subjected to misuse or damage (including water damage, physical abuse, and/or improper installation). 3. Your product has been modified in any way. 4. Your receipt or proof-of-purchase is from a non-authorized dealer or internet auction site including E-bay, U-bid, or other non-authorized resellers.

LIMITATION OF WARRANTY: EXCEPT AS EXPRESSLY PROVIDED HEREIN, YOU ARE ACQUIRING THE PRODUCT "AS IS" AND "WHERE IS", WITHOUT REPRESENTATION OR WARRANTY. COBRA SPECIFICALLY DISCLAIMS ANY REPRESENTATION OR WARRANTY INCLUDING, BUT NOT LIMITED TO THOSE CONCERNING THE MERCHANTABILITY AND SUITABILITY OF THE PRODUCT FOR A PARTICULAR PURPOSE. COBRA SHALL NOT BE LIABLE FOR CONSEQUENTIAL, SPECIAL OR INCIDENTAL DAMAGES INCLUDING, WITHOUT LIMITATION, DAMAGES ARISING OUT OF THE USE, MISUSE OR MOUNTING OF THE PRODUCT.

The above limitations or exclusions shall be limited to the extent they violate the laws of any particular state. Cobra is not responsible for products lost in shipment between the owner and our service center.

General Warranty Information

Each product we manufacture is covered by our factory warranty. While each product may have unique components and policy, the general guideline below will apply to most Cobra products.

All Cobra products purchased factory-direct or from our Authorized Resellers will come with a full one to three (1-3) year warranty from the date of the original retail purchase (see policy statement above for full warranty details and exclusions).

Standard accessories packaged with each model will have a one-year factory warranty.

Accessory items have a one-year factory warranty.

Shipping to our facility is not covered in our warranty. Return shipping is included within the US.

This warranty is non-transferrable.

For the sake of clarity, 'repair or replace the Product or its defective part' does not include removal or installation work, costs or expenses which include but are not limited to labor costs or expenses.

Cobra will not be responsible for lost packages.

Product Service

If you have any questions about operation or installing your new Cobra product, PLEASE CONTACT COBRA FIRST...do not return this product to any retail store.

The contact information for Cobra will vary depending on the country in which you purchased and utilize the product. For the latest contact information, please go to www.cobra.com/support

For products purchased in the U.S.A. you may call 1800-543-1608.

For products purchased in the U.S.A., if your product should require factory service, please go to www.cobra.com/support and follow the instructions for returning your product to the Cobra Factory Service Department for service. Should there be any problems with this product or further information is needed on its features please visit www.cobra.com for support, frequently asked questions, Declarations of Conformity, and full manuals.

For Products Purchased Outside the U.S.A. or Canada

Please contact your local dealer for product service information.

For Products Used in Canada

Industry Canada Notice

This device complies with Industry Canada license-exempt RSS standard(s). Operation is subject to the following two conditions:

- (1) this device may not cause interference, and
- (2) this device must accept any interference, including interference that may cause undesired operation of the device.

Le présent appareil est conforme aux CNR d'Industrie Canada applicables aux appareils radio exempts de licence. L'exploitation est autorisée aux deux conditions suivantes:

- (1) l'appareil ne doit pas produire de brouillage, et
- (2) l'utilisateur de l'appareil doit accepter tout brouillage radioélectrique subi, même si le brouillage est susceptible d'en compromettre le fonctionnement.



29 LX MAX

Professional CB Radio

Bluetooth® Connectivity for Hands-Free Calls



OWNER'S MANUAL

Nothing Comes Close to a Cobra®

For more information or to order any of our products, please visit our website: www.cobra.com

©2021 Cobra Electronics Corporation

Cobra®, Dynamike®, Nothing Comes Close to a Cobra® and the snake design are registered trademarks of Cobra Electronics Corporation, USA.

Cobra Electronics Corporation™ is a trademark of Cobra Electronics Corporation, USA.

Pat. www.cobra.com/patents

The CB Story

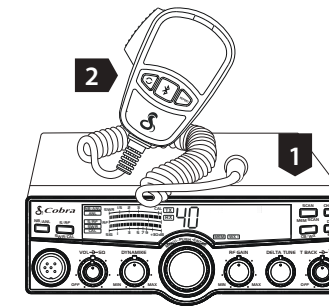

The Citizens Band lies between the shortwave broadcast and 10-meter Amateur radio bands, and was established by law in 1949. The Class D two-way communications service was opened in 1959. (CB also includes a Class A citizens band and Class C remote control frequencies.)

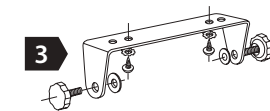

Federal Communications FCC Regulations
FCC regulations permit only "transmissions" (one party to another) rather than "broadcasts" (to a wide audience). Thus, advertising is not allowed on CB Channels because that is "broadcasting."

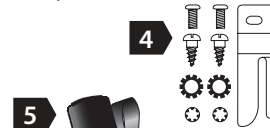

FCC Warnings

All transmitter adjustments other than those supplied by the manufacturer as front panel operating controls, must be made by, or under the supervision of, the holder of an FCC-issued general Radio-Telephone Operator's License.



Replacement or substitution of transistors, regular diodes or other parts of a unique nature, with parts other than those recommended by Cobra, may cause violation of the technical regulations of Part 95 of the FCC Rules, or violation of Type Acceptance requirements of Part 2 of the Rules.



What's Included with Your 29 LX MAX

- 1 CB Transceiver
- 2 Microphone
- 3 Transceiver Bracket
- 4 Microphone Bracket
- 5 External Microphone
- 6 DC Power Cord
- 7 Operating Manual

A1

Controls and Indicators

Front Side

1. 6-Pin Microphone Connector
2. Power On/Off, Volume
3. Squelch
4. RF Gain
5. Menu/Enter/Channel Selector
6. Dynamike
7. Delta Tune
8. Talk Back Control
9. SWR Calibration
10. Dim/Escapes Button
11. Channel 9/Channel 19 Button
12. Scan/Memory Scan
13. CB/WX Weather Button
14. LCD Display
15. RX (Receive)/TX (Transmit), Indicators
16. Signal Strength Meter
17. S/RF SWR CAL Button
18. NB/ANL Button
19. Microphone

On Microphone

20. Push-To-Talk (PTT) Button
21. Rewind-Say-Again™ Button
22. Bluetooth® Button
23. Report Button

Back Side

23. External Microphone Jack
24. External Push-To-Talk Jack
25. External Speaker Jack
26. Antenna Connector
27. Power Jack

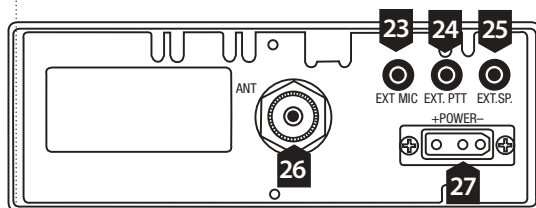
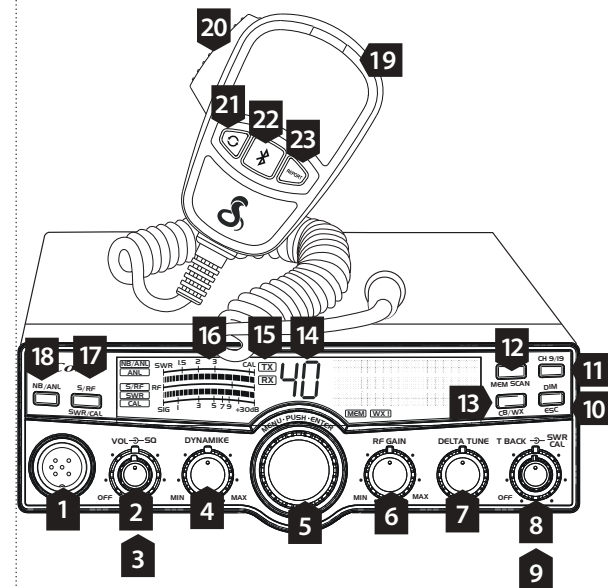

Our Thanks to You

Thank you for purchasing the Cobra 29 LX MAX CB Radio. Properly used, this Cobra product will give you many years of reliable service.

Customer Support

Should you encounter any problems with the product or not understand its many features, please refer to this owner's manual. If, after referring to the manual, you still need help, call Cobra Customer Service at 800-543-1608.

Cobra Assistance

Should you encounter any problems with this product, or not understand its many features, please refer to this owner's manual. If you require further assistance after reading this manual, Cobra Electronics offers the following customer assistance services:

Monday-Friday 9:00 AM-5:00 PM EST

Call: 800-543-1608

SERVICE

Monday-Thursday 9:00AM-5:00PM EST

Call: 800-543-1608

Office:

6500 West Cortland Street,
Chicago, IL, 60707

Have questions? We can help.

Contact us at 800-543-1608

M-F 9:00AM-5PM EST

For Assistance Outside the U.S.A.

Contact Your Local Dealer

Ordering Info

You can find quality Cobra products and accessories at your local Cobra dealer, or in the U.S.A., you can order directly from Cobra.

Please visit www.cobra.com

Web orders will normally ship the next business day if received by us before 2:00 PM Eastern Time. Orders do not ship on weekends or holidays. All standard deliveries are Monday-Friday only. Saturday delivery can be requested in certain areas of the country for an additional shipping fee by calling Sales at 800-543-1608.

Certain orders may require additional days to process prior to shipping. Holidays may also impact processing and shipping time frame. Occasionally, items may not ship due to inventory depletion. If you need your item to be expedited, we recommend calling Sales at **800-543-1608**.

Order Acceptance

Once your order has been accepted and processed, you will receive an email that will include the shipping carrier and tracking information.

Shipping and Delivery

Free ground shipping is included to 48 states. Hawaii, Alaska and Puerto Rico ship based on assessed fee at checkout.

We require a physical address for shipping. Sorry, no P.O. Boxes or APO/FPO addresses. Please select 2-day or next day air for shipments to Hawaii or Alaska. Shipping charges are calculated on a per-product basis. Please make note of the shipping charges associated with each item.

Note: For safety reasons, we cannot ship products containing lithium-ion batteries via air delivery methods. These items are available to ship via ground service only.

Note: For your protection, some orders may require a signature for delivery.