



849 NW STATE ROAD 45  
 NEWBERRY, FL 32669 USA  
 PH: 888.472.2424 OR 352.472.5500  
 FAX: 352.472.2030  
 EMAIL: [INFO@TIMCOENGR.COM](mailto:INFO@TIMCOENGR.COM)  
[HTTP://WWW.TIMCOENGR.COM](http://WWW.TIMCOENGR.COM)

**FCC PART 95 AND IC RSS-210 (i8)  
 FRS/GMRS TRANSCEIVER  
 TEST REPORT**

Applicant	COBRA ELECTRONICS CORPORATION
	6500 WEST CORTLAND STREET CHICAGO, IL 60707 USA
FCC ID	BBO21410A
IC Cert #	906A-21410A
Model Numbers	CXT1035R FLT, CXT1095 FLT, CXT1035 CAMO FLT
Product Description	FRS/GMRS TRANSCEIVER
FCC Standard Applied	47 CFR § 95 Personal Radio Service Subpart A – General Mobile Radio Service (GMRS) Subpart B – Family Radio Service (FRS)
IC Standard Applied	IC Standard RSS-210 (i8), Annex 6
Date Sample Received	12/26/2013
Date Tested	12/27/2013
Tested By	Cory Leverett
Approved By	Cory Leverett
Timco Report No.	2240AUT13TestReport.docx
Test Results	<input checked="" type="checkbox"/> PASS <input type="checkbox"/> FAIL

**THE ATTACHED REPORT SHALL NOT BE REPRODUCED EXCEPT IN FULL  
 WITHOUT THE WRITTEN APPROVAL OF TIMCO ENGINEERING, INC.**





**TABLE OF CONTENTS**

GENERAL REMARKS .....3

GENERAL INFORMATION .....4

DUT External Photo’s.....5

TEST PROCEDURES.....6

RF POWER OUTPUT .....7

    The rated output power:..... 8

    Radiated Output Power: ..... 8

    DC Input into the final amplifier..... 8

MODULATION CHARACTERISTICS.....9

    Audio Frequency Response Plot..... 9

    Audio Input vs Modulation Plot ..... 10

    Post Limiter Filter Plot ..... 11

EMISSION DESIGNATOR AND FREQUENCIES .....12

OCCUPIED BANDWIDTH .....13

    Occupied Bandwidth Plot GMRS CH 22..... 14

    Occupied Bandwidth Plot FRS CH 8 ..... 15

SPURIOUS EMISSIONS AT ANTENNA TERMINALS (CONDUCTED).....16

FIELD STRENGTH OF SPURIOUS EMISSIONS - TX.....17

    Test Data (FRS 467.5625MHz): ..... 18

    Test Data (GMRS 462.725MHz HI Power):..... 19

    Test Data (GMRS 462.725MHz LO Power):..... 20

FREQUENCY STABILITY.....21

TEST EQUIPMENT LIST .....22

\*EMI Test Receiver firmware version information .....22

DUT Test Setup Photo’s .....23



**GENERAL REMARKS**

The attached report shall not be reproduced except in full without the written permission of Timco Engineering Inc.

**Summary**

The device under test does:

- fulfill the general approval requirements as identified in this test report
- not fulfill the general approval requirements as identified in this test report

**Attestations**

This equipment has been tested in accordance with the standards identified in this test report. To the best of my knowledge and belief, these tests were performed using the measurement procedures described in this report.

All instrumentation and accessories used to test products for compliance to the indicated standards are calibrated regularly in accordance with ISO 17025 requirements.



Testing Certificate # 0955-01

I attest that the necessary measurements were made, under my supervision, at:

Timco Engineering Inc.  
849 NW State Road 45  
Newberry, FL 32669

**Authorized Signatory Name:**



Cory Leverett  
Engineering Project Manager

**Date:**

1/8/2014



**GENERAL INFORMATION**

**EUT SPECIFICATIONS**

The test results relate only to the items tested.	
EUT Description	FRS/GMRS TRANSCEIVER
FCC ID	BBO21410A
IC Cert #	906A-21410A
Model Number	CXT1035R FLT, CXT1095 FLT, CXT1035 CAMO
Operating Frequency	462.5500-462.7250, 462.5625-467.7125
No. of Channels	22
Type of Emission	10K5F3E
Modulation	FM
EUT Power Source	<input type="checkbox"/> 110-120Vac/50- 60Hz
	<input type="checkbox"/> DC Power
	<input checked="" type="checkbox"/> Battery Operated Exclusively
Test Item	<input type="checkbox"/> Prototype
	<input checked="" type="checkbox"/> Pre-Production
	<input type="checkbox"/> Production
Type of Equipment	<input type="checkbox"/> Fixed
	<input type="checkbox"/> Mobile
	<input checked="" type="checkbox"/> Portable
Antenna	Fixed
Test Facility	Timco Engineering Inc. located at 849 NW State Road 45 Newberry, FL 32669 USA.
Conditions in the Test laboratory	Temperature: 26 C Humidity: 55% RH
Revision History of EUT	None
Test Exercise	The EUT was placed in continuous transmit mode of operation

Applicant: COBRA ELECTRONICS CORPORATION  
 FCC ID: BBO21410A  
 IC Cert #: 906A-21410A  
 Report: C\COBRA\2240AUT13\2240AUT13TestReport.docx



**DUT External Photo's**



## TEST PROCEDURES

**Bandwidth:** The measurements were made with the spectrum analyzer's resolution bandwidth (RBW) = 1 MHz and the video bandwidth (VBW) = 3 MHz and the span set as shown on plot.

**Power Output:** RF power was conducted per ANSI/TIA 603-C: 2004 using the substitution method

**Antenna Conducted Emissions:** The RBW = 100 kHz, VBW = 300 kHz and the span set to 10.0 MHz and the spectrum was scanned from 30 MHz to the 10<sup>th</sup> Harmonic of the fundamental. Above 1 GHz the resolution bandwidth was 1 MHz and the VBW = 3 MHz and the span to 50 MHz.

**Radiation Interference:** The test procedure used was ANSI/TIA 603-C: 2004 using an Agilent spectrum receiver with pre-selector. The bandwidth (RBW) of the spectrum receiver was 100 kHz up to 1 GHz and 1 MHz above 1 GHz with an appropriate sweep speed. The VBW above 1 GHz was 3 MHz. The analyzer was calibrated in dB above a microvolt at the output of the antenna.

**RF POWER OUTPUT**

**Rule Part No.:** 2.1033(c)(6)(7), 2.1046(a), Part 95, RSS-210

**Requirements:** Power output shall not exceed 0.50 Watts effective radiated power for the FRS channels. There can be no provisions for increasing the power or varying the power. No GMRS channel, under any condition of modulation, shall exceed:

1. 50W Carrier power (average TP during one modulated RF cycle) when transmitting emissions type A1D, F1D, G1D, A3E, F3E, or G3E.
2. 50W peak envelope TP when transmitting emission type H1D, J1D, R1D, H3E, J3E, or R3E.

**Method of Measurement:** RF power is measured as ERP as the antenna is permanently attached. The substitution method was used. With a nominal battery voltage, and the transmitter properly adjusted the RF output measures:

**Test Setup Diagram:**

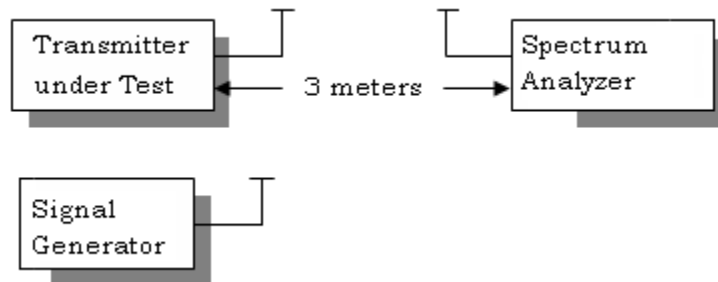

**The rated output power:**

	<b>W</b>	<b>dBm</b>
<b>GMRS HI</b>	<b>2</b>	<b>33</b>
<b>GMRS LO</b>	<b>.5</b>	<b>27</b>
<b>FRS</b>	<b>.5</b>	<b>27</b>

**Test Data:**

**Radiated Output Power:**

<b>Tuned Frequency MHz</b>	<b>dBm</b>	<b>Watts</b>
<b>GMRS 462.725 HI Power</b>	<b>33</b>	<b>2.0</b>
<b>GMRS 462.725 LO Power</b>	<b>26.49</b>	<b>.45</b>
<b>FRS 467.562</b>	<b>26.91</b>	<b>.49</b>

**Rule Part No.: 2.1033 (C)(8), RSS-210**

**DC Input into the final amplifier**

FRS CH 8 (4.5V)(.36A) = **1.2 Watts**  
 GMRS CH 22 LO Power (4.5V)(.56A) = **2.5 Watts**  
 GMRS CH 22 HI Power (4.5V)(.68A) = **3 Watts**



**MODULATION CHARACTERISTICS**

**Rule Part No.:** Part 2.1047(a)(b), RSS-210

**Test Requirements:**

**Method of Measurement:**

The audio frequency response was measured in accordance with ANSI/TIA 603-C: 2004. The audio frequency response curve is shown below. The audio signal was fed into a dummy microphone circuit and into the microphone connector. The input required to produce 30 percent modulation level was measured.

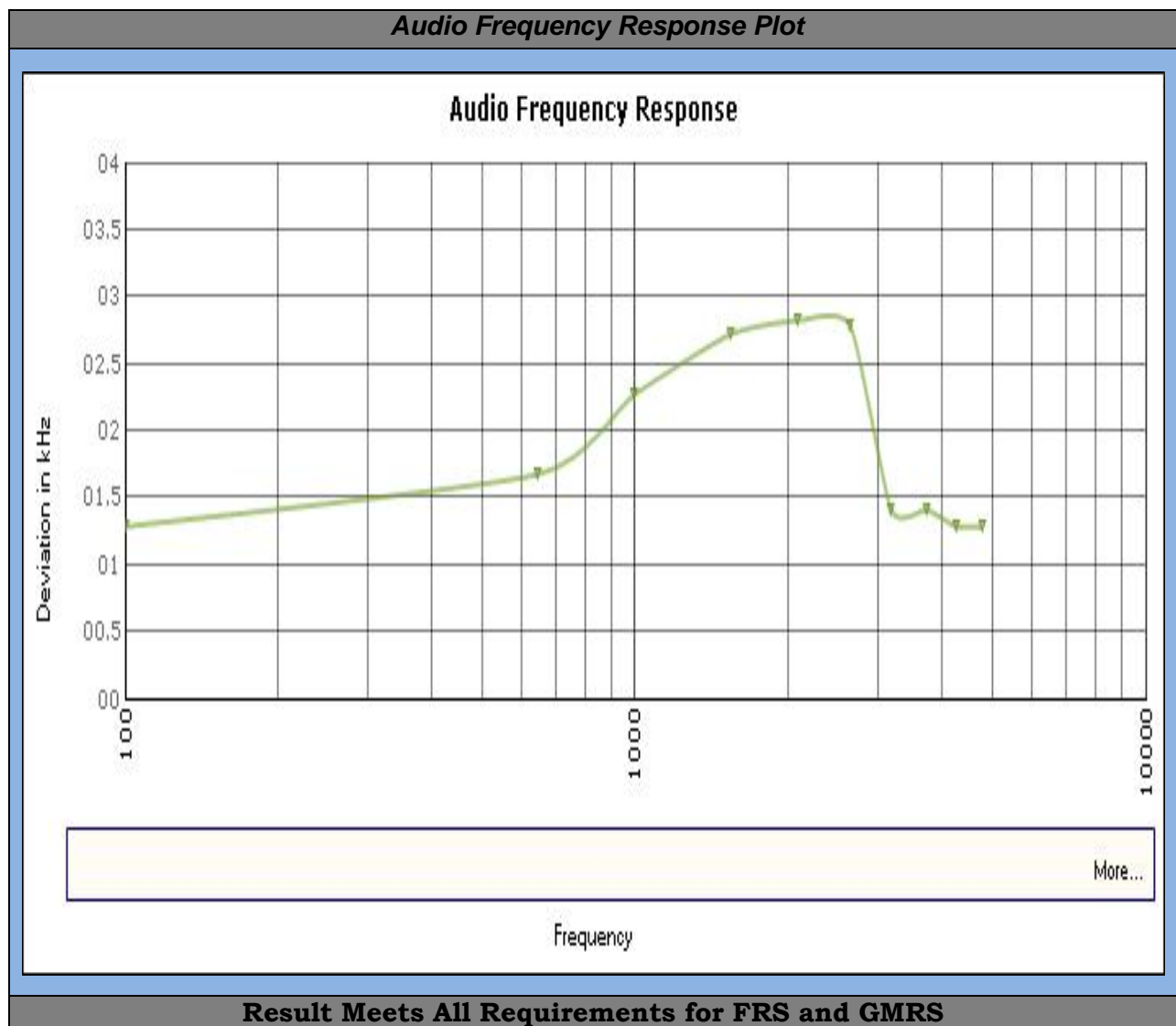

### Audio input versus modulation

The audio input level needed for a particular percentage of modulation was measured in accordance with ANSI/TIA 603-C: 2004. Curves are provided for audio input frequencies of 300, 1000, and 2500 Hz. See the plot below..

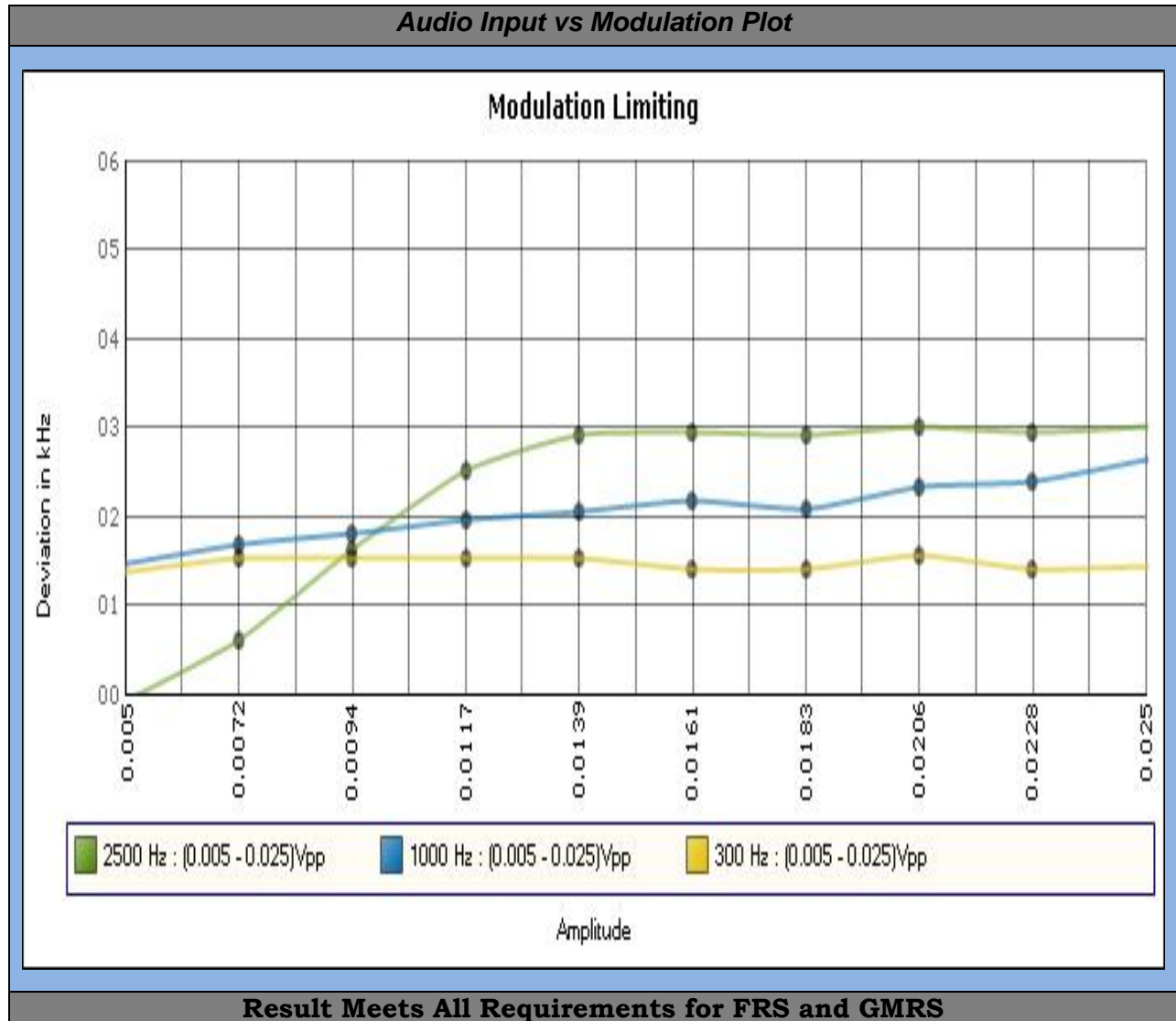

### Post Limiter Filter

Each GMRS transmitter, except a mobile station transmitter with a power of 2.5Watts or less, must be equipped with an audio low pass filter. At any frequency between 3 & 20 kHz the filter must have an attenuation of  $60\log(f/3)$  greater than the attenuation at 1 kHz. See below.





**EMISSION DESIGNATOR AND FREQUENCIES**

RSS-210

2.1033(c) (4) Type of Emission: 10K5F3E  
95.631

$B_n = 2M + 2DK$   
 $M = 3000$   
 $D = 2.25K$   
 $B_n = 2(3000) + 2(2250) = 10.5K$

GMRS Authorized Bandwidth 20.0 kHz

2.1033(c)(5) GMRS Frequency Range:  
95.621

- |              |              |
|--------------|--------------|
| 1. 462.5500  | 13. 462.7000 |
| 2. 462.5625  | 14. 462.7125 |
| 3. 462.5750  | 15. 462.7250 |
| 4. 462.5875  |              |
| 5. 462.6000  |              |
| 6. 462.6125  |              |
| 7. 462.6250  |              |
| 8. 462.6375  |              |
| 9. 462.6500  |              |
| 10. 462.6625 |              |
| 11. 462.6750 |              |
| 12. 462.6875 |              |

FRS Authorized Bandwidth 12.5 kHz

2.1033(c)(5) FRS Frequency Range:  
95.627

- |             |                  |
|-------------|------------------|
| 1. 462.5625 | 8. 467.5625      |
| 2. 462.5875 | 9. 467.5875      |
| 3. 462.6125 | 10. 467.6125     |
| 4. 462.6375 | 11. 467.6375     |
| 5. 462.6625 | 12. 467.6625     |
| 6. 462.6875 | 13. 467.6875     |
| 7. 462.7125 | 14. 467.7125 MHz |



## OCCUPIED BANDWIDTH

**Part 2.1049(c)** EMISSION BANDWIDTH:  
95.635(b)(1)(3)(7)  
RSS-210

At least 25 dB on any frequency removed from the center of the authorized bandwidth by more than 50% up to and including 100% of the authorized bandwidth. At least 35 dB on any frequency removed from the center of the authorized BW by more than 100% up to and including 250% of the authorized BW. At least  $43 + \log_{10}(TP)$  dB on any frequency removed from the center of the authorized bandwidth by more than 250%. See the following plot on next two pages.

**Test procedure:** ANSI/TIA-603-C: 2004 paragraph 2.2.11.

### OCCUPIED BANDWIDTH MEASUREMENT

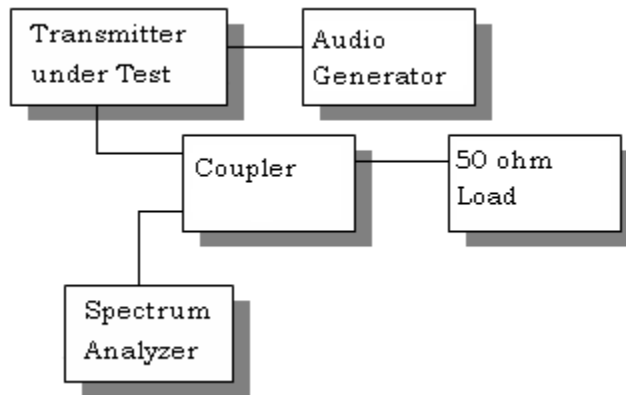

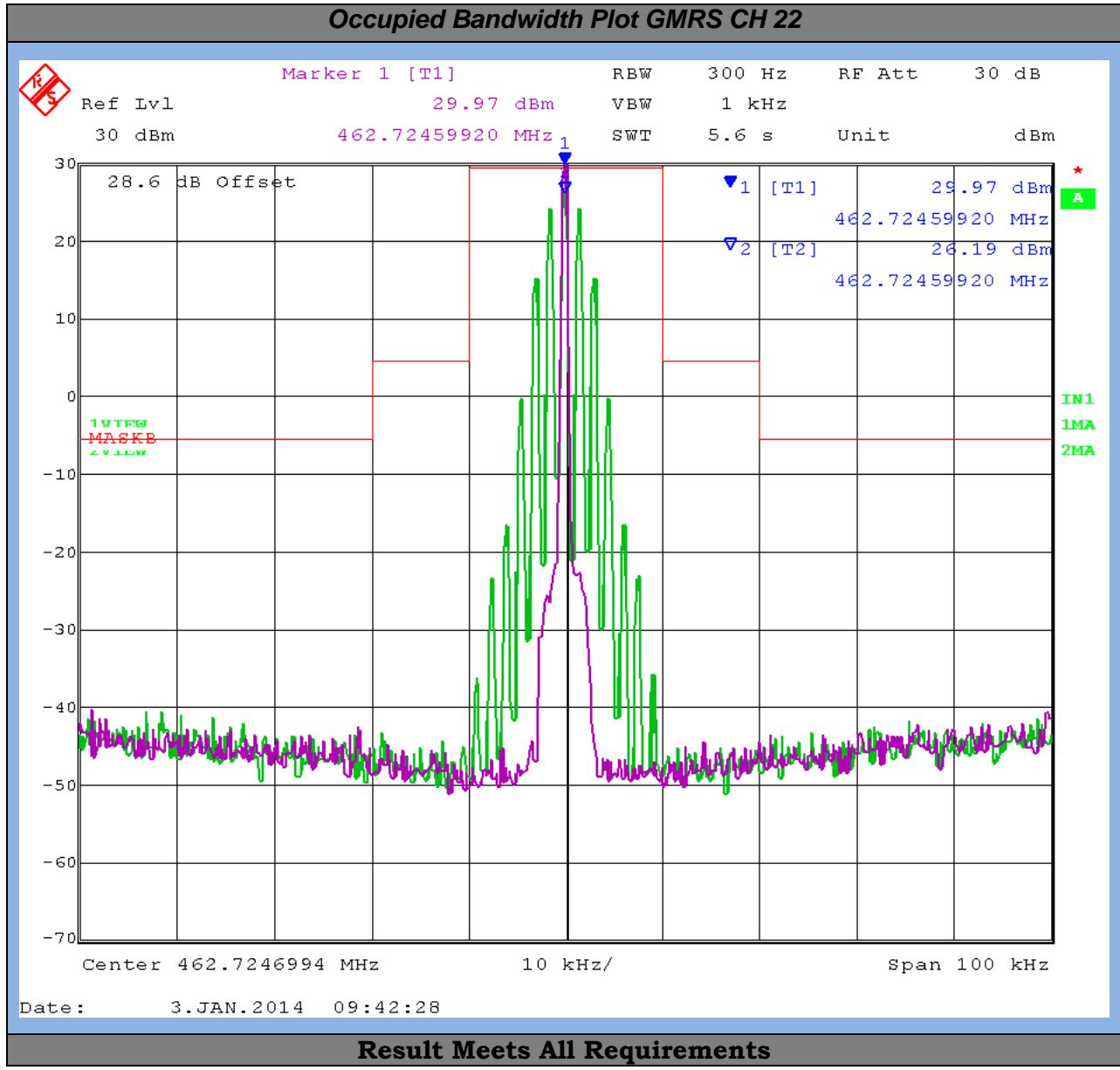

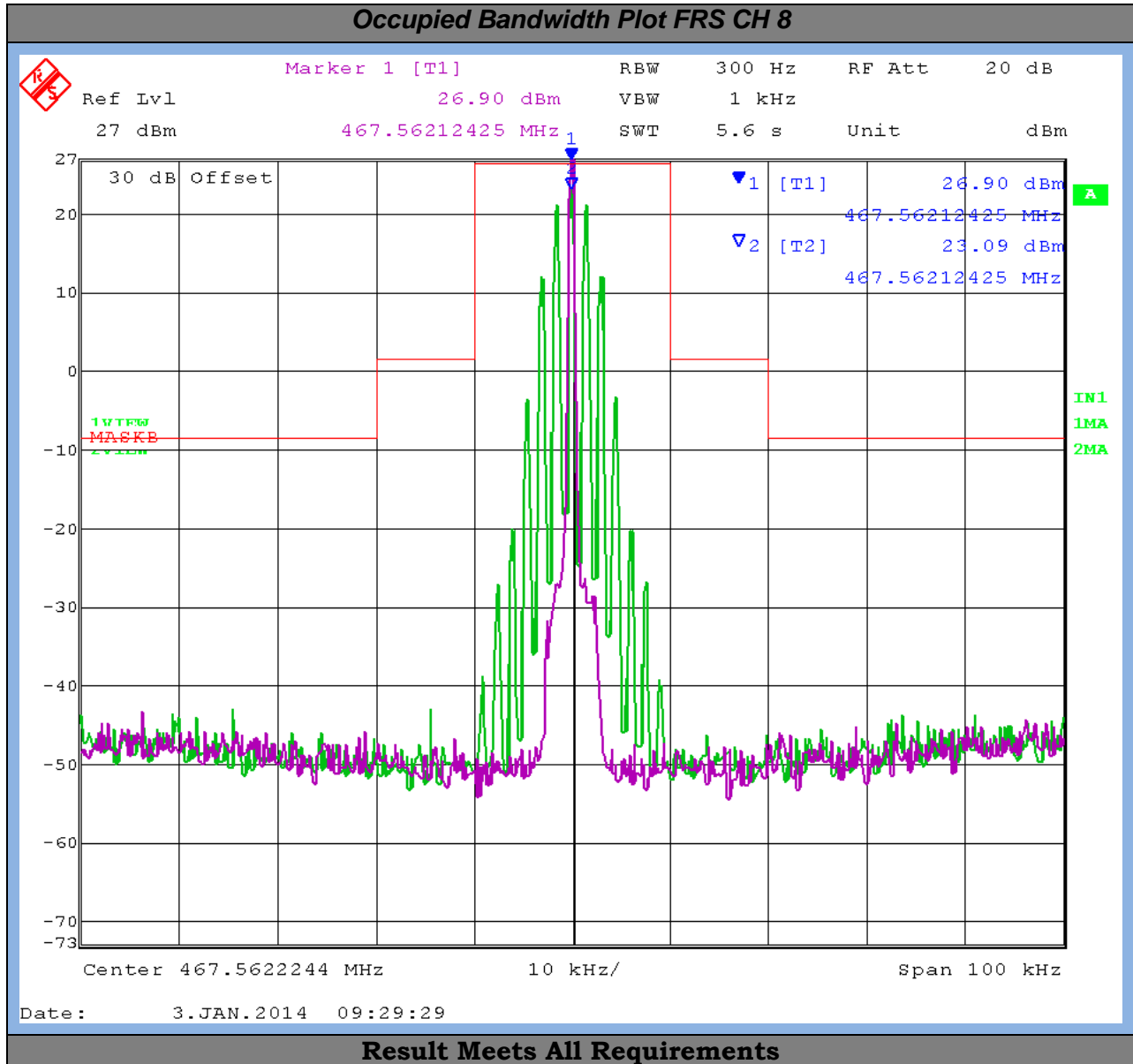



**SPURIOUS EMISSIONS AT ANTENNA TERMINALS (CONDUCTED)**

2.1051 Not applicable, no antenna terminal allowed.





**FIELD STRENGTH OF SPURIOUS EMISSIONS - TX**

**Rule Parts. No.:** Part 2.1053  
95.635(b)(7)  
RSS-210

**Requirements:** FRS :  $43 + 10\log(0.50) = 40.0$  dB

**METHOD OF MEASUREMENT:** The tabulated data shows the results of the radiated field strength emissions test. The spectrum was scanned from 30 MHz to at least the tenth harmonic of the fundamental. This test was conducted per ANSI/TIA 603-C: 2004 using the substitution method. Measurements were made at the test site of TIMCO ENGINEERING, INC. located at 849 NW State Road 45, Newberry, FL 32669.

**Test Setup Diagram:**

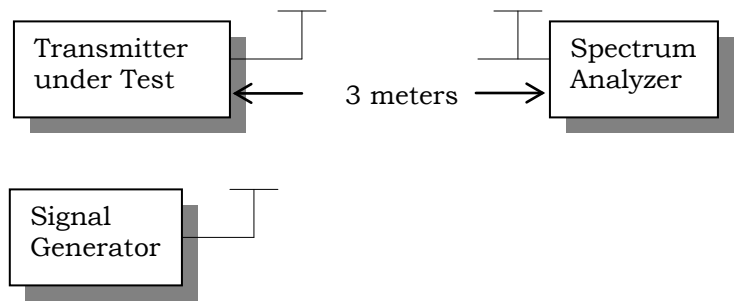

**The plots on the following pages represent the emissions or noise floor discovered to the tenth harmonic of the fundamental frequency being tested.**

**Test Data (FRS 467.5625MHz):**

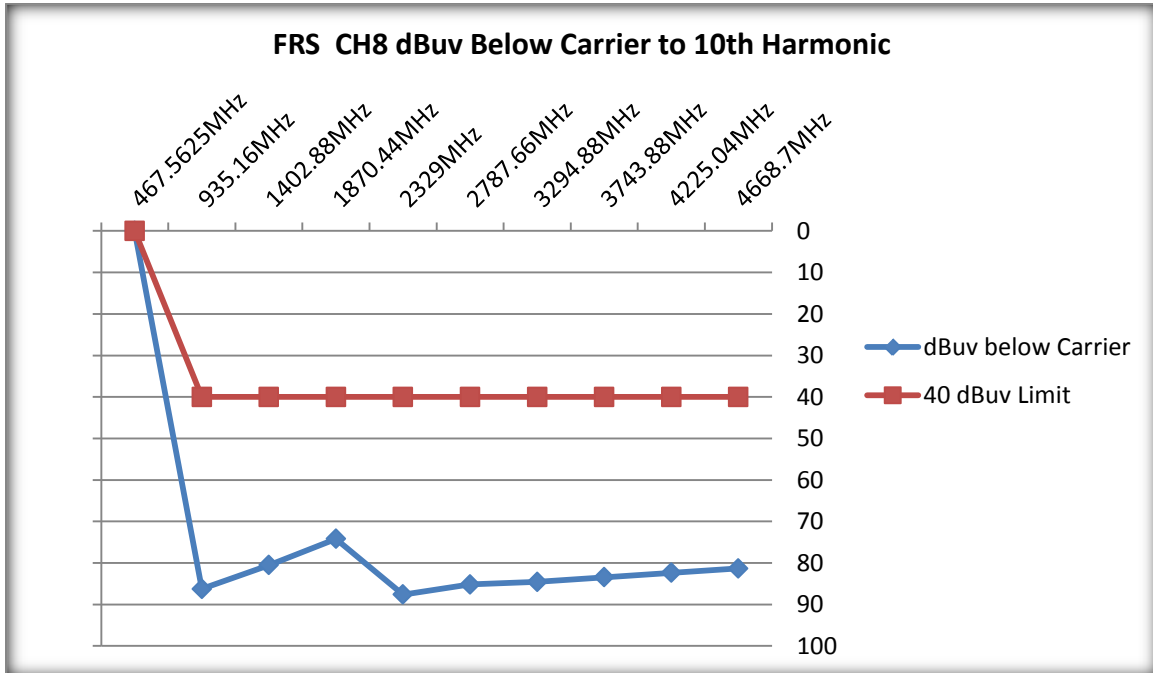

Emission Frequency MHz	Ant. Polarity	dB Below Carrier (dBc)
467.5625	V	0
935.16	V	86.25
1402.88	H	80.52
1870.44	V	74.21
2329.00	H	87.6
2787.66	V	85.19
3294.88	V	84.57
3743.88	V	83.43
4225.04	V	82.35
4668.70	H	81.34

**Rule Parts. No.:** Part 2.1053  
95.635(b)(7)  
RSS-210

**Requirements:** GMRS:  $43 + 10\log(2.0) = 46.0$  dB

**Test Data (GMRS 462.725MHz HI Power):**

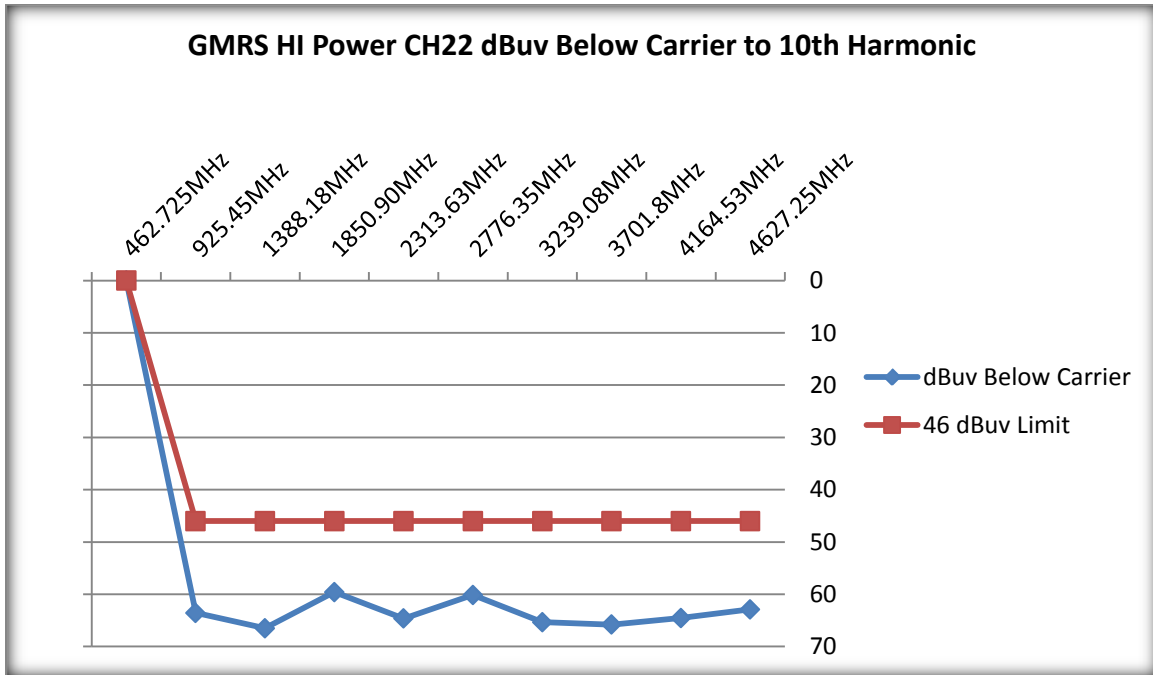

Emission Frequency MHz	Ant. Polarity	dB Below Carrier (dBc)
462.725	V	0.00
925.45	H	63.55
1388.18	V	66.49
1850.90	V	59.58
2313.63	H	64.63
2776.35	V	60.13
3239.08	H	65.35
3701.80	H	65.79
4164.53	H	64.53
4627.25	H	62.90

Applicant: COBRA ELECTRONICS CORPORATION  
FCC ID: BBO21410A  
IC Cert #: 906A-21410A  
Report: C\COBRA\2240AUT13\2240AUT13TestReport.docx

**Rule Parts. No.:** Part 2.1053  
95.635(b)(7)  
RSS-210

**Requirements:** GMRS:  $43 + 10\log(.5) = 40.0$  dB

**Test Data (GMRS 462.725MHz LO Power):**

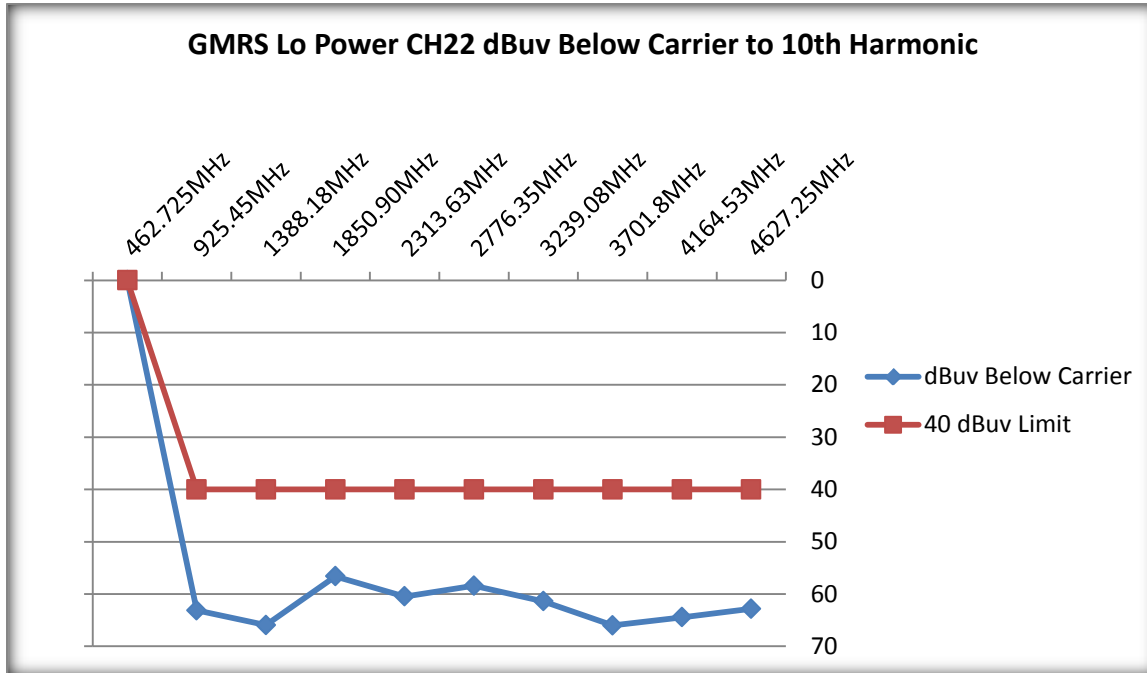

Emission Frequency MHz	Ant. Polarity	dB Below Carrier (dBc)
462.725	V	0.00
925.45	V	63.14
1388.18	H	65.95
1850.90	H	56.61
2313.63	V	60.46
2776.35	H	58.42
3239.08	V	61.40
3701.80	H	66.02
4164.53	V	64.46
4627.25	V	62.82



## FREQUENCY STABILITY

**Rule Parts. No.:** Part 2.1055, Part 95.621(b), RSS-210

**Requirements:** Temperature and voltage tests were performed to verify that the frequency remains within the 0.0005%, 5 ppm specification limit. The test was conducted as follows: The transmitter was placed in the temperature chamber at 25° C and allowed to stabilize for one hour. The transmitter was keyed ON for one minute during which four frequency readings were recorded at 15 second intervals. The worse case number was taken for temperature plotting. The assigned channel frequency was considered to be the reference frequency. The temperature was then reduced to -30° C after which the transmitter was again allowed to stabilize for one hour. The transmitter was keyed ON for one minute, and again frequency readings were noted at 15 second intervals. The worst case number was recorded for temperature plotting. This procedure was repeated in 10 degree increments up to + 50° C.

**Method of Measurements:** ANSI/TIA 603-C: 2004.

### Test Data:

<b>Assigned Frequency (Ref. Frequency) (MHz)</b>		<b>467.562357</b>
<b>Temperature (°C)</b>	<b>Frequency (MHz)</b>	<b>Frequency Stability (PPM)</b>
-30	467.5615	-1.92
-20	467.562	-0.74
-10	467.5627	0.80
0	467.562357	1.35
+10	467.5628	1.05
+20	467.5626	0.47
+30	467.5621	-0.62
+40	467.562	-0.81
+50	467.5622	-0.24

<b>Assigned Frequency (Ref. Frequency) (MHz)</b>		
<b>Battery %</b>	<b>Frequency (MHz)</b>	<b>Frequency Stability (PPM)</b>
-15%	467.5624	-0.05
0	467.562357	0.00
+15%	467.5623	-0.2

Note: This EUT meets the frequency stability requirement for a FRS: +/- 2.5ppm over temp range of -20 degrees C to +50 degrees C. It also meets the GMRS frequency stability requirements: +/- 5ppm over the temp range -30 degrees C to +50 degrees C.

Applicant: COBRA ELECTRONICS CORPORATION  
FCC ID: BBO21410A  
IC Cert #: 906A-21410A  
Report: C\COBRA\2240AUT13\2240AUT13TestReport.docx



**TEST EQUIPMENT LIST**

Device	Manufacturer	Model	Serial Number	Cal/Char Date	Due Date
3-Meter Semi-Anechoic Chamber	Panashield	N/A	N/A	12/31/11	12/31/13
Antenna: Biconnical	Eaton	94455-1	1096	05/10/13	05/10/15
Antenna: Log-Periodic	Electro-Metrics	LPA-25	1122	05/09/13	05/09/15
Antenna: Double-Ridged Horn/ETS Horn 2	ETS-Lindgren	3117	00041534	10/5/12	10/5/14
Temperature Chamber	Tenney Engineering	TTRC	11717-7	2/15/11	2/15/13
EMI Receiver	Rohde & Schwarz	ESIB40*	100274	3/16/2012	3/16/2014
EMI Receiver	Rohde & Schwarz	ESU40*	100320	3/21/13	3/21/15
Signal Generator	HP	8648C	3847A04696	9/18/13	9/18/15
Modulation Analyzer	HP	8901A	3050A05856	9/26/12	9/26/14
Function Generator	Stanford Research Systems	DS345	25200	6/19/13	6/19/15
DC Power Supply	HP	6286A	2411A-09414	5/6/13	5/6/15

**\*EMI Test Receiver firmware version information**

Manufacturer	Model	Receiver Firmware	BIOS Ver
Rohde & Schwarz	ESU40	4.43 SP3	V5.1-24-3
Rohde & Schwarz	ESIB40	4.34.3	3.3

**DUT Test Setup Photo's**

