



849 NW STATE ROAD 45
NEWBERRY, FL 32669 USA
PH: 888.472.2424 OR 352.472.5500
FAX: 352.472.2030
EMAIL: INFO@TIMCOENGR.COM
[HTTP://WWW.TIMCOENGR.COM](http://WWW.TIMCOENGR.COM)

**FCC PART 95 AND IC RSS-210
FRS/GMRS TRANSCEIVER
TEST REPORT**

APPLICANT	COBRA ELECTRONICS CORPORATION
	6500 WEST CORTLAND STREET CHICAGO, IL 60707 USA
FCC ID	BBO1133A
IC CERT #	906A-1133A
MODEL NUMBERS	CXT390, CX312, CXT345, CXT395
PRODUCT DESCRIPTION	GMRS/ FRS PORTABLE TWO-WAY RADIO
DATE SAMPLE RECEIVED	1/9/2013
DATE TESTED	1/15/2013
TESTED BY	JOE SCOGGIO
APPROVED BY	Mario de Aranzeta
TIMCO REPORT NO.	57AUT13TestReport.doc
TEST RESULTS	<input checked="" type="checkbox"/> PASS <input type="checkbox"/> FAIL

**THE ATTACHED REPORT SHALL NOT BE REPRODUCED EXCEPT IN FULL
WITHOUT THE WRITTEN APPROVAL OF TIMCO ENGINEERING, INC.**





TABLE OF CONTENTS

GENERAL REMARKS3

GENERAL INFORMATION4

 DUT SPECIFICATIONS..... 4

TEST PROCEDURES.....5

RF POWER OUTPUT6

MODULATION CHARACTERISTICS.....7

EMISSION DESIGNATOR AND FREQUENCIES.....10

OCCUPIED BANDWIDTH11

SPURIOUS EMISSIONS AT ANTENNA TERMINALS (CONDUCTED).....14

FIELD STRENGTH OF SPURIOUS EMISSIONS - TX.....15

FREQUENCY STABILITY.....17

TEST EQUIPMENT LIST.....18

GENERAL REMARKS

The attached report shall not be reproduced except in full without the written permission of Timco Engineering Inc.

Summary

The device under test does:

- fulfill the general approval requirements as identified in this test report
- not fulfill the general approval requirements as identified in this test report

Attestations

This equipment has been tested in accordance with the standards identified in this test report. To the best of my knowledge and belief, these tests were performed using the measurement procedures described in this report.

All instrumentation and accessories used to test products for compliance to the indicated standards are calibrated regularly in accordance with ISO 17025: 2005 requirements.



Testing Certificate # 0955-01

I attest that the necessary measurements were made, under my supervision, at:

Timco Engineering Inc.
849 NW State Road 45
Newberry, Fl 32669



Authorized Signatory Name:

Joe Scoglio
Testing Technician



Mario de Aranzeta
Engineer/ Lab Supervisor
Date: January/15/2013

Applicant: COBRA ELECTRONICS CORPORATION
FCC ID: BBO1133A
IC Cert #: 906A-1133A
Report: C\COBRA\57AUT13\57AUT13TestReport.doc

GENERAL INFORMATION

DUT SPECIFICATIONS

The test results relate only to the items tested.	
DUT Description	GMRS/ FRS PORTABLE TWO-WAY RADIO
FCC ID	BBO1133A
IC Cert #	906A-1133A
Model Number	CXT390, CX312, CXT345, CXT395
Operating Frequency	462.5500-462.7250, 462.5625-467.7125
No. of Channels	22
Type of Emission	10K5F3E
Modulation	FM
DUT Power Source	<input type="checkbox"/> 110-120Vac/50- 60Hz
	<input type="checkbox"/> DC Power
	<input checked="" type="checkbox"/> Battery Operated Exclusively
Test Item	<input type="checkbox"/> Prototype
	<input checked="" type="checkbox"/> Pre-Production
	<input type="checkbox"/> Production
Type of Equipment	<input type="checkbox"/> Fixed
	<input type="checkbox"/> Mobile
	<input checked="" type="checkbox"/> Portable
Antenna	Fixed
Test Facility	Timco Engineering Inc. located at 849 NW State Road 45 Newberry, FL 32669 USA.
Test Lab Conditions	Temperature: 26 C Humidity: 55% RH
Modifications	None
Test Exercise	The DUT was placed in continuous transmit mode of operation
Applicable Standards	TIA 603-C , FCC CFR 47 Part 2 & Part 95, Industry Canada RSS-210



TEST PROCEDURES

Bandwidth: The measurements were made with the spectrum analyzer's resolution bandwidth (RBW) = 1 MHz and the video bandwidth (VBW) = 3 MHz and the span set as shown on plot.

Power Output: RF power was conducted per ANSI/TIA 603-C: 2004 using the substitution method

Antenna Conducted Emissions: The RBW = 100 kHz, VBW = 300 kHz and the span set to 10.0 MHz and the spectrum was scanned from 30 MHz to the 10th Harmonic of the fundamental. Above 1 GHz the resolution bandwidth was 1 MHz and the VBW = 3 MHz and the span to 50 MHz.

Radiation Interference: The test procedure used was ANSI/TIA 603-C: 2004 using an Agilent spectrum receiver with pre-selector. The bandwidth (RBW) of the spectrum receiver was 100 kHz up to 1 GHz and 1 MHz above 1 GHz with an appropriate sweep speed. The VBW above 1 GHz was 3 MHz. The analyzer was calibrated in dB above a microvolt at the output of the antenna.

RF POWER OUTPUT

Rule Part No.: 2.1033(c)(6)(7), 2.1046(a), Part 95, RSS-210

Requirements: Power output shall not exceed 0.50 Watts effective radiated power for the FRS channels. There can be no provisions for increasing the power or varying the power. No GMRS channel, under any condition of modulation, shall exceed:

1. 50W Carrier power (average TP during one modulated RF cycle) when transmitting emissions type A1D, F1D, G1D, A3E, F3E, or G3E.
2. 50W peak envelope TP when transmitting emission type H1D, J1D, R1D, H3E, J3E, or R3E.

Method of Measurement: RF power is measured as ERP as the antenna is permanently attached. The substitution method was used. With a nominal battery voltage, and the transmitter properly adjusted the RF output measures:

Test Setup Diagram:

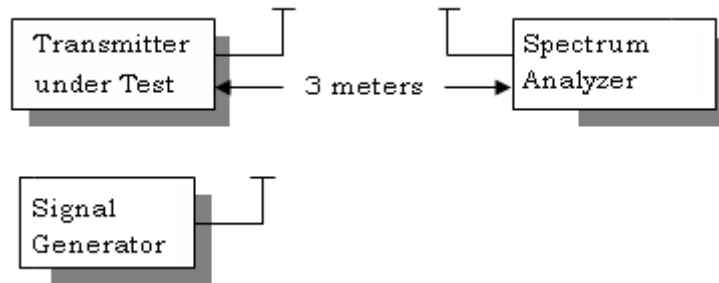

Test Data:

RF OUTPUT POWER: GMRS: 1.0 W
FRS: 0.5 W

Rule Part No.: 2.1033 (C)(8) DC Input into the final amplifier

GMRS (3.6V)(.50A) = 1.8 Watts

FRS (3.6V)(.23A) = 0.83 Watts

MODULATION CHARACTERISTICS

Rule Part No.: Part 2.1047(a)(b)

Test Requirements:

Method of Measurement:

The audio frequency response was measured in accordance with ANSI/TIA 603-C: 2004. The audio frequency response curve is shown below. The audio signal was fed into a dummy microphone circuit and into the microphone connector. The input required to produce 30 percent modulation level was measured.

AUDIO FREQUENCY RESPONSE PLOT

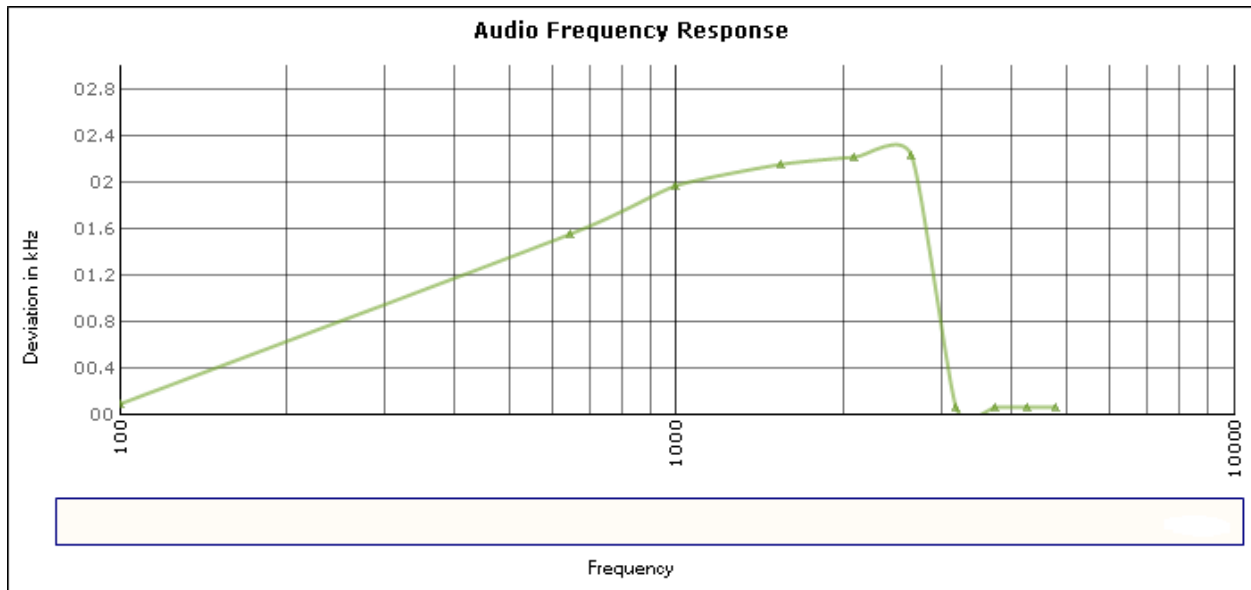

Audio input versus modulation

The audio input level needed for a particular percentage of modulation was measured in accordance with ANSI/TIA 603-C: 2004. Curves are provided for audio input frequencies of 300, 1000, and 2500 Hz. See the plot below..

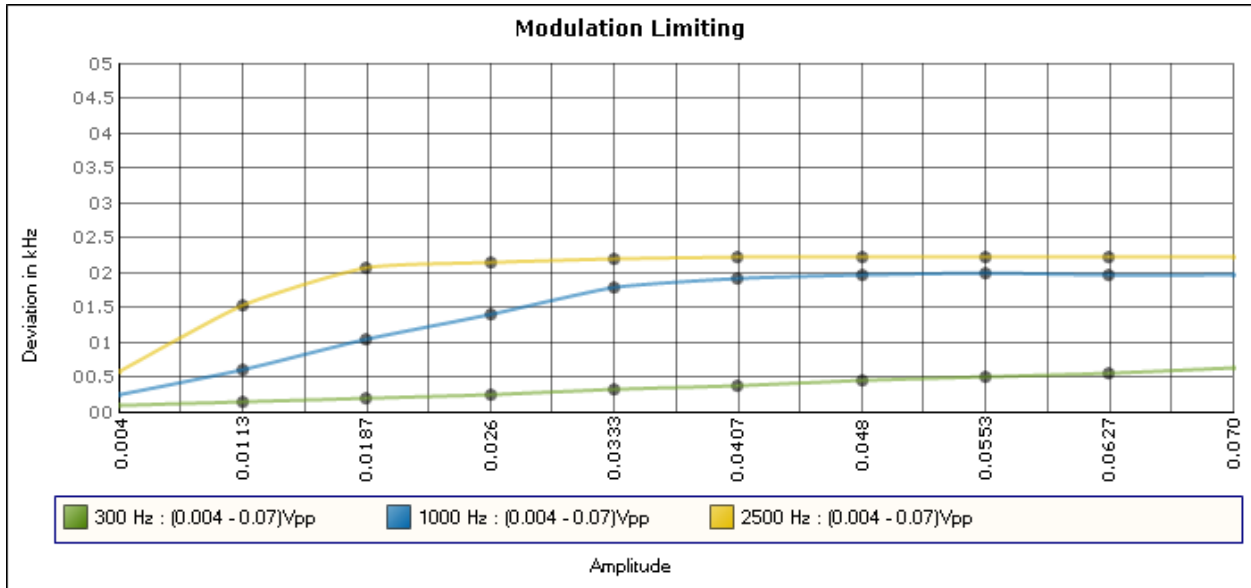

Post Limiter Filter

Each GMRS transmitter, except a mobile station transmitter with a power of 2.5Watts or less, must be equipped with an audio low pass filter. At any frequency between 3 & 20 kHz the filter must have an attenuation of $60\log(f/3)$ greater than the attenuation at 1 kHz. See below.

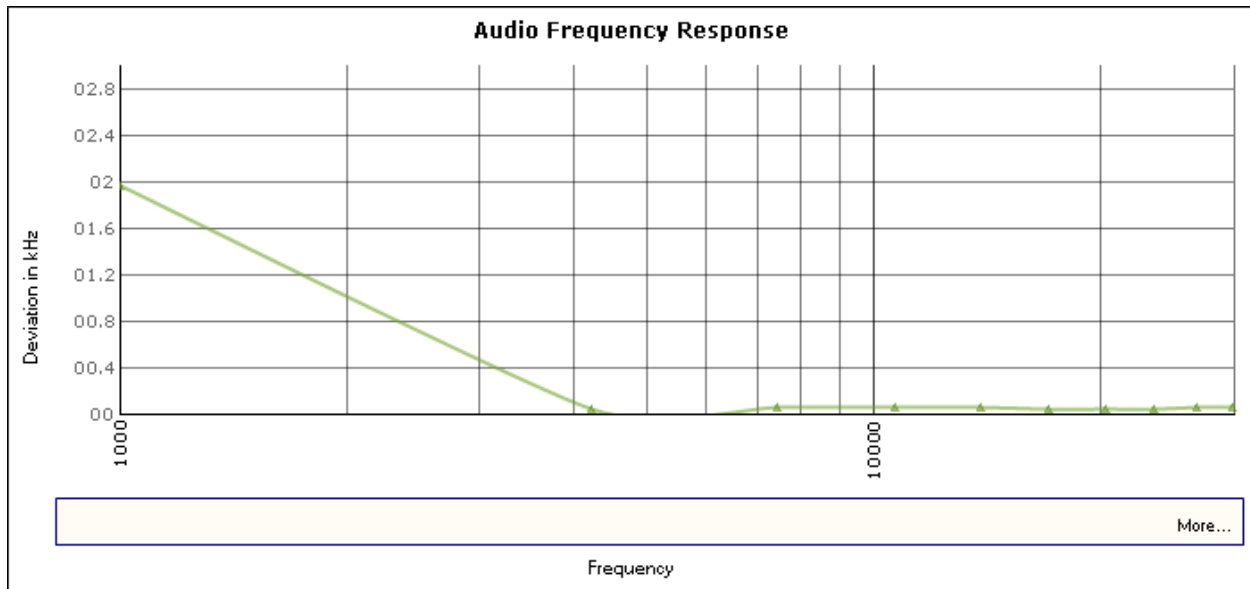



EMISSION DESIGNATOR AND FREQUENCIES

2.1033(c) (4) Type of Emission: 10K5F3E
95.631

$$\begin{aligned} B_n &= 2M + 2DK \\ M &= 3000 \\ D &= 2.25K \\ B_n &= 2(3000) + 2(2250) = 10.5K \end{aligned}$$

GMRS Authorized Bandwidth 20.0 kHz

2.1033(c)(5) GMRS Frequency Range:
95.621

- 1. 462.5500
- 2. 462.5625
- 3. 462.5750
- 4. 462.5875
- 5. 462.6000
- 6. 462.6125
- 7. 462.6250
- 8. 462.6375
- 9. 462.6500
- 10. 462.6625
- 11. 462.6750
- 12. 462.6875
- 13. 462.7000
- 14. 462.7125
- 15. 462.7250

FRS Authorized Bandwidth 12.5 kHz

2.1033(c)(5) FRS Frequency Range:
95.627

- 1. 462.5625
- 2. 462.5875
- 3. 462.6125
- 4. 462.6375
- 5. 462.6625
- 6. 462.6875
- 7. 462.7125
- 8. 467.5625
- 9. 467.5875
- 10. 467.6125
- 11. 467.6375
- 12. 467.6625
- 13. 467.6875
- 14. 467.7125 MHz

OCCUPIED BANDWIDTH

Part 2.1049(c) EMISSION BANDWIDTH:
95.635(b)(1)(3)(7)

At least 25 dB on any frequency removed from the center of the authorized bandwidth by more than 50% up to and including 100% of the authorized bandwidth. At least 35 dB on any frequency removed from the center of the authorized BW by more than 100% up to and including 250% of the authorized BW. At least $43 + \log_{10}(TP)$ dB on any frequency removed from the center of the authorized bandwidth by more than 250%. See the following plot.

Test procedure: ANSI/TIA-603-C: 2004 paragraph 2.2.11.

OCCUPIED BANDWIDTH MEASUREMENT

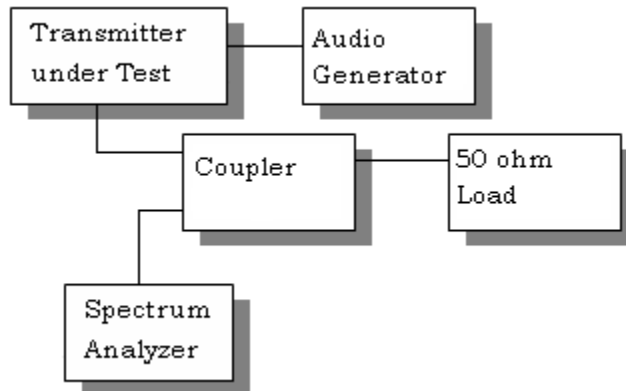

FRS Channel 14

NOTES:

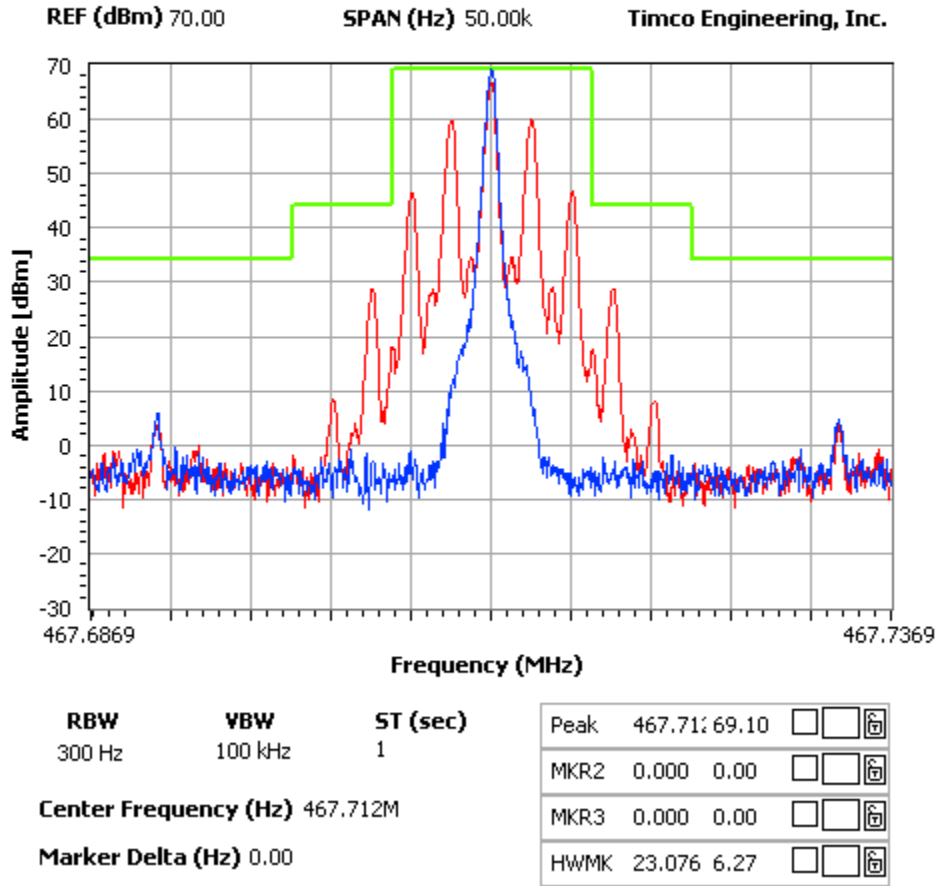

Applicant: COBRA ELECTRONICS CORPORATION
 FCC ID: BBO1133A
 IC Cert #: 906A-1133A
 Report: C\COBRA\57AUT13\57AUT13TestReport.doc

GMRS Channel 15

NOTES:

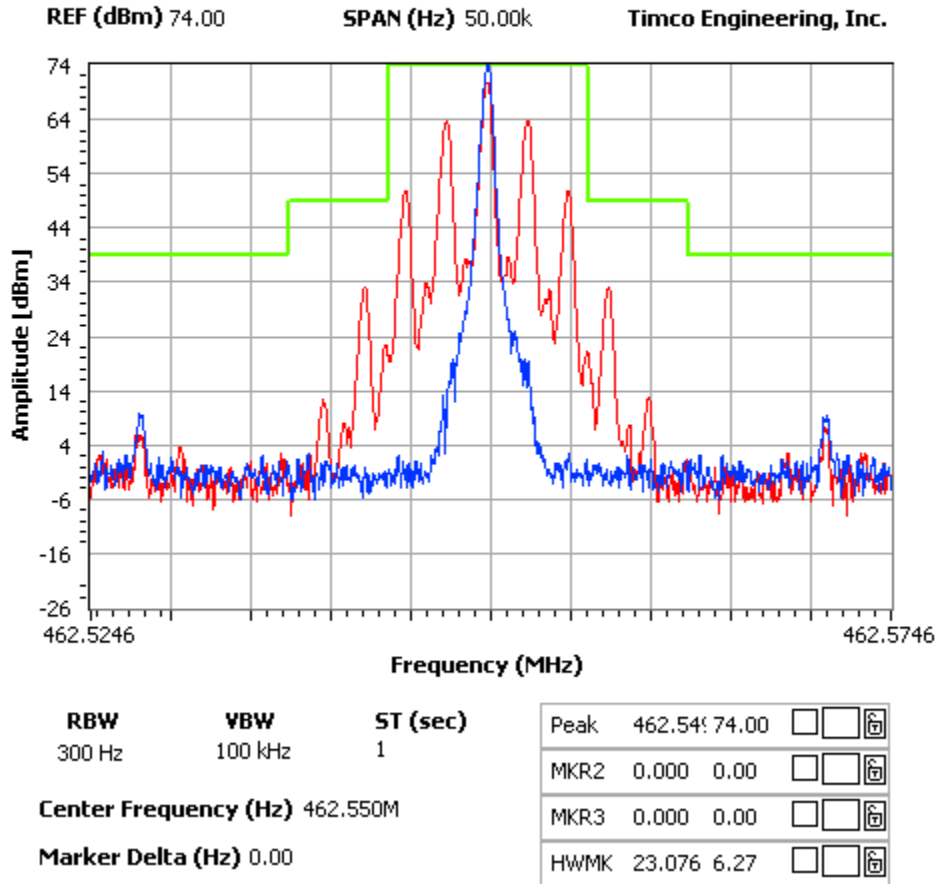

Applicant: COBRA ELECTRONICS CORPORATION
 FCC ID: BBO1133A
 IC Cert #: 906A-1133A
 Report: C\COBRA\57AUT13\57AUT13TestReport.doc



SPURIOUS EMISSIONS AT ANTENNA TERMINALS (CONDUCTED)

2.1051 Not applicable, no antenna terminal allowed.

FIELD STRENGTH OF SPURIOUS EMISSIONS - TX

Rule Parts. No.: Part 2.1053
95.635(b)(7)

Requirements: GMRS: $43 + 10\log(1.2) = 43.8$ dBc

METHOD OF MEASUREMENT: The tabulated data shows the results of the radiated field strength emissions test. The spectrum was scanned from 30 MHz to at least the tenth harmonic of the fundamental. This test was conducted per ANSI/TIA 603-C: 2004 using the substitution method. Measurements were made at the test site of TIMCO ENGINEERING, INC. located at 849 NW State Road 45, Newberry, FL 32669.

Test Setup Diagram:

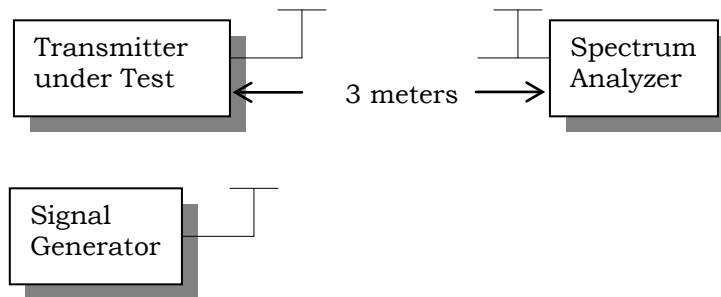

Test Data (GMRS):

Emission Frequency MHz	dB Below Carrier (dBc)
462.50	0
925.10	55.0
1387.60	76.2
1850.20	73.6
2312.70	79.0
2775.30	78.2
3237.80	66.4
3700.40	64.2
4162.90	79.7
4625.50	78.5

Rule Parts. No.: Part 2.1053
95.635(b)(7)

Requirements: FRS : $43 + 10\log(0.5) = 40$ dB

Test Data (FRS):

Emission Frequency MHz	dB Below Carrier (dBc)
467.70	0
935.40	52.5
1403.10	73.3
1870.80	60.5
2338.50	59.0
2806.20	68.8
3273.90	59.1
3741.70	58.2
4209.40	69.8
4677.10	69.8



FREQUENCY STABILITY

Rule Parts. No.: Part 2.1055, Part 95.621(b), RSS-210

Requirements: Temperature and voltage tests were performed to verify that the frequency remains within the 0.0005%, 5 ppm specification limit. The test was conducted as follows: The transmitter was placed in the temperature chamber at 25° C and allowed to stabilize for one hour. The transmitter was keyed ON for one minute during which four frequency readings were recorded at 15 second intervals. The worse case number was taken for temperature plotting. The assigned channel frequency was considered to be the reference frequency. The temperature was then reduced to -30° C after which the transmitter was again allowed to stabilize for one hour. The transmitter was keyed ON for one minute, and again frequency readings were noted at 15 second intervals. The worst case number was recorded for temperature plotting. This procedure was repeated in 10 degree increments up to + 50° C.

Method of Measurements: ANSI/TIA 603-C: 2004.

Test Data:

Assigned Frequency (Ref. Frequency) (MHz)		
Temperature (°C)	Frequency (MHz)	Frequency Stability (PPM)
REFERENCE	467.711258	-1.37
-30	467.711728	-0.37
-20	467.71223	0.70
-10	467.712627	1.55
0	467.712486	1.25
+10	467.712161	0.56
+20	467.711567	-0.71
+30	467.711172	-1.56
+40	467.711795	-0.23
+50	467.711258	-1.37

Assigned Frequency (Ref. Frequency) (MHz)		
Battery %	Frequency (MHz)	Frequency Stability (PPM)
-15%	467.711885	-0.03
0	467.711901	0.00
+15%	467.7119	0.00

Note: This EUT meets the frequency stability requirement for a FRS: +/- 2.5ppm over temp range of -20 degrees C to +50 degrees C. It also meets the GMRS frequency stability requirements: +/- 5ppm over the temp range -30 degrees C to +50 degrees C.

Applicant: COBRA ELECTRONICS CORPORATION
FCC ID: BBO1133A
IC Cert #: 906A-1133A
Report: C\COBRA\57AUT13\57AUT13TestReport.doc



TEST EQUIPMENT LIST

Device	Manufacturer	Model	Serial Number	Cal/Char Date	Due Date
3/10-Meter OATS	TEI	N/A	N/A	12/31/11	12/31/13
3-Meter OATS	TEI	N/A	N/A	12/31/11	12/31/13
3-Meter Semi-Anechoic Chamber	Panashield	N/A	N/A	12/31/11	12/31/13
Analyzer Tan Tower Preamplifier	HP	8449B-H02	3008A00372	10/28/11	10/28/13
Analyzer Tan Tower Quasi-Peak Adapter	HP	85650A	3303A01690	10/28/11	10/28/13
Analyzer Tan Tower RF Preselector	HP	85685A	3221A01400	10/28/11	10/28/13
Analyzer Tan Tower Spectrum Analyzer	HP	8566B Opt 462	3138A07786 3144A20661	10/28/11	10/28/13
Antenna: Biconnical	Eaton	94455-1	1057	05/31/11	05/31/13
Antenna: Biconnical	Eaton	94455-1	1096	05/04/11	05/04/13
Antenna: Biconnical	Electro-Metrics	BIA-25	1171	06/13/12	06/13/14
Antenna: Log-Periodic	Eaton	96005	1243	05/31/11	05/31/13
Antenna: Log-Periodic	Electro-Metrics	LPA-25	1122	05/04/11	05/04/13
LISN	Electro-Metrics	ANS-25/2	2604	10/28/11	10/28/13
LISN	Electro-Metrics	EM-7820	2682	02/01/11	02/01/13
Horn antenna	ETS-Lindgren	3117	35923	12/20/11	12/20/13

Applicant: COBRA ELECTRONICS CORPORATION
 FCC ID: BBO1133A
 IC Cert #: 906A-1133A
 Report: C\COBRA\57AUT13\57AUT13TestReport.doc