

**FT0106B Internal photos**

**[CPU Board]**

■ Component side

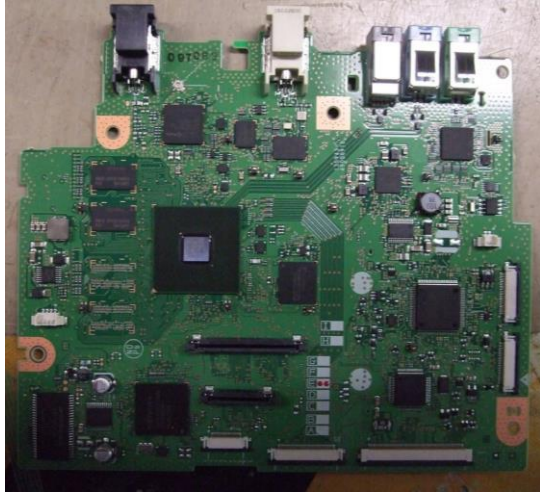

■ Solder side

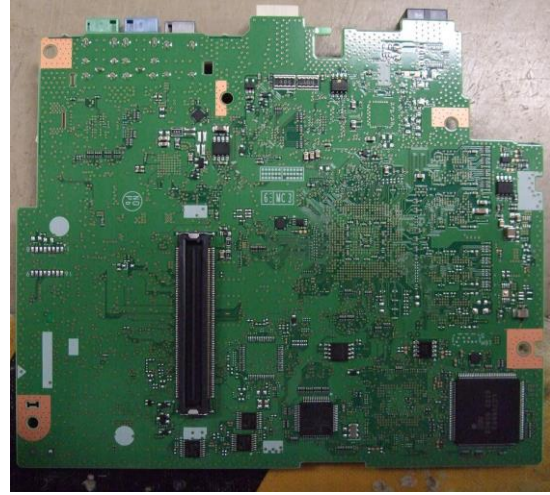

**[AUDIO Board]**

■ Component side

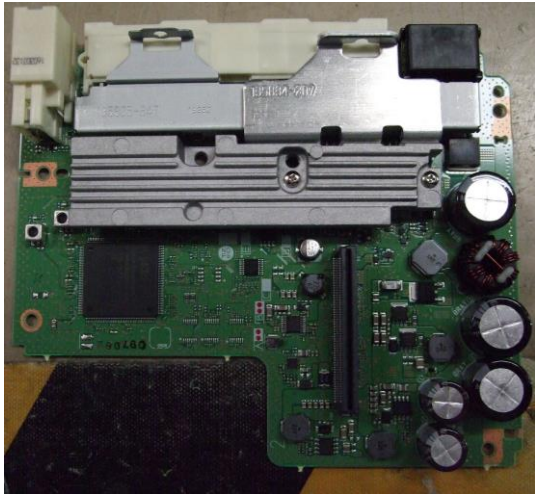

■ Solder side



**[XM Board]**

■ Component side

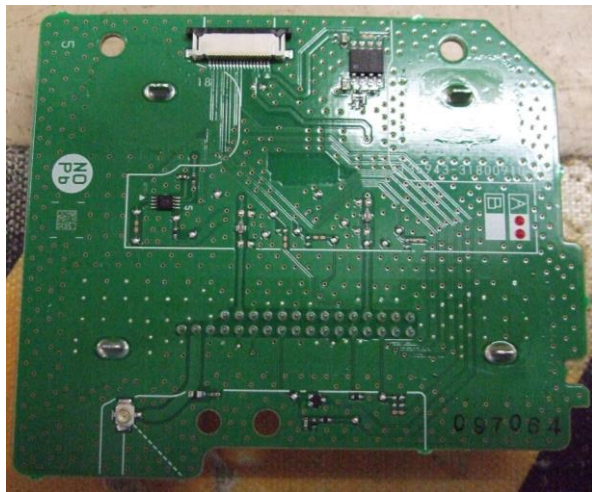

■ Solder side





# FT0106B Internal photos

[SW Board]

■ Component side

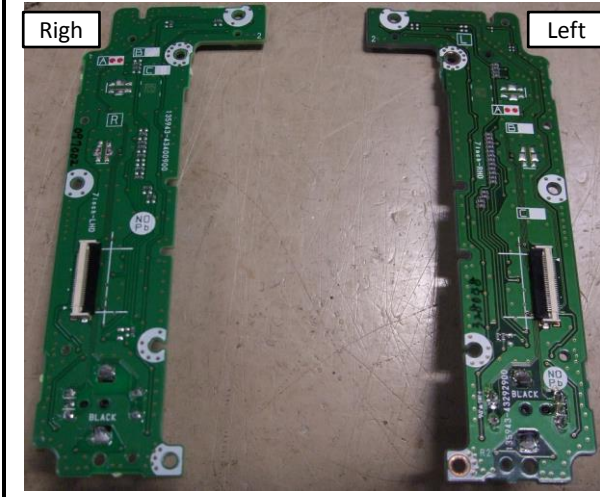

■ Solder side

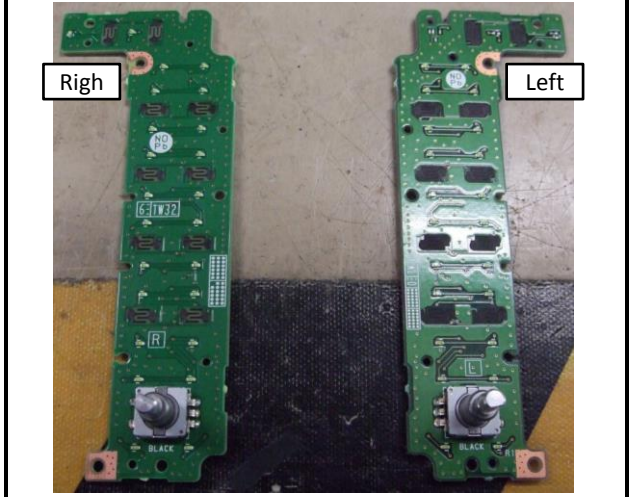

[DISP Board]

■ Component side

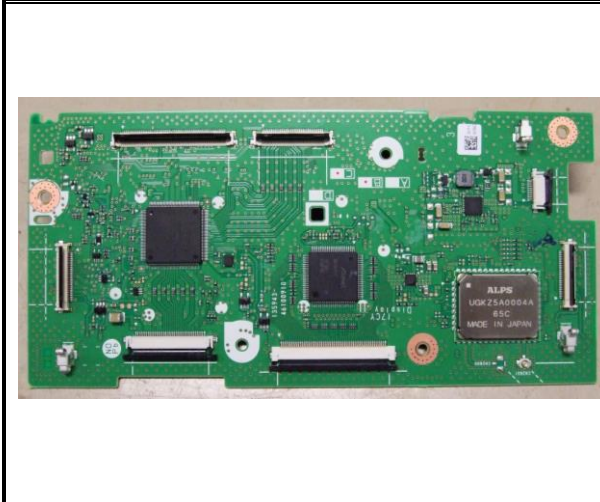

■ Solder side

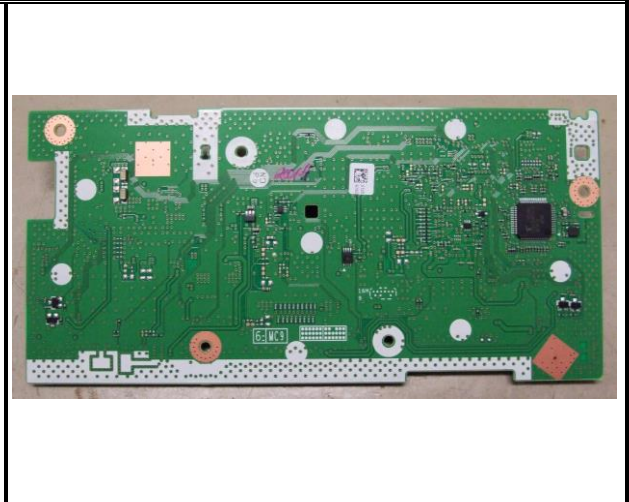

[FT0106B RF Module Position, RF Antenna Position]

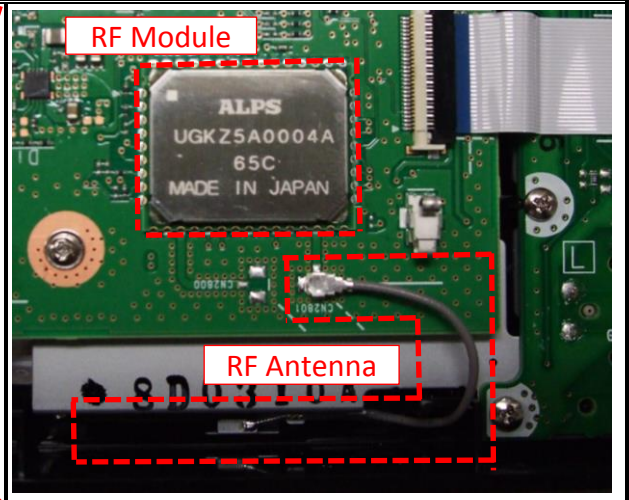
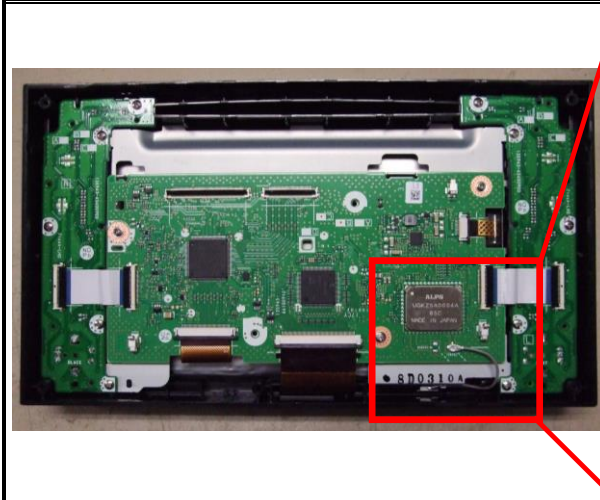

DENSO TEN CONFIDENTIAL