



AEGIS LABS INC.

Modular Approval
Test Report
And Application for Grant of Equipment Authorization

Pertaining To:

Equipment Under Test	FCC ID:
Intel PRO/Wireless 3945ABG Network Connection, MN: WM3945ABG	B94WM3945ABG

Configuration
802.11a / 802.11b / 802.11g with a set of HP Altima & Jakarta 3.0 Antennas

MEASUREMENTS PERFORMED IN ACCORDANCE WITH

Regulatory Standard(s)
47 CFR Part 15, Subpart E Section 15.407 (UNII Devices)
Test Method: ANSI C63.4: 2003 American National Standard for Methods of Measurement of Radio-Noise Emissions from Low-Voltage Electrical and Electronic Equipment in the Range of 9 kHz to 40 GHz



Certificate Number: 1111.01

APPLICANT:

Hewlett-Packard Company
20555 SH 249
Mail Stop 060607
Houston, TX 77070-2698
Contact(s): Mr. Walter Overcash

PREPARED BY:

Aegis Labs, Inc.
22431 Antonio Parkway B160-417
Rancho S. Margarita, CA 92688

Agent(s): Mr. Steve Kuiper
Mr. Rick Candelas
Mr. Johnny Candelas

Test Report #: INTEL-051105F
Test Report Revision: Rev. C

	REPORT BODY	APPENDICES	TOTAL PAGES
PAGES	16	A 49	65

The contents of this report shall not be reproduced except in full, without the written approval of Aegis Labs, Inc.

Page 1 of 16
Report Number: INTEL-051105F
FCC ID: B94WM3945ABG



TABLE OF CONTENTS

SECTION	TITLE	PAGE
	COVER SHEET.....	01
	TABLE OF CONTENTS.....	02
1.0	CERTIFICATION OF TEST DATA.....	03
2.0	SUMMARY OF TEST RESULTS.....	04
3.0	ADMINISTRATIVE DATA AND TEST DESCRIPTION.....	05
4.0	DESCRIPTION OF EUT.....	07
4.1	EUT Description.....	07
4.2	EUT Configuration.....	08
4.3	List of EUT Sub-Assemblies and Host Equipment.....	09
4.4	I/O Cabling Diagram and Description.....	10
5.0	TEST EQUIPMENT AND TEST SETUPS.....	11
5.1	AC Power Line Conducted Emissions.....	11
5.2	Spurious Radiated Emissions.....	12
5.3	Conducted Emissions At The Antenna Port.....	12
5.4	Test and Measurement Equipment Used.....	13
6.0	SAMPLE CALCULATIONS.....	14
7.0	MODIFICATIONS AND RECOMMENDATIONS.....	16

APPENDICES

A	Test Data
---	-----------



1.0 CERTIFICATION OF TEST DATA

Aegis Labs, Inc. operates as both a Nevada and California Corporation with no organizational or financial relationship with any company, institution, or private individual.

Testing and engineering functions provided by Aegis Labs are furnished through the use of part-time, full-time or consulting engineers with the appropriate qualifications to carry out their duties. The intended purpose of this test report is to describe the measurement procedure and to determine whether the equipment under test "EUT" complies with both the conducted and radiated limits. Limits for emissions testing are described under Subpart E of Part 15 of the FCC rules for Unlicensed National Information Infrastructure (UNII) Devices.

The data, data evaluation and equipment configuration represented herein are a true and accurate representation of the Equipment Under Test (EUT) under the requirements specified in the emissions standard as described below. The test results contained in this report are only representative of the test sample tested as described in Section 3.0 of this report. Certification of the EUT is required as a prerequisite to marketing as defined in Part 2 of the FCC Rules.

Report Prepared By:

11/10/05

Johnny Candelas
Test Technician
Aegis Labs, Inc

Date:

Report Reviewed By:

11/10/05

Rick Candelas
Lab Manager
Aegis Labs, Inc.

Date:

Report Approved By:

11/10/05

Steve J. Kuiper
Quality Assurance Manager
Aegis Labs, Inc.

Date:



2.0 SUMMARY OF TEST RESULTS

The test results provided within this report, indicate that the EUT has been found to be in **COMPLIANCE** with the test specifications based upon the following RF compliance standards:

Pass/Fail determination is based upon the nominal values of the test data.

EMISSIONS STANDARD			
FCC Part 15 Section	Description	Results	Comments
Operation in the 5.15-5.25 GHz Band			
15.407(d)	Any UNII device shall use a transmitting antenna that is an integral part of the device.	PASSED	The antenna will be integral when installed in a notebook computer
15.407(e)	UNII devices will be restricted to indoor operations.	PASSED	Refer to "User's Manual" Exhibit
15.407(a)(1)	26dB emissions bandwidth in MHz.	N/A	5.18 GHz = 23.33 MHz
15.407(a)(1)	Peak transmit power shall not exceed the lesser of 50mW or 4dBm+10logB (where B = 26dB emissions bandwidth).	PASSED	5.18 GHz = 16.61dBm (45.81mW) 5.24 GHz = 16.68dBm (46.56mW)
15.407(a)(1)	The peak power spectral density shall not exceed 4dBm in any 1MHz band.	PASSED	5.18 GHz = 3.50dBm
15.407(a)(1)	Peak transmit power and the peak power spectral density shall be reduced by the amount in dB that the transmitting antenna exceeds 6dBi.	N/A	All antennas tested have less than 6dBi antenna gain (Please see the antenna data sheets)
15.407(b)(6) 15.209	Unwanted emissions below 1 GHz must comply with the general field strength limits set forth in Section 15.209.	PASSED	See Data Sheets
15.407(b)(1)	All emissions outside of the 5.15-5.35 GHz band shall not exceed an EIRP of -27dBm/MHz.	PASSED	See Data Sheets
Operation in the 5.25-5.35 GHz Band			
15.407(a)(2)	26dB emissions bandwidth in MHz.	N/A	5.26 GHz = 23.33 MHz 5.32 GHz = 25.33 MHz
15.407(a)(2)	Peak transmit power shall not exceed the lesser of 250mW or 11dBm+10logB (where B = 26dB emissions bandwidth).	PASSED	5.26 GHz = 18.30dBm (67.61mW) 5.32 GHz = 18.22dBm (66.37mW)
15.407(a)(2)	The peak power spectral density shall not exceed 11dBm in any 1MHz band.	PASSED	5.26 GHz = 7.33dBm 5.32 GHz = 7.00dBm
15.407(a)(2)	Peak transmit power and the peak power spectral density shall be reduced by the amount in dB that the transmitting antenna exceeds 6dBi.	N/A	All antennas tested have less than 6dBi antenna gain (Please see the antenna data sheets)
15.407(b)(6) 15.209	Unwanted emissions below 1 GHz must comply with the general field strength limits set forth in Section 15.209.	PASSED	See Data Sheets
15.407(b)(2)	All emissions outside of the 5.15-5.35 GHz band shall not exceed an EIRP of -27dBm/MHz. Must meet all applicable technical requirements for operating in the 5.15-5.25 GHz band.	PASSED	See Data Sheets



2.0 SUMMARY OF TEST RESULTS (Continued)

EMISSIONS STANDARD			
FCC Part 15 Section	Description	Results	Comments
General Requirements For All Bands			
15.407(a)(6)	The ratio of the peak excursion of the modulation envelope to the peak transmit power shall not exceed 13dB across any 1 MHz bandwidth or the emissions bandwidth whichever is less.	PASSED	5.18 GHz = 5.00 dB 5.26 GHz = 5.00 dB 5.32 GHz = 5.00 dB
15.407(f)	Radio frequency radiation exposure requirement.	PASSED	Refer to MPE Calculations Exhibit
15.407(b)(6) 15.207	UNII devices using AC power line are required to comply with the conducted limits set forth in Section 15.207.	PASSED	See Data Sheets



3.0 ADMINISTRATIVE DATA AND TEST DESCRIPTION

DEVICE TESTED:	ITE Type: Intel PRO/Wireless 3945ABG Network Connection Model Number(s): WM3945ABG Serial Number: 00B11A295CVD26965002 FCC ID: B94WM3945ABG
TEST DATE(S):	November 4-30, 2005
DATE EUT RECEIVED:	October 31, 2005
ORIGIN OF TEST SAMPLE(S):	Production Unit
RESPONSIBLE PARTY:	Hewlett-Packard Company 20555 SH 249 Mail Stop 060607 Houston, TX 77070-2698
CLIENT CONTACT:	Mr. Walter Overcash
MANUFACTURER:	Hewlett-Packard Company
TEST LOCATION:	Aegis Labs, Inc. 32231 Trabuco Creek Road Trabuco Canyon, CA 92678 Conducted Site #2 Radiated Site #2
A2LA CERTIFICATE:	1111.01, Valid through February 28, 2006
PURPOSE OF TEST:	To demonstrate compliance with the relevant standards described in Section 2.0 of this report.
TEST(S) PERFORMED:	Refer to Table in Section 2.0 of this report.

All calibration vendors were responsible for certifying Aegis Labs, Inc. test equipment as per the manufacturer's specifications and that the equipment is calibrated using instruments and standards where the accuracy is traceable to the National Institute of Standards and Technology (NIST). Calibration of all test equipment conforms to ANSI/NCSL Z540-1 and ISO 10012-1 and/or ISO/IEC Guide 17025 compliance (Additionally, other pertinent test equipment will carry MIL-STD-45662A). All calibration documents are on file with Aegis Labs, Inc., with copies provided upon request.



4.0 DESCRIPTION OF EUT

4.1 EUT Description

Equipment Under Test (EUT)		
Trade Name:	Intel PRO/Wireless 3945ABG Network Connection	
Model Number:	WM3945ABG	
Frequency Range:	5.15-5.35 GHz	
Enclosure:	The EUT contains it's own shield made of aluminum approximately 3.5cm wide by 3.5cm deep by 2mm high.	
Transfer Rate:	6/36/52 Mbps	
Antenna Type:	<u>HP Altima</u> Main/Aux = PIFA	<u>HP Jakarta 3.0</u> Main/Aux = PIFA
Antenna Gain (See Note 2):	<u>HP Altima</u> 2.84 dBi @ 5 GHz	<u>HP Jakarta 3.0</u> 0.97 dBi @ 5 GHz
Transmit Output Power:	16 dBm (Typical) for 5.15-5.25 GHz 18 dBm (Typical) for 5.25-5.35 GHz Please see Appendix A (Data Sheets) for actual output power.	
Power Supply:	3.3VDC from computer MPCPI slot.	
Number of External Test Ports Exercised:	2 Antenna Ports (1 Main & 1 Auxiliary)	

The Intel PRO/Wireless 3945ABG Network Connection is an embedded 802.11a/b/g network adapter operating in the 2.4 GHz and 5 GHz spectrum. The EUT is based on the Mini Card form factor designed to meet the space and size requirements for thin and light notebook PCs. It is capable of a data rate of up to 52 Mbps.

NOTE 1: For a more detailed description, please refer to the manufacture's specifications or User's Manual.

NOTE 2: Refer to the antenna specifications for a further description of the antennas. Antennas will be professionally installed inside the laptop computer by the laptop vendor.



4.2 EUT Configuration

The EUT was tested installed in the Mini PCI-E slot of the host computer as a modular device using a PCI extender board to extend the EUT outside the computer chassis. The EUT was then connected to a set of antennas via its Main and AUX antenna ports. Data for a set of HP Altima and Jakarta 3.0 Antennas can be found in Appendix A (Data Sheets)

The low, middle, and high channels were tested in 802.11a, b, & g modes. Also, the EUT was tested once transmitting from the MAIN antenna port and once transmitting from the AUX antenna port. The EUT was placed in either continuous transmit or continuous receive mode by a program provided by the manufacturer (GRTT *Version 1.1.1*).



4.3 List of EUT, Sub-Assemblies, and Host Equipment

LIST OF EUT AND SUB-ASSEMBLIES			
Equipment Name	Manufacturer	Model Number	Serial Number
Intel PRO/Wireless 3945ABG Network Connection	Intel Corporation	WM3945ABG	00B11A295CV D26965002
EUT Sub-Assemblies			
Main Multi Band Antenna	Wistron NeWeb Corp.	EBC-C4	N/A
Auxiliary Multi Band Antenna	Wistron NeWeb Corp.	EBC-C4	N/A
Main Multi Band Antenna	Hon Hai Precision Ind. Co., LTD.	CT6	N/A
Auxiliary Multi Band Antenna	Hon Hai Precision Ind. Co., LTD.	CT6	N/A

HOST EQUIPMENT LIST			
Equipment Name	Manufacturer	Model Number	Serial Number
Computer	Intel	Generic	IZTGVV4312035
Monitor	Compaq	610	712BC060B526
Keyboard	Logitech	Y-BF37	MCTZ5200581
Mouse	Logitech	M-BJ58	PMA32715049

NOTE: All the power cords of the above support equipment are standard non-shielded, 1.8 meters long.



4.4 I/O Cabling Diagram and Description

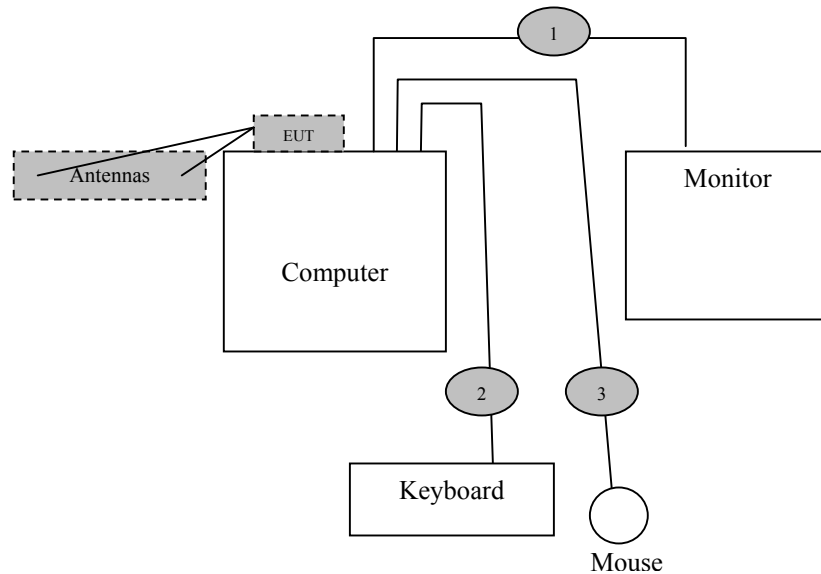

- Cable 1: This is a 6-foot braid and foil shielded round cable connecting the host computer with the monitor. It has metallic DB-15 type connector at the computer end and is hardwired to the monitor. The cable is bundled to a length of one meter and the shield of the cable is grounded to the chassis of both devices via the connector shells.
- Cable 2: This is a 6-foot braid and foil shielded round cable connecting the host computer to the keyboard. It has a metallic 6-pin mini din type connector at the computer end and is hardwired to the keyboard. The shield of the cable is grounded to the chassis of the computer via the connector shell.
- Cable 3: This is a 6-foot braid and foil shielded round cable connecting the host computer to the mouse. It has a metallic 6-pin mini din type connector at the computer end and is hardwired to the mouse. The shield of the cable is grounded to the chassis of the computer via the connector shell.



5.0 TEST EQUIPMENT AND TEST SETUPS

The test equipment settings and functions are selected using the guidance of ANSI C63.4-2003. All test equipment setups and operations during conducted and radiated emissions testing are in accordance with this reference document.

5.1 AC Power Line Conducted Emissions

During conducted emissions measurements, a spectrum analyzer was used as the measuring instrument along with a preselector and quasi-peak detector. A 10 dB attenuation pad was used for the protection of the spectrum analyzer input stage. The conducted emissions from the EUT in the frequency range from 150 kHz to 30 MHz were captured for graphical display through the use of automated LABVIEW EMI measurement software. All graphical readings were measured in the “Peak” mode only to reduce testing time. Upon completion of the graphical scan, the test lab personnel performed the conducted measurement scan manually using the spectrum analyzer front panel keys. All peak measurements coming within 3 dB of the limit line were “Averaged” and/or “Quasi-Peaked” and denoted appropriately in the EXCEL spreadsheet.

The Equipment Under Test (EUT) was configured as a system with peripherals connected, so that at least one interface port of each type is connected to one external peripheral when tested for conducted emissions according to ANSI C63.4: 2003. Excess power cord length was wrapped in a bundle 30 to 40 centimeters in length near the center of the cord. The EUT was tested in a tabletop configuration.

The emission readings for Line 1 and Line 2 are highlighted on the data sheets in Appendix A. The graphical scans only reflect peak readings while the tabulated data sheets reflect peak, average, and/or quasi-peak readings which ever applies.



5.2 Spurious Radiated Emissions

A spectrum analyzer was used as the measuring instrumentation along with a preselector and quasi-peak-detector. The pre-amplifiers were used to increase the sensitivity of the instrument. The spectrum analyzer was used in the peak detector mode with the “max-hold” feature activated and in Positive Peak mode. In this mode, the spectrum analyzer records the highest measured reading over all the sweeps. The quasi-peak detector was used only for those readings, which are marked accordingly in the data sheet. The effective measurement bandwidth used for the radiated emissions test was 120 kHz for (30 MHz- 1000 MHz). The spectrum analyzer operated such that the modulation of the signal was filtered out to set the analyzer in linear mode. For testing beyond 1000 MHz a spectrum analyzer capable of taking reading above 1000 MHz was connected to the high frequency amplifier, where these measurement readings were taken with the transducer placed at a 3-meter test distance from the EUT.

The Open Area Test Sites (OATS) was used for radiated emission testing. These test sites are designed according to ANSI C63.4: 2003 and ANSI C63.7: 1992 guidelines. The Measurements were conducted in accordance with ANSI C63.4: 2003 and ANSI C63.7: 1992 requirements.

Broadband biconical, log periodic, and horn antennas were used as transducers during the measurement reading phase. The frequency spans were wide (30 MHz-88 MHz, 88 MHz- 216 MHz, 216 MHz- 300 MHz, and 300 MHz- 1000 MHz). After 1000 MHz the horn antenna was used to measure emissions. The emission readings in both horizontal and vertical polarities are highlighted on the data sheets in Appendix A.

5.3 Conducted Emissions at the Antenna Port

A spectrum analyzer or power meter was used as the measuring instrumentation along with an attenuator and/or filter connected to the EUT antenna port. The attenuator and filters are used to ensure that the front end of the measurement instrument is not overloaded by the fundamental transmission. . The instruments recorded the measured readings with the bandwidths (video and resolution) set in accordance with the FCC Rules and regulations.

The measured readings are on the data sheets in Appendix A.



5.4 Test and Measurement Equipment Used

TEST EQUIPMENT USED					
Equipment Name	Manufacturer	Model Number	Serial Number	Calibration Due Date	Calibration Cycle
Spectrum Analyzer	Agilent	8564EC	4046A00387	08/15/06	1 Year
Preamp	Miteq	JS42-01001800-25-10P	815980	07/21/06	1 Year
2.4 GHz Notch Filter	Micro-Tronics	BRM50702-02	003	04/21/06	1 Year
5.15-5.35 GHz Notch Filter	Microwave Circuits	N0452502	3173-01	06/27/06	1 Year
5.725-5.850 GHz Notch Filter	Microwave Circuits	N0257881	3173-01	06/27/06	1 Year
Horn Antenna	EMCO	3115	2230	02/06/06	1 Year
Antenna - 18-26.5 GHz Pre-amplified Horn	Aegis Labs, Inc.	H042	SLK-35-3W	11/04/06	1 Year
Antenna - 26.5-40 GHz Pre-amplified Horn	Aegis Labs, Inc.	H028	GM1260-10	11/04/06	1 Year
Cable	Semflex	60637	S1L29BFS1348	04/11/06	1 Year
Temperature/Humidity Monitor	Dickson	TH550	7255185	N/A	N/A
Power Meter	Anritsu	ML2487A	6K00001785	04/12/06	1 Year
Wide Bandwidth Sensor	Anritsu	MA2491A	31193	04/12/06	1 Year
12dB Attenuator	Narda	4779-12	203	08/06/06	1 Year
Antenna - Biconical	EMCO	3110	9108-1421	05/17/06	1 Year
Antenna - Log Periodic	EMCO	3148	4947	05/11/06	1 Year
LISN (EUT)	FCC	FCC-LISN-50-25-2	9931	02/06/06	1 Year
LISN (Access)	Com-Power	LI-200	12019	07/05/07	1 Year
LISN (Access)	Com-Power	LI-200	12018	07/05/07	1 Year
Spectrum Analyzer	Rohde & Schwarz	FSP 40	100205	08/15/06	1 Year



6.0 SAMPLE CALCULATIONS

If a preamplifier is used during the Radiated Emissions Testing, it is required that the amplifier gain be subtracted from the Spectrum Analyzer (Meter) Reading. In addition, a correction factor for the antenna, cable and a distance factor, if any, must be applied to the Meter Reading before a true field strength reading can be obtained. In the Automatic Mode of A.R.M.S. measurements, these considerations are automatically presented as a part of the printout. In the case of manual measurements and for greater efficiency and convenience, usage of the calibration correction factors in the Appendices is necessary to calculate the Corrected Meter Reading. These correlation factors for each meter reading, shall be modified to reflect these correlation factors at each frequency value so that the meter readings can be compared directly to the modified specification limit. This modified specification limit is referred to as the "Corrected Meter Reading Limit" (CML).

The equation shall be derived in the following manner:

$$\text{Corrected Meter Reading} = \text{Meter Reading} + F + C - G - D$$

Where, F = Antenna Factor

C = Cable Factor

G = Amplifier Gain

D = Distance Factor

Therefore, the equation for determining the Corrected Meter Reading Limit (CML) is:

$$\text{CML} = \text{Specification Limit} - F - C + G + D$$

For the manual mode of measurement, a table of corrected meter reading limits shall be used to permit immediate comparison of the meter reading to determine if the measured emission amplitude exceeded the specification limit at that specific frequency. There shall be two calculation sheets done, one for three meter and one for ten-meter measurement distances, where applicable. The correction factors for the antenna and the amplifier gain are attached in the Appendices.



6.0 Sample Calculations (Continued)

Peak Transmit Power Output:

A correction factor for the cable must be applied to the Conducted Power before a true power reading can be obtained. This is referred to as the “Corrected Power” (CP).

The equation shall be derived in the following manner:

$$\text{Corrected Power Reading} = \text{Conducted Power Reading} + C$$

Where, C = Cable Factor

The conducted power is taken in units of dBm. To obtain units of mW the following equation is used:

$$\text{mW} = 10^{(\text{dBm}/10)}$$



7.0 MODIFICATIONS AND RECOMMENDATIONS

No modifications were made to the EUT.



AEGIS LABS INC.

APPENDIX A

TEST DATA

Page 1 of 49 (Appendix A)
Report Number: INTEL-051105F
FCC ID: B94WM3945ABG

**AC POWER LINE CONDUCTED EMISSIONS TEST RESULTS**

CLIENT:	Hewlett-Packard Company	DATE:	09/06/05
EUT:	Intel PRO/Wireless 3945ABG Network Connection	PROJECT NUMBER:	INTEL-050901
MODEL NUMBER:	WM3945ABG	TEST ENGINEER:	JC/RJ
SERIAL NUMBER:	00B11A295CVD26965002	SITE #:	2
CONFIGURATION:	Tested installed in the host computer's mini PCI slot.	TEMPERATURE:	34 C
		HUMIDITY:	14% RH
		TIME:	1:45 PM

Standard:	FCC CFR 47, 15.407(b)(6) 15.207
Description:	U-NII devices using an AC power line are required to comply with the conducted limits set forth in Sec. 15.207.
Results:	Passes the conducted limits by -9.86@ 0.5900 MHz

Conducted Limits		
Frequency (MHz)	Quasi-Peak Limit (dBuV)	Average Limit (dBuV)
0.15-0.5	66 to 56*	56 to 46*
0.5-5	56	46
5-30	60	50

*Decreases with the logarithm of the frequency.

NOTE: During preliminary scans, there wasn't any difference which channel or data rate was used with the EUT; therefore the final testing was made with the EUT at the low channel and a data rate of 6 Mbps.



AC Power Line Conducted Emissions Test Results (Continued)

CONDUCTED EMISSIONS – LINE 1						
Freq. (MHz)	Meter Reading (dBuV)	Detector (PK/QP/AV)	Average Limit (dBuV)	Average Delta(dB)	Quasi-Peak Limit (dBuV)	Quasi-Peak Delta(dB)
0.1800	38.82	PK	55.14	-16.32	65.14	-26.32
0.5900	36.14	PK	46.00	-9.86	56.00	-19.86
0.6600	36.12	PK	46.00	-9.88	56.00	-19.88
7.9300	39.76	PK	50.00	-10.24	60.00	-20.24
9.4700	39.32	PK	50.00	-10.68	60.00	-20.68
10.4000	39.67	PK	50.00	-10.33	60.00	-20.33

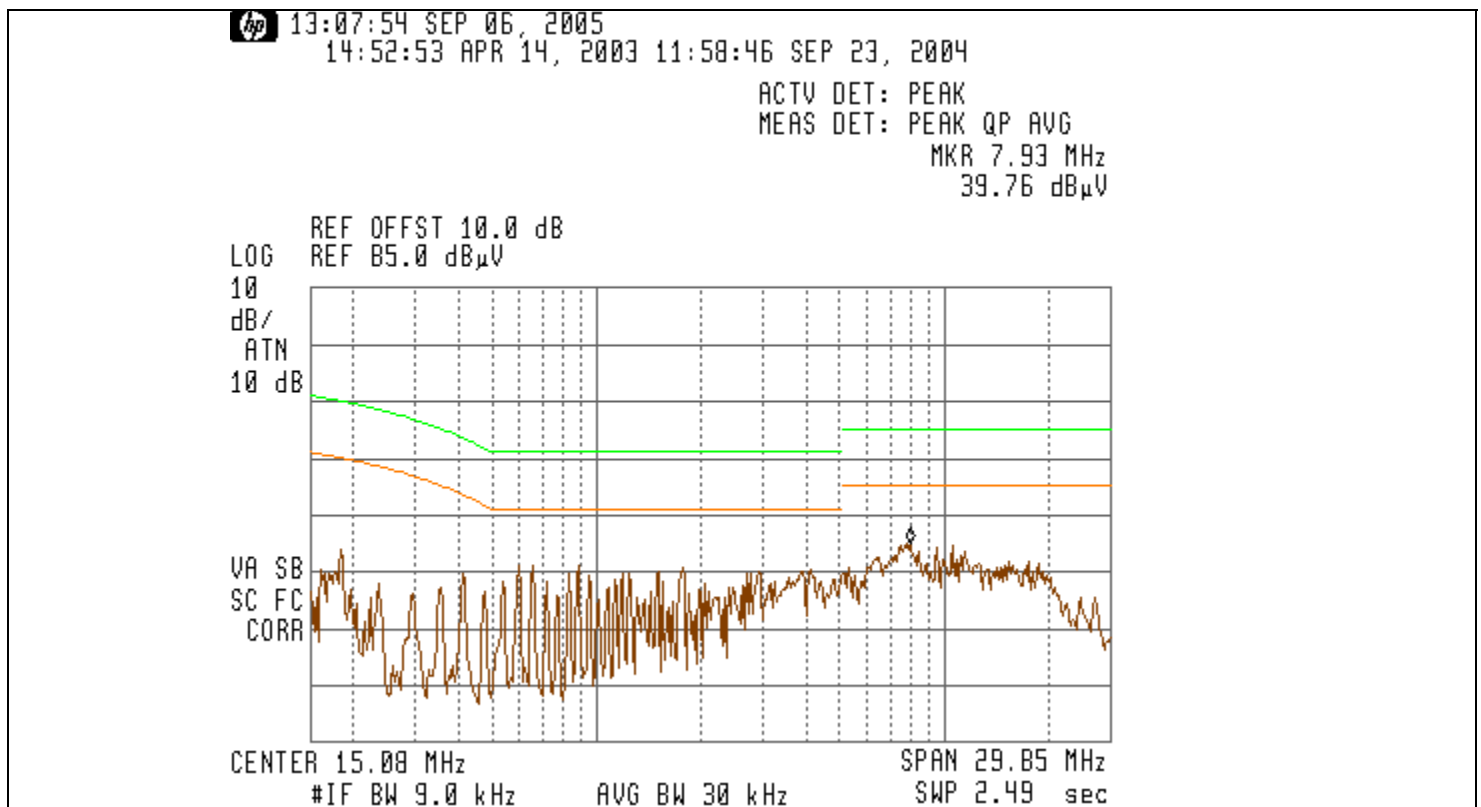



AC Power Line Conducted Emissions Test Results (Continued)

CONDUCTED EMISSIONS - LINE 2						
Freq. (MHz)	Meter Reading (dBuV)	Detector (PK/QP/AV)	Average Limit (dBuV)	Average Delta(dB)	Quasi-Peak Limit (dBuV)	Quasi-Peak Delta(dB)
0.1600	34.48	PK	55.71	-21.23	65.71	-31.23
0.1800	34.57	PK	55.14	-20.57	65.14	-30.57
1.7700	33.88	PK	46.00	-12.12	56.00	-22.12
7.9300	39.99	PK	50.00	-10.01	60.00	-20.01
11.4200	38.87	PK	50.00	-11.13	60.00	-21.13
17.3500	37.55	PK	50.00	-12.45	60.00	-22.45

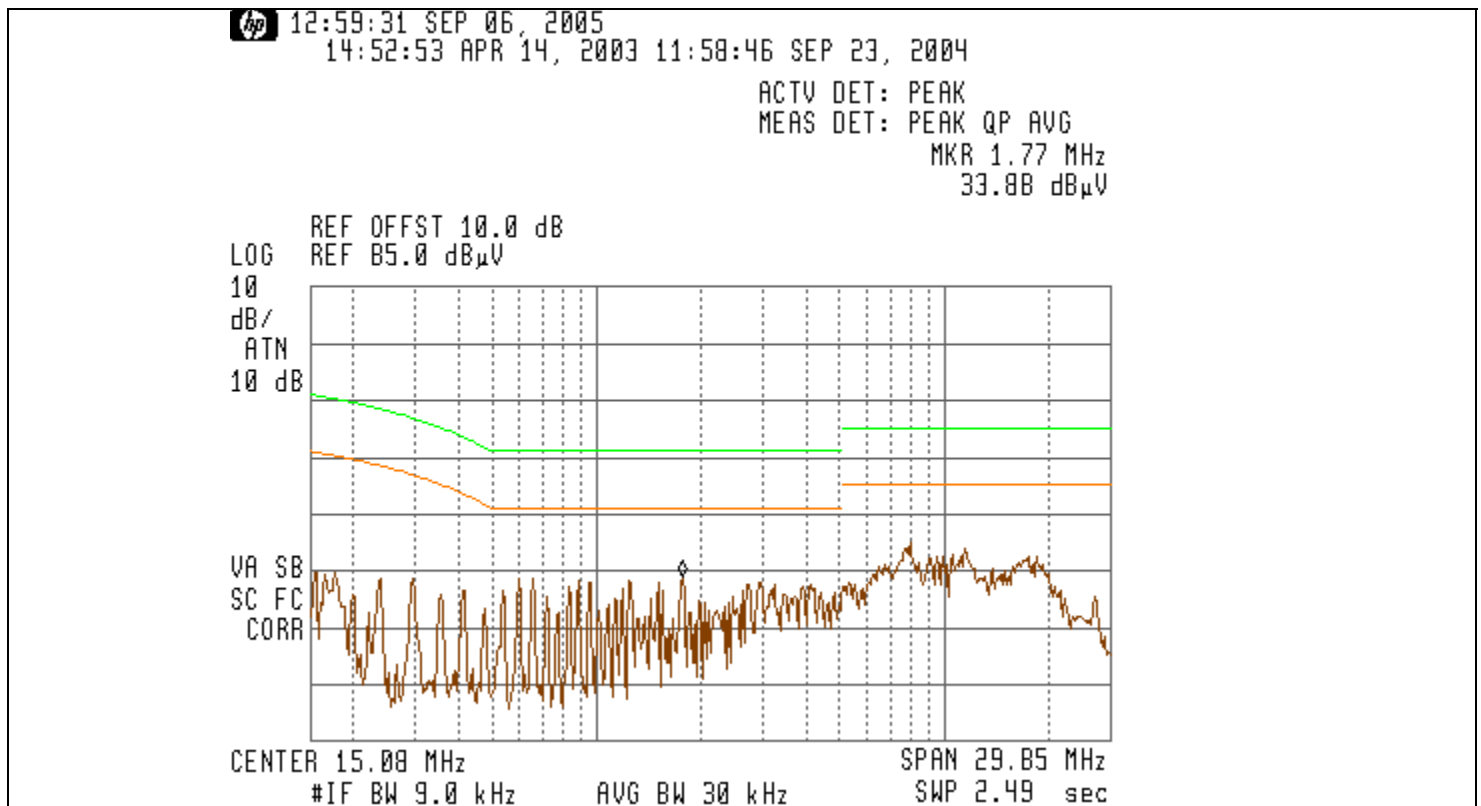

**SPURIOUS RADIATED EMISSIONS TEST RESULTS**

CLIENT:	Hewlett-Packard Company	DATE:	09/06/05
EUT:	Intel PRO/Wireless 3945ABG Network Connection	PROJECT NUMBER:	INTEL-050901
MODEL NUMBER:	WM3945ABG	TEST ENGINEER:	JC
SERIAL NUMBER:	00B11A295CVD26965002	SITE #:	2
CONFIGURATION:	Tested installed in the host computer's mini PCI slot.	TEMPERATURE:	21 C
		HUMIDITY:	45% RH
		TIME:	8:30 AM

Standard:	FCC CFR 47, Part 15.407(b)(6) 15.209
Description:	Unwanted emissions below 1 GHz must comply with the general field strength limits set forth in Sec. 15.209. (Using CISPR22 Class B Limits)
Results:	Passes the radiated limits by -6.43@ 120.04 MHz (Vertical antenna polarization)

Radiated Limits	
Frequency (MHz)	Quasi-Peak Limit (dBuV)
30-88	40
88-216	43.52
216-960	46.02
960-1000	54

NOTE: During preliminary scans, there wasn't any difference which channel or data rate was used with the EUT; therefore the final testing was made with the EUT at the low channel and a data rate of 6 Mbps



SPURIOUS RADIATED EMISSIONS TEST RESULTS

RADIATED EMISSIONS - Horizontal Antenna Polarization

Freq. (MHz)	Meter Reading (dBuV)	Antenna Height (cm)	Azimuth (degrees)	Quasi pk or AVG (dBuV)		Cable Factor (dB)	Ant. Factor (dB)	10 Meter Distance Factor (dB)	Corrected Reading (dBuV)	Limits (dBuV)	Diff (dB) +=FAIL
64.02	10.22	400	315			1.24	7.76	10.46	29.68	40.00	-10.32
136.03	6.40	400	180			1.90	14.38	10.46	33.14	43.50	-10.36
166.52	8.54	400	225			2.04	15.76	10.46	36.80	43.50	-6.70
199.27	6.83	400	180			2.29	16.89	10.46	29.64	43.50	-13.86
240.01	9.22	400	180			2.68	17.42	10.46	30.56	46.00	-15.44
336.03	9.60	350	225			3.12	15.17	10.46	38.34	46.00	-7.66
375.02	9.71	300	225			3.35	14.80	10.46	38.32	46.00	-7.68

RADIATED EMISSIONS - Vertical Antenna Polarization

Freq. (MHz)	Meter Reading (dBuV)	Antenna Height (cm)	Azimuth (degrees)	Quasi pk or AVG (dBuV)		Cable Factor (dB)	Ant. Factor (dB)	10 Meter Distance Factor (dB)	Corrected Reading (dBuV)	Limits (dBuV)	Diff (dB) +=FAIL
61.26	16.51	100	90			1.21	7.52	10.46	35.71	40.00	-4.29
120.04	12.70	100	135			1.80	12.11	10.46	37.07	43.50	-6.43
147.63	10.12	100	180			1.90	14.56	10.46	37.04	43.50	-6.46
216.01	8.31	100	135	6.06	Q	2.43	17.50	10.46	36.45	46.00	-9.55
280.02	5.84	100	180			2.82	19.78	10.46	33.06	46.00	-12.94
336.02	6.09	100	315			3.12	15.60	10.46	35.27	46.00	-10.73
384.01	7.81	100	270			3.40	15.85	10.46	37.52	46.00	-8.48

NOTE: The measurements were taken at 10 meters and extrapolated to 3 meters.



AEGIS LABS INC.

***HP Altima
TEST DATA***

*Page 7 of 49 (Appendix A)
Report Number: INTEL-051105F
FCC ID: B94WM3945ABG*



Spurious Radiated Emissions Test Results (Continued)

CLIENT:	Hewlett-Packard Company	DATE:	11/04/05
EUT:	Intel PRO/Wireless 3945ABG Network Connection	PROJECT NUMBER:	INTEL-051104
MODEL NUMBER:	WM3945ABG	TEST ENGINEER:	BM/JC
SERIAL NUMBER:	00B11A295CVD26965002	SITE #:	2
CONFIGURATION:	Tested installed in the host computer's mini PCI slot in 802.11a (5150-5350 MHz) mode with the HP Altima Antennas.	TEMPERATURE:	16 C
		HUMIDITY:	64% RH
		TIME:	4:30 PM

Standard:	FCC CFR 47, Part 15.407(b)(7)
Description:	The provisions of Sec. 15.205 apply to intentional radiators operating under this section.
Results:	Passes (See Data Sheets)

Unwanted Spurious Emissions Limits

Frequency (MHz)	Field Strength (uV/m)	Field Strength (dBuV/m) (Emissions in the restricted bands)	Field Strength (dBm/MHz) (Emissions outside the restricted bands)
Above 960	500	54.00 (Average) 74.00 (Peak)	EIRP < -27dBm/MHz (68.3dBuV/m)



Spurious Radiated Emissions Test Results (Continued)

Fundamental Measurements in 802.11a mode (5150-5350 MHz)
Channels 36, 48, 52, & 64
Continuous TX at MAIN Antenna port with HP Altima Antennas
Aegis Labs, Inc. File #: INTEL-051104-02

RADIATED EMISSIONS - Horizontal Antenna Polarization											
<i>Freq. (MHz)</i>	<i>Meter Reading (dBuV)</i>	<i>Antenna Height (cm)</i>	<i>Azimuth (degrees)</i>	<i>Quasi pk or AVG (dBuV)</i>		<i>Preamp Factor (dB)</i>	<i>Cable Factor (dB)</i>	<i>Ant. Factor (dB)</i>	<i>Corrected Reading (dBuV)</i>	<i>Limits (dBuV)</i>	<i>Diff (dB) +=FAIL</i>
5180.00	68.67	100	135				4.51	34.77	107.95		
5180.00				58.44	A		4.51	34.77	97.72		
5240.00	67.83	100	315				4.53	34.80	107.16		
5240.00				57.59	A		4.53	34.80	96.92		
5260.00	69.17	100	315				4.54	34.80	108.51		
5260.00				59.23	A		4.54	34.80	98.57		
5320.00	69.83	100	135				4.56	34.83	109.22		
5320.00				59.96	A		4.56	34.83	99.35		

RADIATED EMISSIONS – Vertical Antenna Polarization											
<i>Freq. (MHz)</i>	<i>Meter Reading (dBuV)</i>	<i>Antenna Height (cm)</i>	<i>Azimuth (degrees)</i>	<i>Quasi pk or AVG (dBuV)</i>		<i>Preamp Factor (dB)</i>	<i>Cable Factor (dB)</i>	<i>Ant. Factor (dB)</i>	<i>Corrected Reading (dBuV)</i>	<i>Limits (dBuV)</i>	<i>Diff (dB) +=FAIL</i>
5180.00	65.00	100	225				4.51	34.64	104.14		
5180.00				55.06	A		4.51	34.64	94.20		
5240.00	65.17	100	270				4.53	34.65	104.35		
5240.00				54.86	A		4.53	34.65	94.04		
5260.00	68.33	100	270				4.54	34.65	107.52		
5260.00				58.24	A		4.54	34.65	97.43		
5320.00	68.17	100	270				4.56	34.66	107.40		
5320.00				58.32	A		4.56	34.66	97.55		

NOTE: Fundamental signals measured to calculate the band edge field strengths using the “Marker Delta Method”.



Spurious Radiated Emissions Test Results (Continued)

Band Edge Field Strength Calculations in 802.11a mode (5150-5350 MHz)
Channels 36 & 64
Continuous TX at MAIN Antenna port with HP Altima Antennas
Aegis Labs, Inc. File #: INTEL-051104-02

RADIATED EMISSIONS - Horizontal Antenna Polarization										
Freq. (MHz)	Meter Reading (dBuV)	Antenna Height (cm)	Azimuth (degrees)	Quasi pk or AVG (dBuV)	Preamp Factor (dB)	Cable Factor (dB)	Ant. Factor (dB)	Corrected Reading (dBuV)	Limits (dBuV)	Diff (dB) +=FAIL
5150.00								62.29	74.00	-11.71
5150.00					A			47.06	54.00	-6.94
5350.00								65.39	74.00	-8.61
5350.00					A			52.19	54.00	-1.81
5353.00								68.39	74.00	-5.61
5353.00					A			50.85	54.00	-3.15

RADIATED EMISSIONS – Vertical Antenna Polarization										
Freq. (MHz)	Meter Reading (dBuV)	Antenna Height (cm)	Azimuth (degrees)	Quasi pk or AVG (dBuV)	Preamp Factor (dB)	Cable Factor (dB)	Ant. Factor (dB)	Corrected Reading (dBuV)	Limits (dBuV)	Diff (dB) +=FAIL
5150.00								58.48	74.00	-15.52
5150.00					A			43.54	54.00	-10.46
5350.00								63.57	74.00	-10.43
5350.00					A			50.39	54.00	-3.61
5353.00								66.57	74.00	-7.43
5353.00					A			49.05	54.00	-4.95

NOTE: The “Band Edge Field Strength” was calculated using the “Fundamental” and “Conducted Band Edge” measurements per the “Marker-Delta Method” with the following formula:

$$BE = Fm - \Delta m$$

Where

BE = Band Edge Field Strength

Fm = Measured Fundamental (Peak or Average)

Δm = Measured Conducted Band Edge Delta (Peak or Average)



Spurious Radiated Emissions Test Results (Continued)

Plots Showing Out-Of-Band Emissions (Peak RBW=VBW=1MHz; Average RBW = 1MHz, VBW = 10Hz)

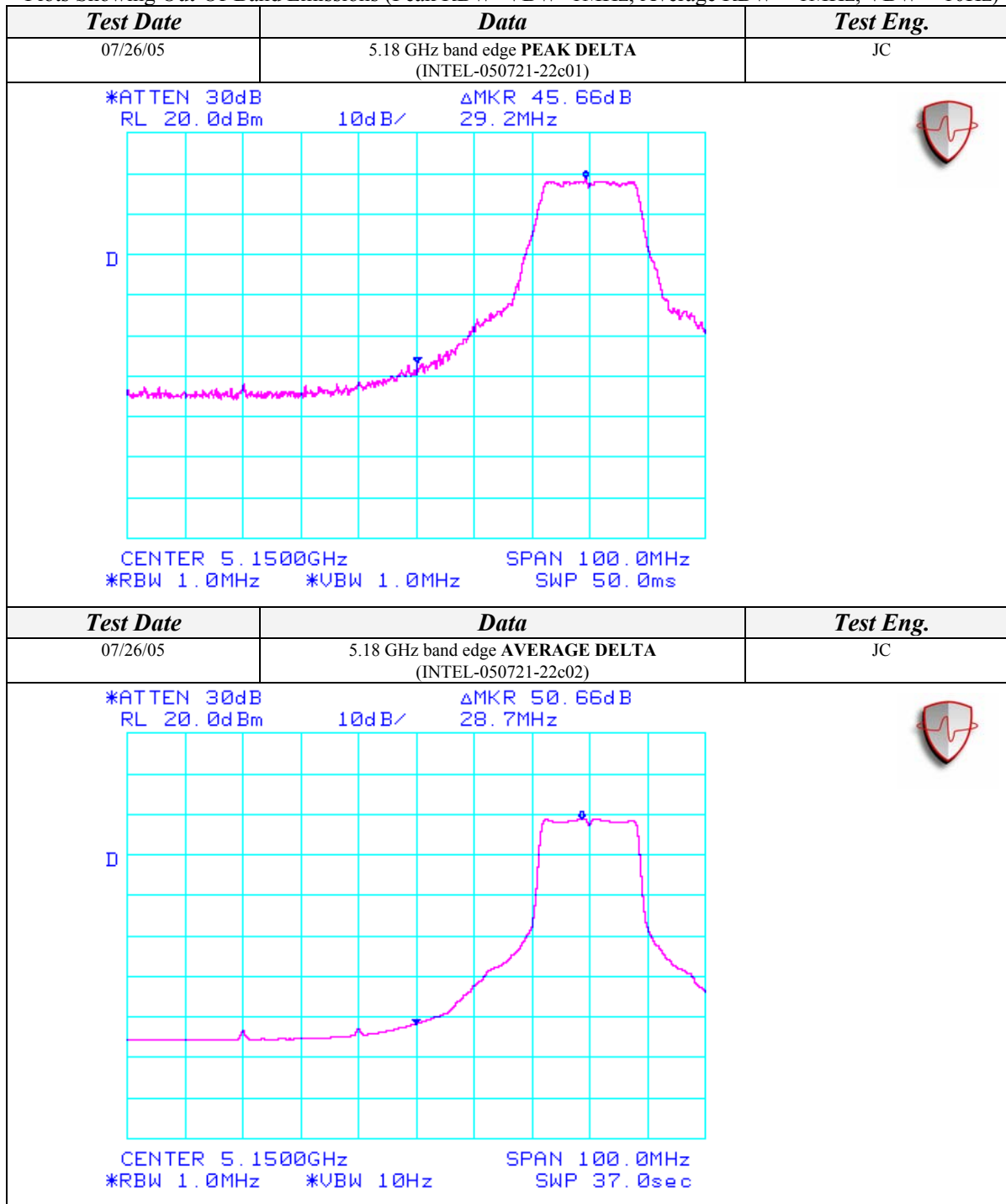



Spurious Radiated Emissions Test Results (Continued)

Spurious Emissions Measurements in 802.11a mode (5150-5350 MHz)
Channels 36, 52, & 64
Continuous TX at MAIN Antenna port with HP Altima Antennas
Aegis Labs, Inc. File #: INTEL-051104-04

RADIATED EMISSIONS - Horizontal Antenna Polarization

Freq. (MHz)	Meter Reading (dBuV)	Antenna Height (cm)	Azimuth (degrees)	Quasi pk or AVG (dBuV)		Preamp Factor (dB)	Cable Factor (dB)	Ant. Factor (dB)	Corrected Reading (dBuV)	Limits (dBuV)	Diff (dB) +=FAIL
EUT in Continuous Transmit Mode on Channel 36 (5.18 GHz)											
3453.33	54.00	100	135			46.84	3.64	31.50	42.29	68.00	-25.71
10360.01	62.50	100	180			45.00	6.48	38.60	62.58	68.00	-5.42
15540.00	58.00	100	180			44.56	8.00	39.08	60.52	74.00	-13.48
15540.00				44.42	A	44.56	8.00	39.08	46.94	54.00	-7.06
EUT in Continuous Transmit Mode on Channel 52 (5.26 GHz)											
3506.66	55.50	100	135			46.85	3.66	31.62	43.93	68.00	-24.07
10520.00	63.67	100	225			45.05	6.55	38.61	63.78	68.00	-4.22
15780.00	62.17	100	135			44.54	8.08	38.93	64.64	74.00	-9.36
15780.00				48.78	A	44.54	8.08	38.93	51.25	54.00	-2.75
EUT in Continuous Transmit Mode on Channel 64 (5.32 GHz)											
3546.66	54.17	100	135			46.84	3.69	31.72	42.74	68.00	-25.26
10639.98	64.33	100	225			45.02	6.58	38.68	64.58	74.00	-9.42
10639.98				52.12	A	45.02	6.58	38.68	52.37	54.00	-1.63
15960.00	61.17	100	135			44.53	8.14	38.82	63.60	74.00	-10.40
15960.00				47.07	A	44.53	8.14	38.82	49.50	54.00	-4.50



Spurious Radiated Emissions Test Results (Continued)

RADIATED EMISSIONS - Vertical Antenna Polarization											
<i>Freq. (MHz)</i>	<i>Meter Reading (dBuV)</i>	<i>Antenna Height (cm)</i>	<i>Azimuth (degrees)</i>	<i>Quasi pk or AVG (dBuV)</i>		<i>Preamp Factor (dB)</i>	<i>Cable Factor (dB)</i>	<i>Ant. Factor (dB)</i>	<i>Corrected Reading (dBuV)</i>	<i>Limits (dBuV)</i>	<i>Diff (dB) +=FAIL</i>
EUT in Continuous Transmit Mode on Channel 36 (5.18 GHz)											
3453.33	55.00	100	180			46.84	3.64	31.52	43.31	68.00	-24.69
10360.02	59.83	100	135			45.00	6.48	38.80	60.11	68.00	-7.89
15540.00	64.33	100	225			44.56	8.00	39.09	66.87	74.00	-7.13
15540.00				50.21	A	44.56	8.00	39.09	52.75	54.00	-1.25
EUT in Continuous Transmit Mode on Channel 52 (5.26 GHz)											
3506.66	55.17	100	180			46.85	3.66	31.62	43.60	68.00	-24.40
10520.00	61.00	100	180			45.05	6.55	38.82	61.32	68.00	-6.68
15780.00	59.67	100	135			44.54	8.08	39.04	62.25	74.00	-11.75
15780.00				45.68	A	44.54	8.08	39.04	48.26	54.00	-5.74
EUT in Continuous Transmit Mode on Channel 64 (5.32 GHz)											
3546.66	56.33	100	180			46.84	3.69	31.72	44.90	68.00	-23.10
10639.98	59.83	100	135			45.02	6.58	38.91	60.30	74.00	-13.70
10639.98				46.19	A	45.02	6.58	38.91	46.66	54.00	-7.34
15960.00	60.83	100	135			44.53	8.14	39.01	63.44	74.00	-10.56
15960.00				47.66	A	44.53	8.14	39.01	50.27	54.00	-3.73



Spurious Radiated Emissions Test Results (Continued)

Spurious Emissions Measurements in 802.11a mode (5150-5350 MHz)
Channels 36, 52, & 64
Continuous TX at MAIN Antenna port with HP Altima Antennas
Aegis Labs, Inc. File #: INTEL-051104-05

RADIATED EMISSIONS - Horizontal Antenna Polarization

Freq. (MHz)	Meter Reading (dBuV)	Antenna Height (cm)	Azimuth (degrees)	Quasi pk or AVG (dBuV)		Cable Factor (dB)	Antenna/ Preamp Factor (dB)	Corrected Reading (dBuV/m)	Limits (dBuV/m)	Diff (dB) +=FAIL
EUT in Continuous Transmit Mode on Channel 36 (5.18 GHz)										
20720.00	51.17	100	225			9.33	3.25	57.26	74.00	-16.74
20720.00				35.10	A	9.33	3.25	41.19	54.00	-12.81
EUT in Continuous Transmit Mode on Channel 52 (5.26 GHz)										
21040.00	54.33	100	225			9.40	3.23	60.50	74.00	-13.50
21040.00				41.15	A	9.40	3.23	47.32	54.00	-6.68
EUT in Continuous Transmit Mode on Channel 64 (5.32 GHz)										
21280.00	54.83	100	225			9.46	3.39	60.90	74.00	-13.10
21280.00				41.15	A	9.46	3.39	47.22	54.00	-6.78

RADIATED EMISSIONS - Vertical Antenna Polarization

Freq. (MHz)	Meter Reading (dBuV)	Antenna Height (cm)	Azimuth (degrees)	Quasi pk or AVG (dBuV)		Cable Factor (dB)	Antenna/ Preamp Factor (dB)	Corrected Reading (dBuV/m)	Limits (dBuV/m)	Diff (dB) +=FAIL
EUT in Continuous Transmit Mode on Channel 36 (5.18 GHz)										
20720.00	53.67	100	225			9.33	2.95	60.06	74.00	-13.94
20720.00				37.92	A	9.33	2.95	44.31	54.00	-9.69
EUT in Continuous Transmit Mode on Channel 52 (5.26 GHz)										
21040.00	54.83	100	225			9.40	2.95	61.28	74.00	-12.72
21040.00				42.56	A	9.40	2.95	49.01	54.00	-4.99
EUT in Continuous Transmit Mode on Channel 64 (5.32 GHz)										
21280.00	61.67	100	225			9.46	3.22	67.92	74.00	-6.08
21280.00				47.24	A	9.46	3.22	53.49	54.00	-0.51



Spurious Radiated Emissions Test Results (Continued)

Spurious Emissions Measurements in 802.11a mode (5150-5350 MHz)
Channels 36, 52, & 64
Continuous RX at MAIN Antenna port with HP Altima Antennas
Aegis Labs, Inc. File #: INTEL-051104-04

RADIATED EMISSIONS - Horizontal Antenna Polarization

Freq. (MHz)	Meter Reading (dBuV)	Antenna Height (cm)	Azimuth (degrees)	Quasi pk or AVG (dBuV)	Preamp Factor (dB)	Cable Factor (dB)	Ant. Factor (dB)	Corrected Reading (dBuV)	Limits (dBuV)	Diff (dB) +=FAIL
EUT in Continuous Transmit Mode on Channel 36 (5.18 GHz)										
3453.33	56.50	100	135			46.84	3.64	31.50	44.79	74.00 -29.21
3453.33				44.60	A	46.84	3.64	31.50	32.89	54.00 -21.11
EUT in Continuous Transmit Mode on Channel 52 (5.26 GHz)										
3506.66	54.83	100	135			46.85	3.66	31.62	43.26	74.00 -30.74
3506.66				44.54	A	46.85	3.66	31.62	32.97	54.00 -21.03
EUT in Continuous Transmit Mode on Channel 64 (5.32 GHz)										
3546.72	54.83	100	135			46.84	3.69	31.72	43.40	74.00 -30.60
3546.72				44.42	A	46.84	3.69	31.72	32.99	54.00 -21.01

RADIATED EMISSIONS - Vertical Antenna Polarization

Freq. (MHz)	Meter Reading (dBuV)	Antenna Height (cm)	Azimuth (degrees)	Quasi pk or AVG (dBuV)	Preamp Factor (dB)	Cable Factor (dB)	Ant. Factor (dB)	Corrected Reading (dBuV)	Limits (dBuV)	Diff (dB) +=FAIL
EUT in Continuous Transmit Mode on Channel 36 (5.18 GHz)										
3453.33	56.50	100	180			46.84	3.64	31.52	44.81	74.00 -29.19
3453.33				47.88	A	46.84	3.64	31.52	36.19	54.00 -17.81
EUT in Continuous Transmit Mode on Channel 52 (5.26 GHz)										
3506.68	55.67	100	180			46.85	3.66	31.62	44.10	74.00 -29.90
3506.68				47.32	A	46.85	3.66	31.62	35.75	54.00 -18.25
EUT in Continuous Transmit Mode on Channel 64 (5.32 GHz)										
3546.66	55.83	100	180			46.84	3.69	31.72	44.40	74.00 -29.60
3546.66				47.10	A	46.84	3.69	31.72	35.67	54.00 -18.33



AEGIS LABS INC.

***HP Jakarta 3.0
TEST DATA***

*Page 17 of 49 (Appendix A)
Report Number: INTEL-051105F
FCC ID: B94WM3945ABG*



Spurious Radiated Emissions Test Results (Continued)

CLIENT:	Hewlett-Packard Company	DATE:	11/28/05
EUT:	Intel PRO/Wireless 3945ABG Network Connection	PROJECT NUMBER:	INTEL-051104
MODEL NUMBER:	WM3945ABG	TEST ENGINEER:	BM
SERIAL NUMBER:	00B11A295CVD26965002	SITE #:	2
CONFIGURATION:	Tested installed in the host computer's mini PCI slot in 802.11a (5150-5350 MHz) mode with the HP Jakarta 3.0 Antennas.	TEMPERATURE:	8 C
		HUMIDITY:	46% RH
		TIME:	7:00 PM

Standard:	FCC CFR 47, Part 15.407(b)(7)
Description:	The provisions of Sec. 15.205 apply to intentional radiators operating under this section.
Results:	Passes (See Data Sheets)

Unwanted Spurious Emissions Limits			
Frequency (MHz)	Field Strength (uV/m)	Field Strength (dBuV/m) (Emissions in the restricted bands)	Field Strength (dBm/MHz) (Emissions outside the restricted bands)
Above 960	500	54.00 (Average) 74.00 (Peak)	EIRP < -27dBm/MHz (68.3dBuV/m)



Spurious Radiated Emissions Test Results (Continued)

Fundamental Measurements in 802.11a mode (5150-5350 MHz)
Channels 36, 48, 52, & 64
Continuous TX at MAIN Antenna port with HP Jakarta 3.0 Antennas
Aegis Labs, Inc. File #: INTEL-051104-06

RADIATED EMISSIONS - Horizontal Antenna Polarization											
<i>Freq. (MHz)</i>	<i>Meter Reading (dBuV)</i>	<i>Antenna Height (cm)</i>	<i>Azimuth (degrees)</i>	<i>Quasi pk or AVG (dBuV)</i>		<i>Preamp Factor (dB)</i>	<i>Cable Factor (dB)</i>	<i>Ant. Factor (dB)</i>	<i>Corrected Reading (dBuV)</i>	<i>Limits (dBuV)</i>	<i>Diff (dB) +=FAIL</i>
5180.00	68.17	100	135				4.51	34.77	107.45		
5180.00				57.92	A		4.51	34.77	97.20		
5240.00	68.17	100	135				4.53	34.80	107.50		
5240.00				58.50	A		4.53	34.80	97.83		
5260.00	69.33	100	135				4.54	34.80	108.67		
5260.00				59.60	A		4.54	34.80	98.94		
5320.00	69.33	100	180				4.56	34.83	108.72		
5320.00				59.57	A		4.56	34.83	98.96		

RADIATED EMISSIONS – Vertical Antenna Polarization											
<i>Freq. (MHz)</i>	<i>Meter Reading (dBuV)</i>	<i>Antenna Height (cm)</i>	<i>Azimuth (degrees)</i>	<i>Quasi pk or AVG (dBuV)</i>		<i>Preamp Factor (dB)</i>	<i>Cable Factor (dB)</i>	<i>Ant. Factor (dB)</i>	<i>Corrected Reading (dBuV)</i>	<i>Limits (dBuV)</i>	<i>Diff (dB) +=FAIL</i>
5180.00	71.33	100	180				4.51	34.64	110.47		
5180.00				61.43	A		4.51	34.64	100.57		
5240.00	74.00	100	180				4.53	34.65	113.18		
5240.00				64.10	A		4.53	34.65	103.28		
5260.00	74.50	100	180				4.54	34.65	113.69		
5260.00				64.52	A		4.54	34.65	103.71		
5320.00	69.33	100	180				4.56	34.66	108.56		
5320.00				59.50	A		4.56	34.66	98.73		

NOTE: Fundamental signals measured to calculate the band edge field strengths using the “Marker Delta Method”.



Spurious Radiated Emissions Test Results (Continued)

Band Edge Field Strength Calculations in 802.11a mode (5150-5350 MHz)
Channels 36 & 64
Continuous TX at MAIN Antenna port with HP Jakarta 3.0 Antennas
Aegis Labs, Inc. File #: INTEL-051104-06

RADIATED EMISSIONS - Horizontal Antenna Polarization										
Freq. (MHz)	Meter Reading (dBuV)	Antenna Height (cm)	Azimuth (degrees)	Quasi pk or AVG (dBuV)	Preamp Factor (dB)	Cable Factor (dB)	Ant. Factor (dB)	Corrected Reading (dBuV)	Limits (dBuV)	Diff (dB) +=FAIL
5150.00								61.79	74.00	-12.21
5150.00					A			46.54	54.00	-7.46
5350.00								64.89	74.00	-9.11
5350.00					A			51.80	54.00	-2.20
5353.00								67.89	74.00	-6.11
5353.00					A			50.46	54.00	-3.54

RADIATED EMISSIONS – Vertical Antenna Polarization										
Freq. (MHz)	Meter Reading (dBuV)	Antenna Height (cm)	Azimuth (degrees)	Quasi pk or AVG (dBuV)	Preamp Factor (dB)	Cable Factor (dB)	Ant. Factor (dB)	Corrected Reading (dBuV)	Limits (dBuV)	Diff (dB) +=FAIL
5150.00								64.81	74.00	-9.19
5150.00					A			49.91	54.00	-4.09
5350.00								64.73	74.00	-9.27
5350.00					A			51.57	54.00	-2.43
5353.00								67.73	74.00	-6.27
5353.00					A			50.23	54.00	-3.77

NOTE: The “Band Edge Field Strength” was calculated using the “Fundamental” and “Conducted Band Edge” measurements per the “Marker-Delta Method” with the following formula:

$$BE = F_m - \Delta m$$

Where

BE = Band Edge Field Strength

F_m = Measured Fundamental (Peak or Average)

Δ_m = Measured Conducted Band Edge Delta (Peak or Average)



Spurious Radiated Emissions Test Results (Continued)

Plots Showing Out-Of-Band Emissions (Peak RBW=VBW=1MHz; Average RBW = 1MHz, VBW = 10Hz)

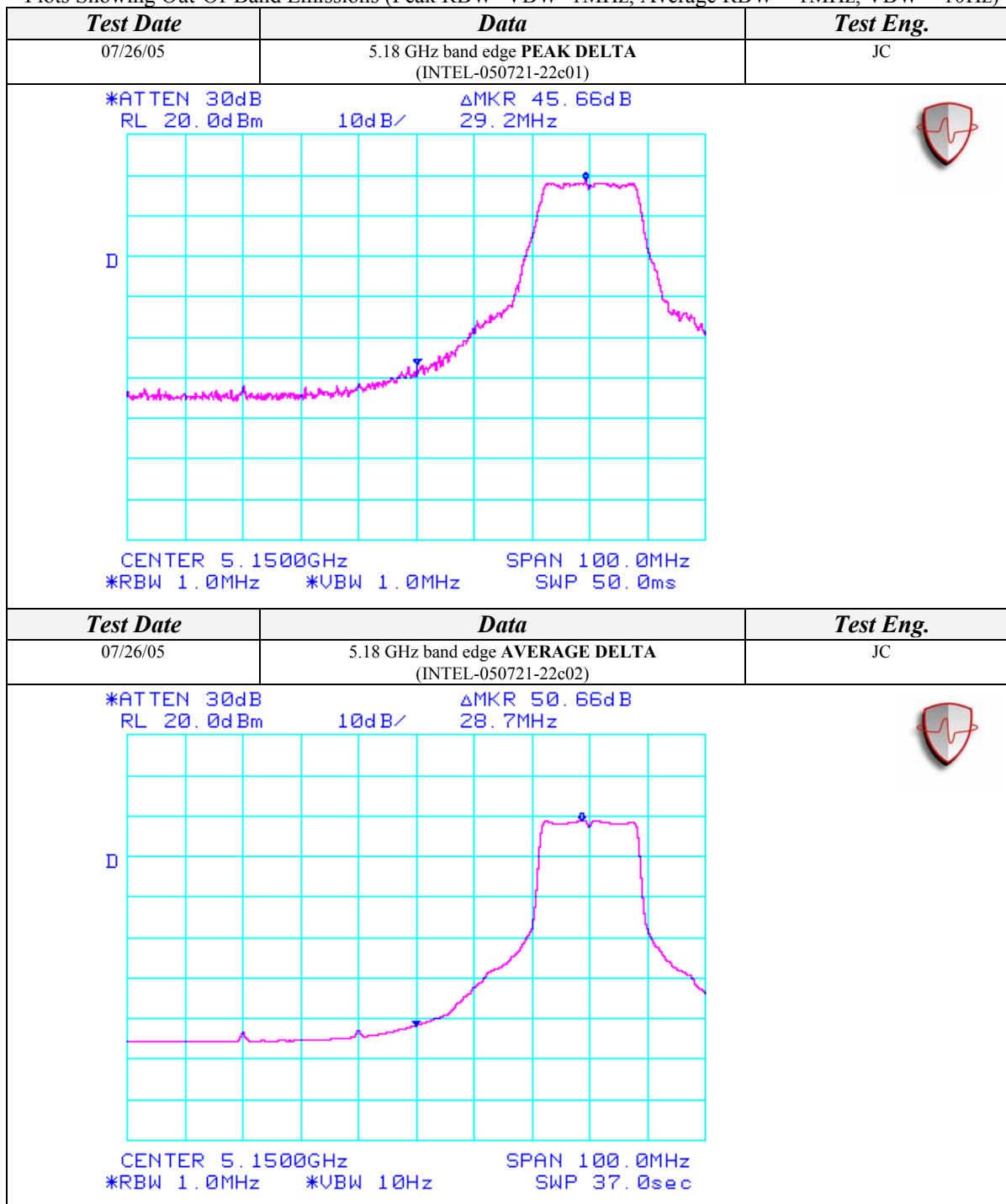



Spurious Radiated Emissions Test Results (Continued)

Plots Showing Out-Of-Band Emissions (Peak RBW=VBW=1MHz; Average RBW = 1MHz, VBW = 10Hz)

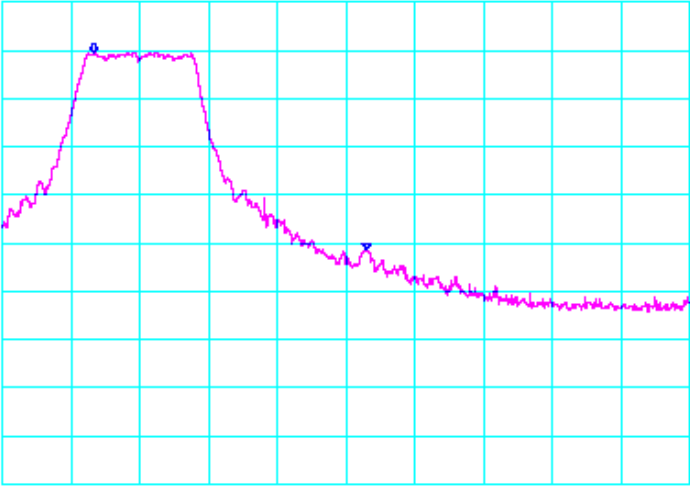
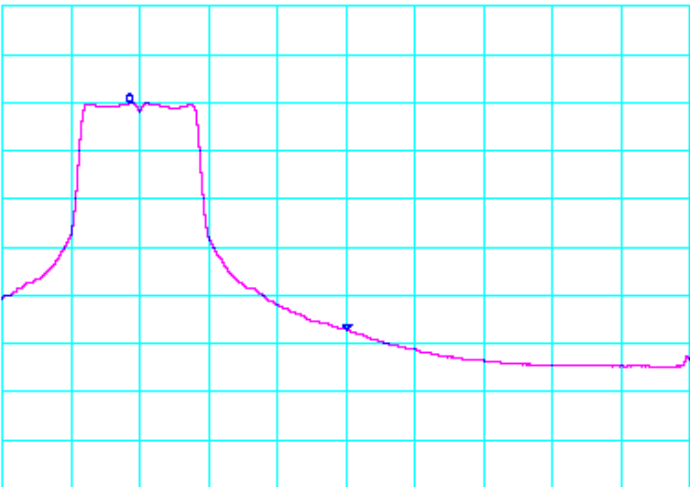
Test Date	Data	Test Eng.
07/26/05	5.32 GHz band edge PEAK DELTA (INTEL-050721-22c03)	JC
<p>*ATTEN 30dB ΔMKR 40.83dB RL 20.0dBm 10dB/ -39.7MHz</p>  <p>CENTER 5.3500GHz SPAN 100.0MHz *RBW 1.0MHz *VBW 1.0MHz SWP 50.0ms</p>		
Test Date	Data	Test Eng.
07/26/05	5.32 GHz band edge AVERAGE DELTA (INTEL-050721-22c04)	JC
<p>*ATTEN 30dB ΔMKR 47.16dB RL 20.0dBm 10dB/ -31.7MHz</p>  <p>CENTER 5.3500GHz SPAN 100.0MHz *RBW 1.0MHz *VBW 10Hz SWP 37.0sec</p>		



Spurious Radiated Emissions Test Results (Continued)

*Spurious Emissions Measurements in 802.11a mode (5150-5350 MHz)
 Channels 36, 52, & 64
 Continuous TX at MAIN Antenna port with HP Jakarta 3.0 Antennas
 Aegis Labs, Inc. File #: INTEL-051104-08*

RADIATED EMISSIONS - Horizontal Antenna Polarization											
<i>Freq. (MHz)</i>	<i>Meter Reading (dBuV)</i>	<i>Antenna Height (cm)</i>	<i>Azimuth (degrees)</i>	<i>Quasi pk or AVG (dBuV)</i>		<i>Preamp Factor (dB)</i>	<i>Cable Factor (dB)</i>	<i>Ant. Factor (dB)</i>	<i>Corrected Reading (dBuV)</i>	<i>Limits (dBuV)</i>	<i>Diff (dB) +=FAIL</i>
EUT in Continuous Transmit Mode on Channel 36 (5.18 GHz)											
3453.33	55.50	100	135			46.84	3.64	31.50	43.79	68.00	-24.21
10360.01	64.50	100	225			45.00	6.48	38.60	64.58	68.00	-3.42
15540.00	57.50	100	180			44.56	8.00	39.08	60.02	74.00	-13.98
15540.00				42.61	A	44.56	8.00	39.08	45.13	54.00	-8.87
EUT in Continuous Transmit Mode on Channel 52 (5.26 GHz)											
3506.66	55.33	125	135			46.85	3.66	31.62	43.76	68.00	-24.24
10520.00	60.67	100	225			45.05	6.55	38.61	60.78	68.00	-7.22
15780.00	58.83	100	135			44.54	8.08	38.93	61.30	74.00	-12.70
15780.00				44.73	A	44.54	8.08	38.93	47.20	54.00	-6.80
EUT in Continuous Transmit Mode on Channel 64 (5.32 GHz)											
3546.66	53.67	100	135			46.84	3.69	31.72	42.24	68.00	-25.76
10639.98	59.17	100	225			45.02	6.58	38.68	59.42	74.00	-14.58
10639.98				43.96	A	45.02	6.58	38.68	44.21	54.00	-9.79
15960.00	60.17	100	135			44.53	8.14	38.82	62.60	74.00	-11.40
15960.00				45.52	A	44.53	8.14	38.82	47.95	54.00	-6.05



Spurious Radiated Emissions Test Results (Continued)

RADIATED EMISSIONS - Vertical Antenna Polarization											
<i>Freq. (MHz)</i>	<i>Meter Reading (dBuV)</i>	<i>Antenna Height (cm)</i>	<i>Azimuth (degrees)</i>	<i>Quasi pk or AVG (dBuV)</i>		<i>Preamp Factor (dB)</i>	<i>Cable Factor (dB)</i>	<i>Ant. Factor (dB)</i>	<i>Corrected Reading (dBuV)</i>	<i>Limits (dBuV)</i>	<i>Diff (dB) +=FAIL</i>
EUT in Continuous Transmit Mode on Channel 36 (5.18 GHz)											
3453.33	56.50	100	180			46.84	3.64	31.52	44.81	68.00	-23.19
10360.02	60.33	100	180			45.00	6.48	38.80	60.61	68.00	-7.39
15540.00	62.33	100	225			44.56	8.00	39.09	64.87	74.00	-9.13
15540.00				45.81	A	44.56	8.00	39.09	48.35	54.00	-5.65
EUT in Continuous Transmit Mode on Channel 52 (5.26 GHz)											
3506.66	56.83	100	180			46.85	3.66	31.62	45.26	68.00	-22.74
10520.00	61.33	125	180			45.05	6.55	38.82	61.65	68.00	-6.35
15780.00	61.17	100	180			44.54	8.08	39.04	63.75	74.00	-10.25
15780.00				47.32	A	44.54	8.08	39.04	49.90	54.00	-4.10
EUT in Continuous Transmit Mode on Channel 64 (5.32 GHz)											
3546.66	55.33	100	180			46.84	3.69	31.72	43.90	68.00	-24.10
10639.98	60.67	100	225			45.02	6.58	38.91	61.14	74.00	-12.86
10639.98				45.84	A	45.02	6.58	38.91	46.31	54.00	-7.69
15960.00	60.00	100	180			44.53	8.14	39.01	62.61	74.00	-11.39
15960.00				45.19	A	44.53	8.14	39.01	47.80	54.00	-6.20



Spurious Radiated Emissions Test Results (Continued)

*Spurious Emissions Measurements in 802.11a mode (5150-5350 MHz)
Channels 36, 52, & 64
Continuous TX at MAIN Antenna port with HP Jakarta 3.0 Antennas
Aegis Labs, Inc. File #: INTEL-051104-09*

RADIATED EMISSIONS - Horizontal Antenna Polarization

Freq. (MHz)	Meter Reading (dBuV)	Antenna Height (cm)	Azimuth (degrees)	Quasi pk or AVG (dBuV)	Cable Factor (dB)	Antenna/Preamp Factor (dB)	Corrected Reading (dBuV/m)	Limits (dBuV/m)	Diff (dB) +=FAIL	
EUT in Continuous Transmit Mode on Channel 36 (5.18 GHz)										
20720.00	54.17	100	225			9.33	3.25	60.26	74.00	-13.74
20720.00				39.04	A	9.33	3.25	45.13	54.00	-8.87
EUT in Continuous Transmit Mode on Channel 52 (5.26 GHz)										
21040.00	54.00	100	225			9.40	3.23	60.17	74.00	-13.83
21040.00				38.89	A	9.40	3.23	45.06	54.00	-8.94
EUT in Continuous Transmit Mode on Channel 64 (5.32 GHz)										
21280.00	55.00	100	225			9.46	3.39	61.07	74.00	-12.93
21280.00				38.63	A	9.46	3.39	44.70	54.00	-9.30

RADIATED EMISSIONS - Vertical Antenna Polarization

Freq. (MHz)	Meter Reading (dBuV)	Antenna Height (cm)	Azimuth (degrees)	Quasi pk or AVG (dBuV)	Cable Factor (dB)	Antenna/Preamp Factor (dB)	Corrected Reading (dBuV/m)	Limits (dBuV/m)	Diff (dB) +=FAIL	
EUT in Continuous Transmit Mode on Channel 36 (5.18 GHz)										
20720.00	58.50	100	225			9.33	2.95	64.89	74.00	-9.11
20720.00				42.85	A	9.33	2.95	49.24	54.00	-4.76
EUT in Continuous Transmit Mode on Channel 52 (5.26 GHz)										
21040.00	61.50	100	225			9.40	2.95	67.95	74.00	-6.05
21040.00				45.29	A	9.40	2.95	51.74	54.00	-2.26
EUT in Continuous Transmit Mode on Channel 64 (5.32 GHz)										
21280.00	57.33	100	225			9.46	3.22	63.58	74.00	-10.42
21280.00				44.10	A	9.46	3.22	50.35	54.00	-3.65



Spurious Radiated Emissions Test Results (Continued)

*Spurious Emissions Measurements in 802.11a mode (5150-5350 MHz)
Channels 36, 52, & 64
Continuous RX at MAIN Antenna port with HP Jakarta 3.0 Antennas
Aegis Labs, Inc. File #: INTEL-051104-08*

RADIATED EMISSIONS - Horizontal Antenna Polarization

Freq. (MHz)	Meter Reading (dBuV)	Antenna Height (cm)	Azimuth (degrees)	Quasi pk or AVG (dBuV)	Preamp Factor (dB)	Cable Factor (dB)	Ant. Factor (dB)	Corrected Reading (dBuV)	Limits (dBuV)	Diff (dB) +=FAIL
EUT in Continuous Transmit Mode on Channel 36 (5.18 GHz)										
3453.33	55.00	100	180			46.84	3.64	31.50	43.29	74.00 -30.71
3453.33				44.95	A	46.84	3.64	31.50	33.24	54.00 -20.76
EUT in Continuous Transmit Mode on Channel 52 (5.26 GHz)										
3506.66	54.17	100	135			46.85	3.66	31.62	42.60	74.00 -31.40
3506.66				44.13	A	46.85	3.66	31.62	32.56	54.00 -21.44
EUT in Continuous Transmit Mode on Channel 64 (5.32 GHz)										
3546.72	55.00	150	135			46.84	3.69	31.72	43.57	74.00 -30.43
3546.72				45.10	A	46.84	3.69	31.72	33.67	54.00 -20.33

RADIATED EMISSIONS - Vertical Antenna Polarization

Freq. (MHz)	Meter Reading (dBuV)	Antenna Height (cm)	Azimuth (degrees)	Quasi pk or AVG (dBuV)	Preamp Factor (dB)	Cable Factor (dB)	Ant. Factor (dB)	Corrected Reading (dBuV)	Limits (dBuV)	Diff (dB) +=FAIL
EUT in Continuous Transmit Mode on Channel 36 (5.18 GHz)										
3453.33	56.33	100	180			46.84	3.64	31.52	44.64	74.00 -29.36
3453.33				47.24	A	46.84	3.64	31.52	35.55	54.00 -18.45
EUT in Continuous Transmit Mode on Channel 52 (5.26 GHz)										
3506.68	55.50	100	180			46.85	3.66	31.62	43.93	74.00 -30.07
3506.68				46.78	A	46.85	3.66	31.62	35.21	54.00 -18.79
EUT in Continuous Transmit Mode on Channel 64 (5.32 GHz)										
3546.66	55.17	100	180			46.84	3.69	31.72	43.74	74.00 -30.26
3546.66				45.79	A	46.84	3.69	31.72	34.36	54.00 -19.64

**PEAK TRANSMIT POWER**

CLIENT:	Hewlett-Packard Company	DATE:	11/04/05
EUT:	Intel PRO/Wireless 3945ABG Network Connection	PROJECT NUMBER:	INTEL-051104
MODEL NUMBER:	WM3945ABG	TEST ENGINEER:	BM
SERIAL NUMBER:	00B11A295CVD26965002	SITE #:	2
CONFIGURATION:	Tested installed in the host computer's mini PCI slot.	TEMPERATURE:	20 C
		HUMIDITY:	59% RH
		TIME:	5:00 PM

Standard:	FCC CFR 47, Part 15.407(a)(1) & 15.407(a)(2)
Description:	For the band 5.15-5.25 GHz, the peak transmit power over the frequency band of operation shall not exceed the lesser of 50 mW or 4 dBm + 10logB, where B is the 26-dB emission bandwidth in MHz. For the band 5.25-5.35 GHz, the peak transmit power over the frequency band of operation shall not exceed the lesser of 250 mW or 11 dBm + 10logB, where B is the 26-dB emission bandwidth in MHz.
Results:	See Data Sheet

Peak Transmit Power Limits		
Frequency (MHz)	Output Power (mW)	Output Power (Note 1)
5150-5250	50 (17 dBm)	4 dBm + 10logB = 17.68 dBm @ 5180 MHz
5250-5350	250 (24 dBm)	11 dBm + 10logB = 24.68 dBm @ 5260 MHz 11 dBm + 10logB = 25.04 dBm @ 5320 MHz

Note 1: Calculated using the 26-dB emissions bandwidth measurements.



Peak Transmit Power (Continued)

Mode	Channel	Frequency (MHz)	Rate (Mbps)	Average Power (dBm)	Average Power (mW)	Peak Power (dBm)	Peak Power (mW)
802.11a	36	5180	6	16.27	42.36	16.61	45.81
802.11a	48	5240	6	16.28	42.46	16.68	46.56
802.11a	52	5260	6	17.15	51.88	18.30	67.61
802.11a	64	5320	6	17.11	51.40	18.22	66.37

Note: Power was measured conducted.

**CONDCUTED BAND EDGE EMISSIONS TEST RESULTS**

CLIENT:	Hewlett-Packard Company	DATE:	11/04/05
EUT:	Intel PRO/Wireless 3945ABG Network Connection	PROJECT NUMBER:	INTEL-051104
MODEL NUMBER:	WM3945ABG	TEST ENGINEER:	BM
SERIAL NUMBER:	00B11A295CVD26965002	SITE #:	2
CONFIGURATION:	Tested installed in the host computer's mini PCI slot.	TEMPERATURE:	16 C
		HUMIDITY:	64% RH
		TIME:	4:30 PM

Standard:	FCC CFR 47, Part 15.407(b)(2)
Description:	For transmitters operating in the 5.25-5.35 GHz band: all emissions outside of the 5.15-5.35 GHz band shall not exceed an EIRP of -27 dBm/MHz. Devices operating in the 5.25-5.35 GHz band that generate emissions in the 5.15-5.25 GHz band must meet all applicable technical requirements for operation in the 5.15-5.25 GHz band (including indoor use) or alternatively meet an out-of-band emission EIRP limit of -27 dBm/MHz in the 5.15-5.25 GHz band.
Results:	Passes (See Data Sheets)

Unwanted Spurious Emissions Limits

Frequency (MHz)	Field Strength (dBm/MHz) (Emissions outside the restricted bands)
5250-5350	EIRP < -27dBm/MHz (68.3dBuV/m)

<i>Freq. (MHz)</i>	<i>Power Spec Den. Reading (dBm/MHz)</i>	<i>Antenna Gain (dBi)</i>	<i>Corrected Reading (dBm/MHz)</i>	<i>Limits (dBm/MHz)</i>	<i>Diff (dB) +=FAIL</i>	<i>Comments</i>
With HP Altima Antenna Gain at 5 GHz						
5250.00	-33.50	2.84	-30.66	-27.00	-3.66	Tx @ 5240 MHz
5250.00	-32.30	2.84	-29.46	-27.00	-2.46	Tx @ 5260 MHz
With HP Jakarta 3.0 Antenna Gain at 5 GHz						
5250.00	-33.50	0.97	-32.53	-27.00	-5.53	Tx @ 5240 MHz
5250.00	-32.30	0.97	-31.33	-27.00	-4.33	Tx @ 5260 MHz



Conducted Band Edge Emissions Test Results (Continued)

Plots Showing Power Spectral Densities

<i>Test Date</i>	<i>Data</i>	<i>Test Eng.</i>
02/03/06	5.24 GHz band edge Power Spectral Density (INTEL-051104-11a3)	JC
<p>*ATTEN 20dB VAUG 100 MKR -31.83dBm RL 12.0dBm 10dB/ 5.25008GHz</p> <p>CENTER 5.25000GHz SPAN 50.00MHz *RBW 1.0MHz *VBW 1.0MHz SWP 50.0ms</p>		
<i>Test Date</i>	<i>Data</i>	<i>Test Eng.</i>
02/03/06	5.26 GHz band edge Power Spectral Density (INTEL-051104-11a4)	JC
<p>*ATTEN 20dB VAUG 100 MKR -29.17dBm RL 12.0dBm 10dB/ 5.25008GHz</p> <p>CENTER 5.25000GHz SPAN 50.00MHz *RBW 1.0MHz *VBW 1.0MHz SWP 50.0ms</p>		



26-dB EMISSIONS BANDWIDTH

CLIENT:	Hewlett-Packard Company	DATE:	09/02/05
EUT:	Intel PRO/Wireless 3945ABG Network Connection	PROJECT NUMBER:	INTEL-050901
MODEL NUMBER:	WM3945ABG	TEST ENGINEER:	JC
SERIAL NUMBER:	00B11A295CVD26965002	SITE #:	2
CONFIGURATION:	Tested installed in the host computer's mini PCI slot.	TEMPERATURE:	17 C
		HUMIDITY:	52% RH
		TIME:	9:00 AM

Standard:	FCC CFR 47, Part 15.407(a)(1) & 15.407(a)(2)
Description:	26-dB emission bandwidth in MHz
Results:	See Data Sheets



26-dB Emissions Bandwidth (Continued)

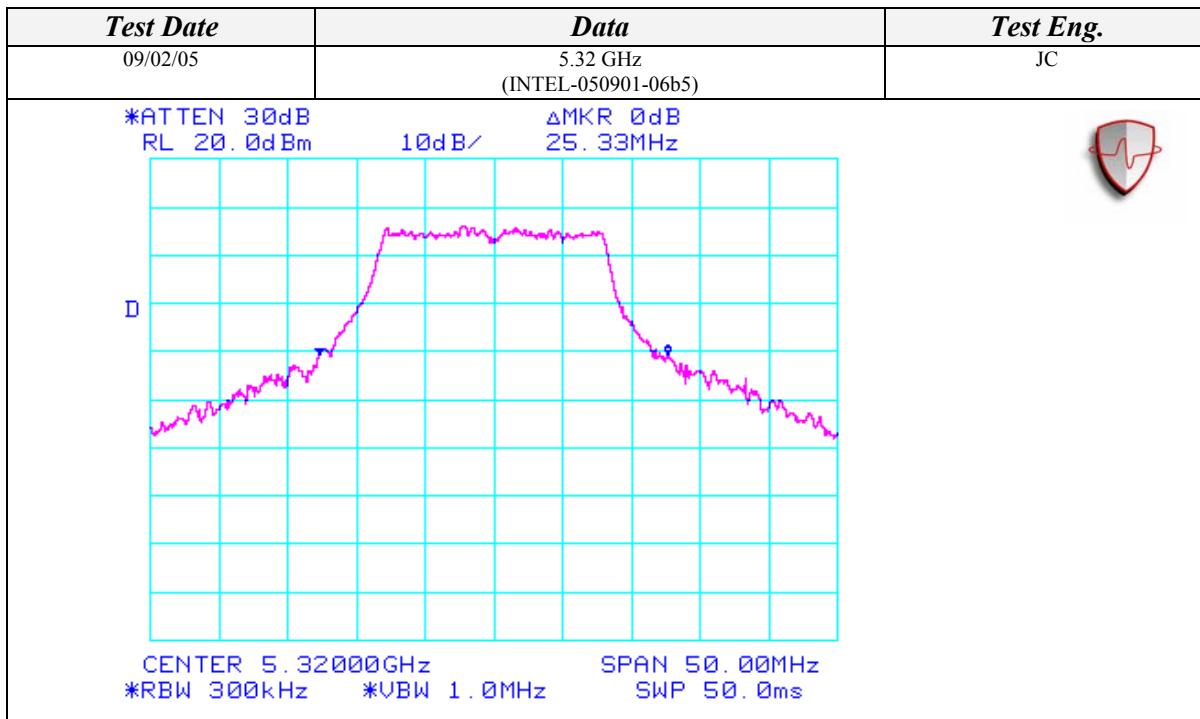

**PEAK POWER SPECTRAL DENSITY**

CLIENT:	Hewlett-Packard Company	DATE:	09/02/05
EUT:	Intel PRO/Wireless 3945ABG Network Connection	PROJECT NUMBER:	INTEL-050901
MODEL NUMBER:	WM3945ABG	TEST ENGINEER:	JC
SERIAL NUMBER:	00B11A295CVD26965002	SITE #:	2
CONFIGURATION:	Tested installed in the host computer's mini PCI slot.	TEMPERATURE:	17 C
		HUMIDITY:	52% RH
		TIME:	9:00 AM

Standard:	FCC CFR 47, Part 15.407(a)(1) & 15.407(a)(2)
Description:	For the band 5.15-5.25 GHz, the peak power spectral density shall not exceed 4 dBm in any 1-MHz band
	For the band 5.2 5-5.35 GHz, the peak power spectral density shall not exceed 11 dBm in any 1-MHz band
Results:	See Data Sheets

Peak Power Spectral Density Limits	
Frequency (MHz)	Limit (dBm)
5150-5250	4
5250-5350	11

Using "Method 2" of the FCC Public Notice (DA 02-2138)



Peak Power Spectral Density (Continued)

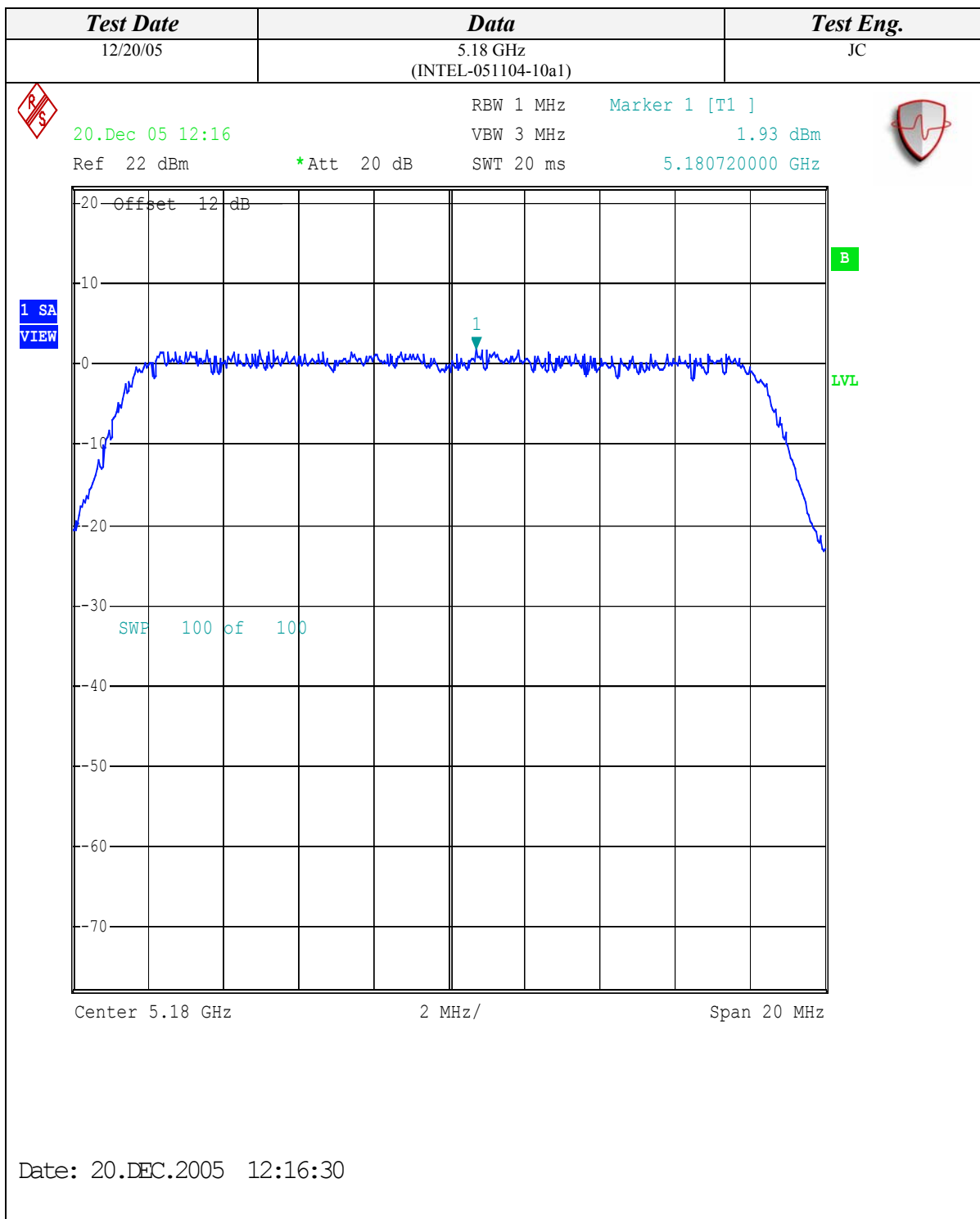



Peak Power Spectral Density (Continued)

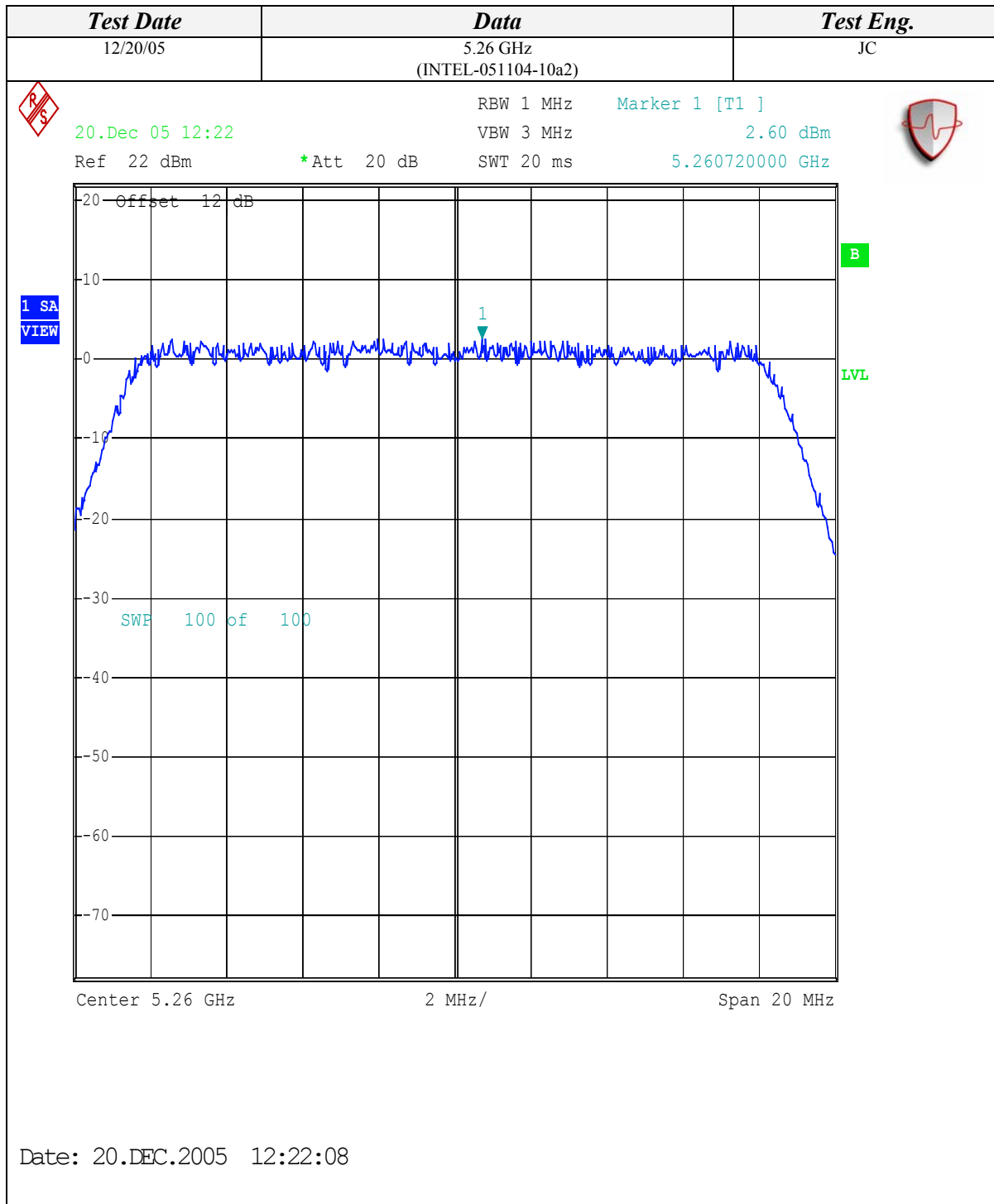



Peak Power Spectral Density (Continued)

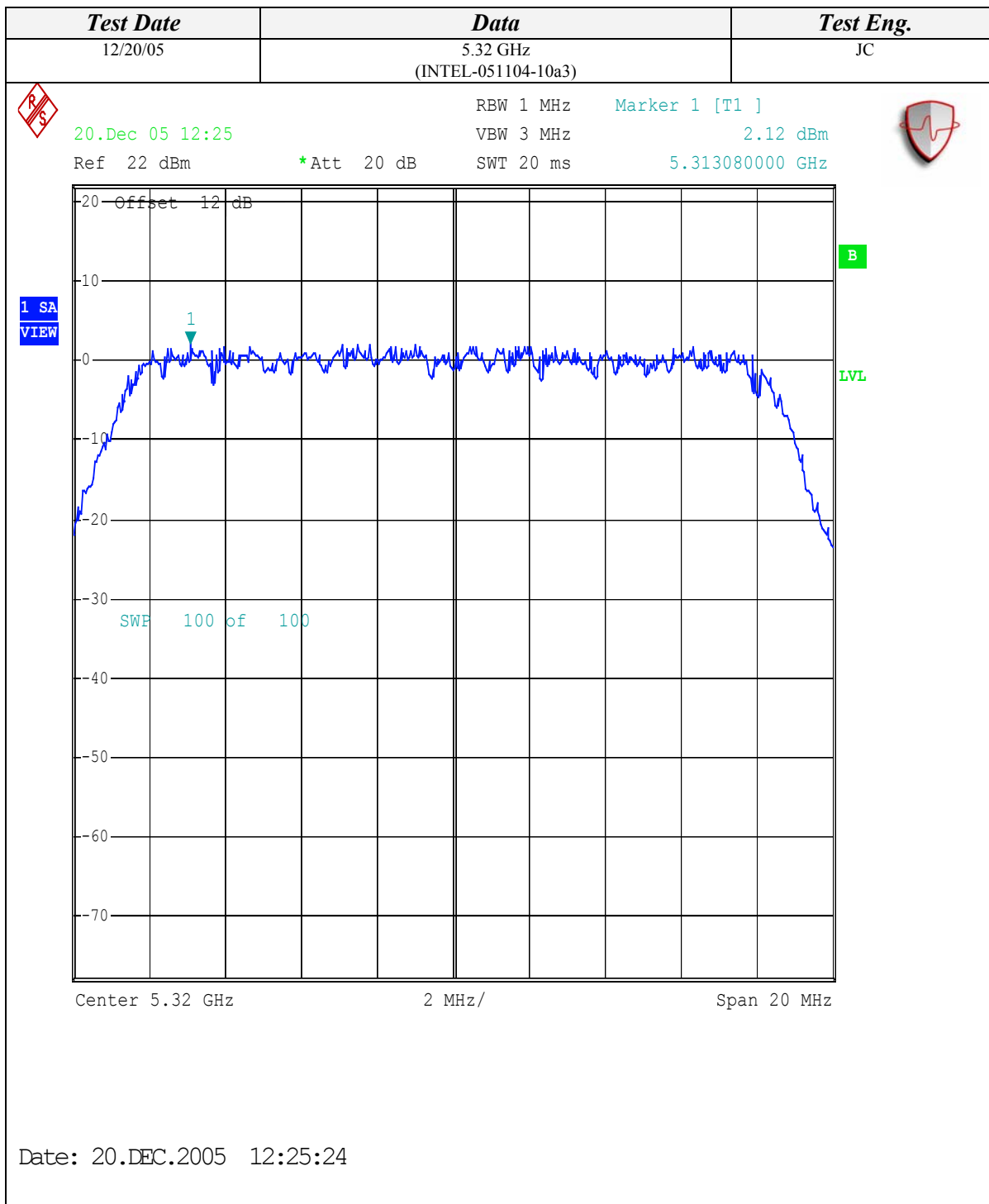



PEAK EXCURSION

CLIENT:	Hewlett-Packard Company	DATE:	09/02/05
EUT:	Intel PRO/Wireless 3945ABG Network Connection	PROJECT NUMBER:	INTEL-050901
MODEL NUMBER:	WM3945ABG	TEST ENGINEER:	JC
SERIAL NUMBER:	00B11A295CVD26965002	SITE #:	2
CONFIGURATION:	Tested installed in the host computer's mini PCI slot.	TEMPERATURE:	17 C
		HUMIDITY:	52% RH
		TIME:	9:00 AM

Standard:	FCC CFR 47, Part 15.407(a)(6)
Description:	The ratio of the peak excursion of the modulation envelope (measured using a peak hold function) to the peak transmit power shall not exceed 13 dB across any 1 MHz bandwidth or the emission bandwidth whichever is less.
Results:	See Data Sheets

Peak Excursion Limits	
Frequency (MHz)	Limit (dB)
5150-5350	13

**CONDUCTED OUT OF BAND EMISSIONS**

CLIENT:	Hewlett-Packard Company	DATE:	09/02/05
EUT:	Intel PRO/Wireless 3945ABG Network Connection	PROJECT NUMBER:	INTEL-050901
MODEL NUMBER:	WM3945ABG	TEST ENGINEER:	JC
SERIAL NUMBER:	00B11A295CVD26965002	SITE #:	2
CONFIGURATION:	Tested installed in the host computer's mini PCI slot.	TEMPERATURE:	17 C
		HUMIDITY:	52% RH
		TIME:	9:00 AM

Standard:	FCC CFR 47, Part 15.407(b)(1) and 15.407(b)(2)
Description:	For transmitters operating in the 5.15-5.25 GHz band: all emissions outside of the 5.15-5.35 GHz band shall not exceed an EIRP of -27 dBm/MHz.
	For transmitters operating in the 5.25-5.35 GHz band: all emissions outside of the 5.15-5.35 GHz band shall not exceed an EIRP of -27 dBm/MHz. Devices operating in the 5.25-5.35 GHz band that generate emissions in the 5.15-5.25 GHz band must meet all applicable technical requirements for operation in the 5.15-5.25 GHz band (including indoor use) or alternatively meet an out-of-band emission EIRP limit of -27 dBm/MHz in the 5.15-5.25 GHz band.



Conducted Out Of Band Emissions (Continued)

Test Date	Data	Test Eng.
09/02/05	5.18 GHz (INTEL-050901-06c3)	JC
<p>*ATTEN 20dB MKR -46.33dBm RL 10.0dBm 10dB/ 5.638GHz</p> <p>START 5.250GHz STOP 10.000GHz *RBW 1.0MHz *VBW 1.0MHz SWP 95.0ms</p>		
Test Date	Data	Test Eng.
09/02/05	5.18 GHz (INTEL-050901-06c4)	JC
<p>*ATTEN 20dB MKR -50.50dBm RL 10.0dBm 10dB/ 13.45GHz</p> <p>START 10.00GHz STOP 20.00GHz *RBW 1.0MHz *VBW 1.0MHz SWP 200ms</p>		

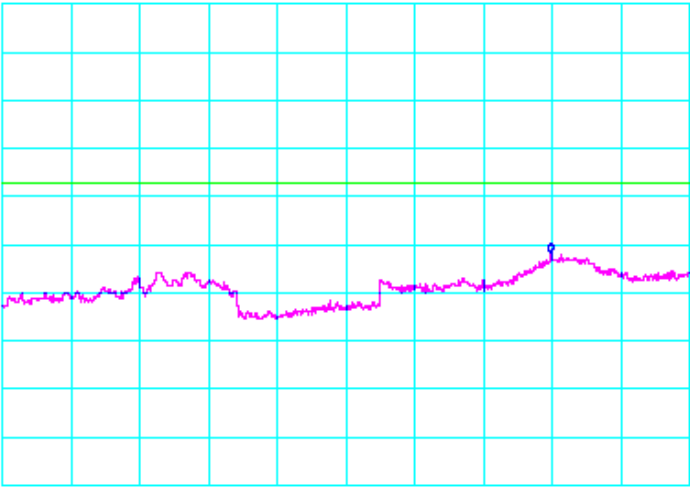
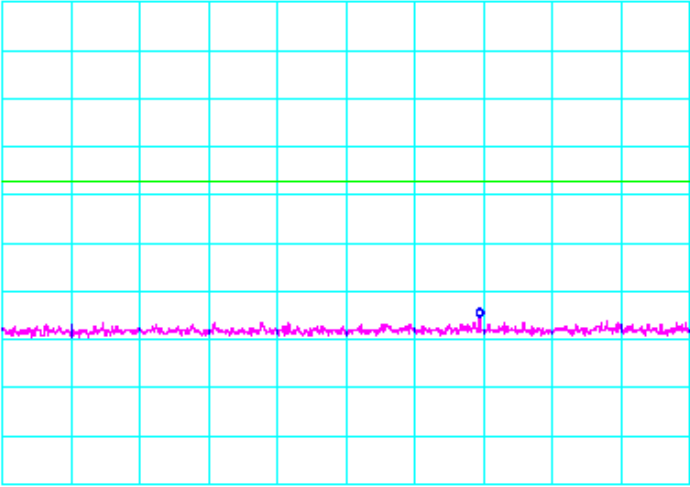

Conducted Out Of Band Emissions (Continued)

Test Date	Data	Test Eng.
09/02/05	5.18 GHz (INTEL-050901-06c5)	JC
<p>*ATTEN 20dB MKR -41.67dBm RL 10.0dBm 10dB/ 35.97GHz</p>  <p>START 20.00GHz STOP 40.00GHz *RBW 1.0MHz *UBW 1.0MHz SWP 400ms</p>		
Test Date	Data	Test Eng.
07/28/05	5.26 GHz (INTEL-050721-26c3)	JC
<p>*ATTEN 20dB MKR -55.50dBm RL 10.0dBm 10dB/ 704.2MHz</p>  <p>START 30.0MHz STOP 1.0000GHz *RBW 1.0MHz *UBW 1.0MHz SWP 50.0ms</p>		

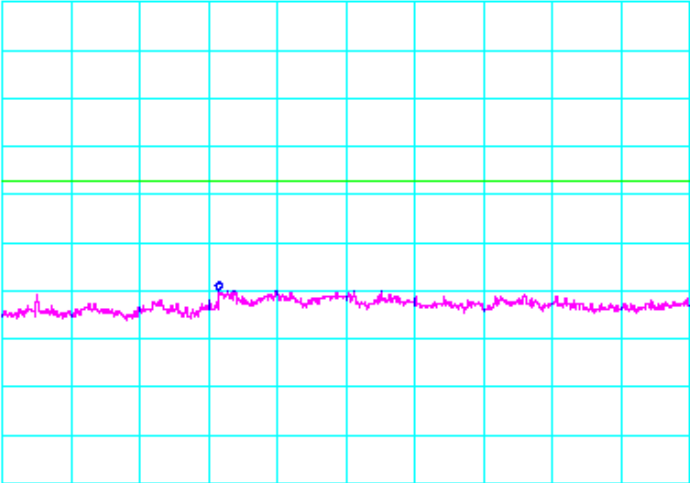
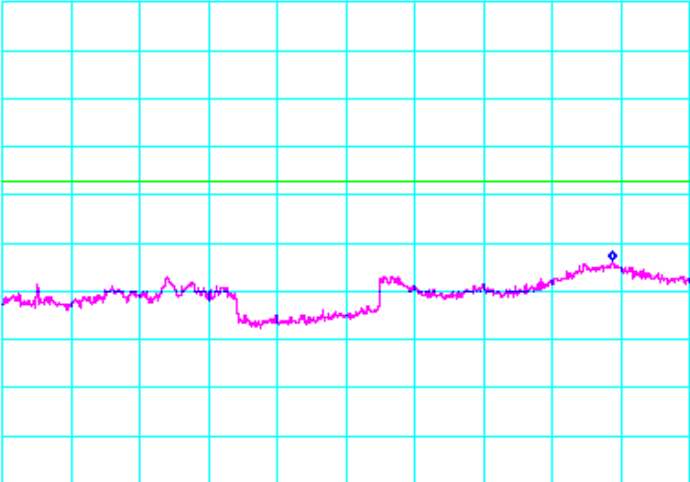

Conducted Out Of Band Emissions (Continued)

Test Date	Data	Test Eng.
07/28/05	5.26 GHz (INTEL-050721-26c6)	JC
*ATTEN 20dB MKR -50.00dBm RL 10.0dBm 10dB/ 13.15GHz		
		
START 10.00GHz STOP 20.00GHz *RBW 1.0MHz *UBW 1.0MHz SWP 200ms		
Test Date	Data	Test Eng.
07/28/05	5.26 GHz (INTEL-050721-26c7)	JC
*ATTEN 20dB MKR -43.67dBm RL 10.0dBm 10dB/ 37.77GHz		
		
START 20.00GHz STOP 40.00GHz *RBW 1.0MHz *UBW 1.0MHz SWP 400ms		



Conducted Out Of Band Emissions (Continued)

<i>Test Date</i>	<i>Data</i>	<i>Test Eng.</i>
09/02/05	5.32 GHz (INTEL-050901-06c13)	JC
<p>*ATTEN 20dB MKR -36.67dBm RL 10.0dBm 10dB/ 5.350GHz</p> <p>START 5.350GHz STOP 10.000GHz *RBW 1.0MHz *VBW 1.0MHz SWP 93.0ms</p>		
<i>Test Date</i>	<i>Data</i>	<i>Test Eng.</i>
09/02/05	5.32 GHz (INTEL-050901-06c14)	JC
<p>*ATTEN 20dB MKR -49.50dBm RL 10.0dBm 10dB/ 10.63GHz</p> <p>START 10.00GHz STOP 20.00GHz *RBW 1.0MHz *VBW 1.0MHz SWP 200ms</p>		



Conducted Out Of Band Emissions (Continued)

