

TEST REPORT

EUT Description	WLAN and BT, 2x2 PCIe M.2 1216 SD adapter card
Brand Name	Intel® Wi-Fi 6 AX201
Model Name	AX201D2W
FCC ID	PD9AX201D2
ISED ID	1000M-AX201D2
Date of Test Start/End	2018-08-22 / 2018-10-03
Features	802.11ax, Dual Band, 2x2 Wi-Fi + Bluetooth® 5 (see section 5)

Applicant	Intel Mobile Communications
Address	100 Center Point Circle, Suite 200 Columbia, South Carolina 29210 USA
Contact Person	Steven Hackett
Telephone/Fax/ Email	steven.c.hackett@intel.com

Reference Standards	FCC CFR Title 47 Part 15 E RSS-247 issue 2, RSS-Gen issue 5 (see section 1)
---------------------	---

Test Report identification	180717-03.TR02
Revision Control	Rev. 00 This test report revision replaces any previous test report revision (see section 8)

The test results relate only to the samples tested.
The test report shall not be reproduced in full, without written approval of the laboratory.

Issued by _____ Reviewed by _____

Gregory ROUSTAN
(Test Engineer Lead)

Cheiel IN
(Technical Manager)

Intel Mobile Communications France S.A.S – WRF Lab
425 rue de Goa – Le Cargo B6 - 06600, Antibes, France
Tel. +33493001400 / Fax +33493001401

Table of Contents

1. Standards, reference documents and applicable test methods	3
2. General conditions, competences and guarantees	3
3. Environmental Conditions	3
4. Test samples	4
5. EUT Features	4
6. Remarks and comments	4
7. Test Verdicts summary	5
7.1. 802.11 A/N/AC/AX – U-NII-2C	5
8. Document Revision History	5
Annex A. Test & System Description	6
A.1 MEASUREMENT SYSTEM	6
A.2 TEST EQUIPMENT LIST	8
A.3 MEASUREMENT UNCERTAINTY EVALUATION	9
Annex B. Test Results U-NII-2C	10
B.1 TEST CONDITIONS	10
B.2 TEST RESULTS TABLES	12
B.2.1 26dB & 99% Bandwidth	12
B.2.2 Power Limits. Maximum Output power & Maximum power spectral Density	17
B.2.3 Undesirable emission limits : Band Edge (Conducted)	33
B.2.4 Radiated spurious emission	35
B.3 TEST RESULTS SCREENSHOTS	61
B.3.1 26dB Bandwidth	61
B.3.2 99% Bandwidth	76
B.3.3 Maximum Output Power & Maximum power spectral Density	92
B.3.4 Maximum output power & Maximum power spectral Density (Overlapped Channel)	129
B.3.5 Undesirable emission limits : Band Edge (Conducted)	141
Annex C. Photographs	175
C.1 TEST SETUP	175
C.2 TEST SAMPLE	177

1. Standards, reference documents and applicable test methods

1. FCC 47 CFR part 15 – Subpart E – Unlicensed National Information Infrastructure Devices.
2. FCC 47 CFR part 15 - Subpart C – §15.209 Radiated emission limits; general requirements.
3. FCC OET KDB 789033 D02 General U-NII Test Procedures New Rules v02r01 – Guidelines for compliance testing of Unlicensed National Information Infrastructure (U-NII) Devices (Part 15, Subpart E)
4. ANSI C63.10-2013 American National Standard of Procedures for Compliance Testing of Unlicensed Wireless Devices.
5. RSS-247 Issue 2 - Digital Transmission Systems (DTSs), Frequency Hopping Systems (FHSs) and Licence-Exempt Local Area Network (LE-LAN) Devices.
6. RSS-Gen Issue 5 - General Requirements for Compliance of Radio Apparatus.

2. General conditions, competences and guarantees

- ✓ Intel Mobile Communications France SAS Wireless RF Lab (Intel WRF Lab) is an ISO/IEC 17025:2005 testing laboratory accredited by the American Association for Laboratory Accreditation (A2LA) with the certificate number 3478.01.
- ✓ Intel Mobile Communications France SAS Wireless RF Lab (Intel WRF Lab) is an Accredited Test Firm recognized by the FCC, with Designation Number FR0011.
- ✓ Intel Mobile Communications France SAS Wireless RF Lab (Intel WRF Lab) is a Registered Test Site listed by ISED, with ISED Assigned Code 1000Y.
- ✓ Intel WRF Lab only provides testing services and is committed to providing reliable, unbiased test results and interpretations.
- ✓ Intel WRF Lab is liable to the client for the maintenance of the confidentiality of all information related to the item under test and the results of the test.
- ✓ Intel WRF Lab has developed calibration and proficiency programs for its measurement equipment to ensure correlated and reliable results to its customers.
- ✓ This report is only referred to the item that has undergone the test.
- ✓ This report does not imply an approval of the product by the Certification Bodies or competent Authorities.

3. Environmental Conditions

- ✓ At the site where the measurements were performed the following limits were not exceeded during the tests:

Temperature	24 °C ±2°C
Humidity	60 % ± 5 %

4. Test samples

Sample	Control #	Description	Model	Serial #	Date of receipt	Note
#1	180717-03.S04	RF MODULE	AX201D2W	WFM : 3413E8C8F81B	2018-08-17	Used for conducted tests
	180717-03.S13	EXTENDER	PCB00651_01	6510818-131	2018-08-21	
	180000-01.S04	ADAPTER	JFP ADAPTER M2	-	2017-04-10	
	170000-01.S01	LAPTOP	LATITUDE E5470	DBLMC2	2017-03-28	
#2	180717-03.S06	RF MODULE	AX201D2W	WFM : 3413E8C8EBC3	2018-08-17	Radiated Spurious emission from 30 MHz to 6.4 GHz
	180326-01.S03	EXTENDER	PCB00651_01	6510818-198	2018-03-27	
	180000-01.S02	ADAPTER	JFP ADAPTER M2	-	2017-08-09	
	170209-01.S16	LAPTOP	LATITUDE E7470	C1HTPF2	2017-02-09	
#3	180717-03.S11	RF MODULE	AX201D2W	WFM : 3413E8C8EBFA	2018-08-17	Radiated Spurious emission from 6.4 GHz to 40 GHz
	180717-03.S18	EXTENDER	PCB00651_01	6510817-133	2018-08-21	
	180000-01.S06	ADAPTER	JFP ADAPTER M2	-	2018-08-20	
	170801-01.S10	LAPTOP	LATITUDE E7470	7KNOXF2	2017-09-07	
#4	180717-03.S08	RF MODULE	AX201D2W	WFM : 3413E8C8F89D	2018-08-17	Radiated Spurious emission from 6.4 GHz to 40 GHz
	180717-03.S18	EXTENDER	PCB00651_01	6510817-133	2018-08-21	
	180000-01.S06	ADAPTER	JFP ADAPTER M2	-	2018-08-20	
	170801-01.S10	LAPTOP	LATITUDE E7470	7KNOXF2	2017-09-07	

5. EUT Features

Brand Name	Intel® Wi-Fi 6 AX201
Model Name	AX201D2W
FCC ID	PD9AX201D2
ISED ID	1000M-AX201D2
Software Version	OEM DRTU_08048_11_1832_0G
Driver Version	99.0.39.1 (V010.16.t64)
Prototype / Production	Production
Supported Radios	802.11b/g/n/ax 2.4GHz (2400.0 – 2483.5 MHz) 802.11a/n/ac/ax 5.2GHz (5150.0 – 5350.0 MHz) 5.6GHz (5470.0 – 5725.0 MHz) 5.8GHz (5725.0 – 5850.0 MHz) Bluetooth 5 2.4GHz (2400.0 – 2483.5 MHz)
Antenna Information	CHAIN A: PIFA antenna. WiFi 2.4GHz & 5GHz and BT CHAIN B: PIFA antenna. WiFi 2.4GHz & 5GHz
Additional Information	

6. Remarks and comments

N/A

7. Test Verdicts summary

7.1. 802.11 a/n/ac/ax – U-NII-2C

FCC part	RSS part	Test name	Verdict
15.407 (a) (2)	RSS-247 Clause 6.2.3.1	Power Limits. Maximum output power	P
15.407 (a) (2)	RSS-247 Clause 6.2.3.1	Peak power spectral density	P
15.407 (b) (3) 15.209 (a)	RSS-247 Clause 6.2.3.2 RSS-GEN Clause 8.9	Undesirable emissions limits: Band Edge (conducted)	P
15.407 (b) (3) 15.209 (a)	RSS-247 Clause 6.2.3.2 RSS-GEN Clause 8.9	Undesirable emissions limits (radiated)	P

8. Document Revision History

Revision #	Date	Modified by	Revision Details
Rev. 00	2018-10-03	M.Lefebvre F. Nsengiyumva	First Issue

Annex A. Test & System Description

A.1 Measurement System

Measurements were performed using the following setups, made in accordance to the general provisions of FCC KDB 789033 D02 General UNII Test Procedures.

The DUT was installed in a test fixture and this test fixture is connected to a laptop computer and AC/DC power adapter. The laptop computer was used to configure the EUT to continuously transmit at a specified output power using all different modes and modulation schemes, using the Intel proprietary tool DRTU.

Conducted Setup

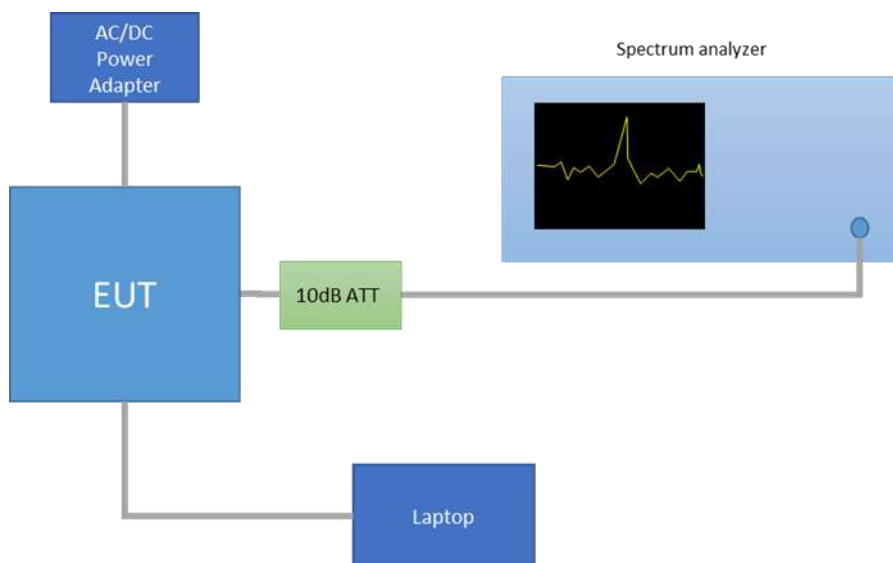

Radiated Setup 30 MHz - 1GHz

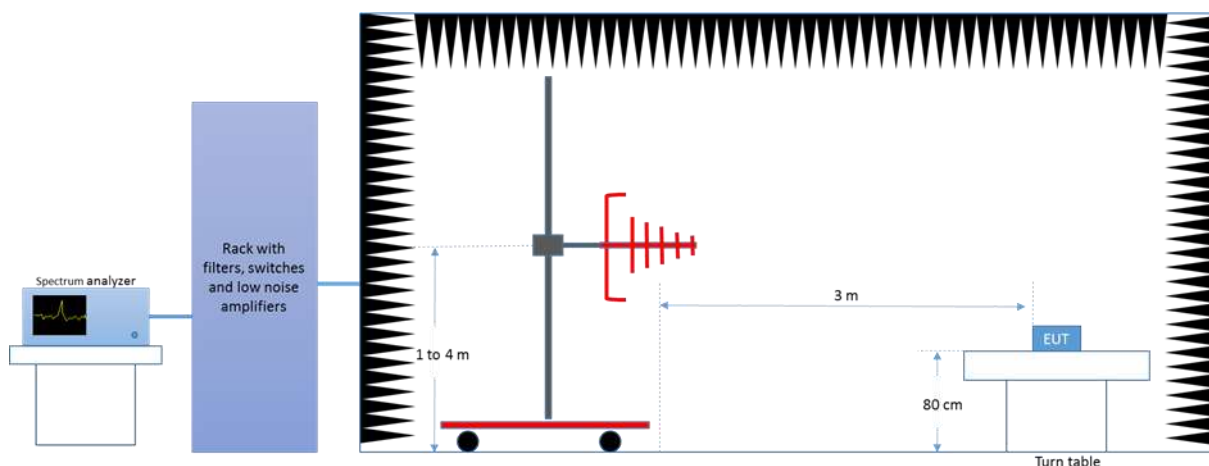

Radiated Setup 1 GHz – 6.4 GHz

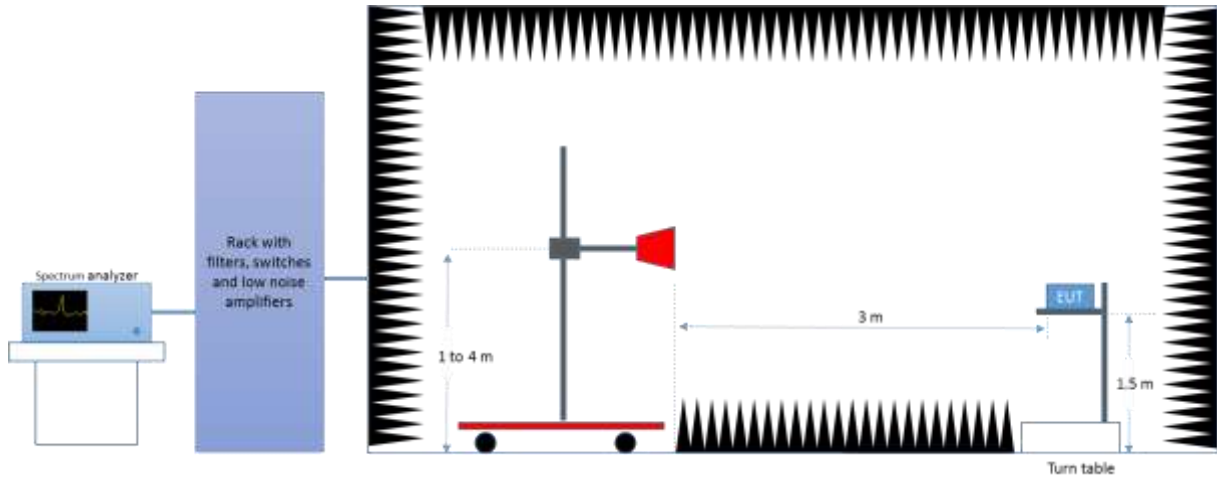

Radiated Setup 6.4 GHz – 18 GHz

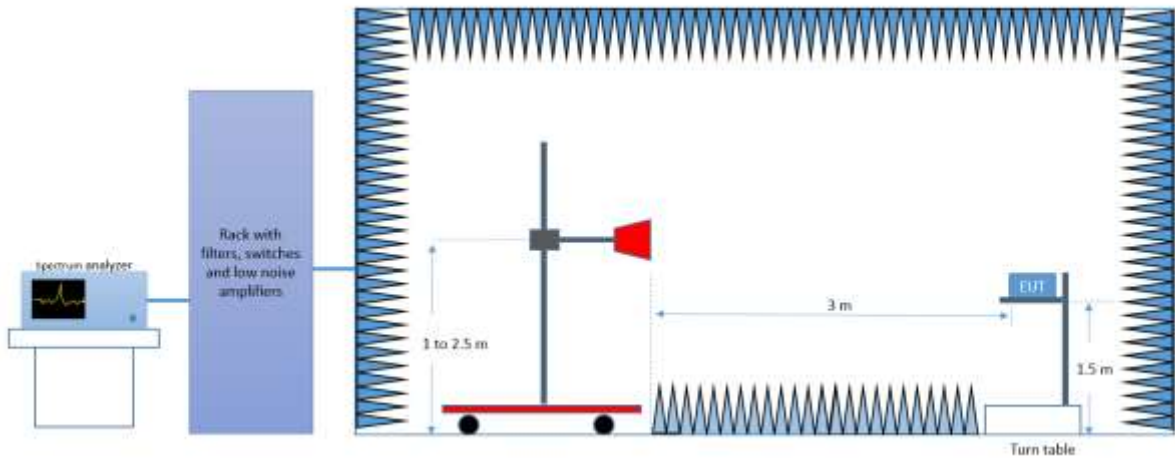

Radiated Setup 18 GHz – 40 GHz

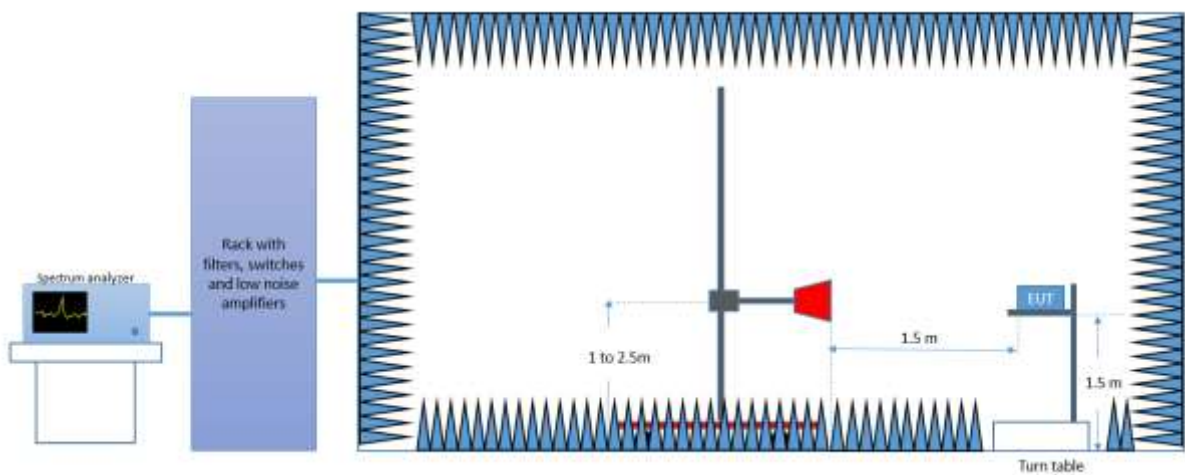

A.2 Test Equipment List

Conducted Setup

ID#	Device	Type/Model	Serial #	Manufacturer	Cal. Date	Cal. Due Date
0315	Spectrum analyzer	FSV30	103307	Rohde & Schwarz	2018-04-10	2020-04-10

Radiated Setup-1

ID#	Device	Type/Model	Serial #	Manufacturer	Cal. Date	Cal. Due Date
0420	Spectrum analyzer	FSV40	101556	Rohde & Schwarz	2018-05-17	2020-05-17
0137	Log antenna 30 MHz – 1 GHz	3142E	00156946	ETS Lindgren	2017-12-19	2019-12-19
0325	Double Ridged Horn Antenna 1 GHz – 18 GHz	3117	00157734	ETS Lindgren	2017-08-22	2019-08-22
0135	Semi Anechoic chamber	FACT 3	5720	ETS Lindgren	2018-04-18	2020-04-18
0530	Measurement Software	EMC32	100623	Rohde & Schwarz	N/A	N/A

N/A: Not Applicable

Radiated Setup-2

ID#	Device	Type/Model	Serial #	Manufacturer	Cal. Date	Cal. Due Date
0133	Spectrum analyzer	FSV40	101358	Rohde & Schwarz	2018-04-11	2020-04-11
0141	Double Ridged Horn Antenna 1 GHz – 18 GHz	3117	00157736	ETS Lindgren	2018-05-11	2020-05-11
0334	Double Ridged Horn Antenna 18 GHz – 40 GHz	3116C-PA	00196308	ETS Lindgren	2017-08-22	2019-08-22
0337	Full Anechoic chamber	RFD_FA_100	5996	ETS Lindgren	2018-04-17	2020-04-17
0329	Measurement Software	EMC32	100401	Rohde & Schwarz	N/A	N/A

N/A: Not Applicable

Radiated Setup - shared equipments

ID#	Device	Type/Model	Serial #	Manufacturer	Cal. Date	Cal. Due Date
0617	Power Sensor 50MHz-18GHz	NRP-Z81	104386	Rohde & Schwarz	2018-04-16	2020-04-16
0618	Power Sensor 50MHz-18GHz	NRP-Z81	104382	Rohde & Schwarz	2018-04-16	2020-04-16

A.3 Measurement Uncertainty Evaluation

The system uncertainty evaluation is shown in the below table:

Measurement type	Uncertainty [±dB]
Conducted Power	±1.0
Conducted Spurious Emission	±2.9
Radiated tests <1GHz	±3.8
Radiated tests 1GHz - 40 GHz	±4.7

Annex B. Test Results U-NII-2C

B.1 Test Conditions

For 802.11a mode the EUT can transmit at both CHAIN A and CHAIN B RF outputs individually, but not simultaneously.

For 802.11n20 & 802.11ax20 (20 MHz channel bandwidth), 802.11n40 & 802.11ax40 (40MHz channel bandwidth), 802.11ac80 & 802.11ax80 (80MHz channel bandwidth) and 802.11ac160 & 802.11ax160 (160MHz channel bandwidth) modes the EUT can transmit at both CHAIN A and CHAIN B RF outputs individually, and also simultaneously.

The conducted RF output power for each chain was adjusted according to the client's supplied Target values (see following table) using the Intel DRTU tool and measuring the power by using a spectrum analyser with the channel integration method according to section II) E) 2) e) (Method SA-2 Alternative) of Guidance 789033 D02.

Measured values for adjustment were within +/- 0.25 dB from the declared Target values.

U-NII-2C

					Conducted Power, Target Value (dBm)		
Mode	BW (MHz)	Data Rate	CH #	Freq. (MHz)	SISO Chain A	SISO Chain B	MIMO at both ports A and B
802.11a	20	6Mbps	100	5500	19.00	19.50	-
			120	5600	21.50	21.50	-
			140	5700	18.50	18.00	-
802.11n	20	HT0 HT8*	100	5500	19.00	19.00	19.00
			120	5600	21.50	21.50	21.50
			140	5700	18.00	18.00	18.00
	40	HT0 HT8*	102F	5510	18.50	18.50	18.00
			118F	5590	21.50	21.50	21.50
			134F	5670	19.50	19.50	21.00
802.11ac	80	VHT0	106ac80	5530	19.00	19.00	19.00
			122ac80	5610	20.00	20.00	21.00
802.11ac	160	VHT0	114ac160	5570	14.50	14.50	14.50
802.11ax	20	HE0	100	5500	19.00	19.00	19.00
			120	5600	21.00	21.00	21.00
			140	5700	17.50	18.00	18.00
	40		102F	5510	18.50	18.50	18.00
			118F	5590	21.00	21.50	21.00
			134F	5670	19.00	19.00	20.50
802.11ax	80	106ax80	5530	19.00	19.00	19.00	
		122ax80	5610	19.50	19.50	21.50	
802.11ax	160		114ax160	5570	14.50	14.50	14.50

Overlapped channels between UNII-2C and UNII-3					Conducted Power, Target Value (dBm)		
Mode	BW (MHz)	Data Rate	CH #	Freq. (MHz)	SISO Chain A	SISO Chain B	MIMO at both ports A and B
802.11n	20	HT0 HT8*	144	5720	20.50	20.50	21.50
	40	HT0 HT8*	142F	5710	20.50	20.50	22.00
802.11ac	80	VHT0	138ac80	5690	21.00	20.50	21.50
802.11ax	20	HE0	144	5720	21.00	21.00	21.50
	40		142F	5710	20.50	21.00	22.00
	80		138ax80	5690	21.00	21.00	22.00

* Note: HT8 for MIMO modes only

The following data rates were selected based on preliminary testing that identified those rates as the worst cases for output power and spurious levels at the band edges:

- 802.11a → 6Mbps
- 802.11n20 and 802.11n40 (SISO) → HT0
- 802.11n20 and 802.11n40 (MIMO) → HT8
- 802.11ac80 (SISO) → VHT0
- 802.11ac80 (MIMO) → VHT0
- 802.11ac160 (SISO) → VHT0
- 802.11ac160 (MIMO) → VHT0
- 802.11ax20 and 802.11ax40 (SISO) → HE0
- 802.11ax20 and 802.11ax40 (MIMO) → HE0
- 802.11ax80 (SISO) → HE0
- 802.11ax80 (MIMO) → HE0
- 802.11ax160 (SISO) → HE0
- 802.11ax160 (MIMO) → HE0

Alternative channels to the lowest and highest channels per band have been also tested for Band Edge compliance.

B.2 Test Results Tables

B.2.1 26dB & 99% Bandwidth

Test procedure

The setup below was used to measure the 26dB & 99% Bandwidth. The antenna terminal of the EUT is connected to the spectrum analyzer through an attenuator, and the spectrum analyzer reading is compensated to include the RF path loss.

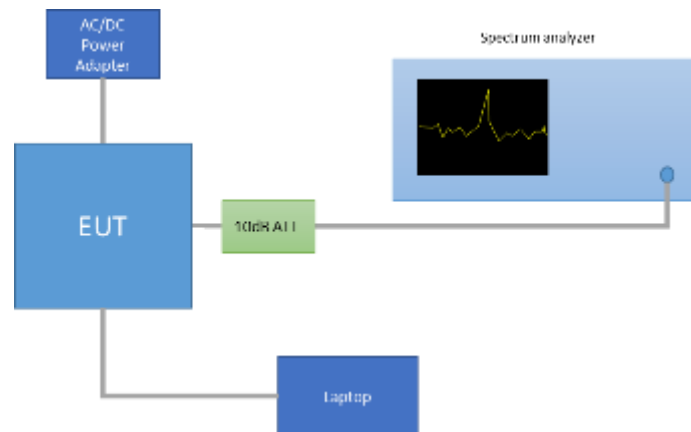

For the overlapped channels between U-NII-2C and U-NII-3 bands, and according to FCC KDB 789033 D02 v02r01, the boundary frequency between the bands is used as one edge for defining the portion of the 26dB bandwidth that falls within a particular U-NII band. This rule is only applicable for the 26dB bandwidth and for those channels marked as overlapped.

Results tables
U-NII-2C channels

Mode	Rate	Antenna	Channel	Freq. [MHz]	26dB BW [MHz]	99% BW [MHz]
802.11a	6Mbps	SISO-A	100	5500	24.85	16.80
			120	5600	29.73	18.08
			140	5700	24.73	16.92
		SISO-B	100	5500	24.42	16.92
			120	5600	28.73	18.08
			140	5700	24.62	16.88
802.11n20	HT0	SISO-A	100	5500	25.38	17.96
			120	5600	30.83	18.88
			140	5700	25.08	18.00
		SISO-B	100	5500	24.82	18.00
			120	5600	29.68	18.76
			140	5700	24.95	17.96
	HT8	MIMO-A	100	5500	25.33	18.00
			120	5600	25.83	18.04
			140	5700	25.38	17.96
		MIMO-B	100	5500	24.87	17.92
			120	5600	25.37	17.96
			140	5700	24.82	17.96
802.11n40	HT0	SISO-A	102F	36.40	45.05	36.64
			118F	36.88	63.78	37.36
			134F	36.32	45.77	36.72
		SISO-B	102F	5510	44.41	36.64
			118F	5590	52.25	37.04
			134F	5670	45.23	36.72
	HT8	MIMO-A	102F	5510	45.49	36.64
			118F	5590	45.41	36.72
			134F	5670	45.77	36.64
		MIMO-B	102F	5510	44.86	36.40
			118F	5590	43.78	36.40
			134F	5670	44.23	36.40
802.11ac80	VHT0	SISO-A	106ac80	5530	88.25	75.24
			122ac80	5610	89.01	75.12
		SISO-B	106ac80	5530	86.54	75.12
			122ac80	5610	89.01	75.24
		MIMO-A	106ac80	5530	87.29	75.12
			122ac80	5610	86.73	75.24
		MIMO-B	106ac80	5530	87.11	75.00
			122ac80	5610	87.49	75.00
802.11ac160	VHT0	SISO-A	114ac160	5570	164.41	153.00
		SISO-B	114ac160	5570	165.95	153.20
		MIMO-A	114ac160	5570	165.17	153.00
		MIMO-B	114ac160	5570	165.17	153.00

Mode	Rate	Antenna	Channel	Freq. [MHz]	26dB BW [MHz]	99% BW [MHz]
802.11ax20	HE0	SISO-A	100	5500	23.97	19.16
			120	5600	27.38	19.28
			140	5700	23.92	19.12
		SISO-B	100	5500	25.03	19.12
			120	5600	26.48	19.24
			140	5700	24.17	19.08
		MIMO-A	100	5500	24.92	19.12
			120	5600	24.57	19.08
			140	5700	24.87	19.12
		MIMO-B	100	5500	24.17	19.12
			120	5600	24.67	19.08
			140	5700	24.57	19.08
802.11ax40	HE0	SISO-A	102F	36.40	44.41	37.84
			118F	36.88	51.35	38.16
			134F	36.32	43.87	37.92
		SISO-B	102F	5510	44.50	37.92
			118F	5590	48.92	38.00
			134F	5670	43.42	37.92
		MIMO-A	102F	5510	44.68	37.84
			118F	5590	44.86	37.84
			134F	5670	44.77	37.92
		MIMO-B	102F	5510	44.05	37.84
			118F	5590	44.96	38.00
			134F	5670	44.86	37.92
802.11ax80	HE0	SISO-A	106ax80	5530	84.06	76.68
			122ax80	5610	84.25	76.80
		SISO-B	106ax80	5530	83.87	76.80
			122ax80	5610	84.64	76.80
		MIMO-A	106ax80	5530	84.44	76.80
			122ax80	5610	84.83	76.80
MIMO-B	106ax80	5530	83.64	76.68		
	122ax80	5610	83.68	76.68		
802.11ax160	HE0	SISO-A	114ax160	5570	164.17	154.60
		SISO-B	114ax160	5570	163.84	154.60
		MIMO-A	114ax160	5570	163.18	154.60
		MIMO-B	114ax160	5570	163.18	154.80

Mode	Rate	Antenna	Channel	Frequency [MHz]	RU Configuration	26dB BW [MHz]	99% BW [MHz]	
802.11ax20	HE0	SISO-A	100	5500	26/0	20.67	18.56	
					52/37	21.54	18.40	
					106/53	21.87	18.24	
		SISO-B			26/0	20.62	18.60	
					52/37	21.42	18.40	
					106/53	21.77	18.32	
		MIMO-A			26/0	20.52	18.48	
					52/37	20.72	18.36	
	106/53		20.97	18.32				
	MIMO-B	26/0	20.32	18.32				
		52/37	20.52	18.16				
		106/53	22.17	18.28				
	HE0	SISO-A	140	5700	26/8	20.87	18.56	
					52/40	22.12	18.44	
					106/54	23.12	18.32	
		SISO-B			26/8	21.07	18.56	
52/40					21.92	18.48		
106/54					22.97	18.32		
MIMO-A		26/8			13.12	18.32		
		52/40			21.27	18.40		
	106/54	23.77	18.28					
MIMO-B	26/8	20.42	18.32					
	52/40	20.37	18.20					
	106/54	23.22	18.20					
802.11ax40	HE0	SISO-A	102F	5510	242/61	24.68	19.12	
		SISO-B			242/61	25.05	19.20	
		MIMO-A			242/61	28.37	19.36	
		MIMO-B			242/61	25.05	19.20	
	HE0	SISO-A	134F	5670	242/62	26.13	19.28	
					SISO-B	242/62	25.32	19.12
					MIMO-B	242/62	28.11	19.28
					MIMO-A	242/62	28.38	19.20
802.11ax80	HE0	106ax80	5530	SISO-A	484/65	44.31	37.92	
				SISO-B	484/65	45.08	38.04	
				MIMO-A	484/65	45.08	38.04	
				MIMO-B	484/65	58.77	38.40	
802.11ax160	HE0	SISO-A	114ax160	5570	996/67	86.22	77.00	
					996/S67	84.89	76.80	
					996/67	85.89	76.80	
					996/S67	86.55	77.00	
	HE0	MIMO-A			996/67	85.56	76.80	
					MIMO-B	996/67	85.89	76.80
					MIMO-A	996/S67	86.22	77.00
					MIMO-B	996/S67	84.89	77.00

Max Value

Overlapped channels between U-NII-2C and U-NII-3

Mode	Rate	Antenna	Channel	Freq. [MHz]	26dB BW UNII-2C [MHz]
802.11n20	HT0	SISO-A	144	5720	17.82
		SISO-B			17.62
	HT8	MIMO-A			17.47
		MIMO-B			17.47
802.11n40	HT0	SISO-A	142F	5710	38.27
		SISO-B			38.27
	HT8	MIMO-A			37.99
		MIMO-B			36.73
802.11ac80	VHT0	SISO-A	138ac80	5690	79.93
		SISO-B			78.98
		MIMO-A			78.60
		MIMO-B			78.41
802.11ax20	HE0	SISO-A	144	5720	17.72
		SISO-B			17.57
		MIMO-A			17.47
		MIMO-B			17.42
802.11ax40	HE0	SISO-A	142F	5710	37.09
		SISO-B			37.73
		MIMO-A			37.09
		MIMO-B			37.00
802.11ax80	HE0	SISO-A	138ax80	5690	77.27
		SISO-B			77.08
		MIMO-A			76.51
		MIMO-B			76.89

Max Value

See Section B.3.1 and Section B.3.2 for the screenshot results.

B.2.2 Power Limits. Maximum Output power & Maximum power spectral Density

Test limits

Part	Limits
FCC 15.407 (a) (2)	For the 5.25–5.35 GHz and 5.47–5.725 GHz bands, the maximum conducted output power over the frequency bands of operation shall not exceed the lesser of 250 mW or $11 \text{ dBm} + 10 \log B$, where B is the 26 dB emission bandwidth in megahertz. In addition, the peak power spectral density shall not exceed 11 dBm in any 1 megahertz band.
RSS-247 Clause 6.2.3 (1)	The maximum conducted output power shall not exceed 250 mW or $11 + 10 \log_{10} B$, dBm, whichever is less. The power spectral density shall not exceed 11 dBm in any 1.0 MHz band. The maximum e.i.r.p. shall not exceed 1.0 W or $17 + 10 \log_{10} B$, dBm, whichever is less. B is the 99% emission bandwidth in megahertz. Note that devices with a maximum e.i.r.p. greater than 500 mW shall implement TPC in order to have the capability to operate at least 6 dB below the maximum permitted e.i.r.p. of 1 W.

Test procedure

The Maximum Conducted Output Power was measured using the channel integration method according to section E) 2) e) (Method SA-2 Alternative) of KDB 789033 D02.

The maximum power spectral density (PSD) was measured using the method according to section F) (Method SA-2 Alternative) of KDB 789033 D02.

In the measure-and-sum approach for MIMO mode, the conducted emission level (e.g., transmit power or power in specified bandwidth) is measured at each antenna port. The measured results at the various antenna ports are then summed mathematically in linear power units to determine the total emission level from the device.

The EIRP power (dBm) is calculated by adding the declared maximum antenna gain to the measured conducted power.

The setup below was used to measure the maximum conducted output power and power spectral density. The antenna terminal of the EUT is connected to the spectrum analyser through an attenuator, and the spectrum analyzer reading is compensated to include the RF path loss.

The declared maximum antenna gain is 5dBi.

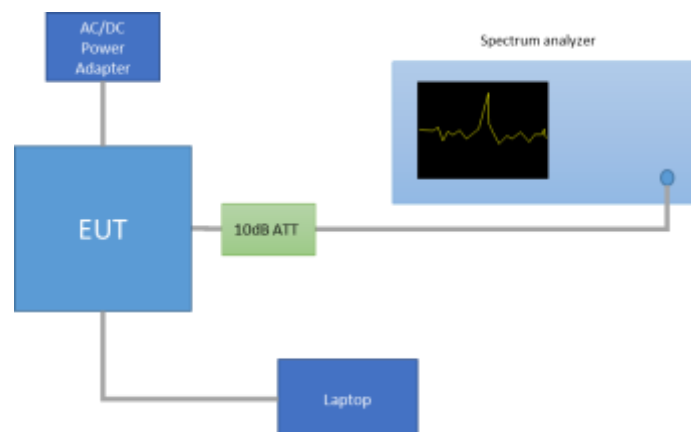

For the overlapped channels between U-NII-2C and U-NII-3, and according to FCC KDB 789033 D02 v02r01, the power is computed based on the portion of the emission bandwidth contained within that band. This rule is only applicable for those channels marked as overlapped

Results tables
Duty cycle

Mode	Rate	Antenna	Transmission Duration [ms]	Transmission Period [ms]	Duty Cycle [%]
802.11a	6Mbps	SISO-A	2.07	2.13	97.38%
		SISO-B	2.07	2.13	97.38%
802.11n20	HT0	SISO-A	4.05	4.10	98.63%
		SISO-B	4.05	4.10	98.63%
	HT8	MIMO-A	3.96	4.02	98.56%
		MIMO-B	3.96	4.02	98.56%
802.11ax20	HE0	SISO-A	3.94	3.99	98.66%
		SISO-B	3.94	3.99	98.66%
		MIMO-A	3.96	4.02	98.68%
		MIMO-B	3.96	4.02	98.68%
802.11n40	HT0	SISO-A	3.96	4.01	98.67%
		SISO-B	3.96	4.01	98.67%
	HT8	MIMO-A	3.96	4.02	98.66%
		MIMO-B	3.96	4.02	98.66%
802.11ax40	HE0	SISO-A	3.95	4.00	98.67%
		SISO-B	3.95	4.00	98.67%
		MIMO-A	3.95	4.00	98.64%
		MIMO-B	3.95	4.00	98.64%
802.11ac80	VHT0	SISO-A	3.95	4.00	98.67%
		SISO-B	3.95	4.00	98.67%
		MIMO-A	3.95	4.01	98.61%
		MIMO-B	3.95	4.01	98.61%
802.11ax80	HE0	SISO-A	3.95	4.01	98.59%
		SISO-B	3.95	4.01	98.59%
		MIMO-A	3.96	4.02	98.66%
		MIMO-B	3.96	4.02	98.66%
802.11ac160	VTH0	SISO-A	3.94	4.00	98.55%
		SISO-B	3.94	4.00	98.55%
		MIMO-A	2.77	2.82	98.22%
		MIMO-B	2.77	2.82	98.22%
802.11ax160	HE0	SISO-A	3.96	4.02	98.61%
		SISO-B	3.96	4.02	98.61%
		MIMO-A	2.28	2.33	97.93%
		MIMO-B	2.28	2.33	97.93%

Maximum output power – U-NII-2C Channels

Mode	Rate	Channel	Freq. [MHz]	Antenna	Average Cond. Output Power [dBm]	Max.* Cond. Output Power [dBm]	Max.* Cond. Output Power [mW]	Max. EIRP [dBm]	
802.11a	6Mbps	100	5500	SISO-A	19.03	19.15	82.14	24.15	
				SISO-B	19.24	19.36	86.20	24.36	
		120	5600	SISO-A	21.37	21.49	140.78	26.49	
				SISO-B	21.34	21.46	139.81	26.46	
		140	5700	SISO-A	18.15	18.27	67.07	23.27	
				SISO-B	18.06	18.18	65.69	23.18	
802.11n20	HT0	100	5500	SISO-A	19.09	19.09	81.10	24.09	
				SISO-B	19.01	19.01	79.62	24.01	
		120	5600	SISO-A	21.42	21.42	138.68	26.42	
				SISO-B	21.47	21.47	140.28	26.47	
		140	5700	SISO-A	18.09	18.09	64.42	23.09	
				SISO-B	18.13	18.13	65.01	23.13	
	HT8	100	5500	MIMO-A	15.87	15.87	38.64	20.87	
				MIMO-B	16.07	16.07	40.46	21.07	
				Combined A+B	18.98	18.98	79.09	23.98	
		120	5600	MIMO-A	18.25	18.25	66.83	23.25	
				MIMO-B	18.33	18.33	68.08	23.33	
				Combined A+B	21.30	21.30	134.91	26.30	
		140	5700	MIMO-A	15.19	15.19	33.04	20.19	
				MIMO-B	15.27	15.27	33.65	20.27	
				Combined A+B	18.24	18.24	66.69	23.24	
	802.11n40	HT0	102F	5510	SISO-A	18.34	18.34	68.23	23.34
					SISO-B	18.48	18.48	70.47	23.48
			118F	5590	SISO-A	21.29	21.29	134.59	26.29
SISO-B					21.35	21.35	136.46	26.35	
134F			5670	SISO-A	19.42	19.42	87.50	24.42	
				SISO-B	19.34	19.34	85.90	24.34	
HT8		102F	5510	MIMO-A	15.13	15.13	32.58	20.13	
				MIMO-B	15.20	15.20	33.11	20.20	
				Combined A+B	18.18	18.18	65.70	23.18	
		118F	5590	MIMO-A	18.24	18.24	66.68	23.24	
				MIMO-B	18.38	18.38	68.87	23.38	
				Combined A+B	21.32	21.32	135.55	26.32	
134F	5670	MIMO-A	17.82	17.82	60.53	22.82			
		MIMO-B	17.83	17.83	60.67	22.83			
		Combined A+B	20.84	20.84	121.21	25.84			

Mode	Rate	Channel	Freq. [MHz]	Antenna	Average Cond. Output Power [dBm]	Max.* Cond. Output Power [dBm]	Max.* Cond. Output Power [mW]	Max.* EIRP [dBm]
802.11ac80	VHT0	106ac80	5530	SISO-A	18.97	18.97	78.89	23.97
				SISO-B	18.99	18.99	79.25	23.99
				MIMO-A	16.08	16.08	40.55	21.08
				MIMO-B	16.16	16.16	41.30	21.16
				Combined A+B	19.13	19.13	81.86	24.13
		122ac80	5610	SISO-A	19.86	19.86	96.83	24.86
				SISO-B	19.94	19.94	98.63	24.94
				MIMO-A	18.19	18.19	65.92	23.19
				MIMO-B	18.25	18.25	66.83	23.25
				Combined A+B	21.23	21.23	132.75	26.23
802.11ac160	VHT0	114ac160	5570	SISO-A	14.59	14.59	28.77	19.59
				SISO-B	14.66	14.66	29.24	19.66
				MIMO-A	11.65	11.65	14.62	16.65
				MIMO-B	11.66	11.66	14.66	16.66
				Combined A+B	14.67	14.67	29.28	19.67

Mode	Rate	Channel	Freq. [MHz]	Antenna	Average Cond. Output Power [dBm]	Max.* Cond. Output Power [dBm]	Max.* Cond. Output Power [mW]	Max. EIRP [dBm]		
802.11ax20	HE0	100	5500	SISO-A	19.03	19.03	79.98	24.03		
				SISO-B	18.99	18.99	79.25	23.99		
		120	5600	SISO-A	21.20	21.20	131.83	26.20		
				SISO-B	21.12	21.12	129.42	26.12		
		140	5700	SISO-A	17.58	17.58	57.28	22.58		
				SISO-B	18.08	18.08	64.27	23.08		
		100	5500	MIMO-A	15.77	15.77	37.76	20.77		
				MIMO-B	15.91	15.91	38.99	20.91		
				Combined A+B	18.85	18.85	76.75	23.85		
		120	5600	MIMO-A	18.13	18.13	65.01	23.13		
				MIMO-B	18.22	18.22	66.37	23.22		
				Combined A+B	21.19	21.19	131.39	26.19		
		140	5700	MIMO-A	15.06	15.06	32.06	20.06		
				MIMO-B	15.13	15.13	32.58	20.13		
				Combined A+B	18.11	18.11	64.65	23.11		
		802.11ax40	HE0	102F	5510	SISO-A	18.30	18.30	67.61	23.30
						SISO-B	18.28	18.28	67.30	23.28
				118F	5590	SISO-A	21.23	21.23	132.74	26.23
						SISO-B	21.42	21.42	138.68	26.42
				134F	5670	SISO-A	19.20	19.20	83.18	24.20
						SISO-B	19.20	19.20	83.18	24.20
102F	5510			MIMO-A	15.21	15.21	33.19	20.21		
				MIMO-B	15.22	15.22	33.27	20.22		
				Combined A+B	18.23	18.23	66.46	23.23		
118F	5590			MIMO-A	18.16	18.16	65.46	23.16		
				MIMO-B	18.20	18.20	66.07	23.20		
				Combined A+B	21.19	21.19	131.53	26.19		
134F	5670			MIMO-A	17.80	17.80	60.26	22.80		
				MIMO-B	17.62	17.62	57.81	22.62		
				Combined A+B	20.72	20.72	118.07	25.72		

Mode	Rate	Channel	Freq. [MHz]	Antenna	Average Cond. Output Power [dBm]	Max.* Cond. Output Power [dBm]	Max.* Cond. Output Power [mW]	Max.* EIRP [dBm]
802.11ax80	HE0	106ax80	5530	SISO-A	18.91	18.91	77.80	23.91
				SISO-B	18.79	18.79	75.68	23.79
				MIMO-A	16.18	16.18	41.50	21.18
				MIMO-B	16.25	16.25	42.17	21.25
				Combined A+B	19.23	19.23	83.67	24.23
		122ax80	5610	SISO-A	19.62	19.62	91.62	24.62
				SISO-B	19.59	19.59	90.99	24.59
				MIMO-A	18.26	18.26	66.99	23.26
				MIMO-B	18.46	18.46	70.15	23.46
				Combined A+B	21.37	21.37	137.13	26.37
		114ax160	5570	SISO-A	14.36	14.36	27.29	19.36
				SISO-B	14.46	14.46	27.93	19.46
				MIMO-A	11.55	11.64	14.59	16.64
				MIMO-B	11.68	11.77	15.03	16.77
				Combined A+B	14.63	14.72	29.63	19.72

Mode	Rate	Antenna	Channel	Freq [MHz]	RU Config.	Average Conducted Output Power [dBm]	Maximum* Conducted Output Power [dBm]	Maximum* Conducted Output Power [mW]	Max of EIRP [dBm]	
802.11ax20	HE0	SISO-A	100	5500	26/0	13.48	13.48	22.28	18.48	
					52/37	16.44	16.44	44.06	21.44	
					106/53	19.67	19.67	92.68	24.67	
		SISO-B			26/0	13.44	13.44	22.08	18.44	
					52/40	16.58	16.58	45.50	21.58	
					106/53	19.57	19.57	90.57	24.57	
		MIMO-A			26/0	10.44	10.44	11.07	15.44	
						MIMO-B	10.55	10.55	11.35	15.55
						Combined A+B	13.51	13.51	22.42	18.51
		MIMO-A			52/37	13.51	13.51	22.44	18.51	
						MIMO-B	13.50	13.50	22.39	18.50
						Combined A+B	16.52	16.52	44.83	21.52
		MIMO-A			106/53	16.62	16.62	45.92	21.62	
						MIMO-B	16.83	16.83	48.19	21.83
	Combined A+B		19.74	19.74		94.11	24.74			
	HE0	SISO-A	140	5700	26/8	13.49	13.49	22.34	18.49	
					52/40	16.54	16.54	45.08	21.54	
					106/54	19.70	19.70	93.33	24.70	
		SISO-B			26/8	13.62	13.62	23.01	18.62	
					52/40	16.68	16.68	46.56	21.68	
					106/54	19.56	19.56	90.36	24.56	
		MIMO-A			26/8	10.71	10.71	11.78	15.71	
						MIMO-B	10.76	10.76	11.91	15.76
						Combined A+B	13.75	13.75	23.69	18.75
		MIMO-A			52/40	13.50	13.50	22.39	18.50	
						MIMO-B	13.24	13.24	21.09	18.24
						Combined A+B	16.38	16.38	43.47	21.38
		MIMO-A			106/54	16.67	16.67	46.45	21.67	
MIMO-B						16.80	16.80	47.86	21.80	
Combined A+B	19.75		19.75	94.31		24.75				

* Maximum values are the duty cycle compensated values calculated from the average (measured) values

Max Value

Min Value

Mode	Rate	Antenna	Channel	Freq [MHz]	RU Configuration	Average Conducted Output Power [dBm]	Maximum* Conducted Output Power [dBm]	Maximum* Conducted Output Power [mW]	Max of EIRP [dBm]	
802.11ax40	HE0	SISO-A	102F	5510	242/61	18.85	18.85	76.74	23.85	
		SISO-B				18.95	18.95	78.52	23.95	
		MIMO-B				15.21	15.21	33.19	20.21	
		MIMO-A				16.79	16.79	47.75	21.79	
		Combined A+B				19.08	19.08	80.94	24.08	
			SISO-A	134F	5670	242/62	19.07	19.07	80.72	24.07
			SISO-B				19.00	19.00	79.43	24.00
			MIMO-B				15.22	15.22	33.27	20.22
			MIMO-A				15.39	15.39	34.59	20.39
			Combined A+B				18.32	18.32	67.86	23.32
802.11ax80	HE0	SISO-A	102ax80	5530	484/65	17.72	17.72	59.16	22.72	
		SISO-B				17.76	17.76	59.70	22.76	
		MIMO-A				15.25	15.25	33.50	20.25	
		MIMO-B				15.81	15.81	38.11	20.81	
		Combined A+B				18.55	18.55	71.60	23.55	
802.11ax160	HE0	SISO-A	114ax160	5570	996/67	16.76	16.76	47.42	21.76	
		SISO-B				18.03	18.03	63.53	23.03	
		SISO-A			996/S67	18.95	18.95	78.52	23.95	
		SISO-B				18.88	18.88	77.27	23.88	
	HE0	MIMO-A			996/67	15.06	15.15	32.74	20.15	
		MIMO-B				15.07	15.16	32.82	20.16	
		Combined A+B				18.08	18.17	65.56	23.17	
		MIMO-A			996/S67	15.92	16.01	39.91	21.01	
		MIMO-B				16.20	16.29	42.57	21.29	
		Combined A+B				19.07	19.16	82.48	24.16	

* Maximum values are the duty cycle compensated values calculated from the average (measured) values

Max Value

Min Value

Maximum output power – Overlapped channels between U-NII-2C and U-NII-3

Mode	Rate	Channel	Freq. [MHz]	Antenna	Average Cond. Output Power - UNII-2C [dBm]	Max.* Cond. Output Power - UNII-2C [dBm]	Max.* Cond. Output Power - UNII-2C [mW]	Max.* EIRP UNII2C [dBm]
802.11n20	HT0	144	5720	SISO-A	19.57	19.63	91.83	24.63
				SISO-B	19.43	19.49	88.91	24.49
	HT8			MIMO-A	17.11	17.17	52.16	22.17
				MIMO-B	17.15	17.21	52.64	22.21
	Combined A+B			20.14	20.20	104.80	25.20	
802.11n40	HT0	142F	5710	SISO-A	20.15	20.21	104.91	25.21
				SISO-B	20.08	20.14	103.24	25.14
	HT8			MIMO-A	18.86	18.92	77.96	23.92
				MIMO-B	18.58	18.64	73.09	23.64
	Combined A+B			21.73	21.79	151.05	26.79	
802.11ac80	VHT0	138ac80	5690	SISO-A	20.60	20.66	116.36	25.66
				SISO-B	20.57	20.63	115.56	25.63
				MIMO-A	18.21	18.27	67.16	23.27
					18.88	18.94	78.36	23.94
				Combined A+B	21.57	21.63	145.51	26.63
802.11ax20	HE0	144	5720	SISO-A	19.72	19.78	95.03	24.78
				SISO-B	19.58	19.64	92.00	24.64
				MIMO-A	17.16	17.22	52.70	22.22
					17.12	17.18	52.22	22.18
				Combined A+B	20.16	20.22	105.16	25.22
802.11ax40	HE0	142F	5710	SISO-A	20.07	20.13	102.99	25.13
				SISO-B	20.28	20.34	108.13	25.34
				MIMO-A	18.78	18.84	76.55	23.84
					18.53	18.59	72.25	23.59
				Combined A+B	21.67	21.73	148.80	26.73
802.11ax80	HE0	138ax80	5690	SISO-A	20.79	20.85	121.58	25.85
				SISO-B	20.67	20.73	118.25	25.73
				MIMO-A	18.70	18.76	75.13	23.76
					18.71	18.77	75.33	23.77
				Combined A+B	21.72	21.77	150.46	26.77

* Maximum values are the duty cycle compensated values calculated from the measured average values

Max Value

Min Value

Maximum Power Spectral Density (PSD) – U-NII-2C channels

Mode	Rate	Channel	Freq. [MHz]	Antenna	Average conducted PSD [dBm/MHz]	Maximum* conducted PSD [dBm/MHz]
802.11a	6Mbps	100	5500	SISO-A	7.39	7.51
				SISO-B	7.57	7.69
		120	5600	SISO-A	9.63	9.75
				SISO-B	9.60	9.72
		140	5700	SISO-A	6.48	6.60
				SISO-B	6.37	6.49
802.11n20	HT0	100	5500	SISO-A	7.11	7.11
				SISO-B	7.07	7.07
		120	5600	SISO-A	9.36	9.36
				SISO-B	9.41	9.41
		140	5700	SISO-A	6.10	6.10
				SISO-B	6.14	6.14
	HT8	100	5500	MIMO-A	3.87	3.87
				MIMO-B	4.10	4.10
				Combined A+B	7.00	7.00
		120	5600	MIMO-A	6.24	6.24
				MIMO-B	6.35	6.35
				Combined A+B	9.31	9.31
		140	5700	MIMO-A	3.19	3.19
				MIMO-B	3.35	3.35
				Combined A+B	6.28	6.28

* Maximum values are the duty cycle compensated values calculated from the average (measured) values

Mode	Rate	Channel	Freq. [MHz]	Antenna	Average Conducted. PSD [dBm/MHz]	Max.* Conducted. PSD [dBm/MHz]
802.11n40	HT0	102F	5510	SISO-A	3.21	3.21
				SISO-B	3.36	3.36
		118F	5590	SISO-A	6.21	6.21
				SISO-B	6.25	6.25
		134F	5670	SISO-A	4.32	4.32
				SISO-B	4.23	4.23
	HT8	102F	5510	MIMO-A	0.09	0.09
				MIMO-B	0.17	0.17
				Combined A+B	3.14	3.14
		118F	5590	MIMO-A	3.13	3.13
				MIMO-B	3.29	3.29
				Combined A+B	6.22	6.22
		134F	5670	MIMO-A	2.72	2.72
				MIMO-B	2.75	2.75
Combined A+B	5.75	5.75				
802.11ac80	VHT0	106ac80	5530	SISO-A	1.42	1.42
				SISO-B	1.46	1.46
				MIMO-A	-1.45	-1.45
				MIMO-B	-1.37	-1.37
				Combined A+B	1.60	1.60
		122ac80	5610	SISO-A	2.31	2.31
				SISO-B	2.42	2.42
				MIMO-A	0.50	0.50
				MIMO-B	0.73	0.73
				Combined A+B	3.63	4.58
802.11ac160	VHT0	114ac160	5570	SISO-A	-5.78	-5.78
				SISO-B	-5.64	-5.64
				MIMO-A	-8.66	-8.66
				MIMO-B	-8.69	-8.69
				Combined A+B	-5.66	-5.66

* Maximum values are the duty cycle compensated values calculated from the average (measured) values

Mode	Rate	Channel	Freq. [MHz]	Antenna	Average conducted PSD [dBm/MHz]	Maximum* conducted PSD [dBm/MHz]
802.11ax20	HE0	100	5500	SISO-A	6.74	6.74
				SISO-B	6.67	6.67
		120	5600	SISO-A	8.90	8.90
				SISO-B	8.80	8.80
		140	5700	SISO-A	5.27	5.27
				SISO-B	5.78	5.78
		100	5500	MIMO-A	3.54	3.54
				MIMO-B	3.64	3.64
				Combined A+B	6.60	6.60
		120	5600	MIMO-A	5.84	5.84
				MIMO-B	5.92	5.92
				Combined A+B	8.89	8.89
		140	5700	MIMO-A	2.75	2.75
				MIMO-B	2.93	2.93
				Combined A+B	5.85	5.85

* Maximum values are the duty cycle compensated values calculated from the average (measured) values

Mode	Rate	Channel	Freq. [MHz]	Antenna	Average Conducted. PSD [dBm/MHz]	Max.* Conducted. PSD [dBm/MHz]		
802.11ax40	HE0	102F	5510	SISO-A	2.96	2.96		
				SISO-B	2.94	2.94		
		118F	5590	SISO-A	5.94	5.94		
				SISO-B	6.11	6.11		
		134F	5670	SISO-A	3.88	3.88		
				SISO-B	3.89	3.89		
		102F	5510	MIMO-A	-0.08	-0.08		
				MIMO-B	-0.12	-0.12		
				Combined A+B	2.91	2.91		
		118F	5590	MIMO-A	2.84	2.84		
				MIMO-B	2.88	2.88		
				Combined A+B	5.87	5.87		
		134F	5670	MIMO-A	2.49	2.49		
				MIMO-B	2.39	2.39		
				Combined A+B	5.45	5.45		
		802.11ax80	HE0	106ax80	5530	SISO-A	1.29	1.29
						SISO-B	1.18	1.18
						MIMO-A	-1.45	-1.45
MIMO-B	-1.38					-1.38		
Combined A+B	1.60					1.60		
122ax80	5610			SISO-A	1.98	1.98		
				SISO-B	1.98	1.98		
				MIMO-A	0.62	0.62		
				MIMO-B	0.83	0.83		
				Combined A+B	3.74	4.36		
802.11ax160	HE0	114ax160	5570	SISO-A	-6.13	-6.13		
				SISO-B	-6.02	-6.02		
				MIMO-A	-8.88	-8.79		
				MIMO-B	-8.77	-8.68		
				Combined A+B	-5.81	-5.72		

* Maximum values are the duty cycle compensated values calculated from the average (measured) values

Mode	Rate	Antenna	Channel	Frequency [MHz]	RU Configuration	Average conducted PSD [dBm/MHz]	Maximum* conducted PSD [dBm/MHz]
802.11ax20	HE0	SISO-A	100	5500	26/0	10.59	10.59
					52/37	10.71	10.71
					106/53	10.81	10.81
		SISO-B			26/0	10.60	10.60
					52/37	10.83	10.83
					106/53	10.78	10.78
		MIMO-A			26/0	7.73	7.73
						7.76	7.76
						10.76	10.76
		MIMO-B			53/37	7.88	7.88
						7.87	7.87
						10.89	10.89
		Combined A+B			106/53	7.84	7.84
						8.03	8.03
						10.95	10.95
802.11ax20	HE0	SISO-A	140	5700	26/8	10.67	10.67
					52/40	10.78	10.78
					106/54	10.86	10.86
		SISO-B			26/8	10.79	10.79
					52/40	10.91	10.91
					106/54	10.75	10.75
		MIMO-A			26/8	7.93	7.93
						7.95	7.95
						10.95	10.95
		MIMO-B			54/40	7.76	7.76
						7.52	7.52
						10.65	10.65
		Combined A+B			106/54	7.85	7.85
						7.93	7.93
						10.90	10.90

* Maximum values are the duty cycle compensated values calculated from the average (measured) values

Mode	Rate	Antenna	Channel	Frequency [MHz]	RU Configuration	Average conducted PSD [dBm/MHz]	Maximum* conducted PSD [dBm/MHz]
802.11ax40	HE0	SISO-A	102F	5510	242/61	6.48	6.48
		SISO-B				6.59	6.59
		MIMO-B				2.85	2.85
		MIMO-A				4.43	4.43
		Combined A+B				6.72	6.72
	HE0	SISO-A	134F	5670	242/62	6.68	6.68
		SISO-B				6.63	6.63
		MIMO-B				2.83	2.83
		MIMO-A				3.03	3.03
		Combined A+B				5.94	5.94
802.11ax80	HE0	SISO-A	106ax80	5530	484/65	2.47	2.47
		SISO-B				2.51	2.51
		MIMO-B				-0.03	-0.03
		MIMO-A				0.49	0.49
		Combined A+B				3.25	3.25
802.11ax160	HE0	SISO-A	114ax160	5570	996/67	-0.78	-0.78
		SISO-B				0.55	0.55
		SISO-A			996/S67	1.33	1.33
		SISO-B				1.29	1.29
	HE0	MIMO-A			996/67	-2.43	-2.34
		MIMO-B				-2.43	-2.34
		Combined A+B				0.58	0.67
		MIMO-A			996/S67	-1.59	-1.50
		MIMO-B				-1.36	-1.27
		Combined A+B				1.54	1.63

* Maximum values are the duty cycle compensated values calculated from the average (measured) values

Maximum Power Spectral Density (PSD) – Overlapped channels between U-NII-2C and U-NII-3

Mode	Rate	Channel	Freq. [MHz]	Antenna	Average conducted PSD UNII-2C [dBm/MHz]	Maximum* conducted PSD UNII-2C [dBm/MHz]
802.11n20	HT0	144	5720	SISO-A	8.55	8.61
				SISO-B	8.44	8.50
	HT8			MIMO-A	6.09	6.15
				MIMO-B	6.00	6.06
				Combined A+B	9.06	9.12
802.11n40	HT0	142F	5710	SISO-A	5.43	5.49
				SISO-B	5.33	5.39
	HT8			MIMO-A	4.13	4.19
				MIMO-B	3.82	3.88
				Combined A+B	6.99	7.05
802.11ac80	VHT0	138ac80	5690	SISO-A	3.11	3.17
				SISO-B	3.10	3.16
				MIMO-A	1.07	1.13
				MIMO-B	1.40	1.46
				Combined A+B	4.25	4.31
802.11ax20	HE0	144	5720	SISO-A	8.47	8.53
				SISO-B	8.31	8.37
				MIMO-A	5.92	5.98
				MIMO-B	5.81	5.87
				Combined A+B	8.88	8.93
802.11ax40	HE0	142F	5710	SISO-A	5.07	5.13
				SISO-B	5.38	5.44
				MIMO-A	3.86	3.92
				MIMO-B	3.63	3.69
				Combined A+B	6.76	6.82
802.11ax80	HE0	138ax80	5690	SISO-A	3.23	3.29
				SISO-B	3.12	3.18
				MIMO-A	1.21	1.27
				MIMO-B	1.15	1.21
				Combined A+B	4.19	4.25

* Maximum values are the duty cycle compensated values calculated from the average (measured) values

See Section B.3.3 for the screenshot results.

B.2.3 Undesirable emission limits : Band Edge (Conducted)

Test limits

FCC part	RSS part	Limits																				
15.407 (b) (3)	RSS-247 Clause 6.2.3 (2)	For transmitters operating in the 5.47–5.725 GHz band: all emissions outside of the 5.47–5.725 GHz band shall not exceed an EIRP of -27 dBm/MHz.																				
15.209	RSS-GEN, Clause 8.9	<p>Radiated emissions which fall in the restricted bands, as defined in §15.205(a), must also comply with the radiated emission limits specified in §15.209(a):</p> <table border="1"> <thead> <tr> <th>Freq Range (MHz)</th> <th>Field Strength ($\mu\text{V}/\text{m}$)</th> <th>Field Strength ($\text{dB}\mu\text{V}/\text{m}$)</th> <th>Meas. Distance (m)</th> </tr> </thead> <tbody> <tr> <td>30-88</td> <td>100</td> <td>40</td> <td>3</td> </tr> <tr> <td>88-216</td> <td>150</td> <td>43.5</td> <td>3</td> </tr> <tr> <td>216-960</td> <td>200</td> <td>46</td> <td>3</td> </tr> <tr> <td>Above 960</td> <td>500</td> <td>54</td> <td>3</td> </tr> </tbody> </table> <p>The emission limits shown in the table above are based on measurements employing CISPR quasi-peak detector except for the frequency bands 9-90 kHz, 110-490 kHz and above 1000 MHz. Radiated emission limits in these three bands are based on measurements employing an average detector.</p> <p>For average radiated emission measurements above 1000 MHz, there is also a limit specified when measuring with peak detector function, corresponding to 20 dB above the indicated values in the table.</p>	Freq Range (MHz)	Field Strength ($\mu\text{V}/\text{m}$)	Field Strength ($\text{dB}\mu\text{V}/\text{m}$)	Meas. Distance (m)	30-88	100	40	3	88-216	150	43.5	3	216-960	200	46	3	Above 960	500	54	3
Freq Range (MHz)	Field Strength ($\mu\text{V}/\text{m}$)	Field Strength ($\text{dB}\mu\text{V}/\text{m}$)	Meas. Distance (m)																			
30-88	100	40	3																			
88-216	150	43.5	3																			
216-960	200	46	3																			
Above 960	500	54	3																			

Test procedure

The setup below was used to measure undesirable emissions on the Band Edge domain. The antenna terminal of the EUT is connected to the spectrum analyzer through an attenuator, and the spectrum analyzer reading is compensated to include the RF path loss and the declared Antenna Gain.

For Band Edge measurements in average mode on the low frequency section, one of the two methods is used according to section G) 6) (KDB 789033 D02):

- 1) Method AD (Average Detection) as per paragraph II.G.6.c.
- 2) Method VB (Averaging using reduced video bandwidth) as per paragraph II.G.6.d.

For the Band Edge High the integration method was used as defined in the band edge measurements section (paragraph II.G.3.d) of KDB 789033 D02.

In case of Band Edge measurements falling in restricted bands, the declared Antenna Gain is also compensated in the graph.

The declared maximum antenna gain is 5dBi.

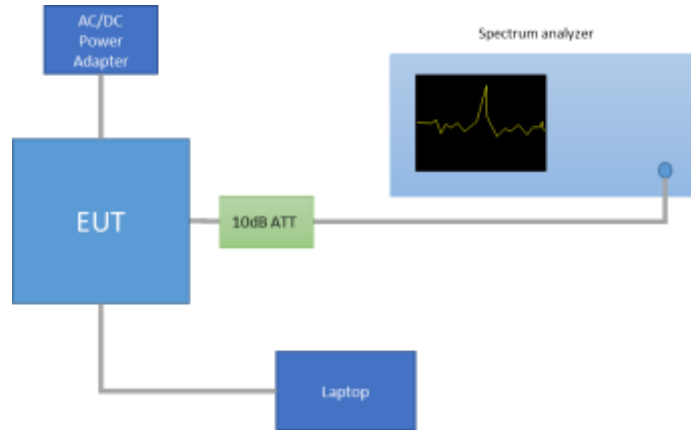

The following limits in dBm were applied for the average detector after the conversion from the limits detailed above in dBμV/m, according to FCC 47 CFR part 15 - Subpart C – §15.209(a). The limits in dBm for peak detector are 20dB above the indicated values in the table.

§15.209(a)			Converted values	
Freq Range (MHz)	Distance (m)	Field strength (microvolts/meter)	Field strength (dB microvolts/meter)	Power (dBm)
Above 960	3	500	53.98	-41.25

See Section B.3.5 for the screenshot results.

B.2.4 Radiated spurious emission

Standard references

FCC part	RSS part	Limits																				
15.407 (b) (3)	RSS-247 Clause 6.2.3 (2)	For transmitters operating in the 5.47–5.725 GHz band: all emissions outside of the 5.47–5.725 GHz band shall not exceed an EIRP of -27 dBm/MHz.																				
15.209	RSS-GEN, Clause 8.9	<p>Radiated emissions which fall in the restricted bands, as defined in §15.205(a), must also comply with the radiated emission limits specified in §15.209(a):</p> <table border="1"> <thead> <tr> <th>Freq Range (MHz)</th> <th>Field Strength ($\mu\text{V}/\text{m}$)</th> <th>Field Strength ($\text{dB}\mu\text{V}/\text{m}$)</th> <th>Meas. Distance (m)</th> </tr> </thead> <tbody> <tr> <td>30-88</td> <td>100</td> <td>40</td> <td>3</td> </tr> <tr> <td>88-216</td> <td>150</td> <td>43.5</td> <td>3</td> </tr> <tr> <td>216-960</td> <td>200</td> <td>46</td> <td>3</td> </tr> <tr> <td>Above 960</td> <td>500</td> <td>54</td> <td>3</td> </tr> </tbody> </table> <p>The emission limits shown in the above table are based on measurements employing CISPR quasi-peak detector except for the frequency bands 9-90 kHz, 110-490 kHz and above 1000 MHz. Radiated emission limits in these three bands are based on measurements employing an average detector.</p> <p>For average radiated emission measurements above 1000 MHz, there is also a limit specified when measuring with peak detector function, corresponding to 20 dB above the indicated values in the table.</p>	Freq Range (MHz)	Field Strength ($\mu\text{V}/\text{m}$)	Field Strength ($\text{dB}\mu\text{V}/\text{m}$)	Meas. Distance (m)	30-88	100	40	3	88-216	150	43.5	3	216-960	200	46	3	Above 960	500	54	3
Freq Range (MHz)	Field Strength ($\mu\text{V}/\text{m}$)	Field Strength ($\text{dB}\mu\text{V}/\text{m}$)	Meas. Distance (m)																			
30-88	100	40	3																			
88-216	150	43.5	3																			
216-960	200	46	3																			
Above 960	500	54	3																			

Test procedure

The setup below was used to measure the radiated spurious emissions.

Depending of the frequency range and bands being tested, different antennas and filters were used.

The final measurement is done by varying the antenna height, the EUT azimuth over 360° and for both Vertical and Horizontal polarizations.

The radiated spurious emission was measured on the worst case configuration selected from the chapter B.2.2 and using the low, middle and high channel.

For technologies 802.11ax20, 802.11ax40, 802.11ax80 and 802.11ax160, the worst case spurious emission result among the low, mid and high channels tested separately on Chain A and B is used to perform the test on MIMO mode (Chain A+B).

For 802.11n20, 802.11n40, 802.11ac80 and 802.11ac160 the worst channel found among all 802.11ax modes mentioned above is chosen to perform the test in Chain A, B ,and MIMO (Chain A+B).

Radiated Setup 30 MHz - 1GHz

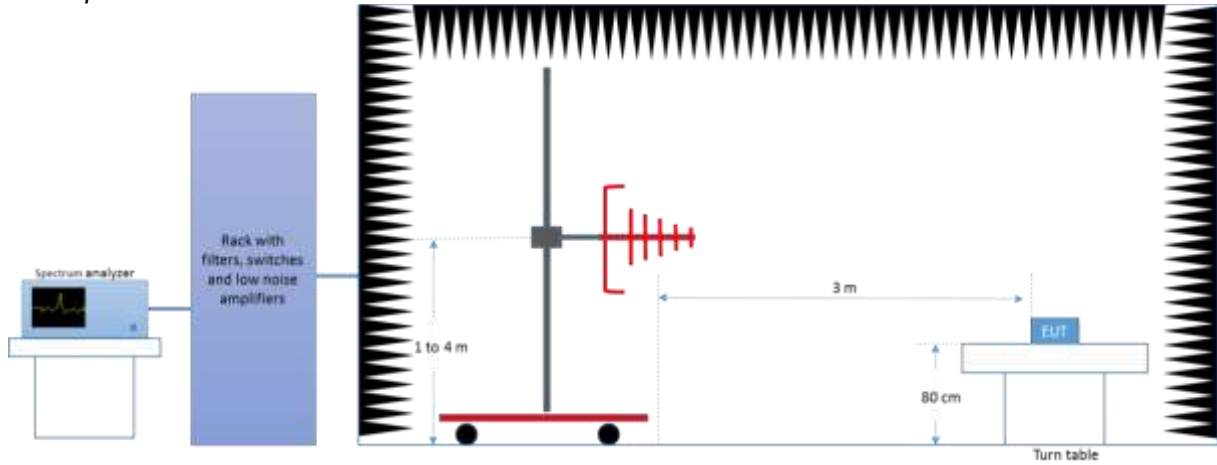

Radiated Setup 1 GHz – 6.4 GHz

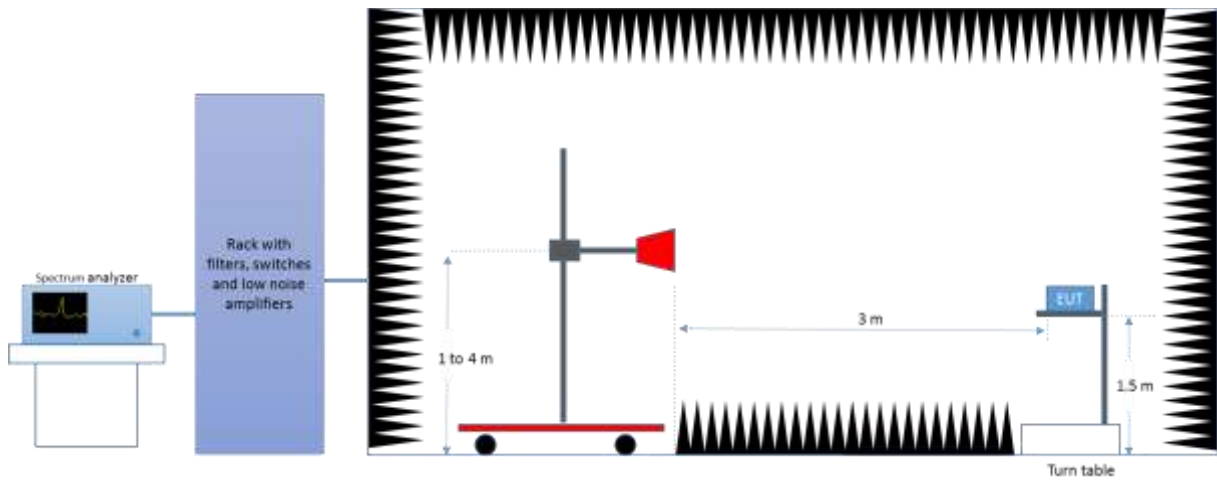

Radiated Setup 6.4 GHz - 18 GHz

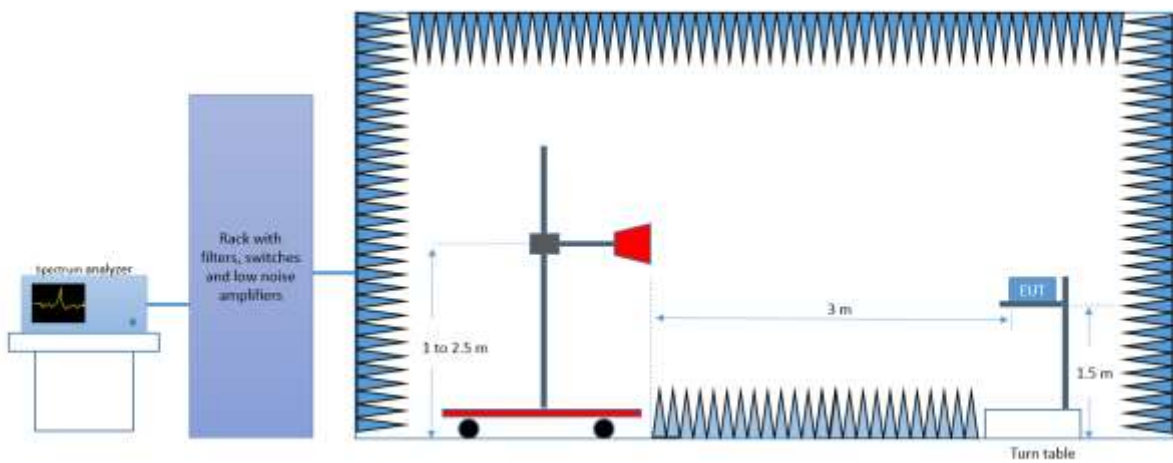

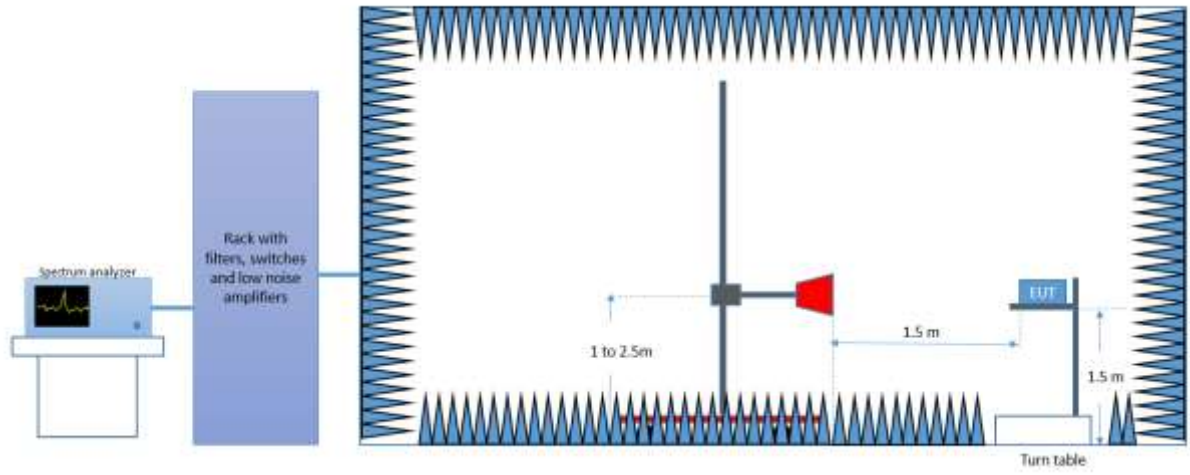

Test Results

30 MHz – 40 GHz, 802.11a, 6Mbps, Chain A

Radiated Spurious – CH100

Frequency	MaxPeak	Avg	Limit	Margin
MHz	dBuV/m	dBuV/m	dBuV/m	dB
174.7	34.3	---	43.6	9.2
836.2	35.7	---	46.0	10.3
1245.0	49.8	---	74.0	24.2
1245.0	---	31.0	54.0	23.0
10996.5	---	39.1	54.0	14.9
10997.5	49.7	---	74.0	24.3
21999.8	---	44.2	54.0	9.8
22000.0	52.3	---	74.0	21.7

Radiated Spurious – CH120

Frequency	MaxPeak	Avg	Limit	Margin
MHz	dBuV/m	dBuV/m	dBuV/m	dB
174.7	36.2	---	43.6	7.3
1243.0	48.6	---	74.0	25.4
1244.0	---	30.5	54.0	23.5
11200.5	---	49.6	54.0	4.4
11204.3	59.3	---	74.0	14.7
22399.8	---	43.9	54.0	10.1
39817.3	59.2	---	74.0	14.8

Radiated Spurious – CH140

Frequency	MaxPeak	Avg	Limit	Margin
MHz	dBuV/m	dBuV/m	dBuV/m	dB
174.7	37.5	---	43.6	6.0
1241.0	49.5	---	74.0	24.5
1246.0	---	30.7	54.0	23.3
11392.8	49.5	---	74.0	24.5
11398.2	---	37.9	54.0	16.1
22800.1	---	45.4	54.0	8.6
22800.4	54.5	---	74.0	19.5

30 MHz – 40 GHz, 802.11a, 6Mbps, Chain B

Radiated Spurious – CH100

Frequency	MaxPeak	Avg	Limit	Margin
MHz	dBuV/m	dBuV/m	dBuV/m	dB
174.7	33.7	---	43.6	9.9
835.9	36.3	---	46.0	9.7
1243.0	48.6	---	74.0	25.4
1243.0	---	30.4	54.0	23.7
16738.0	---	40.8	54.0	13.2
16751.6	52.6	---	74.0	21.4
22000.0	52.8	---	74.0	21.2
22000.0	---	44.5	54.0	9.5

Radiated Spurious – CH120

Frequency	MaxPeak	Avg	Limit	Margin
MHz	dBuV/m	dBuV/m	dBuV/m	dB
174.7	32.4	---	43.6	11.2
1241.0	48.4	---	74.0	25.6
1243.5	---	30.5	54.0	23.5
11200.0	53.6	---	74.0	20.4
11201.0	---	43.0	54.0	11.0
22399.8	53.9	---	74.0	20.1
22399.8	---	43.7	54.0	10.3

Radiated Spurious – CH140

Frequency	MaxPeak	Avg	Limit	Margin
MHz	dBuV/m	dBuV/m	dBuV/m	dB
174.7	36.5	---	43.6	7.1
1243.0	---	30.4	54.0	23.6
1243.0	48.7	---	74.0	25.3
11398.2	---	37.7	54.0	16.3
11401.1	48.8	---	74.0	25.2
22799.6	52.6	---	74.0	21.4
22799.8	---	45.0	54.0	9.0

30 MHz – 40 GHz, 802.11n20, HT0, Chain A
Radiated Spurious – CH120

Frequency	MaxPeak	Avg	Limit	Margin
MHz	dBuV/m	dBuV/m	dBuV/m	dB
174.7	34.7	---	43.6	8.8
1243.0	49.6	---	74.0	24.4
1247.5	---	30.6	54.0	23.4
11199.0	56.8	---	74.0	17.2
11200.0	---	47.1	54.0	6.9
22400.1	---	44.7	54.0	9.3
39070.2	60.1	---	74.0	13.9

Radiated Spurious – CH140

Frequency	MaxPeak	Avg	Limit	Margin
MHz	dBuV/m	dBuV/m	dBuV/m	dB
202.3	32.7	---	43.6	10.8
6311.0	---	43.2	54.0	10.8
6322.5	56.2	---	74.0	17.8
11400.1	---	38.7	54.0	15.3
11400.1	48.4	---	74.0	25.6
22800.0	---	46.5	54.0	7.5
22800.3	53.7	---	74.0	20.3

30 MHz – 40 GHz, 802.11n20, HT0, Chain B

Radiated Spurious – CH120

Frequency	MaxPeak	Avg	Limit	Margin
MHz	dBuV/m	dBuV/m	dBuV/m	dB
174.7	32.3	---	43.6	11.3
1244.0	49.1	---	74.0	24.9
1244.0	---	30.7	54.0	23.3
11200.5	51.3	---	74.0	22.7
11202.9	---	40.3	54.0	13.7
22399.8	---	44.1	54.0	9.9
22400.1	52.5	---	74.0	21.5
22567.2	---	44.0	54.0	10.0

Radiated Spurious – CH140

Frequency	MaxPeak	Avg	Limit	Margin
MHz	dBuV/m	dBuV/m	dBuV/m	dB
195.0	31.9	---	43.6	11.6
6307.0	55.9	---	74.0	18.1
6323.0	---	43.4	54.0	10.6
11397.2	48.4	---	74.0	25.6
11399.1	---	37.8	54.0	16.2
22799.8	53.2	---	74.0	20.8
22800.0	---	46.0	54.0	8.0

30 MHz – 40 GHz, 802.11n20, HT8, Chain A+B

Radiated Spurious – CH120

Frequency	MaxPeak	Avg	Limit	Margin
MHz	dBuV/m	dBuV/m	dBuV/m	dB
174.7	38.0	---	43.6	5.6
1241.5	48.0	---	74.0	26.0
1247.0	---	30.5	54.0	23.5
11202.9	55.2	---	74.0	18.8
11203.9	---	43.8	54.0	10.2
22399.8	52.8	---	74.0	21.2
22400.1	---	48.6	54.0	5.4
22424.8	---	43.1	54.0	10.9

Radiated Spurious – CH140

Frequency	MaxPeak	Avg	Limit	Margin
MHz	dBuV/m	dBuV/m	dBuV/m	dB
174.7	41.3	---	43.6	2.2
6308.0	56.0	---	74.0	18.0
6321.0	---	43.4	54.0	10.6
11400.1	---	38.5	54.0	15.5
11403.0	49.9	---	74.0	24.1
22800.0	52.8	---	74.0	21.2
22800.0	---	46.2	54.0	7.8

30 MHz – 40 GHz, 802.11ax20, HE0, Chain A

Radiated Spurious – CH100

Frequency	MaxPeak	Avg	Limit	Margin
MHz	dBuV/m	dBuV/m	dBuV/m	dB
174.7	33.5	---	43.6	10.0
1242.0	49.6	---	74.0	24.4
1247.5	---	30.7	54.0	23.3
10983.0	---	48.7	54.0	5.3
10983.9	56.9	---	74.0	17.1
21965.8	---	43.2	54.0	10.8
22000.0	---	45.0	54.0	9.0
22000.3	52.9	---	74.0	21.1

Radiated Spurious – CH120

Frequency	MaxPeak	Avg	Limit	Margin
MHz	dBuV/m	dBuV/m	dBuV/m	dB
174.7	32.2	---	43.6	11.4
1244.0	48.7	---	74.0	25.3
1244.0	---	30.6	54.0	23.4
11183.1	59.7	---	74.0	14.3
11183.1	---	50.7	54.0	3.3
22399.8	---	43.0	54.0	11.0
22400.1	52.3	---	74.0	21.7

Radiated Spurious – CH140

Frequency	MaxPeak	Avg	Limit	Margin
MHz	dBuV/m	dBuV/m	dBuV/m	dB
174.7	32.1	---	43.6	11.5
1242.5	48.3	---	74.0	25.7
1246.5	---	31.1	54.0	23.0
11383.2	---	50.5	54.0	3.5
11383.7	57.7	---	74.0	16.3
22765.8	---	48.3	54.0	5.7
22766.9	58.1	---	74.0	15.9
22799.8	---	45.6	54.0	8.4

30 MHz – 40 GHz, 802.11ax20, HE0, Chain B

Radiated Spurious – CH100

Frequency	MaxPeak	Avg	Limit	Margin
MHz	dBuV/m	dBuV/m	dBuV/m	dB
174.7	32.3	---	43.6	11.3
1242.0	48.8	---	74.0	25.2
1246.0	---	31.1	54.0	22.9
10983.0	---	41.5	54.0	12.5
10983.9	50.7	---	74.0	23.3
22000.0	---	46.4	54.0	7.6
22000.3	53.1	---	74.0	20.9

Radiated Spurious – CH120

Frequency	MaxPeak	Avg	Limit	Margin
MHz	dBuV/m	dBuV/m	dBuV/m	dB
174.7	31.7	---	43.6	11.8
1238.0	---	30.2	54.0	23.9
1242.0	48.7	---	74.0	25.3
11183.1	---	46.6	54.0	7.4
11183.6	53.3	---	74.0	20.7
22399.5	52.2	---	74.0	21.8
22399.8	---	43.8	54.0	10.2

Radiated Spurious – CH140

Frequency	MaxPeak	Avg	Limit	Margin
MHz	dBuV/m	dBuV/m	dBuV/m	dB
174.7	31.5	---	43.6	12.1
1242.5	---	30.4	54.0	23.6
1245.5	48.2	---	74.0	25.8
11388.0	51.0	---	74.0	23.0
11393.8	---	39.2	54.0	14.8
22766.4	---	45.5	54.0	8.5
22767.4	55.5	---	74.0	18.5
22799.8	---	47.8	54.0	6.2

30 MHz – 40 GHz, 802.11ax20, HE0, Chain A+B

Radiated Spurious – CH120

Frequency	MaxPeak	Avg	Limit	Margin
MHz	dBuV/m	dBuV/m	dBuV/m	dB
174.7	37.2	---	43.6	6.4
1242.5	49.8	---	74.0	24.2
1245.0	---	30.7	54.0	23.3
1386.0	44.8	---	74.0	29.2
1386.5	---	32.1	54.0	21.9
11183.1	---	50.7	54.0	3.3
11184.0	57.8	---	74.0	16.2
22399.8	---	44.8	54.0	9.2
22400.1	52.2	---	74.0	21.8

Radiated Spurious – CH140

Frequency	MaxPeak	Avg	Limit	Margin
MHz	dBuV/m	dBuV/m	dBuV/m	dB
174.7	40.7	---	43.6	2.8
6311.5	55.7	---	74.0	18.3
6317.5	---	43.3	54.0	10.7
11388.0	51.0	---	74.0	23.0
11393.8	---	39.3	54.0	14.8
22800.0	52.5	---	74.0	21.5
22800.3	---	45.8	54.0	8.2

30 MHz – 40 GHz, 802.11n40, HT0, Chain A
Radiated Spurious – CH118F

Frequency	MaxPeak	Avg	Limit	Margin
MHz	dBuV/m	dBuV/m	dBuV/m	dB
174.7	36.7	---	43.6	6.8
6287.0	---	42.6	54.0	11.4
6317.5	55.7	---	74.0	18.3
11179.7	---	44.8	54.0	9.2
11193.2	55.7	---	74.0	18.3
22360.0	---	44.9	54.0	9.1
22360.2	52.5	---	74.0	21.5

Radiated Spurious – CH134F

Frequency	MaxPeak	Avg	Limit	Margin
MHz	dBuV/m	dBuV/m	dBuV/m	dB
174.7	27.8	---	43.6	15.8
1242.5	49.5	---	74.0	24.5
1247.0	---	30.8	54.0	23.2
11322.8	53.5	---	74.0	20.5
11322.8	---	42.3	54.0	11.7
22680.0	---	44.9	54.0	9.1
22680.3	53.0	---	74.0	21.0
22799.8	---	47.8	54.0	6.2

30 MHz – 40 GHz, 802.11n40, HT0, Chain B

Radiated Spurious – CH118F

Frequency	MaxPeak	Avg	Limit	Margin
MHz	dBuV/m	dBuV/m	dBuV/m	dB
174.7	37.5	---	43.6	6.0
5992.5	---	45.0	54.0	9.0
5994.0	63.8	---	74.0	10.2
11181.1	---	41.0	54.0	13.0
11185.0	51.1	---	74.0	22.9
22360.0	---	44.6	54.0	9.4
22363.7	53.2	---	74.0	20.8

Radiated Spurious – CH134F

Frequency	MaxPeak	Avg	Limit	Margin
MHz	dBuV/m	dBuV/m	dBuV/m	dB
174.7	31.7	---	43.6	11.8
1242.0	48.9	---	74.0	25.1
1247.0	---	30.2	54.0	23.8
11339.2	49.6	---	74.0	24.4
11339.7	---	38.2	54.0	15.8
22680.0	---	45.1	54.0	8.9
22680.6	53.1	---	74.0	20.9

30 MHz – 26.5 GHz, 802.11n40, HT8, Chain A+B

Radiated Spurious – CH118F

Frequency	MaxPeak	Avg	Limit	Margin
MHz	dBuV/m	dBuV/m	dBuV/m	dB
174.7	37.1	---	43.6	6.4
5936.0	---	50.9	54.0	3.1
5937.0	72.2	---	74.0	1.8
11186.0	---	45.5	54.0	8.5
11204.3	55.3	---	74.0	18.7
22359.4	52.3	---	74.0	21.7
22360.0	---	44.5	54.0	9.5

Radiated Spurious – CH134F

Frequency	MaxPeak	Avg	Limit	Margin
MHz	dBuV/m	dBuV/m	dBuV/m	dB
174.7	39.2	---	43.6	4.3
1244.5	48.2	---	74.0	25.8
1245.5	---	30.8	54.0	23.3
11328.6	---	38.3	54.0	15.8
11339.7	49.8	---	74.0	24.3
22680.0	53.3	---	74.0	20.7
22680.0	---	43.7	54.0	10.3

30 MHz – 40 GHz, 802.11ax40, HE0, Chain A

Radiated Spurious – CH102F

Frequency	MaxPeak	Avg	Limit	Margin
MHz	dBuV/m	dBuV/m	dBuV/m	dB
174.7	30.3	---	43.6	13.3
1239.5	---	29.9	54.0	24.1
1240.5	48.0	---	74.0	26.0
16738.0	---	40.9	54.0	13.1
17131.5	53.2	---	74.0	20.8
22039.6	53.2	---	74.0	20.8
22039.9	---	45.5	54.0	8.5

Radiated Spurious – CH118F

Frequency	MaxPeak	Avg	Limit	Margin
MHz	dBuV/m	dBuV/m	dBuV/m	dB
174.7	25.9	---	43.6	17.7
6046.0	54.5	---	74.0	19.5
6081.5	---	41.9	54.0	12.1
11151.7	---	51.1	54.0	2.9
11152.1	56.8	---	74.0	17.2
22358.6	52.5	---	74.0	21.5
22360.0	---	44.2	54.0	9.8

Radiated Spurious – CH134F

Frequency	MaxPeak	Avg	Limit	Margin
MHz	dBuV/m	dBuV/m	dBuV/m	dB
174.7	31.1	---	43.6	12.5
1244.0	48.9	---	74.0	25.1
1245.5	---	30.6	54.0	23.4
11308.7	59.4	---	74.0	14.6
11311.6	---	50.3	54.0	3.7
22680.0	---	44.7	54.0	9.3
22680.3	53.0	---	74.0	21.0

30 MHz – 40 GHz, 802.11ax40, HE0, Chain B

Radiated Spurious – CH102F

Frequency	MaxPeak	Avg	Limit	Margin
MHz	dBuV/m	dBuV/m	dBuV/m	dB
174.7	30.6	---	43.6	13.0
1244.5	47.8	---	74.0	26.2
1244.5	---	30.6	54.0	23.4
16750.1	---	40.9	54.0	13.1
17842.9	53.2	---	74.0	20.8
22039.9	---	44.3	54.0	9.7
22040.4	52.6	---	74.0	21.4

Radiated Spurious – CH118F

Frequency	MaxPeak	Avg	Limit	Margin
MHz	dBuV/m	dBuV/m	dBuV/m	dB
174.7	33.0	---	43.6	10.5
1241.0	---	30.5	54.0	23.5
1243.5	49.6	---	74.0	24.4
11143.9	50.7	---	74.0	23.3
11143.9	---	41.4	54.0	12.6
22359.7	---	43.4	54.0	10.6
22375.4	53.2	---	74.0	20.8

Radiated Spurious – CH134F

Frequency	MaxPeak	Avg	Limit	Margin
MHz	dBuV/m	dBuV/m	dBuV/m	dB
174.7	31.4	---	43.6	12.1
1243.0	49.0	---	74.0	25.0
1244.0	---	30.9	54.0	23.1
11303.4	54.5	---	74.0	19.5
11303.9	---	46.1	54.0	7.9
22679.8	53.4	---	74.0	20.6
22679.8	---	44.5	54.0	9.5

30 MHz – 26.5 GHz, 802.11ax40, HE0, Chain A+B

Radiated Spurious – CH118F

Frequency	MaxPeak	Avg	Limit	Margin
MHz	dBuV/m	dBuV/m	dBuV/m	dB
174.7	37.5	---	43.6	6.0
6318.0	---	43.3	54.0	10.8
6335.0	55.8	---	74.0	18.2
11143.9	---	52.0	54.0	2.0
11144.9	62.0	---	74.0	12.0
22360.2	52.5	---	74.0	21.5
22360.5	---	44.9	54.0	9.1

Radiated Spurious – CH134F

Frequency	MaxPeak	Avg	Limit	Margin
MHz	dBuV/m	dBuV/m	dBuV/m	dB
174.7	29.2	---	43.6	14.4
1241.0	---	30.1	54.0	23.9
1241.5	47.2	---	74.0	26.8
11303.4	---	51.2	54.0	2.8
11304.4	57.4	---	74.0	16.6
22679.5	52.6	---	74.0	21.4
22680.0	---	44.1	54.0	9.9

30 MHz – 40 GHz, 802.11ac80, HT0, Chain A

Radiated Spurious – CH106ac80

Frequency	MaxPeak	Avg	Limit	Margin
MHz	dBuV/m	dBuV/m	dBuV/m	dB
174.7	32.4	---	43.6	11.2
1242.5	---	30.8	54.0	23.2
1244.0	50.0	---	74.0	24.0
16753.5	---	41.0	54.0	13.0
16758.8	52.9	---	74.0	21.1
22119.8	52.3	---	74.0	21.7
22120.1	---	45.2	54.0	8.8

Radiated Spurious – CH122ac80

Frequency	MaxPeak	Avg	Limit	Margin
MHz	dBuV/m	dBuV/m	dBuV/m	dB
174.7	26.4	---	43.6	17.1
6283.5	55.8	---	74.0	18.2
6310.5	---	43.4	54.0	10.6
11218.8	54.2	---	74.0	19.8
11224.6	---	44.0	54.0	10.0
22439.4	53.2	---	74.0	20.8
22439.9	---	45.0	54.0	9.0

Radiated Spurious – CH138ac80

Frequency	MaxPeak	Avg	Limit	Margin
MHz	dBuV/m	dBuV/m	dBuV/m	dB
174.7	37.1	---	43.6	6.5
6263.0	55.4	---	74.0	18.6
6317.5	---	43.2	54.0	10.8
11337.3	52.6	---	74.0	21.4
11367.2	---	42.1	54.0	11.9
22760.0	---	45.8	54.0	8.2
22760.3	53.7	---	74.0	20.3

30 MHz – 40 GHz, 802.11ac80, HT0, Chain B

Radiated Spurious – CH106ac80

Frequency	MaxPeak	Avg	Limit	Margin
MHz	dBuV/m	dBuV/m	dBuV/m	dB
187.5	26.5	---	43.6	17.1
1246.0	48.9	---	74.0	25.1
1248.5	---	30.0	54.0	24.0
6167.5	53.8	---	74.0	20.2
6261.0	---	42.4	54.0	11.6
16743.8	52.7	---	74.0	21.3
16757.8	---	41.1	54.0	12.9
22119.8	---	43.7	54.0	10.3
22120.6	52.2	---	74.0	21.8

Radiated Spurious – CH122ac80

Frequency	MaxPeak	Avg	Limit	Margin
MHz	dBuV/m	dBuV/m	dBuV/m	dB
178.9	25.0	---	43.6	18.6
6261.5	56.0	---	74.0	18.0
6289.0	---	42.8	54.0	11.2
16743.3	---	40.7	54.0	13.3
16754.0	52.0	---	74.0	22.0
21858.5	53.6	---	74.0	20.4
21867.8	---	43.2	54.0	10.8

Radiated Spurious – CH138ac80

Frequency	MaxPeak	Avg	Limit	Margin
MHz	dBuV/m	dBuV/m	dBuV/m	dB
174.7	37.8	---	43.6	5.8
6172.0	---	42.4	54.0	11.6
6173.5	56.0	---	74.0	18.0
17056.5	---	49.5	54.0	4.5
17064.3	60.8	---	74.0	13.2
22760.3	53.5	---	74.0	20.5
22760.3	---	46.4	54.0	7.6

30 MHz – 26.5 GHz, 802.11ac80, HT8, Chain A+B

Radiated Spurious – CH106ac80

Frequency	MaxPeak	Avg	Limit	Margin
MHz	dBuV/m	dBuV/m	dBuV/m	dB
174.7	28.9	---	43.6	14.7
1240.5	47.7	---	74.0	26.3
1251.0	---	29.6	54.0	24.4
6020.0	55.1	---	74.0	18.9
6081.5	---	42.2	54.0	11.8
22119.6	52.2	---	74.0	21.8
22120.1	---	44.3	54.0	9.7

Radiated Spurious – CH122ac80

Frequency	MaxPeak	Avg	Limit	Margin
MHz	dBuV/m	dBuV/m	dBuV/m	dB
174.7	25.8	---	43.6	17.7
6318.0	---	43.4	54.0	10.6
6325.5	56.0	---	74.0	18.0
11231.4	---	40.3	54.0	13.7
11236.2	50.7	---	74.0	23.3
22440.2	---	43.8	54.0	10.2
22441.0	52.5	---	74.0	21.5
22599.6	---	44.4	54.0	9.6
22602.0	53.0	---	74.0	21.0

Radiated Spurious – CH138ac80

Frequency	MaxPeak	Avg	Limit	Margin
MHz	dBuV/m	dBuV/m	dBuV/m	dB
174.7	36.7	---	43.6	6.9
6327.5	---	43.0	54.0	11.0
6335.5	55.3	---	74.0	18.7
11365.8	50.0	---	74.0	24.0
11374.0	---	38.8	54.0	15.2
22760.3	53.1	---	74.0	20.9
22760.3	---	45.3	54.0	8.7

30 MHz – 40 GHz, 802.11ax80, HE0, Chain A

Radiated Spurious – CH106ac80

Frequency	MaxPeak	Avg	Limit	Margin
MHz	dBuV/m	dBuV/m	dBuV/m	dB
187.5	26.2	---	43.6	17.4
6255.0	---	42.3	54.0	11.7
6257.0	55.4	---	74.0	18.6
10983.5	---	49.8	54.0	4.2
10984.9	58.9	---	74.0	15.1
21966.3	54.4	---	74.0	19.6
21967.9	---	45.2	54.0	8.8
22119.8	---	44.6	54.0	9.4
22120.1	52.2	---	74.0	21.8

Radiated Spurious – CH122ac80

Frequency	MaxPeak	Avg	Limit	Margin
MHz	dBuV/m	dBuV/m	dBuV/m	dB
174.7	35.2	---	43.6	8.4
6318.0	---	43.2	54.0	10.8
6320.5	55.9	---	74.0	18.1
11145.9	---	49.8	54.0	4.2
11145.9	53.3	---	74.0	20.7
22439.9	52.1	---	74.0	21.9
22439.9	---	43.5	54.0	10.5

Radiated Spurious – CH138ac80

Frequency	MaxPeak	Avg	Limit	Margin
MHz	dBuV/m	dBuV/m	dBuV/m	dB
174.7	36.9	---	43.6	6.7
5803.0	59.9	---	74.0	14.1
5804.0	---	49.6	54.0	4.4
11310.2	59.8	---	74.0	14.2
11310.7	---	49.6	54.0	4.4
22607.3	---	46.6	54.0	7.4
22610.7	56.4	---	74.0	17.6

30 MHz – 40 GHz, 802.11ax80, HE0, Chain B

Radiated Spurious – CH106ac80

Frequency	MaxPeak	Avg	Limit	Margin
MHz	dBuV/m	dBuV/m	dBuV/m	dB
215.2	32.4	---	43.6	11.1
6298.5	---	42.8	54.0	11.2
6305.5	56.0	---	74.0	18.0
10983.9	---	43.2	54.0	10.8
10984.4	53.9	---	74.0	20.1
22120.1	52.7	---	74.0	21.3
22120.1	---	44.1	54.0	9.9

Radiated Spurious – CH122ac80

Frequency	MaxPeak	Avg	Limit	Margin
MHz	dBuV/m	dBuV/m	dBuV/m	dB
170.6	35.2	---	43.6	8.4
6284.5	55.9	---	74.0	18.1
6316.5	---	43.2	54.0	10.8
11143.4	---	41.3	54.0	12.7
11145.4	49.6	---	74.0	24.4
21593.6	53.3	---	74.0	20.7
21601.9	---	43.8	54.0	10.2

Radiated Spurious – CH138ac80

Frequency	MaxPeak	Avg	Limit	Margin
MHz	dBuV/m	dBuV/m	dBuV/m	dB
174.7	37.7	---	43.6	5.9
5803.5	60.1	---	74.0	13.9
5803.5	---	49.4	54.0	4.6
11303.9	---	43.1	54.0	10.9
11304.4	52.3	---	74.0	21.7
22759.7	53.5	---	74.0	20.5
22760.3	---	44.5	54.0	9.5

30 MHz – 26.5 GHz, 802.11ax80, HE0, Chain A+B

Radiated Spurious – CH106ac80

Frequency	MaxPeak	Avg	Limit	Margin
MHz	dBuV/m	dBuV/m	dBuV/m	dB
174.7	34.8	---	43.6	8.8
6316.5	---	43.4	54.0	10.6
6364.0	55.1	---	74.0	18.9
10983.5	54.3	---	74.0	19.7
10983.9	---	46.5	54.0	7.5
22119.8	---	43.5	54.0	10.5
22120.4	51.7	---	74.0	22.3

Radiated Spurious – CH122ac80

Frequency	MaxPeak	Avg	Limit	Margin
MHz	dBuV/m	dBuV/m	dBuV/m	dB
174.7	34.8	---	43.6	8.7
6257.5	54.5	---	74.0	19.5
6261.5	---	42.4	54.0	11.6
11143.9	---	49.4	54.0	4.6
11144.9	57.5	---	74.0	16.5
22440.2	52.3	---	74.0	21.7
22440.2	---	44.6	54.0	9.4

Radiated Spurious – CH138ac80

Frequency	MaxPeak	Avg	Limit	Margin
MHz	dBuV/m	dBuV/m	dBuV/m	dB
166.4	38.8	---	43.6	4.8
6320.0	56.2	---	74.0	17.8
6336.0	---	42.6	54.0	11.4
11308.7	56.4	---	74.0	17.6
11310.7	---	47.6	54.0	6.4
16956.5	---	39.6	54.0	14.4
16957.9	53.3	---	74.0	20.7
22760.3	53.0	---	74.0	21.0
22760.3	---	45.4	54.0	8.6

30 MHz – 40 GHz, 802.11ac160, HT0, Chain A

Radiated Spurious – CH114ac160

Frequency	MaxPeak	Avg	Limit	Margin
MHz	dBuV/m	dBuV/m	dBuV/m	dB
174.7	37.0	---	43.6	6.5
6255.5	55.4	---	74.0	18.6
6270.5	---	42.2	54.0	11.8
16711.0	52.7	---	74.0	21.3
16727.9	---	40.8	54.0	13.2
22279.8	52.5	---	74.0	21.5
22280.0	---	45.0	54.0	9.0

30 MHz – 40 GHz, 802.11ac160, HT0, Chain B

Radiated Spurious – CH114ac160

Frequency	MaxPeak	Avg	Limit	Margin
MHz	dBuV/m	dBuV/m	dBuV/m	dB
174.7	37.1	---	43.6	6.5
6319.0	---	43.3	54.0	10.7
6332.5	55.7	---	74.0	18.3
16731.7	52.5	---	74.0	21.5
16754.9	---	41.0	54.0	13.0
22280.3	---	45.3	54.0	8.7
22281.1	52.7	---	74.0	21.3

30 MHz – 40 GHz, 802.11ac160, HT0, Chain A+B

Radiated Spurious – CH114ac160

Frequency	MaxPeak	Avg	Limit	Margin
MHz	dBuV/m	dBuV/m	dBuV/m	dB
174.7	37.5	---	43.6	6.0
6314.0	56.0	---	74.0	18.0
6317.0	---	43.3	54.0	10.7
16745.8	52.4	---	74.0	21.6
16754.0	---	41.0	54.0	13.0
22280.0	---	44.9	54.0	9.1
22280.3	52.9	---	74.0	21.1

30 MHz – 40 GHz, 802.11ax160, HE0, Chain A

Radiated Spurious – CH114ac160

Frequency	MaxPeak	Avg	Limit	Margin
MHz	dBuV/m	dBuV/m	dBuV/m	dB
166.4	37.9	---	43.6	5.7
5180.0	---	46.3	54.0	7.7
5182.5	59.4	---	74.0	14.6
5803.5	61.8	---	74.0	12.2
5804.0	---	50.8	54.0	3.2
10983.5	---	50.0	54.0	4.0
10984.4	59.5	---	74.0	14.5
21967.1	---	44.6	54.0	9.4
21969.2	56.4	---	74.0	17.6
22280.3	---	44.4	54.0	9.6

30 MHz – 40 GHz, 802.11ax160, HE0, Chain B

Radiated Spurious – CH114ac160

Frequency	MaxPeak	Avg	Limit	Margin
MHz	dBuV/m	dBuV/m	dBuV/m	dB
174.7	37.2	---	43.6	6.3
5803.5	54.6	---	74.0	19.4
5803.9	---	43.7	54.0	10.3
10983.9	---	45.5	54.0	8.5
10984.9	53.7	---	74.0	20.3
22279.2	52.7	---	74.0	21.3
22280.3	---	44.9	54.0	9.1

30 MHz – 40 GHz, 802.11ax160, HE0, Chain A+B

Radiated Spurious – CH114ac160

Frequency	MaxPeak	Avg	Limit	Margin
MHz	dBuV/m	dBuV/m	dBuV/m	dB
174.7	36.8	---	43.6	6.7
5802.7	53.5	---	74.0	20.5
5804.3	---	43.3	54.0	10.7
10983.5	---	45.5	54.0	8.5
10984.9	54.2	---	74.0	19.8
22280.0	53.7	---	74.0	20.3
22280.0	---	44.7	54.0	9.3

B.3 Test Results Screenshots

B.3.1 26dB Bandwidth

SISO-A, 802.11a, 6Mbps

Channel 120

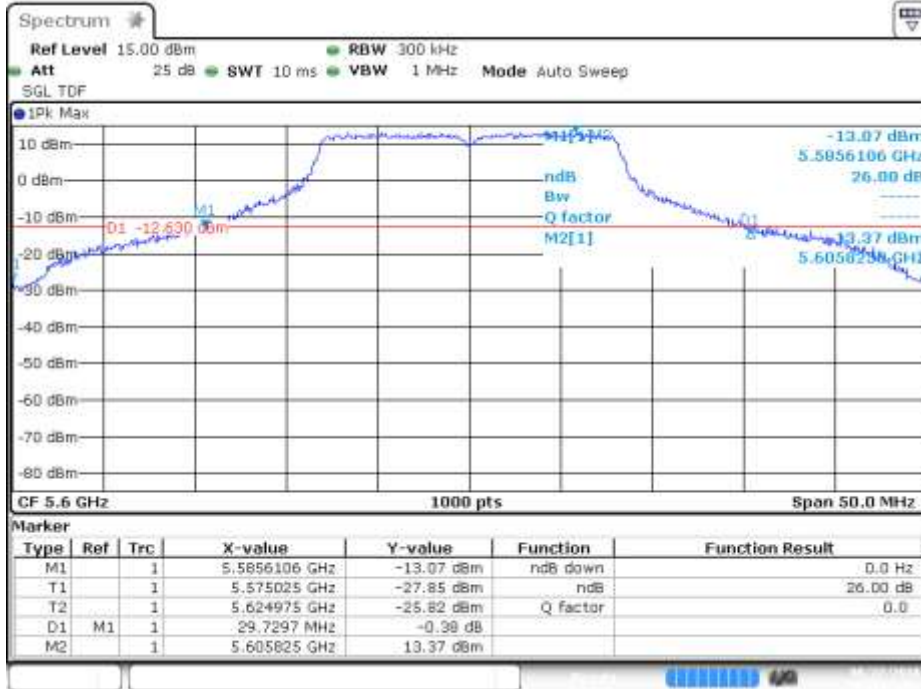

SISO-A, 802.11n20, HT0

Channel 120

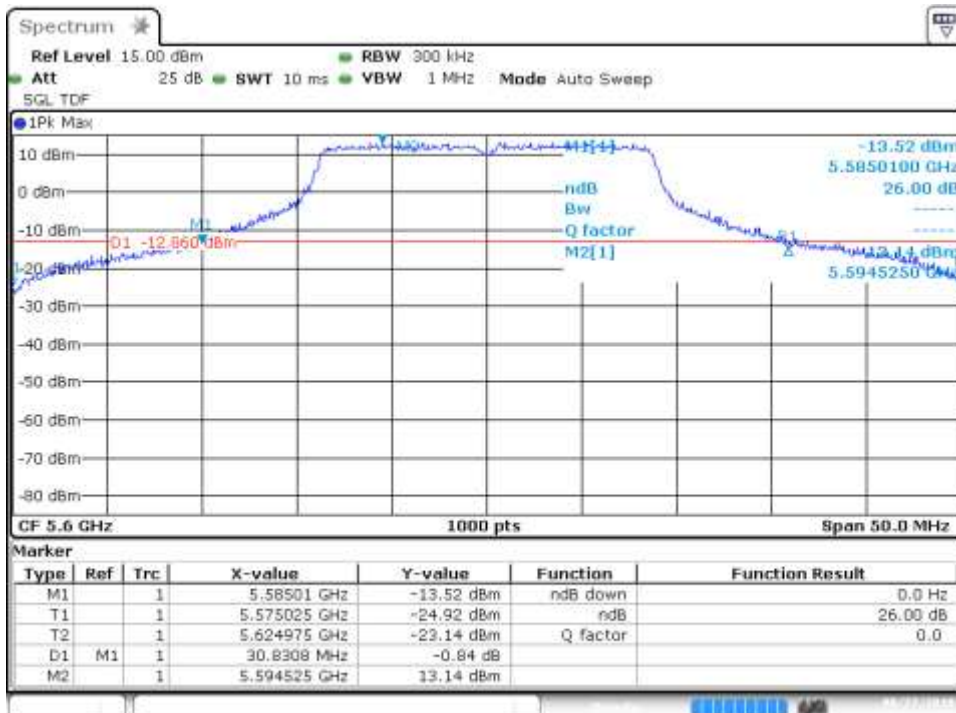

SISO-A, 802.11n40, HT0

Channel 118F

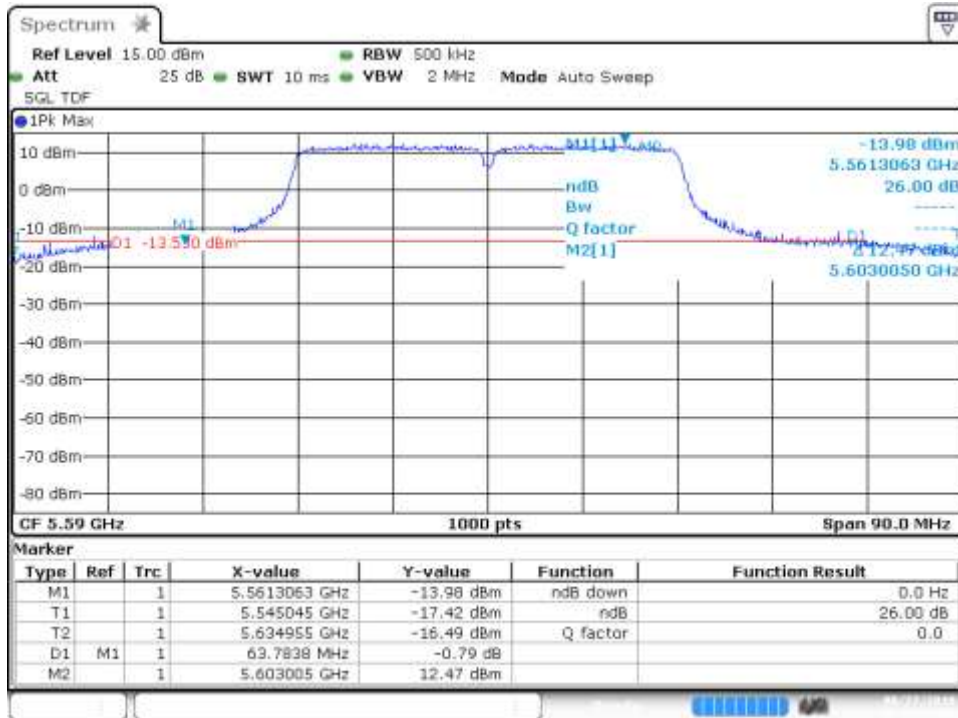

MIMO-A, 802.11n20, HT8

Channel 120

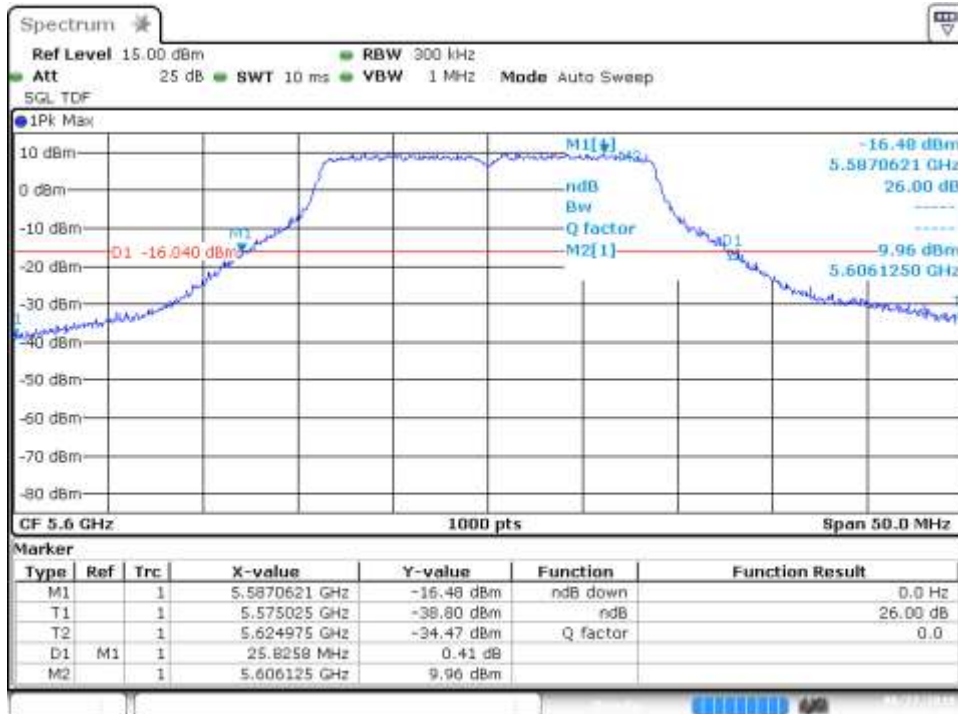

MIMO-A, 802.11n40, HT8

Channel 134F

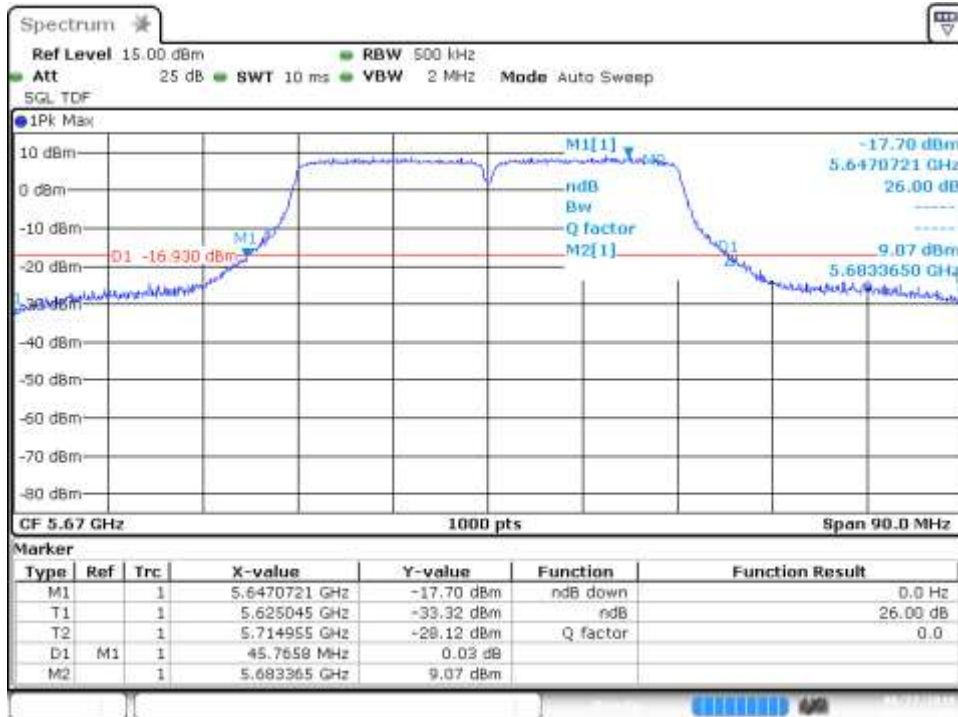

SISO-A, 802.11ac80, VHT0

Channel 122ac80

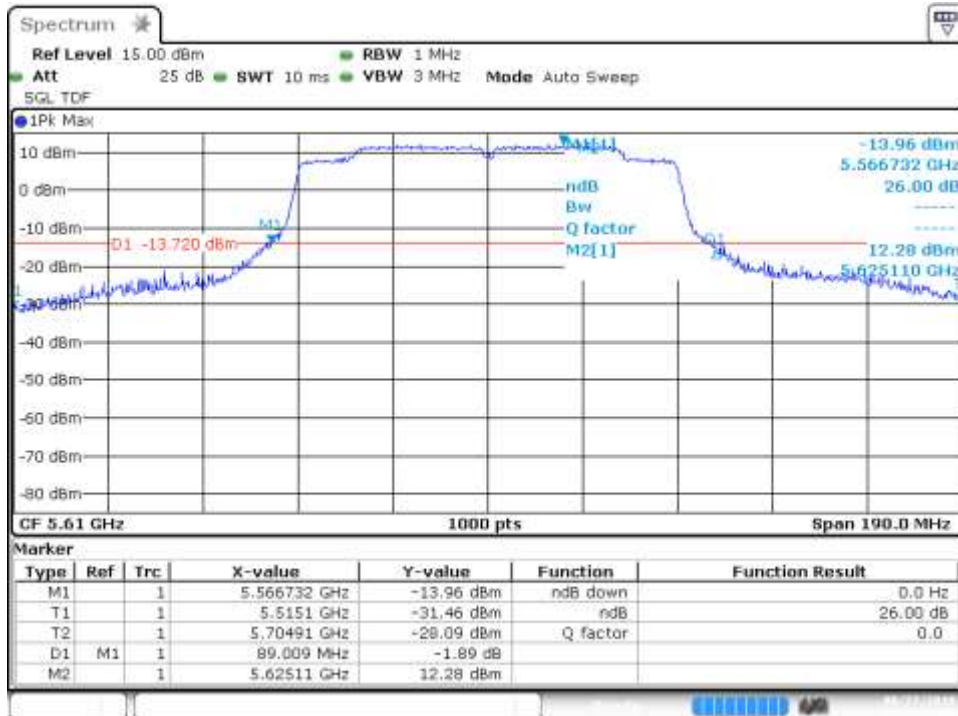

MIMO-B, 802.11ac80, VHT0

Channel 122ac80

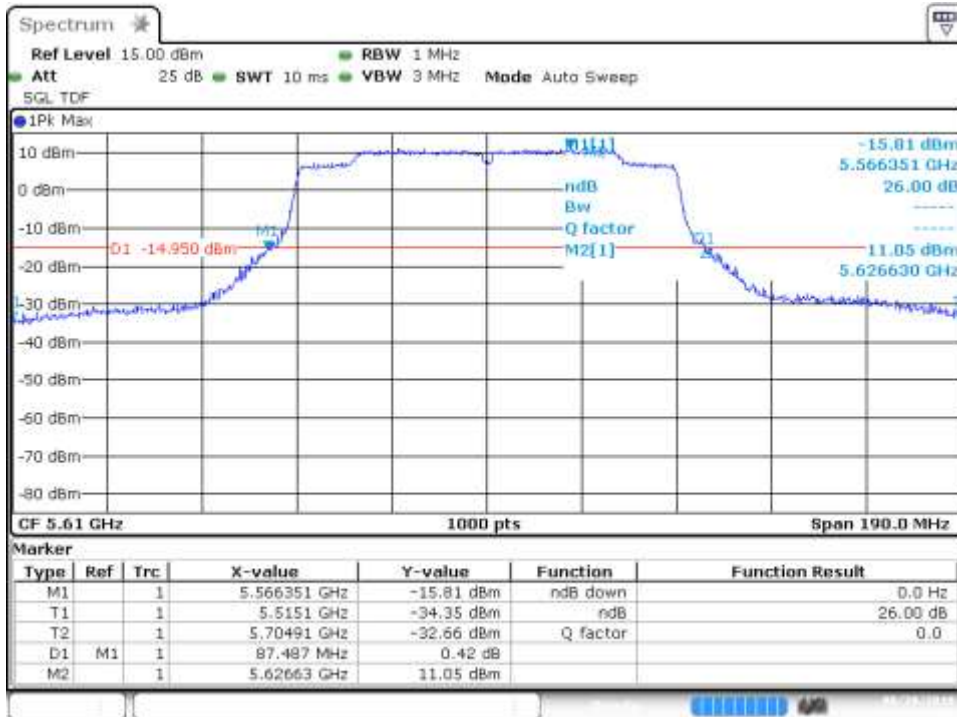

SISO-B, 802.11ac160, VHT0

Channel 114ac160

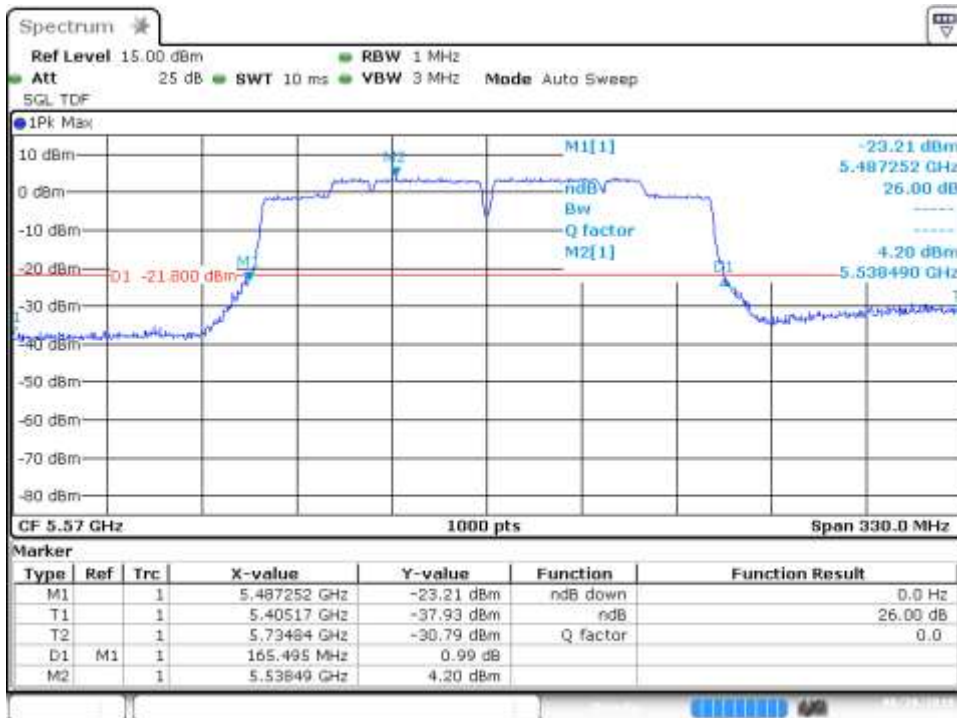

MIMO-A, 802.11ac160, VHT0

Channel 114ac160

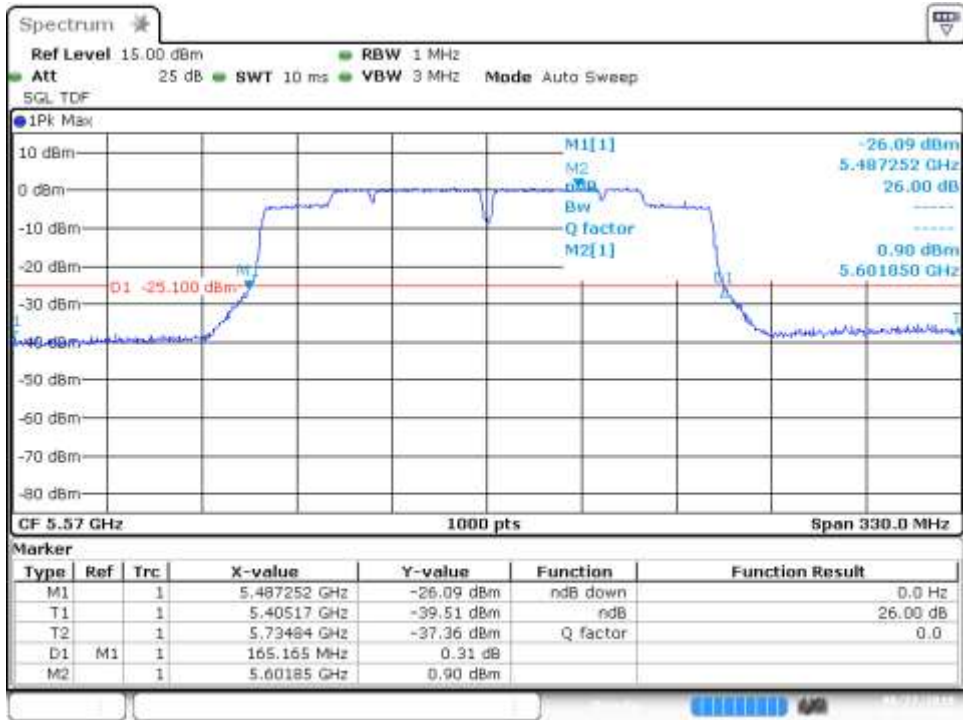

SISO-A, 802.11ax20, HE0

Channel 120

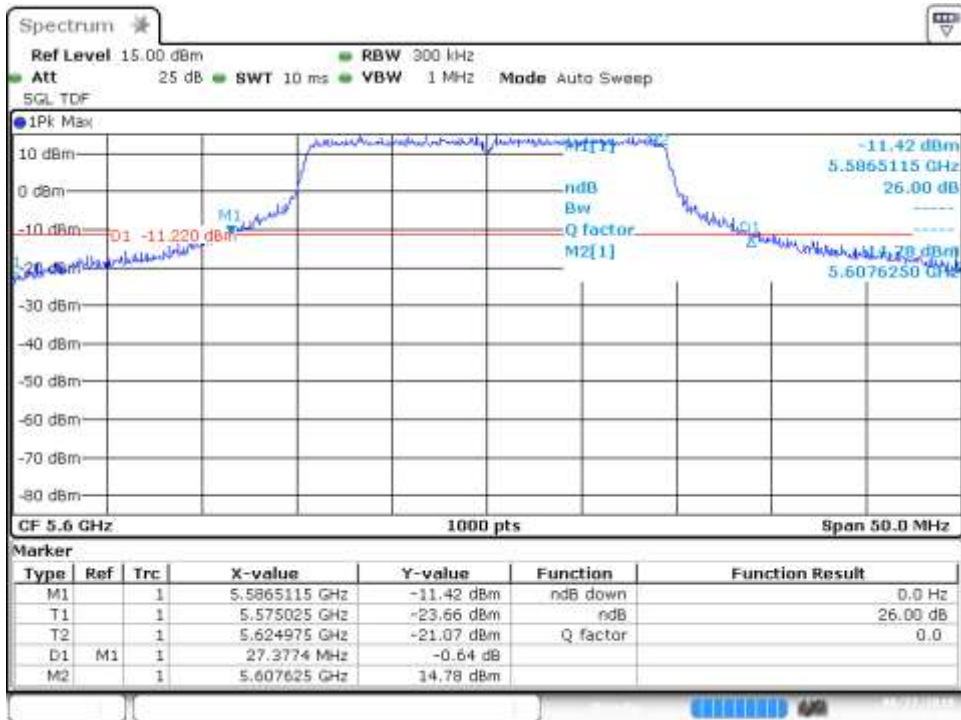

MIMO-A, 802.11ax20, HE0

Channel 100

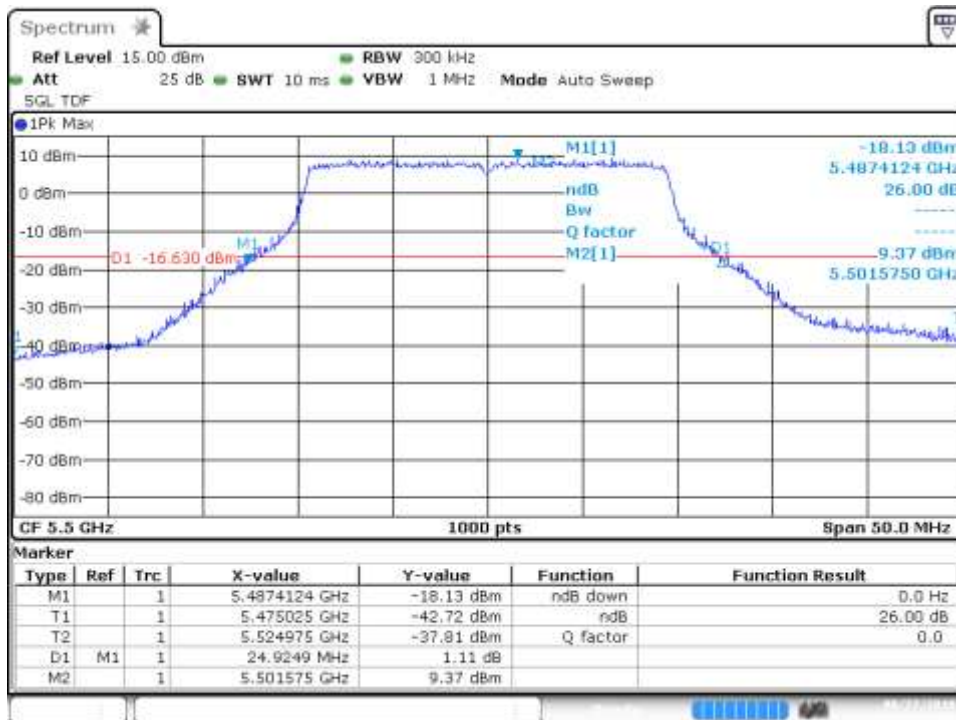

SISO-A, 802.11ax40, HE0

Channel 118F

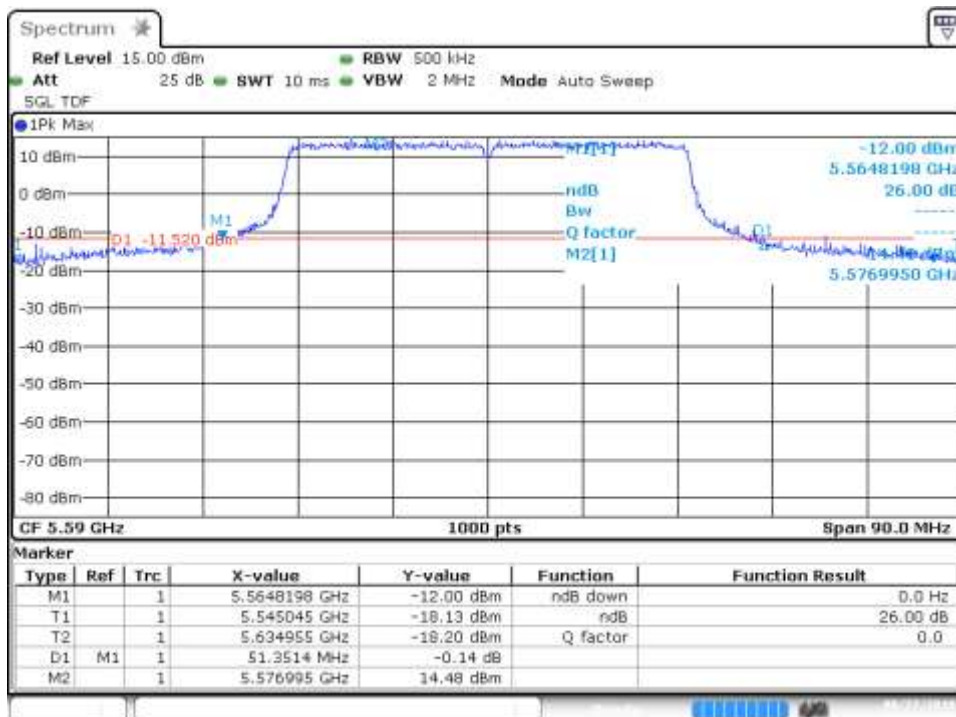

MIMO-A, 802.11ax40, HE0

Channel 118F

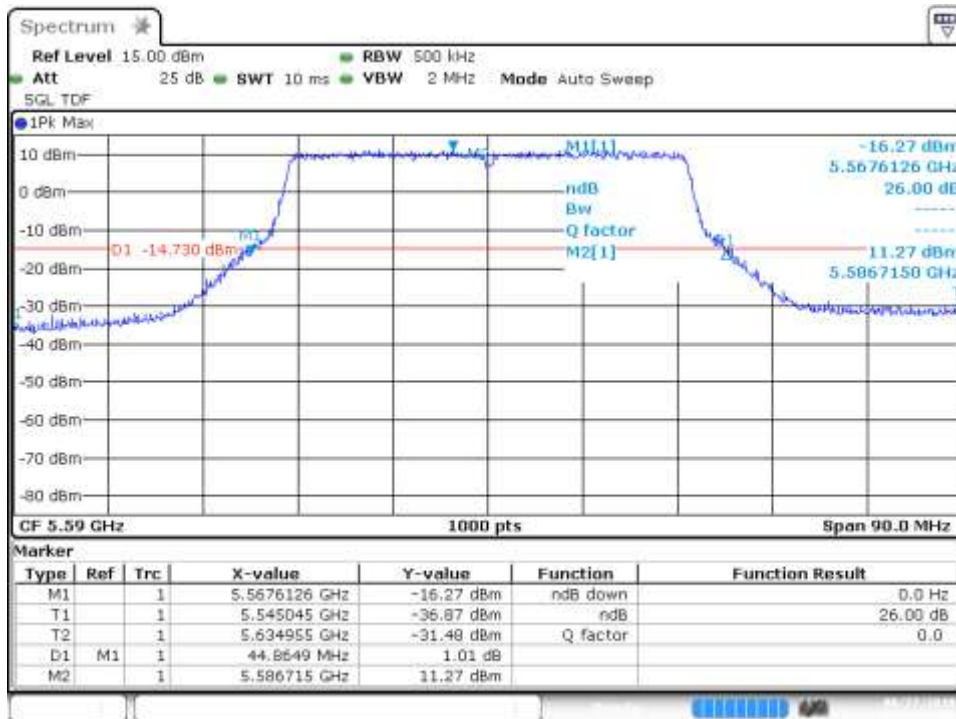

SISO-B, 802.11ax80, HE0

Channel 122ac80

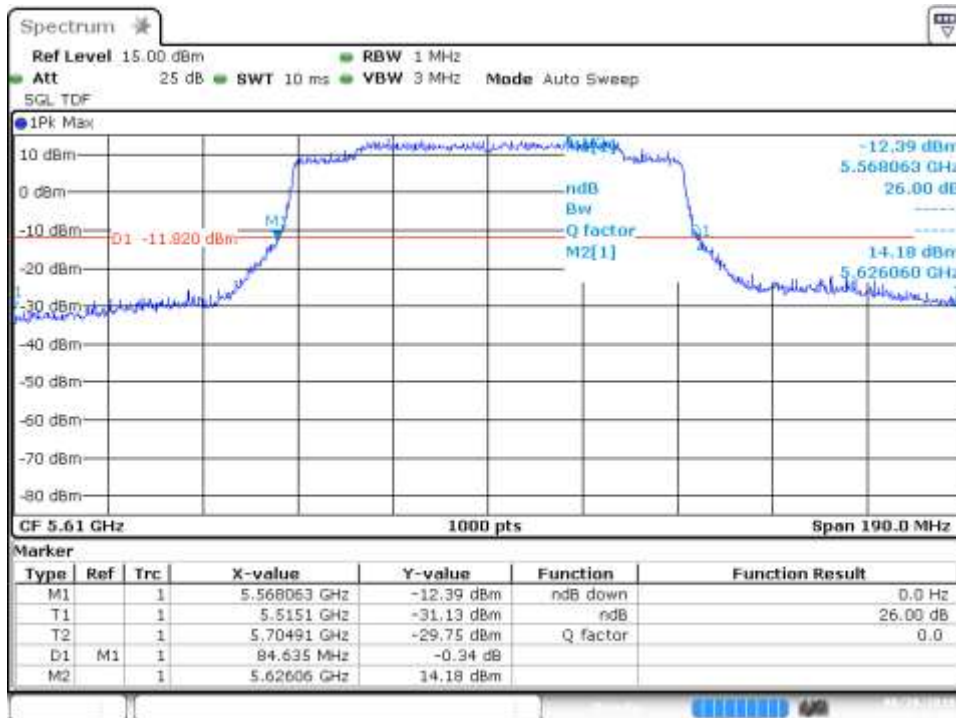

MIMO-A, 802.11ax80, HE0

Channel 122ac80

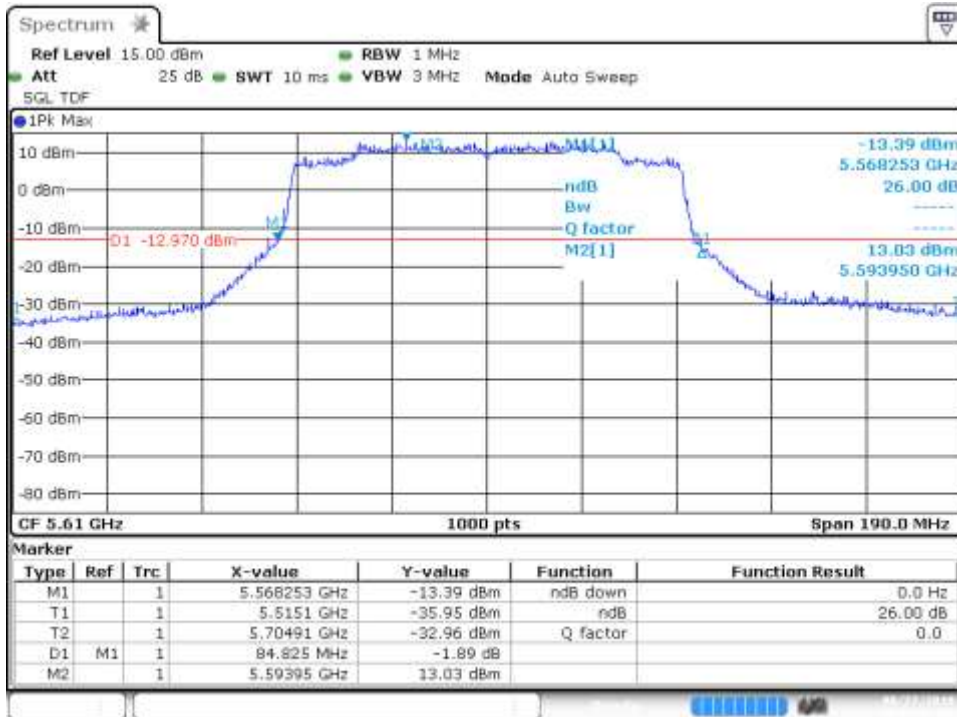

SISO-A, 802.11ax160, HE0

Channel 114ac160

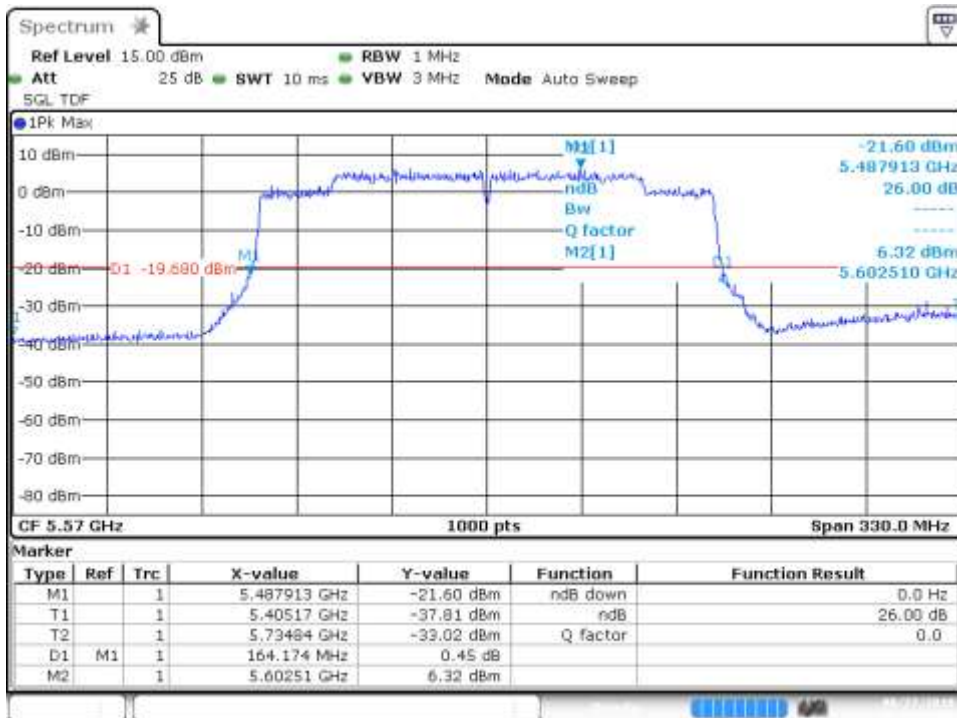

MIMO-B, 802.11ax160, HE0

Channel 114ac160

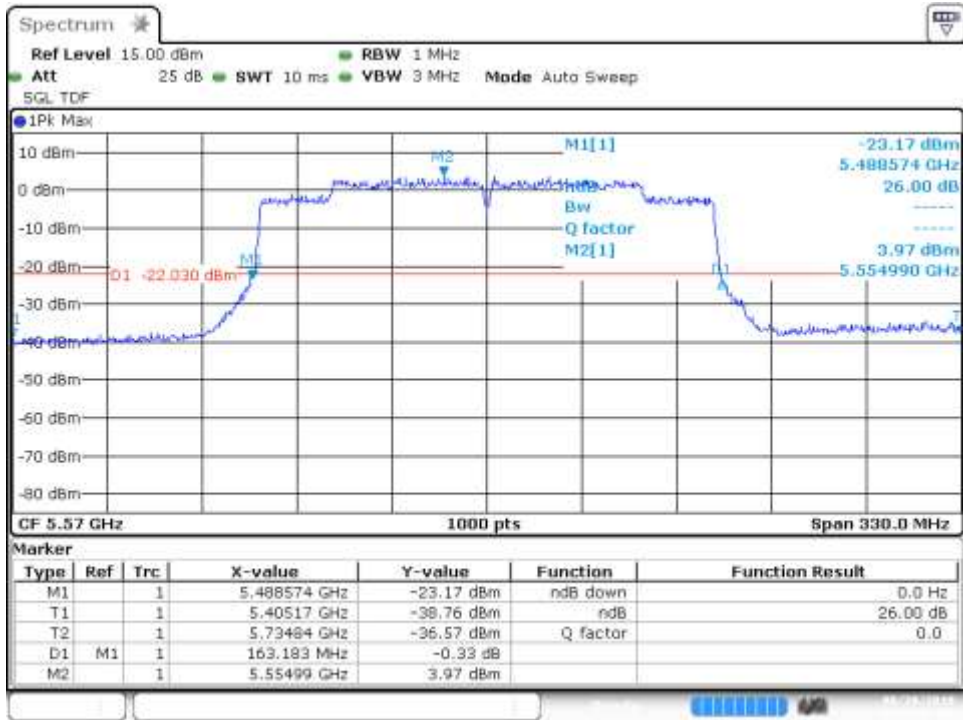

SISO-A, 802.11ax20, HE0, RU106/53

Channel 100



MIMO-B, 802.11ax20, HE0, RU 106/53

Channel 100

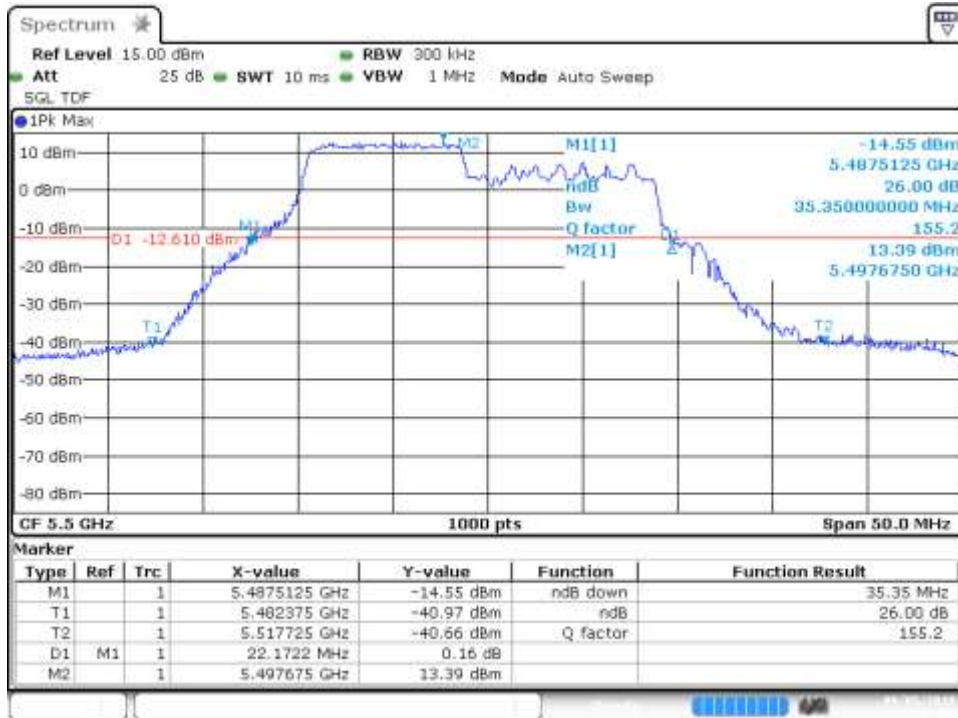

SISO-B, 802.11ax20, HE0, RU106/54

Channel 140

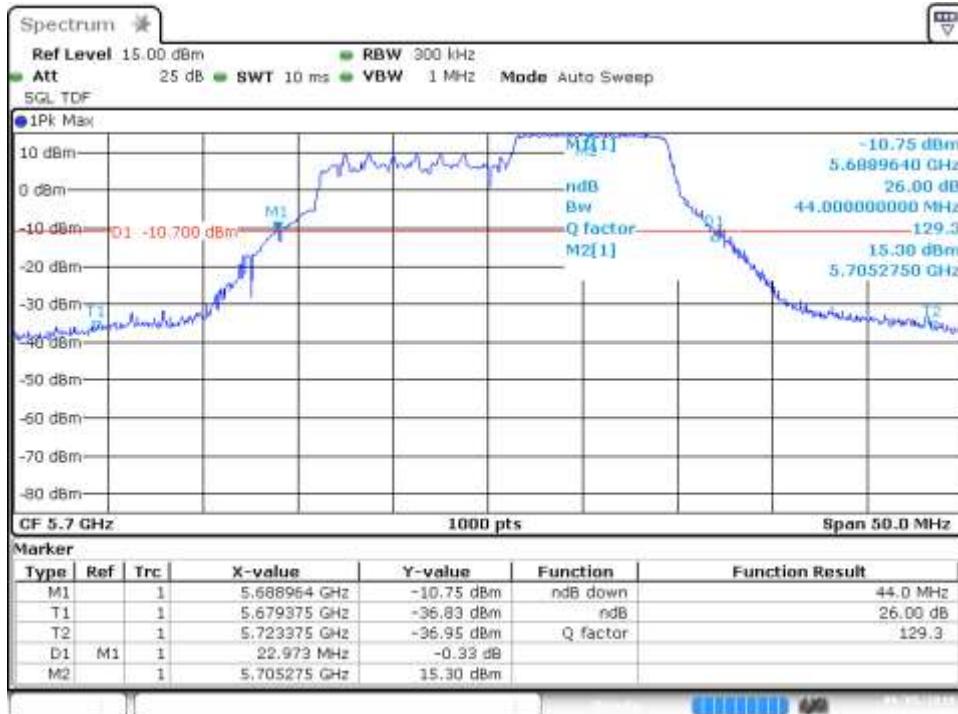

MIMO-A, 802.11ax20, HE0, RU106/54

Channel 140

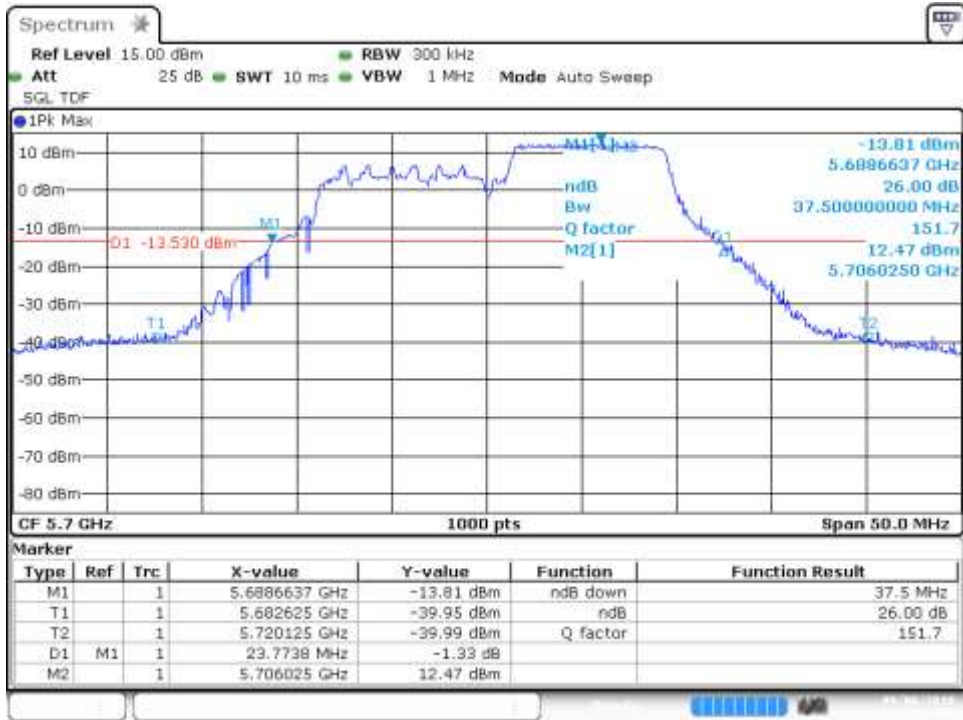

SISO-B, 802.11ax40, HE0, RU 242/61

Channel 102F

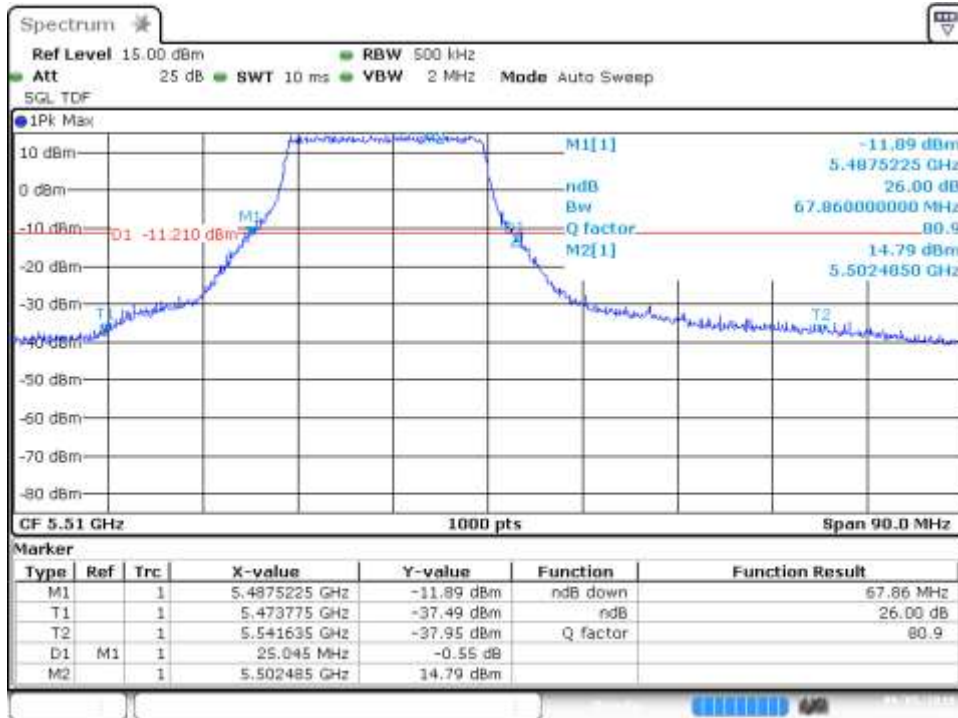

MIMO-A, 802.11ax20, HE0, RU 242/61

Channel 102F

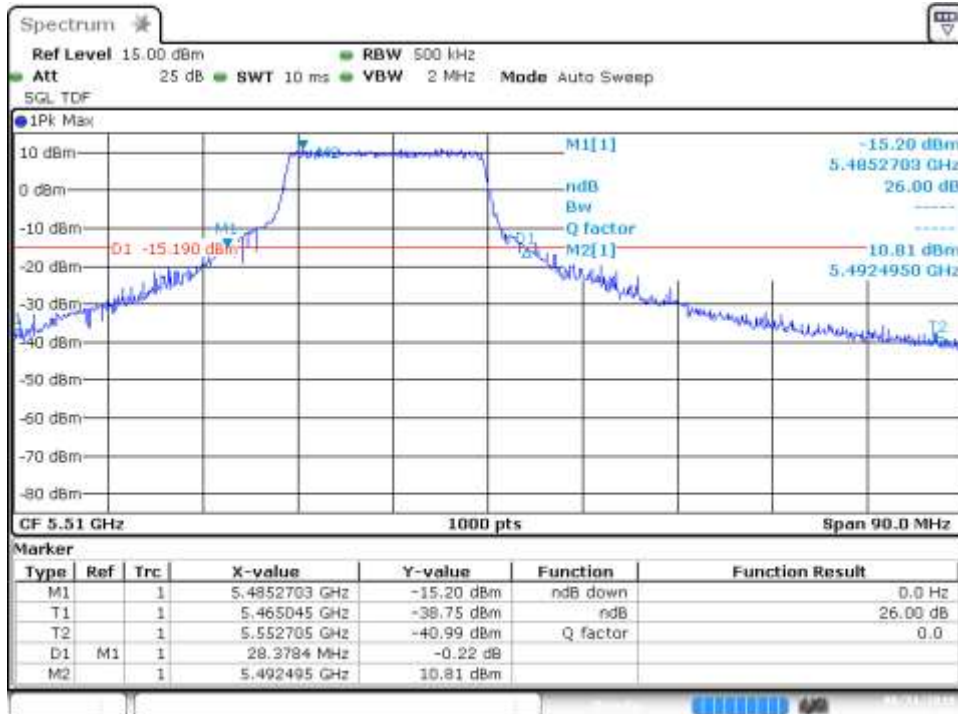

SISO-A, 802.11ax40, HE0, RU 242/62

Channel 134F

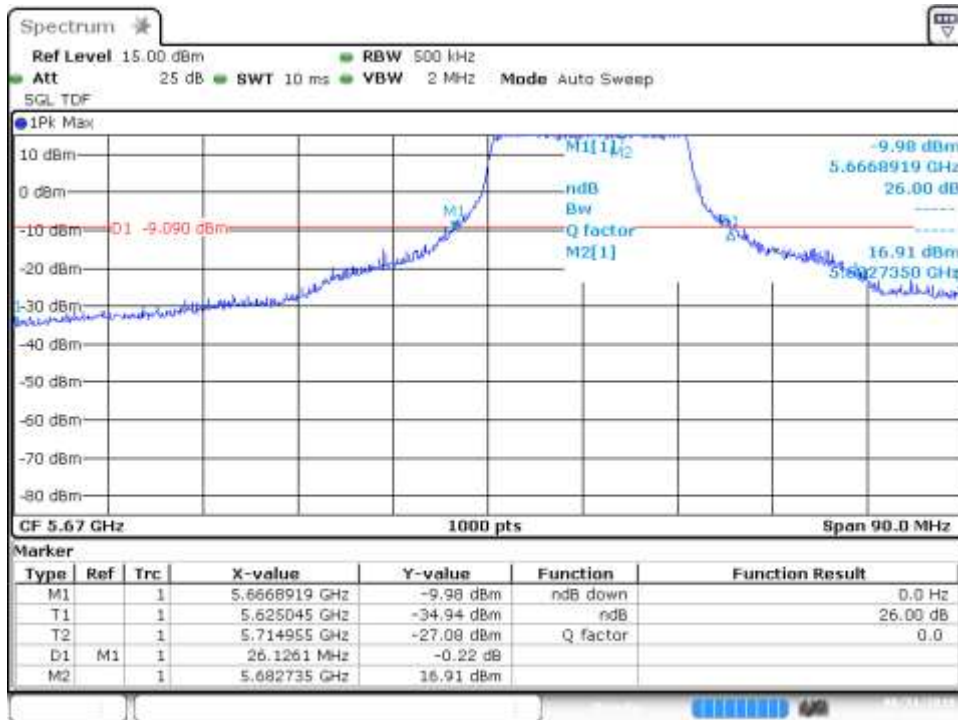

MIMO-B, 802.11ax40, HE0, RU 242/62

Channel 134F

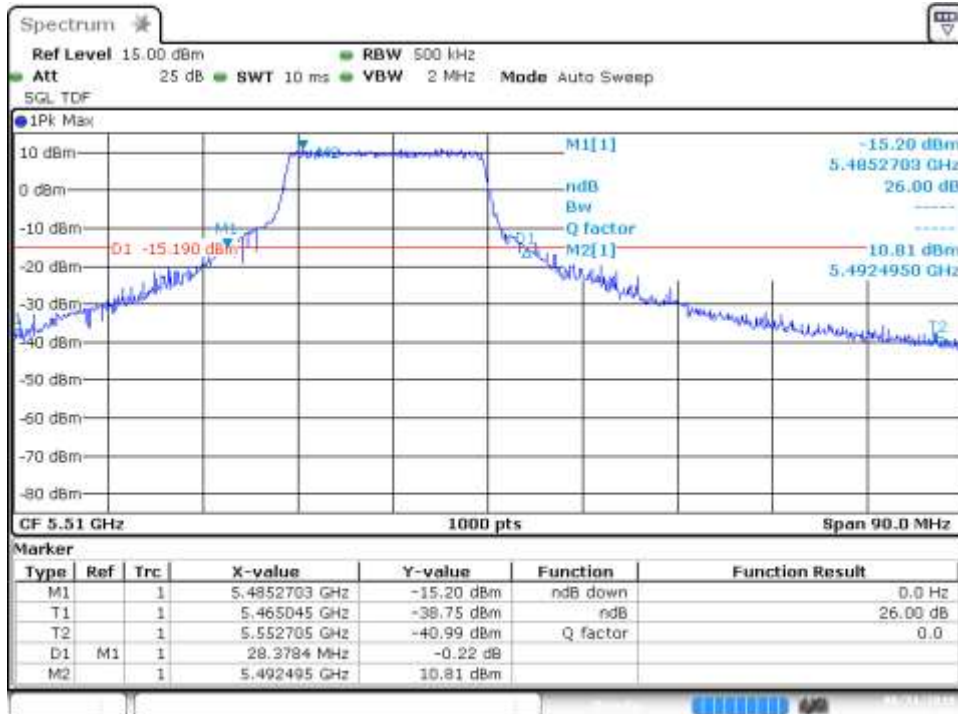

SISO-B, 802.11ax80, HE0, RU 484/65

Channel 106ac80

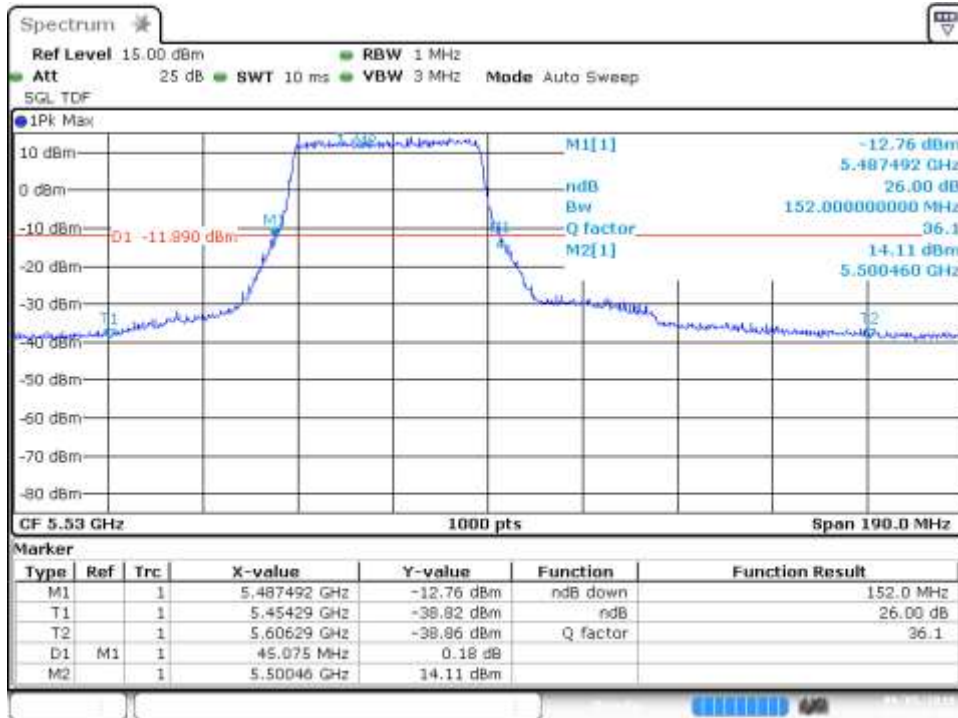

MIMO-A, 802.11ax80, HE0, RU 484/65

Channel 106ac80

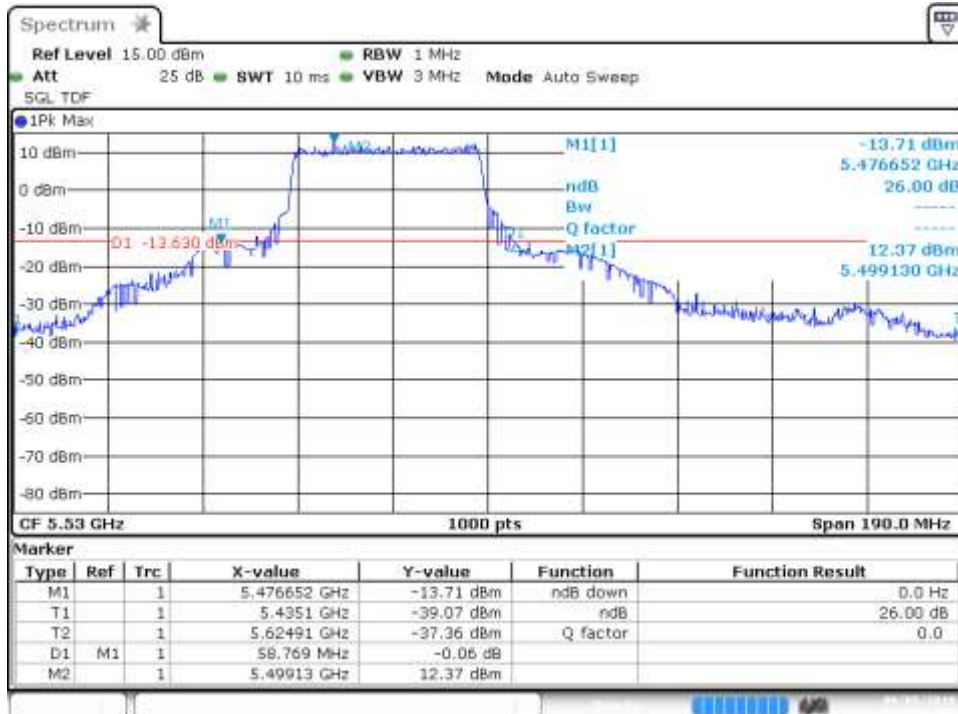

SISO-B, 802.11ax160, HE0, RU 996/S67

Channel 114ac80

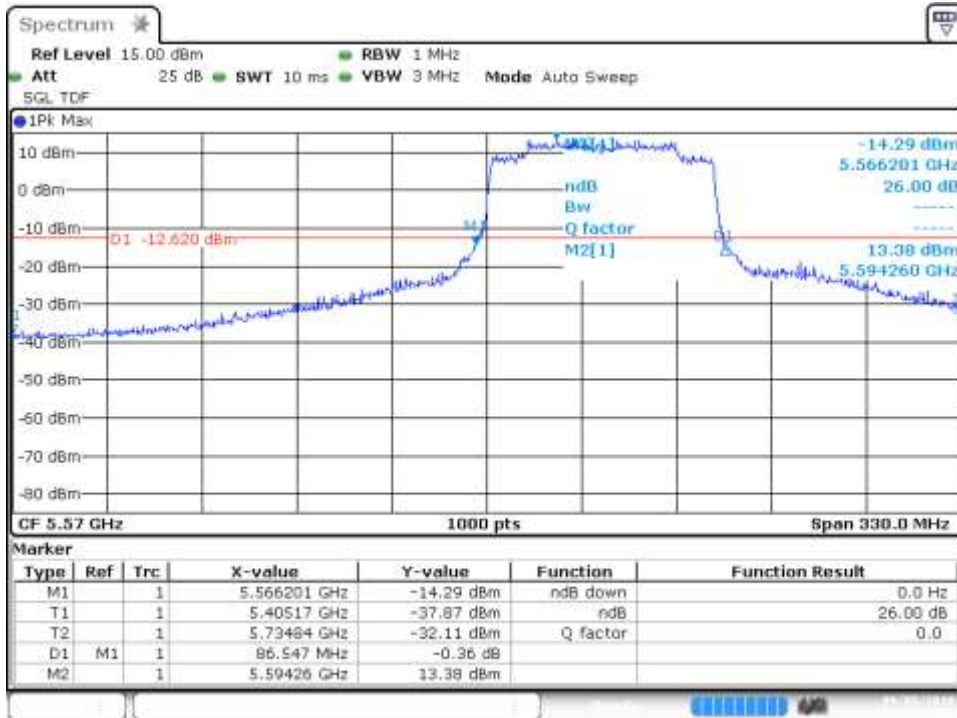

MIMO-A, 802.11ax160, HE0, RU 996/67

Channel 114ac80

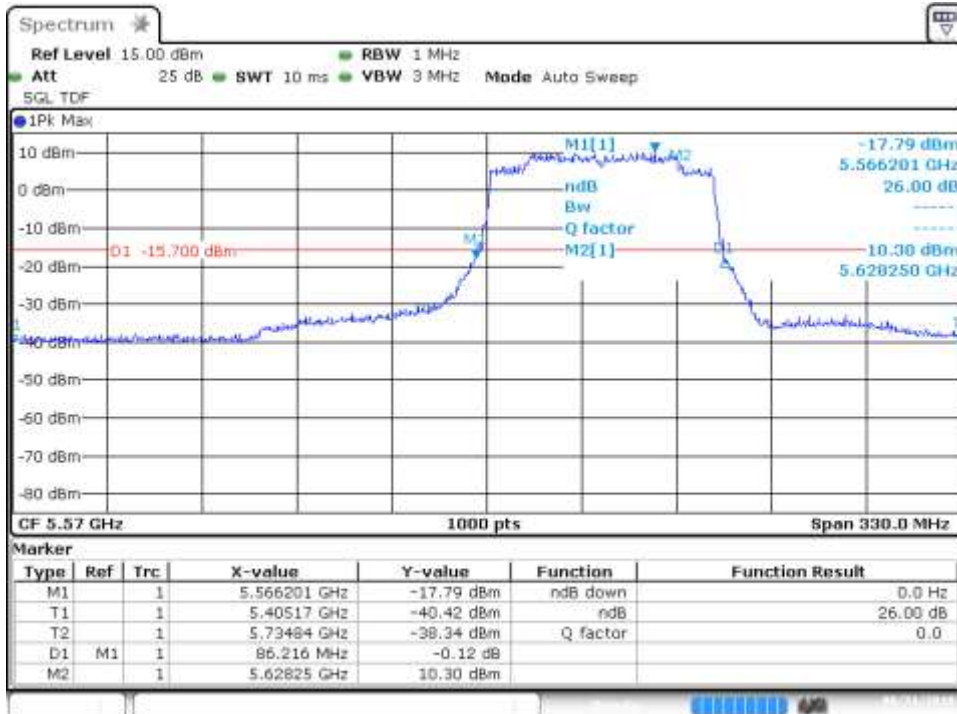

B.3.2 99% Bandwidth

SISO-A, 802.11a, 6Mbps

Channel 120

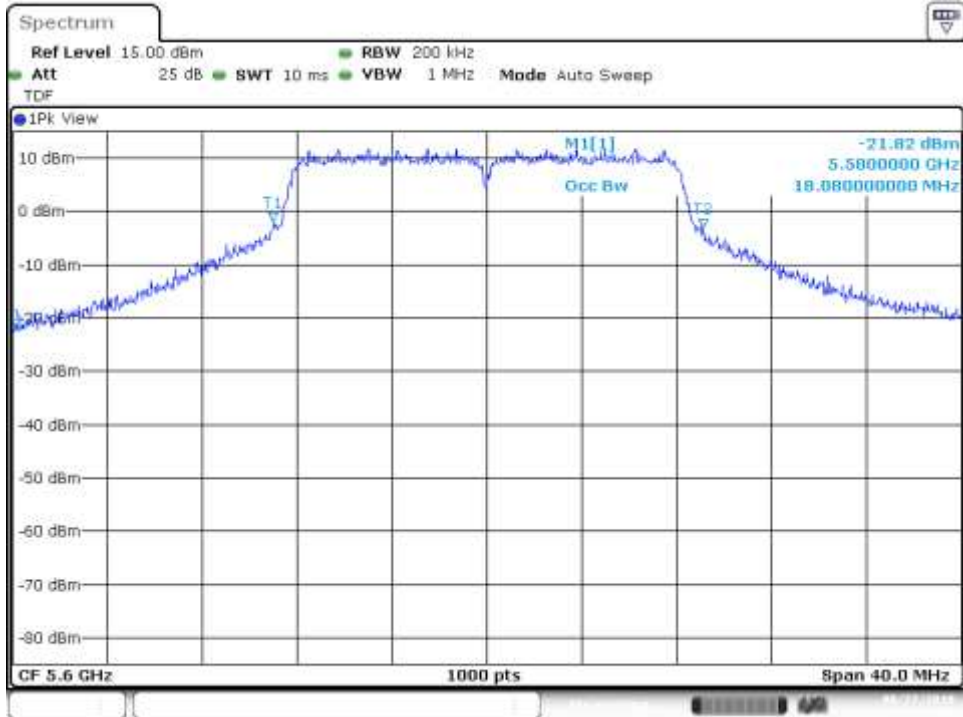

SISO-A, 802.11n20, HT0

Channel 120

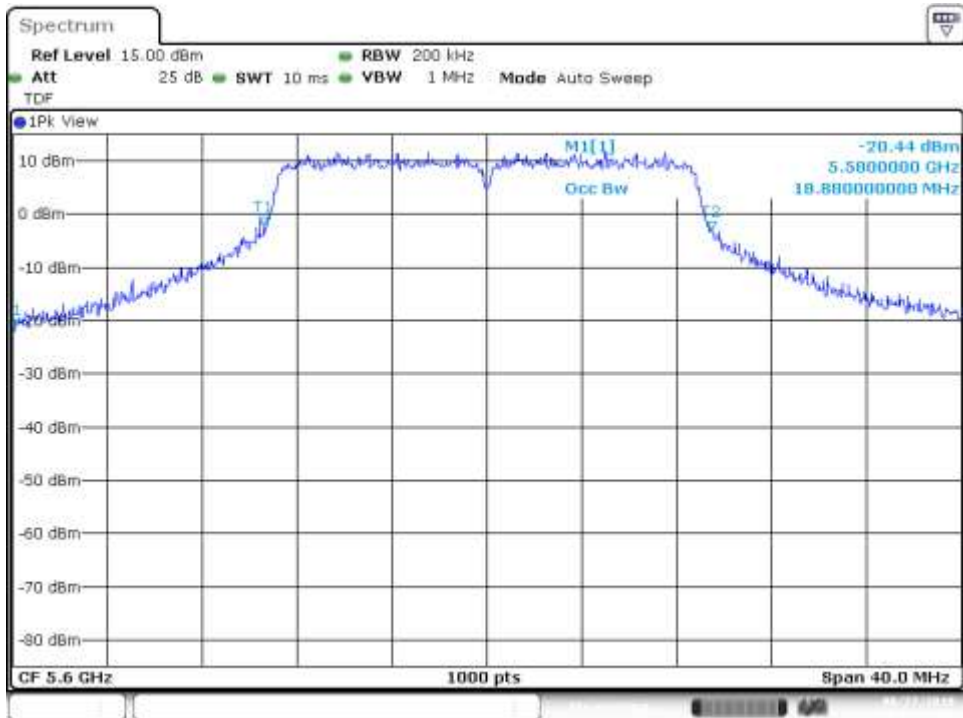

SISO-A, 802.11n40, HT0

Channel 118F

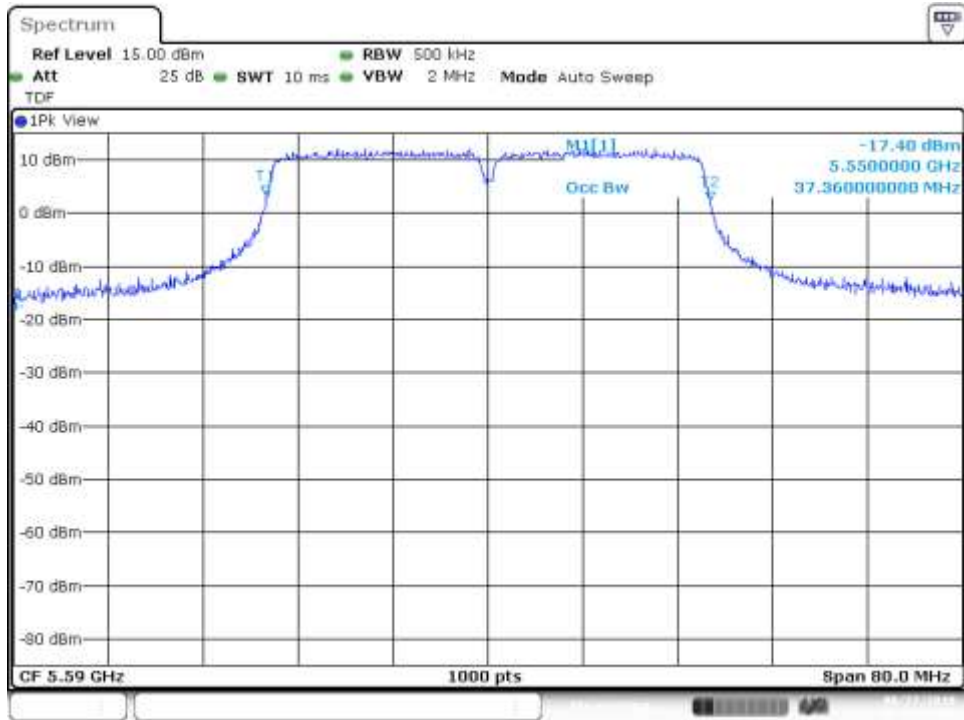

MIMO-A, 802.11n20, HT8

Channel 120



MIMO-A, 802.11n40, HT8

Channel 118F



SISO-A, 802.11ac80, VHT0

Channel 106ac80

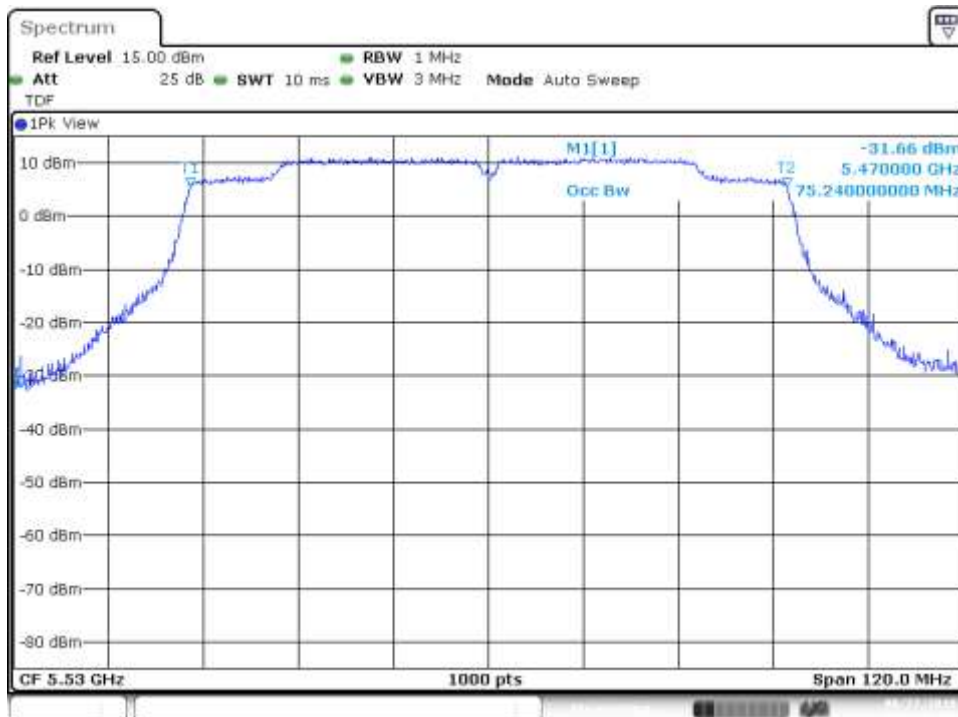

MIMO-A, 802.11ac80, VHT0

Channel 122ac80



SISO-A, 802.11ax20, HE0

Channel 120

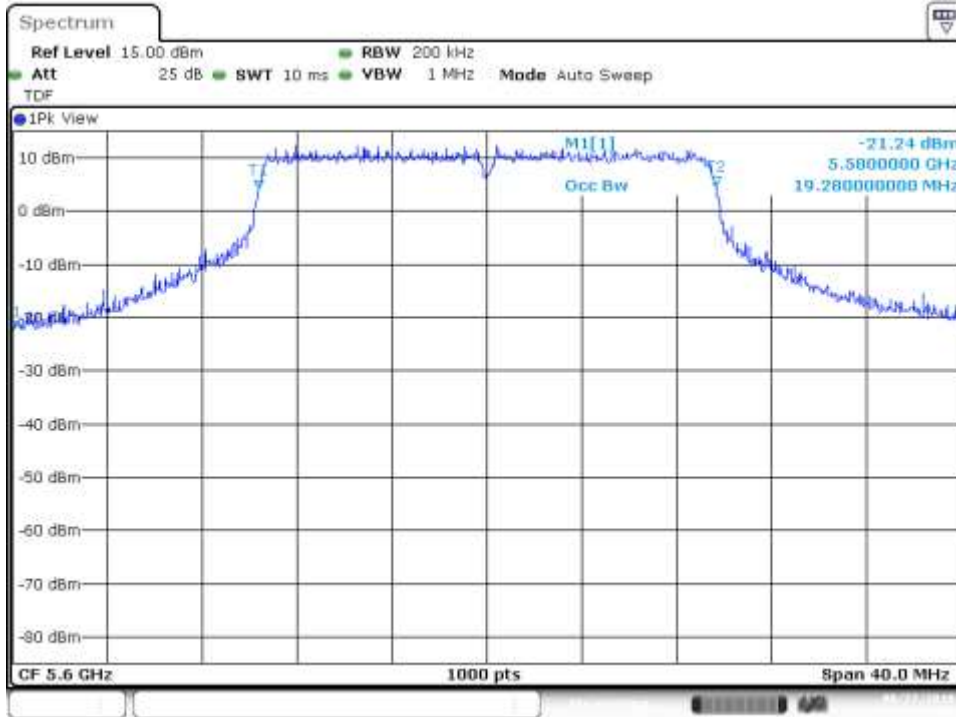

MIMO-A, 802.11ax20, HE0

Channel 100

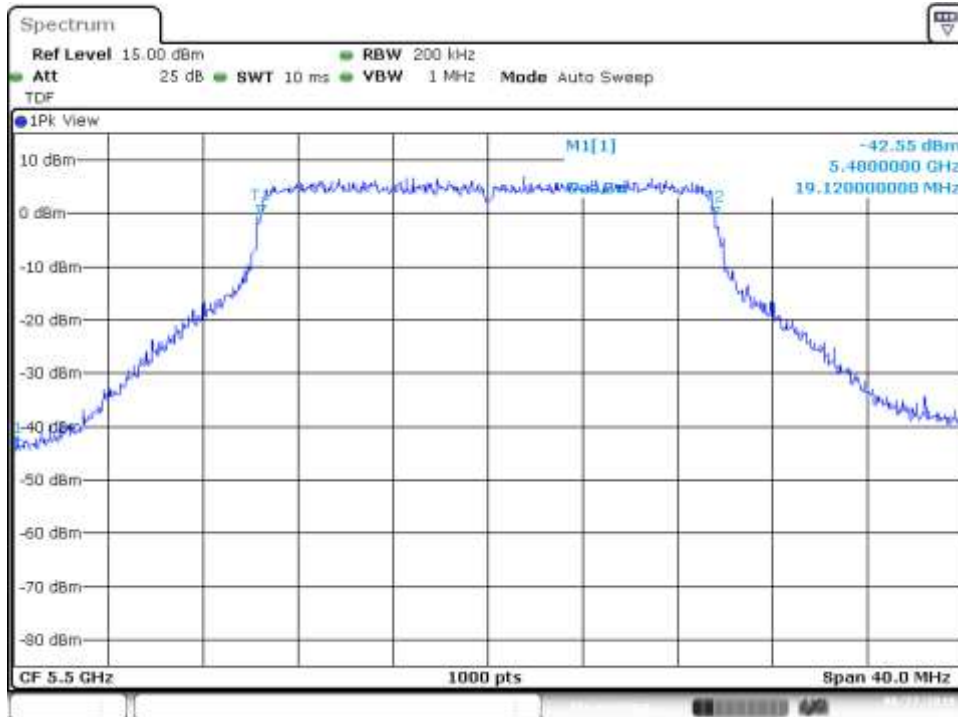

SISO-A, 802.11ax40, HE0

Channel 118F

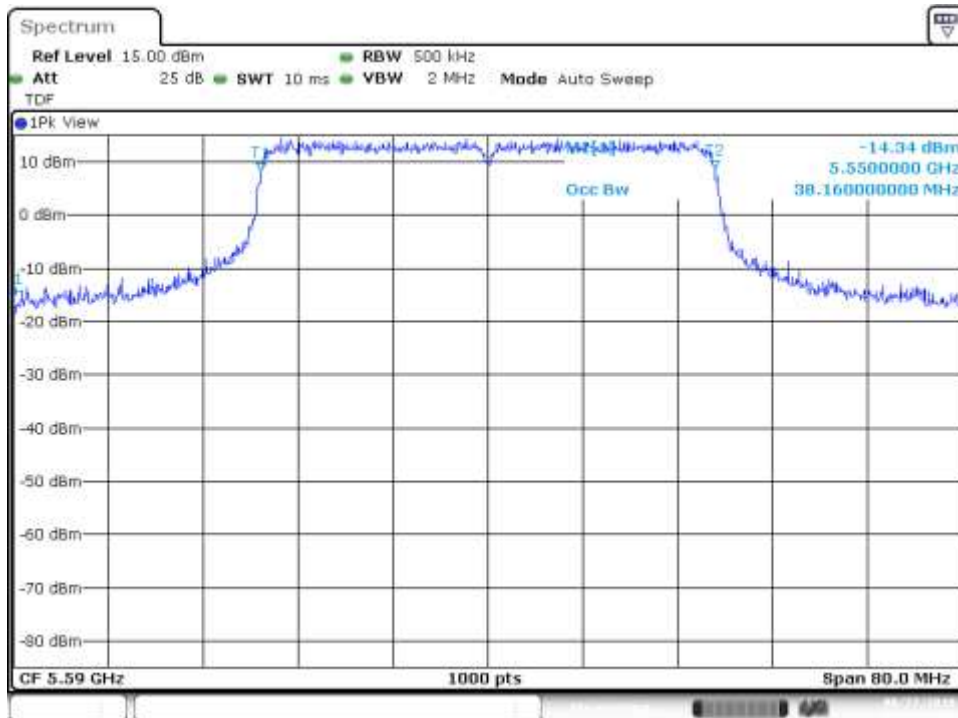

MIMO-A, 802.11ax40, HE0

Channel 118F

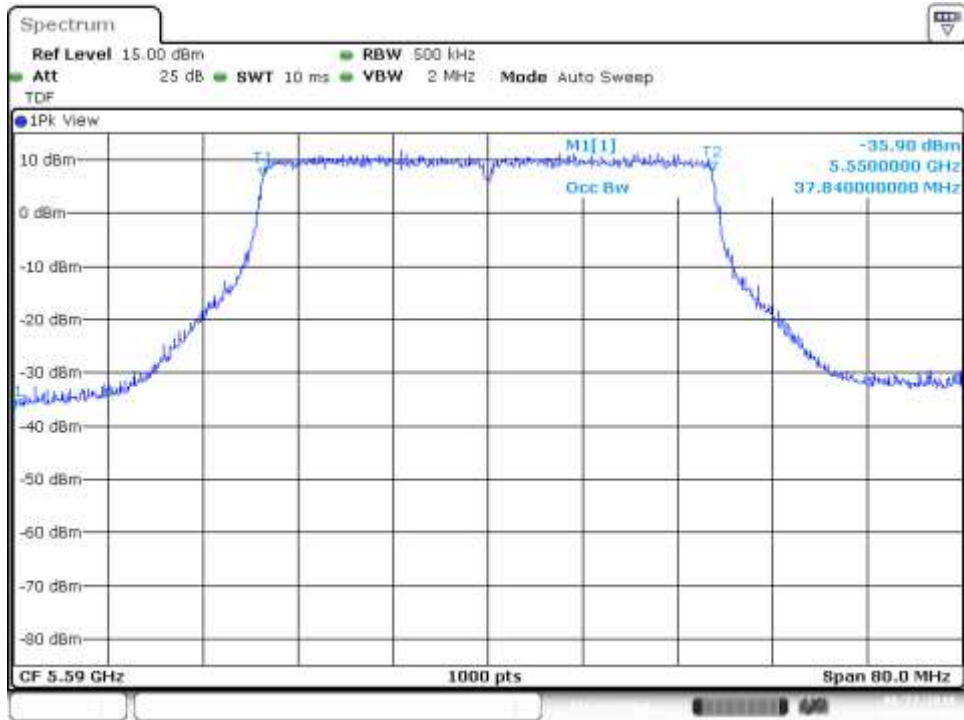

SISO-B, 802.11ax80, HE0

Channel 122ax80

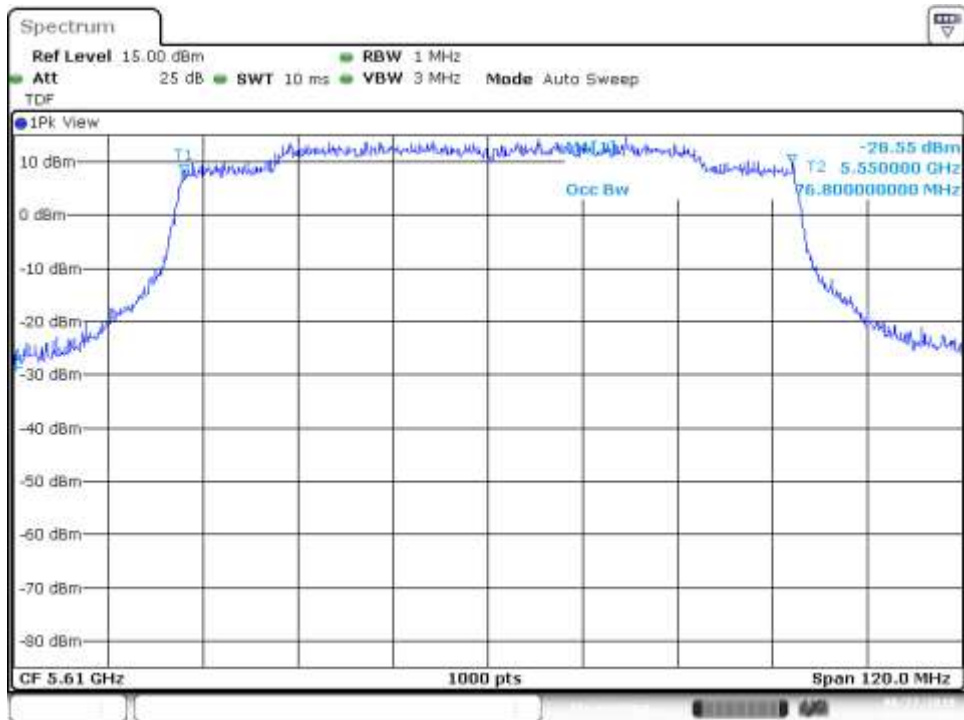

MIMO-A, 802.11ax80, HE0

Channel 106ax80

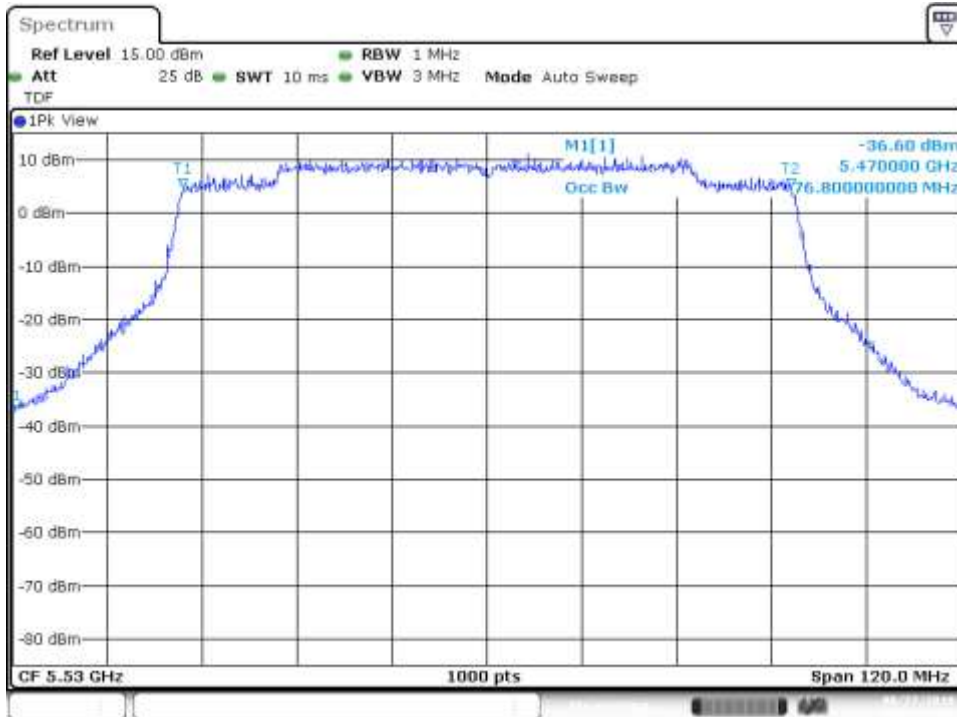

SISO-A, 802.11ax160, HE0

Channel 114ax160

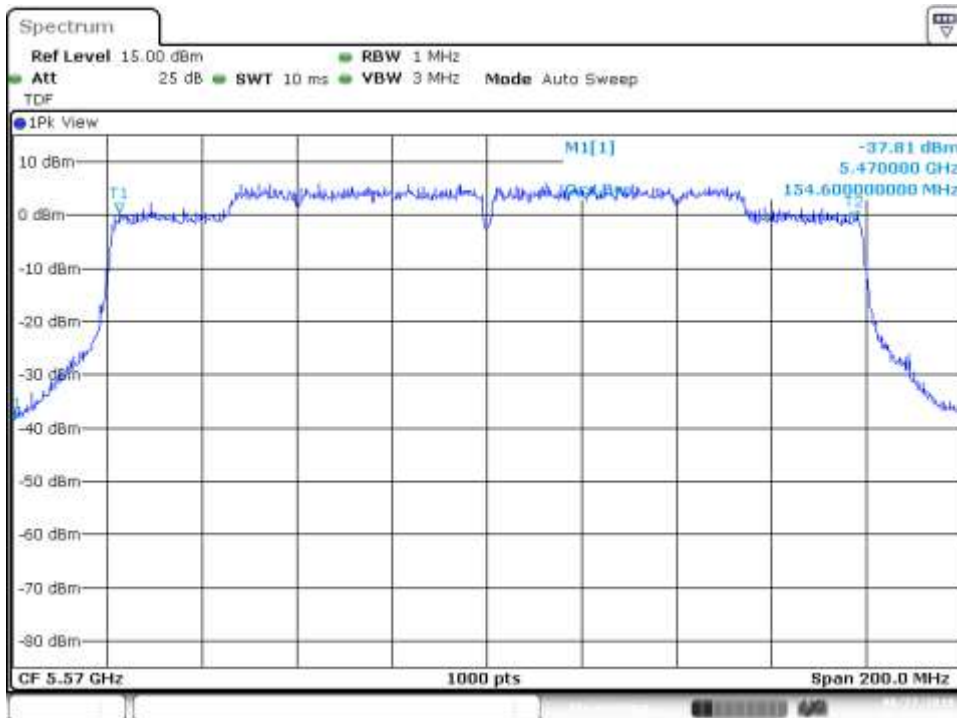

MIMO-B, 802.11ax160, HE0

Channel 114ax160

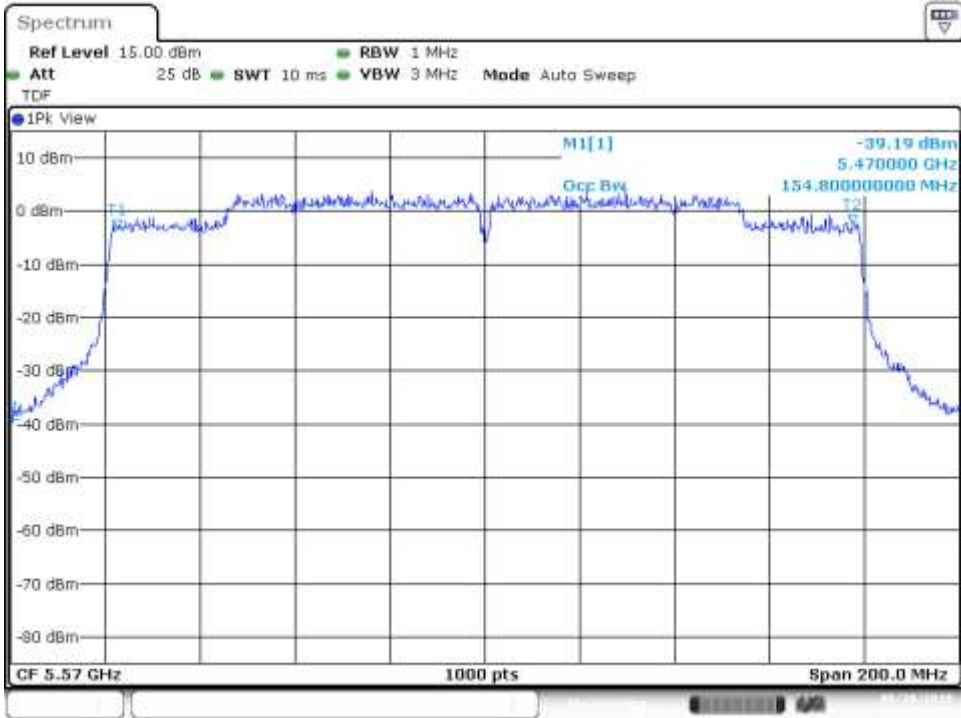

SISO-B, 802.11ax20, HE0, RU 26/0

Channel 100

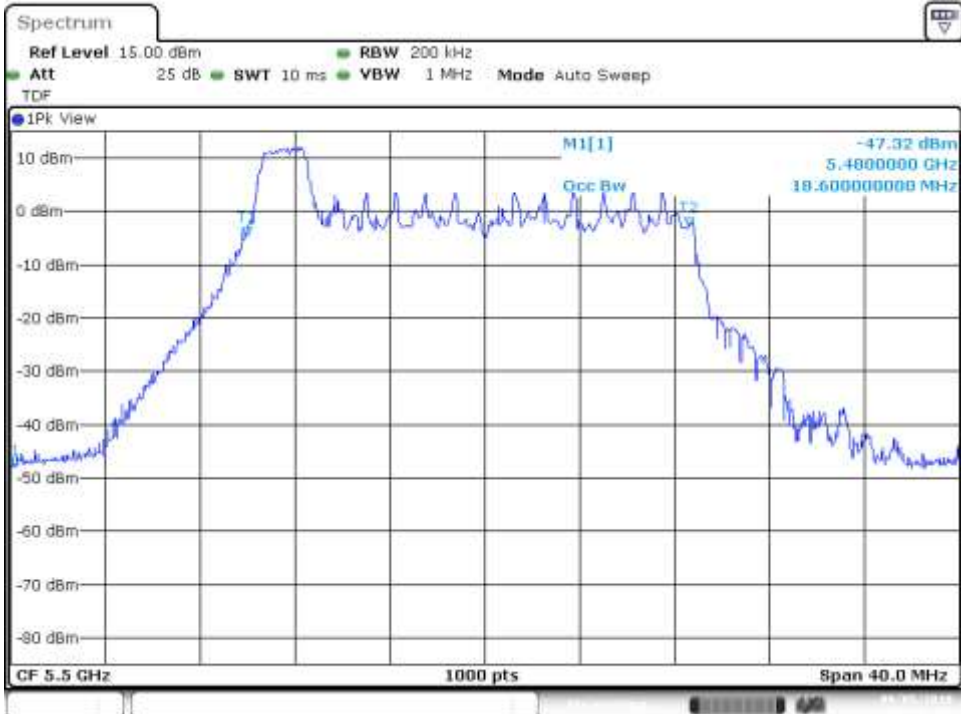

MIMO-A, 802.11ax20, HE0, RU 26/0

Channel 100

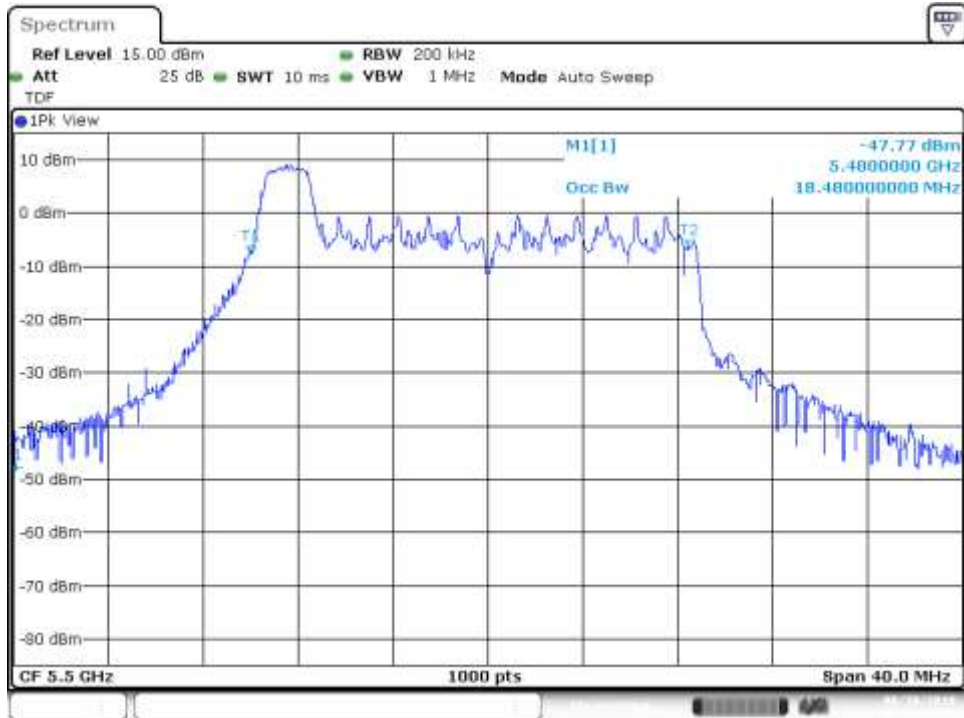

SISO-A, 802.11ax20, HE0, RU 26/8

Channel 140

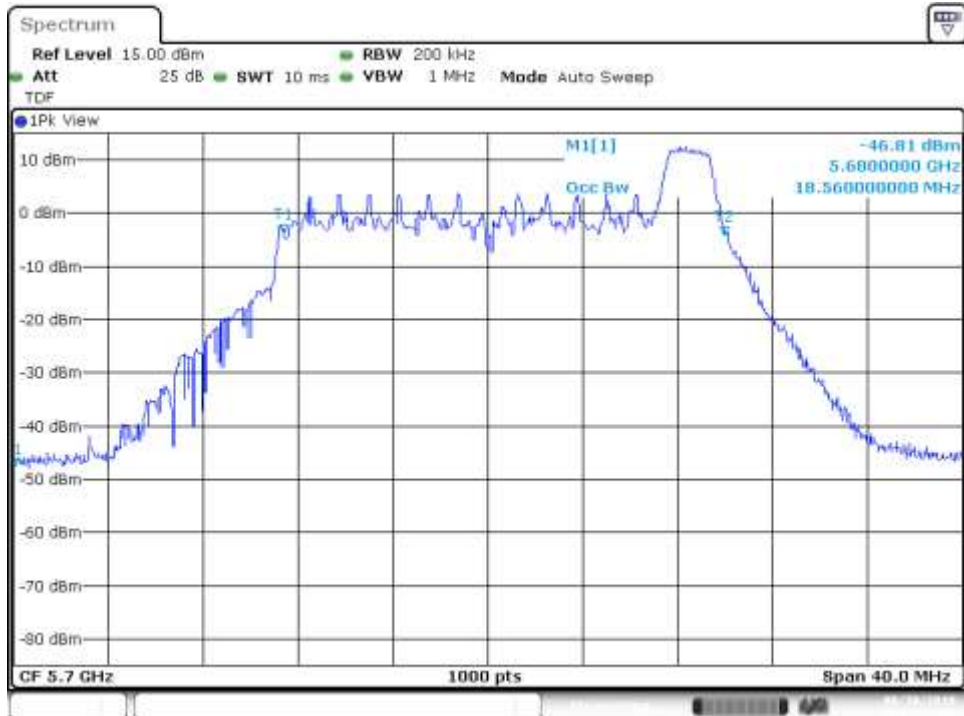

MIMO-A, 802.11ax20, HE0, RU 52/40

Channel 140

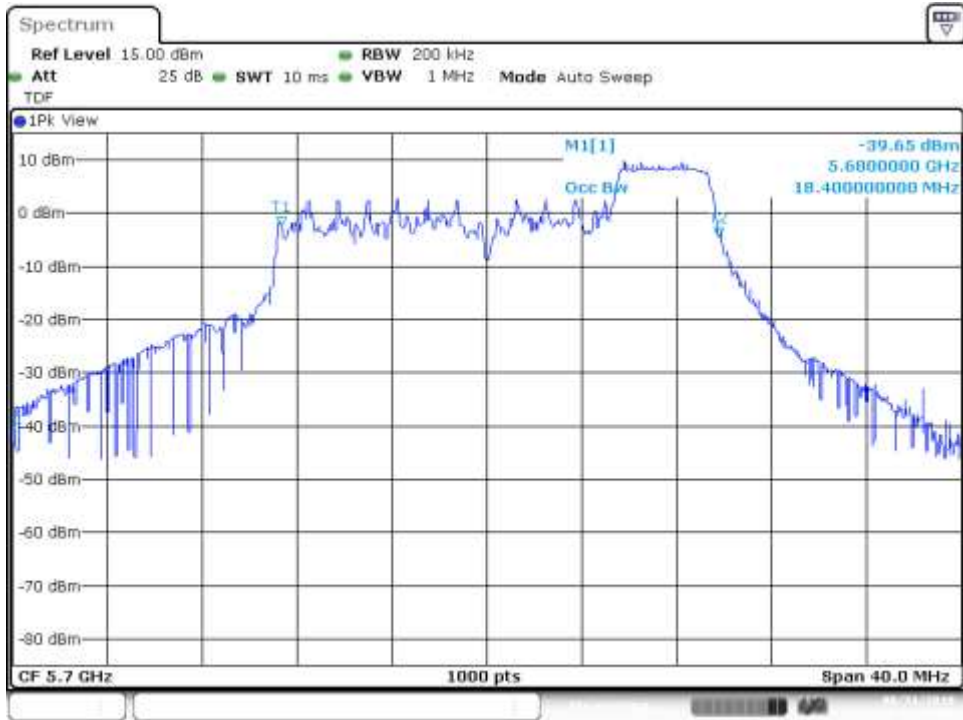

SISO-B, 802.11ax40, HE0, RU 242/61

Channel 102F

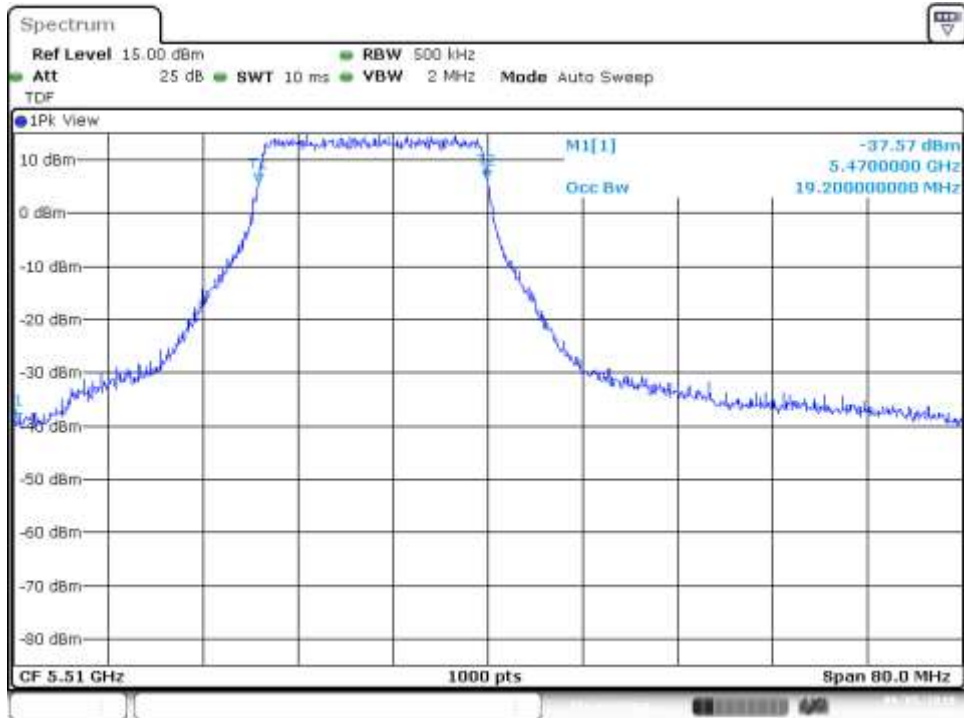

MIMO-A, 802.11ax20, HE0, RU 242/61

Channel 102F

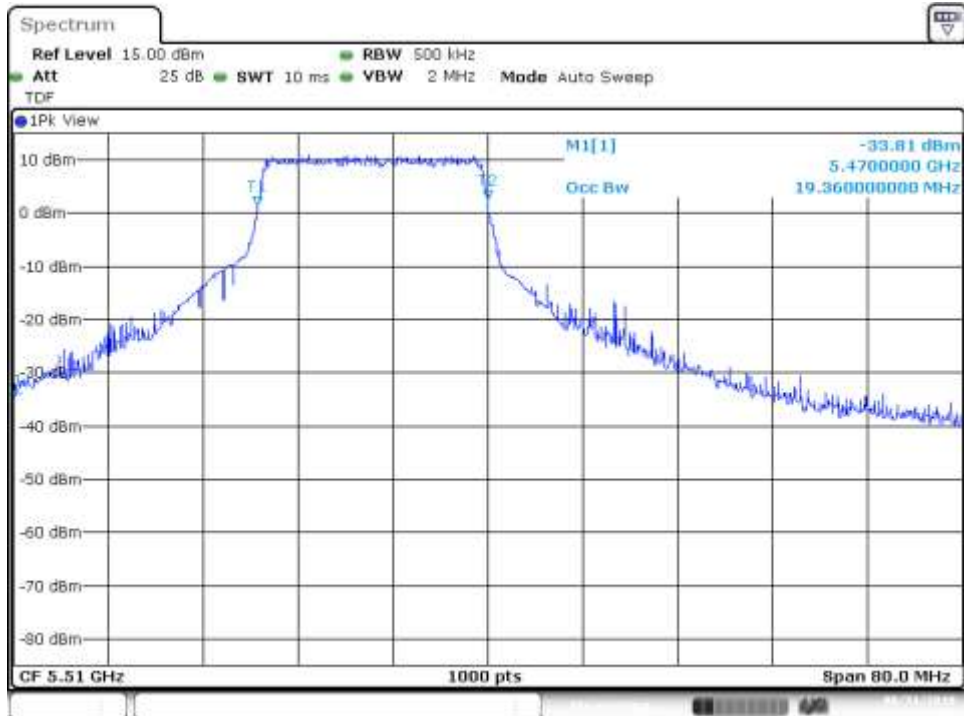

SISO-A, 802.11ax40, HE0, RU 242/62

Channel 134F

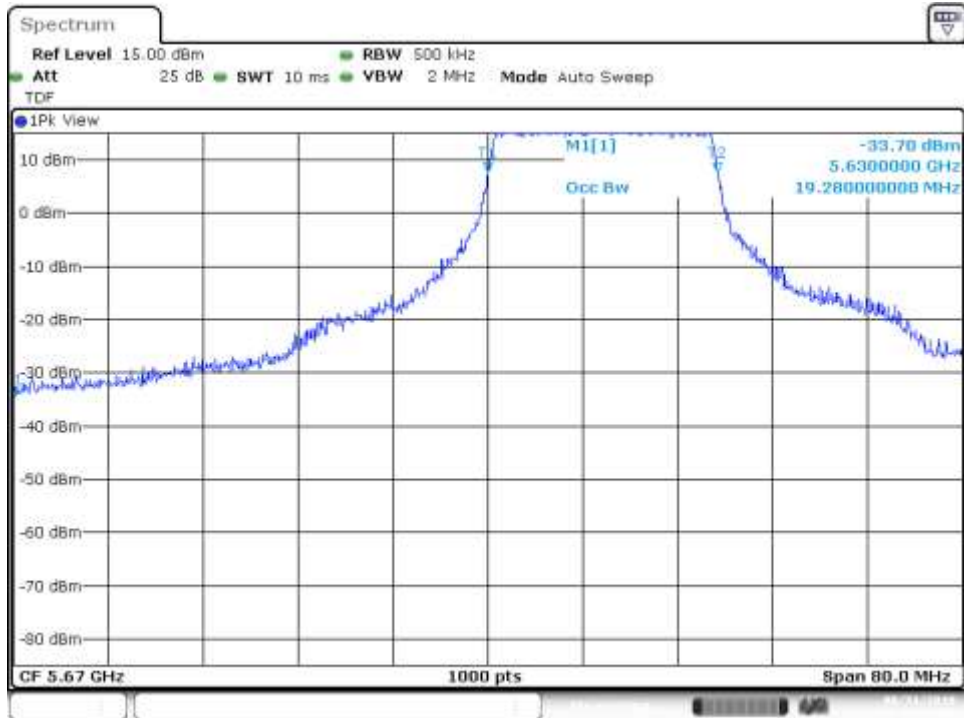

MIMO-B, 802.11ax40, HE0, RU 242/62

Channel 134F

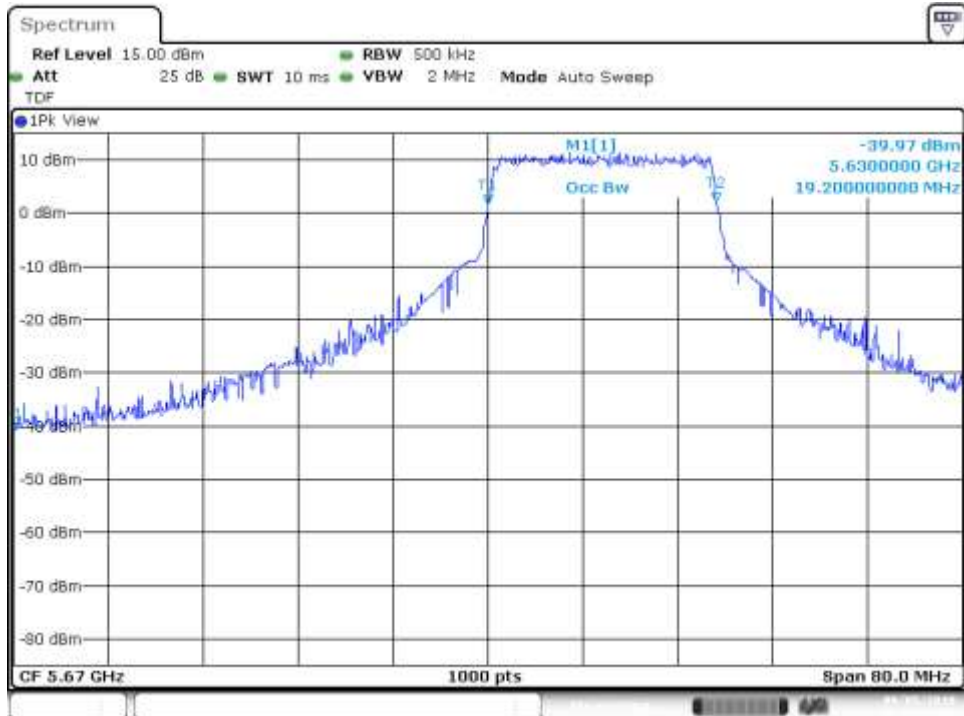

SISO-B, 802.11ax80, HE0, RU 484/65

Channel 106ax80

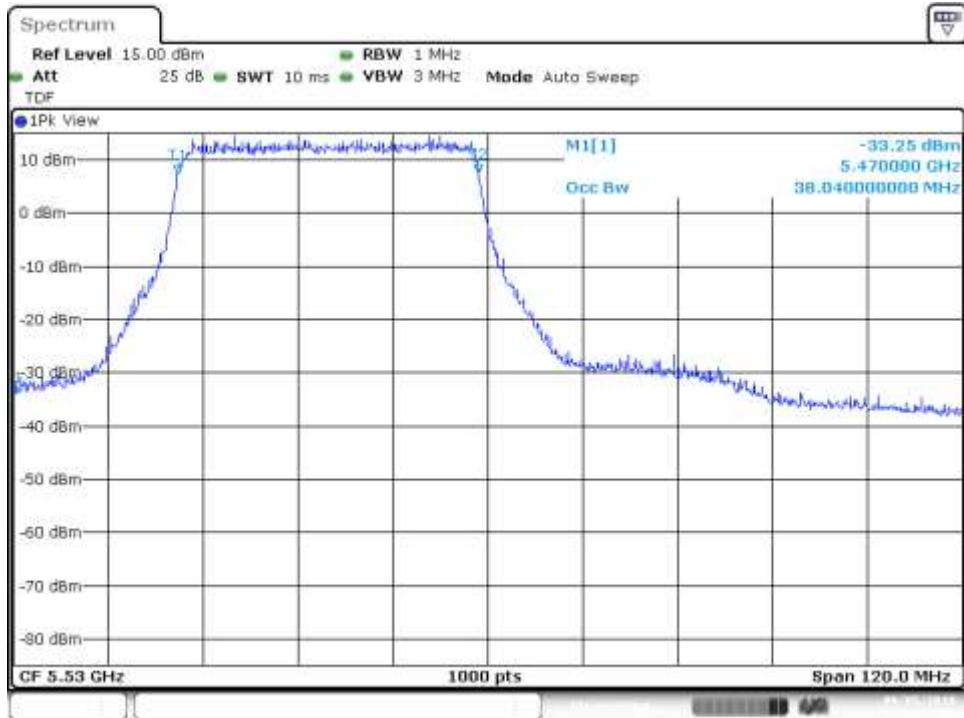

MIMO-B, 802.11ax80, HE0, RU 484/65

Channel 106ax80



SISO-B, 802.11ax160, HE0, RU 996/S67

Channel 114ax160

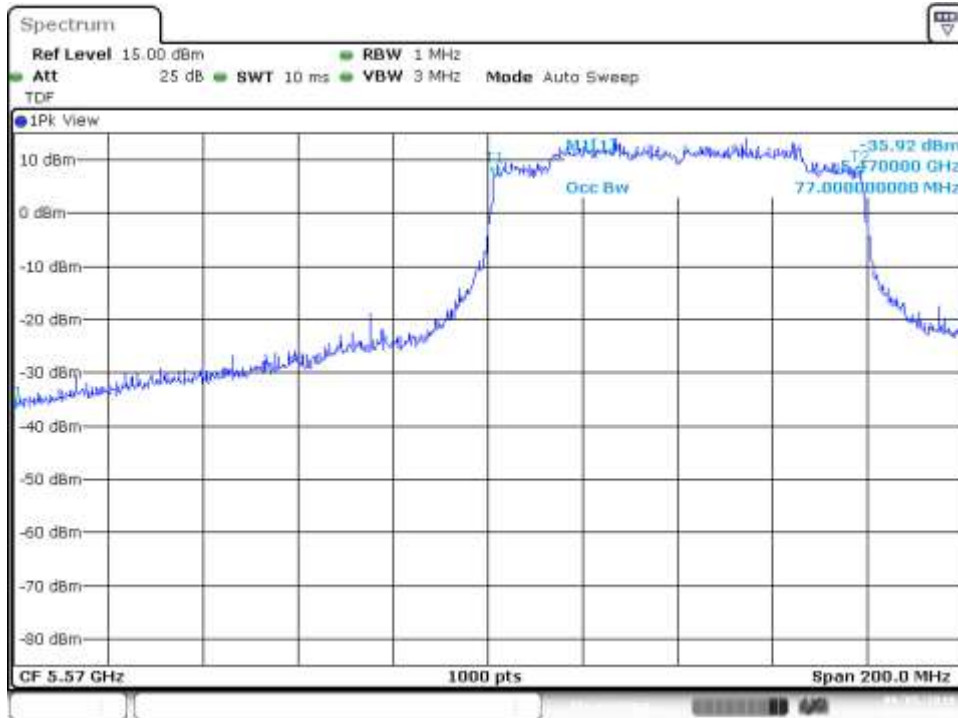

MIMO-A, 802.11ax160, HE0, RU 996/s67

Channel 114ax160

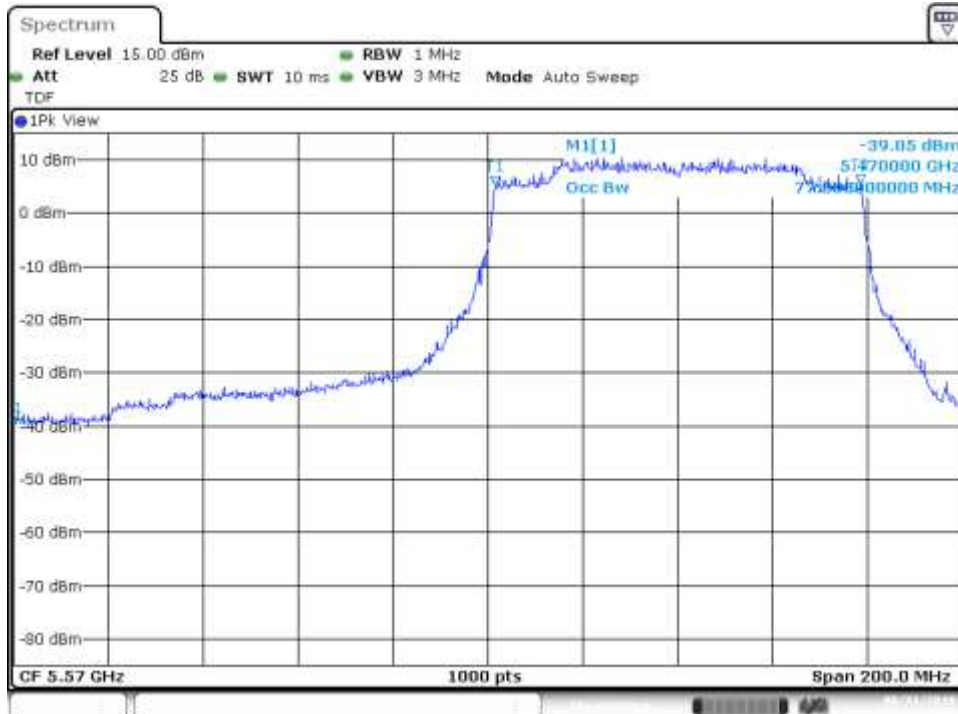

B.3.3 Maximum Output Power & Maximum power spectral Density**SISO-A, 802.11a, 6Mbps**

Channel 120

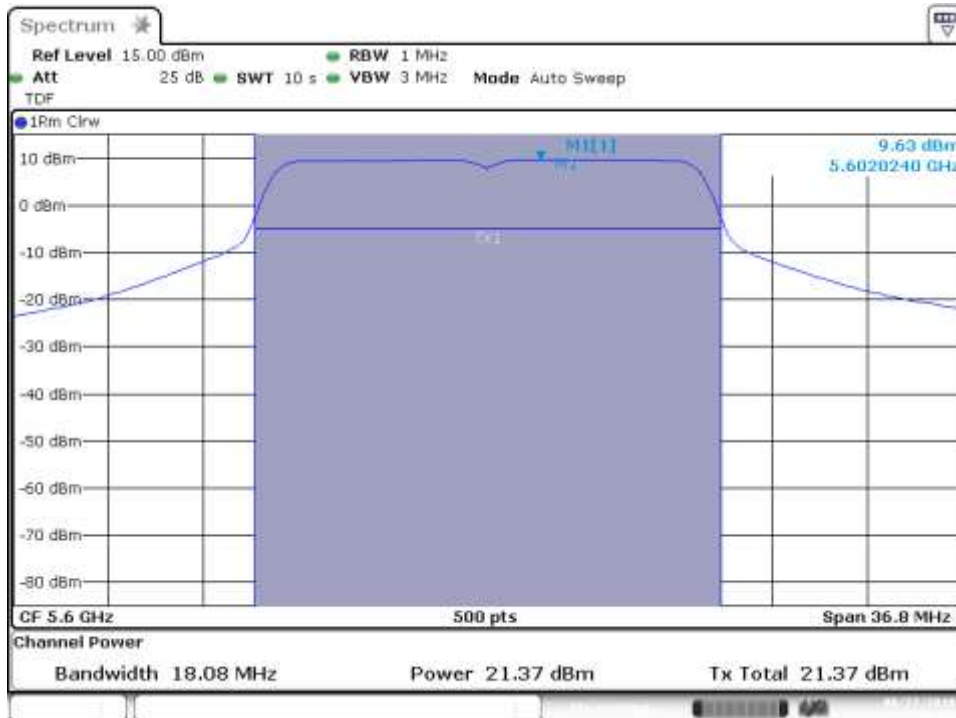
**SISO-B, 802.11a, 6Mbps**

Channel 140

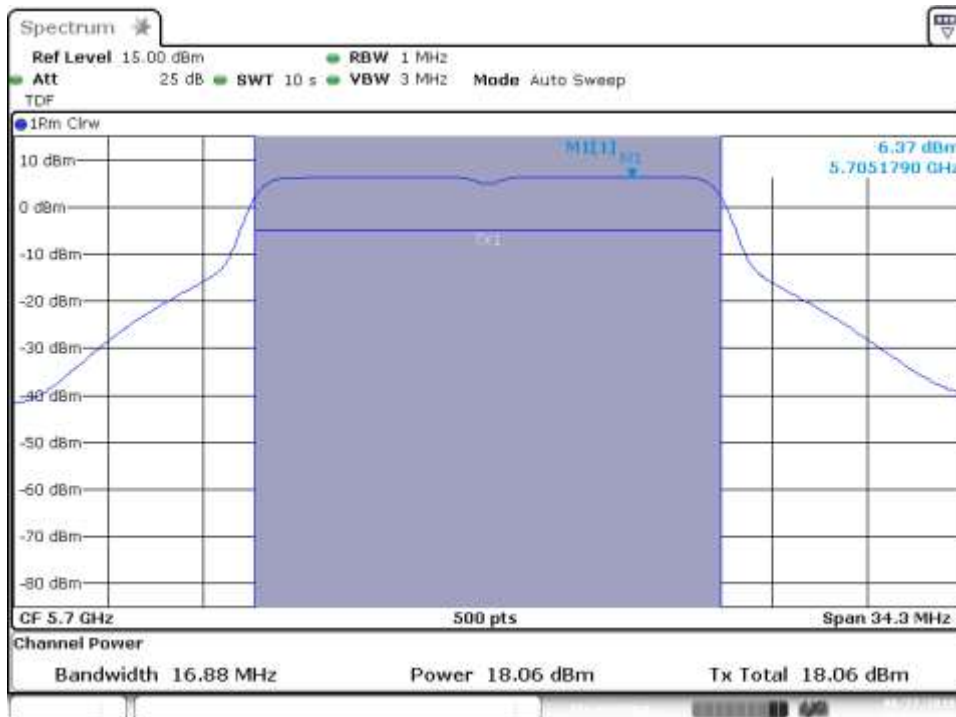

SISO-B, 802.11n20, HT0

Channel 120

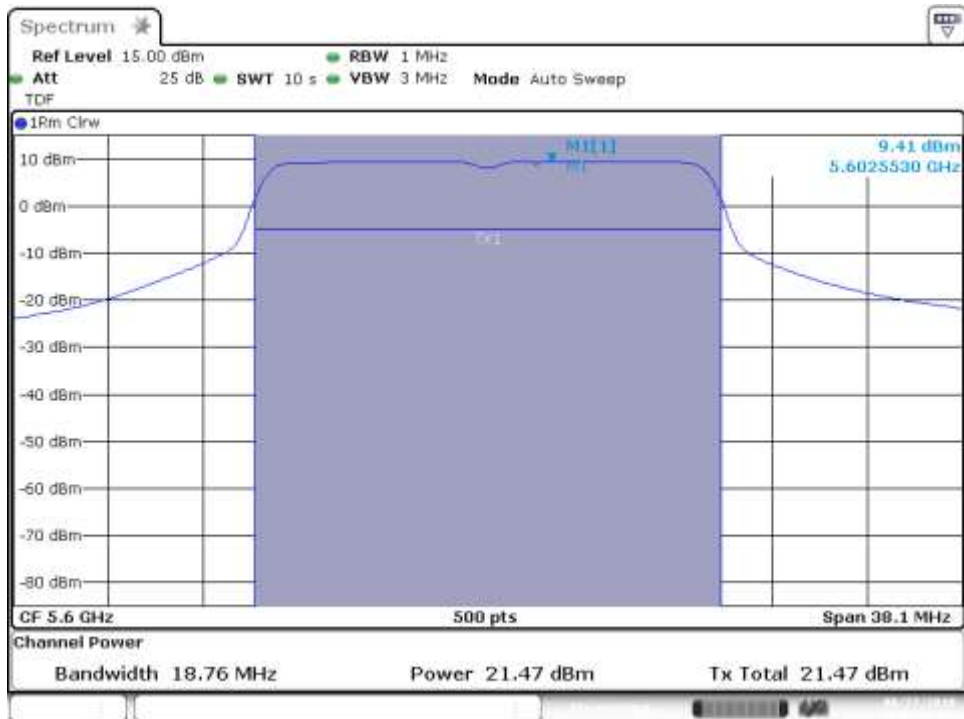

SISO-A, 802.11n20, HT0

Channel 140

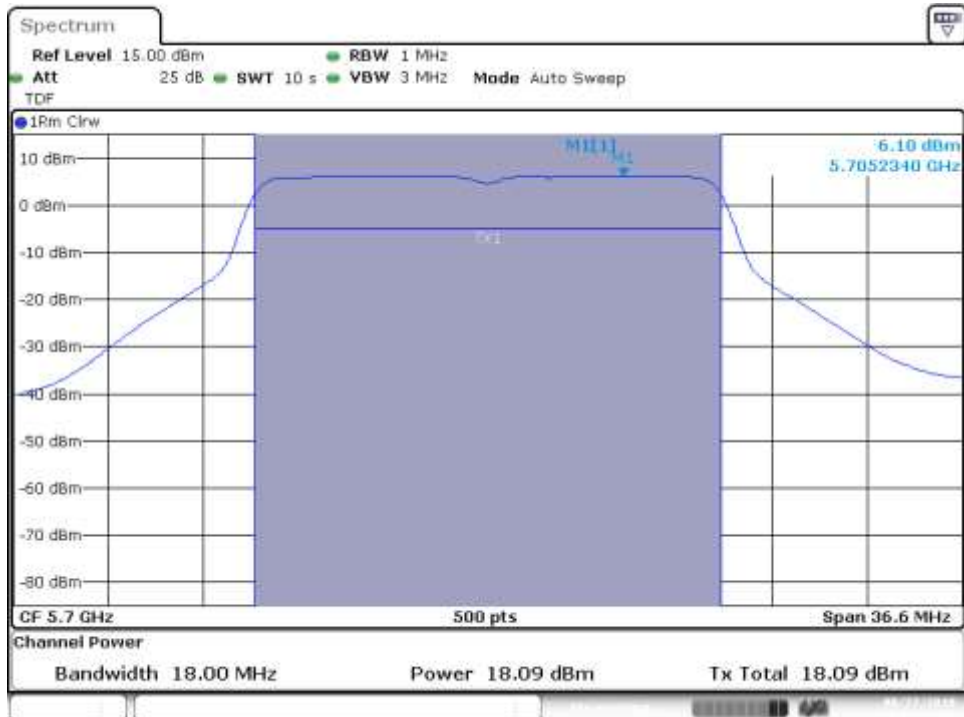

SISO-B, 802.11n40, HT0

Channel 118F

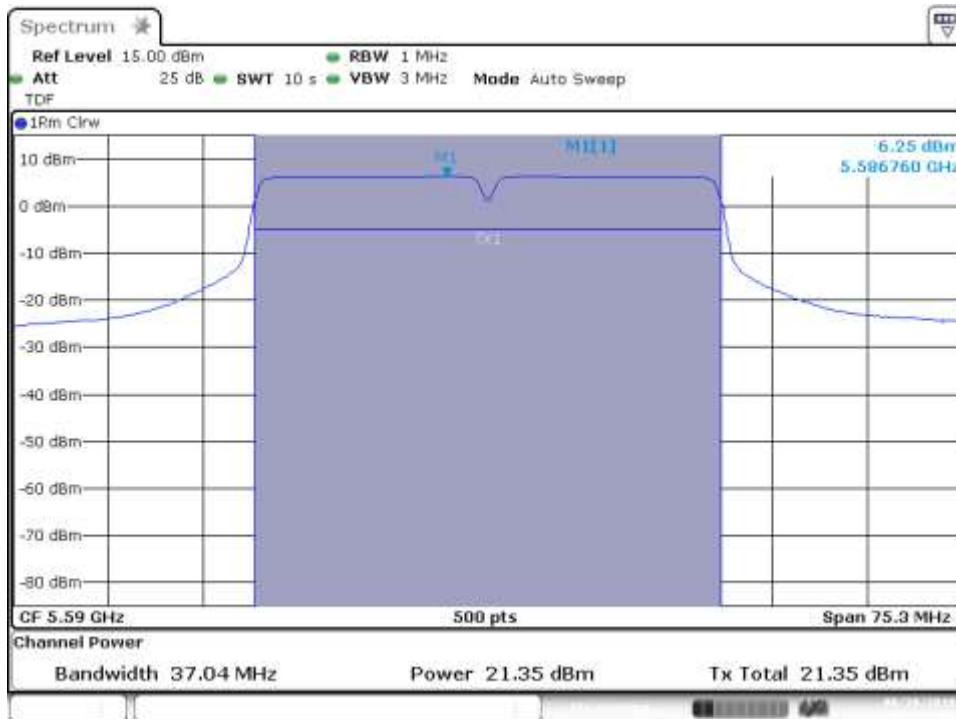

SISO-B, 802.11n40, HT0

Channel 102F

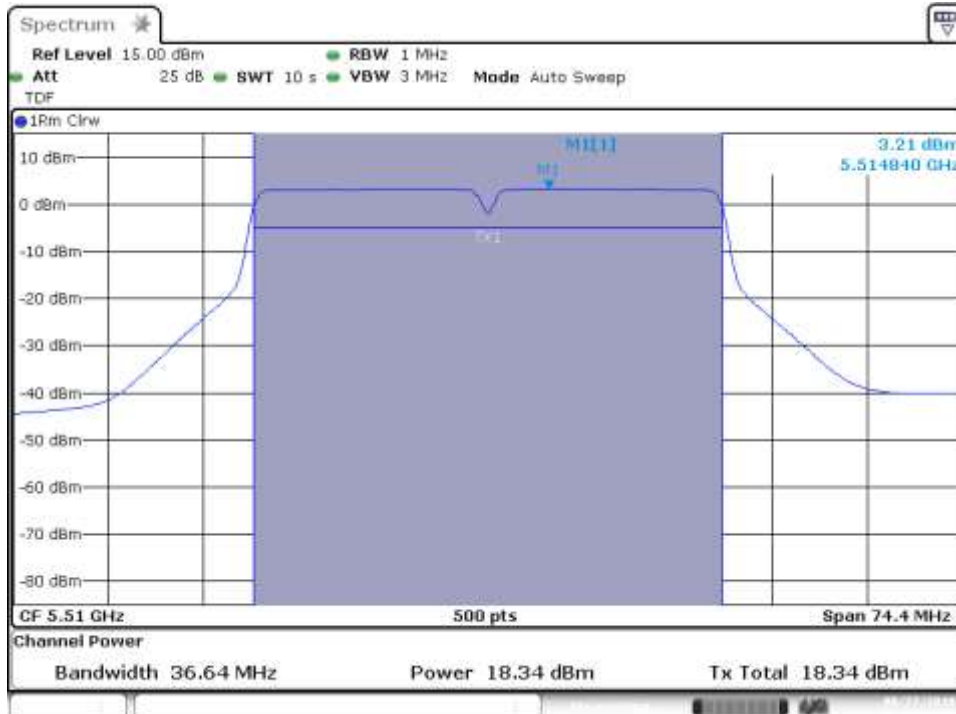

MIMO-A, 802.11n20, HT8

Channel 120

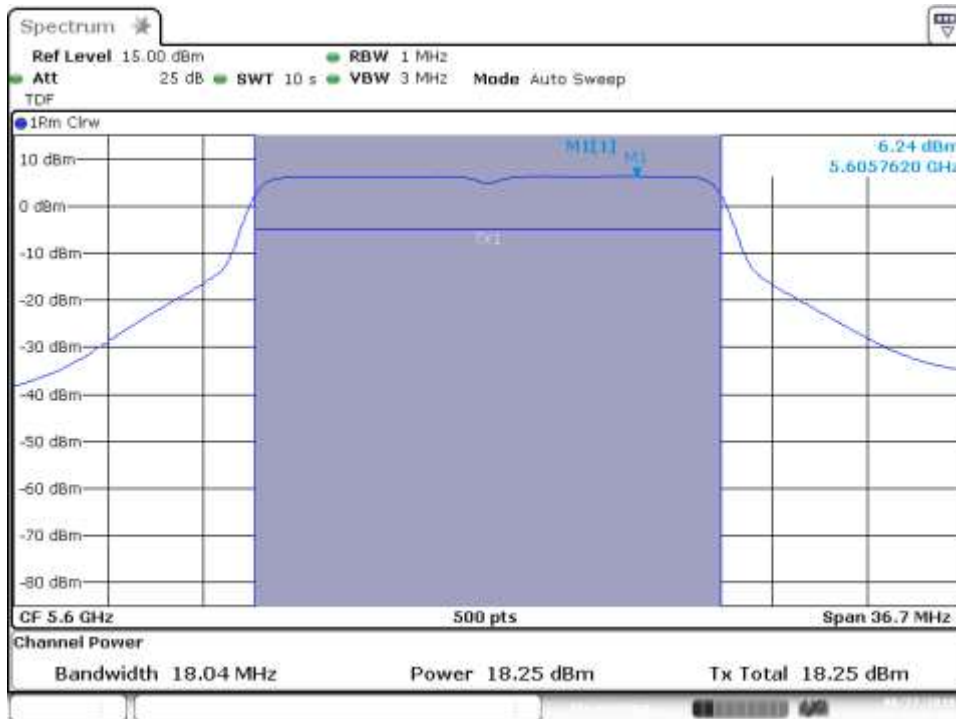

MIMO-B, 802.11n20, HT8

Channel 120

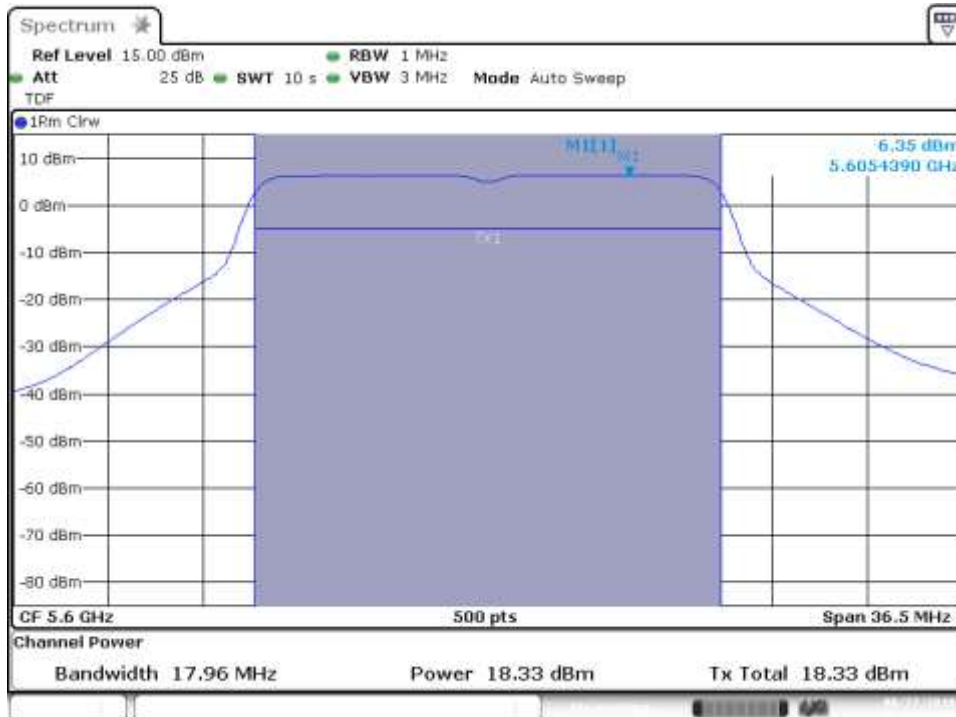

MIMO-A, 802.11n20, HT8

Channel 140

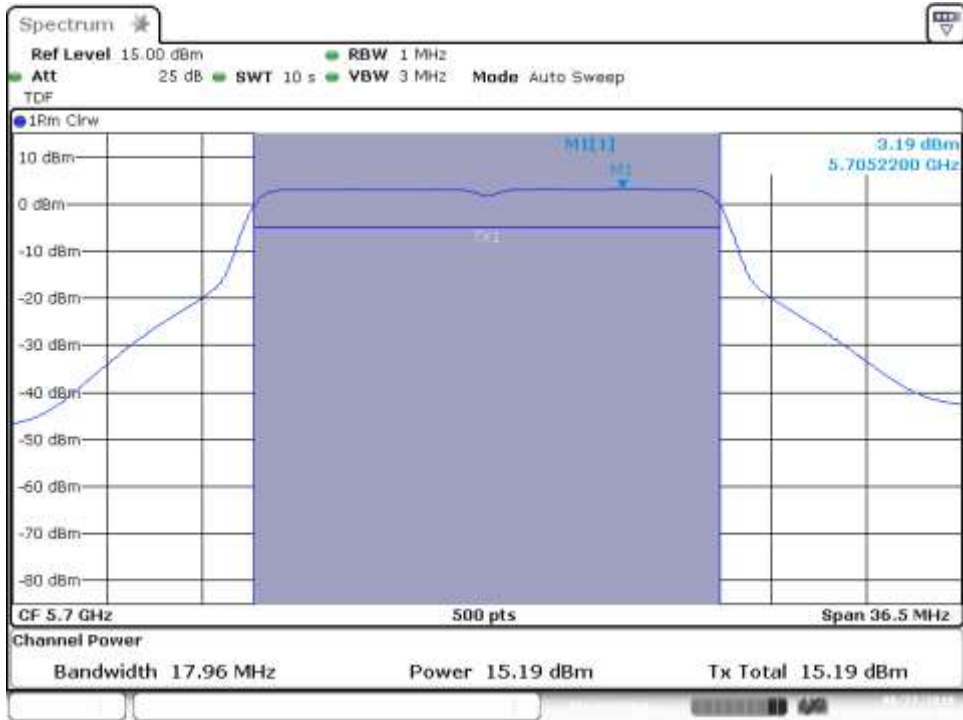

MIMO-B, 802.11n20, HT8

Channel 140

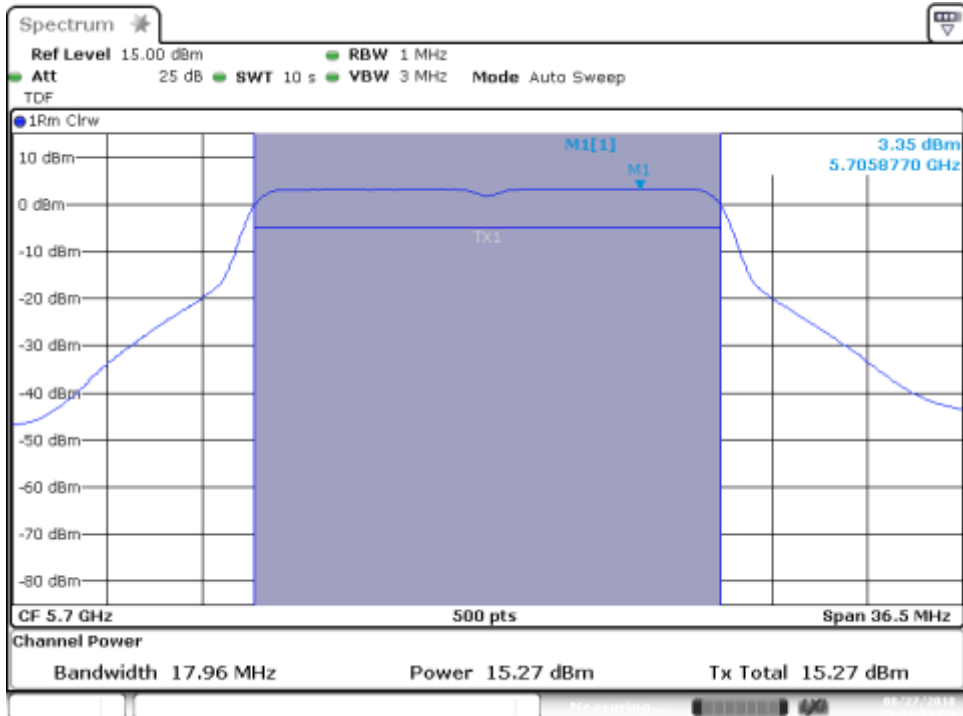

MIMO-A, 802.11n40, HT8

Channel 102F

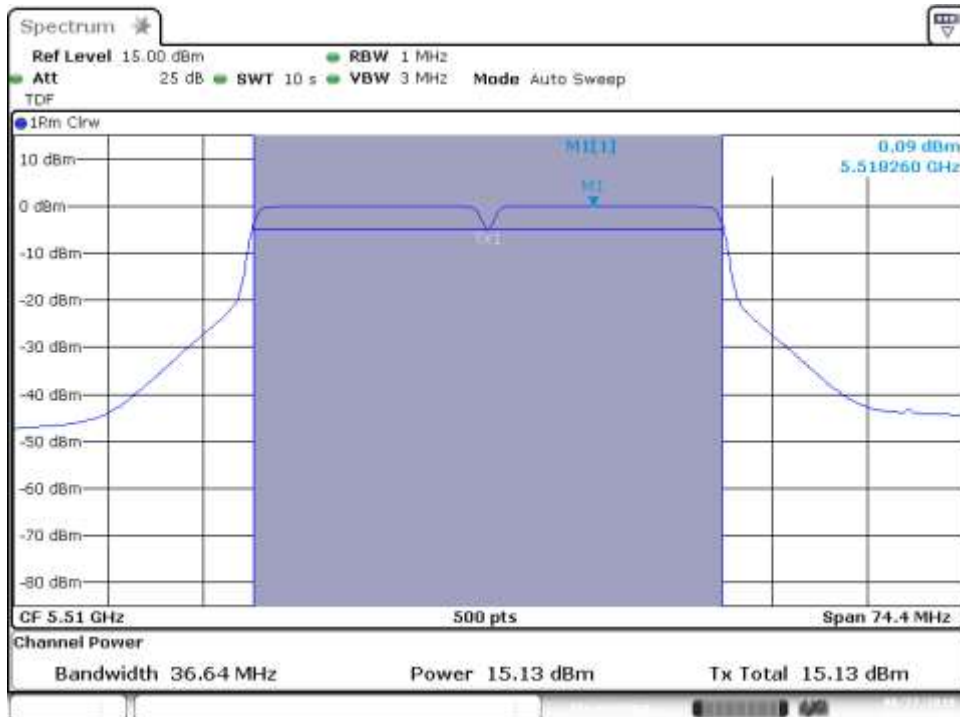

MIMO-B, 802.11n40, HT8

Channel 102F

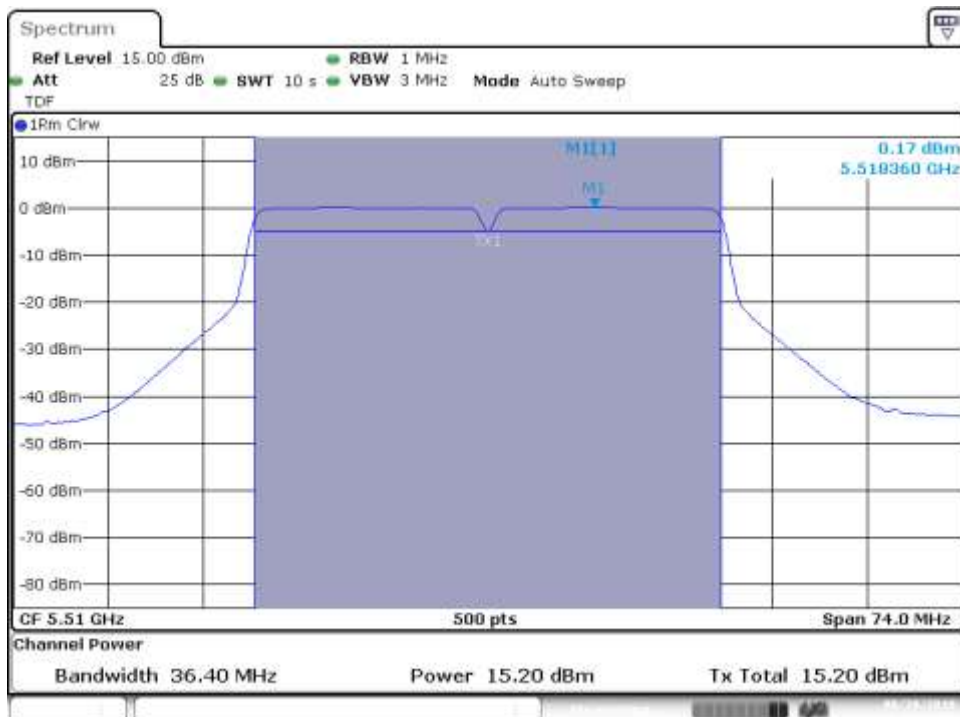

MIMO-A, 802.11n40, HT8

Channel 118F

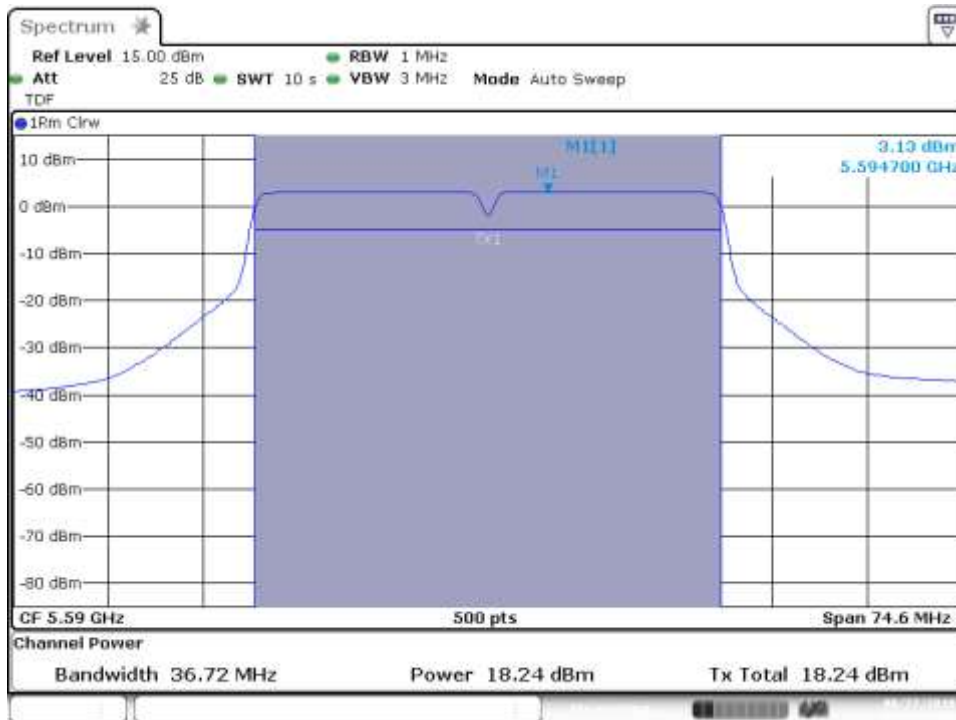

MIMO-B, 802.11n40, HT8

Channel 118F

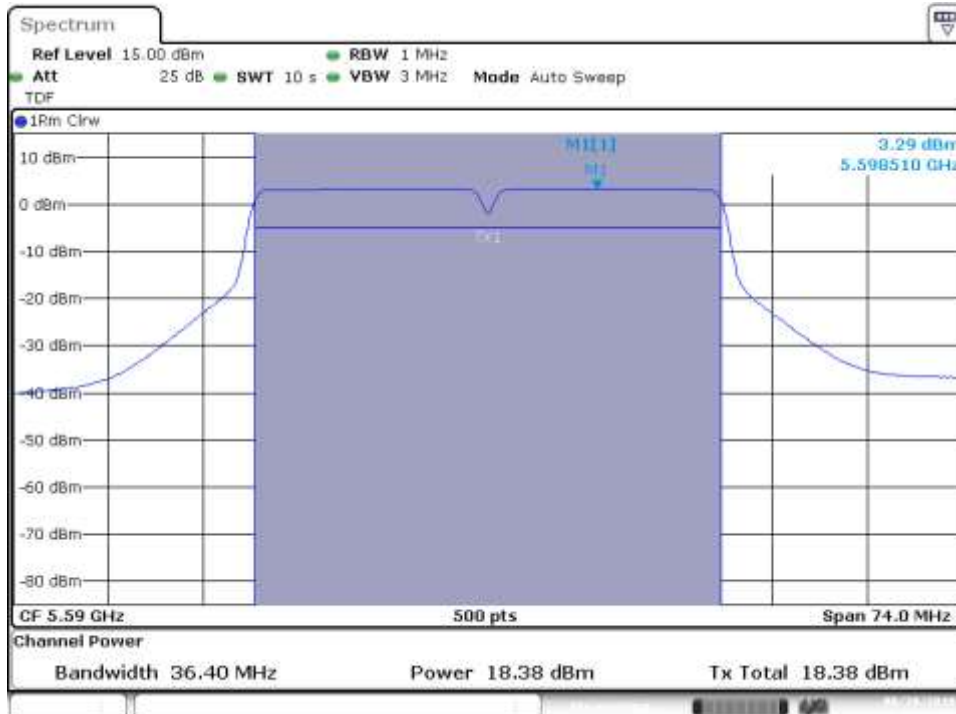

SISO-A, 802.11ac80, VHT0

Channel 106ac80

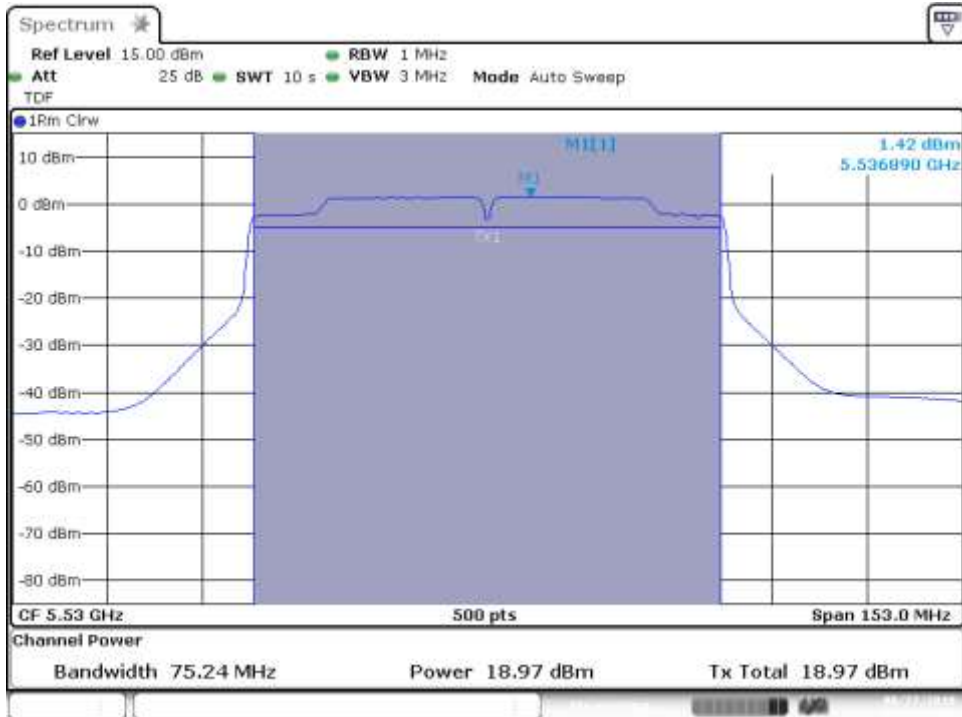

SISO-B, 802.11ac80, VHT0

Channel 122ac80

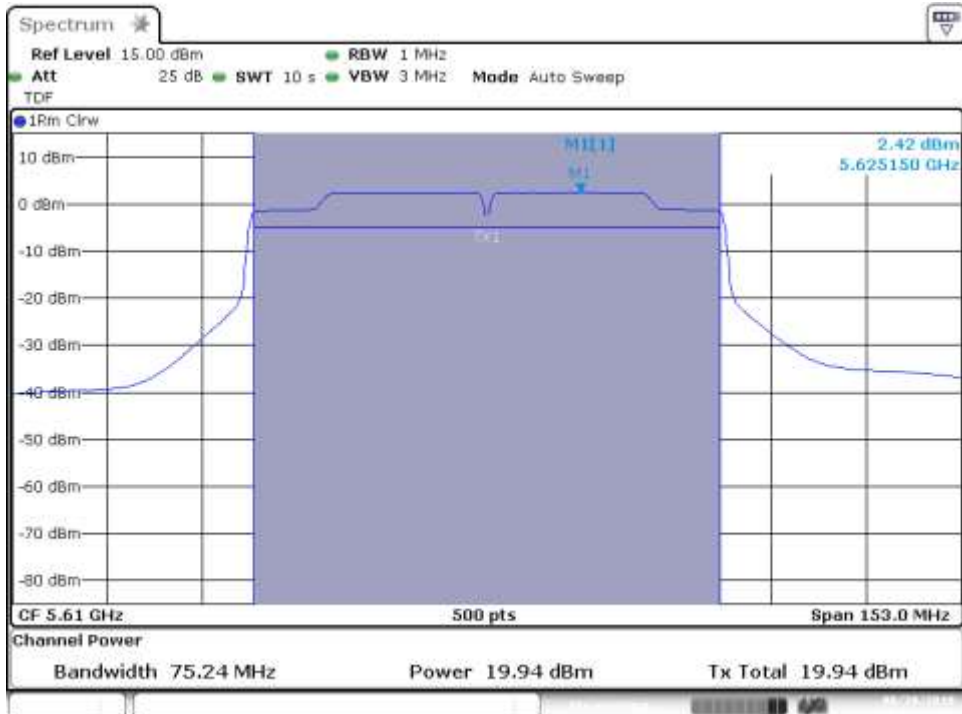

MIMO-A, 802.11ac80, VHT0

Channel 106ac80

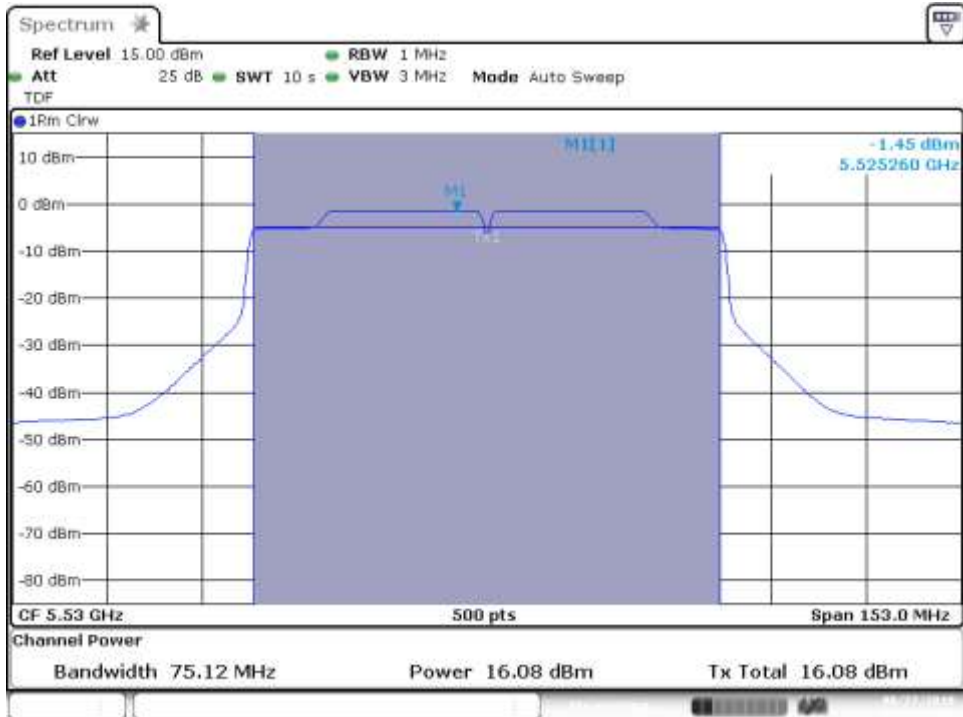

MIMO-B, 802.11ac80, VHT0

Channel 106ac80

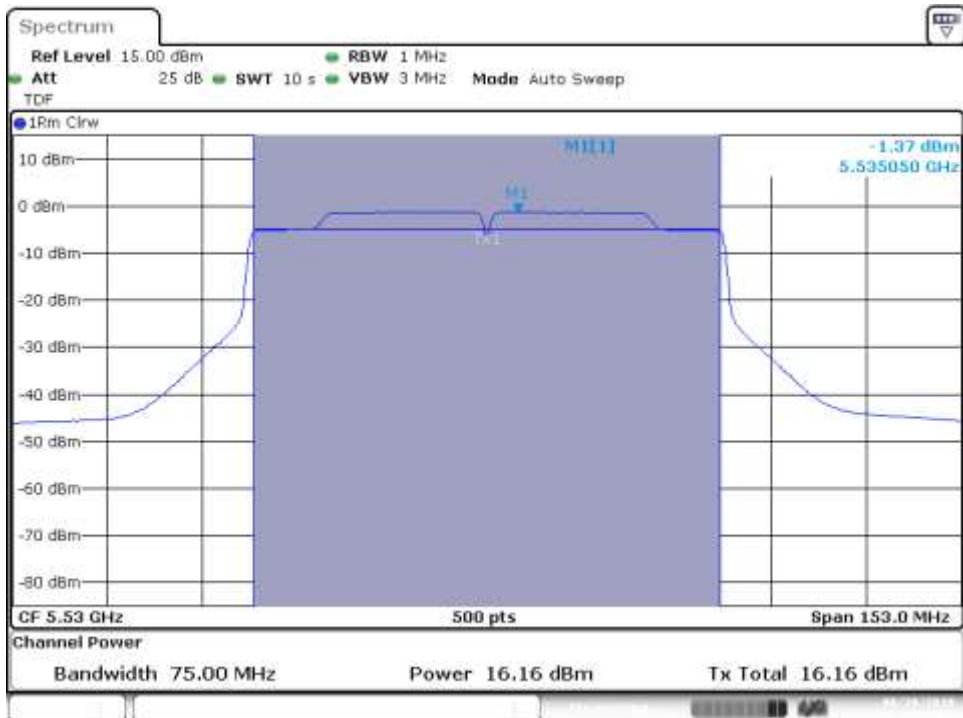

MIMO-A, 802.11ac80, VHT0

Channel 122ac80

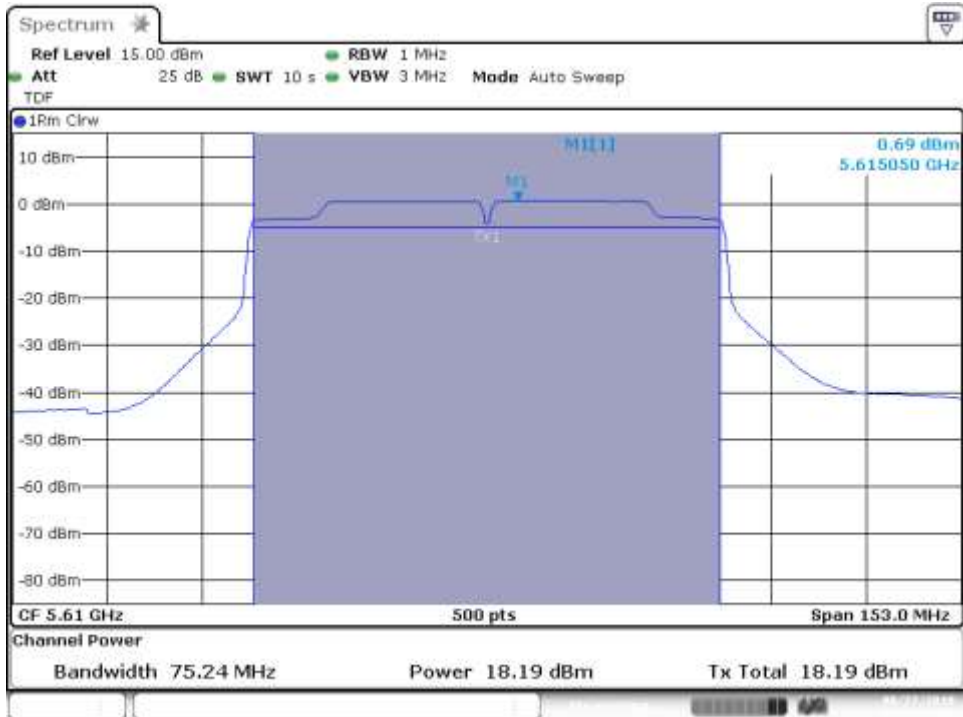

MIMO-B, 802.11ac80, VHT0

Channel 122ac80

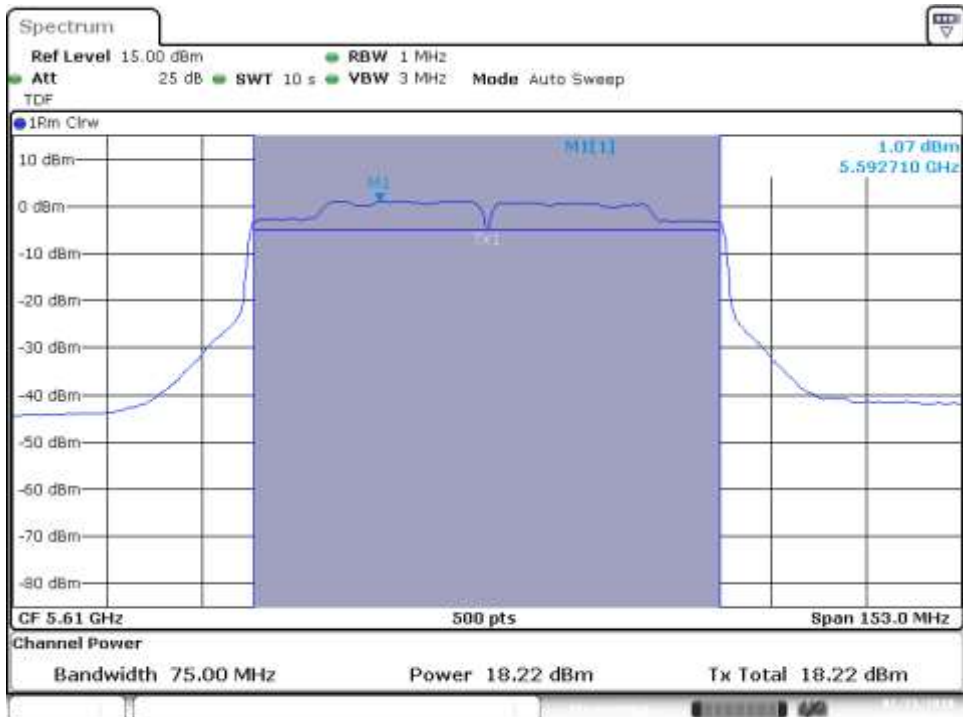

Date: 23 FEB 2018 12:28:40

SISO-A, 802.11ac160,VHT0

Channel 114ac160

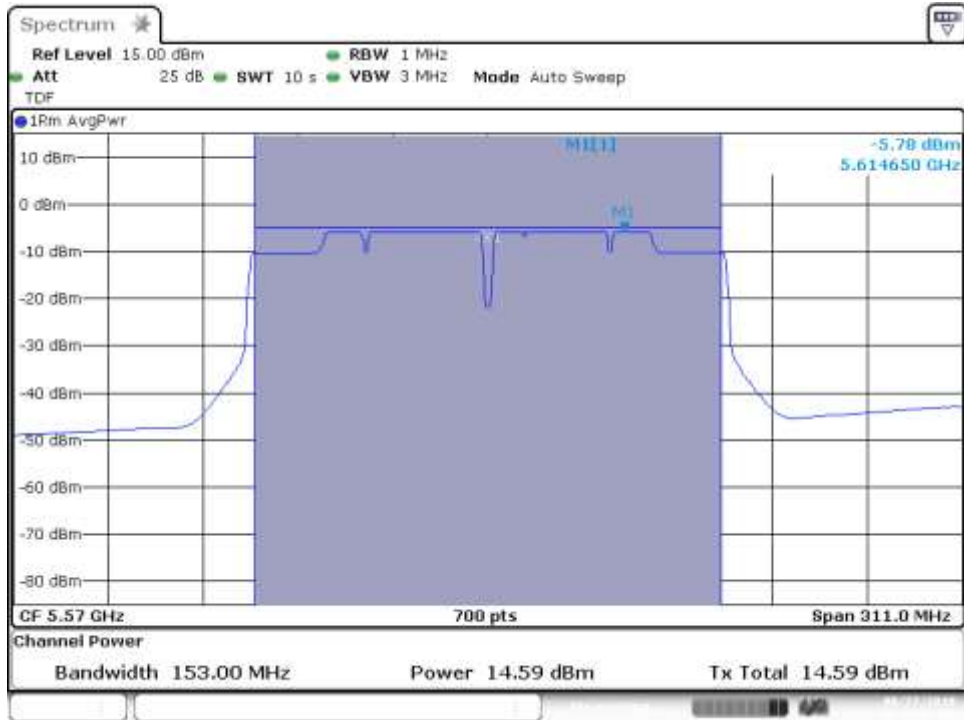

SISO-B, 802.11ac160,VHT0

Channel 114ac160

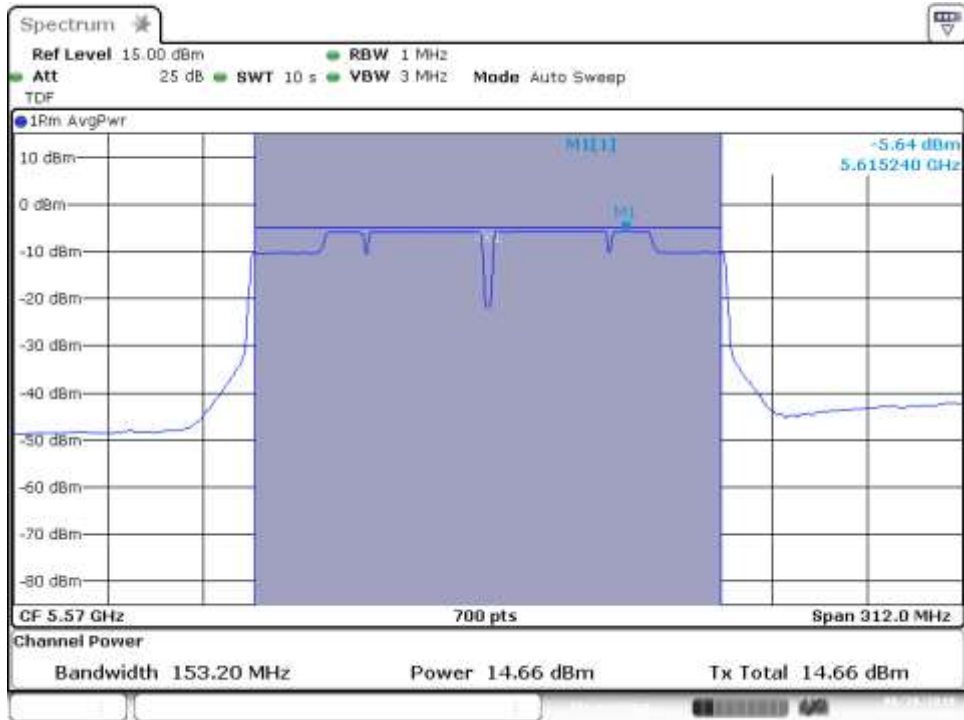

MIMO-A, 802.11ac160,VHT0

Channel 114ac160

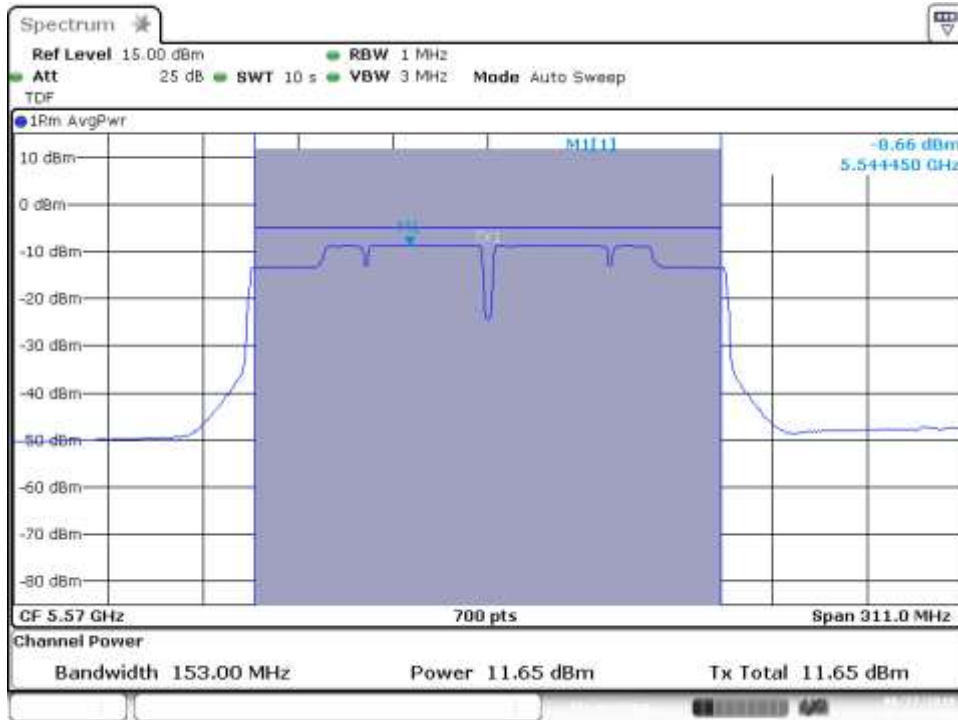

MIMO-B, 802.11ac160,VHT0

Channel 114ac160

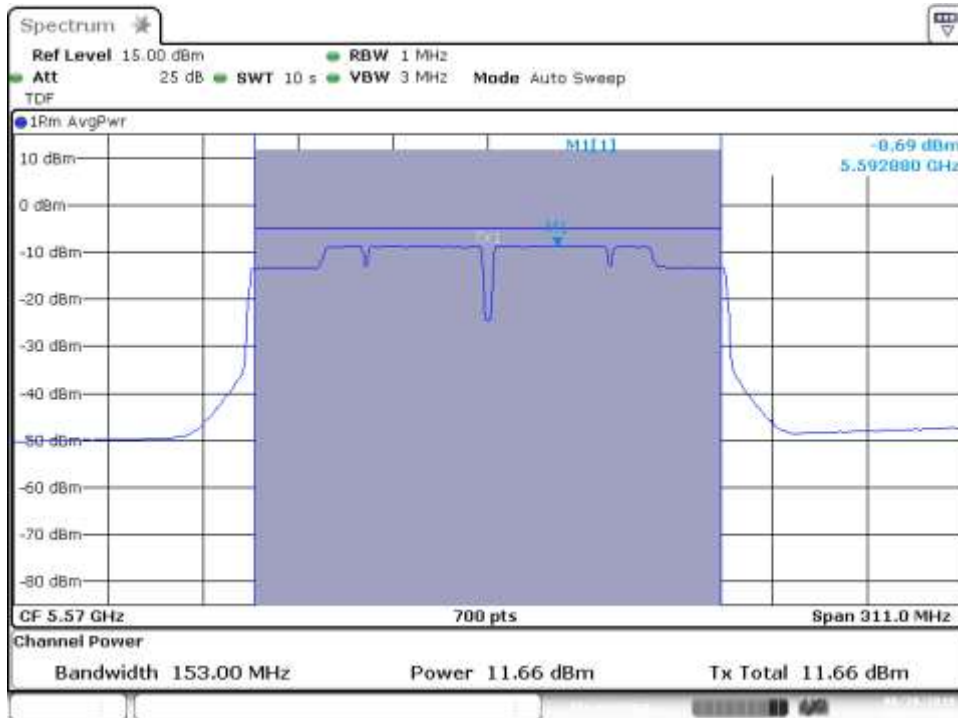

SISO-A, 802.11ax20, HE0

Channel 120

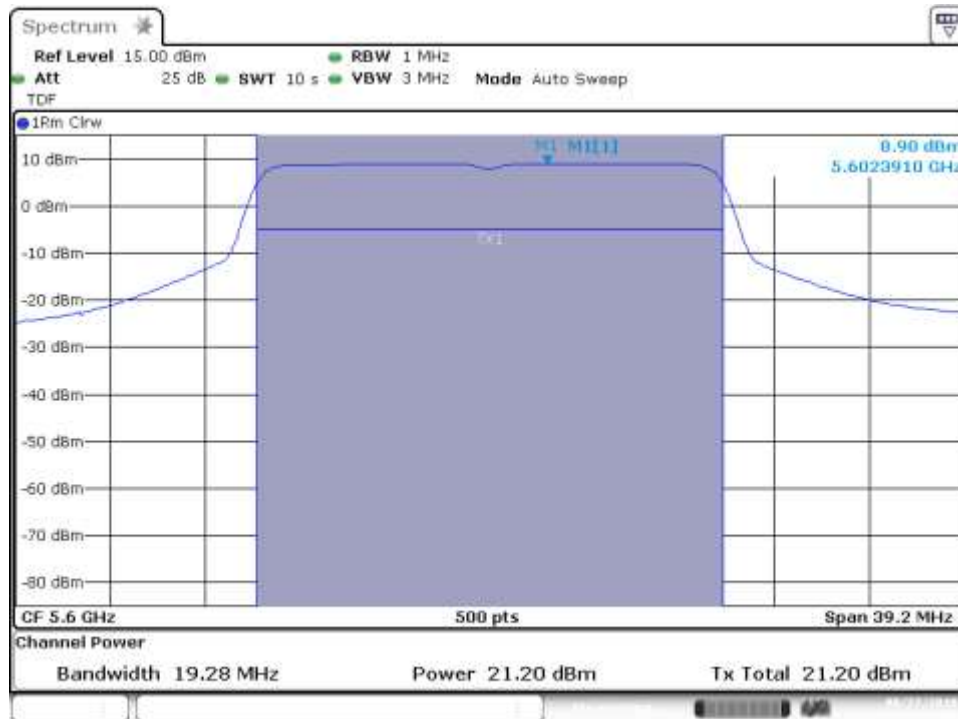

SISO-A, 802.11ax20, HE0

Channel 140

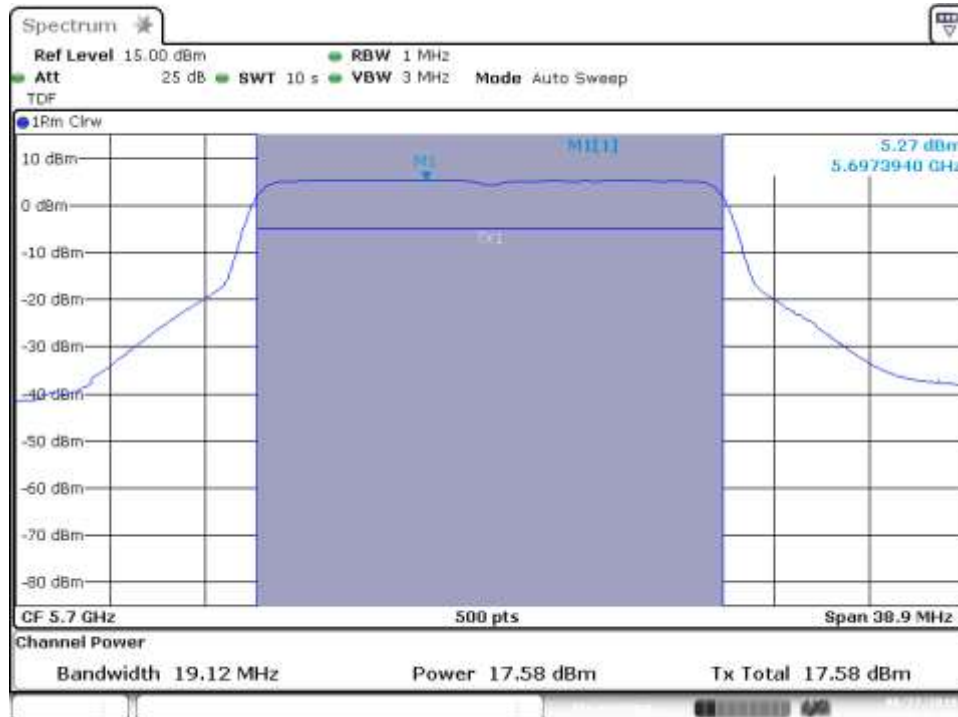

MIMO-A, 802.11ax20, HE0

Channel 120

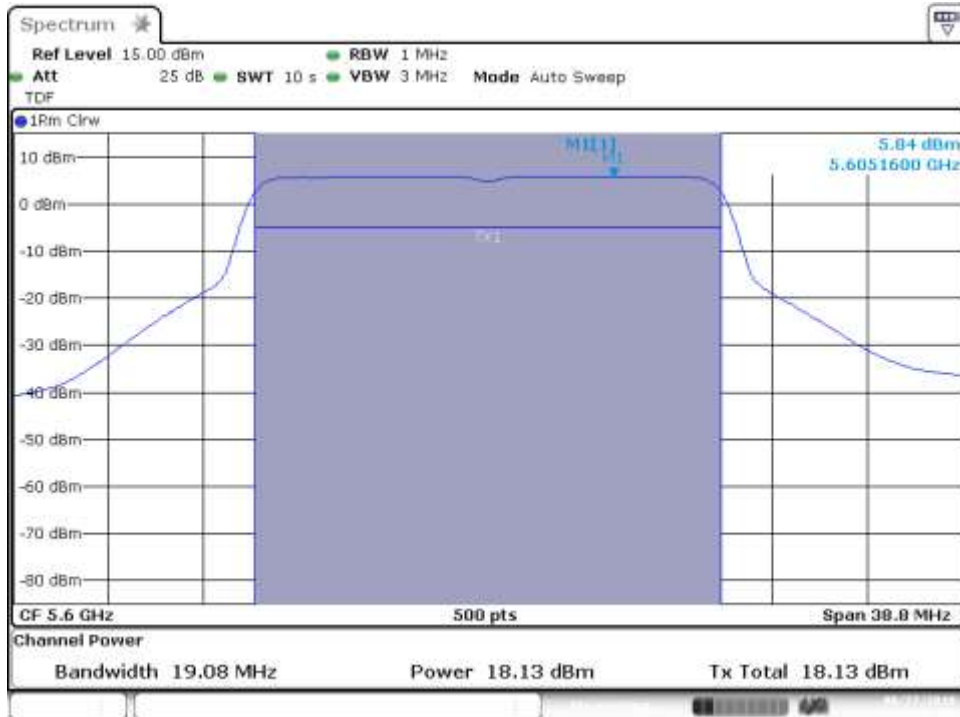

MIMO-B, 802.11ax20, HE0

Channel 120

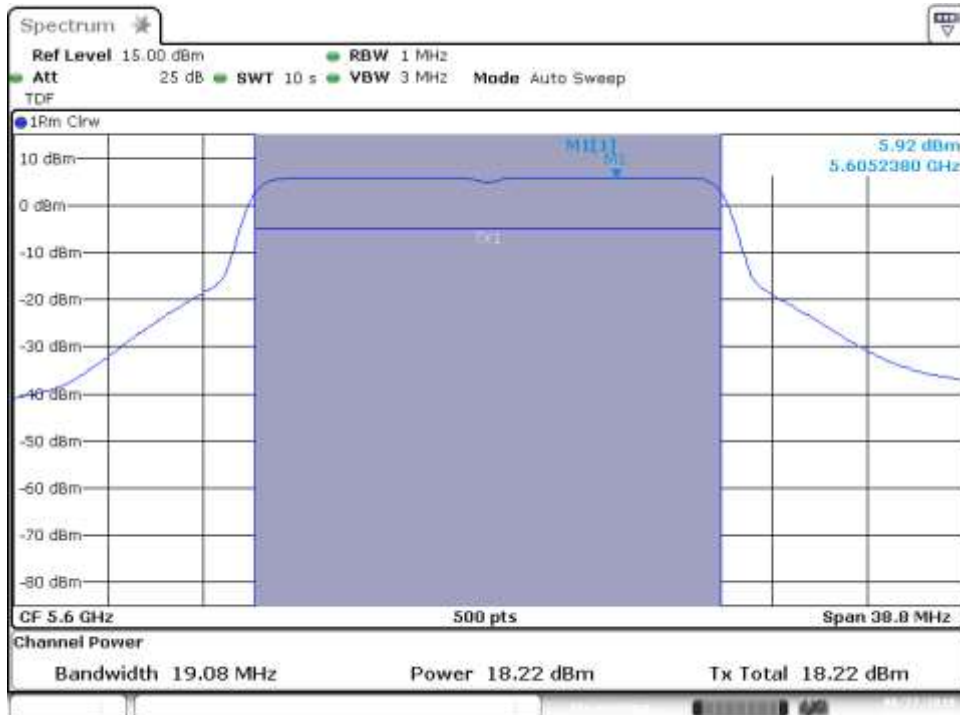

MIMO-A, 802.11ax20, HE0

Channel 140

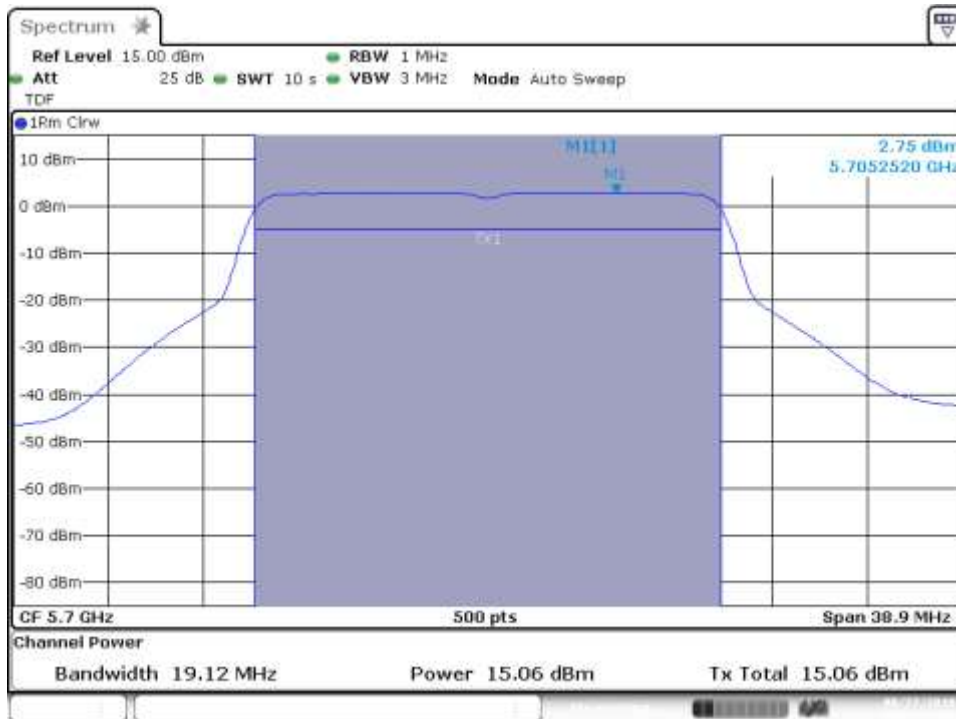

MIMO-B, 802.11ax20, HE0

Channel 140

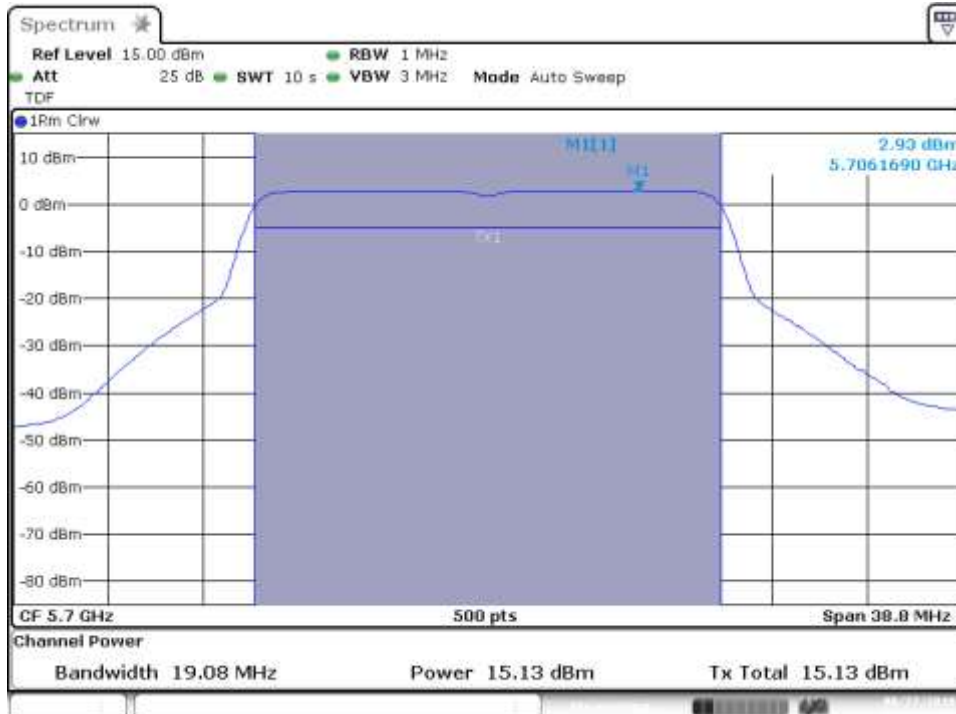

SISO-B, 802.11ax40, HE0

Channel 102F

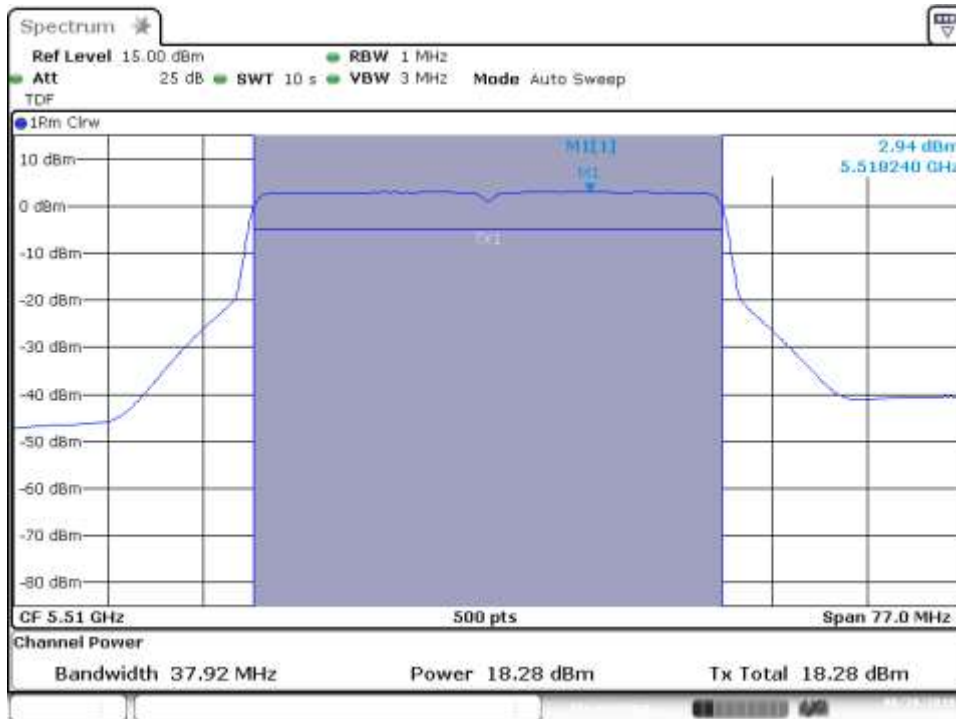

SISO-B, 802.11ax40, HE0

Channel 118F

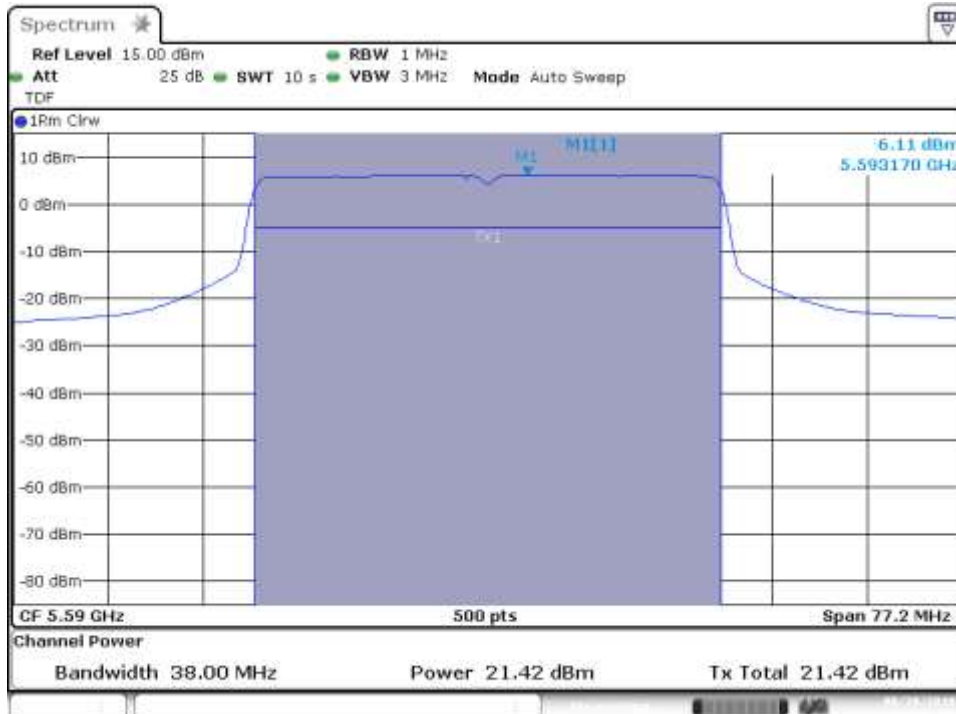

MIMO-A, 802.11ax40, HE0

Channel 102F

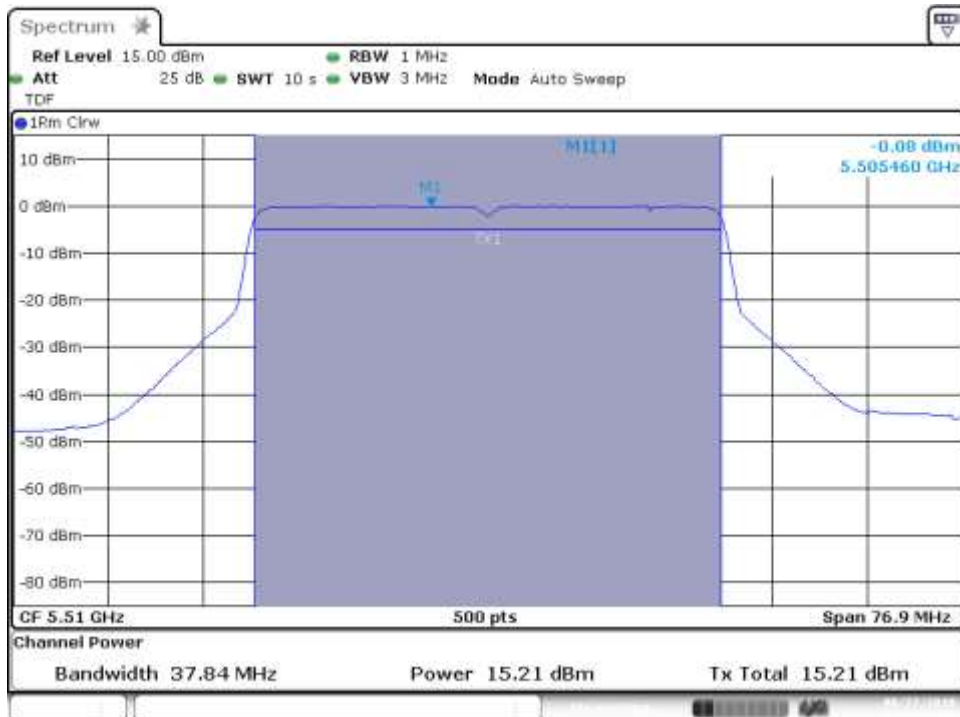

MIMO-B, 802.11ax40, HE0

Channel 102F

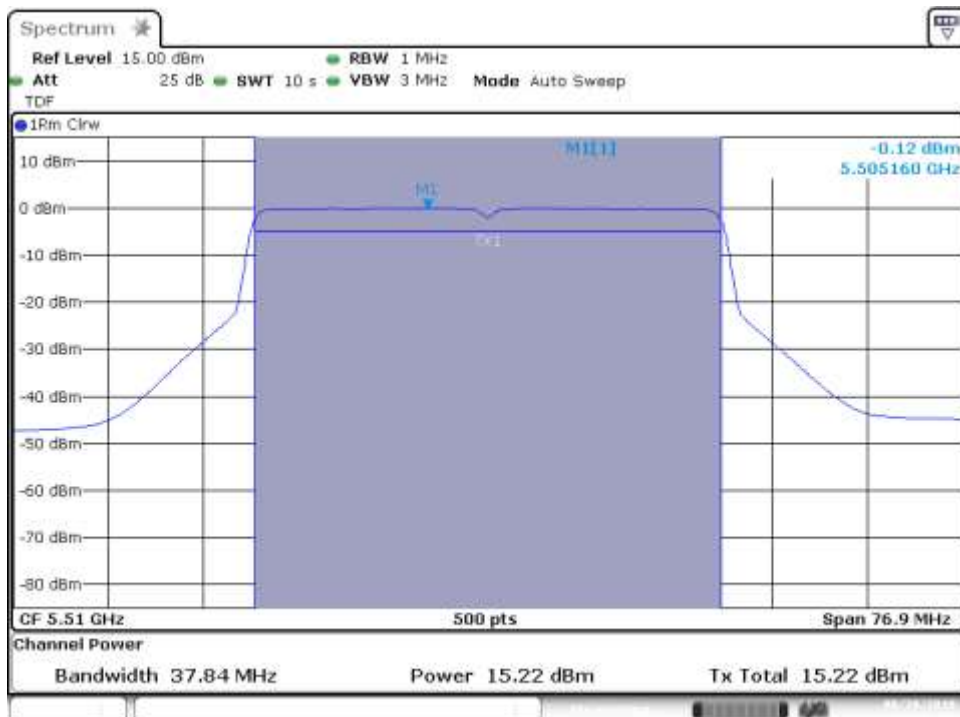

MIMO-A, 802.11ax40, HE0

Channel 118F

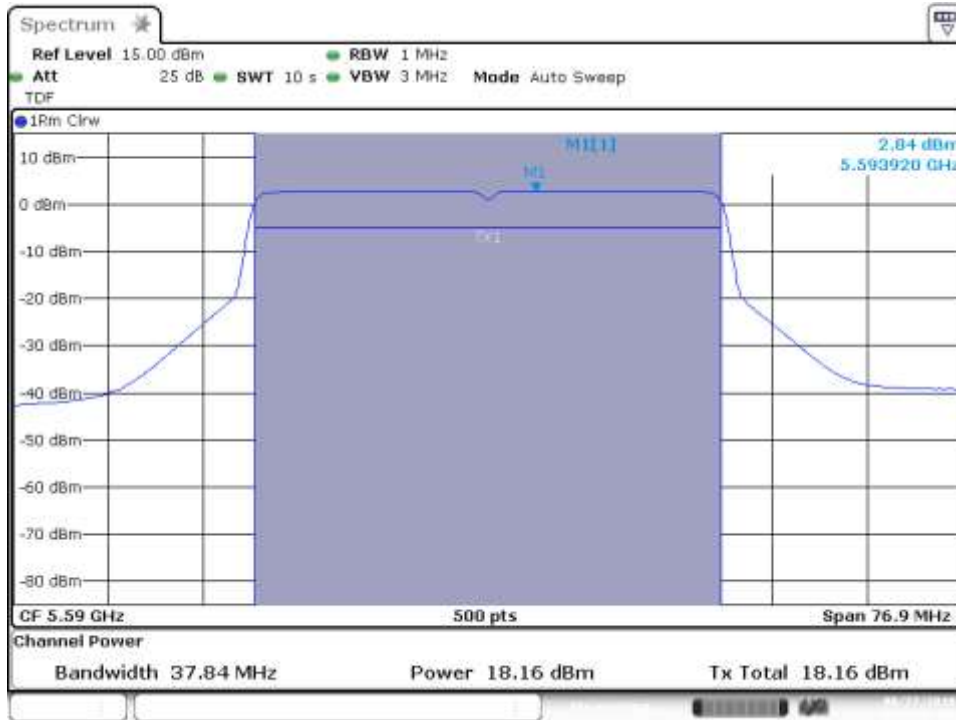

MIMO-B, 802.11ax40, HE0

Channel 118F

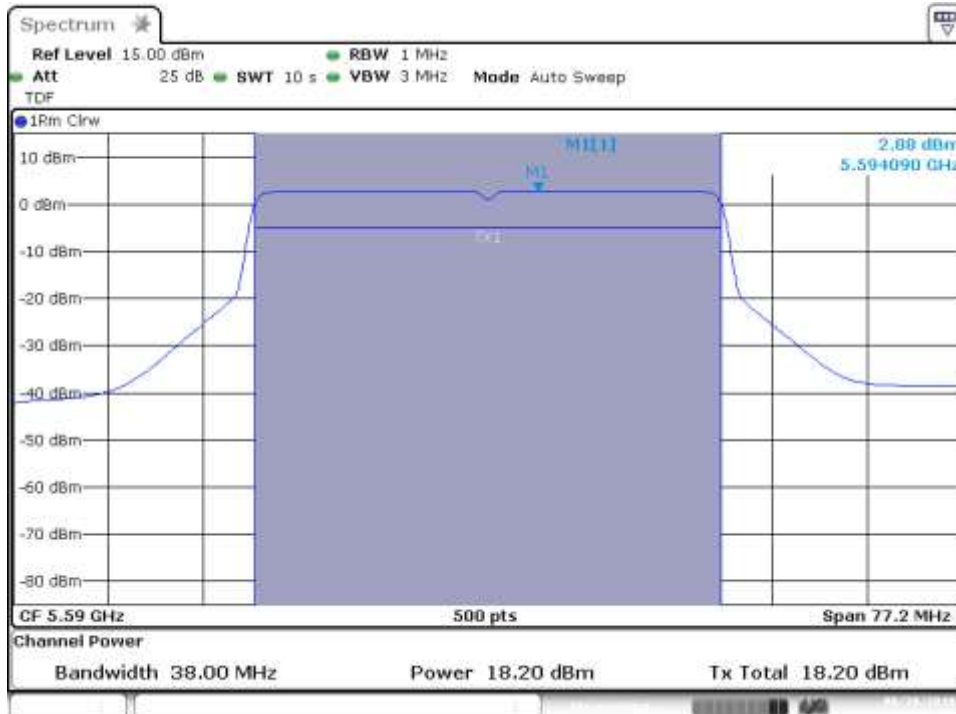

SISO-B, 802.11ax80, HE0

Channel 106ax80

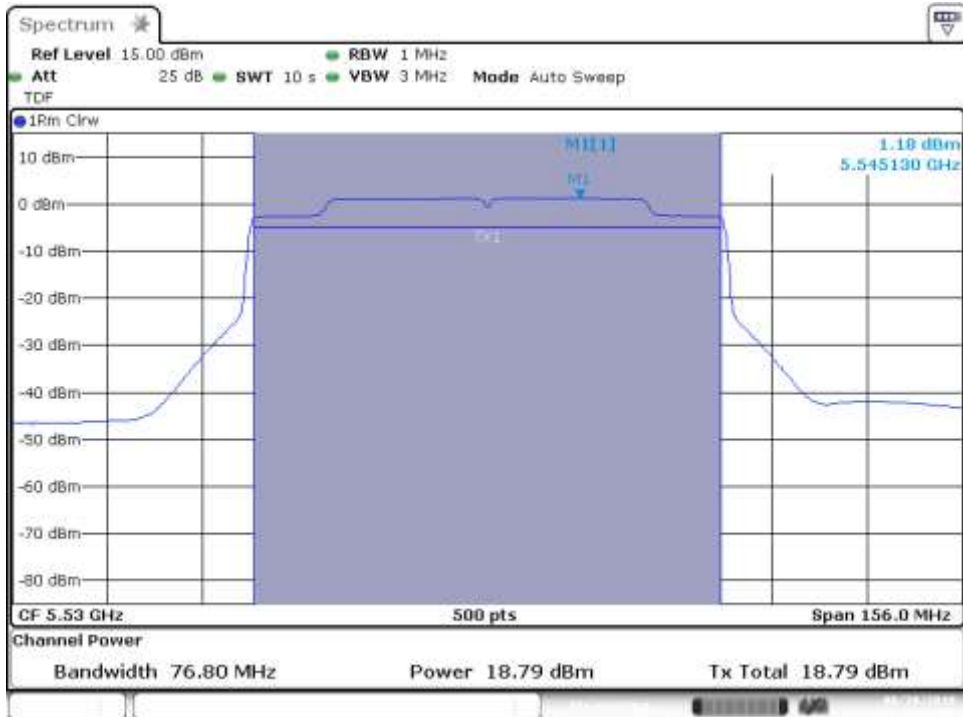

SISO-A, 802.11ax80, HE0

Channel 122ax80

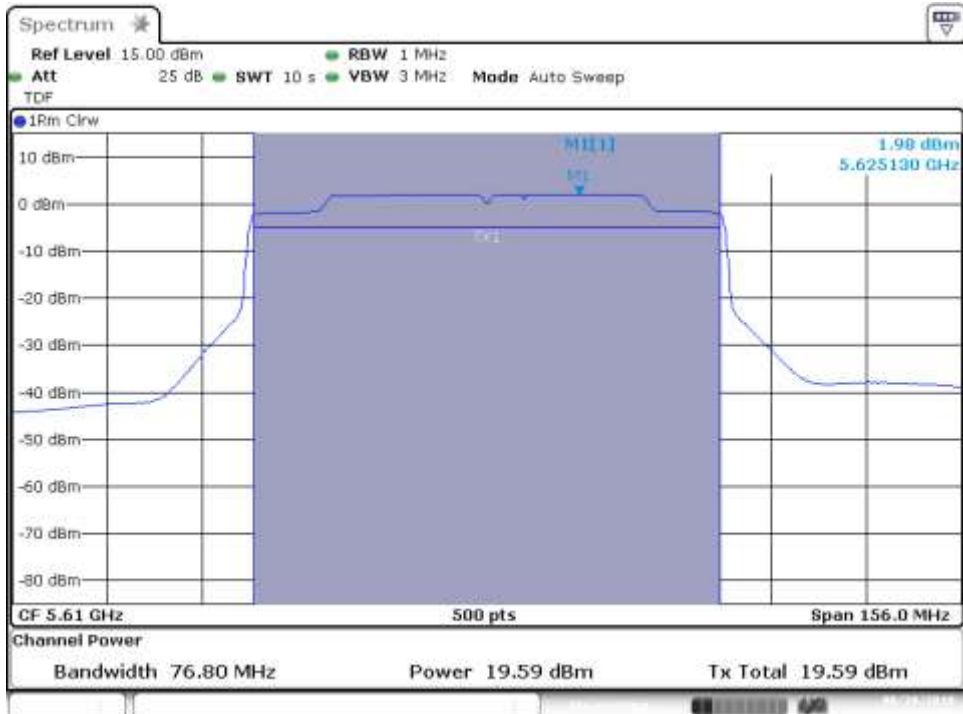

MIMO-A, 802.11ax80, HE0

Channel 106ax80

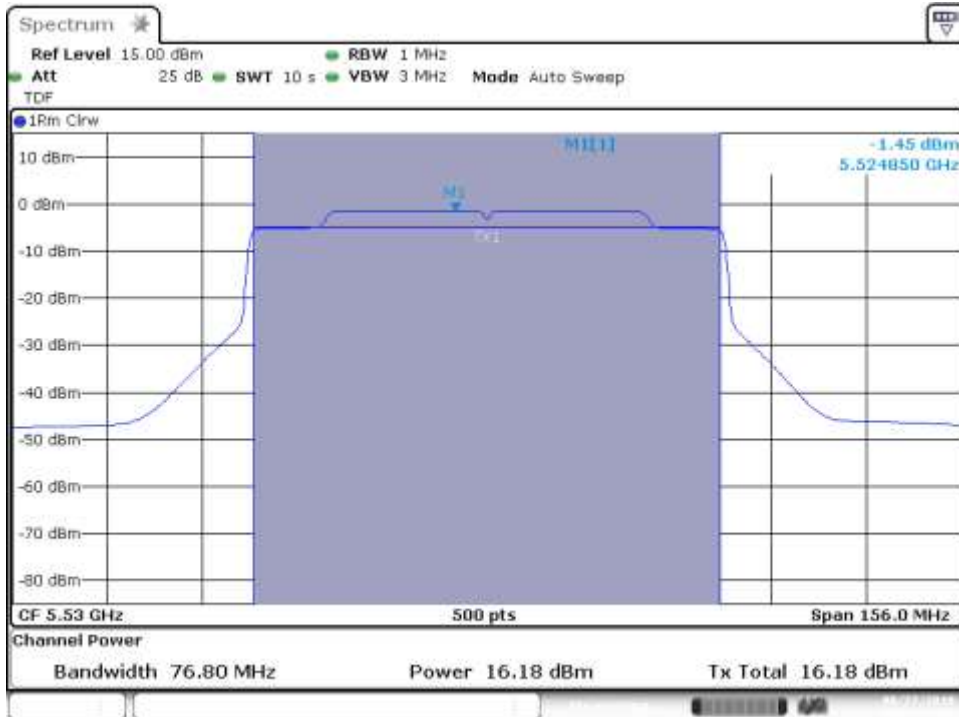

MIMO-B, 802.11ax80, HE0

Channel 106ax80

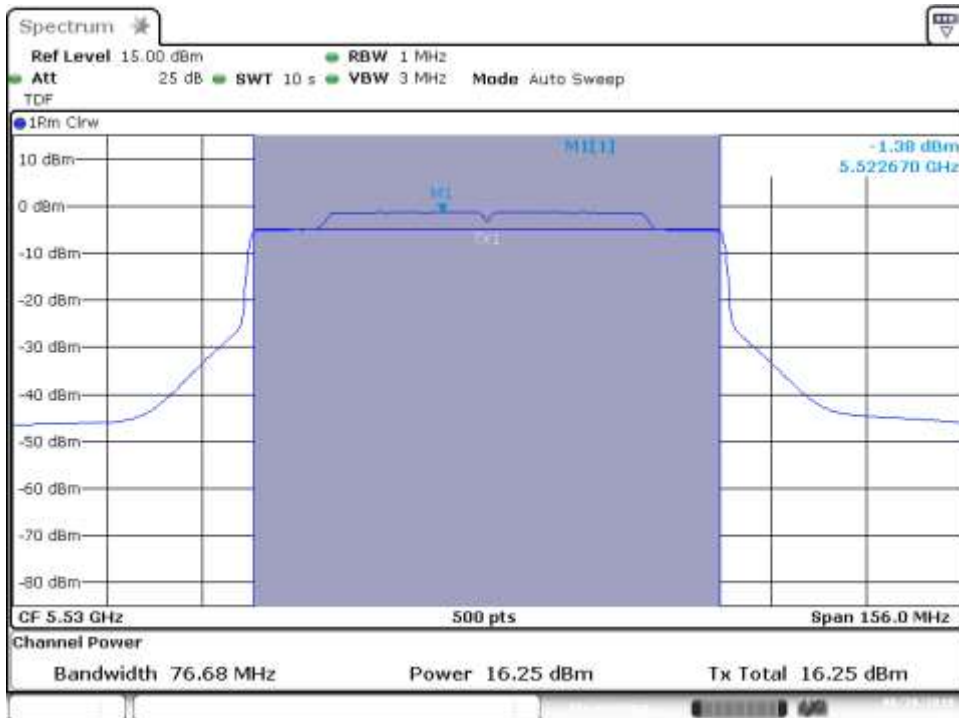

MIMO-A, 802.11ax80, HE0

Channel 122ax80

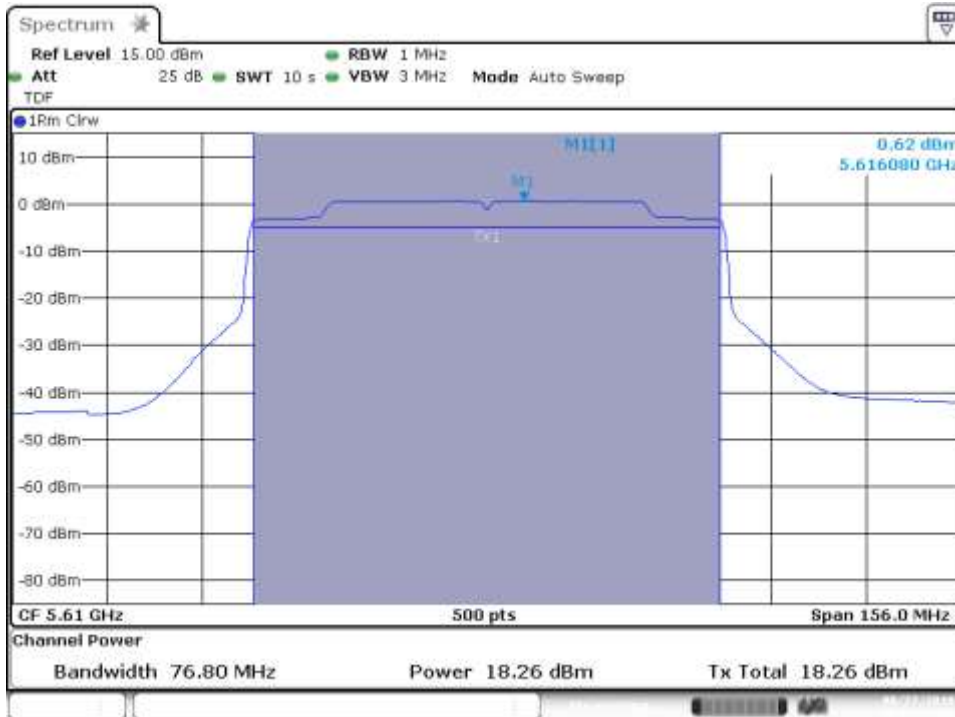

MIMO-B, 802.11ax80, HE0

Channel 122ax80

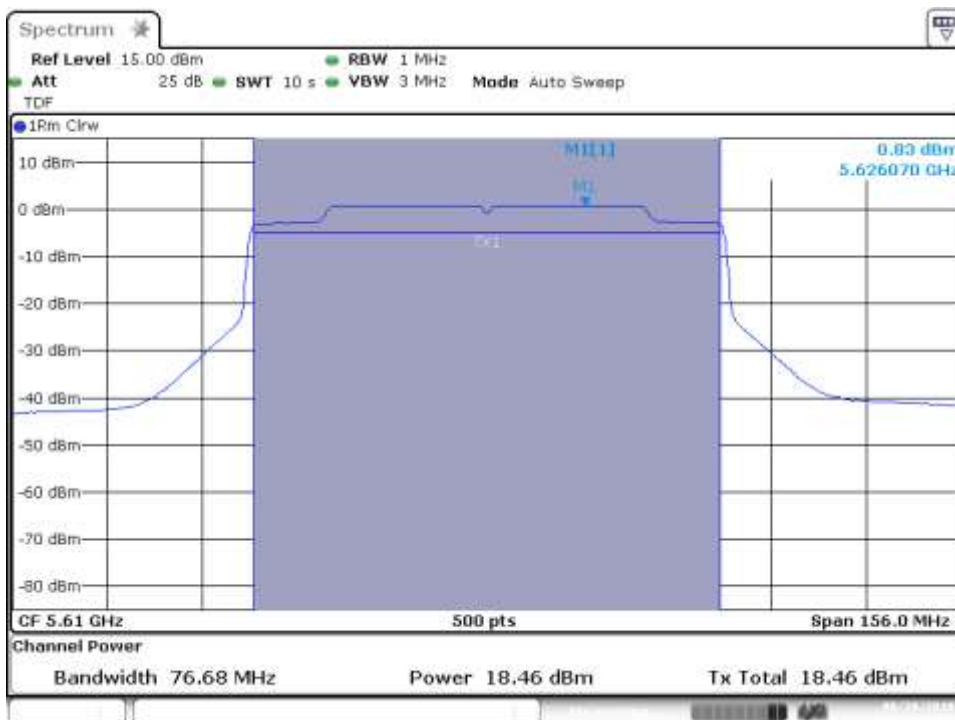

SISO-A, 802.11ax160, HE0

Channel 114ax160

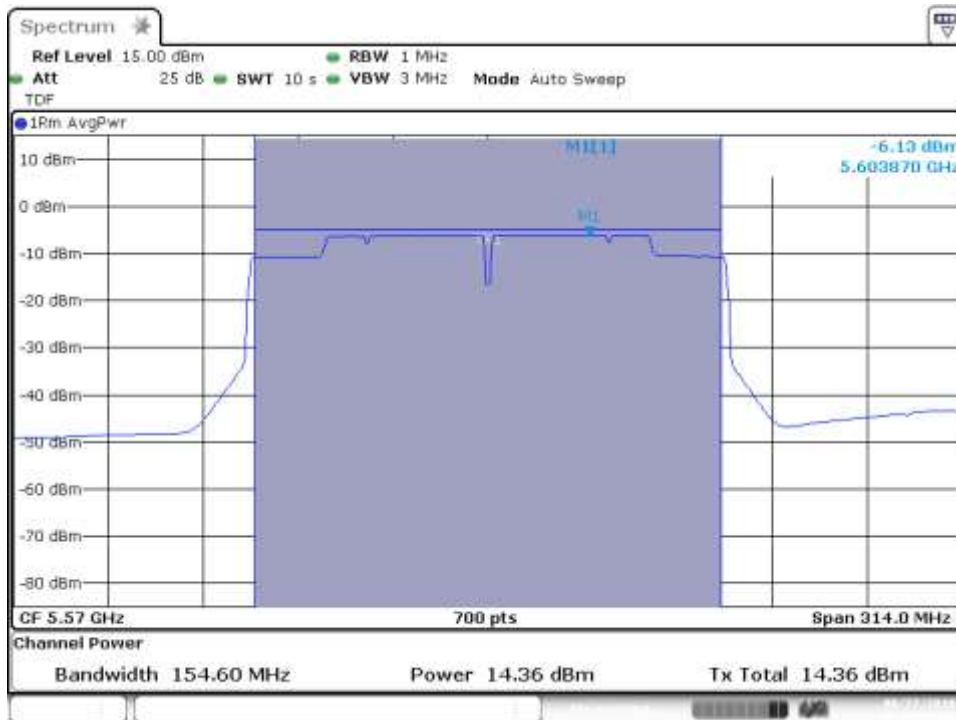

SISO-B, 802.11ax160, HE0

Channel 114ax160

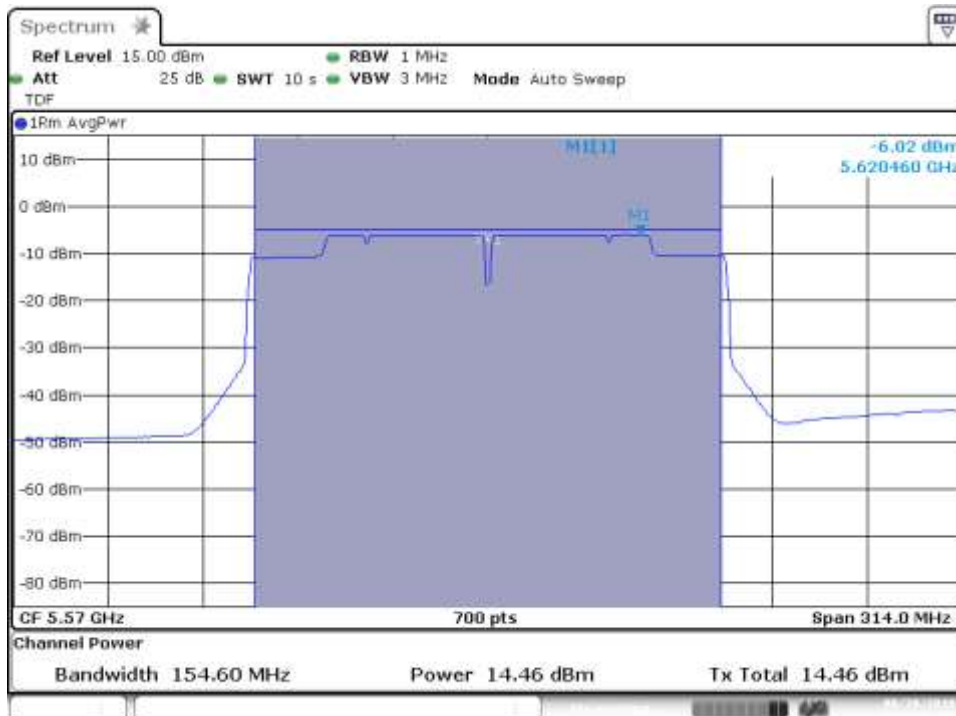

MIMO-A, 802.11ax160, HE0

Channel 114ax160

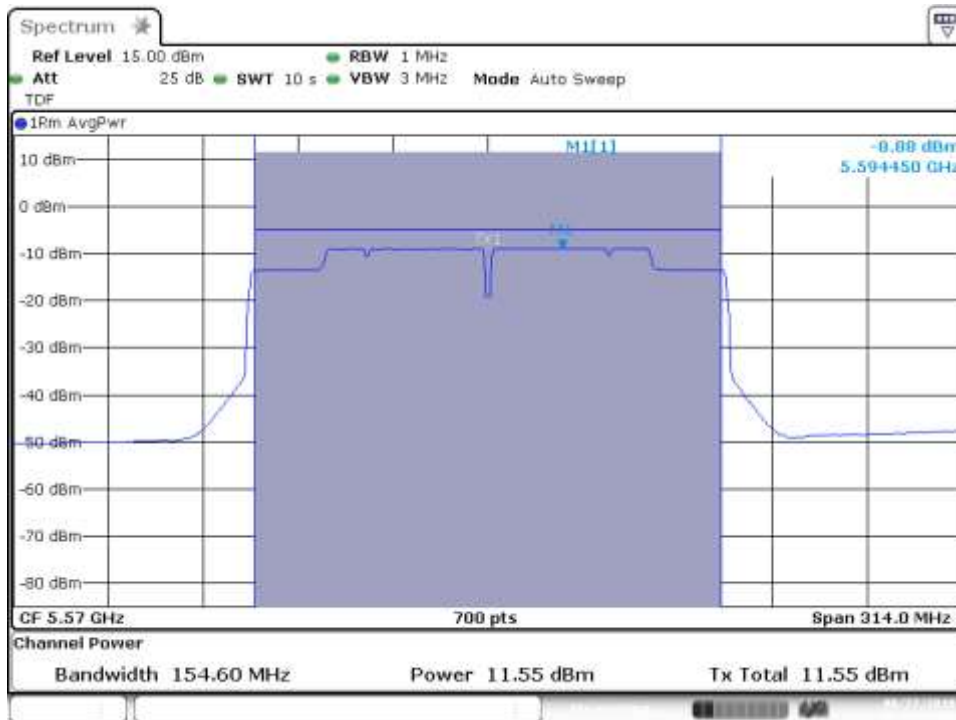

MIMO-B, 802.11ax160, HE0

Channel 114ax160

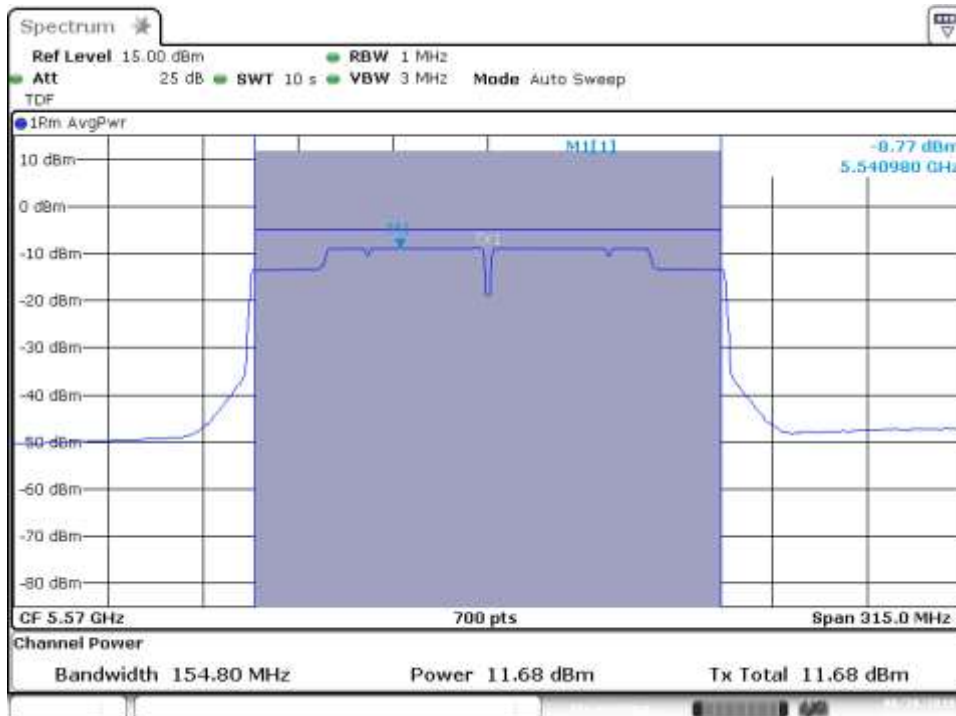

SISO-A, 802.11ax20, HE0 RU 106/53

Channel 100

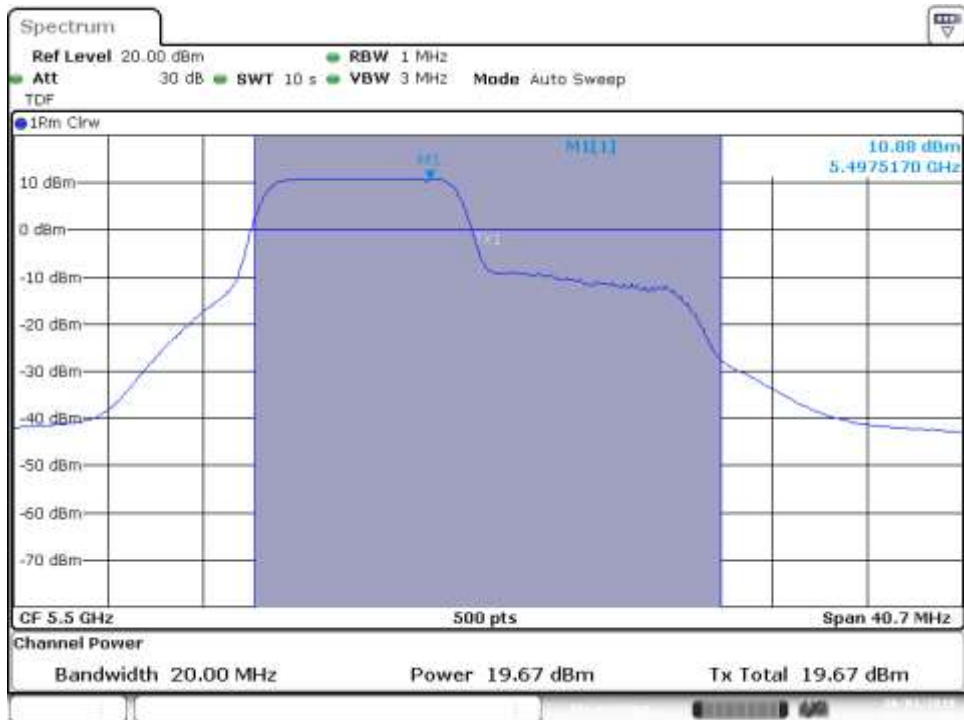

SISO-B, 802.11ax20, HE0 RU 26/0

Channel 100

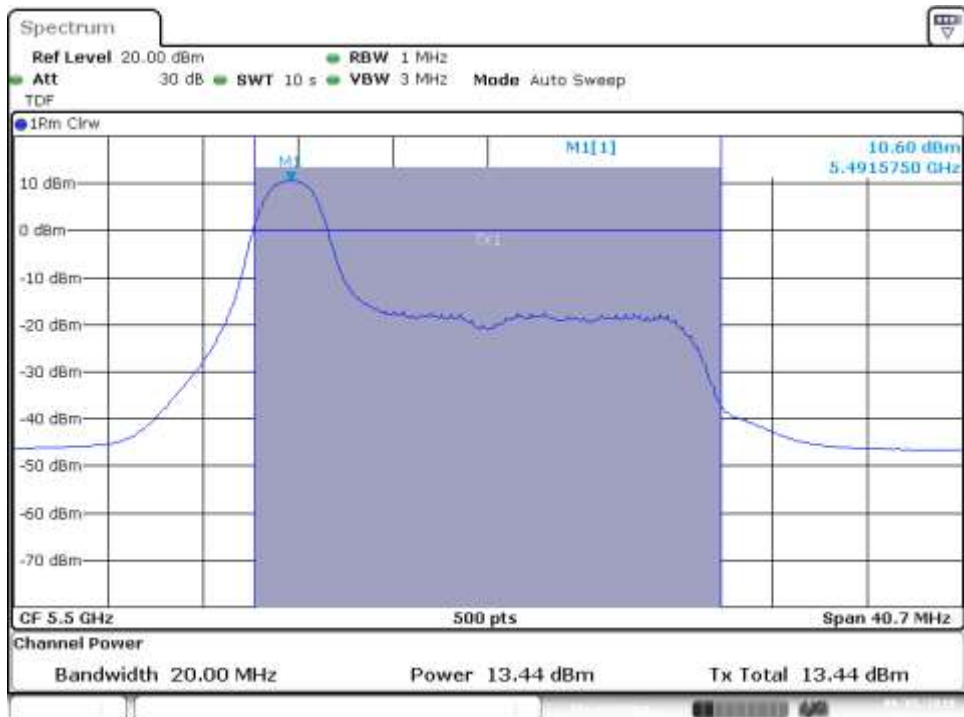

MIMO-A, 802.11ax20, HE0 RU 26/0

Channel 100

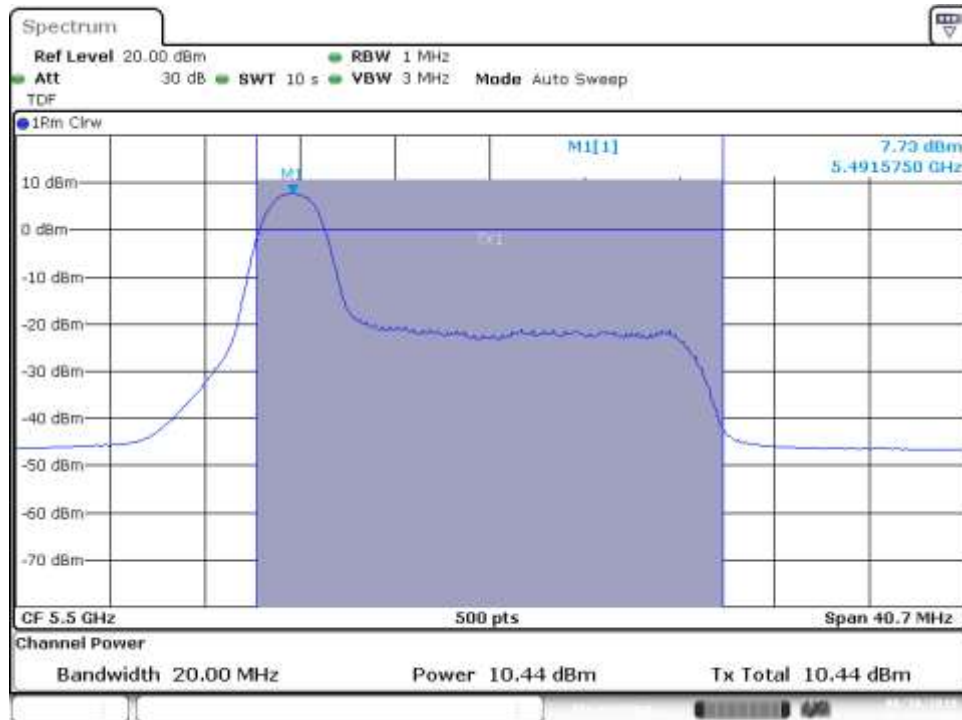

MIMO-B, 802.11ax20, HE0 RU 26/0

Channel 100

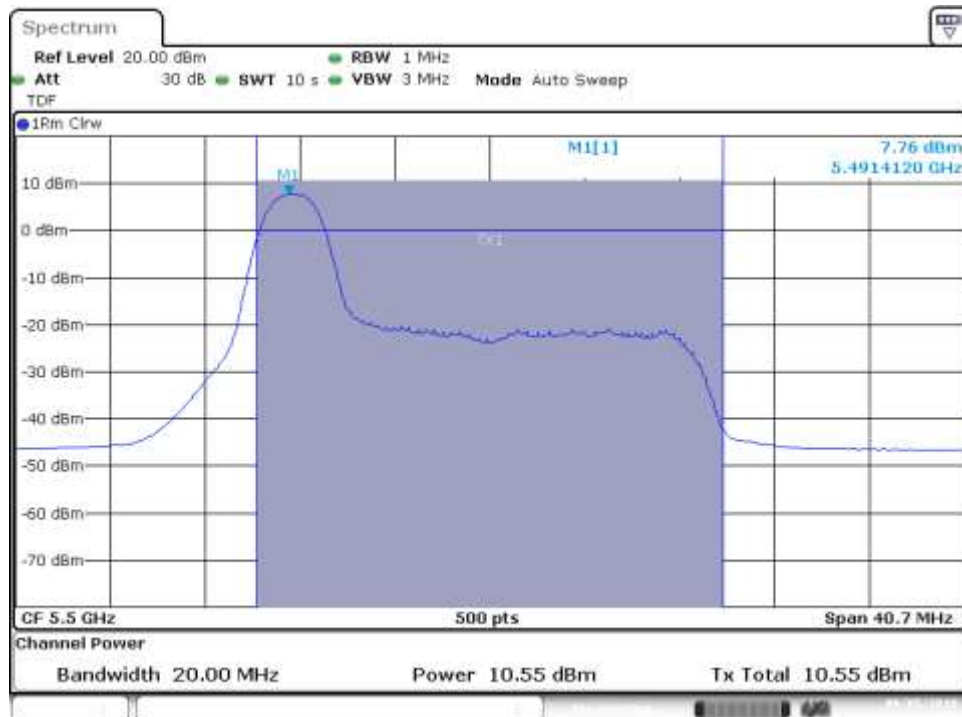

MIMO-A, 802.11ax20, HE0 RU 106/53

Channel 100

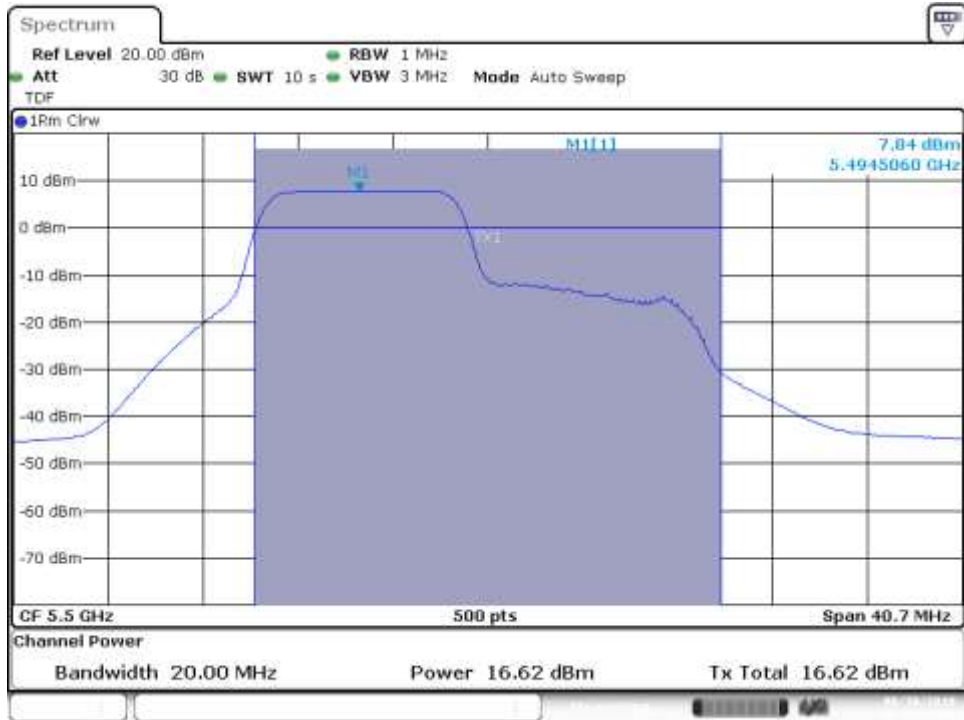

MIMO-B, 802.11ax20, HE0 RU 106/53

Channel 100

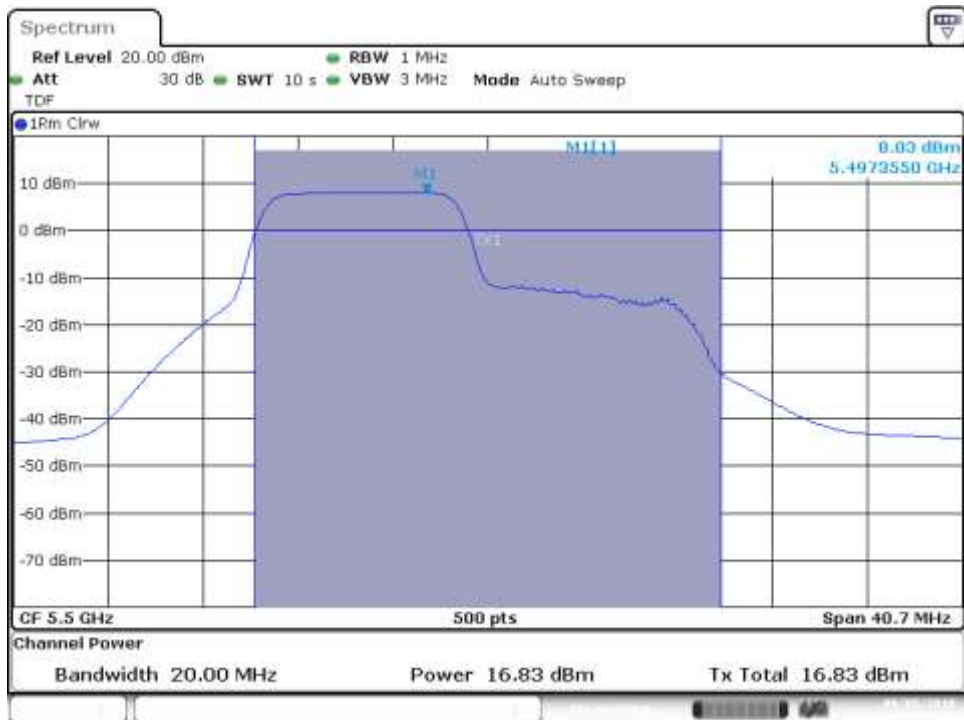

SISO-A, 802.11ax20, HE0 RU 26/8

Channel 140

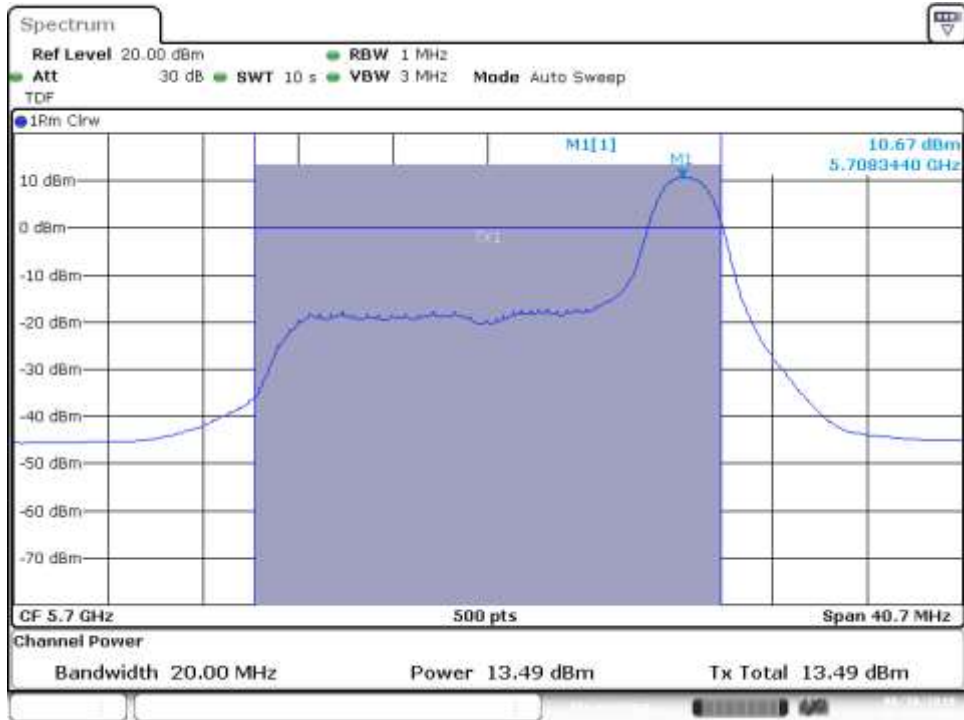

SISO-A, 802.11ax20, HE0 RU 106/54

Channel 140

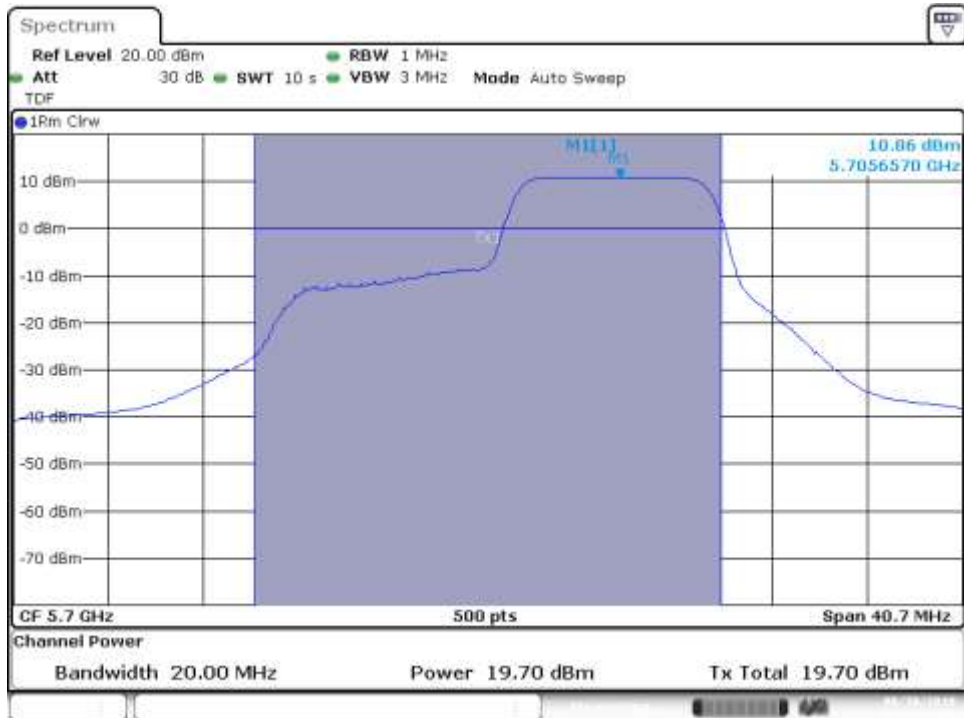

MIMO-A, 802.11ax20, HE0 RU 26/8

Channel 140

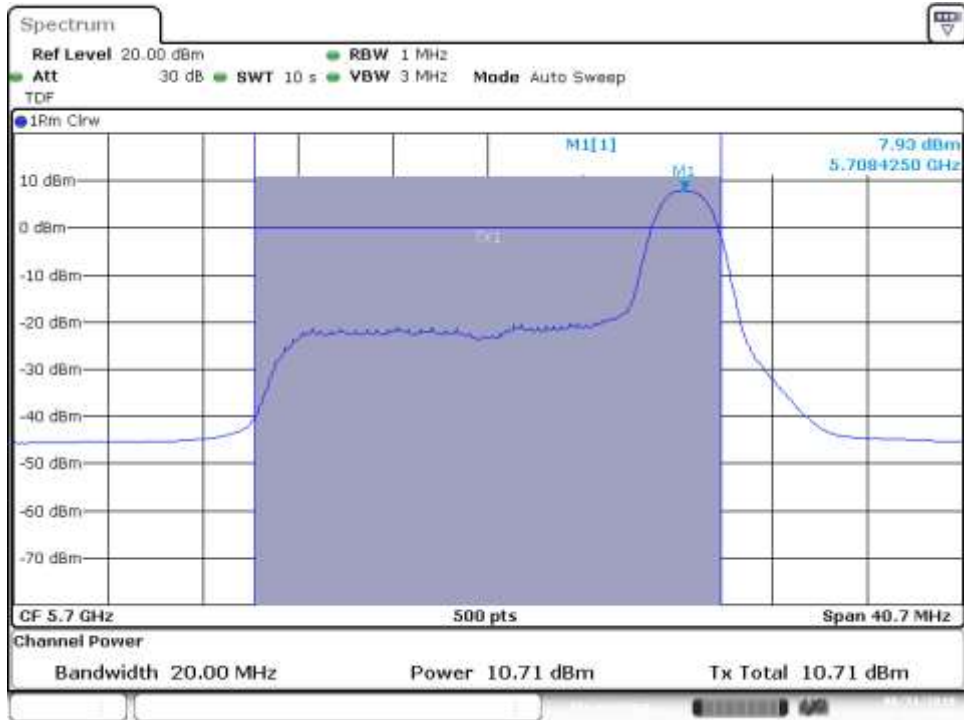

MIMO-B, 802.11ax20, HE0 RU 26/8

Channel 140

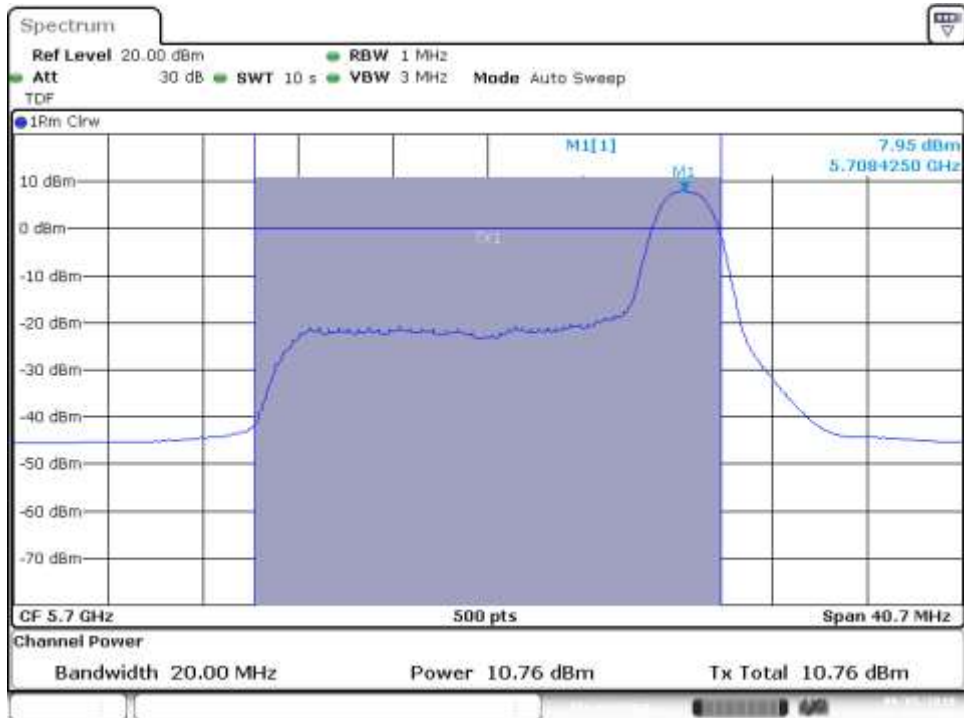

MIMO-A, 802.11ax20, HE0 RU 106/54

Channel 140

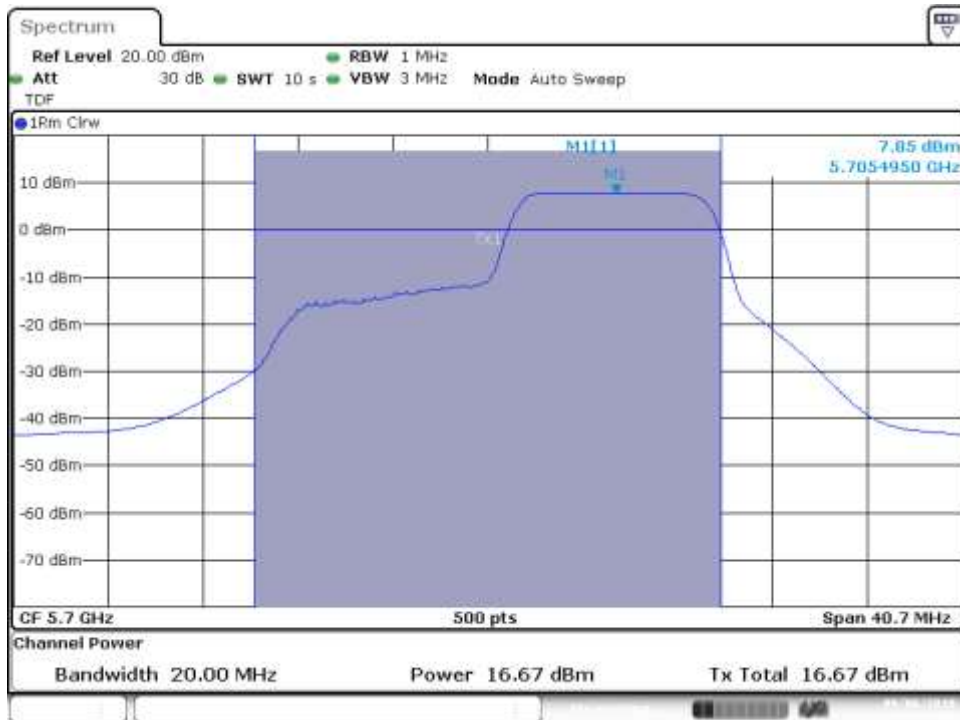

MIMO-B, 802.11ax20, HE0 RU 106/54

Channel 140

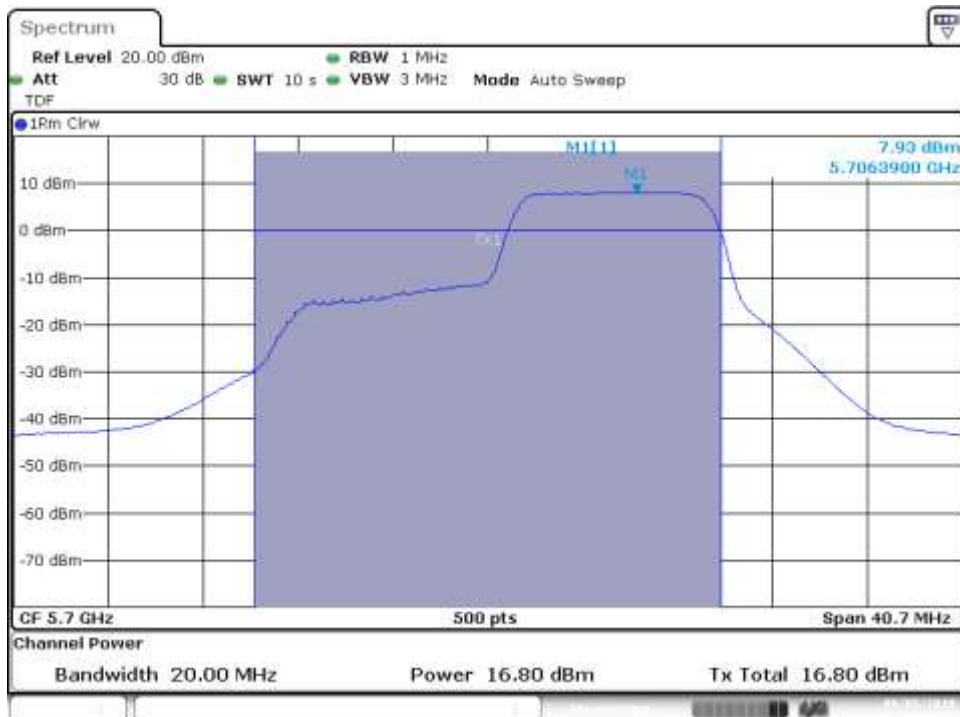

SISO-A, 802.11ax40, HE0 RU 242/61

Channel 102F

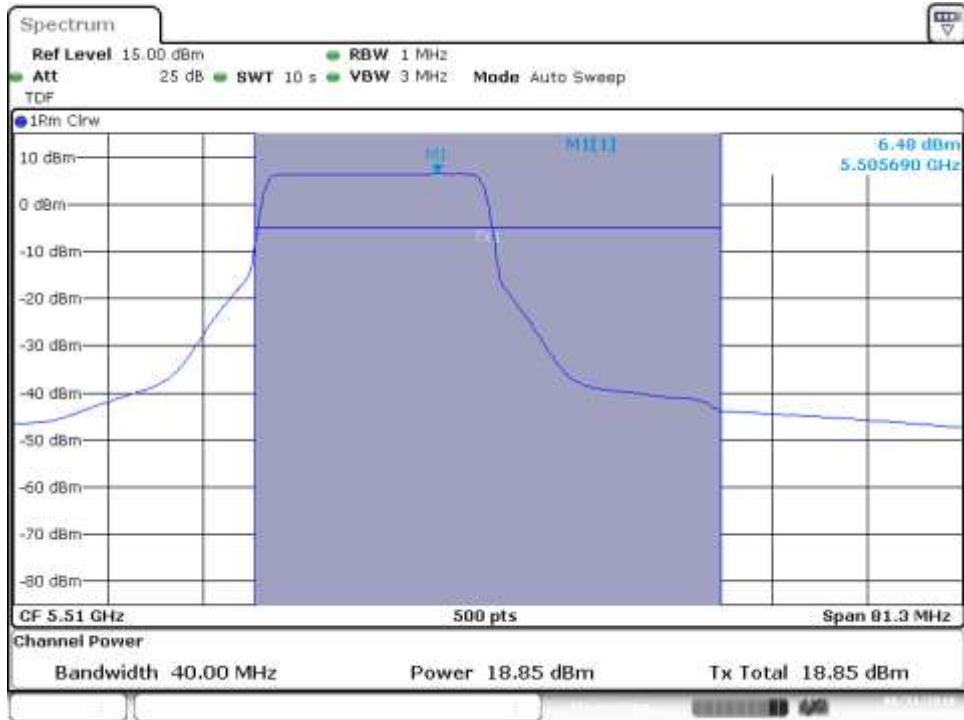

SISO-B, 802.11ax40, HE0 RU 242/62

Channel 102F

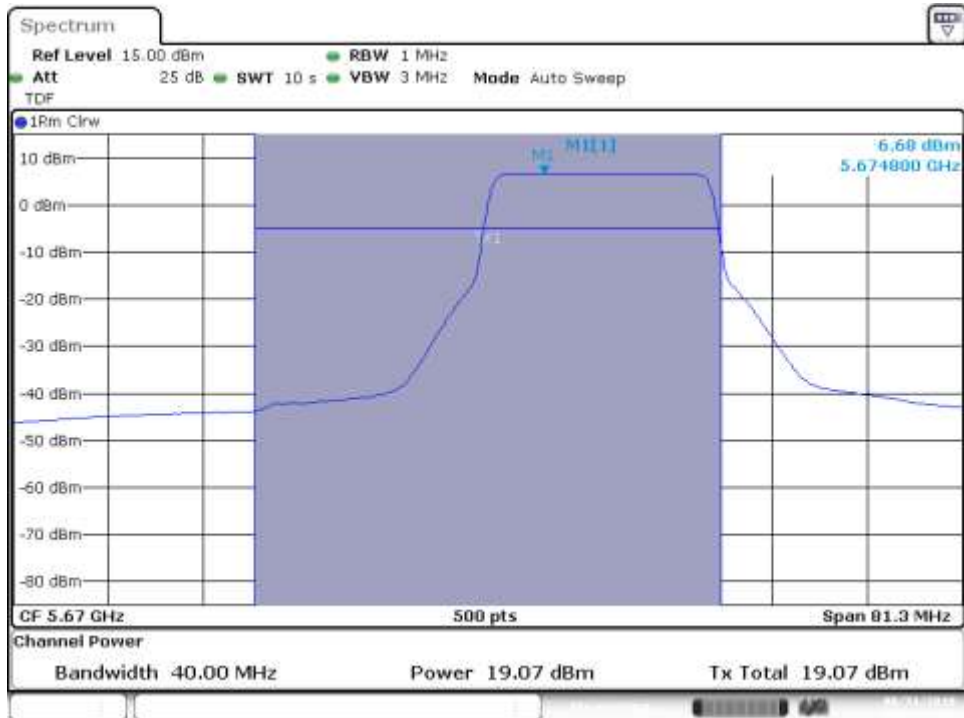

MIMO-A, 802.11ax40, HE0 RU 242/61

Channel 102F

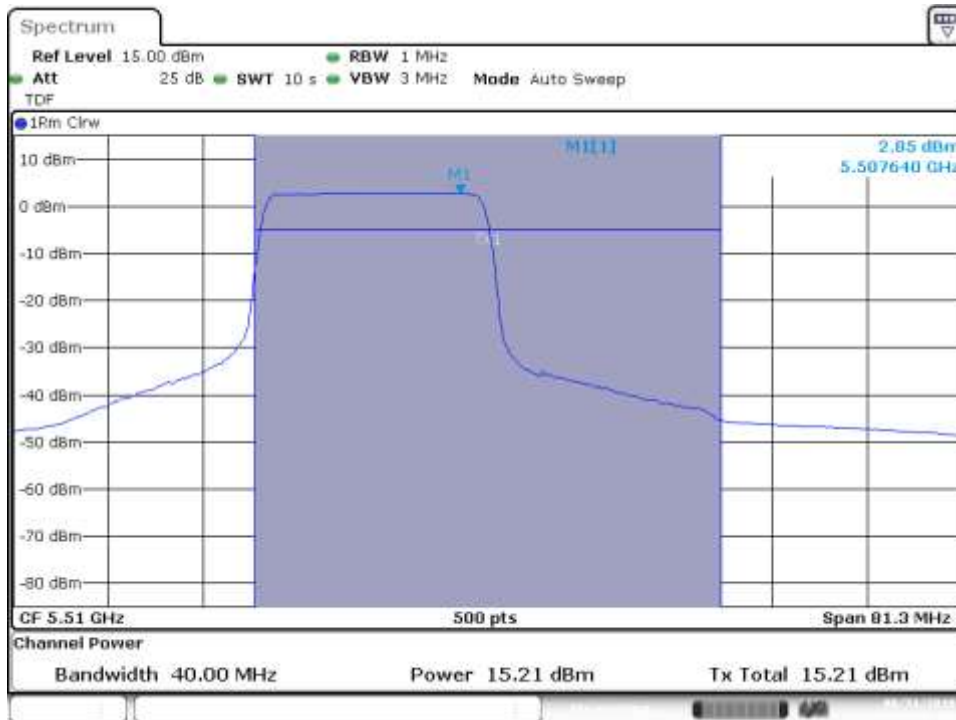

MIMO-B, 802.11ax40, HE0 RU 242/61

Channel 102F

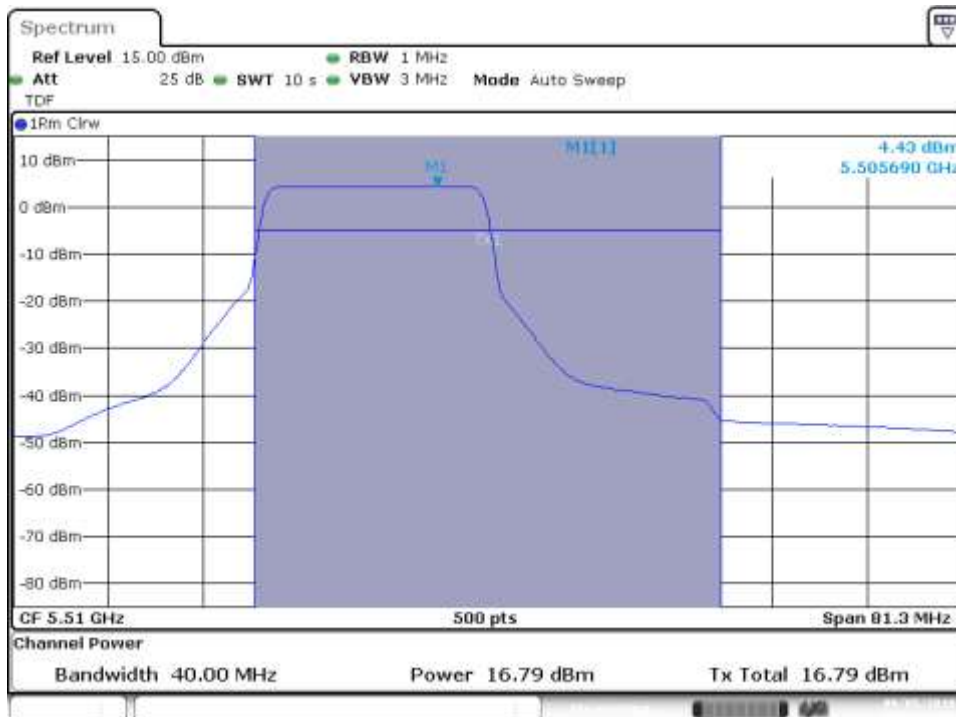

MIMO-A, 802.11ax40, HE0 RU 242/62

Channel 134F



MIMO-B, 802.11ax40, HE0 RU 242/62

Channel 134F

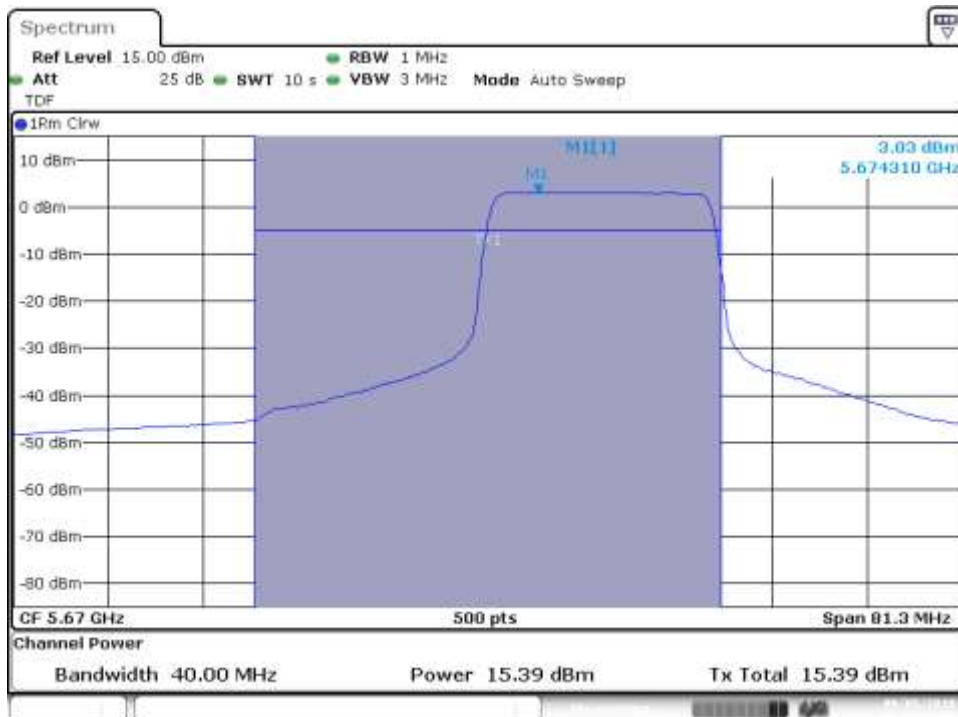

SISO-A, 802.11ax80, HE0 RU 484/65

Channel 106ax80

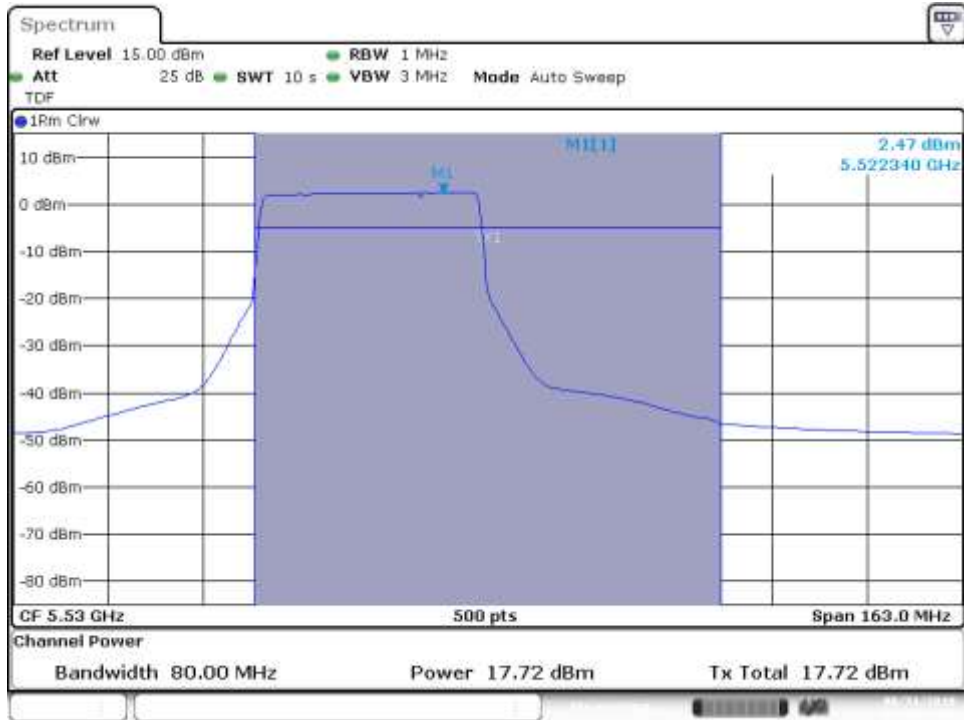

SISO-B, 802.11ax80, HE0 RU 484/65

Channel 106ax80

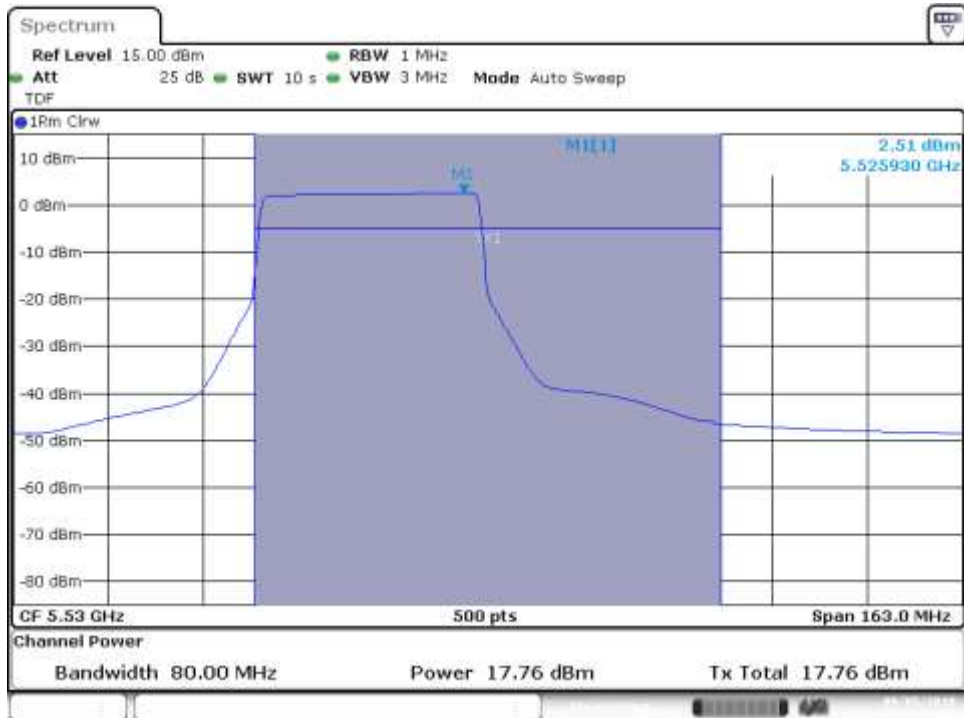

MIMO-A, 802.11ax80, HE0 RU 484/65

Channel 106ax80

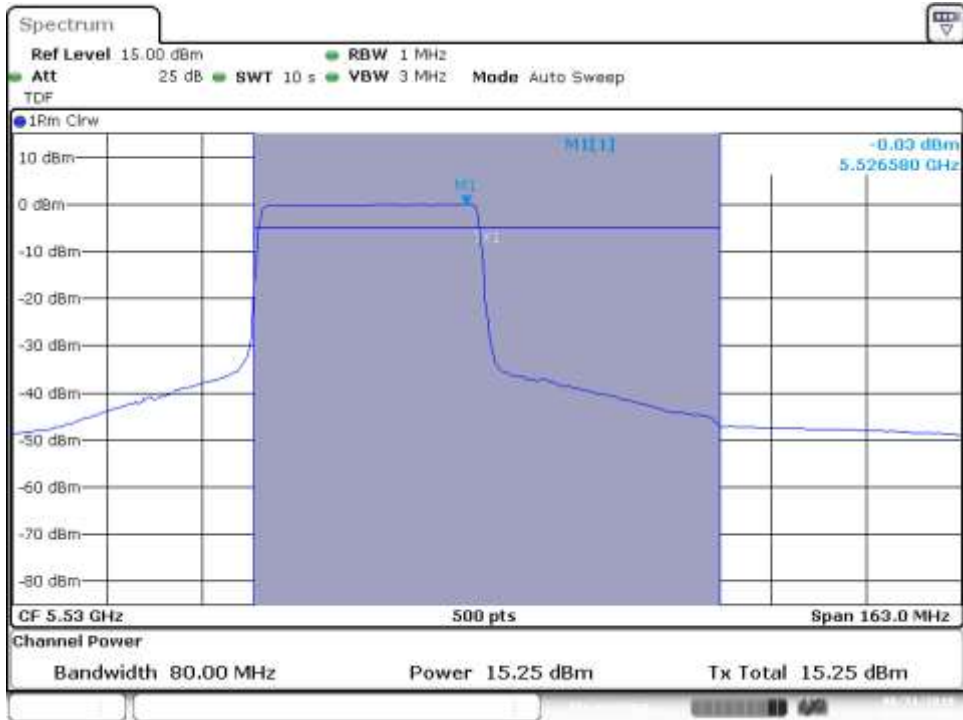

MIMO-B, 802.11ax80, HE0 RU 484/65

Channel 106ax80

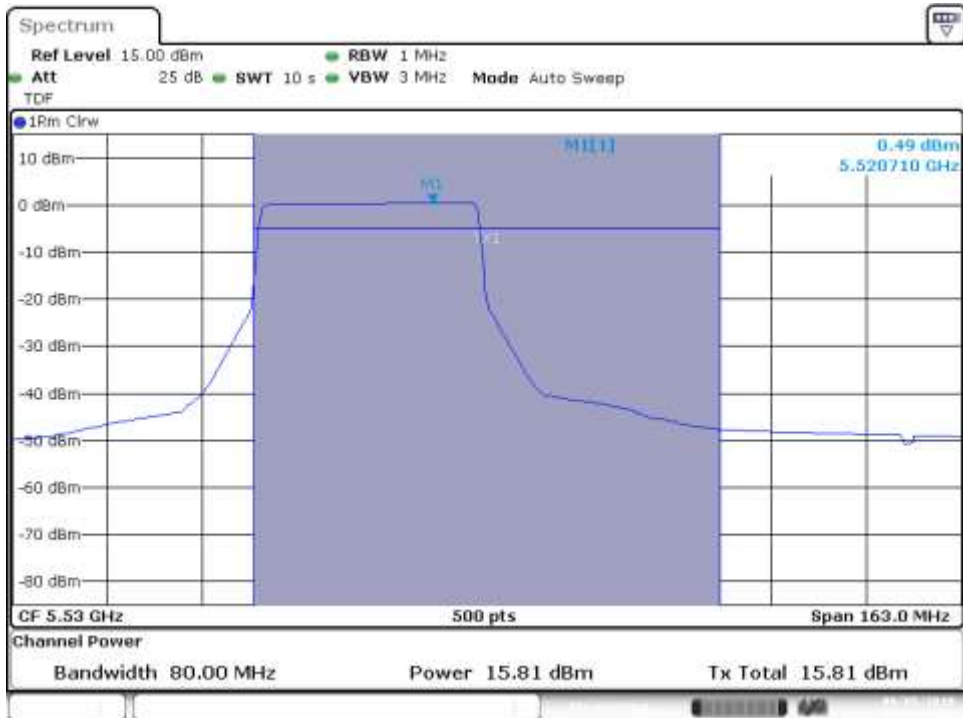

SISO-A, 802.11ax160, HE0 RU 996/67

Channel 114ax160

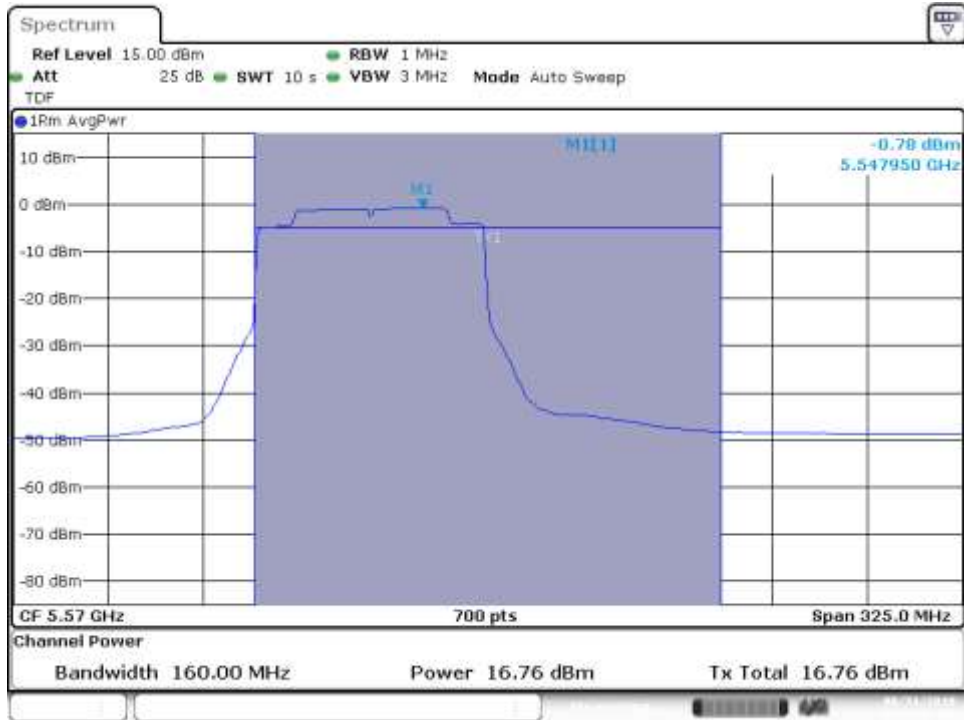

SISO-A, 802.11ax160, HE0 RU 996/S67

Channel 114ax160

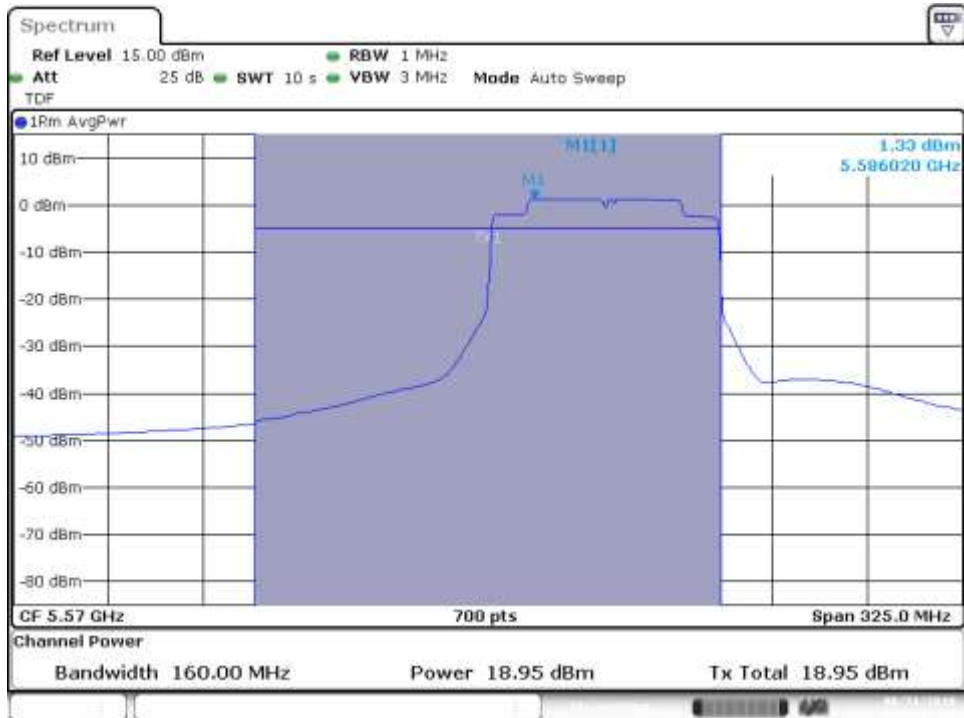

MIMO-A, 802.11ax160, HE0 RU 996/67

Channel 114ax160

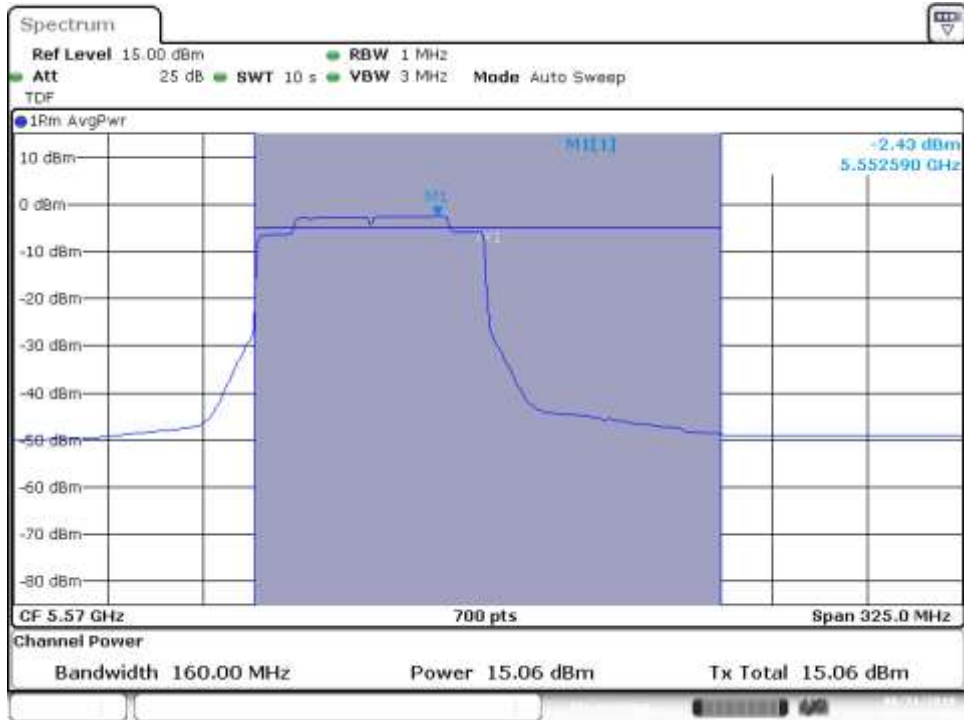

MIMO-B, 802.11ax160, HE0 RU 996/67

Channel 114ax160

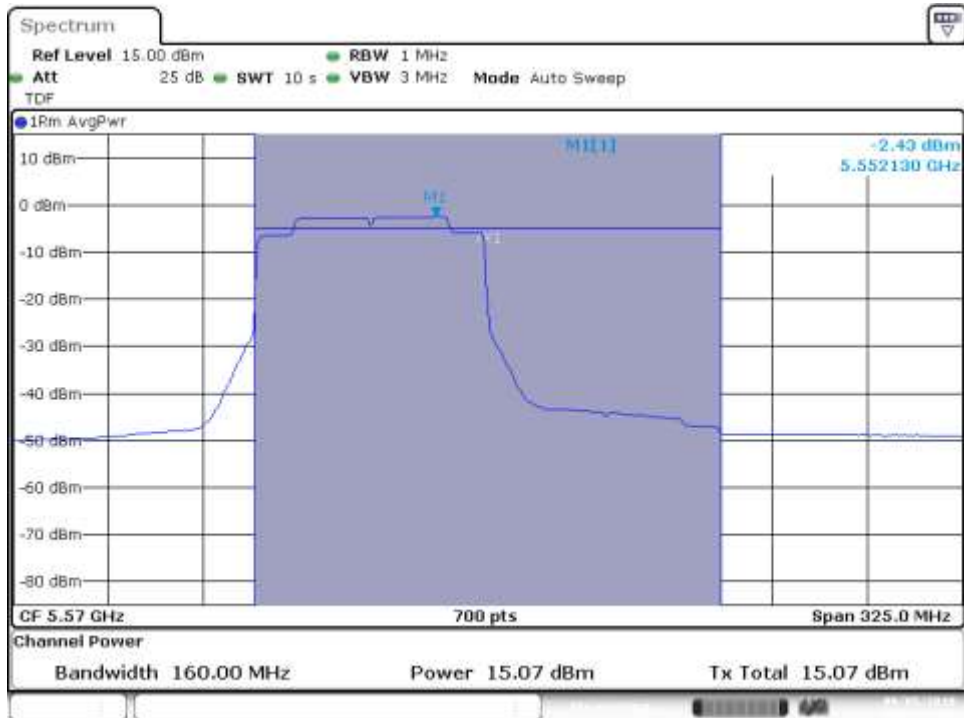

MIMO-A, 802.11ax160, HE0 RU 996/S67

Channel 114ax160

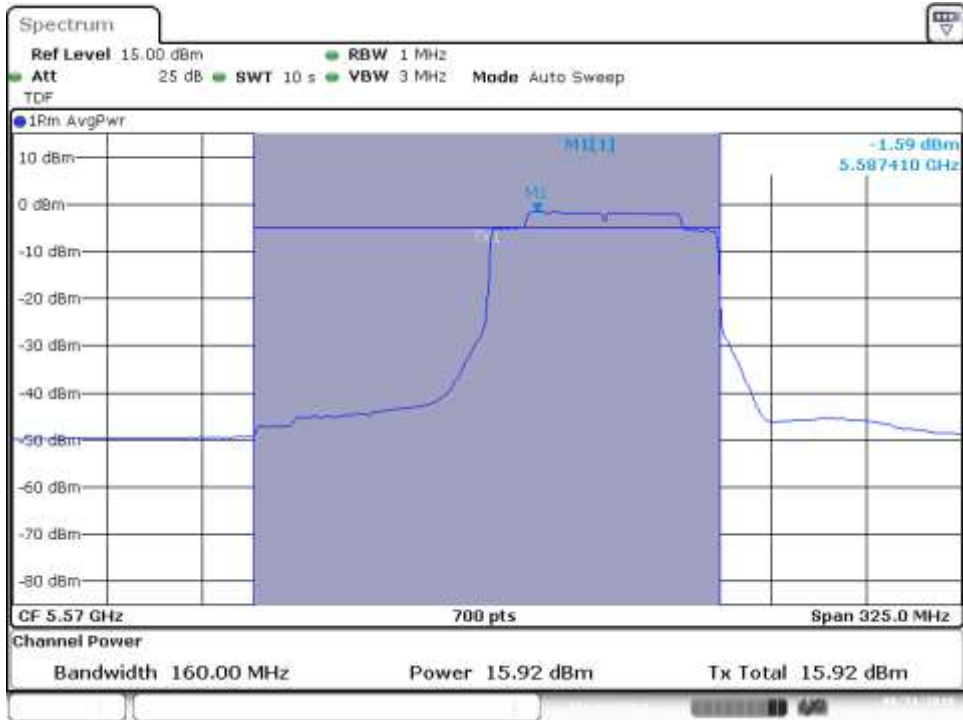

MIMO-B, 802.11ax160, HE0 RU 996/S67

Channel 114ax160

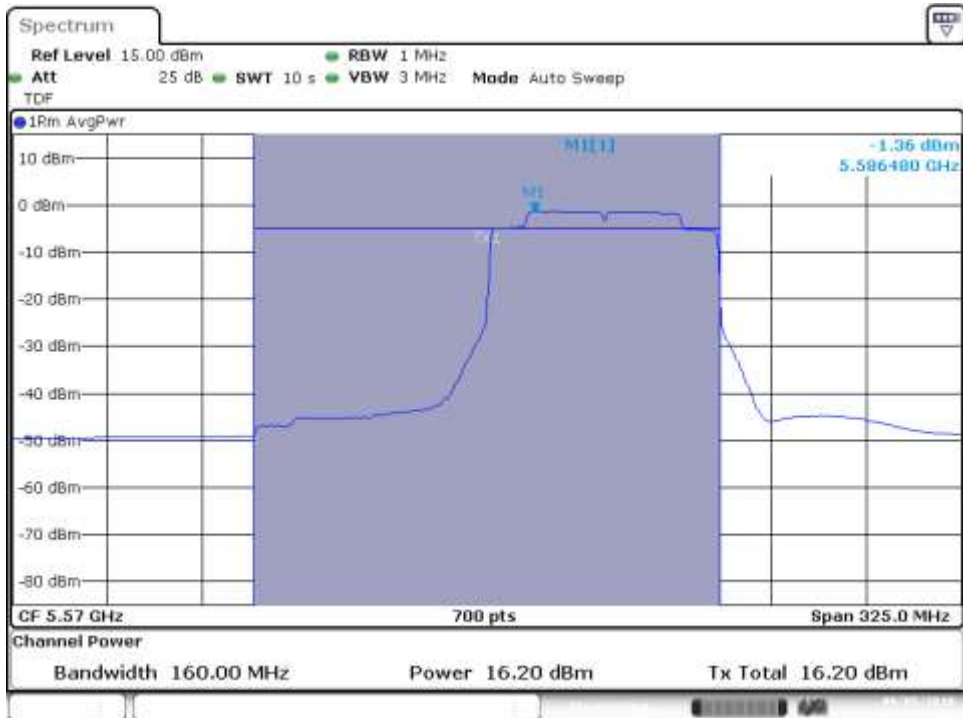

B.3.4 Maximum output power & Maximum power spectral Density (Overlapped Channel)**SISO-A, 802.11n20, HT0**

Channel 144 (Overlapped Channel)

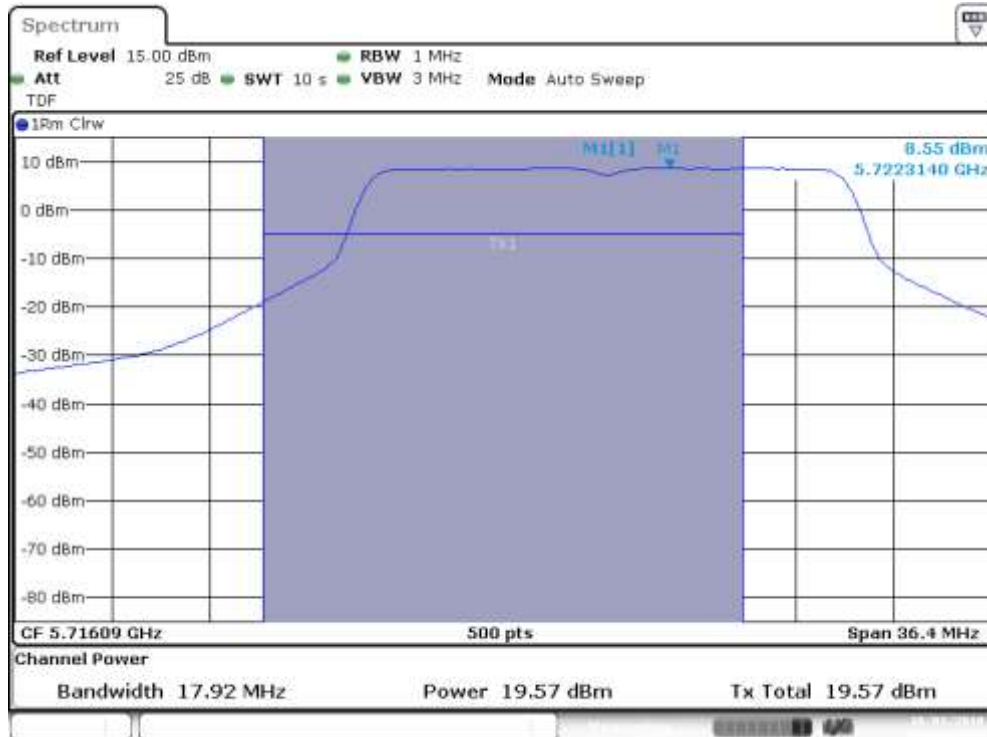
**SISO-B, 802.11n20, HT0**

Channel 144 (Overlapped Channel)

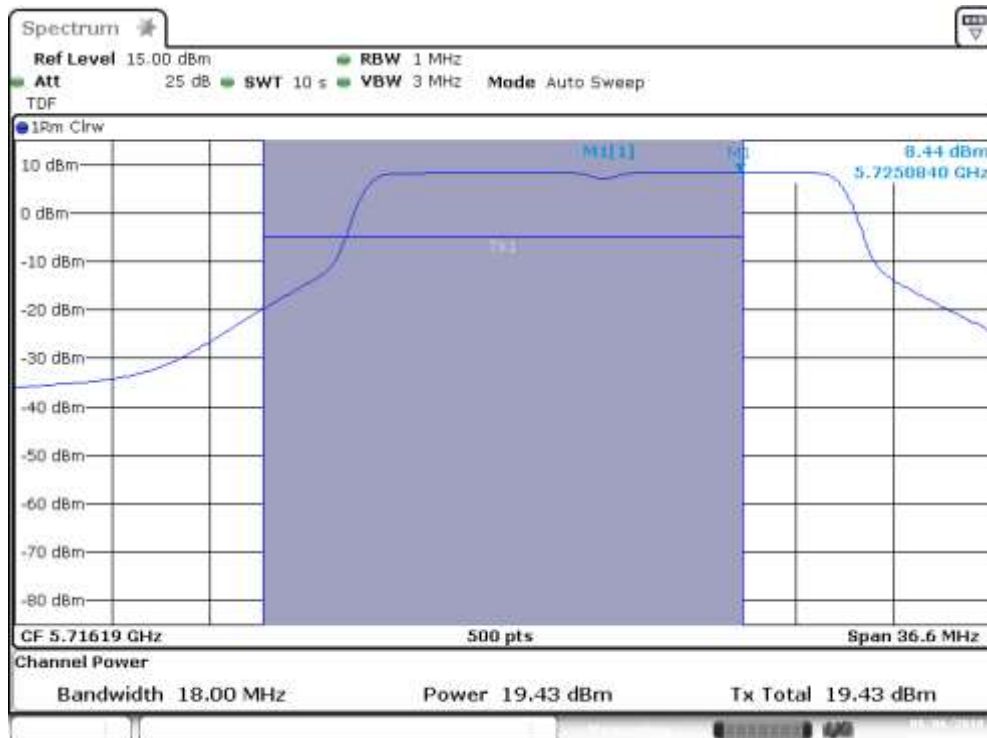

MIMO-A, 802.11n20, HT8

Channel 144 (Overlapped Channel)

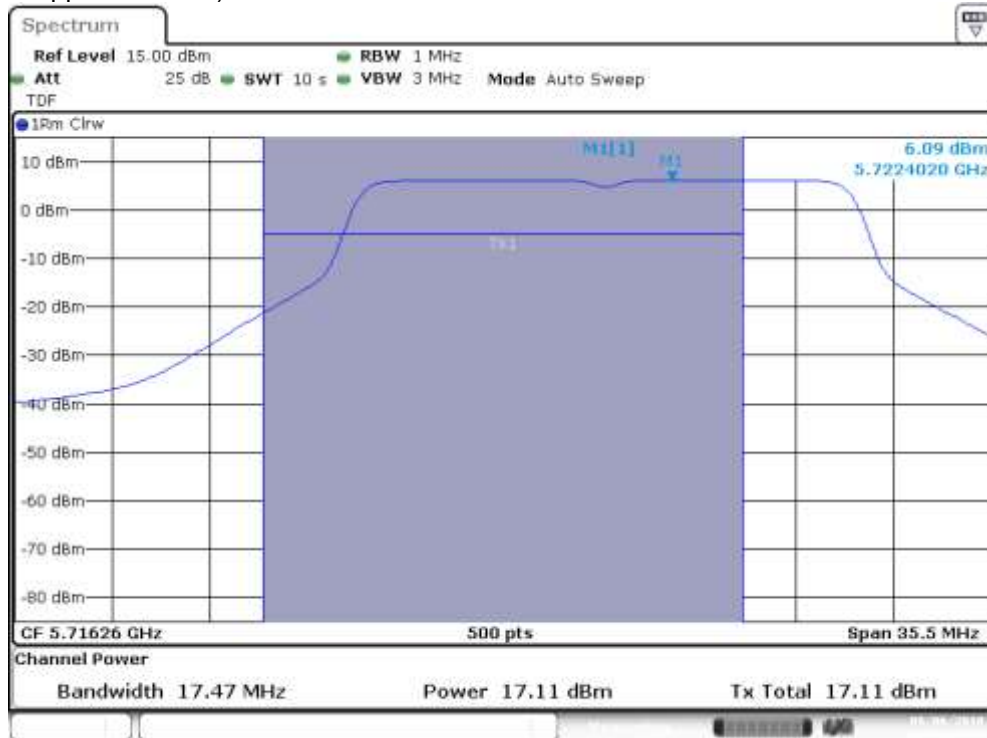

MIMO-B, 802.11n20, HT8

Channel 144 (Overlapped Channel)

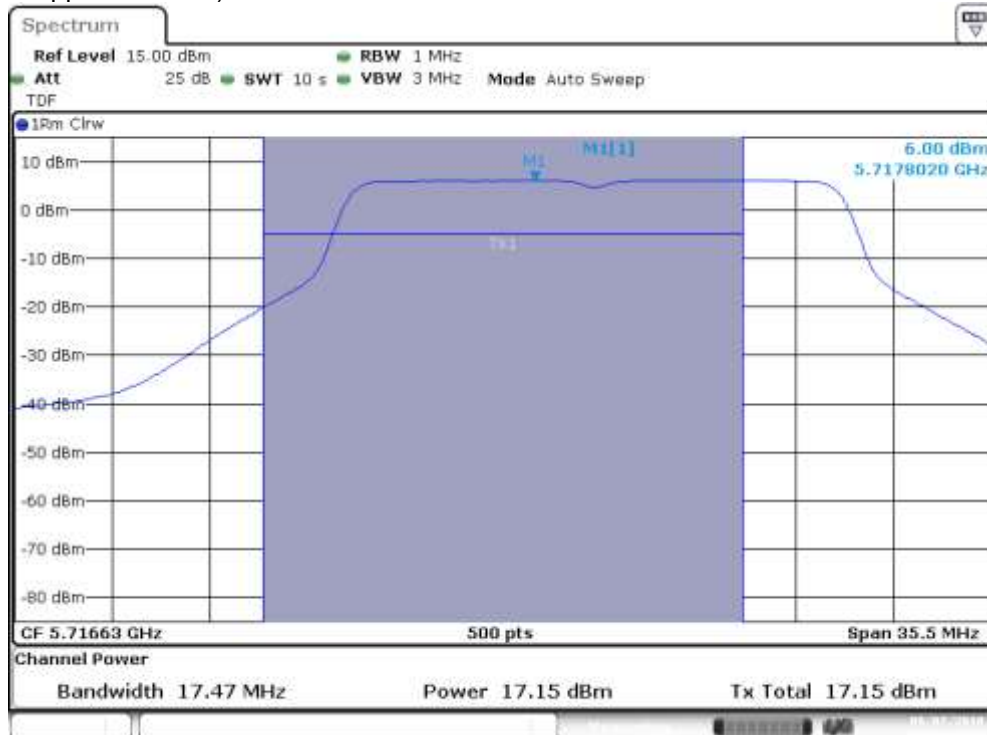

SISO-A, 802.11n40, HT0

Channel 142F (Overlapped Channel)

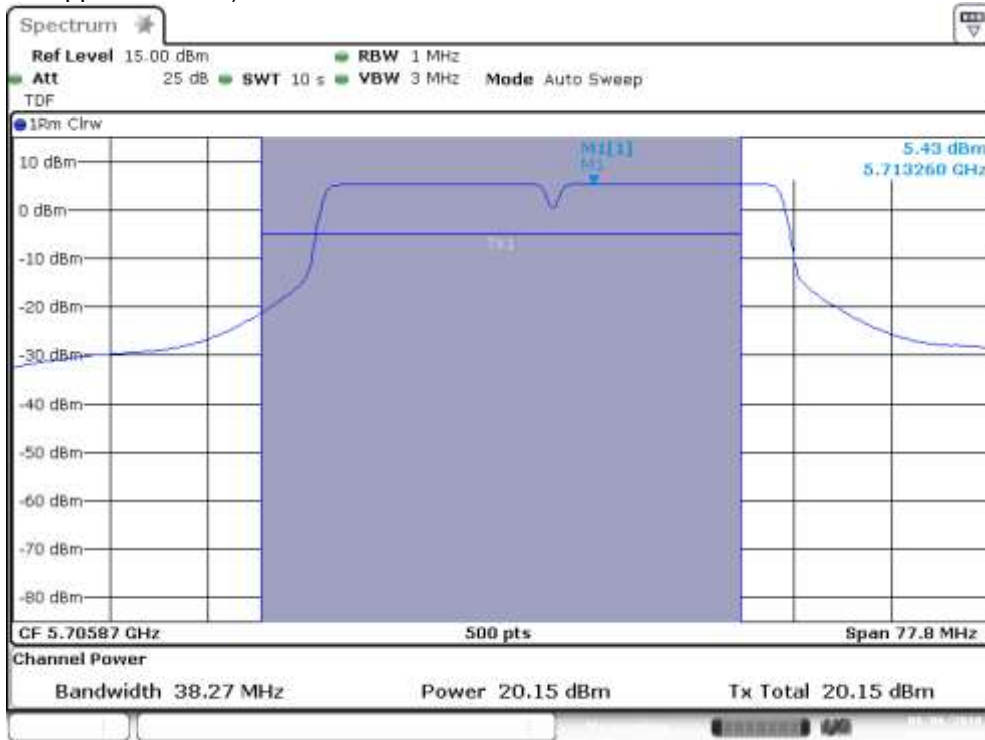

SISO-B, 802.11n40, HT0

Channel 142F (Overlapped Channel)

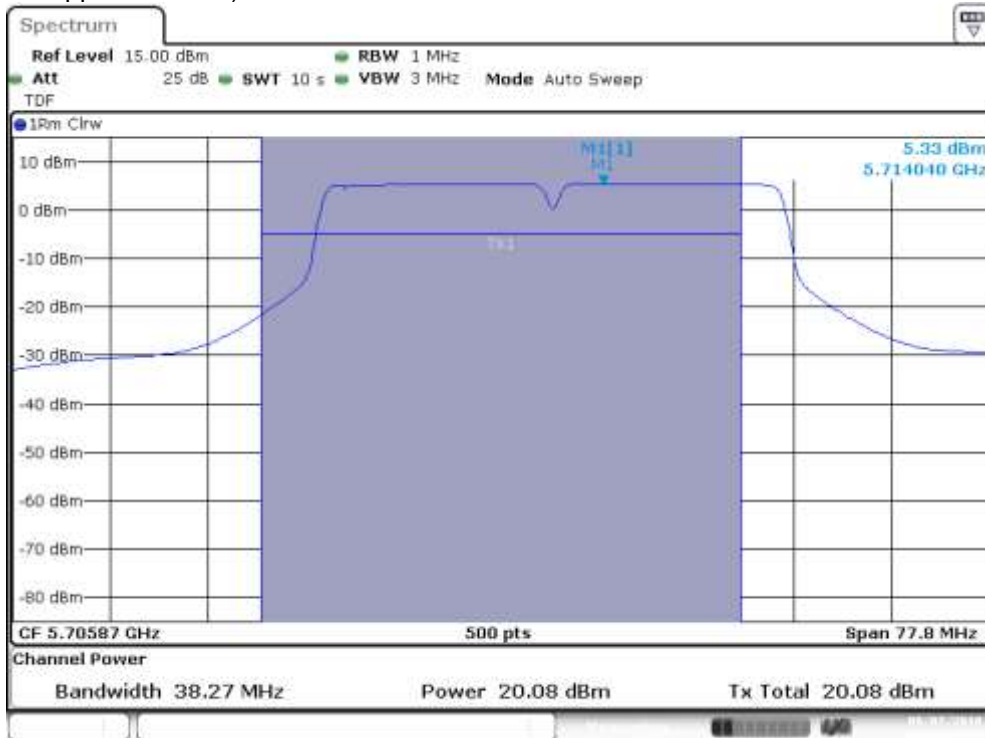

MIMO-A, 802.11n40, HT8

Channel 142F (Overlapped Channel)

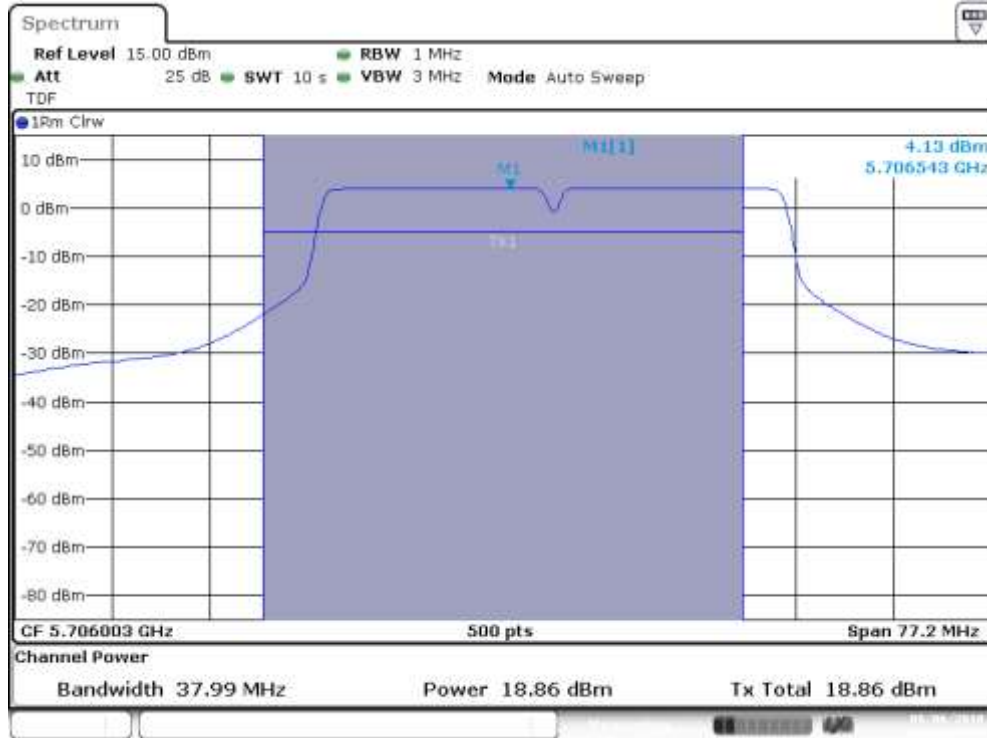

MIMO-B, 802.11n40, HT8

Channel 142F (Overlapped Channel)

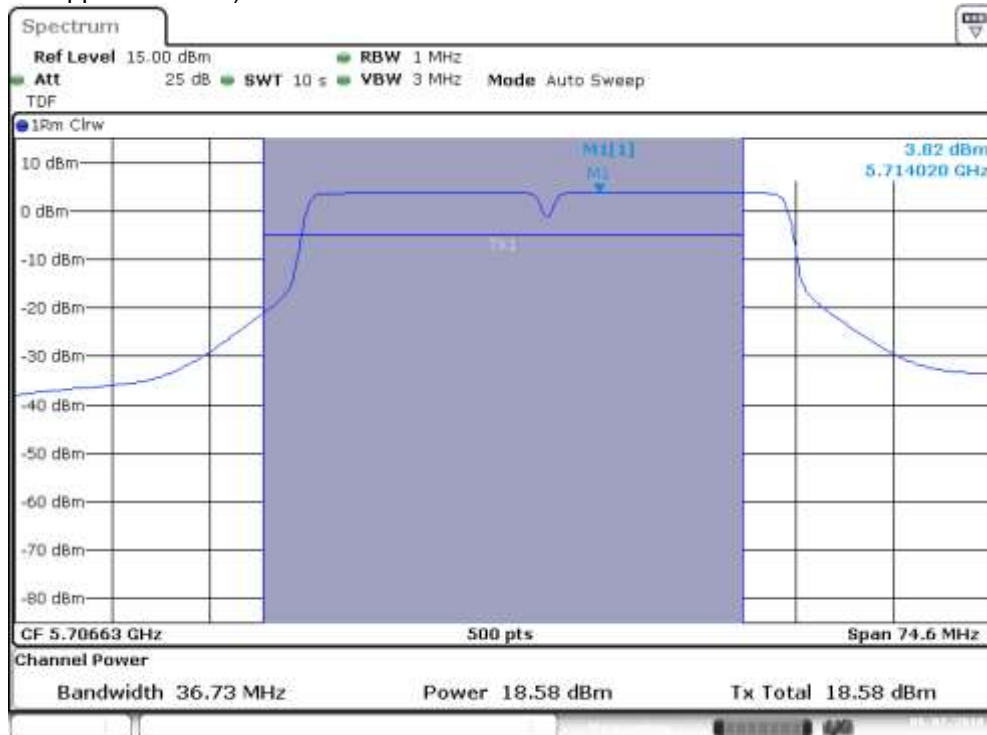

SISO-A, 802.11ac80, VHT0

Channel 138ac80 (Overlapped Channel)

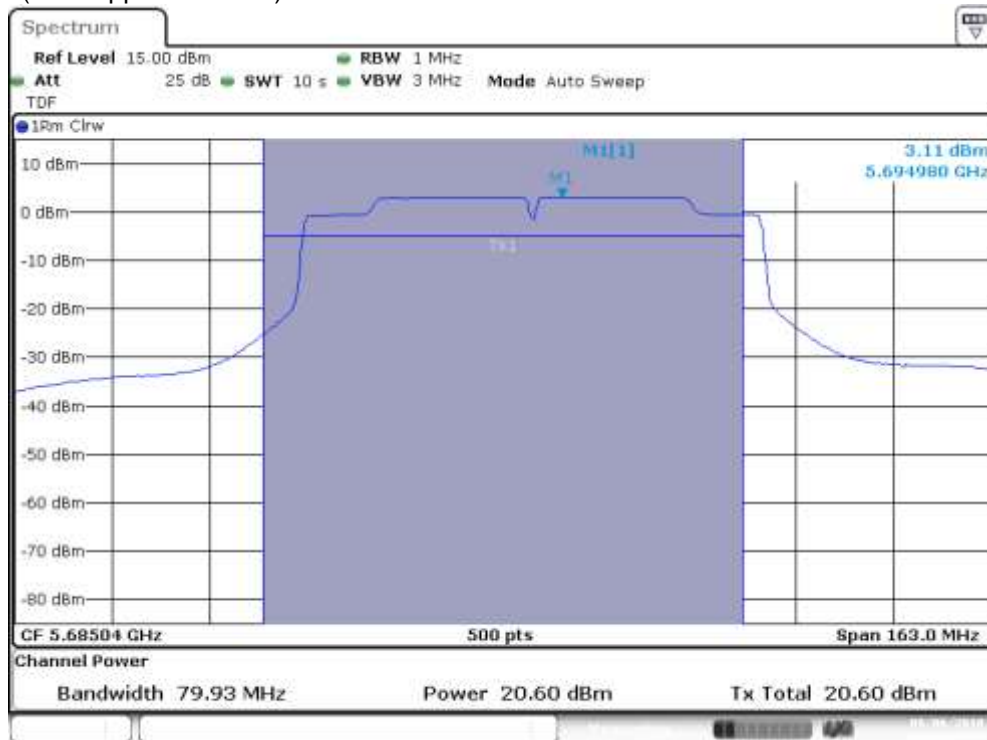

SISO-B, 802.11ac80, VHT0

Channel 138ac80 (Overlapped Channel)

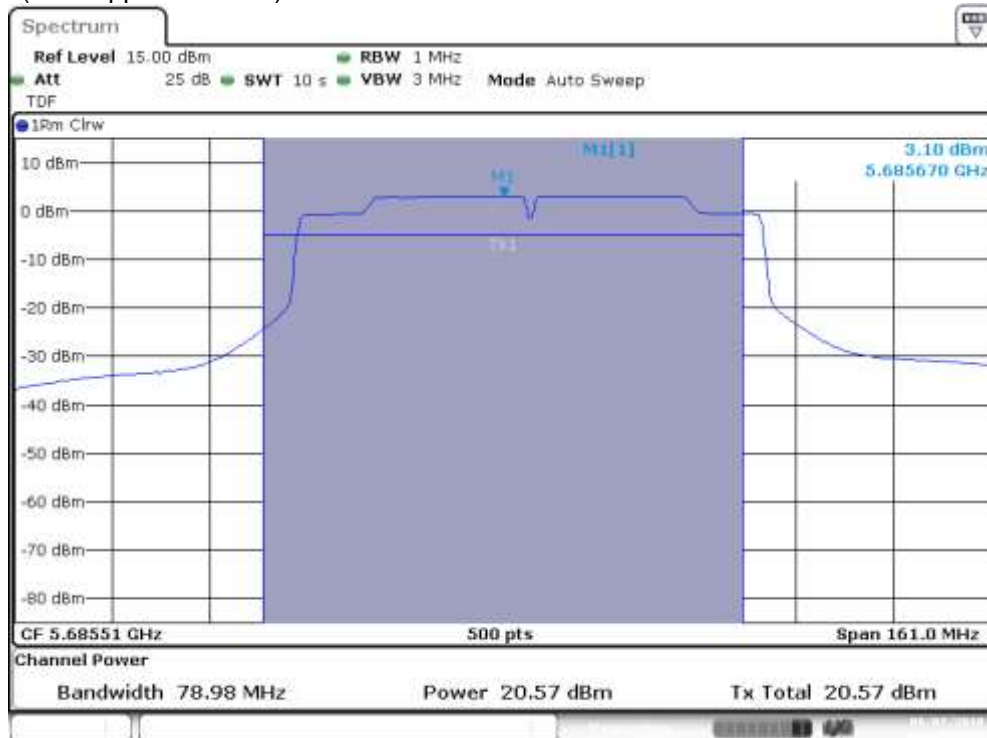

MIMO-A, 802.11ac80, VHT0

Channel 138ac80 (Overlapped Channel)

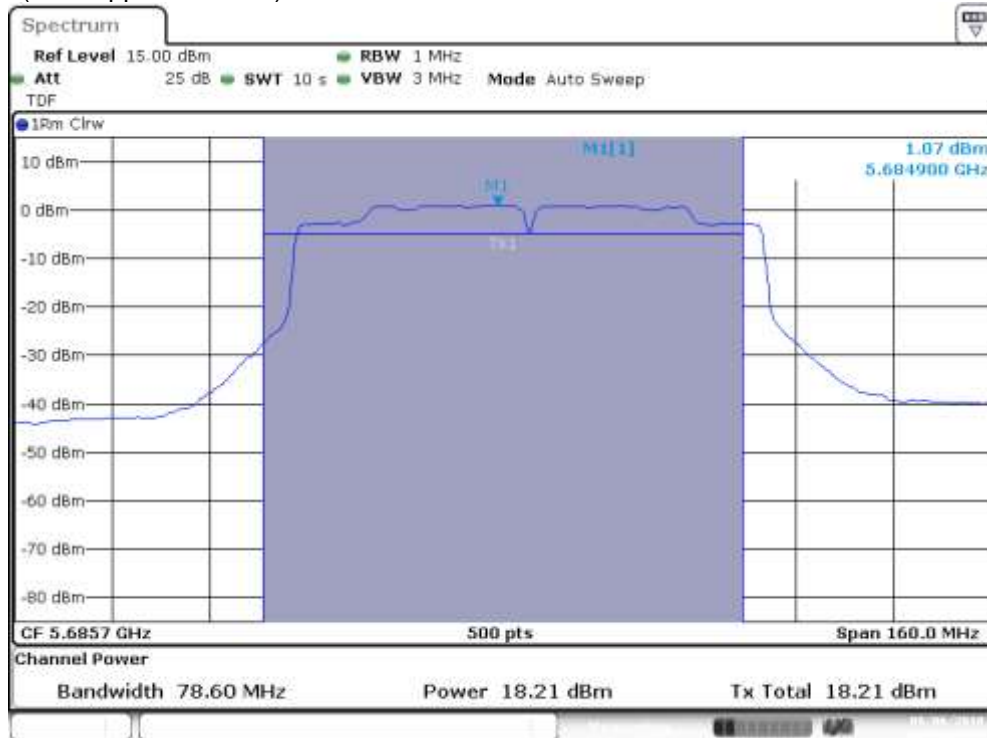

MIMO-B, 802.11ac80, VHT0

Channel 138ac80 (Overlapped Channel)

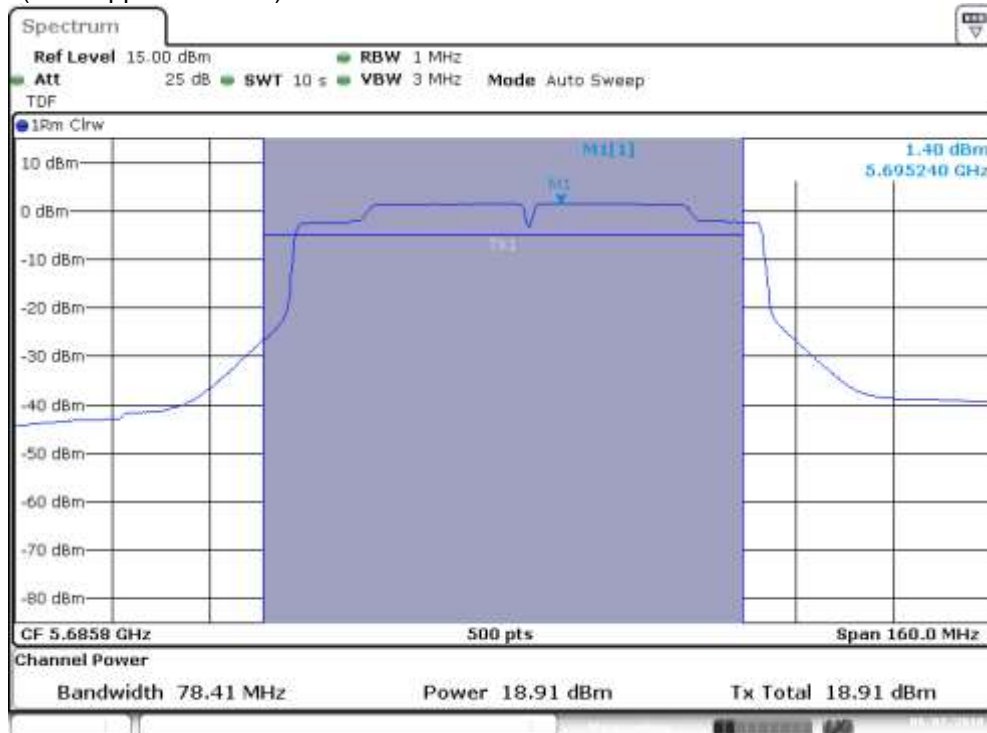

SISO-A, 802.11ax20, HE0

Channel 144 (Overlapped Channel)

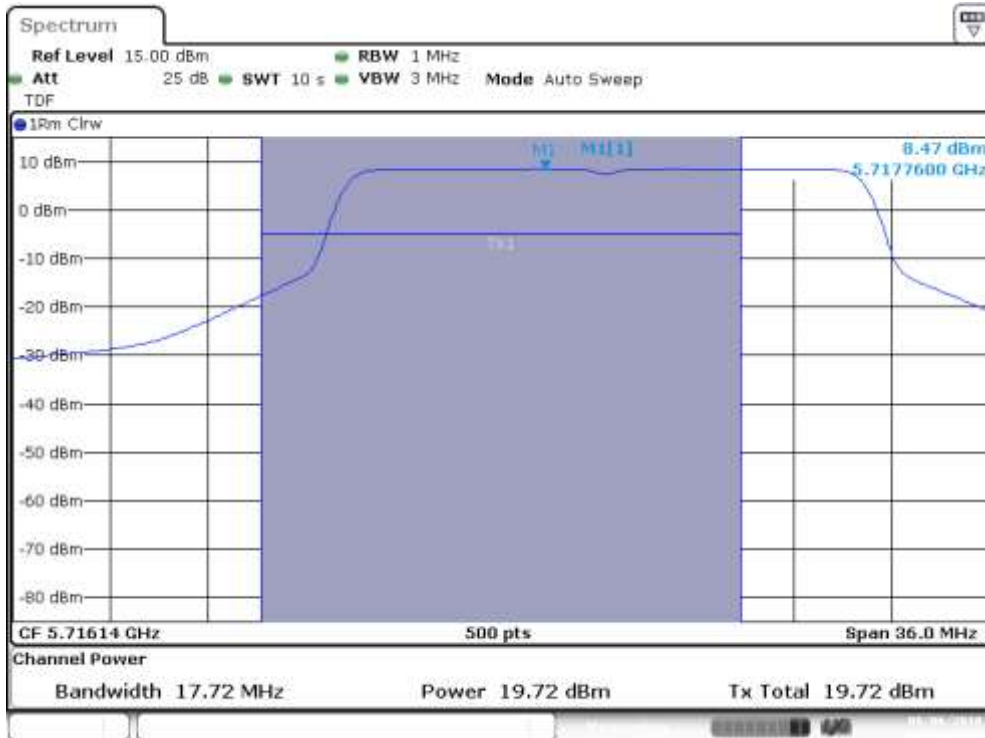

SISO-B, 802.11ax20, HE0

Channel 144 (Overlapped Channel)

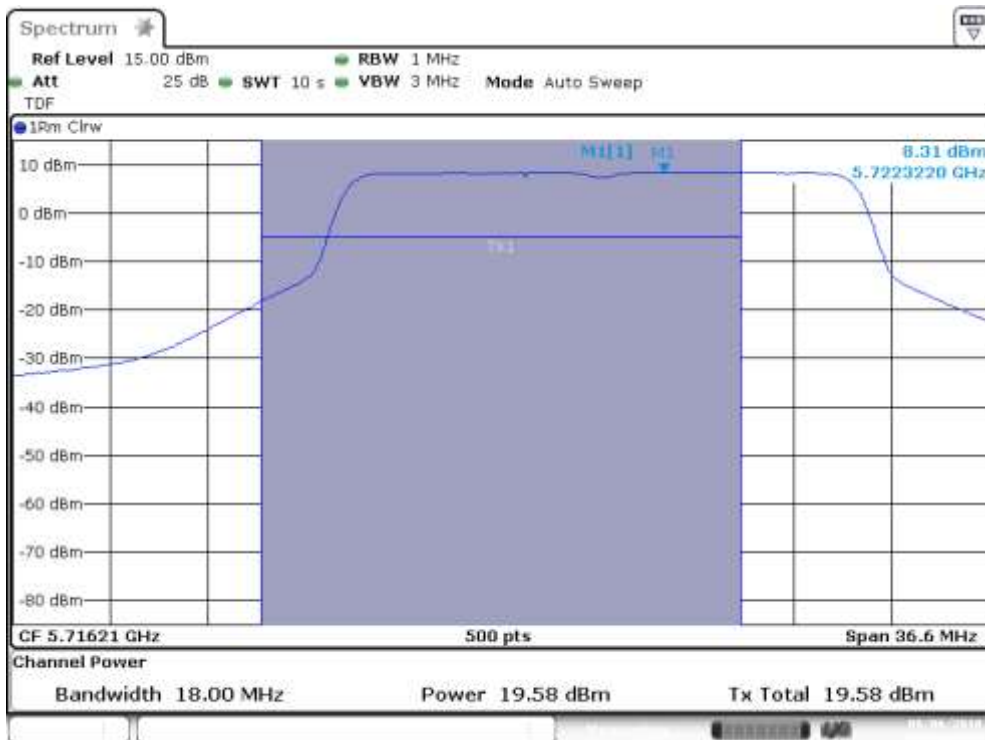

MIMO-A, 802.11ax20, HE0

Channel 144 (Overlapped Channel)

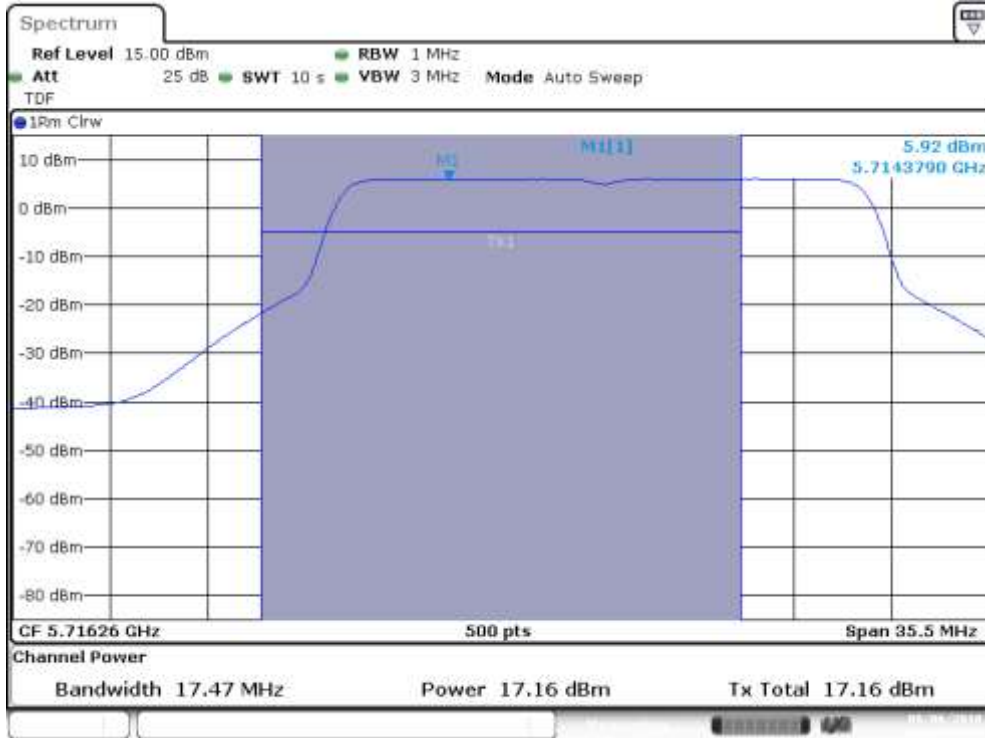

MIMO-B, 802.11ax20, HE0

Channel 144 (Overlapped Channel)

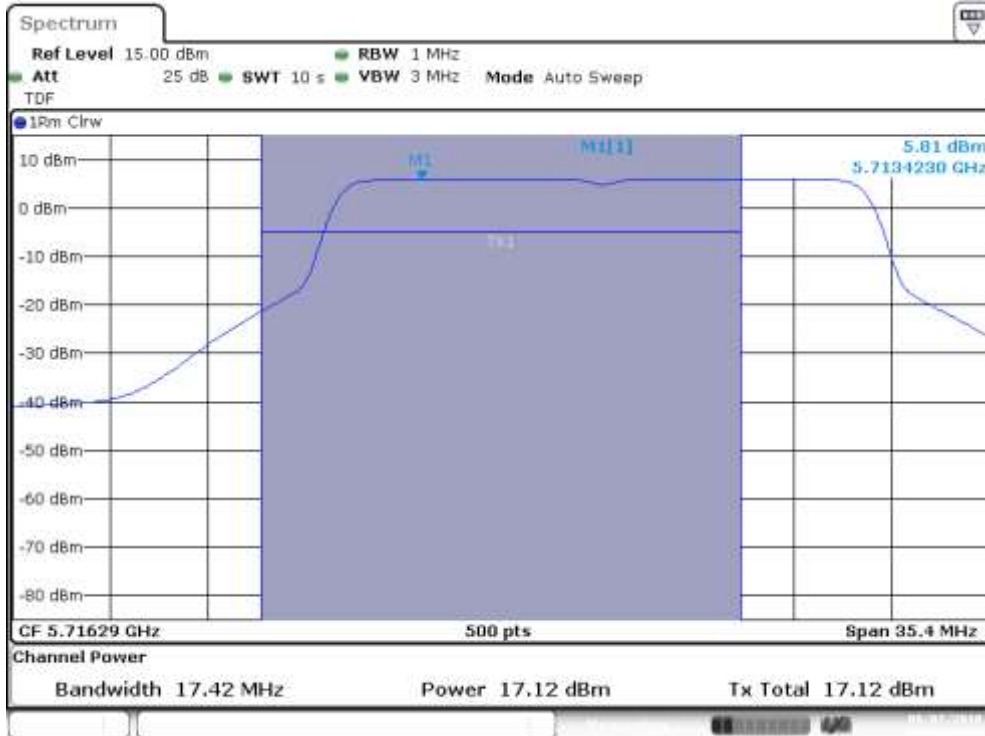

SISO-A, 802.11ax40, HE0

Channel 142F (Overlapped Channel)

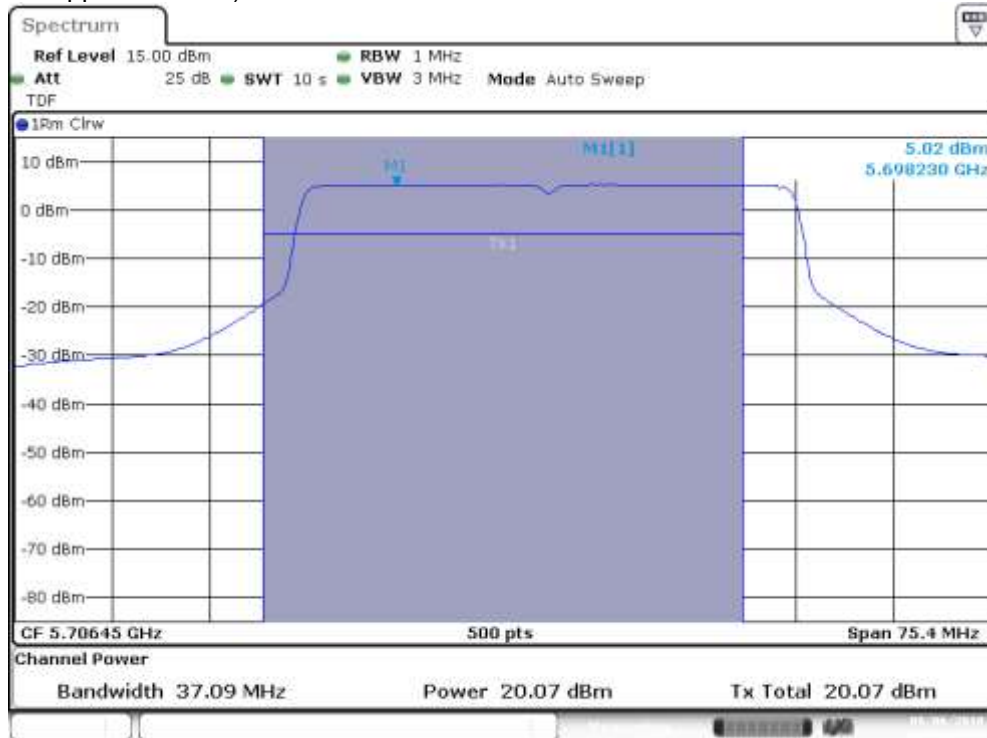

SISO-B, 802.11ax40, HE0

Channel 142F (Overlapped Channel)

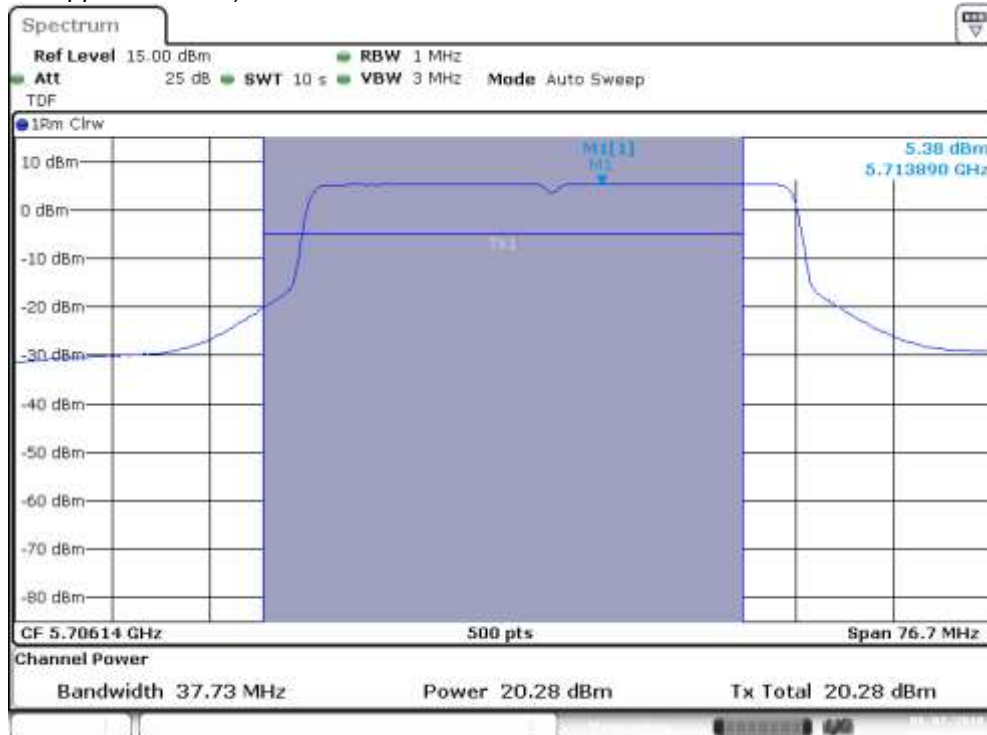

MIMO-A, 802.11ax40, HE0

Channel 142F (Overlapped Channel)

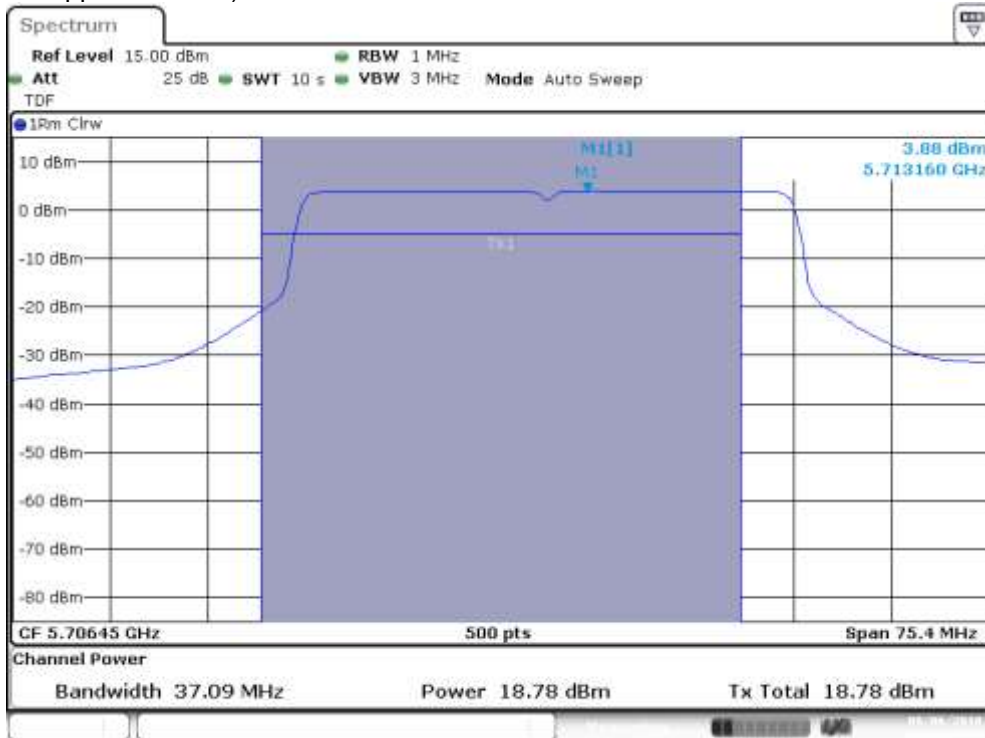

MIMO-B, 802.11ax40, HE0

Channel 142F (Overlapped Channel)

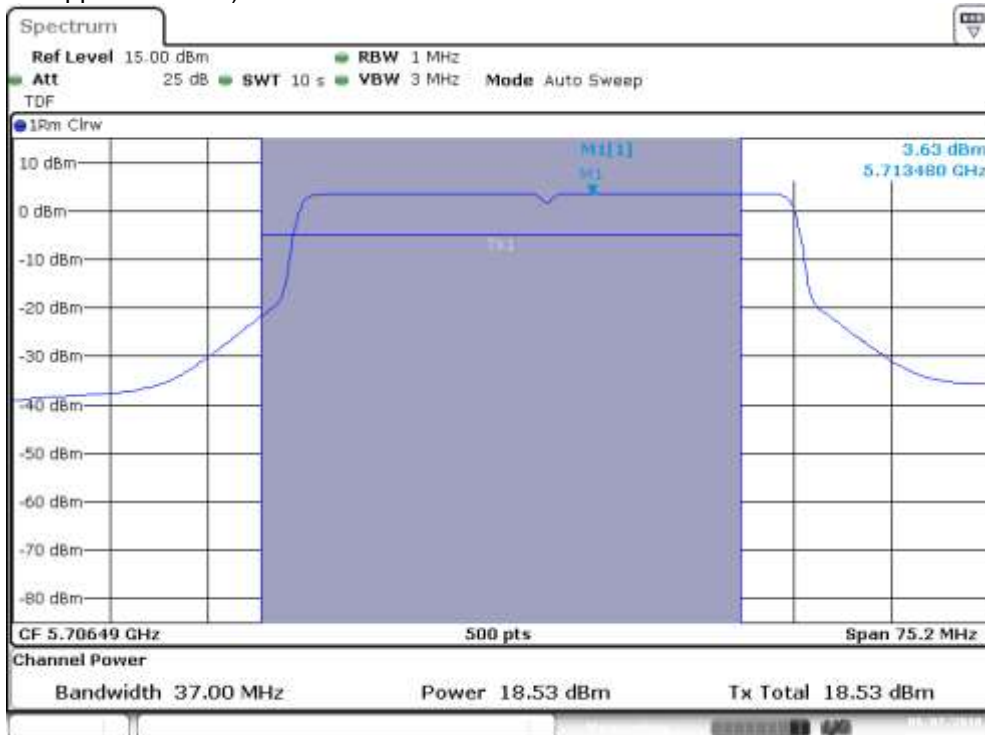

SISO-A, 802.11ax80, HE0

Channel 138ax80 (Overlapped Channel)

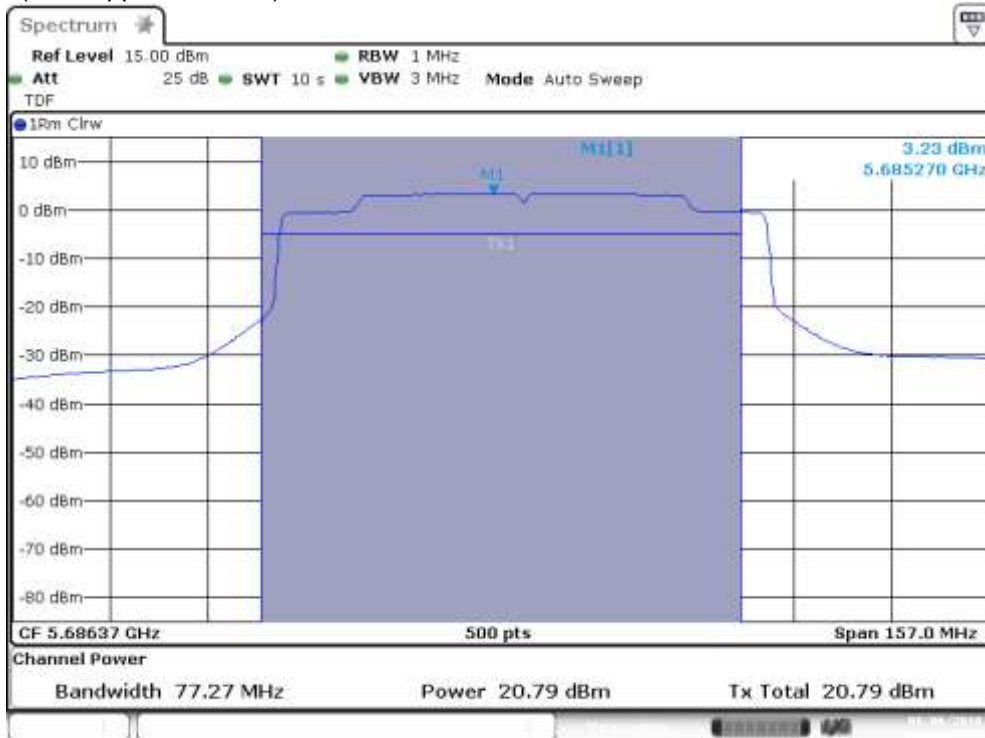

SISO-B, 802.11ax80, HE0

Channel 138ax80 (Overlapped Channel)

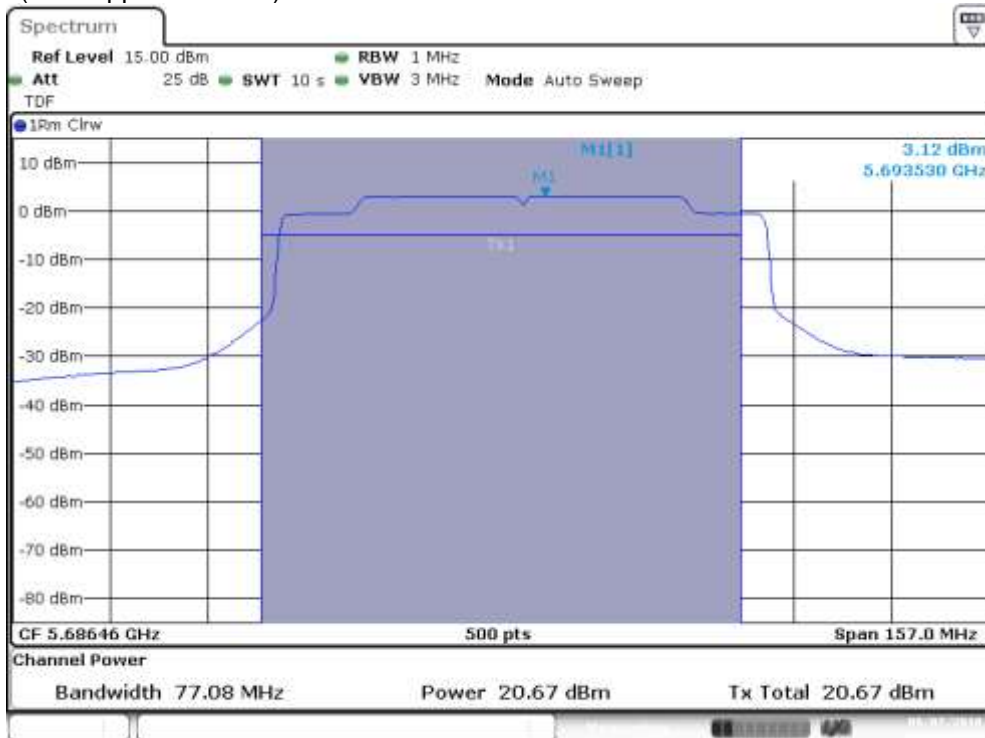

MIMO-A, 802.11ax80, HE0

Channel 138ax80 (Overlapped Channel)

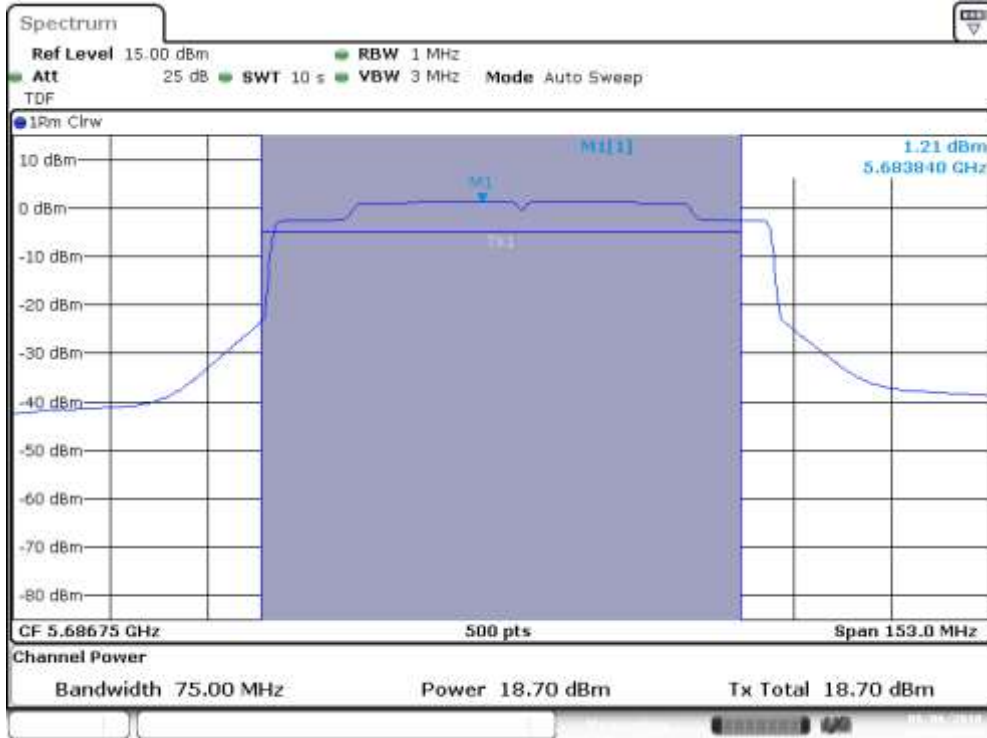

MIMO-B, 802.11ax80, HE0

Channel 138ax80 (Overlapped Channel)

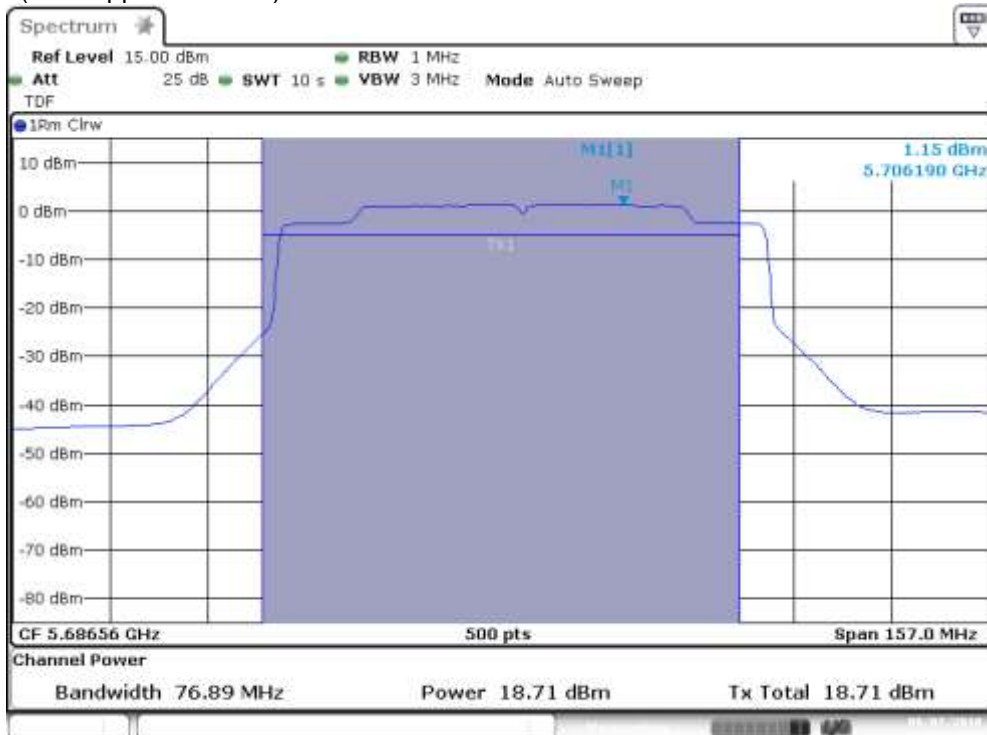

B.3.5 Undesirable emission limits : Band Edge (Conducted)

802.11a, 6Mbps – Chain A

BE Low Freq Section, Peak – CH100

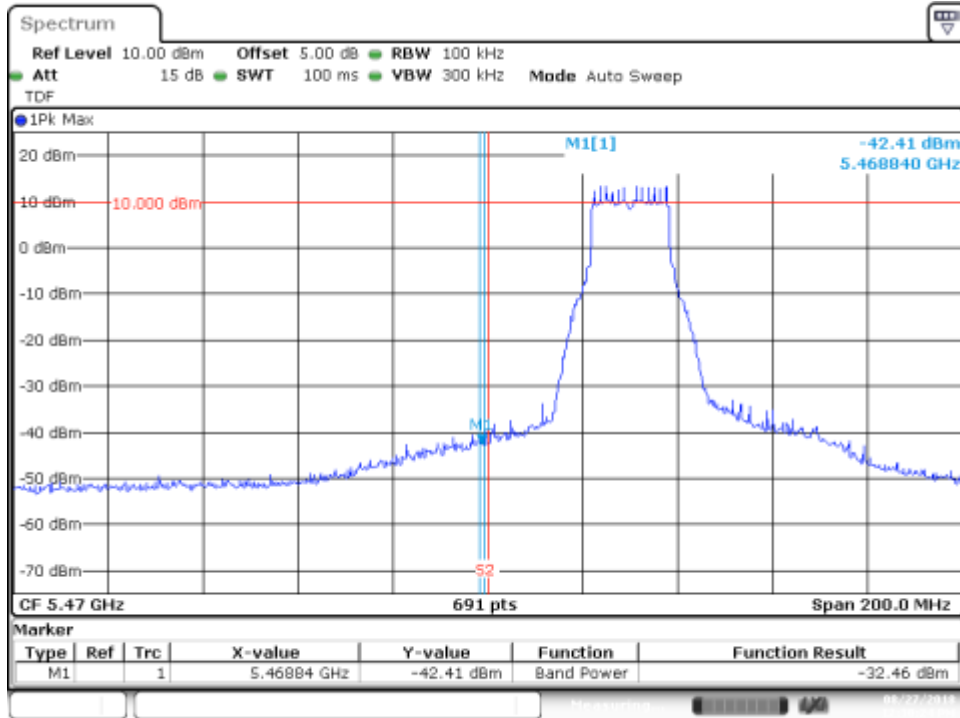

Date: 27.AUG.2018 12:30:24

BE High Freq Section, Peak – CH140

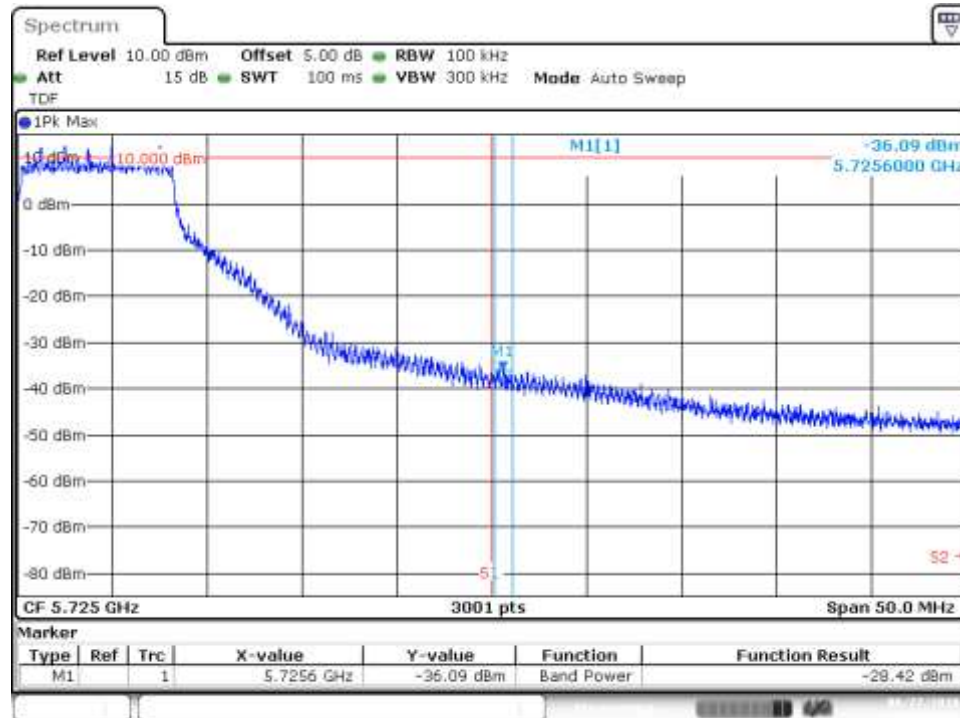

Date: 27.AUG.2018 12:38:57

802.11a, 6Mbps – Chain B

BE Low Freq Section, Peak – CH100

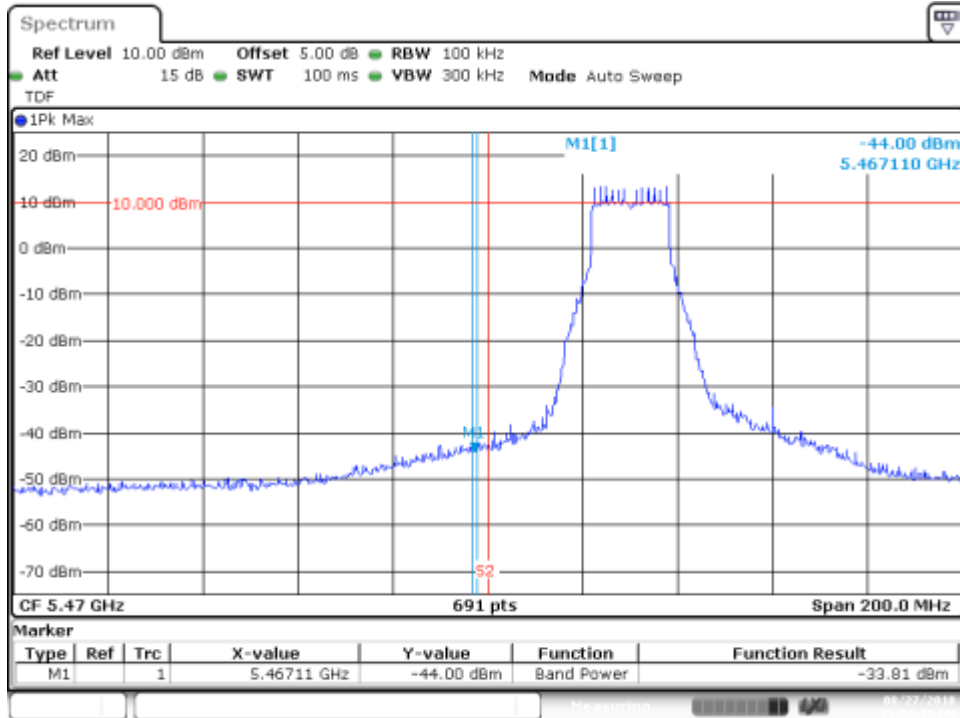

Date: 27.AUG.2018 18:50:43

BE High Freq Section, Peak – CH140

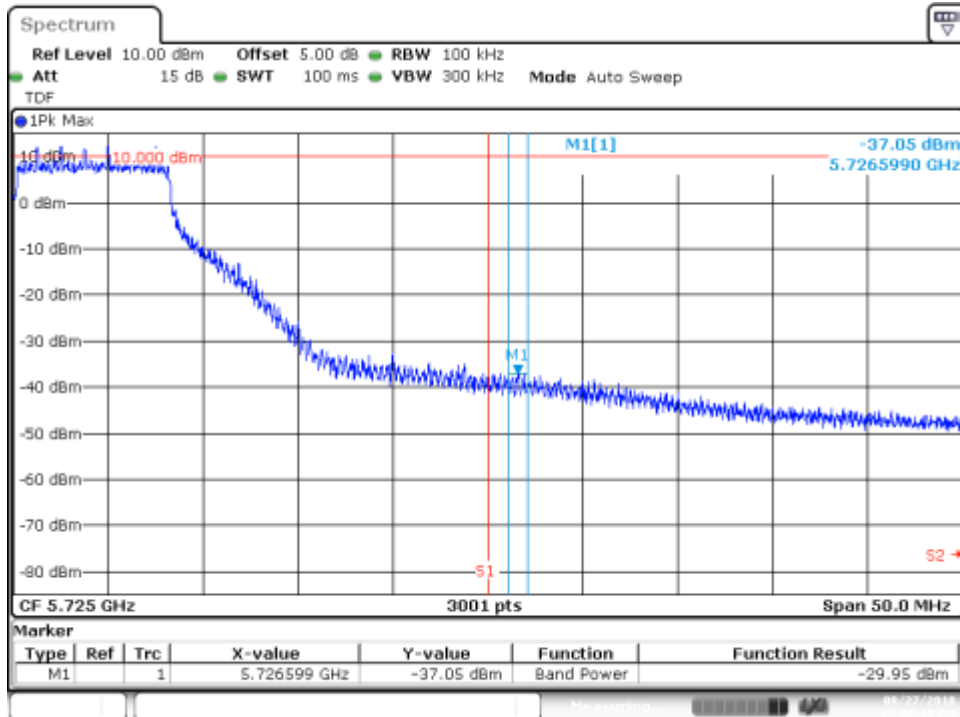

Date: 27.AUG.2018 19:00:19

802.11n20, HT0 (SISO) – Chain A

BE Low Freq Section, Peak – CH100

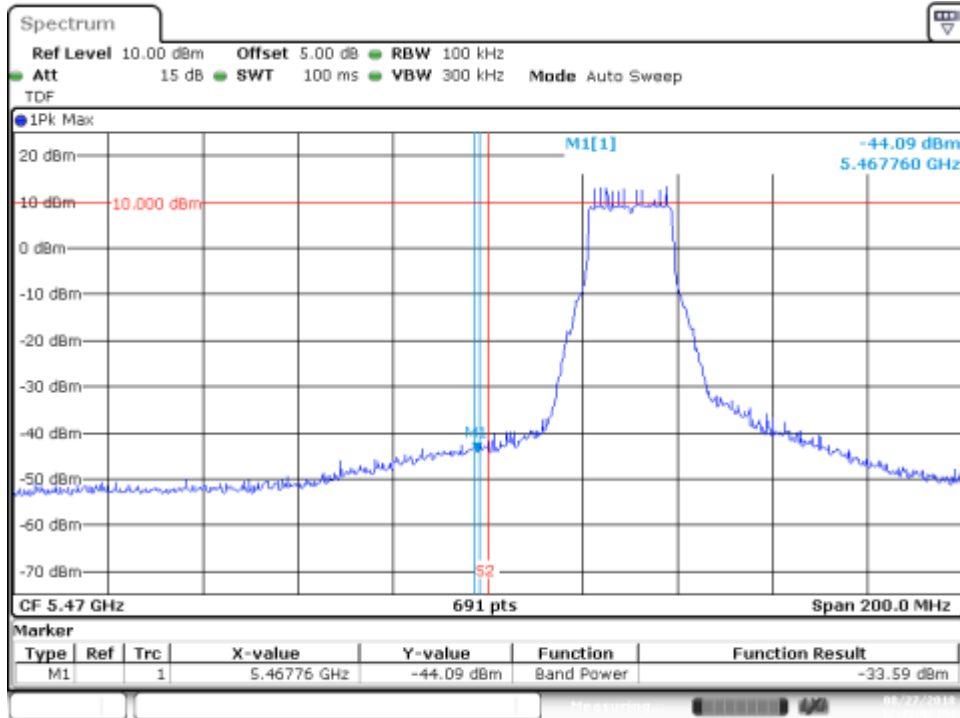

Date: 27.AUG.2018 12:42:42

BE High Freq Section, Peak – CH140

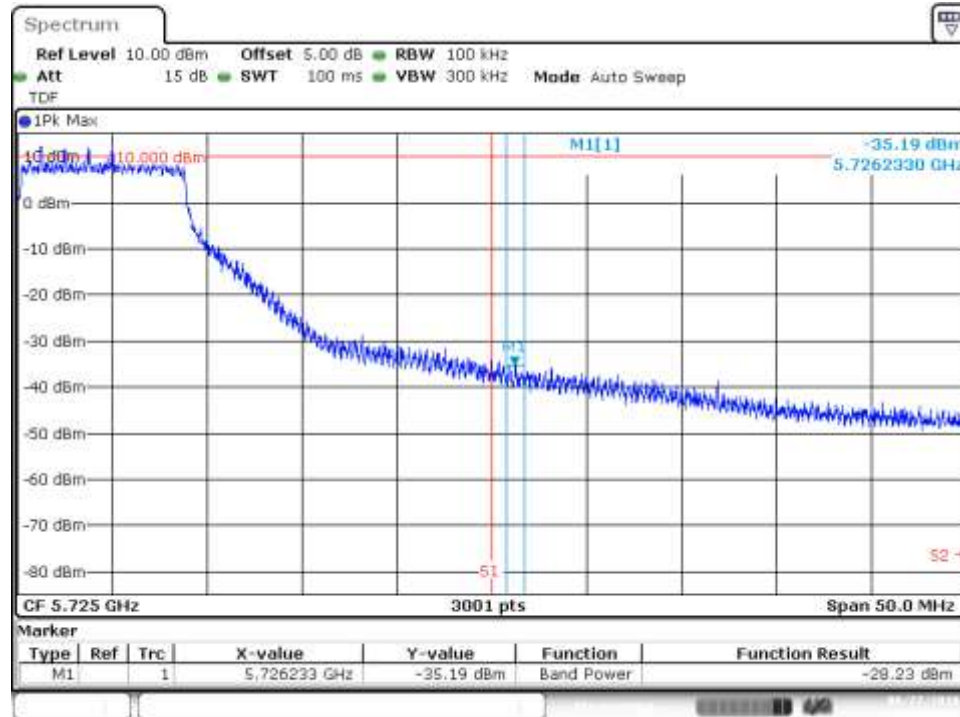

Date: 27.AUG.2018 13:06:57

802.11n20, HT0 (SISO) – Chain B

BE Low Freq Section, Peak – CH100

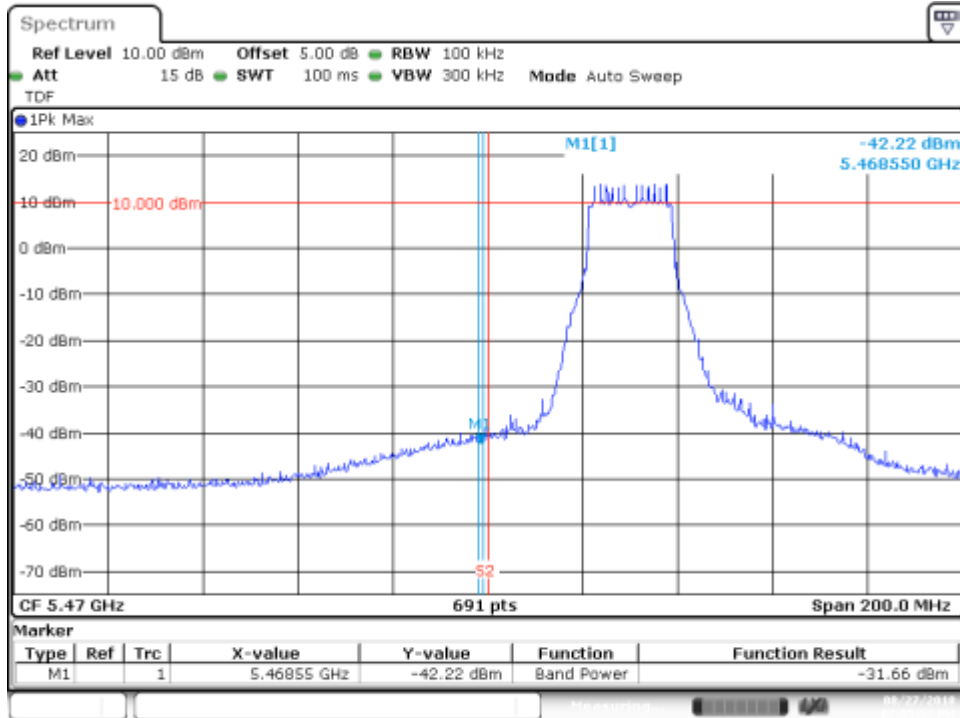

Date: 27.AUG.2018 19:05:32

BE High Freq Section, Peak – CH140

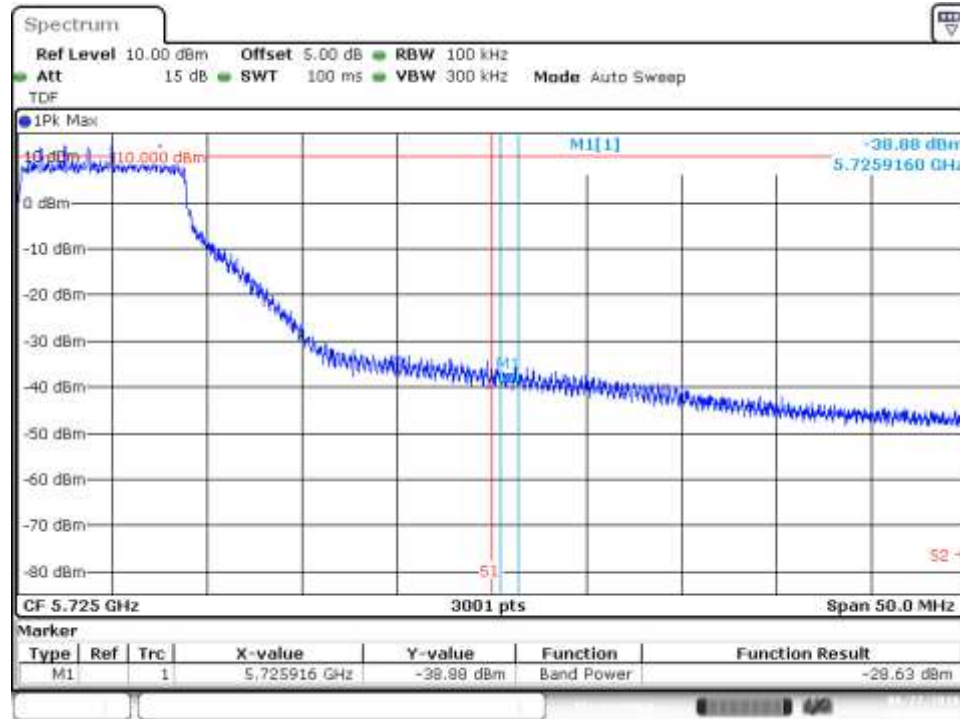

Date: 27.AUG.2018 19:11:04

802.11n20, HT8 (MIMO) – Chain A

BE Low Freq Section, Peak – CH100

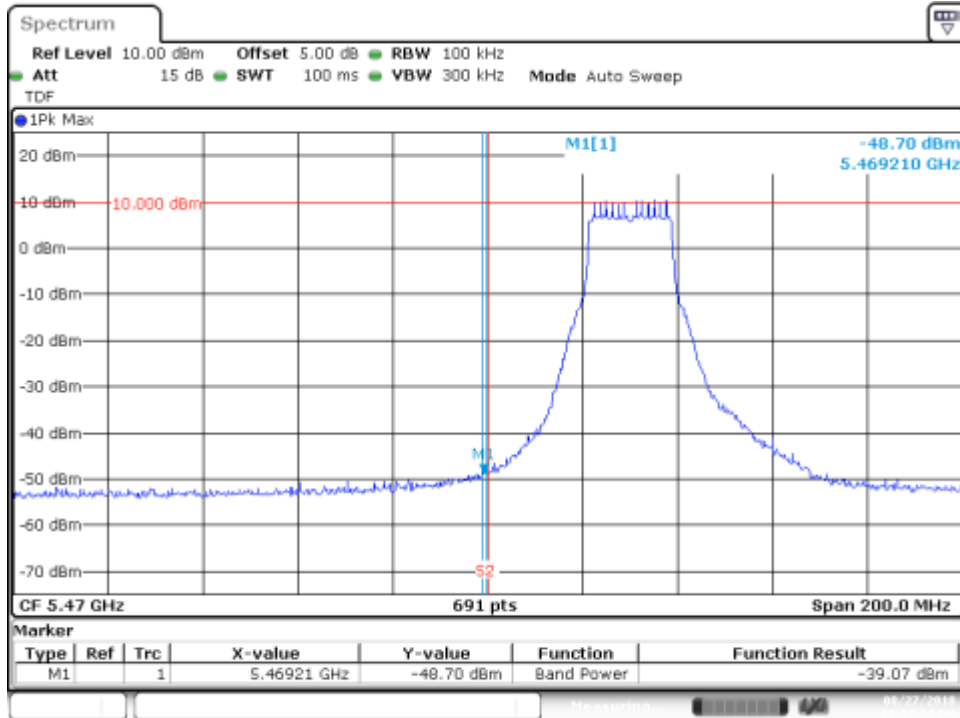

Date: 27.AUG.2018 13:11:24

BE High Freq Section, Peak – CH140

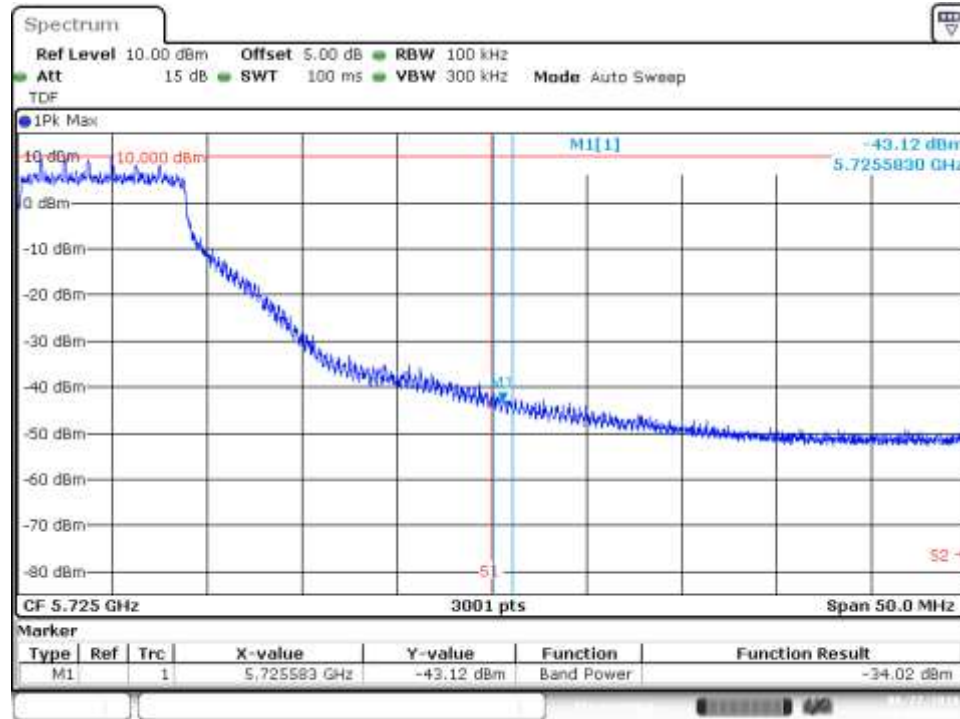

Date: 27.AUG.2018 13:17:23

802.11n20, HT8 (MIMO) – Chain B

BE Low Freq Section, Peak – CH100

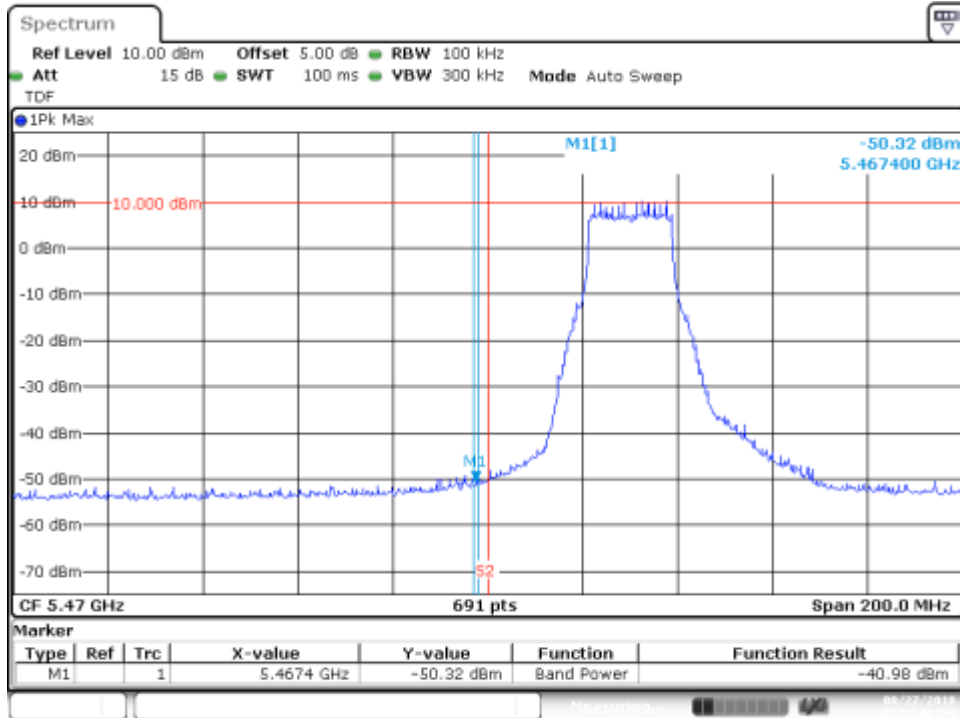

Date: 27.AUG.2018 19:15:08

BE High Freq Section, Peak – CH140

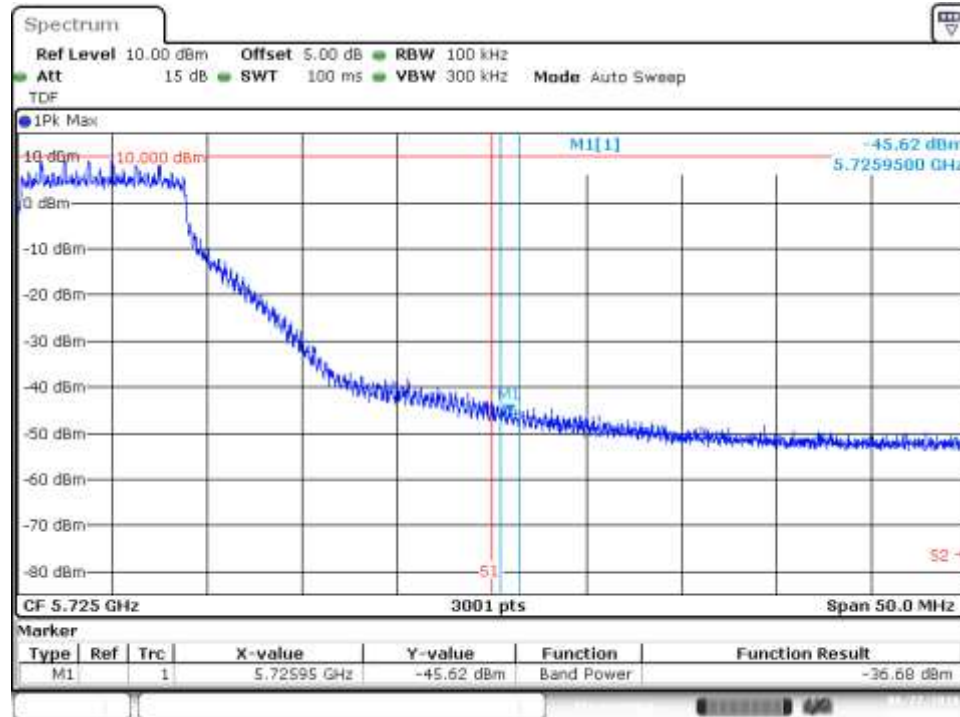

Date: 27.AUG.2018 19:20:57

802.11n40, HT0 (SISO) – Chain A

BE Low Freq Section, Peak – CH102F

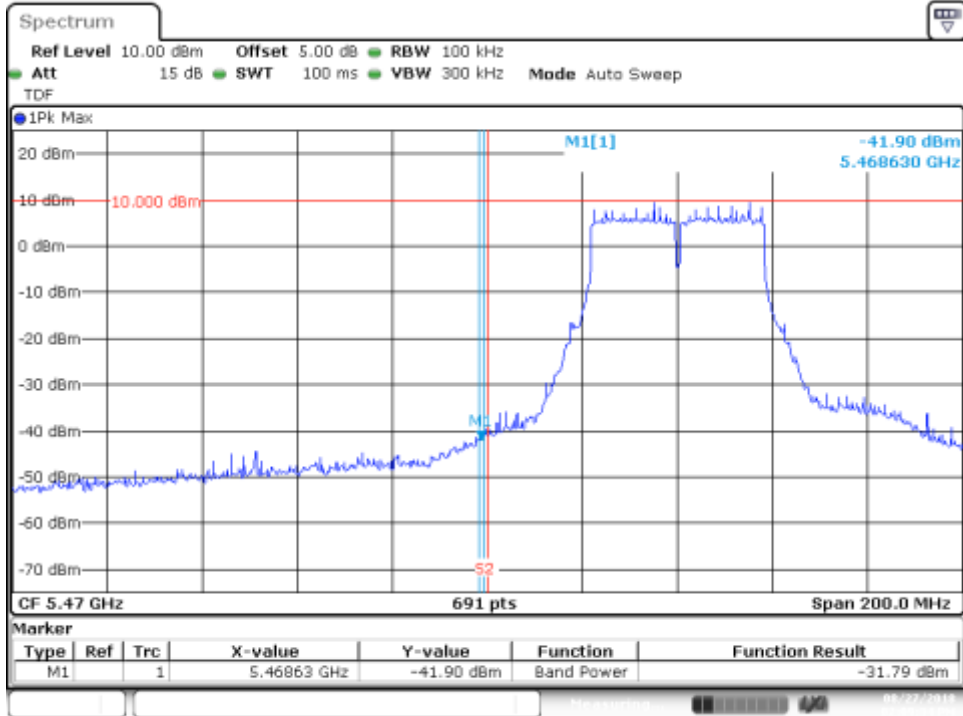

Date: 27.AUG.2018 14:09:34

BE High Freq Section, Peak – CH134F

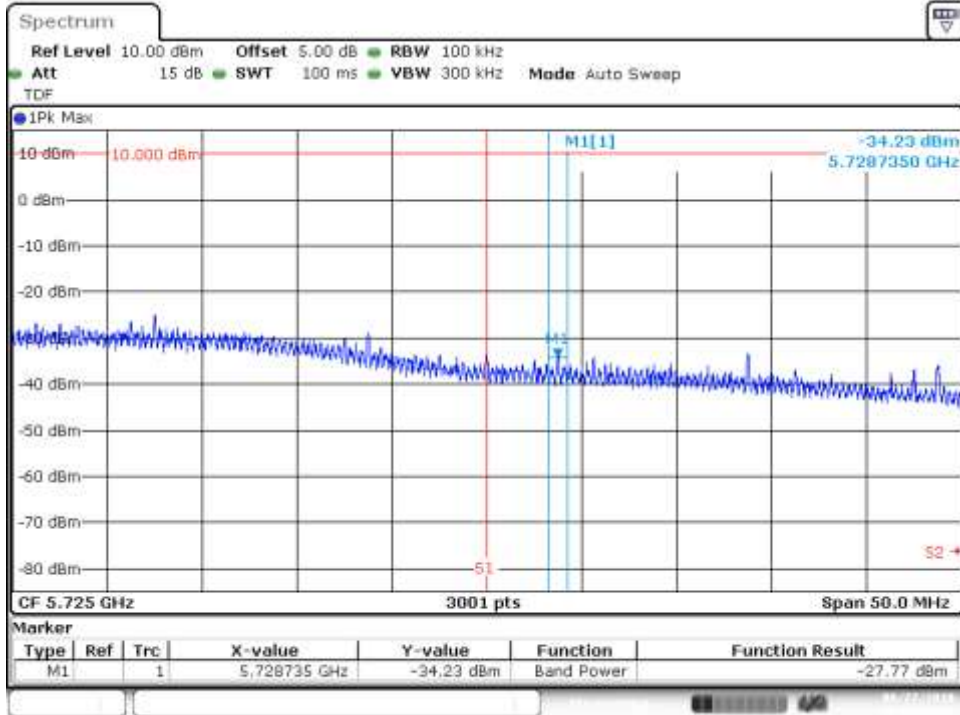

Date: 27.AUG.2018 14:19:35

802.11n40, HT0 (SISO) – Chain B

BE Low Freq Section, Peak – CH102F

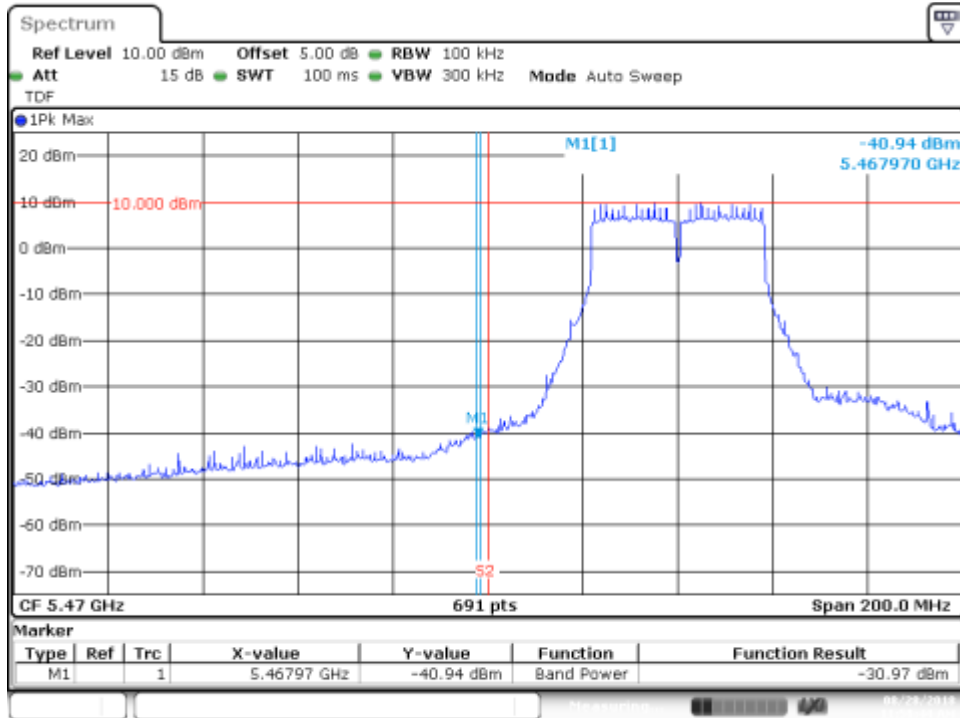

Date: 28.AUG.2018 11:58:44

BE High Freq Section, Peak – CH134F

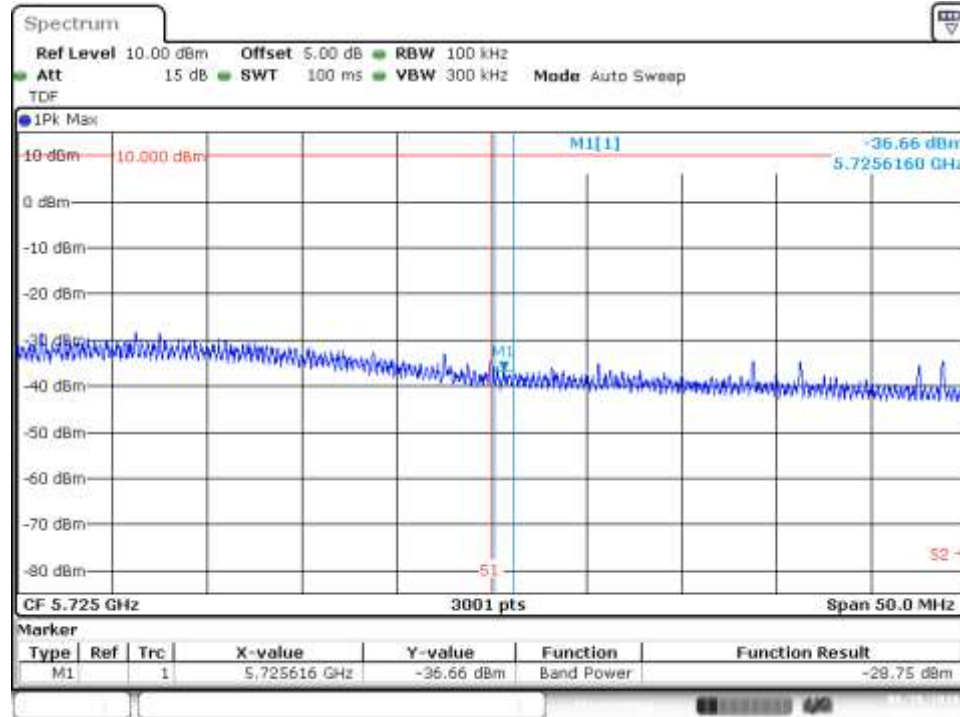

Date: 28.AUG.2018 12:12:02

802.11n40, HT8 (MIMO) – Chain A

BE Low Freq Section, Peak – CH102F

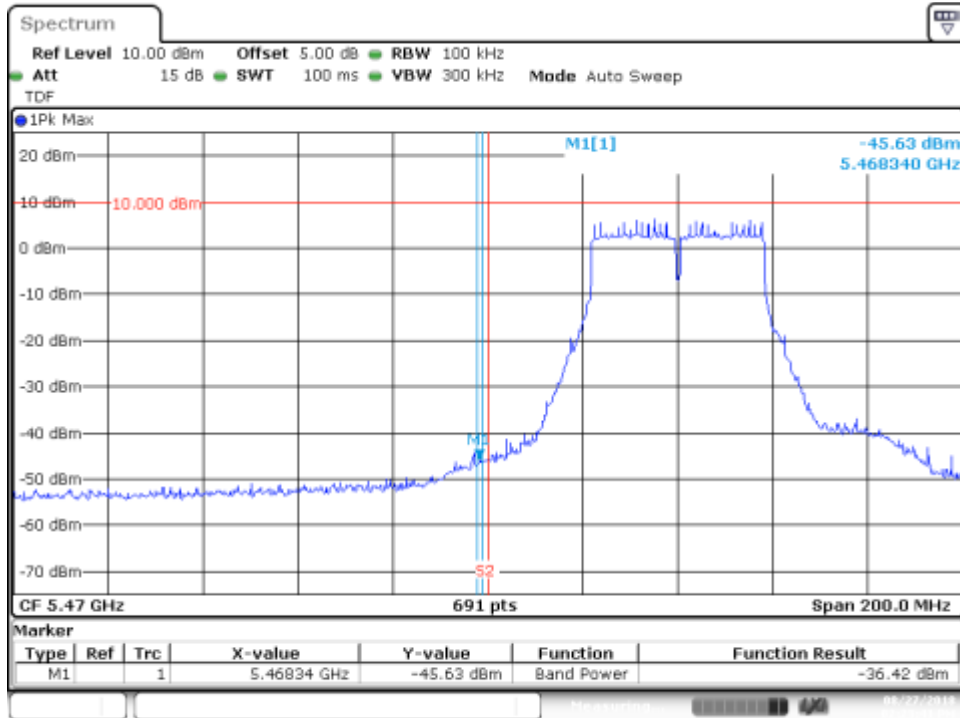

Date: 27.AUG.2018 14:23:41

BE High Freq Section, Peak – CH134F

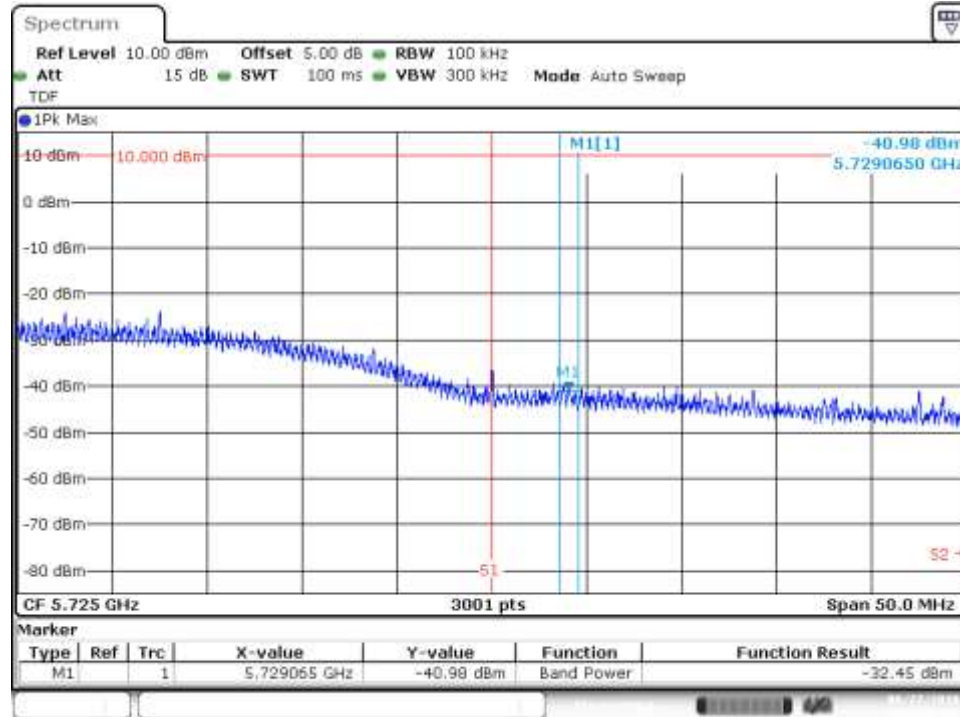

Date: 27.AUG.2018 14:29:45