

FCC Test Report

(PART 27)

Report No.: RF170106C02-3

FCC ID: ZMOL850GL

Test Model: L850-GL

Received Date: Jan. 06, 2017

Test Date: Jan. 11, 2017 ~ Jan. 17, 2017

Issued Date: Feb. 21, 2017

Applicant: Fibocom Wireless Inc.

Address: 5/F, Tower A, Technology Building II, 1057 Nanhai Blvd, Nanshan,
Shenzhen, China

Issued By: Bureau Veritas Consumer Products Services (H.K.) Ltd., Taoyuan Branch

Lab Address: No. 47-2, 14th Ling, Chia Pau Vil., Lin Kou Dist., New Taipei City, Taiwan
(R.O.C)

Test Location: No. 19, Hwa Ya 2nd Rd, Wen Hwa Tsuen, Kwei Shan Hsiang, Taoyuan
Hsien 333, Taiwan, R.O.C.



This report is for your exclusive use. Any copying or replication of this report to or for any other person or entity, or use of our name or trademark, is permitted only with our prior written permission. This report sets forth our findings solely with respect to the test samples identified herein. The results set forth in this report are not indicative or representative of the quality or characteristics of the lot from which a test sample was taken or any similar or identical product unless specifically and expressly noted. Our report includes all of the tests requested by you and the results thereof based upon the information that you provided to us. You have 60 days from date of issuance of this report to notify us of any material error or omission caused by our negligence, provided, however, that such notice shall be in writing and shall specifically address the issue you wish to raise. A failure to raise such issue within the prescribed time shall constitute your unqualified acceptance of the completeness of this report, the tests conducted and the correctness of the report contents. Unless specific mention, the uncertainty of measurement has been explicitly taken into account to declare the compliance or non-compliance to the specification. The report must not be used by the client to claim product certification, approval, or endorsement by TAF or any government agency

Table of Contents

Release Control Record	3
1 Certificate of Conformity	4
2 Summary of Test Results	5
2.1 Measurement Uncertainty	5
2.2 Test Site And Instruments	6
3 General Information	8
3.1 General Description of EUT	8
3.2 Configuration of System Under Test	8
3.2.1 Description of Support Units	8
3.3 Test Mode Applicability and Tested Channel Detail	8
3.4 EUT Operating Conditions	10
3.5 General Description of Applied Standards.....	10
4 Test Types and Results	11
4.1 Output Power Measurement	11
4.1.1 Limits of Output Power Measurement	11
4.1.2 Test Procedures.....	11
4.1.3 Test Setup	12
4.1.4 Test Results	13
4.2 Frequency Stability Measurement	15
4.2.1 Limits of Frequency Stability Measurement.....	15
4.2.2 Test Procedure	15
4.2.3 Test Setup	15
4.2.4 Test Results	16
4.3 Occupied Bandwidth Measurement.....	18
4.3.1 Limits of Occupied Bandwidth Measurement	18
4.3.2 Test Procedure	18
4.3.3 Test Setup	18
4.3.4 Test Result	19
4.4 Band Edge Measurement	20
4.4.1 Limits of Band Edge Measurement	20
4.4.2 Test Setup	20
4.4.3 Test Procedures.....	20
4.4.4 Test Results	21
4.5 Conducted Spurious Emissions	23
4.5.1 Limits of Conducted Spurious Emissions Measurement.....	23
4.5.2 Test Setup	23
4.5.3 Test Procedure	23
4.5.4 Test Results	24
4.6 Radiated Emission Measurement.....	26
4.6.1 Limits of Radiated Emission Measurement	26
4.6.2 Test Procedure	26
4.6.3 Deviation from Test Standard	26
4.6.4 Test Setup	26
4.6.5 Test Results	27
5 Pictures of Test Arrangements	29
Appendix – Information on the Testing Laboratories	30

Release Control Record

Issue No.	Description	Date Issued
RF170106C02-3	Original Release	Feb. 21, 2017

1 Certificate of Conformity

Product: LTE module

Brand: Fibocom

Test Model: L850-GL

Sample Status: Identical Prototype

Applicant: Fibocom Wireless Inc.

Test Date: Jan. 11, 2017 ~ Jan. 17, 2017

Standards: FCC Part 27, Subpart C

The above equipment has been tested by **Bureau Veritas Consumer Products Services (H.K.) Ltd., Taoyuan Branch**, and found compliance with the requirement of the above standards. The test record, data evaluation & Equipment Under Test (EUT) configurations represented herein are true and accurate accounts of the measurements of the sample's EMC characteristics under the conditions specified in this report.

Prepared by : Gina Liu , **Date:** Feb. 21, 2017
Gina Liu / Specialist

Approved by : David Huang , **Date:** Feb. 21, 2017
David Huang / Project Engineer

2 Summary of Test Results

Applied Standard: FCC Part 27 & Part 2			
FCC Clause	Test Item	Result	Remarks
2.1046 27.50(a)(3)	Equivalent Isotropic Radiated Power	Pass	Meet the requirement of limit.
2.1055 27.54	Frequency Stability	Pass	Meet the requirement of limit.
2.1049	Occupied Bandwidth	Pass	Meet the requirement of limit.
2.1051 27.53(a)(4)	Band Edge Measurements	Pass	Meet the requirement of limit.
2.1051 27.53(a)(4)	Conducted Spurious Emissions	Pass	Meet the requirement of limit.
2.1053 27.53(a)(4)	Radiated Spurious Emissions	Pass	Meet the requirement of limit. Minimum passing margin is -17.20 dB at 6930 MHz.

2.1 Measurement Uncertainty

Where relevant, the following measurement uncertainty levels have been estimated for tests performed on the EUT as specified in CISPR 16-4-2:

Measurement	Frequency	Expanded Uncertainty (k=2) (±)
Conducted Emissions at mains ports	150 kHz ~ 30 MHz	2.44 dB
Radiated Emissions up to 1 GHz	30 MHz ~ 200 MHz	2.93 dB
	200 MHz ~ 1000 MHz	2.95 dB
Radiated Emissions above 1 GHz	1 GHz ~ 18 GHz	2.26 dB
	18 GHz ~ 40 GHz	1.94 dB

2.2 Test Site And Instruments

Description & Manufacturer	Model No.	Serial No.	Date of Calibration	Due Date of Calibration
Test Receiver Agilent Technologies	N9038A	MY52260177	Jun. 21, 2016	Jun. 20, 2017
Spectrum Analyzer Agilent	N9010A	MY52220314	Dec. 16, 2016	Dec. 15, 2017
Spectrum Analyzer ROHDE & SCHWARZ	FSU43	101261	Dec. 13, 2016	Dec. 12, 2017
BILOG Antenna SCHWARZBECK	VULB9168	9168-472	Dec. 26, 2016	Dec. 27, 2017
HORN Antenna SCHWARZBECK	BBHA 9120 D	9120D-969	Dec. 12, 2016	Dec. 13, 2017
Double Ridge Guide Horn Antenna EMCO	3115	5619	Dec. 26, 2016	Dec. 27, 2017
BILOG Antenna SCHWARZBECK	VULB 9168	9168-153	Dec. 12, 2016	Dec. 13, 2017
Agilent Communications Tester-Wireless	8960 Series 10	MY53201073	Jul. 03, 2015	Jul. 02, 2017
Preamplifier EMCI	EMC 012645	980115	Oct. 21, 2016	Oct. 20, 2017
Preamplifier EMCI	EMC 184045	980116	Oct. 21, 2016	Oct. 20, 2017
Preamplifier EMCI	EMC 330H	980112	Oct. 21, 2016	Oct. 20, 2017
Power Meter Anritsu	ML2495A	1232002	Sep. 08, 2016	Sep. 07, 2017
Power Sensor Anritsu	MA2411B	1207325	Sep. 08, 2016	Sep. 07, 2017
RF signal cable HUBER+SUHNNER	SUCOFLEX 104	309219/4 2950114	Oct. 21, 2016	Oct. 20, 2017
RF signal cable HUBER+SUHNNER	SUCOFLEX 104	250130/4	Oct. 21, 2016	Oct. 20, 2017
RF Coaxial Cable Worken	8D-FB	Cable-Ch10-01	Oct. 21, 2016	Oct. 20, 2017
Software BV ADT	E3 6.120103	NA	NA	NA
Antenna Tower MF	MFA-440H	NA	NA	NA
Turn Table MF	MFT-201SS	NA	NA	NA
Antenna Tower & Turn Table Controller MF	MF-7802	NA	NA	NA
Radio Communication Analyzer	MT8820C	6201300640	Aug. 10, 2015	Aug. 09, 2017
Temperature & Humidity Chamber	GTH-120-40-CP-A R	MAA1306-019	Sep. 02, 2016	Sep. 01, 2017
DC Power Supply Topward	33010D	807748	Oct. 25, 2016	Oct. 24, 2018
Digital Multimeter Fluke	87-III	70360742	Jul. 01, 2016	Jun. 30, 2017

- Note:
1. The calibration interval of the above test instruments is 12 / 24 months and the calibrations are traceable to NML/ROC and NIST/USA.
 2. The test was performed in HwaYa Chamber 10.
 3. The horn antenna and preamplifier (model: EMC 184045) are used only for the measurement of emission frequency above 1 GHz if tested.
 4. The FCC Site Registration No. is 690701.
 5. The IC Site Registration No. is IC7450F-10.

3 General Information

3.1 General Description of EUT

Product	LTE module	
Brand	Fibocom	
Test Model	L850-GL	
Status of EUT	Identical Prototype	
Power Supply Rating	3.3 Vdc (from Host Equipment)	
Modulation Type	QPSK, 16QAM	
Frequency Range	LTE Band 30 (Channel Bandwidth: 5 MHz)	2307.5 ~ 2312.5 MHz
	LTE Band 30 (Channel Bandwidth: 10 MHz)	2310 MHz
Max. EIRP Power	LTE Band 30 (Channel Bandwidth: 5 MHz)	89.76 mW
	LTE Band 30 (Channel Bandwidth: 10 MHz)	74.49 mW
Emission Designator	LTE Band 30 (Channel Bandwidth: 5 MHz)	4M50G7D
	LTE Band 30 (Channel Bandwidth: 10 MHz)	8M98G7D
Antenna Type	External Antenna	
Accessory Device	Refer to Note as below	
Data Cable Supplied	Refer to Note as below	

Note:

1. The above EUT information is declared by manufacturer and for more detailed features description, please refer to the manufacturer's specifications or user's manual.

3.2 Configuration of System Under Test

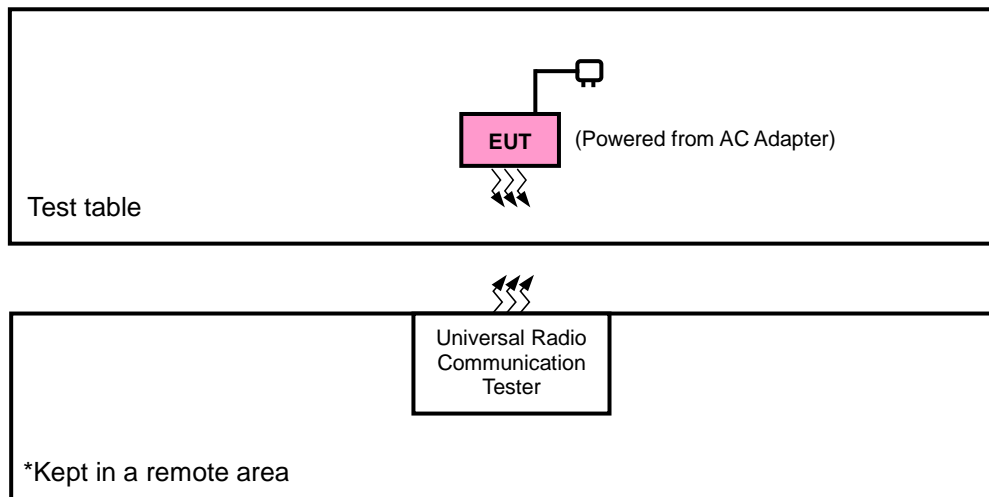

3.2.1 Description of Support Units

The EUT has been tested as an independent unit together with other necessary accessories or support units.

3.3 Test Mode Applicability and Tested Channel Detail

Pre-Scan has been conducted to determine the worst-case mode from all possible combinations between available modulations, data rates, XYZ axis and antenna ports

The worst case was found when positioned on X-plane for EIRP and Z-axis for radiated emission. Following

channel(s) was (were) selected for the final test as listed below:

EUT Configure Mode	Test Item	Available Channel	Tested Channel	Channel Bandwidth	Modulation	Mode
-	EIRP	27685 to 27735	27685, 27710, 27735	5 MHz	QPSK, 16QAM	1 RB / 24 RB Offset
		27710	27710	10 MHz	QPSK, 16QAM	1 RB / 49 RB Offset
-	Frequency Stability	27685 to 27735	27685, 27735	5 MHz	QPSK	1 RB / 24 RB Offset
		27710	27710	10 MHz	QPSK	1 RB / 49 RB Offset
-	Occupied Bandwidth	27685 to 27735	27685, 27710, 27735	5 MHz	QPSK, 16QAM	25 RB / 0 RB Offset
		27710	27710	10 MHz	QPSK, 16QAM	50 RB / 0 RB Offset
-	Band Edge	27685 to 27735	27685, 27710, 27735	5 MHz	QPSK, 16QAM	25 RB / 0 RB Offset
		27710	27710	10 MHz	QPSK, 16QAM	50 RB / 0 RB Offset
-	Conducted Emission	27685 to 27735	27710	5 MHz	QPSK	1 RB / 24 RB Offset
		27710	27710	10 MHz	QPSK	1 RB / 49 RB Offset
-	Radiated Emission	27685 to 27735	27685, 27710, 27735	5 MHz	QPSK	1 RB / 49 RB Offset

Note: This device was tested under all bandwidths, RB configurations and modulations. The worst case was found in QPSK modulation.

Test Condition:

Test Item	Environmental Conditions	Input Power	Tested By
EIRP	25 deg. C, 65 % RH	3.3 Vdc	Getaz Yang
Frequency Stability	25 deg. C, 65 % RH	3.3 Vdc	Carlos Chen
Occupied Bandwidth	25 deg. C, 65 % RH	3.3 Vdc	Carlos Chen
Band Edge	25 deg. C, 65 % RH	3.3 Vdc	Carlos Chen
Condcudeted Emission	25 deg. C, 65 % RH	3.3 Vdc	Carlos Chen
Radiated Emission	25 deg. C, 65 % RH	120 Vac, 60 Hz	Getaz Yang

3.4 EUT Operating Conditions

The EUT makes a call to the communication simulator. The communication simulator station system controlled a EUT to export maximum output power under transmission mode and specific channel frequency

3.5 General Description of Applied Standards

The EUT is a RF Product. According to the specifications of the manufacturer, it must comply with the requirements of the following standards:

FCC 47 CFR Part 2

FCC 47 CFR Part 27

KDB 971168 D01 Power Meas License Digital Systems v02r02

ANSI/TIA/EIA-603-D 2010

NOTE: All test items have been performed and recorded as per the above standards.

4 Test Types and Results

4.1 Output Power Measurement

4.1.1 Limits of Output Power Measurement

Mobile and portable stations. (i) For mobile and portable stations transmitting in the 2305-2315 MHz band or the 2350-2360 MHz band, the average EIRP must not exceed 50 milliwatts within any 1 megahertz of authorized bandwidth, except that for mobile and portable stations compliant with 3GPP LTE standards or another advanced mobile broadband protocol that avoids concentrating energy at the edge of the operating band the average EIRP must not exceed 250 milliwatts within any 5 megahertz of authorized bandwidth but may exceed 50 milliwatts within any 1 megahertz of authorized bandwidth. For mobile and portable stations using time division duplexing (TDD) technology, the duty cycle must not exceed 38 percent in the 2305-2315 MHz and 2350-2360 MHz bands. Mobile and portable stations using FDD technology are restricted to transmitting in the 2305-2315 MHz band. Power averaging shall not include intervals in which the transmitter is off.

4.1.2 Test Procedures

EIRP Measurement:

- a. All measurements were done at low, middle and high operational frequency range. RBW and VBW is 10 MHz for LTE mode.
- b. Substitution method is used for E.I.R.P measurement. In the semi-anechoic chamber, EUT placed on the 0.8 m height of Turn Table, rotated the table around 360 degrees to search the maximum radiation power and receiver antenna shall be rotated vertical and horizontal polarization and moved height from 1 m to 4 m to find the maximum polar radiated power. The "Read Value" is the spectrum reading the maximum power value.
- c. The substitution horn antenna is substituted for EUT at the same position and signals generator export the CW signal to the substitution antenna via a tx cable. Rotated the Turn Table and moved receiving antenna to find the maximum radiation power. Adjust output power level of S.G to get a Value of spectrum reading equal to "Read Value" of step b. Record the power level of S.G.
- d. $EIRP = \text{Output power level of S.G} - \text{TX cable loss} + \text{Antenna gain of substitution horn}.$

Conducted Power Measurement:

- a. The EUT was set up for the maximum power with LTE link data modulation and link up with simulator.
- b. Set the EUT to transmit under low, middle and high channel and record the power level shown on simulator.

4.1.3 Test Setup

EIRP / ERP Measurement:

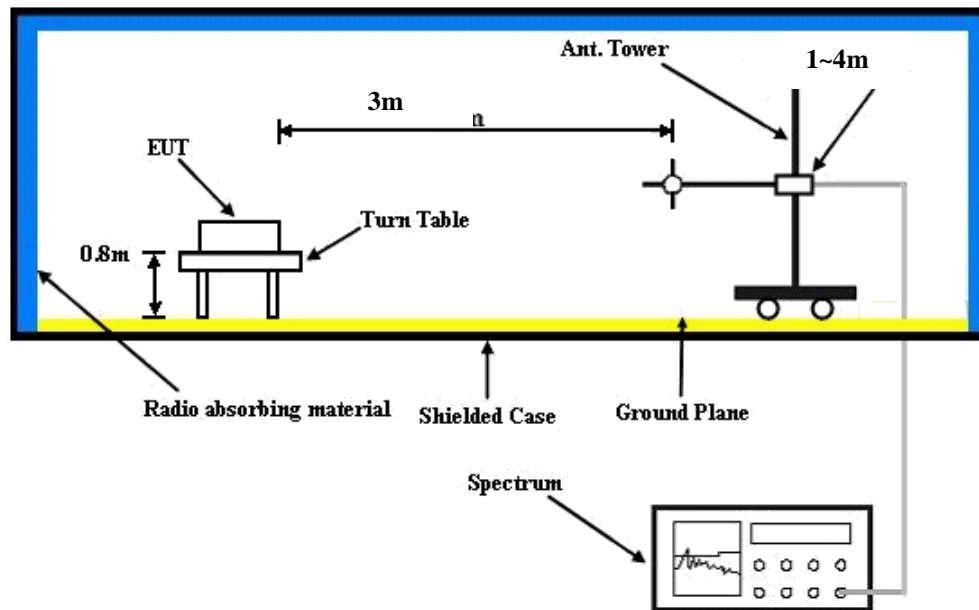

For the actual test configuration, please refer to the attached file (Test Setup Photo).

Conducted Power Measurement:



4.1.4 Test Results

Conducted Output Power (dBm)

LTE Band / BW	RB Size	RB Offset	QPSK			3GPP MPR (dB)	16QAM			3GPP MPR (dB)
			Low Ch 27685	Mid Ch 27710	High Ch 27735		Low Ch 27685	Mid Ch 27710	High Ch 27735	
			2307.5 MHz	2310.0 MHz	2312.5 MHz		2307.5 MHz	2310.0 MHz	2312.5 MHz	
30 / 5M	1	0	22.76	22.88	22.78	0	21.71	21.87	21.75	1
	1	12	22.65	22.72	22.63	0	21.63	21.69	21.65	1
	1	24	22.39	22.56	22.51	0	21.41	21.48	21.55	1
	12	0	21.69	21.94	21.73	1	20.49	20.91	20.68	2
	12	6	21.60	21.80	21.59	1	20.56	20.77	20.57	2
	12	13	21.46	21.64	21.47	1	20.36	20.56	20.43	2
	25	0	21.64	21.74	21.73	1	20.45	20.62	20.66	2

LTE Band / BW	RB Size	RB Offset	QPSK		3GPP MPR (dB)	16QAM		3GPP MPR (dB)
			Mid Ch 27710	2310.0 MHz		Mid Ch 27710	2310.0 MHz	
			2310.0 MHz	2310.0 MHz		2310.0 MHz	2310.0 MHz	
30 / 10M	1	0	23.03	2310.0 MHz	0	21.95	2310.0 MHz	1
	1	24	22.89	2310.0 MHz	0	21.88	2310.0 MHz	1
	1	49	22.75	2310.0 MHz	0	21.68	2310.0 MHz	1
	25	0	21.99	2310.0 MHz	1	20.97	2310.0 MHz	2
	25	12	21.89	2310.0 MHz	1	20.81	2310.0 MHz	2
	25	25	21.61	2310.0 MHz	1	20.66	2310.0 MHz	2
	50	0	22.02	2310.0 MHz	1	20.94	2310.0 MHz	2

EIRP Power (dBm)

LTE Band 30							
Channel Bandwidth: 5 MHz / QPSK							
Plane	Channel	Frequency (MHz)	LVL (dBm)	Correction Factor (dB)	EIRP (dBm)	EIRP (mW)	Polarization (H/V)
X	27685	2307.5	-19.19	38.67	19.48	88.76	H
	27710	2310.0	-18.89	38.42	19.53	89.76	
	27735	2312.5	-19.25	38.70	19.45	88.17	
	27685	2307.5	-21.84	39.07	17.23	52.89	V
	27710	2310.0	-22.08	39.32	17.24	52.97	
	27735	2312.5	-22.19	39.34	17.15	51.84	
Channel Bandwidth: 5 MHz / 16QAM							
X	27685	2307.5	-20.01	38.67	18.66	73.49	H
	27710	2310.0	-19.70	38.42	18.72	74.49	
	27735	2312.5	-19.99	38.70	18.71	74.35	
	27685	2307.5	-22.86	39.07	16.21	41.82	V
	27710	2310.0	-23.03	39.32	16.29	42.56	
	27735	2312.5	-23.15	39.34	16.19	41.56	

LTE Band 30							
Channel Bandwidth: 10 MHz / QPSK							
Plane	Channel	Frequency (MHz)	LVL (dBm)	Correction Factor (dB)	EIRP (dBm)	EIRP (mW)	Polarization (H/V)
X	27710	2310.0	-18.76	38.42	19.66	92.49	H
	27710	2310.0	-21.96	39.32	17.36	54.45	V
Channel Bandwidth: 10 MHz / 16QAM							
X	27710	2310.0	-19.57	38.42	18.85	76.75	H
	27710	2310.0	-22.96	39.32	16.36	43.25	V

4.2 Frequency Stability Measurement

4.2.1 Limits of Frequency Stability Measurement

The frequency stability shall be sufficient to ensure that the fundamental emissions stay within the authorized bands of operation.

4.2.2 Test Procedure

- Device is placed at the oven room. The oven room could control the temperatures and humidity. Power warm up is at least 15 min and power applied should perform before recording frequency error.
- EUT is connected the external power supply to control the DC input power. The test voltage range is from minimum to maximum working voltage. Each step shall be record the frequency error rate.
- The temperature range step is 10 degrees in this test items. All temperature levels shall be hold the ± 0.5 °C during the measurement testing. The each temperature step shall be at least 0.5 hours, consider the EUT could be test under the stability condition.

Note: The frequency error was recorded frequency error from the communication simulator.

4.2.3 Test Setup

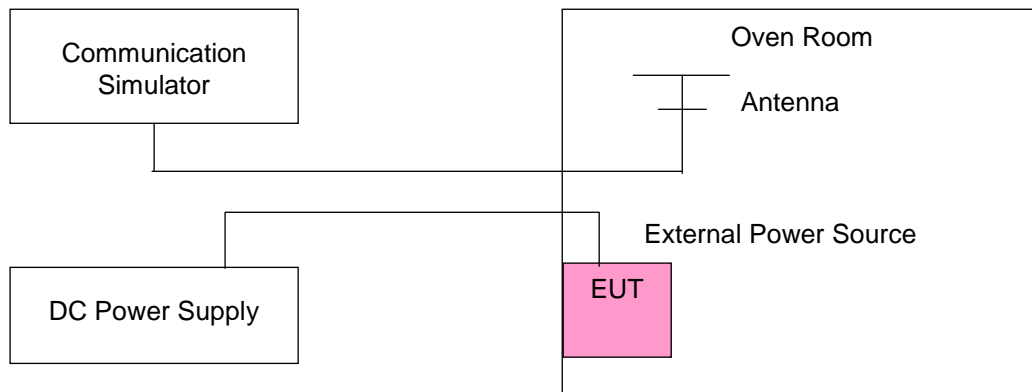

4.2.4 Test Results

Frequency Error vs. Voltage

Voltage (Volts)	LTE Band 30				Limit (ppm)
	Channel Bandwidth: 5 MHz				
	Low Channel		High Channel		
	Frequency (MHz)	Frequency Error (ppm)	Frequency (MHz)	Frequency Error (ppm)	
3.3	2307.500003	0.001	2312.500002	0.001	2.5
3.14	2307.500002	0.001	2312.500002	0.001	2.5
4.4	2307.500002	0.001	2312.500001	0.001	2.5

Note: The applicant defined the normal working voltage of the battery is from 3.14 Vdc to 4.4 Vdc.

Frequency Error vs. Temperature

Temp. (°C)	LTE Band 30				Limit (ppm)
	Channel Bandwidth: 5 MHz				
	Low Channel		High Channel		
	Frequency (MHz)	Frequency Error (ppm)	Frequency (MHz)	Frequency Error (ppm)	
-20	2307.500003	0.001	2312.500003	0.001	2.5
-10	2307.500004	0.002	2312.500001	0.001	2.5
0	2307.500002	0.001	2312.500001	0.001	2.5
10	2307.500002	0.001	2312.500004	0.002	2.5
20	2307.499996	-0.002	2312.499997	-0.001	2.5
30	2307.499997	-0.002	2312.499997	-0.002	2.5
40	2307.499997	-0.002	2312.499996	-0.002	2.5
50	2307.499999	-0.001	2312.499997	-0.001	2.5
55	2307.499997	-0.001	2312.499996	-0.002	2.5

Frequency Error vs. Voltage

Voltage (Volts)	LTE Band 30		Limit (ppm)
	Channel Bandwidth: 10 MHz		
	Frequency (MHz)	Frequency Error (ppm)	
3.3	2310.000001	0.001	2.5
3.14	2310.000001	0.000	2.5
4.4	2310.000003	0.001	2.5

Note: The applicant defined the normal working voltage of the battery is from 3.14 Vdc to 4.4 Vdc.

Frequency Error vs. Temperature

Temp. (°C)	LTE Band 30		Limit (ppm)
	Channel Bandwidth: 10 MHz		
	Frequency (MHz)	Frequency Error (ppm)	
-20	2310.000003	0.001	2.5
-10	2310.000002	0.001	2.5
0	2310.000003	0.001	2.5
10	2310.000001	0.000	2.5
20	2309.999997	-0.001	2.5
30	2309.999998	-0.001	2.5
40	2309.999998	-0.001	2.5
50	2309.999996	-0.002	2.5
55	2309.999996	-0.002	2.5

4.3 Occupied Bandwidth Measurement

4.3.1 Limits of Occupied Bandwidth Measurement

The width of a frequency band such that, below the lower and above the upper frequency limits, the mean powers emitted are each equal to a specified percentage 0.5 % of the total mean power of a given emission.

4.3.2 Test Procedure

- a. The conducted occupied bandwidth used the power splitter via EUT RF power connector between simulation base station and spectrum analyzer.
- b. Use OBW measurement function of Spectrum analyzer to measure 99 % occupied bandwidth.

4.3.3 Test Setup

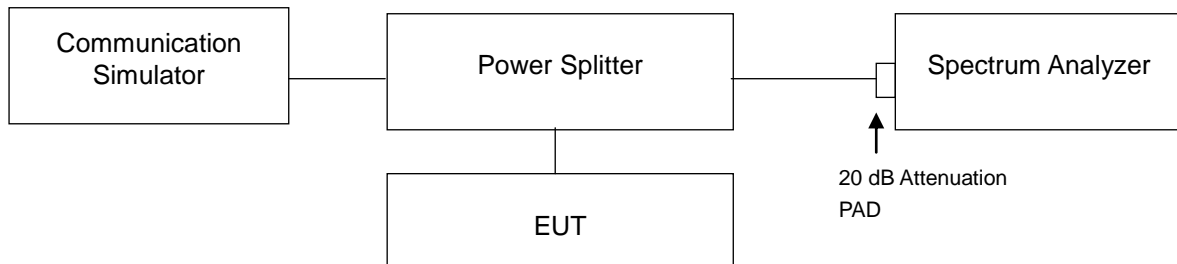

4.3.4 Test Result

LTE Band 30							
Channel Bandwidth: 5 MHz				Channel Bandwidth: 10 MHz			
Channel	Frequency (MHz)	99 % Occupied Bandwidth (MHz)		Channel	Frequency (MHz)	99 % Occupied Bandwidth (MHz)	
		QPSK	16QAM			QPSK	16QAM
27685	2307.5	4.50	4.50	27710	2310.0	8.99	8.99
27710	2310.0	4.50	4.49				
27735	2312.5	4.49	4.93				

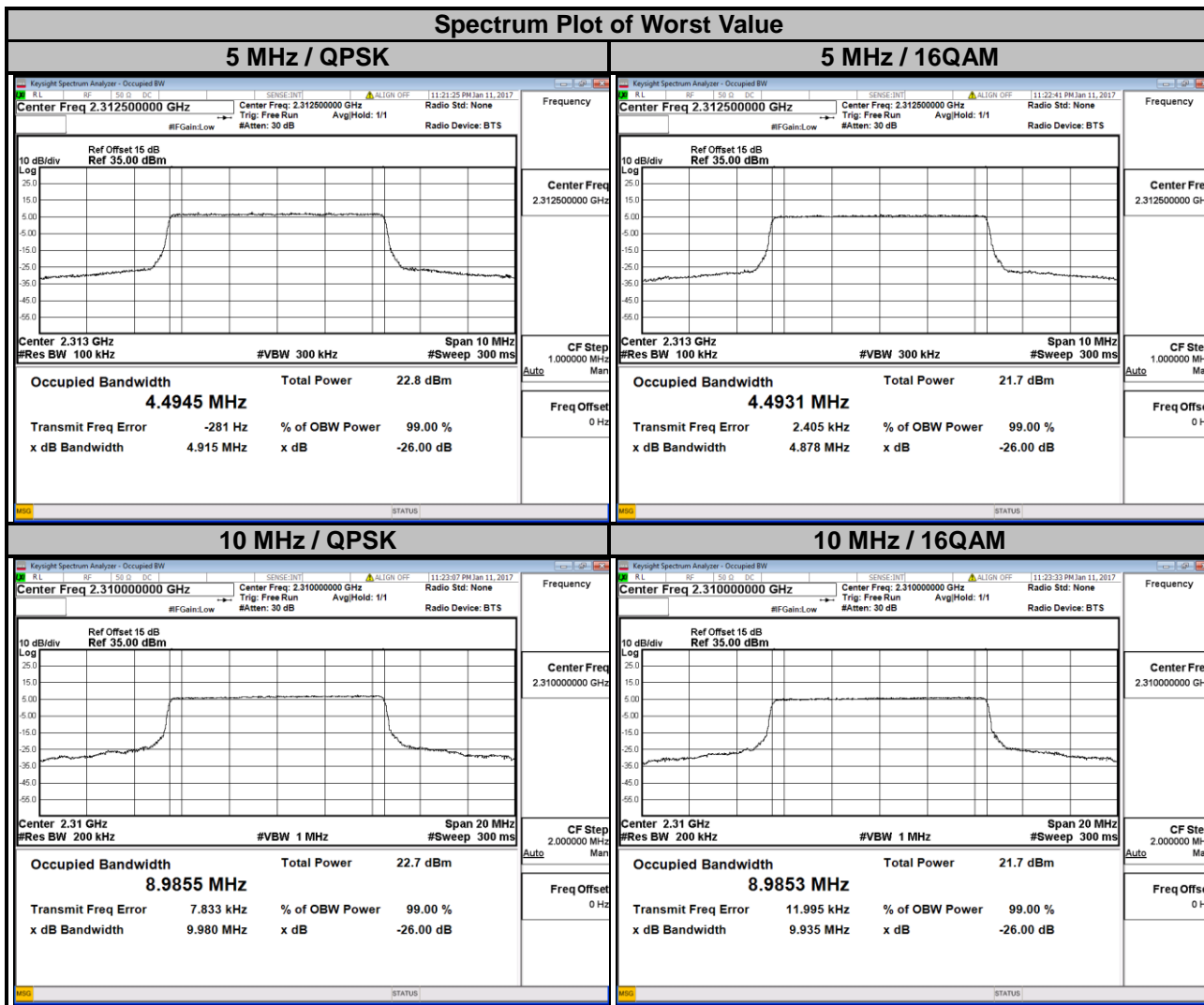

4.4 Band Edge Measurement

4.4.1 Limits of Band Edge Measurement

According to FCC 27.53(a) (4) For mobile and portable stations operating in the 2305-2315 MHz and 2350-2360 MHz bands:

- (i) By a factor of not less than: $43 + 10 \log (P)$ dB on all frequencies between 2305 and 2320 MHz and on all frequencies between 2345 and 2360 MHz that are outside the licensed band(s) of operation, not less than $55 + 10 \log (P)$ dB on all frequencies between 2320 and 2324 MHz and on all frequencies between 2341 and 2345 MHz, not less than $61 + 10 \log (P)$ dB on all frequencies between 2324 and 2328 MHz and on all frequencies between 2337 and 2341 MHz, and not less than $67 + 10 \log (P)$ dB on all frequencies between 2328 and 2337 MHz;
- (ii) By a factor of not less than $43 + 10 \log (P)$ dB on all frequencies between 2300 and 2305 MHz, $55 + 10 \log (P)$ dB on all frequencies between 2296 and 2300 MHz, $61 + 10 \log (P)$ dB on all frequencies between 2292 and 2296 MHz, $67 + 10 \log (P)$ dB on all frequencies between 2288 and 2292 MHz, and $70 + 10 \log (P)$ dB below 2288 MHz;
- (iii) By a factor of not less than $43 + 10 \log (P)$ dB on all frequencies between 2360 and 2365 MHz, and not less than $70 + 10 \log (P)$ dB above 2365 MHz.

4.4.2 Test Setup

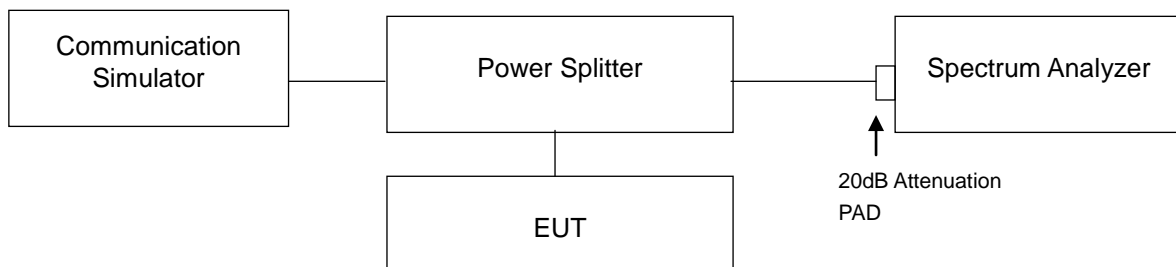

4.4.3 Test Procedures

- a. The EUT was set up for the maximum peak power with LTE link data modulation. The power was measured with R&S Spectrum Analyzer. All measurements were done at 2 channels (low and high operational frequency range).
- b. The band edge measurement used the power splitter via EUT RF power connector between simulation base station and spectrum analyzer.
- c. Measuring frequency range is from 2200 MHz to 2395 MHz for LTE Band 30. 10 dB attenuation pad is connected with spectrum. RBW=1 MHz and VBW=3 MHz are used for conducted emission measurement.
- d. Record the max trace plot into the test report.

4.4.4 Test Results

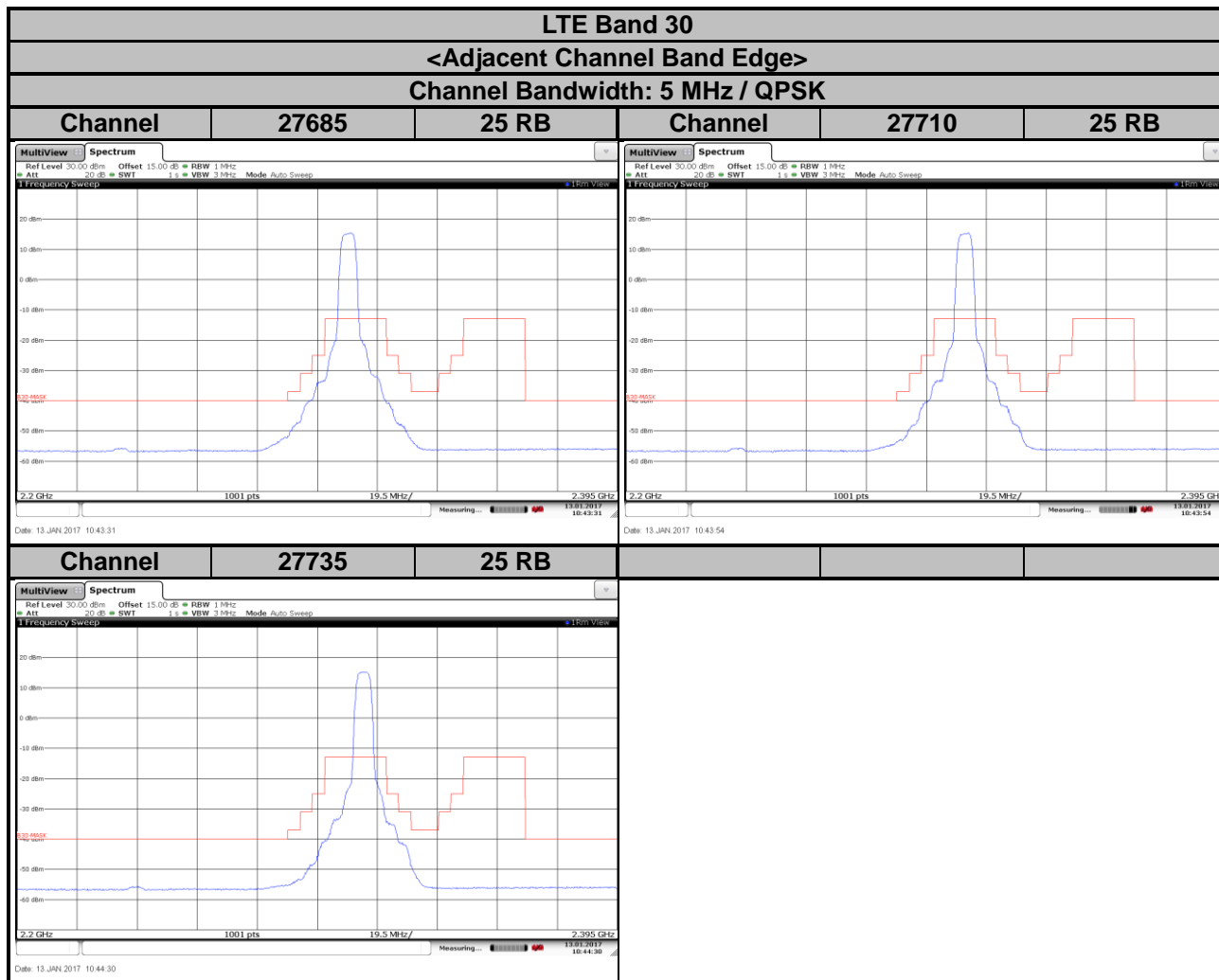

LTE Band 30
<Adjacent Channel Band Edge>
Channel Bandwidth: 5 MHz / 16QAM

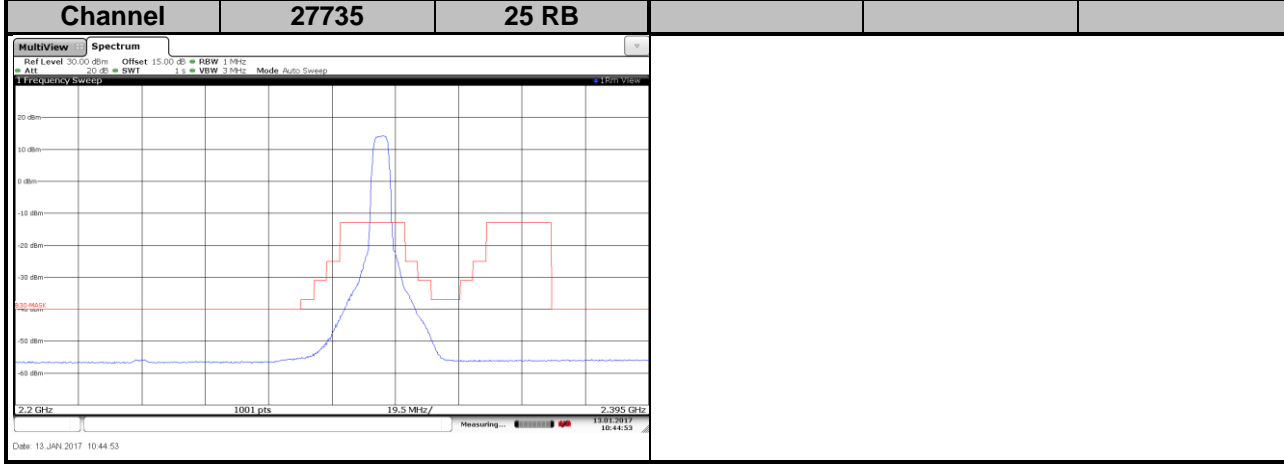
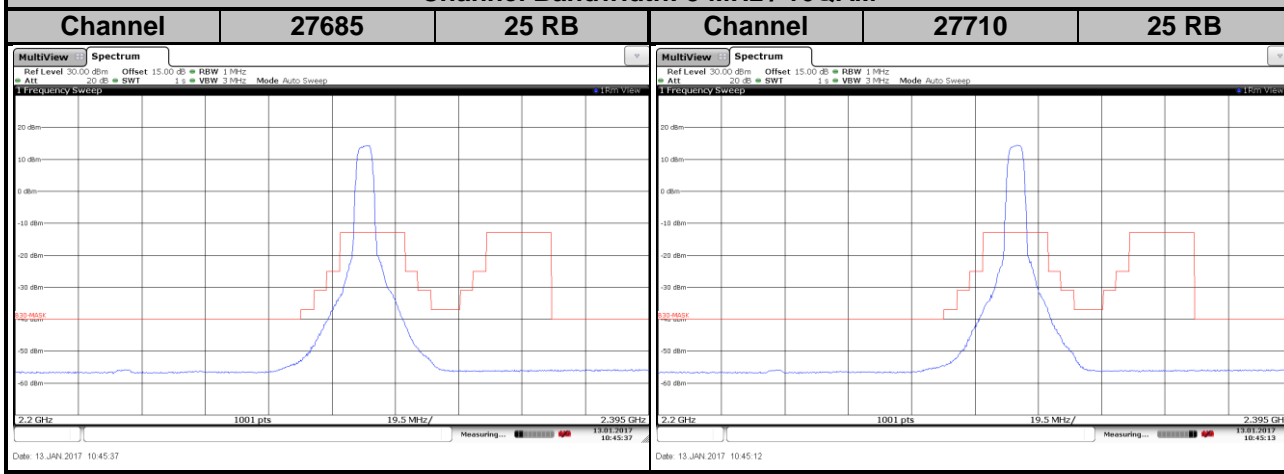

LTE Band 30
Channel Bandwidth: 10 MHz / QPSK

Channel Bandwidth: 10MHz / QPSK	Channel Bandwidth: 10MHz / 16QAM

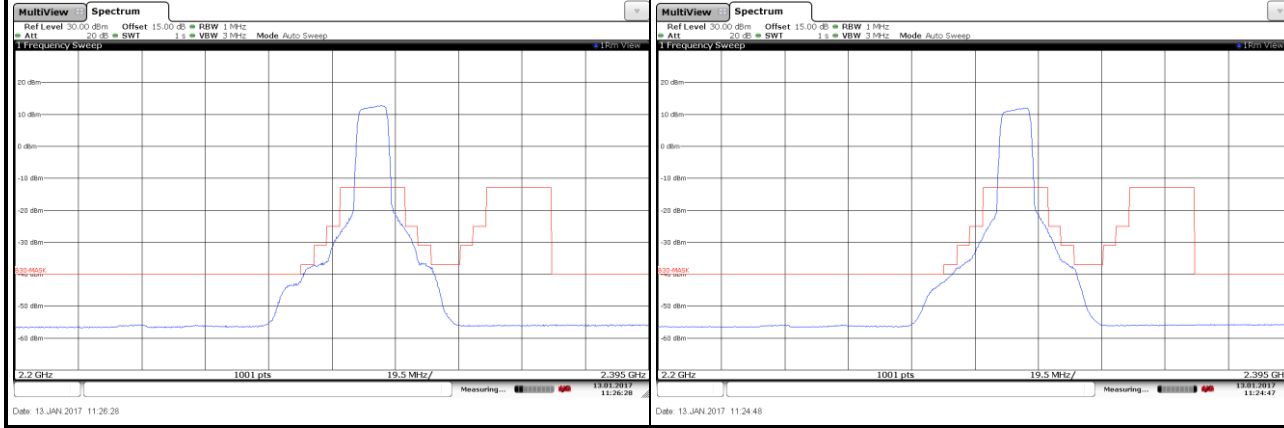

4.5 Conducted Spurious Emissions

4.5.1 Limits of Conducted Spurious Emissions Measurement

The power of any emission outside a licensee's frequency block shall be attenuated below the transmitter power (P) by at least $70 + 10 \log_{10}(P)$ dB. The limit of emission is equal to -40 dBm.

4.5.2 Test Setup

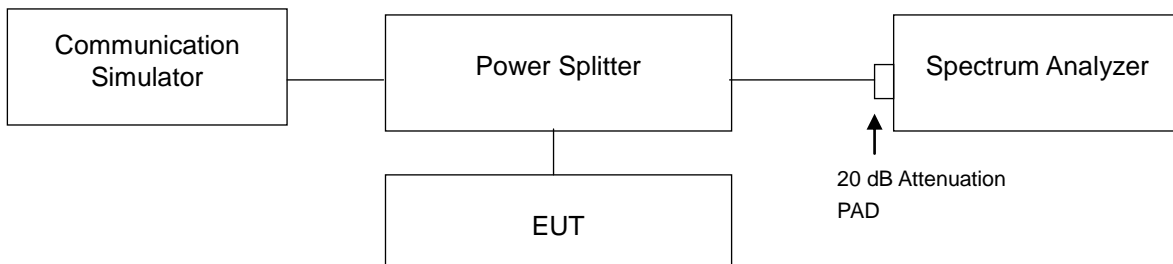

4.5.3 Test Procedure

- The EUT makes a phone call to the communication simulator. All measurements were done at low, middle and high operational frequency range.
- Measuring frequency range is from 30 MHz to 23.5 GHz for LTE Band 30. 10 dB attenuation pad is connected with spectrum. RBW=1 MHz and VBW=3 MHz are used for conducted emission measurement.

4.5.4 Test Results

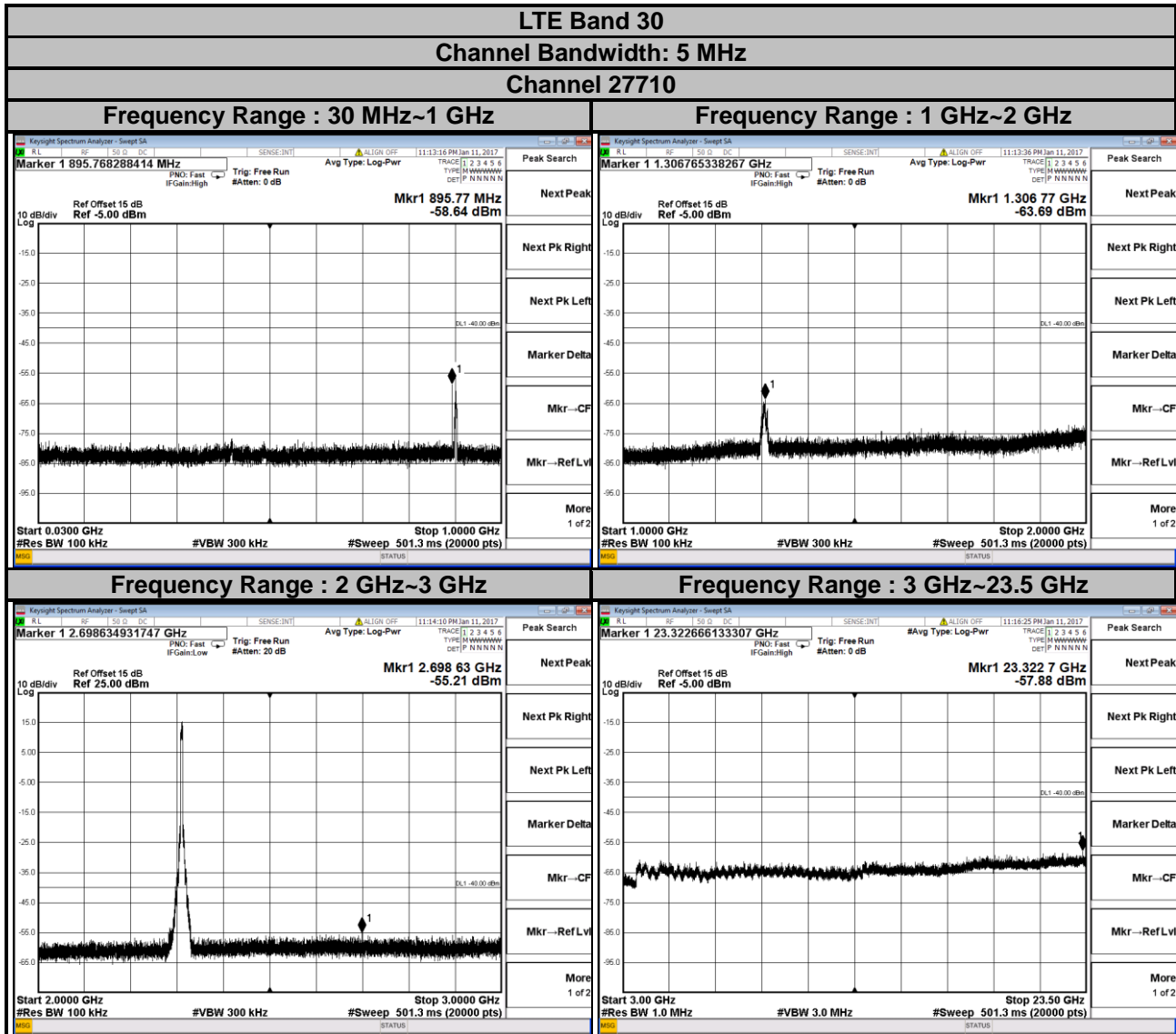

LTE Band 30
Channel Bandwidth: 10 MHz
Channel 27710

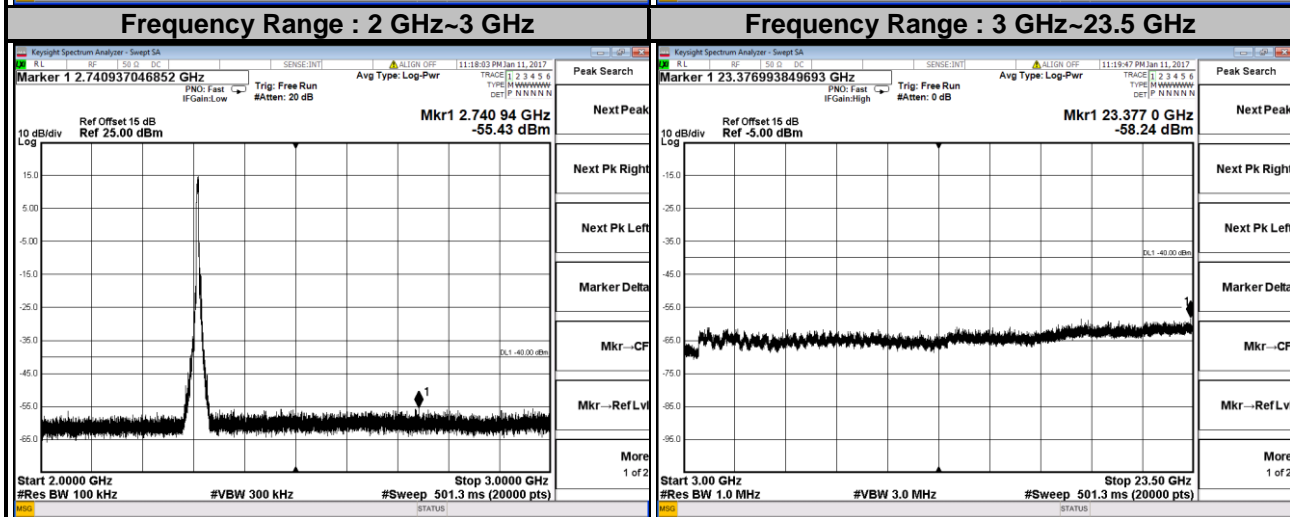
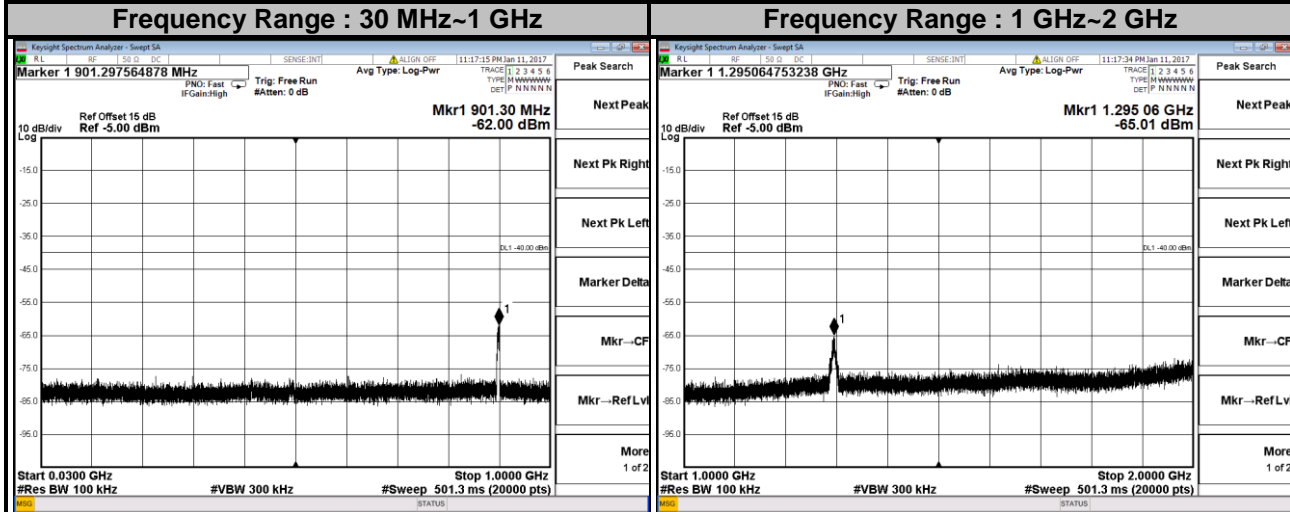

4.6 Radiated Emission Measurement

4.6.1 Limits of Radiated Emission Measurement

The power of any emission outside a licensee's frequency block shall be attenuated below the transmitter power (P) by at least $70 + 10 \log_{10}(P)$ dB. The limit of emission is equal to -40 dBm.

4.6.2 Test Procedure

- Substitution method is used for E.I.R.P measurement. In the semi-anechoic chamber, EUT placed on the 0.8 m height of Turn Table, rotated the table around 360 degrees to search the maximum radiation power and receiver antenna shall be rotated vertical and horizontal polarization and moved height from 1 m to 4 m to find the maximum polar radiated power. The "Read Value" is the spectrum reading the maximum power value.
- The substitution horn antenna is substituted for EUT at the same position and signals generator export the CW signal to the substitution antenna via a TX cable. Rotated the Turn Table and moved receiving antenna to find the maximum radiation power. Adjust output power level of S.G to get a Value of spectrum reading equal to "Read Value " of step a. Record the power level of S.G
- $EIRP = \text{Output power level of S.G} - \text{TX cable loss} + \text{Antenna gain of substitution horn.}$
- E.R.P power can be calculated form E.I.R.P power by subtracting the gain of dipole, $E.R.P \text{ power} = E.I.P.R \text{ power} - 2.15 \text{ dBi.}$

Note: The resolution bandwidth of spectrum analyzer is 1 MHz and the video bandwidth is 3 MHz.

4.6.3 Deviation from Test Standard

No deviation.

4.6.4 Test Setup

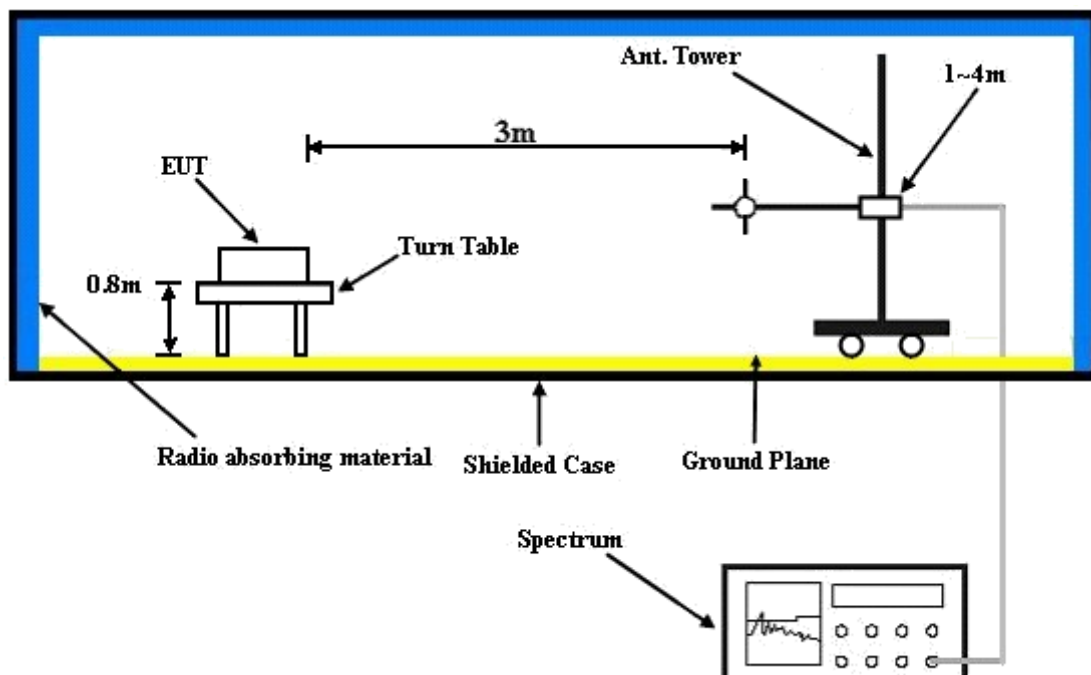

For the actual test configuration, please refer to the attached file (Test Setup Photo).

4.6.5 Test Results

LTE Band 30
Channel Bandwidth: 20 MHz / QPSK
Middle Channel



Bureau Veritas Consumer Products Services Ltd., Taoyuan Branch

A D T

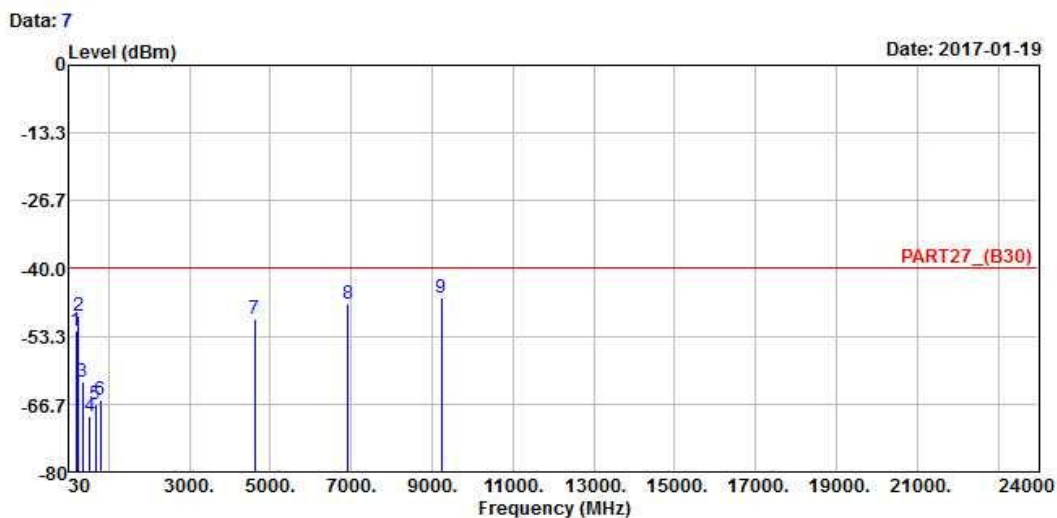

Site : 966 Chamber 5
Condition: PART27_(B30) HORIZONTAL
Remak : LTE Band 30 QPSK_20M_M-CH Link
Tested by: Getaz Yang

	Freq	Level	Read Level	Limit Line	Over Limit	Factor	Remark
	MHz	dBm	dBm	dBm	dB	dB	
1	191.99	-52.36	-45.08	-40.00	-12.36	-7.28	Peak
2	247.28	-49.40	-43.29	-40.00	-9.40	-6.11	Peak
3	350.10	-62.22	-55.98	-40.00	-22.22	-6.24	Peak
4	531.49	-69.16	-65.65	-40.00	-29.16	-3.51	Peak
5	677.96	-66.73	-66.28	-40.00	-26.73	-0.45	Peak
6	807.94	-65.71	-66.38	-40.00	-25.71	0.67	Peak
7	4620.00	-49.76	-45.68	-40.00	-9.76	-4.08	Peak
8	6930.00	-47.04	-51.33	-40.00	-7.04	4.29	Peak
9 pp	9240.00	-45.65	-53.31	-40.00	-5.65	7.66	Peak



Bureau Veritas Consumer Products Services Ltd., Taoyuan Branch

A D T

Data: 8

Date: 2017-01-19

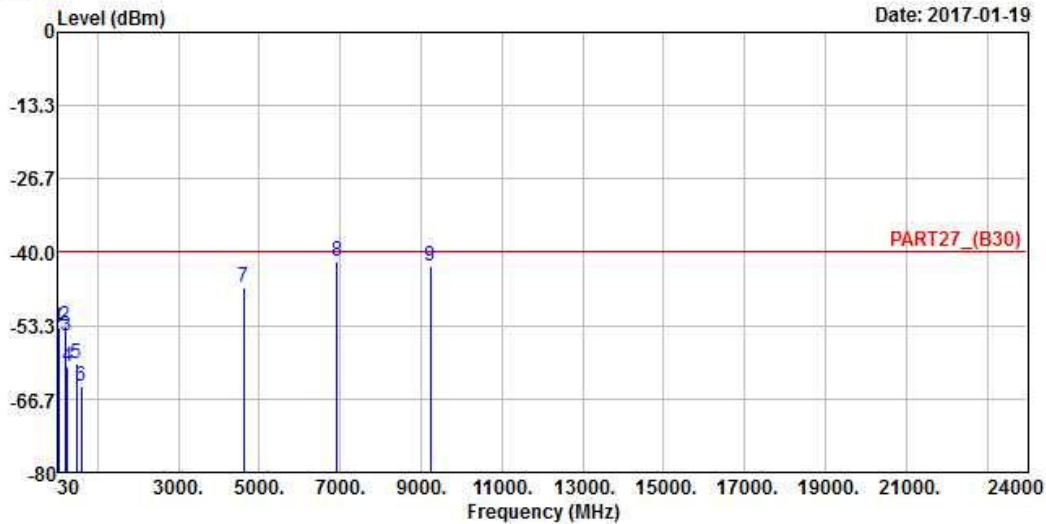

Site : 966 Chamber 5
 Condition: PART27_(B30) VERTICAL
 Remak : LTE Band 30 QPSK_20M_M-CH Link
 Tested by: Getaz Yang

	Freq	Level	Read Level	Limit Line	Over Limit	Factor	Remark
	MHz	dBm	dBm	dBm	dB	dB	
1	43.58	-53.77	-52.30	-40.00	-13.77	-1.47	Peak
2	200.72	-53.45	-45.47	-40.00	-13.45	-7.98	Peak
3	226.91	-55.10	-48.17	-40.00	-15.10	-6.93	Peak
4	254.07	-60.85	-54.78	-40.00	-20.85	-6.07	Peak
5	470.38	-60.28	-55.11	-40.00	-20.28	-5.17	Peak
6	590.66	-64.49	-63.33	-40.00	-24.49	-1.16	Peak
7	4620.00	-46.35	-42.27	-40.00	-6.35	-4.08	Peak
8 pp	6930.00	-41.56	-45.85	-40.00	-1.56	4.29	Peak
9	9240.00	-42.46	-50.12	-40.00	-2.46	7.66	Peak

5 Pictures of Test Arrangements

Please refer to the attached file (Test Setup Photo).

Appendix – Information on the Testing Laboratories

We, Bureau Veritas Consumer Products Services (H.K.) Ltd., Taoyuan Branch, were founded in 1988 to provide our best service in EMC, Radio, Telecom and Safety consultation. Our laboratories are accredited and approved according to ISO/IEC 17025.

If you have any comments, please feel free to contact us at the following:

Linko EMC/RF Lab

Tel: 886-2-26052180

Fax: 886-2-26051924

Hsin Chu EMC/RF/Telecom Lab

Tel: 886-3-6668565

Fax: 886-3-6668323

Hwa Ya EMC/RF/Safety

Tel: 886-3-3183232

Fax: 886-3-3270892

Email: service.adt@tw.bureauveritas.com

Web Site: www.bureauveritas-adt.com

The address and road map of all our labs can be found in our web site also.

--- END ---