

FCC Test Report (Part 24)

Report No.: RF200109E02-1

FCC ID: 2AQ68T99W175

Test Model: T99W175

Received Date: Jan. 10, 2020

Test Date: Feb. 13 ~ Feb. 25, 2020

Issued Date: Mar. 13, 2020

Applicant: Hon Lin Technology Co., Ltd.

Address: 11F, No.32, Jihu Rd., Neihu Dist., Taipei City 114, Taiwan R.O.C.

Issued By: Bureau Veritas Consumer Products Services (H.K.) Ltd., Taoyuan Branch
Lin Kou Laboratories

Lab Address: No. 47-2, 14th Ling, Chia Pau Vil., Lin Kou Dist., New Taipei City, Taiwan

Test Location: No.19, Hwa Ya 2nd Rd., Wen Hwa Vil., Kwei Shan Dist., Taoyuan City
33383, Taiwan

FCC Registration / 788550 / TW0003

Designation Number:



This report is for your exclusive use. Any copying or replication of this report to or for any other person or entity, or use of our name or trademark, is permitted only with our prior written permission. This report sets forth our findings solely with respect to the test samples identified herein. The results set forth in this report are not indicative or representative of the quality or characteristics of the lot from which a test sample was taken or any similar or identical product specifically and expressly noted. Our report includes all of the tests requested by you and the results thereof based upon the information that you provided to us. You have 60 days from date of issuance of this report to notify us of any material error or omission caused by our negligence, provided, however, that such notice shall be in writing and shall specifically address the issue you wish to raise. A failure to raise such issue within the prescribed time shall constitute your unqualified acceptance of the completeness of this report, the tests conducted and the correctness of the report contents. Unless specific mention, the uncertainty of measurement has been explicitly taken into account to declare the compliance or non-compliance to the specification. The report must not be used by the client to claim product certification, approval, or endorsement by TAF or any government agencies

Table of Contents

Release Control Record	4
1 Certificate of Conformity	5
2 Summary of Test Results	6
2.1 Measurement Uncertainty.....	6
2.2 Test Site and Instruments.....	7
3 General Information	8
3.1 General Description of EUT.....	8
3.2 Configuration of System under Test.....	12
3.2.1 Description of Support Units.....	12
3.3 Test Mode Applicability and Tested Channel Detail.....	13
3.4 EUT Operating Conditions.....	20
3.5 General Description of Applied Standards and References.....	20
4 Test Types and Results	21
4.1 Output Power Measurement.....	21
4.1.1 Limits of Output Power Measurement.....	21
4.1.2 Test Procedures.....	21
4.1.3 Test Setup.....	21
4.1.4 Test Results.....	22
4.2 Modulation Characteristics Measurement.....	48
4.2.1 Limits of Modulation Characteristics.....	48
4.2.2 Test Procedure.....	48
4.2.3 Test Setup.....	48
4.2.4 Test Results.....	49
4.3 Frequency Stability Measurement.....	52
4.3.1 Limits of Frequency Stability Measurement.....	52
4.3.2 Test Procedure.....	52
4.3.3 Conducted Setup.....	52
4.3.4 Test Results.....	53
4.4 Occupied Bandwidth Measurement.....	66
4.4.1 Test Procedure.....	66
4.4.2 Test Setup.....	66
4.4.3 Test Result.....	67
4.5 Band Edge Measurement.....	77
4.5.1 Limits of Band Edge Measurement.....	77
4.5.2 Test Setup.....	77
4.5.3 Test Procedures.....	77
4.5.4 Test Results.....	78
4.6 Peak to Average Ratio.....	91
4.6.1 Limits of Peak to Average Ratio Measurement.....	91
4.6.2 Test Setup.....	91
4.6.3 Test Procedures.....	91
4.6.4 Test Results.....	92
4.7 Conducted Spurious Emissions.....	97
4.7.1 Limits of Conducted Spurious Emissions Measurement.....	97
4.7.2 Test Setup.....	97
4.7.3 Test Procedure.....	97
4.7.4 Test Results.....	98
4.8 Radiated Emission Measurement.....	119
4.8.1 Limits of Radiated Emission Measurement.....	119
4.8.2 Test Procedure.....	119
4.8.3 Deviation from Test Standard.....	119
4.8.4 Test Setup.....	120
4.8.5 Test Results.....	121

5	Pictures of Test Arrangements.....	141
	Appendix – Information of the Testing Laboratories	142

Release Control Record

Issue No.	Description	Date Issued
RF200109E02-1	Original release	Mar. 13, 2020

1 Certificate of Conformity

Product: 5G WWAN Module

Brand: Foxconn

Test Model: T99W175

Sample Status: Engineering Sample

Applicant: Hon Lin Technology Co., Ltd.

Test Date: Feb. 13 ~ Feb. 25, 2020

Standards: FCC Part 24, Subpart E

The above equipment has been tested by **Bureau Veritas Consumer Products Services (H.K.) Ltd., Taoyuan Branch**, and found compliance with the requirement of the above standards. The test record, data evaluation & Equipment Under Test (EUT) configurations represented herein are true and accurate accounts of the measurements of the sample's RF characteristics under the conditions specified in this report.

Prepared by : Pettie Chen , **Date:** Mar. 13, 2020
Pettie Chen / Senior Specialist

Approved by : Bruce Chen , **Date:** Mar. 13, 2020
Bruce Chen / Senior Project Engineer

2 Summary of Test Results

Applied Standard: FCC Part 24 & Part 2			
FCC Clause	Test Item	Result	Remarks
2.1046 24.232	Effective radiated power	Pass	Meet the requirement of limit.
2.1046 24.232(d)	Peak To Average Ratio	Pass	Meet the requirement of limit.
2.1047	Modulation Characteristics	Pass	Meet the requirement
2.1055 24.235	Frequency Stability	Pass	Meet the requirement of limit.
2.1049 24.238(b)	Occupied Bandwidth	Pass	Meet the requirement of limit.
24.238(b)	Band Edge Measurements	Pass	Meet the requirement of limit.
2.1051 24.238	Conducted Spurious Emissions	Pass	Meet the requirement of limit.
2.1053 24.238	Radiated Spurious Emissions	Pass	Meet the requirement of limit. Minimum passing margin is -23.1dB at 54.25MHz.

Note:

Determining compliance based on the results of the compliance measurement, not taking into account measurement instrumentation uncertainty.

2.1 Measurement Uncertainty

Where relevant, the following measurement uncertainty levels have been estimated for tests performed on the EUT as specified in CISPR 16-4-2:

Measurement	Frequency	Expanded Uncertainty (k=2) (\pm)
Radiated Emissions up to 1 GHz	9kHz ~ 30MHz	3.04 dB
	30MHz ~ 200MHz	3.63 dB
	200MHz ~ 1000MHz	3.64 dB
Radiated Emissions above 1 GHz	1GHz ~ 18GHz	2.29 dB
	18GHz ~ 40GHz	2.29 dB

2.2 Test Site and Instruments

Description & Manufacturer	Model No.	Serial No.	Cal. Date	Cal. Due
Test Receiver ROHDE & SCHWARZ	ESCI	100424	Dec. 31, 2019	Dec. 30, 2020
Spectrum Analyzer ROHDE & SCHWARZ	FSP40	100040	Sep. 23, 2019	Sep. 22, 2020
Spectrum Analyzer KEYSIGHT	N9030B	MY57140953	Jul. 03, 2019	Jul. 02, 2020
Radio Communication Analyzer Anritsu	MT8821C	6261806803	Jan. 18, 2020	Jan. 17, 2021
MXG Vector signal generator Agilent	N5182B	MY53050162	Jan. 14, 2020	Jan. 13, 2021
BILOG Antenna SCHWARZBECK	VULB9168	9168-158	Nov. 08, 2019	Nov. 07, 2020
BILOG Antenna SCHWARZBECK	VULB9168	9168-155	Nov. 11, 2019	Nov. 10, 2020
HORN Antenna SCHWARZBECK	BBHA 9120D	9120D-1170	Nov. 24, 2019	Nov. 23, 2020
HORN Antenna ETS	3117	00034128	Nov. 24, 2019	Nov. 23, 2020
HORN Antenna SCHWARZBECK	BBHA 9170	BBHA9170241	Nov. 24, 2019	Nov. 23, 2020
Loop Antenna TESEQ	HLA 6121	45745	Jul. 01, 2019	Jun. 30, 2020
Preamplifier Agilent (Below 1GHz)	8447D	2944A10631	Jul. 11, 2019	Jul. 10, 2020
Preamplifier KEYSIGHT (Above 1GHz)	83017A	MY53270295	Jun. 11, 2019	Jun. 10, 2020
RF Coaxial Cable WOKEN With 5dB PAD	8D-FB	Cable-CH4-01	Aug. 20, 2019	Aug. 19, 2020
RF Coaxial Cable EMCI	EMC102-KM-KM-3000	150929	Aug. 20, 2019	Aug. 19, 2020
RF Coaxial Cable EMCI	EMC102-KM-KM-600	150928	Aug. 20, 2019	Aug. 19, 2020
RF signal cable HUBER+SUHNER	SUCOFLEX 104	MY 13380+295012/04	Jul. 11, 2019	Jul. 10, 2020
RF signal cable HUBER+SUHNER	SUCOFLEX 104	Cable-CH4-03 (250724)	Jul. 11, 2019	Jul. 10, 2020
Software BV ADT	ADT_Radiated_ V7.6.15.9.5	NA	NA	NA
Antenna Tower inn-co GmbH	MA 4000	010303	NA	NA
Antenna Tower Controller BV ADT	AT100	AT93021703	NA	NA
Boresight Antenna Fixture	FBA-01	FBA-SIP01	NA	NA
Standard Temperature And Humidity Chamber	MHU-225AU	920842	May 31, 2019	May 30, 2020
JFW 20dB attenuation	50HF-020-SMA	NA	NA	NA
True RMS Clamp Meter Fluke	325	31130711WS	May 21, 2019	May 20, 2020
DC power supply	U8002A	MY56330015	NA	NA

Note: 1. The calibration interval of the above test instruments is 12 months and the calibrations are traceable to NML/ROC and NIST/USA.
2. The test was performed in HwaYa Chamber 4.

3 General Information

3.1 General Description of EUT

Product	5G WWAN Module	
Brand	Foxconn	
Test Model	T99W175	
Sample Status	Engineering Sample	
Power Supply Rating	5 Vdc (Host equipment) 3.135Vdc~3.63Vdc (Module)	
Modulation Type	WCDMA: BPSK, QPSK HSDPA: BPSK HSUPA: QPSK LTE: QPSK, 16QAM, 64QAM	
Operating Frequency	WCDMA Band 2	1852.4~1907.6MHz
	LTE Band 2 (Channel Bandwidth 1.4MHz)	1850.7~1909.3MHz
	LTE Band 2 (Channel Bandwidth 3MHz)	1851.5~1908.5MHz
	LTE Band 2 (Channel Bandwidth 5MHz)	1852.5~1907.5MHz
	LTE Band 2 (Channel Bandwidth 10MHz)	1855.0~1905.0MHz
	LTE Band 2 (Channel Bandwidth 15MHz)	1857.5~1902.5MHz
	LTE Band 2 (Channel Bandwidth 20MHz)	1860.0~1900.0MHz
	LTE Band 25 (Channel Bandwidth: 1.4MHz)	1850.7~1914.3MHz
	LTE Band 25 (Channel Bandwidth: 3MHz)	1851.5~1913.5MHz
	LTE Band 25 (Channel Bandwidth: 5MHz)	1852.5~1912.5MHz
	LTE Band 25 (Channel Bandwidth: 10MHz)	1855.0~1910.0MHz
	LTE Band 25 (Channel Bandwidth: 15MHz)	1857.5~1907.5MHz
	LTE Band 25 (Channel Bandwidth: 20MHz)	1860.0~1905.0MHz

Max. EIRP Power	WCDMA Band 2	601.174mW (27.79dBm)		
		QPSK	16QAM	64QAM
	LTE Band 2 (Channel Bandwidth 1.4MHz)	587.489mW (27.69dBm)	533.335mW (27.27dBm)	408.319mW (26.11dBm)
	LTE Band 2 (Channel Bandwidth 3MHz)	598.412mW (27.77dBm)	515.229mW (27.12dBm)	414.000mW (26.17dBm)
	LTE Band 2 (Channel Bandwidth 5MHz)	606.736mW (27.83dBm)	498.884mW (26.98dBm)	418.794mW (26.22dBm)
	LTE Band 2 (Channel Bandwidth 10MHz)	580.794mW (27.64dBm)	535.797mW (27.29dBm)	408.319mW (26.11dBm)
	LTE Band 2 (Channel Bandwidth 15MHz)	605.341mW (27.82dBm)	549.541mW (27.40dBm)	448.745mW (26.52dBm)
	LTE Band 2 (Channel Bandwidth 20MHz)	644.169mW (28.09dBm)	555.904mW (27.45dBm)	429.536mW (26.33dBm)
	LTE Band 25 (Channel Bandwidth: 1.4MHz)	584.790mW (27.67dBm)	538.270mW (27.31dBm)	413.048mW (26.16dBm)
	LTE Band 25 (Channel Bandwidth: 3MHz)	612.350mW (27.87dBm)	532.108mW (27.26dBm)	415.911mW (26.19dBm)
	LTE Band 25 (Channel Bandwidth: 5MHz)	602.560mW (27.80dBm)	524.807mW (27.20dBm)	414.000mW (26.17dBm)
	LTE Band 25 (Channel Bandwidth: 10MHz)	574.116mW (27.59dBm)	524.807mW (27.20dBm)	434.510mW (26.38dBm)
	LTE Band 25 (Channel Bandwidth: 15MHz)	629.506mW (27.99dBm)	558.470mW (27.47dBm)	439.542mW (26.43dBm)
	LTE Band 25 (Channel Bandwidth: 20MHz)	587.489mW (27.69dBm)	510.505mW (27.08dBm)	412.098mW (26.15dBm)
Emission Designator	WCDMA Band 2	4M16F9W		
		QPSK	16QAM	64QAM
	LTE Band 2 (Channel Bandwidth 1.4MHz)	1M09G7D	1M09D7W	1M09D7W
	LTE Band 2 (Channel Bandwidth 3MHz)	2M70G7D	2M69D7W	2M70D7W
	LTE Band 2 (Channel Bandwidth 5MHz)	4M49G7D	4M49D7W	4M49D7W
	LTE Band 2 (Channel Bandwidth 10MHz)	8M96G7D	8M96D7W	8M95D7W
	LTE Band 2 (Channel Bandwidth 15MHz)	13M5G7D	13M5D7W	13M5D7W
	LTE Band 2 (Channel Bandwidth 20MHz)	18M0G7D	18M0D7W	18M0D7W
	LTE Band 25 (Channel Bandwidth: 1.4MHz)	1M09G7D	1M09D7W	1M09D7W
	LTE Band 25 (Channel Bandwidth: 3MHz)	2M70G7D	2M70D7W	2M70D7W
	LTE Band 25 (Channel Bandwidth: 5MHz)	4M49G7D	4M49D7W	4M49D7W
	LTE Band 25 (Channel Bandwidth: 10MHz)	8M96G7D	8M96D7W	8M95D7W
	LTE Band 25 (Channel Bandwidth: 15MHz)	13M5G7D	13M4D7W	13M4D7W
LTE Band 25 (Channel Bandwidth: 20MHz)	17M9G7D	17M9D7W	17M9D7W	
Antenna Type	Refer to Note as below			
Antenna Connector	Refer to Note as below			
Accessory Device	NA			
Cable Supplied	NA			

Note:

1. There has five Difference HW of T99W175.

Brand	Model	HW
Foxconn	T99W175	1. 3G+LTE+Sub6+mmWave+eSIM
		2. 3G+LTE+Sub6+eSIM
		3. 3G+LTE+Sub6 only w/o eSIM
		4. 3G+LTE+Sub6+eSIM+GNSS connector
		5. 3G+LTE+Sub6 only+w/o eSIM+GNSS connector

*After pre-testing, "HW: 1. 3G+LTE+Sub6+mmWave+eSIM" is the worst for the final tests.

2. The following antennas were provided to the EUT.

Antenna No.	RF Chain No.	Brand	Model	Antenna Net Gain(dBi)	Frequency range (MHz)	Antenna Type	Connector Type
1		WHA YU	C107-511720-A	4.41	660~803	PCB	I-PEX
2		WHA YU	C107-511721-A	3.81 4.03	791~960 1447.9~1606	PCB	I-PEX
3		WHA YU	C107-511722-A	4.27 5.31	1710~2170 2500~2690	PCB	I-PEX
4		WHA YU	C107-511723-A	2.99 0.92	2300~2400 3500~3700	PCB	I-PEX
5		WHA YU	C107-511724-A	6.45	5150~5925	PCB	I-PEX
6		WHA YU	C107-511725-A	4.89	3400~3700	PCB	I-PEX
7		AVX	5000106-R1-X01	2.91	699~803	Monopole	I-PEX
8		AVX	5000107-R1-X01	2.59	791~960	Monopole	I-PEX
9		AVX	5000108-R1-X01	2.85	1427~1610	Monopole	I-PEX
10		AVX	5000109-R1-X01	2.23 2.94	1710~2200 5150~5925	Monopole	I-PEX
11		AVX	5000110-R1-X01	0.9	2300~2690	Monopole	I-PEX
12		AVX	5000111-R1-X01	0.87	3300~5000	Monopole	I-PEX
13	Tx1/ Rx1	Ethertronics	5003806	0.4 -1.61 0.39 2.95 1.98 0.38 0.83 2.31	698-821 824-960 1425-1515 1710-2200 2300-2690 3300-4200 4400-5000 5150-5925	PIFA	I-PEX
	Rx2	Ethertronics	5003807	-2.24 -4.52 2.87 2.99 2.93 2.91 2.23 -0.85 -3.04	716-821 824-960 1425-1515 1557-1610 1805-2200 2300-2690 3300-4200 4400-5000 5150-5925	PIFA	I-PEX
	Tx2/ Rx3	Ethertronics	5003806	2.21 2.25 -0.45 2.6	1710-2200 2300-2690 3300-4200 4400-5000	PIFA	I-PEX
	Rx4	Ethertronics	5003700	1.38 2.87 0.6 -2.09	1805-2200 2300-2690 3300-4200 4400-5000	PIFA	I-PEX

Antenna No.	RF Chain No.	Brand	Model	Antenna Net Gain(dBi)	Frequency range (MHz)	Antenna Type	Connector Type
14	Ant. 0 (TX/RX)	Master Wave	NA	2.4 2.2 2.9 2.9 2.9 NA	880~960 1020~2170 2545~2595 3565~3600 3900~4000 GPS	PCB	I-PEX
	Ant. 2 (TX/RX)	Master Wave	NA	NA 2.2 2.8 2.9 2.8 NA	880~960 1020~2170 2545~2595 3565~3600 3900~4000 GPS	PCB	I-PEX
	Ant. 1 (RX)	Master Wave	NA	NA 5.3 5.1 4.3 4.5 NA	880~960 1020~2170 2545~2595 3565~3600 3900~4000 GPS	PCB	I-PEX
	Ant. 3 (RX)	Master Wave	NA	1.3 6.8 3.7 6.4 6.2 3.7	880~960 1020~2170 2545~2595 3565~3600 3900~4000 GPS	PCB	I-PEX

3.2 Configuration of System under Test

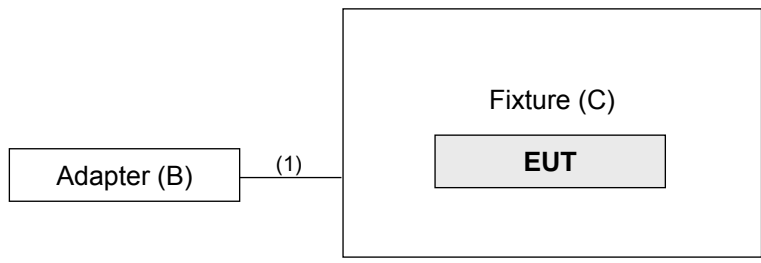

Remote site

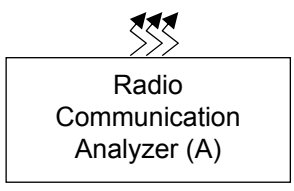

3.2.1 Description of Support Units

The EUT has been tested as an independent unit together with other necessary accessories or support units. The following support units or accessories were used to form a representative test configuration during the tests.

ID	Product	Brand	Model No.	Serial No.	FCC ID	Remarks
A.	Radio Communication Analyzer	Anritsu	MT8821C	6261806803	NA	-
B.	Adapter	LITEON	PA-1050-39	NA	NA	-
C.	Fixture	NA	NA	NA	NA	Provided by client.

Note:

1. All power cords of the above support units are non-shielded (1.8m).
2. Item A acted as a communication partner to transfer data.

ID	Descriptions	Qty.	Length (m)	Shielding (Yes/No)	Cores (Qty.)	Remarks
1.	USB cable	1	1.5	Y	0	-

3.3 Test Mode Applicability and Tested Channel Detail

Pre-Scan has been conducted to determine the worst-case mode from all possible combinations between available modulations, data rates, XYZ axis and antenna ports. The worst case was found when positioned on Z-plane. Following channel(s) was (were) selected for the final test as listed below:

WCDMA Band 2

EUT Configure Mode	Test Item	Available Channel	Tested Channel	Mode
-	EIRP	9262 to 9538	9262 (1852.4MHz), 9400 (1880.0MHz), 9538 (1907.6MHz)	WCDMA
-	Modulation Characteristics	9262 to 9538	9400 (1880.0MHz)	WCDMA, HSDPA, HSUPA
-	Frequency Stability	9262 to 9538	9262 (1852.4MHz), 9538 (1907.6MHz)	WCDMA
-	Occupied Bandwidth	9262 to 9538	9262 (1852.4MHz), 9400 (1880.0MHz), 9538 (1907.6MHz)	WCDMA, HSDPA, HSUPA
-	Band Edge	9262 to 9538	9262 (1852.4MHz), 9538 (1907.6MHz)	WCDMA, HSDPA, HSUPA
-	Peak To Average Ratio	9262 to 9538	9262 (1852.4MHz), 9400 (1880.0MHz), 9538 (1907.6MHz)	WCDMA, HSDPA, HSUPA
-	Conducted Emission	9262 to 9538	9262 (1852.4MHz), 9400 (1880.0MHz), 9538 (1907.6MHz)	WCDMA, HSDPA, HSUPA
-	Radiated Emission Below 1GHz	9262 to 9538	9538 (1907.6MHz)	WCDMA
-	Radiated Emission Above 1GHz	9262 to 9538	9262 (1852.4MHz), 9400 (1880.0MHz), 9538 (1907.6MHz)	WCDMA

LTE Band 2

EUT Configure Mode	Test item	Available channel	Tested Channel	Channel Bandwidth	Modulation	Mode
-	EIRP	18607 to 19193	18607 (1850.70MHz), 18900 (1880.00MHz), 19193 (1909.30MHz)	1.4MHz	QPSK / 16QAM / 64QAM	1 RB / 2 RB Offset
		18615 to 19185	18615 (1851.50MHz), 18900 (1880.00MHz), 19185 (1908.50MHz)	3MHz	QPSK / 16QAM / 64QAM	1 RB / 14 RB Offset
		18625 to 19175	18625 (1852.50MHz), 18900 (1880.00MHz), 19175 (1907.50MHz)	5MHz	QPSK / 16QAM / 64QAM	1 RB / 12 RB Offset
		18650 to 19150	18650 (1855.00MHz), 18900 (1880.00MHz), 19150 (1905.00MHz)	10MHz	QPSK / 16QAM / 64QAM	1 RB / 49 RB Offset
		18675 to 19125	18675 (1857.50MHz), 18900 (1880.00MHz), 19125 (1902.50MHz)	15MHz	QPSK / 16QAM / 64QAM	1 RB / 0 RB Offset
		18700 to 19100	18700 (1860.00MHz), 18900 (1880.00MHz), 19100 (1900.00MHz)	20MHz	QPSK / 16QAM / 64QAM	1 RB / 0 RB Offset
-	Modulation Characteristics	18700 to 19100	18900 (1880.00MHz)	20MHz	QPSK / 16QAM / 64QAM	100 RB / 0 RB Offset
-	Frequency Stability	18607 to 19193	18607 (1850.70MHz), 19193 (1909.30MHz)	1.4MHz	QPSK	5 RB / 0 RB Offset
		18615 to 19185	18615 (1851.50MHz), 19185 (1908.50MHz)	3MHz	QPSK	15 RB / 0 RB Offset
		18625 to 19175	18625 (1852.50MHz), 19175 (1907.50MHz)	5MHz	QPSK	25 RB / 0 RB Offset
		18650 to 19150	18650 (1855.00MHz), 19150 (1905.00MHz)	10MHz	QPSK	50 RB / 0 RB Offset
		18675 to 19125	18675 (1857.50MHz), 19125 (1902.50MHz)	15MHz	QPSK	75 RB / 0 RB Offset
		18700 to 19100	18700 (1860.00MHz), 19100 (1900.00MHz)	20MHz	QPSK	100 RB / 0 RB Offset
-	Occupied Bandwidth	18607 to 19193	18607 (1850.70MHz), 18900 (1880.00MHz), 19193 (1909.30MHz)	1.4MHz	QPSK / 16QAM / 64QAM	5 RB / 0 RB Offset
		18615 to 19185	18615 (1851.50MHz), 18900 (1880.00MHz), 19185 (1908.50MHz)	3MHz	QPSK / 16QAM / 64QAM	15 RB / 0 RB Offset
		18625 to 19175	18625 (1852.50MHz), 18900 (1880.00MHz), 19175 (1907.50MHz)	5MHz	QPSK / 16QAM / 64QAM	25 RB / 0 RB Offset
		18650 to 19150	18650 (1855.00MHz), 18900 (1880.00MHz), 19150 (1905.00MHz)	10MHz	QPSK / 16QAM / 64QAM	50 RB / 0 RB Offset
		18675 to 19125	18675 (1857.50MHz), 18900 (1880.00MHz), 19125 (1902.50MHz)	15MHz	QPSK / 16QAM / 64QAM	75 RB / 0 RB Offset
		18700 to 19100	18700 (1860.00MHz), 18900 (1880.00MHz), 19100 (1900.00MHz)	20MHz	QPSK / 16QAM / 64QAM	100 RB / 0 RB Offset

EUT Configure Mode	Test item	Available channel	Tested Channel	Channel Bandwidth	Modulation	Mode
-	Band Edge	18607 to 19193	18607 (1850.70MHz), 19193 (1909.30MHz)	1.4MHz	QPSK	1 RB / 0 RB Offset 1 RB / 5 RB Offset 6 RB / 0 RB Offset
		18615 to 19185	18615 (1851.50MHz), 19185 (1908.50MHz)	3MHz	QPSK	1 RB / 0 RB Offset 1 RB / 14 RB Offset 15 RB / 0 RB Offset
		18625 to 19175	18625 (1852.50MHz), 19175 (1907.50MHz)	5MHz	QPSK	1 RB / 0 RB Offset 1 RB / 24 RB Offset 25 RB / 0 RB Offset
		18650 to 19150	18650 (1855.00MHz), 19150 (1905.00MHz)	10MHz	QPSK	1 RB / 0 RB Offset 1 RB / 49 RB Offset 50 RB / 0 RB Offset
		18675 to 19125	18675 (1857.50MHz), 19125 (1902.50MHz)	15MHz	QPSK	1 RB / 0 RB Offset 1 RB / 74 RB Offset 75 RB / 0 RB Offset
		18700 to 19100	18700 (1860.00MHz), 19100 (1900.00MHz)	20MHz	QPSK	1 RB / 0 RB Offset 1 RB / 99 RB Offset 100 RB / 0 RB Offset
-	Peak to Average Ratio	18607 to 19193	18607 (1850.70MHz), 18900 (1880.00MHz), 19193 (1909.30MHz)	1.4MHz	QPSK / 16QAM / 64QAM	1 RB / 2 RB Offset
		18615 to 19185	18615 (1851.50MHz), 18900 (1880.00MHz), 19185 (1908.50MHz)	3MHz	QPSK / 16QAM / 64QAM	1 RB / 14 RB Offset
		18625 to 19175	18625 (1852.50MHz), 18900 (1880.00MHz), 19175 (1907.50MHz)	5MHz	QPSK / 16QAM / 64QAM	1 RB / 12 RB Offset
		18650 to 19150	18650 (1855.00MHz), 18900 (1880.00MHz), 19150 (1905.00MHz)	10MHz	QPSK / 16QAM / 64QAM	1 RB / 49 RB Offset
		18675 to 19125	18675 (1857.50MHz), 18900 (1880.00MHz), 19125 (1902.50MHz)	15MHz	QPSK / 16QAM / 64QAM	1 RB / 0 RB Offset
		18700 to 19100	18700 (1860.00MHz), 18900 (1880.00MHz), 19100 (1900.00MHz)	20MHz	QPSK / 16QAM / 64QAM	1 RB / 0 RB Offset
-	Conducted Emission	18607 to 19193	18607 (1850.70MHz), 18900 (1880.00MHz), 19193 (1909.30MHz)	1.4MHz	QPSK	1 RB / 2 RB Offset
		18615 to 19185	18615 (1851.50MHz), 18900 (1880.00MHz), 19185 (1908.50MHz)	3MHz	QPSK	1 RB / 14 RB Offset
		18625 to 19175	18625 (1852.50MHz), 18900 (1880.00MHz), 19175 (1907.50MHz)	5MHz	QPSK	1 RB / 12 RB Offset
		18650 to 19150	18650 (1855.00MHz), 18900 (1880.00MHz), 19150 (1905.00MHz)	10MHz	QPSK	1 RB / 49 RB Offset
		18675 to 19125	18675 (1857.50MHz), 18900 (1880.00MHz), 19125 (1902.50MHz)	15MHz	QPSK	1 RB / 0 RB Offset
		18700 to 19100	18700 (1860.00MHz), 18900 (1880.00MHz), 19100 (1900.00MHz)	20MHz	QPSK	1 RB / 0 RB Offset

EUT Configure Mode	Test item	Available channel	Tested Channel	Channel Bandwidth	Modulation	Mode
-	Radiated Emission Below 1GHz	18700 to 19100	18900 (1880.00MHz)	20MHz	QPSK	1 RB / 0 RB Offset
-	Radiated Emission Above 1GHz	18607 to 19193	18607 (1850.70MHz), 18900 (1880.00MHz), 19193 (1909.30MHz)	1.4MHz	QPSK	1 RB / 2 RB Offset
		18615 to 19185	18615 (1851.50MHz), 18900 (1880.00MHz), 19185 (1908.50MHz)	3MHz	QPSK	1 RB / 14 RB Offset
		18625 to 19175	18625 (1852.50MHz), 18900 (1880.00MHz), 19175 (1907.50MHz)	5MHz	QPSK	1 RB / 12 RB Offset
		18650 to 19150	18650 (1855.00MHz), 18900 (1880.00MHz), 19150 (1905.00MHz)	10MHz	QPSK	1 RB / 49 RB Offset
		18675 to 19125	18675 (1857.50MHz), 18900 (1880.00MHz), 19125 (1902.50MHz)	15MHz	QPSK	1 RB / 0 RB Offset
		18700 to 19100	18700 (1860.00MHz), 18900 (1880.00MHz), 19100 (1900.00MHz)	20MHz	QPSK	1 RB / 0 RB Offset

Note:

1. For radiated emission below 1GHz, select the worst radiated emission (above 1GHz) channel for final testing.
2. For radiated emission above 1GHz, according to 3GPP 36.521 Section 6.6.3.1.4, choose the lowest, 5MHz & highest channel bandwidth for final test.
3. The conducted output power for QPSK, 16QAM and 64QAM, measured value of QPSK is higher than 16QAM and 64QAM mode. Therefore, only EIRP, occupied bandwidth and Peak to average ratio items had been tested under QPSK, 16QAM and 64QAM modes, the other test items were performed under QPSK mode only.

LTE Band 25

EUT Configure Mode	Test item	Available channel	Tested Channel	Channel Bandwidth	Modulation	Mode
-	EIRP	26047 to 26683	26047 (1850.7MHz), 26365 (1882.5MHz), 26683 (1914.3MHz)	1.4MHz	QPSK / 16QAM / 64QAM	1 RB / 2 RB Offset
		26055 to 26675	26055 (1851.5MHz), 26365 (1882.5MHz), 26675 (1913.5MHz)	3MHz	QPSK / 16QAM / 64QAM	1 RB / 14 RB Offset
		26065 to 26665	26065 (1852.5MHz), 26365 (1882.5MHz), 26665 (1912.5MHz)	5MHz	QPSK / 16QAM / 64QAM	1 RB / 12 RB Offset
		26090 to 26640	26090 (1855.0MHz), 26365 (1882.5MHz), 26640 (1910.0MHz)	10MHz	QPSK / 16QAM / 64QAM	1 RB / 0 RB Offset
		26115 to 26615	26115 (1857.5MHz), 26365 (1882.5MHz), 26615 (1907.5MHz)	15MHz	QPSK / 16QAM / 64QAM	1 RB / 74 RB Offset
		26140 to 26590	26140 (1860.0MHz), 26365 (1882.5MHz), 26590 (1905.0MHz)	20MHz	QPSK / 16QAM / 64QAM	1 RB / 0 RB Offset
-	Modulation Characteristics	26065 to 26665	26365 (1882.5MHz)	20MHz	QPSK / 16QAM / 64QAM	100 RB / 0 RB Offset
-	Frequency Stability	26047 to 26683	26047 (1850.7MHz), 26683 (1914.3MHz)	1.4MHz	QPSK	6 RB / 0 RB Offset
		26055 to 26675	26055 (1851.5MHz), 26675 (1913.5MHz)	3MHz	QPSK	15 RB / 0 RB Offset
		26065 to 26665	26065 (1852.5MHz), 26665 (1912.5MHz)	5MHz	QPSK	25 RB / 0 RB Offset
		26090 to 26640	26090 (1855.0MHz), 26640 (1910.0MHz)	10MHz	QPSK	50 RB / 0 RB Offset
		26115 to 26615	26115 (1857.5MHz), 26615 (1907.5MHz)	15MHz	QPSK	75 RB / 0 RB Offset
		26140 to 26590	26140 (1860.0MHz), 26590 (1905.0MHz)	20MHz	QPSK	100 RB / 0 RB Offset
-	Occupied Bandwidth	26047 to 26683	26047 (1850.7MHz), 26365 (1882.5MHz), 26683 (1914.3MHz)	1.4MHz	QPSK / 16QAM / 64QAM	6 RB / 0 RB Offset
		26055 to 26675	26055 (1851.5MHz), 26365 (1882.5MHz), 26675 (1913.5MHz)	3MHz	QPSK / 16QAM / 64QAM	15 RB / 0 RB Offset
		26065 to 26665	26065 (1852.5MHz), 26365 (1882.5MHz), 26665 (1912.5MHz)	5MHz	QPSK / 16QAM / 64QAM	25 RB / 0 RB Offset
		26090 to 26640	26090 (1855.0MHz), 26365 (1882.5MHz), 26640 (1910.0MHz)	10MHz	QPSK / 16QAM / 64QAM	50 RB / 0 RB Offset
		26115 to 26615	26115 (1857.5MHz), 26365 (1882.5MHz), 26615 (1907.5MHz)	15MHz	QPSK / 16QAM / 64QAM	75 RB / 0 RB Offset
		26140 to 26590	26140 (1860.0MHz), 26365 (1882.5MHz), 26590 (1905.0MHz)	20MHz	QPSK / 16QAM / 64QAM	100 RB / 0 RB Offset

EUT Configure Mode	Test item	Available channel	Tested Channel	Channel Bandwidth	Modulation	Mode
-	Band Edge	26047 to 26683	26047 (1850.7MHz), 26683 (1914.3MHz)	1.4MHz	QPSK	1 RB / 0 RB Offset 1 RB / 5 RB Offset 6 RB / 0 RB Offset
		26055 to 26675	26055 (1851.5MHz), 26675 (1913.5MHz)	3MHz	QPSK	1 RB / 0 RB Offset 1 RB / 14 RB Offset 15 RB / 0 RB Offset
		26065 to 26665	26065 (1852.5MHz), 26665 (1912.5MHz)	5MHz	QPSK	1 RB / 0 RB Offset 1 RB / 24 RB Offset 25 RB / 0 RB Offset
		26090 to 26640	26090 (1855.0MHz), 26640 (1910.0MHz)	10MHz	QPSK	1 RB / 0 RB Offset 1 RB / 49 RB Offset 50 RB / 0 RB Offset
		26115 to 26615	26115 (1857.5MHz), 26615 (1907.5MHz)	15MHz	QPSK	1 RB / 0 RB Offset 1 RB / 74 RB Offset 75 RB / 0 RB Offset
		26140 to 26590	26140 (1860.0MHz), 26590 (1905.0MHz)	20MHz	QPSK	1 RB / 0 RB Offset 1 RB / 99 RB Offset 100 RB / 0 RB Offset
-	Peak to Average Ratio	26047 to 26683	26047 (1850.7MHz), 26365 (1882.5MHz), 26683 (1914.3MHz)	1.4MHz	QPSK / 16QAM / 64QAM	1 RB / 2 RB Offset
		26055 to 26675	26055 (1851.5MHz), 26365 (1882.5MHz), 26675 (1913.5MHz)	3MHz	QPSK / 16QAM / 64QAM	1 RB / 14 RB Offset
		26065 to 26665	26065 (1852.5MHz), 26365 (1882.5MHz), 26665 (1912.5MHz)	5MHz	QPSK / 16QAM / 64QAM	1 RB / 12 RB Offset
		26090 to 26640	26090 (1855.0MHz), 26365 (1882.5MHz), 26640 (1910.0MHz)	10MHz	QPSK / 16QAM / 64QAM	1 RB / 0 RB Offset
		26115 to 26615	26115 (1857.5MHz), 26365 (1882.5MHz), 26615 (1907.5MHz)	15MHz	QPSK / 16QAM / 64QAM	1 RB / 74 RB Offset
		26140 to 26590	26140 (1860.0MHz), 26365 (1882.5MHz), 26590 (1905.0MHz)	20MHz	QPSK / 16QAM / 64QAM	1 RB / 0 RB Offset
-	Conducted Emission	26047 to 26683	26047 (1850.7MHz), 26365 (1882.5MHz), 26683 (1914.3MHz)	1.4MHz	QPSK	1 RB / 2 RB Offset
		26055 to 26675	26055 (1851.5MHz), 26365 (1882.5MHz), 26675 (1913.5MHz)	3MHz	QPSK	1 RB / 14 RB Offset
		26065 to 26665	26065 (1852.5MHz), 26365 (1882.5MHz), 26665 (1912.5MHz)	5MHz	QPSK	1 RB / 12 RB Offset
		26090 to 26640	26090 (1855.0MHz), 26365 (1882.5MHz), 26640 (1910.0MHz)	10MHz	QPSK	1 RB / 0 RB Offset
		26115 to 26615	26115 (1857.5MHz), 26365 (1882.5MHz), 26615 (1907.5MHz)	15MHz	QPSK	1 RB / 74 RB Offset
		26140 to 26590	26140 (1860.0MHz), 26365 (1882.5MHz), 26590 (1905.0MHz)	20MHz	QPSK	1 RB / 0 RB Offset
-	Radiated Emission Below 1GHz	26140 to 26590	26140 (1860.0MHz)	20MHz	QPSK	1 RB / 0 RB Offset

EUT Configure Mode	Test item	Available channel	Tested Channel	Channel Bandwidth	Modulation	Mode
-	Radiated Emission Above 1GHz	26047 to 26683	26047 (1850.7MHz), 26365 (1882.5MHz), 26683 (1914.3MHz)	1.4MHz	QPSK	1 RB / 2 RB Offset
		26055 to 26675	26055 (1851.5MHz), 26365 (1882.5MHz), 26675 (1913.5MHz)	3MHz	QPSK	1 RB / 14 RB Offset
		26065 to 26665	26065 (1852.5MHz), 26365 (1882.5MHz), 26665 (1912.5MHz)	5MHz	QPSK	1 RB / 12 RB Offset
		26090 to 26640	26090 (1855.0MHz), 26365 (1882.5MHz), 26640 (1910.0MHz)	10MHz	QPSK	1 RB / 0 RB Offset
		26115 to 26615	26115 (1857.5MHz), 26365 (1882.5MHz), 26615 (1907.5MHz)	15MHz	QPSK	1 RB / 74 RB Offset
		26140 to 26590	26140 (1860.0MHz), 26365 (1882.5MHz), 26590 (1905.0MHz)	20MHz	QPSK	1 RB / 0 RB Offset

Note:

1. For radiated emission below 1GHz, low, mid and high channels were pre-tested in chamber. Low channel was the worst case for all final tests.
2. The conducted output power for QPSK, 16QAM and 64QAM, measured value of QPSK is higher than 16QAM mode. Therefore, Occupied bandwidth and Peak to average ratio items were tested under QPSK, 16QAM and 64QAM modes, and the other test items were tested under QPSK mode only.

Test Condition:

Test Item	Environmental Conditions	Input Power (system)	Tested By
EIRP	25deg. C, 70%RH	5Vdc	James Yang
Modulation Characteristics	24deg. C, 64%RH	5Vdc	James Yang
Frequency Stability	24deg. C, 64%RH	5Vdc	James Yang
Occupied Bandwidth	24deg. C, 64%RH	5Vdc	James Yang
Band Edge	24deg. C, 64%RH	5Vdc	James Yang
Peak To Average Ratio	24deg. C, 64%RH	5Vdc	James Yang
Conducted Emission	24deg. C, 64%RH	5Vdc	James Yang
Radiated Emission	22deg. C, 68%RH 25deg. C, 70%RH	120Vac, 60Hz	Greg Lin Luis Lee

3.4 EUT Operating Conditions

The EUT makes a call to the communication simulator. The communication simulator station system controlled a EUT to export maximum output power under transmission mode and specific channel frequency

3.5 General Description of Applied Standards and References

The EUT is a RF Product. According to the specifications of the manufacturer, it must comply with the requirements of the following standards and References:

Test Standard:

FCC 47 CFR Part 2
FCC 47 CFR Part 24
ANSI/TIA/EIA-603-E 2016
ANSI 63.26-2015

All test items have been performed and recorded as per the above standards.

References Test Guidance:

KDB 971168 D01 Power Meas License Digital Systems v03r01

All test items have been performed as a reference to the above KDB test guidance.

4 Test Types and Results

4.1 Output Power Measurement

4.1.1 Limits of Output Power Measurement

Mobile / Portable station are limited to 2 watts e.r.p.

4.1.2 Test Procedures

EIRP / ERP Measurement:

Conducted Power Measurement:

The EUT was set up for the maximum power with WCDMA and LTE link data modulation and link up with simulator. Set the EUT to transmit under low, middle and high channel and record the power level shown on simulator.

Maximum EIRP

The relevant equation for determining the maximum ERP or EIRP from the measured RF output power is given in Equation as follows:

$$\text{ERP or EIRP} = P_{\text{Meas}} + G_{\text{T}}$$

where

ERP or EIRP effective radiated power or equivalent isotropically radiated power, respectively
(expressed in the same units as P_{Meas} , e.g., dBm or dBW)

P_{Meas} measured transmitter output power or PSD, in dBm or dBW

G_{T} gain of the transmitting antenna, in dBd (ERP) or dBi (EIRP)

4.1.3 Test Setup

Conducted Power Measurement:



For the actual test configuration, please refer to the attached file (Test Setup Photo).

4.1.4 Test Results

Conducted Output Power (dBm)

Band	WCDMA II		
Channel	9262	9400	9538
Frequency	1852.4	1880	1907.6
RMC 12.2K	23.46	23.38	23.52
HSDPA Subtest-1	22.18	22.06	22.15
HSDPA Subtest-2	22.12	22.03	22.18
HSDPA Subtest-3	22.06	22.10	22.13
HSDPA Subtest-4	22.14	22.11	22.16
HSUPA Subtest-1	21.35	21.29	21.38
HSUPA Subtest-2	21.29	21.33	21.35
HSUPA Subtest-3	21.20	21.18	21.26
HSUPA Subtest-4	21.22	21.16	21.25

LTE Band 2						
BW	MCS Index	RB Size	RB Offset	Low	Mid	High
		Channel		18607	18900	19193
		Frequency (MHz)		1850.7	1880	1909.3
1.4M	QPSK	1	0	23.32	23.35	23.24
		1	2	23.42	23.39	23.30
		1	5	23.31	23.27	23.24
		3	0	23.31	23.39	23.26
		3	1	23.37	23.41	23.32
		3	3	23.38	23.40	23.25
		6	0	22.40	22.37	22.26
	16QAM	1	0	22.68	22.47	22.76
		1	2	23.00	22.62	22.87
		1	5	22.88	22.34	22.75
		3	0	22.47	22.49	22.41
		3	1	22.51	22.51	22.41
		3	3	22.46	22.51	22.37
		6	0	21.51	21.30	21.31
	64QAM	1	0	21.49	21.45	21.76
		1	2	21.58	21.62	21.84
		1	5	21.49	21.46	21.77
		3	0	21.41	21.53	21.20
		3	1	21.46	21.48	21.18
		3	3	21.44	21.46	21.21
		6	0	20.35	20.60	20.24

LTE Band 2						
BW	MCS Index	Channel		18615	18900	19185
		Frequency (MHz)		1851.5	1880	1908.5
3M	QPSK	1	0	23.36	23.41	23.29
		1	7	23.39	23.48	23.34
		1	14	23.50	23.47	23.31
		8	0	22.46	22.50	22.37
		8	3	22.47	22.53	22.40
		8	7	22.43	22.51	22.39
		15	0	22.48	22.46	22.35
	16QAM	1	0	22.40	22.45	22.82
		1	7	22.42	22.59	22.85
		1	14	22.48	22.70	22.84
		8	0	21.58	21.53	21.45
		8	3	21.60	21.56	21.42
		8	7	21.55	21.58	21.42
		15	0	21.60	21.47	21.50
	64QAM	1	0	21.88	21.31	21.75
		1	7	21.47	21.49	21.79
		1	14	21.60	21.68	21.90
		8	0	20.58	20.40	20.32
		8	3	20.61	20.44	20.39
		8	7	20.54	20.52	20.37
		15	0	20.47	20.39	20.37

LTE Band 2						
BW	MCS Index	Channel		18625	18900	19175
		Frequency (MHz)		1852.5	1880	1907.5
5M	QPSK	1	0	23.34	23.44	23.27
		1	12	23.46	23.56	23.34
		1	24	23.36	23.52	23.38
		12	0	22.43	22.46	22.44
		12	6	22.56	22.50	22.42
		12	13	22.45	22.55	22.45
		25	0	22.51	22.45	22.38
	16QAM	1	0	22.70	22.50	22.41
		1	12	22.67	22.62	22.40
		1	24	22.71	22.62	22.50
		12	0	21.46	21.51	21.41
		12	6	21.50	21.51	21.39
		12	13	21.53	21.56	21.49
		25	0	21.49	21.42	21.37
	64QAM	1	0	21.48	21.88	21.52
		1	12	21.47	21.95	21.49
		1	24	21.61	21.94	21.64
		12	0	20.44	20.45	20.30
		12	6	20.52	20.47	20.42
		12	13	20.46	20.50	20.35
		25	0	20.36	20.48	20.35

LTE Band 2						
BW	MCS Index	Channel		18650	18900	19150
		Frequency (MHz)		1855	1880	1905
10M	QPSK	1	0	23.22	23.36	23.18
		1	24	23.26	23.32	23.00
		1	49	23.35	23.37	23.27
		25	0	22.42	22.43	22.25
		25	12	22.54	22.38	22.34
		25	25	22.45	22.55	22.38
		50	0	22.40	22.36	22.34
	16QAM	1	0	22.94	22.68	22.63
		1	24	22.95	22.67	22.76
		1	49	23.02	22.71	22.74
		25	0	21.47	21.43	21.16
		25	12	21.55	21.41	21.30
		25	25	21.47	21.41	21.27
		50	0	21.58	21.52	21.28
	64QAM	1	0	21.76	21.62	21.24
		1	24	21.56	21.69	21.69
		1	49	21.60	21.84	21.55
		25	0	20.52	20.42	20.17
		25	12	20.52	20.49	20.25
		25	25	20.35	20.61	20.37
		50	0	20.40	20.39	20.37

LTE Band 2						
BW	MCS Index	Channel		18675	18900	19125
		Frequency (MHz)		1857.5	1880	1902.5
15M	QPSK	1	0	23.55	23.52	23.21
		1	37	23.31	23.51	23.35
		1	74	23.51	23.50	23.30
		36	0	22.49	22.46	22.24
		36	19	22.63	22.58	22.50
		36	39	22.51	22.56	22.52
		75	0	22.62	22.52	22.45
	16QAM	1	0	22.85	23.13	22.34
		1	37	22.75	22.96	22.40
		1	74	22.66	23.00	22.40
		36	0	21.50	21.52	21.46
		36	19	21.63	21.52	21.50
		36	39	21.69	21.62	21.59
		75	0	21.59	21.56	21.55
	64QAM	1	0	21.75	22.25	21.64
		1	37	22.05	21.77	21.78
		1	74	21.76	21.88	21.66
		36	0	20.63	20.63	20.12
		36	19	20.63	20.56	20.50
		36	39	20.69	20.72	20.64
		75	0	20.66	20.66	20.41

LTE Band 2						
BW	MCS Index	Channel		18700	18900	19100
		Frequency (MHz)		1860	1880	1900
20M	QPSK	1	0	23.82	23.57	23.41
		1	50	23.54	23.49	23.10
		1	99	23.51	23.53	23.41
		50	0	22.57	22.65	22.24
		50	25	22.72	22.58	22.29
		50	50	22.66	22.63	22.38
		100	0	22.70	22.51	22.38
	16QAM	1	0	23.18	22.72	22.65
		1	50	23.11	22.91	22.15
		1	99	23.13	22.78	22.64
		50	0	21.70	21.58	21.14
		50	25	21.70	21.43	21.43
		50	50	21.62	21.64	21.56
		100	0	21.64	21.54	21.51
	64QAM	1	0	21.91	21.58	22.06
		1	50	22.05	21.83	21.23
		1	99	21.68	21.58	21.96
		50	0	20.63	20.54	20.40
		50	25	20.73	20.68	20.20
		50	50	20.60	20.65	20.59
		100	0	20.60	20.52	20.51

LTE Band 25						
BW	MCS Index	RB Size	RB Offset	Low	Mid	High
		Channel		26047	26365	26683
		Frequency (MHz)		1850.7	1882.5	1914.3
1.4M	QPSK	1	0	23.29	23.28	22.92
		1	2	23.40	23.28	23.08
		1	5	23.35	23.27	23.02
		3	0	23.33	23.21	22.87
		3	1	23.28	23.39	22.94
		3	3	23.25	23.30	22.95
		6	0	23.30	22.39	21.94
	16QAM	1	0	22.72	22.56	22.51
		1	2	22.91	22.65	22.72
		1	5	23.04	22.73	22.50
		3	0	22.33	22.42	22.10
		3	1	22.37	22.47	22.02
		3	3	22.39	22.48	22.00
		6	0	21.45	21.47	21.00
	64QAM	1	0	21.70	21.27	21.35
		1	2	21.89	21.41	21.42
		1	5	21.71	21.31	21.33
		3	0	21.40	21.39	21.30
		3	1	21.36	21.46	21.40
		3	3	21.31	21.26	21.29
		6	0	20.41	20.28	20.50

LTE Band 25						
BW	MCS Index	Channel		26055	26365	26675
		Frequency (MHz)		1851.5	1882.5	1913.5
3M	QPSK	1	0	23.37	23.29	22.94
		1	7	23.48	23.51	22.42
		1	14	23.60	23.56	22.86
		8	0	22.52	22.42	21.30
		8	3	22.54	22.44	22.10
		8	7	22.52	22.56	21.99
		15	0	22.48	22.46	21.42
	16QAM	1	0	22.36	22.92	21.78
		1	7	22.37	22.92	21.76
		1	14	22.44	22.99	21.73
		8	0	21.65	21.48	20.77
		8	3	21.62	21.46	20.77
		8	7	21.55	21.59	20.51
		15	0	21.45	21.50	20.40
	64QAM	1	0	21.92	21.61	21.73
		1	7	21.88	21.58	21.64
		1	14	21.87	21.64	21.70
		8	0	20.53	20.43	20.40
		8	3	20.54	20.34	20.49
		8	7	20.52	20.44	20.48
		15	0	20.49	20.48	20.35

LTE Band 25						
BW	MCS Index	Channel		26065	26365	26665
		Frequency (MHz)		1852.5	1882.5	1912.5
5M	QPSK	1	0	23.34	23.35	23.20
		1	12	23.37	23.53	22.90
		1	24	23.37	23.43	22.60
		12	0	22.44	22.35	22.25
		12	6	22.42	22.42	22.20
		12	13	22.44	22.42	21.85
		25	0	22.42	22.35	22.20
	16QAM	1	0	22.49	22.79	22.22
		1	12	22.75	22.80	22.10
		1	24	22.79	22.93	21.99
		12	0	21.48	21.36	21.23
		12	6	21.40	21.45	21.08
		12	13	21.43	21.53	21.06
		25	0	21.40	21.38	21.13
	64QAM	1	0	21.90	21.53	21.77
		1	12	21.83	21.73	21.82
		1	24	21.53	21.79	21.82
		12	0	20.37	20.34	20.41
		12	6	20.41	20.39	20.43
		12	13	20.54	20.41	20.41
		25	0	20.47	20.34	20.39

LTE Band 25						
BW	MCS Index	Channel		26090	26365	26640
		Frequency (MHz)		1855	1882.5	1910
10M	QPSK	1	0	23.32	23.20	23.11
		1	24	23.26	23.30	23.01
		1	49	23.12	23.28	23.09
		25	0	22.44	22.28	22.31
		25	12	22.49	22.41	22.39
		25	25	22.37	22.46	22.21
		50	0	22.38	22.39	22.16
	16QAM	1	0	22.88	22.56	22.76
		1	24	22.92	22.76	22.41
		1	49	22.93	22.84	22.30
		25	0	21.50	21.44	21.21
		25	12	21.36	21.28	21.45
		25	25	21.47	21.43	21.42
		50	0	21.56	21.32	21.12
	64QAM	1	0	21.57	21.23	21.63
		1	24	21.74	22.11	21.31
		1	49	21.24	21.67	21.86
		25	0	20.38	20.35	20.36
		25	12	20.45	20.41	20.34
		25	25	20.39	20.48	20.44
		50	0	20.46	20.46	20.34

LTE Band 25						
BW	MCS Index	Channel		26115	26365	26615
		Frequency (MHz)		1857.5	1882.5	1907.5
15M	QPSK	1	0	23.59	23.68	23.26
		1	37	23.44	23.64	23.44
		1	74	23.65	23.72	23.54
		36	0	22.72	22.64	22.51
		36	19	22.76	22.65	22.53
		36	39	22.74	22.66	22.58
		75	0	22.75	22.69	22.56
	16QAM	1	0	22.91	23.20	22.47
		1	37	22.81	23.03	22.42
		1	74	22.90	23.16	22.42
		36	0	21.56	21.66	21.41
		36	19	21.63	21.67	21.61
		36	39	21.64	21.65	21.67
		75	0	21.67	21.58	21.58
	64QAM	1	0	21.55	22.16	21.40
		1	37	21.72	22.05	21.92
		1	74	22.07	21.72	22.01
		36	0	20.64	20.60	20.44
		36	19	20.62	20.60	20.54
		36	39	20.54	20.68	20.62
		75	0	20.68	20.47	20.53

LTE Band 25						
BW	MCS Index	Channel		26140	26365	26590
		Frequency (MHz)		1860	1882.5	1905
20M	QPSK	1	0	23.36	23.42	23.35
		1	50	23.24	23.38	23.29
		1	99	23.28	23.30	23.01
		50	0	22.39	22.29	21.97
		50	25	22.25	22.33	22.22
		50	50	22.16	22.29	22.18
		100	0	22.30	22.22	22.22
	16QAM	1	0	22.81	22.63	21.96
		1	50	22.65	22.43	22.21
		1	99	22.66	22.61	22.00
		50	0	21.37	21.39	21.03
		50	25	21.36	21.35	21.23
		50	50	21.30	21.34	21.12
		100	0	21.38	21.24	21.16
	64QAM	1	0	21.58	21.68	21.72
		1	50	21.70	21.64	21.08
		1	99	21.74	21.88	21.79
		50	0	20.56	20.56	20.24
		50	25	20.58	20.60	20.37
		50	50	20.68	20.63	20.63
		100	0	20.63	20.53	20.42

EIRP Power (dBm)

Band	WCDMA II		
	9262	9400	9538
Channel	1852.4	1880	1907.6
Frequency	27.73	27.65	27.79
RMC 12.2K	26.45	26.33	26.42
HSDPA Subtest-1	26.39	26.30	26.45
HSDPA Subtest-2	26.33	26.37	26.40
HSDPA Subtest-3	26.41	26.38	26.43
HSDPA Subtest-4	25.62	25.56	25.65
HSUPA Subtest-1	25.56	25.60	25.62
HSUPA Subtest-2	25.47	25.45	25.53
HSUPA Subtest-3	25.49	25.43	25.52
HSUPA Subtest-4			

*EIRP = Conducted + antenna gain (4.27dBi)

LTE Band 2						
BW	MCS Index	RB Size	RB Offset	Low	Mid	High
		Channel		18607	18900	19193
		Frequency (MHz)		1850.7	1880	1909.3
1.4M	QPSK	1	0	27.59	27.62	27.51
		1	2	27.69	27.66	27.57
		1	5	27.58	27.54	27.51
		3	0	27.58	27.66	27.53
		3	1	27.64	27.68	27.59
		3	3	27.65	27.67	27.52
		6	0	26.67	26.64	26.53
	16QAM	1	0	26.95	26.74	27.03
		1	2	27.27	26.89	27.14
		1	5	27.15	26.61	27.02
		3	0	26.74	26.76	26.68
		3	1	26.78	26.78	26.68
		3	3	26.73	26.78	26.64
		6	0	25.78	25.57	25.58
	64QAM	1	0	25.76	25.72	26.03
		1	2	25.85	25.89	26.11
		1	5	25.76	25.73	26.04
		3	0	25.68	25.80	25.47
		3	1	25.73	25.75	25.45
		3	3	25.71	25.73	25.48
		6	0	24.62	24.87	24.51

*EIRP = Conducted + antenna gain (4.27dBi)

LTE Band 2						
BW	MCS Index	Channel		18615	18900	19185
		Frequency (MHz)		1851.5	1880	1908.5
3M	QPSK	1	0	27.63	27.68	27.56
		1	7	27.66	27.75	27.61
		1	14	27.77	27.74	27.58
		8	0	26.73	26.77	26.64
		8	3	26.74	26.80	26.67
		8	7	26.70	26.78	26.66
		15	0	26.75	26.73	26.62
	16QAM	1	0	26.67	26.72	27.09
		1	7	26.69	26.86	27.12
		1	14	26.75	26.97	27.11
		8	0	25.85	25.80	25.72
		8	3	25.87	25.83	25.69
		8	7	25.82	25.85	25.69
		15	0	25.87	25.74	25.77
	64QAM	1	0	26.15	25.58	26.02
		1	7	25.74	25.76	26.06
		1	14	25.87	25.95	26.17
		8	0	24.85	24.67	24.59
		8	3	24.88	24.71	24.66
		8	7	24.81	24.79	24.64
		15	0	24.74	24.66	24.64

*EIRP = Conducted + antenna gain (4.27dBi)

LTE Band 2						
BW	MCS Index	Channel		18625	18900	19175
		Frequency (MHz)		1852.5	1880	1907.5
5M	QPSK	1	0	27.61	27.71	27.54
		1	12	27.73	27.83	27.61
		1	24	27.63	27.79	27.65
		12	0	26.70	26.73	26.71
		12	6	26.83	26.77	26.69
		12	13	26.72	26.82	26.72
		25	0	26.78	26.72	26.65
	16QAM	1	0	26.97	26.77	26.68
		1	12	26.94	26.89	26.67
		1	24	26.98	26.89	26.77
		12	0	25.73	25.78	25.68
		12	6	25.77	25.78	25.66
		12	13	25.80	25.83	25.76
		25	0	25.76	25.69	25.64
	64QAM	1	0	25.75	26.15	25.79
		1	12	25.74	26.22	25.76
		1	24	25.88	26.21	25.91
		12	0	24.71	24.72	24.57
		12	6	24.79	24.74	24.69
		12	13	24.73	24.77	24.62
		25	0	24.63	24.75	24.62

*EIRP = Conducted + antenna gain (4.27dBi)

LTE Band 2						
BW	MCS Index	Channel		18650	18900	19150
		Frequency (MHz)		1855	1880	1905
10M	QPSK	1	0	27.49	27.63	27.45
		1	24	27.53	27.59	27.27
		1	49	27.62	27.64	27.54
		25	0	26.69	26.70	26.52
		25	12	26.81	26.65	26.61
		25	25	26.72	26.82	26.65
		50	0	26.67	26.63	26.61
	16QAM	1	0	27.21	26.95	26.90
		1	24	27.22	26.94	27.03
		1	49	27.29	26.98	27.01
		25	0	25.74	25.70	25.43
		25	12	25.82	25.68	25.57
		25	25	25.74	25.68	25.54
		50	0	25.85	25.79	25.55
	64QAM	1	0	26.03	25.89	25.51
		1	24	25.83	25.96	25.96
		1	49	25.87	26.11	25.82
		25	0	24.79	24.69	24.44
		25	12	24.79	24.76	24.52
		25	25	24.62	24.88	24.64
		50	0	24.67	24.66	24.64

*EIRP = Conducted + antenna gain (4.27dBi)

LTE Band 2						
BW	MCS Index	Channel		18675	18900	19125
		Frequency (MHz)		1857.5	1880	1902.5
15M	QPSK	1	0	27.82	27.79	27.48
		1	37	27.58	27.78	27.62
		1	74	27.78	27.77	27.57
		36	0	26.76	26.73	26.51
		36	19	26.90	26.85	26.77
		36	39	26.78	26.83	26.79
		75	0	26.89	26.79	26.72
	16QAM	1	0	27.12	27.40	26.61
		1	37	27.02	27.23	26.67
		1	74	26.93	27.27	26.67
		36	0	25.77	25.79	25.73
		36	19	25.90	25.79	25.77
		36	39	25.96	25.89	25.86
		75	0	25.86	25.83	25.82
	64QAM	1	0	26.02	26.52	25.91
		1	37	26.32	26.04	26.05
		1	74	26.03	26.15	25.93
		36	0	24.90	24.90	24.39
		36	19	24.90	24.83	24.77
		36	39	24.96	24.99	24.91
		75	0	24.93	24.93	24.68

*EIRP = Conducted + antenna gain (4.27dBi)

LTE Band 2						
BW	MCS Index	Channel		18700	18900	19100
		Frequency (MHz)		1860	1880	1900
20M	QPSK	1	0	28.09	27.84	27.68
		1	50	27.81	27.76	27.37
		1	99	27.78	27.80	27.68
		50	0	26.84	26.92	26.51
		50	25	26.99	26.85	26.56
		50	50	26.93	26.90	26.65
		100	0	26.97	26.78	26.65
	16QAM	1	0	27.45	26.99	26.92
		1	50	27.38	27.18	26.42
		1	99	27.40	27.05	26.91
		50	0	25.97	25.85	25.41
		50	25	25.97	25.70	25.70
		50	50	25.89	25.91	25.83
		100	0	25.91	25.81	25.78
	64QAM	1	0	26.18	25.85	26.33
		1	50	26.32	26.10	25.50
		1	99	25.95	25.85	26.23
		50	0	24.90	24.81	24.67
		50	25	25.00	24.95	24.47
		50	50	24.87	24.92	24.86
		100	0	24.87	24.79	24.78

*EIRP = Conducted + antenna gain (4.27dBi)

LTE Band 25						
BW	MCS Index	RB Size	RB Offset	Low	Mid	High
		Channel		26047	26365	26683
		Frequency (MHz)		1850.7	1882.5	1914.3
1.4M	QPSK	1	0	27.56	27.55	27.19
		1	2	27.67	27.55	27.35
		1	5	27.62	27.54	27.29
		3	0	27.60	27.48	27.14
		3	1	27.55	27.66	27.21
		3	3	27.52	27.57	27.22
		6	0	27.57	26.66	26.21
	16QAM	1	0	26.99	26.83	26.78
		1	2	27.18	26.92	26.99
		1	5	27.31	27.00	26.77
		3	0	26.60	26.69	26.37
		3	1	26.64	26.74	26.29
		3	3	26.66	26.75	26.27
		6	0	25.72	25.74	25.27
	64QAM	1	0	25.97	25.54	25.62
		1	2	26.16	25.68	25.69
		1	5	25.98	25.58	25.60
		3	0	25.67	25.66	25.57
		3	1	25.63	25.73	25.67
		3	3	25.58	25.53	25.56
		6	0	24.68	24.55	24.77

*EIRP = Conducted + antenna gain (4.27dBi)

LTE Band 25						
BW	MCS Index	Channel		26055	26365	26675
		Frequency (MHz)		1851.5	1882.5	1913.5
3M	QPSK	1	0	27.64	27.56	27.21
		1	7	27.75	27.78	26.69
		1	14	27.87	27.83	27.13
		8	0	26.79	26.69	25.57
		8	3	26.81	26.71	26.37
		8	7	26.79	26.83	26.26
		15	0	26.75	26.73	25.69
	16QAM	1	0	26.63	27.19	26.05
		1	7	26.64	27.19	26.03
		1	14	26.71	27.26	26.00
		8	0	25.92	25.75	25.04
		8	3	25.89	25.73	25.04
		8	7	25.82	25.86	24.78
		15	0	25.72	25.77	24.67
	64QAM	1	0	26.19	25.88	26.00
		1	7	26.15	25.85	25.91
		1	14	26.14	25.91	25.97
		8	0	24.80	24.70	24.67
		8	3	24.81	24.61	24.76
		8	7	24.79	24.71	24.75
		15	0	24.76	24.75	24.62

*EIRP = Conducted + antenna gain (4.27dBi)

LTE Band 25						
BW	MCS Index	Channel		26065	26365	26665
		Frequency (MHz)		1852.5	1882.5	1912.5
5M	QPSK	1	0	27.61	27.62	27.47
		1	12	27.64	27.80	27.17
		1	24	27.64	27.70	26.87
		12	0	26.71	26.62	26.52
		12	6	26.69	26.69	26.47
		12	13	26.71	26.69	26.12
		25	0	26.69	26.62	26.47
	16QAM	1	0	26.76	27.06	26.49
		1	12	27.02	27.07	26.37
		1	24	27.06	27.20	26.26
		12	0	25.75	25.63	25.50
		12	6	25.67	25.72	25.35
		12	13	25.70	25.80	25.33
		25	0	25.67	25.65	25.40
	64QAM	1	0	26.17	25.80	26.04
		1	12	26.10	26.00	26.09
		1	24	25.80	26.06	26.09
		12	0	24.64	24.61	24.68
		12	6	24.68	24.66	24.70
		12	13	24.81	24.68	24.68
		25	0	24.74	24.61	24.66

*EIRP = Conducted + antenna gain (4.27dBi)

LTE Band 25						
BW	MCS Index	Channel		26090	26365	26640
		Frequency (MHz)		1855	1882.5	1910
10M	QPSK	1	0	27.59	27.47	27.38
		1	24	27.53	27.57	27.28
		1	49	27.39	27.55	27.36
		25	0	26.71	26.55	26.58
		25	12	26.76	26.68	26.66
		25	25	26.64	26.73	26.48
		50	0	26.65	26.66	26.43
	16QAM	1	0	27.15	26.83	27.03
		1	24	27.19	27.03	26.68
		1	49	27.20	27.11	26.57
		25	0	25.77	25.71	25.48
		25	12	25.63	25.55	25.72
		25	25	25.74	25.70	25.69
		50	0	25.83	25.59	25.39
	64QAM	1	0	25.84	25.50	25.90
		1	24	26.01	26.38	25.58
		1	49	25.51	25.94	26.13
		25	0	24.65	24.62	24.63
		25	12	24.72	24.68	24.61
		25	25	24.66	24.75	24.71
		50	0	24.73	24.73	24.61

*EIRP = Conducted + antenna gain (4.27dBi)

LTE Band 25						
BW	MCS Index	Channel		26115	26365	26615
		Frequency (MHz)		1857.5	1882.5	1907.5
15M	QPSK	1	0	27.86	27.95	27.53
		1	37	27.71	27.91	27.71
		1	74	27.92	27.99	27.81
		36	0	26.99	26.91	26.78
		36	19	27.03	26.92	26.80
		36	39	27.01	26.93	26.85
		75	0	27.02	26.96	26.83
	16QAM	1	0	27.18	27.47	26.74
		1	37	27.08	27.30	26.69
		1	74	27.17	27.43	26.69
		36	0	25.83	25.93	25.68
		36	19	25.90	25.94	25.88
		36	39	25.91	25.92	25.94
		75	0	25.94	25.85	25.85
	64QAM	1	0	25.82	26.43	25.67
		1	37	25.99	26.32	26.19
		1	74	26.34	25.99	26.28
		36	0	24.91	24.87	24.71
		36	19	24.89	24.87	24.81
		36	39	24.81	24.95	24.89
		75	0	24.95	24.74	24.80

*EIRP = Conducted + antenna gain (4.27dBi)

LTE Band 25						
BW	MCS Index	Channel		26140	26365	26590
		Frequency (MHz)		1860	1882.5	1905
20M	QPSK	1	0	27.63	27.69	27.62
		1	50	27.51	27.65	27.56
		1	99	27.55	27.57	27.28
		50	0	26.66	26.56	26.24
		50	25	26.52	26.60	26.49
		50	50	26.43	26.56	26.45
		100	0	26.57	26.49	26.49
	16QAM	1	0	27.08	26.90	26.23
		1	50	26.92	26.70	26.48
		1	99	26.93	26.88	26.27
		50	0	25.64	25.66	25.30
		50	25	25.63	25.62	25.50
		50	50	25.57	25.61	25.39
		100	0	25.65	25.51	25.43
	64QAM	1	0	25.85	25.95	25.99
		1	50	25.97	25.91	25.35
		1	99	26.01	26.15	26.06
		50	0	24.83	24.83	24.51
		50	25	24.85	24.87	24.64
		50	50	24.95	24.90	24.90
		100	0	24.90	24.80	24.69

*EIRP = Conducted + antenna gain (4.27dBi)

4.2 Modulation Characteristics Measurement

4.2.1 Limits of Modulation Characteristics

N/A

4.2.2 Test Procedure

Connect the EUT to Communication Simulator via the antenna connector, The frequency band is set as EUT supported Modulation and Channels, the EUT output is matched with 50 ohm load, the waveform quality and constellation of the EUT was tested.

4.2.3 Test Setup



4.2.4 Test Results

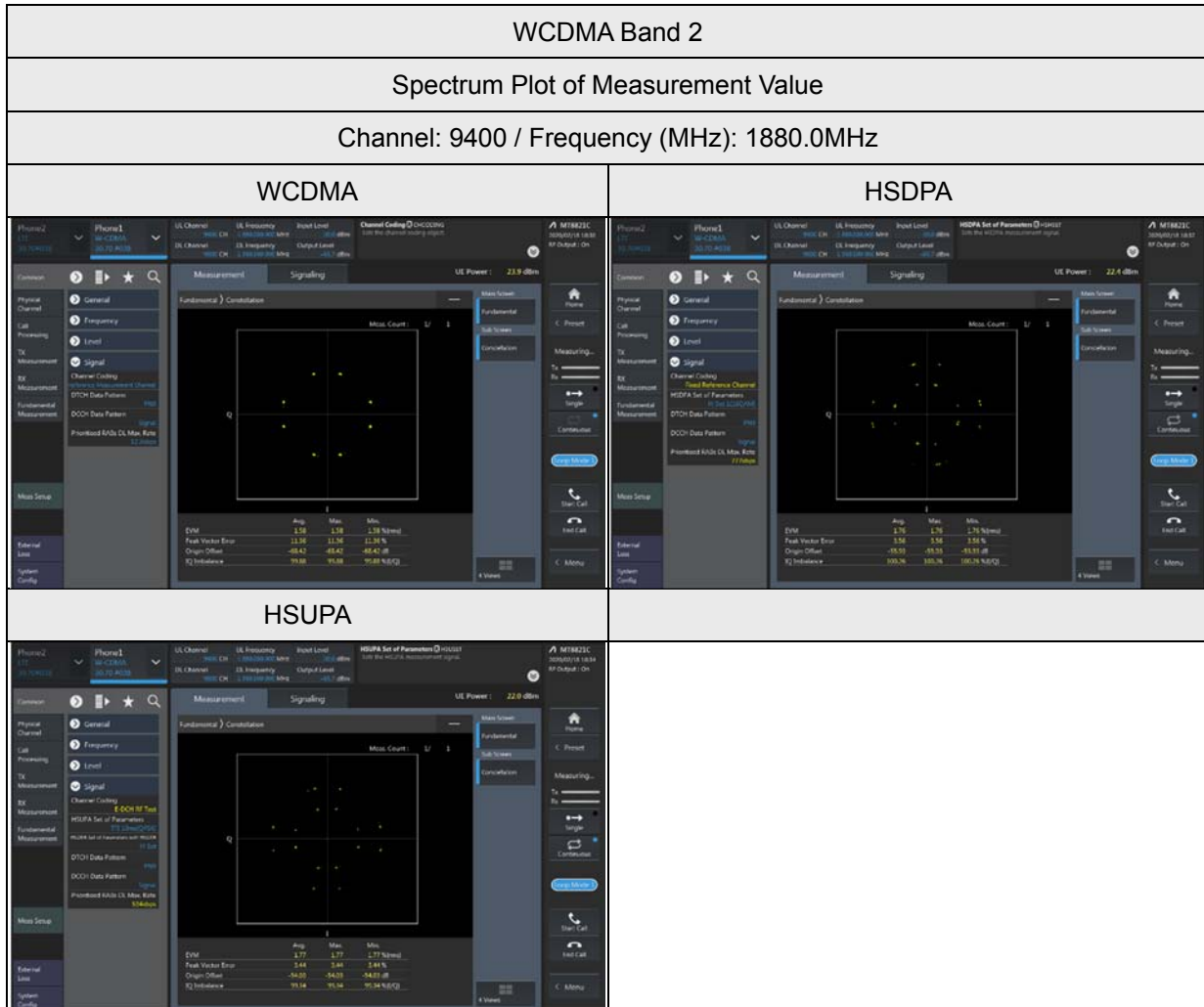

LTE Band 2

Spectrum Plot of Measurement Value

Channel: 18900 / Frequency (MHz): 1880.0MHz

QPSK

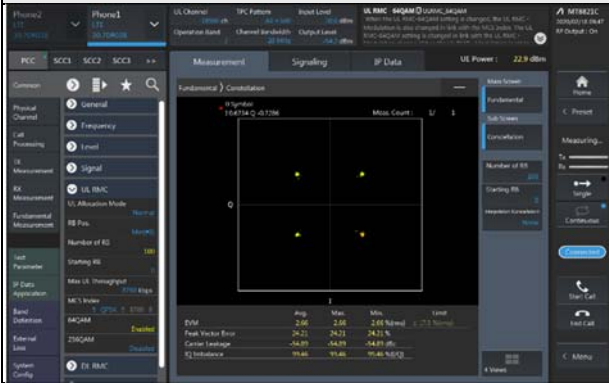

16QAM

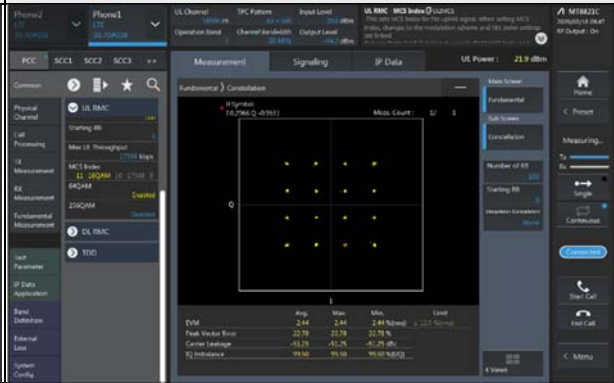

64QAM

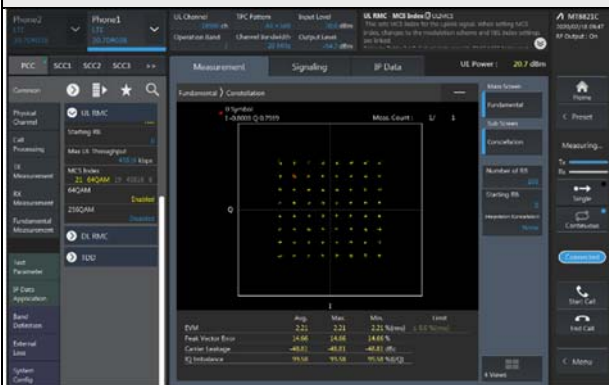

LTE Band 25

Spectrum Plot of Measurement Value

Channel: 26365 / Frequency (MHz): 1882.5MHz

QPSK

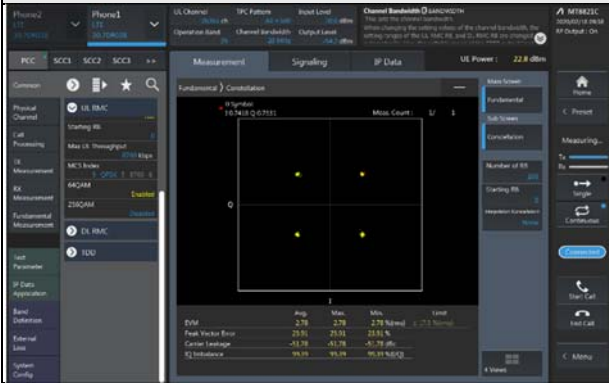

16QAM

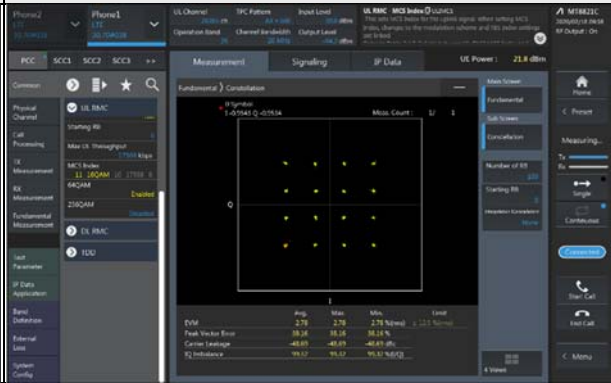

64QAM

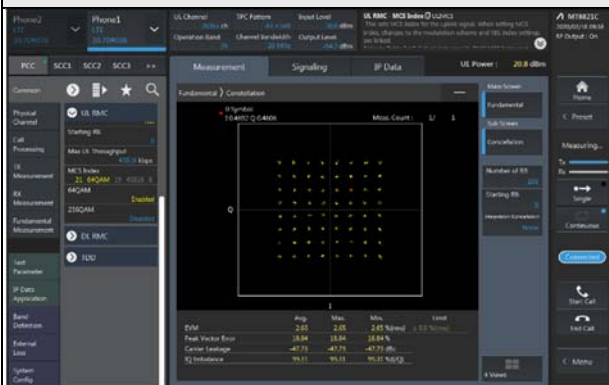

4.3 Frequency Stability Measurement

4.3.1 Limits of Frequency Stability Measurement

1.5 ppm is for base and fixed station. 2.5 ppm is for mobile station.

4.3.2 Test Procedure

- Device is placed at the oven room. The oven room could control the temperatures and humidity. Power warm up is at least 15 min and power applied should perform before recording frequency error.
- EUT is connected the external power supply to control the DC input power. The test voltage range is from minimum to maximum working voltage. Each step shall be record the frequency error rate.
- The temperature range step is 10 degrees in this test items. All temperature levels shall be hold the ± 0.5 °C during the measurement testing. The each temperature step shall be at least 0.5 hours, consider the EUT could be test under the stability condition.

Note: The frequency error was recorded frequency error from the communication simulator.

4.3.3 Conducted Setup

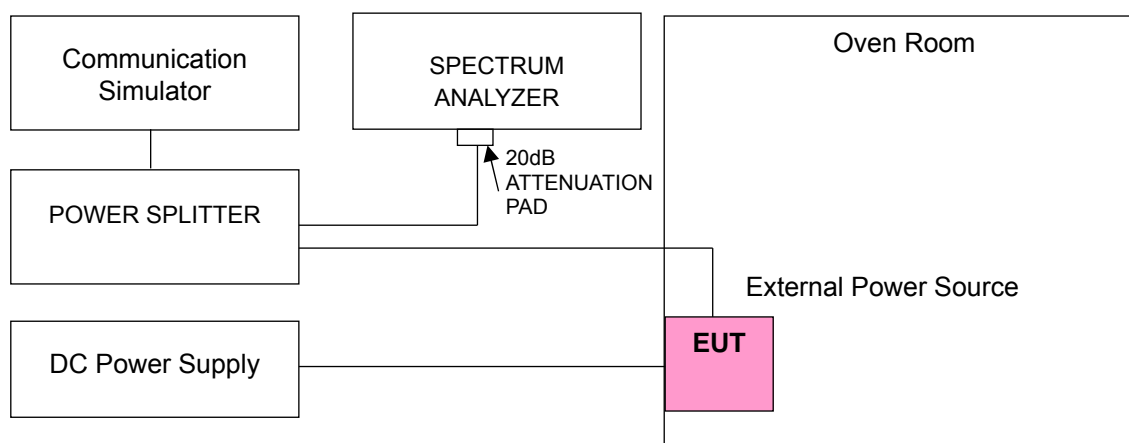

4.3.4 Test Results

Frequency Error vs. Voltage

Voltage (Volts)	WCDMA Band 2			
	Low Channel		High Channel	
	Frequency (MHz)	Frequency Error (ppm)	Frequency (MHz)	Frequency Error (ppm)
4.25	1852.400004	0.002	1907.600002	0.001
5	1852.400002	0.001	1907.600003	0.002
5.75	1852.400003	0.002	1907.600002	0.001

Note: The applicant defined the normal working voltage is from 4.25Vdc to 5.75Vdc.

Frequency Error vs. Temperature

Temp. (°C)	WCDMA Band 2			
	Low Channel		High Channel	
	Frequency (MHz)	Frequency Error (ppm)	Frequency (MHz)	Frequency Error (ppm)
-30	1852.400004	0.002	1907.600002	0.001
-20	1852.400003	0.002	1907.600003	0.001
-10	1852.400001	0.001	1907.600001	0.001
0	1852.400003	0.002	1907.600003	0.001
10	1852.400004	0.002	1907.600003	0.002
20	1852.399998	-0.001	1907.599998	-0.001
30	1852.399997	-0.002	1907.599997	-0.002
40	1852.399998	-0.001	1907.599996	-0.002
50	1852.399996	-0.002	1907.599998	-0.001

Frequency Error vs. Voltage

Voltage (Volts)	LTE Band 2			
	Channel Bandwidth: 1.4 MHz			
	Low Channel		High Channel	
	Frequency (MHz)	Frequency Error (ppm)	Frequency (MHz)	Frequency Error (ppm)
4.25	1850.700001	0.001	1909.300000	0.001
5	1850.700003	0.002	1909.300001	0.001
5.75	1850.700002	0.001	1909.300003	0.002

Note: The applicant defined the normal working voltage is from 4.25Vdc to 5.75Vdc.

Frequency Error vs. Temperature

Temp. (°C)	LTE Band 2			
	Channel Bandwidth: 1.4 MHz			
	Low Channel		High Channel	
	Frequency (MHz)	Frequency Error (ppm)	Frequency (MHz)	Frequency Error (ppm)
-30	1850.700002	0.001	1909.300003	0.002
-20	1850.700002	0.001	1909.300002	0.001
-10	1850.700003	0.002	1909.300002	0.001
0	1850.700001	0.001	1909.300002	0.001
10	1850.700002	0.001	1909.300004	0.002
20	1850.699997	-0.002	1909.299997	-0.002
30	1850.699998	-0.001	1909.299996	-0.002
40	1850.699998	-0.001	1909.299997	-0.002
50	1850.699998	-0.001	1909.299998	-0.001

Frequency Error vs. Voltage

Voltage (Volts)	LTE Band 2			
	Channel Bandwidth: 3 MHz			
	Low Channel		High Channel	
	Frequency (MHz)	Frequency Error (ppm)	Frequency (MHz)	Frequency Error (ppm)
4.25	1851.500003	0.002	1907.500002	0.001
5	1851.500003	0.002	1907.500002	0.001
5.75	1851.500002	0.001	1907.500004	0.002

Note: The applicant defined the normal working voltage is from 4.25Vdc to 5.75Vdc.

Frequency Error vs. Temperature

Temp. (°C)	LTE Band 2			
	Channel Bandwidth: 3 MHz			
	Low Channel		High Channel	
	Frequency (MHz)	Frequency Error (ppm)	Frequency (MHz)	Frequency Error (ppm)
-30	1851.500003	0.002	1907.500003	0.001
-20	1851.500001	0.001	1907.500002	0.001
-10	1851.500002	0.001	1907.500002	0.001
0	1851.500001	0.001	1907.500004	0.002
10	1851.500002	0.001	1907.500001	0.001
20	1851.499996	-0.002	1907.499997	-0.002
30	1851.499998	-0.001	1907.499998	-0.001
40	1851.499998	-0.001	1907.499998	-0.001
50	1851.499997	-0.002	1907.499997	-0.002

Frequency Error vs. Voltage

Voltage (Volts)	LTE Band 2			
	Channel Bandwidth: 5 MHz			
	Low Channel		High Channel	
	Frequency (MHz)	Frequency Error (ppm)	Frequency (MHz)	Frequency Error (ppm)
4.25	1852.500002	0.001	1907.500002	0.001
5	1852.500002	0.001	1907.500001	0.001
5.75	1852.500002	0.001	1907.500002	0.001

Note: The applicant defined the normal working voltage is from 4.25Vdc to 5.75Vdc.

Frequency Error vs. Temperature

Temp. (°C)	LTE Band 2			
	Channel Bandwidth: 5 MHz			
	Low Channel		High Channel	
	Frequency (MHz)	Frequency Error (ppm)	Frequency (MHz)	Frequency Error (ppm)
-30	1852.500001	0.001	1907.500002	0.001
-20	1852.500001	0.001	1907.500001	0.001
-10	1852.500003	0.002	1907.500002	0.001
0	1852.500003	0.002	1907.500002	0.001
10	1852.500001	0.001	1907.500004	0.002
20	1852.499998	-0.001	1907.499999	-0.001
30	1852.499996	-0.002	1907.499998	-0.001
40	1852.499997	-0.002	1907.499997	-0.001
50	1852.499998	-0.001	1907.499997	-0.002

Frequency Error vs. Voltage

Voltage (Volts)	LTE Band 2			
	Channel Bandwidth: 10 MHz			
	Low Channel		High Channel	
	Frequency (MHz)	Frequency Error (ppm)	Frequency (MHz)	Frequency Error (ppm)
4.25	1855.000003	0.001	1905.000003	0.002
5	1855.000004	0.002	1905.000003	0.001
5.75	1855.000003	0.002	1905.000002	0.001

Note: The applicant defined the normal working voltage is from 4.25Vdc to 5.75Vdc.

Frequency Error vs. Temperature

Temp. (°C)	LTE Band 2			
	Channel Bandwidth: 10 MHz			
	Low Channel		High Channel	
	Frequency (MHz)	Frequency Error (ppm)	Frequency (MHz)	Frequency Error (ppm)
-30	1855.000002	0.001	1905.000002	0.001
-20	1855.000003	0.002	1905.000002	0.001
-10	1855.000004	0.002	1905.000004	0.002
0	1855.000002	0.001	1905.000004	0.002
10	1855.000002	0.001	1905.000002	0.001
20	1854.999998	-0.001	1904.999998	-0.001
30	1854.999999	-0.001	1904.999998	-0.001
40	1854.999998	-0.001	1904.999997	-0.002
50	1854.999998	-0.001	1904.999996	-0.002

Frequency Error vs. Voltage

Voltage (Volts)	LTE Band 2			
	Channel Bandwidth: 15 MHz			
	Low Channel		High Channel	
	Frequency (MHz)	Frequency Error (ppm)	Frequency (MHz)	Frequency Error (ppm)
4.25	1857.500004	0.002	1902.500003	0.002
5	1857.500002	0.001	1902.500002	0.001
5.75	1857.500002	0.001	1902.500002	0.001

Note: The applicant defined the normal working voltage is from 4.25Vdc to 5.75Vdc.

Frequency Error vs. Temperature

Temp. (°C)	LTE Band 2			
	Channel Bandwidth: 15 MHz			
	Low Channel		High Channel	
	Frequency (MHz)	Frequency Error (ppm)	Frequency (MHz)	Frequency Error (ppm)
-30	1857.500002	0.001	1902.500004	0.002
-20	1857.500001	0.001	1902.500001	0.001
-10	1857.500002	0.001	1902.500001	0.001
0	1857.500003	0.001	1902.500003	0.002
10	1857.500002	0.001	1902.500002	0.001
20	1857.499999	-0.001	1902.499998	-0.001
30	1857.499998	-0.001	1902.499999	-0.001
40	1857.499999	-0.001	1902.499998	-0.001
50	1857.499997	-0.002	1902.499998	-0.001

Frequency Error vs. Voltage

Voltage (Volts)	LTE Band 2			
	Channel Bandwidth: 20 MHz			
	Low Channel		High Channel	
	Frequency (MHz)	Frequency Error (ppm)	Frequency (MHz)	Frequency Error (ppm)
4.25	1860.000002	0.001	1900.000003	0.002
5	1860.000004	0.002	1900.000003	0.002
5.75	1860.000003	0.001	1900.000003	0.001

Note: The applicant defined the normal working voltage is from 4.25Vdc to 5.75Vdc.

Frequency Error vs. Temperature

Temp. (°C)	LTE Band 2			
	Channel Bandwidth: 20 MHz			
	Low Channel		High Channel	
	Frequency (MHz)	Frequency Error (ppm)	Frequency (MHz)	Frequency Error (ppm)
-30	1860.000003	0.001	1900.000004	0.002
-20	1860.000003	0.001	1900.000004	0.002
-10	1860.000002	0.001	1900.000001	0.001
0	1860.000003	0.001	1900.000003	0.001
10	1860.000002	0.001	1900.000001	0.001
20	1859.999998	-0.001	1899.999998	-0.001
30	1859.999998	-0.001	1899.999997	-0.001
40	1859.999997	-0.002	1899.999996	-0.002
50	1859.999997	-0.002	1899.999997	-0.001

Frequency Error vs. Voltage

Voltage (Volts)	LTE Band 25			
	Channel Bandwidth: 1.4 MHz			
	Low Channel		High Channel	
	Frequency (MHz)	Frequency Error (ppm)	Frequency (MHz)	Frequency Error (ppm)
4.25	1850.700002	0.001	1914.300001	0.001
5	1850.700004	0.002	1914.300004	0.002
5.75	1850.700003	0.002	1914.300003	0.002

Note: The applicant defined the normal working voltage is from 4.25Vdc to 5.75Vdc.

Frequency Error vs. Temperature

Temp. (°C)	LTE Band 25			
	Channel Bandwidth: 1.4 MHz			
	Low Channel		High Channel	
	Frequency (MHz)	Frequency Error (ppm)	Frequency (MHz)	Frequency Error (ppm)
-30	1850.700004	0.002	1914.300002	0.001
-20	1850.700002	0.001	1914.300003	0.001
-10	1850.700004	0.002	1914.300004	0.002
0	1850.700001	0.001	1914.300003	0.001
10	1850.700003	0.002	1914.300002	0.001
20	1850.699998	-0.001	1914.299998	-0.001
30	1850.699997	-0.002	1914.299996	-0.002
40	1850.699998	-0.001	1914.299997	-0.002
50	1850.699998	-0.001	1914.299997	-0.002

Frequency Error vs. Voltage

Voltage (Volts)	LTE Band 25			
	Channel Bandwidth: 3 MHz			
	Low Channel		High Channel	
	Frequency (MHz)	Frequency Error (ppm)	Frequency (MHz)	Frequency Error (ppm)
4.25	1851.500002	0.001	1913.500002	0.001
5	1851.500004	0.002	1913.500004	0.002
5.75	1851.500004	0.002	1913.500003	0.002

Note: The applicant defined the normal working voltage is from 4.25Vdc to 5.75Vdc.

Frequency Error vs. Temperature

Temp. (°C)	LTE Band 25			
	Channel Bandwidth: 3 MHz			
	Low Channel		High Channel	
	Frequency (MHz)	Frequency Error (ppm)	Frequency (MHz)	Frequency Error (ppm)
-30	1851.500002	0.001	1913.500003	0.002
-20	1851.500002	0.001	1913.500003	0.002
-10	1851.500003	0.001	1913.500004	0.002
0	1851.500004	0.002	1913.500002	0.001
10	1851.500001	0.001	1913.500003	0.002
20	1851.499999	-0.001	1913.499998	-0.001
30	1851.499997	-0.002	1913.499999	-0.001
40	1851.499998	-0.001	1913.499999	-0.001
50	1851.499996	-0.002	1913.499998	-0.001

Frequency Error vs. Voltage

Voltage (Volts)	LTE Band 25			
	Channel Bandwidth: 5 MHz			
	Low Channel		High Channel	
	Frequency (MHz)	Frequency Error (ppm)	Frequency (MHz)	Frequency Error (ppm)
4.25	1852.500003	0.002	1912.500003	0.002
5	1852.500001	0.001	1912.500002	0.001
5.75	1852.500003	0.002	1912.500003	0.002

Note: The applicant defined the normal working voltage is from 4.25Vdc to 5.75Vdc.

Frequency Error vs. Temperature

Temp. (°C)	LTE Band 25			
	Channel Bandwidth: 5 MHz			
	Low Channel		High Channel	
	Frequency (MHz)	Frequency Error (ppm)	Frequency (MHz)	Frequency Error (ppm)
-30	1852.500002	0.001	1912.500003	0.002
-20	1852.500003	0.001	1912.500002	0.001
-10	1852.500001	0.001	1912.500002	0.001
0	1852.500003	0.002	1912.500001	0.001
10	1852.500002	0.001	1912.500002	0.001
20	1852.499997	-0.001	1912.499997	-0.002
30	1852.499996	-0.002	1912.499998	-0.001
40	1852.499998	-0.001	1912.499998	-0.001
50	1852.499997	-0.002	1912.499996	-0.002

Frequency Error vs. Voltage

Voltage (Volts)	LTE Band 25			
	Channel Bandwidth: 10 MHz			
	Low Channel		High Channel	
	Frequency (MHz)	Frequency Error (ppm)	Frequency (MHz)	Frequency Error (ppm)
4.25	1855.000004	0.002	1910.000001	0.001
5	1855.000002	0.001	1910.000002	0.001
5.75	1855.000002	0.001	1910.000002	0.001

Note: The applicant defined the normal working voltage is from 4.25Vdc to 5.75Vdc.

Frequency Error vs. Temperature

Temp. (°C)	LTE Band 25			
	Channel Bandwidth: 10 MHz			
	Low Channel		High Channel	
	Frequency (MHz)	Frequency Error (ppm)	Frequency (MHz)	Frequency Error (ppm)
-30	1855.000002	0.001	1910.000004	0.002
-20	1855.000001	0.001	1910.000003	0.002
-10	1855.000001	0.001	1910.000004	0.002
0	1855.000003	0.002	1910.000002	0.001
10	1855.000002	0.001	1910.000003	0.002
20	1854.999996	-0.002	1909.999996	-0.002
30	1854.999996	-0.002	1909.999998	-0.001
40	1854.999999	-0.001	1909.999997	-0.001
50	1854.999998	-0.001	1909.999997	-0.002

Frequency Error vs. Voltage

Voltage (Volts)	LTE Band 25			
	Channel Bandwidth: 15 MHz			
	Low Channel		High Channel	
	Frequency (MHz)	Frequency Error (ppm)	Frequency (MHz)	Frequency Error (ppm)
4.25	1857.500004	0.002	1907.500002	0.001
5	1857.500001	0.001	1907.500002	0.001
5.75	1857.500003	0.002	1907.500004	0.002

Note: The applicant defined the normal working voltage is from 4.25Vdc to 5.75Vdc.

Frequency Error vs. Temperature

Temp. (°C)	LTE Band 25			
	Channel Bandwidth: 15 MHz			
	Low Channel		High Channel	
	Frequency (MHz)	Frequency Error (ppm)	Frequency (MHz)	Frequency Error (ppm)
-30	1857.500003	0.002	1907.500002	0.001
-20	1857.500003	0.001	1907.500001	0.001
-10	1857.500003	0.002	1907.500003	0.002
0	1857.500002	0.001	1907.500003	0.002
10	1857.500001	0.001	1907.500002	0.001
20	1857.499997	-0.002	1907.499999	-0.001
30	1857.499999	-0.001	1907.499996	-0.002
40	1857.499996	-0.002	1907.499997	-0.001
50	1857.499998	-0.001	1907.499997	-0.002

Frequency Error vs. Voltage

Voltage (Volts)	LTE Band 25			
	Channel Bandwidth: 20 MHz			
	Low Channel		High Channel	
	Frequency (MHz)	Frequency Error (ppm)	Frequency (MHz)	Frequency Error (ppm)
4.25	1860.000002	0.001	1905.000003	0.001
5	1860.000003	0.002	1905.000004	0.002
5.75	1860.000003	0.002	1905.000003	0.002

Note: The applicant defined the normal working voltage is from 4.25Vdc to 5.75Vdc.

Frequency Error vs. Temperature

Temp. (°C)	LTE Band 25			
	Channel Bandwidth: 20 MHz			
	Low Channel		High Channel	
	Frequency (MHz)	Frequency Error (ppm)	Frequency (MHz)	Frequency Error (ppm)
-30	1860.000004	0.002	1905.000004	0.002
-20	1860.000004	0.002	1905.000001	0.001
-10	1860.000001	0.001	1905.000002	0.001
0	1860.000004	0.002	1905.000003	0.002
10	1860.000003	0.002	1905.000003	0.001
20	1859.999998	-0.001	1904.999997	-0.001
30	1859.999998	-0.001	1904.999997	-0.002
40	1859.999997	-0.002	1904.999999	-0.001
50	1859.999998	-0.001	1904.999999	-0.001

4.4 Occupied Bandwidth Measurement

4.4.1 Test Procedure

The EUT makes a call to the communication simulator. All measurements were done at low, middle and high operational frequency range. The communication simulator station system controlled a EUT to export maximum output power under transmission mode and specific channel frequency. Use OBW measurement function of Spectrum analyzer to measure 99 % occupied bandwidth.

4.4.2 Test Setup

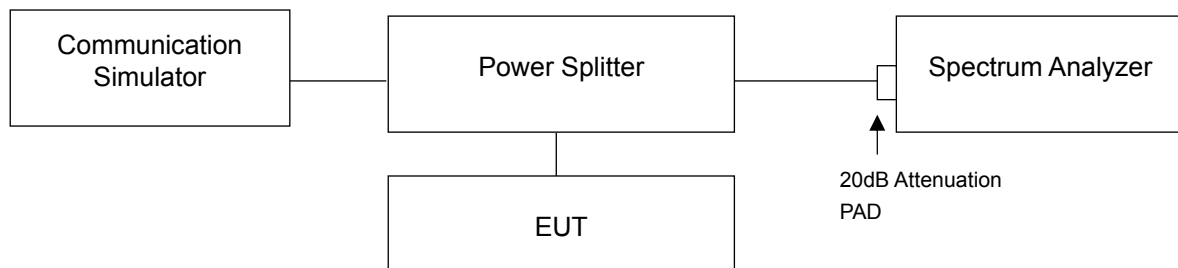

4.4.3 Test Result

Occupied Bandwidth

WCDMA Band 2				
Channel	Frequency (MHz)	99% Occupied Bandwidth (MHz)		
		WCDMA	HSDPA	HSUPA
9262	1852.4	4.13	4.13	4.13
9400	1880.0	4.15	4.15	4.15
9538	1907.6	4.15	4.13	4.16

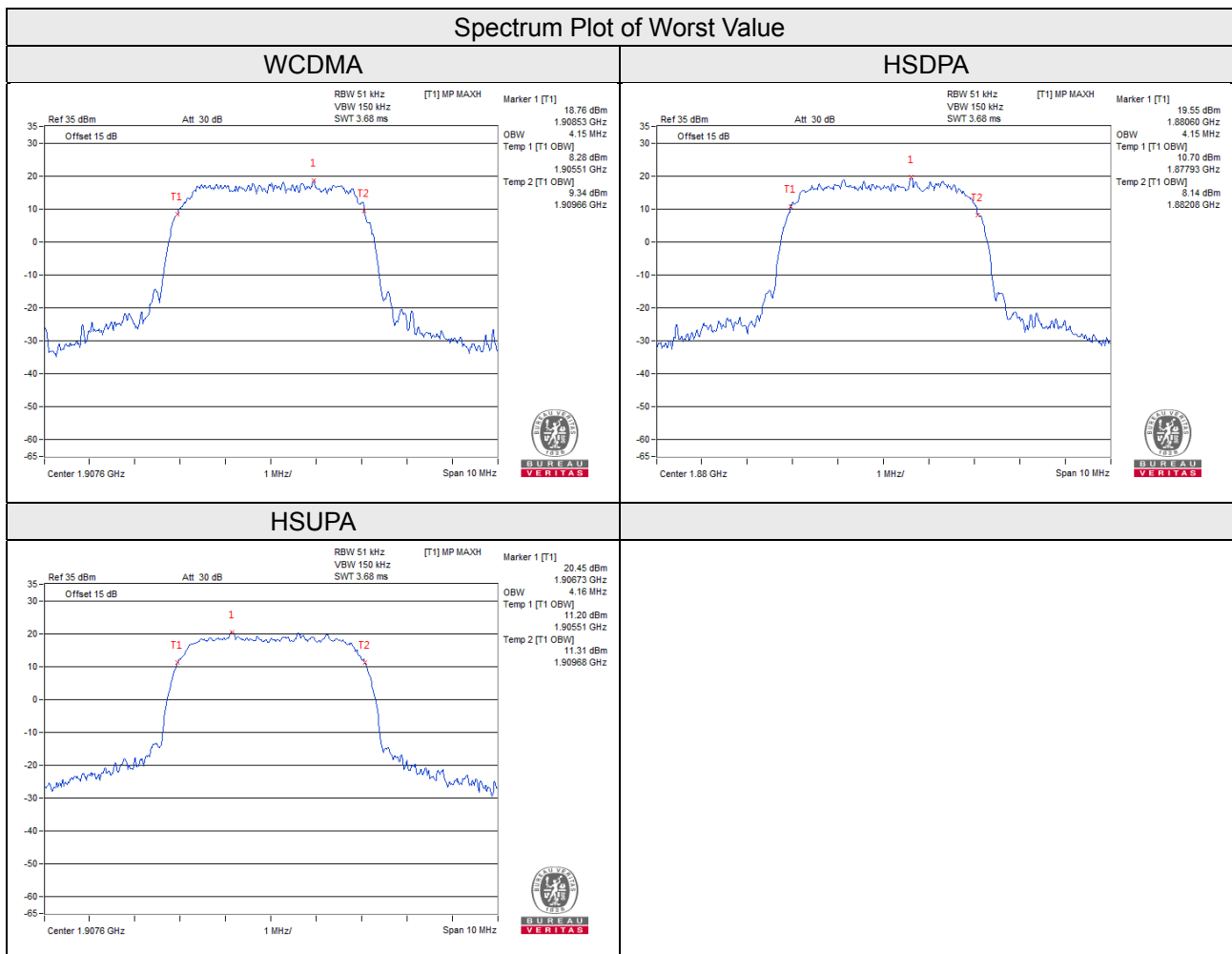

LTE Band 2, Channel Bandwidth 1.4MHz				
Channel	Frequency (MHz)	99% Occupied Bandwidth (MHz)		
		QPSK	16QAM	64QAM
18607	1850.7	1.09	1.09	1.09
18900	1880.0	1.09	1.09	1.09
19193	1909.3	1.09	1.09	1.09

LTE Band 2, Channel Bandwidth 3MHz				
Channel	Frequency (MHz)	99% Occupied Bandwidth (MHz)		
		QPSK	16QAM	64QAM
18615	1851.5	2.70	2.69	2.70
18900	1880.0	2.70	2.69	2.70
19185	1908.5	2.70	2.69	2.70

LTE Band 2, Channel Bandwidth 5MHz				
Channel	Frequency (MHz)	99% Occupied Bandwidth (MHz)		
		QPSK	16QAM	64QAM
18625	1852.5	4.49	4.49	4.49
18900	1880.0	4.49	4.49	4.49
19175	1907.5	4.49	4.49	4.49

LTE Band 2, Channel Bandwidth 10MHz				
Channel	Frequency (MHz)	99% Occupied Bandwidth (MHz)		
		QPSK	16QAM	64QAM
18650	1855.0	8.95	8.96	8.95
18900	1880.0	8.95	8.96	8.95
19150	1905.0	8.96	8.96	8.95

LTE Band 2, Channel Bandwidth 15MHz				
Channel	Frequency (MHz)	99% Occupied Bandwidth (MHz)		
		QPSK	16QAM	64QAM
18675	1857.5	13.45	13.44	13.43
18900	1880.0	13.45	13.44	13.44
19125	1902.5	13.47	13.46	13.45

LTE Band 2, Channel Bandwidth 20MHz				
Channel	Frequency (MHz)	99% Occupied Bandwidth (MHz)		
		QPSK	16QAM	64QAM
18700	1860.0	17.91	17.92	17.92
18900	1880.0	17.91	17.94	17.93
19100	1900.0	17.96	17.97	17.97

Spectrum Plot of Worst Value

1.4MHz / 16QAM

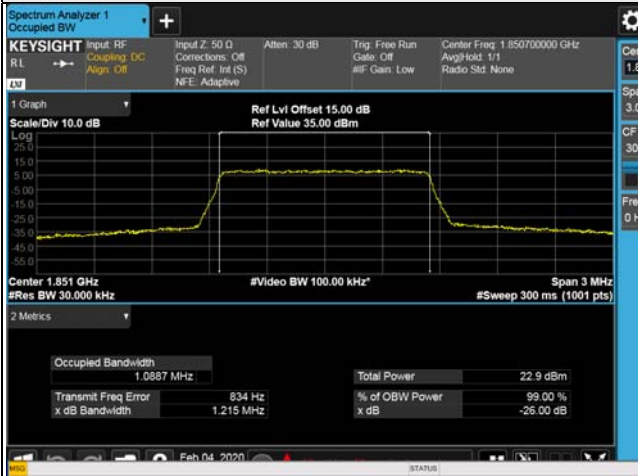

3MHz / 64QAM

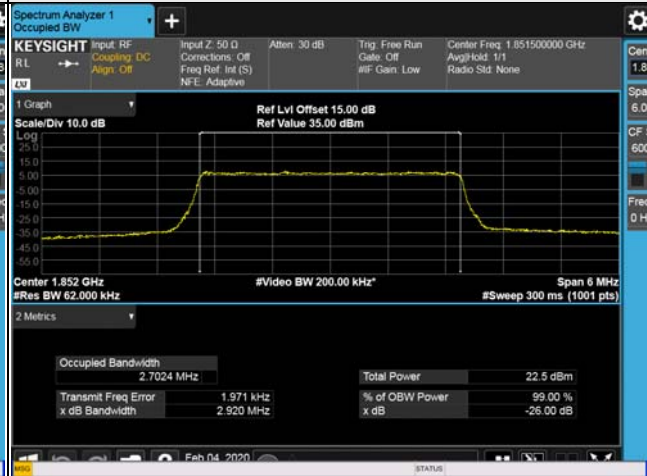

5MHz / 64QAM

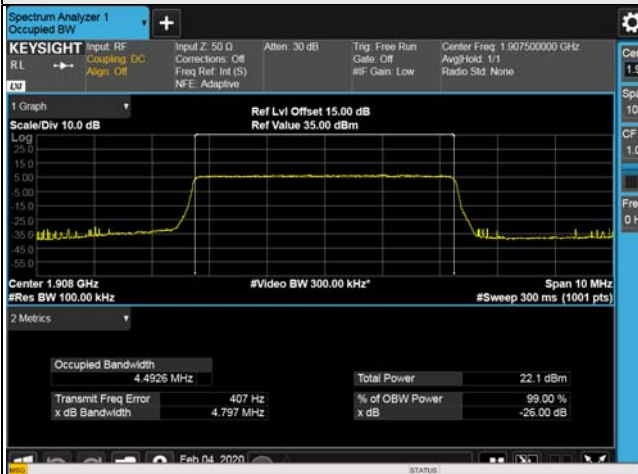

10MHz / 16QAM

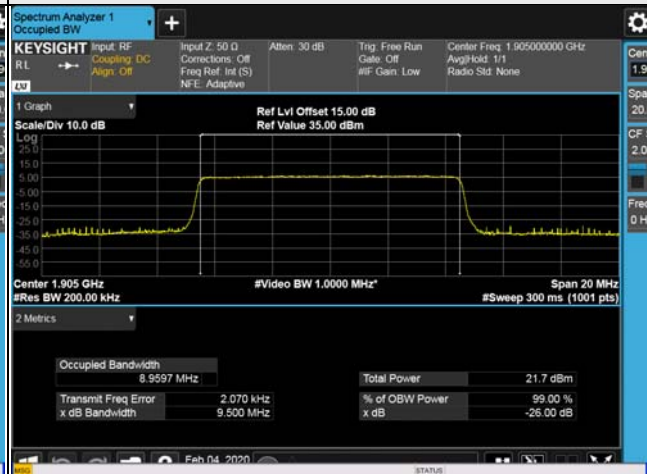

15MHz / QPSK

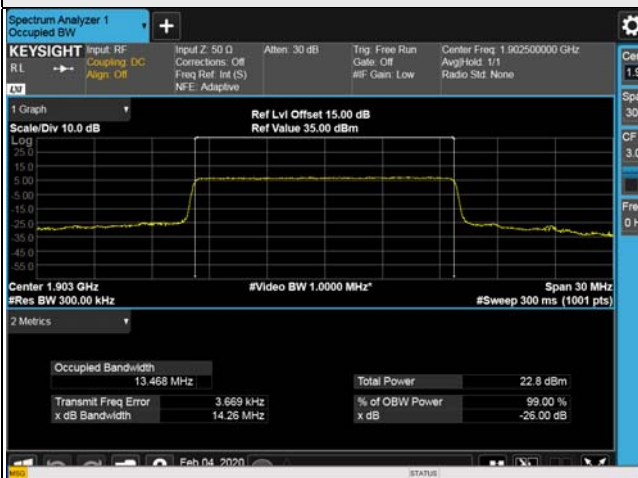

20MHz / 64QAM

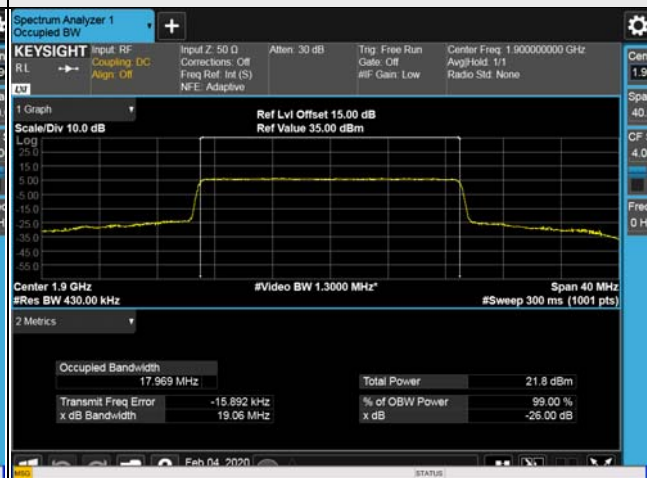

LTE Band 25, Channel Bandwidth 1.4MHz				
Channel	Frequency (MHz)	99% Occupied Bandwidth (MHz)		
		QPSK	16QAM	64QAM
26047	1850.7	1.09	1.09	1.09
26365	1882.5	1.09	1.09	1.09
26683	1914.3	1.09	1.09	1.09

LTE Band 25, Channel Bandwidth 3MHz				
Channel	Frequency (MHz)	99% Occupied Bandwidth (MHz)		
		QPSK	16QAM	64QAM
26055	1851.5	2.70	2.69	2.70
26365	1882.5	2.70	2.70	2.70
26675	1913.5	2.70	2.70	2.70

LTE Band 25, Channel Bandwidth 5MHz				
Channel	Frequency (MHz)	99% Occupied Bandwidth (MHz)		
		QPSK	16QAM	64QAM
26065	1852.5	4.49	4.49	4.49
26365	1882.5	4.48	4.49	4.49
26665	1912.5	4.49	4.49	4.49

LTE Band 25, Channel Bandwidth 10MHz				
Channel	Frequency (MHz)	99% Occupied Bandwidth (MHz)		
		QPSK	16QAM	64QAM
26090	1855.0	8.95	8.95	8.95
26365	1882.5	8.96	8.96	8.95
26640	1910.0	8.95	8.95	8.95

LTE Band 25, Channel Bandwidth 15MHz				
Channel	Frequency (MHz)	99% Occupied Bandwidth (MHz)		
		QPSK	16QAM	64QAM
26115	1857.5	13.45	13.44	13.44
26365	1882.5	13.44	13.43	13.43
26615	1907.5	13.44	13.43	13.43

LTE Band 25, Channel Bandwidth 20MHz				
Channel	Frequency (MHz)	99% Occupied Bandwidth (MHz)		
		QPSK	16QAM	64QAM
26140	1860.0	17.91	17.93	17.93
26365	1882.5	17.91	17.92	17.93
26590	1905.0	17.92	17.94	17.93

Spectrum Plot of Worst Value

1.4MHz / 16QAM

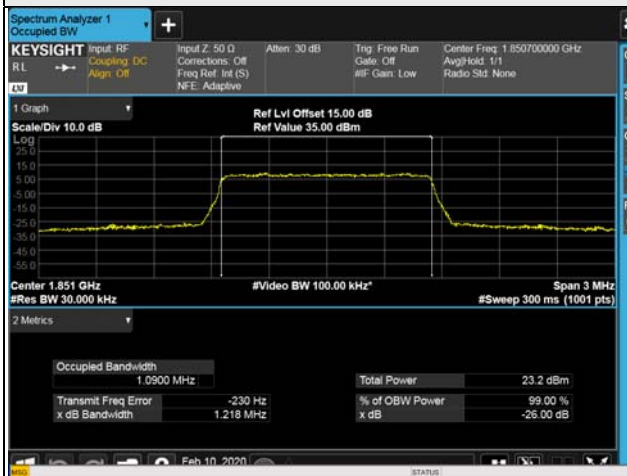

3MHz / 64QAM

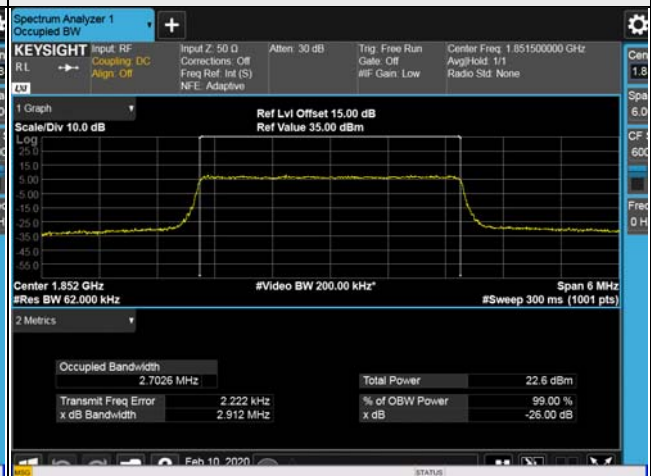

5MHz / 64QAM

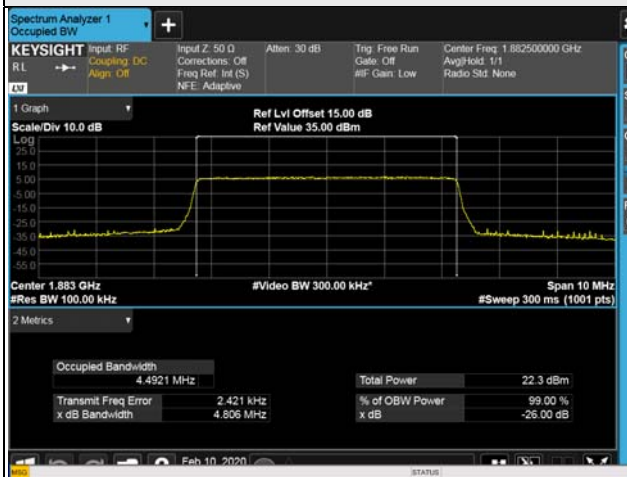

10MHz / QPSK

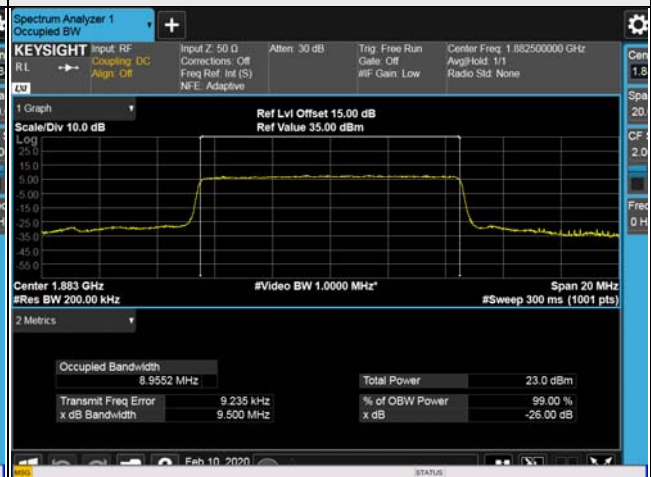

15MHz / QPSK



20MHz / 16QAM



26dB Bandwidth

WCDMA Band 2				
Channel	Frequency (MHz)	26dBc Bandwidth (MHz)		
		WCDMA	HSDPA	HSUPA
9262	1852.4	4.69	4.68	4.70
9400	1880.0	4.71	4.69	4.70
9538	1907.6	4.67	4.70	4.72

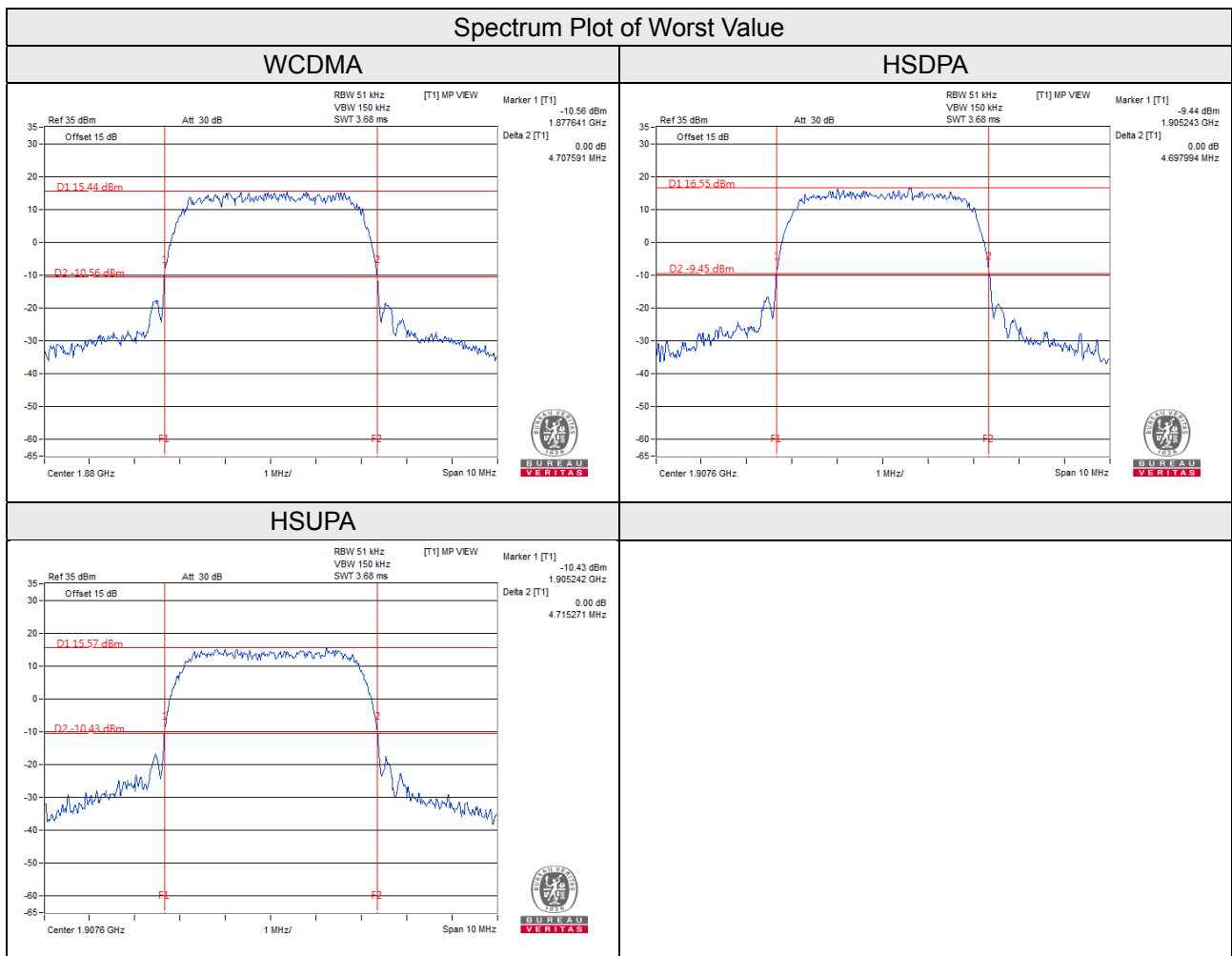

LTE Band 2, Channel Bandwidth 1.4MHz				
Channel	Frequency (MHz)	26dBc Bandwidth (MHz)		
		QPSK	16QAM	64QAM
18607	1850.7	1.22	1.22	1.21
18900	1880.0	1.21	1.22	1.22
19193	1909.3	1.22	1.22	1.21

LTE Band 2, Channel Bandwidth 3MHz				
Channel	Frequency (MHz)	26dBc Bandwidth (MHz)		
		QPSK	16QAM	64QAM
18615	1851.5	2.91	2.93	2.92
18900	1880.0	2.91	2.92	2.92
19185	1908.5	2.92	2.93	2.92

LTE Band 2, Channel Bandwidth 5MHz				
Channel	Frequency (MHz)	26dBc Bandwidth (MHz)		
		QPSK	16QAM	64QAM
18625	1852.5	4.80	4.80	4.79
18900	1880.0	4.79	4.81	4.80
19175	1907.5	4.79	4.79	4.80

LTE Band 2, Channel Bandwidth 10MHz				
Channel	Frequency (MHz)	26dBc Bandwidth (MHz)		
		QPSK	16QAM	64QAM
18650	1855.0	9.51	9.51	9.50
18900	1880.0	9.49	9.50	9.50
19150	1905.0	9.51	9.50	9.51

LTE Band 2, Channel Bandwidth 15MHz				
Channel	Frequency (MHz)	26dBc Bandwidth (MHz)		
		QPSK	16QAM	64QAM
18675	1857.5	14.26	14.26	14.24
18900	1880.0	14.24	14.26	14.23
19125	1902.5	14.26	14.26	14.25

LTE Band 2, Channel Bandwidth 20MHz				
Channel	Frequency (MHz)	26dBc Bandwidth (MHz)		
		QPSK	16QAM	64QAM
18700	1860.0	19.01	19.02	19.02
18900	1880.0	19.02	19.02	19.02
19100	1900.0	19.08	19.05	19.06

Spectrum Plot of Worst Value

1.4MHz / 64QAM

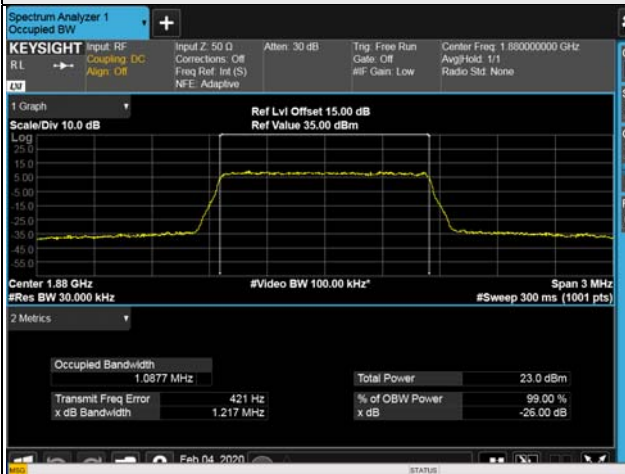

3MHz / 16QAM



5MHz / 16QAM



10MHz / 16QAM

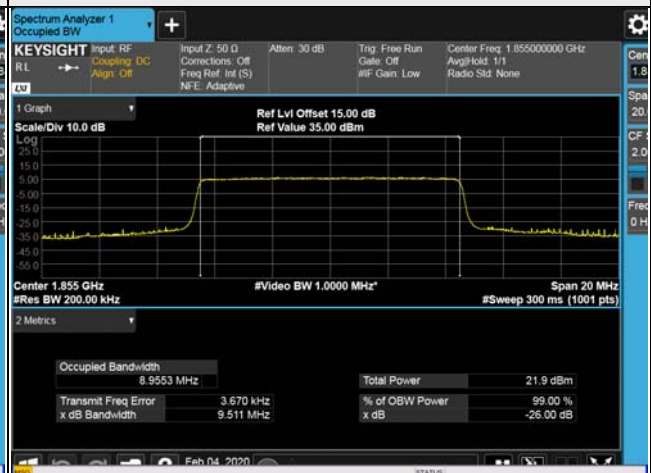

15MHz / 16QAM



20MHz / QPSK



LTE Band 25, Channel Bandwidth 1.4MHz				
Channel	Frequency (MHz)	26dBc Bandwidth (MHz)		
		QPSK	16QAM	64QAM
26047	1850.7	1.21	1.22	1.22
26365	1882.5	1.21	1.22	1.22
26683	1914.3	1.21	1.21	1.21

LTE Band 25, Channel Bandwidth 3MHz				
Channel	Frequency (MHz)	26dBc Bandwidth (MHz)		
		QPSK	16QAM	64QAM
26055	1851.5	2.91	2.92	2.91
26365	1882.5	2.93	2.92	2.91
26675	1913.5	2.92	2.92	2.93

LTE Band 25, Channel Bandwidth 5MHz				
Channel	Frequency (MHz)	26dBc Bandwidth (MHz)		
		QPSK	16QAM	64QAM
26065	1852.5	4.81	4.80	4.79
26365	1882.5	4.80	4.79	4.81
26665	1912.5	4.79	4.79	4.81

LTE Band 25, Channel Bandwidth 10MHz				
Channel	Frequency (MHz)	26dBc Bandwidth (MHz)		
		QPSK	16QAM	64QAM
26090	1855.0	9.50	9.50	9.50
26365	1882.5	9.50	9.51	9.50
26640	1910.0	9.48	9.51	9.52

LTE Band 25, Channel Bandwidth 15MHz				
Channel	Frequency (MHz)	26dBc Bandwidth (MHz)		
		QPSK	16QAM	64QAM
26115	1857.5	14.25	14.25	14.26
26365	1882.5	14.24	14.23	14.23
26615	1907.5	14.26	14.26	14.23

LTE Band 25, Channel Bandwidth 20MHz				
Channel	Frequency (MHz)	26dBc Bandwidth (MHz)		
		QPSK	16QAM	64QAM
26140	1860.0	19.02	19.03	19.03
26365	1882.5	19.01	19.03	19.03
26590	1905.0	19.03	19.02	19.07

Spectrum Plot of Worst Value

1.4MHz / 64QAM



3MHz / 64QAM



5MHz / QPSK

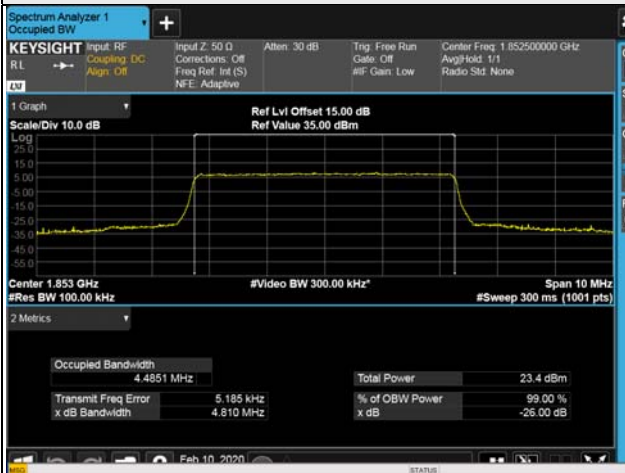

10MHz / 64QAM

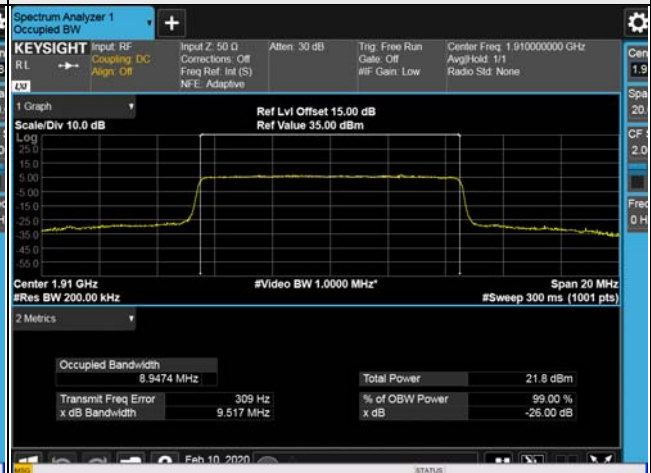

15MHz / 64QAM



20MHz / 64QAM

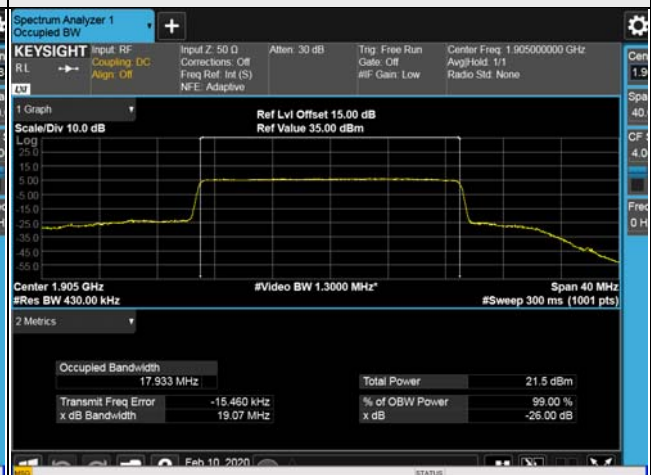

4.5 Band Edge Measurement

4.5.1 Limits of Band Edge Measurement

Power of any emission outside of the authorized operating frequency ranges must be attenuated below the transmitting power (P) by a factor of at least $43 + 10 \log(P)$ dB. In the 1 MHz bands immediately outside and adjacent to the frequency block a resolution bandwidth of at least one percent of the emission bandwidth of the fundamental emission of the transmitter may be employed.

4.5.2 Test Setup

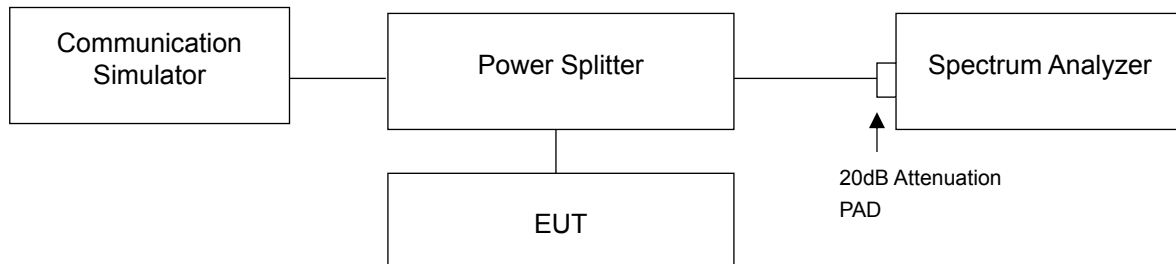

4.5.3 Test Procedures

- a. All measurements were done at low and high operational frequency range.
- b. The center frequency of spectrum is the band edge frequency and span is 10MHz. RB of the spectrum is 51kHz and VB of the spectrum is 150kHz (WCDMA / HSDPA / HSUPA).
- c. The center frequency of spectrum is the band edge frequency and span is 1MHz. RB of the spectrum is 15kHz and VB of the spectrum is 51kHz (LTE Channel Bandwidth 1.4MHz).
- d. The center frequency of spectrum is the band edge frequency and span is 1MHz. RB of the spectrum is 30kHz and VB of the spectrum is 100kHz (LTE Channel Bandwidth 3MHz).
- e. The center frequency of spectrum is the band edge frequency and span is 1MHz. RB of the spectrum is 51kHz and VB of the spectrum is 160kHz (LTE Channel Bandwidth 5MHz).
- f. The center frequency of spectrum is the band edge frequency and span is 1MHz. RB of the spectrum is 100kHz and VB of the spectrum is 300kHz (LTE Channel Bandwidth 10MHz).
- g. The center frequency of spectrum is the band edge frequency and span is 1MHz. RB of the spectrum is 150kHz and VB of the spectrum is 470kHz (LTE Channel Bandwidth 15MHz).
- h. The center frequency of spectrum is the band edge frequency and span is 1MHz. RB of the spectrum is 200kHz and VB of the spectrum is 1MHz (LTE Channel Bandwidth 20MHz).
- i. Record the max trace plot into the test report.

4.5.4 Test Results

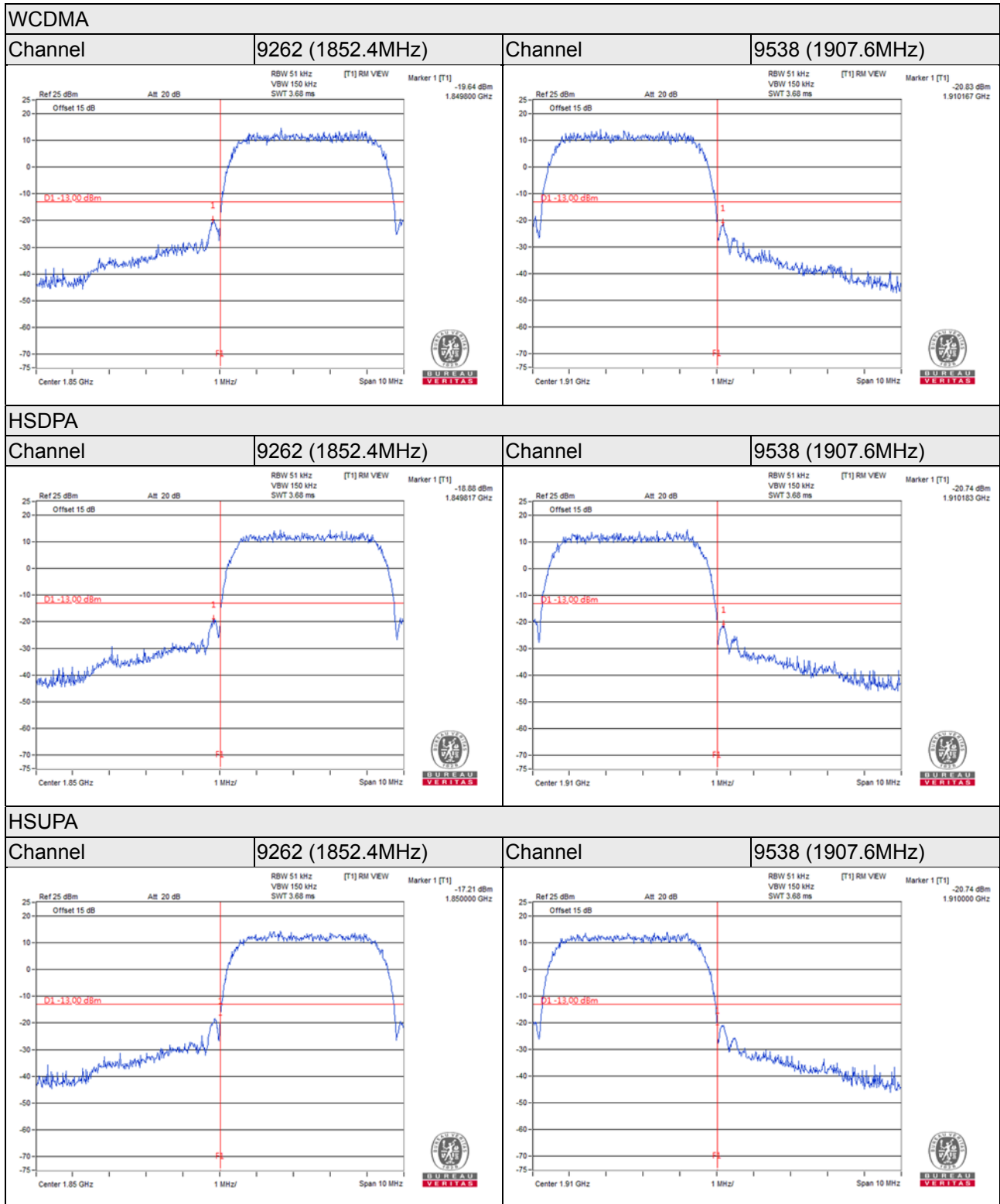

LTE Band 2, Channel Bandwidth 1.4MHz

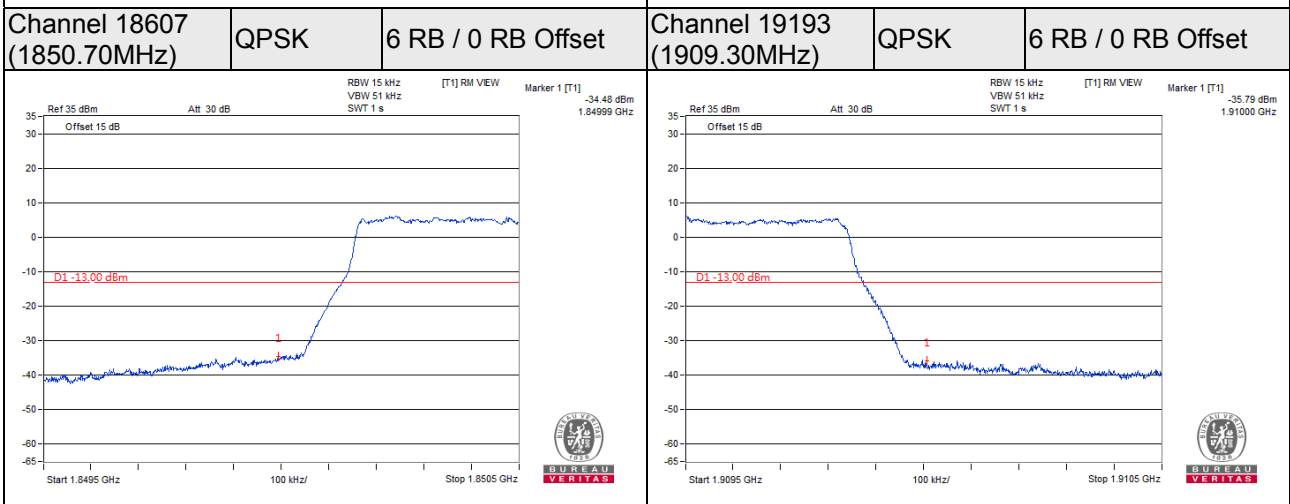
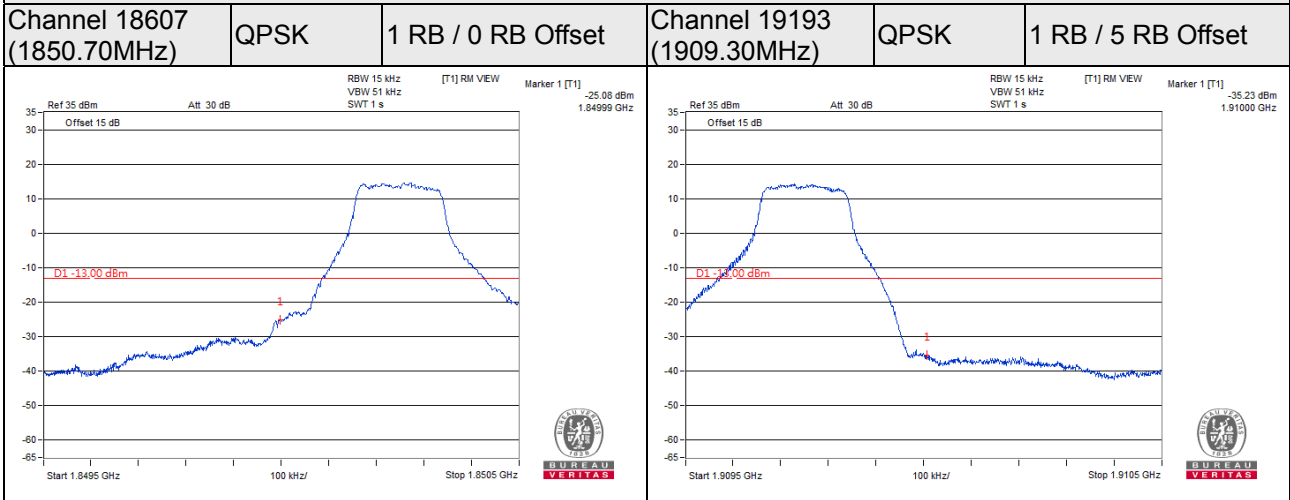

LTE Band 2, Channel Bandwidth 3MHz

Channel 18615 (1851.50MHz)	QPSK	1 RB / 0 RB Offset	Channel 19185 (1908.50MHz)	QPSK	1 RB / 14 RB Offset
-------------------------------	------	--------------------	-------------------------------	------	---------------------

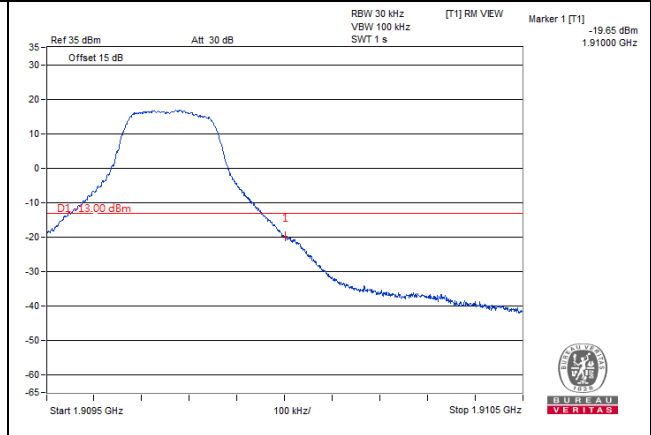
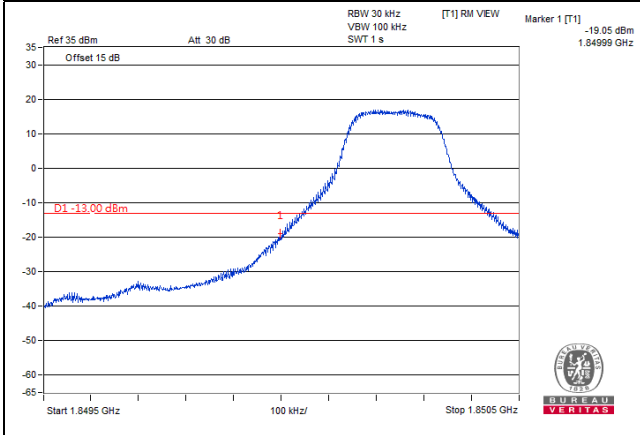

Channel 18615 (1851.50MHz)	QPSK	15 RB / 0 RB Offset	Channel 19185 (1908.50MHz)	QPSK	15 RB / 0 RB Offset
-------------------------------	------	---------------------	-------------------------------	------	---------------------

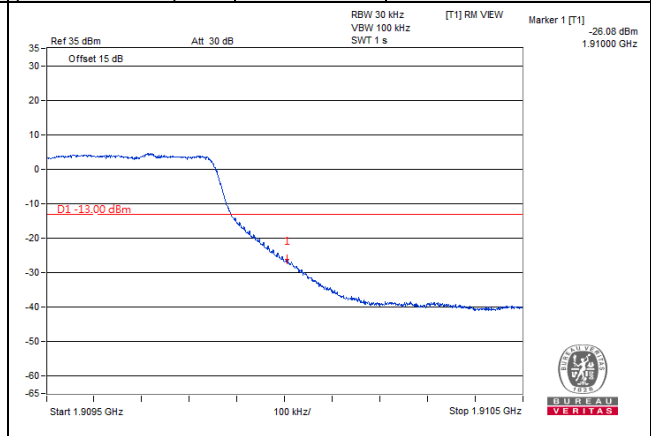
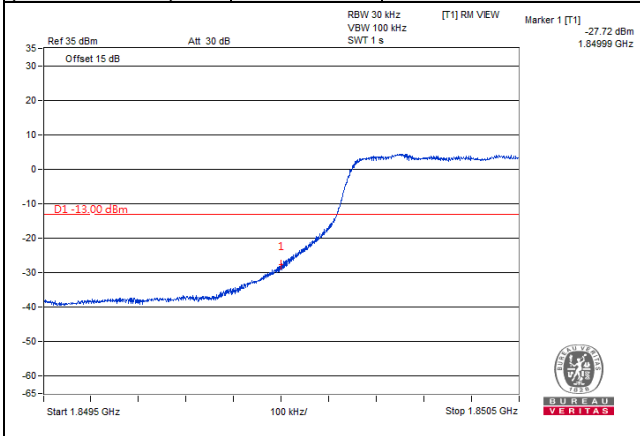

LTE Band 2, Channel Bandwidth 5MHz

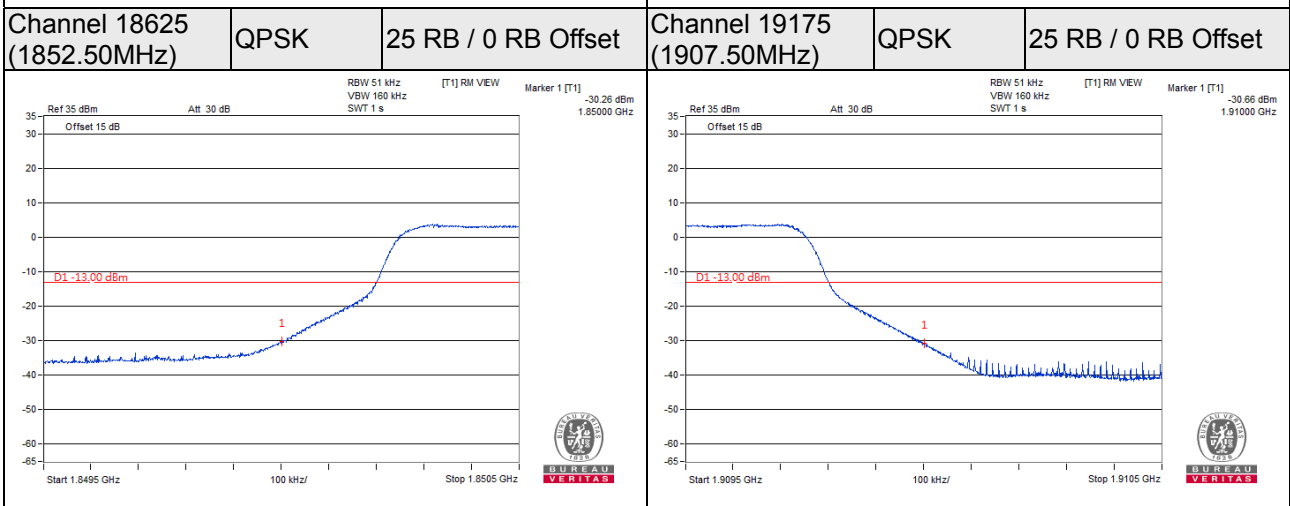
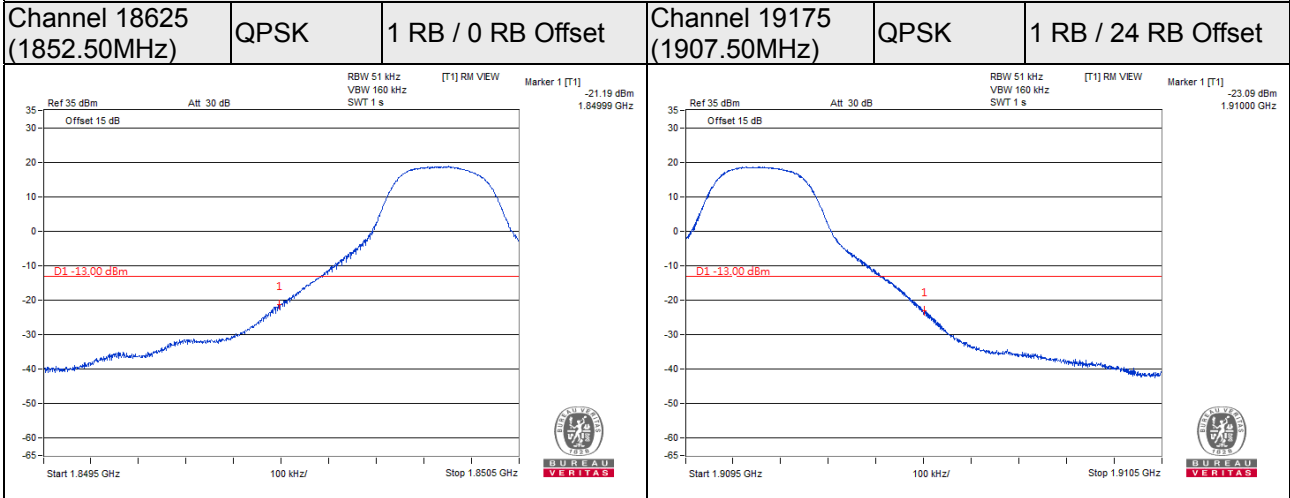

LTE Band 2, Channel Bandwidth 10MHz

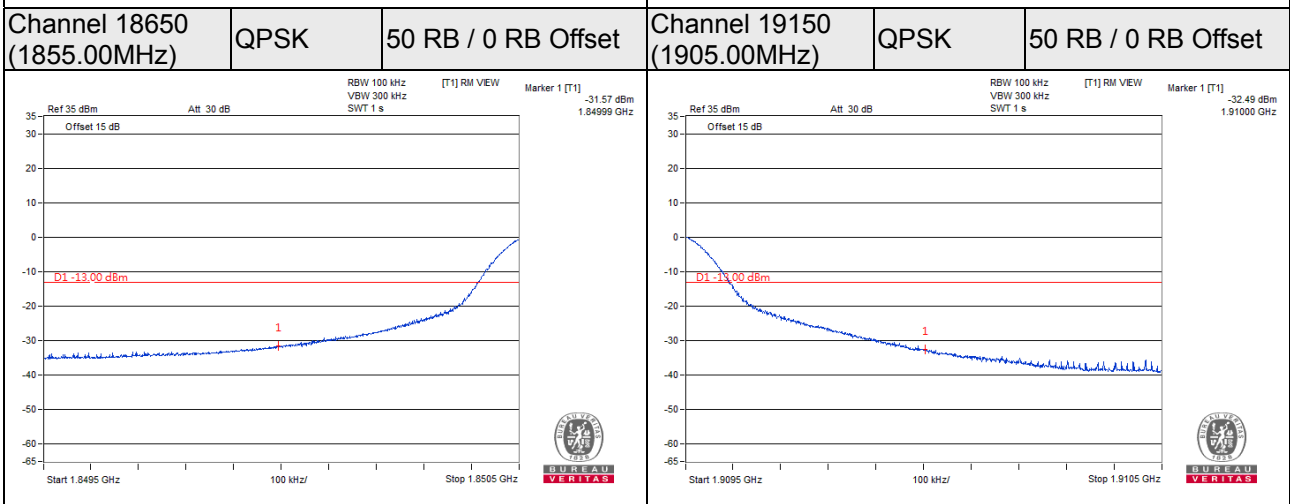
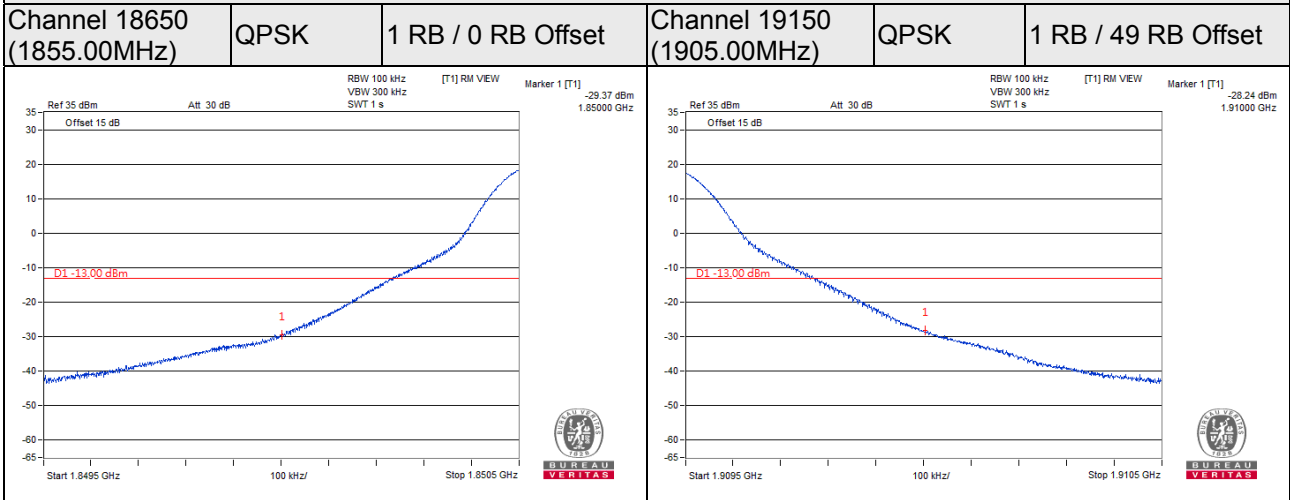

LTE Band 2, Channel Bandwidth 15MHz

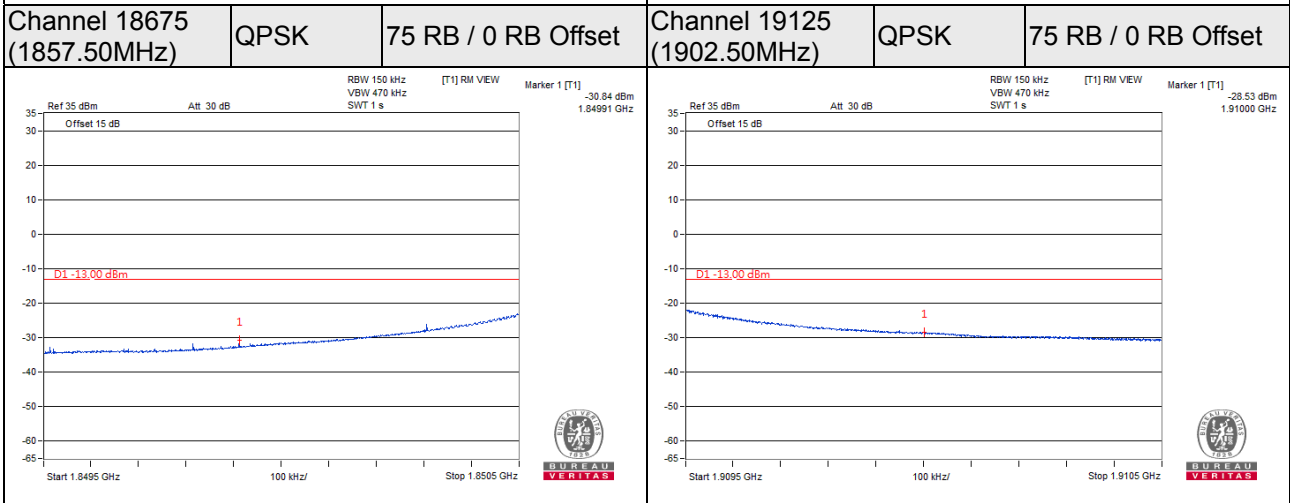
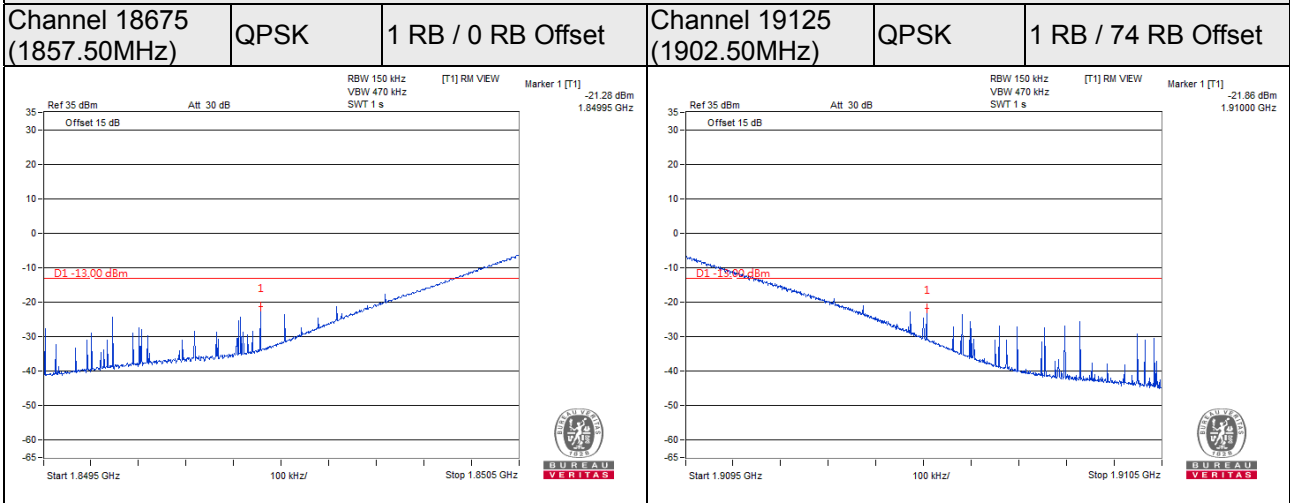

LTE Band 2, Channel Bandwidth 20MHz

Channel 18700 (1860.00MHz)	QPSK	1 RB / 0 RB Offset	Channel 19100 (1900.00 MHz)	QPSK	1 RB / 99 RB Offset
---------------------------------------	-------------	---------------------------	----------------------------------------	-------------	----------------------------

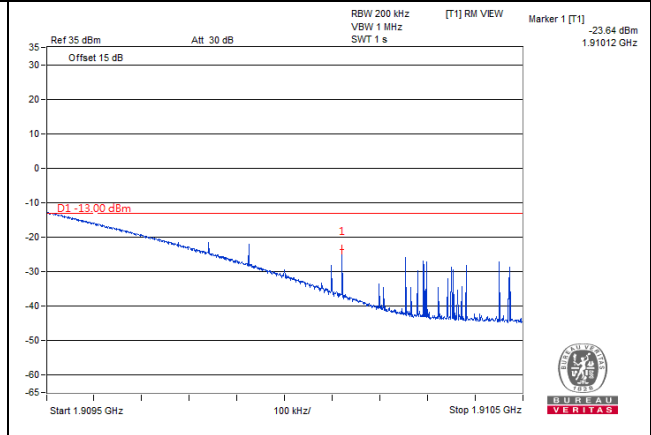
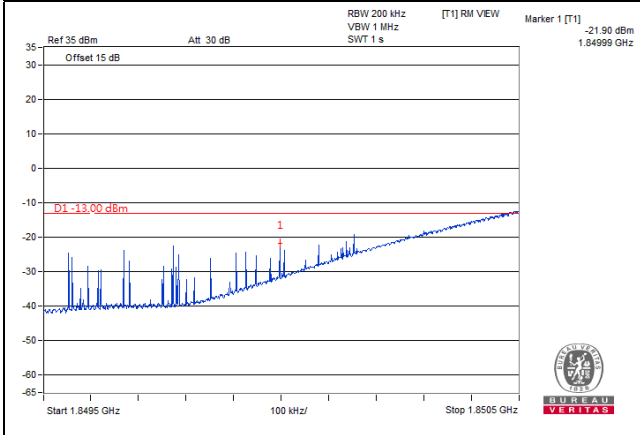

Channel 18700 (1860.00MHz)	QPSK	100 RB / 0 RB Offset	Channel 19100 (1900.00 MHz)	QPSK	100 RB / 0 RB Offset
---------------------------------------	-------------	-----------------------------	----------------------------------------	-------------	-----------------------------

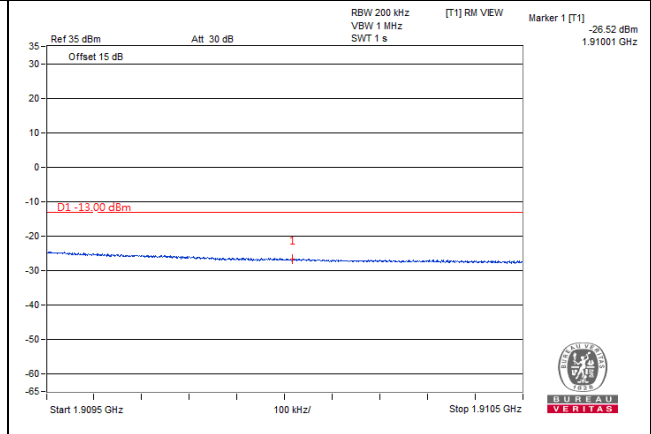
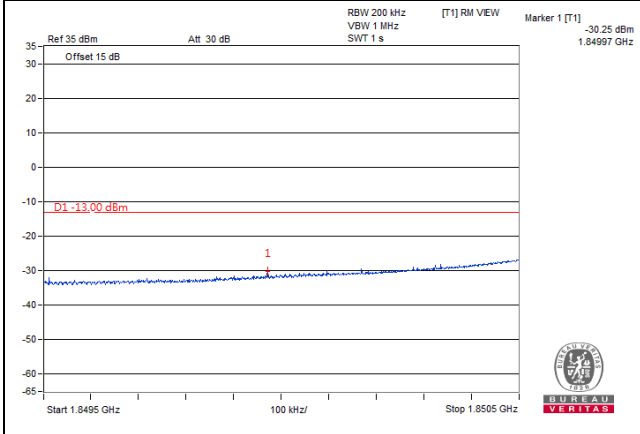

LTE Band 25, Channel Bandwidth 1.4MHz

Channel 26047
(1850.7MHz)

QPSK

1 RB / 0 RB Offset

Channel 26683
(1914.3MHz)

QPSK

1 RB / 5 RB Offset

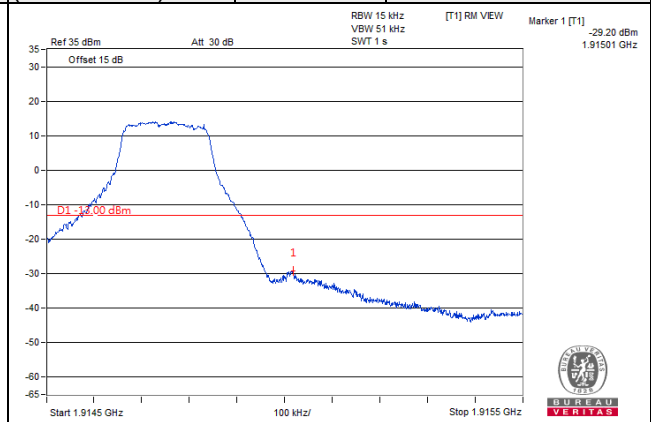
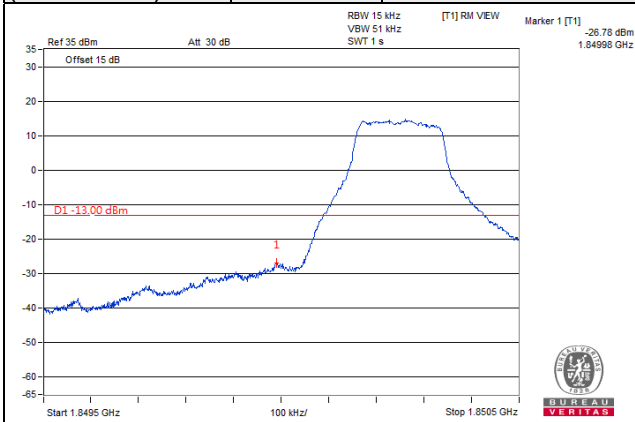

Channel 26047
(1850.7MHz)

QPSK

6 RB / 0 RB Offset

Channel 26683
(1914.3MHz)

QPSK

6 RB / 0 RB Offset

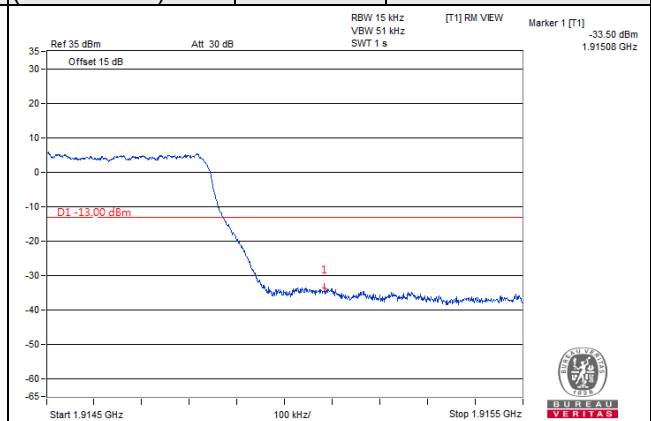
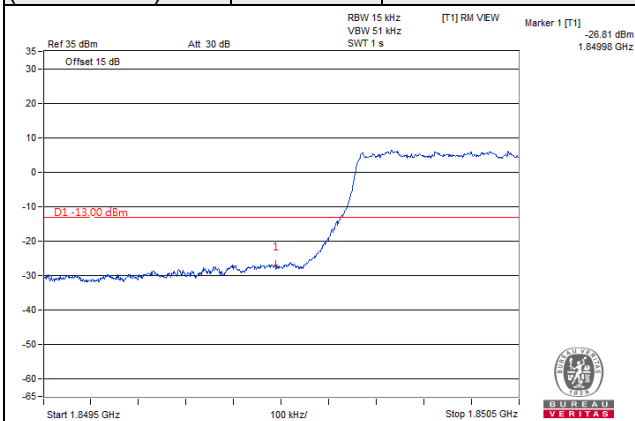

LTE Band 25, Channel Bandwidth 3MHz

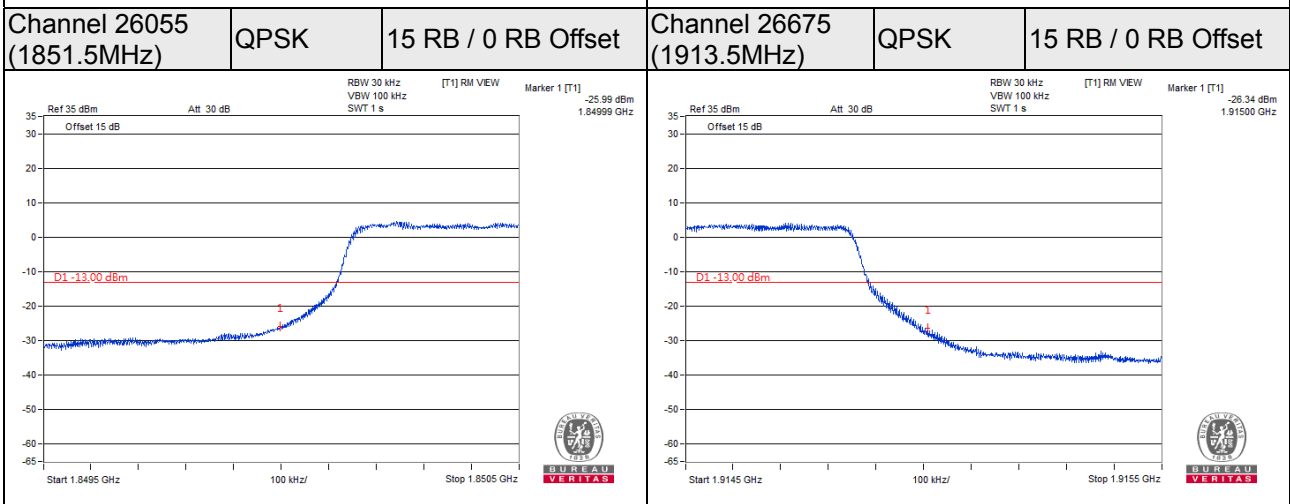
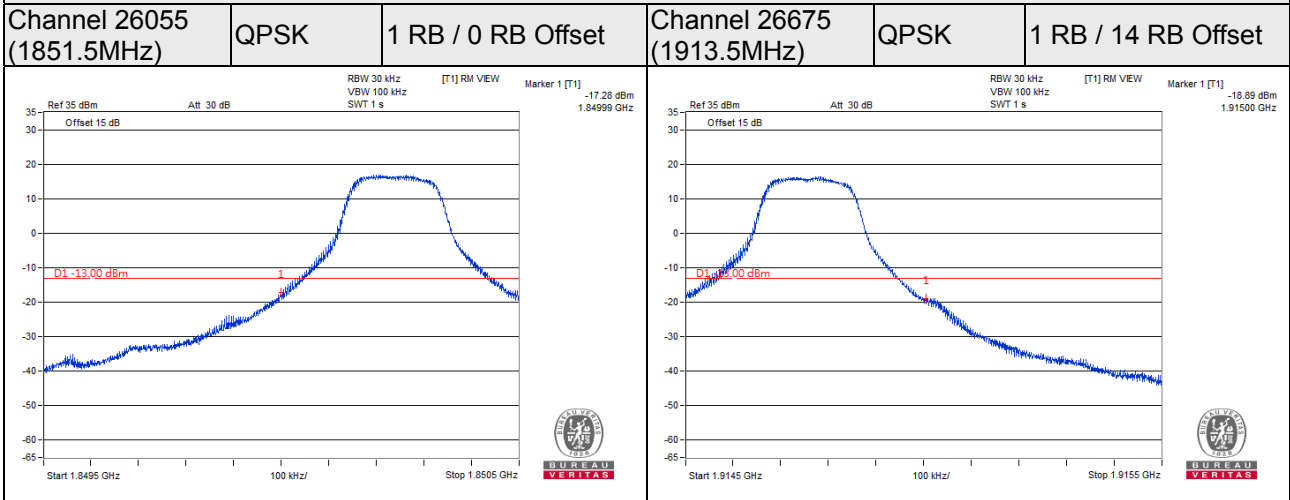

LTE Band 25, Channel Bandwidth 5MHz

Channel 26065 (1852.5MHz)	QPSK	1 RB / 0 RB Offset	Channel 26665 (1912.5MHz)	QPSK	1 RB / 24 RB Offset
------------------------------	------	--------------------	------------------------------	------	---------------------

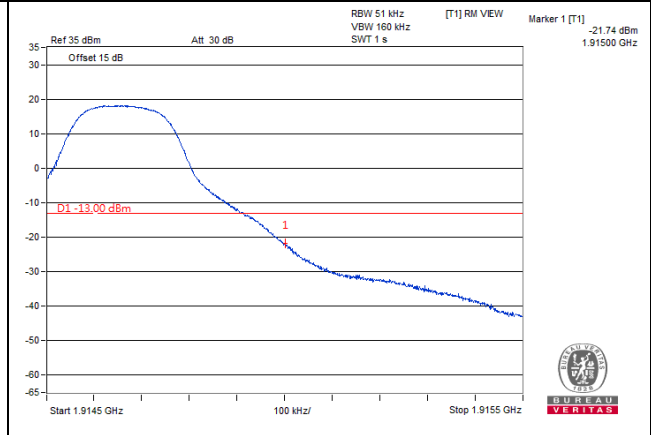
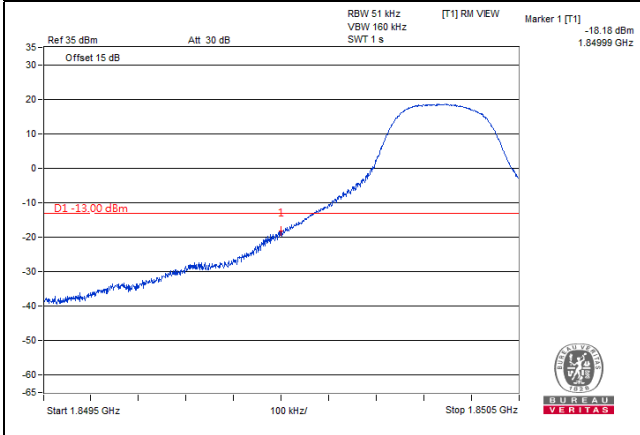

Channel 26065 (1852.5MHz)	QPSK	25 RB / 0 RB Offset	Channel 26665 (1912.5MHz)	QPSK	25 RB / 0 RB Offset
------------------------------	------	---------------------	------------------------------	------	---------------------

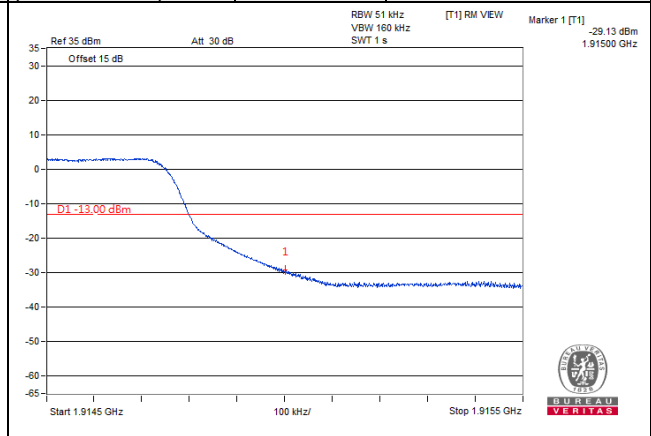
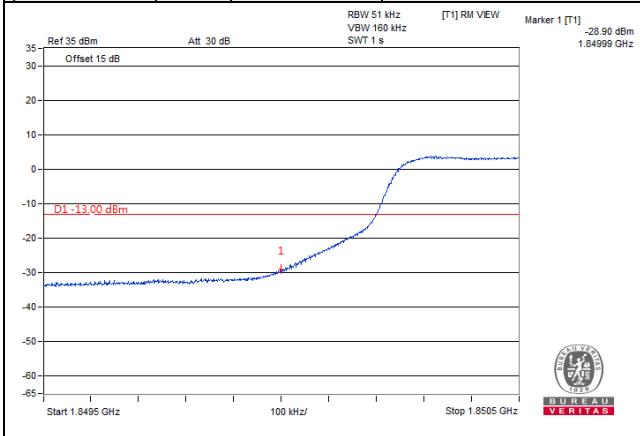

LTE Band 25, Channel Bandwidth 10MHz

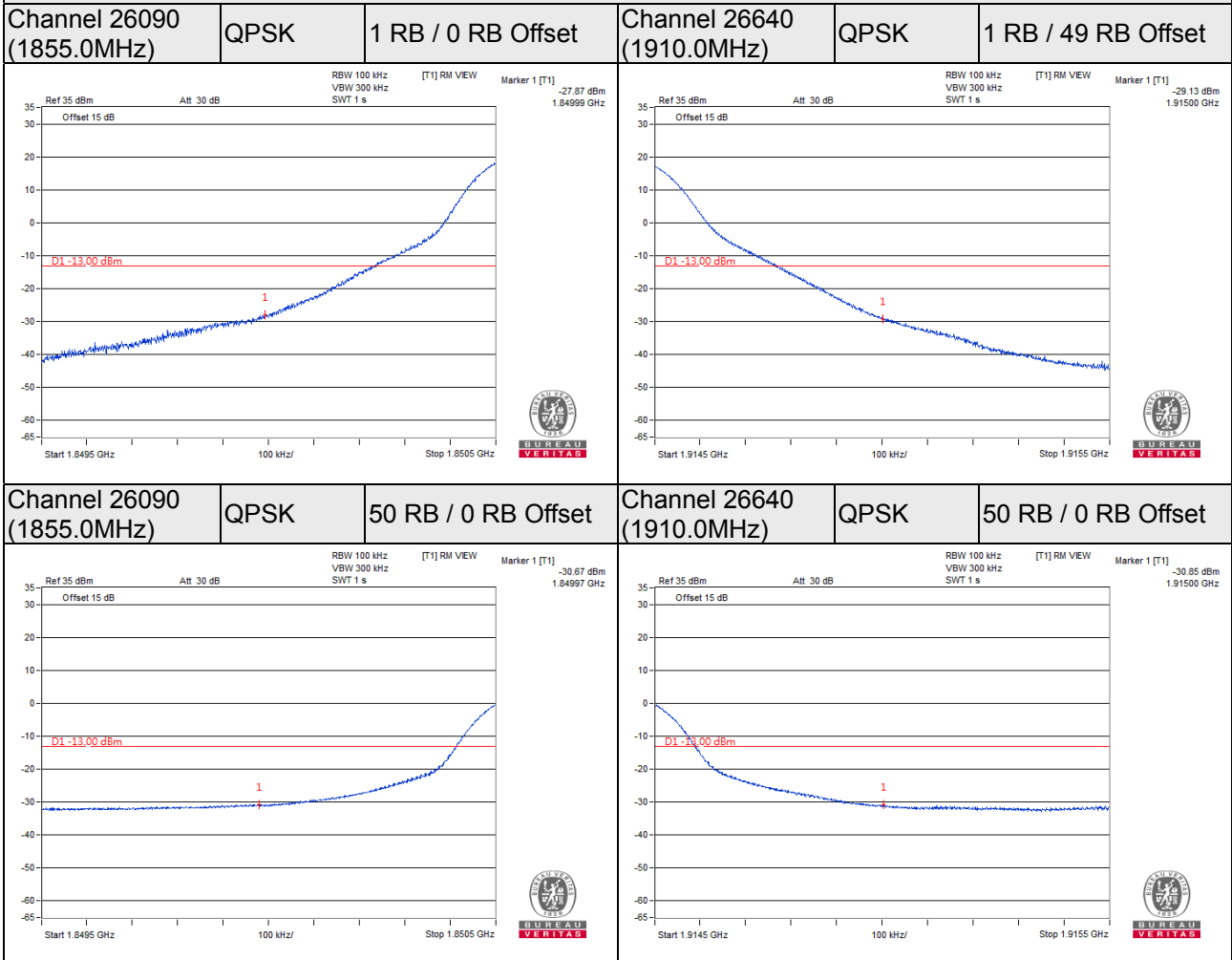

LTE Band 25, Channel Bandwidth 15MHz

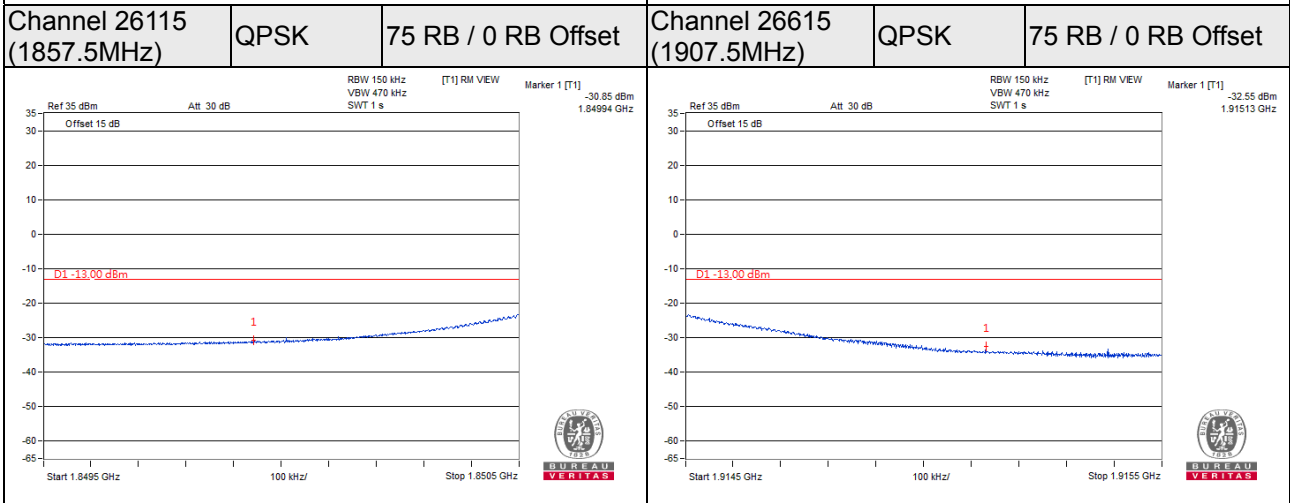
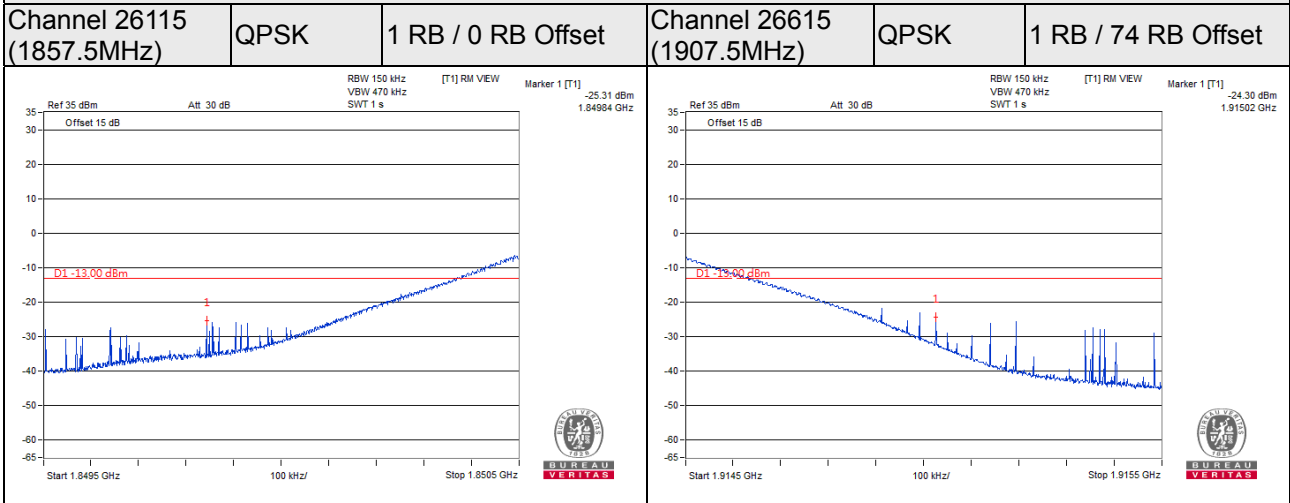

LTE Band 25, Channel Bandwidth 20MHz

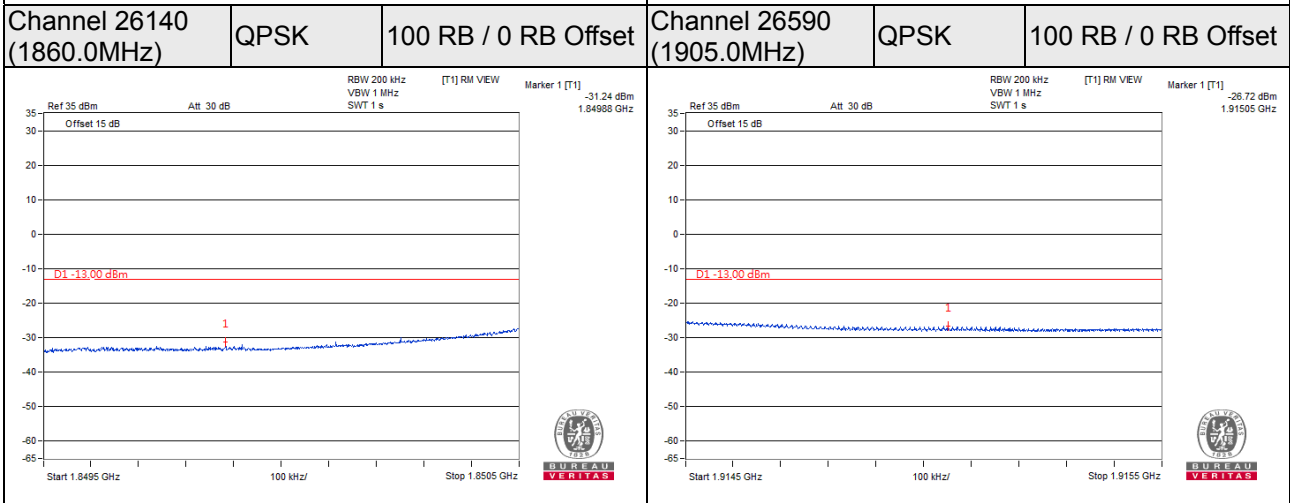
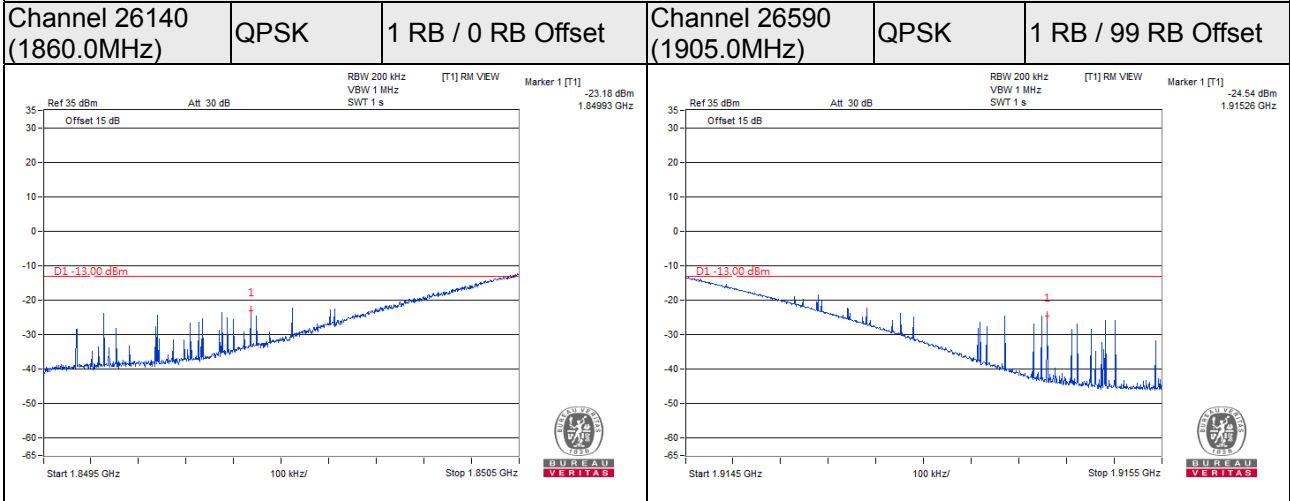

4.6 Peak to Average Ratio

4.6.1 Limits of Peak to Average Ratio Measurement

In measuring transmissions in this band using an average power technique, the peak to-average ratio (PAR) of the transmission may not exceed 13 dB

4.6.2 Test Setup

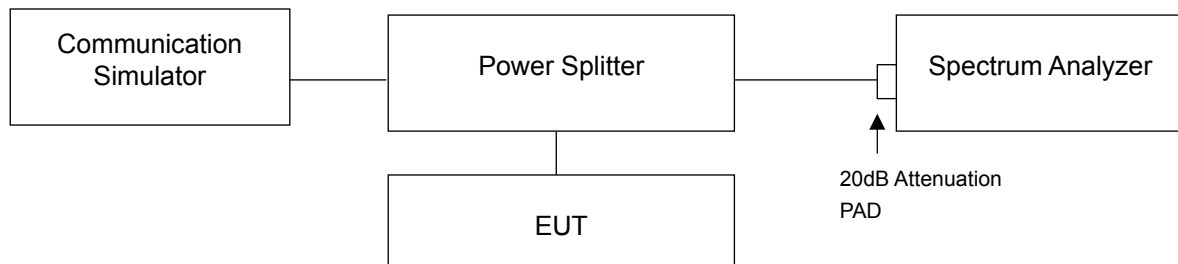

4.6.3 Test Procedures

- Set resolution/measurement bandwidth \geq signal's occupied bandwidth;
- Set the number of counts to a value that stabilizes the measured CCDF curve;
- Record the maximum PAPR level associated with a probability of 0.1%.

4.6.4 Test Results

WCDMA Band 2				
Channel	Frequency (MHz)	Peak To Average Ratio (dB)		
		WCDMA	HSDPA	HSUPA
9262	1852.4	2.94	2.95	2.94
9400	1880.0	2.95	2.94	2.94
9538	1907.6	2.91	2.90	2.91

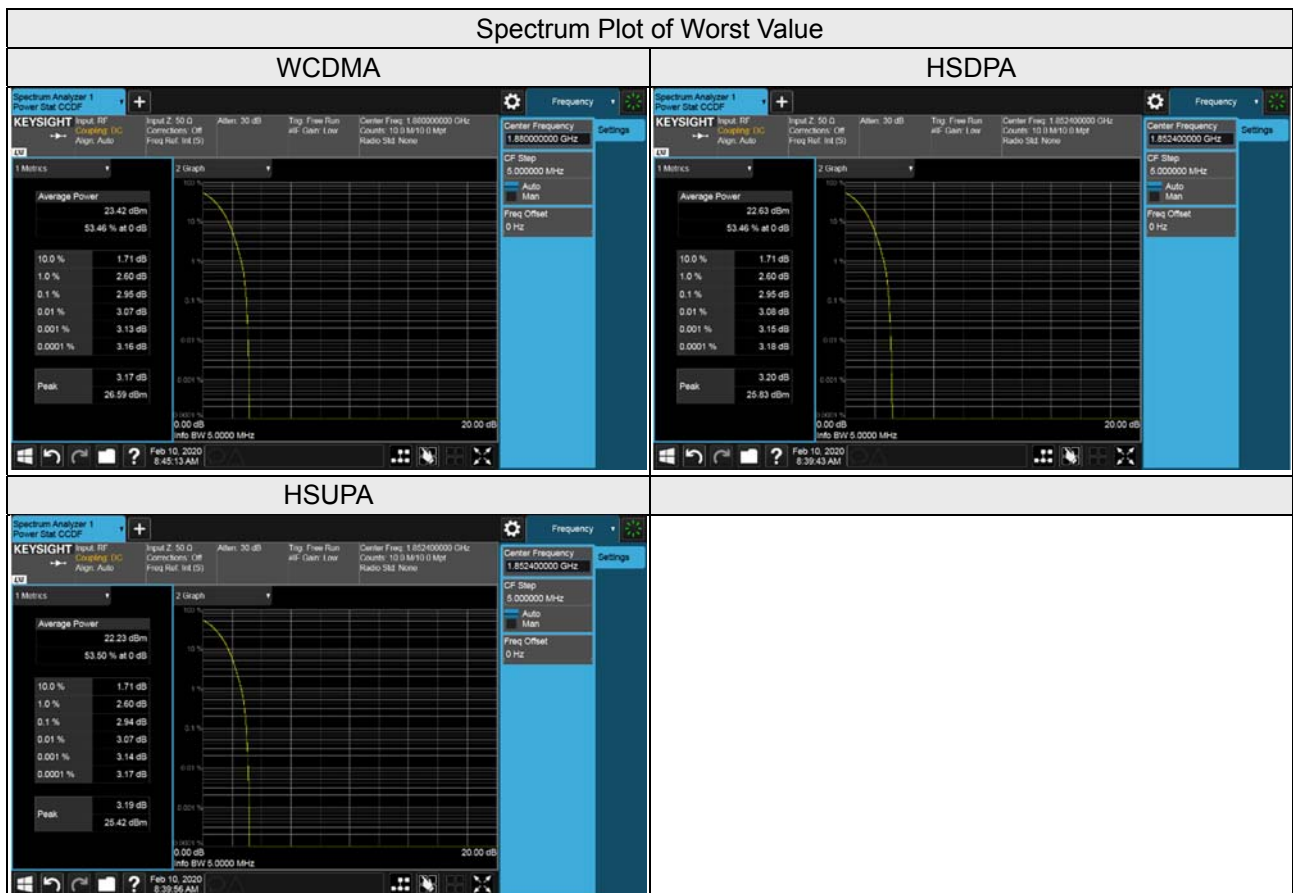

LTE Band 2, Channel Bandwidth 1.4MHz				
Channel	Frequency (MHz)	Peak To Average Ratio (dB)		
		QPSK	16QAM	64QAM
18607	1850.7	4.00	5.33	5.58
18900	1880.0	4.04	5.42	5.53
19193	1909.3	3.88	4.82	5.07

LTE Band 2, Channel Bandwidth 3MHz				
Channel	Frequency (MHz)	Peak To Average Ratio (dB)		
		QPSK	16QAM	64QAM
18615	1851.5	3.60	5.46	5.52
18900	1880.0	3.83	5.38	5.45
19185	1908.5	3.71	4.95	5.09

LTE Band 2, Channel Bandwidth 5MHz				
Channel	Frequency (MHz)	Peak To Average Ratio (dB)		
		QPSK	16QAM	64QAM
18625	1852.5	3.74	5.49	5.60
18900	1880.0	3.70	5.48	5.53
19175	1907.5	3.71	4.95	5.00

LTE Band 2, Channel Bandwidth 10MHz				
Channel	Frequency (MHz)	Peak To Average Ratio (dB)		
		QPSK	16QAM	64QAM
18650	1855.0	3.92	5.53	5.51
18900	1880.0	3.87	5.26	5.38
19150	1905.0	3.61	4.32	4.32

LTE Band 2, Channel Bandwidth 15MHz				
Channel	Frequency (MHz)	Peak To Average Ratio (dB)		
		QPSK	16QAM	64QAM
18675	1857.5	3.95	5.41	5.62
18900	1880.0	3.69	5.17	5.34
19125	1902.5	3.35	4.06	4.15

LTE Band 2, Channel Bandwidth 20MHz				
Channel	Frequency (MHz)	Peak To Average Ratio (dB)		
		QPSK	16QAM	64QAM
18700	1860.0	3.75	5.27	5.50
18900	1880.0	3.50	5.10	5.23
19100	1900.0	3.49	4.55	4.63

Spectrum Plot of Worst Value

1.4MHz / 64QAM



3MHz / 64QAM



5MHz / 64QAM

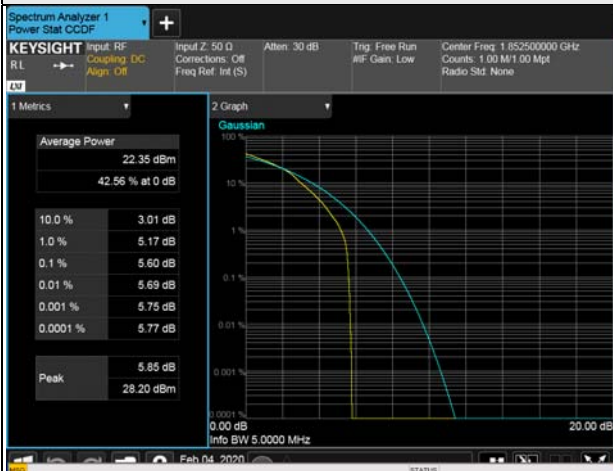

10MHz / 16QAM



15MHz / 64QAM



20MHz / 64QAM



LTE Band 25, Channel Bandwidth 1.4MHz				
Channel	Frequency (MHz)	Peak To Average Ratio (dB)		
		QPSK	16QAM	64QAM
26047	1850.7	3.61	4.42	4.47
26365	1882.5	3.85	4.71	4.77
26683	1914.3	3.69	4.38	4.39

LTE Band 25, Channel Bandwidth 3MHz				
Channel	Frequency (MHz)	Peak To Average Ratio (dB)		
		QPSK	16QAM	64QAM
26055	1851.5	3.53	4.28	4.41
26365	1882.5	3.70	4.87	5.04
26675	1913.5	3.64	4.40	4.35

LTE Band 25, Channel Bandwidth 5MHz				
Channel	Frequency (MHz)	Peak To Average Ratio (dB)		
		QPSK	16QAM	64QAM
26065	1852.5	3.77	4.26	4.43
26365	1882.5	4.03	5.03	5.14
26665	1912.5	3.51	4.34	4.40

LTE Band 25, Channel Bandwidth 10MHz				
Channel	Frequency (MHz)	Peak To Average Ratio (dB)		
		QPSK	16QAM	64QAM
26090	1855.0	4.09	4.53	4.84
26365	1882.5	4.37	5.45	5.45
26640	1910.0	3.97	5.08	5.12

LTE Band 25, Channel Bandwidth 15MHz				
Channel	Frequency (MHz)	Peak To Average Ratio (dB)		
		QPSK	16QAM	64QAM
26115	1857.5	3.98	4.73	4.83
26365	1882.5	4.16	5.16	5.39
26615	1907.5	3.64	4.39	4.51

LTE Band 25, Channel Bandwidth 20MHz				
Channel	Frequency (MHz)	Peak To Average Ratio (dB)		
		QPSK	16QAM	64QAM
26140	1860.0	3.74	4.34	4.01
26365	1882.5	3.84	5.20	5.57
26590	1905.0	3.58	4.22	4.48

Spectrum Plot of Worst Value

1.4MHz / 64QAM



3MHz / 64QAM



5MHz / 64QAM



10MHz / 64QAM



15MHz / 64QAM



20MHz / 64QAM



4.7 Conducted Spurious Emissions

4.7.1 Limits of Conducted Spurious Emissions Measurement

The power of any emission outside of the authorized operating frequency ranges must be attenuated below the transmitting power (P) by a factor of at least $43 + 10 \log(P)$ dB. The emission limit equal to -13dBm .

4.7.2 Test Setup

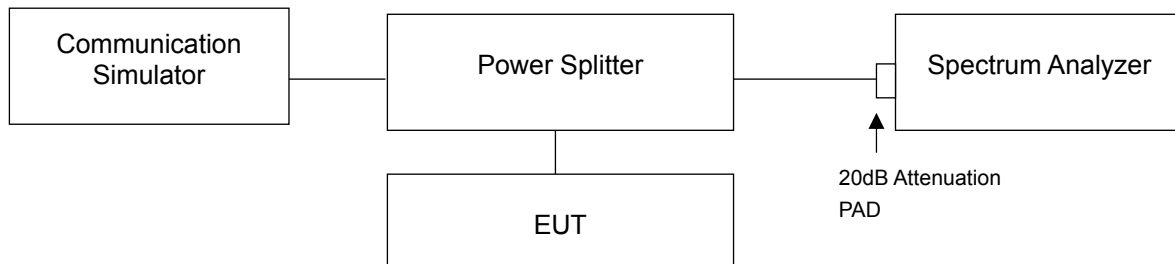

4.7.3 Test Procedure

- The EUT makes a phone call to the communication simulator. All measurements were done at low, middle and high operational frequency range.
- Measuring frequency range is from 9kHz to 26.5GHz or 27GHz. 20dB attenuation pad is connected with spectrum. RBW=1MHz and VBW=3MHz is used for conducted emission measurement.

4.7.4 Test Results



WCDMA

Channel 9400 (1880.0MHz)

Frequency Range : 9kHz~1GHz

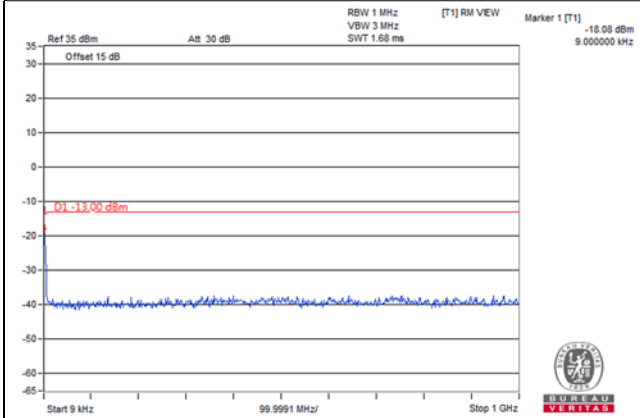

Frequency Range : 1GHz~10GHz

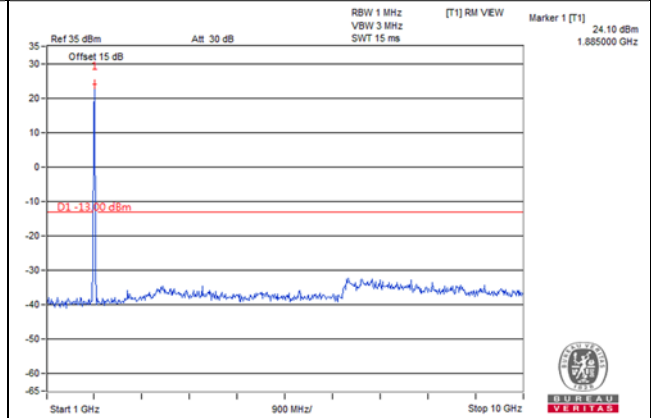

Frequency Range : 10GHz~26.5GHz

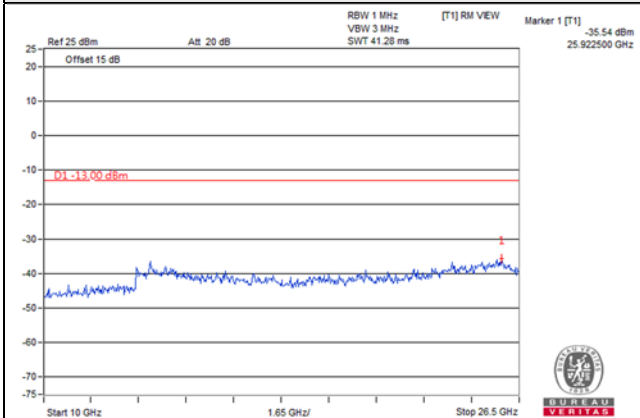

WCDMA

Channel 9538 (1907.6MHz)

Frequency Range : 9kHz~1GHz

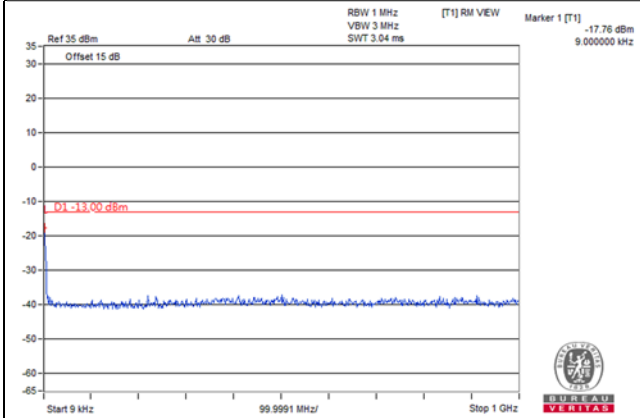

Frequency Range : 1GHz~10GHz

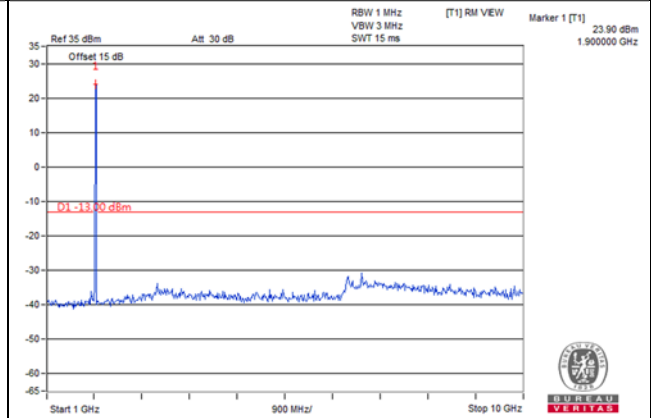

Frequency Range : 10GHz~26.5GHz

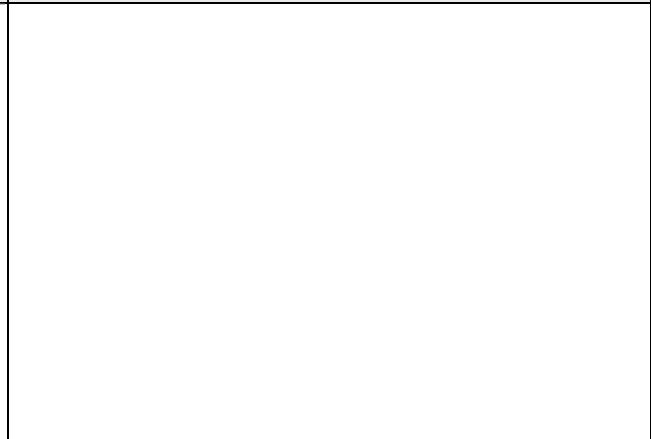
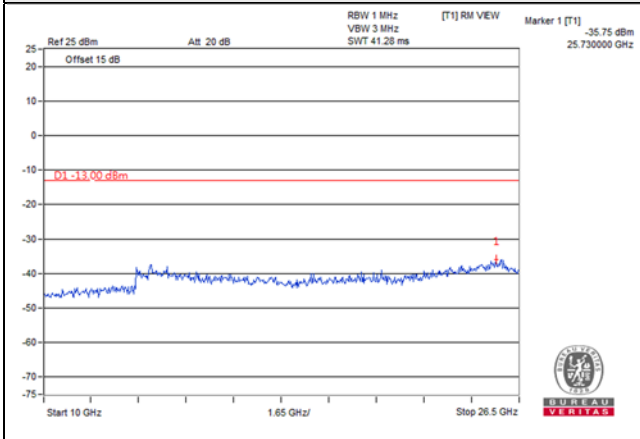

HSDPA

Channel 9262 (1852.4MHz)

Frequency Range : 9kHz~1GHz

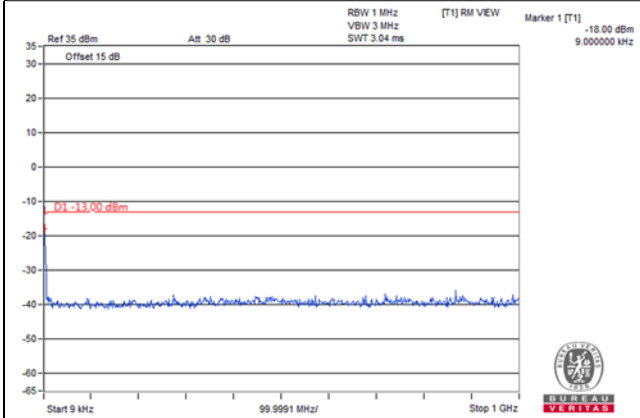

Frequency Range : 1GHz~10GHz

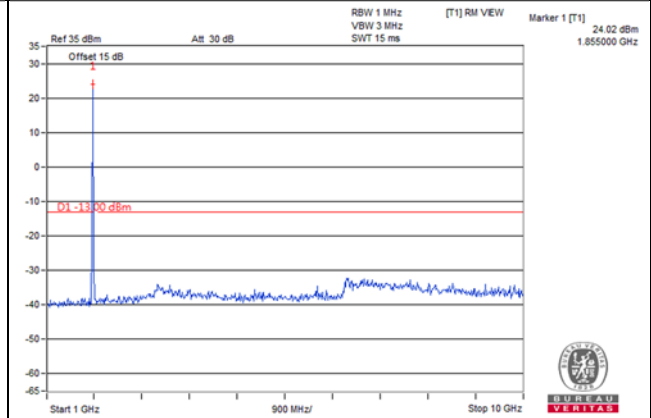

Frequency Range : 10GHz~26.5GHz

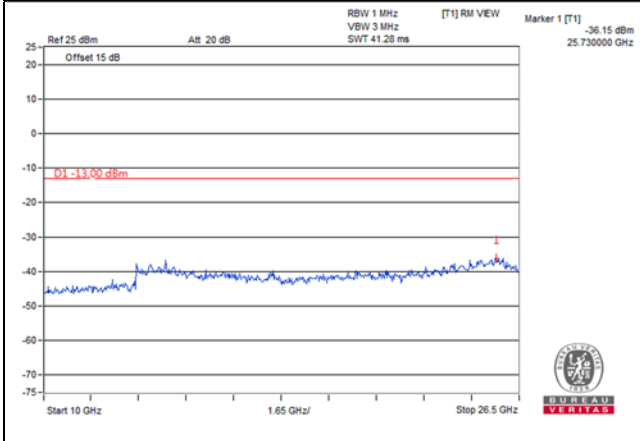

HSDPA

Channel 9400 (1880.0MHz)

Frequency Range : 9kHz~1GHz

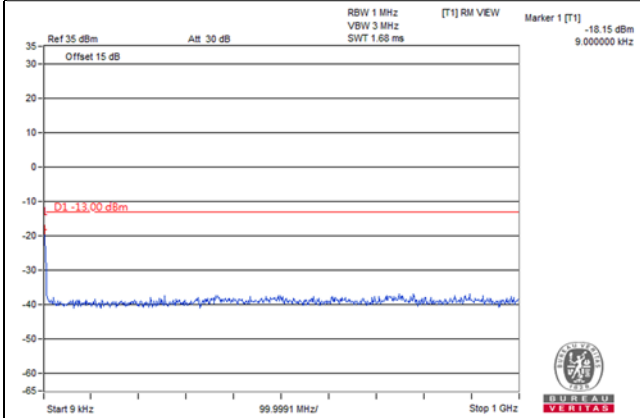

Frequency Range : 1GHz~10GHz

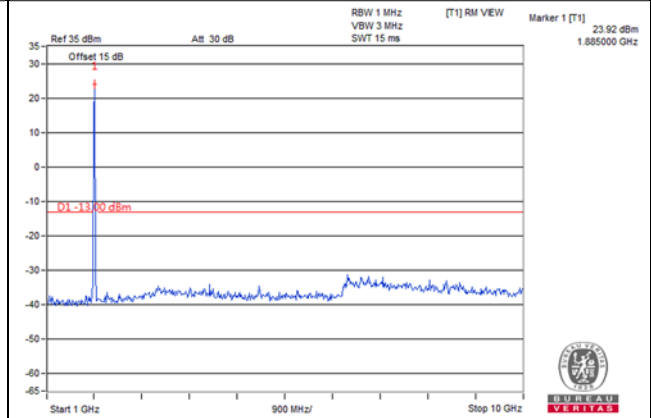

Frequency Range : 10GHz~26.5GHz

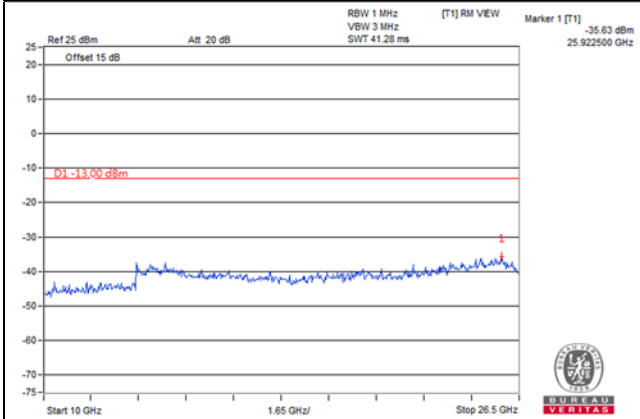

HSDPA

Channel 9538 (1907.6MHz)

Frequency Range : 9kHz~1GHz

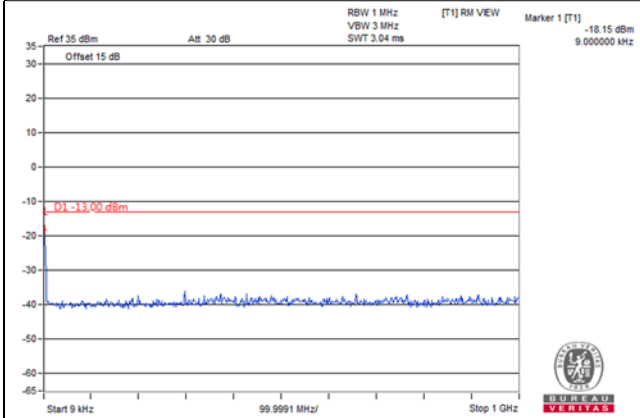

Frequency Range : 1GHz~10GHz

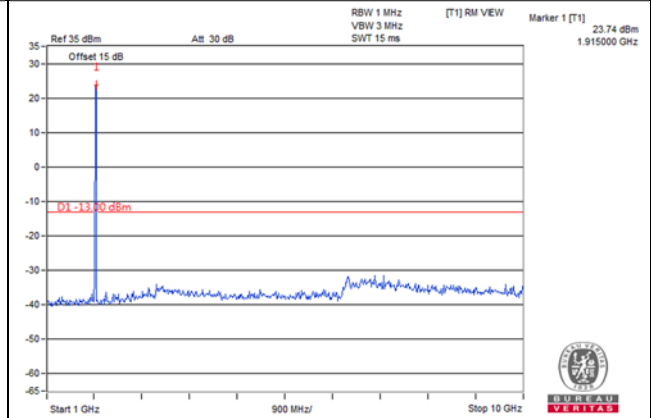

Frequency Range : 10GHz~26.5GHz

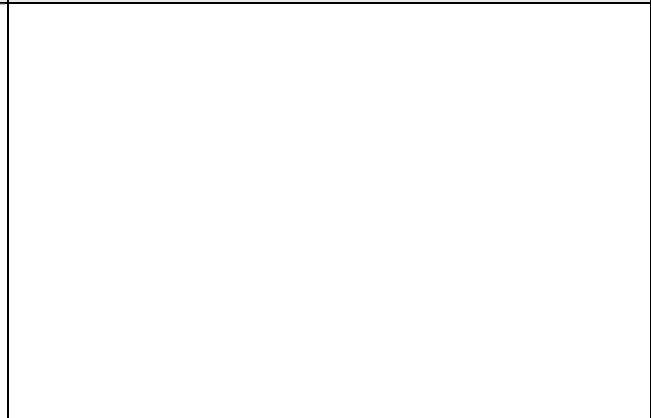
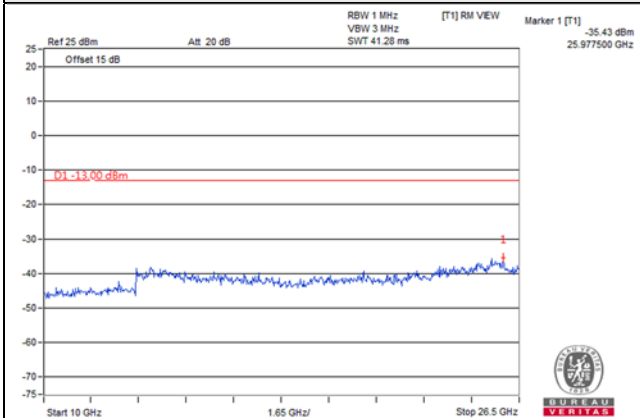

HSUPA

Channel 9262 (1852.4MHz)

Frequency Range : 9kHz~1GHz

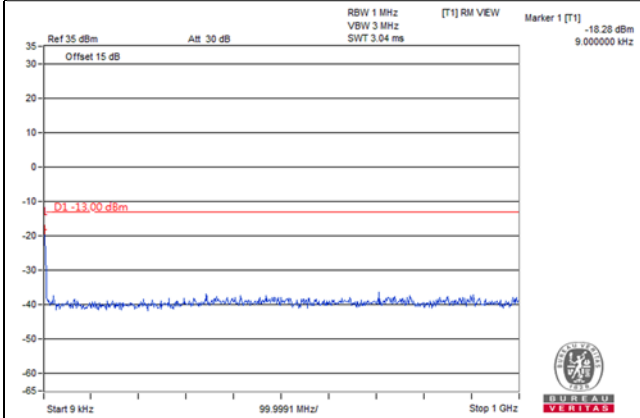

Frequency Range : 1GHz~10GHz

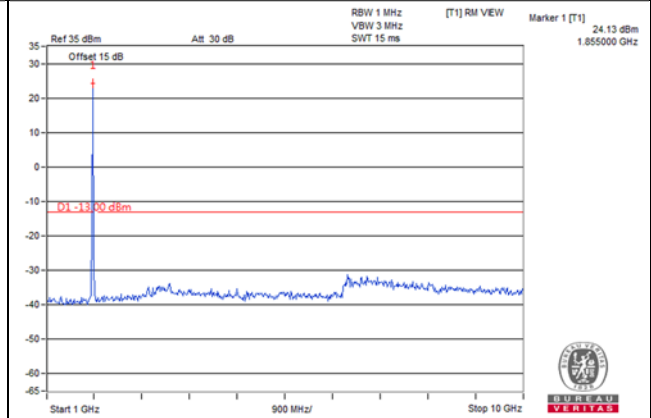

Frequency Range : 10GHz~26.5GHz

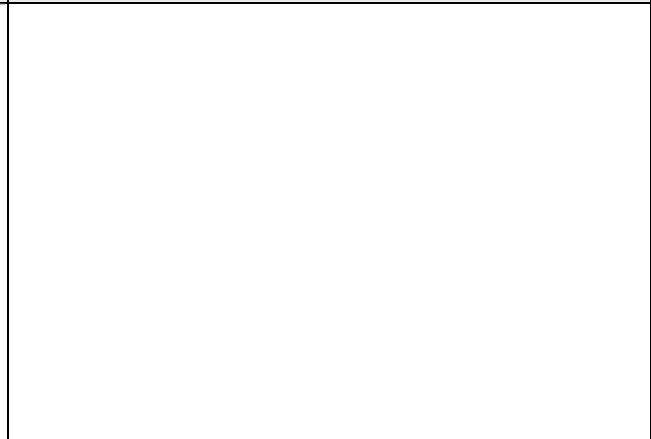
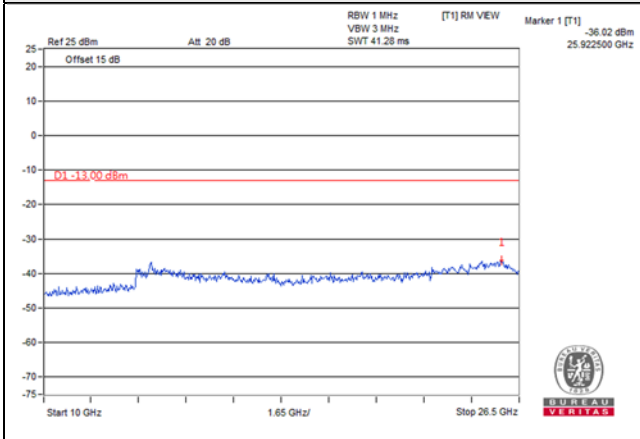

HSUPA

Channel 9400 (1880.0MHz)

Frequency Range : 9kHz~1GHz

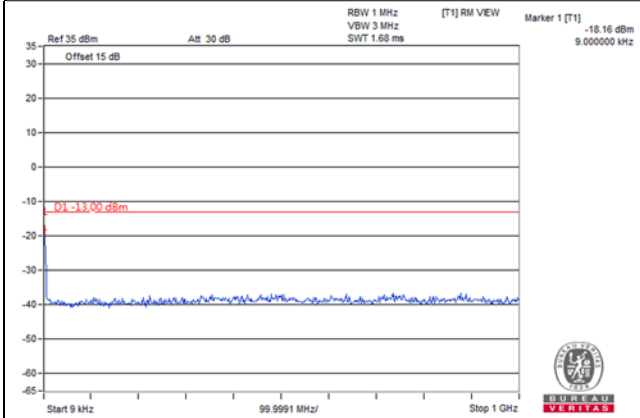

Frequency Range : 1GHz~10GHz

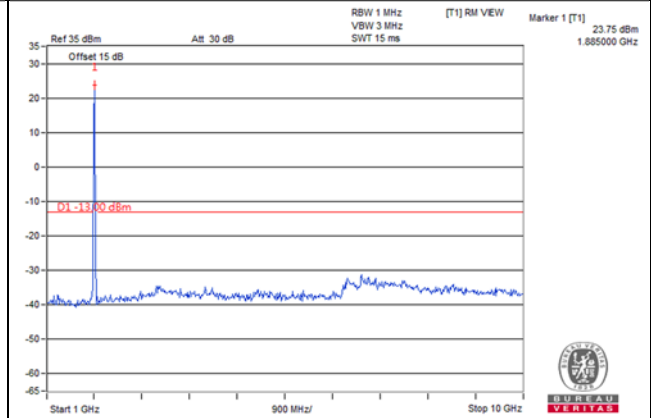

Frequency Range : 10GHz~26.5GHz

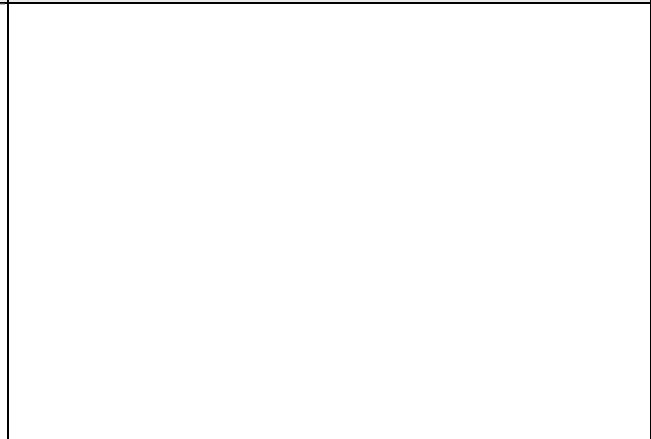
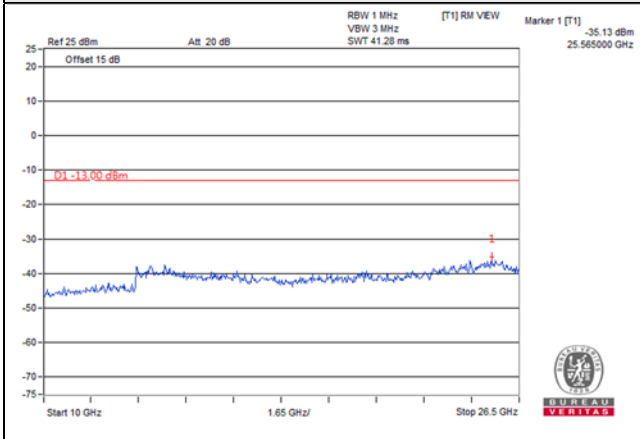

HSUPA

Channel 9538 (1907.6MHz)

Frequency Range : 9kHz~1GHz

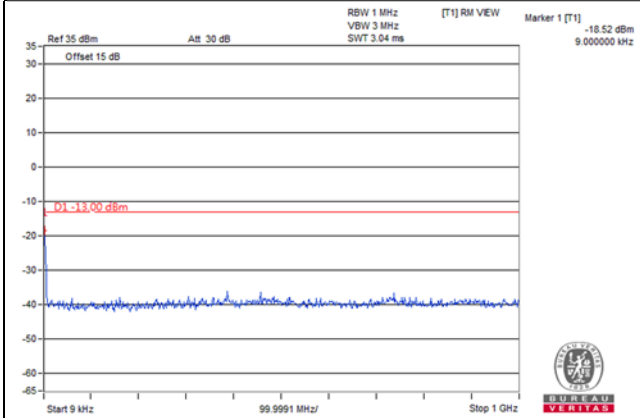

Frequency Range : 1GHz~10GHz

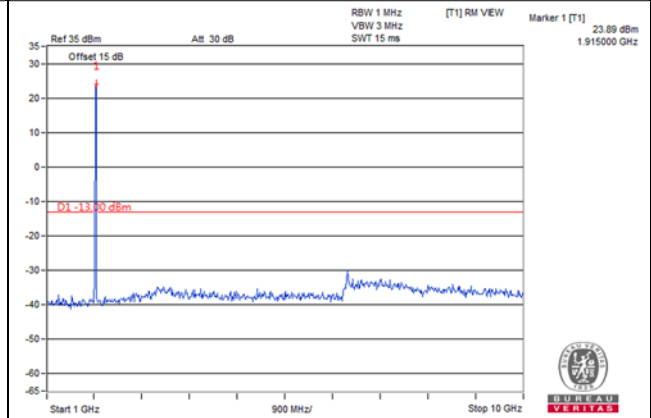

Frequency Range : 10GHz~26.5GHz

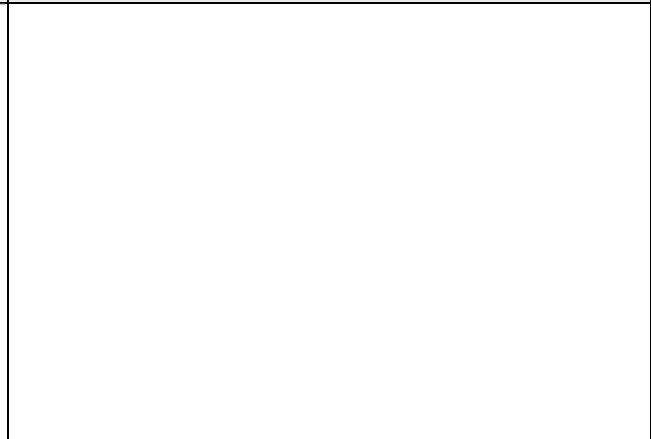
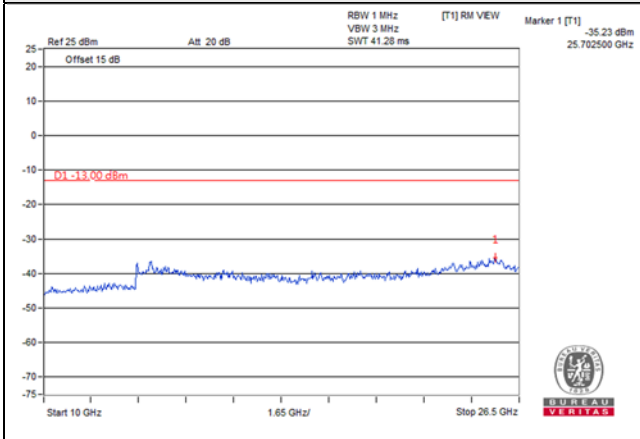

LTE Band 2, Channel Bandwidth 1.4MHz

Channel 18607 (1850.70MHz)

Frequency Range : 9kHz~1GHz

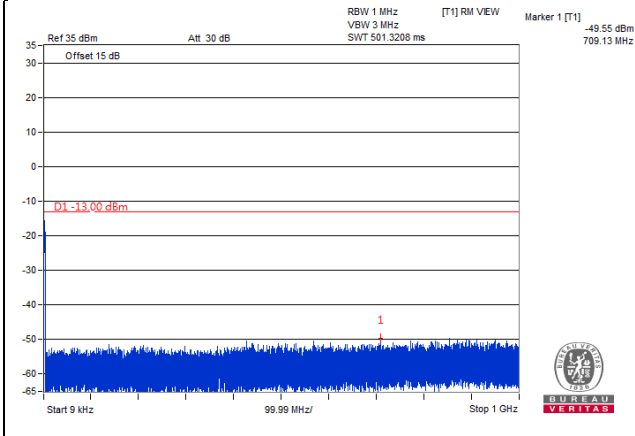

Frequency Range : 1GHz~20GHz

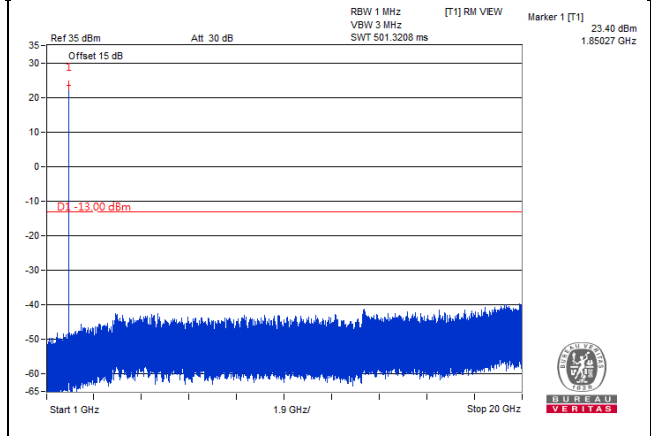

Channel 18900 (1880.00MHz)

Frequency Range : 9kHz~1GHz

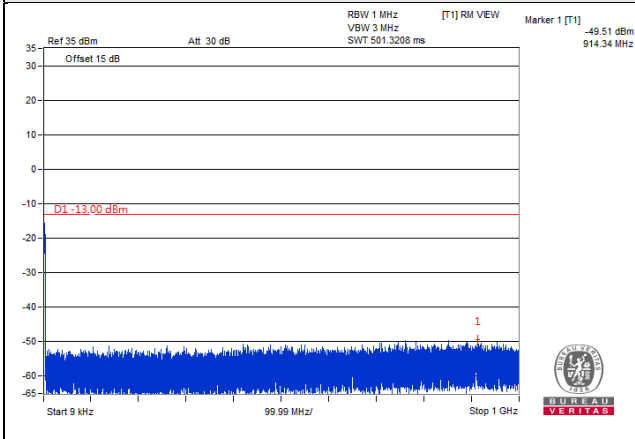

Frequency Range : 1GHz~20GHz

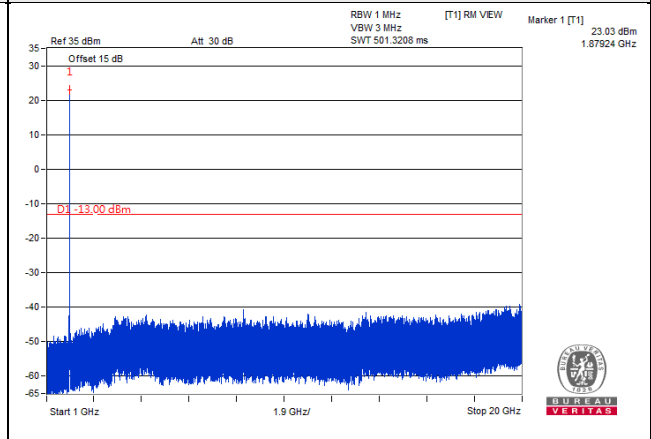

Channel 19193 (1909.30MHz)

Frequency Range : 9kHz~1GHz

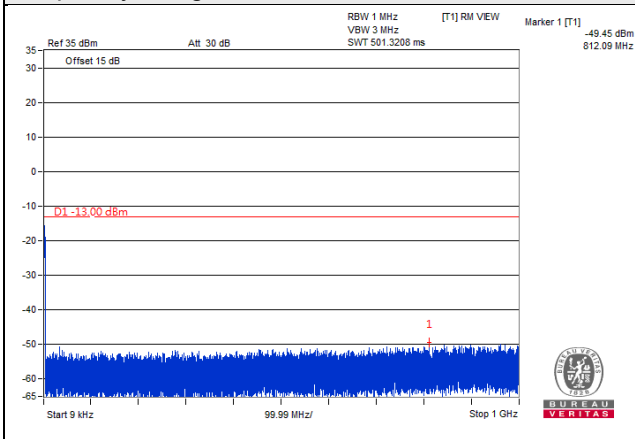

Frequency Range : 1GHz~20GHz

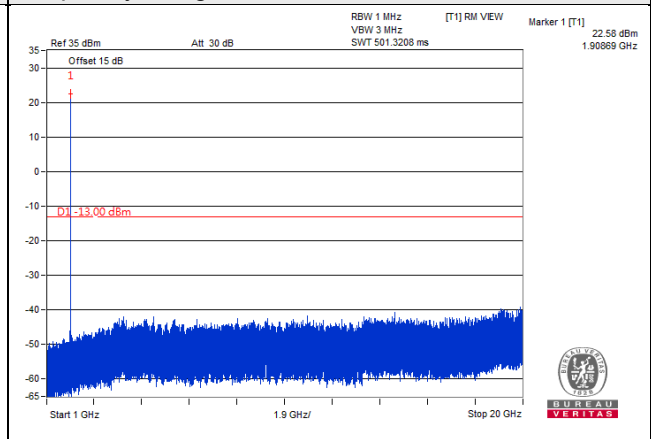

LTE Band 2, Channel Bandwidth 3MHz

Channel 18615 (1851.50MHz)

Frequency Range : 9kHz~1GHz

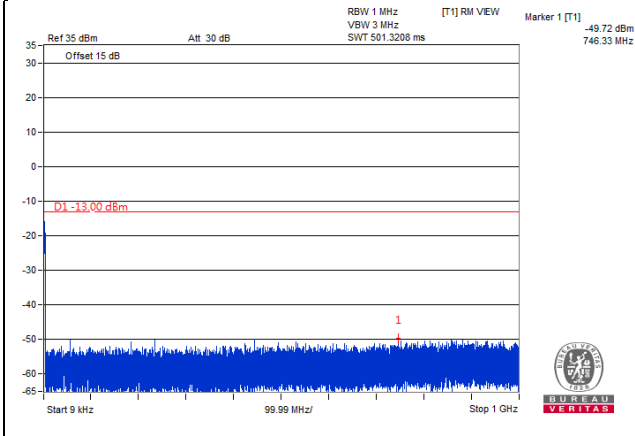

Frequency Range : 1GHz~20GHz

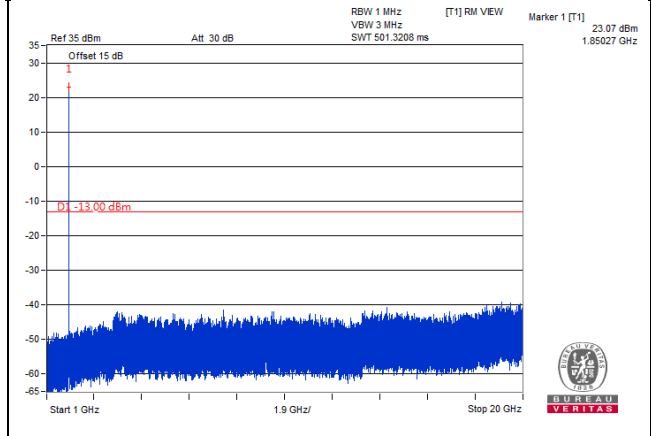

Channel 18900 (1880.00MHz)

Frequency Range : 9kHz~1GHz

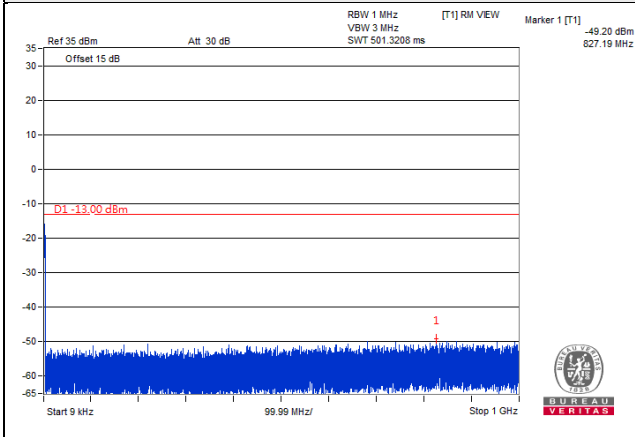

Frequency Range : 1GHz~20GHz

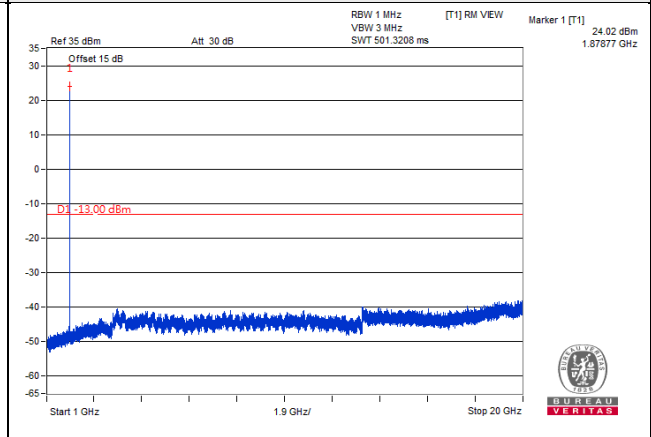

Channel 19185 (1908.50MHz)

Frequency Range : 9kHz~1GHz

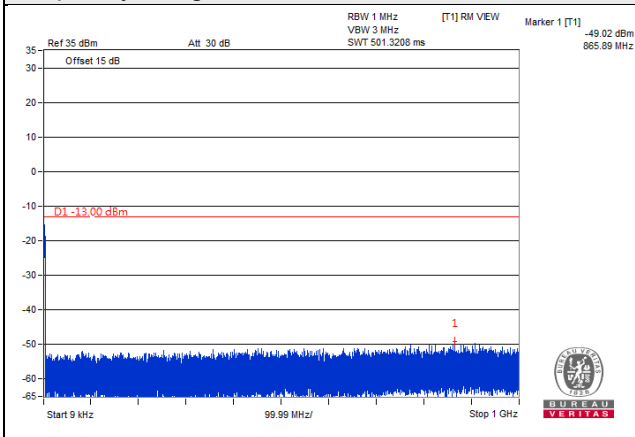

Frequency Range : 1GHz~20GHz

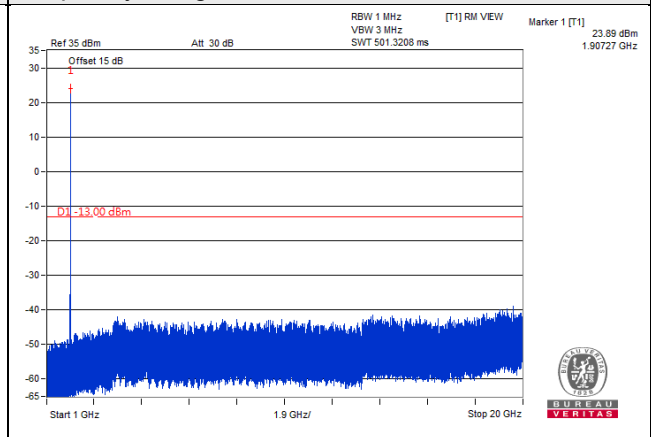

LTE Band 2, Channel Bandwidth 5MHz

Channel 18625 (1852.50MHz)

Frequency Range : 9kHz~1GHz

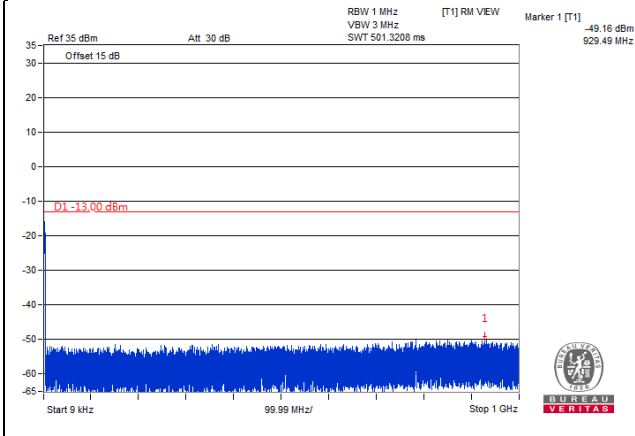

Frequency Range : 1GHz~20GHz

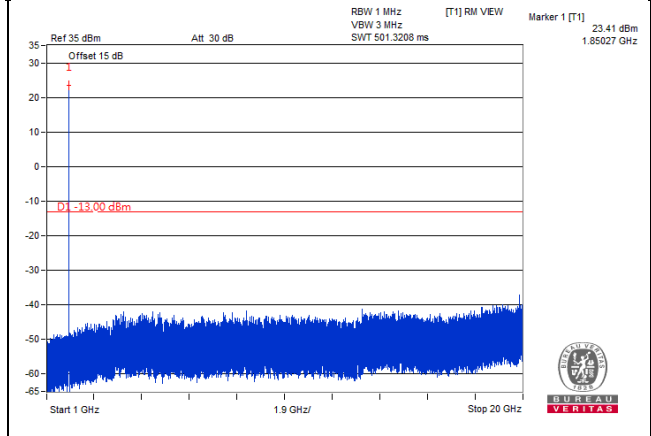

Channel 18900 (1880.00MHz)

Frequency Range : 9kHz~1GHz

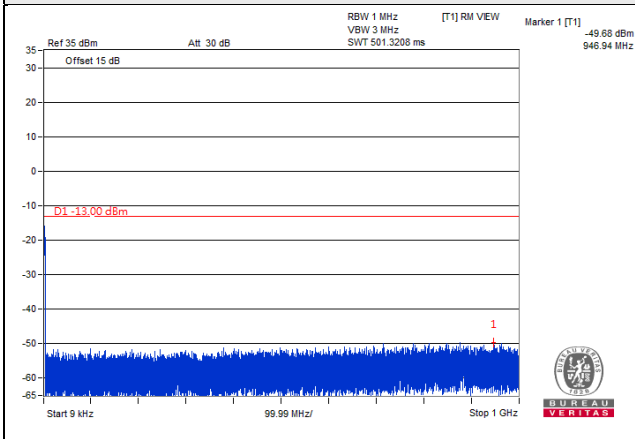

Frequency Range : 1GHz~20GHz

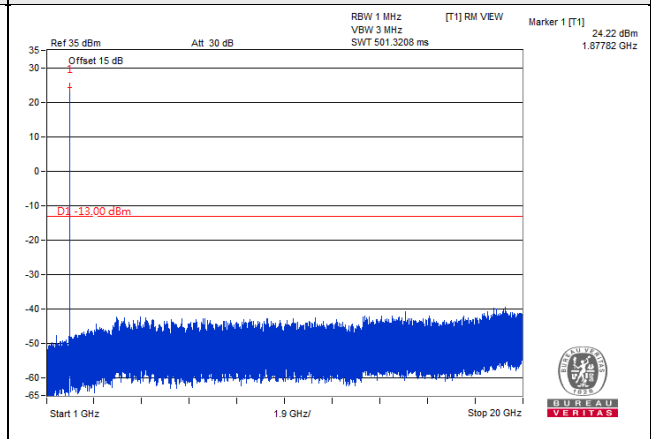

Channel 19175 (1907.50MHz)

Frequency Range : 9kHz~1GHz

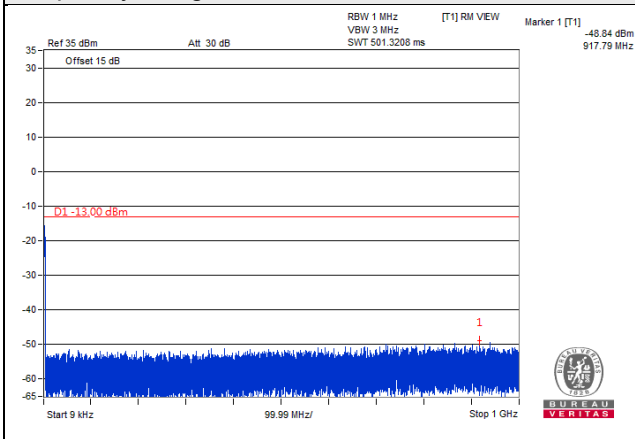

Frequency Range : 1GHz~20GHz

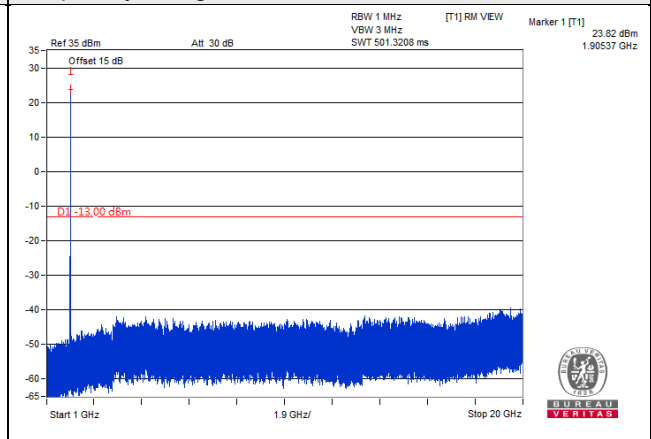

LTE Band 2, Channel Bandwidth 10MHz

Channel 18650 (1855.00MHz)

Frequency Range : 9kHz~1GHz

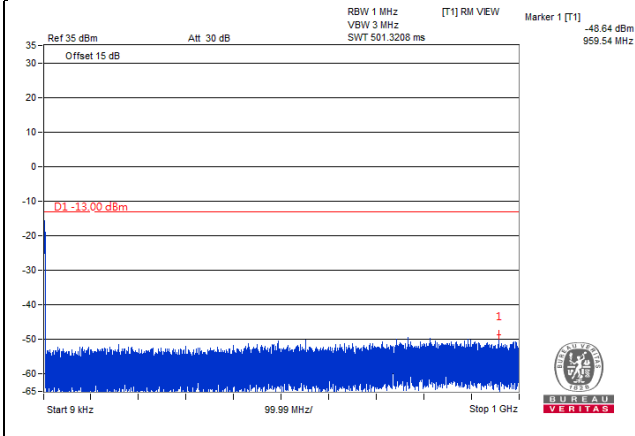

Frequency Range : 1GHz~20GHz

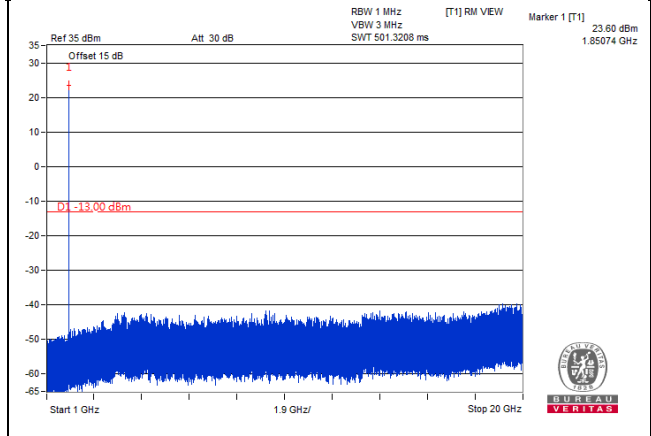

Channel 18900 (1880.00MHz)

Frequency Range : 9kHz~1GHz

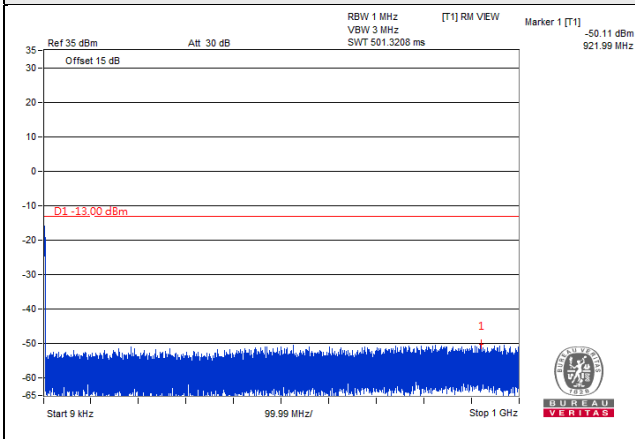

Frequency Range : 1GHz~20GHz

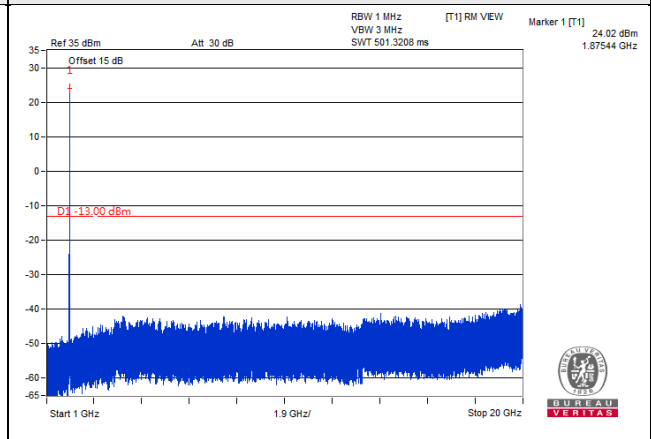

Channel 19150 (1905.00MHz)

Frequency Range : 9kHz~1GHz

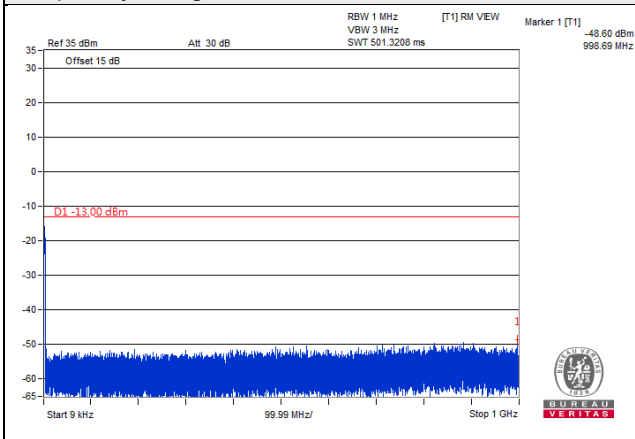

Frequency Range : 1GHz~20GHz

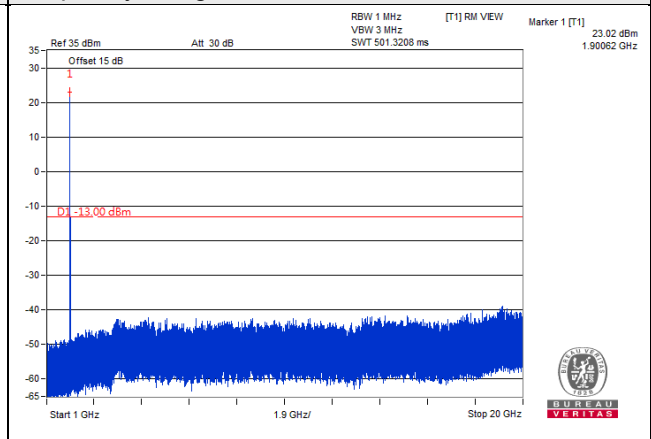

LTE Band 2, Channel Bandwidth 15MHz

Channel 18675 (1857.50MHz)

Frequency Range : 9kHz~1GHz

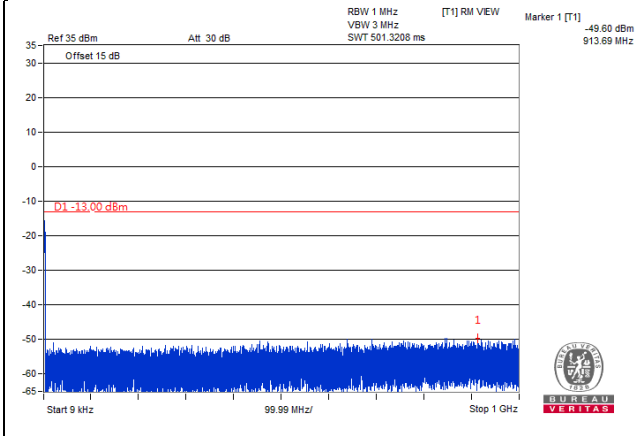

Frequency Range : 1GHz~20GHz

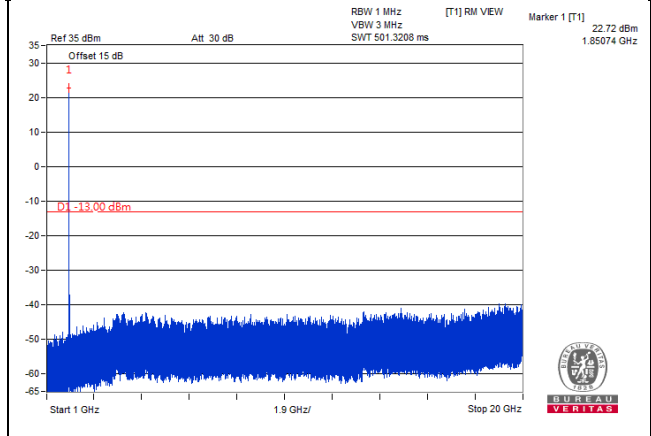

Channel 18900 (1880.00MHz)

Frequency Range : 9kHz~1GHz

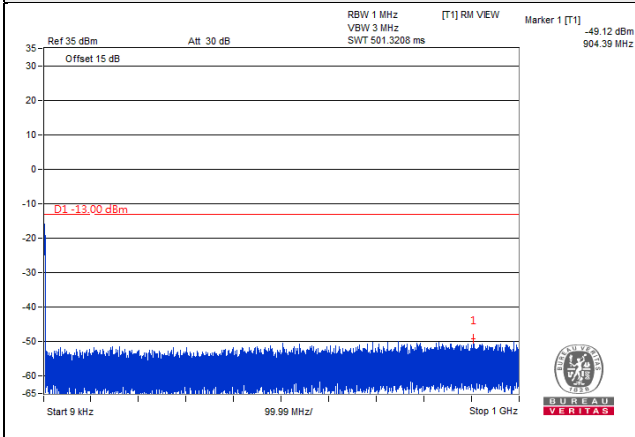

Frequency Range : 1GHz~20GHz

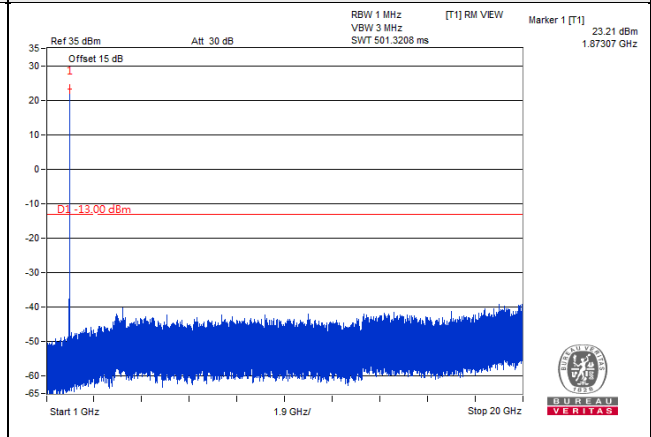

Channel 19125 (1902.50MHz)

Frequency Range : 9kHz~1GHz

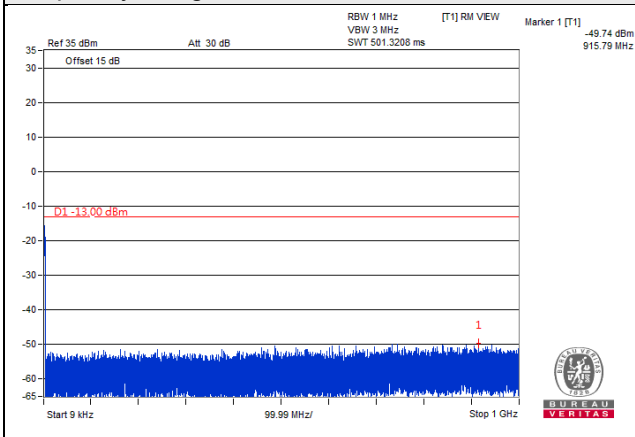

Frequency Range : 1GHz~20GHz

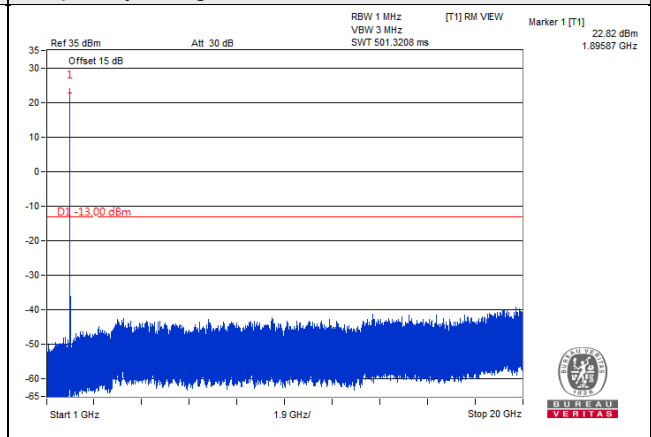

LTE Band 2, Channel Bandwidth 20MHz

Channel 18700 (1860.00MHz)

Frequency Range : 9kHz~1GHz

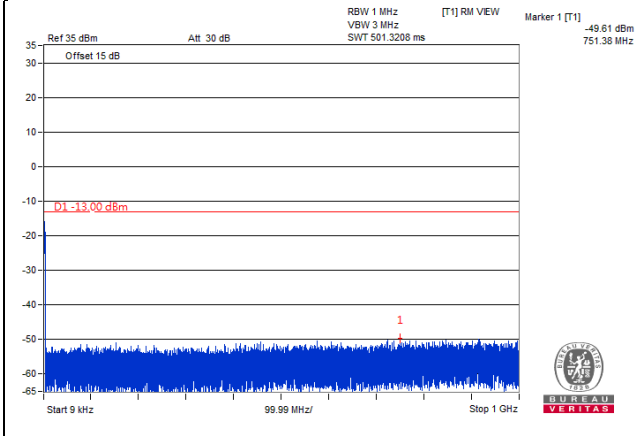

Frequency Range : 1GHz~20GHz

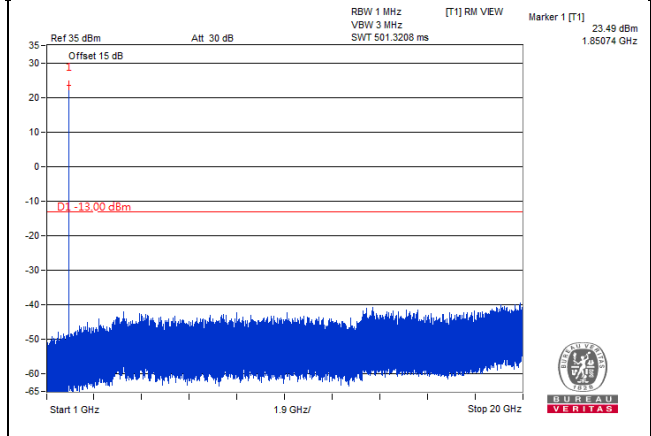

Channel 18900 (1880.00MHz)

Frequency Range : 9kHz~1GHz

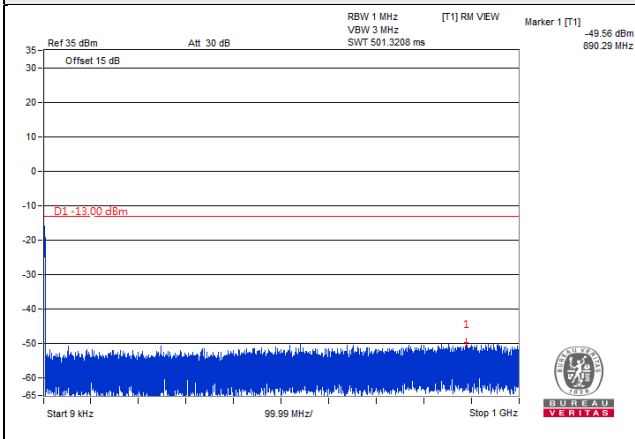

Frequency Range : 1GHz~20GHz

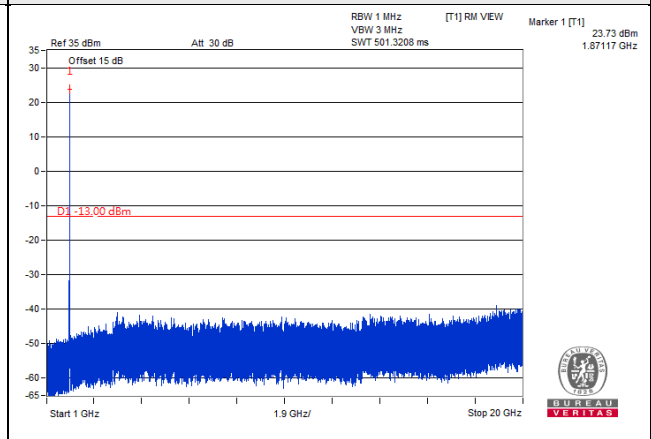

Channel 19100 (1900.00MHz)

Frequency Range : 9kHz~1GHz

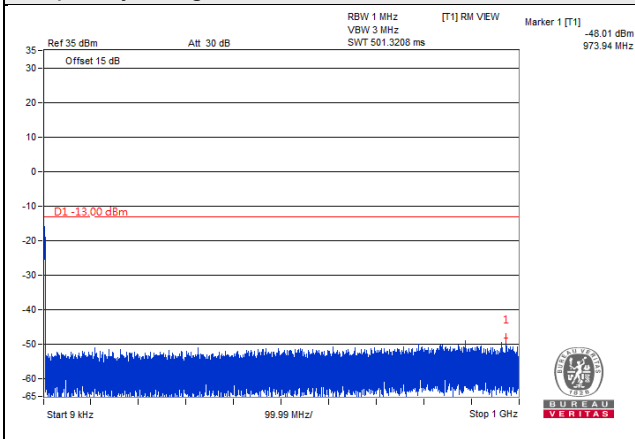

Frequency Range : 1GHz~20GHz

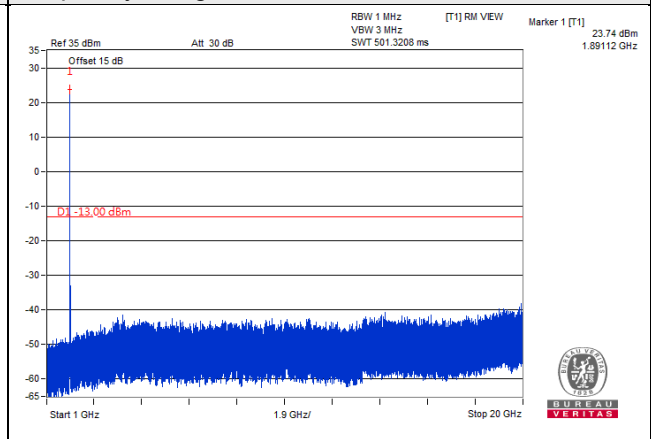

LTE Band 25, Channel Bandwidth 1.4MHz

Channel 26047 (1850.7MHz)

Frequency Range : 9kHz~1GHz

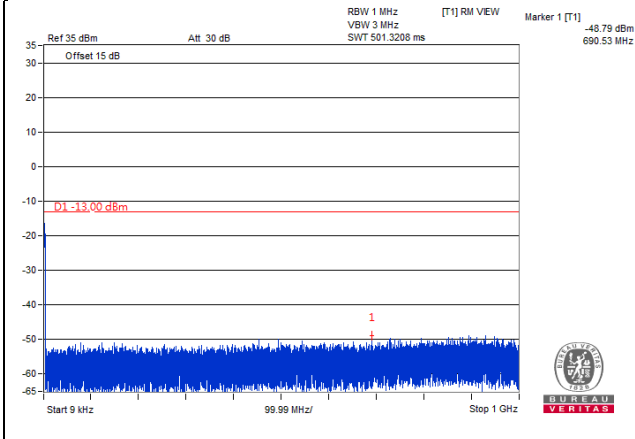

Frequency Range : 1GHz~20GHz

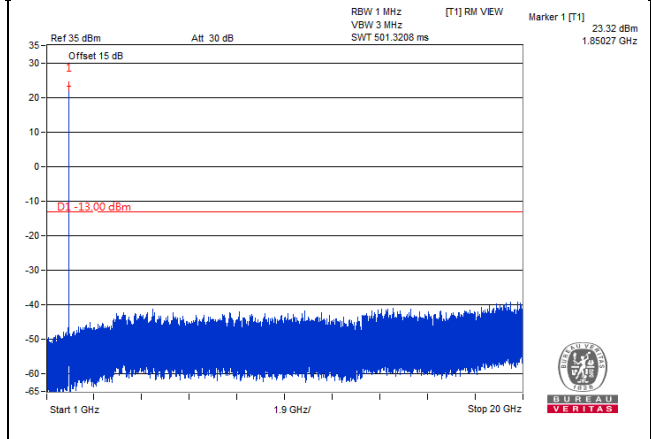

Channel 26365 (1882.5MHz)

Frequency Range : 9kHz~1GHz

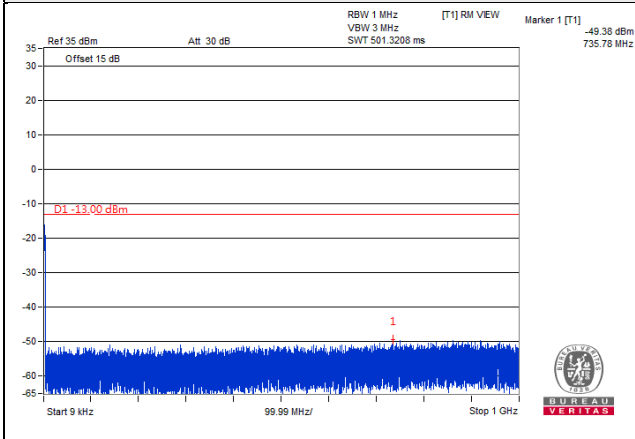

Frequency Range : 1GHz~20GHz

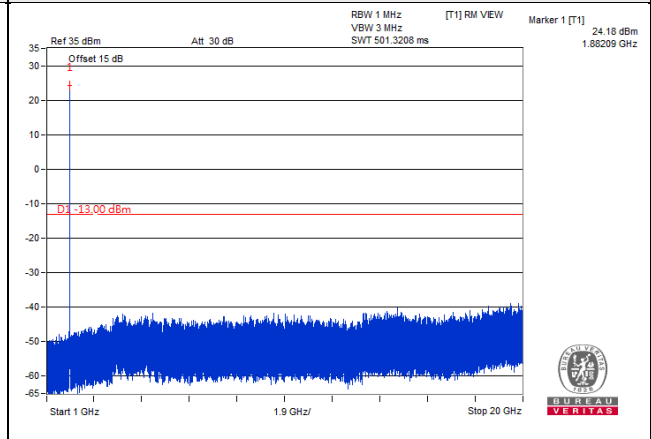

Channel 26683 (1914.3MHz)

Frequency Range : 9kHz~1GHz

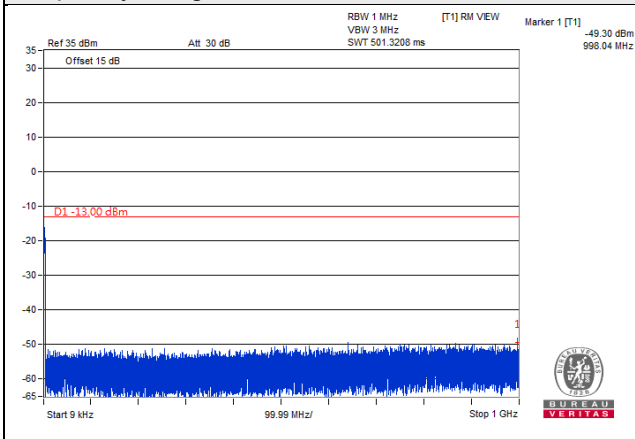

Frequency Range : 1GHz~20GHz

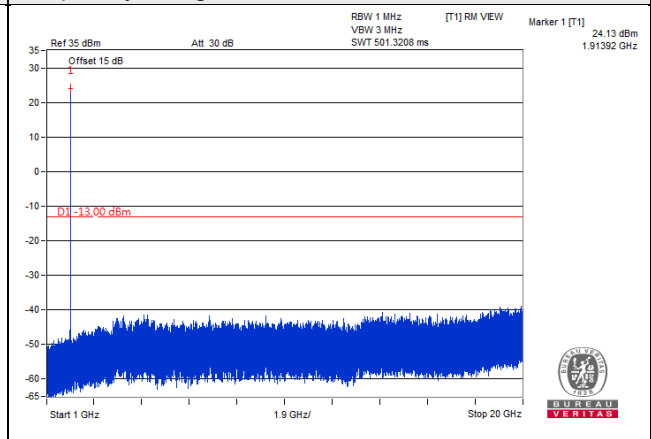

LTE Band 25, Channel Bandwidth 3MHz

Channel 26055 (1851.5MHz)

Frequency Range : 9kHz~1GHz

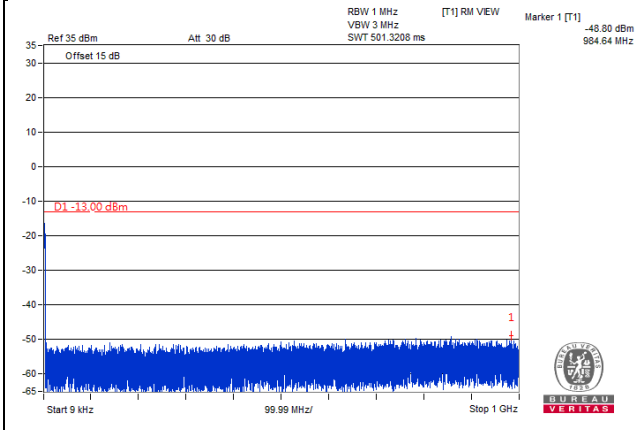

Frequency Range : 1GHz~20GHz

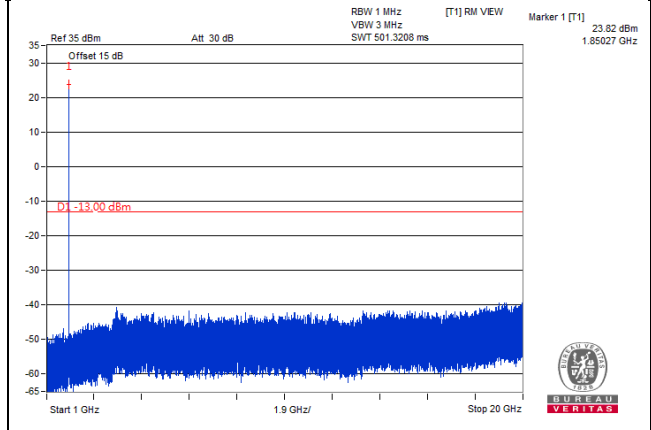

Channel 26365 (1882.5MHz)

Frequency Range : 9kHz~1GHz

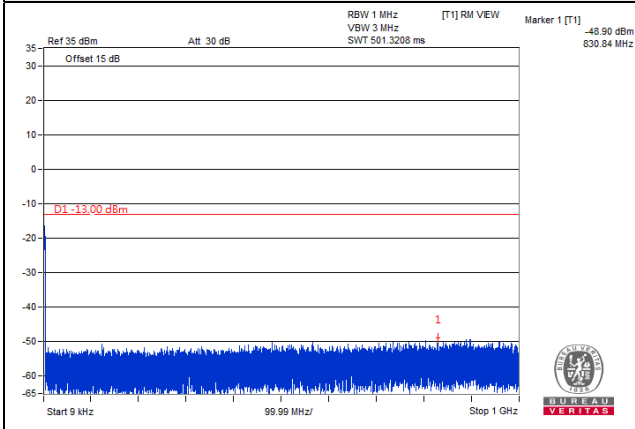

Frequency Range : 1GHz~20GHz

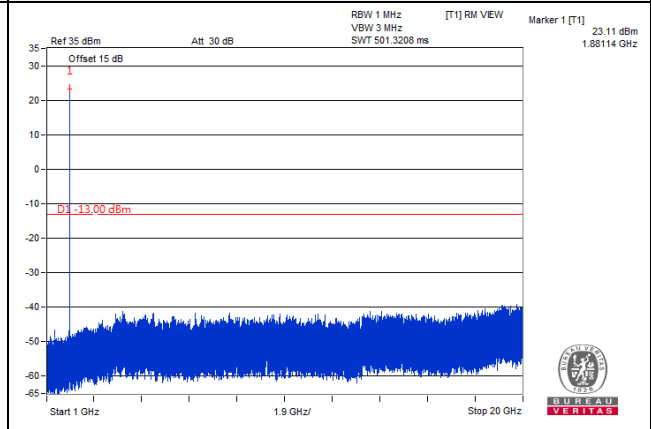

Channel 26675 (1913.5MHz)

Frequency Range : 9kHz~1GHz

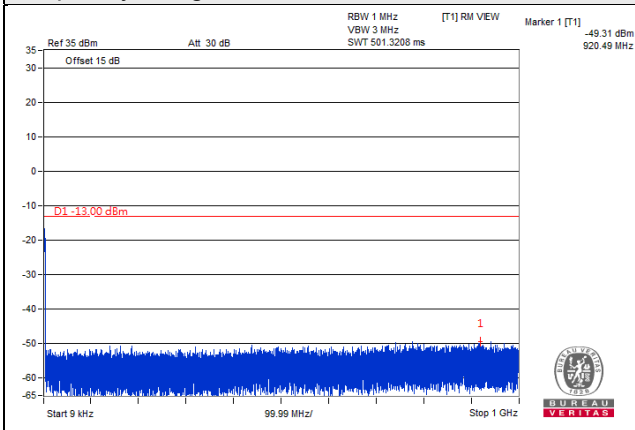

Frequency Range : 1GHz~20GHz

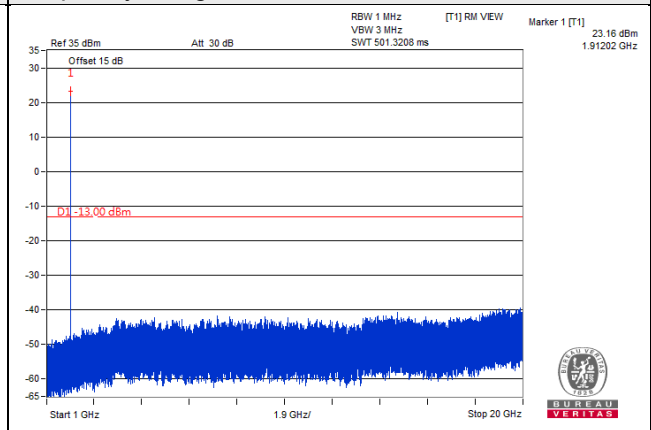

LTE Band 25, Channel Bandwidth 5MHz

Channel 26065 (1852.5MHz)

Frequency Range : 9kHz~1GHz

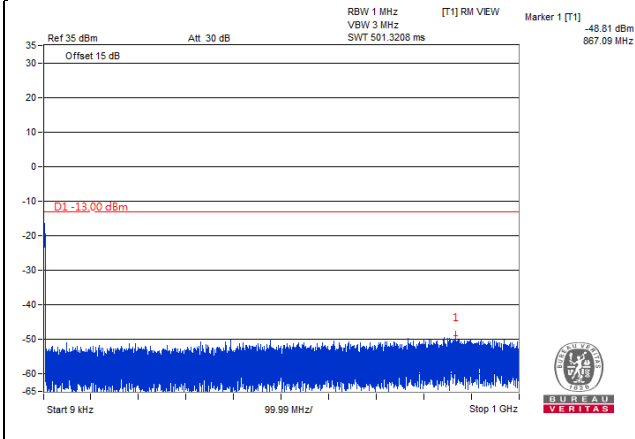

Frequency Range : 1GHz~20GHz

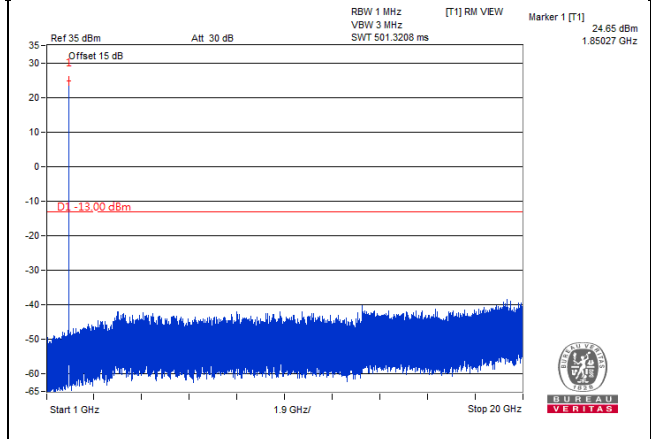

Channel 26365 (1882.5MHz)

Frequency Range : 9kHz~1GHz

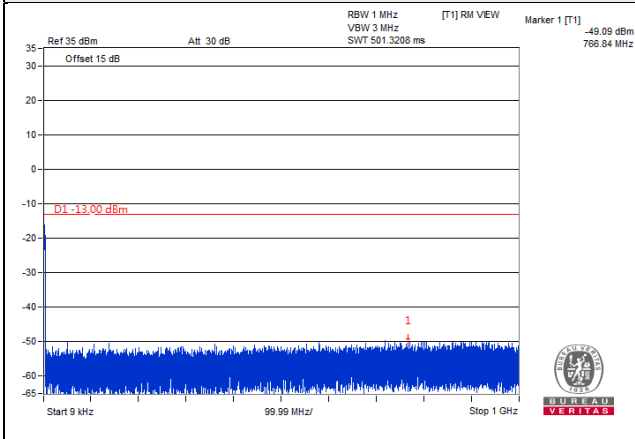

Frequency Range : 1GHz~20GHz

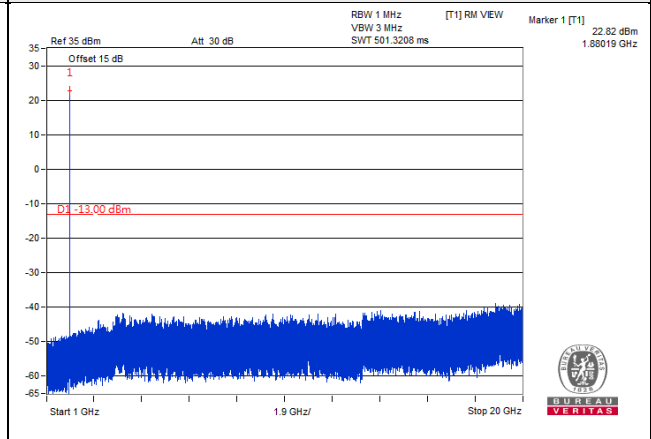

Channel 26665 (1912.5MHz)

Frequency Range : 9kHz~1GHz

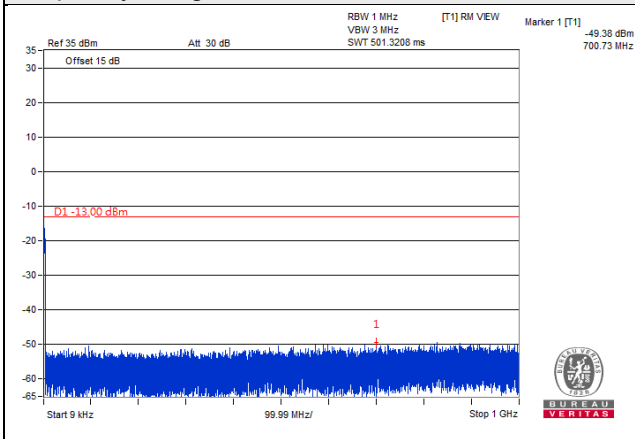

Frequency Range : 1GHz~20GHz

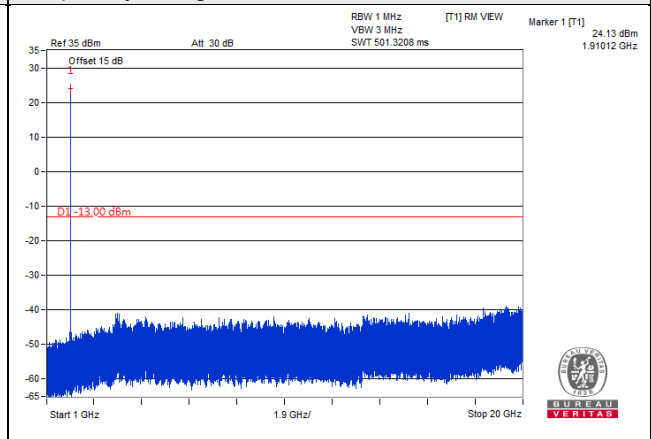

LTE Band 25, Channel Bandwidth 10MHz

Channel 26090 (1855.0MHz)

Frequency Range : 9kHz~1GHz

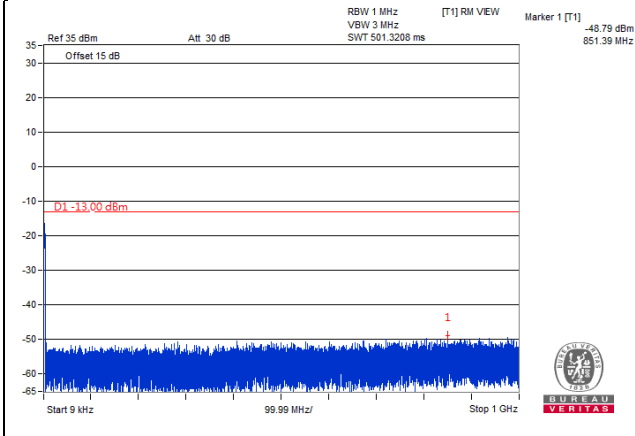

Frequency Range : 1GHz~20GHz

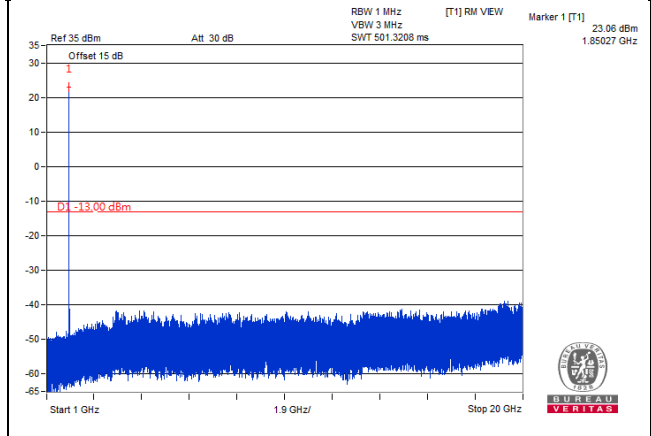

Channel 26365 (1882.5MHz)

Frequency Range : 9kHz~1GHz

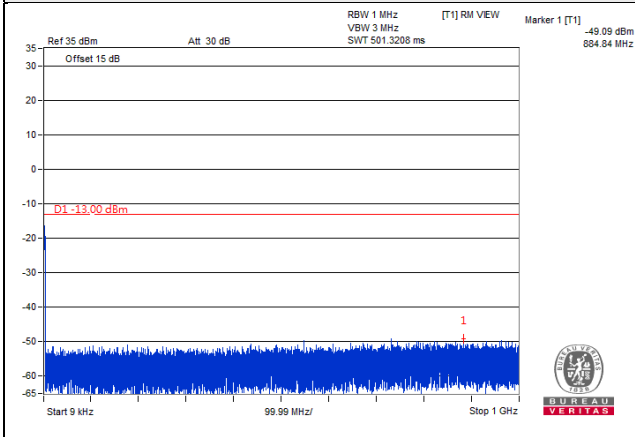

Frequency Range : 1GHz~20GHz

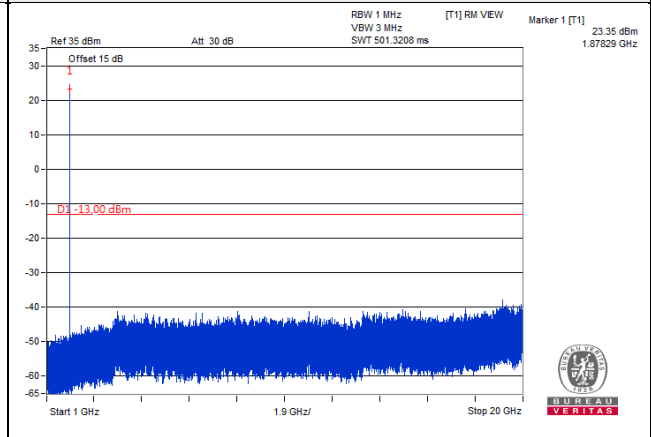

Channel 26640 (1910.0MHz)

Frequency Range : 9kHz~1GHz

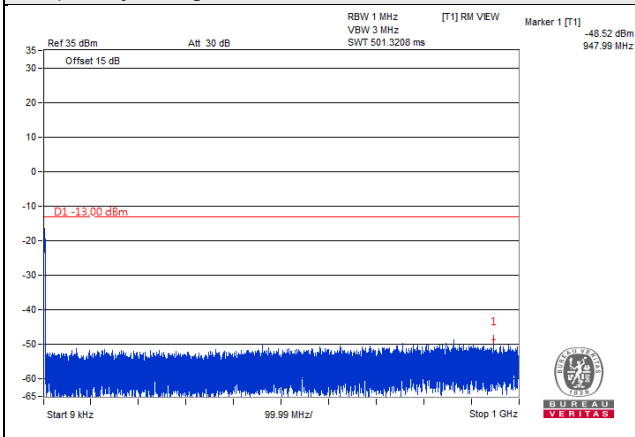

Frequency Range : 1GHz~20GHz

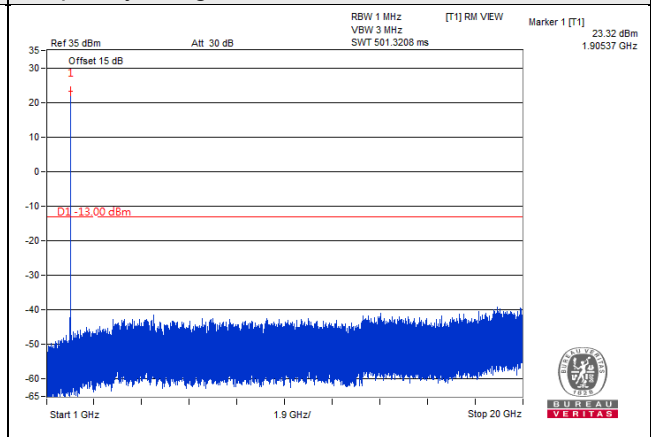

LTE Band 25, Channel Bandwidth 15MHz

Channel 26115 (1857.5MHz)

Frequency Range : 9kHz~1GHz

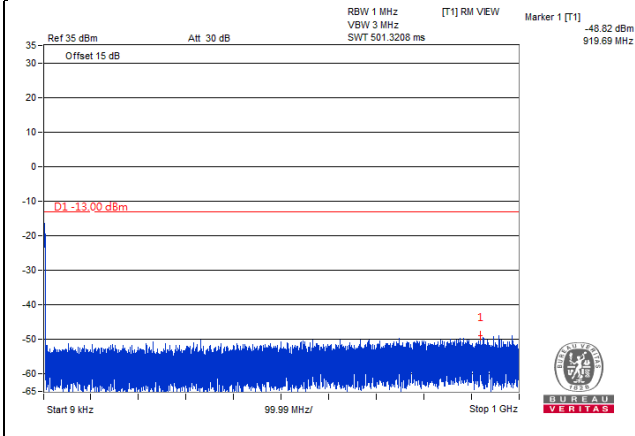

Frequency Range : 1GHz~20GHz

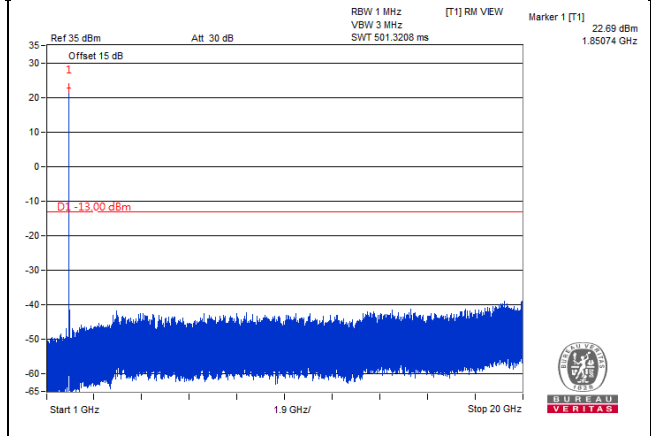

Channel 26365 (1882.5MHz)

Frequency Range : 9kHz~1GHz

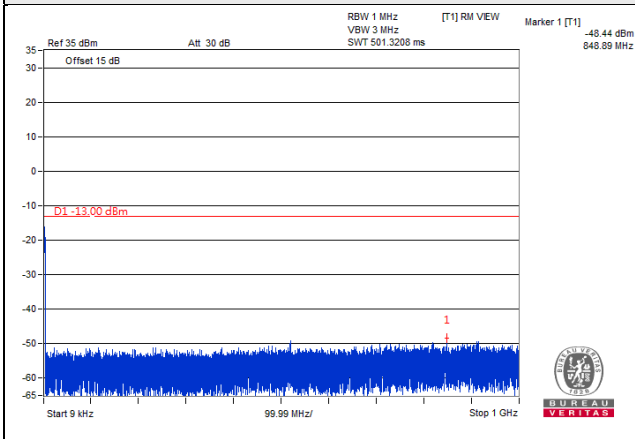

Frequency Range : 1GHz~20GHz

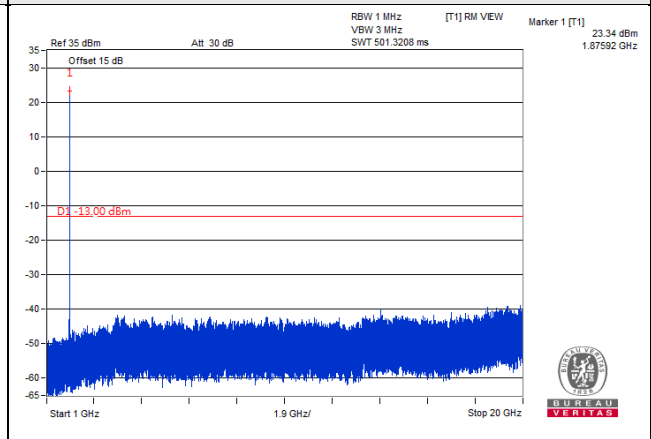

Channel 26615 (1907.5MHz)

Frequency Range : 9kHz~1GHz

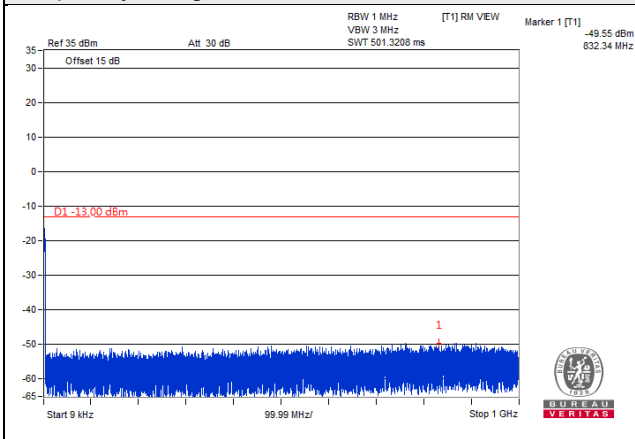

Frequency Range : 1GHz~20GHz

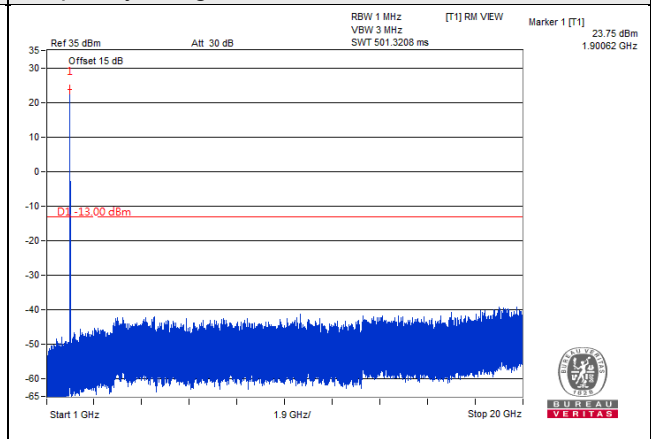

LTE Band 25, Channel Bandwidth 20MHz

Channel 26140 (1860.0MHz)

Frequency Range : 9kHz~1GHz

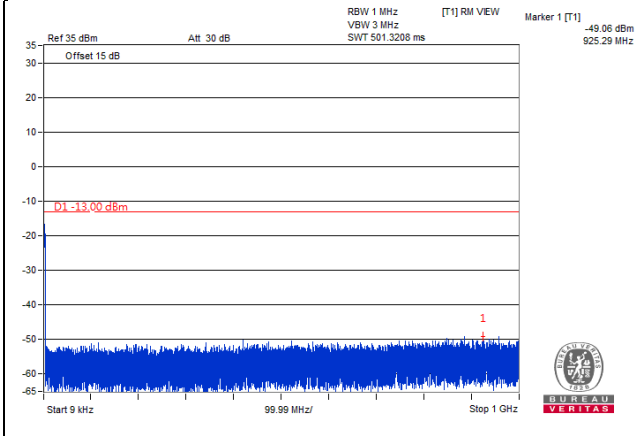

Frequency Range : 1GHz~20GHz

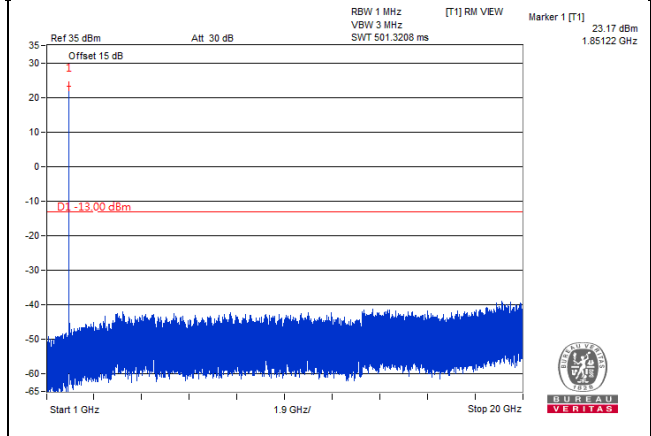

Channel 26365 (1882.5MHz)

Frequency Range : 9kHz~1GHz

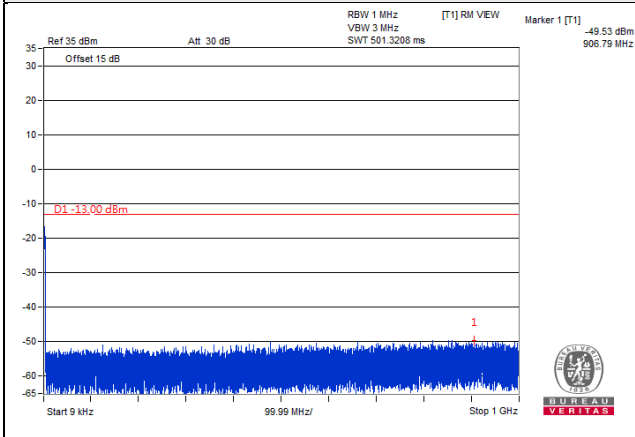

Frequency Range : 1GHz~20GHz

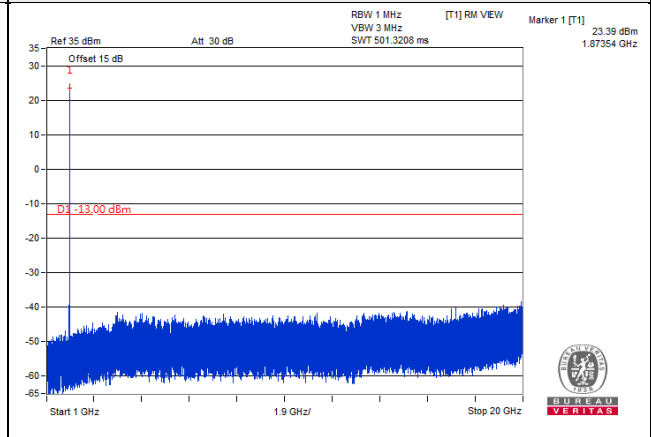

Channel 26590 (1905.0MHz)

Frequency Range : 9kHz~1GHz

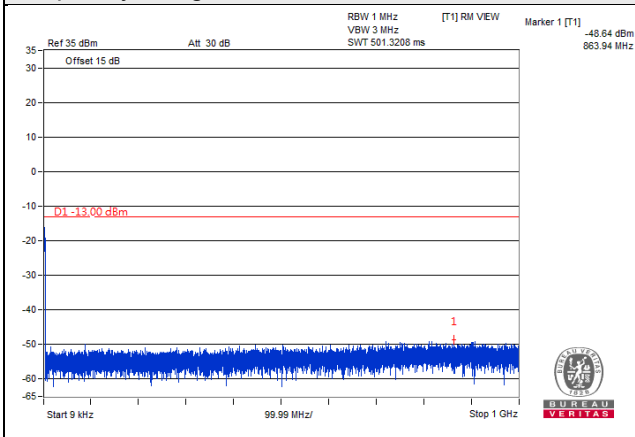

Frequency Range : 1GHz~20GHz

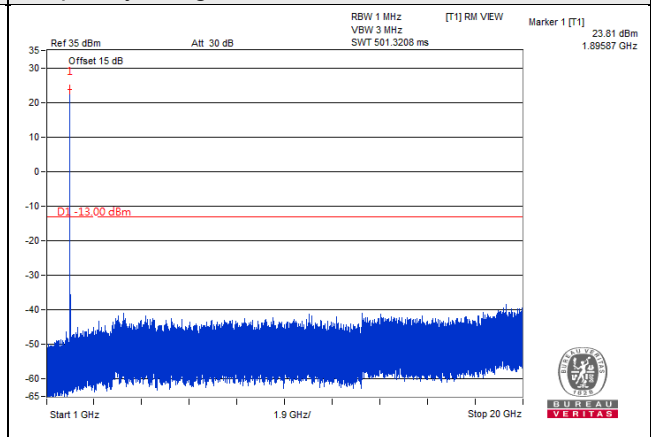

4.8 Radiated Emission Measurement

4.8.1 Limits of Radiated Emission Measurement

The power of any emission outside of the authorized operating frequency ranges must be attenuated below the transmitting power (P) by a factor of at least $43 + 10 \log(P)$ dB. The emission limit equal to -13dBm .

4.8.2 Test Procedure

- a. Substitution method is used for E.I.R.P measurement. In the semi-anechoic chamber, EUT placed on the 0.8m (below or equal 1 GHz) and/or 1.5 m (above 1 GHz) height of Turn Table, rotated the table around 360 degrees to search the maximum radiation power and receiver antenna shall be rotated vertical and horizontal polarization and moved height from 1m to 4m to find the maximum polar radiated power. The "Read Value" is the spectrum reading the maximum power value.
- b. The substitution horn antenna is substituted for EUT at the same position and signals generator export the CW signal to the substitution antenna via a TX cable. Rotated the Turn Table and moved receiving antenna to find the maximum radiation power. Adjust output power level of S.G to get a Value of spectrum reading equal to "Read Value" of step a. Record the power level of S.G
- c. $\text{EIRP} = \text{Output power level of S.G} - \text{TX cable loss} + \text{Antenna gain of substitution horn}$.
- d. E.R.P power can be calculated form E.I.R.P power by subtracting the gain of dipole, $\text{E.R.P power} = \text{E.I.R.P power} - 2.15\text{dBi}$.

NOTE: The resolution bandwidth and video bandwidth of test receiver/spectrum analyzer is 1MHz/3MHz.

4.8.3 Deviation from Test Standard

No deviation.

4.8.4 Test Setup

For radiated emission 30MHz to 1GHz

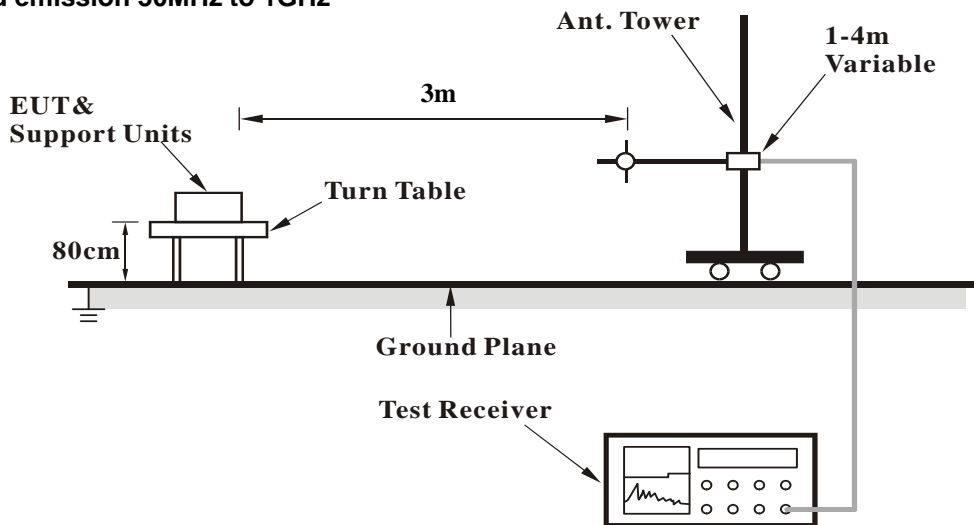

For radiated emission above 1GHz

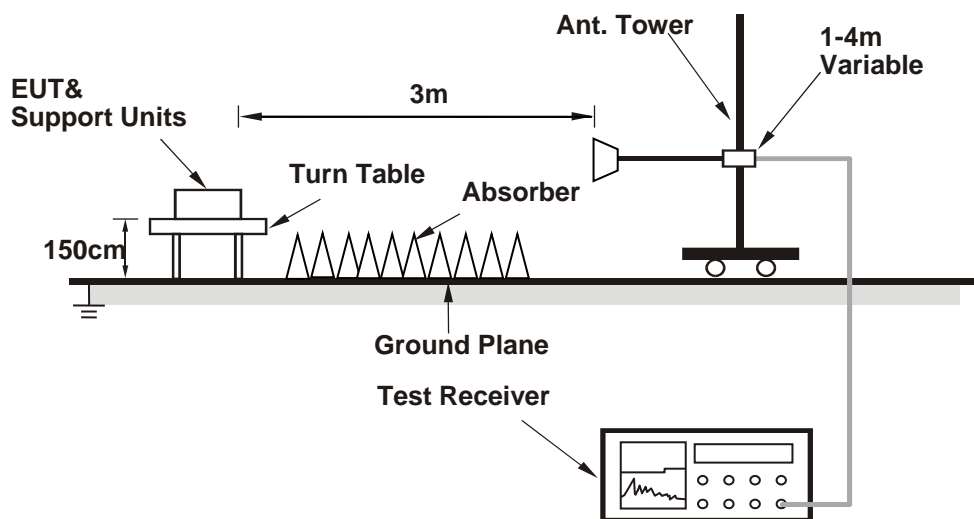

For the actual test configuration, please refer to the attached file (Test Setup Photo).

4.8.5 Test Results

Below 1GHz
WCDMA Band 2

Mode	TX channel 9538 (1907.6MHz)	Frequency Range	Below 1000 MHz
Environmental Conditions	22deg. C, 68%RH	Input Power	120Vac, 60Hz
Tested By	Greg Lin		

Antenna Polarity & Test Distance: Horizontal at 3 M							
No.	Freq. (MHz)	Reading (dBm)	S.G Power Value (dBm)	Correction Factor (dB)	EIRP (dBm)	Limit (dBm)	Margin (dB)
1	30.00	-49.0	-25.6	-19.4	-45.0	-13.0	-32.0
2	86.26	-38.6	-45.5	0.1	-45.4	-13.0	-32.4
3	205.57	-48.0	-54.1	-2.0	-56.1	-13.0	-43.1
4	257.95	-50.4	-54.0	-1.6	-55.6	-13.0	-42.6
5	296.75	-54.0	-55.0	-1.8	-56.8	-13.0	-43.8
6	775.93	-54.9	-54.1	4.0	-50.1	-13.0	-37.1

Remarks:

1. EIRP (dBm) = S.G Value (dBm) + Correction Factor (dB).
2. Correction Factor (dB) = Substitution Antenna Gain (dB) + Cable Loss (dB).

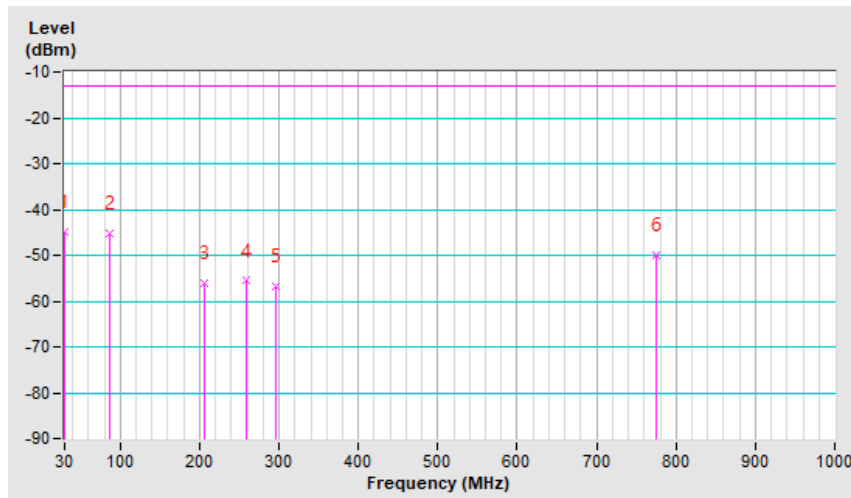

Mode	TX channel 9538 (1907.6MHz)	Frequency Range	Below 1000 MHz
Environmental Conditions	22deg. C, 68%RH	Input Power	120Vac, 60Hz
Tested By	Greg Lin		

Antenna Polarity & Test Distance: Vertical at 3 M							
No.	Freq. (MHz)	Reading (dBm)	S.G Power Value (dBm)	Correction Factor (dB)	EIRP (dBm)	Limit (dBm)	Margin (dB)
1	44.55	-47.3	-44.8	-10.9	-55.7	-13.0	-42.7
2	89.17	-46.3	-52.5	-0.1	-52.6	-13.0	-39.6
3	206.54	-55.0	-55.5	-2.0	-57.5	-13.0	-44.5
4	261.83	-56.6	-53.9	-1.6	-55.5	-13.0	-42.5
5	596.48	-62.7	-63.0	3.8	-59.2	-13.0	-46.2
6	737.13	-57.2	-54.2	3.7	-50.5	-13.0	-37.5

Remarks:

1. EIRP (dBm) = S.G Value (dBm) + Correction Factor (dB).
2. Correction Factor (dB) = Substitution Antenna Gain (dB) + Cable Loss (dB).

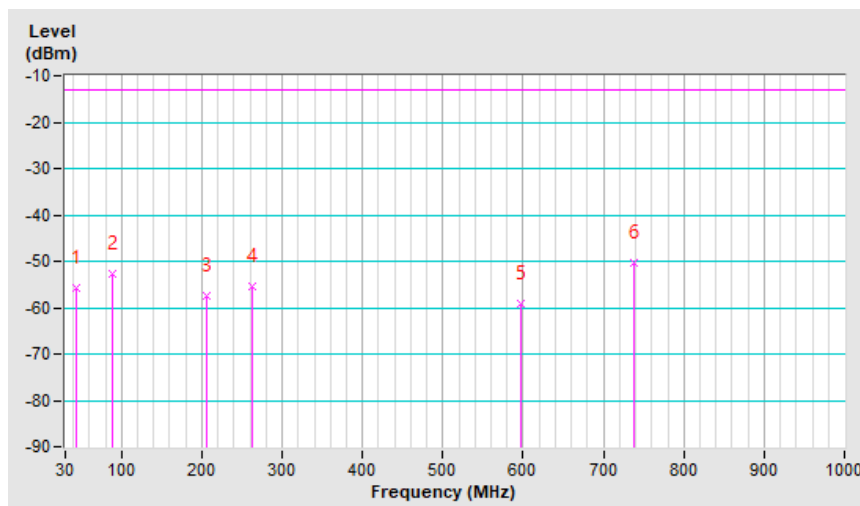

LTE Band 2, Channel Bandwidth: 20MHz

Mode	TX channel 18900 (1880.00MHz)	Frequency Range	Below 1000 MHz
Environmental Conditions	22deg. C, 68%RH	Input Power	120Vac, 60Hz
Tested By	Greg Lin		

Antenna Polarity & Test Distance: Horizontal at 3 M							
No.	Freq. (MHz)	Reading (dBm)	S.G Power Value (dBm)	Correction Factor (dB)	EIRP (dBm)	Limit (dBm)	Margin (dB)
1	45.52	-51.8	-40.6	-10.4	-51.0	-13.0	-38.0
2	98.87	-44.2	-51.4	-1.4	-52.8	-13.0	-39.8
3	204.60	-49.4	-55.4	-2.0	-57.4	-13.0	-44.4
4	307.42	-52.6	-60.8	3.9	-56.9	-13.0	-43.9
5	702.21	-59.1	-59.7	3.4	-56.3	-13.0	-43.3
6	780.78	-56.6	-55.5	4.0	-51.5	-13.0	-38.5

Remarks:

1. EIRP (dBm) = S.G Value (dBm) + Correction Factor (dB).
2. Correction Factor (dB) = Substitution Antenna Gain (dB) + Cable Loss (dB).

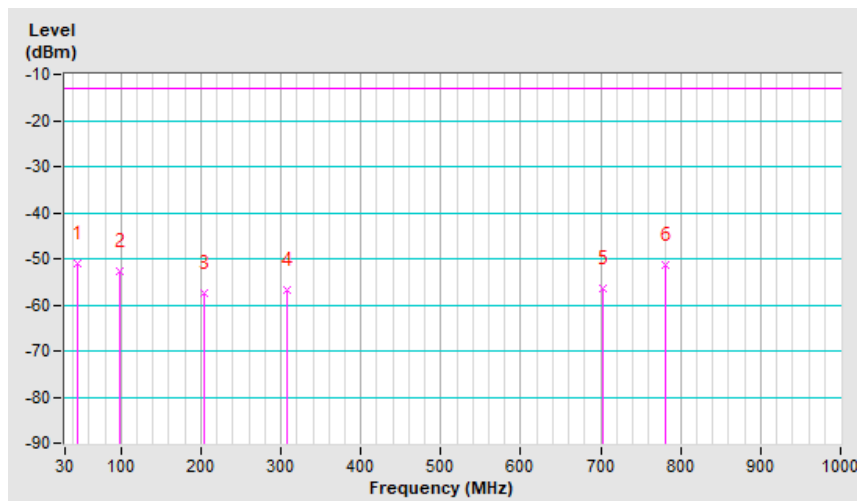

Mode	TX channel 18900 (1880.00MHz)	Frequency Range	Below 1000 MHz
Environmental Conditions	22deg. C, 68%RH	Input Power	120Vac, 60Hz
Tested By	Greg Lin		

Antenna Polarity & Test Distance: Vertical at 3 M							
No.	Freq. (MHz)	Reading (dBm)	S.G Power Value (dBm)	Correction Factor (dB)	EIRP (dBm)	Limit (dBm)	Margin (dB)
1	73.65	-43.2	-48.9	0.1	-48.8	-13.0	-35.8
2	202.66	-56.5	-55.9	-2.1	-58.0	-13.0	-45.0
3	256.01	-57.1	-55.2	-1.5	-56.7	-13.0	-43.7
4	597.45	-63.2	-63.6	3.9	-59.7	-13.0	-46.7
5	729.37	-57.4	-54.6	3.6	-51.0	-13.0	-38.0
6	885.54	-52.6	-48.2	3.4	-44.8	-13.0	-31.8

Remarks:

1. EIRP (dBm) = S.G Value (dBm) + Correction Factor (dB).
2. Correction Factor (dB) = Substitution Antenna Gain (dB) + Cable Loss (dB).

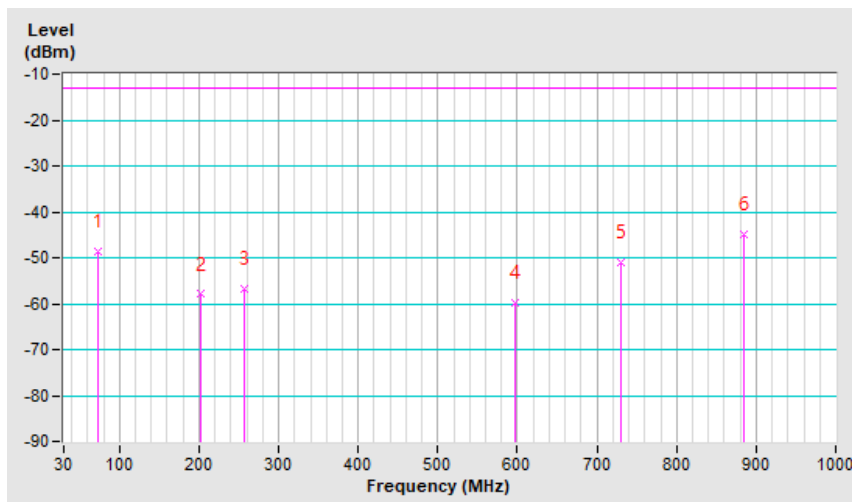

LTE Band 25, Channel Bandwidth: 20MHz

Mode	TX channel 26140 (1860.0MHz)	Frequency Range	Below 1000 MHz
Environmental Conditions	22deg. C, 68%RH	Input Power	120Vac, 60Hz
Tested By	Greg Lin		

Antenna Polarity & Test Distance: Horizontal at 3 M							
No.	Freq. (MHz)	Reading (dBm)	S.G Power Value (dBm)	Correction Factor (dB)	EIRP (dBm)	Limit (dBm)	Margin (dB)
1	30.00	-48.9	-25.5	-19.4	-44.9	-13.0	-31.9
2	70.74	-42.7	-48.5	-0.4	-48.9	-13.0	-35.9
3	205.57	-49.7	-55.8	-2.0	-57.8	-13.0	-44.8
4	297.72	-53.4	-54.4	-1.7	-56.1	-13.0	-43.1
5	600.36	-61.0	-63.3	3.8	-59.5	-13.0	-46.5
6	747.80	-55.1	-54.8	3.7	-51.1	-13.0	-38.1

Remarks:

1. EIRP (dBm) = S.G Value (dBm) + Correction Factor (dB).
2. Correction Factor (dB) = Substitution Antenna Gain (dB) + Cable Loss (dB).

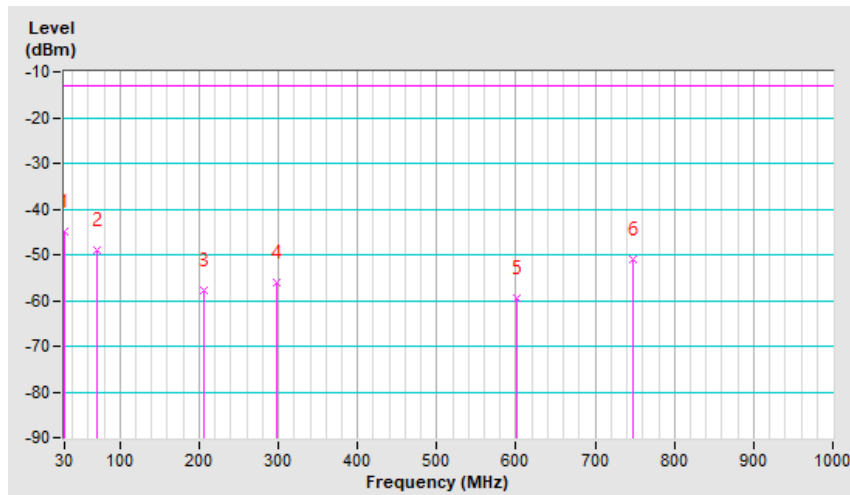

Mode	TX channel 26140 (1860.0MHz)	Frequency Range	Below 1000 MHz
Environmental Conditions	22deg. C, 68%RH	Input Power	120Vac, 60Hz
Tested By	Greg Lin		

Antenna Polarity & Test Distance: Vertical at 3 M							
No.	Freq. (MHz)	Reading (dBm)	S.G Power Value (dBm)	Correction Factor (dB)	EIRP (dBm)	Limit (dBm)	Margin (dB)
1	54.25	-29.3	-30.4	-5.7	-36.1	-13.0	-23.1
2	88.20	-49.0	-55.2	-0.2	-55.4	-13.0	-42.4
3	204.60	-55.9	-55.8	-2.0	-57.8	-13.0	-44.8
4	358.83	-62.6	-67.0	4.0	-63.0	-13.0	-50.0
5	617.82	-64.2	-63.1	3.7	-59.4	-13.0	-46.4
6	776.90	-57.5	-54.4	4.0	-50.4	-13.0	-37.4

Remarks:

1. EIRP (dBm) = S.G Value (dBm) + Correction Factor (dB).
2. Correction Factor (dB) = Substitution Antenna Gain (dB) + Cable Loss (dB).

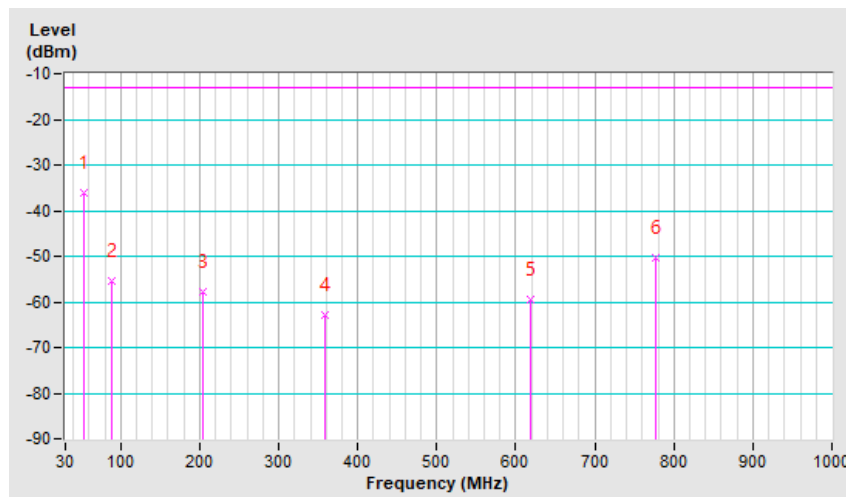

Above 1GHz
WCDMA Band 2

Mode	TX channel 9262 (1852.4MHz)	Frequency Range	1GHz ~ 20GHz
Environmental Conditions	25deg. C, 70%RH	Input Power	120Vac, 60Hz
Tested By	Luis Lee		

Antenna Polarity & Test Distance: Horizontal at 3 M							
No.	Freq. (MHz)	Reading (dBm)	S.G Power Value (dBm)	Correction Factor (dB)	EIRP (dBm)	Limit (dBm)	Margin (dB)
1	3704.80	-51.4	-45.4	7.1	-38.3	-13.0	-25.3
Antenna Polarity & Test Distance: Vertical at 3 M							
No.	Freq. (MHz)	Reading (dBm)	S.G Power Value (dBm)	Correction Factor (dB)	EIRP (dBm)	Limit (dBm)	Margin (dB)
1	3704.80	-61.2	-54.1	7.1	-47.0	-13.0	-34.0

Remarks:

1. EIRP (dBm) = S.G Value (dBm) + Correction Factor (dB).
2. Correction Factor (dB) = Substitution Antenna Gain (dB) + Cable Loss (dB).

Mode	TX channel 9400 (1880.0MHz)	Frequency Range	1GHz ~ 20GHz
Environmental Conditions	25deg. C, 70%RH	Input Power	120Vac, 60Hz
Tested By	Luis Lee		

Antenna Polarity & Test Distance: Horizontal at 3 M							
No.	Freq. (MHz)	Reading (dBm)	S.G Power Value (dBm)	Correction Factor (dB)	EIRP (dBm)	Limit (dBm)	Margin (dB)
1	3760.00	-51.5	-45.0	7.1	-37.9	-13.0	-24.9
Antenna Polarity & Test Distance: Vertical at 3 M							
No.	Freq. (MHz)	Reading (dBm)	S.G Power Value (dBm)	Correction Factor (dB)	EIRP (dBm)	Limit (dBm)	Margin (dB)
1	3760.00	-61.5	-54.1	7.1	-47.0	-13.0	-34.0

Remarks:

1. EIRP (dBm) = S.G Value (dBm) + Correction Factor (dB).
2. Correction Factor (dB) = Substitution Antenna Gain (dB) + Cable Loss (dB).

Mode	TX channel 9538 (1907.6MHz)	Frequency Range	1GHz ~ 20GHz
Environmental Conditions	25deg. C, 70%RH	Input Power	120Vac, 60Hz
Tested By	Luis Lee		

Antenna Polarity & Test Distance: Horizontal at 3 M							
No.	Freq. (MHz)	Reading (dBm)	S.G Power Value (dBm)	Correction Factor (dB)	EIRP (dBm)	Limit (dBm)	Margin (dB)
1	3815.20	-51.7	-44.9	7.1	-37.8	-13.0	-24.8
Antenna Polarity & Test Distance: Vertical at 3 M							
No.	Freq. (MHz)	Reading (dBm)	S.G Power Value (dBm)	Correction Factor (dB)	EIRP (dBm)	Limit (dBm)	Margin (dB)
1	3815.20	-61.7	-54.0	7.1	-46.9	-13.0	-33.9

Remarks:

1. EIRP (dBm) = S.G Value (dBm) + Correction Factor (dB).
2. Correction Factor (dB) = Substitution Antenna Gain (dB) + Cable Loss (dB).

LTE Band 2, Channel Bandwidth 1.4MHz

Mode	TX channel 18607 (1850.70MHz)	Frequency Range	1GHz ~ 20GHz
Environmental Conditions	22deg. C, 68%RH	Input Power	120Vac, 60Hz
Tested By	Greg Lin		

Antenna Polarity & Test Distance: Horizontal at 3 M							
No.	Freq. (MHz)	Reading (dBm)	S.G Power Value (dBm)	Correction Factor (dB)	EIRP (dBm)	Limit (dBm)	Margin (dB)
1	3701.40	-61.3	-52.8	1.4	-51.4	-13.0	-38.4
Antenna Polarity & Test Distance: Vertical at 3 M							
No.	Freq. (MHz)	Reading (dBm)	S.G Power Value (dBm)	Correction Factor (dB)	EIRP (dBm)	Limit (dBm)	Margin (dB)
1	3701.40	-59.1	-50.9	1.4	-49.5	-13.0	-36.5

Remarks:

1. EIRP (dBm) = S.G Value (dBm) + Correction Factor (dB).
2. Correction Factor (dB) = Substitution Antenna Gain (dB) + Cable Loss (dB).

Mode	TX channel 18900 (1880.00MHz)	Frequency Range	1GHz ~ 20GHz
Environmental Conditions	22deg. C, 68%RH	Input Power	120Vac, 60Hz
Tested By	Greg Lin		

Antenna Polarity & Test Distance: Horizontal at 3 M							
No.	Freq. (MHz)	Reading (dBm)	S.G Power Value (dBm)	Correction Factor (dB)	EIRP (dBm)	Limit (dBm)	Margin (dB)
1	3760.00	-61.2	-52.7	1.3	-51.4	-13.0	-38.4
Antenna Polarity & Test Distance: Vertical at 3 M							
No.	Freq. (MHz)	Reading (dBm)	S.G Power Value (dBm)	Correction Factor (dB)	EIRP (dBm)	Limit (dBm)	Margin (dB)
1	3760.00	-59.4	-51.1	1.3	-49.8	-13.0	-36.8

Remarks:

1. EIRP (dBm) = S.G Value (dBm) + Correction Factor (dB).
2. Correction Factor (dB) = Substitution Antenna Gain (dB) + Cable Loss (dB).

Mode	TX channel 19193 (1909.30MHz)	Frequency Range	1GHz ~ 20GHz
Environmental Conditions	22deg. C, 68%RH	Input Power	120Vac, 60Hz
Tested By	Greg Lin		

Antenna Polarity & Test Distance: Horizontal at 3 M							
No.	Freq. (MHz)	Reading (dBm)	S.G Power Value (dBm)	Correction Factor (dB)	EIRP (dBm)	Limit (dBm)	Margin (dB)
1	3818.60	-60.6	-52.3	1.4	-50.9	-13.0	-37.9
Antenna Polarity & Test Distance: Vertical at 3 M							
No.	Freq. (MHz)	Reading (dBm)	S.G Power Value (dBm)	Correction Factor (dB)	EIRP (dBm)	Limit (dBm)	Margin (dB)
1	3818.60	-59.6	-51.4	1.4	-50.0	-13.0	-37.0

Remarks:

1. EIRP (dBm) = S.G Value (dBm) + Correction Factor (dB).
2. Correction Factor (dB) = Substitution Antenna Gain (dB) + Cable Loss (dB).

LTE Band 2, Channel Bandwidth 5MHz

Mode	TX channel 18625 (1852.50MHz)	Frequency Range	1GHz ~ 20GHz
Environmental Conditions	22deg. C, 68%RH	Input Power	120Vac, 60Hz
Tested By	Greg Lin		

Antenna Polarity & Test Distance: Horizontal at 3 M							
No.	Freq. (MHz)	Reading (dBm)	S.G Power Value (dBm)	Correction Factor (dB)	EIRP (dBm)	Limit (dBm)	Margin (dB)
1	3705.00	-61.3	-52.8	1.4	-51.4	-13.0	-38.4
Antenna Polarity & Test Distance: Vertical at 3 M							
No.	Freq. (MHz)	Reading (dBm)	S.G Power Value (dBm)	Correction Factor (dB)	EIRP (dBm)	Limit (dBm)	Margin (dB)
1	3705.00	-59.3	-51.1	1.4	-49.7	-13.0	-36.7

Remarks:

1. EIRP (dBm) = S.G Value (dBm) + Correction Factor (dB).
2. Correction Factor (dB) = Substitution Antenna Gain (dB) + Cable Loss (dB).

Mode	TX channel 18900 (1880.00MHz)	Frequency Range	1GHz ~ 20GHz
Environmental Conditions	22deg. C, 68%RH	Input Power	120Vac, 60Hz
Tested By	Greg Lin		

Antenna Polarity & Test Distance: Horizontal at 3 M							
No.	Freq. (MHz)	Reading (dBm)	S.G Power Value (dBm)	Correction Factor (dB)	EIRP (dBm)	Limit (dBm)	Margin (dB)
1	3760.00	-60.6	-52.1	1.3	-50.8	-13.0	-37.8
Antenna Polarity & Test Distance: Vertical at 3 M							
No.	Freq. (MHz)	Reading (dBm)	S.G Power Value (dBm)	Correction Factor (dB)	EIRP (dBm)	Limit (dBm)	Margin (dB)
1	3760.00	-59.0	-50.7	1.3	-49.4	-13.0	-36.4

Remarks:

1. EIRP (dBm) = S.G Value (dBm) + Correction Factor (dB).
2. Correction Factor (dB) = Substitution Antenna Gain (dB) + Cable Loss (dB).

Mode	TX channel 19175 (1907.50MHz)	Frequency Range	1GHz ~ 20GHz
Environmental Conditions	22deg. C, 68%RH	Input Power	120Vac, 60Hz
Tested By	Greg Lin		

Antenna Polarity & Test Distance: Horizontal at 3 M							
No.	Freq. (MHz)	Reading (dBm)	S.G Power Value (dBm)	Correction Factor (dB)	EIRP (dBm)	Limit (dBm)	Margin (dB)
1	3815.00	-61.4	-53.1	1.4	-51.7	-13.0	-38.7
Antenna Polarity & Test Distance: Vertical at 3 M							
No.	Freq. (MHz)	Reading (dBm)	S.G Power Value (dBm)	Correction Factor (dB)	EIRP (dBm)	Limit (dBm)	Margin (dB)
1	3815.00	-59.2	-51.0	1.4	-49.6	-13.0	-36.6

Remarks:

1. EIRP (dBm) = S.G Value (dBm) + Correction Factor (dB).
2. Correction Factor (dB) = Substitution Antenna Gain (dB) + Cable Loss (dB).

LTE Band 2, Channel Bandwidth 20MHz

Mode	TX channel 18700 (1860.00MHz)	Frequency Range	1GHz ~ 20GHz
Environmental Conditions	22deg. C, 68%RH	Input Power	120Vac, 60Hz
Tested By	Greg Lin		

Antenna Polarity & Test Distance: Horizontal at 3 M							
No.	Freq. (MHz)	Reading (dBm)	S.G Power Value (dBm)	Correction Factor (dB)	EIRP (dBm)	Limit (dBm)	Margin (dB)
1	3720.00	-61.5	-53.0	1.4	-51.6	-13.0	-38.6
Antenna Polarity & Test Distance: Vertical at 3 M							
No.	Freq. (MHz)	Reading (dBm)	S.G Power Value (dBm)	Correction Factor (dB)	EIRP (dBm)	Limit (dBm)	Margin (dB)
1	3720.00	-59.7	-51.5	1.4	-50.1	-13.0	-37.1

Remarks:

1. EIRP (dBm) = S.G Value (dBm) + Correction Factor (dB).
2. Correction Factor (dB) = Substitution Antenna Gain (dB) + Cable Loss (dB).

Mode	TX channel 18900 (1880.00MHz)	Frequency Range	1GHz ~ 20GHz
Environmental Conditions	22deg. C, 68%RH	Input Power	120Vac, 60Hz
Tested By	Greg Lin		

Antenna Polarity & Test Distance: Horizontal at 3 M							
No.	Freq. (MHz)	Reading (dBm)	S.G Power Value (dBm)	Correction Factor (dB)	EIRP (dBm)	Limit (dBm)	Margin (dB)
1	3760.00	-60.8	-52.3	1.3	-51.0	-13.0	-38.0
Antenna Polarity & Test Distance: Vertical at 3 M							
No.	Freq. (MHz)	Reading (dBm)	S.G Power Value (dBm)	Correction Factor (dB)	EIRP (dBm)	Limit (dBm)	Margin (dB)
1	3760.00	-58.9	-50.6	1.3	-49.3	-13.0	-36.3

Remarks:

1. EIRP (dBm) = S.G Value (dBm) + Correction Factor (dB).
2. Correction Factor (dB) = Substitution Antenna Gain (dB) + Cable Loss (dB).

Mode	TX channel 19100 (1900.00MHz)	Frequency Range	1GHz ~ 20GHz
Environmental Conditions	22deg. C, 68%RH	Input Power	120Vac, 60Hz
Tested By	Greg Lin		

Antenna Polarity & Test Distance: Horizontal at 3 M							
No.	Freq. (MHz)	Reading (dBm)	S.G Power Value (dBm)	Correction Factor (dB)	EIRP (dBm)	Limit (dBm)	Margin (dB)
1	3800.00	-60.8	-52.4	1.3	-51.1	-13.0	-38.1
Antenna Polarity & Test Distance: Vertical at 3 M							
No.	Freq. (MHz)	Reading (dBm)	S.G Power Value (dBm)	Correction Factor (dB)	EIRP (dBm)	Limit (dBm)	Margin (dB)
1	3800.00	-59.3	-51.1	1.3	-49.8	-13.0	-36.8

Remarks:

1. EIRP (dBm) = S.G Value (dBm) + Correction Factor (dB).
2. Correction Factor (dB) = Substitution Antenna Gain (dB) + Cable Loss (dB).

LTE Band 25, Channel Bandwidth 1.4MHz

Mode	TX channel 26047 (1850.7MHz)	Frequency Range	1GHz ~ 20GHz
Environmental Conditions	22deg. C, 68%RH	Input Power	120Vac, 60Hz
Tested By	Greg Lin		

Antenna Polarity & Test Distance: Horizontal at 3 M							
No.	Freq. (MHz)	Reading (dBm)	S.G Power Value (dBm)	Correction Factor (dB)	EIRP (dBm)	Limit (dBm)	Margin (dB)
1	3701.40	-60.9	-52.4	1.4	-51.0	-13.0	-38.0
Antenna Polarity & Test Distance: Vertical at 3 M							
No.	Freq. (MHz)	Reading (dBm)	S.G Power Value (dBm)	Correction Factor (dB)	EIRP (dBm)	Limit (dBm)	Margin (dB)
1	3701.40	-58.5	-50.3	1.4	-48.9	-13.0	-35.9

Remarks:

1. EIRP (dBm) = S.G Value (dBm) + Correction Factor (dB).
2. Correction Factor (dB) = Substitution Antenna Gain (dB) + Cable Loss (dB).

Mode	TX channel 26365 (1882.5MHz)	Frequency Range	1GHz ~ 20GHz
Environmental Conditions	22deg. C, 68%RH	Input Power	120Vac, 60Hz
Tested By	Greg Lin		

Antenna Polarity & Test Distance: Horizontal at 3 M							
No.	Freq. (MHz)	Reading (dBm)	S.G Power Value (dBm)	Correction Factor (dB)	EIRP (dBm)	Limit (dBm)	Margin (dB)
1	3765.00	-60.5	-52.0	1.3	-50.7	-13.0	-37.7
Antenna Polarity & Test Distance: Vertical at 3 M							
No.	Freq. (MHz)	Reading (dBm)	S.G Power Value (dBm)	Correction Factor (dB)	EIRP (dBm)	Limit (dBm)	Margin (dB)
1	3765.00	-58.3	-50.0	1.3	-48.7	-13.0	-35.7

Remarks:

1. EIRP (dBm) = S.G Value (dBm) + Correction Factor (dB).
2. Correction Factor (dB) = Substitution Antenna Gain (dB) + Cable Loss (dB).

Mode	TX channel 26683 (1914.3MHz)	Frequency Range	1GHz ~ 20GHz
Environmental Conditions	22deg. C, 68%RH	Input Power	120Vac, 60Hz
Tested By	Greg Lin		

Antenna Polarity & Test Distance: Horizontal at 3 M							
No.	Freq. (MHz)	Reading (dBm)	S.G Power Value (dBm)	Correction Factor (dB)	EIRP (dBm)	Limit (dBm)	Margin (dB)
1	3828.60	-60.4	-52.1	1.4	-50.7	-13.0	-37.7
Antenna Polarity & Test Distance: Vertical at 3 M							
No.	Freq. (MHz)	Reading (dBm)	S.G Power Value (dBm)	Correction Factor (dB)	EIRP (dBm)	Limit (dBm)	Margin (dB)
1	3828.60	-58.4	-50.1	1.4	-48.7	-13.0	-35.7

Remarks:

1. EIRP (dBm) = S.G Value (dBm) + Correction Factor (dB).
2. Correction Factor (dB) = Substitution Antenna Gain (dB) + Cable Loss (dB).

LTE Band 25, Channel Bandwidth 5MHz

Mode	TX channel 26065 (1852.5MHz)	Frequency Range	1GHz ~ 20GHz
Environmental Conditions	22deg. C, 68%RH	Input Power	120Vac, 60Hz
Tested By	Greg Lin		

Antenna Polarity & Test Distance: Horizontal at 3 M							
No.	Freq. (MHz)	Reading (dBm)	S.G Power Value (dBm)	Correction Factor (dB)	EIRP (dBm)	Limit (dBm)	Margin (dB)
1	3705.00	-60.2	-51.7	1.4	-50.3	-13.0	-37.3
Antenna Polarity & Test Distance: Vertical at 3 M							
No.	Freq. (MHz)	Reading (dBm)	S.G Power Value (dBm)	Correction Factor (dB)	EIRP (dBm)	Limit (dBm)	Margin (dB)
1	3705.00	-58.4	-50.2	1.4	-48.8	-13.0	-35.8

Remarks:

1. EIRP (dBm) = S.G Value (dBm) + Correction Factor (dB).
2. Correction Factor (dB) = Substitution Antenna Gain (dB) + Cable Loss (dB).

Mode	TX channel 26365 (1882.5MHz)	Frequency Range	1GHz ~ 20GHz
Environmental Conditions	22deg. C, 68%RH	Input Power	120Vac, 60Hz
Tested By	Greg Lin		

Antenna Polarity & Test Distance: Horizontal at 3 M							
No.	Freq. (MHz)	Reading (dBm)	S.G Power Value (dBm)	Correction Factor (dB)	EIRP (dBm)	Limit (dBm)	Margin (dB)
1	3765.00	-61.1	-52.6	1.3	-51.3	-13.0	-38.3
Antenna Polarity & Test Distance: Vertical at 3 M							
No.	Freq. (MHz)	Reading (dBm)	S.G Power Value (dBm)	Correction Factor (dB)	EIRP (dBm)	Limit (dBm)	Margin (dB)
1	3765.00	-58.7	-50.4	1.3	-49.1	-13.0	-36.1

Remarks:

1. EIRP (dBm) = S.G Value (dBm) + Correction Factor (dB).
2. Correction Factor (dB) = Substitution Antenna Gain (dB) + Cable Loss (dB).

Mode	TX channel 26665 (1912.5MHz)	Frequency Range	1GHz ~ 20GHz
Environmental Conditions	22deg. C, 68%RH	Input Power	120Vac, 60Hz
Tested By	Greg Lin		

Antenna Polarity & Test Distance: Horizontal at 3 M							
No.	Freq. (MHz)	Reading (dBm)	S.G Power Value (dBm)	Correction Factor (dB)	EIRP (dBm)	Limit (dBm)	Margin (dB)
1	3825.00	-60.5	-52.2	1.4	-50.8	-13.0	-37.8
Antenna Polarity & Test Distance: Vertical at 3 M							
No.	Freq. (MHz)	Reading (dBm)	S.G Power Value (dBm)	Correction Factor (dB)	EIRP (dBm)	Limit (dBm)	Margin (dB)
1	3825.00	-58.4	-50.2	1.4	-48.8	-13.0	-35.8

Remarks:

1. EIRP (dBm) = S.G Value (dBm) + Correction Factor (dB).
2. Correction Factor (dB) = Substitution Antenna Gain (dB) + Cable Loss (dB).

LTE Band 25, Channel Bandwidth 20MHz

Mode	TX channel 26140 (1860.0MHz)	Frequency Range	1GHz ~ 20GHz
Environmental Conditions	22deg. C, 68%RH	Input Power	120Vac, 60Hz
Tested By	Greg Lin		

Antenna Polarity & Test Distance: Horizontal at 3 M							
No.	Freq. (MHz)	Reading (dBm)	S.G Power Value (dBm)	Correction Factor (dB)	EIRP (dBm)	Limit (dBm)	Margin (dB)
1	3720.00	-60.3	-51.8	1.4	-50.4	-13.0	-37.4
Antenna Polarity & Test Distance: Vertical at 3 M							
No.	Freq. (MHz)	Reading (dBm)	S.G Power Value (dBm)	Correction Factor (dB)	EIRP (dBm)	Limit (dBm)	Margin (dB)
1	3720.00	-57.8	-49.6	1.4	-48.2	-13.0	-35.2

Remarks:

1. EIRP (dBm) = S.G Value (dBm) + Correction Factor (dB).
2. Correction Factor (dB) = Substitution Antenna Gain (dB) + Cable Loss (dB).

Mode	TX channel 26365 (1882.5MHz)	Frequency Range	1GHz ~ 20GHz
Environmental Conditions	22deg. C, 68%RH	Input Power	120Vac, 60Hz
Tested By	Greg Lin		

Antenna Polarity & Test Distance: Horizontal at 3 M							
No.	Freq. (MHz)	Reading (dBm)	S.G Power Value (dBm)	Correction Factor (dB)	EIRP (dBm)	Limit (dBm)	Margin (dB)
1	3765.00	-60.2	-51.7	1.3	-50.4	-13.0	-37.4
Antenna Polarity & Test Distance: Vertical at 3 M							
No.	Freq. (MHz)	Reading (dBm)	S.G Power Value (dBm)	Correction Factor (dB)	EIRP (dBm)	Limit (dBm)	Margin (dB)
1	3765.00	-58.6	-50.3	1.3	-49.0	-13.0	-36.0

Remarks:

1. EIRP (dBm) = S.G Value (dBm) + Correction Factor (dB).
2. Correction Factor (dB) = Substitution Antenna Gain (dB) + Cable Loss (dB).

Mode	TX channel 26590 (1905.0MHz)	Frequency Range	1GHz ~ 20GHz
Environmental Conditions	22deg. C, 68%RH	Input Power	120Vac, 60Hz
Tested By	Greg Lin		

Antenna Polarity & Test Distance: Horizontal at 3 M							
No.	Freq. (MHz)	Reading (dBm)	S.G Power Value (dBm)	Correction Factor (dB)	EIRP (dBm)	Limit (dBm)	Margin (dB)
1	3810.00	-60.2	-51.8	1.3	-50.5	-13.0	-37.5
Antenna Polarity & Test Distance: Vertical at 3 M							
No.	Freq. (MHz)	Reading (dBm)	S.G Power Value (dBm)	Correction Factor (dB)	EIRP (dBm)	Limit (dBm)	Margin (dB)
1	3810.00	-58.4	-50.1	1.3	-48.8	-13.0	-35.8

Remarks:

1. EIRP (dBm) = S.G Value (dBm) + Correction Factor (dB).
2. Correction Factor (dB) = Substitution Antenna Gain (dB) + Cable Loss (dB).

5 Pictures of Test Arrangements

Please refer to the attached file (Test Setup Photo).

Appendix – Information of the Testing Laboratories

We, Bureau Veritas Consumer Products Services (H.K.) Ltd., Taoyuan Branch, were founded in 1988 to provide our best service in EMC, Radio, Telecom and Safety consultation. Our laboratories are FCC recognized accredited test firms and accredited and approved according to ISO/IEC 17025.

If you have any comments, please feel free to contact us at the following:

Lin Kou EMC/RF Lab

Tel: 886-2-26052180

Fax: 886-2-26051924

Hsin Chu EMC/RF/Telecom Lab

Tel: 886-3-6668565

Fax: 886-3-6668323

Hwa Ya EMC/RF/Safety Lab

Tel: 886-3-3183232

Fax: 886-3-3270892

Email: service.adt@tw.bureauveritas.com

Web Site: www.bureauveritas-adt.com

The address and road map of all our labs can be found in our web site also.

--- END ---