

TEST REPORT

EUT Description	WLAN and BT, 1x1 PCIe M.2 2230 adapter card
Brand Name	Intel® Wireless-AC 9461
Model Name	9461NGW
FCC ID	PD99461NG
Date of Test Start/End	2017-07-28 / 2017-09-07
Features	802.11 a/b/g/n/ac Wireless LAN + Bluetooth 5 (see section 5)

Applicant	Intel Mobile Communications
Address	100 Center Point Circle, Suite 200 Columbia, South Carolina 29210 USA
Contact Person	Steven Hackett
Telephone/Fax/ Email	steven.c.hackett@intel.com

Reference Standards	FCC CFR Title 47 Part 15 E (see section 1)
---------------------	--

Test Report identification	170727-01.TR01
Revision Control	Rev. 00 This test report revision replaces any previous test report revision (see section 8)

The test results relate only to the samples tested.
The test report shall not be reproduced in full, without written approval of the laboratory.

Issued by _____ Reviewed by _____

Walid EL HAJJ
(Test Engineer Lead)

Olivier FARGANT
(Technical Manager)

Intel Mobile Communications France S.A.S – WRF Lab
425 rue de Goa – Le Cargo B6 - 06600, Antibes, France
Tel. +33493001400 / Fax +33493001401

Table of Contents

1. Standards, reference documents and applicable test methods	3
2. General conditions, competences and guarantees	3
3. Environmental Conditions	3
4. Test samples	4
5. EUT Features	4
6. Remarks and comments	4
7. Test Verdicts summary	5
7.1. 802.11 A/N/AC – U-NII-1	5
7.2. 802.11 A/N/AC – U-NII-2A	5
8. Document Revision History	5
Annex A. Test & System Description	6
A.1 MEASUREMENT SYSTEM	6
A.2 TEST EQUIPMENT LIST	8
A.3 MEASUREMENT UNCERTAINTY EVALUATION	10
Annex B. Test Results U-NII-1 & U-NII-2A	11
B.1 TEST CONDITIONS	11
B.2 TEST RESULTS TABLES U-NII-1	12
B.2.1 26dB & 99% Bandwidth	12
B.2.2 Power Limits. Maximum Output power & Peak power spectral density	13
B.2.3 Undesirable emission limits : Band Edge (Conducted)	16
B.2.4 Radiated spurious emission	18
B.2.5 AC power-line conducted emission	25
B.3 TEST RESULTS SCREENSHOT U-NII-1	29
B.3.1 26dB Bandwidth	29
B.3.2 99% Bandwidth	31
B.3.3 Power Limits. Maximum Output power & Peak power spectral density	33
B.3.4 Undesirable emission limits : Band Edge (Conducted)	37
B.4 TEST RESULTS TABLES U-NII-2A	44
B.4.1 26dB & 99% Bandwidth	44
B.4.2 Power Limits. Maximum Output power & Peak power spectral density	45
B.4.3 Undesirable emissions limits : Band Edge (Conducted)	48
B.4.4 Radiated spurious emission	50
B.4.5 AC power-line conducted emission	59
B.5 TEST RESULTS SCREENSHOT U-NII-2A	63
B.5.1 26dB Bandwidth	63
B.5.2 99% Bandwidth	65
B.5.3 Power Limits. Maximum Output power & Peak power spectral density	67
B.5.4 Undesirable emissions limits : Band Edge (Conducted)	71
Annex C. Photographs	74
C.1 TEST SETUP	74
C.2 TEST SAMPLE	77

1. Standards, reference documents and applicable test methods

1. FCC 47 CFR part 15 – Subpart E – Unlicensed National Information Infrastructure Devices.
2. FCC 47 CFR part 15 - Subpart C – §15.207 Conducted emission limits.
3. FCC 47 CFR part 15 - Subpart C – §15.209 Radiated emission limits; general requirements.
4. FCC OET KDB 789033 D02 General U-NII Test Procedures New Rules v01r04 – Guidelines for compliance testing of Unlicensed National Information Infrastructure (U-NII) Devices (Part 15, Subpart E).
5. FCC OET KDB 644545 D03 Guidance for IEEE 802.11ac v01 - GUIDANCE FOR IEEE Std 802.11ac™ DEVICES EMISSION TESTING.
6. ANSI C63.10-2013 American National Standard of Procedures for Compliance Testing of Unlicensed Wireless Devices.

2. General conditions, competences and guarantees

- ✓ Intel Mobile Communications France SAS Wireless RF Lab (Intel WRF Lab) is an ISO/IEC 17025:2005 testing laboratory accredited by the American Association for Laboratory Accreditation (A2LA) with the certificate number 3478.01.
- ✓ Intel Mobile Communications France SAS Wireless RF Lab (Intel WRF Lab) is an Accredited Test Firm recognized by the FCC, with Designation Number FR0011.
- ✓ Intel WRF Lab only provides testing services and is committed to providing reliable, unbiased test results and interpretations.
- ✓ Intel WRF Lab is liable to the client for the maintenance of the confidentiality of all information related to the item under test and the results of the test.
- ✓ Intel WRF Lab has developed calibration and proficiency programs for its measurement equipment to ensure correlated and reliable results to its customers.
- ✓ This report is only referred to the item that has undergone the test.
- ✓ This report does not imply an approval of the product by the Certification Bodies or competent Authorities.

3. Environmental Conditions

- ✓ At the site where the measurements were performed the following limits were not exceeded during the tests:

Temperature	23°C ± 1°C
Humidity	60% ± 12%

4. Test samples

Sample	Control #	Description	Model	Serial #	Date of receipt	Note
#01	170727-01.S01	Module	9461NGW	WFM 3413E86AD85D	2017-07-28	Used for conducted tests
	170524-02.S15	Extender Board	PCB00609_01	6092416-442	2017-05-30	
	170000-01.S04	Laptop	Latitude E5470	DMRKMC2	2017-05-10	
#02	170727-01.S06	Module	9461NGW	WFM 3413E86AD7B3	2017-07-28	Used for radiated tests
	170220-02.S03	Extender Board	PCB00609_01	6092416-446	2017-02-20	
	170000-01.S13	Laptop	Latitude E5470	FT6LMC2	2017-04-25	
#03	170727-01.S04	Module	9461NGW	WFM 3413E86AD7BD	2017-07-28	Used for AC power-line conducted emission measurements
	170524-02.S13	Extender Board	PCB00609_01	6092416-418	2017-02-20	
	170000-01.S02	Laptop	Latitude E5470	21HTPF2	2017-04-25	

5. EUT Features

Brand Name	Intel® Wireless-AC 9461	
Model Name	9461NGW	
FCC ID	PD99461NG	
Software Version	10.1730.0-05594	
Driver Version	99.0.28.6	
Prototype / Production	Production	
Supported Radios	802.11b/g/n 802.11a/n/ac Bluetooth 5	2.4GHz (2400.0 – 2483.5 MHz) 5.2GHz (5150.0 – 5350.0 MHz) 5.6GHz (5470.0 – 5725.0 MHz) 5.8GHz (5725.0 – 5850.0 MHz) 2.4GHz (2400.0 – 2483.5 MHz)
Antenna Information	WLAN/BT: Slot antenna. WiFi 2.4GHz & 5GHz and BT (DRTU CHAIN A)	

6. Remarks and comments

N/A

7. Test Verdicts summary

7.1. 802.11 a/n/ac – U-NII-1

FCC part	Test name	Verdict
15.407 (a) (1)	Power Limits. Maximum output power	P
15.407 (a) (1)	Peak power spectral density	P
15.407 (b) (1) 15.209	Undesirable emissions limits: Band Edge (conducted)	P
15.407 (b) (1) 15.209	Undesirable emissions limits (radiated)	P
15.407 (6) 15.207	AC power-line conducted emission	P

7.2. 802.11 a/n/ac – U-NII-2A

FCC part	Test name	Verdict
15.407 (a) (2)	Power Limits. Maximum output power	P
15.407 (a) (2)	Peak power spectral density	P
15.407 (b) (2) 15.209	Undesirable emissions limits: Band Edge (conducted)	P
15.407 (b) (2) 15.209	Undesirable emissions limits (radiated)	P
15.407 (6) 15.207	AC power-line conducted emission	P

P: Pass
 F: Fail
 NM: Not Measured
 NA: Not Applicable

8. Document Revision History

Revision #	Date	Modified by	Revision Details
Rev. 00	2017-09-11	BLavenant	First Issue

Annex A. Test & System Description

A.1 Measurement System

Measurements were performed using the following setups, made in accordance to the general provisions of FCC KDB 789033 D02 General U-NII Test Procedures

The DUT was installed in a test fixture and this test fixture is connected to a laptop computer and AC/DC power adapter. The laptop computer was used to configure the EUT to continuously transmit at a specified output power using all different modes and modulation schemes, using the Intel proprietary tool DRTU.

Conducted Setup

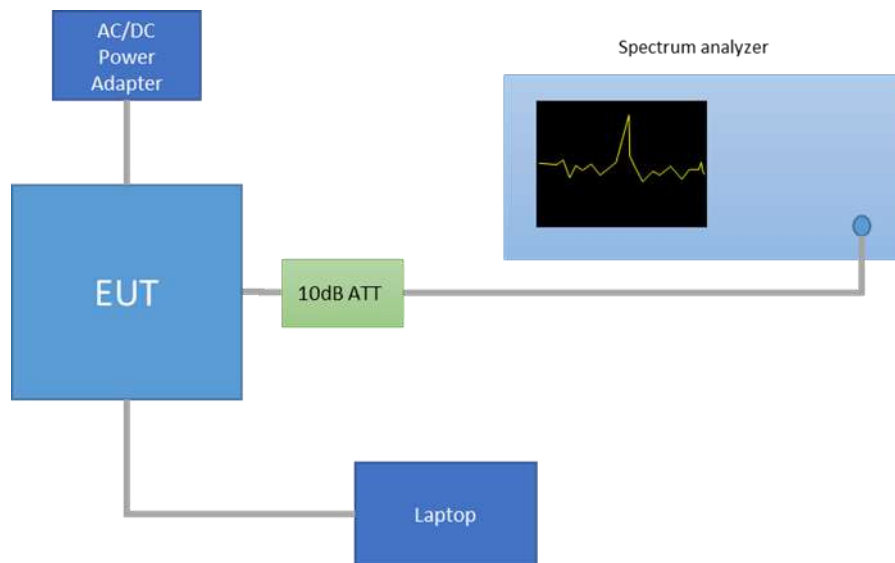

Radiated Setup < 1GHz

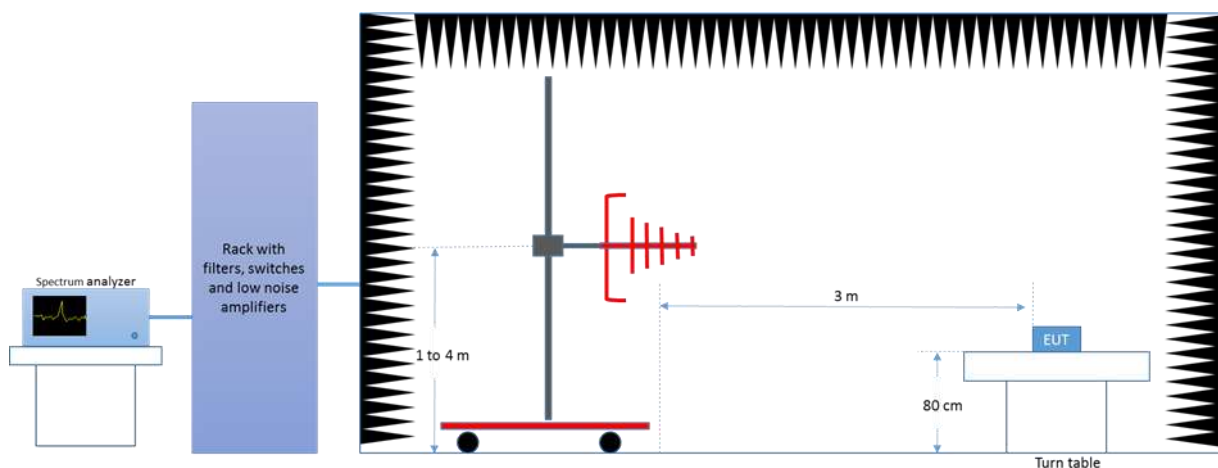

Radiated Setup 1 GHz – 18 GHz

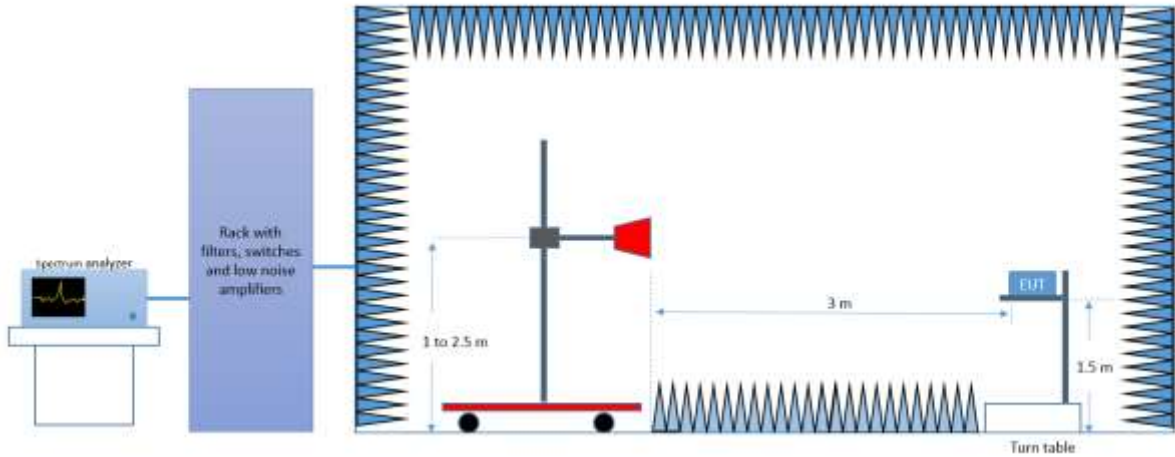

Radiated Setup 18 GHz – 40 GHz

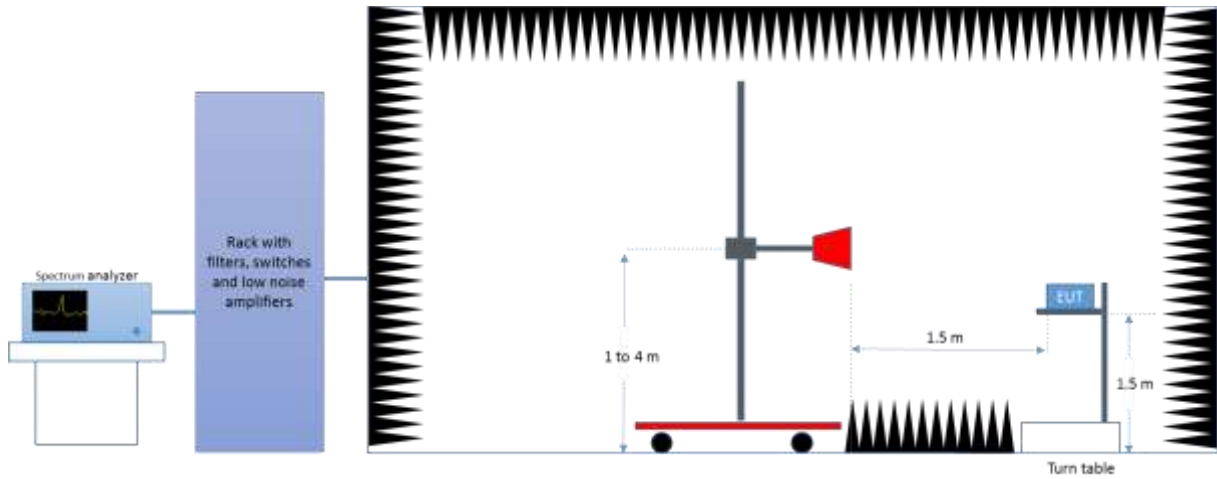

AC power-line conducted emission Setup 150 kHz – 30 MHz

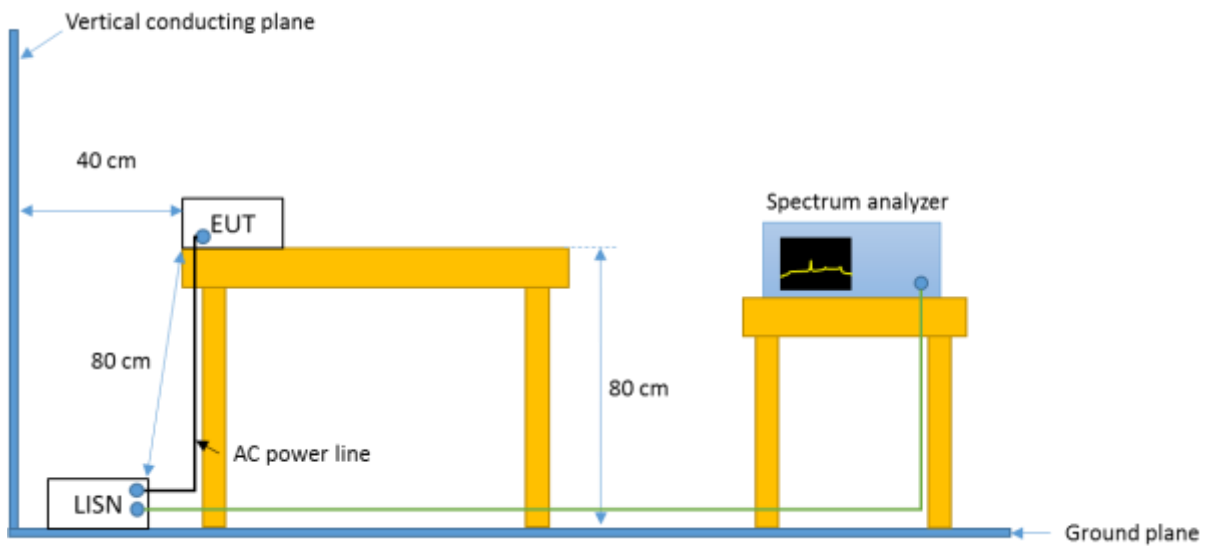

A.2 Test Equipment List

Conducted Setup

ID#	Device	Type/Model	Serial #	Manufacturer	Cal. Date	Cal. Due Date
0316	Spectrum analyzer	FSV30	103309	Rohde & Schwarz	2017-01-30	2019-01-30

Radiated Setup-1

ID#	Device	Type/Model	Serial #	Manufacturer	Cal. Date	Cal. Due Date
0133	Spectrum analyzer	FSV40	101358	Rohde & Schwarz	2016-04-15	2018-04-15
0137	Log antenna 30 MHz – 1 GHz	3142E	00156946	ETS Lindgren	2015-12-11	2017-12-11
0139	Horn Antenna 18 GHz - 26.5 GHz	114514	00167100	ETS Lindgren	2016-03-16	2018-03-16
0140	Horn Antenna 26.5 GHz - 40 GHz	120722	00169638	ETS Lindgren	2016-07-26	2018-07-26
0135	Semi Anechoic chamber	FACT 3	5720	ETS Lindgren	2016-04-28	2018-04-28
0530	Measurement Software	EMC32	100623	Rohde & Schwarz	N/A	N/A
0296	Power Supply	6673A	MY41000318	Agilent	N/A	N/A
0346	Multimeter	34401A	US36054685	HP	2016-02-04	2018-02-04

N/A: Not Applicable

Radiated Setup-2

ID#	Device	Type/Model	Serial #	Manufacturer	Cal. Date	Cal. Due Date
0420	Spectrum analyzer	FSV40	101556	Rohde & Schwarz	2016-04-15	2018-04-15
0138	Horn antenna 1 GHz – 6.4 GHz	3117	00152266	ETS Lindgren	2016-03-14	2018-03-14
0141	Double Ridge Horn Antenna 1 GHz – 18 GHz	3117	00157736	ETS Lindgren	2016-04-13	2018-04-13
0409	PreAmplifier	3117-PA	00157993	ETS Lindgren	N/A	N/A
0337	Full Anechoic chamber	RFD_FA_100	5996	ETS Lindgren	2016-04-28	2018-04-28
0329	Measurement Software	EMC32	100401	Rohde & Schwarz	N/A	N/A

N/A: Not Applicable

Radiated Setup - shared equipments

ID#	Device	Type/Model	Serial #	Manufacturer	Cal. Date	Cal. Due Date
0014	Power Sensor	NRP-Z57	101280	Rohde & Schwarz	2017-04-25	2019-04-25

AC power-line conducted emission Setup

ID#	Device	Type/Model	Serial Number	Manufacturer	Cal. Date	Cal. Due Date
0027	Measurement software	EMC32	1300.7010.02	Rohde & Schwarz	NA	NA
0317	Spectrum Analyzer	FSV30	103308	Rohde & Schwarz	2017-08-05	2019-08-05
0532	LISN	ENV216	101321	Rohde & Schwarz	2016-09-13	2018-09-13
0607	LISN	ENV216	101342	Rohde & Schwarz	2017-09-06	2018-09-06
0538	Transformer	Monophase	TIMM3.15	Montelem	NA	NA
095	Millivoltmeter	2000	4009301	KEITHLEY	2015-10-26	2017-10-26
0624	AC power source	61604	SM135546	CHROMA	NA	NA
0346	Multimeter	34401A	US36054685	HP	2016-02-04	2018-02-04

N/A: Not Applicable

A.3 Measurement Uncertainty Evaluation

The system uncertainty evaluation is shown in the below table:

Measurement type	Uncertainty [±dB]
Conducted Power	±1.0
Conducted Spurious Emission	±2.9
Radiated tests <1GHz	±3.8
Radiated tests 1GHz - 40 GHz	±4.7
AC power-line conducted emission	±1.45

Annex B. Test Results U-NII-1 & U-NII-2A

B.1 Test Conditions

The conducted RF output power at chain A was adjusted according to the client's supplied Target values (see following table) using the Intel DRTU tool and measuring the power by using a spectrum analyser with the channel integration method according to point II) E) 2) e) (Method SA-2 Alternative) of Guidance 789033 D02. Measured values for adjustment were within +/- 0.25 dB from the declared Target values.

U-NII-1					Conducted Power Target Value (dBm)
Mode	BW (MHz)	Data Rate	CH #	Freq. (MHz)	SISO Chain A
802.11a	20	6Mbps	36	5180	17.5
			40	5200	21.5
			48	5240	21
802.11n	20	HT0	36	5180	17.5
			40	5200	21.5
			48	5240	21
	40	HT0	38F	5190	18
			46F	5230	21.5
802.11ac	80	VHT0	42ac80	5210	18.5

U-NII-2A					Conducted Power Target Value (dBm)
Mode	BW (MHz)	Data Rate	CH #	Freq. (MHz)	SISO Chain A
802.11a	20	6Mbps	52	5260	20.50
			56	5280	21.00
			64	5320	17.50
802.11n	20	HT0	52	5260	23.00
			56	5280	23.00
			64	5320	19.50
	40	HT0	54F	5270	20.00
			62F	5310	15.50
802.11ac	80	VHT0	58ac80	5290	17.50

The following data rates were selected based on preliminary testing that identified those rates as the worst cases for output power and spurious levels at the band edges:

- 802.11a → 6Mbps
- 802.11n20 and 802.11n40 (SISO) → HT0
- 802.11ac80 (SISO) → VHT0

Alternative channels to the lowest and highest channels per band have been also tested for Band Edge compliance.

B.2 Test Results Tables U-NII-1

B.2.1 26dB & 99% Bandwidth

Test procedure

The setup below was used to measure the 26dB & 99% Bandwidth. The antenna terminal of the EUT is connected to the spectrum analyzer through an attenuator, and the spectrum analyzer reading is compensated to include the RF path loss.

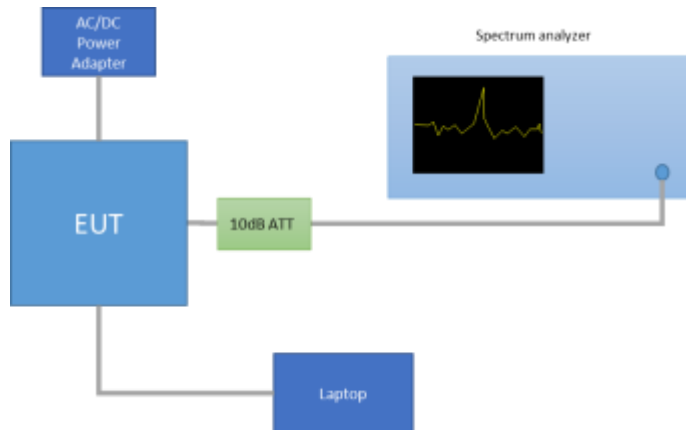

Results tables

Mode	Rate	Antenna	Channel	Frequency [MHz]	26dB BW [MHz]	99% BW [MHz]
802.11a	6Mbps	SISO CHAIN A	36	5180	24.62	17.92
			40	5200	28.38	18.28
			48	5240	41.99	22.80
802.11n20	HT0		36	5180	24.47	17.88
			40	5200	29.68	18.28
			48	5240	30.33	18.44
802.11n40	HT0		38F	5190	45.04	36.56
802.11ac80	VHT0		46F	5230	50.45	37.12
			42ac80	5210	83.68	75.12

Max Value

See Section B.3.1 and Section B.3.2 for the screenshot results.

B.2.2 Power Limits. Maximum Output power & Peak power spectral density

Test limits

FCC part	Limits
15.407 (a) (1) (iv)	For mobile and portable client devices in the 5.15-5.25 GHz band, the maximum conducted output power over the frequency band of operation shall not exceed 250 mW provided the maximum antenna gain does not exceed 6 dBi. In addition, the maximum power spectral density shall not exceed 11 dBm in any 1 megahertz band.

Test procedure

The Maximum Conducted Output Power was measured using the channel integration method according to point E) 2) e) (Method SA-2 Alternative) of KDB 789033 D02.

The maximum power spectral density (PSD) was measured using the method according to point F) (Method SA-2 Alternative) of KDB 789033 D02.

The EIRP power (dBm) is calculated by adding the declared maximum antenna gain to the measured conducted power.

The setup below was used to measure the maximum conducted output power and power spectral density. The antenna terminal of the EUT is connected to the spectrum analyser through an attenuator, and the spectrum analyzer reading is compensated to include the RF path loss.

The declared maximum antenna gain is 5dBi.

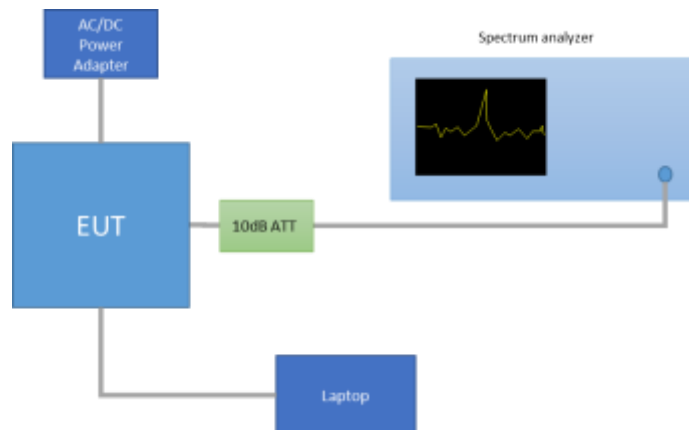

Results tables

Duty cycle

Mode	Rate	Antenna	Transmission Duration [ms]	Transmission Period [ms]	Duty Cycle [%]
802.11a	6Mbps	SISO-A	2.036	2.071	98.31%
802.11n20	HT0	SISO-A	1.894	1.929	98.19%
802.11n40	HT0	SISO-A	0.937	0.969	96.70%
802.11ac80	VHT0	SISO-A	0.458	0.493	92.90%

Maximum output power

Mode	Rate	Channel	Freq. [MHz]	Antenna	Average Conducted Output Power [dBm]	Maximum* Conducted Output Power [dBm]	Maximum* Conducted Output Power [mW]	Max of EIRP [dBm]
802.11a	6Mbps	36	5180	SISO CHAIN A	17.38	17.38	54.70	22.38
		40	5200	SISO CHAIN A	21.43	21.43	139.00	26.43
		48	5240	SISO CHAIN A	21.16	21.16	130.62	26.16
802.11n20	HT0	36	5180	SISO CHAIN A	17.29	17.29	53.58	22.29
		40	5200	SISO CHAIN A	21.36	21.36	136.77	26.36
		48	5240	SISO CHAIN A	21.19	21.19	131.52	26.19
802.11n40	HT0	38F	5190	SISO CHAIN A	17.66	17.81	60.34	22.81
		46F	5230	SISO CHAIN A	21.35	21.50	141.12	26.50
802.11ac80	VHT0	42ac80	5210	SISO CHAIN A	17.95	18.27	67.14	23.27

* Maximum values are the duty cycle compensated values calculated from the average (measured) values

Max Value

Min Value

Maximum power spectral Density (PSD)

Mode	Rate	Channel	Freq. [MHz]	Antenna	Average conducted PSD [dBm/MHz]	Maximum* conducted PSD [dBm/MHz]	Maximum* EIRP PSD [dBm/MHz]
802.11a	6Mbps	36	5180	SISO CHAIN A	5.47	5.47	10.47
		40	5200	SISO CHAIN A	9.45	9.45	14.45
		48	5240	SISO CHAIN A	9.44	9.44	14.44
802.11n20	HT0	36	5180	SISO CHAIN A	5.39	5.39	10.39
		40	5200	SISO CHAIN A	9.40	9.40	14.40
		48	5240	SISO CHAIN A	9.21	9.21	14.21
802.11n40	HT0	38F	5190	SISO CHAIN A	2.57	2.72	7.72
		46F	5230	SISO CHAIN A	6.29	6.44	11.44
802.11ac80	VHT0	42ac80	5210	SISO CHAIN A	0.51	0.83	5.83

* Maximum values are the duty cycle compensated values calculated from the measured average values

See Section B.3.3 for the screenshot results.

B.2.3 Undesirable emission limits : Band Edge (Conducted)

Test limits

FCC part	Limits																				
15.407 (b) (1)	For transmitters operating in the 5.15-5.25 GHz band: All emissions outside of the 5.15-5.35 GHz band shall not exceed an e.i.r.p. of -27 dBm/MHz.																				
15.209	<p>Radiated emissions which fall in the restricted bands, as defined in §15.205(a), must also comply with the radiated emission limits specified in §15.209(a):</p> <table border="1"> <thead> <tr> <th>Freq Range (MHz)</th> <th>Field Strength (μV/m)</th> <th>Field Strength (dBμV/m)</th> <th>Meas. Distance (m)</th> </tr> </thead> <tbody> <tr> <td>30-88</td> <td>100</td> <td>40</td> <td>3</td> </tr> <tr> <td>88-216</td> <td>150</td> <td>43.5</td> <td>3</td> </tr> <tr> <td>216-960</td> <td>200</td> <td>46</td> <td>3</td> </tr> <tr> <td>Above 960</td> <td>500</td> <td>54</td> <td>3</td> </tr> </tbody> </table> <p>The emission limits shown in the above table are based on measurements employing CISPR quasi-peak detector except for the frequency bands 9-90 kHz, 110-490 kHz and above 1000 MHz. Radiated emission limits in these three bands are based on measurements employing an average detector.</p> <p>For average radiated emission measurements above 1000 MHz, there is also a limit specified when measuring with peak detector function, corresponding to 20 dB above the indicated values in the table.</p>	Freq Range (MHz)	Field Strength (μV/m)	Field Strength (dBμV/m)	Meas. Distance (m)	30-88	100	40	3	88-216	150	43.5	3	216-960	200	46	3	Above 960	500	54	3
Freq Range (MHz)	Field Strength (μV/m)	Field Strength (dBμV/m)	Meas. Distance (m)																		
30-88	100	40	3																		
88-216	150	43.5	3																		
216-960	200	46	3																		
Above 960	500	54	3																		

Test procedure

The setup below was used to measure undesirable emissions on the Band Edge domain. The antenna terminal of the EUT is connected to the spectrum analyzer through an attenuator, and the spectrum analyzer reading is compensated to include the RF path loss and the declared Antenna Gain.

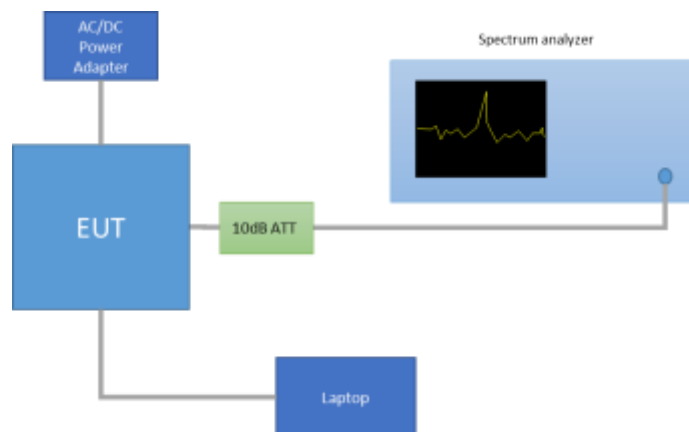

Band Edge measurements in average mode on the low frequency section was done with the Video Bandwidth Method was used according to section G) 6) (KDB 789033 D02), with the following parameters:

- When the duty cycle is > 98 %, VBW = 10Hz
- When the duty cycle is < 98 %, VBW > 1/T, where T is defined in section II.B.1.a

In case of Band Edge measurements falling in restricted bands, the declared Antenna Gain is also compensated in the graph. The declared maximum antenna gain is 5dBi.

For Band Edge measurements falling in restricted bands, the following limits in dBm were applied for the average detector after the conversion from the limits detailed above in dB μ V/m, according to FCC 47 CFR part 15 - Subpart C – §15.209(a). The limits in dBm for peak detector are 20dB above the indicated values in the table.

§15.209(a)			Converted values	
Freq Range (MHz)	Distance (m)	Field strength (microvolts/meter)	Field strength (dB microvolts/meter)	Power (dBm)
Above 960	3	500	54.0	-41.2

See Section B.3.4 for the screenshot results.

B.2.4 Radiated spurious emission

Standard references

FCC part	Limits																																
15.407 (b) (1)	For transmitters operating in the 5.15-5.25 GHz band: All emissions outside of the 5.15-5.35 GHz band shall not exceed an e.i.r.p. of -27 dBm/MHz.																																
15.209	<p>Radiated emissions which fall in the restricted bands, as defined in §15.205(a), must also comply with the radiated emission limits specified in §15.209(a):</p> <table border="1" data-bbox="541 562 1331 911"> <thead> <tr> <th data-bbox="547 568 740 631">Freq Range (MHz)</th> <th data-bbox="740 568 933 631">Field Strength ($\mu\text{V}/\text{m}$)</th> <th data-bbox="933 568 1126 631">Field Strength ($\text{dB}\mu\text{V}/\text{m}$)</th> <th data-bbox="1126 568 1326 631">Meas. Distance (m)</th> </tr> </thead> <tbody> <tr> <td data-bbox="547 631 740 672">0.009-0.490</td> <td data-bbox="740 631 933 672">2400/f(kHz)</td> <td data-bbox="933 631 1126 672">-</td> <td data-bbox="1126 631 1326 672">300</td> </tr> <tr> <td data-bbox="547 672 740 712">0.490-1.705</td> <td data-bbox="740 672 933 712">24000/f(kHz)</td> <td data-bbox="933 672 1126 712">-</td> <td data-bbox="1126 672 1326 712">300</td> </tr> <tr> <td data-bbox="547 712 740 752">1.705-30.0</td> <td data-bbox="740 712 933 752">30</td> <td data-bbox="933 712 1126 752">-</td> <td data-bbox="1126 712 1326 752">30</td> </tr> <tr> <td data-bbox="547 752 740 792">30-88</td> <td data-bbox="740 752 933 792">100</td> <td data-bbox="933 752 1126 792">40</td> <td data-bbox="1126 752 1326 792">3</td> </tr> <tr> <td data-bbox="547 792 740 833">88-216</td> <td data-bbox="740 792 933 833">150</td> <td data-bbox="933 792 1126 833">43.5</td> <td data-bbox="1126 792 1326 833">3</td> </tr> <tr> <td data-bbox="547 833 740 873">216-960</td> <td data-bbox="740 833 933 873">200</td> <td data-bbox="933 833 1126 873">46</td> <td data-bbox="1126 833 1326 873">3</td> </tr> <tr> <td data-bbox="547 873 740 911">Above 960</td> <td data-bbox="740 873 933 911">500</td> <td data-bbox="933 873 1126 911">54</td> <td data-bbox="1126 873 1326 911">3</td> </tr> </tbody> </table> <p data-bbox="389 943 1485 1061">The emission limits shown in the above table are based on measurements employing CISPR quasi-peak detector except for the frequency bands 9-90 kHz, 110-490 kHz and above 1000 MHz. Radiated emission limits in these three bands are based on measurements employing an average detector.</p> <p data-bbox="389 1066 1485 1153">For average radiated emission measurements above 1000 MHz, there is also a limit specified when measuring with peak detector function, corresponding to 20 dB above the indicated values in the table.</p>	Freq Range (MHz)	Field Strength ($\mu\text{V}/\text{m}$)	Field Strength ($\text{dB}\mu\text{V}/\text{m}$)	Meas. Distance (m)	0.009-0.490	2400/f(kHz)	-	300	0.490-1.705	24000/f(kHz)	-	300	1.705-30.0	30	-	30	30-88	100	40	3	88-216	150	43.5	3	216-960	200	46	3	Above 960	500	54	3
Freq Range (MHz)	Field Strength ($\mu\text{V}/\text{m}$)	Field Strength ($\text{dB}\mu\text{V}/\text{m}$)	Meas. Distance (m)																														
0.009-0.490	2400/f(kHz)	-	300																														
0.490-1.705	24000/f(kHz)	-	300																														
1.705-30.0	30	-	30																														
30-88	100	40	3																														
88-216	150	43.5	3																														
216-960	200	46	3																														
Above 960	500	54	3																														

Test procedure

The setup below was used to measure the radiated spurious emissions.

Depending of the frequency range and bands being tested, different antennas and filters were used.

The final measurement is done by varying the antenna height, the EUT azimuth over 360° and for both Vertical and Horizontal polarizations.

The radiated spurious emission was measured on the worst case configuration selected from the chapter B.2.2 and using the low, middle and high channel.

Radiated Setup < 1GHz

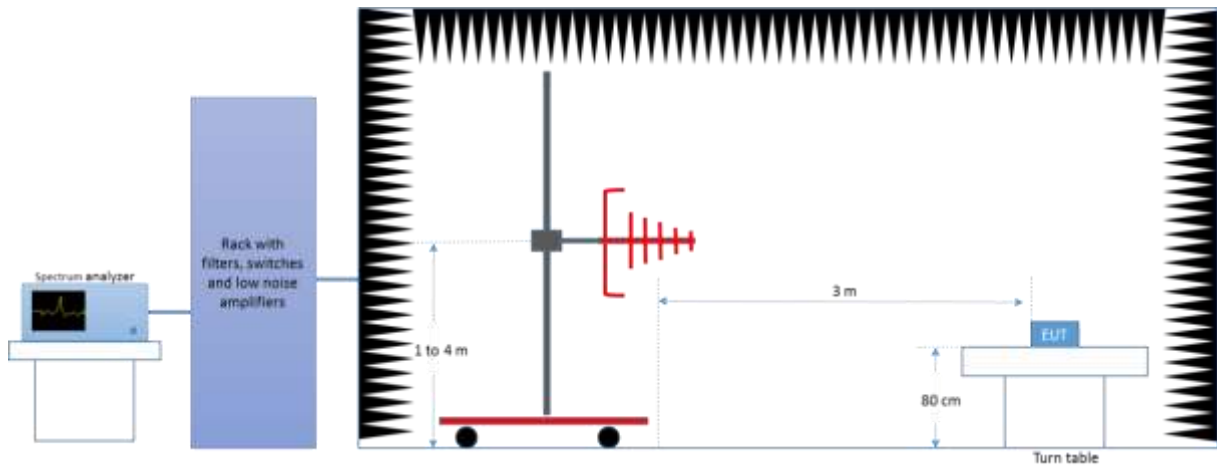

Radiated Setup 1 GHz - 18 GHz

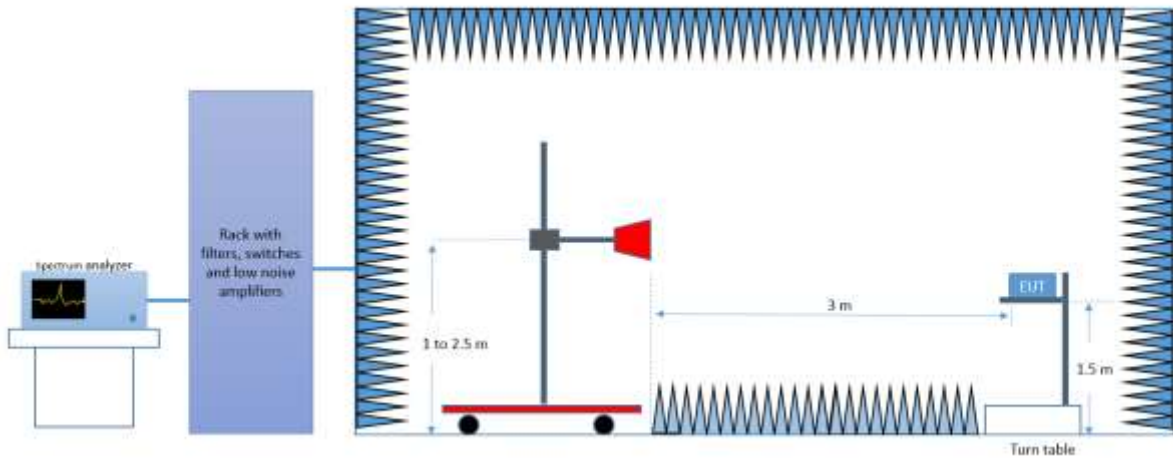

Radiated Setup 18 GHz - 40 GHz

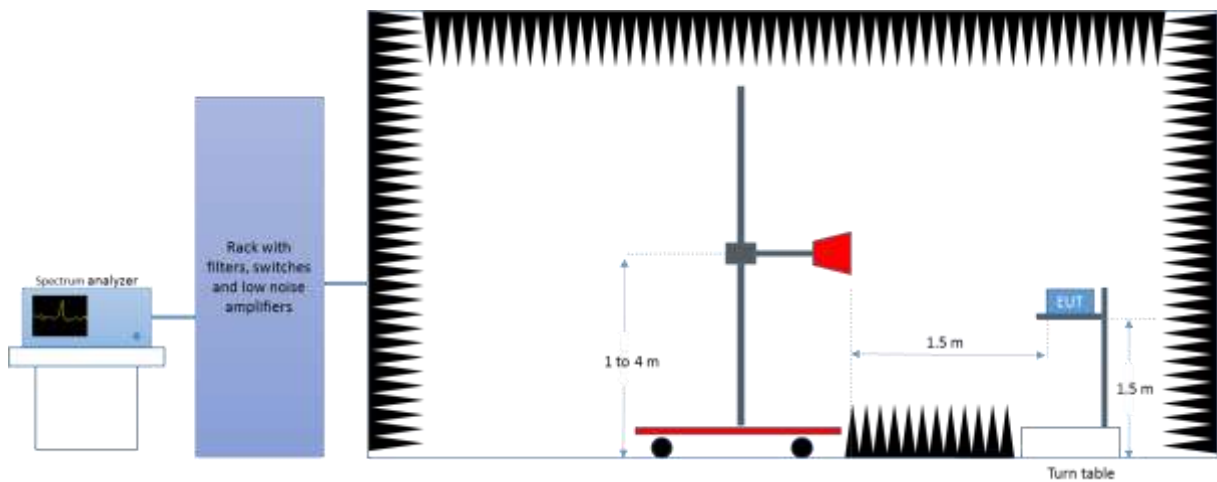

Sample Calculation

The field strength is deduced from the radiated measurement using the following equation:

$$E = 126.8 - 20\log(\lambda) + P - G$$

where

E is the field strength of the emission at the measurement distance, in dB μ V/m

P is the power measured at the output of the test antenna, in dBm

λ is the wavelength of the emission under investigation [$300/f_{MHz}$], in m

G is the gain of the test antenna, in dBi

NOTE – The measured power P includes all applicable instrument correction factors up to the connection to the test Antenna e.g. cable losses, amplifier gains.

For field strength measurements made at other than the distance at which the applicable limit is specified, the field strength of the emission at the distance specified by the limit is deduced as follows:

$$E_{SpecLimit} = E_{Meas} + 20\log(D_{Meas}/D_{SpecLimit})$$

where

E_{SpecLimit} is the field strength of the emission at the distance specified by the limit, in dB μ V/m

E_{Meas} is the field strength of the emission at the measurement distance, in dB μ V/m

D_{Meas} is the measurement distance, in m

D_{SpecLimit} is the distance specified by the limit, in m

Test Results

30 MHz – 40 GHz, 802.11a, 6Mbps, Chain A
Radiated Spurious – CH36

Frequency	MaxPeak	Avg	Limit	Margin
MHz	dB μ V/m	dB μ V/m	dB μ V/m	dB
500.0	36.2	---	46.0	9.8
6072.1	---	48.6	54.0	5.4
6095.9	61.8	---	74.0	12.2
15540.4	54.9	---	74.0	19.1
15540.8	---	45.2	54.0	8.8
20720.0	---	39.0	54.0	15.0
20720.0	45.6	---	74.0	28.4
32139.1	46.4	---	74.0	27.6
32139.6	---	34.1	54.0	19.9

Radiated Spurious – CH40

Frequency	MaxPeak	Avg	Limit	Margin
MHz	dB μ V/m	dB μ V/m	dB μ V/m	dB
500.0	36.4	---	46.0	9.6
6048.0	---	49.1	54.0	4.9
6149.6	59.9	---	74.0	14.1
15601.9	54.5	---	74.0	19.5
15602.4	---	44.2	54.0	9.8
20799.8	---	39.0	54.0	15.0
20800.3	45.4	---	74.0	28.6
37831.8	---	35.2	54.0	18.8
37831.8	47.2	---	74.0	26.8

Radiated Spurious – CH48

Frequency	MaxPeak	Avg	Limit	Margin
MHz	dB μ V/m	dB μ V/m	dB μ V/m	dB
62.4	30.4	---	40.0	9.6
6019.5	---	48.9	54.0	5.1
6058.3	60.7	---	74.0	13.3
15720.2	---	44.2	54.0	9.8
15721.0	55.6	---	74.0	18.4
20959.9	---	39.2	54.0	14.9
20967.0	49.3	---	74.0	24.7
37811.1	46.6	---	74.0	27.4
37811.6	---	34.7	54.0	19.3

30 MHz – 40 GHz, 802.11n20, HT0, Chain A

Radiated Spurious – CH36

Frequency	MaxPeak	Avg	Limit	Margin
MHz	dBµV/m	dBµV/m	dBµV/m	dB
500.0	37.5	---	46.0	8.6
6053.7	---	49.3	54.0	4.7
6071.1	62.0	---	74.0	12.0
15538.1	55.3	---	74.0	18.7
15544.4	---	44.7	54.0	9.3
20719.5	45.2	---	74.0	28.8
20720.0	---	37.8	54.0	16.2
39148.5	46.1	---	74.0	27.9
39151.9	---	34.6	54.0	19.4

Radiated Spurious – CH40

Frequency	MaxPeak	Avg	Limit	Margin
MHz	dBµV/m	dBµV/m	dBµV/m	dB
62.5	29.4	---	40.0	10.6
6098.1	61.0	---	74.0	13.0
6112.8	---	48.9	54.0	5.1
15603.3	---	43.8	54.0	10.2
15603.3	56.1	---	74.0	17.9
20799.8	---	39.0	54.0	15.1
20799.8	45.6	---	74.0	28.4
35044.1	---	35.1	54.0	18.9
35044.1	46.4	---	74.0	27.6

Radiated Spurious – CH48

Frequency	MaxPeak	Avg	Limit	Margin
MHz	dBµV/m	dBµV/m	dBµV/m	dB
62.5	28.9	---	40.0	11.1
6094.9	61.2	---	74.0	12.8
6103.5	---	48.8	54.0	5.2
15719.3	---	44.0	54.0	10.0
15722.4	55.4	---	74.0	18.6
20955.6	49.3	---	74.0	24.7
20959.9	---	38.8	54.0	15.2
37540.1	---	34.5	54.0	19.5
37545.9	45.9	---	74.0	28.1

30 MHz – 40 GHz, 802.11n40, HT0, Chain A

Radiated Spurious – CH38F

Frequency	MaxPeak	Avg	Limit	Margin
MHz	dBµV/m	dBµV/m	dBµV/m	dB
62.5	28.5	---	40.0	11.5
6079.4	---	49.2	54.0	4.9
6139.3	60.2	---	74.0	13.8
17991.1	---	49.8	54.0	4.2
17996.4	60.5	---	74.0	13.5
20759.7	44.9	---	74.0	29.1
20759.7	---	38.7	54.0	15.3
37468.8	46.7	---	74.0	27.3
37469.2	---	34.2	54.0	19.8

Radiated Spurious – CH46F

Frequency	MaxPeak	Avg	Limit	Margin
MHz	dBµV/m	dBµV/m	dBµV/m	dB
62.5	28.3	---	40.0	11.7
6058.3	60.4	---	74.0	13.6
6072.3	---	48.9	54.0	5.2
17986.2	60.9	---	74.0	13.1
18000.0	---	49.8	54.0	4.3
20919.8	---	38.5	54.0	15.5
20919.8	45.2	---	74.0	28.9
36576.8	47.0	---	74.0	27.0
36580.2	---	34.9	54.0	19.1

30 MHz – 40 GHz, 802.11ac80, VHT0, Chain A**Radiated Spurious – CH42ac80**

Frequency	MaxPeak	Avg	Limit	Margin
MHz	dB μ V/m	dB μ V/m	dB μ V/m	dB
500.0	35.8	---	46.0	10.2
6058.6	60.2	---	74.0	13.8
6087.0	---	49.1	54.0	4.9
17995.5	61.1	---	74.0	12.9
18000.0	---	49.8	54.0	4.2
20839.9	44.2	---	74.0	29.9
20839.9	---	38.6	54.0	15.4
35051.3	---	34.4	54.0	19.6
35051.8	48.0	---	74.0	26.0

B.2.5 AC power-line conducted emission

Standard references:

FCC part	RSS part	Limits														
15.207 15.407 (6)	RSS-GEN, Clause 8.8	<p>Except as shown in paragraphs (b) and (c) of this section, for an intentional radiator that is designed to be connected to the public utility (AC) power line, the radio frequency voltage that is conducted back onto the AC power line on any frequency or frequencies, within the band 150 kHz to 30 MHz, shall not exceed the limits in the following table, as measured using a 50 μH/50 ohms line impedance stabilization network (LISN). Compliance with the provisions of this paragraph shall be based on the measurement of the radio frequency voltage between each power line and ground at the power terminal. The lower limit applies at the boundary between the frequency ranges.</p> <table border="1"> <thead> <tr> <th rowspan="2">Frequency of emission (MHz)</th> <th colspan="2">Conducted limit (dBμV)</th> </tr> <tr> <th>Quasi-peak</th> <th>Average</th> </tr> </thead> <tbody> <tr> <td>0.15-0.5</td> <td>66 to 56*</td> <td>56 to 46*</td> </tr> <tr> <td>0.5-5</td> <td>56</td> <td>46</td> </tr> <tr> <td>5-30</td> <td>60</td> <td>50</td> </tr> </tbody> </table> <p>*Decreases with the logarithm of the frequency.</p>	Frequency of emission (MHz)	Conducted limit (dB μ V)		Quasi-peak	Average	0.15-0.5	66 to 56*	56 to 46*	0.5-5	56	46	5-30	60	50
Frequency of emission (MHz)	Conducted limit (dB μ V)															
	Quasi-peak	Average														
0.15-0.5	66 to 56*	56 to 46*														
0.5-5	56	46														
5-30	60	50														

Test procedure:

The EUT and peripherals are placed on a wooden table with a nominal size of 1.0 m by 1.5 m, raised 80 cm above the reference ground plane. The EUT is connected to AC-Power line through a Line Impedance Stabilization Network (LISN) to accommodate a 50 Ω /50 μ H coupling impedance for the measurement system. The EUT control PC is considered as a peripheral and therefore is connected to a second LISN which has the measurement port connected to a 50 ohms impedance.

Each measurement is done for each current-carrying conductor (Line and Neutral) at the end plug of the EUT power cord. The EUT is tested for several transmission modes (frequency channel, modulation, etc.) and the result providing the maximum measured emission is reported.

The exploratory measurement is done over the frequency range from 150 kHz to 30 MHz, while the measurement receiver is recording the Peak and Average signal at 10 kHz steps in Max Hold mode. The cables manipulation is performed within the range of likely configurations to determine the maximum emission. Once the EUT cable configuration, arrangement and mode of operation that produced the emission with the highest amplitude relative to the limit is found the six highest AC power-line conducted emissions relative to 20 dB of the limit are reported as the final measurement. If fewer than six emission frequencies are within 20 dB of the limit, the noise level is reported. For the final measurement, the measurement receiver records the Quasi Peak values with 9 kHz resolution bandwidth and the average values with 10 kHz resolution bandwidth.

EUT arrangement for AC power-line conducted emission tests

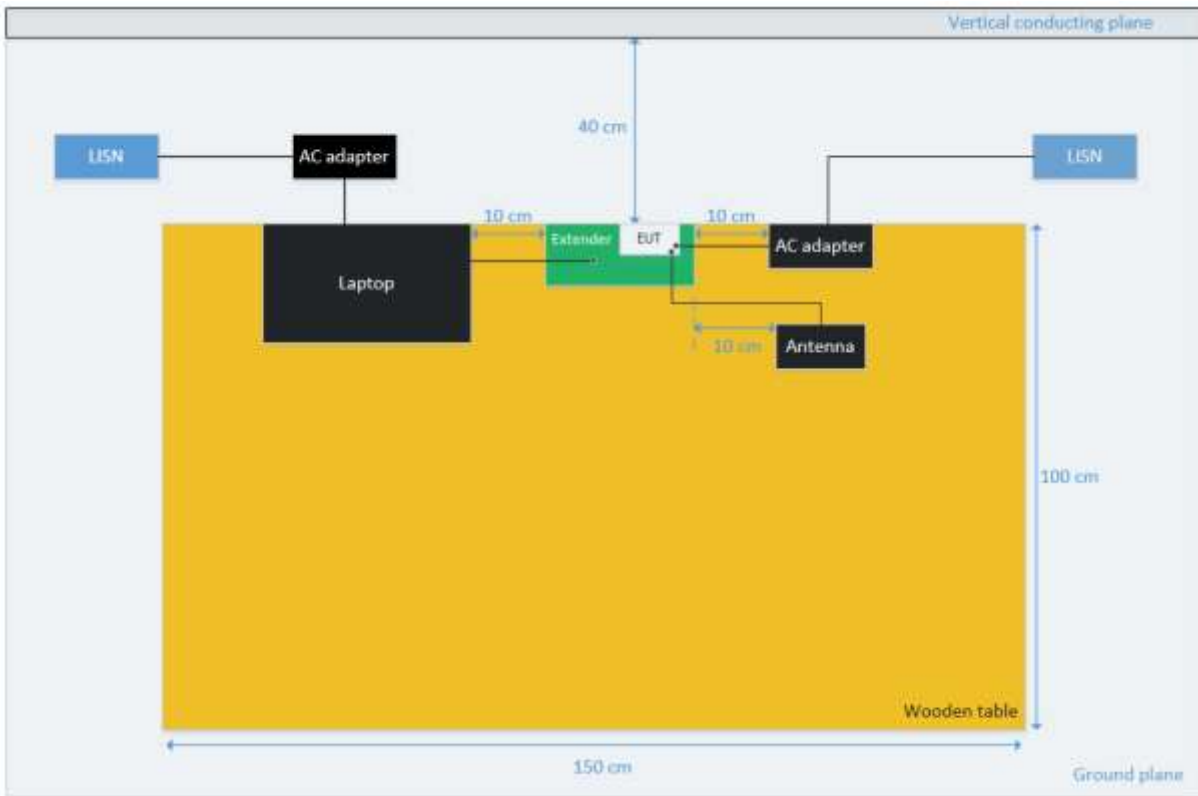

Sample Calculation:

The measured level at the spectrum analyzer in dBuV is corrected by a transducer factor taking into account the losses of the RF cable and the LISN as follows:

$$\text{Conducted Emission level (dBuV)} = SA_{\text{Level}} + RFCable_{\text{Losses}} + LISN_{\text{Losses}}$$

Where:

SA_{Level} is the voltage level displayed on the measurement receiver, in dBuV.

$RFCable_{\text{Losses}}$ is the value of the cable losses between the LISN and the measurement receiver, in dB.

$LISN_{\text{Losses}}$ is the value of the insertion losses of the LISN, in dB.

Test Results:

150kHz – 30MHz, all modes

AC power-line conducted – Phase L1

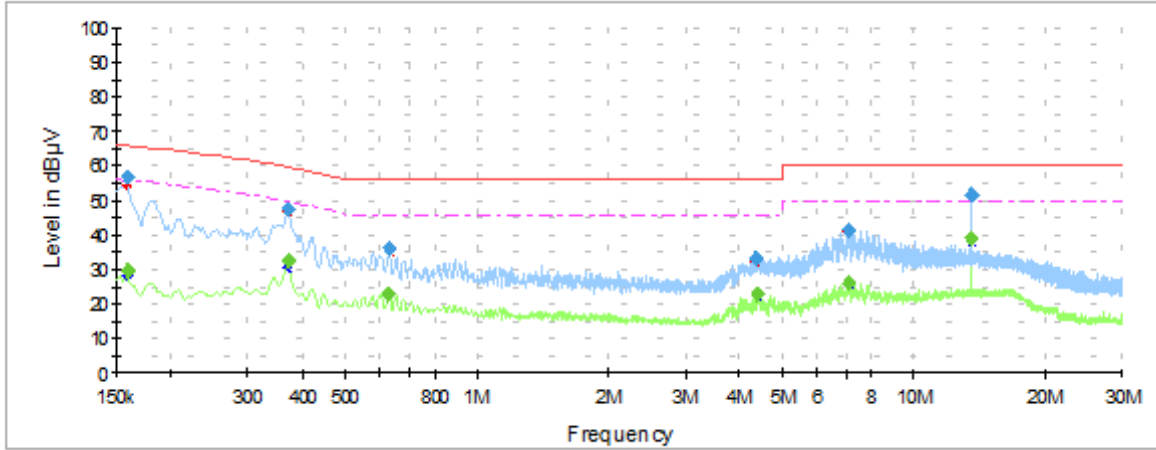

—◆ Peak measurements
 —◆ Avg measurements
 — Limit FCC Quasi-Peak
 - - - Limit FCC Avg

Frequency MHz	Max Peak dBµV	Avg dBµV	Limit dBµV	Margin dB
0.1589	56.8	--	65.7	8.9
0.1589	--	29.7	55.7	26
0.3708	47.5	--	59.7	12.2
0.3708	--	32.3	49.7	17.4
0.6305	36.3	--	56.00	19.7
0.6335	--	22.8	46.00	23.2
4.358	33.2	--	60.00	26.8
4.373	--	22.9	50.00	27.1
7.091	41.3	--	60.00	18.7
7.093	--	26.2	50.00	23.8
13.561	51.5	--	60.00	8.5
13.570	--	38.9	50.00	11.1

Note: The emissions found do not change with the modulation and/or frequency.

AC power-line conducted – Neutral N

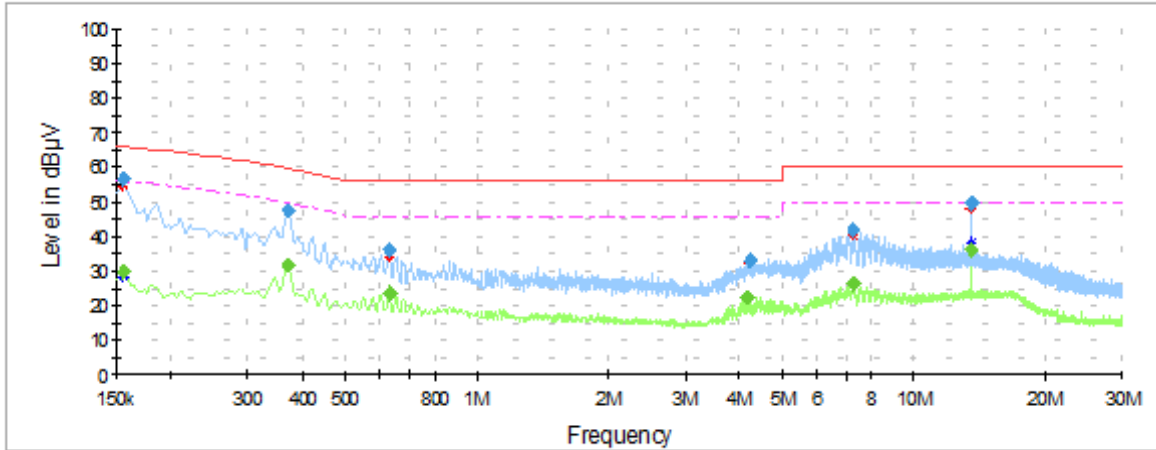

— Peak measurements — Avg measurements — Limit FCC Quasi-Peak - - - Limit FCC Avg

Frequency	Max Peak	Avg	Limit	Margin
MHz	dBµV	dBµV	dBµV	dB
0.1559	56.6	--	65.8	9.2
0.1559	--	29.8	55.8	26
0.3708	47.7	--	59.7	12
0.3708	--	31.7	49.7	18
0.6305	36.3	--	56.0	19.7
0.6333	--	23.7	46.0	22.3
4.155	32.8	--	60.0	27.2
4.215	--	22.4	50.0	27.6
7.275	42.0	--	60.0	18
7.281	--	26.2	50.0	23.8
13.555	49.8	--	60.0	10.2
13.573	--	36.3	50.0	13.7

Note: The emissions found do not change with the modulation and/or frequency.

B.3 Test Results Screenshot U-NII-1

B.3.1 26dB Bandwidth

SISO-A, 802.11a, 6Mbps

Channel 48

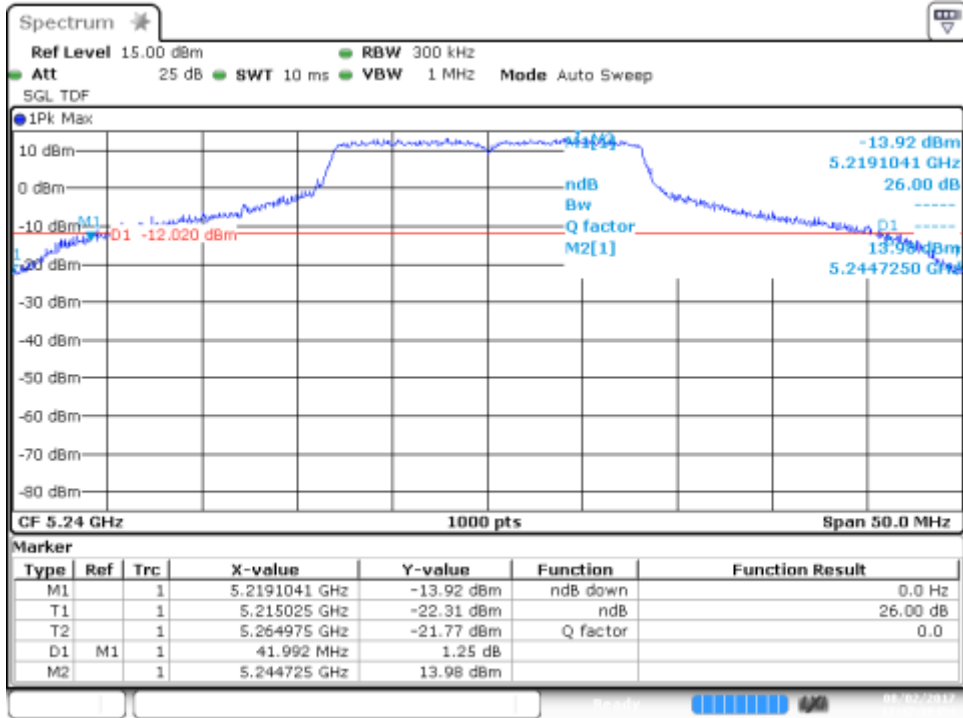

SISO-A, 802.11n20, HT0

Channel 48

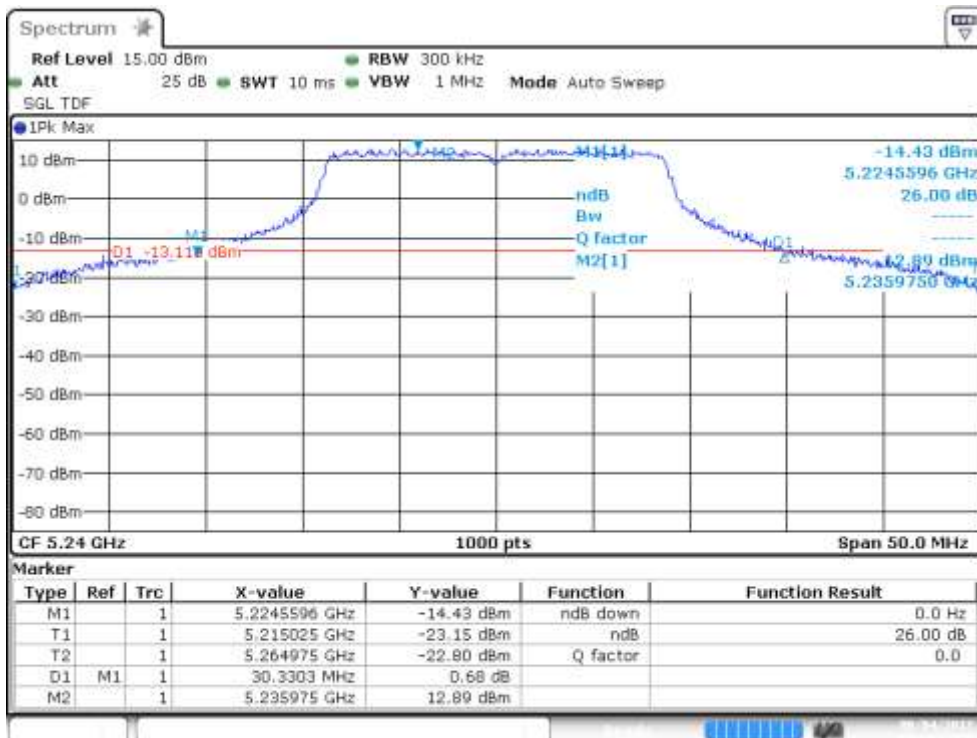

SISO-A, 802.11n40, HT0

Channel 46F

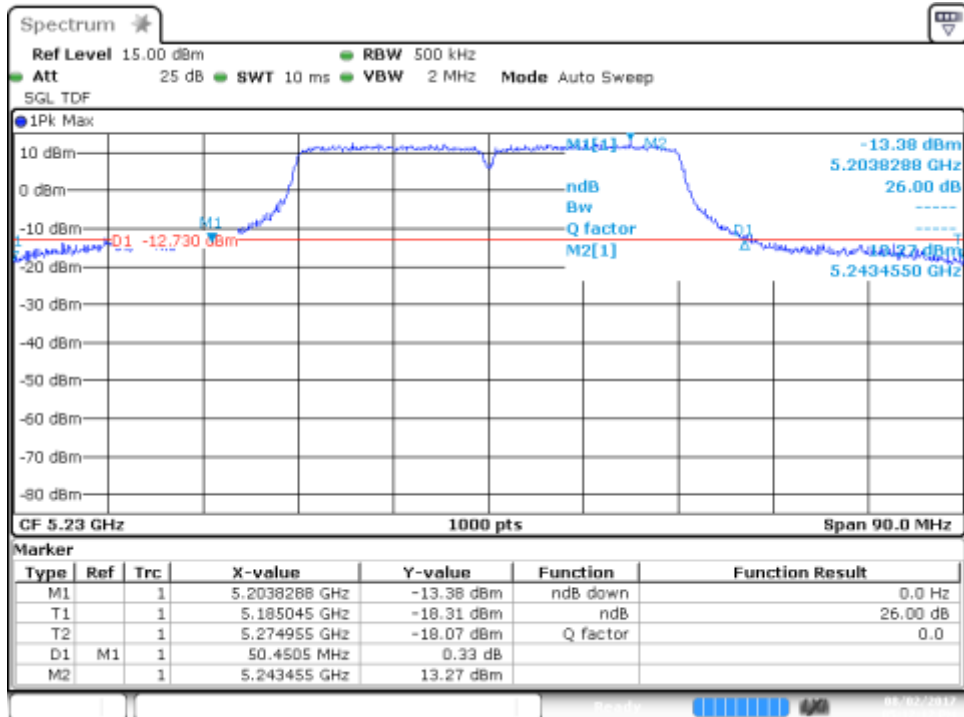

SISO-A, 802.11ac80, VHT0

Channel 42ac80

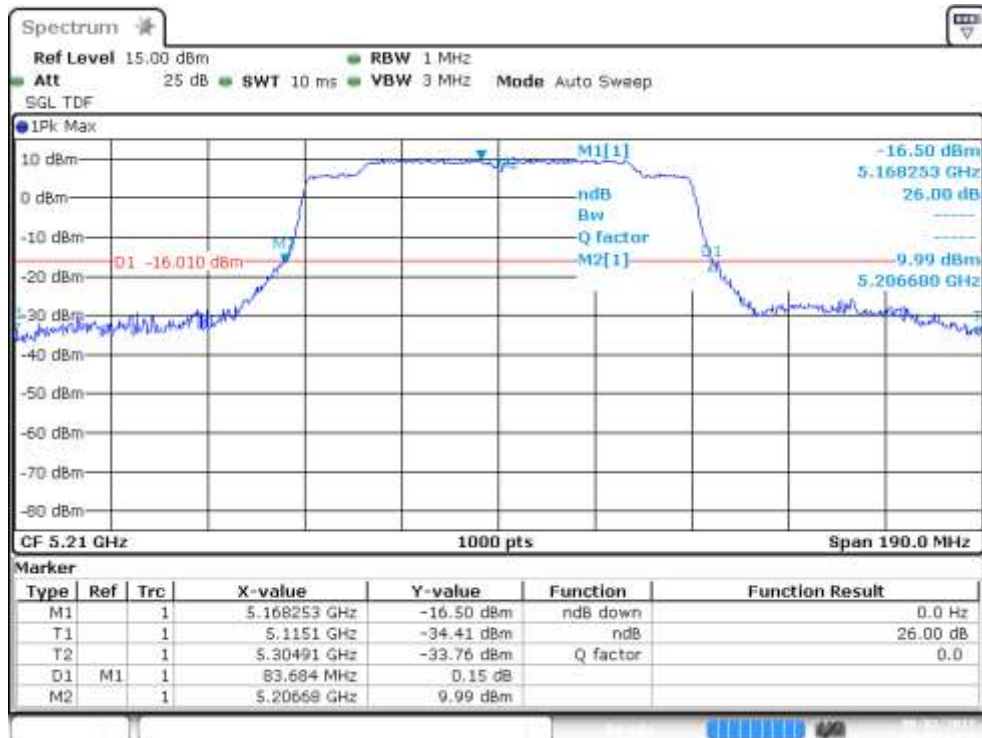

B.3.2 99% Bandwidth

SISO-A, 802.11a, 6Mbps

Channel 48

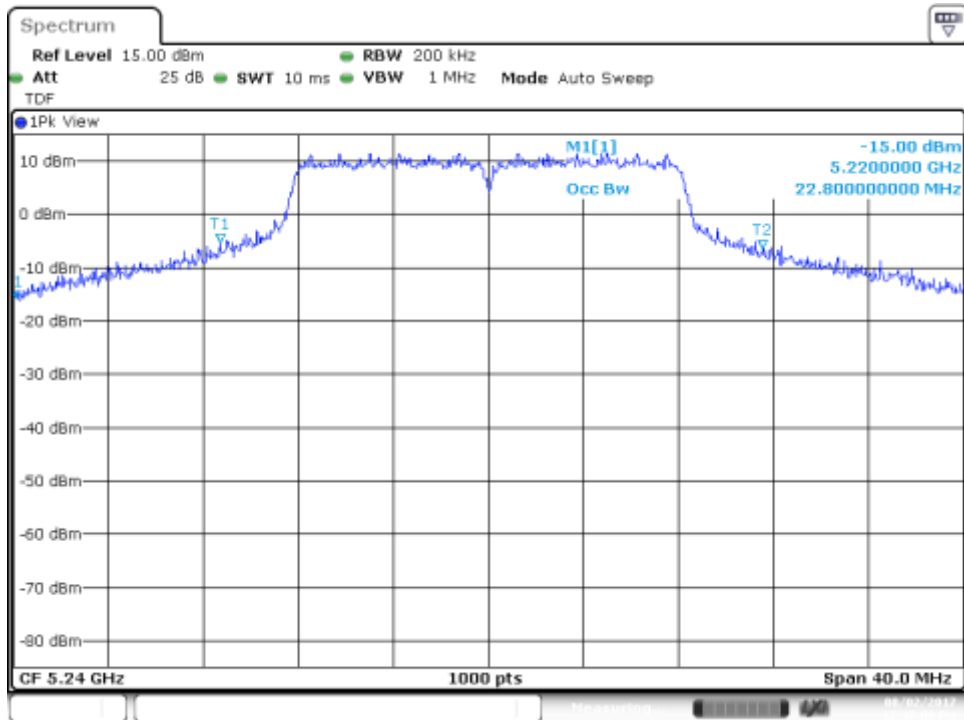

SISO-A, 802.11n20, HT0

Channel 48

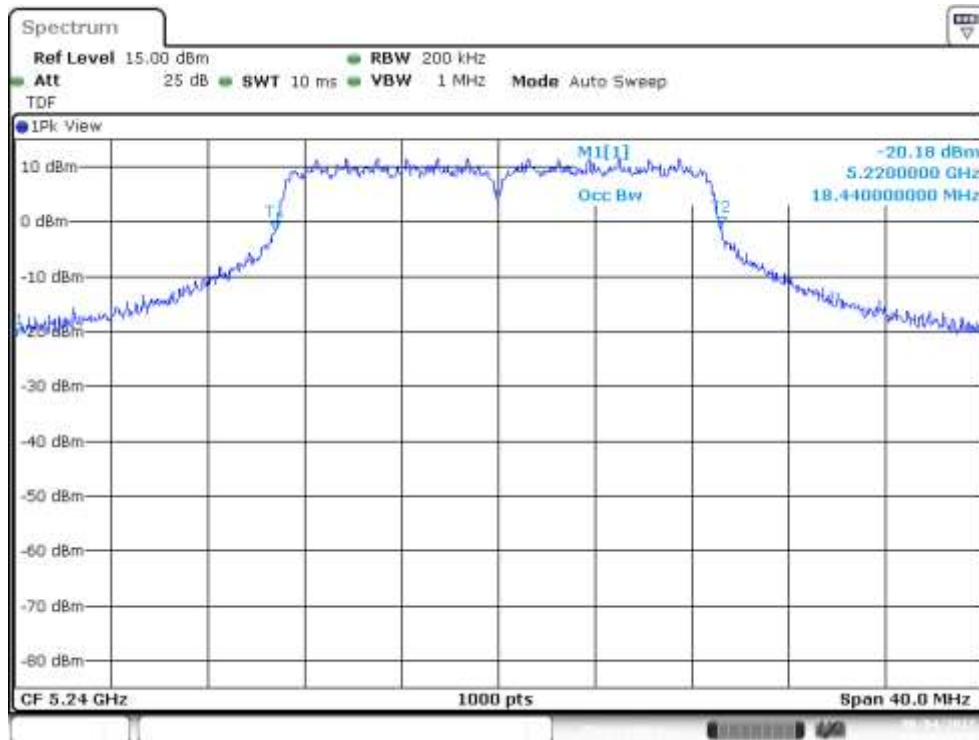

SISO-A, 802.11n40, HT0

Channel 46F

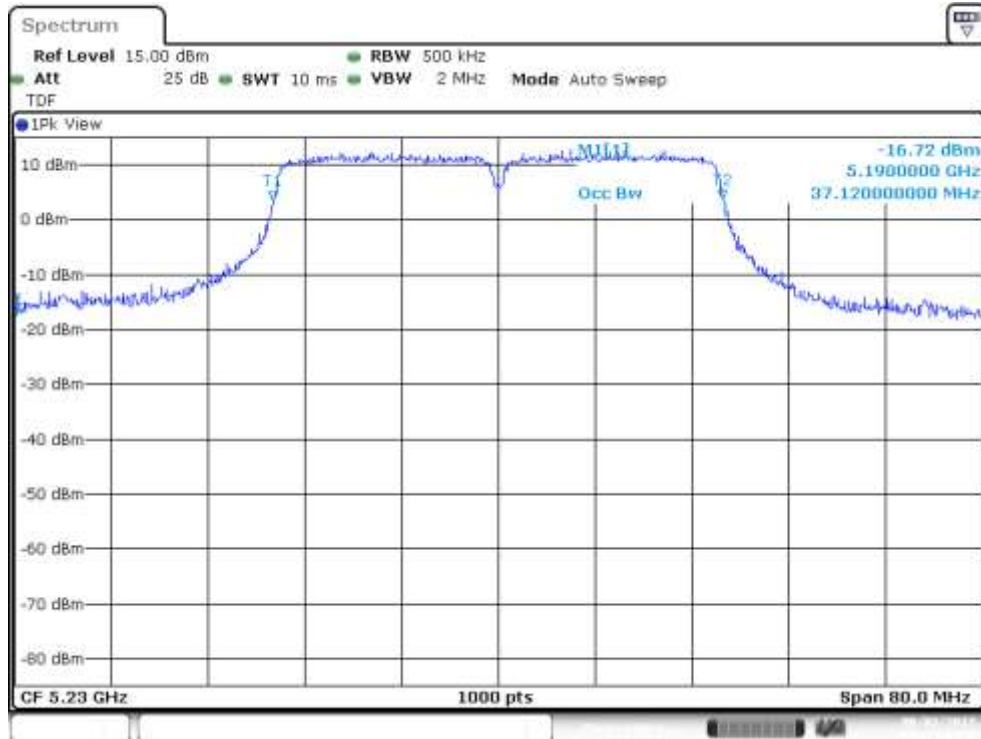

SISO-A, 802.11ac80, VHT0

Channel 42ac80

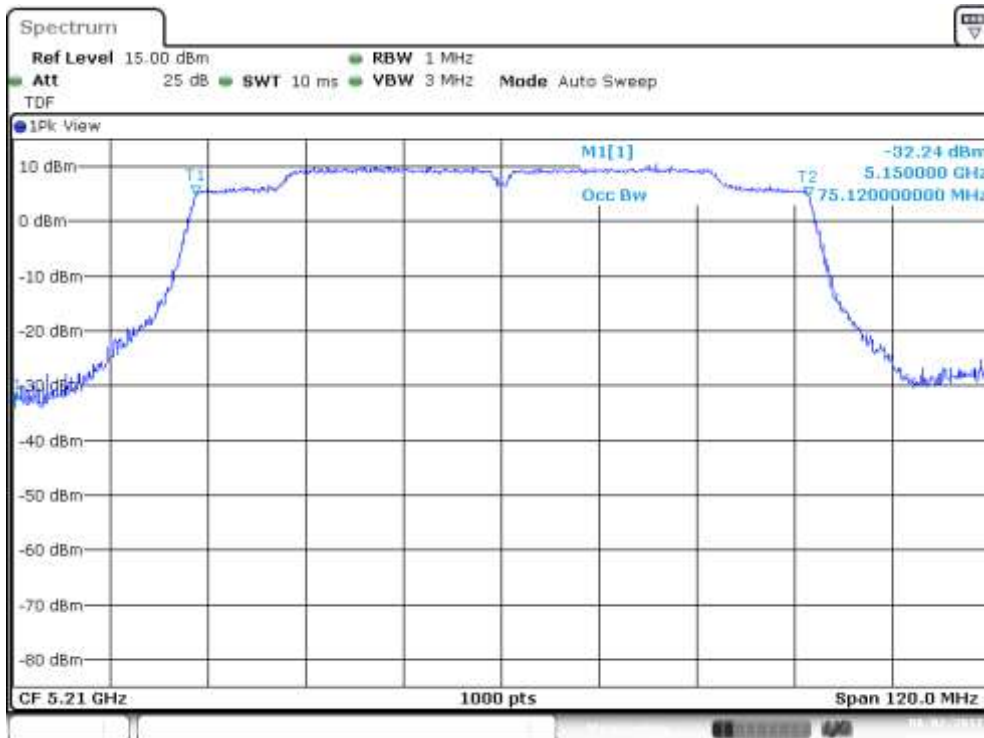

B.3.3 Power Limits. Maximum Output power & Peak power spectral density

SISO-A, 802.11a, 6Mbps

Channel 40

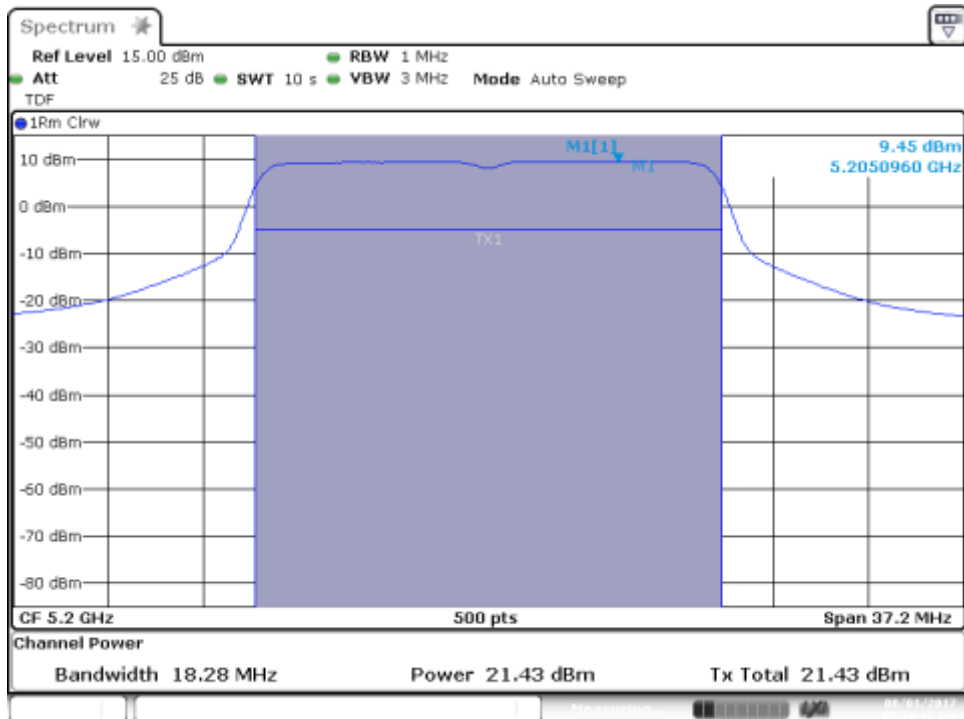

Channel 36

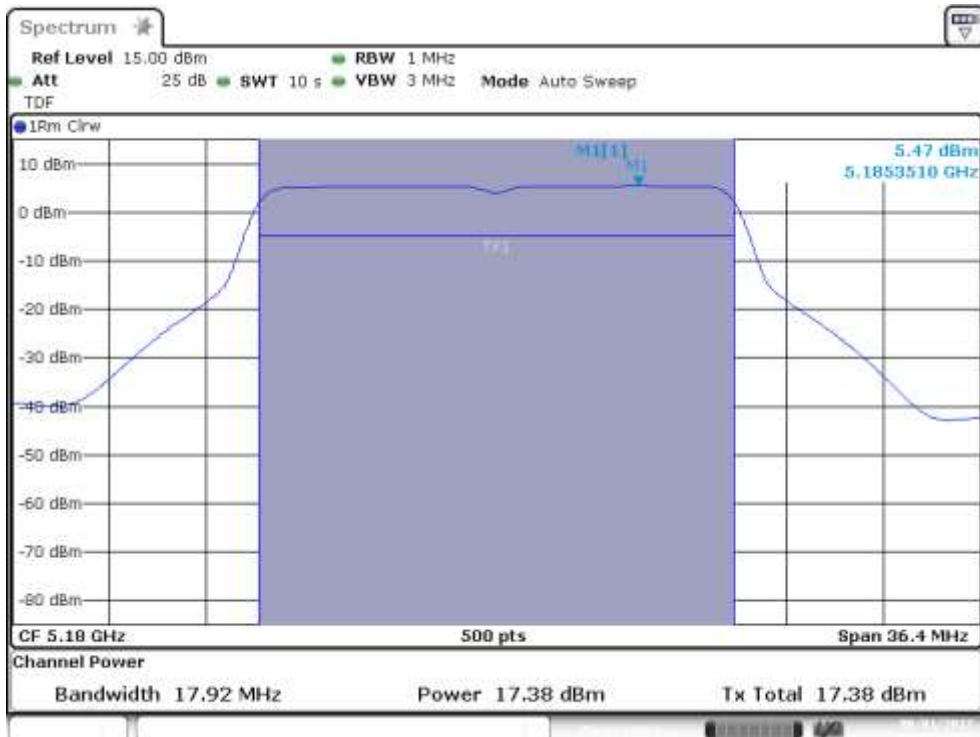

SISO-A, 802.11n20, HT0

Channel 40

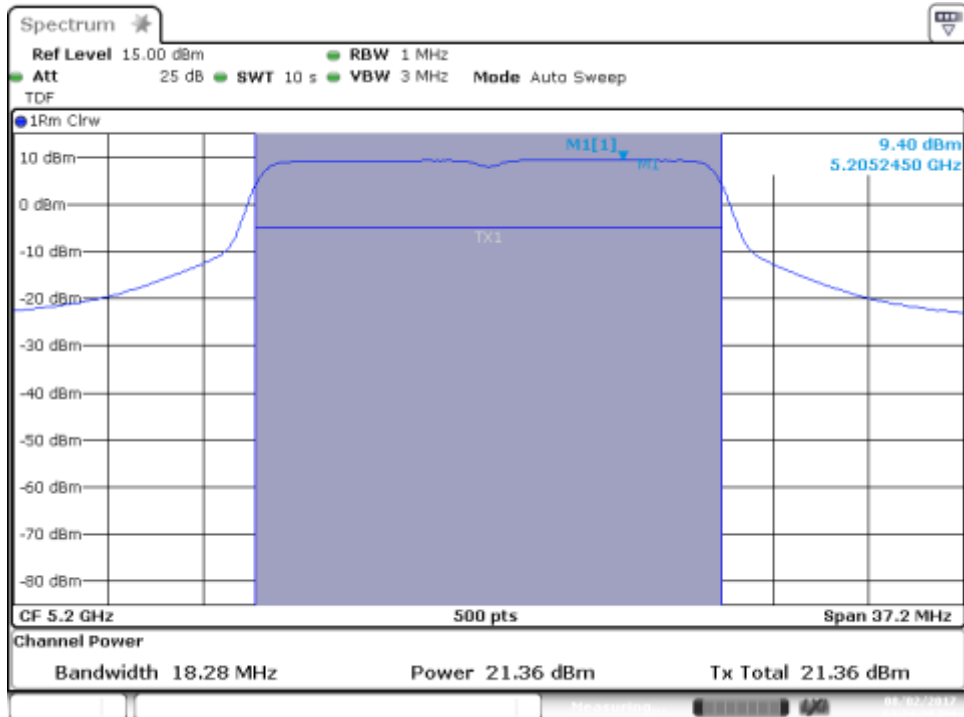

Channel 36

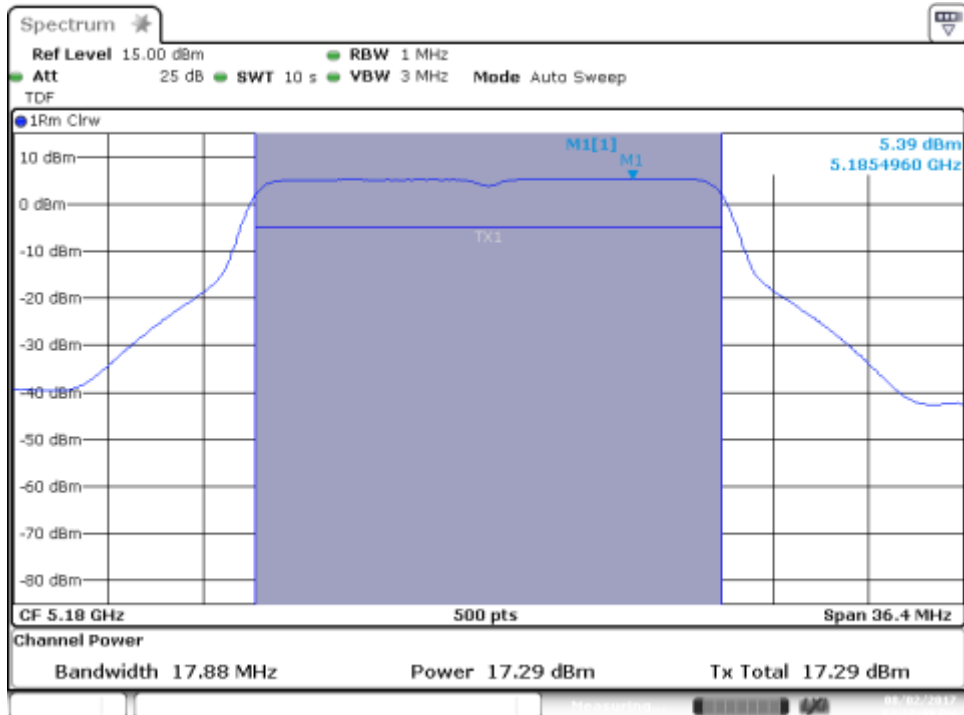

SISO-A, 802.11n40, HT0

Channel 46F

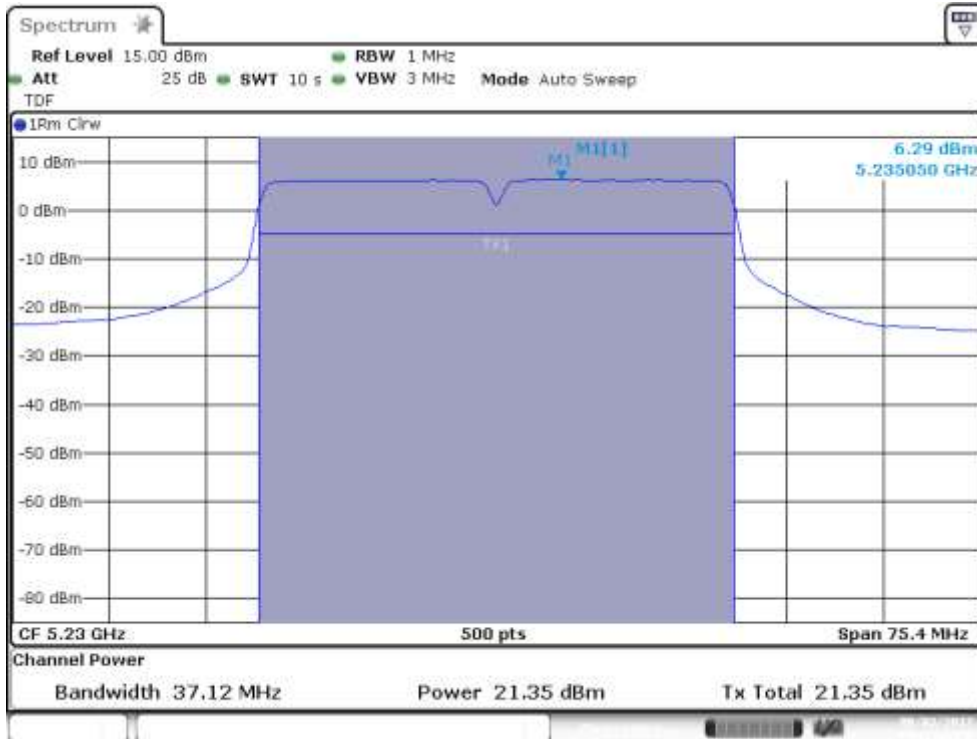

Channel 38F

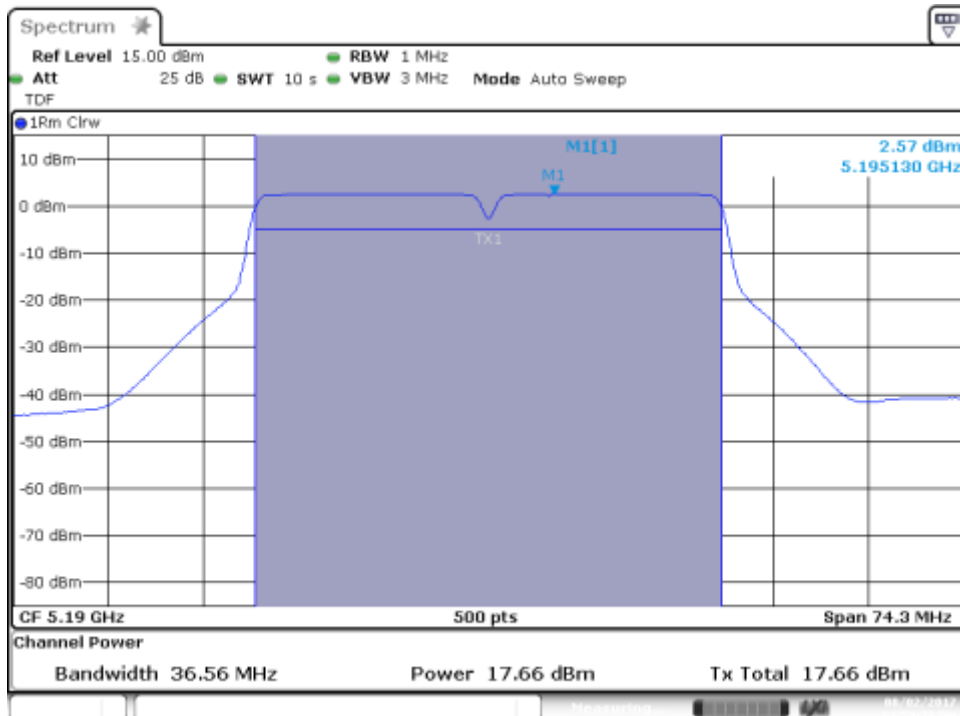

SISO-A, 802.11ac80, VHT0

Channel 42ac80

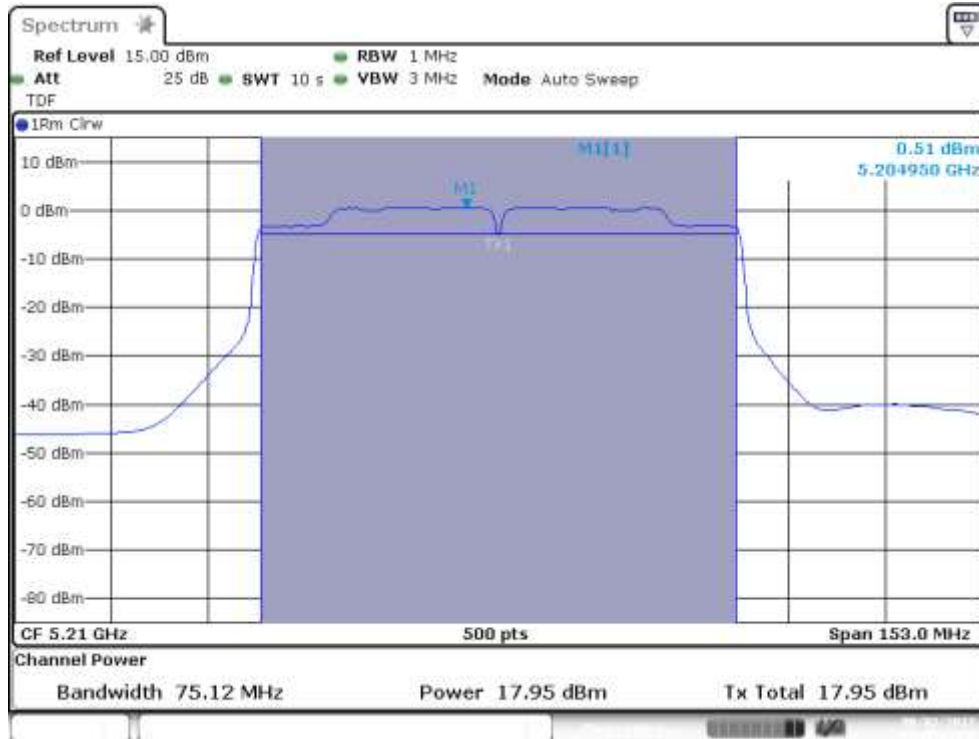

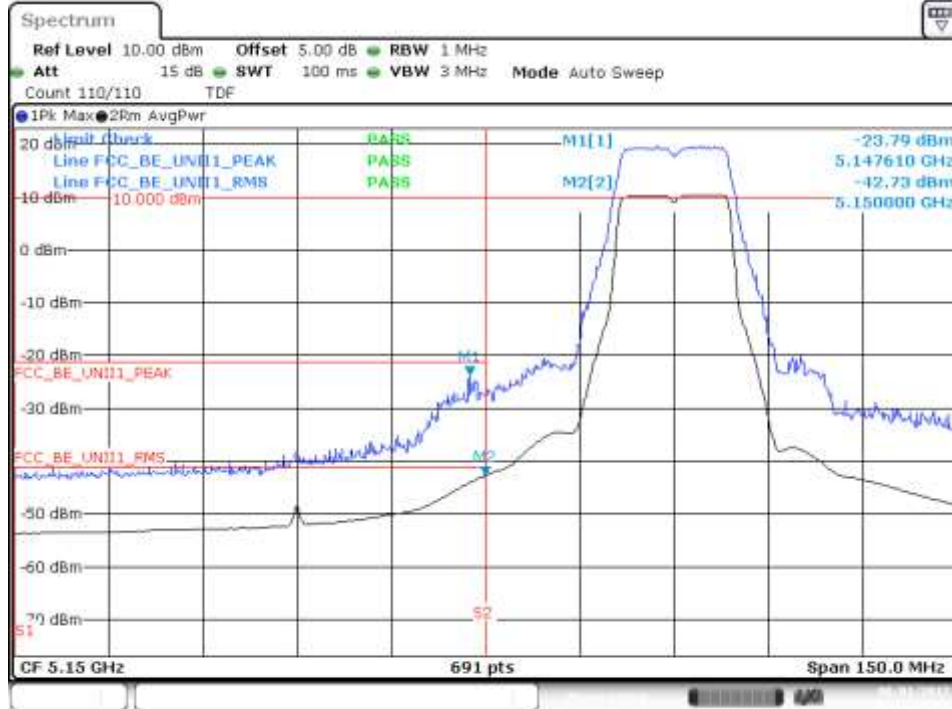
B.3.4 Undesirable emission limits : Band Edge (Conducted)**802.11a, 6Mbps – Chain A****BE Low Freq Section, Peak, RMS – CH36**

Date: 1.AUG.2017 17:09:42

BE Low Freq Section, Peak – CH40

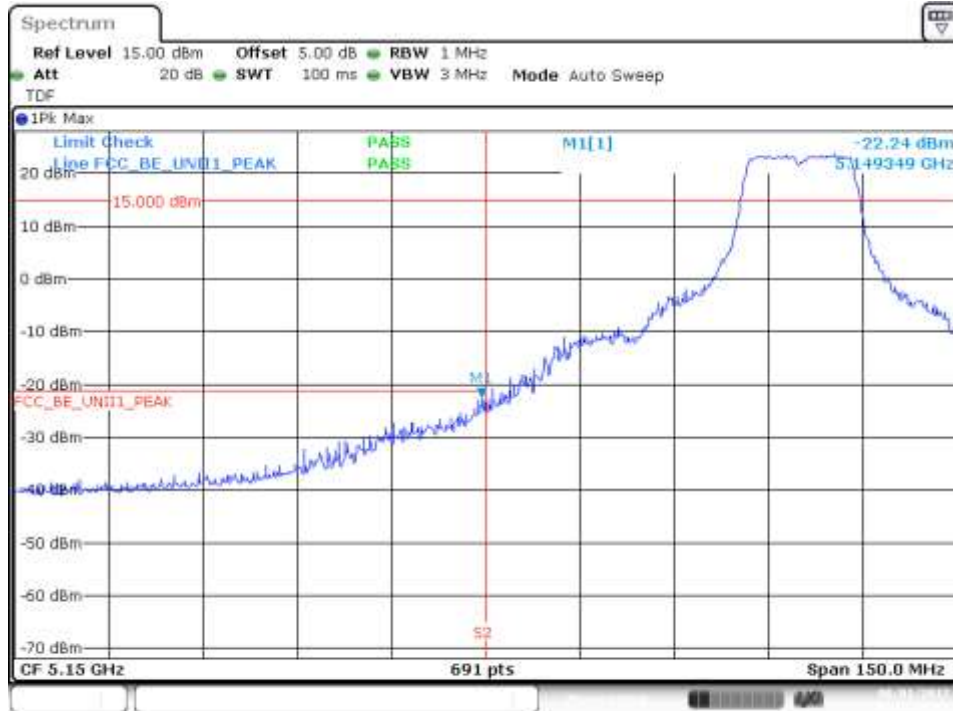

Date: 1.AUG2017 17:18:54

BE Low Freq Section, RMS – CH40



Date: 1.AUG2017 17:18:08

802.11n20, HT0 (SISO) – Chain A

BE Low Freq Section, Peak, RMS – CH36



Date: 2AUG2017 16:12:08

BE Low Freq Section, Peak – CH40

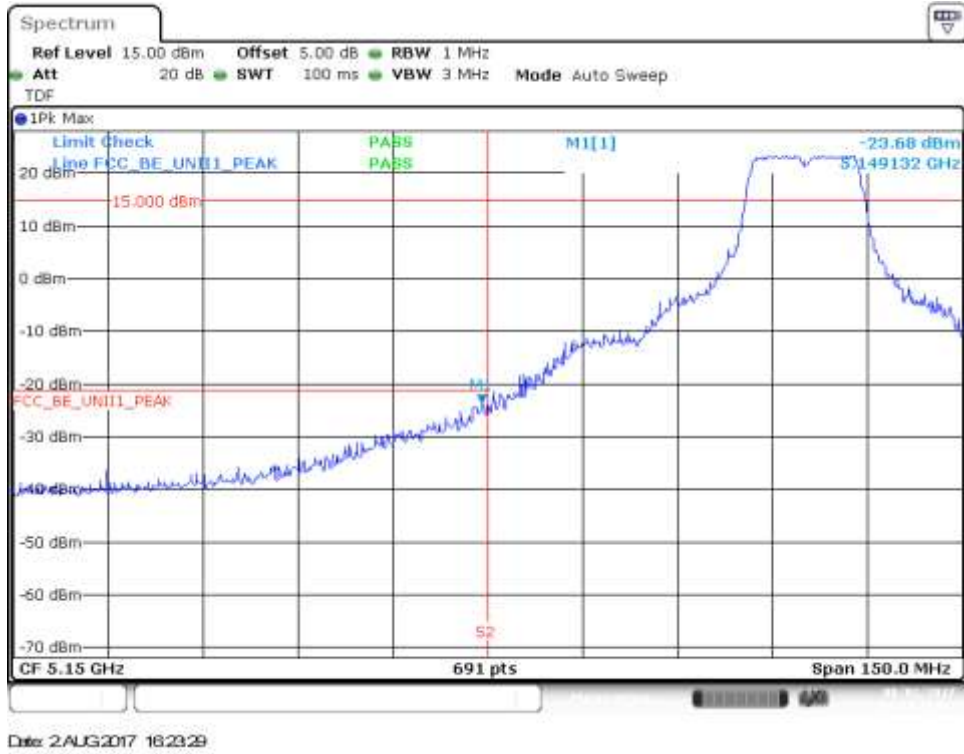

BE Low Freq Section, RMS – CH40

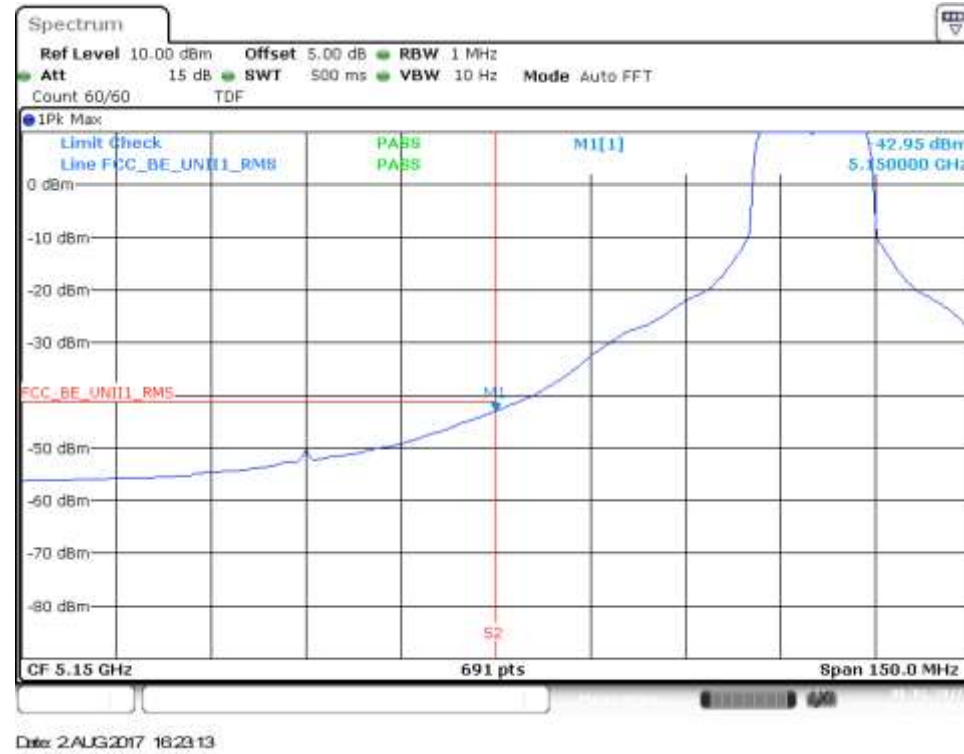

802.11n40, HT0 (SISO) – Chain A

BE Low Freq Section, Peak – CH38F

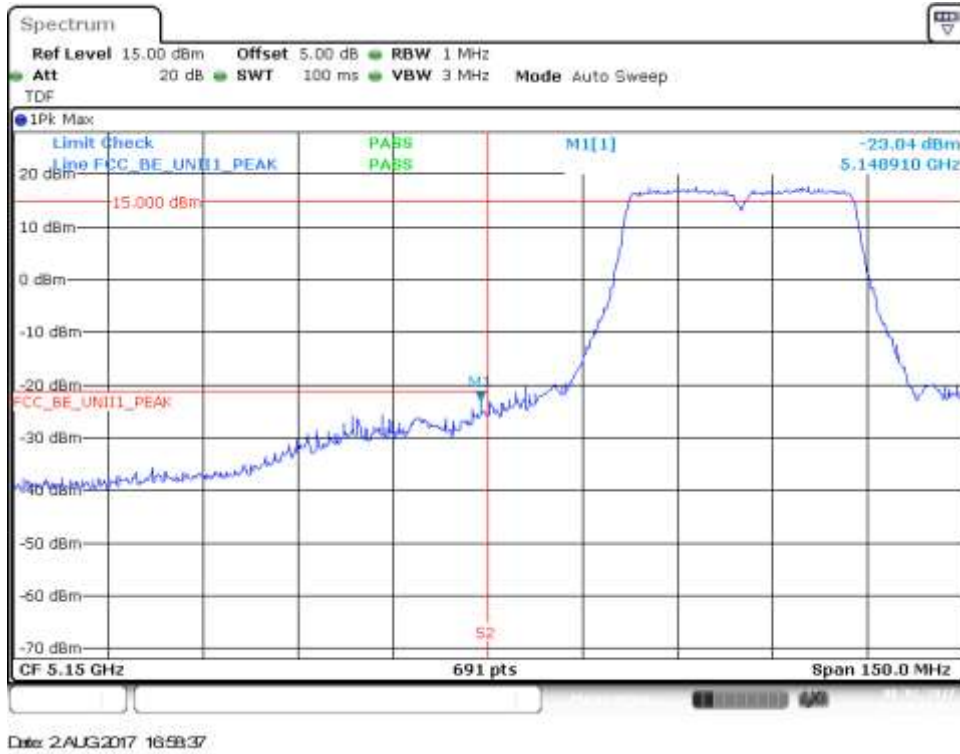

BE Low Freq Section, RMS – CH38F



BE Low Freq Section, Peak – CH46F

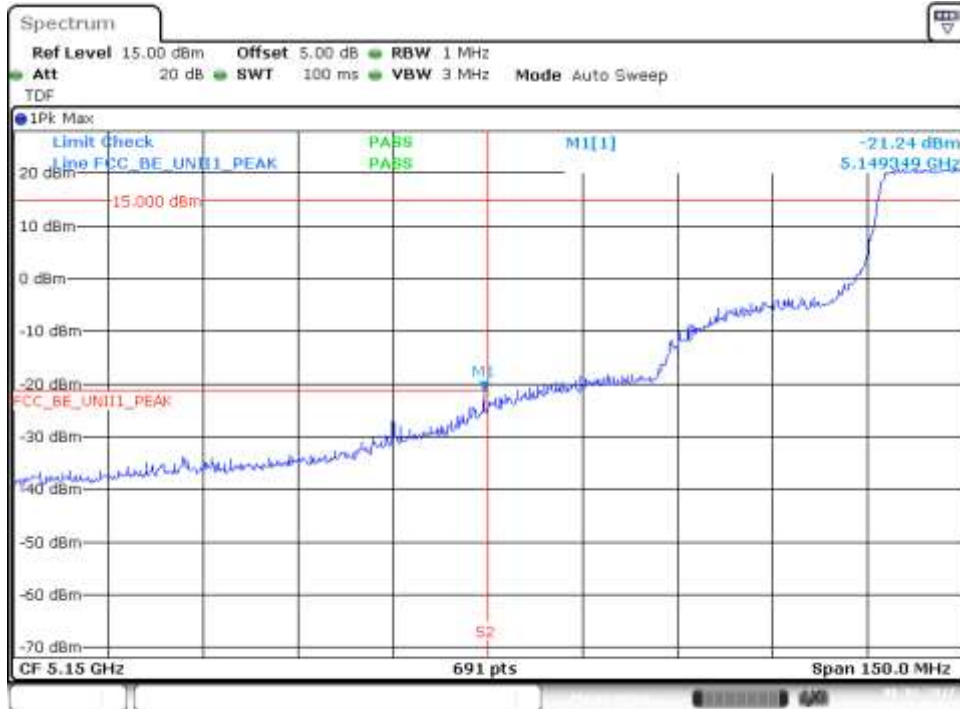

Date: 2.AUG.2017 17:11:08

BE Low Freq Section, RMS – CH46F



Date: 2.AUG.2017 17:09:53

B.4 Test Results Tables U-NII-2A

B.4.1 26dB & 99% Bandwidth

Test procedure

The setup below was used to measure the 26dB & 99% Bandwidth. The antenna terminal of the EUT is connected to the spectrum through an attenuator, and the spectrum analyzer reading is compensated to include the RF path loss.

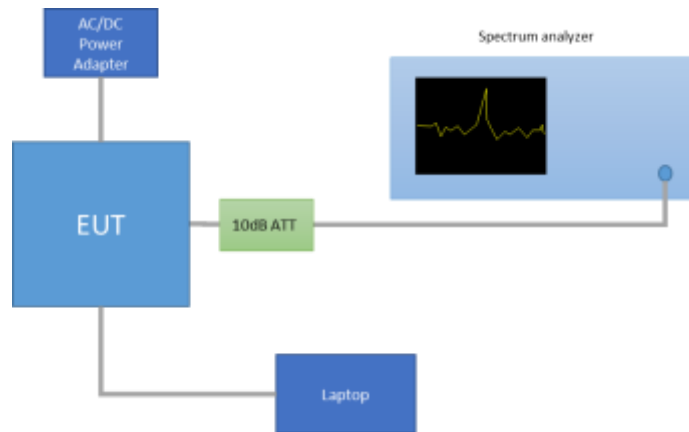

Results tables

Mode	Rate	Antenna	Channel	Frequency [MHz]	26dB BW [MHz]	99% BW [MHz]
802.11a	6Mbps	SISO CHAIN A	52	5260	26.58	17.04
			56	5280	31.83	17.92
			64	5320	23.82	16.80
802.11n20	HT0		52	5260	28.88	18.32
			56	5280	28.93	18.36
			64	5320	24.62	17.88
802.11n40	HT0		54F	5270	45.59	36.72
			62F	5310	43.97	36.56
802.11ac80	VHT0		58ac80	5290	86.35	75.24

Max Value

See Section B.5.1 and Section B.5.2 for the screenshot results.

B.4.2 Power Limits. Maximum Output power & Peak power spectral density

Test limits

FCC part	Limits
15.407 (a) (2)	For the 5.25–5.35 GHz and 5.47–5.725 GHz bands, the maximum conducted output power over the frequency bands of operation shall not exceed the lesser of 250 mW or 11 dBm + 10 log B, where B is the 26 dB emission bandwidth in megahertz. In addition, the peak power spectral density shall not exceed 11 dBm in any 1 megahertz band.

Test procedure

The Maximum Conducted Output Power was measured using the channel integration method according to point E) 2) e) (Method SA-2 Alternative) of KDB 789033 D02.

The maximum power spectral density (PSD) was measured using the method according to point F) (Method SA-2 Alternative) of KDB 789033 D02.

The EIRP power (dBm) is calculated by adding the declared maximum antenna gain to the measured conducted power.

The setup below was used to measure the maximum conducted output power and power spectral density. The antenna terminal of the EUT is connected to the spectrum analyzer through an attenuator, and the spectrum analyzer reading is compensated to include the RF path loss.

The declared maximum antenna gain is 5dBi.

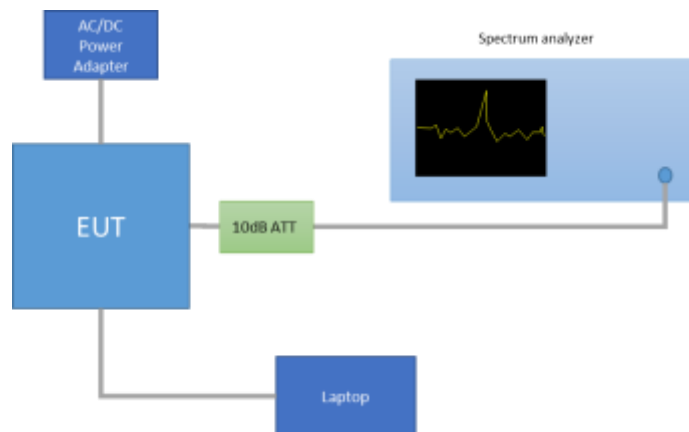

Results tables

Duty cycle

Mode	Rate	Antenna	Transmission Duration [ms]	Transmission Period [ms]	Duty Cycle [%]
802.11a	6Mbps	SISO-A	2.036	2.071	98.31%
802.11n20	HT0	SISO-A	1.894	1.929	98.19%
802.11n40	HT0	SISO-A	0.937	0.969	96.70%
802.11ac80	VHT0	SISO-A	0.458	0.493	92.90%

Maximum output power

Mode	Rate	Channel	Freq. [MHz]	Antenna	Average Conducted Output Power [dBm]	Maximum* Conducted Output Power [dBm]	Maximum* Conducted Output Power [mW]	Max of EIRP [dBm]
802.11a	6Mbps	52	5260	SISO CHAIN A	20.62	20.62	115.35	25.62
		56	5280	SISO CHAIN A	21.18	21.18	131.22	26.18
		64	5320	SISO CHAIN A	17.33	17.33	54.08	22.33
802.11n20	HT0	52	5260	SISO CHAIN A	22.89	22.89	194.54	27.89
		56	5280	SISO CHAIN A	22.78	22.78	189.67	27.78
		64	5320	SISO CHAIN A	19.29	19.29	84.92	24.29
802.11n40	HT0	54F	5270	SISO CHAIN A	20.04	20.19	104.37	25.19
		62F	5310	SISO CHAIN A	15.14	15.29	33.77	20.29
802.11ac80	VHT0	58ac80	5290	SISO CHAIN A	17.00	17.32	53.95	22.32

* Maximum values are the duty cycle compensated values calculated from the average (measured) values

Max Value

Min Value

Maximum Power Spectral Density (PSD)

Mode	Rate	Channel	Freq. [MHz]	Antenna	Average conducted PSD [dBm/MHz]	Maximum* conducted PSD [dBm/MHz]
802.11a	6Mbps	52	5260	SISO CHAIN A	8.94	8.94
		56	5280	SISO CHAIN A	9.46	9.46
		64	5320	SISO CHAIN A	5.67	5.67
802.11n20	HT0	52	5260	SISO CHAIN A	10.91	10.91
		56	5280	SISO CHAIN A	10.89	10.89
		64	5320	SISO CHAIN A	7.35	7.35
802.11n40	HT0	54F	5270	SISO CHAIN A	4.94	5.09
		62F	5310	SISO CHAIN A	0.08	0.23
802.11ac80	VHT0	58ac80	5290	SISO CHAIN A	-0.40	-0.08

* Maximum values are the duty cycle compensated values calculated from the measured average values

See Section B.5.3 for the screenshot results.

B.4.3 Undesirable emissions limits : Band Edge (Conducted)

Test limits

FCC part	Limits																				
15.407 (b) (2)	For transmitters operating in the 5.25–5.35 GHz band: all emissions outside of the 5.15–5.35 GHz band shall not exceed an EIRP of –27 dBm/MHz.																				
15.209	<p>Radiated emissions which fall in the restricted bands, as defined in §15.205(a), must also comply with the radiated emission limits specified in §15.209(a):</p> <table border="1"> <thead> <tr> <th>Freq Range (MHz)</th> <th>Field Strength ($\mu\text{V}/\text{m}$)</th> <th>Field Strength ($\text{dB}\mu\text{V}/\text{m}$)</th> <th>Meas. Distance (m)</th> </tr> </thead> <tbody> <tr> <td>30-88</td> <td>100</td> <td>40</td> <td>3</td> </tr> <tr> <td>88-216</td> <td>150</td> <td>43.5</td> <td>3</td> </tr> <tr> <td>216-960</td> <td>200</td> <td>46</td> <td>3</td> </tr> <tr> <td>Above 960</td> <td>500</td> <td>54</td> <td>3</td> </tr> </tbody> </table> <p>The emission limits shown in the above table are based on measurements employing CISPR quasi-peak detector except for the frequency bands 9-90 kHz, 110-490 kHz and above 1000 MHz. Radiated emission limits in these three bands are based on measurements employing an average detector.</p> <p>For average radiated emission measurements above 1000 MHz, there is also a limit specified when measuring with peak detector function, corresponding to 20 dB above the indicated values in the table.</p>	Freq Range (MHz)	Field Strength ($\mu\text{V}/\text{m}$)	Field Strength ($\text{dB}\mu\text{V}/\text{m}$)	Meas. Distance (m)	30-88	100	40	3	88-216	150	43.5	3	216-960	200	46	3	Above 960	500	54	3
Freq Range (MHz)	Field Strength ($\mu\text{V}/\text{m}$)	Field Strength ($\text{dB}\mu\text{V}/\text{m}$)	Meas. Distance (m)																		
30-88	100	40	3																		
88-216	150	43.5	3																		
216-960	200	46	3																		
Above 960	500	54	3																		

Test procedure

The setup below was used to measure undesirable emissions on the Band Edge domain. The antenna terminal of the EUT is connected to the spectrum analyzer through an attenuator, and the spectrum analyzer reading is compensated to include the RF path loss and the declared Antenna Gain.

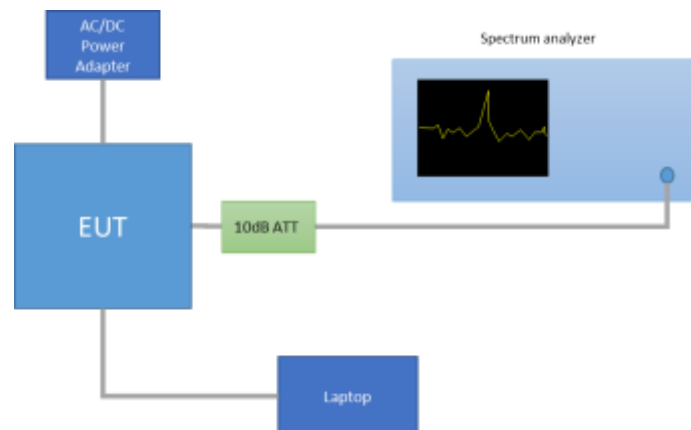

Band Edge measurements in average mode on the high frequency section was done with the primary and the Video Bandwidth Method according to section G) 6) (KDB 789033 D02), with the following parameters:

- When the duty cycle is > 98 %, VBW = 10Hz
- When the duty cycle is < 98 %, VBW > 1/T, where T is defined in section II.B.1.a

In case of Band Edge measurements falling in restricted bands, the declared Antenna Gain is also compensated in the graph. The declared maximum antenna gain is 5dBi.

The following limits in dBm were applied for the average detector after the conversion from the limits detailed above in dB μ V/m, according to FCC 47 CFR part 15 - Subpart C – §15.209(a). The limits in dBm for peak detector are 20dB above the indicated values in the table.

§15.209(a)			Converted values	
Freq Range (MHz)	Distance (m)	Field strength (microvolts/meter)	Field strength (dB microvolts/meter)	Power (dBm)
960-25000	3	500	53.98	-41.2

See Section B.5.4 for the screenshot results.

B.4.4 Radiated spurious emission

Standard references

FCC part	Limits																				
15.407 (b) (2)	For transmitters operating in the 5.25-5.35 GHz band: All emissions outside of the 5.15-5.35 GHz band shall not exceed an e.i.r.p. of -27 dBm/MHz.																				
15.209	<p>Radiated emissions which fall in the restricted bands, as defined in §15.205(a), must also comply with the radiated emission limits specified in §15.209(a):</p> <table border="1" data-bbox="541 568 1331 779"> <thead> <tr> <th data-bbox="547 568 740 629">Freq Range (MHz)</th> <th data-bbox="740 568 933 629">Field Strength (μV/m)</th> <th data-bbox="933 568 1126 629">Field Strength (dBμV/m)</th> <th data-bbox="1126 568 1324 629">Meas. Distance (m)</th> </tr> </thead> <tbody> <tr> <td data-bbox="547 629 740 667">30-88</td> <td data-bbox="740 629 933 667">100</td> <td data-bbox="933 629 1126 667">40</td> <td data-bbox="1126 629 1324 667">3</td> </tr> <tr> <td data-bbox="547 667 740 705">88-216</td> <td data-bbox="740 667 933 705">150</td> <td data-bbox="933 667 1126 705">43.5</td> <td data-bbox="1126 667 1324 705">3</td> </tr> <tr> <td data-bbox="547 705 740 743">216-960</td> <td data-bbox="740 705 933 743">200</td> <td data-bbox="933 705 1126 743">46</td> <td data-bbox="1126 705 1324 743">3</td> </tr> <tr> <td data-bbox="547 743 740 779">Above 960</td> <td data-bbox="740 743 933 779">500</td> <td data-bbox="933 743 1126 779">54</td> <td data-bbox="1126 743 1324 779">3</td> </tr> </tbody> </table> <p>The emission limits shown in the above table are based on measurements employing CISPR quasi-peak detector except for the frequency bands 9-90 kHz, 110-490 kHz and above 1000 MHz. Radiated emission limits in these three bands are based on measurements employing an average detector.</p> <p>For average radiated emission measurements above 1000 MHz, there is also a limit specified when measuring with peak detector function, corresponding to 20 dB above the indicated values in the table.</p>	Freq Range (MHz)	Field Strength (μ V/m)	Field Strength (dB μ V/m)	Meas. Distance (m)	30-88	100	40	3	88-216	150	43.5	3	216-960	200	46	3	Above 960	500	54	3
Freq Range (MHz)	Field Strength (μ V/m)	Field Strength (dB μ V/m)	Meas. Distance (m)																		
30-88	100	40	3																		
88-216	150	43.5	3																		
216-960	200	46	3																		
Above 960	500	54	3																		

Test procedure

The below setups were used to measure the radiated spurious emissions.

Depending of the frequency range and bands being tested, different antennas and filters were used.

The final measurement is done by varying the antenna height, the EUT azimuth over 360° and for both Vertical and Horizontal polarizations.

The radiated spurious emissions were measured on the worst case configuration selected from the chapter B.4.2 and using the lowest, middle and highest channels.

Radiated Setup < 1GHz

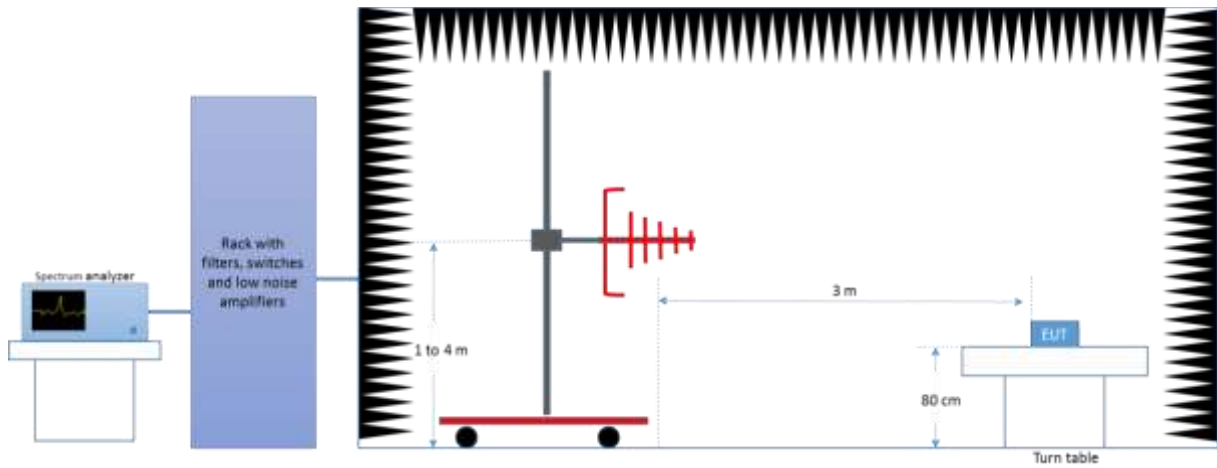

Radiated Setup 1 GHz - 18 GHz

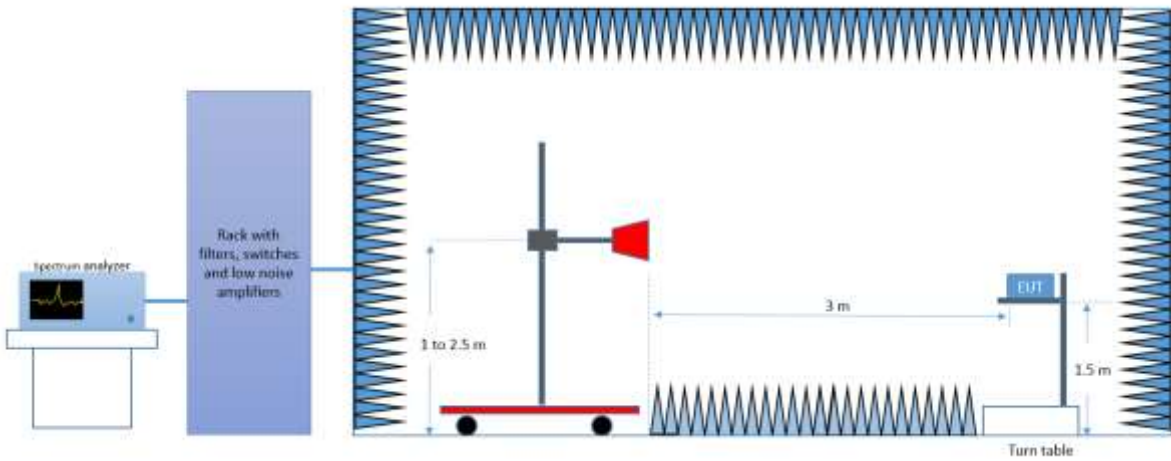

Radiated Setup 18 GHz - 40 GHz

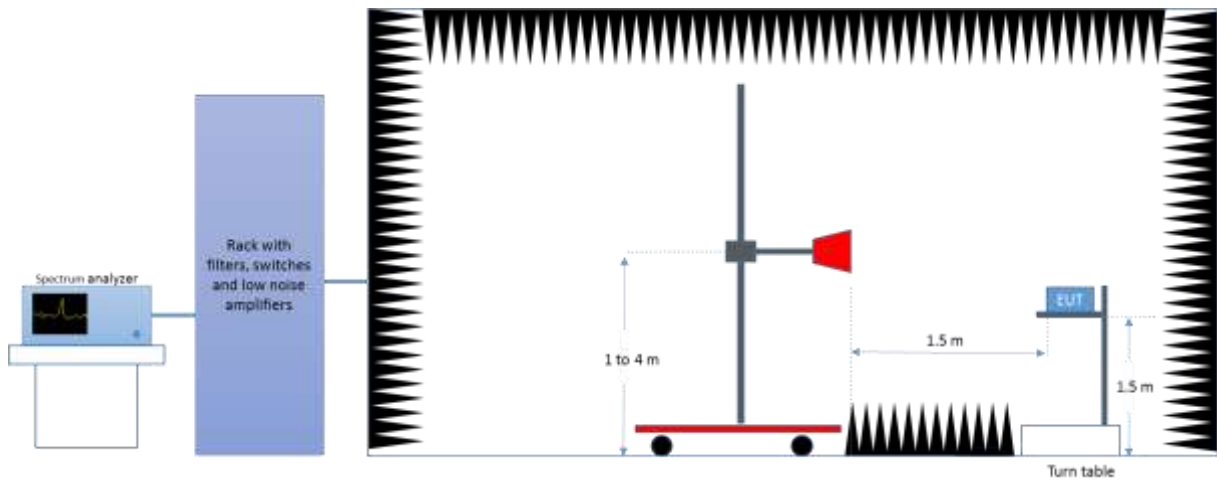

Sample Calculation

The field strength is deduced from the radiated measurement using the following equation:

$$E = 126.8 - 20\log(\lambda) + P - G$$

where

E is the field strength of the emission at the measurement distance, in dB μ V/m

P is the power measured at the output of the test antenna, in dBm

λ is the wavelength of the emission under investigation [$300/f_{MHz}$], in m

G is the gain of the test antenna, in dBi

NOTE – The measured power P includes all applicable instrument correction factors up to the connection to the test Antenna e.g. cable losses, amplifier gains.

For field strength measurements made at other than the distance at which the applicable limit is specified, the field strength of the emission at the distance specified by the limit is deduced as follows:

$$E_{SpecLimit} = E_{Meas} + 20\log(D_{Meas}/D_{SpecLimit})$$

where

E_{SpecLimit} is the field strength of the emission at the distance specified by the limit, in dB μ V/m

E_{Meas} is the field strength of the emission at the measurement distance, in dB μ V/m

D_{Meas} is the measurement distance, in m

D_{SpecLimit} is the distance specified by the limit, in m

Test Results

30 MHz – 40 GHz, 802.11a, 6Mbps, Chain A

Radiated Spurious – CH52

Frequency	MaxPeak	Avg	Limit	Margin
MHz	dBµV/m	dBµV/m	dBµV/m	dB
64.9	31.2	---	40.0	8.8
6017.8	60.0	---	74.0	14.0
6072.1	---	48.9	54.0	5.2
15783.1	55.2	---	74.0	18.8
15784.0	---	44.7	54.0	9.3
21035.4	47.2	---	74.0	26.8
21040.2	---	38.6	54.0	15.4
31784.3	---	32.9	54.0	21.2
31784.3	46.0	---	74.0	28.0

Radiated Spurious – CH56

Frequency	MaxPeak	Avg	Limit	Margin
MHz	dBµV/m	dBµV/m	dBµV/m	dB
47.4	32.6	---	40.0	7.5
6072.3	---	49.0	54.0	5.0
6083.9	60.2	---	74.0	13.8
15833.5	55.1	---	74.0	18.9
15839.7	---	45.0	54.0	9.0
21120.0	---	38.0	54.0	16.0
21120.4	44.4	---	74.0	29.6
31381.2	---	33.9	54.0	20.1
31381.2	46.4	---	74.0	27.6

Radiated Spurious – CH64

Frequency	MaxPeak	Avg	Limit	Margin
MHz	dB μ V/m	dB μ V/m	dB μ V/m	dB
46.6	34.2	---	40.0	5.8
6125.8	60.2	---	74.0	13.8
6143.0	---	48.9	54.0	5.1
15960.2	---	44.4	54.0	9.6
15961.1	56.4	---	74.0	17.6
21280.1	---	38.7	54.0	15.3
21280.1	44.3	---	74.0	29.7
31582.8	---	34.7	54.0	19.3
31583.2	46.2	---	74.0	27.8

30 MHz – 40 GHz, 802.11n20, HT0, Chain A

Radiated Spurious – CH52

Frequency	MaxPeak	Avg	Limit	Margin
MHz	dBµV/m	dBµV/m	dBµV/m	dB
62.5	27.3	---	40.0	12.7
6057.3	---	49.1	54.0	4.9
6118.5	61.1	---	74.0	13.0
15777.3	---	44.5	54.0	9.5
15788.4	54.3	---	74.0	19.7
21039.2	47.8	---	74.0	26.2
21040.2	---	38.6	54.0	15.4
33079.3	45.9	---	74.0	28.1
33080.3	---	34.0	54.0	20.0

Radiated Spurious – CH56

Frequency	MaxPeak	Avg	Limit	Margin
MHz	dBµV/m	dBµV/m	dBµV/m	dB
52.9	32.4	---	40.0	7.6
6100.3	---	48.6	54.0	5.4
6141.8	60.8	---	74.0	13.2
15839.28	---	43.90	54.00	10.10
15845.52	55.17	---	74.00	18.83
21120.0	---	38.6	54.0	15.4
21120.0	44.2	---	74.0	29.9
35011.8	---	34.9	54.0	19.1
35011.8	46.1	---	74.0	28.0

Radiated Spurious – CH64

Frequency	MaxPeak	Avg	Limit	Margin
MHz	dB μ V/m	dB μ V/m	dB μ V/m	dB
62.5	31.6	---	40.0	8.4
6001.9	60.9	---	74.0	13.1
6012.9	---	48.9	54.0	5.2
15960.2	---	44.4	54.0	9.6
15966.4	54.9	---	74.0	19.1
21279.6	---	39.1	54.0	14.9
21280.1	45.8	---	74.0	28.2
36608.1	---	34.1	54.0	19.9
36608.1	47.0	---	74.0	27.0

30 MHz – 40 GHz, 802.11n40, HT0, Chain A

Radiated Spurious – CH54F

Frequency	MaxPeak	Avg	Limit	Margin
MHz	dBµV/m	dBµV/m	dBµV/m	dB
46.8	33.2	---	40.0	6.8
6081.9	60.6	---	74.0	13.4
6092.4	---	48.8	54.0	5.2
17035.4	55.6	---	74.0	18.4
17036.3	---	44.5	54.0	9.5
21079.8	---	38.1	54.0	15.9
21079.8	44.8	---	74.0	29.2
35413.4	---	33.7	54.0	20.4
35413.4	46.6	---	74.0	27.5

Radiated Spurious – CH62F

Frequency	MaxPeak	Avg	Limit	Margin
MHz	dBµV/m	dBµV/m	dBµV/m	dB
46.8	32.4	---	40.0	7.6
2459.0	---	49.1	54.0	4.9
2459.2	58.1	---	74.0	15.9
6025.9	---	48.9	54.0	5.1
6046.3	60.1	---	74.0	13.9
15936.5	---	43.9	54.0	10.1
15980.7	55.1	---	74.0	18.9
21239.9	---	41.5	54.0	12.5
21239.9	45.9	---	74.0	28.1
36497.2	---	34.4	54.0	19.7
36497.7	46.3	---	74.0	27.7

30 MHz – 40 GHz, 802.11ac80, HT0, Chain A

Radiated Spurious – CH58ac80

Frequency	MaxPeak	Avg	Limit	Margin
MHz	dBµV/m	dBµV/m	dBµV/m	dB
62.4	34.4	---	40.0	5.6
6094.7	60.0	---	74.0	14.0
6129.0	---	48.8	54.0	5.2
17996.0	---	49.5	54.0	4.5
17997.8	60.5	---	74.0	13.5
21160.1	---	38.6	54.0	15.4
21160.1	44.2	---	74.0	29.9
35049.4	---	34.5	54.0	19.5
35049.4	46.2	---	74.0	27.8

B.4.5 AC power-line conducted emission

Standard references:

FCC part	RSS part	Limits															
<p>15.207 15.407 (6)</p>	<p>RSS-GEN, Clause 8.8</p>	<p>Except as shown in paragraphs (b) and (c) of this section, for an intentional radiator that is designed to be connected to the public utility (AC) power line, the radio frequency voltage that is conducted back onto the AC power line on any frequency or frequencies, within the band 150 kHz to 30 MHz, shall not exceed the limits in the following table, as measured using a 50 μH/50 ohms line impedance stabilization network (LISN). Compliance with the provisions of this paragraph shall be based on the measurement of the radio frequency voltage between each power line and ground at the power terminal. The lower limit applies at the boundary between the frequency ranges.</p>															
		<table border="1"> <thead> <tr> <th data-bbox="483 674 1034 734">Frequency of emission (MHz)</th> <th colspan="2" data-bbox="1034 674 1481 703">Conducted limit (dBμV)</th> </tr> <tr> <td></td> <th data-bbox="1034 703 1286 734">Quasi-peak</th> <th data-bbox="1286 703 1481 734">Average</th> </tr> </thead> <tbody> <tr> <td data-bbox="483 734 1034 766">0.15-0.5</td> <td data-bbox="1034 734 1286 766">66 to 56*</td> <td data-bbox="1286 734 1481 766">56 to 46*</td> </tr> <tr> <td data-bbox="483 766 1034 797">0.5-5</td> <td data-bbox="1034 766 1286 797">56</td> <td data-bbox="1286 766 1481 797">46</td> </tr> <tr> <td data-bbox="483 797 1034 831">5-30</td> <td data-bbox="1034 797 1286 831">60</td> <td data-bbox="1286 797 1481 831">50</td> </tr> </tbody> </table>	Frequency of emission (MHz)	Conducted limit (dB μ V)			Quasi-peak	Average	0.15-0.5	66 to 56*	56 to 46*	0.5-5	56	46	5-30	60	50
		Frequency of emission (MHz)	Conducted limit (dB μ V)														
			Quasi-peak	Average													
0.15-0.5	66 to 56*	56 to 46*															
0.5-5	56	46															
5-30	60	50															
<p>*Decreases with the logarithm of the frequency.</p>																	

Test procedure:

The EUT and peripherals are placed on a wooden table with a nominal size of 1.0 m by 1.5 m, raised 80 cm above the reference ground plane. The EUT is connected to AC-Power line through a Line Impedance Stabilization Network (LISN) to accommodate a 50 Ω /50 μ H coupling impedance for the measurement system. The EUT control PC is considered as a peripheric and therefore is connected to a second LISN which has the measurement port connected to a 50 ohms impedance.

Each measurement is done for each current-carrying conductor (Line and Neutral) at the end plug of the EUT power cord. The EUT is tested for several transmission modes (frequency channel, modulation, etc.) and the result providing the maximum measured emission is reported.

The exploratory measurement is done over the frequency range from 150 kHz to 30 MHz, while the measurement receiver is recording the Peak and Average signal at 10 kHz steps in Max Hold mode. The cables manipulation is performed within the range of likely configurations to determine the maximum emission. Once the EUT cable configuration, arrangement and mode of operation that produced the emission with the highest amplitude relative to the limit is found the six highest AC power-line conducted emissions relative to 20 dB of the limit are reported as the final measurement. If fewer than six emission frequencies are within 20 dB of the limit, the noise level is reported. For the final measurement, the measurement receiver records the Quasi Peak values with 9 kHz resolution bandwidth and the average values with 10 kHz resolution bandwidth.

EUT arrangement for AC power-line conducted emission tests

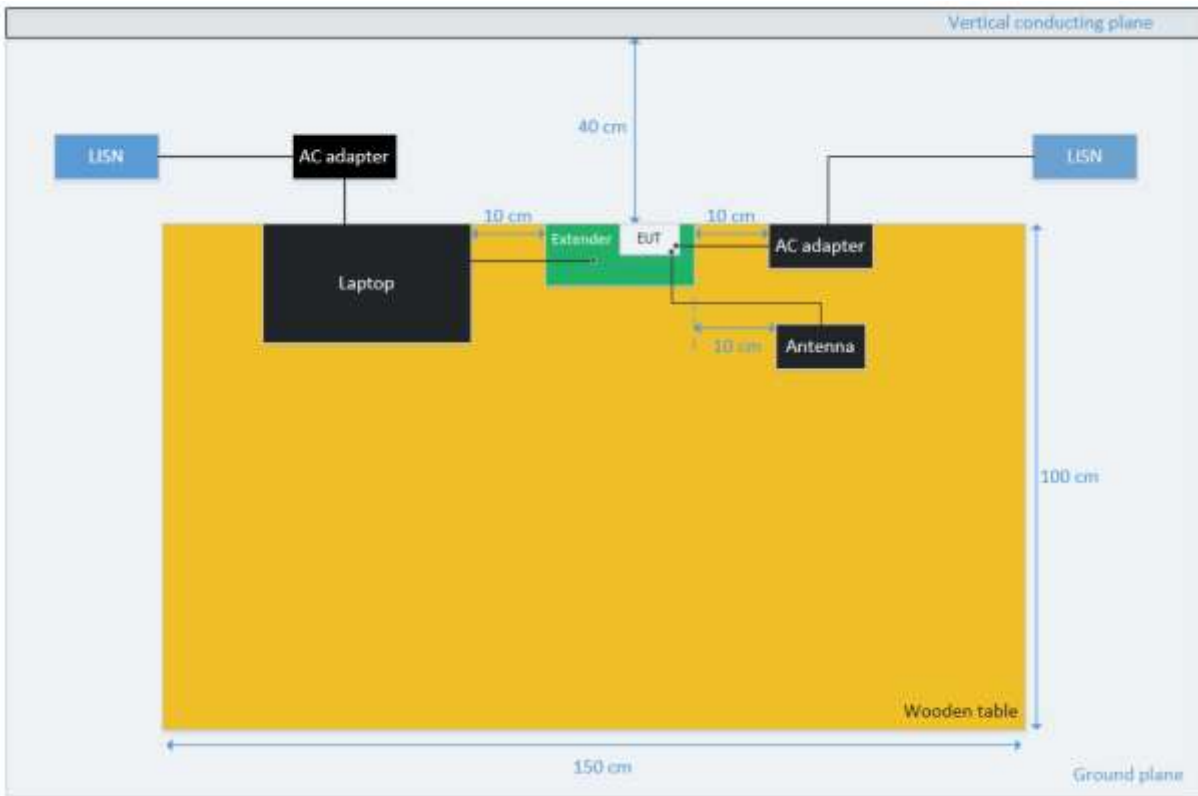

Sample Calculation:

The measured level at the spectrum analyzer in dBuV is corrected by a transducer factor taking into account the losses of the RF cable and the LISN as follows:

$$\text{Conducted Emission level (dBuV)} = \text{SA}_{\text{Level}} + \text{RFCable}_{\text{Losses}} + \text{LISN}_{\text{Losses}}$$

Where:

SA_{Level} is the voltage level displayed on the measurement receiver, in dBuV.

$\text{RFCable}_{\text{Losses}}$ is the value of the cable losses between the LISN and the measurement receiver, in dB.

$\text{LISN}_{\text{Losses}}$ is the value of the insertion losses of the LISN, in dB.

Test Results:

150kHz – 30MHz, all modes

AC power-line conducted – Phase L1

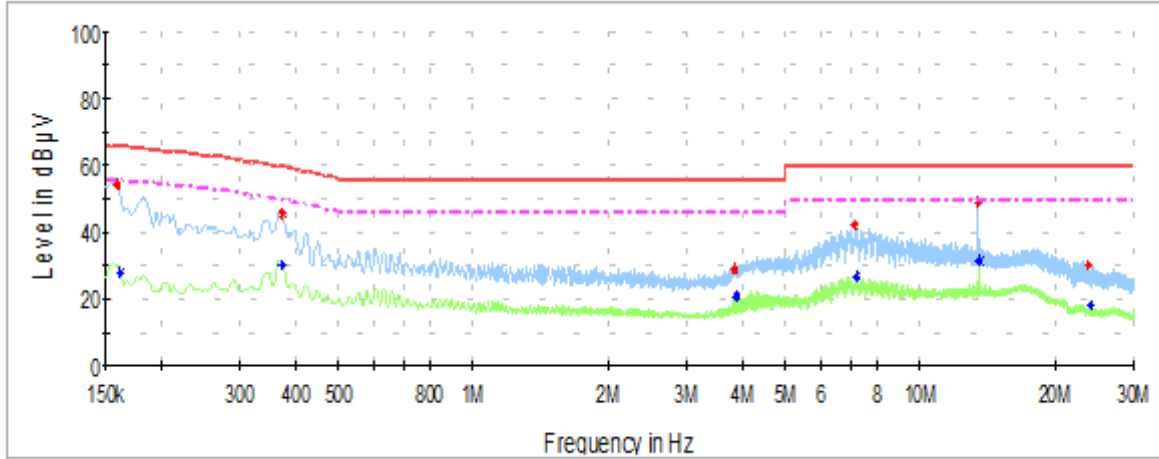

— Peak measurements — Avg measurements — Limit FCC Quasi-Peak - - - Limit FCC Avg

Frequency	Max Peak	Avg	Limit	Margin
MHz	dBµV	dBµV	dBµV	dB
0.1590	54.1	---	65.7	11.6
0.1619	---	27.7	55.7	28.0
0.3739	45.4	---	59.6	14.2
0.3739	---	30.0	49.6	19.6
3.8424	28.8	---	56.0	27.2
3.8902	---	20.7	46.0	25.3
7.1468	41.9	---	60.0	18.1
7.1946	---	26.6	50.0	23.4
13.5467	48.9	---	60.0	11.1
13.5676	---	31.3	50.0	18.7
23.8748	30.0	---	60.0	30.0
24.1673	---	17.9	50.0	32.1

Note: The emissions found do not change with the modulation and/or frequency.

AC power-line conducted – Neutral N

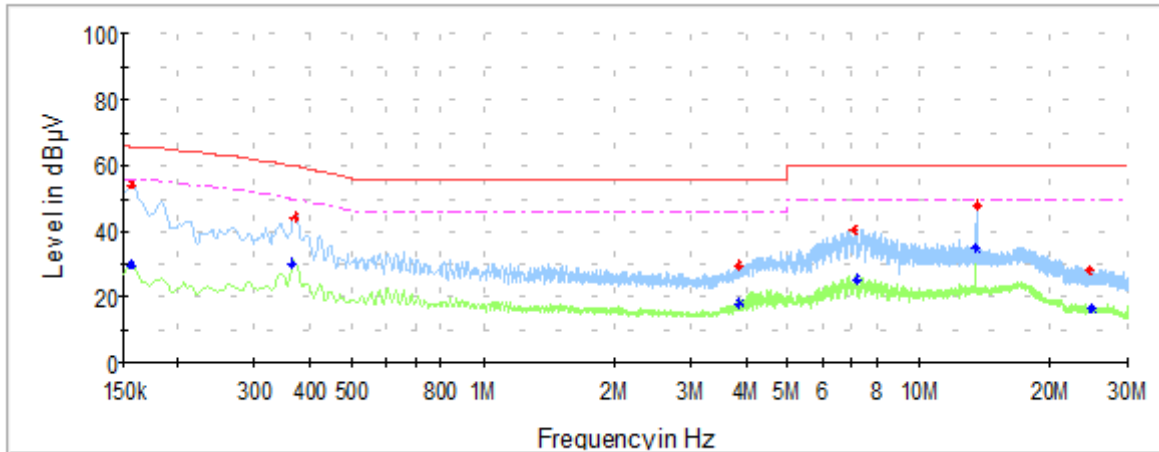

— Peak measurements — Avg measurements — Limit FCC Quasi-Peak - - - Limit FCC Avg

Frequency	Max Peak	Avg	Limit	Margin
MHz	dBµV	dBµV	dBµV	dB
0.1560	54.2	---	65.8	11.6
0.1560	---	29.6	55.8	26.2
0.3709	44.4	---	59.7	15.3
0.3649	---	30.1	49.9	19.8
3.8604	29.8	---	56.0	26.2
3.8783	---	18.0	46.0	28.0
7.1170	40.3	---	60.0	19.7
7.1737	---	25.5	50.0	24.5
13.5735	47.7	---	60.0	12.3
13.5646	---	34.9	50.0	15.1
24.5554	27.7	---	60.0	32.3
24.8360	---	16.2	50.0	33.8

Note: The emissions found do not change with the modulation and/or frequency.

B.5 Test Results Screenshot U-NII-2A

B.5.1 26dB Bandwidth

SISO-A, 802.11a, 6Mbps

Channel 56

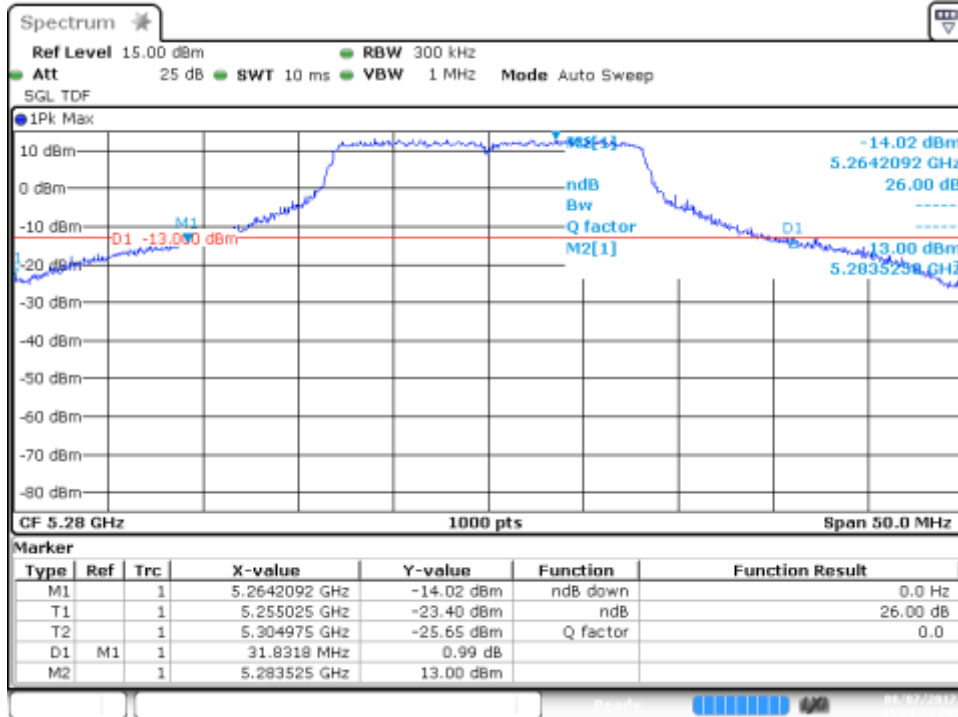

SISO-A, 802.11n20, HT0

Channel 56

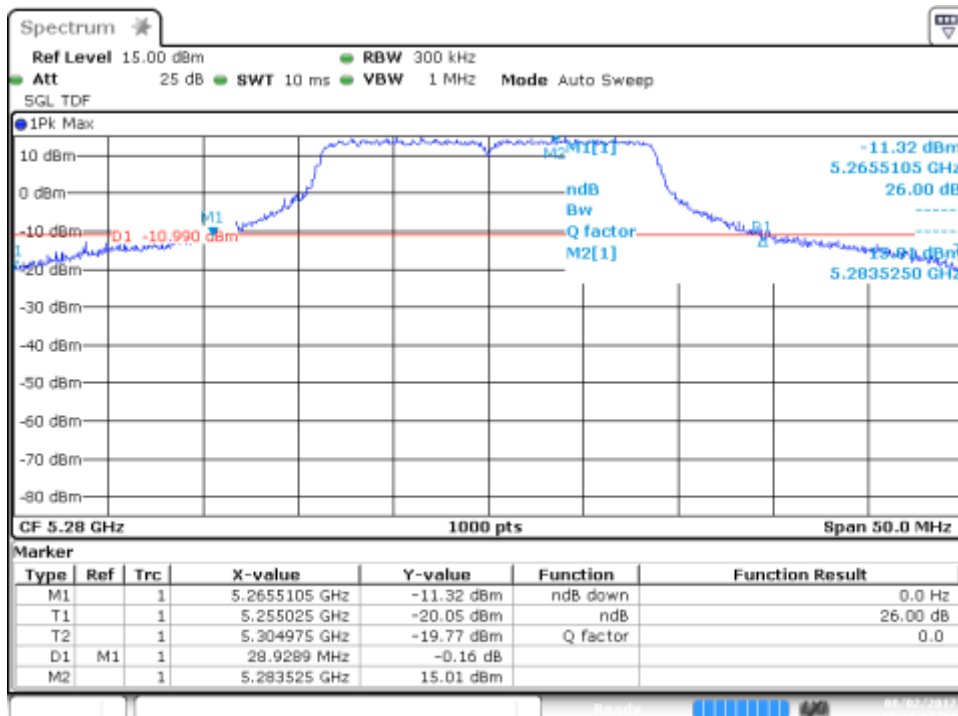

SISO-A, 802.11n40, HT0

Channel 54F

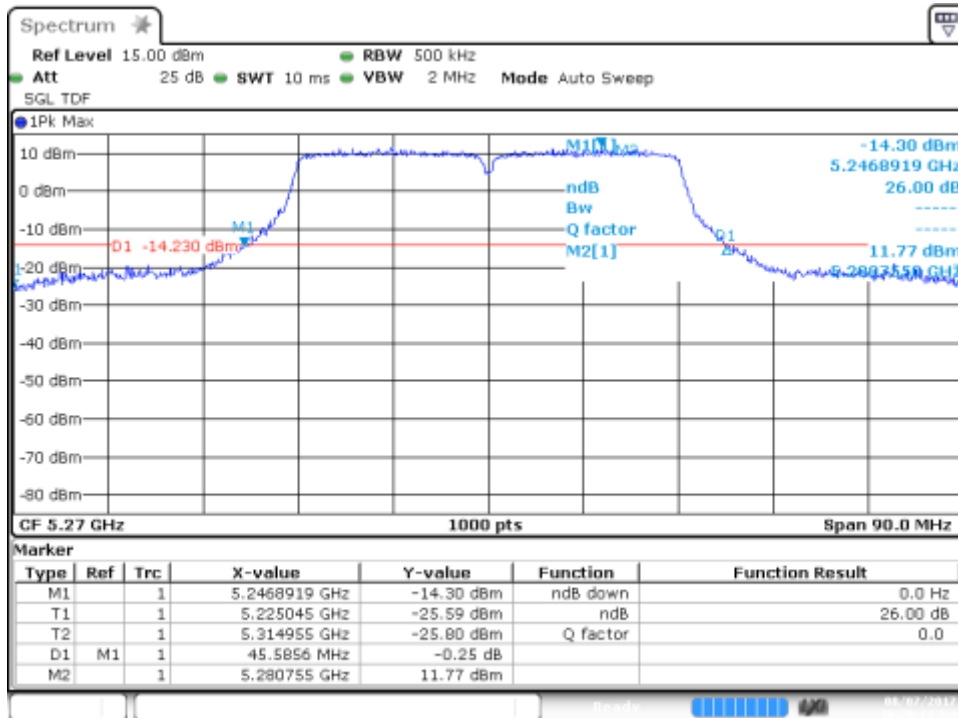

SISO-A, 802.11ac80, VHT0

Channel 58ac80

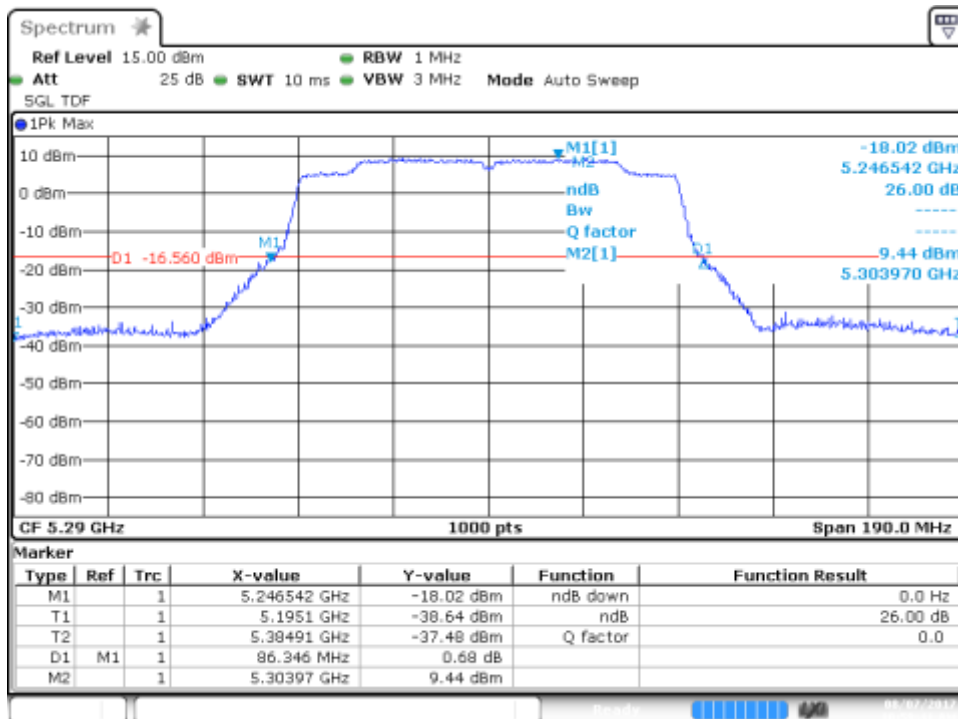

B.5.2 99% Bandwidth

SISO-A, 802.11a, 6Mbps

Channel 56

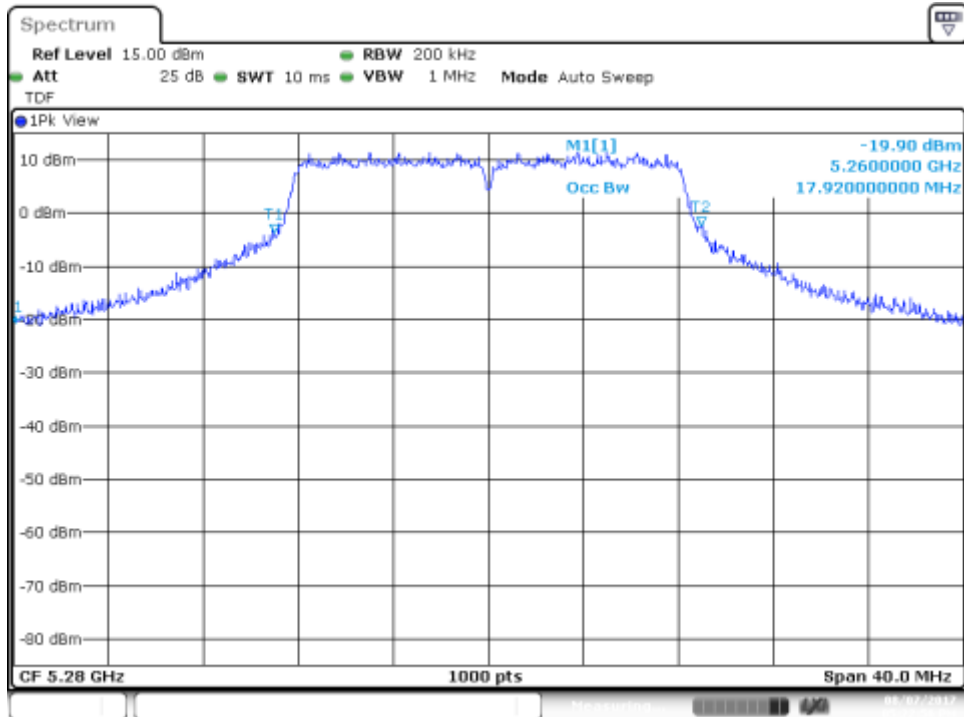

SISO-A, 802.11n20, HT0

Channel 56

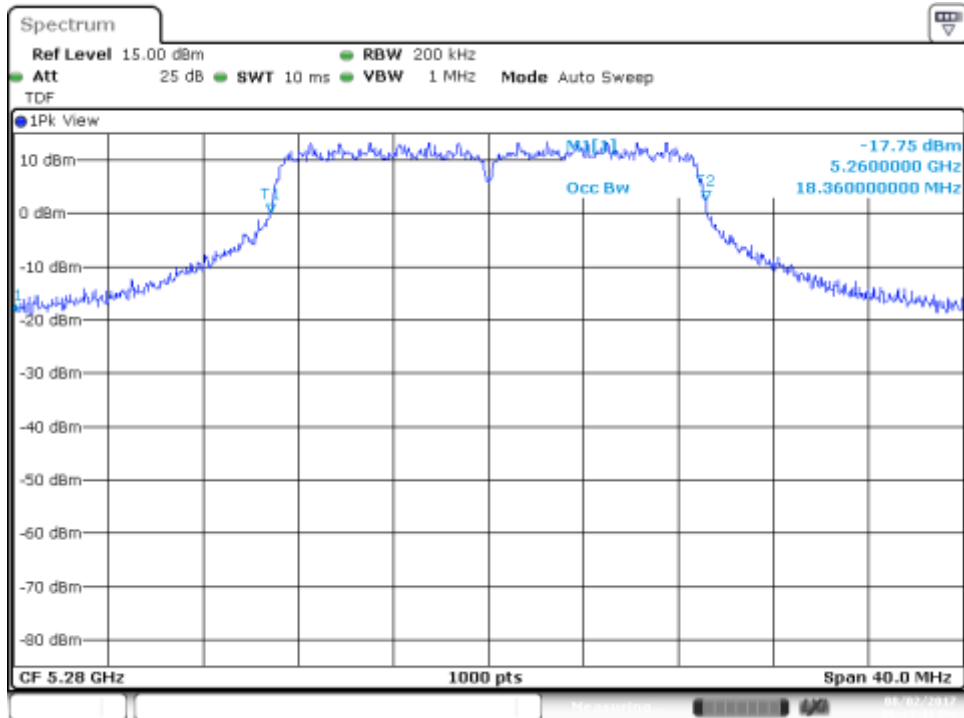

SISO-A, 802.11n40, HT0

Channel 54F

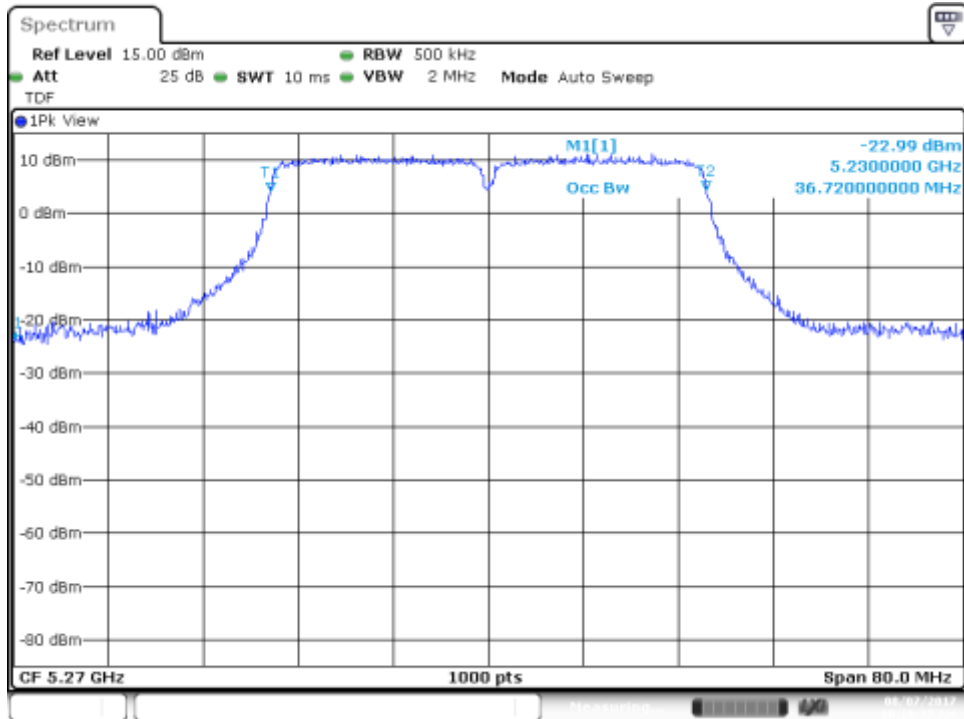

SISO-A, 802.11ac80, VHT0

Channel 58ac80

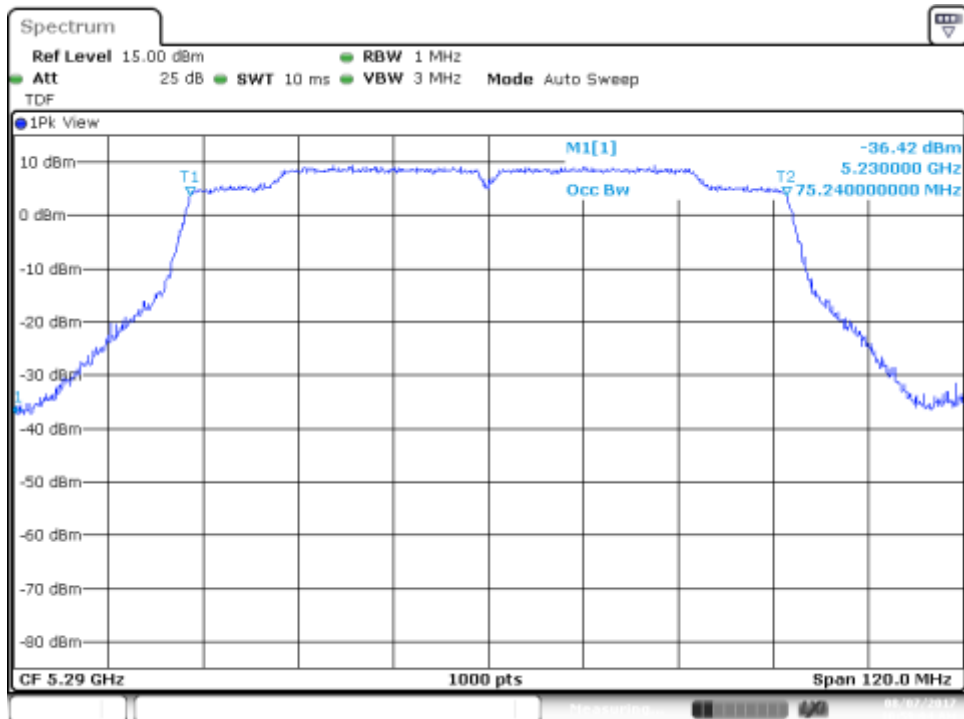

B.5.3 Power Limits. Maximum Output power & Peak power spectral density

SISO-A, 802.11a, 6Mbps

Channel 56

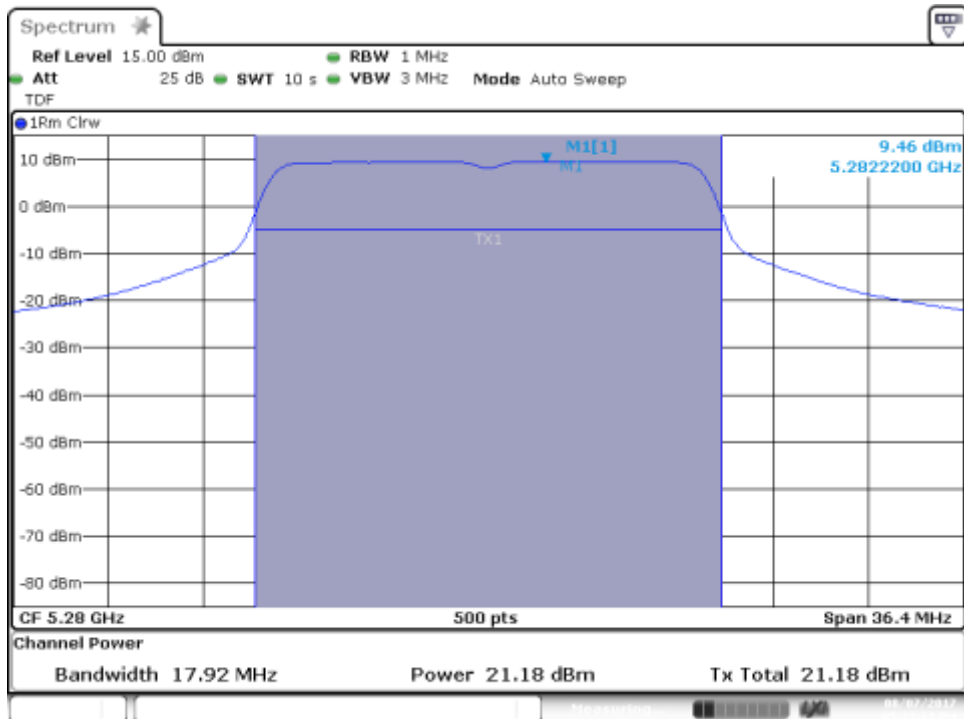

Channel 64

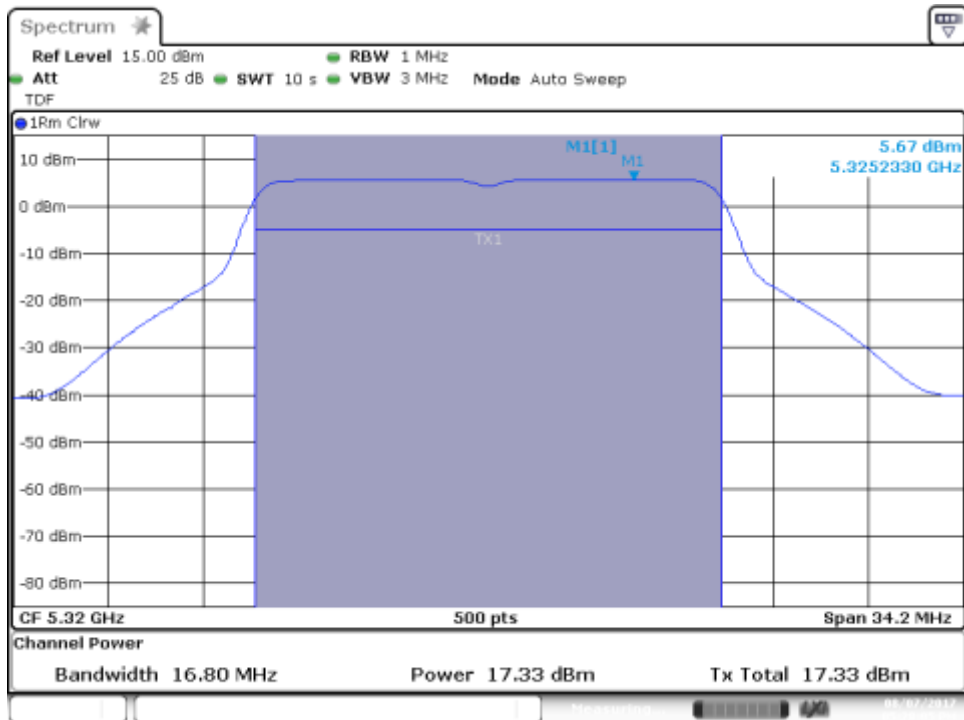

SISO-A, 802.11n20, HT0

Channel 52

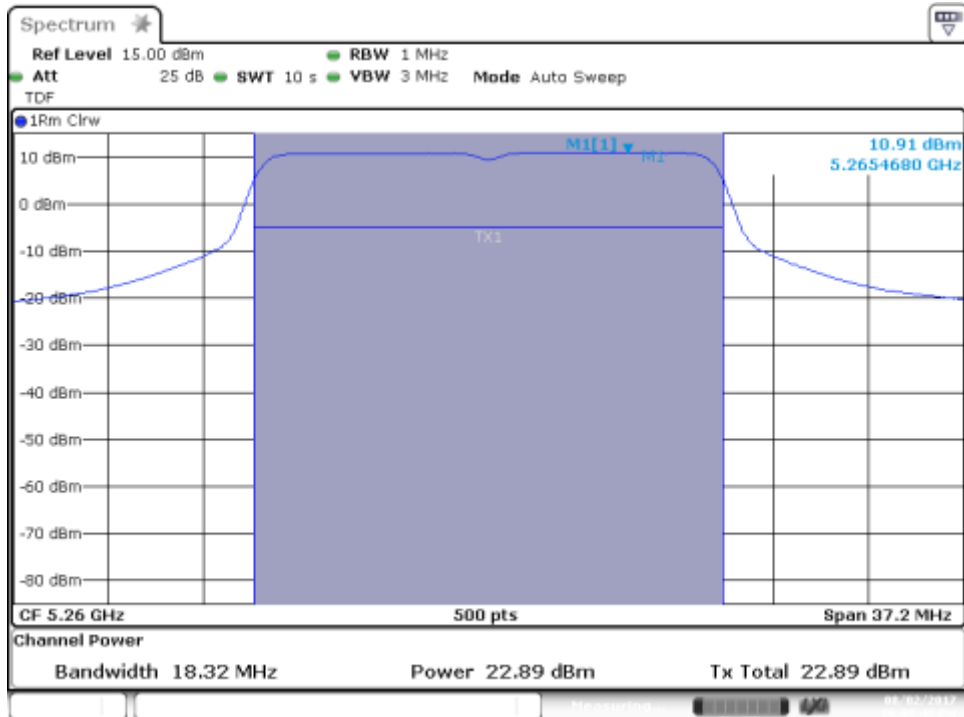

Channel 64

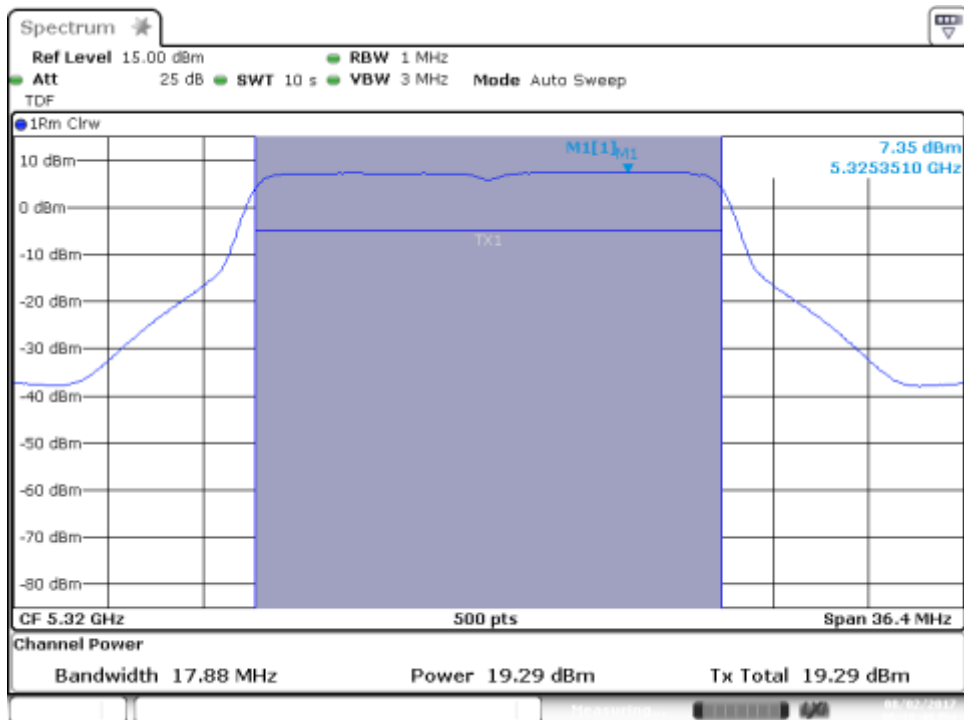

SISO-A, 802.11n40, HT0

Channel 54F

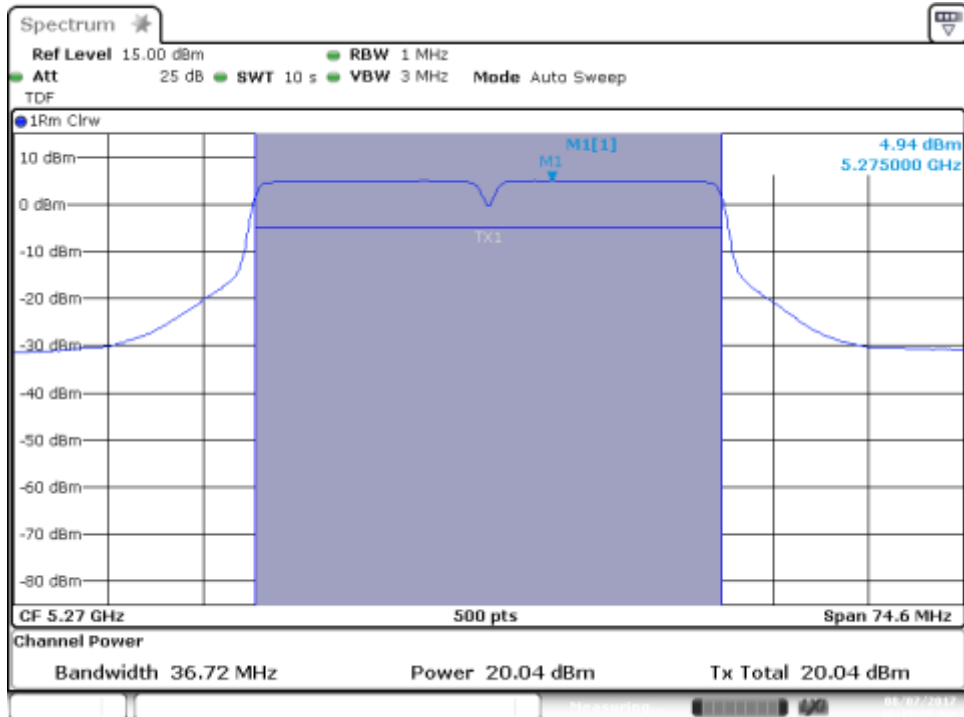

Channel 62F

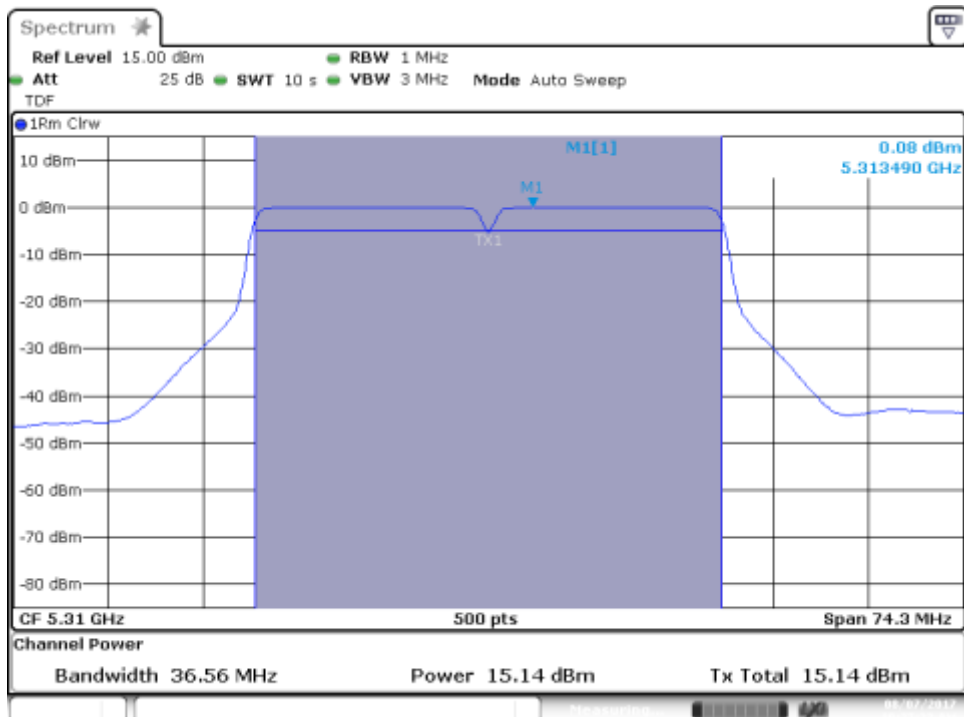

SISO-A, 802.11ac80, VHT0

Channel 58ac80

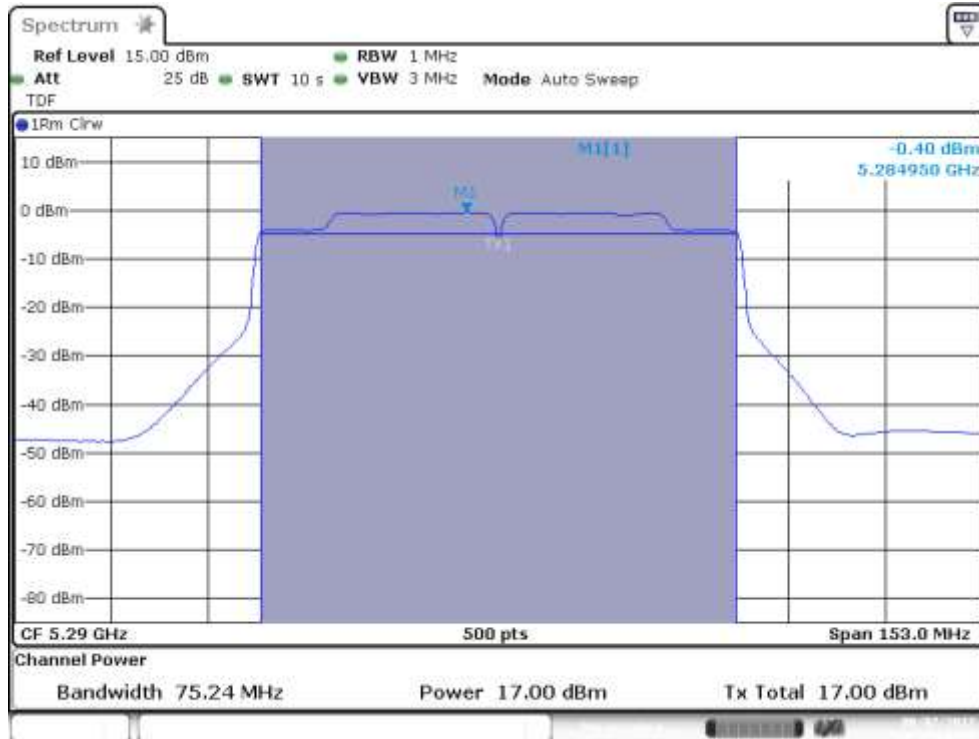

B.5.4 Undesirable emissions limits : Band Edge (Conducted)

802.11a, 6Mbps – Chain A

BE High Freq Section, Peak, RMS – CH64

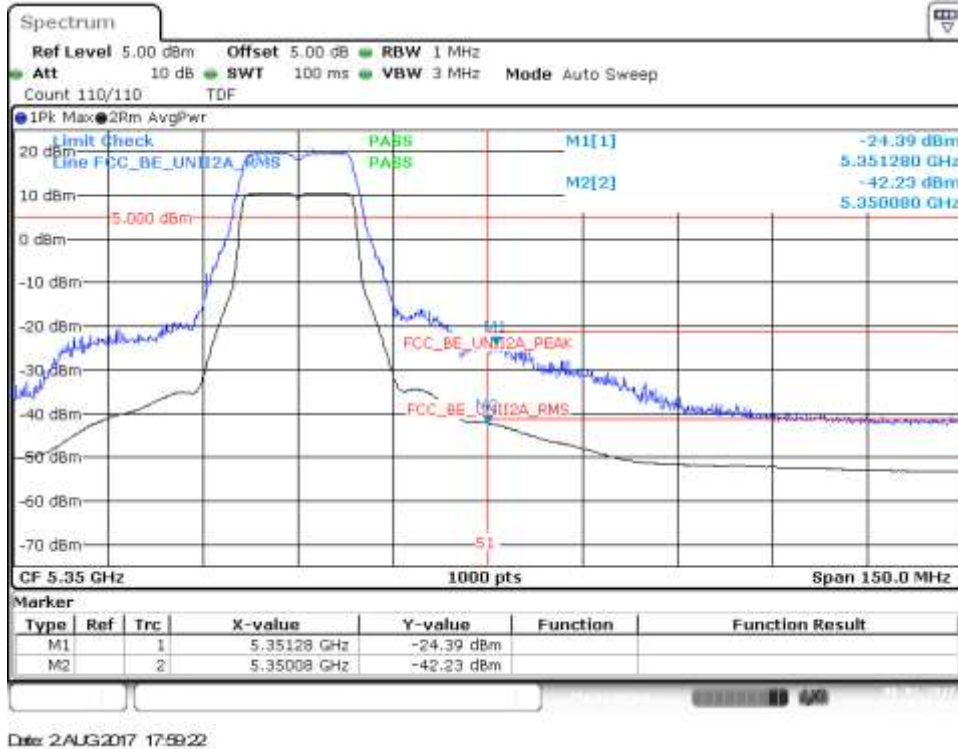

802.11n20, HT0 (SISO) - Chain A

BE High Freq Section, Peak, RMS – CH64

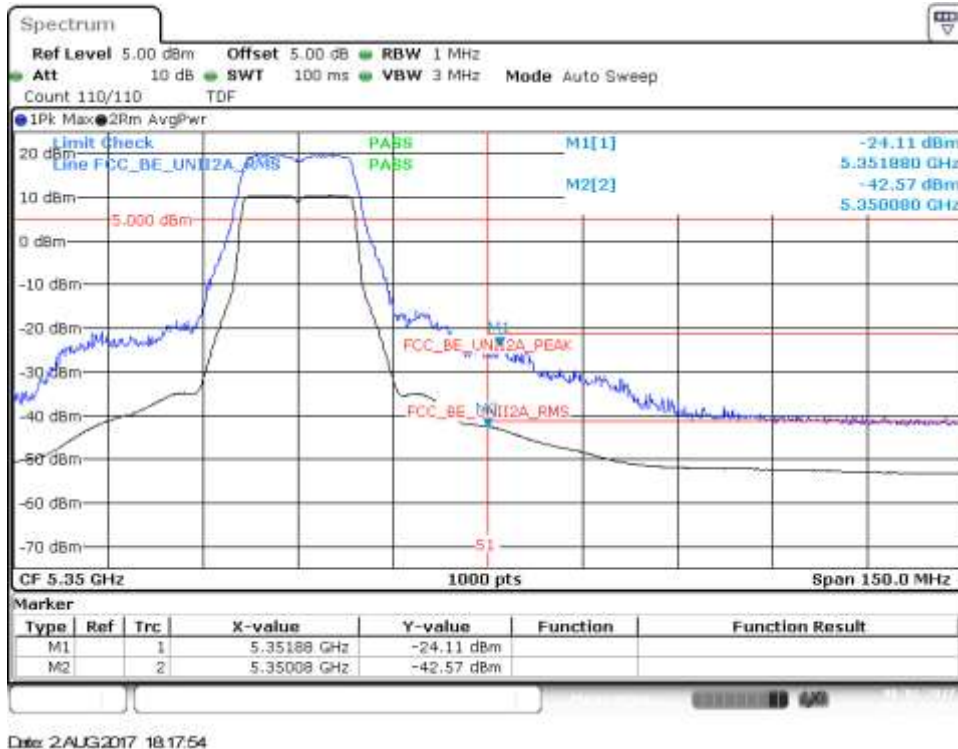

802.11n40, HT0 (SISO) - Chain A

BE High Freq Section, Peak – CH62F

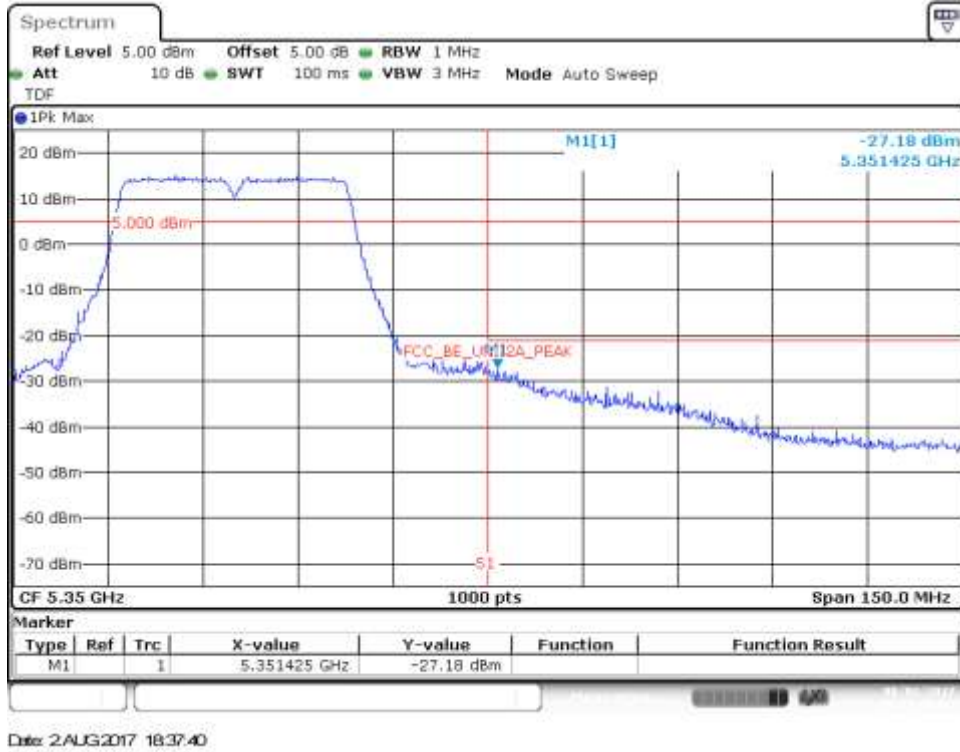

BE High Freq Section, RMS – CH62F



802.11ac80, VHT0 (SISO) - Chain A

BE High Freq Section, Peak – CH58ac80

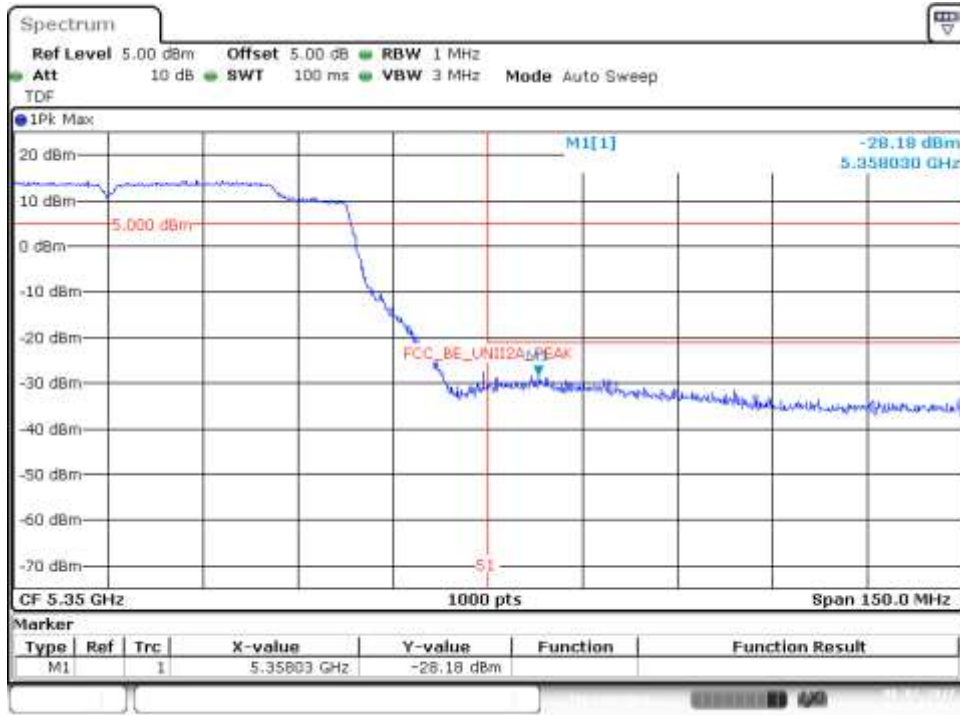

Date: 7.AUG.2017 10:57:04

BE High Freq Section, RMS – CH58ac80

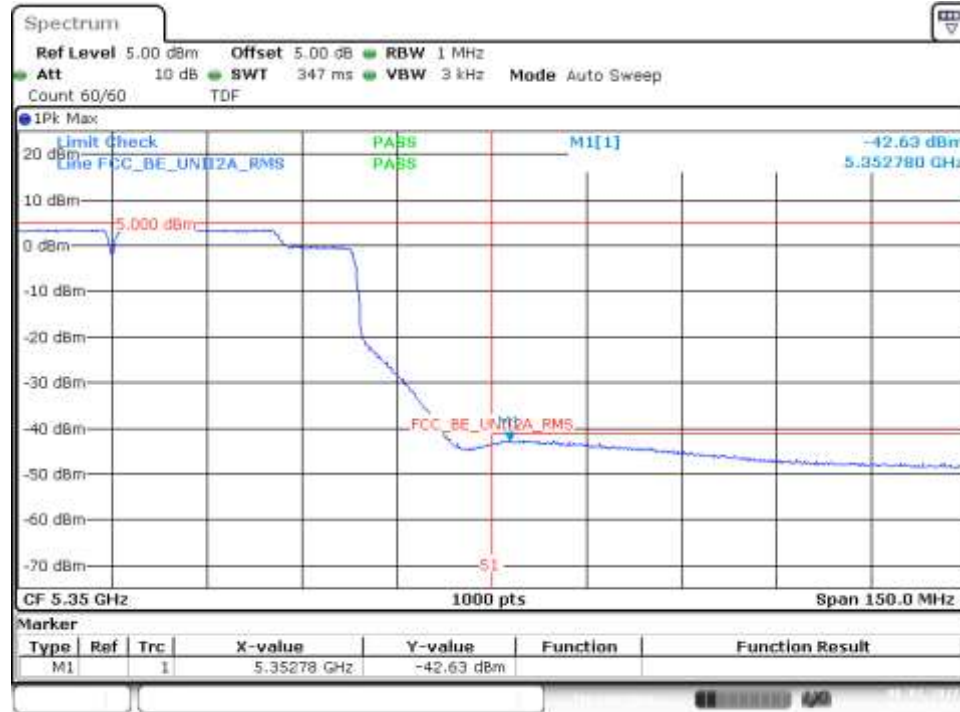

Date: 7.AUG.2017 10:58:28