

# TEST REPORT

EUT Description	<b>WLAN and BT, 1x1 PCIe M.2 2230 adapter card</b>
Brand Name	<b>Intel® Wireless-AC 9461</b>
Model Name	<b>9461NGW</b>
FCC ID	<b>PD99461NG</b>
ISED ID	<b>1000M-9461NG</b>
Date of Test Start/End	<b>2017-07-28 / 2017-08-18</b>
Features	<b>802.11 a/b/g/n/ac Wireless LAN + Bluetooth 5</b> (see section 5)

Applicant	<b>Intel Mobile Communications</b>
Address	<b>100 Center Point Circle, Suite 200 Columbia, South Carolina 29210 USA</b>
Contact Person	<b>Steven Hackett</b>
Telephone/Fax/ Email	<b>steven.c.hackett@intel.com</b>

Reference Standards	<b>FCC CFR Title 47 Part 15 C RSS-247 issue 2, RSS-Gen issue 4</b> (see section 1)
---------------------	---

Test Report identification	<b>170727-01.TR04</b>
Revision Control	<b>Rev. 00</b> <b>This test report revision replaces any previous test report revision</b> (see section 8)

The test results relate only to the samples tested.  
The test report shall not be reproduced in full, without written approval of the laboratory.

Issued by \_\_\_\_\_

Reviewed by \_\_\_\_\_

Walid EL HAJJ  
(RF Test Lead)

Olivier FARGANT  
(Technical Manager)

**Intel Mobile Communications France S.A.S – WRF Lab**  
**425 rue de Goa – Le Cargo B6 - 06600, Antibes, France**  
**Tel. +33493001400 / Fax +33493001401**

# Table of Contents

---

<b>1. Standards, reference documents and applicable test methods</b>	<b>3</b>
<b>2. General conditions, competences and guarantees</b>	<b>3</b>
<b>3. Environmental Conditions</b>	<b>3</b>
<b>4. Test samples</b>	<b>4</b>
<b>5. EUT Features</b>	<b>4</b>
<b>6. Remarks and comments</b>	<b>4</b>
<b>7. Test Verdicts summary</b>	<b>5</b>
7.1. 802.11 B/G/N 2.4GHZ	5
7.2. BLE	5
<b>8. Document Revision History</b>	<b>5</b>
<b>Annex A. Test &amp; System Description</b>	<b>6</b>
A.1 MEASUREMENT SYSTEM	6
A.2 MEASUREMENT UNCERTAINTY EVALUATION	11
<b>Annex B. Test Results DTS</b>	<b>12</b>
B.1 TEST CONDITIONS	12
B.2 TEST RESULTS TABLES	13
B.2.1 6dB & 99% Bandwidth	13
B.2.2 Maximum Output Power and antenna gain	15
B.2.3 Power Spectral Density	19
B.2.4 Out-of-band emission (conducted)	21
B.2.5 Radiated spurious emission	24
B.2.6 AC power-line conducted emission	35
B.3 TEST RESULTS SCREENSHOTS	39
B.3.1 6dB Bandwidth	39
B.3.2 99% Bandwidth	41
B.3.3 Maximum output power and antenna gain	43
B.3.4 Power spectral density	47
B.3.5 Out of band emissions - band-edge low (conducted)	49
B.3.6 Out of band emissions - band-edge high (conducted)	53
B.3.7 Out of band emissions - spurious	65
<b>Annex C. Test Results BLE</b>	<b>73</b>
C.1 TEST RESULTS BLE	73
C.1.1 6dB & 99% Bandwidth	73
C.1.2 Maximum Output Power and antenna gain	77
C.1.3 Power Spectral Density	83
C.1.4 Out-of-band emission (Conducted)	86
C.1.5 Radiated spurious emission	96
C.1.6 AC power-line conducted emission	101
<b>Annex D. Photographs</b>	<b>105</b>
D.1 TEST SETUP	105
D.2 TEST SAMPLE	108

## 1. Standards, reference documents and applicable test methods

1. FCC 47 CFR part 15 - Subpart C – §15.247 Operation within the bands 902-928 MHz, 2400-2483.5 MHz, and 5725-5850 MHz.
2. FCC 47 CFR part 15 - Subpart C – §15.207 Conducted emission limits
3. FCC 47 CFR part 15 - Subpart C – §15.209 Radiated emission limits; general requirements.
4. FCC OET KDB 558074 D01 DTS Meas Guidance v04 – Guidance for Performing Compliance Measurements on Digital Transmission Systems (DTS) Operating Under §15.247.
5. RSS-247 Issue 2 – Digital Transmission Systems (DTSs), Frequency Hopping Systems (FHSs) and Licence-Exempt Local Area Network (LE-LAN) Devices
6. RSS-Gen Issue 4 – General Requirements for Compliance of Radio Apparatus.
7. ANSI C63.10-2013 – American National Standard of Procedures for Compliance Testing of Unlicensed Wireless Devices.

## 2. General conditions, competences and guarantees

- ✓ Intel Mobile Communications France SAS Wireless RF Lab (Intel WRF Lab) is an ISO/IEC 17025:2005 testing laboratory accredited by the American Association for Laboratory Accreditation (A2LA) with the certificate number 3478.01.
- ✓ Intel Mobile Communications France SAS Wireless RF Lab (Intel WRF Lab) is an Accredited Test Firm recognized by the FCC, with Designation Number FR0011.
- ✓ Intel Mobile Communications France SAS Wireless RF Lab (Intel WRF Lab) is a Registered Test Site listed by ISED, with ISED Assigned Code 1000Y.
- ✓ Intel WRF Lab only provides testing services and is committed to providing reliable, unbiased test results and interpretations.
- ✓ Intel WRF Lab is liable to the client for the maintenance of the confidentiality of all information related to the item under test and the results of the test.
- ✓ Intel WRF Lab has developed calibration and proficiency programs for its measurement equipment to ensure correlated and reliable results to its customers.
- ✓ This report is only referred to the item that has undergone the test.
- ✓ This report does not imply an approval of the product by the Certification Bodies or competent Authorities.

## 3. Environmental Conditions

- ✓ At the site where the measurements were performed the following limits were not exceeded during the tests:

Temperature	23°C ± 3°C
Humidity	50% ± 20%

#### 4. Test samples

Sample	Control #	Description	Model	Serial #	Date of receipt	Note
#01	170727-01.S01	Module	9461NGW	WFM 3413E86AD85D	2017-07-28	Used for conducted tests
	170524-02.S15	Extender Board	PCB00609_01	6092416-442	2017-05-30	
	170000-01.S04	Laptop	Latitude E5470	DMRKMC2	2017-05-10	
#02	170727-01.S06	Module	9461NGW	WFM 3413E86AD7B3	2017-07-28	Used for radiated tests
	170220-02.S03	Extender Board	PCB00609_01	6092416-446	2017-02-20	
	170000-01.S13	Laptop	Latitude E5470	FT6LMC2	2017-04-25	
#03	170727-01.S04	Module	9461NGW	WFM 3413E86AD7BD	2017-07-28	Used for AC power-line conducted emission measurements
	170524-02.S13	Extender Board	PCB00609_01	6092416-418	2017-02-20	
	170000-01.S02	Laptop	Latitude E5470	21HTPF2	2017-04-25	

#### 5. EUT Features

Brand Name	Intel® Wireless-AC 9461		
Model Name	9461NGW		
FCC ID	PD99461NG		
ISED ID	1000M-9461NG		
Software Version	10.1730.0-05594		
Driver Version	99.0.28.6		
Prototype / Production	Production		
Supported Radios	802.11b/g/n	2.4GHz (2400.0 – 2483.5 MHz)	
	802.11a/n/ac	5.2GHz (5150.0 – 5350.0 MHz)	
		5.6GHz (5470.0 – 5725.0 MHz)	
		5.8GHz (5725.0 – 5850.0 MHz)	
	Bluetooth 5	2.4GHz (2400.0 – 2483.5 MHz)	
Antenna Information	<b>WLAN/BT:</b> Slot antenna. WiFi 2.4GHz & 5GHz and BT (DRTU CHAIN A)		

#### 6. Remarks and comments

N/A

## 7. Test Verdicts summary

### 7.1. 802.11 b/g/n 2.4GHz

FCC part	RSS part	Test name	Verdict
15.247 (a) (2)	RSS-247 Clause 5.2 (a)	6dB Bandwidth	P
15.247 (b) (3)	RSS-247 Clause 5.4 (d)	Maximum output power and E.I.R.P	P
15.247 (e)	RSS-247 Clause 5.2 (b)	Power spectral density	P
15.247 (d) 15.209	RSS-247 Clause 5.5 RSS-Gen Clause 8.9	Out-of-band Emission (conducted)	P
15.247 (d) 15.209	RSS-247 Clause 5.5 RSS-Gen Clause 8.9	Out-of-band Emission (radiated)	P
15.407 (6) 15.207	RSS-GEN Clause 8.8	AC power-line conducted emission	P

### 7.2. BLE

FCC part	RSS part	Test name	Verdict
15.247 (a) (2)	RSS-247 Clause 5.2 (a)	6dB Bandwidth	P
15.247 (b) (3)	RSS-247 Clause 5.4 (d)	Maximum output power and E.I.R.P.	P
15.247 (e)	RSS-247 Clause 5.2 (b)	Power spectral density	P
15.247 (d) 15.209	RSS-247 Clause 5.5 RSS-Gen Clause 8.9	Out-of-band Emissions (conducted)	P
15.247 (d) 15.209	RSS-247 Clause 5.5 RSS-Gen Clause 8.9	Out-of-band Emissions (radiated)	P
15.407 (6) 15.207	RSS-GEN Clause 8.8	AC power-line conducted emission	P

P: Pass  
 F: Fail  
 NM: Not Measured  
 NA: Not Applicable

## 8. Document Revision History

Revision #	Date	Modified by	Revision Details
Rev. 00	2017-08-21	BLavenant	First Issue

# Annex A. Test & System Description

---

## A.1 Measurement System

Measurements were performed using the following setups, made in accordance to the general provisions of FCC DTS Measurement KDB 558074 D01 DTS Meas Guidance.

The DUT was installed in a test fixture and this test fixture is connected to a laptop computer and AC/DC power adapter. The laptop computer was used to configure the EUT to continuously transmit at a specified output power using all different modes and modulation schemes, using the Intel proprietary tool DRTU.

### Conducted Setup

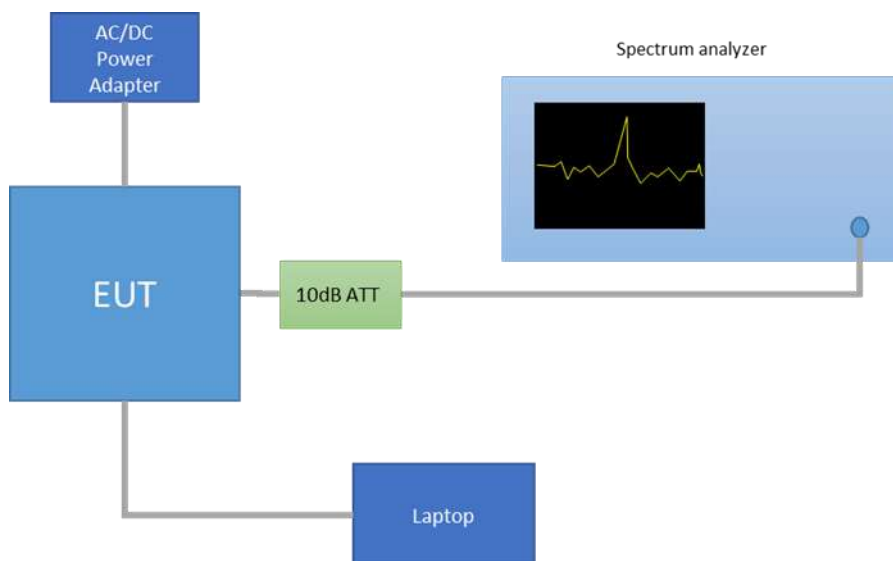

*Radiated Setup < 1GHz*

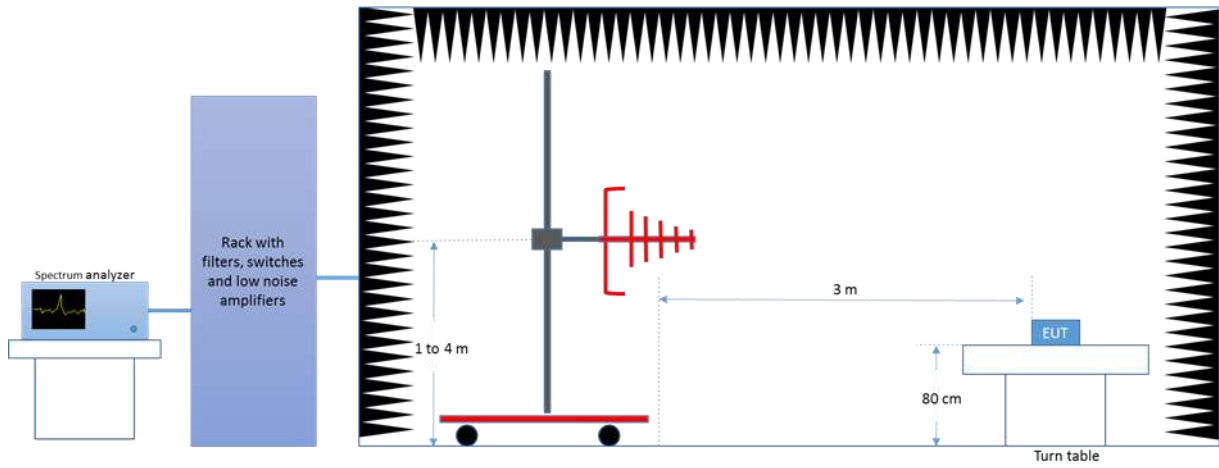

*Radiated Setup 1 GHz – 18 GHz*

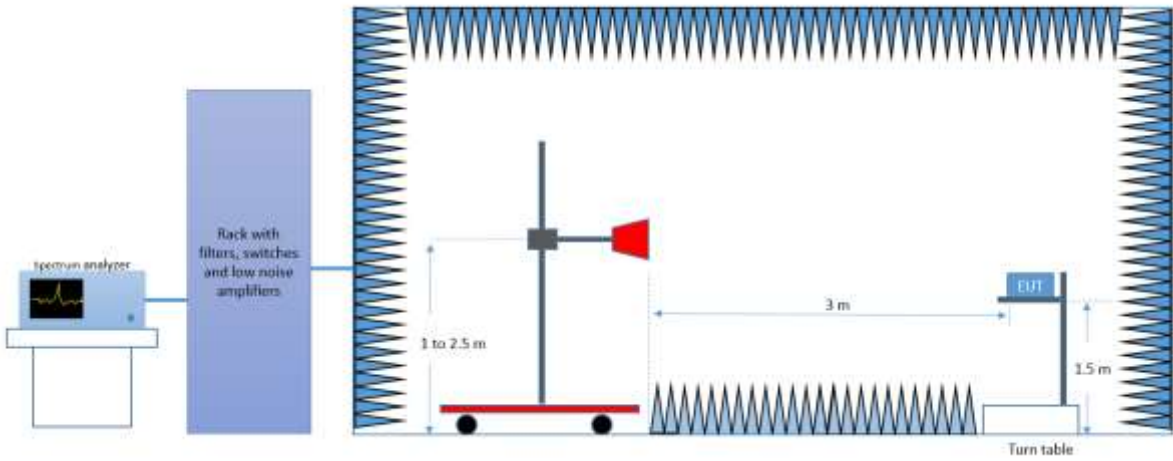

*Radiated Setup > 18 GHz*

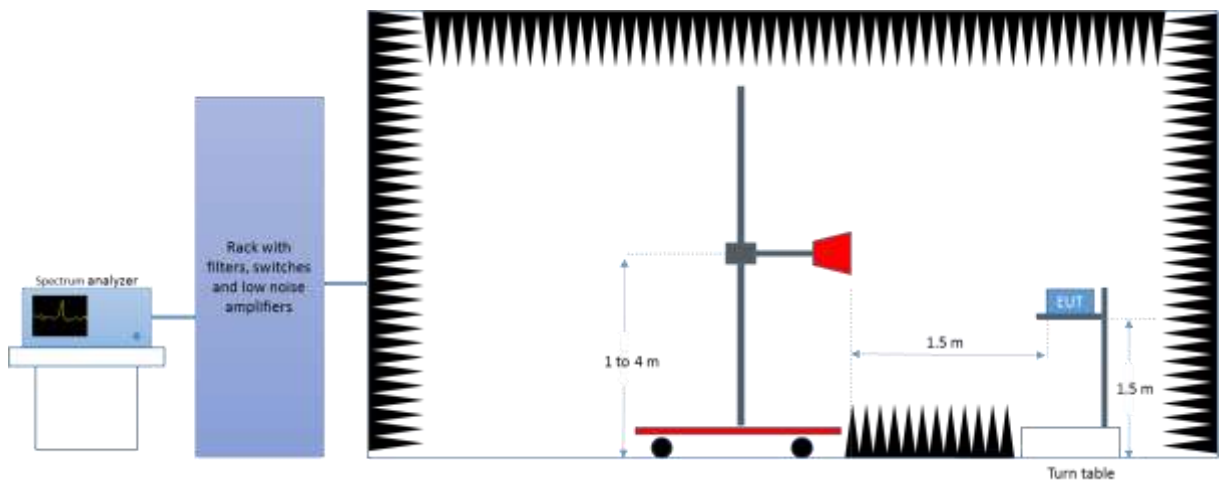

*AC power-line conducted emission Setup 150 kHz – 30 MHz*

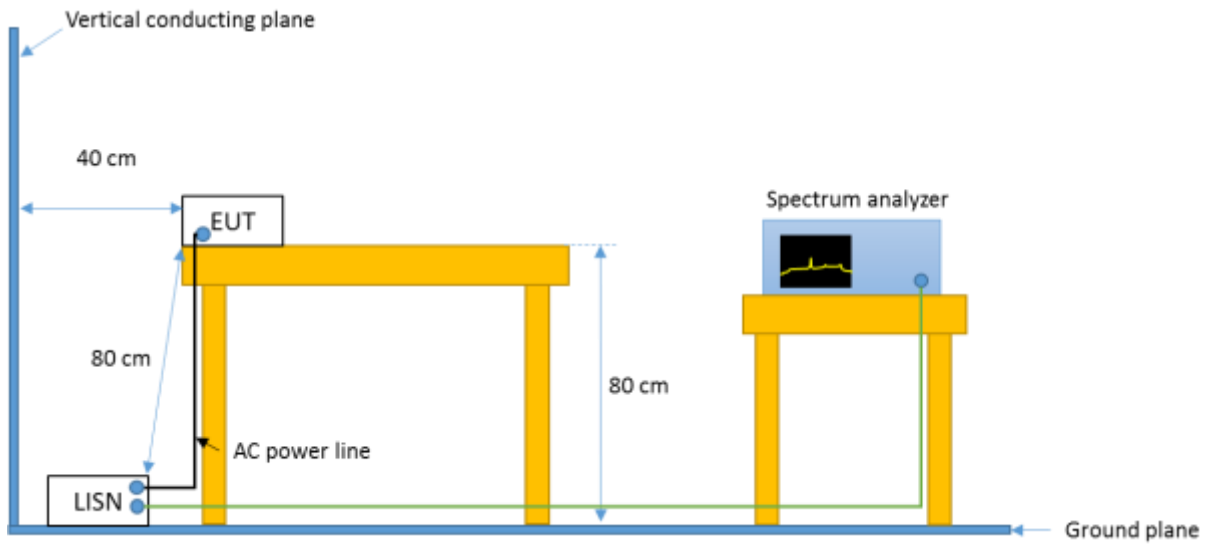



## Test Equipment List

### Conducted Setup

ID#	Device	Type/Model	Serial #	Manufacturer	Cal. Date	Cal. Due Date
0316	Spectrum analyzer	FSV30	103309	Rohde & Schwarz	2017-01-30	2019-01-30

### Radiated Setup-1

ID#	Device	Type/Model	Serial #	Manufacturer	Cal. Date	Cal. Due Date
0133	Spectrum analyzer	FSV40	101358	Rohde & Schwarz	2016-04-15	2018-04-15
0137	Log antenna 30 MHz – 1 GHz	3142E	00156946	ETS Lindgren	2015-12-11	2017-12-11
0139	Horn Antenna 18 GHz - 26.5 GHz	114514	00167100	ETS Lindgren	2016-03-16	2018-03-16
0135	Semi Anechoic chamber	FACT 3	5720	ETS Lindgren	2016-04-28	2018-04-28
0530	Measurement Software	EMC32	100623	Rohde & Schwarz	N/A	N/A
0296	Power Supply	6673A	MY41000318	Agilent	N/A	N/A
0346	Multimeter	34401A	US36054685	HP	2016-02-04	2018-02-04

N/A: Not Applicable

### Radiated Setup-2

ID#	Device	Type/Model	Serial #	Manufacturer	Cal. Date	Cal. Due Date
0420	Spectrum analyzer	FSV40	101556	Rohde & Schwarz	2016-04-15	2018-04-15
0138	Horn antenna 1 GHz – 6.4 GHz	3117	00152266	ETS Lindgren	2016-03-14	2018-03-14
0141	Double Ridge Horn Antenna 1 GHz – 18 GHz	3117	00157736	ETS Lindgren	2016-04-13	2018-04-13
0409	PreAmplifier	3117-PA	00157993	ETS Lindgren	N/A	N/A
0337	Full Anechoic chamber	RFD_FA_100	5996	ETS Lindgren	2016-04-28	2018-04-28
0329	Measurement Software	EMC32	100401	Rohde & Schwarz	N/A	N/A

N/A: Not Applicable

### Radiated Setup - shared equipments

ID#	Device	Type/Model	Serial #	Manufacturer	Cal. Date	Cal. Due Date
0014	Power Sensor	NRP-Z57	101280	Rohde & Schwarz	2017-04-25	2019-04-25

## AC power-line conducted emission Setup

ID#	Device	Type/Model	Serial Number	Manufacturer	Cal. Date	Cal. Due Date
0027	Measurement software	EMC32	1300.7010.02	Rohde & Schwarz	NA	NA
0317	Spectrum Analyzer	FSV30	103308	Rohde & Schwarz	2017-08-05	2019-08-05
0532	LISN	ENV216	101321	Rohde & Schwarz	2016-09-13	2018-09-13
0607	LISN	ENV216	101342	Rohde & Schwarz	2017-09-06	2018-09-06
0538	Transformer	Monophase	TIMM3.15	Montelem	NA	NA
095	Millivoltmeter	2000	4009301	KEITHLEY	2015-10-26	2017-10-26
0624	AC power source	61604	SM135546	CHROMA	NA	NA
0346	Multimeter	34401A	US36054685	HP	2016-02-04	2018-02-04

N/A: Not Applicable

## A.2 Measurement Uncertainty Evaluation

The system uncertainty evaluation is shown in the below table:

Measurement type	Uncertainty [ ±dB]
Conducted Power	±1.0
Conducted Spurious Emission	±2.9
Radiated tests <1GHz	±3.8
Radiated tests 1GHz - 40 GHz	±4.7
AC power-line conducted emission	±1.45

# Annex B. Test Results DTS

## B.1 Test Conditions

The conducted RF output power at each chain was adjusted according to the client's supplied Target values (see following table) using the Intel DRTU tool and measuring the power by using a spectrum analyzer with the channel integration method according to point 9.2.2.2 (Method AVGSA-1) of KDB 558074 D01.

Measured values for adjustment were within +/-0.25 dB from the declared Target values.

2.4GHz DTS & BLE					Conducted Power, Target Value (dBm)
Mode	BW (MHz)	Data Rate	CH #	Freq. (MHz)	SISO Chain A
802.11b	20	1Mbps	1	2412	19.50
			7	2442	21.00
			11	2462	18.00
			12	2467	17.00
			13	2472	16.00
802.11g	20	6Mbps	1	2412	17.50
			7	2442	20.00
			11	2462	17.00
			12	2467	14.50
			13	2472	-5.50
802.11n	20	HT0	1	2412	17.00
			7	2442	19.50
			11	2462	17.00
			12	2467	14.00
			13	2472	-5.50
802.11n	40	HT0	3F	2422	14.50
			7F	2442	16.00
			9F	2452	14.50
			10F	2457	11.50
			11F	2462	3.50
Bluetooth Low Energy	2	1Mbps	0	2412	9.50
			19	2440	9.50
			39	2462	9.50

The following data rates were selected based on preliminary testing that identified those rates as the worst cases for output power and spurious levels at the band edges:

802.11b → 1Mbps

802.11g → 6Mbps

802.11n20 and 802.11n40 (SISO) → HT0

Alternative channels to the lowest and highest channels per band have been also tested for Band Edge compliance.

**B.2 Test Results Tables**

**B.2.1 6dB & 99% Bandwidth**

**Test limits**

FCC part	RSS part	Limits
15.247 (a) (2)	RSS-247 Clause 5.2 (a)	Systems using digital modulation techniques may operate in the 902-928 MHz, 2400-2483.5 MHz, and 5725-5850 MHz bands. The minimum 6 dB bandwidth shall be at least 500 kHz.

**Test procedure**

The setup below was used to measure the 6dB & 99% Bandwidth. The antenna terminal of the EUT is connected to the spectrum through an attenuator, and the spectrum analyzer reading is compensated to include the RF path loss.

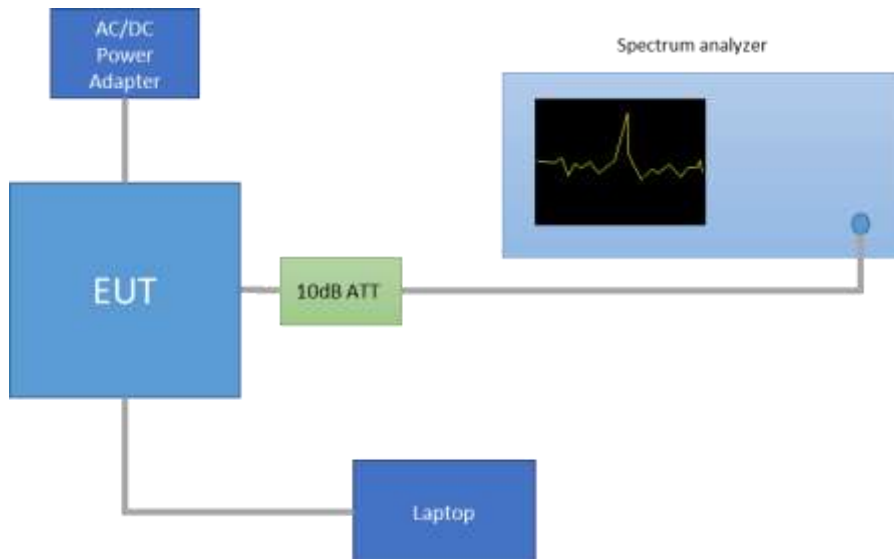

**Results tables**

Mode	Rate	Antenna	Channel	Frequency [MHz]	6dB BW [MHz]	99% BW [MHz]
802.11b	1Mbps	SISO CHAIN A	1	2412	10.10	13.75
			7	2442	10.08	<b>14.85</b>
			11	2462	10.11	13.79
			12	2467	10.11	13.57
			13	2472	10.09	13.41
802.11g	6Mbps	SISO CHAIN A	1	2412	16.34	16.79
			7	2442	16.35	<b>22.91</b>
			11	2462	16.35	16.77
			12	2467	16.34	16.77
			13	2472	16.35	16.82
802.11n20	HT0	SISO CHAIN A	1	2412	17.58	17.89
			7	2442	17.58	<b>21.01</b>
			11	2462	17.58	17.90
			12	2467	17.59	17.88
			13	2472	17.59	17.91
802.11n40	HT0	SISO CHAIN A	3F	2422	36.34	36.49
			7F	2442	36.34	<b>36.50</b>
			9F	2452	36.35	36.48
			10F	2457	36.34	36.46
			11F	2462	36.36	36.47

**Max Value**

**See Section B.3.1 and Section B.3.2 for the screenshot results.**

## B.2.2 Maximum Output Power and antenna gain

### Test limits

	Limits
<p>FCC Part 15.247 (b) (3)</p>	<p>(b) The maximum peak conducted output power of the intentional radiator shall not exceed the following:</p> <p>(3) For systems using digital modulation in the 902-928 MHz, 2400-2483.5 MHz, and 5725-5850 MHz bands: 1 Watt. As an alternative to a peak power measurement, compliance with the one Watt limit can be based on a measurement of the maximum conducted output power. Maximum Conducted Output Power is defined as the total transmit power delivered to all antennas and antenna elements averaged across all symbols in the signaling alphabet when the transmitter is operating at its maximum power control level. Power must be summed across all antennas and antenna elements. The average must not include any time intervals during which the transmitter is off or is transmitting at a reduced power level.</p> <p>(4) The conducted output power limit specified in paragraph (b) of this section is based on the use of antennas with directional gains that do not exceed 6 dBi.</p>
<p>RSS-247 Clause 5.4 (d)</p>	<p>For DTSs employing digital modulation techniques operating in the bands 902-928 MHz and 2400-2483.5 MHz, the maximum peak conducted output power shall not exceed 1W. The e.i.r.p. shall not exceed 4 W, except as provided in section 5.4(e). As an alternative to a peak power measurement, compliance can be based on a measurement of the maximum conducted output power. The maximum conducted output power is the total transmit power delivered to all antennas and antenna elements, averaged across all symbols in the signalling alphabet when the transmitter is operating at its maximum power control level. Power must be summed across all antennas and antenna elements. The average must not include any time intervals during which the transmitter is off or transmitting at a reduced power level. If multiple modes of operation are implemented, the maximum conducted output power is the highest total transmit power occurring in any mode.</p>

Test procedure

The Maximum Peak Conducted Output Power was measured using the channel integration method as authorized in chapter 2.0 "Power limits, definitions and device configuration" of FCC KDB 558074 D01.

The EIRP power (dBm) is calculated by adding the declared maximum antenna gain to the measured conducted power. The declared maximum antenna gain is 3.24dBi.

The setup below was used to measure the maximum conducted output power. The antenna terminal of the EUT is connected to the spectrum through an attenuator, and the spectrum analyzer reading is compensated to include the RF path loss.

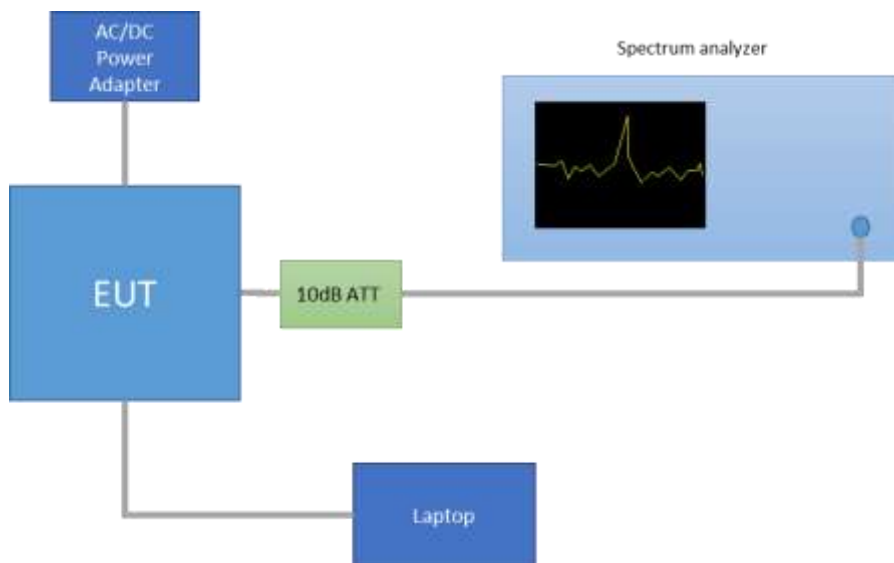



Results tables

Maximum peak conducted output power

Mode	Rate	CH	Freq [MHz]	Antenna	Measured Conducted Output power [dBm]	EIRP [dBm]	EIRP [mW]	Conducted power [mW]
802.11b	1Mbps	1	2412	SISO A	22.21	25.45	350.75	166.34
		7	2442	SISO A	24.07	27.31	538.27	<b>255.27</b>
		11	2462	SISO A	20.84	24.08	255.86	121.34
		12	2467	SISO A	20.15	23.39	218.27	103.51
		13	2472	SISO A	19.13	22.37	172.58	<b>81.85</b>
802.11g	6Mbps	1	2412	SISO A	25.80	29.04	801.68	380.19
		7	2442	SISO A	28.78	32.02	1592.21	<b>755.09</b>
		11	2462	SISO A	25.44	28.68	737.90	349.95
		12	2467	SISO A	22.99	26.23	419.76	199.07
		13	2472	SISO A	2.95	6.19	4.16	<b>1.97</b>
802.11n20	HT0	1	2412	SISO A	25.66	28.90	776.25	368.13
		7	2442	SISO A	28.48	31.72	1485.94	<b>704.69</b>
		11	2462	SISO A	25.41	28.65	732.82	347.54
		12	2467	SISO A	22.76	26.00	398.11	188.80
		13	2472	SISO A	2.92	6.16	4.13	<b>1.96</b>
802.11n40	HT0	3F	2422	SISO A	23.18	26.42	438.53	207.97
		7F	2442	SISO A	24.62	27.86	610.94	<b>289.73</b>
		9F	2452	SISO A	23.11	26.35	431.52	204.64
		10F	2457	SISO A	19.76	23.00	199.53	94.62
		11F	2462	SISO A	11.95	15.19	33.04	<b>15.67</b>

**Max Value**

**Min Value**

Maximum (Average) conducted output power\*

Mode	Rate	CH	Freq [MHz]	Antenna	Measured average conducted power [dBm]	Maximum** (average) conducted output power [dBm]	EIRP [dBm]	Average Output Power [mW]
802.11b	1Mbps	1	2412	SISO A	19.60	19.60	22.84	91.20
		7	2442	SISO A	21.05	21.05	24.29	127.35
		11	2462	SISO A	17.81	17.81	21.05	60.39
		12	2467	SISO A	17.02	17.02	20.26	50.35
		13	2472	SISO A	16.10	16.10	19.34	40.74
802.11g	6Mbps	1	2412	SISO A	17.33	17.33	20.57	54.08
		7	2442	SISO A	19.78	19.78	23.02	95.06
		11	2462	SISO A	16.90	16.90	20.14	48.98
		12	2467	SISO A	14.47	14.47	17.71	27.99
		13	2472	SISO A	-5.61	-5.61	-2.37	0.27
802.11n20	HT0	1	2412	SISO A	17.18	17.18	20.42	52.24
		7	2442	SISO A	19.56	19.56	22.80	90.36
		11	2462	SISO A	16.86	16.86	20.10	48.53
		12	2467	SISO A	14.21	14.21	17.45	26.36
		13	2472	SISO A	-5.65	-5.65	-2.41	0.27
802.11n40	HT0	3F	2422	SISO A	14.41	14.57	17.81	28.64
		7F	2442	SISO A	15.85	16.01	19.25	39.90
		9F	2452	SISO A	14.28	14.44	17.68	27.80
		10F	2457	SISO A	11.22	11.38	14.62	13.74
		11F	2462	SISO A	3.43	3.59	6.83	2.29

\* Maximum (average) conducted output power are shown for indicative purpose only.

\*\* Duty cycle compensated

**See Section B.3.3 for the screenshot results.**

### B.2.3 Power Spectral Density

Test limits

FCC part	RSS part	Limits
15.247 (e)	RSS-247 Clause 5.2 (b)	For digitally modulated systems, the power spectral density conducted from the intentional radiator to the antenna shall not be greater than 8 dBm in any 3 kHz band during any time interval of continuous transmission. This power spectral density shall be determined in accordance with the provisions of paragraph (b) of this section. The same method of determining the conducted output power shall be used to determine the power spectral density.

Test procedure

The peak power spectral density level in the fundamental emission was measured using the *Method PKPSD (peak PSD)* according to point 10.2 of KDB 558074 D01 DTS Meas Guidance. This method was used for 802.11b, 802.11g, 802.11n20 and 802.11n40 modes.

The setup below was used to measure the power spectral density. The antenna terminal of the EUT is connected to the spectrum through an attenuator, and the spectrum analyzer reading is compensated to include the RF path loss.

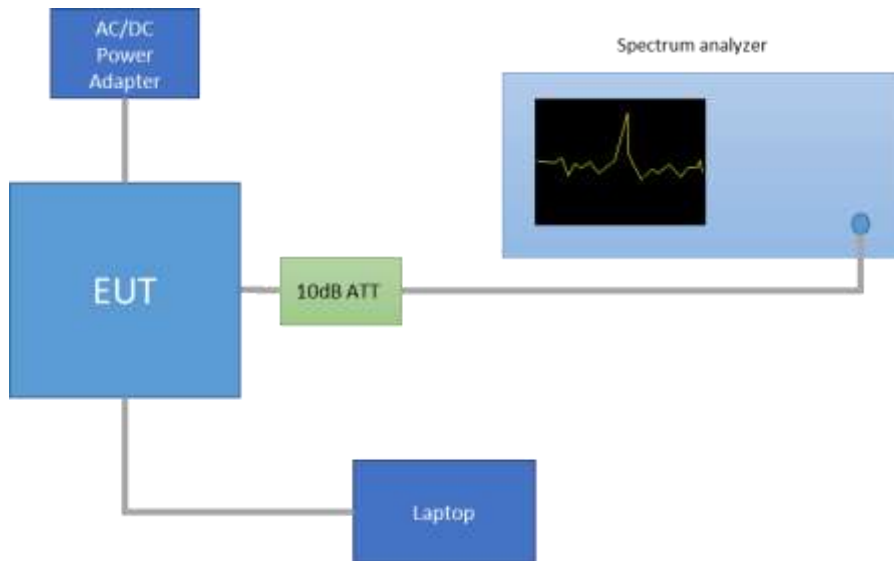

Results tables

Mode	Rate	Channel	Frequency [MHz]	Antenna	PSD Peak [dBm]
802.11b	1Mbps	1	2412	SISO CHAIN A	-2.96
		7	2442	SISO CHAIN A	-1.63
		11	2462	SISO CHAIN A	-4.83
		12	2467	SISO CHAIN A	-5.50
		13	2472	SISO CHAIN A	-6.49
802.11g	6Mbps	1	2412	SISO CHAIN A	-7.02
		7	2442	SISO CHAIN A	-4.39
		11	2462	SISO CHAIN A	-7.56
		12	2467	SISO CHAIN A	-9.96
		13	2472	SISO CHAIN A	-30.29
802.11n20	HT0	1	2412	SISO CHAIN A	-6.74
		7	2442	SISO CHAIN A	-4.33
		11	2462	SISO CHAIN A	-6.82
		12	2467	SISO CHAIN A	-10.10
		13	2472	SISO CHAIN A	-29.48
802.11n40	HT0	3F	2422	SISO CHAIN A	-13.09
		7F	2442	SISO CHAIN A	-11.30
		9F	2452	SISO CHAIN A	-12.55
		10F	2457	SISO CHAIN A	-16.07
		11F	2462	SISO CHAIN A	-24.09

**See Section B.3.4 for the screenshot results**

## B.2.4 Out-of-band emission (conducted)

### Test Limits

FCC part	RSS part	Limits																				
15.247 (d)	RSS-247 Clause 5.5	In any 100 kHz bandwidth outside the frequency band in which the spread spectrum or digitally modulated intentional radiator is operating, the radio frequency power that is produced by the intentional radiator shall be at least 20 dB below that in the 100 kHz bandwidth within the band that contains the highest level of the desired power, based on either an RF conducted or a radiated measurement, provided the transmitter demonstrates compliance with the peak conducted power limits.																				
15.209	RSS-Gen Clause 8.9	<p>Radiated emissions which fall in the restricted bands, as defined in §15.205(a), must also comply with the radiated emission limits specified in §15.209(a):</p> <table border="1"> <thead> <tr> <th>Freq Range (MHz)</th> <th>Field Strength (μV/m)</th> <th>Field Strength (dBμV/m)</th> <th>Meas. Distance (m)</th> </tr> </thead> <tbody> <tr> <td>30-88</td> <td>100</td> <td>40</td> <td>3</td> </tr> <tr> <td>88-216</td> <td>150</td> <td>43.5</td> <td>3</td> </tr> <tr> <td>216-960</td> <td>200</td> <td>46</td> <td>3</td> </tr> <tr> <td>Above 960</td> <td>500</td> <td>54</td> <td>3</td> </tr> </tbody> </table> <p>The emission limits shown in the above table are based on measurements employing CISPR quasi-peak detector except for the frequency bands 9-90 kHz, 110-490 kHz and above 1000 MHz. Radiated emission limits in these three bands are based on measurements employing an average detector.</p> <p>For average radiated emission measurements above 1000 MHz, there is also a limit specified when measuring with peak detector function, corresponding to 20 dB above the indicated values in the table.</p>	Freq Range (MHz)	Field Strength (μV/m)	Field Strength (dBμV/m)	Meas. Distance (m)	30-88	100	40	3	88-216	150	43.5	3	216-960	200	46	3	Above 960	500	54	3
Freq Range (MHz)	Field Strength (μV/m)	Field Strength (dBμV/m)	Meas. Distance (m)																			
30-88	100	40	3																			
88-216	150	43.5	3																			
216-960	200	46	3																			
Above 960	500	54	3																			

### Test procedure

The setup below was used to measure the out-of-band emissions. The antenna terminal of the EUT is connected to the spectrum analyzer through an attenuator, and the spectrum analyzer reading is compensated to include the RF path loss.

The Band Edge High, was measured using the method according to point 13.3 (Integration Method) of KDB 558074 D01 DTS Meas Guidance v04.

In case of Band Edge measurements falling in restricted bands, the declared Antenna Gain is also compensated in the graph. The declared maximum antenna gain is 3.24dBi.

For Band Edge measurements falling in restricted bands, the following limits in dBm were applied for the average detector after the conversion from the limits detailed above in dBμV/m, according to FCC 47 CFR part 15 - Subpart C – §15.209(a). The limits in dBm for peak detector are 20dB above the indicated values in the table.

§15.209(a)			Converted values	
Freq Range (MHz)	Distance (m)	Field strength (microvolts/meter)	Field strength (dB microvolts/meter)	Power (dBm)
Above 960	3	500	54.0	-41.2

The setup below was used to measure the out-of-band emissions. The antenna terminal of the EUT is connected to the spectrum through an attenuator, and the spectrum analyzer reading is compensated to include the RF path loss.

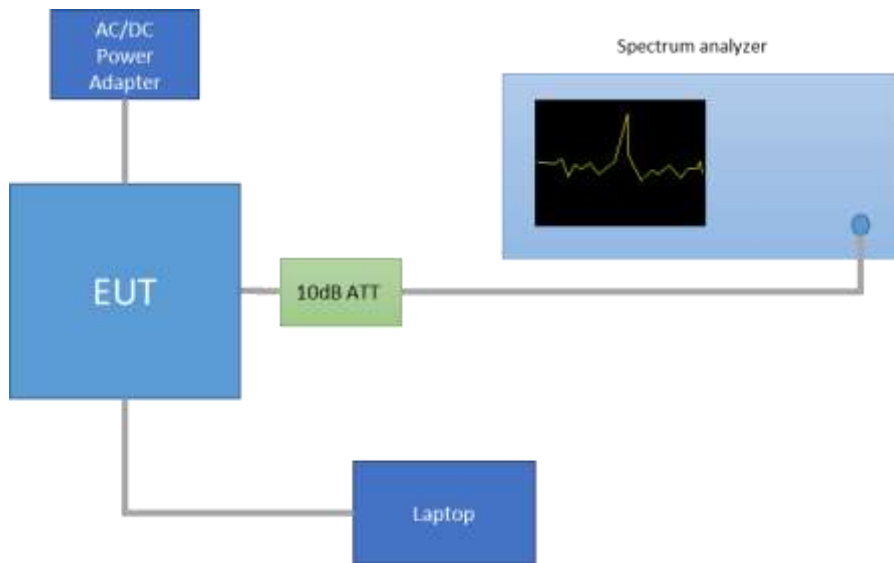

Note: these PSD<sub>Peak</sub> values are shown just as a reference for the compliance of the Spurious Out-of-band Measurements only. Thus the RBW used for these measurements was 100kHz.

Mode	Rate	Measured Duty Cycle [%]	Channel	Frequency [MHz]	Antenna	PSD Peak [dBm]
802.11b	1Mbps	98.65%	1	2412	SISO CHAIN A	10.40
			7	2437	SISO CHAIN A	11.87
			11	2462	SISO CHAIN A	8.53
			12	2467	SISO CHAIN A	7.88
			13	2472	SISO CHAIN A	6.86
802.11g	6Mbps	98.36%	1	2412	SISO CHAIN A	6.62
			7	2442	SISO CHAIN A	9.42
			11	2462	SISO CHAIN A	6.10
			12	2467	SISO CHAIN A	3.66
			13	2472	SISO CHAIN A	-16.44
802.11n20	HT0	98.14%	1	2412	SISO CHAIN A	6.52
			7	2442	SISO CHAIN A	9.14
			11	2462	SISO CHAIN A	6.11
			12	2467	SISO CHAIN A	3.45
			13	2472	SISO CHAIN A	-16.41
802.11n40	HT0	96.38%	3F	2422	SISO CHAIN A	0.62
			7F	2442	SISO CHAIN A	2.01
			9F	2452	SISO CHAIN A	0.44
			10F	2457	SISO CHAIN A	-2.91
			11F	2462	SISO CHAIN A	-10.85

See Section B.3.5, Section B.3.6 and Section B.3.7 for the screenshot results.

## B.2.5 Radiated spurious emission

### Standard references

FCC part	RSS part	Limits			
15.247 (d) 15.209	RSS-247 Clause 5.5 RSS-Gen Clause 8.9	Radiated emissions which fall in the restricted bands, as defined in §15.205(a), must also comply with the radiated emission limits specified in §15.209(a):			
		Freq Range (MHz)	Field Strength ( $\mu\text{V}/\text{m}$ )	Field Strength ( $\text{dB}\mu\text{V}/\text{m}$ )	Meas. Distance (m)
		30-88	100	40	3
		88-216	150	43.5	3
		216-960	200	46	3
		Above 960	500	54	3
<p>The emission limits shown in the above table are based on measurements employing CISPR quasi-peak detector except for the frequency bands 9-90 kHz, 110-490 kHz and above 1000 MHz. Radiated emission limits in these three bands are based on measurements employing an average detector.</p> <p>For average radiated emission measurements above 1000 MHz, there is also a limit specified when measuring with peak detector function corresponding to 20 dB above the indicated values in the table.</p>					

### Test procedure

The setups below were used to measure the radiated spurious emissions.

Depending of the frequency range and bands being tested, different antennas and filters were used.

The final measurement is done by varying the antenna height from 1 to 4 meters, the EUT azimuth over 360° and for both Vertical and Horizontal polarizations.

The radiated spurious emissions were measured on the worst case configuration selected from the chapter 0 and using the lowest, middle and highest channels.



*Radiated Setup < 1GHz*

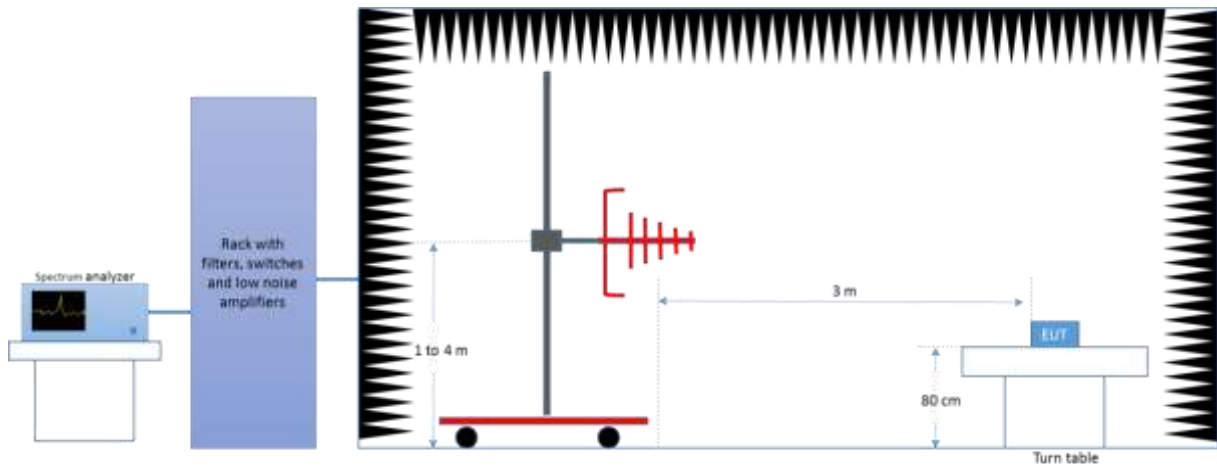

*Radiated Setup 1 GHz - 18 GHz*

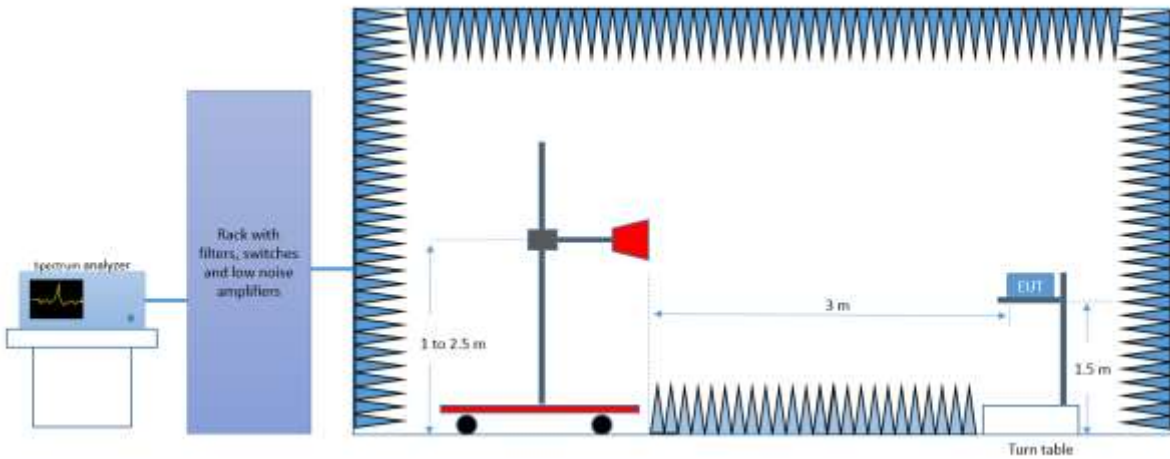

*Radiated Setup > 18GHz*

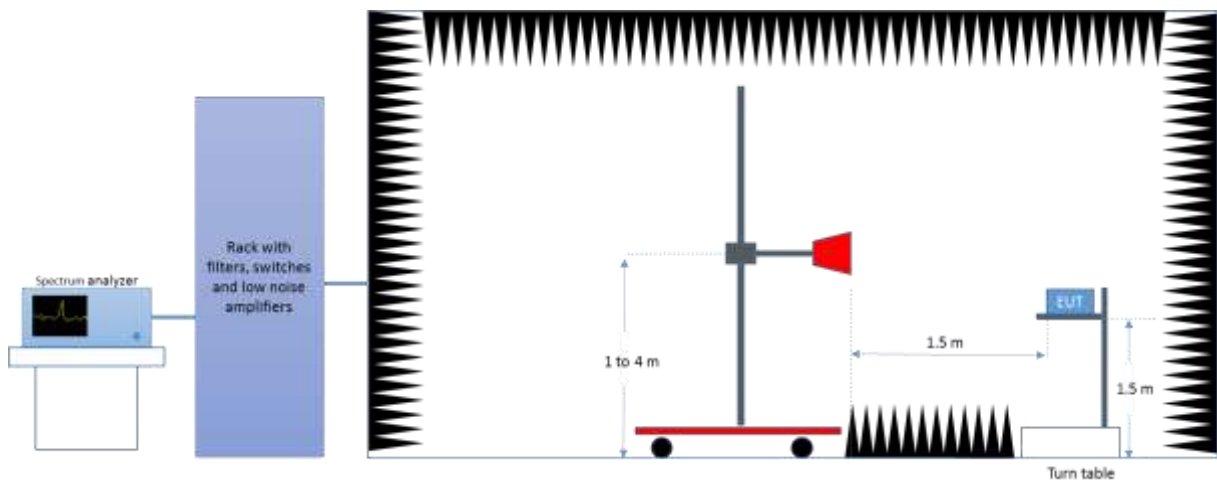

Sample Calculation

The field strength is deduced from the radiated measurement using the following equation:

$$E = 126.8 - 20\log(\lambda) + P - G$$

where

*E* is the field strength of the emission at the measurement distance, in dB $\mu$ V/m

*P* is the power measured at the output of the test antenna, in dBm

$\lambda$  is the wavelength of the emission under investigation [ $300/f_{MHz}$ ], in m

*G* is the gain of the test antenna, in dBi

NOTE – The measured power P includes all applicable instrument correction factors up to the connection to the test Antenna e.g. cable losses, amplifier gains.

For field strength measurements made at other than the distance at which the applicable limit is specified, the field strength of the emission at the distance specified by the limit is deduced as follows:

$$E_{SpecLimit} = E_{Meas} + 20\log(D_{Meas}/D_{SpecLimit})$$

where

*E<sub>SpecLimit</sub>* is the field strength of the emission at the distance specified by the limit, in dB $\mu$ V/m

*E<sub>Meas</sub>* is the field strength of the emission at the measurement distance, in dB $\mu$ V/m

*D<sub>Meas</sub>* is the measurement distance, in m

*D<sub>SpecLimit</sub>* is the distance specified by the limit, in m

Test Results

**30 MHz – 26.5 GHz, 802.11b, 1Mbps, Chain A**

**Radiated Spurious – CH1**

Frequency	MaxPeak	Avg	Limit	Margin
MHz	dBuV/m	dBuV/m	dBuV/m	dB
46.7	32.4	---	40.0	7.6
3455.0	59.3	---	74.0	14.8
3479.7	---	46.6	54.0	7.4
9648.0	---	40.3	54.0	13.8
9648.0	45.9	---	74.0	28.1
17985.7	60.9	---	74.0	13.1
17987.1	---	<b>49.9</b>	54.0	4.1
19295.8	45.8	---	74.0	28.3

**Radiated Spurious – CH7**

Frequency	MaxPeak	Avg	Limit	Margin
MHz	dBuV/m	dBuV/m	dBuV/m	dB
500.0	37.0	---	46.0	9.0
3456.3	---	46.7	54.0	7.3
3485.0	58.4	---	74.0	15.6
17992.4	---	<b>49.8</b>	54.0	4.2
17995.1	60.8	---	74.0	13.3
19535.7	---	38.0	54.0	16.0
19535.7	43.3	---	74.0	30.8

**Radiated Spurious – CH11**

Frequency	MaxPeak	Avg	Limit	Margin
MHz	dBuV/m	dBuV/m	dBuV/m	dB
54.7	30.9	---	40.0	9.1
3473.4	59.1	---	74.0	14.9
3474.4	---	46.6	54.0	7.5
9847.4	47.0	---	74.0	27.0
9847.9	---	40.4	54.0	13.6
17991.5	61.8	---	74.0	12.2
17997.3	---	<b>49.9</b>	54.0	4.1
19695.8	---	37.5	54.0	16.5
19695.8	43.2	---	74.0	30.8

**Radiated Spurious – CH13**

Frequency	MaxPeak	Avg	Limit	Margin
MHz	dBuV/m	dBuV/m	dBuV/m	dB
500.0	35.7	---	46.0	10.3
3464.1	---	46.5	54.0	7.5
3465.9	59.1	---	74.0	14.9
9888.0	---	43.2	54.0	10.8
9888.0	47.7	---	74.0	26.3
17969.7	60.5	---	74.0	13.5
17990.2	---	<b>49.9</b>	54.0	4.2
19776.0	---	37.2	54.0	16.8
19776.0	43.3	---	74.0	30.7

**30 MHz – 26.5 GHz, 802.11g, 6Mbps, Chain A**

**Radiated Spurious – CH1**

Frequency	MaxPeak	Avg	Limit	Margin
MHz	dBuV/m	dBuV/m	dBuV/m	dB
55.0	30.6	---	40.0	9.4
3463.1	---	46.8	54.0	7.3
3496.3	58.9	---	74.0	15.1
17978.6	60.8	---	74.0	13.2
17998.2	---	49.9	54.0	4.1
19295.8	---	38.0	54.0	16.0
19295.8	44.2	---	74.0	29.9

**Radiated Spurious – CH7**

Frequency	MaxPeak	Avg	Limit	Margin
MHz	dBuV/m	dBuV/m	dBuV/m	dB
55.0	35.1	---	40.0	4.9
3442.8	---	46.5	54.0	7.6
3460.3	58.0	---	74.0	16.0
17992.9	---	49.8	54.0	4.2
17993.3	61.0	---	74.0	13.0
19535.7	---	37.1	54.0	16.9
19536.1	43.4	---	74.0	30.6

**Radiated Spurious – CH11**

Frequency	MaxPeak	Avg	Limit	Margin
MHz	dBuV/m	dBuV/m	dBuV/m	dB
62.5	<b>36.6</b>	---	40.0	3.4
3447.5	---	46.6	54.0	7.4
3493.1	58.5	---	74.0	15.5
17987.1	60.3	---	74.0	13.7
17998.7	---	49.8	54.0	4.2
19695.3	43.9	---	74.0	30.2
19695.8	---	36.2	54.0	17.8

**Radiated Spurious – CH13**

Frequency	MaxPeak	Avg	Limit	Margin
MHz	dBuV/m	dBuV/m	dBuV/m	dB
62.5	<b>35.9</b>	---	40.0	4.1
3471.2	57.40	---	74.00	16.60
3485.3	---	46.90	54.00	7.10
17984.8	---	49.9	54.0	4.1
17992.0	61.3	---	74.0	12.7
19776.0	---	34.2	54.0	19.8
19776.0	41.8	---	74.0	32.2

**30 MHz – 26.5 GHz, 802.11n20, HT0, Chain A**

**Radiated Spurious – CH1**

Frequency	MaxPeak	Avg	Limit	Margin
MHz	dBuV/m	dBuV/m	dBuV/m	dB
55.0	33.3	---	40.0	6.7
3474.7	---	46.5	54.0	7.5
3480.3	57.9	---	74.0	16.1
17867.0	---	46.5	54.0	7.5
17976.4	60.5	---	74.0	13.5
19295.8	---	37.9	54.0	16.1
19295.8	42.9	---	74.0	31.2

**Radiated Spurious – CH7**

Frequency	MaxPeak	Avg	Limit	Margin
MHz	dBuV/m	dBuV/m	dBuV/m	dB
62.5	32.3	---	40.0	7.7
3453.4	57.8	---	74.0	16.2
3455.3	---	46.9	54.0	7.1
17995.1	60.6	---	74.0	13.5
17999.1	---	49.8	54.0	4.2
19535.7	---	37.5	54.0	16.5

**Radiated Spurious – CH11**

Frequency	MaxPeak	Avg	Limit	Margin
MHz	dBuV/m	dBuV/m	dBuV/m	dB
62.5	32.6	---	40.0	7.4
3458.8	---	46.4	54.0	7.7
3463.8	59.0	---	74.0	15.0
17977.2	---	49.8	54.0	4.2
17978.1	60.8	---	74.0	13.2
19695.3	42.4	---	74.0	31.7
19695.8	---	36.7	54.0	17.3

**Radiated Spurious – CH13**

Frequency	MaxPeak	Avg	Limit	Margin
MHz	dBuV/m	dBuV/m	dBuV/m	dB
62.5	36.3	---	40.0	3.7
3470.6	---	46.6	54.0	7.4
3485.9	57.9	---	74.0	16.1
17988.4	61.7	---	74.0	12.3
17992.9	---	<b>50.0</b>	54.0	4.0
19764.2	41.7	---	74.0	32.3
19775.6	---	33.9	54.0	20.1



**30 MHz – 26.5 GHz, 802.11n40, HT0, Chain A****Radiated Spurious – CH3F**

Frequency	MaxPeak	Avg	Limit	Margin
MHz	dBuV/m	dBuV/m	dBuV/m	dB
62.5	30.8	---	40.0	9.2
3474.4	---	46.5	54.0	7.5
3480.6	57.9	---	74.0	16.1
17869.7	---	46.5	54.0	7.5
17969.2	60.8	---	74.0	13.2
19375.6	43.6	---	74.0	30.4
19376.1	---	37.5	54.0	16.5

**Radiated Spurious – CH6F**

Frequency	MaxPeak	Avg	Limit	Margin
62.5	30.2	---	40.0	9.8
3460.0	59.2	---	74.0	14.8
3491.3	---	46.6	54.0	7.5
17993.8	---	49.8	54.0	4.2
17997.3	62.8	---	74.0	11.2
19496.0	---	38.1	54.0	15.9
19496.0	43.3	---	74.0	30.7

**Radiated Spurious – CH9F**

Frequency	MaxPeak	Avg	Limit	Margin
MHz	dBuV/m	dBuV/m	dBuV/m	dB
62.5	28.5	---	40.0	11.5
3458.4	---	46.6	54.0	7.4
3488.1	57.8	---	74.0	16.2
17996.9	60.8	---	74.0	13.2
17998.2	---	<b>50.0</b>	54.0	4.0
19615.9	---	36.7	54.0	17.3
19615.9	42.6	---	74.0	31.4

**Radiated Spurious – CH11F**

Frequency	MaxPeak	Avg	Limit	Margin
MHz	dBuV/m	dBuV/m	dBuV/m	dB
62.5	29.2	---	40.0	10.8
3455.3	---	46.5	54.0	7.5
3480.9	58.8	---	74.0	15.2
17969.2	61.5	---	74.0	12.5
17997.3	---	49.9	54.0	4.1
19695.8	---	34.5	54.0	19.5
19697.6	42.0	---	74.0	32.0

## B.2.6 AC power-line conducted emission

### Standard references:

FCC part	RSS part	Limits														
<p>15.207 15.407 (6)</p>	<p>RSS-GEN, Clause 8.8</p>	<p>Except as shown in paragraphs (b) and (c) of this section, for an intentional radiator that is designed to be connected to the public utility (AC) power line, the radio frequency voltage that is conducted back onto the AC power line on any frequency or frequencies, within the band 150 kHz to 30 MHz, shall not exceed the limits in the following table, as measured using a 50 <math>\mu</math>H/50 ohms line impedance stabilization network (LISN). Compliance with the provisions of this paragraph shall be based on the measurement of the radio frequency voltage between each power line and ground at the power terminal. The lower limit applies at the boundary between the frequency ranges.</p>														
		<table border="1"> <thead> <tr> <th data-bbox="483 674 1034 734" rowspan="2">Frequency of emission (MHz)</th> <th colspan="2" data-bbox="1034 674 1481 703">Conducted limit (dB<math>\mu</math>V)</th> </tr> <tr> <th data-bbox="1034 703 1286 734">Quasi-peak</th> <th data-bbox="1286 703 1481 734">Average</th> </tr> </thead> <tbody> <tr> <td data-bbox="483 734 1034 766">0.15-0.5</td> <td data-bbox="1034 734 1286 766">66 to 56*</td> <td data-bbox="1286 734 1481 766">56 to 46*</td> </tr> <tr> <td data-bbox="483 766 1034 797">0.5-5</td> <td data-bbox="1034 766 1286 797">56</td> <td data-bbox="1286 766 1481 797">46</td> </tr> <tr> <td data-bbox="483 797 1034 831">5-30</td> <td data-bbox="1034 797 1286 831">60</td> <td data-bbox="1286 797 1481 831">50</td> </tr> </tbody> </table>	Frequency of emission (MHz)	Conducted limit (dB $\mu$ V)		Quasi-peak	Average	0.15-0.5	66 to 56*	56 to 46*	0.5-5	56	46	5-30	60	50
		Frequency of emission (MHz)		Conducted limit (dB $\mu$ V)												
			Quasi-peak	Average												
		0.15-0.5	66 to 56*	56 to 46*												
0.5-5	56	46														
5-30	60	50														
<p>*Decreases with the logarithm of the frequency.</p>																

### Test procedure:

The EUT and peripherals are placed on a wooden table with a nominal size of 1.0 m by 1.5 m, raised 80 cm above the reference ground plane. The EUT is connected to AC-Power line through a Line Impedance Stabilization Network (LISN) to accommodate a 50  $\Omega$ /50  $\mu$ H coupling impedance for the measurement system. The EUT control PC is considered as a peripheric and therefore is connected to a second LISN which has the measurement port connected to a 50 ohms impedance.

Each measurement is done for each current-carrying conductor (Line and Neutral) at the end plug of the EUT power cord. The EUT is tested for several transmission modes (frequency channel, modulation, etc.) and the result providing the maximum measured emission is reported.

The exploratory measurement is done over the frequency range from 150 kHz to 30 MHz, while the measurement receiver is recording the Peak and Average signal at 10 kHz steps in Max Hold mode. The cables manipulation is performed within the range of likely configurations to determine the maximum emission. Once the EUT cable configuration, arrangement and mode of operation that produced the emission with the highest amplitude relative to the limit is found the six highest AC power-line conducted emissions relative to 20 dB of the limit are reported as the final measurement. If fewer than six emission frequencies are within 20 dB of the limit, the noise level is reported. For the final measurement, the measurement receiver records the Quasi Peak values with 9 kHz resolution bandwidth and the average values with 10 kHz resolution bandwidth.

*EUT arrangement for AC power-line conducted emission tests*

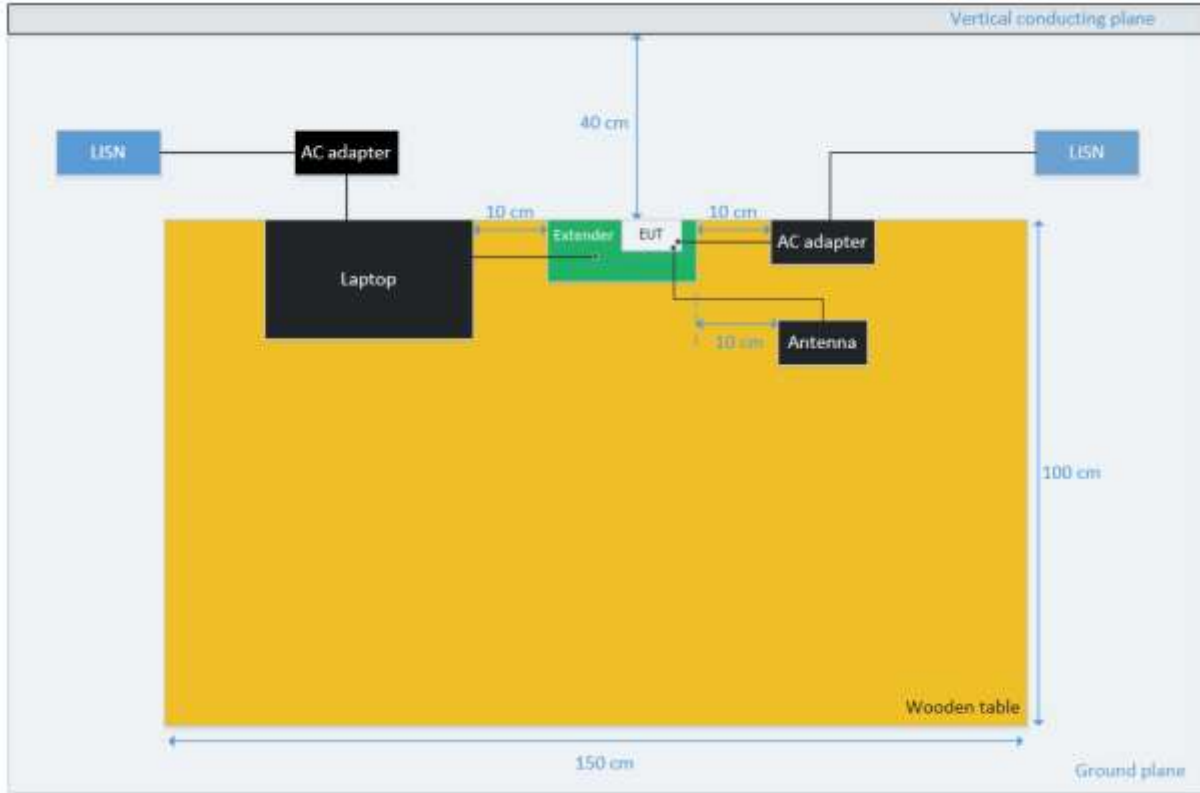

Sample Calculation:

The measured level at the spectrum analyzer in dBuV is corrected by a transducer factor taking into account the losses of the RF cable and the LISN as follows:

$$\text{Conducted Emission level (dBuV)} = SA_{\text{Level}} + RFCable_{\text{Losses}} + LISN_{\text{Losses}}$$

Where:

$SA_{\text{Level}}$  is the voltage level displayed on the measurement receiver, in dBuV.

$RFCable_{\text{Losses}}$  is the value of the cable losses between the LISN and the measurement receiver, in dB.

$LISN_{\text{Losses}}$  is the value of the insertion losses of the LISN, in dB.

**Test Results:**

**150kHz – 30MHz, all mode**

**AC power-line conducted – Phase L1**

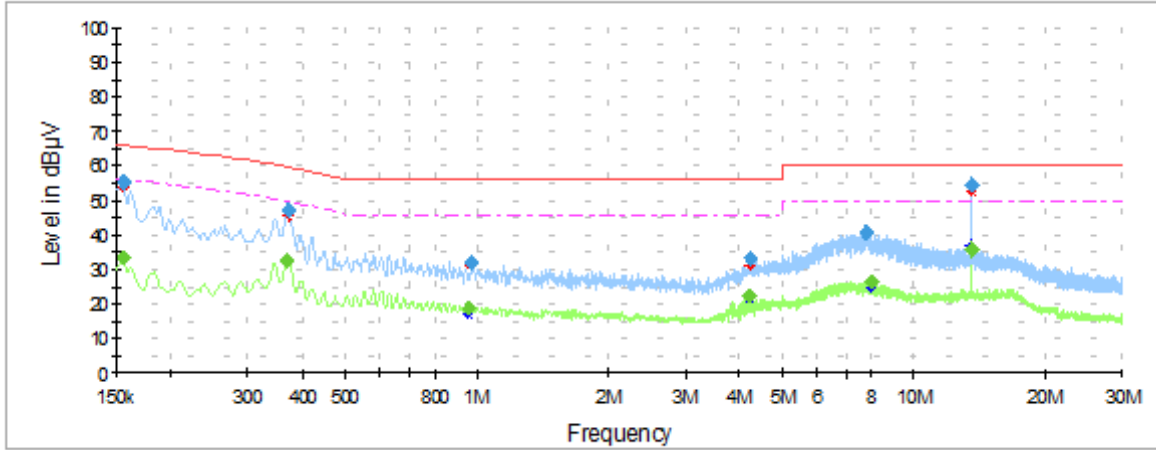

— Peak measurements      — Avg measurements      — Limit FCC Quasi-Peak      - - - Limit FCC Avg

Frequency MHz	Max Peak dBµV	Avg dBµV	Limit dBµV	Margin dB
0.1559	55.3	--	65.8	10.5
0.1559	--	33.3	55.8	22.5
0.3708	47.2	--	59.8	12.6
0.3708	--	32.7	49.8	17.1
0.9604	31.9	--	56.0	24.1
0.9708	--	18.5	46.0	27.5
4.204	33.4	--	60.0	26.6
4.245	--	22.4	50.0	27.6
7.756	40.5	--	60.0	19.5
7.987	--	26.3	50.0	23.7
13.567	54.7	--	60.0	5.3
13.568	--	36.0	50.0	14.0

Note: The emissions found do not change with the modulation and/or frequency.

**AC power-line conducted – Neutral N**

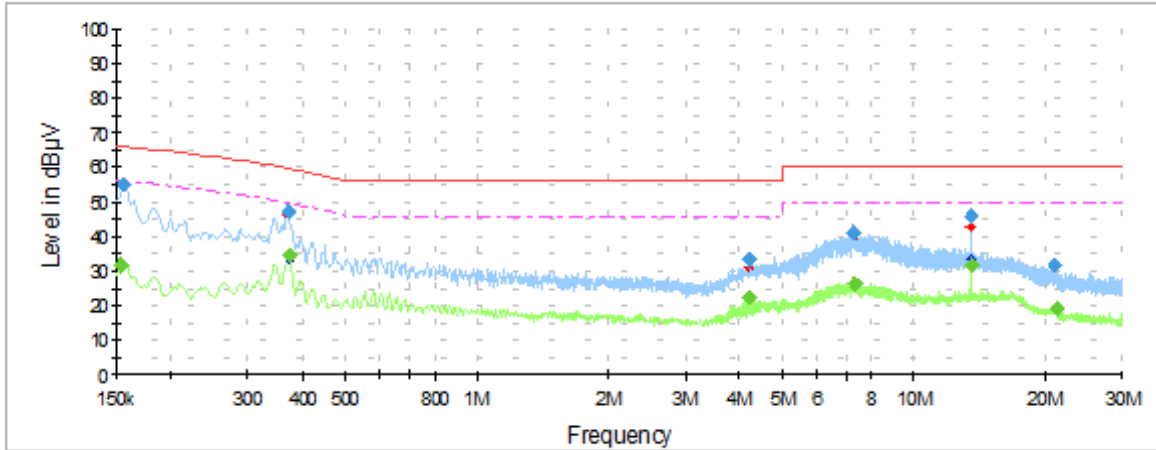

— Peak measurements      — Avg measurements      — Limit FCC Quasi-Peak      - - - Limit FCC Avg

Frequency	Max Peak	Avg	Limit	Margin
MHz	dBµV	dBµV	dBµV	dB
0.1589	54.7	--	65.8	11.1
0.1589	--	31.8	55.8	24
0.3679	47.1	--	59.7	12.6
0.3679	--	34.5	49.7	15.2
4.230	33.2	--	56.0	22.8
4.230	--	22.2	46.0	23.8
7.218	41.0	--	60.0	19.0
7.218	--	26.6	50.0	23.4
13.564	45.8	--	60.0	14.2
13.564	--	31.7	50.0	18.3
20.573	31.6	--	60.0	28.4
20.573	--	19.0	50.0	31.0

Note: The emissions found do not change with the modulation and/or frequency.

### B.3 Test Results Screenshots

#### B.3.1 6dB Bandwidth

## SISO-A,802.11b,1Mbps

Channel 11

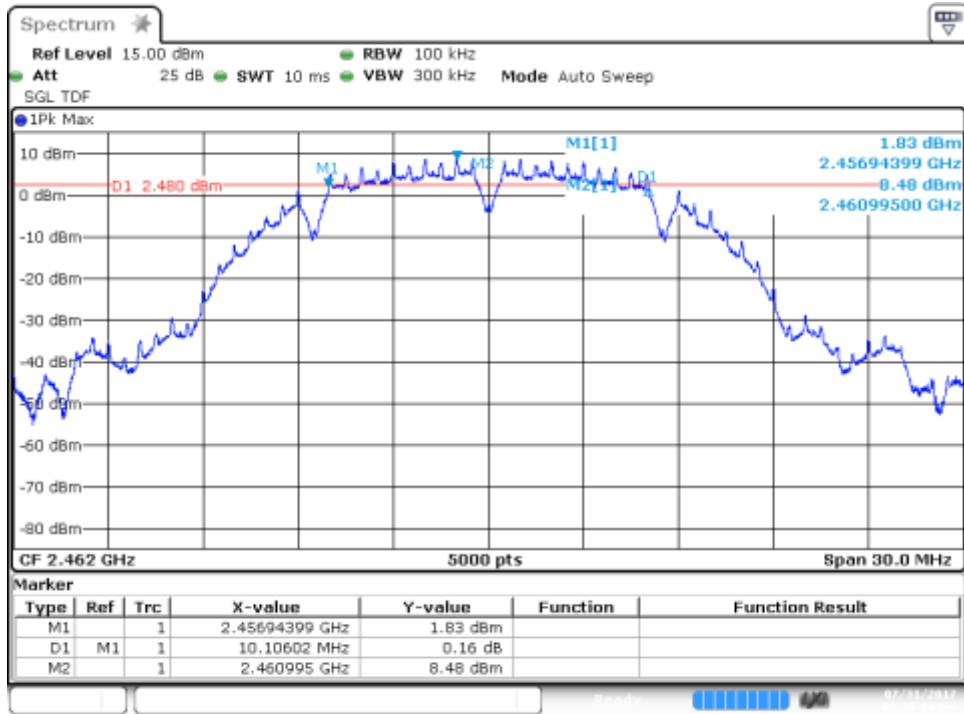

Date: 31.JUL.2017 14:30:34

## SISO-A,802.11g,6Mbps

Channel 7

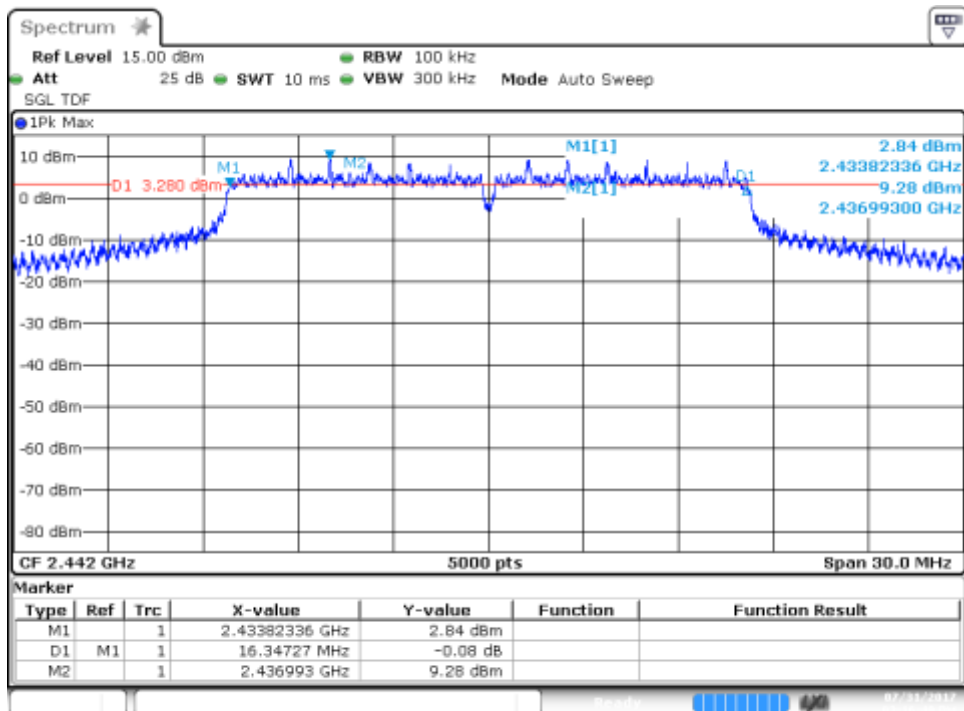

Date: 31.JUL.2017 15:18:49

### SISO-A,802.11n20,HT0

Channel 13

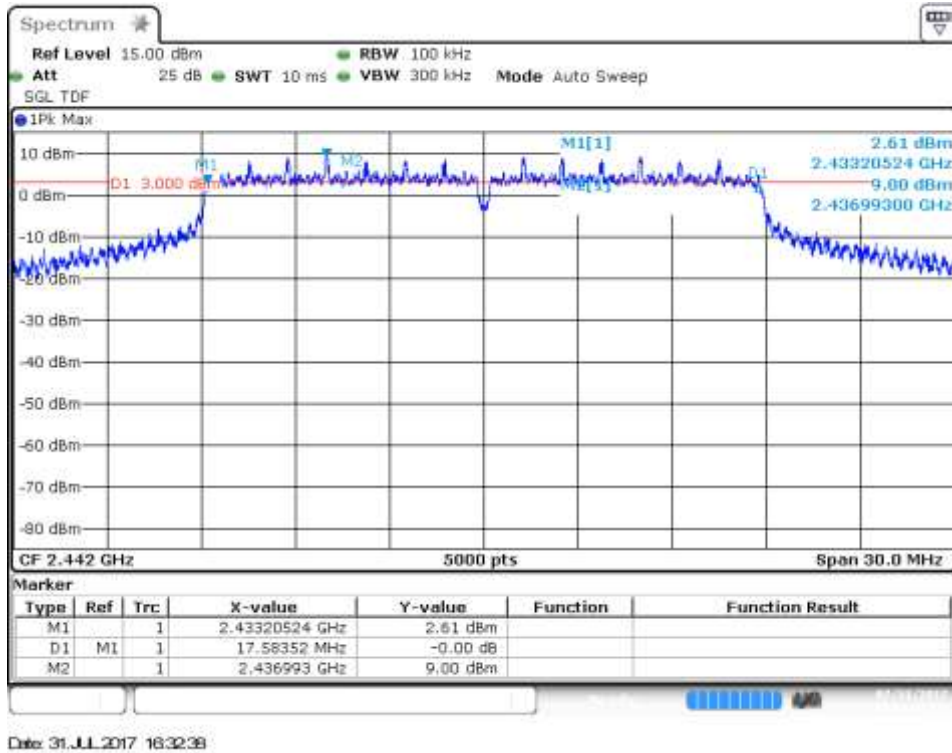

### SISO-A,802.11n40,HT0

Channel 11F

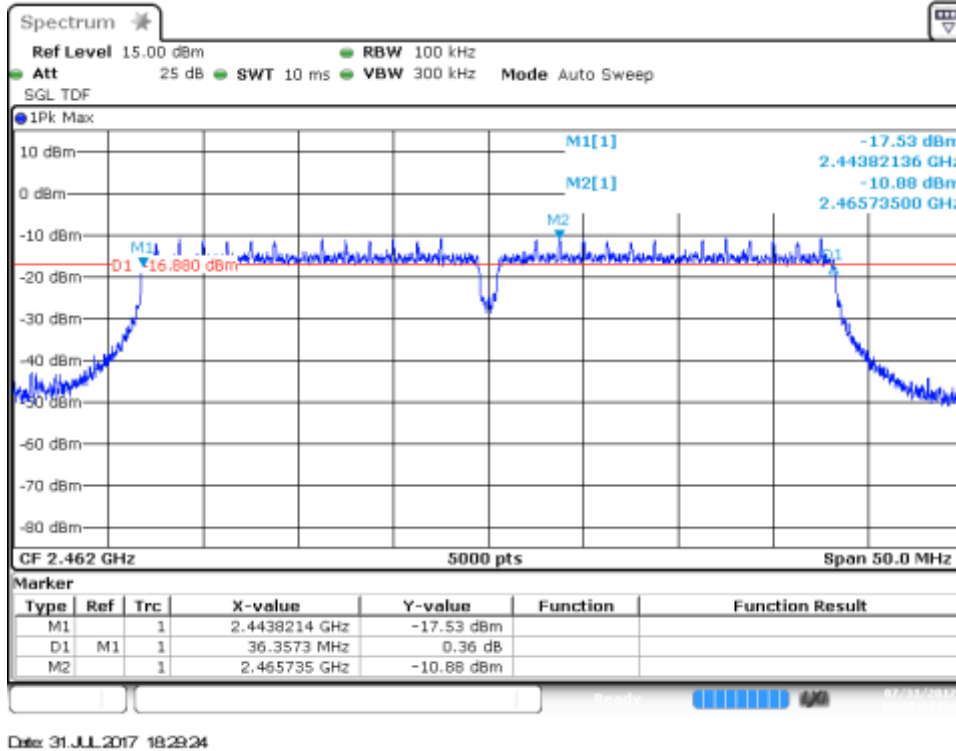



### B.3.2 99% Bandwidth

## SISO-A,802.11b,1Mbps

Channel 7



## SISO-A,802.11g,6Mbps

Channel 7

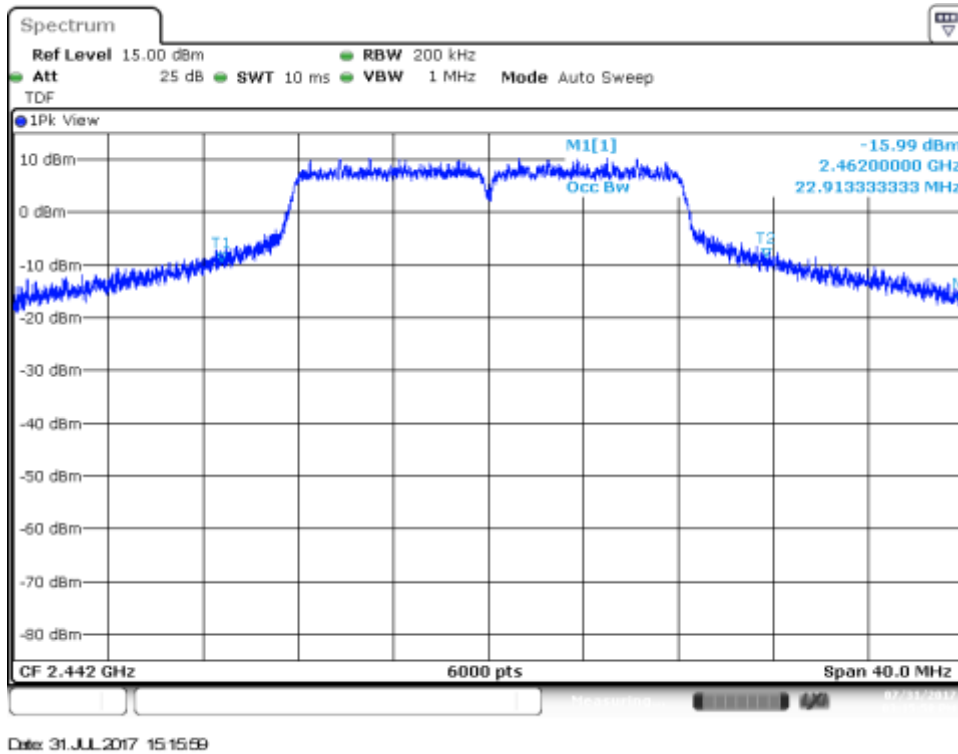

## SISO-A,802.11n20,HT0

Channel 7

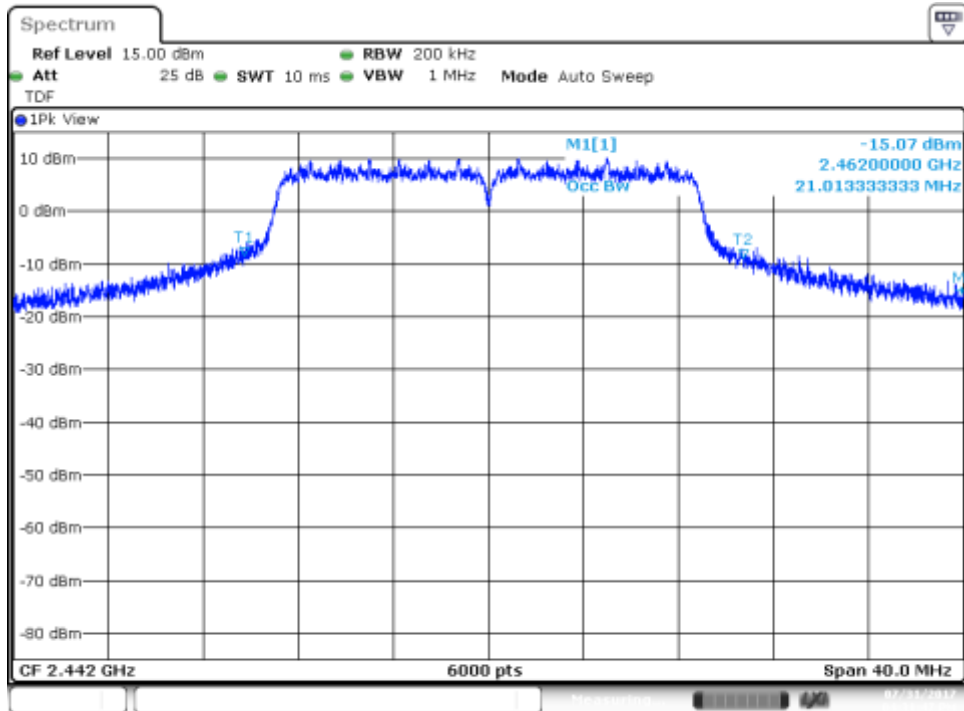

## SISO-A,802.11n40,HT0

Channel 7F

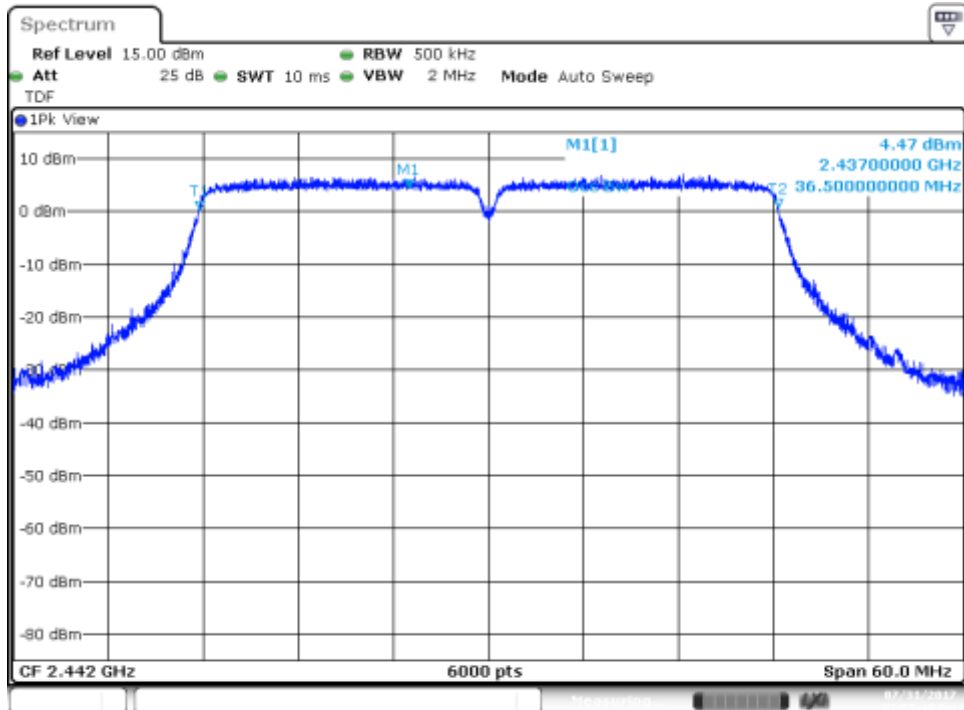

**B.3.3 Maximum output power and antenna gain****SISO-A,802.11b,1Mbps**

Channel 7

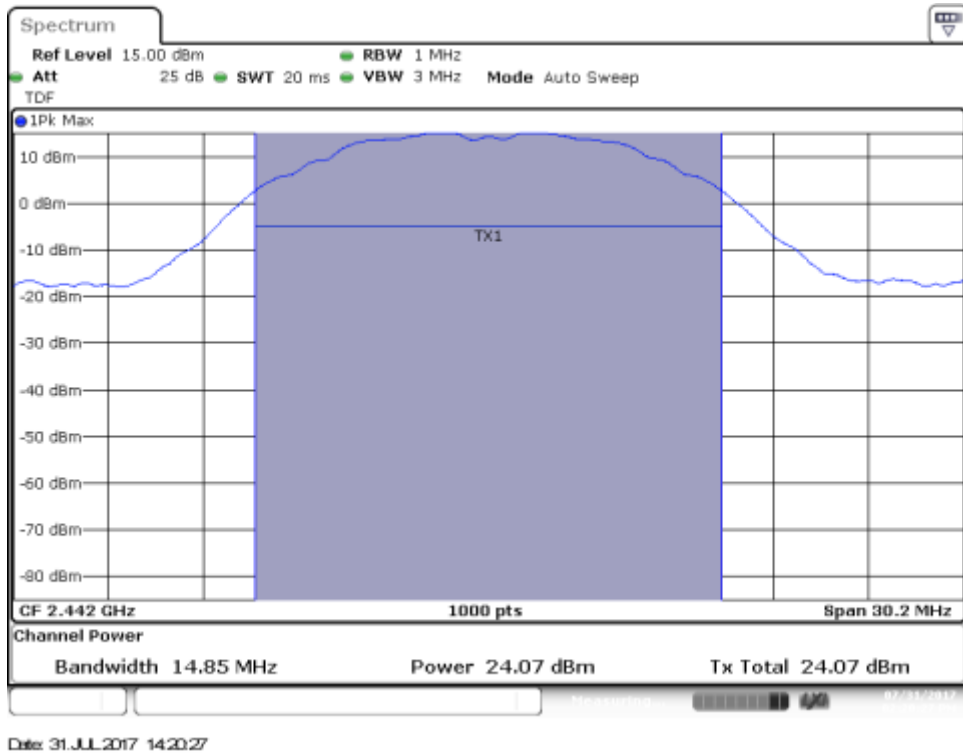

Channel 13

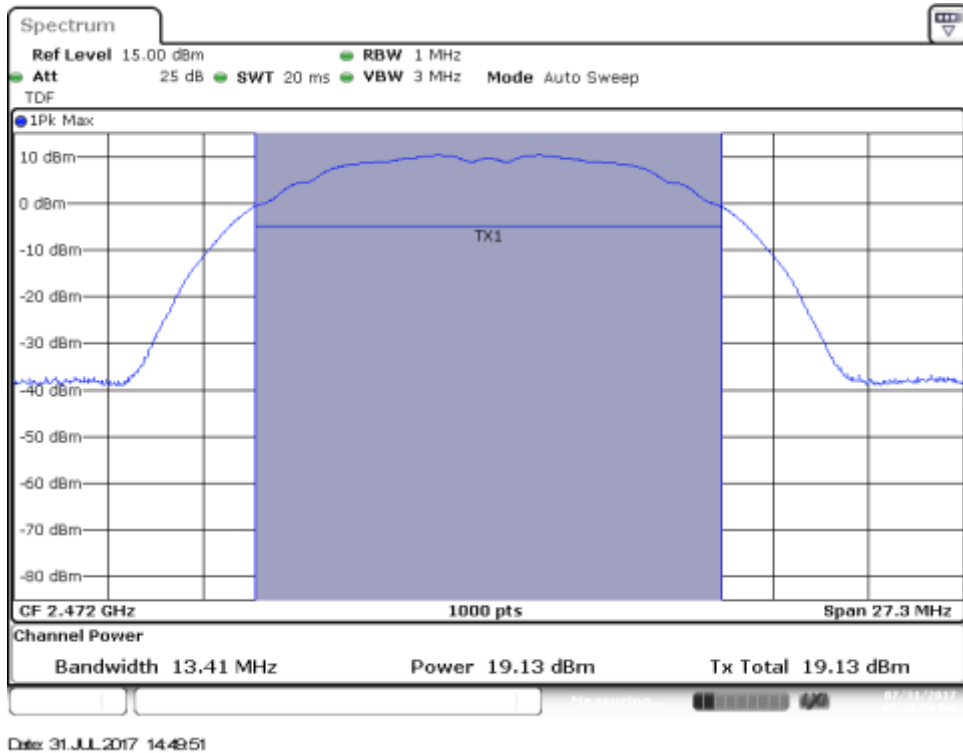

# SISO-A,802.11g,6Mbps

Channel 7

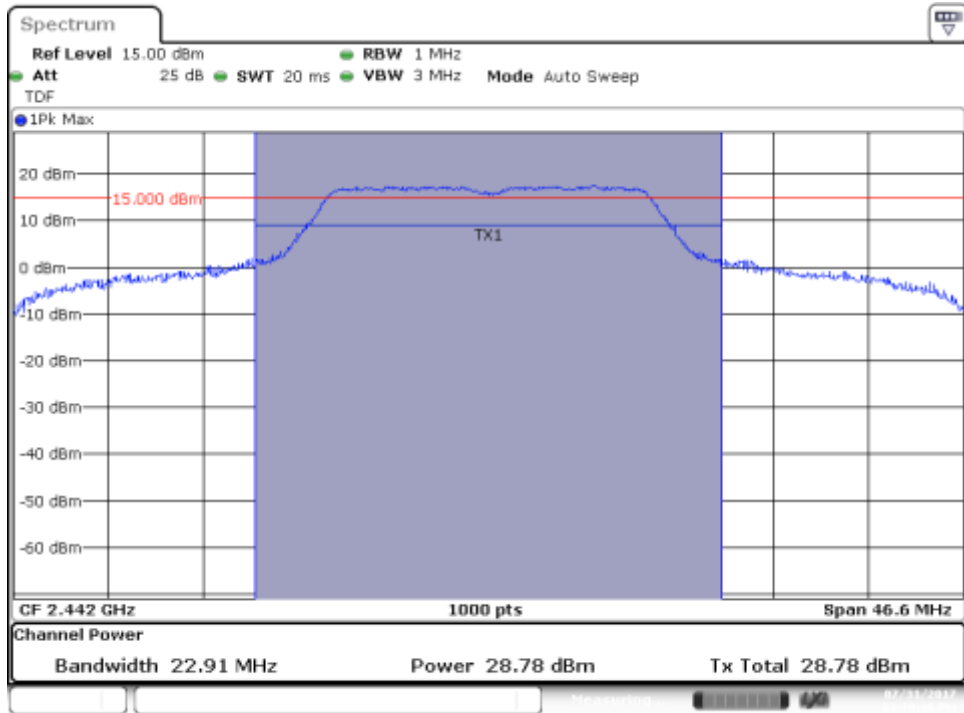

Date: 31.JUL.2017 15:20:16

Channel 13

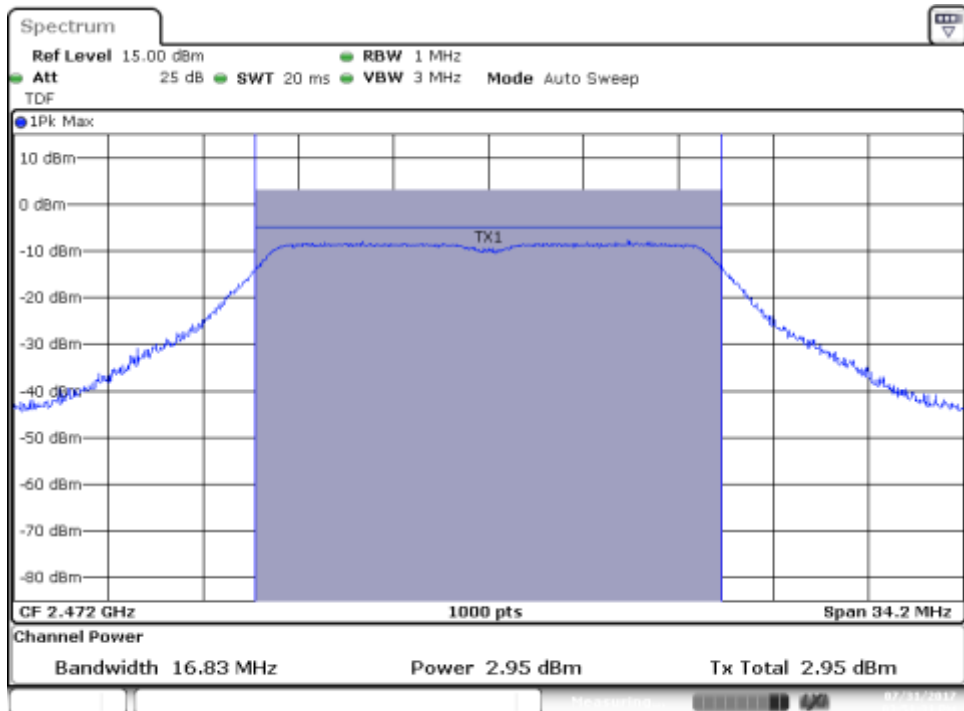

Date: 31.JUL.2017 15:51:32

# SISO-A,802.11n20,HT0

Channel 7

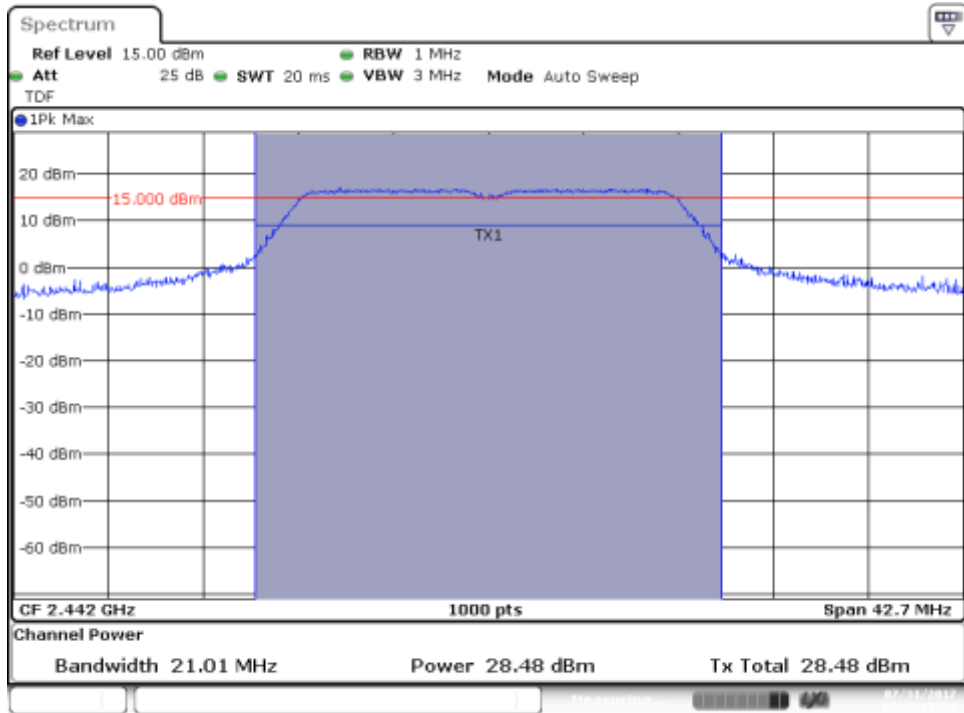

Date: 31.JUL.2017 18:41:17

Channel 13

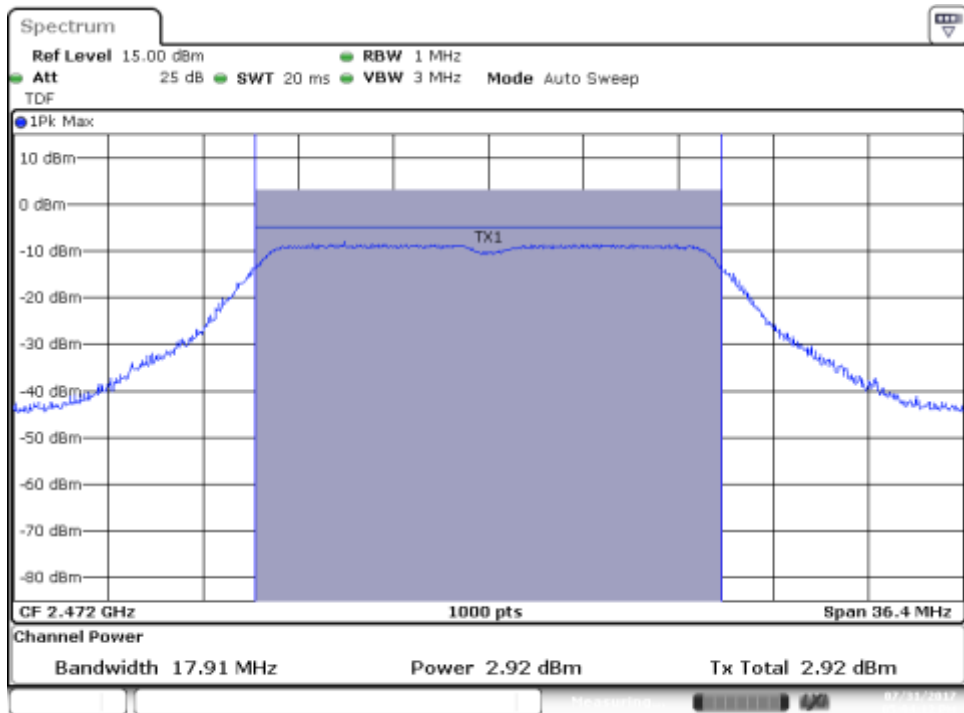

Date: 31.JUL.2017 17:04:13

# SISO-A,802.11n40,HT0

Channel 7F

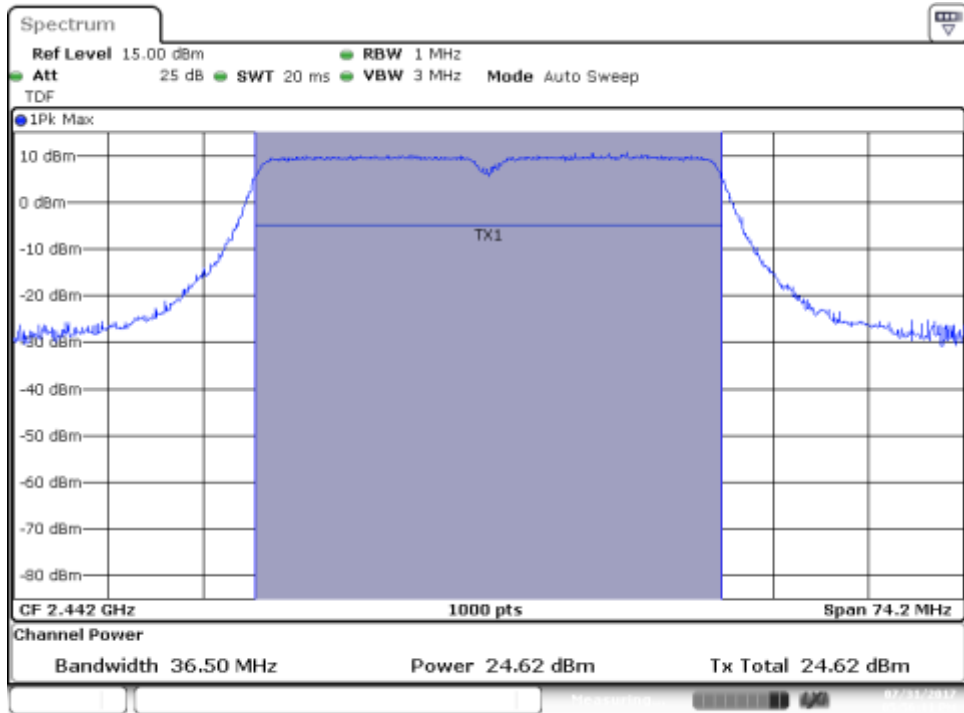

Date: 31.JUL.2017 17:58:11

Channel 11F

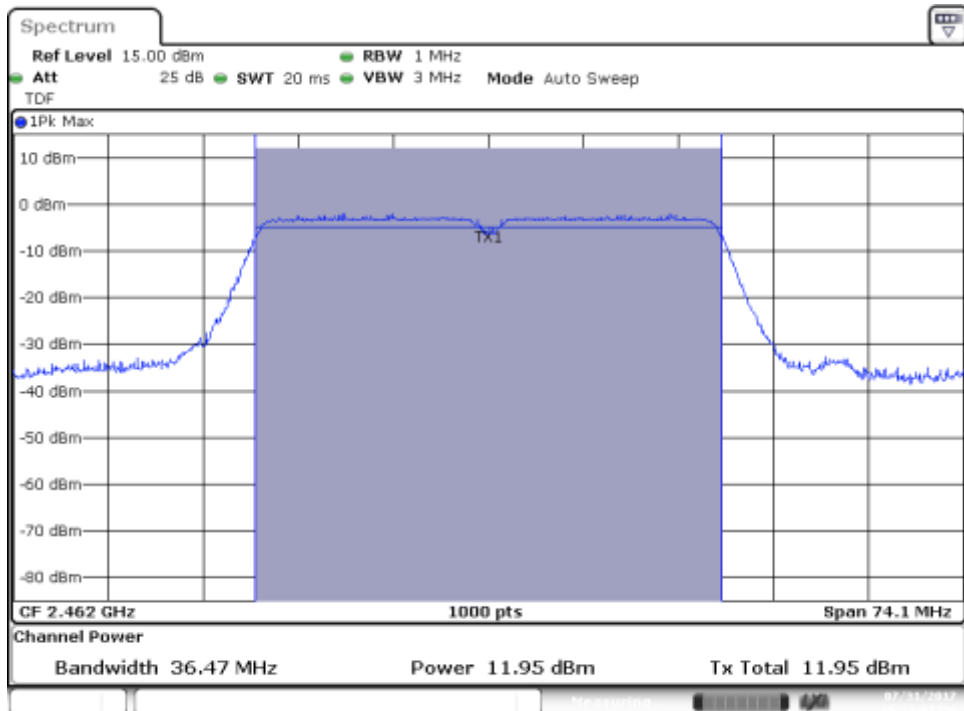

Date: 31.JUL.2017 18:29:03

### B.3.4 Power spectral density

## SISO-A,802.11b,1Mbps

Channel 7

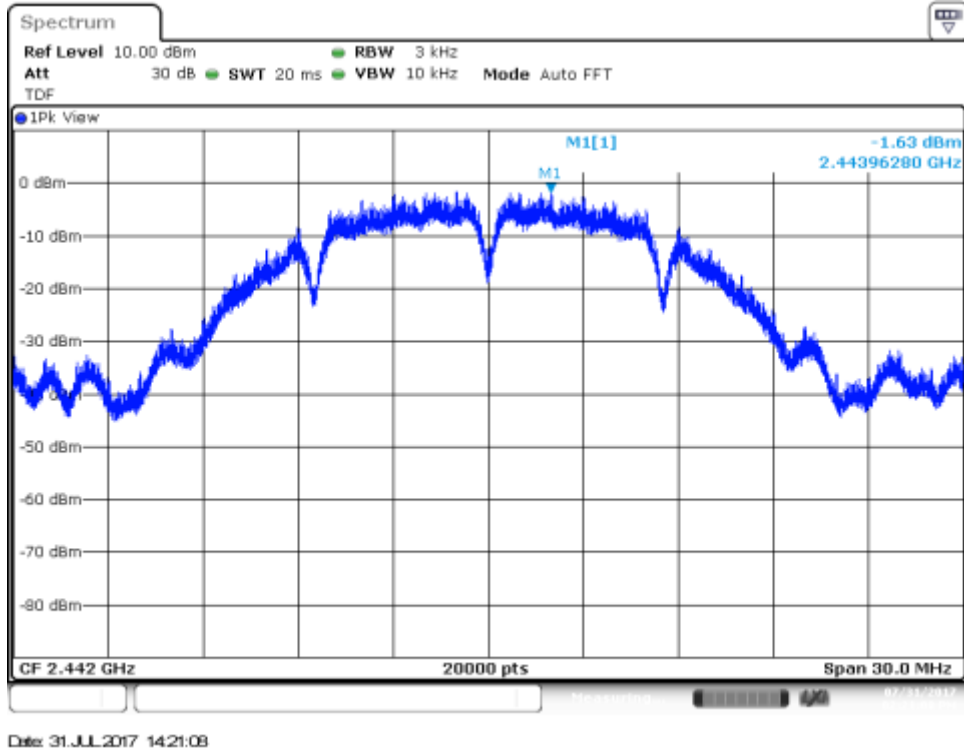

## SISO-A,802.11g,6Mbps

Channel 7

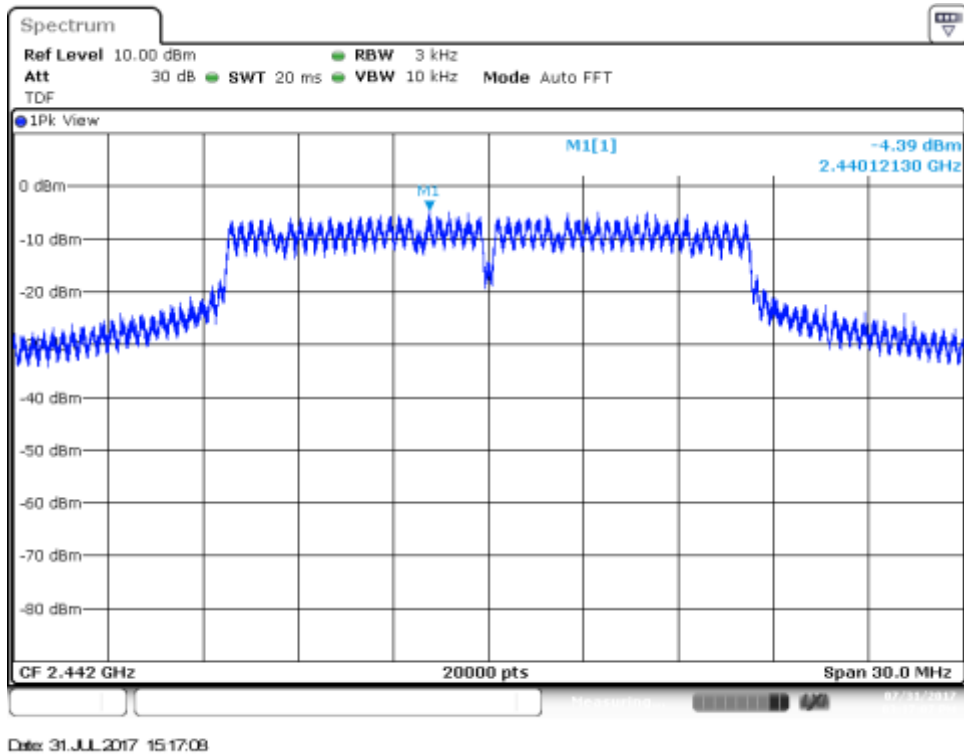

### SISO-A,802.11n20,HT0

Channel 7

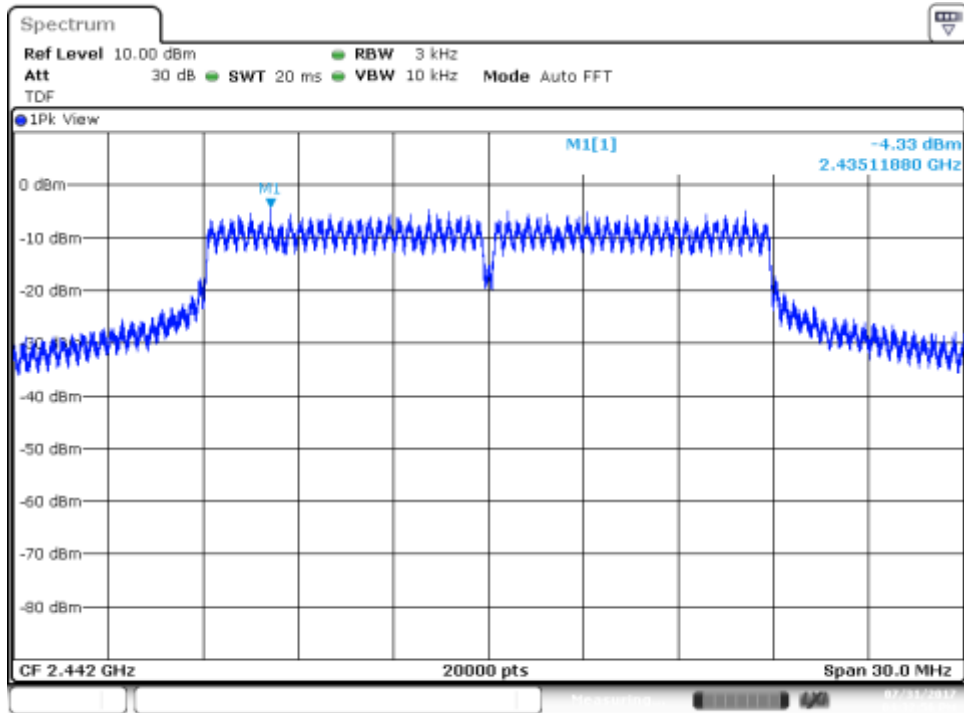

Date: 31.JUL.2017 18:32:58

### SISO-A,802.11n40,HT0

Channel 7F

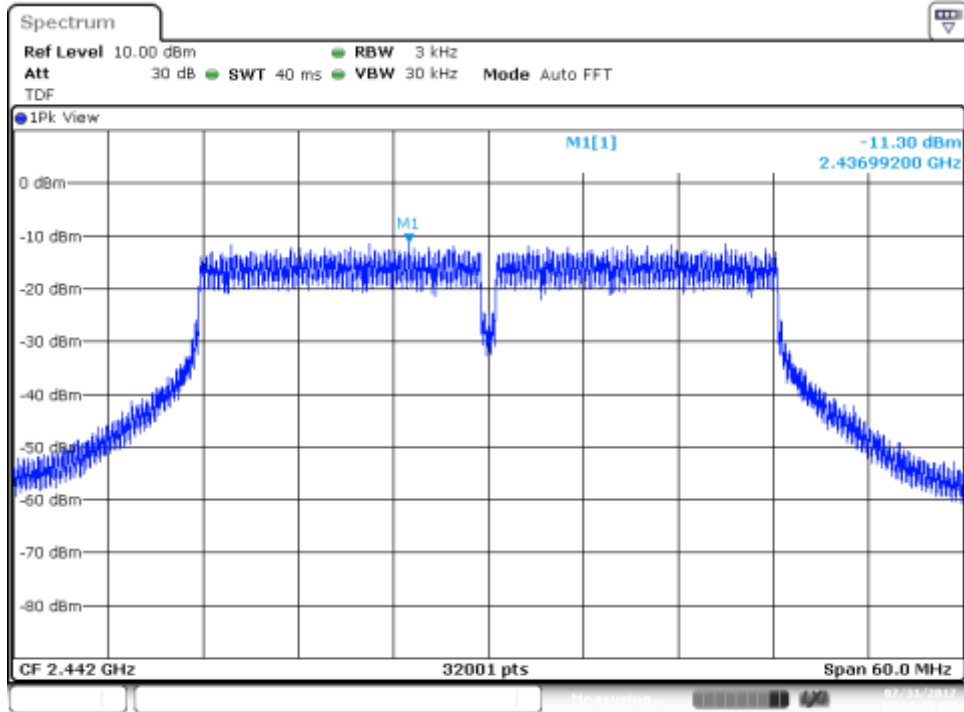

Date: 31.JUL.2017 17:58:50



**B.3.5 Out of band emissions - band-edge low (conducted)**

**SISO-A, 802.11b, 1Mbps**

Channel 1

BE Low Freq Section

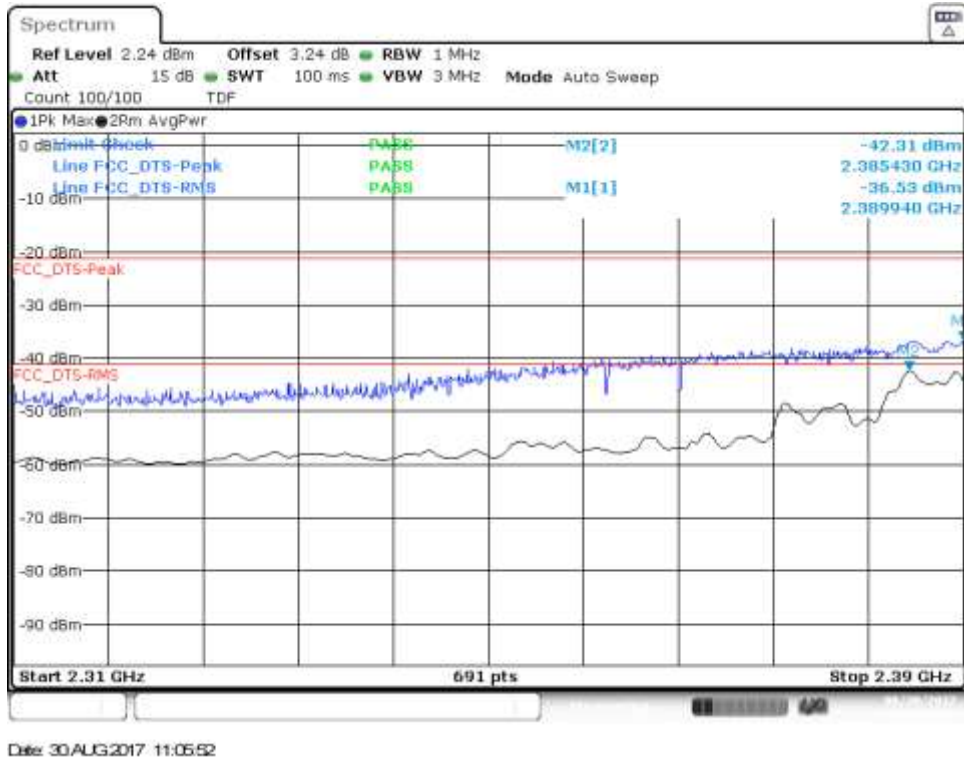

BE Low (Non Restricted)

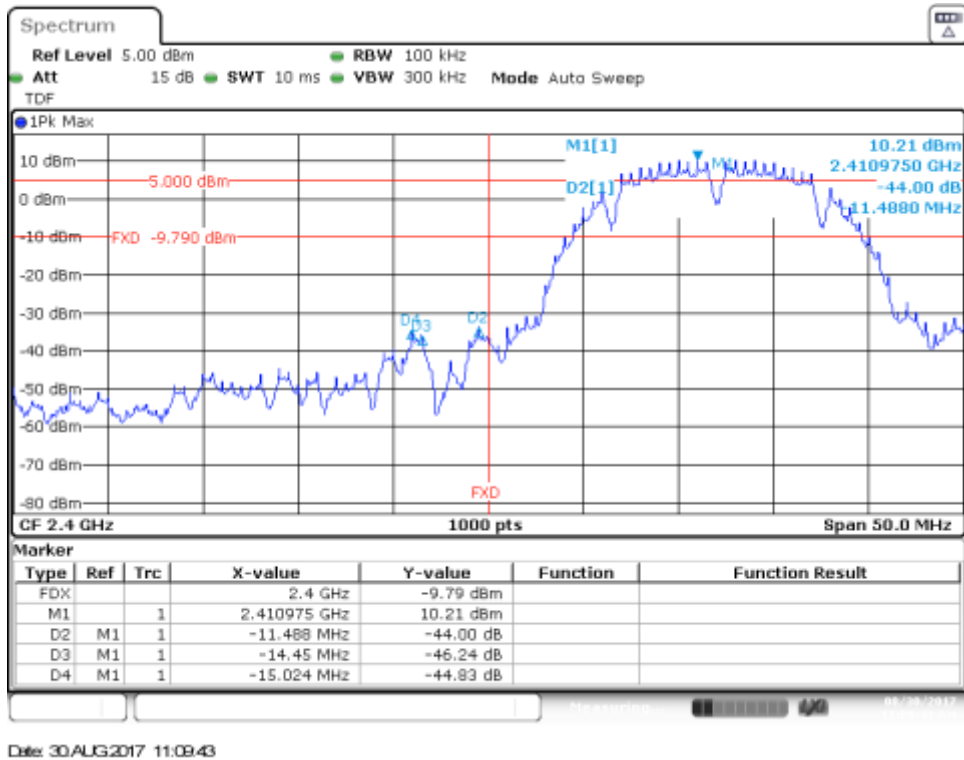

# SISO-A, 802.11g, 6Mbps

Channel 1

BE Low Freq Section

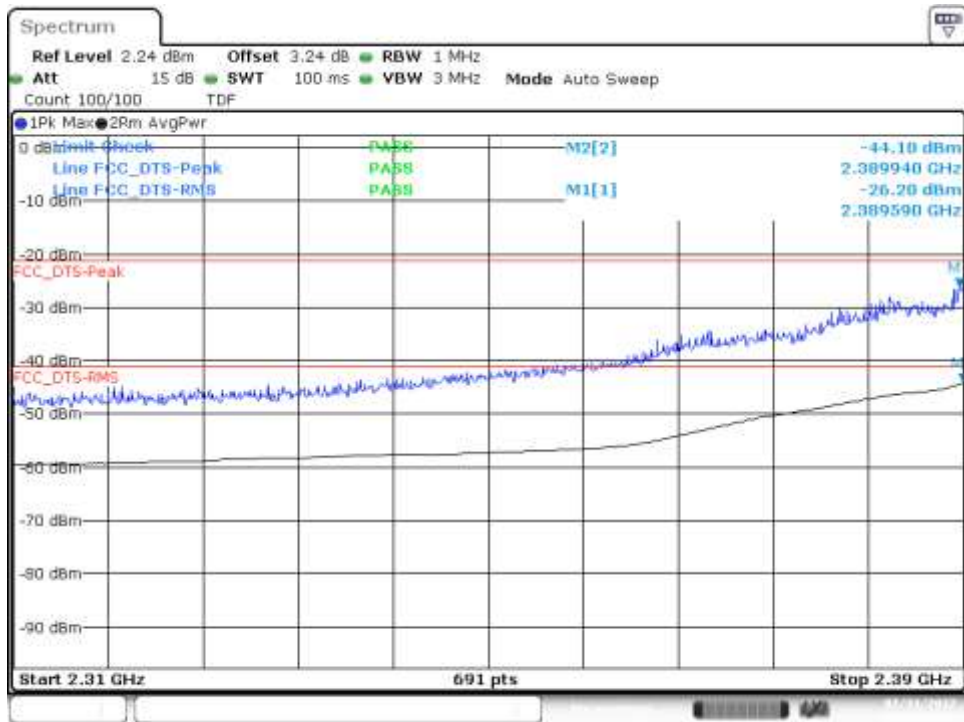

Date: 31.JUL.2017 15:01:08

BE Low (Non Restricted)

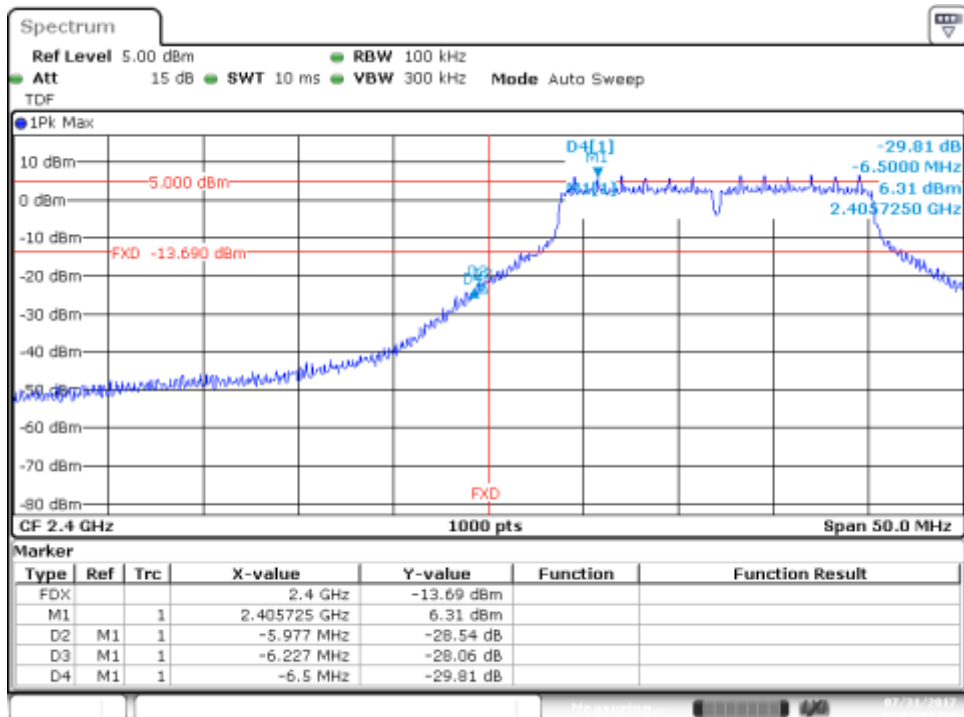

Date: 31.JUL.2017 15:03:00

# SISO-A, 802.11n20, HT0

Channel 1

BE Low Freq Section

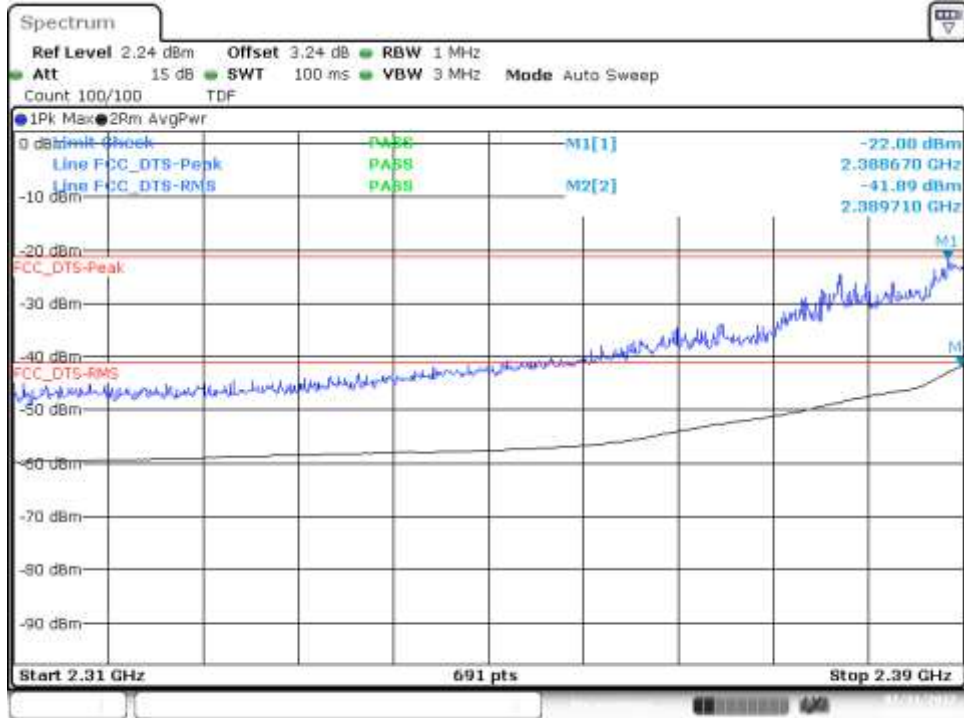

Date: 31.JUL.2017 15:59:20

BE Low (Non Restricted)

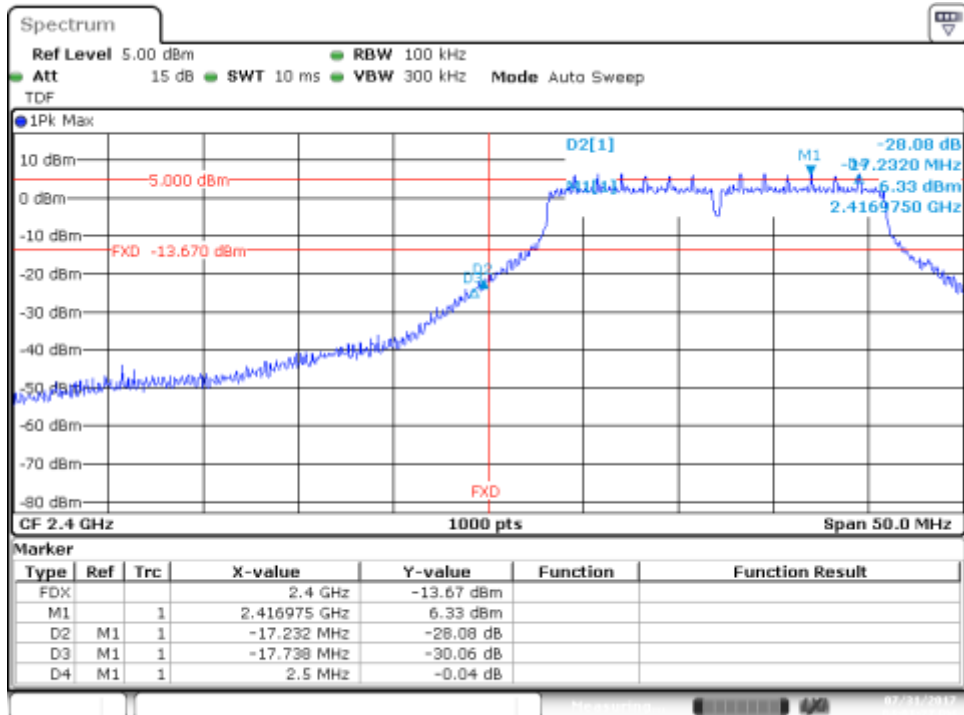

Date: 31.JUL.2017 16:01:27

# SISO-A, 802.11n40, HT0

Channel 3F

BE Low Freq Section

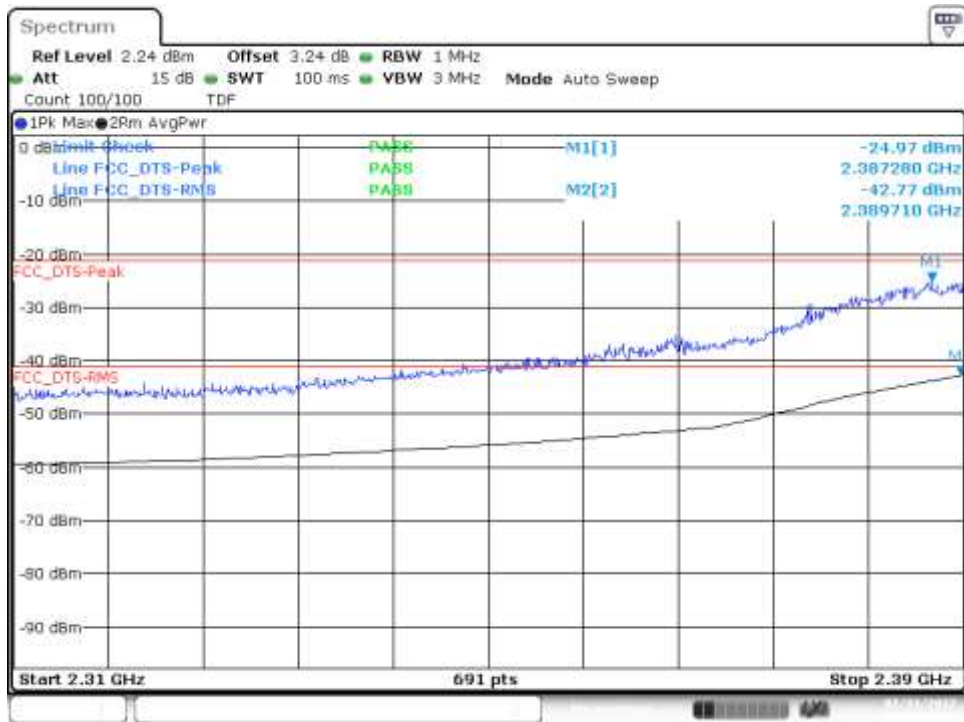

Date: 31.JUL.2017 17:3208

BE Low (Non Restricted)

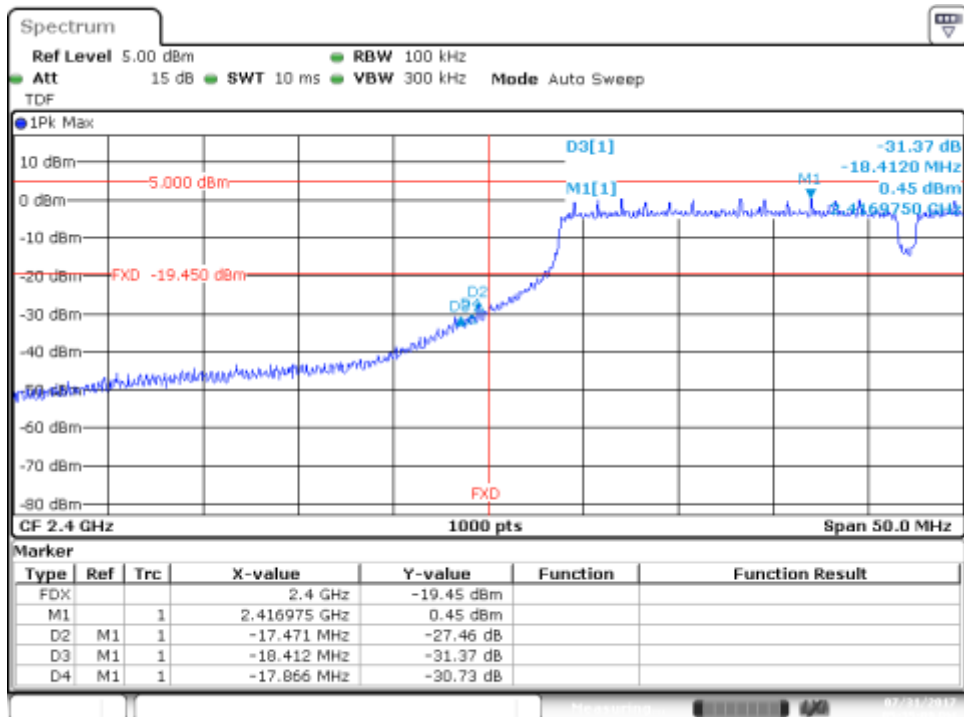

Date: 31.JUL.2017 17:3610

### B.3.6 Out of band emissions - band-edge high (conducted)

## SISO-A, 802.11b, 1Mbps

Channel 11 - BE High Freq Section (restricted)



Channel 12 - BE High Freq Section (restricted)



Test Report N° 170727-01.TR04

Channel 13 - BE High Freq Section (restricted)

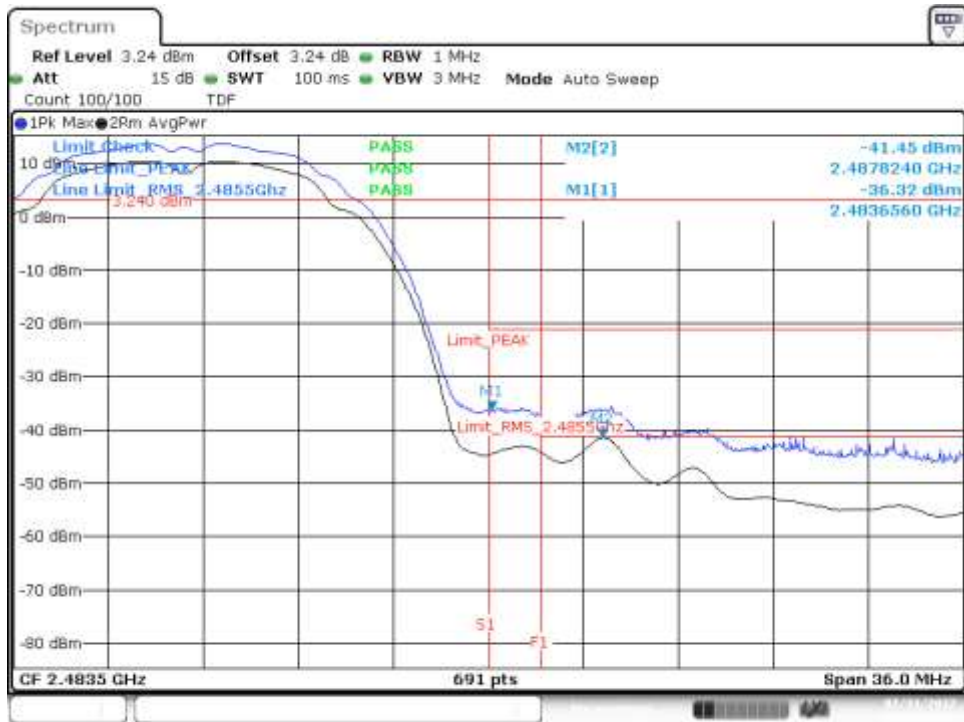

Date: 31.JUL.2017 14:48:30

Channel 11 - BE High Freq Section RMS within 2MHz (restricted)

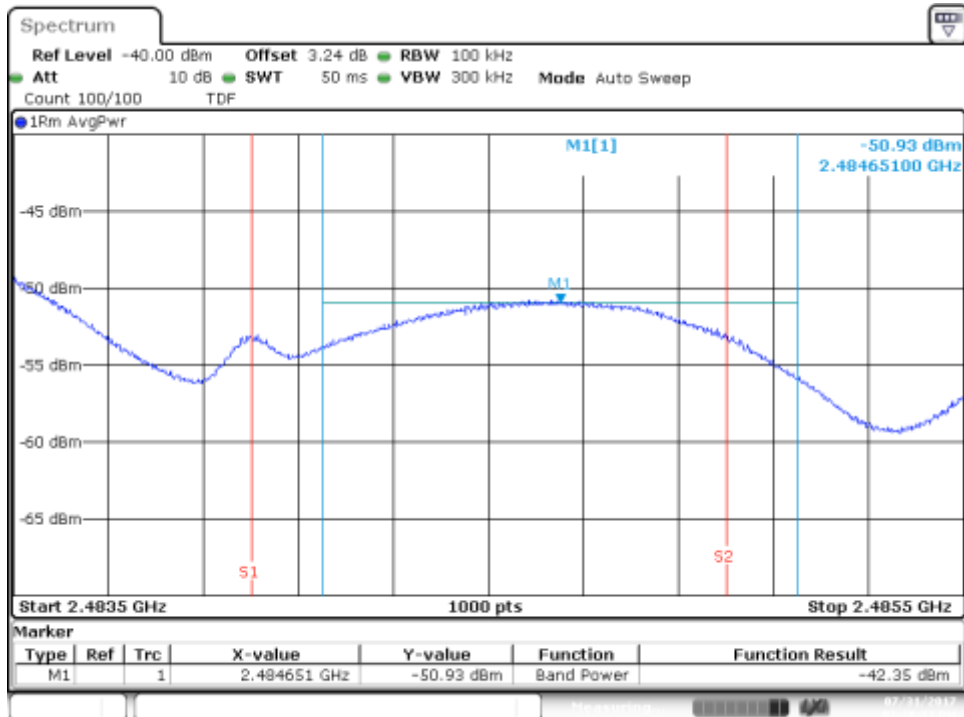

Date: 31.JUL.2017 14:28:32

Test Report N° 170727-01.TR04

Channel 12 - BE High Freq Section RMS within 2MHz (restricted)

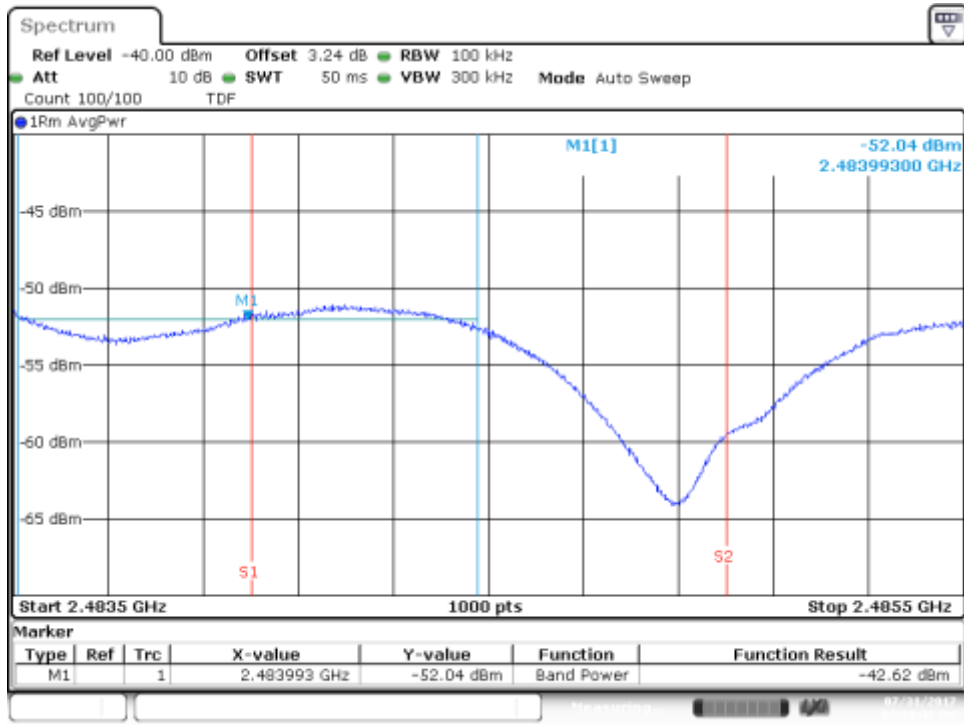

Date: 31.JUL.2017 14:38:43

Channel 13 - BE High Freq Section RMS within 2MHz (restricted)

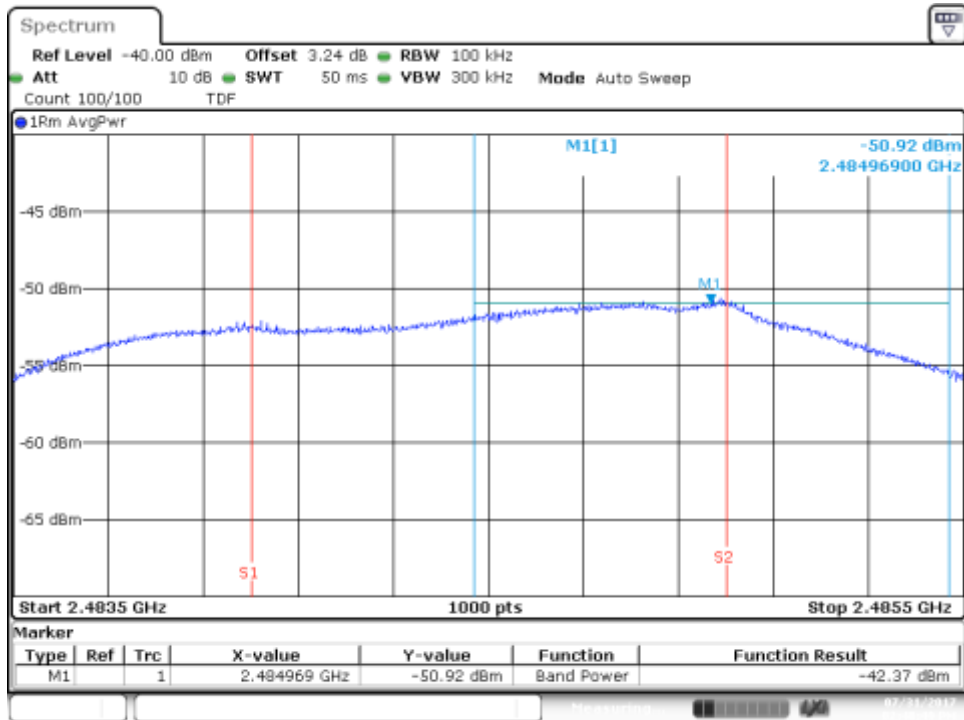

Date: 31.JUL.2017 14:48:50

# SISO-A, 802.11g, 6Mbps

Channel 11 - BE High Freq Section (restricted)

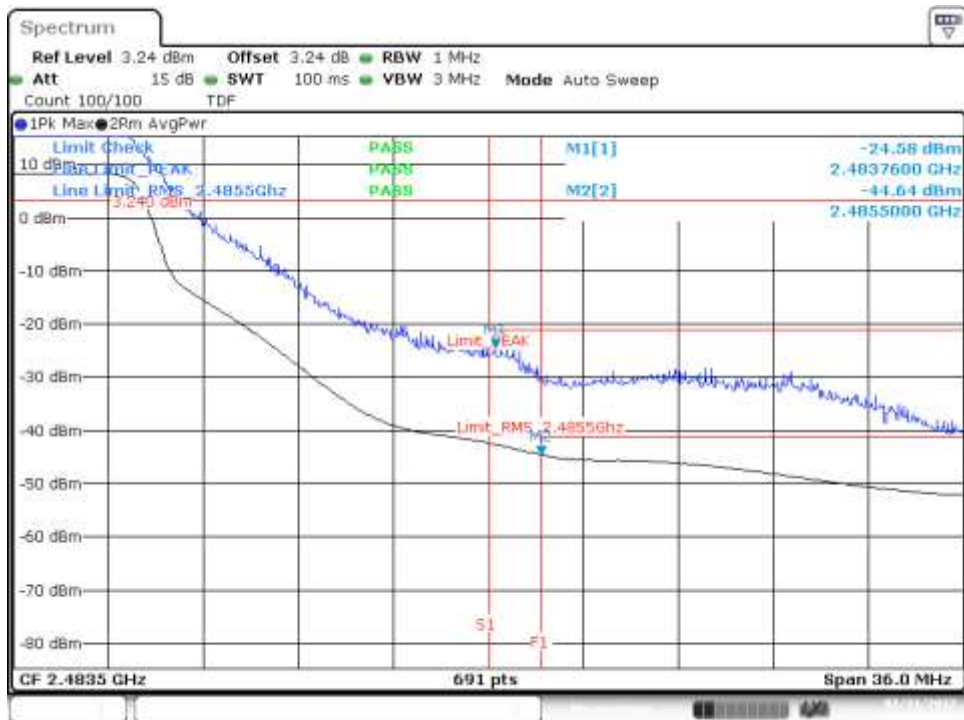

Date: 31.JUL.2017 15:26:52

Channel 12 - BE High Freq Section (restricted)

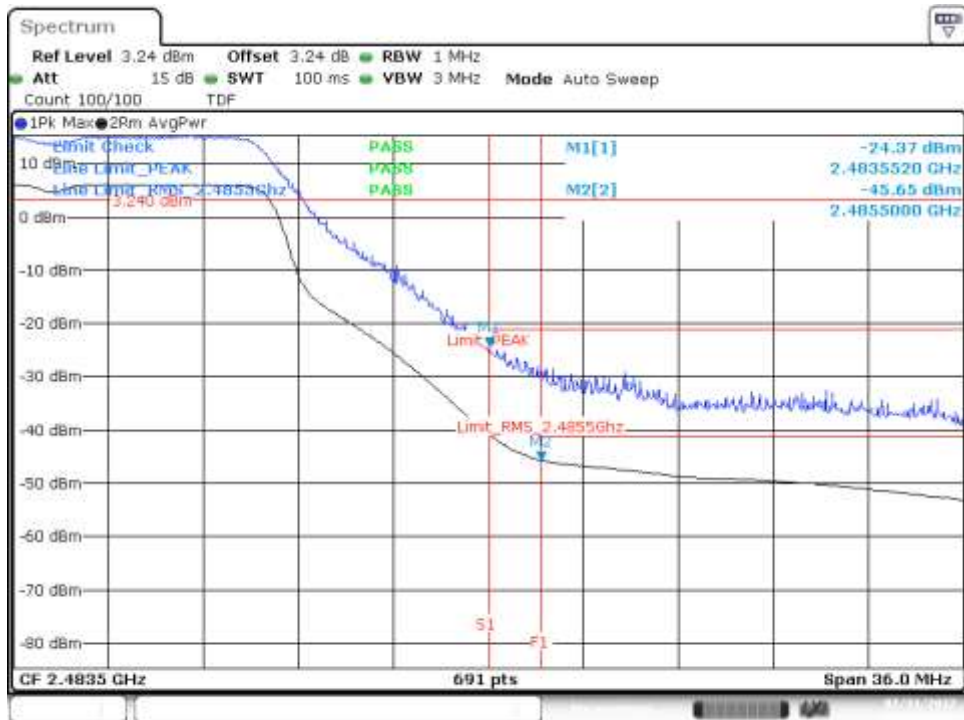

Date: 31.JUL.2017 15:38:58



Test Report N° 170727-01.TR04

Channel 13 - BE High Freq Section (restricted)

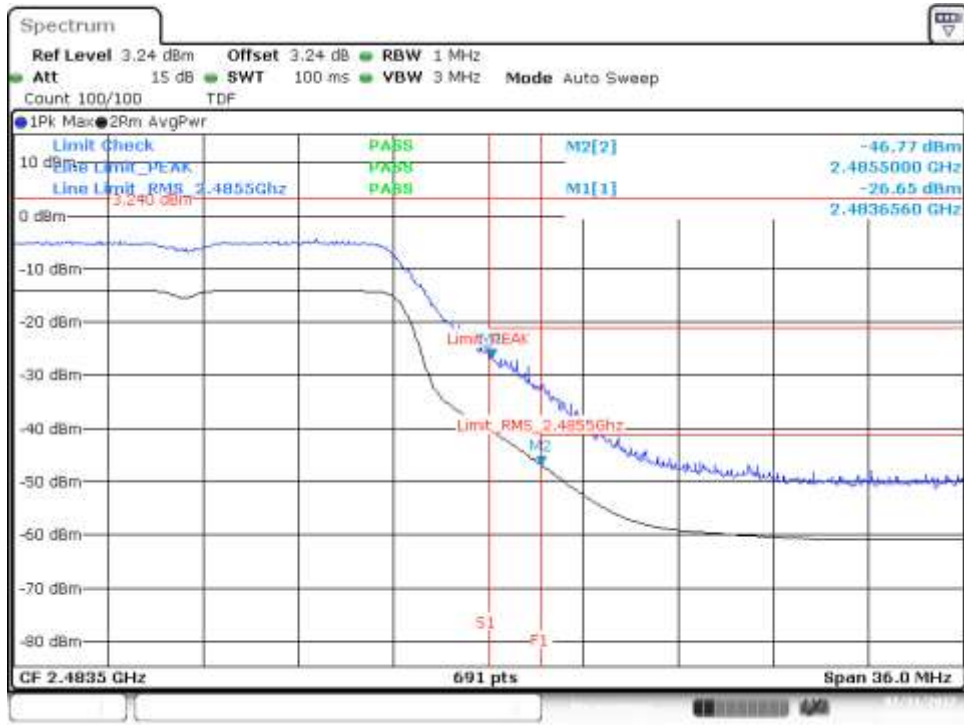

Date: 31.JUL.2017 15:48:39

Channel 11 - BE High Freq Section RMS within 2MHz (restricted)

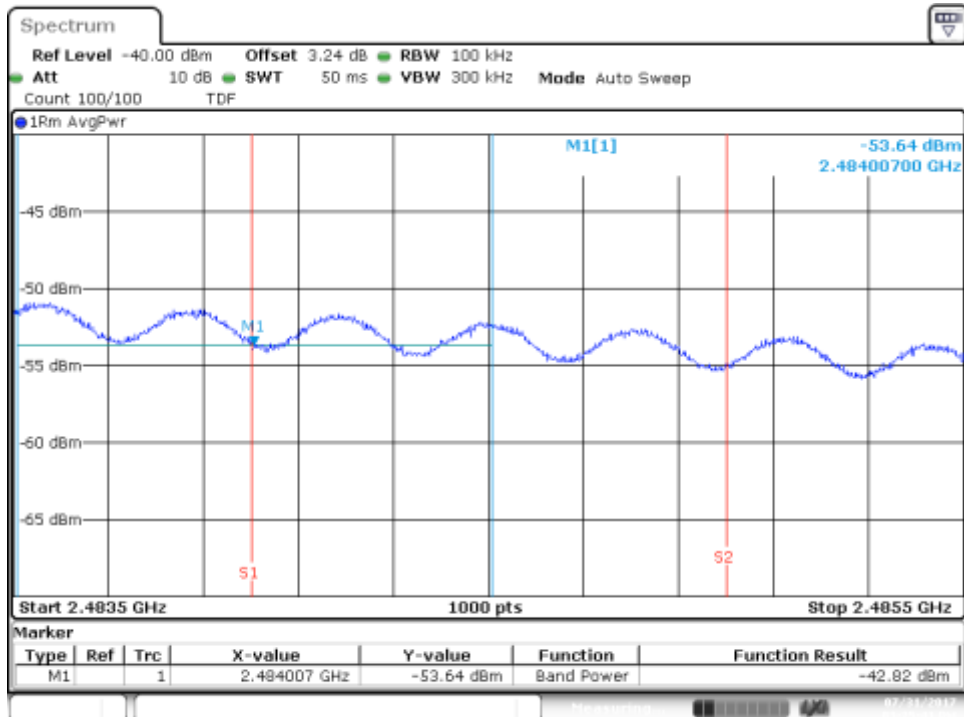

Date: 31.JUL.2017 15:25:41

Test Report N° 170727-01.TR04

Channel 12 - BE High Freq Section RMS within 2MHz (restricted)

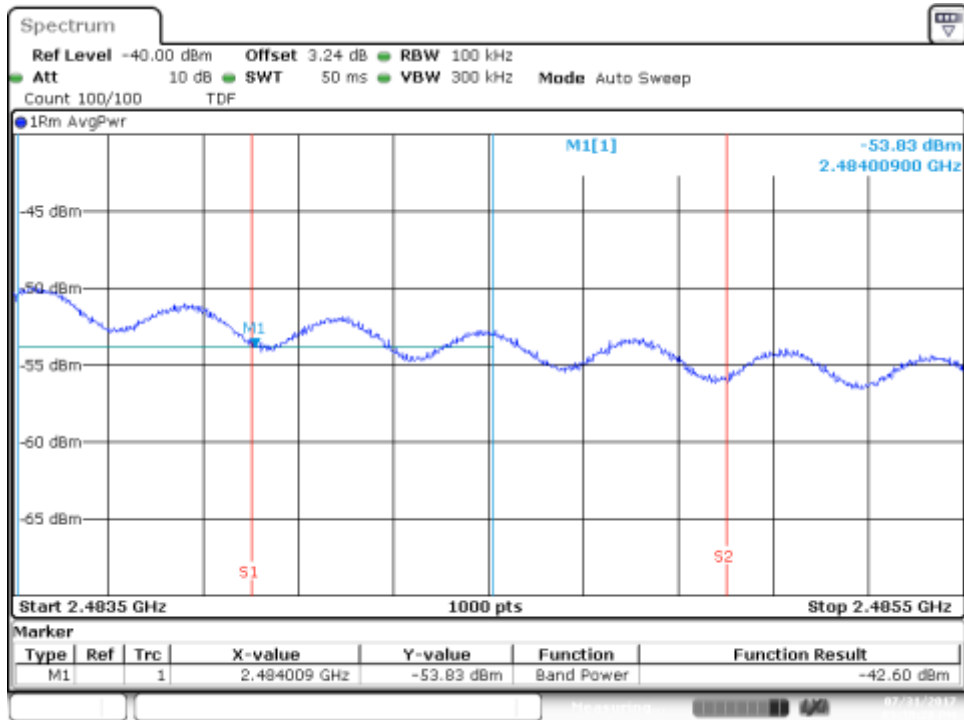

Date: 31.JUL.2017 15:38:21

Channel 13 - BE High Freq Section RMS within 2MHz (restricted)

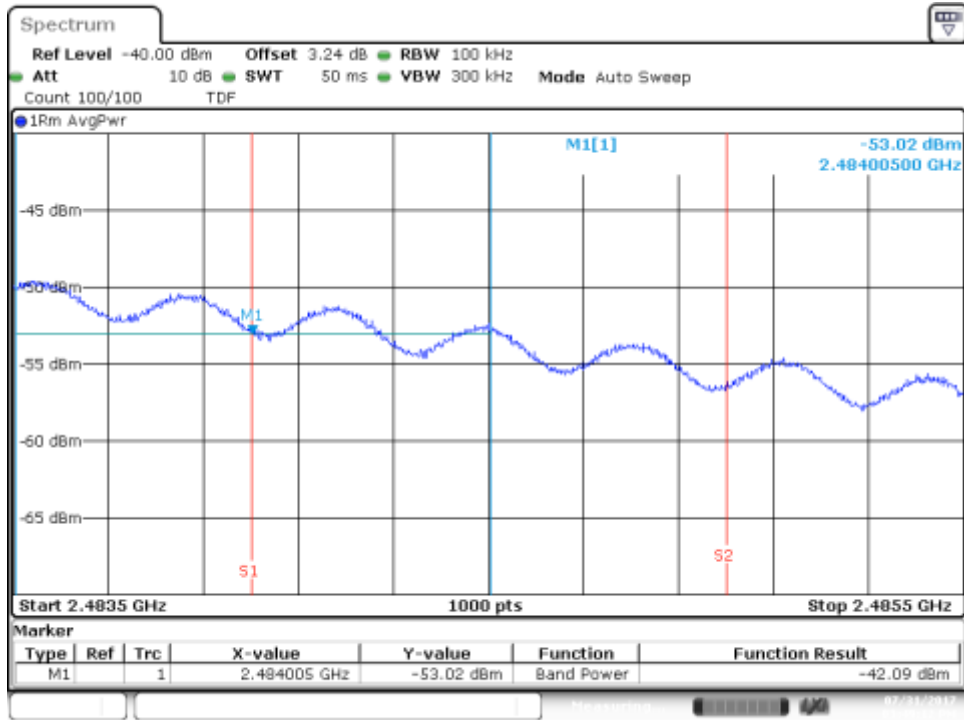

Date: 31.JUL.2017 15:48:12

# SISO-A, 802.11n20, HT0

Channel 11 - BE High Freq Section (restricted)

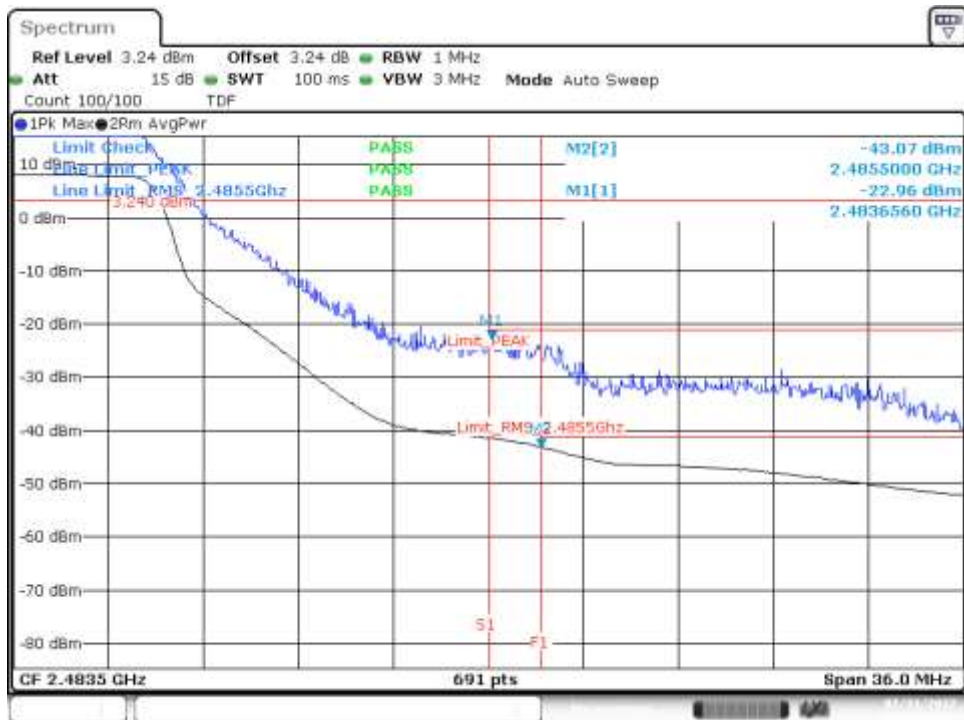

Channel 12 - BE High Freq Section (restricted)

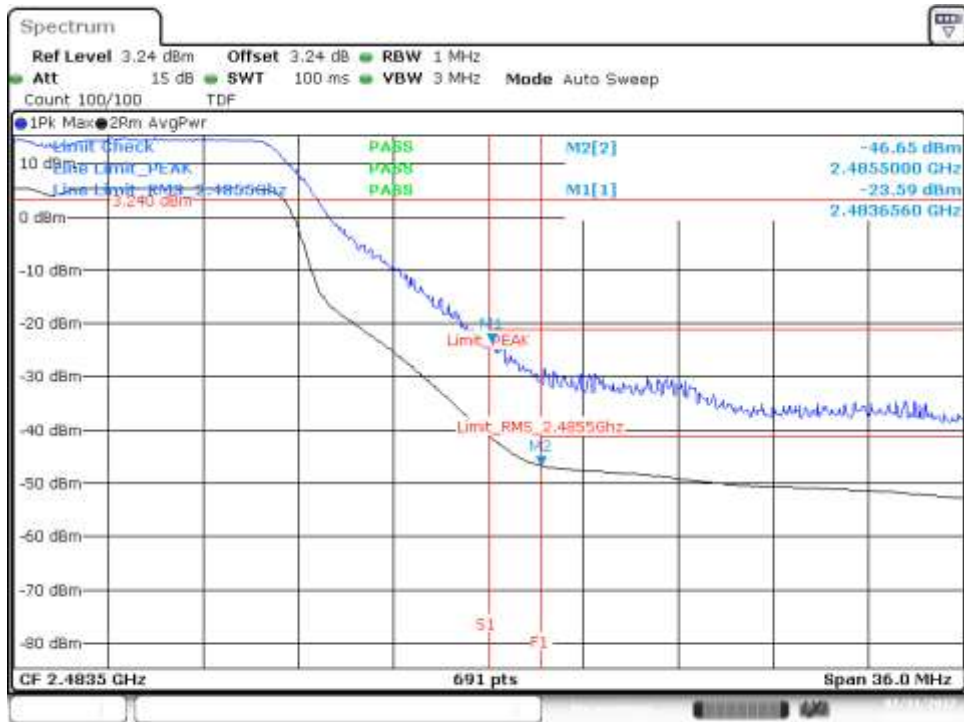

Test Report N° 170727-01.TR04

Channel 13 - BE High Freq Section (restricted)

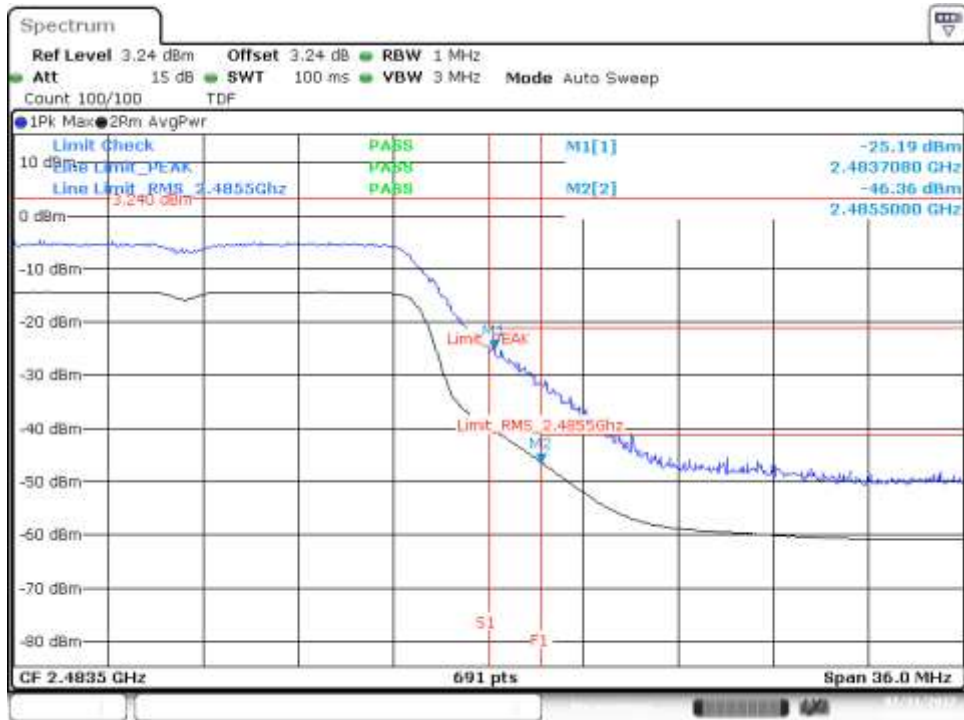

Date: 31.JUL.2017 17:03:08

Channel 11 - BE High Freq Section RMS within 2MHz (restricted)

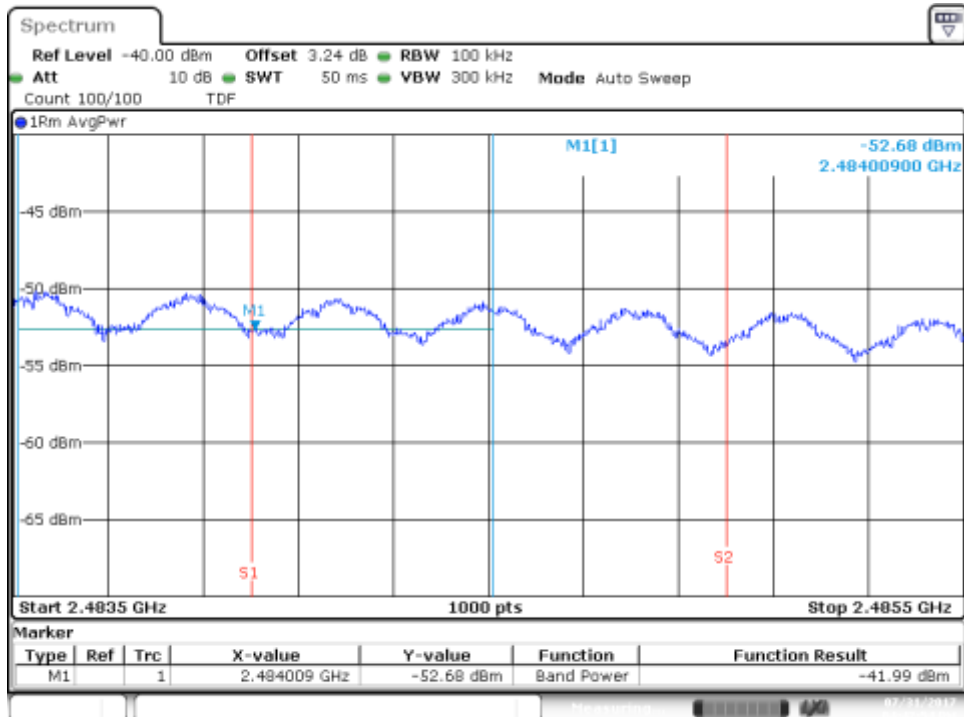

Date: 31.JUL.2017 18:42:54

Test Report N° 170727-01.TR04

Channel 12 - BE High Freq Section RMS within 2MHz (restricted)

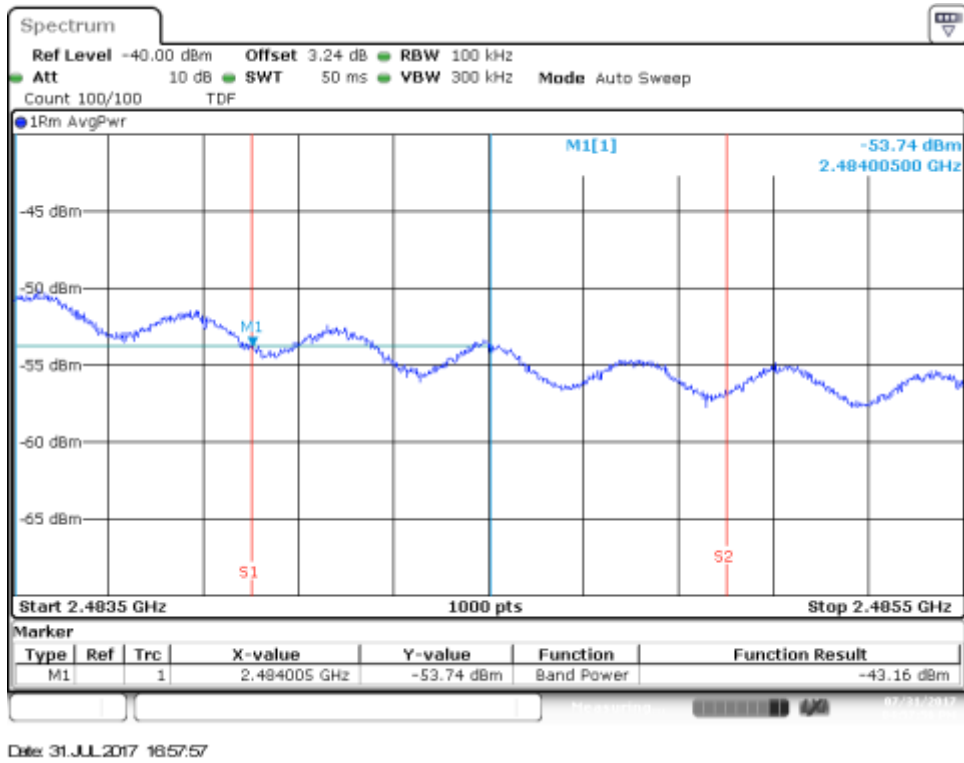

Channel 13 - BE High Freq Section RMS within 2MHz (restricted)

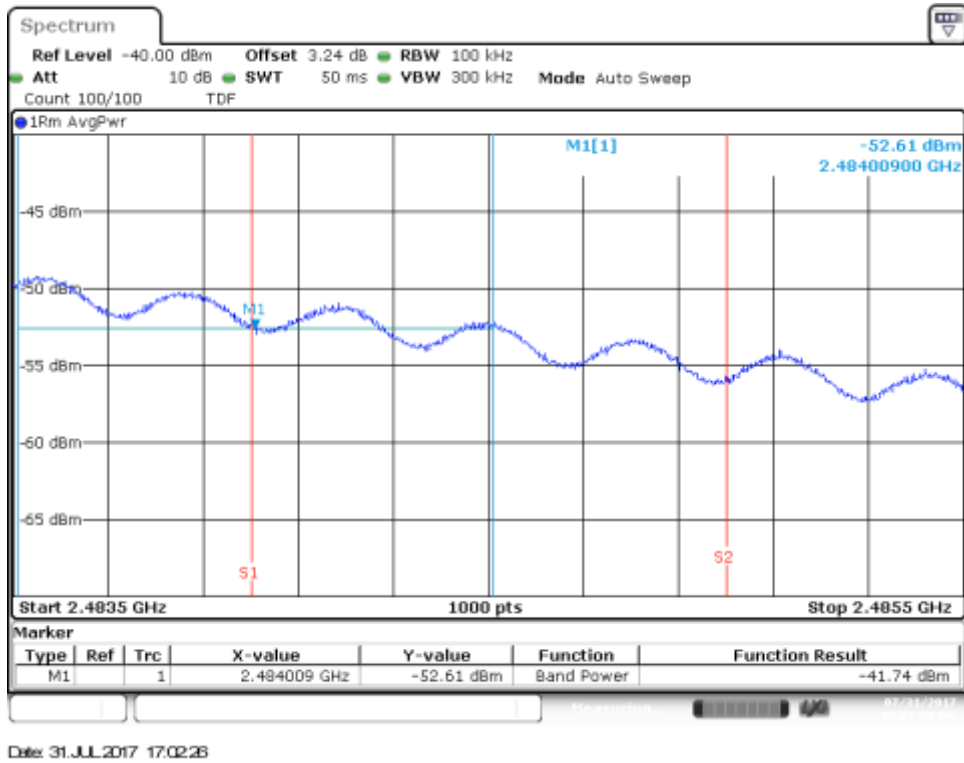

# SISO-A, 802.11n40, HT0

Channel 9F - BE High Freq Section (restricted)

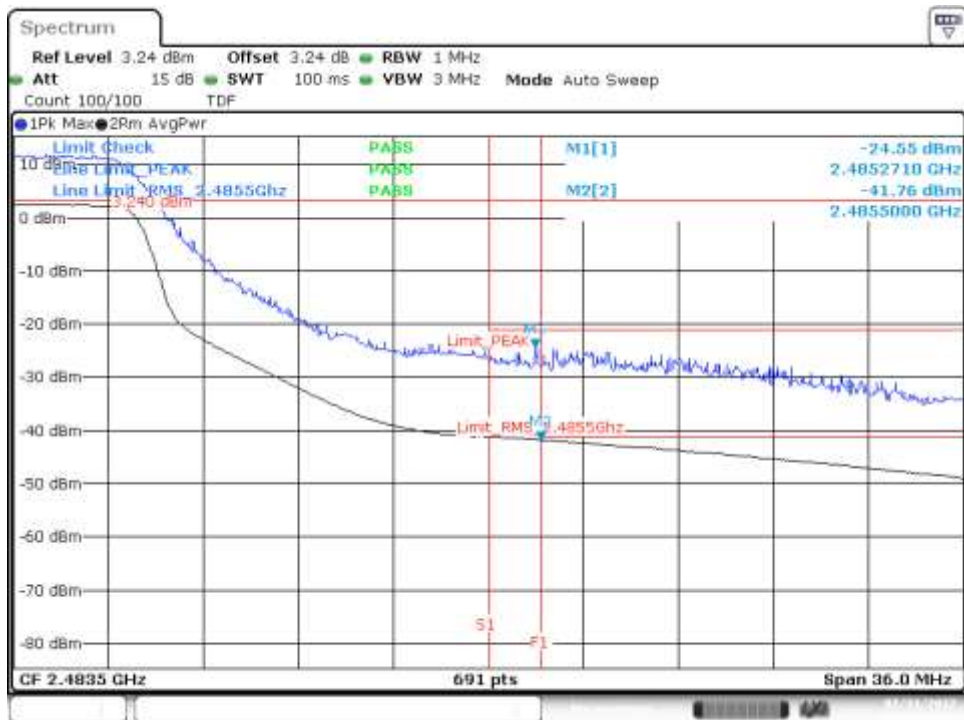

Date: 31.JUL.2017 18:02:52

Channel 11F - BE High Freq Section (restricted)

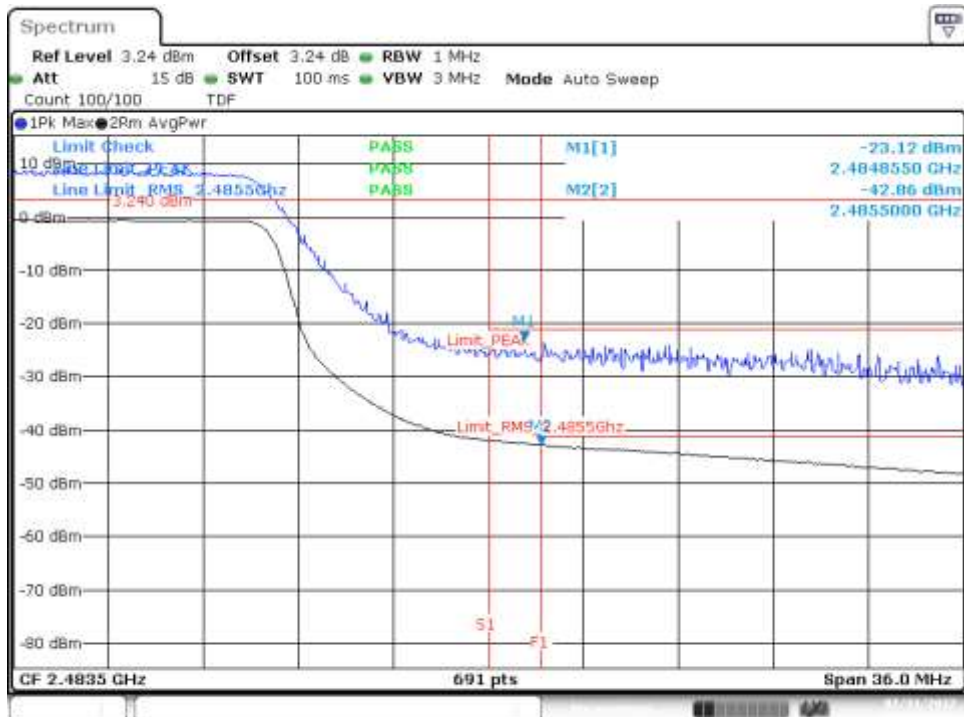

Date: 31.JUL.2017 18:14:22

Test Report N° 170727-01.TR04

Channel 11F - BE High Freq Section (restricted)



Date: 31.JUL.2017 18:25:19

Channel 9F - BE High Freq Section RMS within 2MHz (restricted)

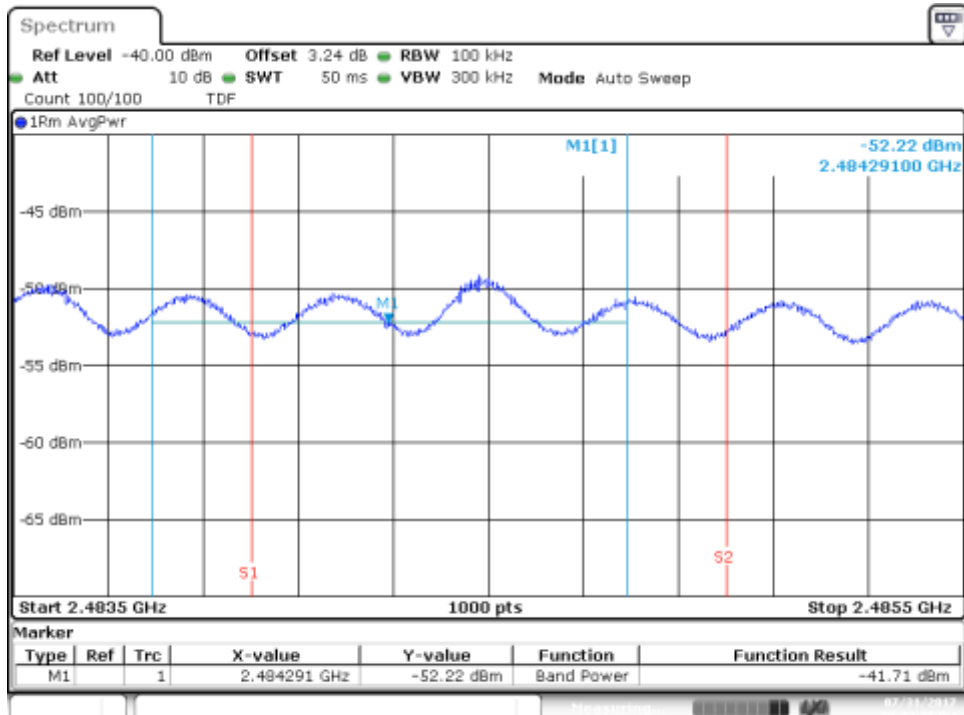

Date: 31.JUL.2017 18:02:25

Test Report N° 170727-01.TR04

Channel 10F - BE High Freq Section RMS within 2MHz (restricted)

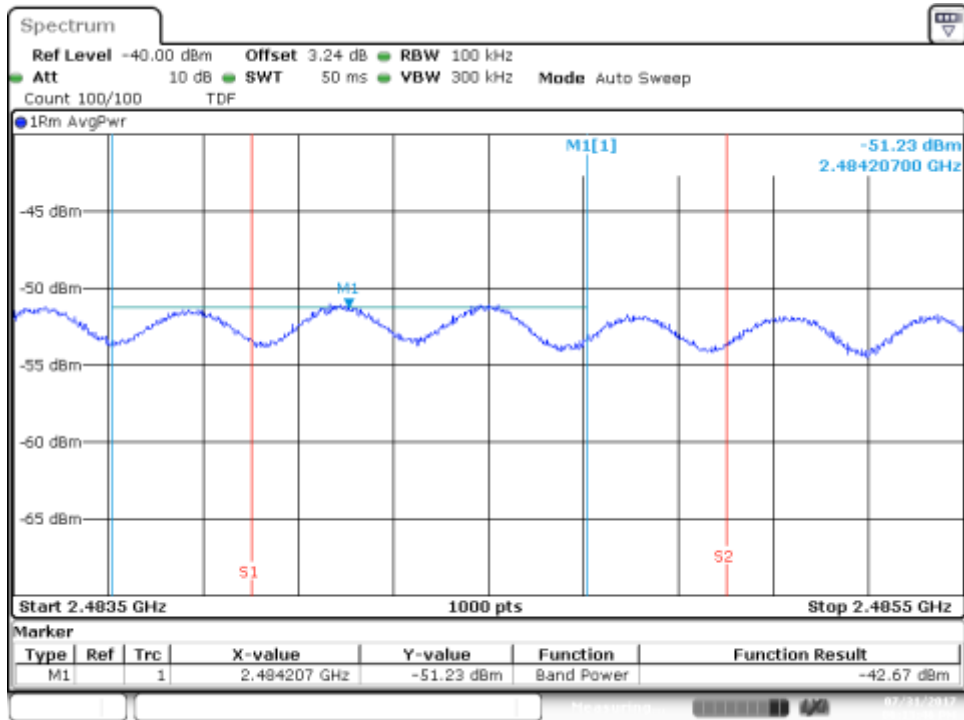

Date: 31.JUL.2017 18:13:47

Channel 11F - BE High Freq Section RMS within 2MHz (restricted)

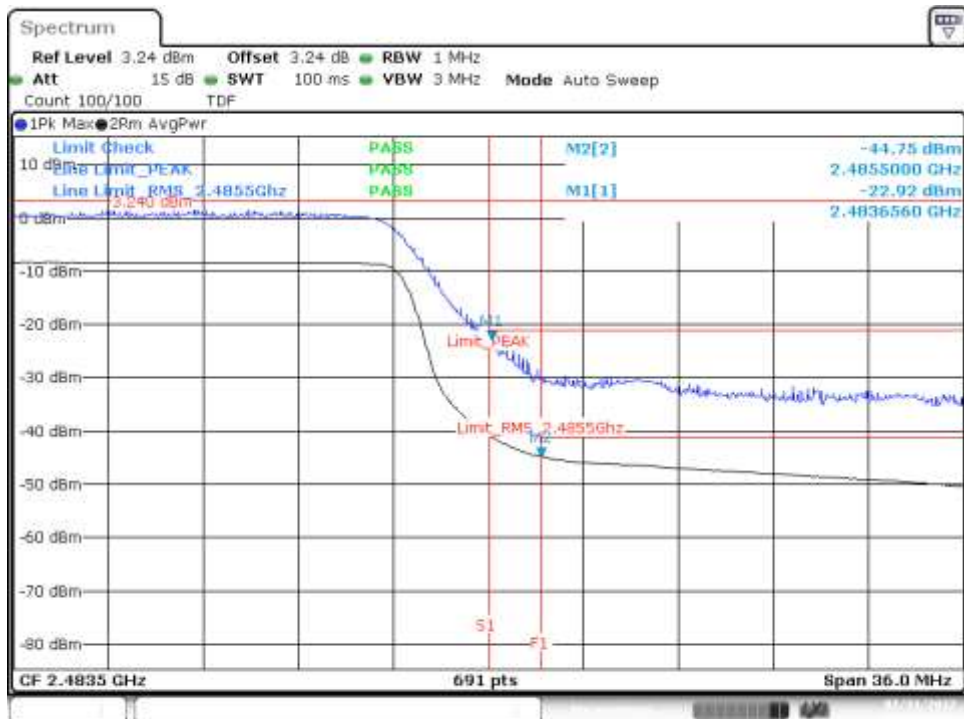

Date: 31.JUL.2017 18:25:19



**B.3.7 Out of band emissions - spurious**

**SISO-A,802.11b,1Mbps**

Channel 7 - Spurious 1 Delta Marker Measurement

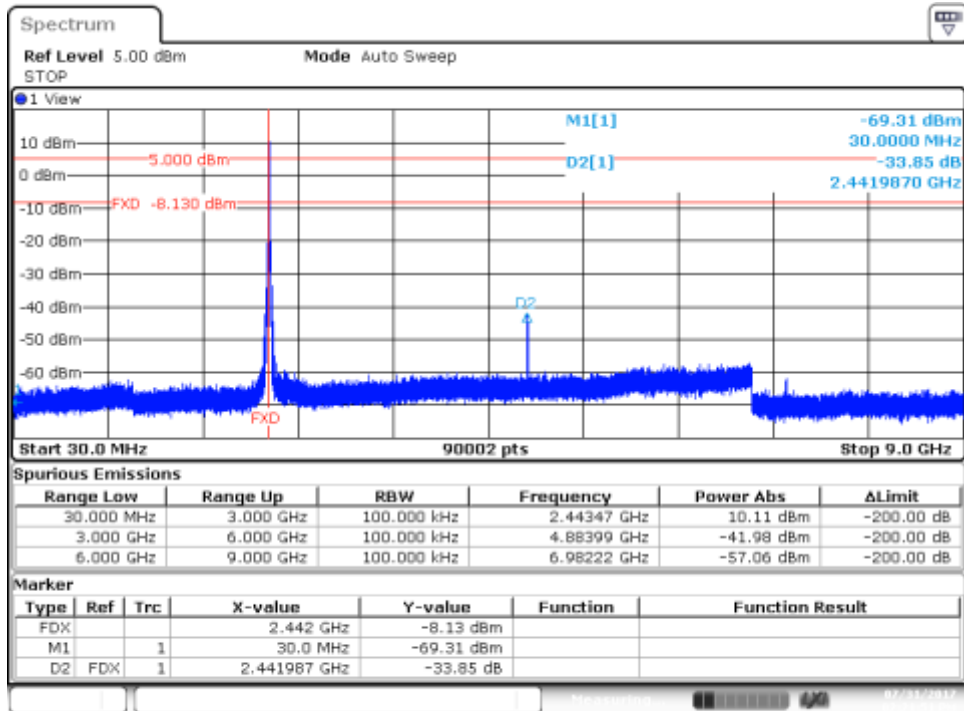

Date: 31.JUL.2017 14:21:52

Channel 7 - Spurious 2 Delta Marker Measurement

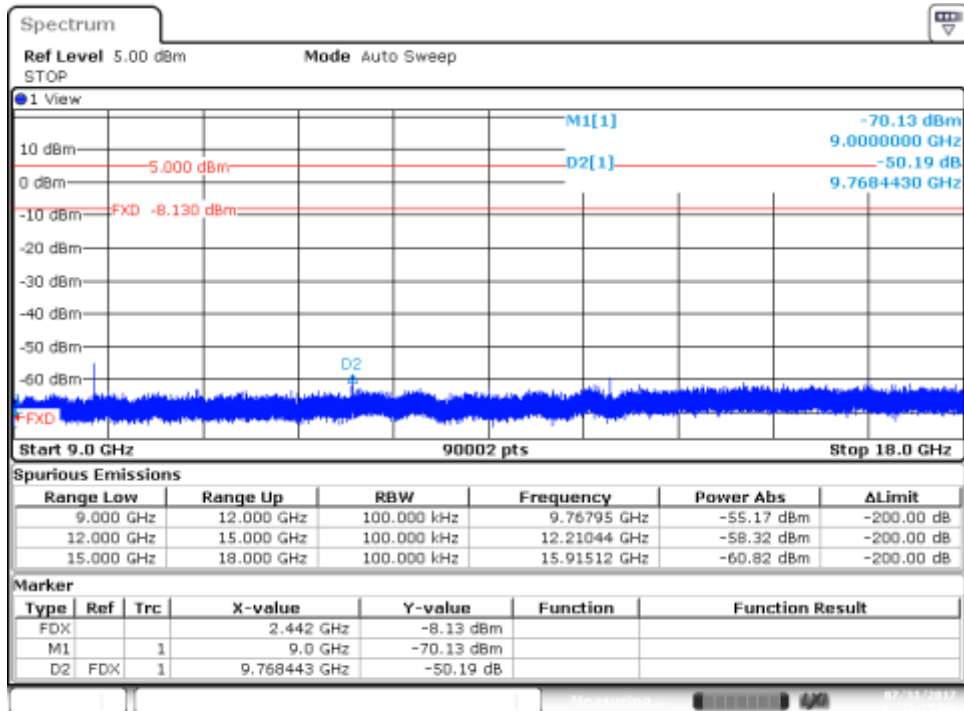

Date: 31.JUL.2017 14:22:16

Test Report N° 170727-01.TR04

Channel 7 - Spurious 3 Delta Marker Measurement

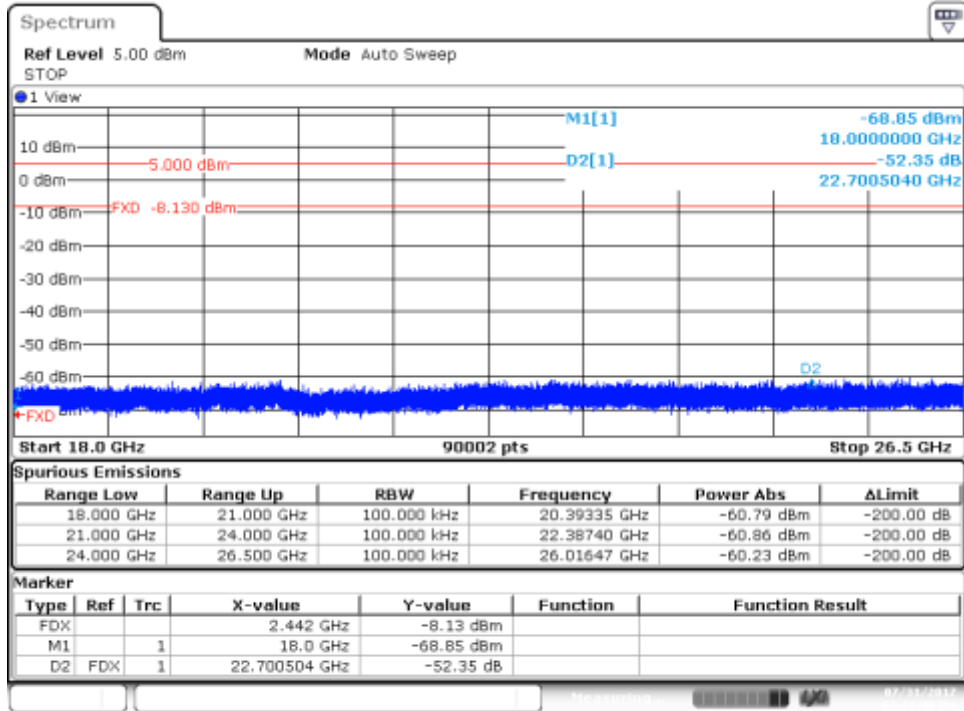

Date: 31.JUL.2017 14:22:40

## SISO-A,802.11g,6Mbps

### Channel 7 - Spurious 1 Delta Marker Measurement

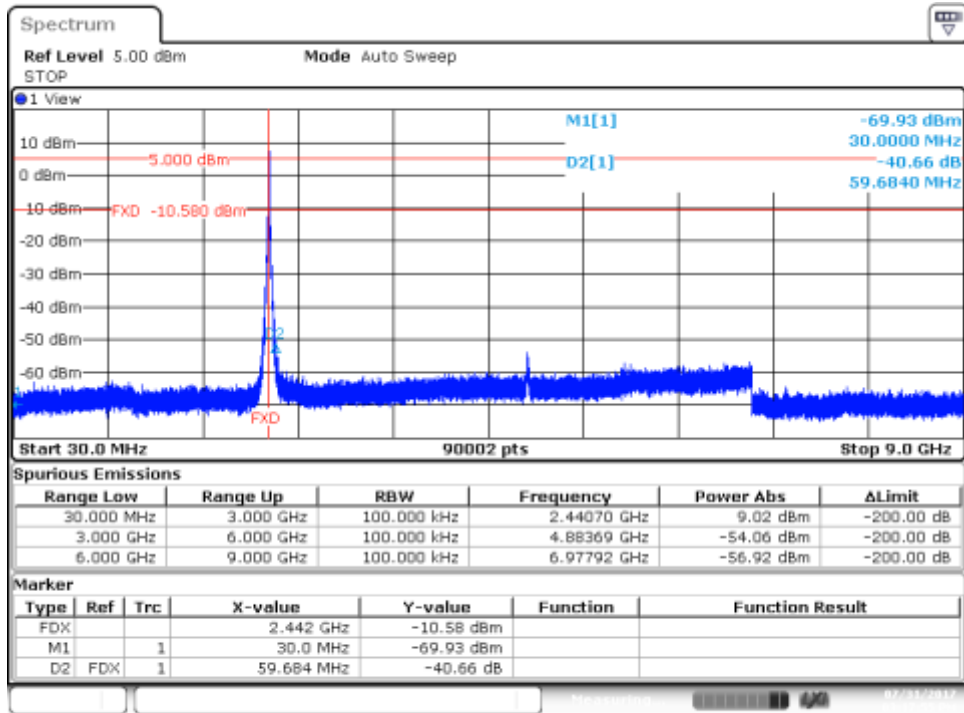

Date: 31.JUL.2017 15:17:54

### Channel 7 - Spurious 2 Delta Marker Measurement

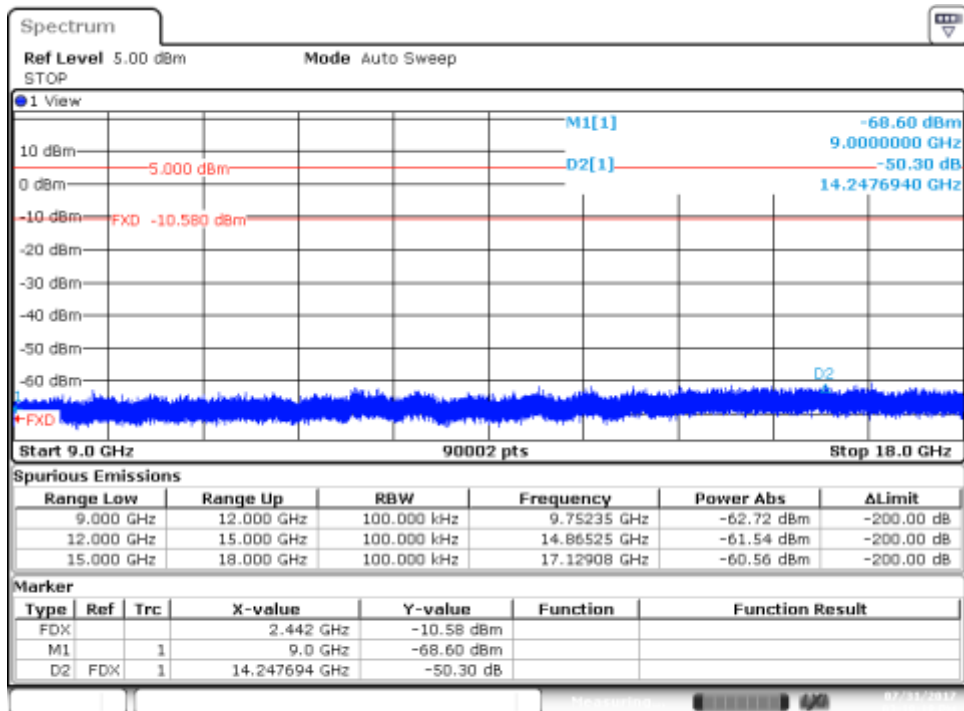

Date: 31.JUL.2017 15:18:18

Test Report N° 170727-01.TR04

Channel 7 - Spurious 3 Delta Marker Measurement

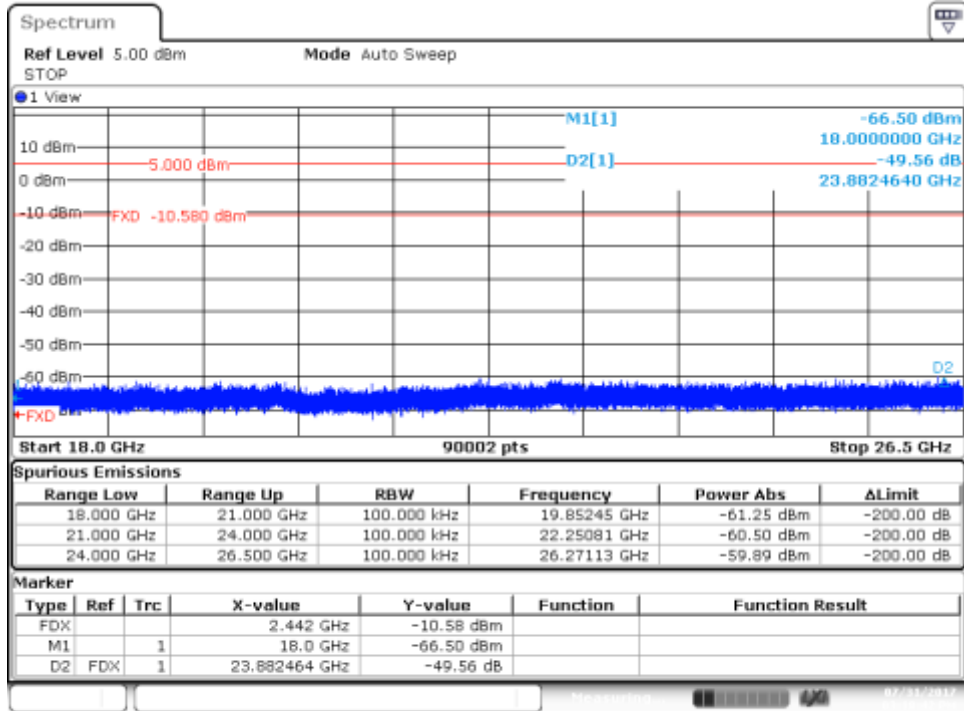

Date: 31.JUL.2017 15:18:42

# SISO-A,802.11n20,HT0

## Channel 7 - Spurious 1 Delta Marker Measurement

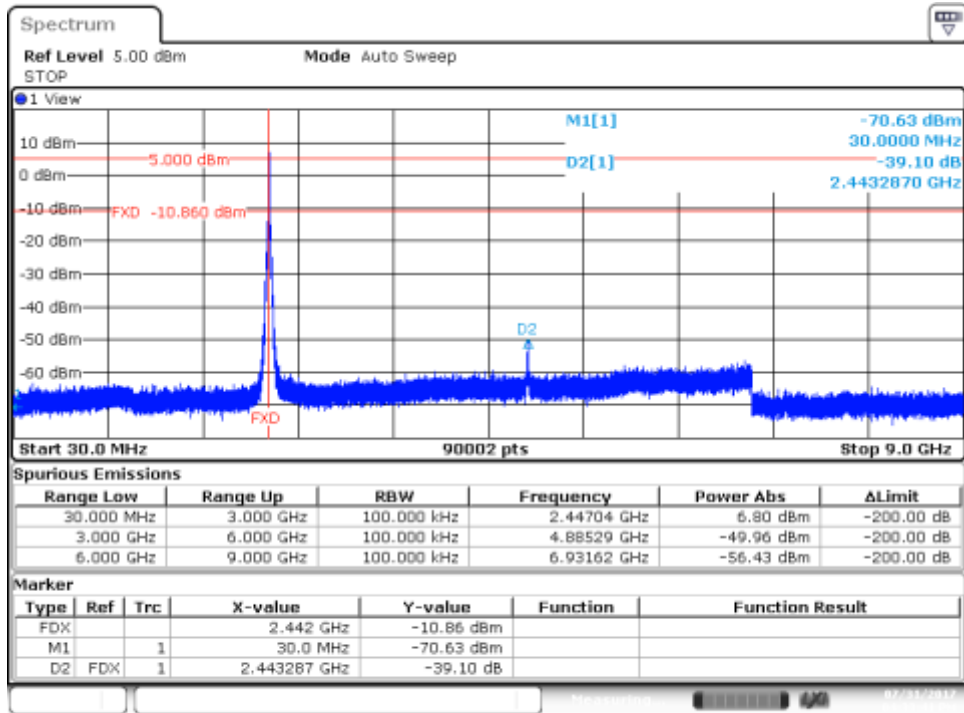

Date: 31.JUL.2017 18:33:42

## Channel 7 - Spurious 2 Delta Marker Measurement

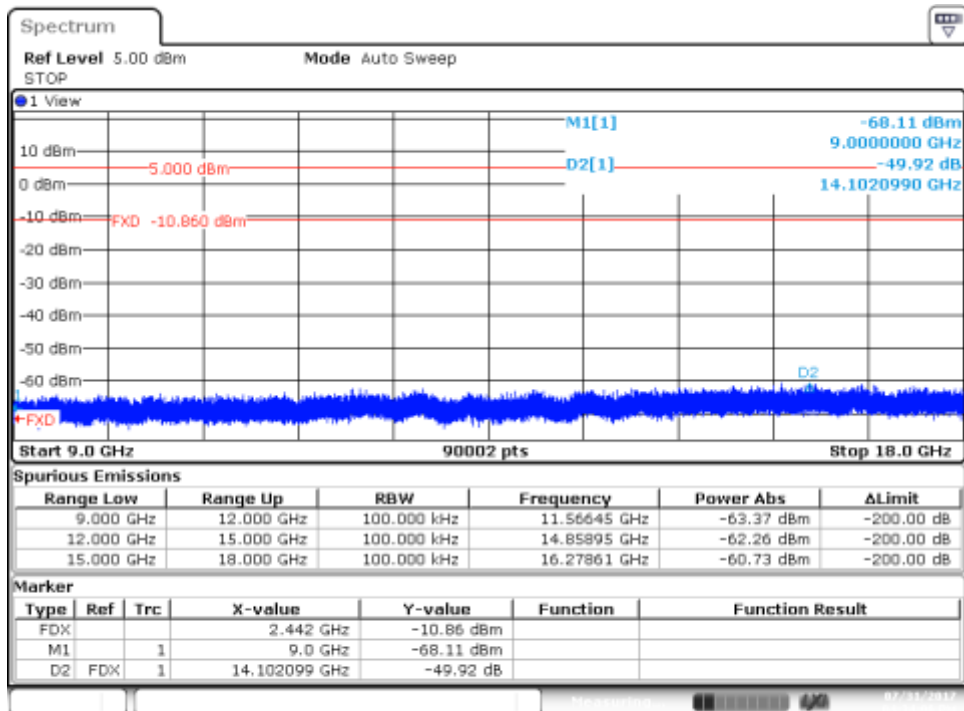

Date: 31.JUL.2017 18:34:08

Test Report N° 170727-01.TR04

Channel 7 - Spurious 3 Delta Marker Measurement

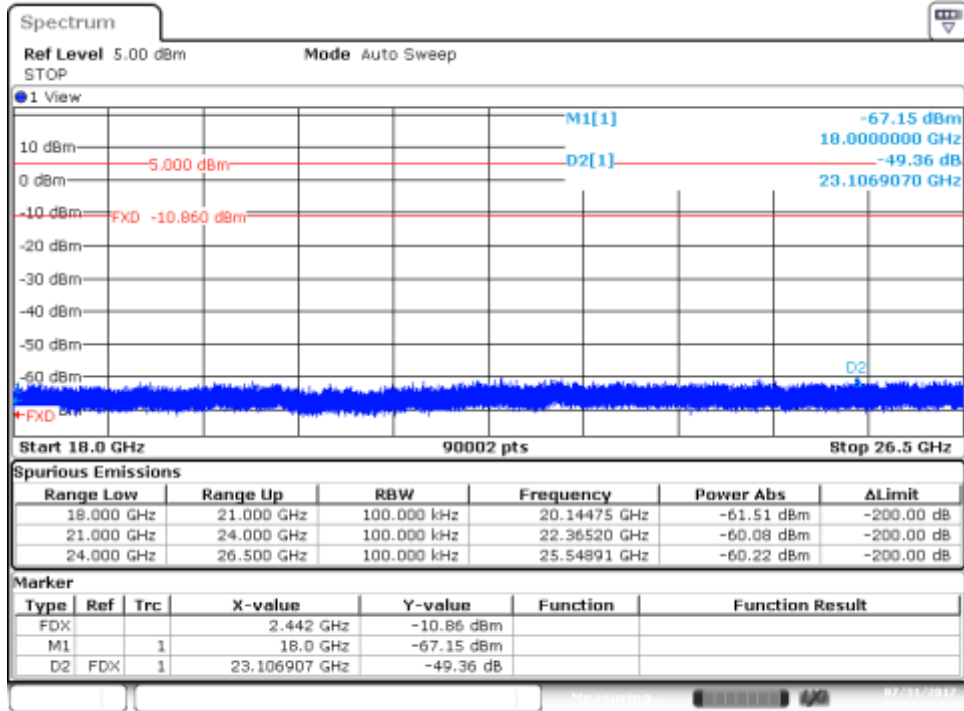

Date: 31.JUL.2017 18:34:30

# SISO-A,802.11n40,HT0

## Channel 7F - Spurious 1 Delta Marker Measurement

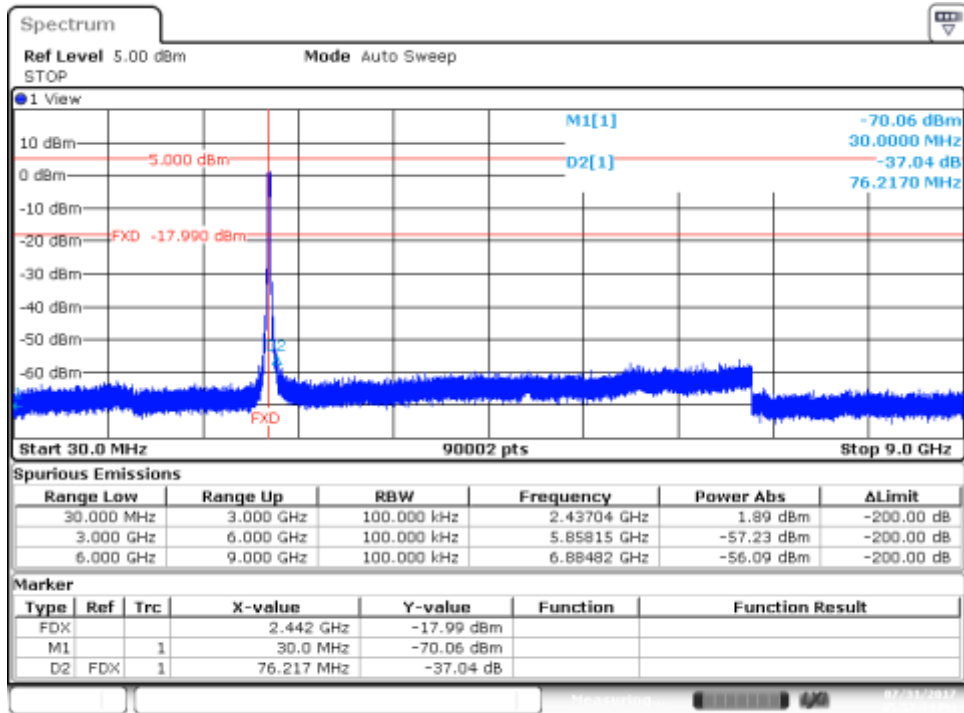

Date: 31.JUL.2017 17:57:34

## Channel 7F - Spurious 2 Delta Marker Measurement

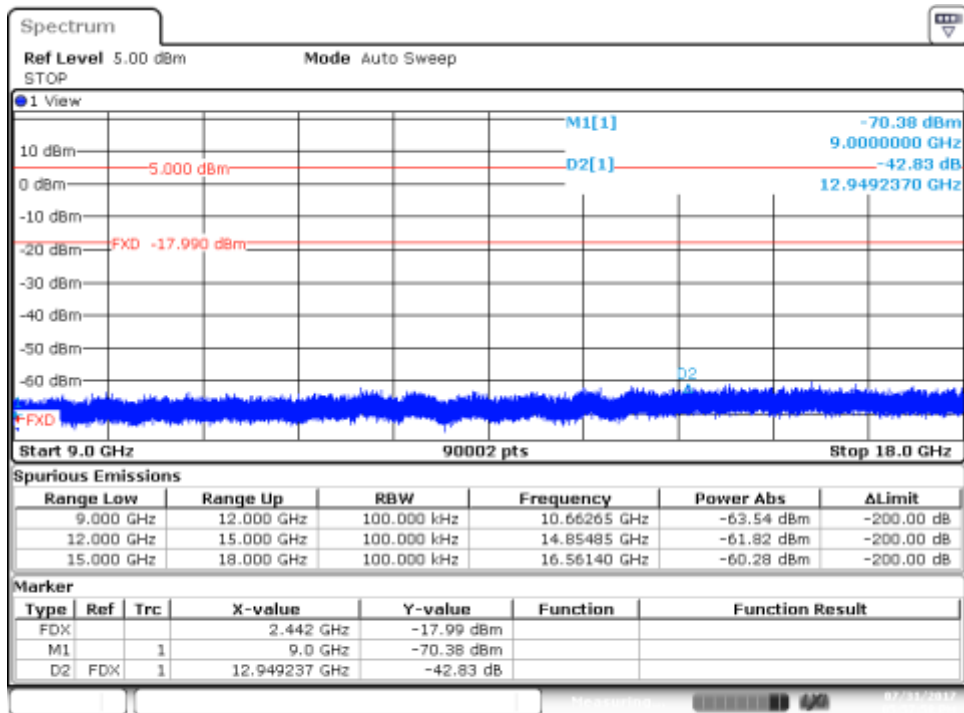

Date: 31.JUL.2017 17:57:58

Channel 7F - Spurious 3 Delta Marker Measurement

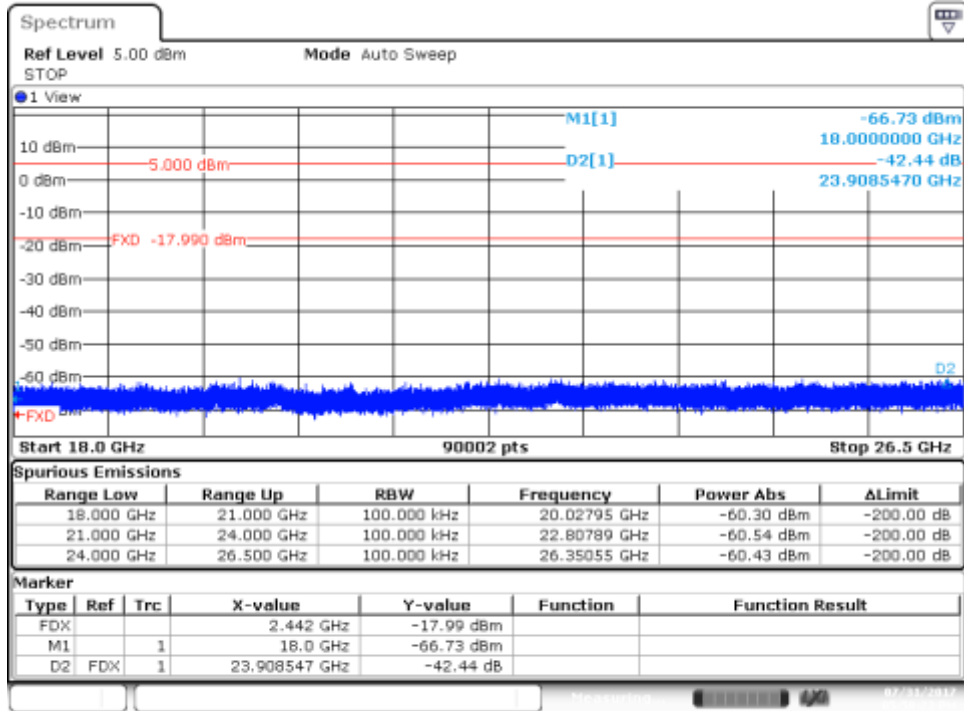

Date: 31.JUL.2017 17:58:23



# Annex C. Test Results BLE

## C.1 Test results BLE

### C.1.1 6dB & 99% Bandwidth

#### Test limits

FCC part	RSS part	Limits
15.247 (a) (2)	RSS-247 Clause 5.2 (a)	Systems using digital modulation techniques may operate in the 902-928 MHz, 2400-2483.5 MHz, and 5725-5850 MHz bands. The minimum 6 dB bandwidth shall be at least 500 kHz.

#### Test procedure

The setup below was used to measure the 6dB & 99% Bandwidth. The antenna terminal of the EUT is connected to the spectrum through an attenuator, and the spectrum analyzer reading is compensated to include the RF path loss.

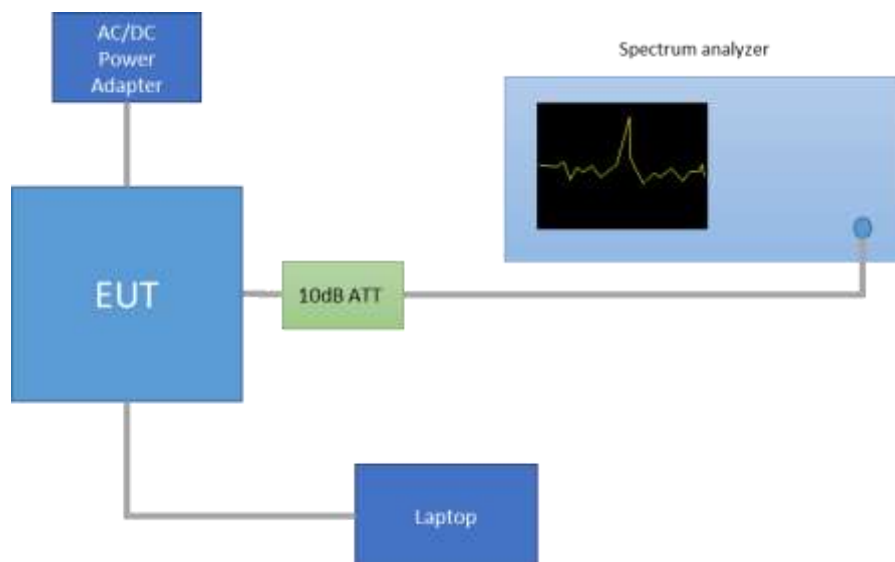

#### Results tables

Mode	Channel	Frequency [MHz]	6dB BW [MHz]	99% BW [MHz]
BLE	0	2402	0.63	1.15
	19	2440	0.65	1.15
	39	2480	0.65	1.15

Results screenshots

## BLE

### 6dB BW – CH0

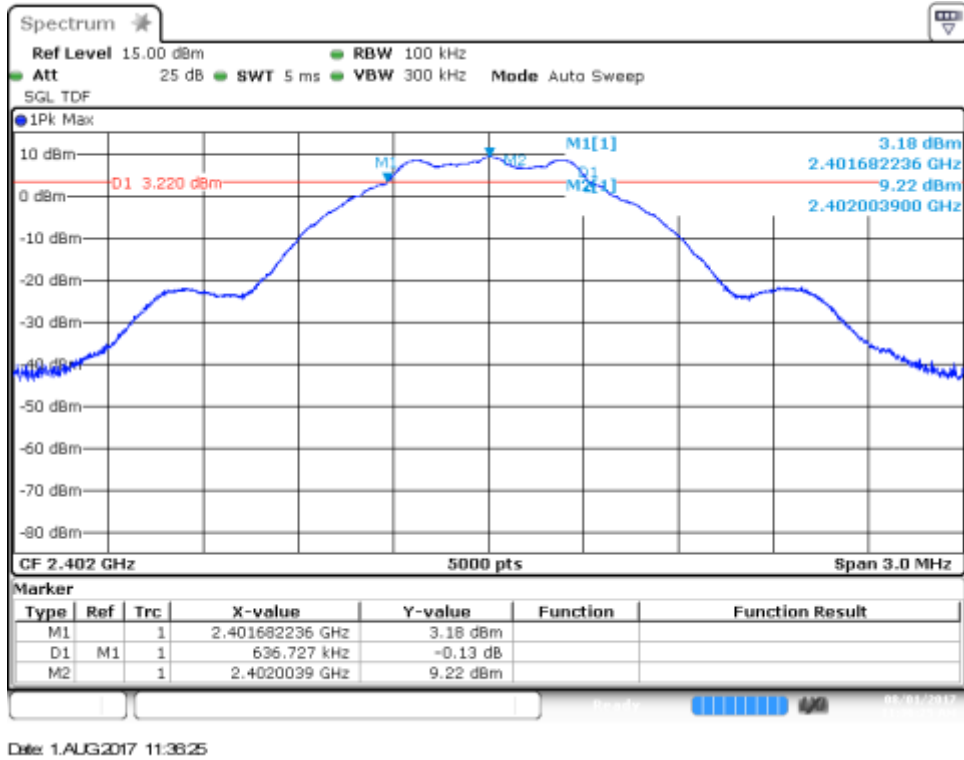

### 99% BW – CH0





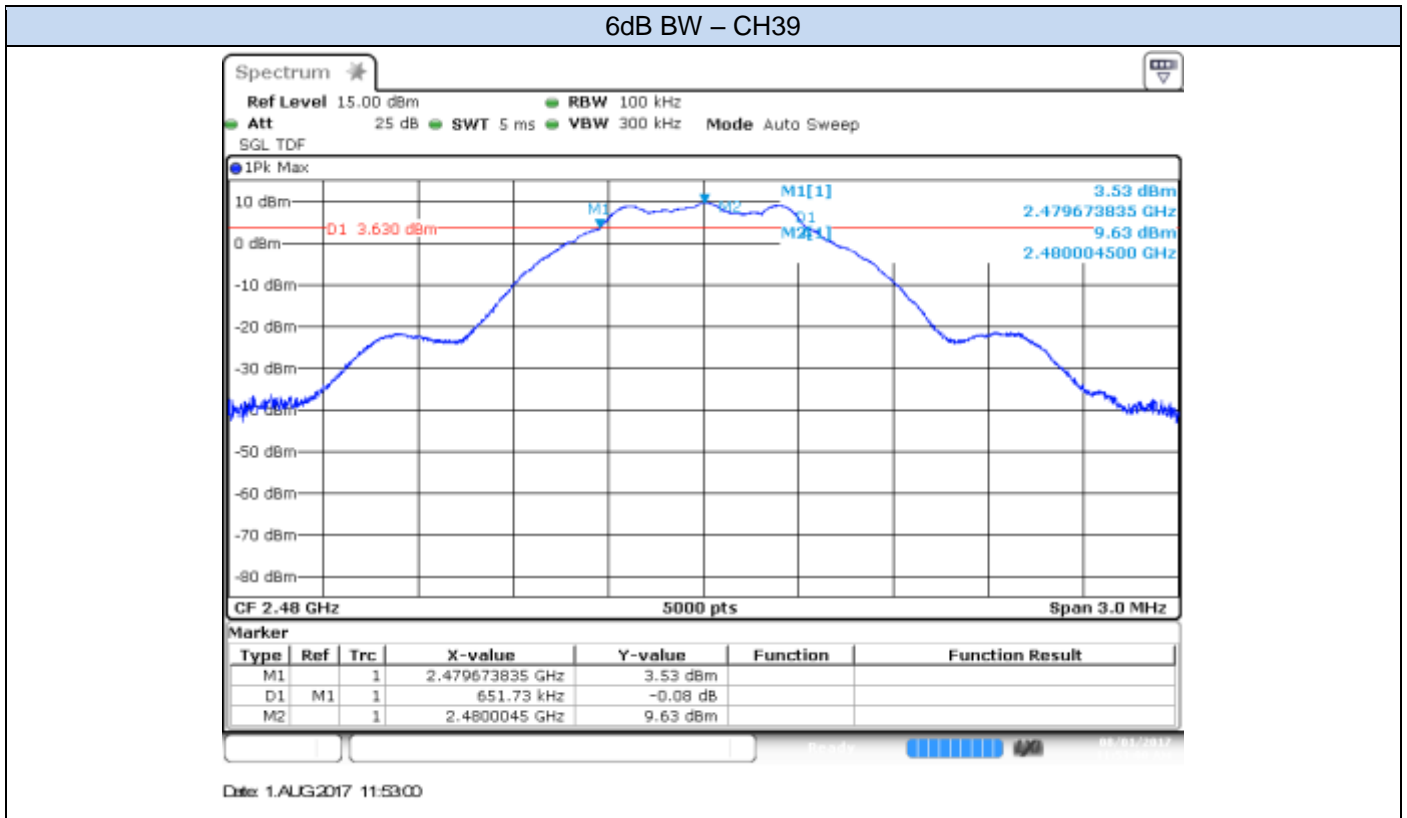

### C.1.2 Maximum Output Power and antenna gain

Test limits

	Limits
<p>FCC Part 15.247 (b) (3)</p>	<p>(b) The maximum peak conducted output power of the intentional radiator shall not exceed the following:</p> <p>(3) For systems using digital modulation in the 902-928 MHz, 2400-2483.5 MHz, and 5725-5850 MHz bands: 1 Watt. As an alternative to a peak power measurement, compliance with the one Watt limit can be based on a measurement of the maximum conducted output power. Maximum Conducted Output Power is defined as the total transmit power delivered to all antennas and antenna elements averaged across all symbols in the signaling alphabet when the transmitter is operating at its maximum power control level. Power must be summed across all antennas and antenna elements. The average must not include any time intervals during which the transmitter is off or is transmitting at a reduced power level.</p> <p>(4) The conducted output power limit specified in paragraph (b) of this section is based on the use of antennas with directional gains that do not exceed 6 dBi.</p>
<p>RSS-247 Clause 5.4 (d)</p>	<p>For DTSs employing digital modulation techniques operating in the bands 902-928 MHz and 2400-2483.5 MHz, the maximum peak conducted output power shall not exceed 1W. The e.i.r.p. shall not exceed 4 W, except as provided in section 5.4(e). As an alternative to a peak power measurement, compliance can be based on a measurement of the maximum conducted output power. The maximum conducted output power is the total transmit power delivered to all antennas and antenna elements, averaged across all symbols in the signalling alphabet when the transmitter is operating at its maximum power control level. Power must be summed across all antennas and antenna elements. The average must not include any time intervals during which the transmitter is off or transmitting at a reduced power level. If multiple modes of operation are implemented, the maximum conducted output power is the highest total transmit power occurring in any mode</p>

**Test procedure:**

The Maximum peak conducted output power was measured using the *RBW ≥ DTS bandwidth* method defined in paragraph 9.1.1 of FCC KDB 558074 D01 - Guidance for Performing Compliance Measurements on Digital Transmission Systems (DTS) Operating Under §15.247.

The Maximum conducted average output power was measured using the channel integration method according to Method AVGSA-2, defined in paragraph 9.2.2.4 of FCC KDB 558074 D01 - Guidance for Performing Compliance Measurements on Digital Transmission Systems (DTS) Operating Under §15.247.

The EIRP power (dBm) is calculated by adding the declared maximum antenna gain to the measured conducted power. The declared maximum antenna gain is 3.24dBi.

The setup below was used to measure the maximum conducted output power. The antenna terminal of the EUT is connected to the spectrum through an attenuator, and the spectrum analyzer reading is compensated to include the RF path loss.

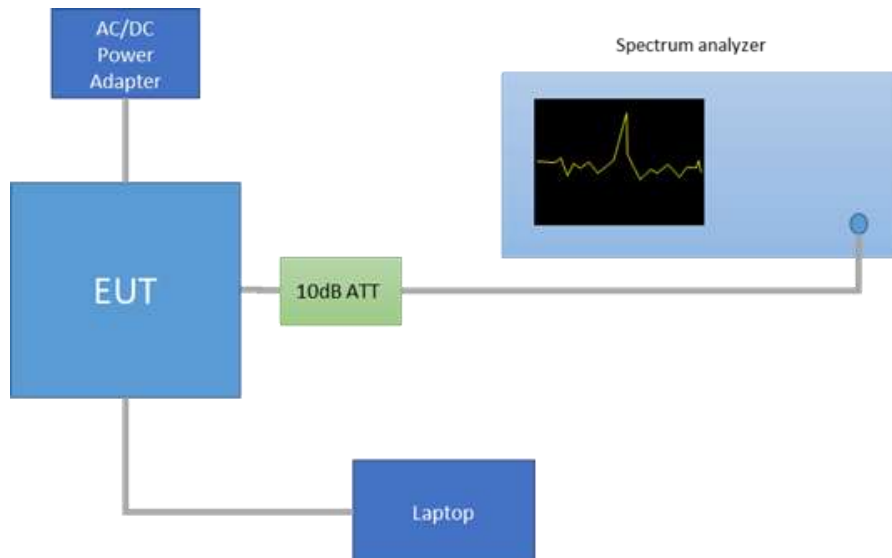

Results tables

Mode	Meas. Duty Cycle [%]	CH	Frequency [MHz]	Peak Power [dBm]		Peak Output Power [mW]
				Measured Conducted Output Power	EIRP	
BLE	63.2	0	2402	9.42	12.66	<b>8.75</b>
		19	2440	9.53	12.77	8.97
		39	2480	9.84	13.08	<b>9.64</b>

**Max Value**

**Min Value**

Mode	Meas. Duty Cycle [%]	CH	Frequency [MHz]	Average Output Power* [dBm]			Average Output Power [mW]
				Maximum Conducted Output Power	Maximum Conducted Output Power Duty cycle Compensated	EIRP	
BLE	63.2	0	2402	6.62	9.27	12.51	8.46
		19	2440	6.75	9.40	12.64	8.72
		39	2480	7.06	9.71	12.95	9.36

\* Output Power RMS values are shown for indicative purpose only

## Results screenshots

**BLE**

## Max Power Peak – CH0

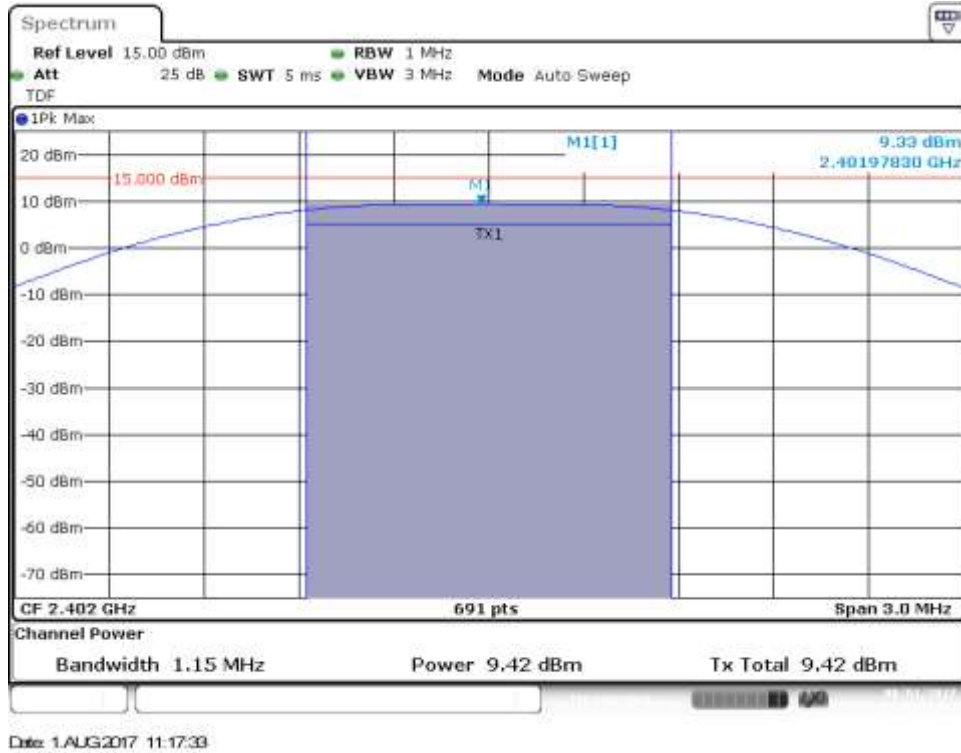

## Max Power RMS – CH0

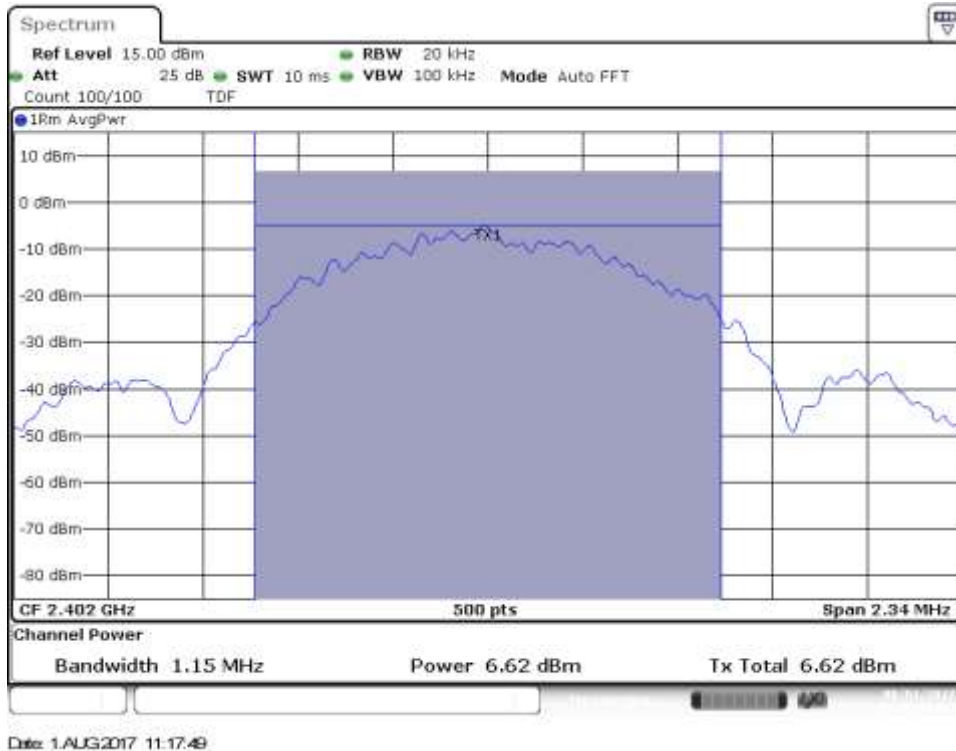

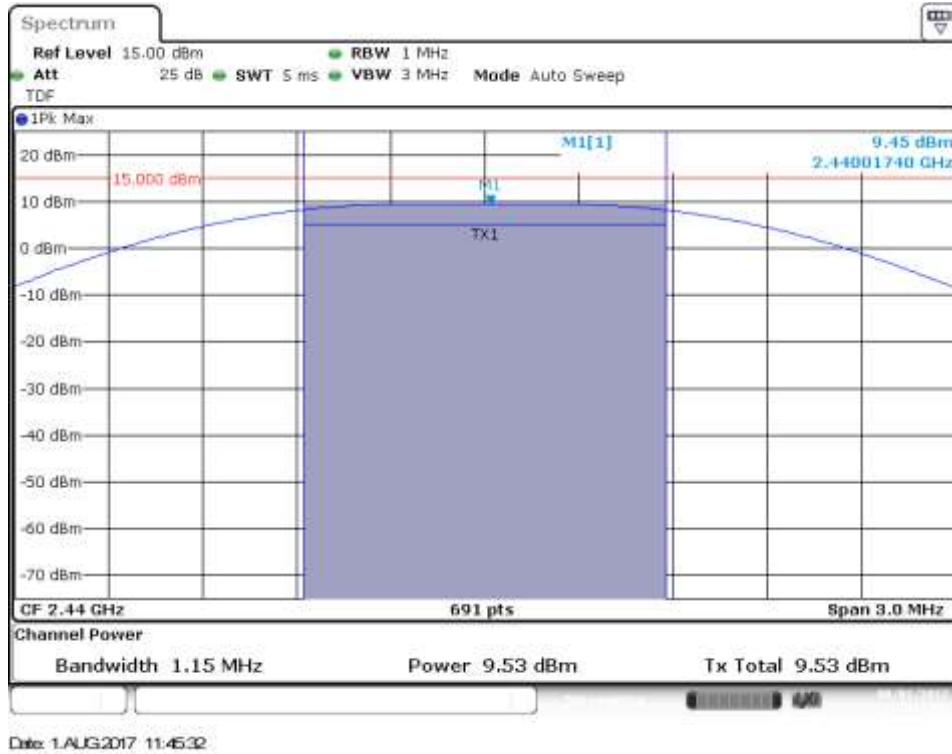
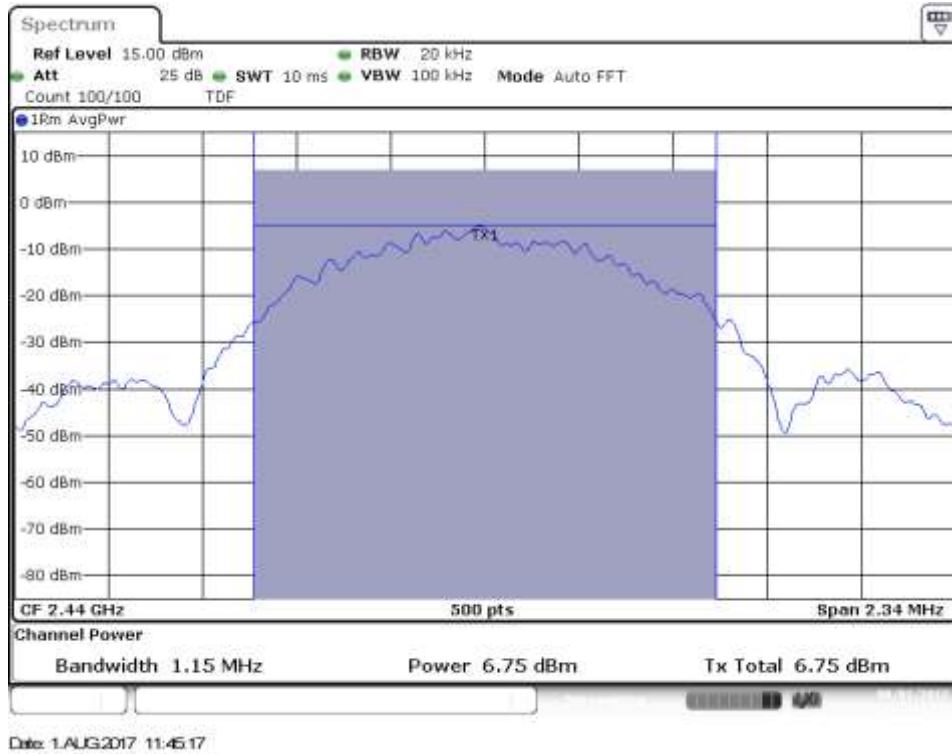

**BLE****Max Power Peak – CH19****Max Power RMS – CH19**

# BLE

## Max Power Peak – CH39

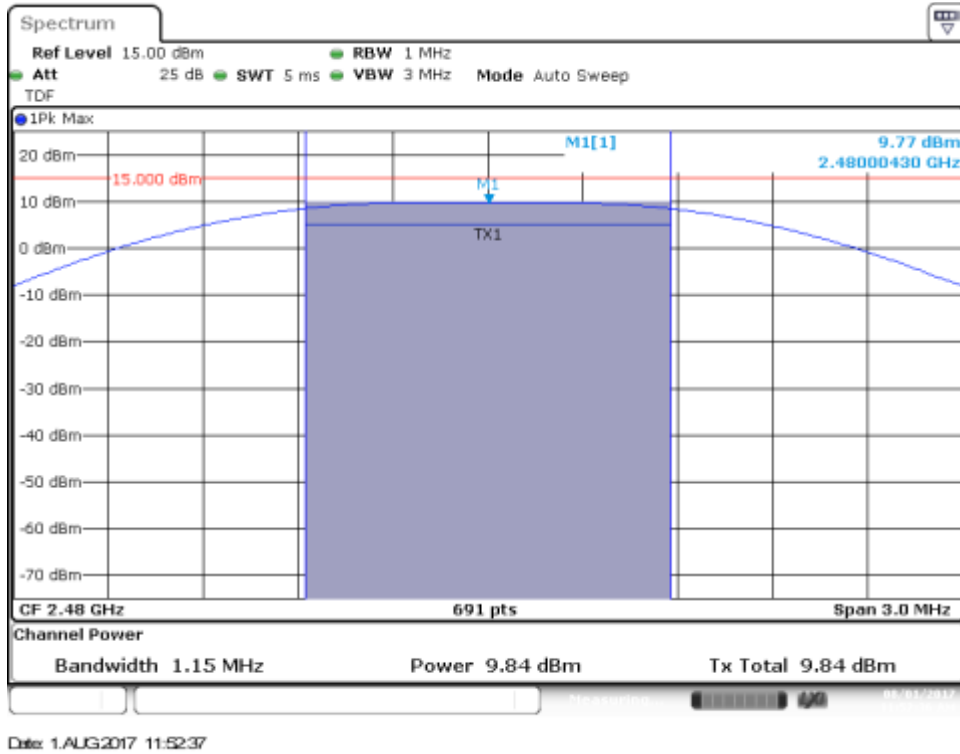

## Max Power RMS – CH39

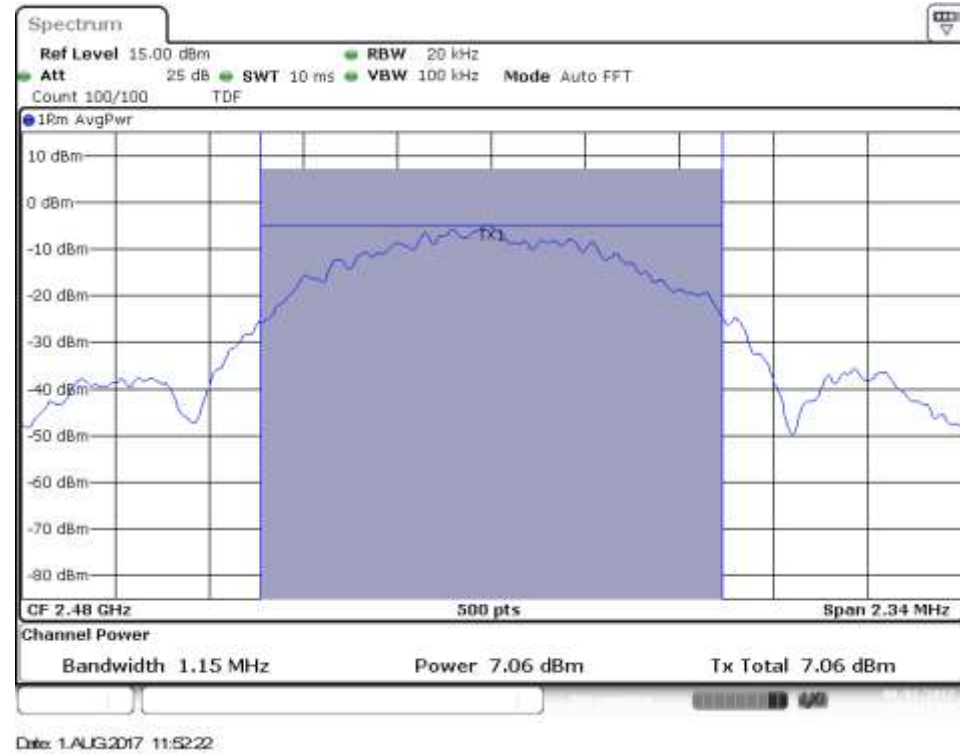

### C.1.3 Power Spectral Density

#### Test limits

FCC part	RSS part	Limits
15.247 (e)	RSS-247 Clause 5.2 (b)	For digitally modulated systems, the power spectral density conducted from the intentional radiator to the antenna shall not be greater than 8 dBm in any 3 kHz band during any time interval of continuous transmission. This power spectral density shall be determined in accordance with the provisions of paragraph (b) of this section. The same method of determining the conducted output power shall be used to determine the power spectral density.

#### Test procedure

The maximum peak power spectral density level of the fundamental emission was measured using the method PKPSD, defined in paragraph 10.2 of FCC KDB 558074 D01 - Guidance for Performing Compliance Measurements on Digital Transmission Systems (DTS) Operating Under §15.247.

The setup below was used to measure the power spectral density. The antenna terminal of the EUT is connected to the spectrum through an attenuator, and the spectrum analyzer reading is compensated to include the RF path loss.

The declared maximum antenna gain is 3.24dBi.

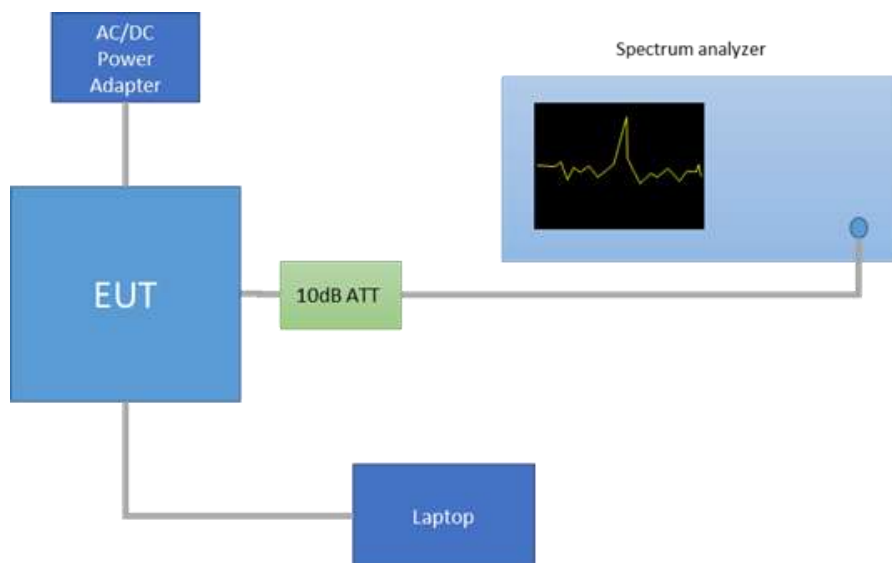

#### Results tables

Mode	CH	Frequency [MHz]	PSD Peak [dBm]
BLE	0	2402	-5.78
	19	2440	-5.47
	39	2480	-5.22

# BLE

## PSD Peak – CH0

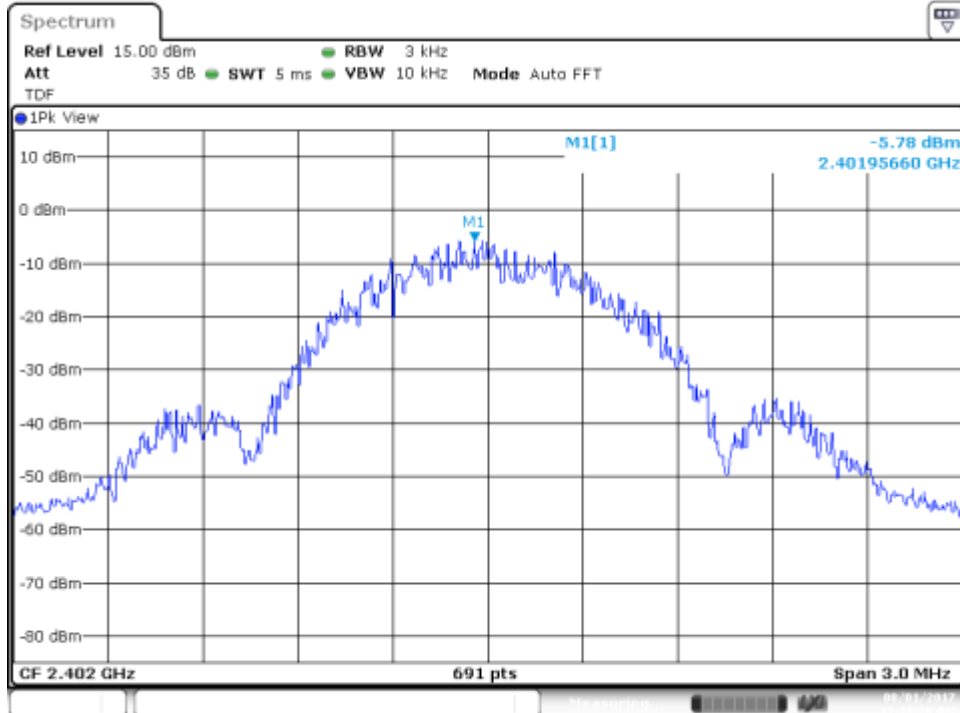

Date: 1.AUG2017 11:18:28

## PSD Peak – CH19

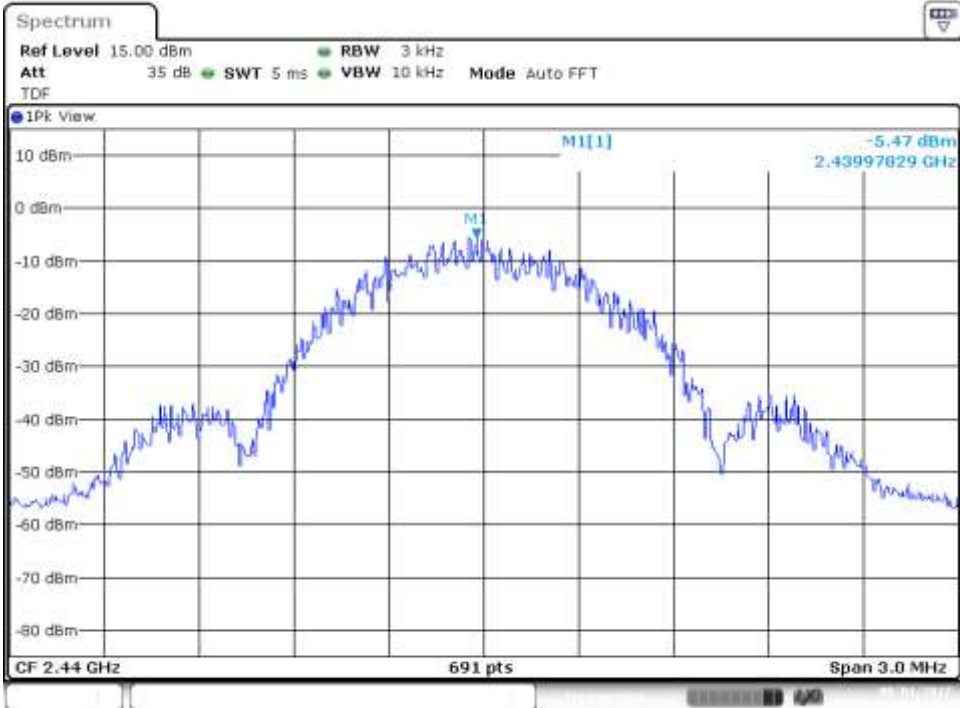

Date: 1.AUG2017 11:48:13

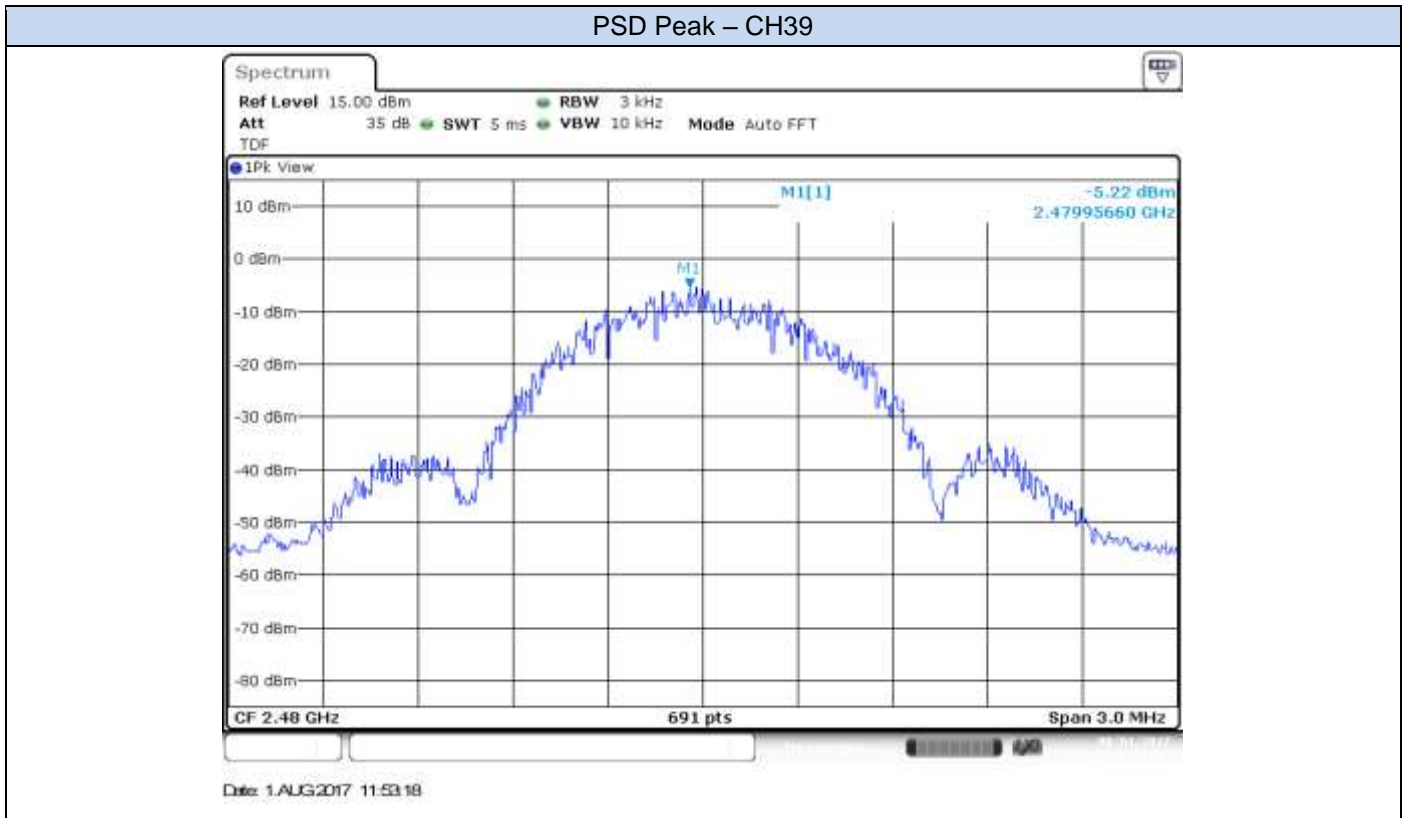

### C.1.4 Out-of-band emission (Conducted)

#### Test Limits

FCC part	RSS part	Limits																				
15.247 (d)	RSS-247 Clause 5.5	In any 100 kHz bandwidth outside the frequency band in which the spread spectrum or digitally modulated intentional radiator is operating, the radio frequency power that is produced by the intentional radiator shall be at least 20 dB below that in the 100 kHz bandwidth within the band that contains the highest level of the desired power, based on either an RF conducted or a radiated measurement, provided the transmitter demonstrates compliance with the peak conducted power limits.																				
15.209	RSS-Gen Clause 8.9	<p>Radiated emissions which fall in the restricted bands, as defined in §15.205(a), must also comply with the radiated emission limits specified in §15.209(a):</p> <table border="1"> <thead> <tr> <th>Freq Range (MHz)</th> <th>Field Strength (μV/m)</th> <th>Field Strength (dBμV/m)</th> <th>Meas. Distance (m)</th> </tr> </thead> <tbody> <tr> <td>30-88</td> <td>100</td> <td>40</td> <td>3</td> </tr> <tr> <td>88-216</td> <td>150</td> <td>43.5</td> <td>3</td> </tr> <tr> <td>216-960</td> <td>200</td> <td>46</td> <td>3</td> </tr> <tr> <td>Above 960</td> <td>500</td> <td>54</td> <td>3</td> </tr> </tbody> </table> <p>The emission limits shown in the above table are based on measurements employing CISPR quasi-peak detector except for the frequency bands 9-90 kHz, 110-490 kHz and above 1000 MHz. Radiated emission limits in these three bands are based on measurements employing an average detector. For average radiated emission measurements above 1000 MHz, there is also a limit specified when measuring with peak detector function, corresponding to 20 dB above the indicated values in the table.</p>	Freq Range (MHz)	Field Strength (μV/m)	Field Strength (dBμV/m)	Meas. Distance (m)	30-88	100	40	3	88-216	150	43.5	3	216-960	200	46	3	Above 960	500	54	3
Freq Range (MHz)	Field Strength (μV/m)	Field Strength (dBμV/m)	Meas. Distance (m)																			
30-88	100	40	3																			
88-216	150	43.5	3																			
216-960	200	46	3																			
Above 960	500	54	3																			

#### Test procedure

The setup below was used to measure the out-of-band emissions. The antenna terminal of the EUT is connected to the spectrum through an attenuator, and the spectrum analyzer reading is compensated to include the RF path loss.

In case of Band Edge measurements falling in restricted bands, the declared Antenna Gain is also compensated in the graph. The declared maximum antenna gain is 3.24dBi.

For Band Edge measurements falling in restricted bands, the following limits in dBm were applied for the average detector after the conversion from the limits detailed above in dBμV/m, according to FCC 47 CFR part 15 - Subpart C – §15.209(a). The limits in dBm for peak detector are 20dB above the indicated values in the table.

§15.209(a)			Converted values	
Freq Range (MHz)	Distance (m)	Field strength (microvolts/meter)	Field strength (dB microvolts/meter)	Power (dBm)
Above 960	3	500	54.0	-41.2

The setup below was used to measure the out-of-band emissions. The antenna terminal of the EUT is connected to the spectrum through an attenuator, and the spectrum analyzer reading is compensated to include the RF path loss.

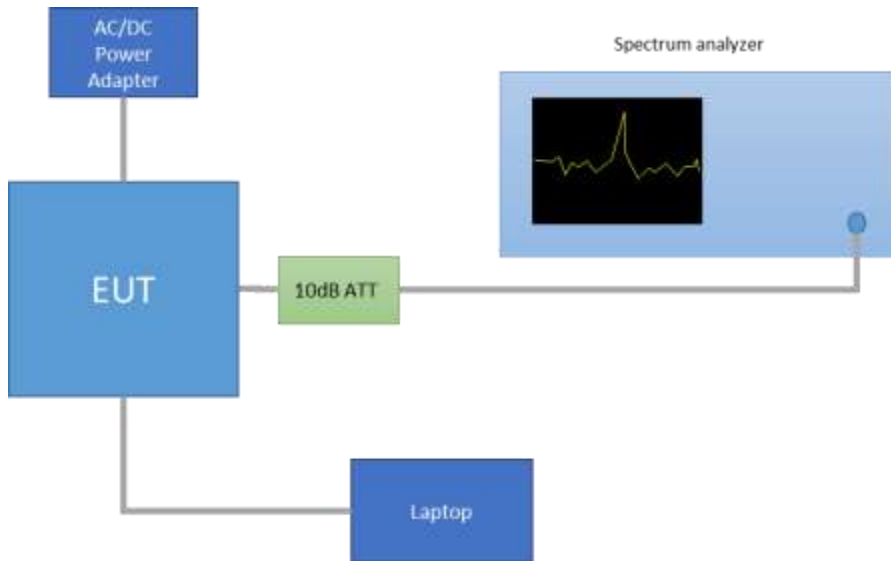

Note: these PSD<sub>Peak</sub> values are shown just as a reference for the compliance of the Out-of-band Measurements. Thus the RBW used for these measurements was 100kHz.

Mode	CH	Frequency [MHz]	PSD Peak [dBm]
BLE	0	2402	9.26
	19	2440	9.34
	39	2480	9.62

Results screenshots

**BLE**

**BE Low Freq Section – CH0**

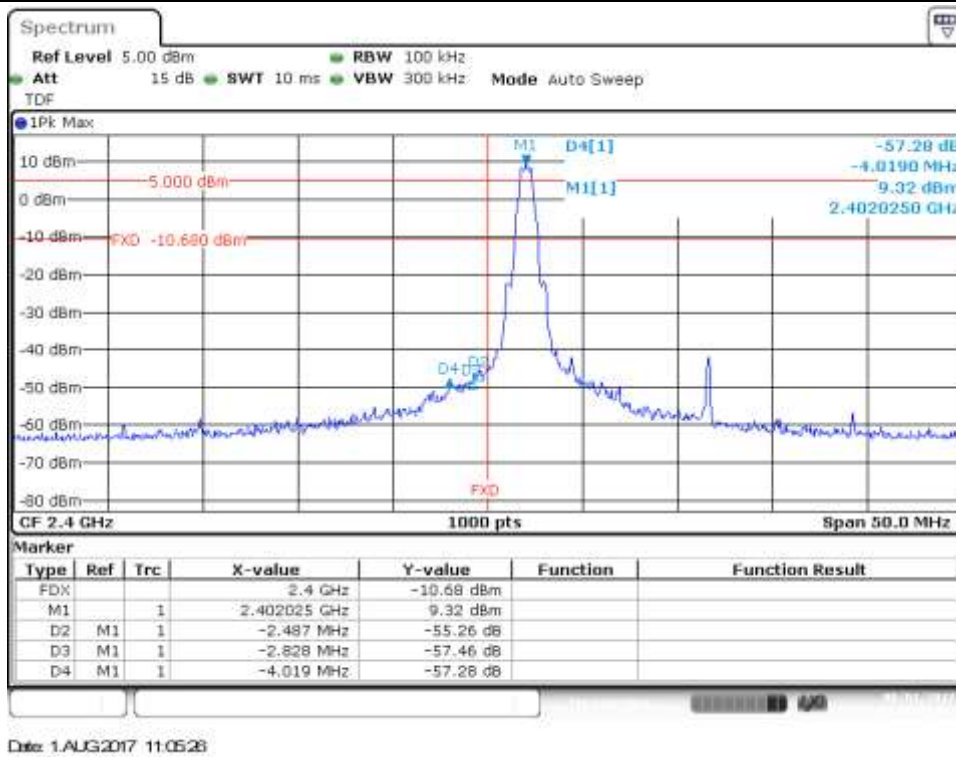

**BE Low (Non Restricted) – CH0**

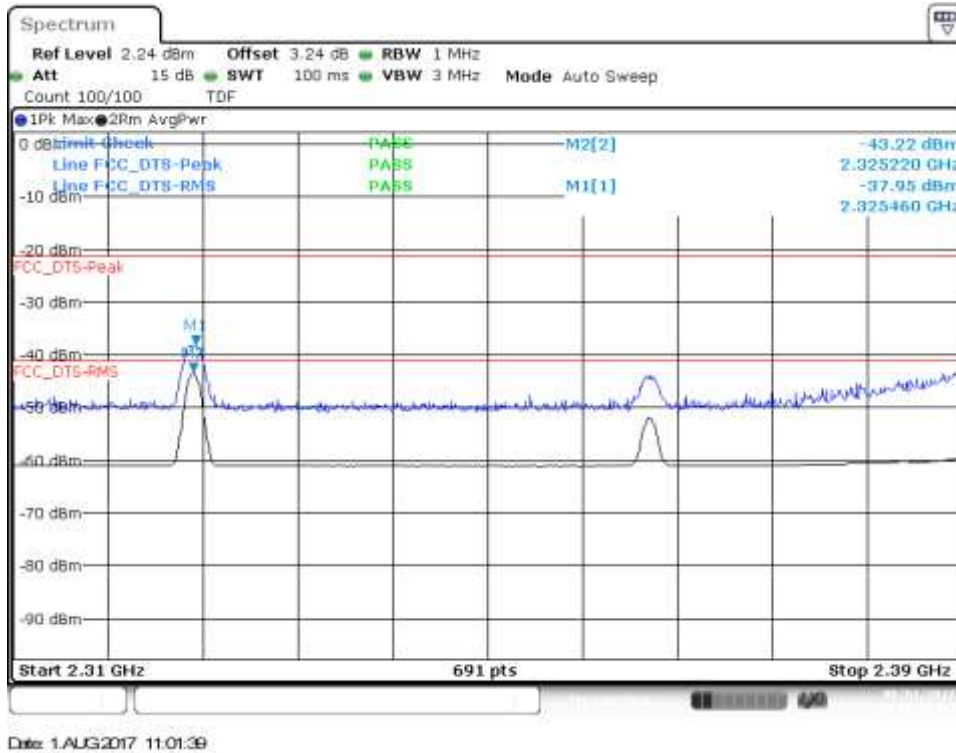



## BE High Freq Section (Restricted) – CH39

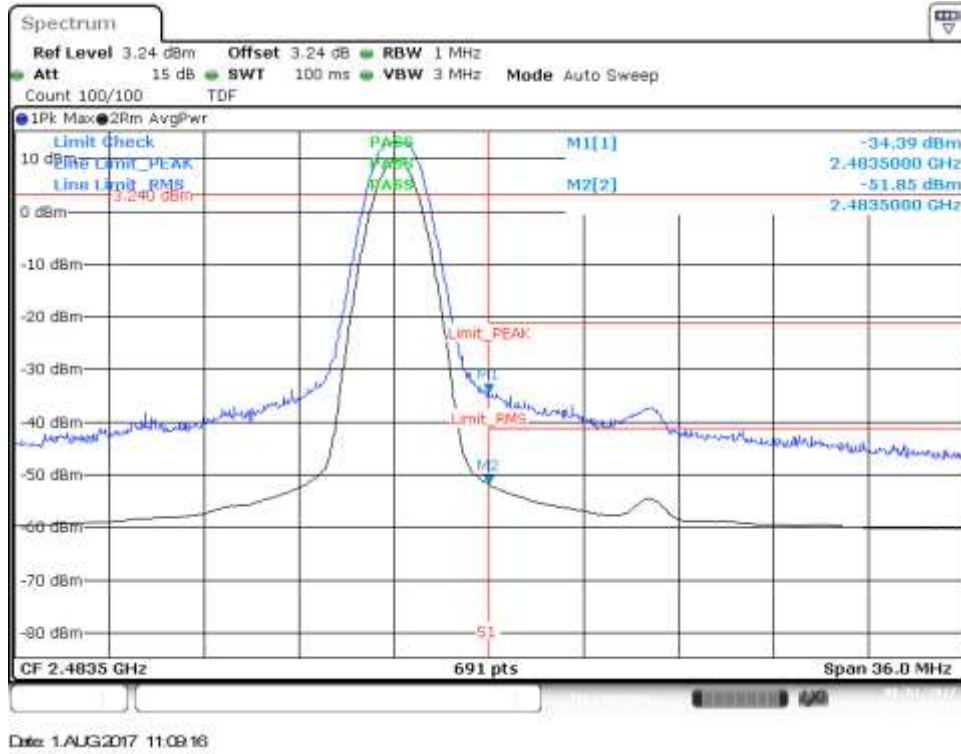

## BLE, CH0

### Cond Spur, 30MHz – 9GHz

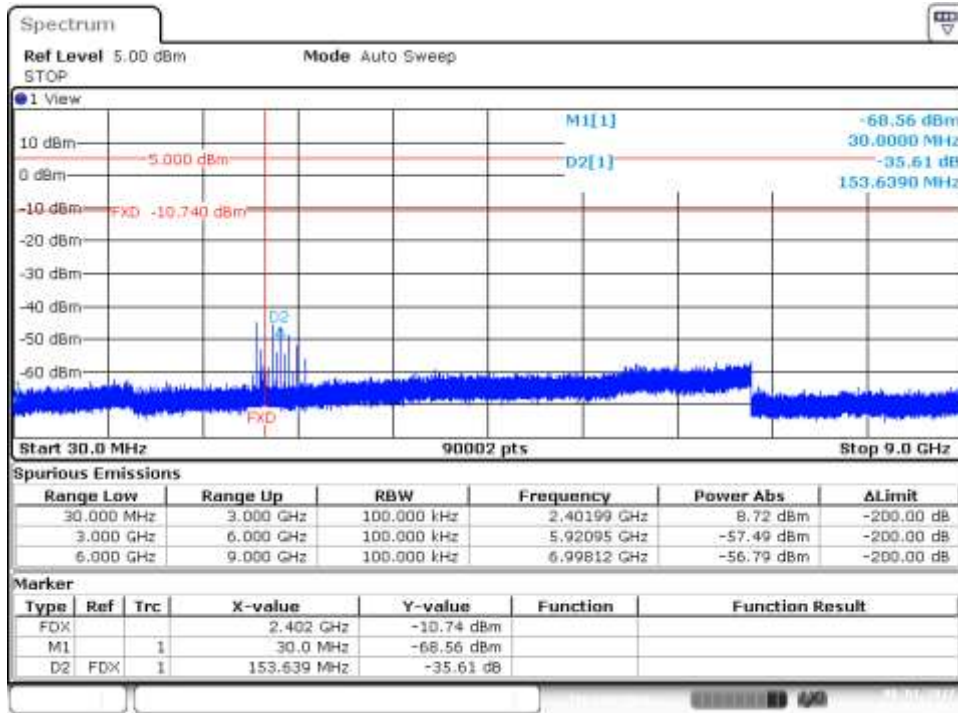

Date: 1.AUG2017 11:19:10

### Cond Spur, 9GHz – 18GHz

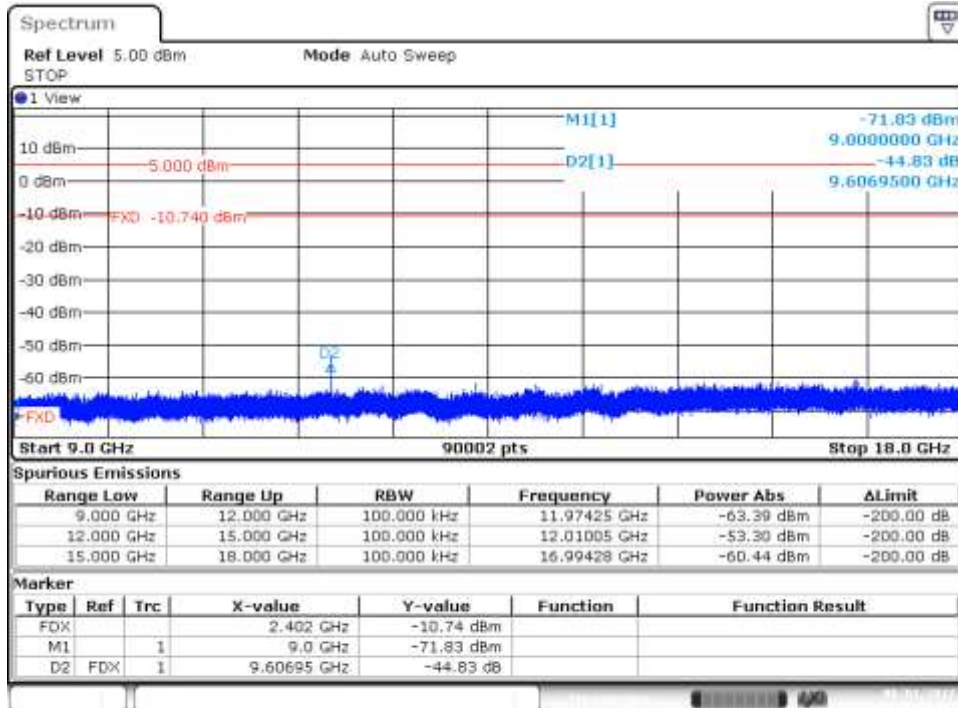

Date: 1.AUG2017 11:19:34

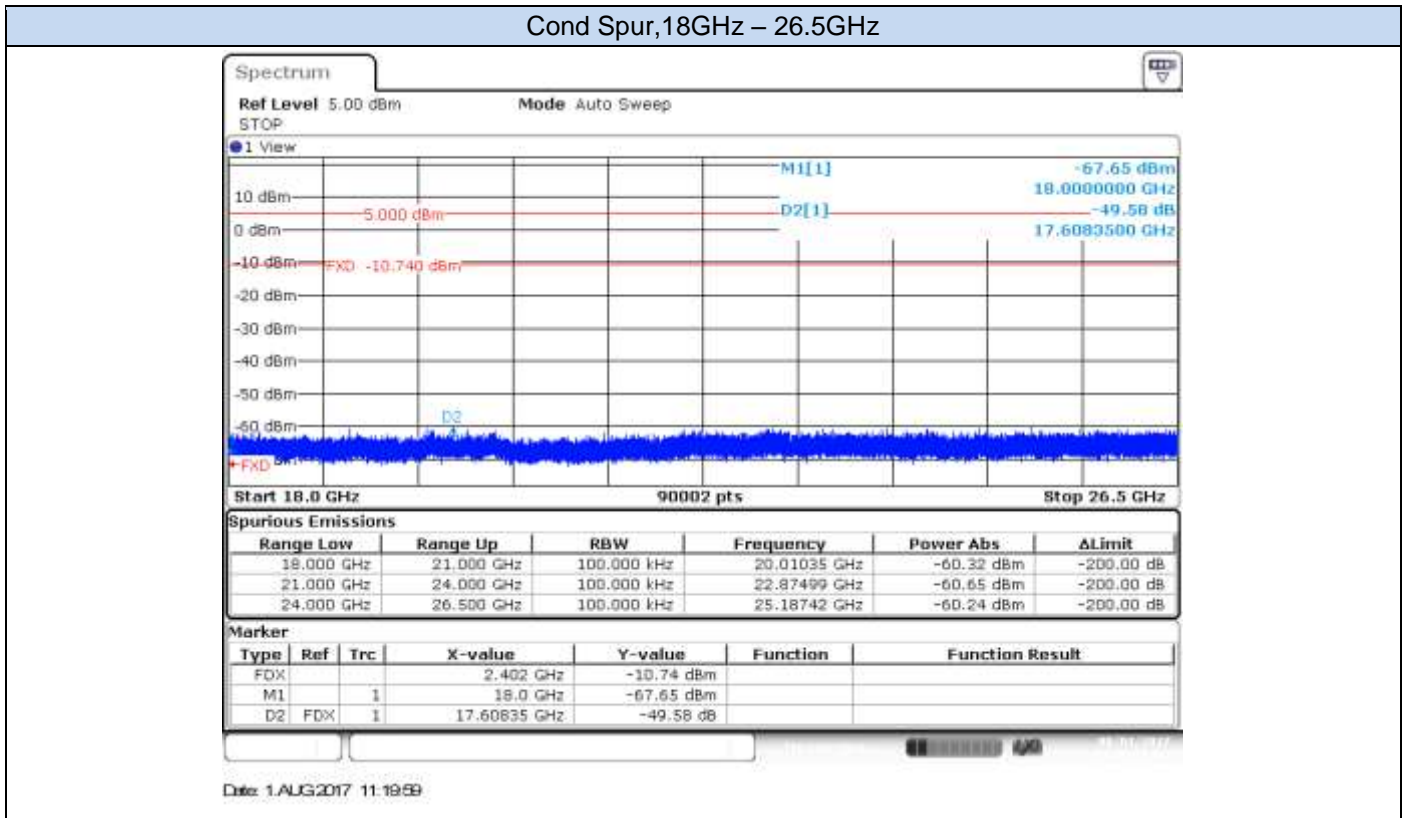





## BLE, CH39

### Cond Spur, 30MHz – 9GHz

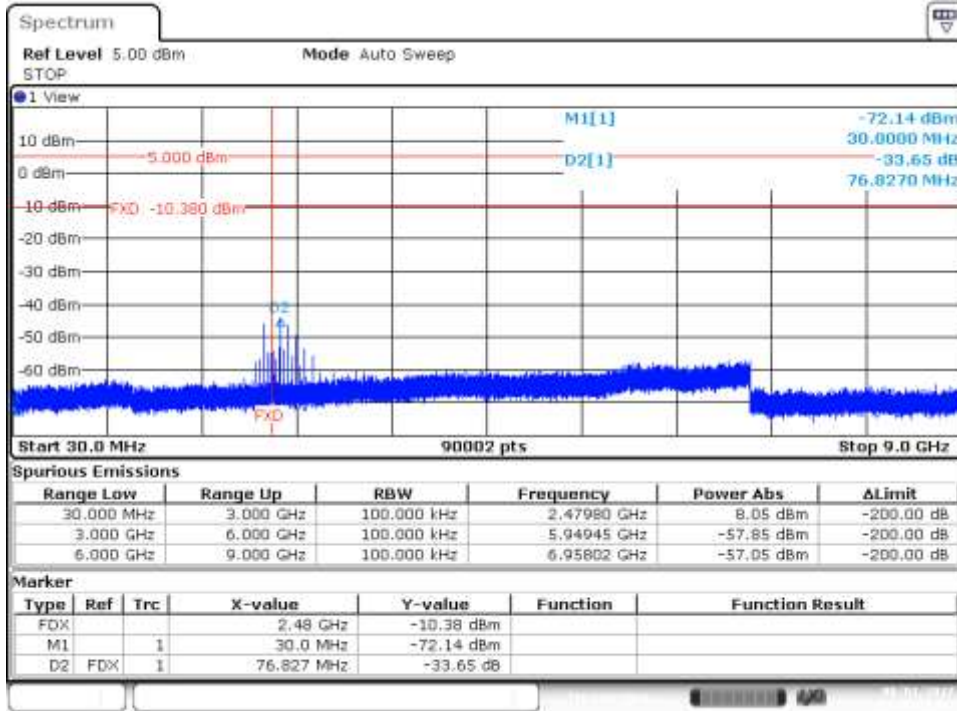

Date: 1.AUG2017 11:54:00

### Cond Spur, 9GHz – 18GHz

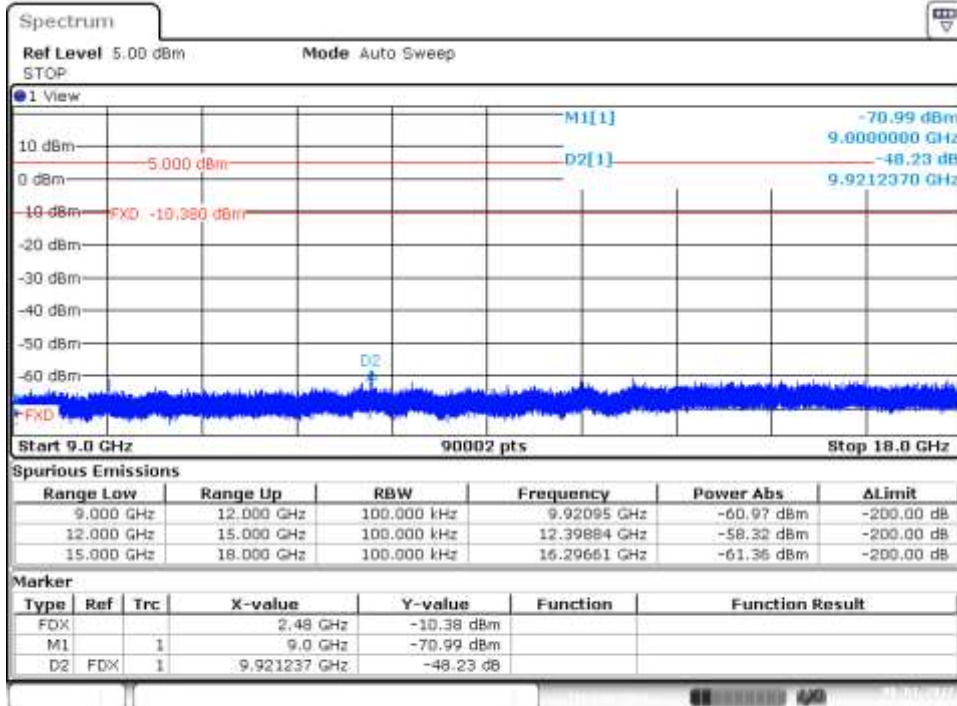

Date: 1.AUG2017 11:54:24

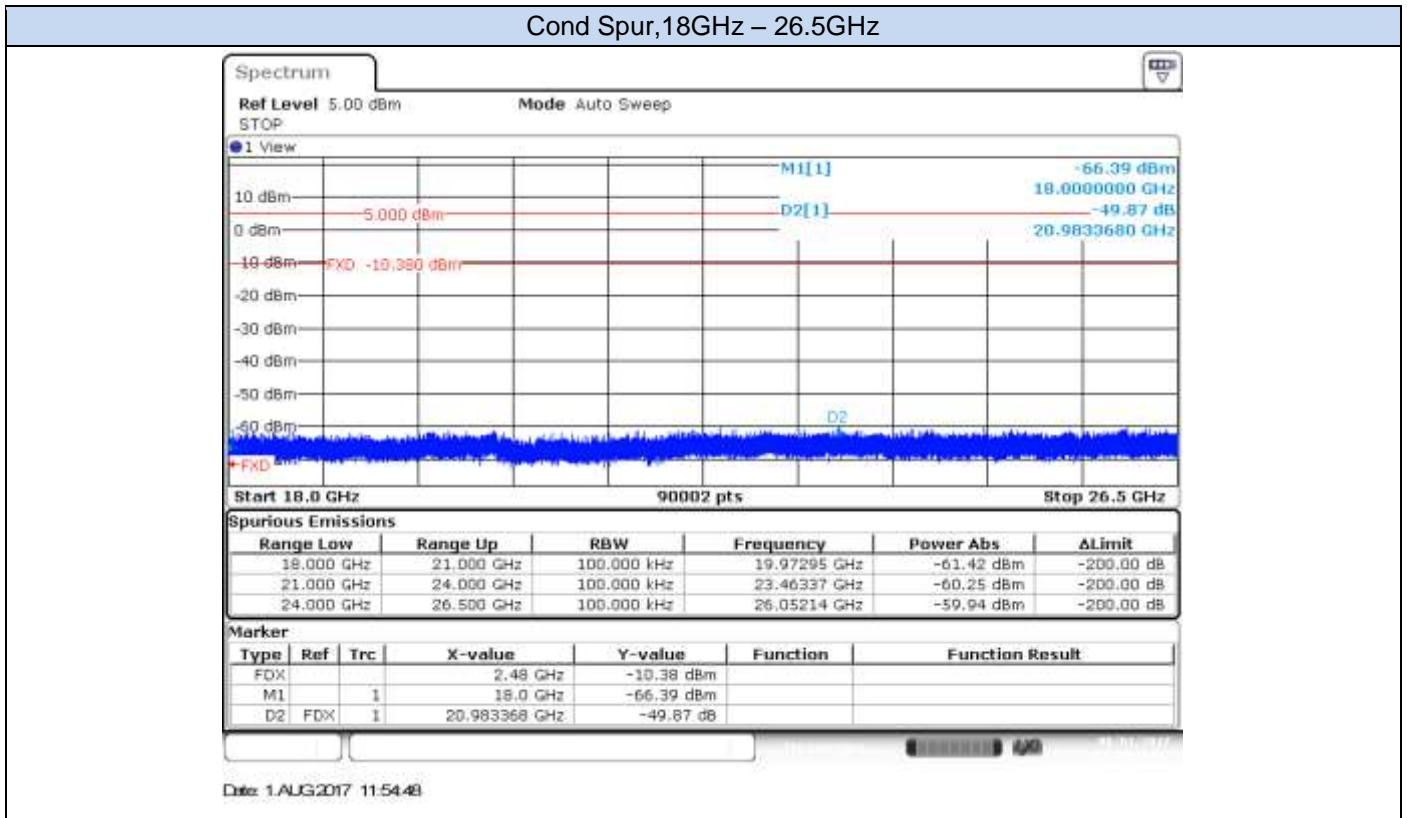

### C.1.5 Radiated spurious emission

#### Standards references

FCC part	RSS part	Limits																					
15.247 (d) 15.209	RSS-247 Clause 5.5 RSS-Gen Clause 8.9	Radiated emissions which fall in the restricted bands, as defined in §15.205(a), must also comply with the radiated emission limits specified in §15.209(a):																					
		<table border="1"> <thead> <tr> <th data-bbox="630 472 783 535">Freq Range (MHz)</th> <th data-bbox="788 472 833 680">Field Strength (<math>\mu\text{V}/\text{m}</math>)</th> <th data-bbox="837 472 1023 680">Field Strength (<math>\text{dB}\mu\text{V}/\text{m}</math>)</th> <th data-bbox="1027 472 1212 680">Meas. Distance (m)</th> </tr> </thead> <tbody> <tr> <td data-bbox="630 535 783 568">30-88</td> <td data-bbox="788 535 833 568">100</td> <td data-bbox="837 535 1023 568">40</td> <td data-bbox="1027 535 1212 568">3</td> </tr> <tr> <td data-bbox="630 575 783 609">88-216</td> <td data-bbox="788 575 833 609">150</td> <td data-bbox="837 575 1023 609">43.5</td> <td data-bbox="1027 575 1212 609">3</td> </tr> <tr> <td data-bbox="630 616 783 649">216-960</td> <td data-bbox="788 616 833 649">200</td> <td data-bbox="837 616 1023 649">46</td> <td data-bbox="1027 616 1212 649">3</td> </tr> <tr> <td data-bbox="630 656 783 680">Above 960</td> <td data-bbox="788 656 833 680">500</td> <td data-bbox="837 656 1023 680">54</td> <td data-bbox="1027 656 1212 680">3</td> </tr> </tbody> </table>	Freq Range (MHz)	Field Strength ( $\mu\text{V}/\text{m}$ )	Field Strength ( $\text{dB}\mu\text{V}/\text{m}$ )	Meas. Distance (m)	30-88	100	40	3	88-216	150	43.5	3	216-960	200	46	3	Above 960	500	54	3	
Freq Range (MHz)	Field Strength ( $\mu\text{V}/\text{m}$ )	Field Strength ( $\text{dB}\mu\text{V}/\text{m}$ )	Meas. Distance (m)																				
30-88	100	40	3																				
88-216	150	43.5	3																				
216-960	200	46	3																				
Above 960	500	54	3																				
<p>The emission limits shown in the above table are based on measurements employing CISPR quasi-peak detector except for the frequency bands 9-90 kHz, 110-490 kHz and above 1000 MHz. Radiated emission limits in these three bands are based on measurements employing an average detector. For average radiated emission measurements above 1000 MHz, there is also a limit specified when measuring with peak detector function, corresponding to 20 dB above the indicated values in the table.</p>																							

#### Test procedure

The setups below were used to measure the radiated spurious emissions.

Depending of the frequency range and bands being tested, different antennas and filters were used.

The final measurement is done by varying the antenna height from 1 to 4 meters, the EUT azimuth over 360° and for both Vertical and Horizontal polarizations.

The radiated spurious emissions were measured on the lowest, middle and highest channels.



*Radiated Setup < 1GHz*

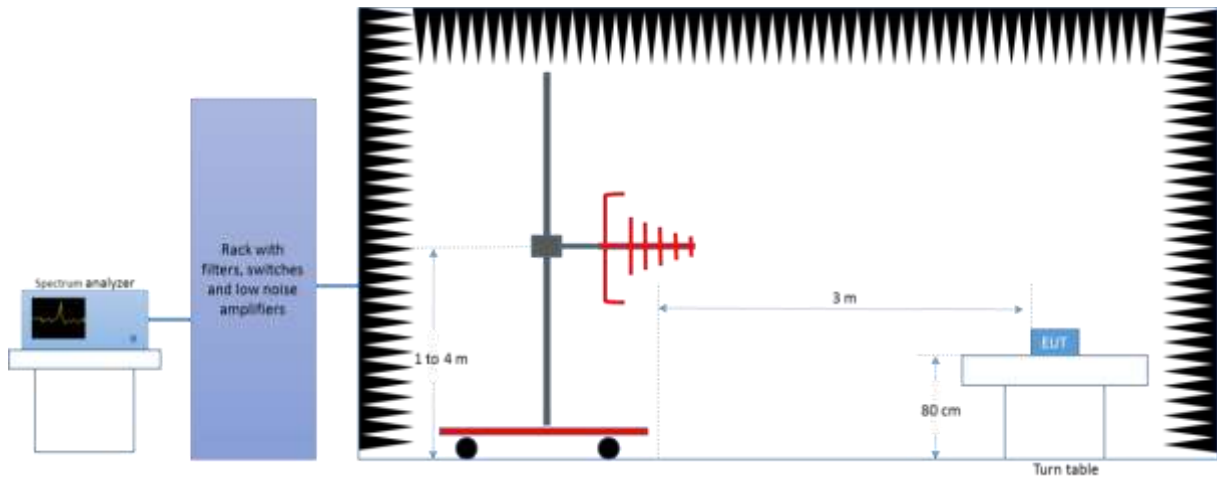

*Radiated Setup 1 GHz - 18 GHz*

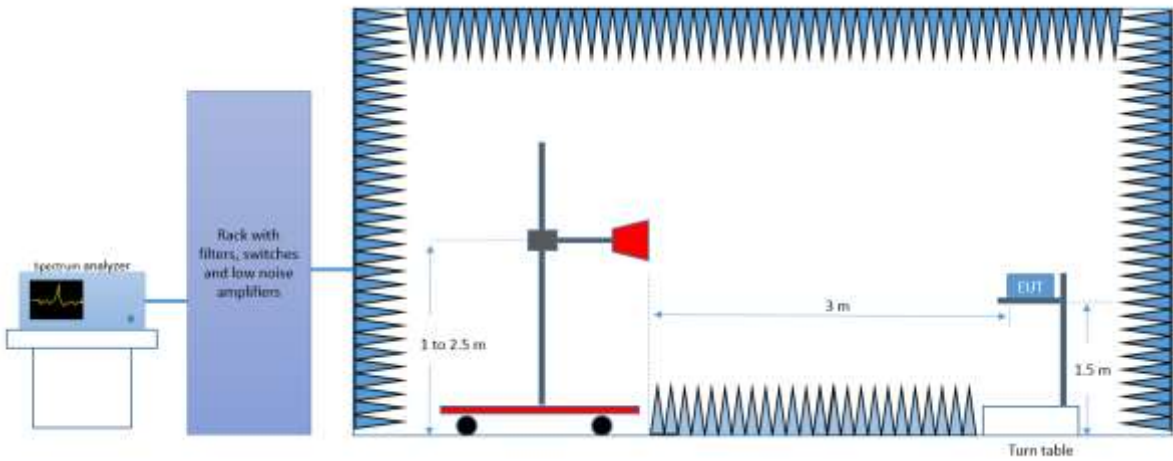

*Radiated Setup > 18 GHz*

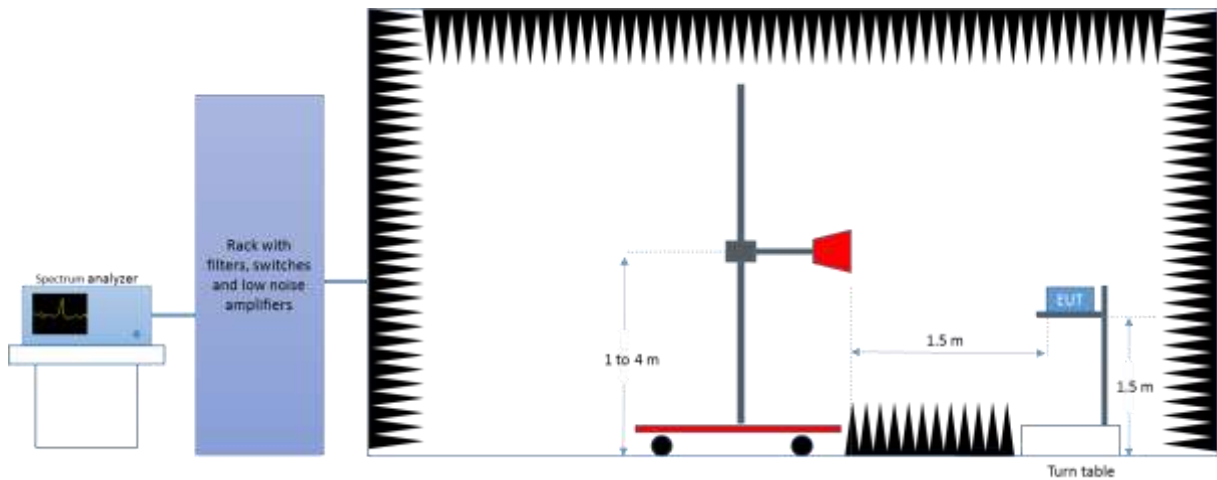

Sample Calculation

The field strength is deduced from the radiated measurement using the following equation:

$$E = 126.8 - 20\log(\lambda) + P - G$$

where

*E* is the field strength of the emission at the measurement distance, in dB $\mu$ V/m

*P* is the power measured at the output of the test antenna, in dBm

$\lambda$  is the wavelength of the emission under investigation [ $300/f_{MHz}$ ], in m

*G* is the gain of the test antenna, in dBi

NOTE – The measured power *P* includes all applicable instrument correction factors up to the connection to the test Antenna e.g. cable losses, amplifier gains.

For field strength measurements made at other than the distance at which the applicable limit is specified, the field strength of the emission at the distance specified by the limit is deduced as follows:

$$E_{SpecLimit} = E_{Meas} + 20\log(D_{Meas}/D_{SpecLimit})$$

where

*E<sub>SpecLimit</sub>* is the field strength of the emission at the distance specified by the limit, in dB $\mu$ V/m

*E<sub>Meas</sub>* is the field strength of the emission at the measurement distance, in dB $\mu$ V/m

*D<sub>Meas</sub>* is the measurement distance, in m

*D<sub>SpecLimit</sub>* is the distance specified by the limit, in m

Test Results

**30 MHz – 26.5 GHz, BLE**

**Radiated Spurious – CH0**

Frequency	MaxPeak	Avg	Limit	Margin
MHz	dBuV/m	dBuV/m	dBuV/m	dB
62.5	29.5	---	40.0	10.5
2325.0	---	47.3	54.0	6.7
2325.3	56.8	---	74.0	17.2
2479.1	---	<b>47.0</b>	54.0	7.0
2479.1	56.8	---	74.0	17.2
3496.3	58.6	---	74.0	15.4
3496.6	---	46.5	54.0	7.5
17499.3	---	45.1	54.0	8.9
17511.4	57.5	---	74.0	16.5
22000.2	---	40.4	54.0	13.6

**Radiated Spurious – CH19**

Frequency	MaxPeak	Avg	Limit	Margin
MHz	dBuV/m	dBuV/m	dBuV/m	dB
62.4	32.1	---	40.0	8.0
2361.3	56.5	---	74.0	17.6
2362.8	---	<b>47.5</b>	54.0	6.5
2516.6	55.9	---	74.0	18.1
2516.9	---	45.9	54.0	8.1
2590.6	55.9	---	74.0	18.1
2593.4	---	46.7	54.0	7.3
3494.1	59.0	---	74.0	15.0
3494.4	---	46.4	54.0	7.6
22000.2	---	39.3	54.0	14.7

**Radiated Spurious – CH78**

Frequency	MaxPeak	Avg	Limit	Margin
MHz	dBuV/m	dBuV/m	dBuV/m	dB
62.5	30.6	---	40.0	9.4
2402.8	56.3	---	74.0	17.7
2403.4	---	47.6	54.0	6.4
2455.0	---	47.1	54.0	6.9
2455.3	57.1	---	74.0	16.9
2556.9	57.1	---	74.0	16.9
2557.2	---	<b>48.0</b>	54.0	6.0
2633.4	---	46.7	54.0	7.3
2633.4	56.5	---	74.0	17.5
3441.3	60.7	---	74.0	13.4
3443.4	---	46.5	54.0	7.5
17491.1	58.1	---	74.0	16.0
17491.5	---	45.0	54.0	9.0
22000.2	45.8	---	74.0	28.2
22000.2	---	41.8	54.0	12.2

### C.1.6 AC power-line conducted emission

**Standard references:**

FCC part	RSS part	Limits														
15.207 15.407 (6)	RSS-GEN, Clause 8.8	<p>Except as shown in paragraphs (b) and (c) of this section, for an intentional radiator that is designed to be connected to the public utility (AC) power line, the radio frequency voltage that is conducted back onto the AC power line on any frequency or frequencies, within the band 150 kHz to 30 MHz, shall not exceed the limits in the following table, as measured using a 50 <math>\mu</math>H/50 ohms line impedance stabilization network (LISN). Compliance with the provisions of this paragraph shall be based on the measurement of the radio frequency voltage between each power line and ground at the power terminal. The lower limit applies at the boundary between the frequency ranges.</p> <table border="1"> <thead> <tr> <th rowspan="2">Frequency of emission (MHz)</th> <th colspan="2">Conducted limit (dB<math>\mu</math>V)</th> </tr> <tr> <th>Quasi-peak</th> <th>Average</th> </tr> </thead> <tbody> <tr> <td>0.15-0.5</td> <td>66 to 56*</td> <td>56 to 46*</td> </tr> <tr> <td>0.5-5</td> <td>56</td> <td>46</td> </tr> <tr> <td>5-30</td> <td>60</td> <td>50</td> </tr> </tbody> </table> <p>*Decreases with the logarithm of the frequency.</p>	Frequency of emission (MHz)	Conducted limit (dB $\mu$ V)		Quasi-peak	Average	0.15-0.5	66 to 56*	56 to 46*	0.5-5	56	46	5-30	60	50
Frequency of emission (MHz)	Conducted limit (dB $\mu$ V)															
	Quasi-peak	Average														
0.15-0.5	66 to 56*	56 to 46*														
0.5-5	56	46														
5-30	60	50														

**Test procedure:**

The EUT and peripherals are placed on a wooden table with a nominal size of 1.0 m by 1.5 m, raised 80 cm above the reference ground plane. The EUT is connected to AC-Power line through a Line Impedance Stabilization Network (LISN) to accommodate a 50  $\Omega$ /50  $\mu$ H coupling impedance for the measurement system. The EUT control PC is considered as a peripheric and therefore is connected to a second LISN which has the measurement port connected to a 50 ohms impedance.

Each measurement is done for each current-carrying conductor (Line and Neutral) at the end plug of the EUT power cord. The EUT is tested for several transmission modes (frequency channel, modulation, etc.) and the result providing the maximum measured emission is reported.

The exploratory measurement is done over the frequency range from 150 kHz to 30 MHz, while the measurement receiver is recording the Peak and Average signal at 10 kHz steps in Max Hold mode. The cables manipulation is performed within the range of likely configurations to determine the maximum emission. Once the EUT cable configuration, arrangement and mode of operation that produced the emission with the highest amplitude relative to the limit is found the six highest AC power-line conducted emissions relative to 20 dB of the limit are reported as the final measurement. If fewer than six emission frequencies are within 20 dB of the limit, the noise level is reported. For the final measurement, the measurement receiver records the Quasi Peak values with 9 kHz resolution bandwidth and the average values with 10 kHz resolution bandwidth.

*EUT arrangement for AC power-line conducted emission tests*

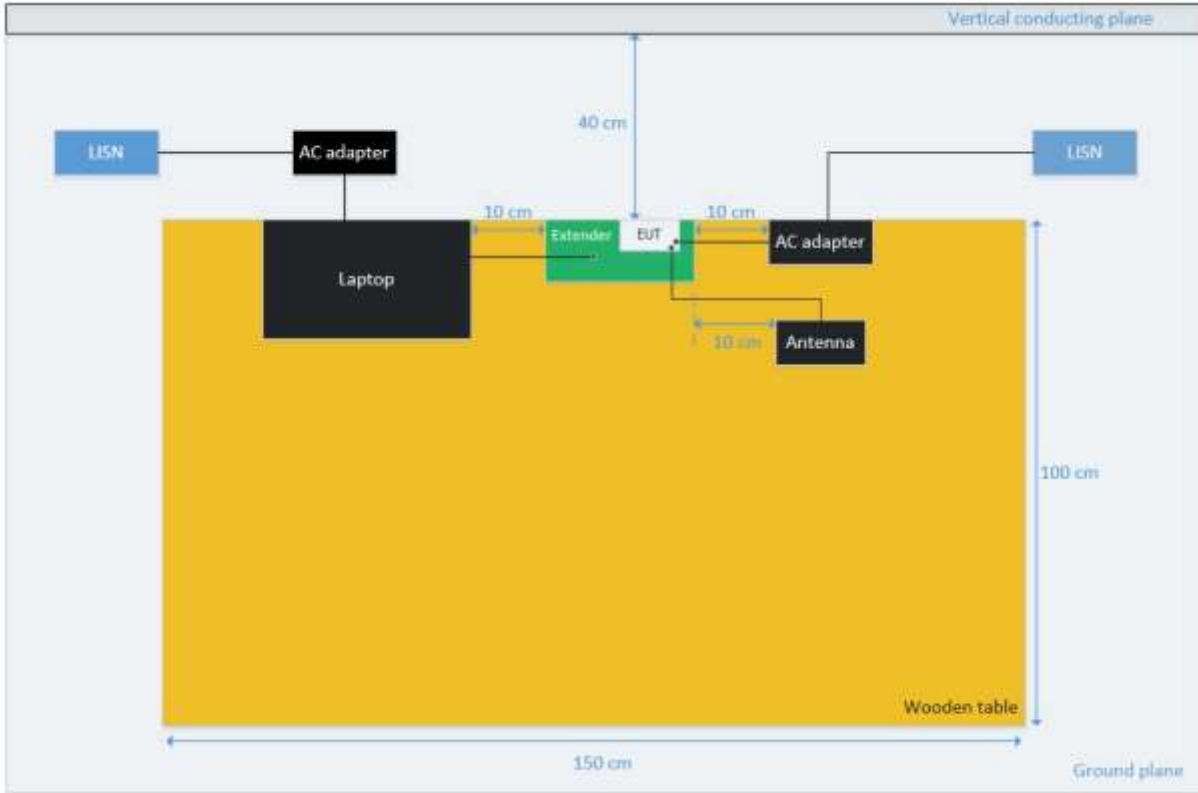

Sample Calculation:

The measured level at the spectrum analyzer in dBuV is corrected by a transducer factor taking into account the losses of the RF cable and the LISN as follows:

$$\text{Conducted Emission level (dBuV)} = \text{SA}_{\text{Level}} + \text{RFCable}_{\text{Losses}} + \text{LISN}_{\text{Losses}}$$

Where:

SA<sub>Level</sub> is the voltage level displayed on the measurement receiver, in dBuV.

RF<sub>Cable</sub><sub>Losses</sub> is the value of the cable losses between the LISN and the measurement receiver, in dB.

LISN<sub>Losses</sub> is the value of the insertion losses of the LISN, in dB.

**Test Results:**

**150kHz – 30MHz**

**AC power-line conducted – Phase L1**

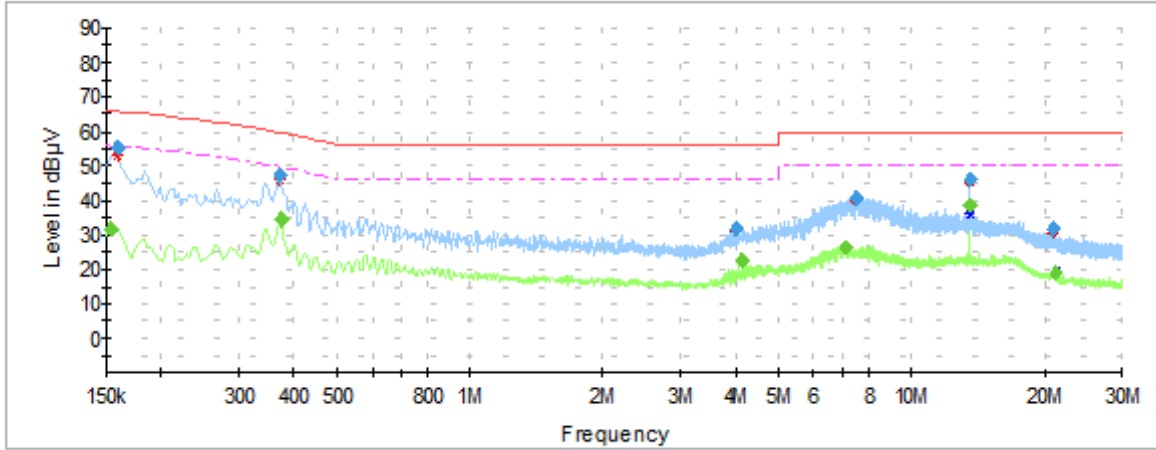

— Peak measurements      — Avg measurements      — Limit FCC Quasi-Peak      - - - Limit FCC Avg

Frequency MHz	Max Peak dBµV	Avg dBµV	Limit dBµV	Margin dB
0.1590	55.2	---	65.7	10.5
0.1530	---	31.7	55.9	24.2
0.3709	47.3	---	59.7	12.4
0.3739	---	34.4	49.6	15.2
3.9947	31.7	---	56.0	24.3
4.1260	---	22.6	46.0	23.4
7.4633	40.6	---	60.0	19.4
7.0842	---	26.4	50.0	23.6
13.5407	46.0	---	60.0	14
13.5616	---	38.4	50.0	11.6
20.9495	31.8	---	60.0	28.2
21.2151	---	19.1	50.0	30.9

Note: The emissions found do not change with the frequency.

**AC power-line conducted – Neutral N**

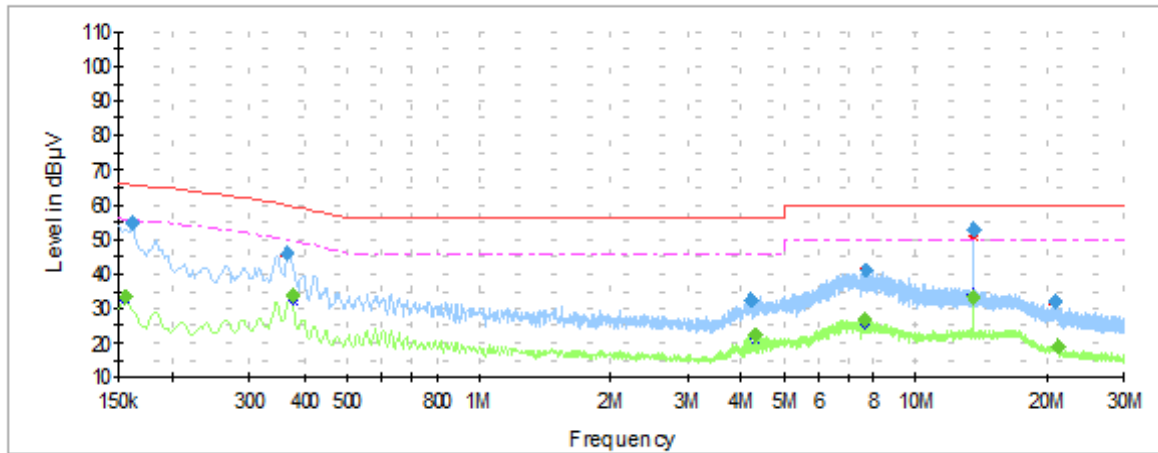

— Peak measurements      — Avg measurements      — Limit FCC Quasi-Peak      - - - Limit FCC Avg

Frequency	Max Peak	Avg	Limit	Margin
MHz	dBµV	dBµV	dBµV	dB
0.1619	54.8	---	65.7	10.9
0.1560	---	33.4	55.8	22.5
0.3649	45.9	---	59.9	14.0
0.3769	---	33.5	49.5	16.0
4.2126	32.4	---	56.0	23.7
4.2932	---	22.1	46.0	23.9
7.7170	41.1	---	60.0	18.9
7.6662	---	26.8	50.0	23.2
13.5676	52.8	---	60.0	7.2
13.5676	---	33.1	50.0	16.9
20.8629	31.9	---	60.0	28.1
21.1763	---	19.1	50.0	30.9

Note: The emissions found do not change with the frequency.