



**FCC CFR47 PART 15 SUBPART C
INDUSTRY CANADA RSS-210 ISSUE 7**

CERTIFICATION TEST REPORT

FOR

802.11 b/g/n WLAN MODULE

MODEL NUMBER: SDGOB-1091

FCC ID: B94SDGOB1091

IC: 466D-SDGOB091

REPORT NUMBER: 10U13408-1

ISSUE DATE: OCTOBER 12, 2010

Prepared for

**HEWLETT PACKARD COMPANY
3000 HANOVER STREET
PALO ALTO, CA 94304, U.S.A.**

Prepared by

**COMPLIANCE CERTIFICATION SERVICES (UL CCS)
47173 BENICIA STREET
FREMONT, CA 94538, U.S.A.
TEL: (510) 771-1000
FAX: (510) 661-0888**



NVLAP LAB CODE 200065-0

Revision History

<u>Rev.</u>	<u>Issue Date</u>	<u>Revisions</u>	<u>Revised By</u>
--	10/12/10	Initial Issue	M. Heckrotte

TABLE OF CONTENTS

1. ATTESTATION OF TEST RESULTS	5
2. TEST METHODOLOGY	6
3. FACILITIES AND ACCREDITATION	6
4. CALIBRATION AND UNCERTAINTY	6
4.1. MEASURING INSTRUMENT CALIBRATION	6
4.2. SAMPLE CALCULATION	6
4.3. MEASUREMENT UNCERTAINTY	6
5. EQUIPMENT UNDER TEST	7
5.1. DESCRIPTION OF EUT	7
5.2. MAXIMUM OUTPUT POWER	7
5.3. DESCRIPTION OF AVAILABLE ANTENNAS	7
5.4. SOFTWARE AND FIRMWARE	7
5.5. NUMBER OF TRANSMIT CHAINS	7
5.6. WORST-CASE CONFIGURATION AND MODE	7
5.7. DESCRIPTION OF TEST SETUP	9
6. TEST AND MEASUREMENT EQUIPMENT	11
7. ANTENNA PORT TEST RESULTS	12
7.1. 802.11b MODE IN THE 2.4 GHz BAND	12
7.1.1. 6 dB BANDWIDTH	12
7.1.2. 99% BANDWIDTH	15
7.1.3. OUTPUT POWER	18
7.1.4. POWER SPECTRAL DENSITY	19
7.1.5. CONDUCTED SPURIOUS EMISSIONS	22
7.2. 802.11g MODE IN THE 2.4 GHz BAND	26
7.2.1. 6 dB BANDWIDTH	26
7.2.2. 99% BANDWIDTH	29
7.2.3. OUTPUT POWER	32
7.2.4. POWER SPECTRAL DENSITY	33
7.2.5. CONDUCTED SPURIOUS EMISSIONS	36
8. RADIATED TEST RESULTS	40
8.1. LIMITS AND PROCEDURE	40
8.1.1. TRANSMITTER ABOVE 1 GHz FOR 802.11b MODE IN THE 2.4 GHz BAND	41
8.1.2. TRANSMITTER ABOVE 1 GHz FOR 802.11g MODE IN THE 2.4 GHz BAND	44
8.2. RECEIVER ABOVE 1 GHz IN THE 2.4 GHz BAND	47
8.3. WORST-CASE BELOW 1 GHz	48

9. AC POWER LINE CONDUCTED EMISSIONS49

10. MAXIMUM PERMISSIBLE EXPOSURE53

11. SETUP PHOTOS56

1. ATTESTATION OF TEST RESULTS

COMPANY NAME: HEWLETT PACKARD COMPANY
3000 HANOVER STREET
PALO ALTO, CA 94304, USA

EUT DESCRIPTION: 802.11 b/g/n WLAN MODULE

MODEL: SDGOB-1091

SERIAL NUMBER: 213

DATE TESTED: SEPTEMBER 16 – 27, 2010

APPLICABLE STANDARDS	
STANDARD	TEST RESULTS
CFR 47 Part 15 Subpart C	Pass
INDUSTRY CANADA RSS-210 Issue 7 Annex 8	Pass
INDUSTRY CANADA RSS-GEN Issue 2	Pass

Compliance Certification Services, Inc. (UL CCS) tested the above equipment in accordance with the requirements set forth in the above standards. All indications of Pass/Fail in this report are opinions expressed by UL CCS based on interpretations and/or observations of test results. Measurement Uncertainties were not taken into account and are published for informational purposes only. The test results show that the equipment tested is capable of demonstrating compliance with the requirements as documented in this report.

Note: The results documented in this report apply only to the tested sample, under the conditions and modes of operation as described herein. This document may not be altered or revised in any way unless done so by UL CCS and all revisions are duly noted in the revisions section. Any alteration of this document not carried out by UL CCS will constitute fraud and shall nullify the document. This report must not be used by the client to claim product certification, approval, or endorsement by NVLAP, NIST, any agency of the Federal Government, or any agency of any government.

Approved & Released For UL CCS By:

Tested By:



MICHAEL HECKROTTE
DIRECTOR OF ENGINEERING
UL CCS

VIEN TRAN
EMC ENGINEER
UL CCS

2. TEST METHODOLOGY

The tests documented in this report were performed in accordance with ANSI C63.4-2003, FCC CFR 47 Part 2, FCC CFR 47 Part 15, RSS-GEN Issue 2, and RSS-210 Issue 7.

3. FACILITIES AND ACCREDITATION

The test sites and measurement facilities used to collect data are located at 47173 Benicia Street, Fremont, California, USA.

UL CCS is accredited by NVLAP, Laboratory Code 200065-0. The full scope of accreditation can be viewed at <http://www.ccsemc.com>.

4. CALIBRATION AND UNCERTAINTY

4.1. MEASURING INSTRUMENT CALIBRATION

The measuring equipment utilized to perform the tests documented in this report has been calibrated in accordance with the manufacturer's recommendations, and is traceable to recognized national standards.

4.2. SAMPLE CALCULATION

Where relevant, the following sample calculation is provided:

$$\begin{aligned} \text{Field Strength (dBuV/m)} &= \text{Measured Voltage (dBuV)} + \text{Antenna Factor (dB/m)} + \\ &\text{Cable Loss (dB)} - \text{Preamp Gain (dB)} \\ 36.5 \text{ dBuV} + 18.7 \text{ dB/m} + 0.6 \text{ dB} - 26.9 \text{ dB} &= 28.9 \text{ dBuV/m} \end{aligned}$$

4.3. MEASUREMENT UNCERTAINTY

Where relevant, the following measurement uncertainty levels have been estimated for tests performed on the apparatus:

PARAMETER	UNCERTAINTY
Conducted Disturbance, 0.15 to 30 MHz	3.52 dB
Radiated Disturbance, 30 to 1000 MHz	4.94 dB

Uncertainty figures are valid to a confidence level of 95%.

5. EQUIPMENT UNDER TEST

5.1. DESCRIPTION OF EUT

The EUT is a transceiver 802.11 b/g/n WLAN printer module.
The radio module is manufactured by Broadcom.

5.2. MAXIMUM OUTPUT POWER

The transmitter has a maximum peak conducted output power as follows:

Frequency Range (MHz)	Mode	Output Power (dBm)	Output Power (mW)
2412 - 2462	802.11b	22.12	162.93
2412 - 2462	802.11g	23.91	246.04
2412 - 2462	802.11n HT20 SISO	Covered by the worst case 802.11g Mode Legacy testing	

5.3. DESCRIPTION OF AVAILABLE ANTENNAS

The radio utilizes an 802.11bgn WLAN antenna, with a maximum gain of 2.40dBi.

5.4. SOFTWARE AND FIRMWARE

The EUT driver software installed during testing was Broadcom version 5.90.42.0.
The test utility software used during testing was Broadcom version 5.90.RC42.0.

5.5. NUMBER OF TRANSMIT CHAINS

Selected measurements were performed on the Main and Auxiliary chains for 802.11b/g mode; however only one of these chains will be transmitting at any time.

5.6. WORST-CASE CONFIGURATION AND MODE

The EUT was tested as an external module installed in a test jig board connected to a host Laptop PC.

Worst-Case data rates were utilized from preliminary testing of the chipset, worst-case data rates used during the testing are as follows:

802.11b Mode (20 MHz BW operation): 1 Mbps, CCK.
802.11g Mode (20 MHz BW operation): 6 Mbps, OFDM.

Worst-case mode and channel used for 30-1000 MHz radiated and power line conducted emissions was the mode and channel with the highest output power, that was determined to be 11g mode, mid channel.

For Radiated Band Edge measurements preliminary testing showed that the worst case was horizontal polarization, so final measurements were performed with horizontal polarization.

5.7. DESCRIPTION OF TEST SETUP

SUPPORT EQUIPMENT

PERIPHERAL SUPPORT EQUIPMENT LIST				
Description	Manufacturer	Model	Serial Number	FCC ID
Laptop	Dell	Latitude D430	N/A	DoC
AC Adapter	Dell	ADP-90AH B	CN-00C8023-48661-5C9-G7X3	N/A
Ribbon Cable	Precisionint	N/A	0138506 38050KL 20	N/A
PCI	N/A	45	N/A	N/A
Adapter Board	Broadcom	BCRM94336SDGPAD	1362612	N/A

I/O CABLES

I/O CABLE LIST						
Cable No.	Port	# of Identical Ports	Connector Type	Cable Type	Cable Length	Remarks
1	AC	1	AC	Unshielded	1.8 m	N/A
2	DC	1	DC	Unshielded	1.8 m	Ferrite on laptop's end
3	Interface	1	Ribbon Cable	Unshielded	0.3m	N/A

TEST SETUP

The EUT is connected to a host laptop computer via PCI card to MiniPCI-E adapter board during the test. Test software exercised the radio card.

SETUP DIAGRAM

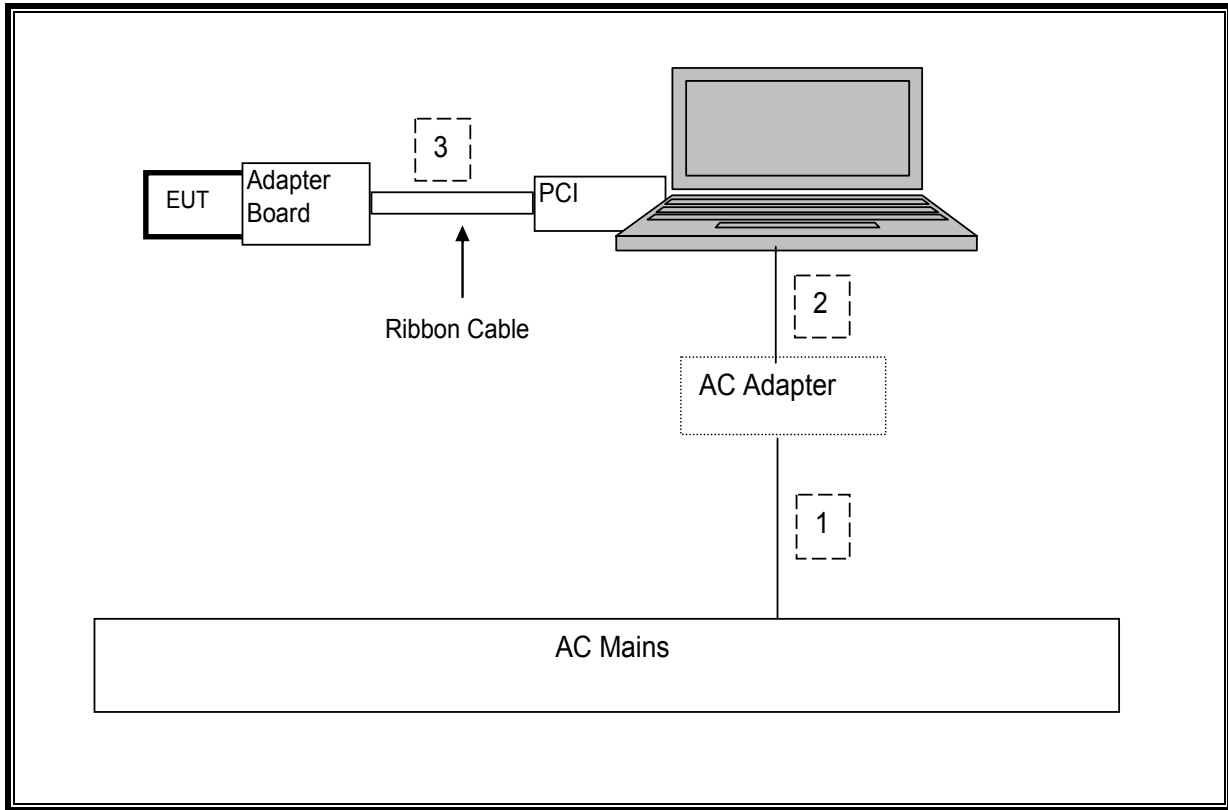

6. TEST AND MEASUREMENT EQUIPMENT

The following test and measurement equipment was utilized for the tests documented in this report:

TEST EQUIPMENT LIST					
Description	Manufacturer	Model	Asset	Cal Date	Cal Due
Antenna, Bilog, 2 GHz	Sunol Sciences	JB1	C01171	01/14/09	07/14/11
Antenna, Horn, 18 GHz	EMCO	3115	C00872	01/29/09	07/29/11
Antenna, Horn, 26.5 GHz	ARA	MWH-1826/B	C00980	01/29/09	07/29/11
Preamplifier, 1300 MHz	Agilent / HP	8447D	C00778	01/06/10	07/06/11
Preamplifier, 26.5 GHz	Agilent / HP	8449B	C00749	02/04/09	08/04/11
Spectrum Analyzer, 44 GHz	Agilent / HP	E4446A	C00996	04/29/10	10/29/10
Peak Power Meter	Boonton	4541	C01186	03/01/10	03/01/11
Peak Power Sensor	Boonton	57318	0	02/24/10	02/24/11
Peak Power Meter	Agilent / HP	E9327A	C00964	01/07/10	12/04/11
Peak Power Sensor	Agilent / HP	E4416A	C00963	12/04/09	12/04/11
EMI Receiver, 6.5 GHz	Agilent / HP	8546A	1963	05/19/10	08/19/11
Reject Filter, 2.4-2.5 GHz	Micro-Tronics	BRM50702	N02685	01/00/00	CNR
LISN, 10 kHz ~ 30 MHz	Solar	8012-50-R-24-	N02481	11/05/09	11/05/10
EMI Test Receiver, 30 MHz	R & S	ESHS 20	N02396	08/06/09	05/06/11

7. ANTENNA PORT TEST RESULTS

7.1. 802.11b MODE IN THE 2.4 GHz BAND

7.1.1. 6 dB BANDWIDTH

LIMITS

FCC §15.247 (a) (2)

IC RSS-210 A8.2 (a)

The minimum 6 dB bandwidth shall be at least 500 kHz.

TEST PROCEDURE

The transmitter output is connected to a spectrum analyzer. The RBW is set to 100 kHz and the VBW is set to 300 kHz. The sweep time is coupled.

RESULTS

Channel	Frequency (MHz)	6 dB Bandwidth (MHz)	Minimum Limit (MHz)
Low	2412	8.00	0.5
Middle	2437	8.00	0.5
High	2462	7.58	0.5

6 dB BANDWIDTH

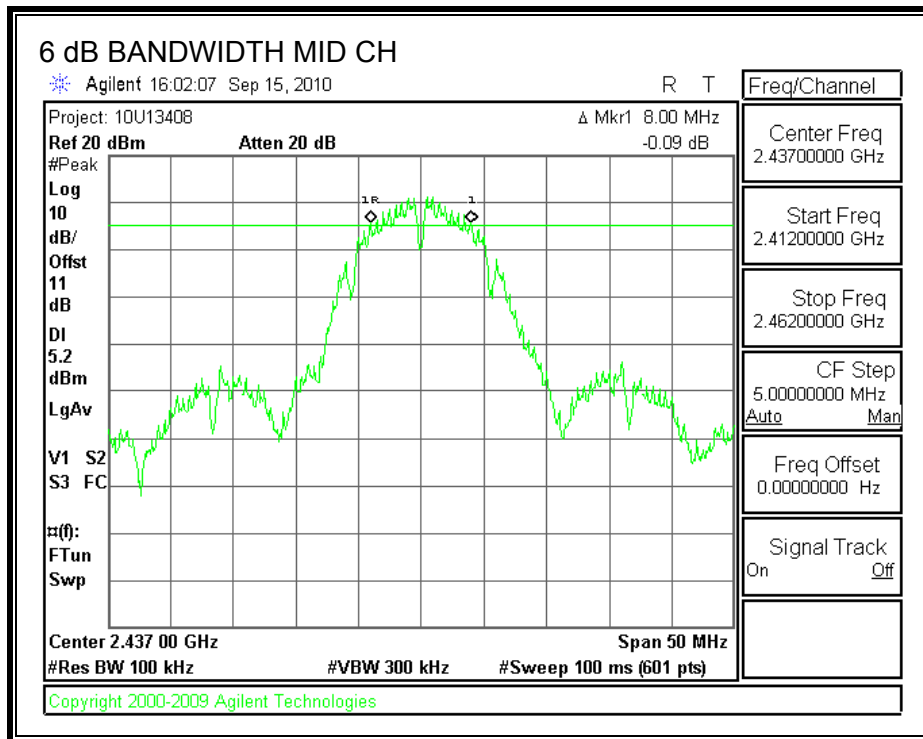
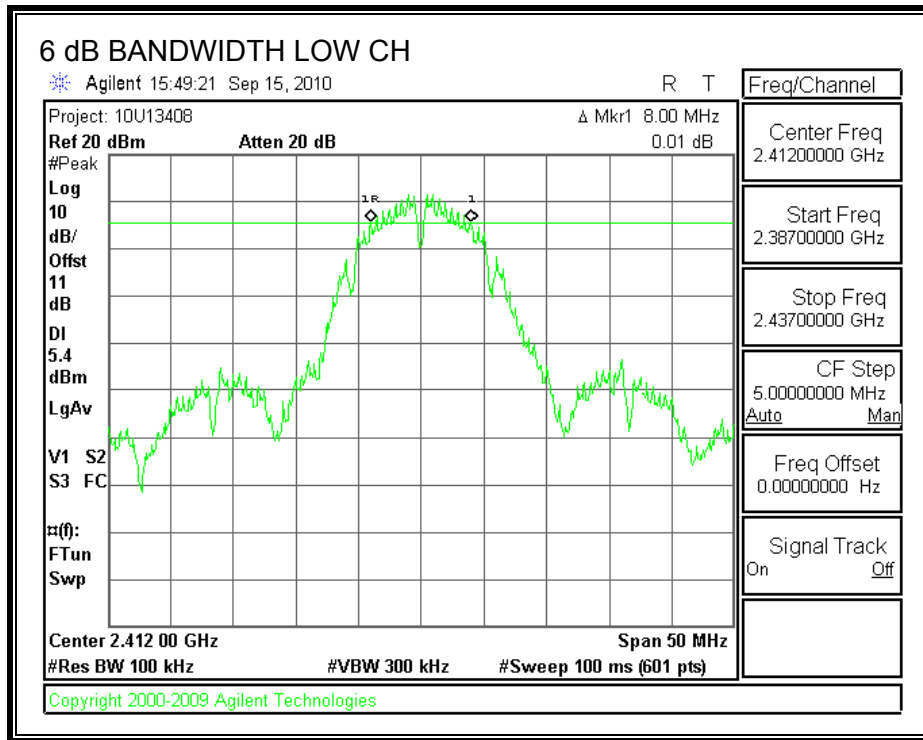

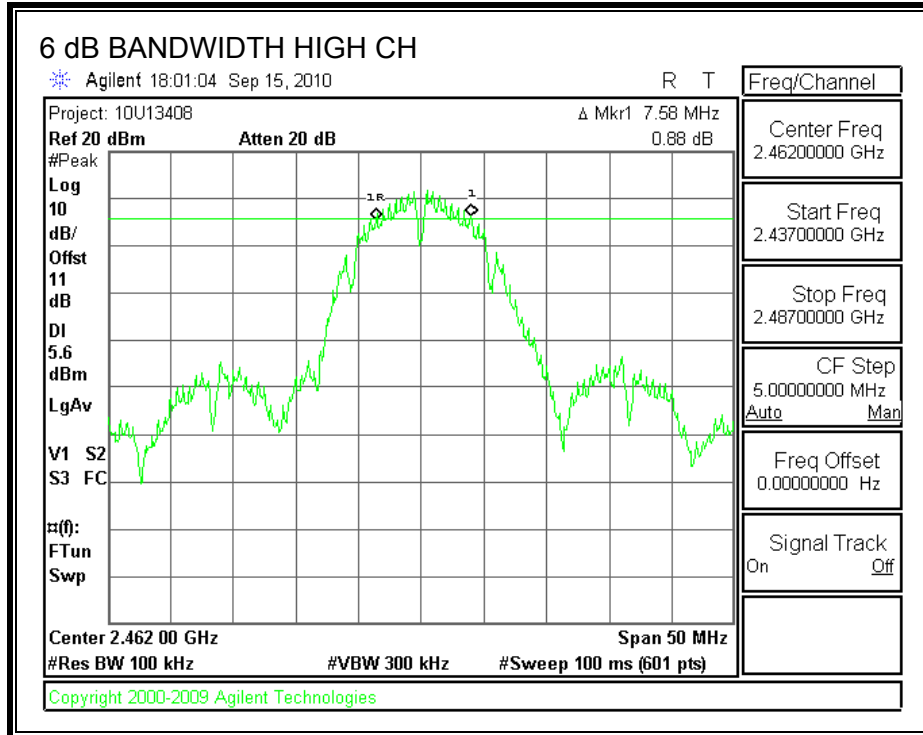

7.1.2. 99% BANDWIDTH

LIMITS

None; for reporting purposes only.

TEST PROCEDURE

The transmitter output is connected to the spectrum analyzer. The RBW is set to 1% to 3% of the 99 % bandwidth. The VBW is set to 3 times the RBW. The sweep time is coupled. The spectrum analyzer internal 99% bandwidth function is utilized.

RESULTS

Channel	Frequency (MHz)	99% Bandwidth (MHz)
Low	2412	11.75
Middle	2437	11.62
High	2462	12.55

99% BANDWIDTH

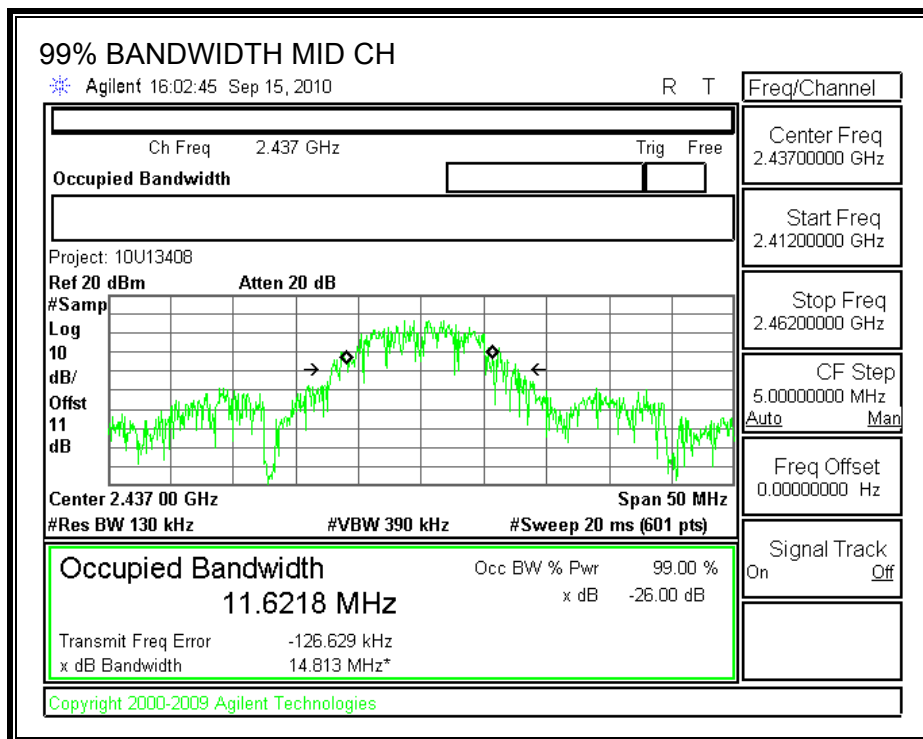
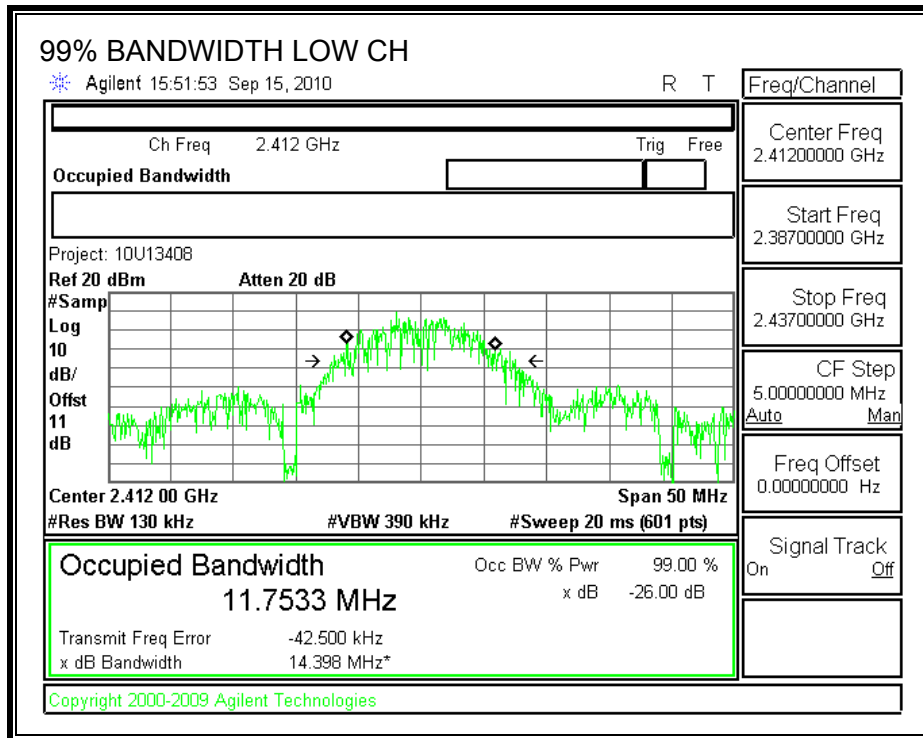

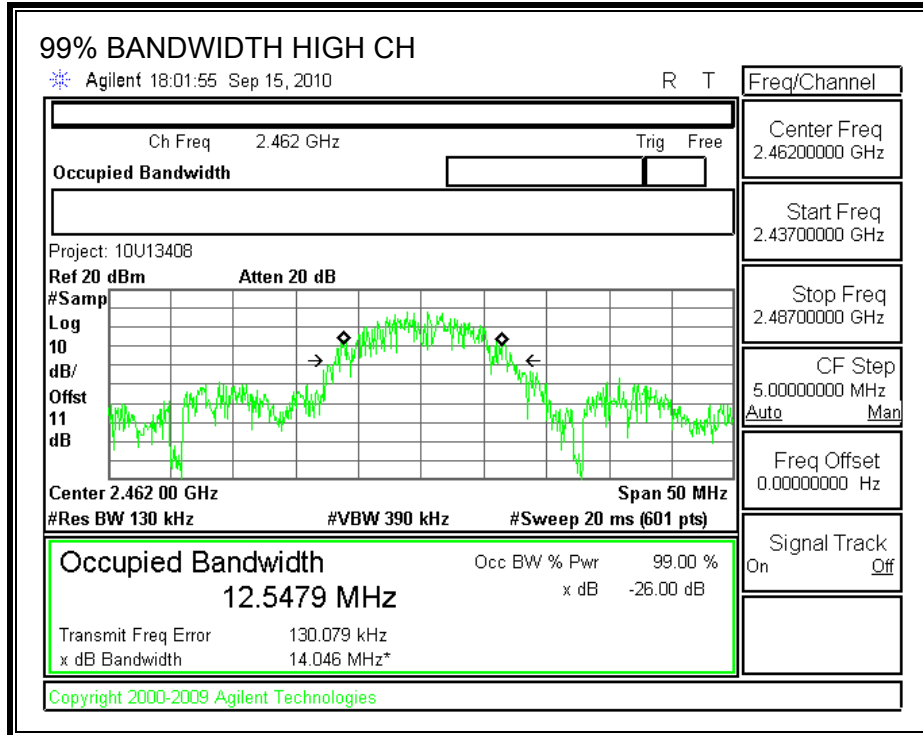

7.1.3. OUTPUT POWER

LIMITS

FCC §15.247 (b)

IC RSS-210 A8.4

The maximum antenna gain is less than or equal to 6 dBi, therefore the limit is 30 dBm.

TEST PROCEDURE

The transmitter output is connected to a power meter.

RESULTS

Channel	Frequency (MHz)	Peak Power Meter Reading (dBm)	Limit (dBm)	Margin (dB)
Low	2412	20.90	30	-9.10
Middle	2437	22.12	30	-7.88
High	2462	20.05	30	-9.95

7.1.4. POWER SPECTRAL DENSITY

LIMITS

FCC §15.247 (e)

IC RSS-210 A8.2 (b)

The power spectral density conducted from the transmitter to the antenna shall not be greater than 8 dBm in any 3 kHz band during any time interval of continuous transmission.

TEST PROCEDURE

Output power was measured based on the use of a peak measurement, therefore the power spectral density was measured using PSD Option 1 in accordance with FCC document "Measurement of Digital Transmission Systems Operating under Section 15.247", March 23, 2005.

RESULTS

Channel	Frequency (MHz)	PPSD (dBm)	Limit (dBm)	Margin (dB)
Low	2412	-0.84	8	-8.84
Middle	2437	-0.51	8	-8.51
High	2462	-0.17	8	-8.17

POWER SPECTRAL DENSITY

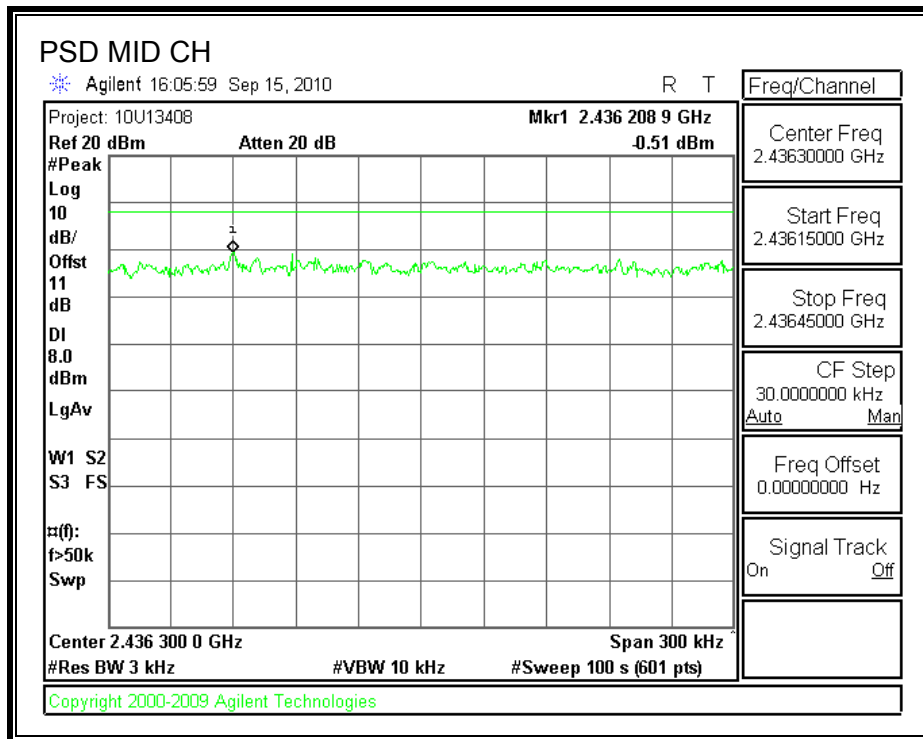
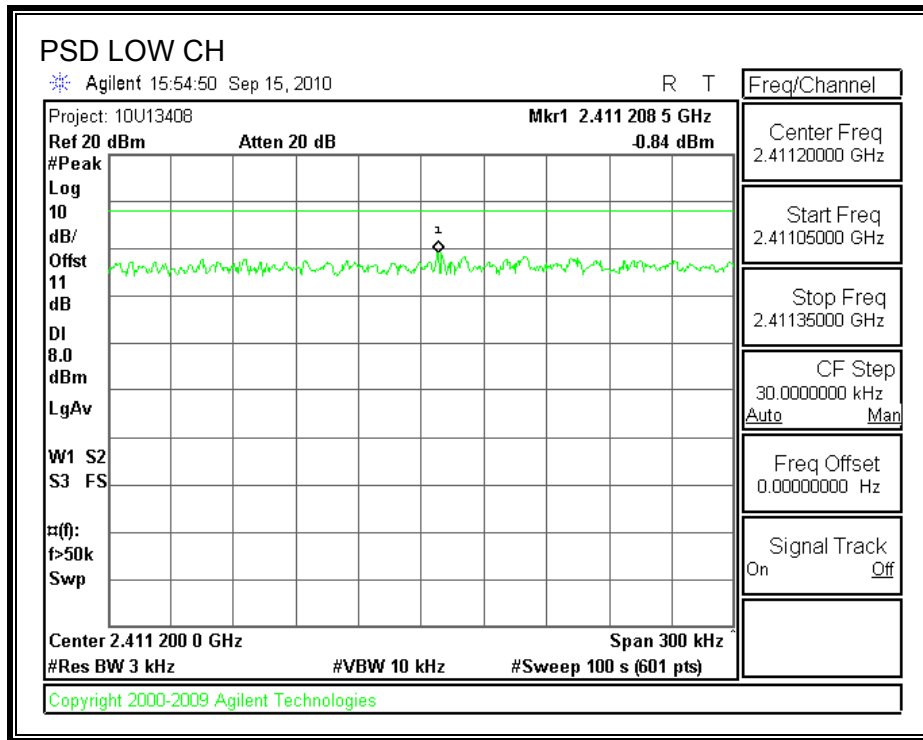

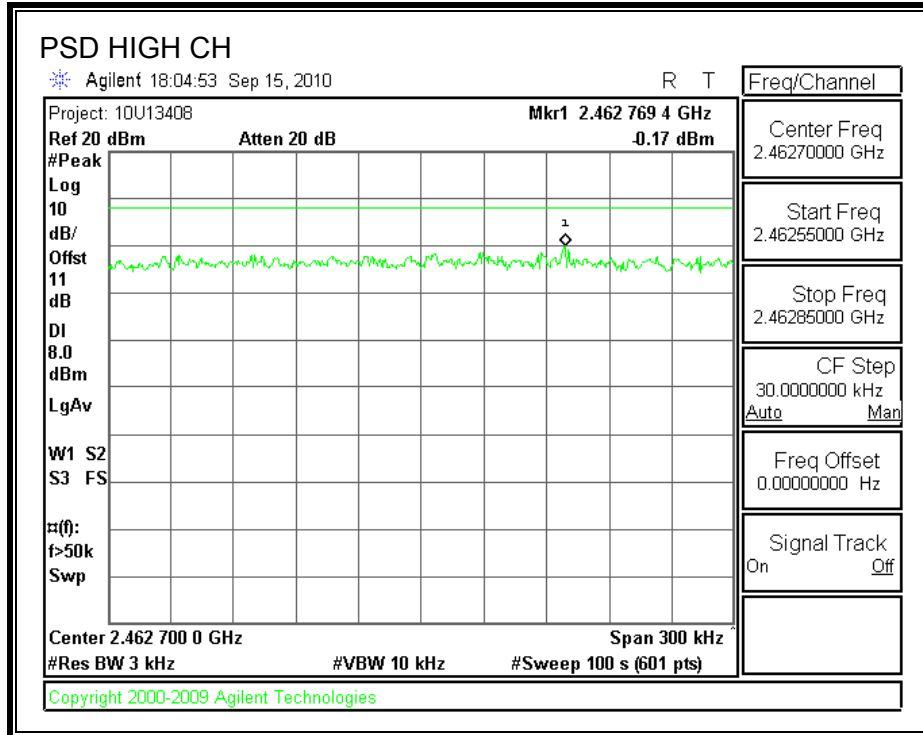

7.1.5. CONDUCTED SPURIOUS EMISSIONS

LIMITS

FCC §15.247 (d)

IC RSS-210 A8.5

Output power was measured based on the use of a peak measurement, therefore the required attenuation is 20 dB.

TEST PROCEDURE

The transmitter output is connected to a spectrum analyzer. The resolution bandwidth is set to 100 kHz. The video bandwidth is set to 300 kHz.

The spectrum from 30 MHz to 26 GHz is investigated with the transmitter set to the lowest, middle, and highest channels.

SPURIOUS EMISSIONS, LOW CHANNEL

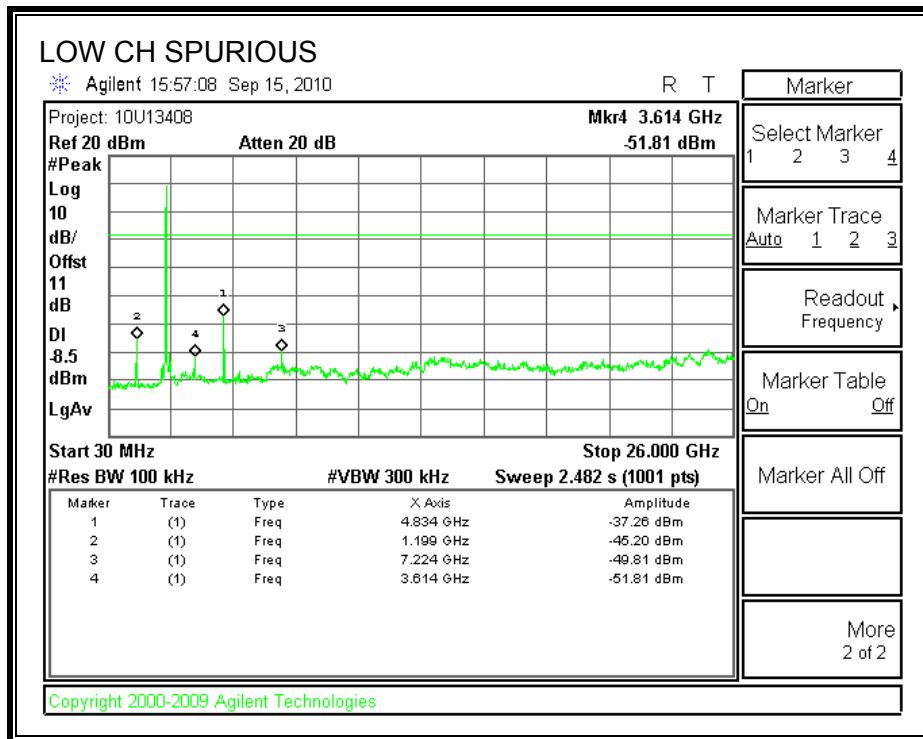
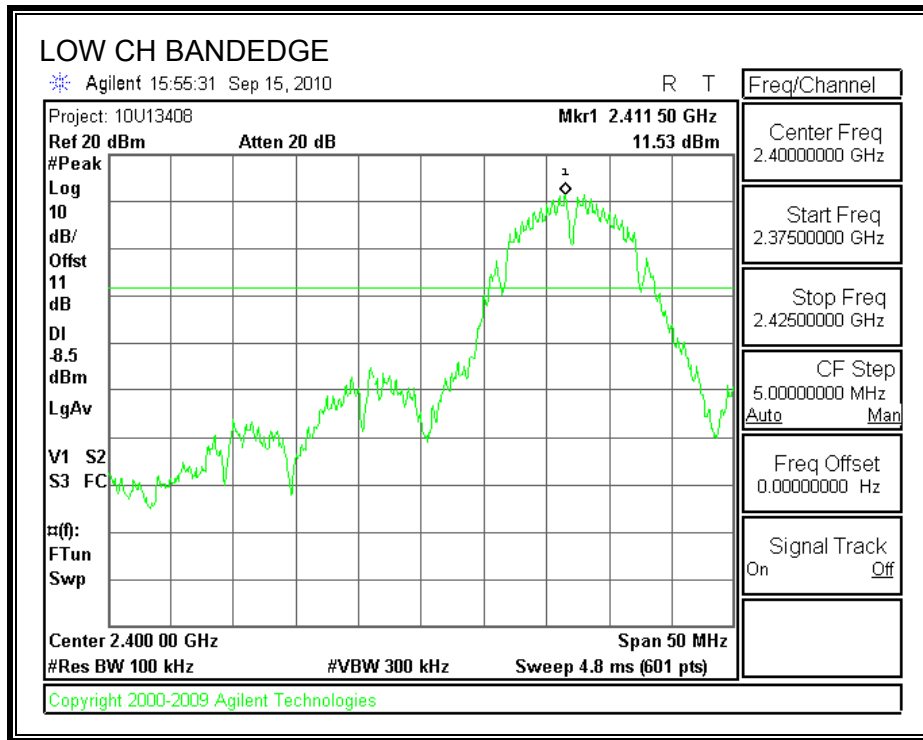

SPURIOUS EMISSIONS, MID CHANNEL

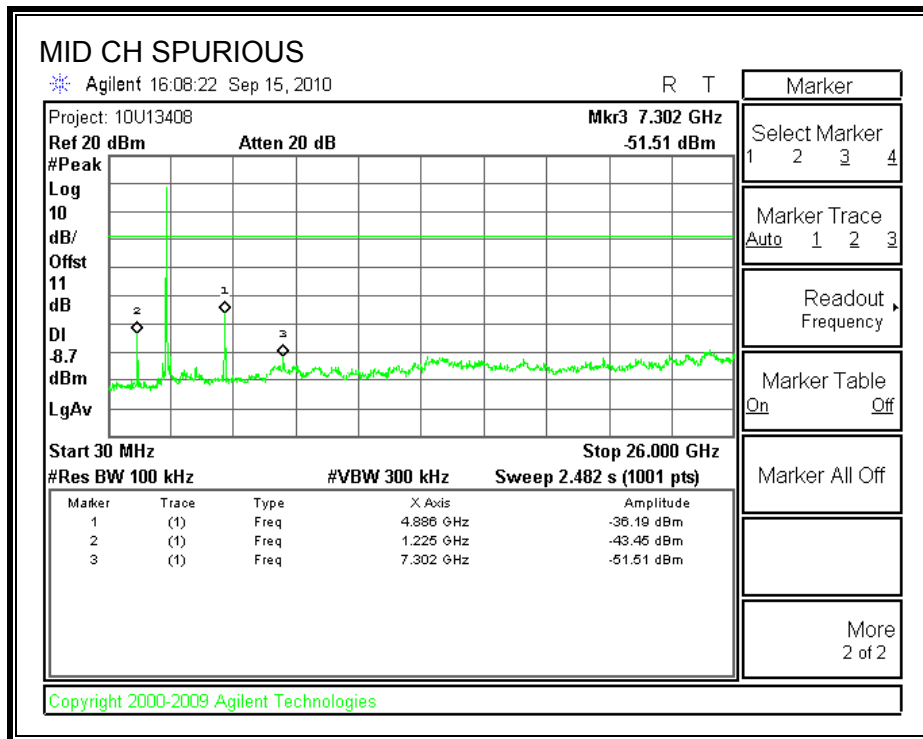
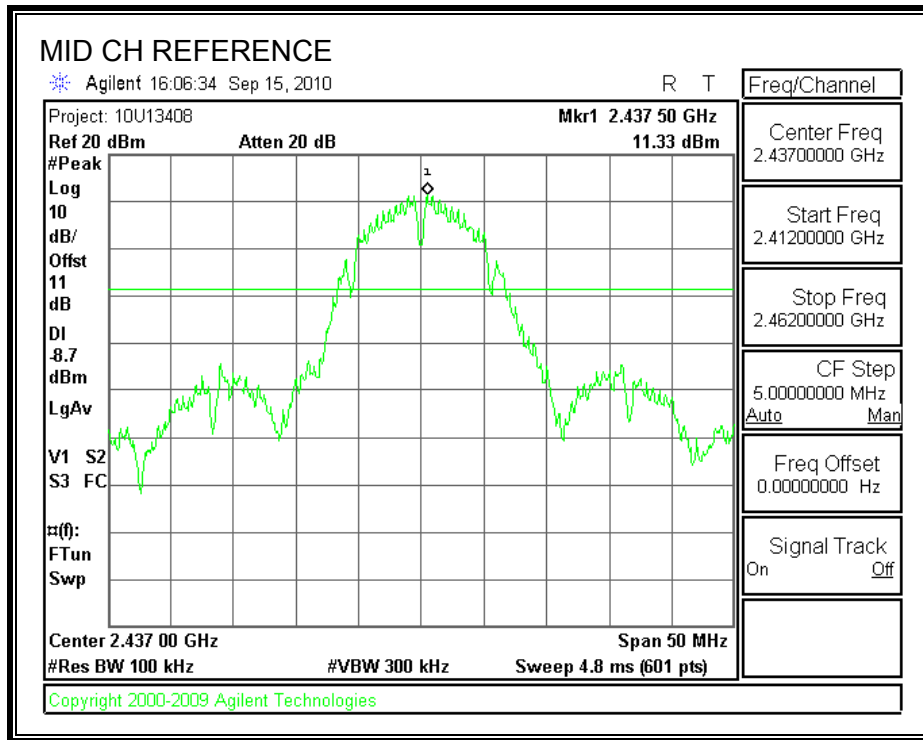

SPURIOUS EMISSIONS, HIGH CHANNEL

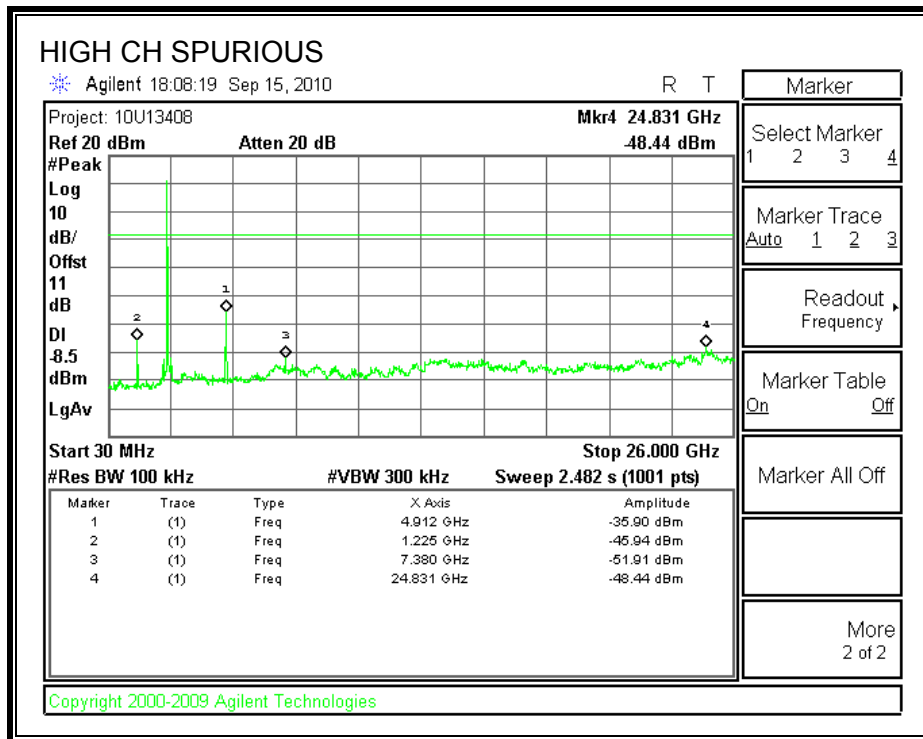
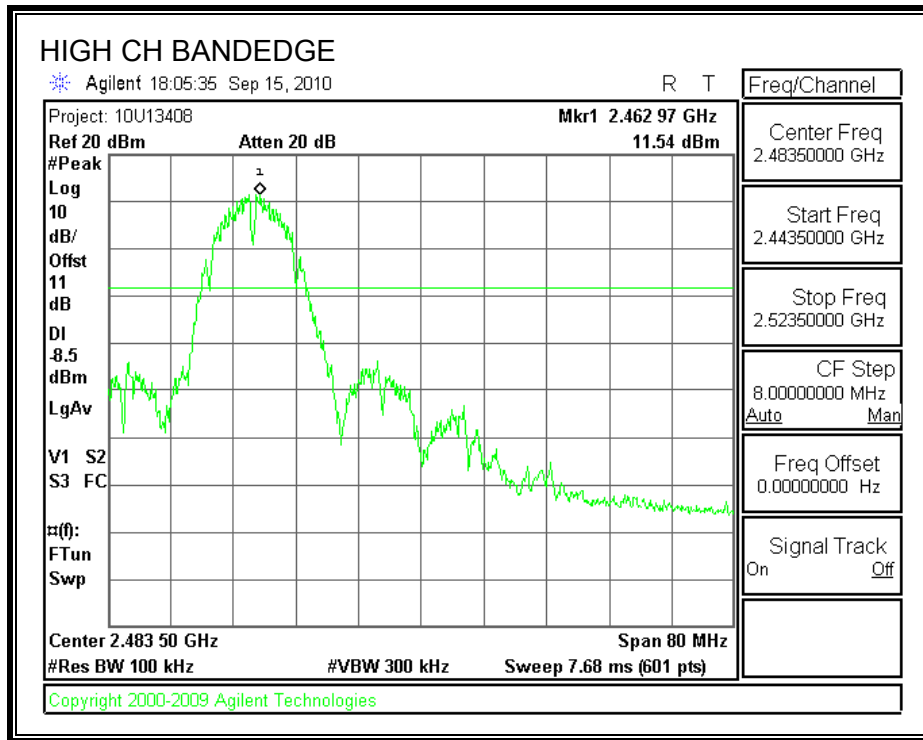

7.2. 802.11g MODE IN THE 2.4 GHz BAND

7.2.1. 6 dB BANDWIDTH

LIMITS

FCC §15.247 (a) (2)

IC RSS-210 A8.2 (a)

The minimum 6 dB bandwidth shall be at least 500 kHz.

TEST PROCEDURE

The transmitter output is connected to a spectrum analyzer. The RBW is set to 100 kHz and the VBW is set to 300 kHz. The sweep time is coupled.

RESULTS

Channel	Frequency (MHz)	6 dB Bandwidth (MHz)	Minimum Limit (MHz)
Low	2412	15.17	0.5
Middle	2437	15.17	0.5
High	2462	15.08	0.5

6 dB BANDWIDTH

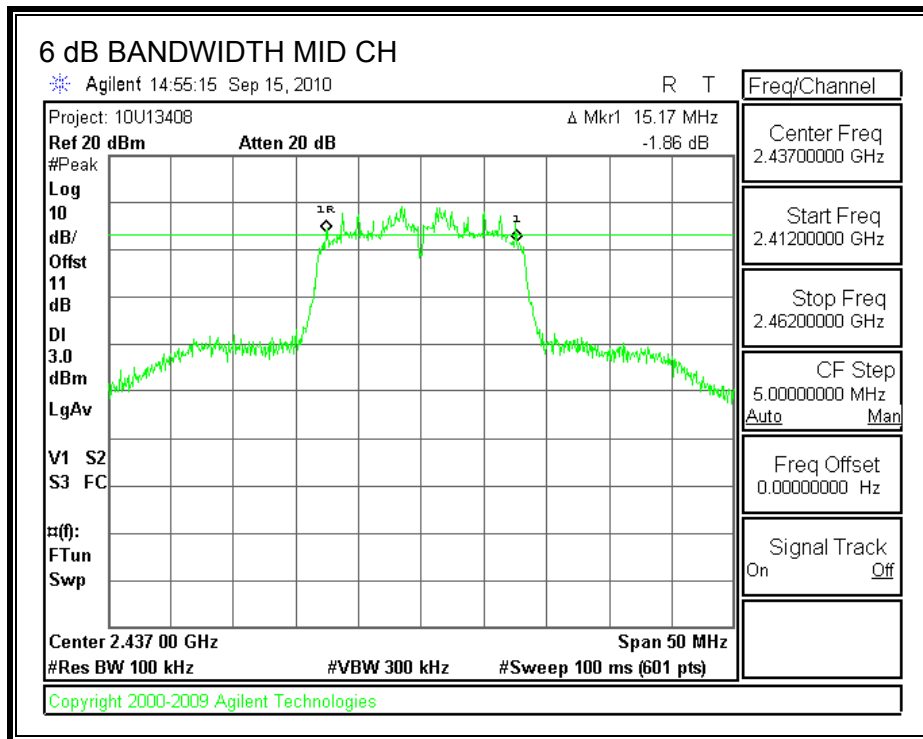
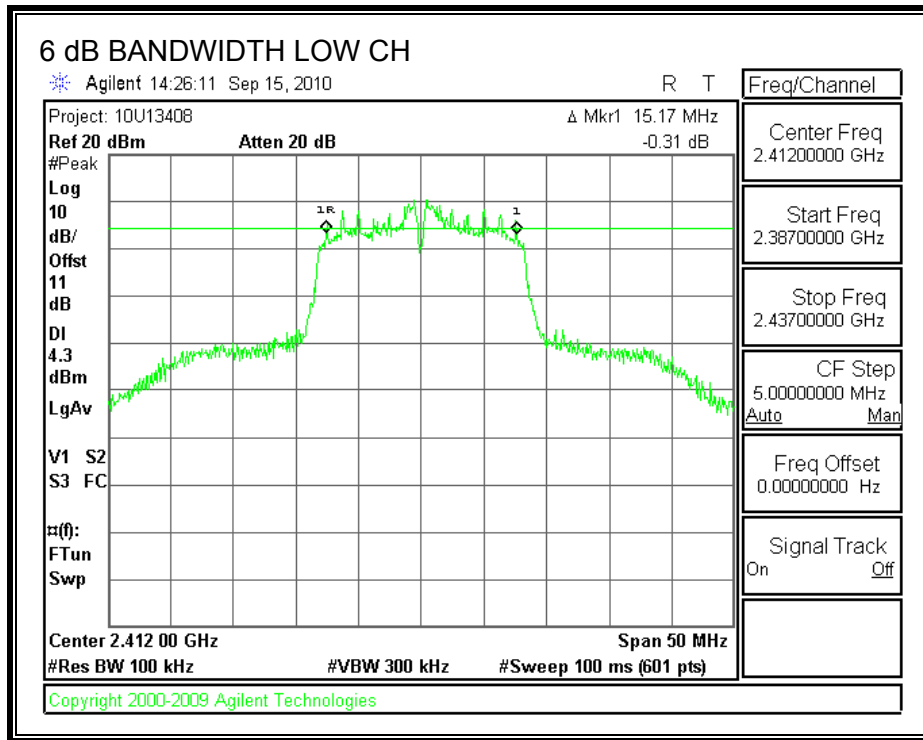

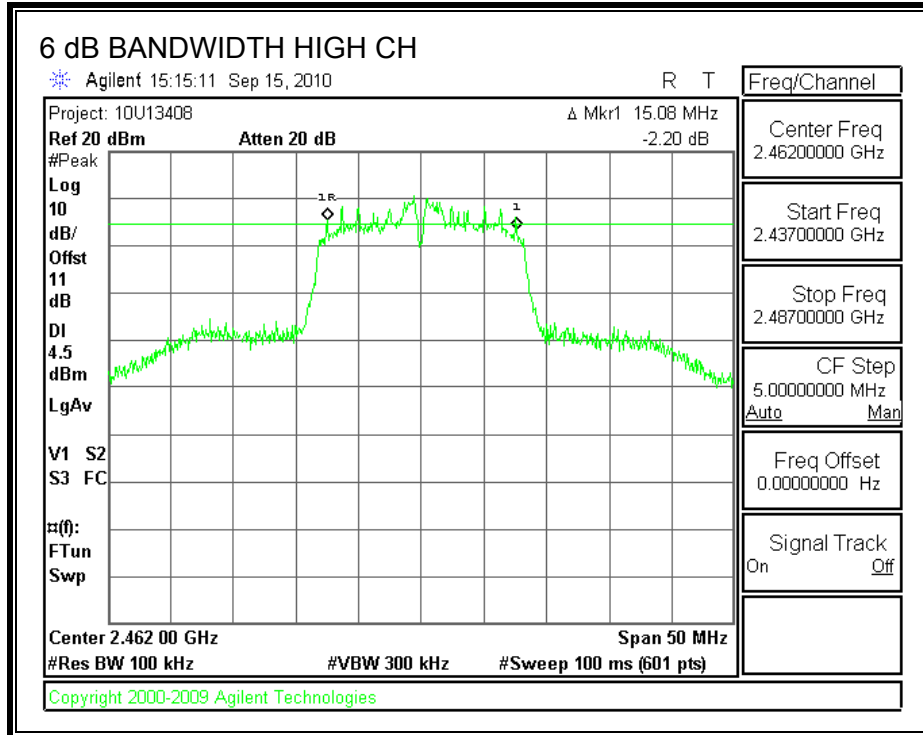

7.2.2. 99% BANDWIDTH

LIMITS

None; for reporting purposes only.

TEST PROCEDURE

The transmitter output is connected to the spectrum analyzer. The RBW is set to 1% to 3% of the 99 % bandwidth. The VBW is set to 3 times the RBW. The sweep time is coupled. The spectrum analyzer internal 99% bandwidth function is utilized.

RESULTS

Channel	Frequency (MHz)	99% Bandwidth (MHz)
Low	2412	16.42
Middle	2437	16.33
High	2462	16.36

99% BANDWIDTH

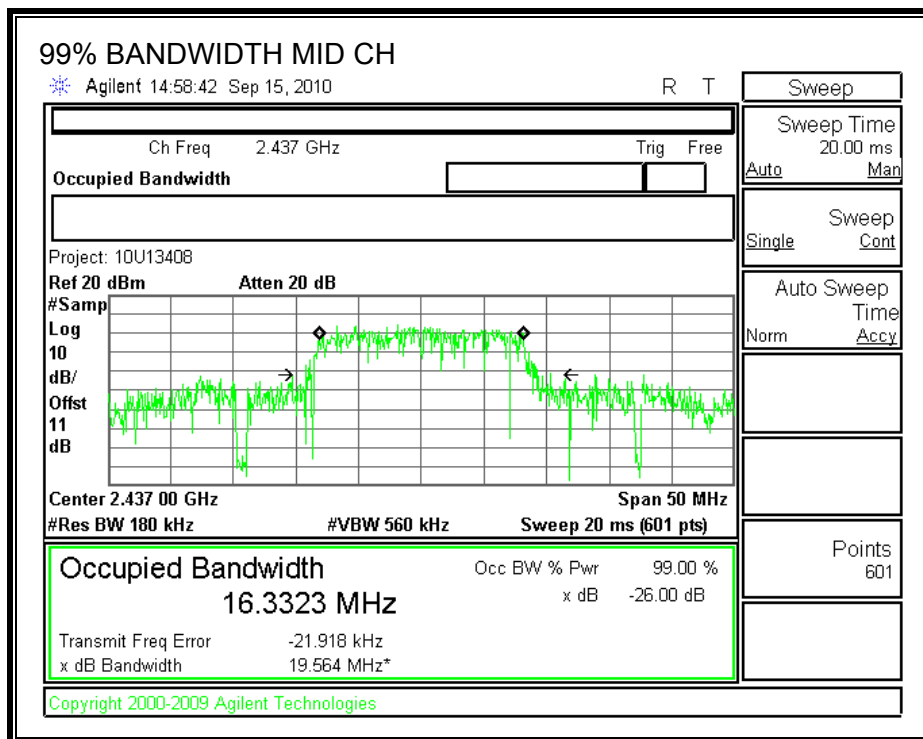
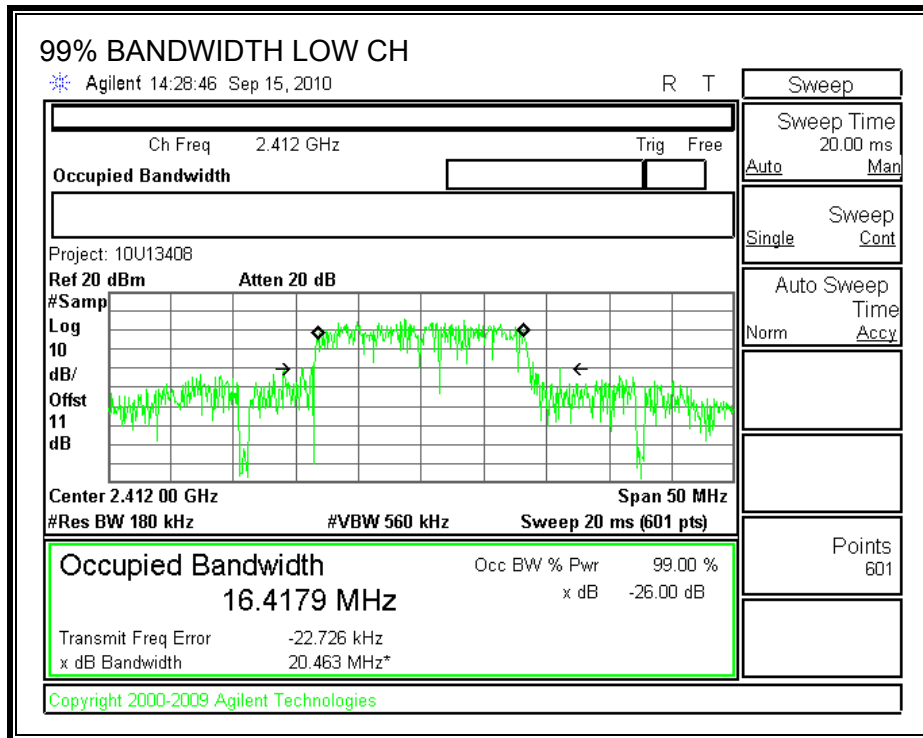

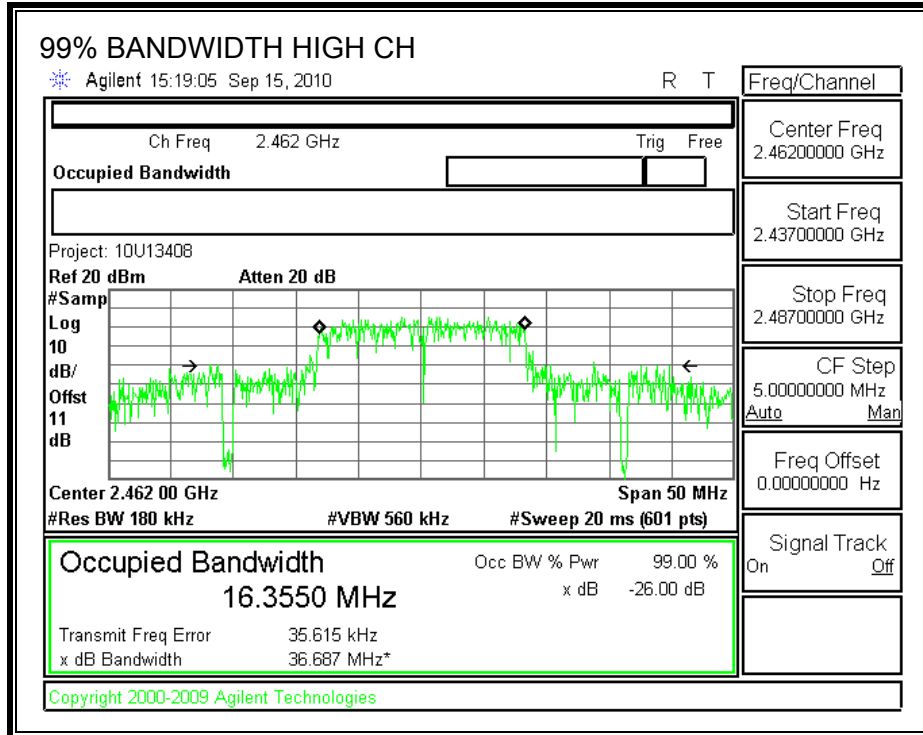

7.2.3. OUTPUT POWER

LIMITS

FCC §15.247 (b)

IC RSS-210 A8.4

The maximum antenna gain is less than or equal to 6 dBi, therefore the limit is 30 dBm.

TEST PROCEDURE

The transmitter output is connected to a power meter.

RESULTS

Channel	Frequency (MHz)	Peak Power Meter Reading (dBm)	Limit (dBm)	Margin (dB)
Low	2412	23.25	30	-6.75
Middle	2437	23.91	30	-6.09
High	2462	21.40	30	-8.60

7.2.4. POWER SPECTRAL DENSITY

LIMITS

FCC §15.247 (e)

IC RSS-210 A8.2 (b)

The power spectral density conducted from the transmitter to the antenna shall not be greater than 8 dBm in any 3 kHz band during any time interval of continuous transmission.

TEST PROCEDURE

Output power was measured based on the use of a peak measurement, therefore the power spectral density was measured using PSD Option 1 in accordance with FCC document "Measurement of Digital Transmission Systems Operating under Section 15.247", March 23, 2005.

RESULTS

Channel	Frequency (MHz)	PPSD (dBm)	Limit (dBm)	Margin (dB)
Low	2412	-4.80	8	-12.80
Middle	2437	-3.66	8	-11.66
High	2462	-3.38	8	-11.38

POWER SPECTRAL DENSITY

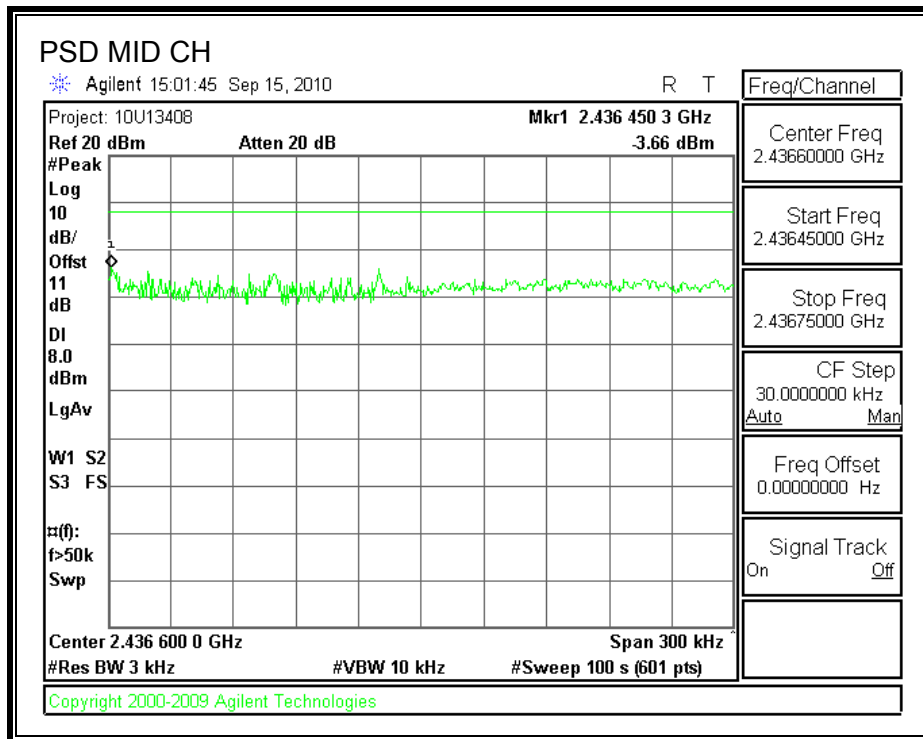
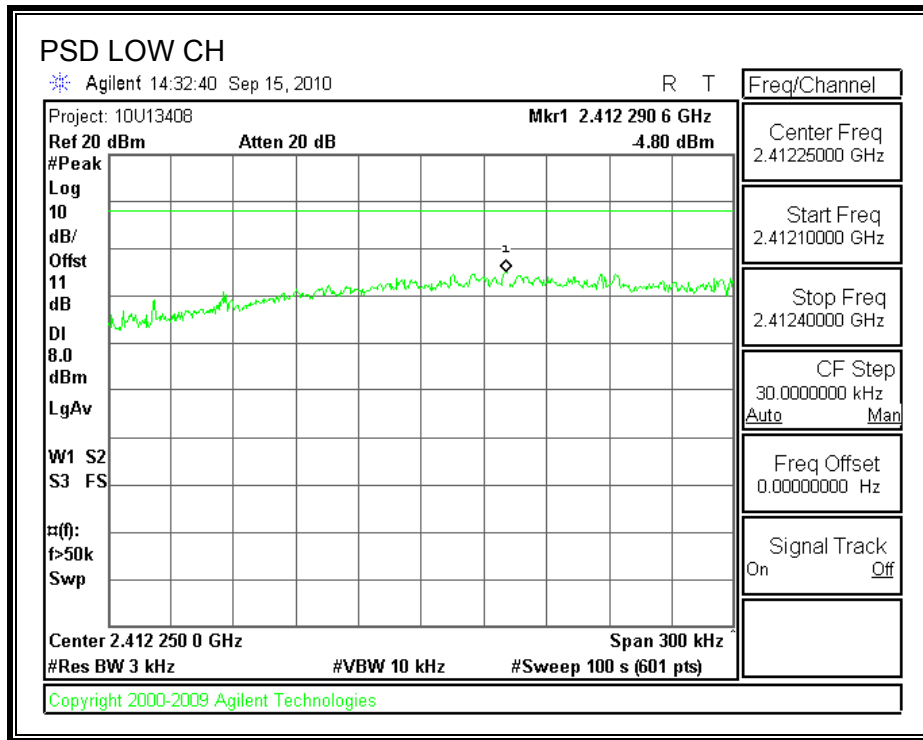

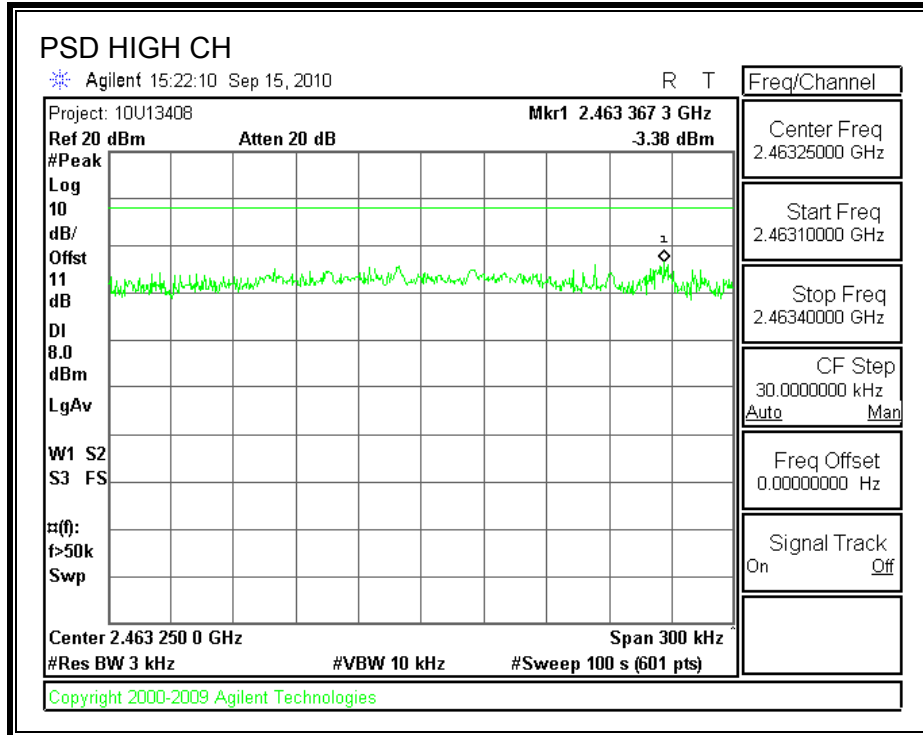

7.2.5. CONDUCTED SPURIOUS EMISSIONS

LIMITS

FCC §15.247 (d)

IC RSS-210 A8.5

Output power was measured based on the use of a peak measurement, therefore the required attenuation is 20 dB.

TEST PROCEDURE

The transmitter output is connected to a spectrum analyzer. The resolution bandwidth is set to 100 kHz. The video bandwidth is set to 300 kHz.

The spectrum from 30 MHz to 26 GHz is investigated with the transmitter set to the lowest, middle, and highest channels.

RESULTS

SPURIOUS EMISSIONS, LOW CHANNEL

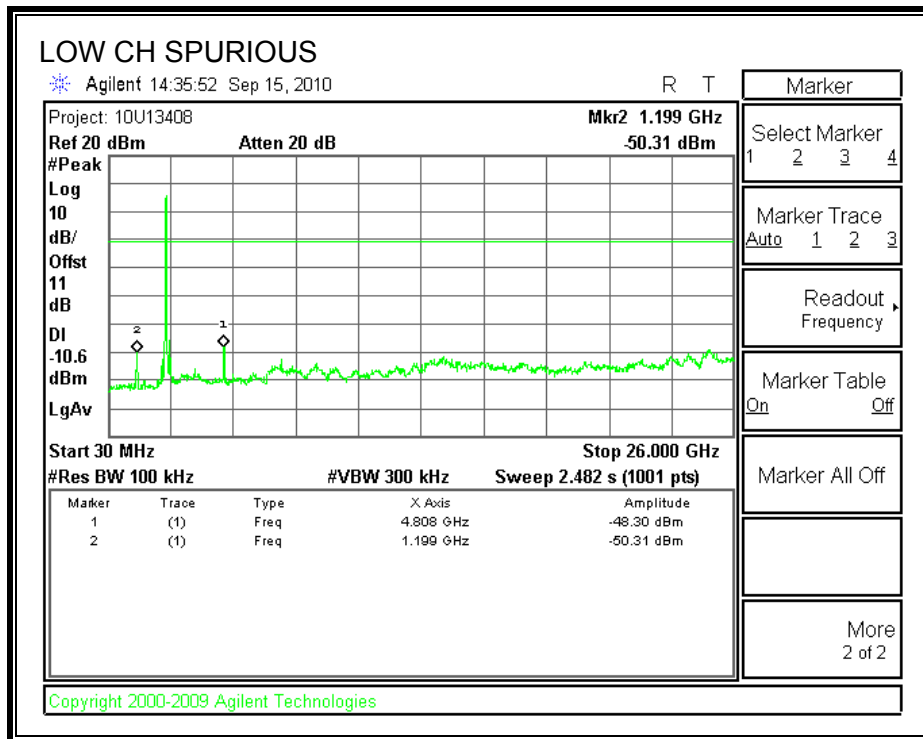
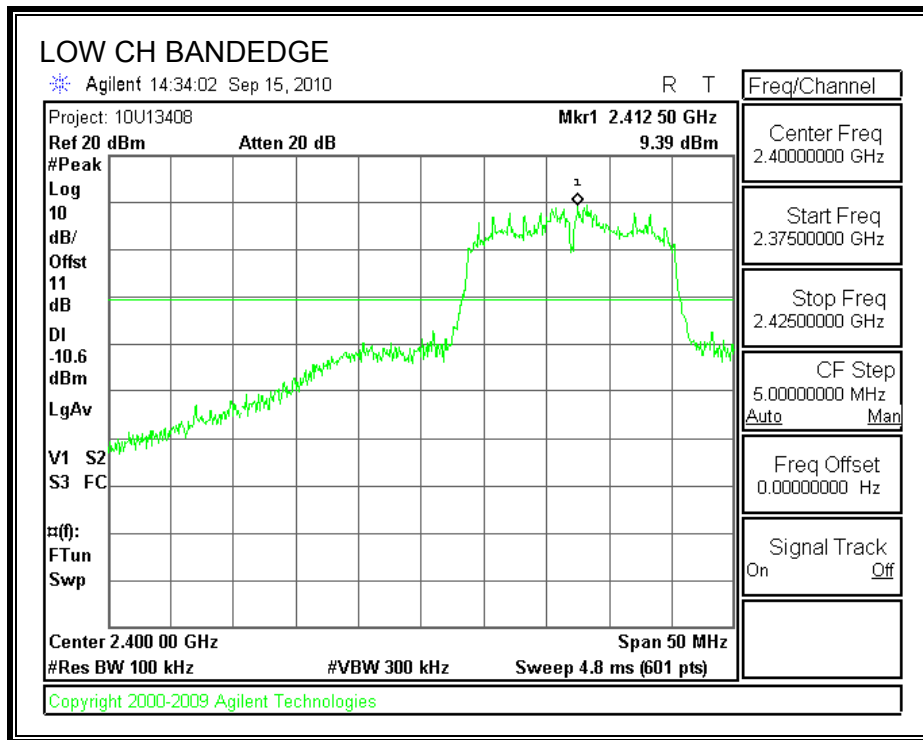

SPURIOUS EMISSIONS, MID CHANNEL

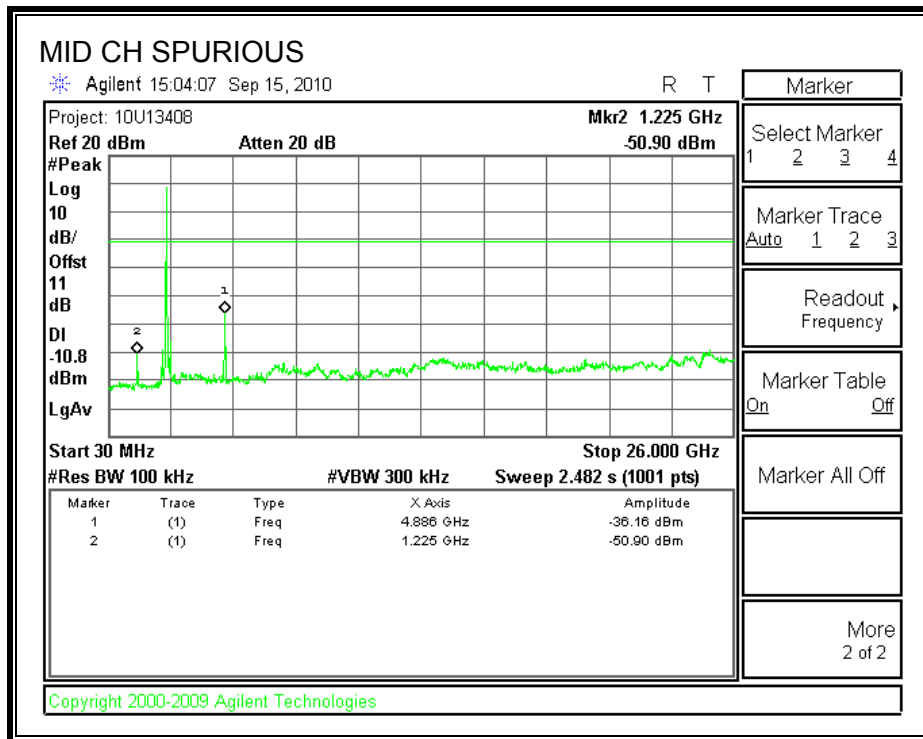
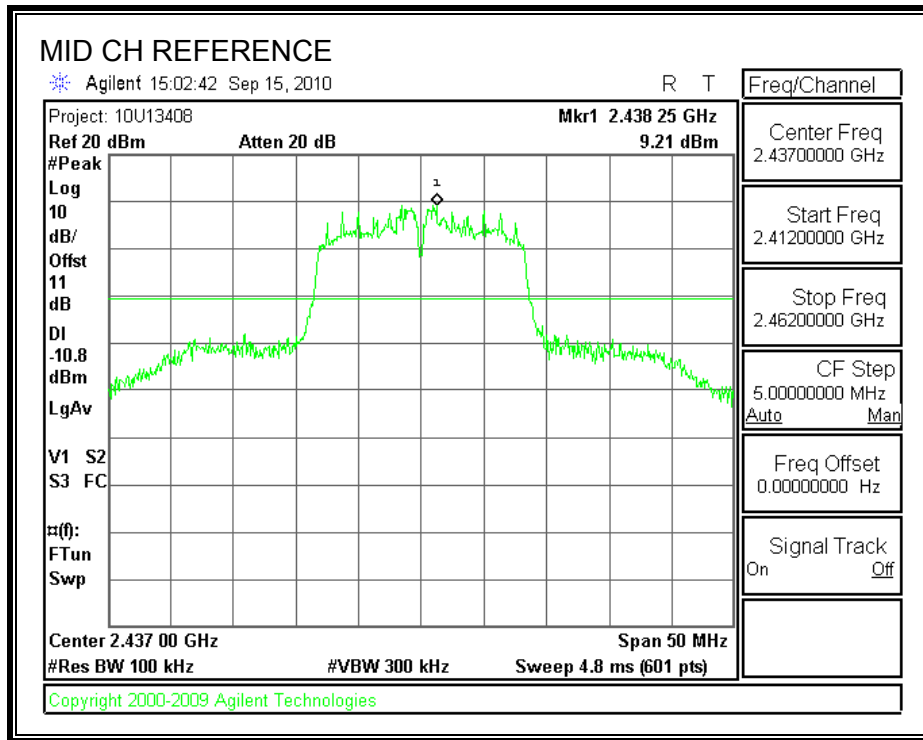

SPURIOUS EMISSIONS, HIGH CHANNEL

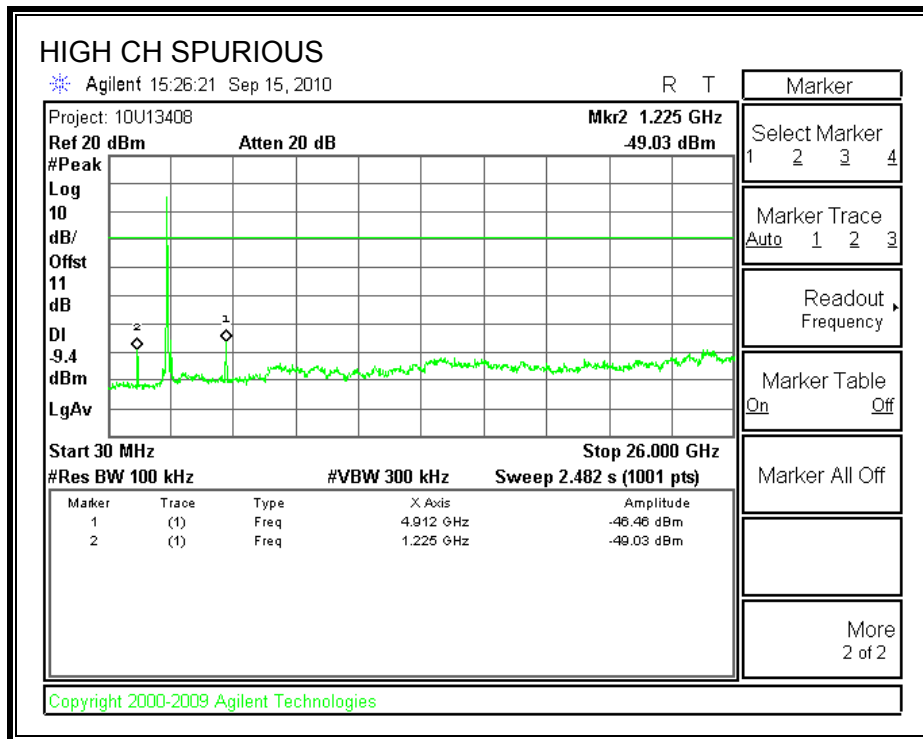
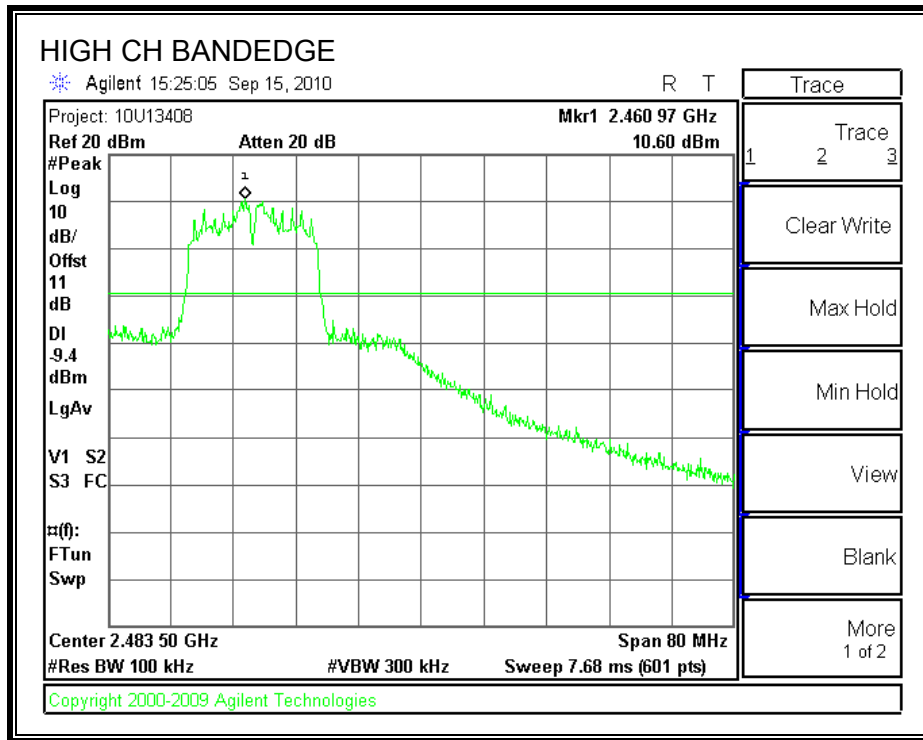

8. RADIATED TEST RESULTS

8.1. LIMITS AND PROCEDURE

LIMITS

FCC §15.205 and §15.209

IC RSS-210 Clause 2.6 (Transmitter)

IC RSS-GEN Clause 6 (Receiver)

Frequency Range (MHz)	Field Strength Limit (uV/m) at 3 m	Field Strength Limit (dBuV/m) at 3 m
30 - 88	100	40
88 - 216	150	43.5
216 - 960	200	46
Above 960	500	54

TEST PROCEDURE

The EUT is placed on a non-conducting table 80 cm above the ground plane. The antenna to EUT distance is 3 meters. The EUT is configured in accordance with ANSI C63.4. The EUT is set to transmit in a continuous mode.

For measurements below 1 GHz the resolution bandwidth is set to 100 kHz for peak detection measurements or 120 kHz for quasi-peak detection measurements. Peak detection is used unless otherwise noted as quasi-peak.

For measurements above 1 GHz the resolution bandwidth is set to 1 MHz, and then the video bandwidth is set to 1 MHz for peak measurements and 10 Hz for average measurements.

The spectrum from 30 MHz to 26 GHz is investigated with the transmitter set to the lowest, middle, and highest channels in the 2.4 GHz band.

The frequency range of interest is monitored at a fixed antenna height and EUT azimuth. The EUT is rotated through 360 degrees to maximize emissions received. The antenna is scanned from 1 to 4 meters above the ground plane to further maximize the emission. Measurements are made with the antenna polarized in both the vertical and the horizontal positions.

RESULTS

8.1.1. TRANSMITTER ABOVE 1 GHz FOR 802.11b MODE IN THE 2.4 GHz BAND

RESTRICTED BANDEDGE (LOW CHANNEL, HORIZONTAL)

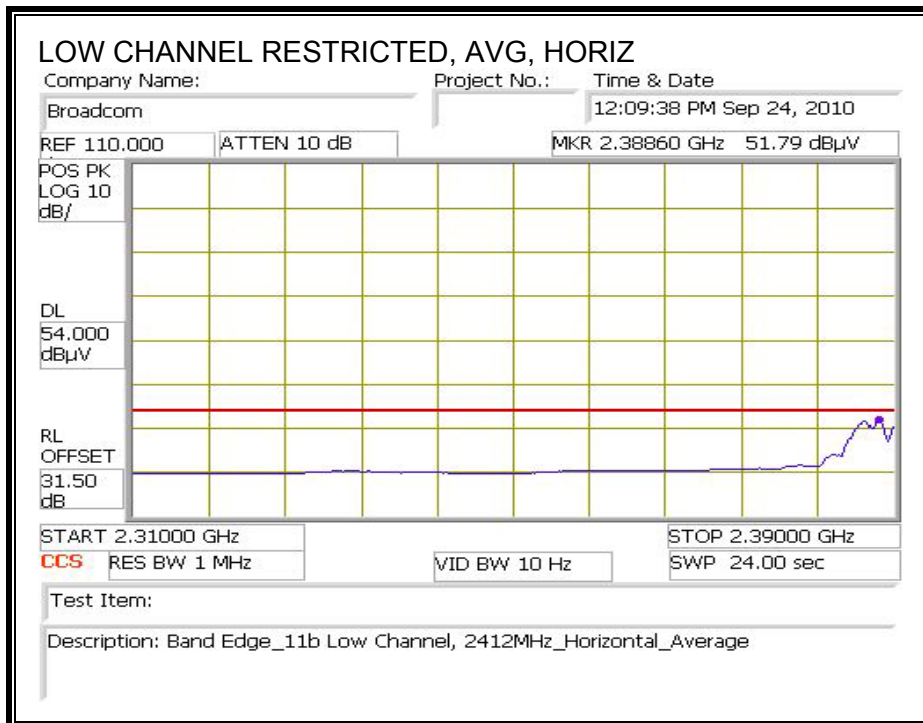
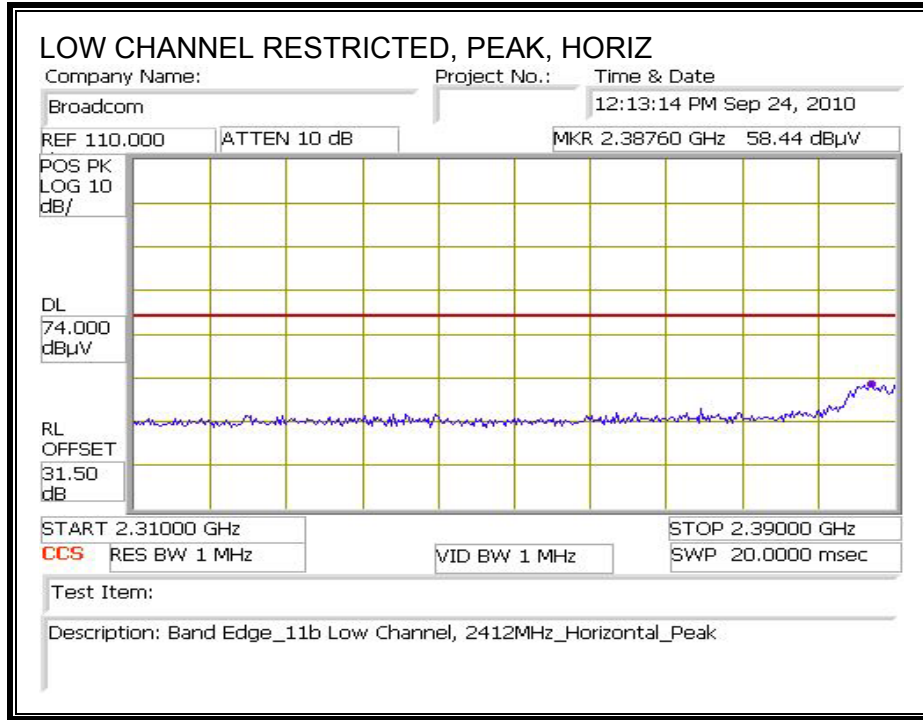

RESTRICTED BANEDGE (HIGH CHANNEL, HORIZONTAL)

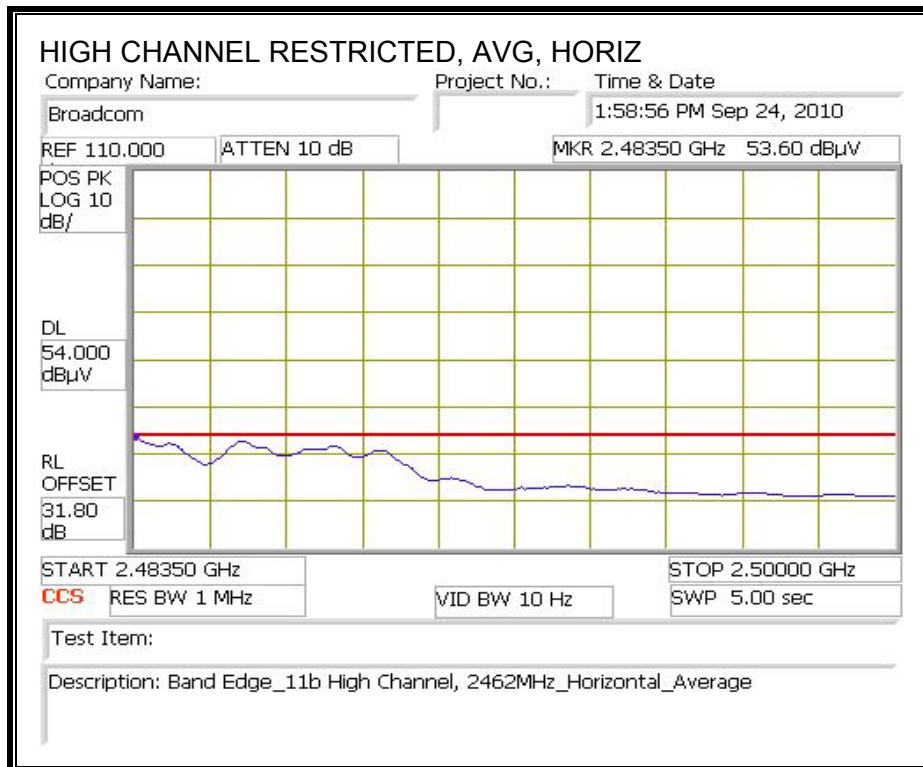
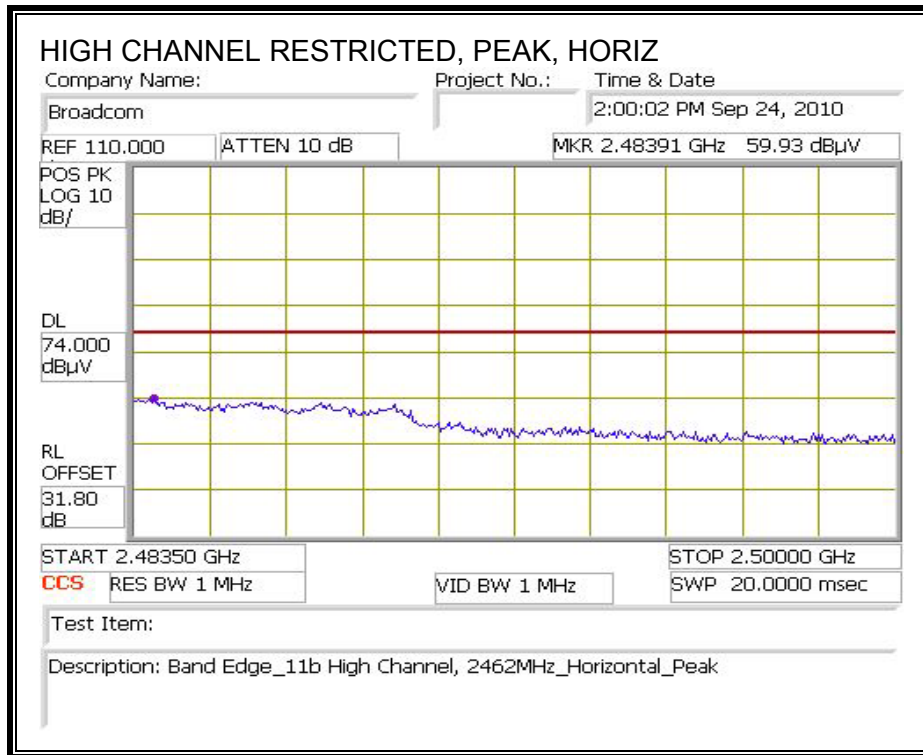

HARMONICS AND SPURIOUS EMISSIONS

High Frequency Measurement													
Compliance Certification Services, Fremont 3m Chamber													
Test Engr:		Vien Tran											
Date:		09/17/10											
Project #:		10U13408											
Company:		Broadcom											
EUT Description:		802.11b/g/n WLAN Module											
EUT M/N:		SDGOB-1091											
Test Target:		FCC Class B											
Mode Oper:		Tx 11b Mode											
f	Measurement Frequency	Amp	Preamp Gain	Average Field Strength Limit									
Dist	Distance to Antenna	D Corr	Distance Correct to 3 meters	Peak Field Strength Limit									
Read	Analyzer Reading	Avg	Average Field Strength @ 3 m	Margin vs. Average Limit									
AF	Antenna Factor	Peak	Calculated Peak Field Strength	Margin vs. Peak Limit									
CL	Cable Loss	HPF	High Pass Filter										
f	Dist	Read	AF	CL	Amp	D Corr	Filtr	Corr.	Limit	Margin	Ant. Pol	Det.	Notes
GHz	(m)	dBuV	dB/m	dB	dB	dB	dB	dBuV/m	dBuV/m	dB	V/H	P/A/QP	
LOW CHANNEL, 2412MHz													
4.824	3.0	36.4	32.7	5.8	-34.8	0.0	0.0	40.0	74.0	-34.0	V	P	
4.824	3.0	25.4	32.7	5.8	-34.8	0.0	0.0	29.0	54.0	-25.0	V	A	
4.824	3.0	36.8	32.7	5.8	-34.8	0.0	0.0	40.4	74.0	-33.6	H	P	
4.824	3.0	25.7	32.7	5.8	-34.8	0.0	0.0	29.4	54.0	-24.6	H	A	
MID CHANNEL, 2437MHz													
4.874	3.0	37.6	32.7	5.8	-34.8	0.0	0.0	41.3	74.0	-32.7	V	P	
4.874	3.0	30.2	32.7	5.8	-34.8	0.0	0.0	33.9	54.0	-20.1	V	A	
7.311	3.0	42.6	35.5	7.3	-34.1	0.0	0.0	51.2	74.0	-22.8	V	P	
7.311	3.0	37.0	35.5	7.3	-34.1	0.0	0.0	45.6	54.0	-8.4	V	A	
4.874	3.0	38.4	32.7	5.8	-34.8	0.0	0.0	42.1	74.0	-31.9	H	P	
4.874	3.0	31.5	32.7	5.8	-34.8	0.0	0.0	35.3	54.0	-18.7	H	A	
7.311	3.0	39.2	35.5	7.3	-34.1	0.0	0.0	47.8	74.0	-26.2	H	P	
7.311	3.0	31.8	35.5	7.3	-34.1	0.0	0.0	40.4	54.0	-13.6	H	A	
HIGH CHANNEL, 2462MHz													
4.924	3.0	39.8	32.7	5.9	-34.8	0.0	0.0	43.7	74.0	-30.3	V	P	
4.924	3.0	33.2	32.7	5.9	-34.8	0.0	0.0	37.0	54.0	-17.0	V	A	
7.386	3.0	42.4	35.6	7.3	-34.1	0.0	0.0	51.2	74.0	-22.8	V	P	
7.386	3.0	36.3	35.6	7.3	-34.1	0.0	0.0	45.1	54.0	-8.9	V	A	
7.386	3.0	37.1	35.6	7.3	-34.1	0.0	0.0	45.9	74.0	-28.1	H	P	
7.386	3.0	27.5	35.6	7.3	-34.1	0.0	0.0	36.3	54.0	-17.7	H	A	
4.924	3.0	40.7	32.7	5.9	-34.8	0.0	0.0	44.5	74.0	-29.5	H	P	
4.924	3.0	35.4	32.7	5.9	-34.8	0.0	0.0	39.2	54.0	-14.8	H	A	
Rev. 4.1.2.7													
Note: No other emissions were detected above the system noise floor.													

Note: High channel 2462MHz was set to highest output power same as middle channel for harmonic measurement.

8.1.2. TRANSMITTER ABOVE 1 GHz FOR 802.11g MODE IN THE 2.4 GHz BAND

RESTRICTED BANDEDGE (LOW CHANNEL, HORIZONTAL)

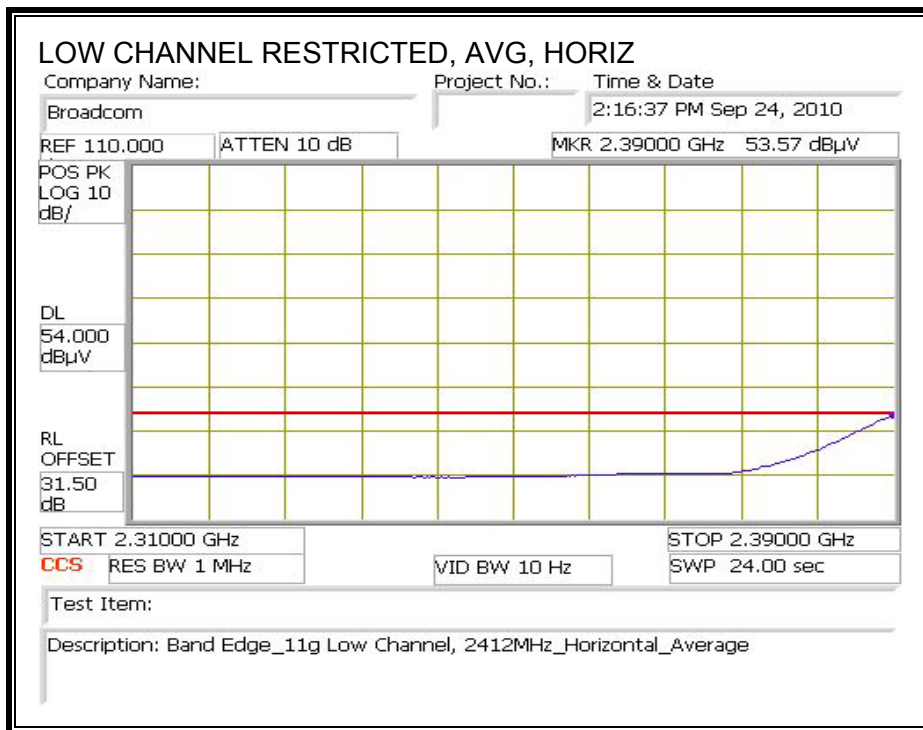
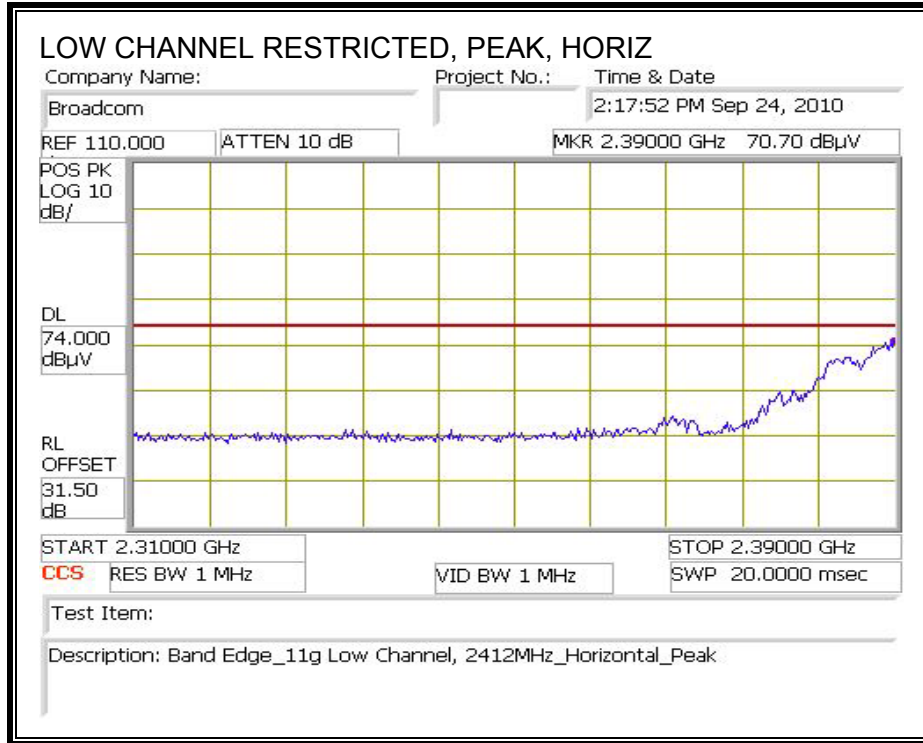

RESTRICTED BANDEDGE (HIGH CHANNEL, HORIZONTAL)

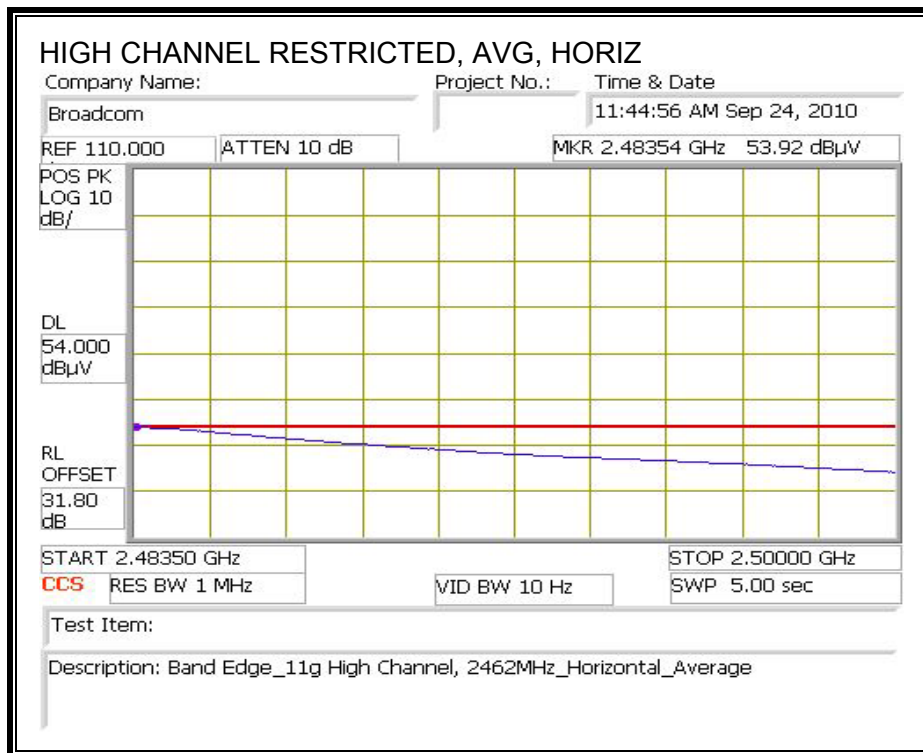
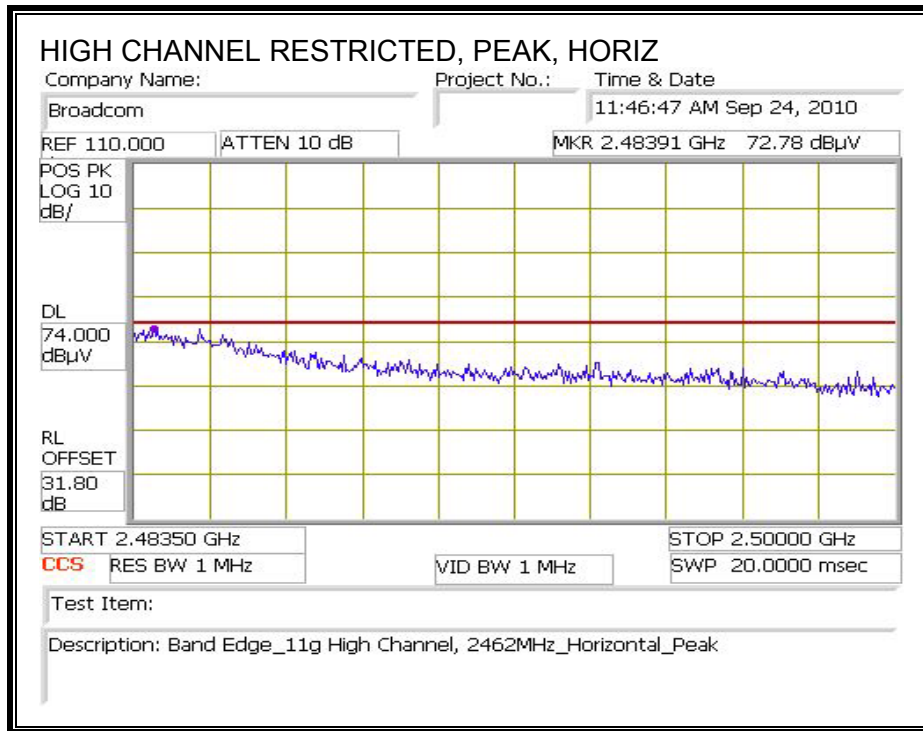

HARMONICS AND SPURIOUS EMISSIONS

High Frequency Measurement													
Compliance Certification Services, Fremont 3m Chamber													
Test Engr:		Vien Tran											
Date:		09/17/10											
Project #:		10U13408											
Company:		Broadcom											
EUT Description:		802.11b/g/n WLAN Module											
EUT M/N:		SDGOB-1091											
Test Target:		FCC Class B											
Mode Oper:		Tx 11g Mode											
f	Measurement Frequency	Amp	Preamp Gain	Average Field Strength Limit									
Dist	Distance to Antenna	D Corr	Distance Correct to 3 meters	Peak Field Strength Limit									
Read	Analyzer Reading	Avg	Average Field Strength @ 3 m	Margin vs. Average Limit									
AF	Antenna Factor	Peak	Calculated Peak Field Strength	Margin vs. Peak Limit									
CL	Cable Loss	HPF	High Pass Filter										
f	Dist	Read	AF	CL	Amp	D Corr	Filtr	Corr.	Limit	Margin	Ant. Pol.	Det.	Notes
GHz	(m)	dBuV	dB/m	dB	dB	dB	dB	dBuV/m	dBuV/m	dB	V/H	P/A/QP	
LOW CHANNEL, 2412MHz													
4.824	3.0	41.1	32.7	5.8	-34.8	0.0	0.0	44.7	74.0	-29.3	V	P	
4.824	3.0	27.3	32.7	5.8	-34.8	0.0	0.0	30.9	54.0	-23.1	V	A	
4.824	3.0	42.2	32.7	5.8	-34.8	0.0	0.0	45.8	74.0	-28.2	H	P	
4.824	3.0	28.6	32.7	5.8	-34.8	0.0	0.0	32.2	54.0	-21.8	H	A	
MID CHANNEL, 2437MHz													
4.874	3.0	41.0	32.7	5.8	-34.8	0.0	0.0	44.8	74.0	-29.2	V	P	
4.874	3.0	27.1	32.7	5.8	-34.8	0.0	0.0	30.8	54.0	-23.2	V	A	
7.311	3.0	41.6	35.5	7.3	-34.1	0.0	0.0	50.2	74.0	-23.8	V	P	
7.311	3.0	29.1	35.5	7.3	-34.1	0.0	0.0	37.7	54.0	-16.3	V	A	
4.874	3.0	43.2	32.7	5.8	-34.8	0.0	0.0	47.0	74.0	-27.0	H	P	
4.874	3.0	31.0	32.7	5.8	-34.8	0.0	0.0	34.7	54.0	-19.3	H	A	
7.311	3.0	35.8	35.5	7.3	-34.1	0.0	0.0	44.4	74.0	-29.6	H	P	
7.311	3.0	23.9	35.5	7.3	-34.1	0.0	0.0	32.6	54.0	-21.4	H	A	
HIGH CHANNEL, 2462MHz													
4.924	3.0	36.6	32.7	5.9	-34.8	0.0	0.0	40.4	74.0	-33.6	V	P	
4.924	3.0	25.1	32.7	5.9	-34.8	0.0	0.0	28.9	54.0	-25.1	V	A	
7.386	3.0	42.7	35.6	7.3	-34.1	0.0	0.0	51.5	74.0	-22.5	V	P	
7.386	3.0	30.8	35.6	7.3	-34.1	0.0	0.0	39.6	54.0	-14.4	V	A	
4.924	3.0	36.6	32.7	5.9	-34.8	0.0	0.0	40.4	74.0	-33.6	H	P	
4.924	3.0	24.0	32.7	5.9	-34.8	0.0	0.0	27.8	54.0	-26.2	H	A	
7.386	3.0	37.4	35.6	7.3	-34.1	0.0	0.0	46.1	74.0	-27.9	H	P	
7.386	3.0	25.5	35.6	7.3	-34.1	0.0	0.0	34.3	54.0	-19.7	H	A	
Rev. 4.1.2.7													
Note: No other emissions were detected above the system noise floor.													

Note: High channel 2462MHz was set to highest output power same as middle channel for harmonic measurement.

8.2. RECEIVER ABOVE 1 GHz IN THE 2.4 GHz BAND

High Frequency Measurement
 Compliance Certification Services, Fremont 3m Chamber

Test Engr: Vien Tran
 Date: 09/27/10
 Project #: 10U13408
 Company: Broadcom
 EUT Description: 802.11b/g/n WLAN Module
 EUT M/N: SDGOB-1091
 Test Target: RX RSS 210
 Mode Oper: Rx Mode

Test Equipment:

Horn 1-18GHz	Pre-amplifier 1-26GHz	Pre-amplifier 26-40GHz	Horn > 18GHz	Limit
T60; S/N: 2238 @3m	T34 HP 8449B			RX RSS 210

Hi Frequency Cables

3' cable 22807700	12' cable 22807600	20' cable 22807500	HPF	Reject Filter	<u>Peak Measurements</u> RBW=VBW=1MHz <u>Average Measurements</u> RBW=1MHz ; VBW=10Hz
3' cable 22807700	12' cable 22807600	20' cable 22807500			

f GHz	Dist (m)	Read Pk dBuV	Read Avg dBuV	AF dB/m	CL dB	Amp dB	D Corr dB	Fltr dB	Peak dBuV/m	Avg dBuV/m	Pk Lim dBuV/m	Avg Lim dBuV/m	Pk Mar dB	Avg Mar dB	Notes (V/H)
1.050	3.0	50.1	44.3	24.6	2.4	-38.2	0.0	0.0	39.0	33.1	74	54	-35.0	-20.9	V
1.125	3.0	49.9	41.9	24.9	2.5	-38.1	0.0	0.0	39.2	31.2	74	54	-34.8	-22.8	V
2.005	3.0	46.5	40.1	27.8	3.5	-36.9	0.0	0.0	40.9	34.5	74	54	-33.1	-19.5	V
1.050	3.0	50.8	45.8	24.6	2.4	-38.2	0.0	0.0	39.6	34.7	74	54	-34.4	-19.3	H
1.125	3.0	50.5	42.3	24.9	2.5	-38.1	0.0	0.0	39.8	31.6	74	54	-34.2	-22.4	H
2.005	3.0	44.3	32.2	27.8	3.5	-36.9	0.0	0.0	38.7	26.6	74	54	-35.3	-27.4	H

f	Measurement Frequency	Amp	Preamp Gain	Avg Lim	Average Field Strength Limit
Dist	Distance to Antenna	D Corr	Distance Correct to 3 meters	Pk Lim	Peak Field Strength Limit
Read	Analyzer Reading	Avg	Average Field Strength @ 3 m	Avg Mar	Margin vs. Average Limit
AF	Antenna Factor	Peak	Calculated Peak Field Strength	Pk Mar	Margin vs. Peak Limit
CL	Cable Loss	HPF	High Pass Filter		

8.3. WORST-CASE BELOW 1 GHz

WORST-CASE CONFIGURATION, HORIZONTAL & VERTICAL

HORIZONTAL & VERTICAL DATA

30-1000MHz Frequency Measurement
 Compliance Certification Services, Fremont 3m Chamber

Test Engr: Vien Tran
 Date: 09/27/10
 Project #: 10U13408
 Company: Broadcom
 EUT Description: 802.11b/g/n WLAN Module
 EUT M/N: SDGOB-1091
 Test Target: FCC Class B
 Mode Oper: Tx Worst-Case

f Measurement Frequency Amp Preamp Gain Margin Margin vs. Limit
 Dist Distance to Antenna D Corr Distance Correct to 3 meters
 Read Analyzer Reading Filter Filter Insert Loss
 AF Antenna Factor Corr. Calculated Field Strength
 CL Cable Loss Limit Field Strength Limit

f MHz	Dist (m)	Read dBuV	AF dB/m	CL dB	Amp dB	D Corr dB	Pad dB	Corr. dBuV/m	Limit dBuV/m	Margin dB	Ant. Pol. V/H	Det. P/A/QP	Notes
Vertical with EUT													
66.482	3.0	52.4	8.1	0.7	28.3	0.0	0.0	32.9	40.0	-7.1	V	EP	
75.002	3.0	52.1	8.1	0.7	28.3	0.0	0.0	32.6	40.0	-7.4	V	EP	
174.966	3.0	49.1	10.3	1.1	27.6	0.0	0.0	32.8	43.5	-10.7	V	EP	
275.05	3.0	49.3	12.6	1.4	27.4	0.0	0.0	36.0	46.0	-10.0	V	EP	
324.972	3.0	53.9	13.9	1.5	27.6	0.0	0.0	41.7	46.0	-4.3	V	EP	
375.014	3.0	47.4	14.6	1.7	27.9	0.0	0.0	35.9	46.0	-10.1	V	EP	
399.975	3.0	40.0	15.0	1.7	28.0	0.0	0.0	28.7	46.0	-17.3	V	EP	
474.978	3.0	49.0	16.4	1.9	28.5	0.0	0.0	38.8	46.0	-7.2	V	EP	
549.981	3.0	44.5	17.7	2.1	28.6	0.0	0.0	35.7	46.0	-10.3	V	EP	
575.062	3.0	48.9	18.1	2.1	28.6	0.0	0.0	40.5	46.0	-5.5	V	EP	
625.105	3.0	45.1	18.6	2.2	28.6	0.0	0.0	37.4	46.0	-8.6	V	EP	
Horizontal													
66.602	3.0	49.1	8.1	0.7	28.3	0.0	0.0	29.7	40.0	-10.3	H	EP	
80.162	3.0	55.1	7.9	0.7	28.3	0.0	0.0	35.5	40.0	-4.5	H	EP	
159.605	3.0	52.1	13.2	1.1	27.7	0.0	0.0	38.6	43.5	-4.9	H	EP	
174.966	3.0	53.3	10.3	1.1	27.6	0.0	0.0	37.1	43.5	-6.4	H	EP	
186.606	3.0	50.1	11.1	1.1	27.4	0.0	0.0	34.9	43.5	-8.6	H	EP	
232.328	3.0	56.1	11.8	1.3	27.4	0.0	0.0	41.8	46.0	-4.2	H	EP	
249.969	3.0	50.8	11.8	1.3	27.4	0.0	0.0	36.5	46.0	-9.5	H	EP	
432.017	3.0	51.7	15.6	1.8	28.2	0.0	0.0	40.9	46.0	-5.1	H	EP	
500.059	3.0	51.0	16.9	2.0	28.6	0.0	0.0	41.2	46.0	-4.8	H	EP	
949.958	3.0	43.6	22.4	2.8	27.7	0.0	0.0	41.1	46.0	-4.9	H	EP	

Rev. 1.27.09

Note: No other emissions were detected above the system noise floor.

9. AC POWER LINE CONDUCTED EMISSIONS

LIMITS

FCC §15.207 (a)

RSS-Gen 7.2.2

Frequency of Emission (MHz)	Conducted Limit (dBuV)	
	Quasi-peak	Average
0.15-0.5	66 to 56*	56 to 46*
0.5-5	56	46
5-30	60	50

*Decreases with the logarithm of the frequency.

TEST PROCEDURE

ANSI C63.4

RESULTS

6 WORST EMISSIONS

CONDUCTED EMISSIONS DATA (115VAC 60Hz)										
Freq. (MHz)	Reading			Class (dB)	Limit QP	FCC B		Margin		Remark L1 / L2
	PK (dBuV)	QP (dBuV)	AV (dBuV)			AV	QP (dB)	AV (dB)		
0.38	44.19	--	36.09	0.00	58.28	48.28	-14.09	-12.19	L1	
1.48	40.11	--	29.61	0.00	56.00	46.00	-15.89	-16.39	L1	
10.45	38.46	--	25.95	0.00	60.00	50.00	-21.54	-24.05	L1	
0.43	45.15	--	38.24	0.00	57.25	47.25	-12.10	-9.01	L2	
2.57	40.94	--	27.96	0.00	56.00	46.00	-15.06	-18.04	L2	
5.71	32.90	--	22.30	0.00	60.00	50.00	-27.10	-27.70	L2	
6 Worst Data										

LINE 1 RESULTS

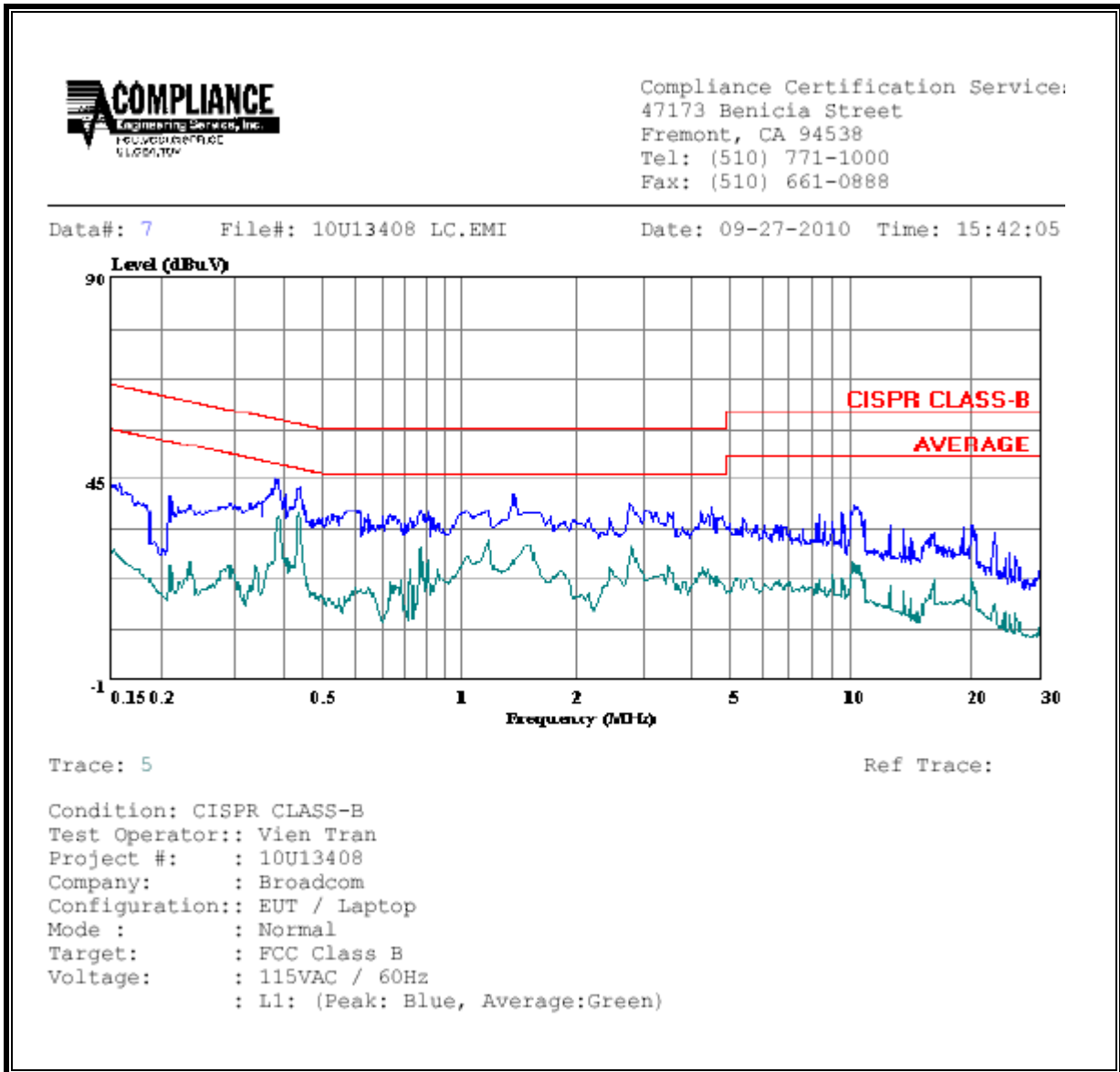

Trace: 5

Ref Trace:

Condition: CISPR CLASS-B
Test Operator:: Vien Tran
Project #: : 10U13408
Company: : Broadcom
Configuration:: EUT / Laptop
Mode : : Normal
Target: : FCC Class B
Voltage: : 115VAC / 60Hz
: L1: (Peak: Blue, Average:Green)

LINE 2 RESULTS

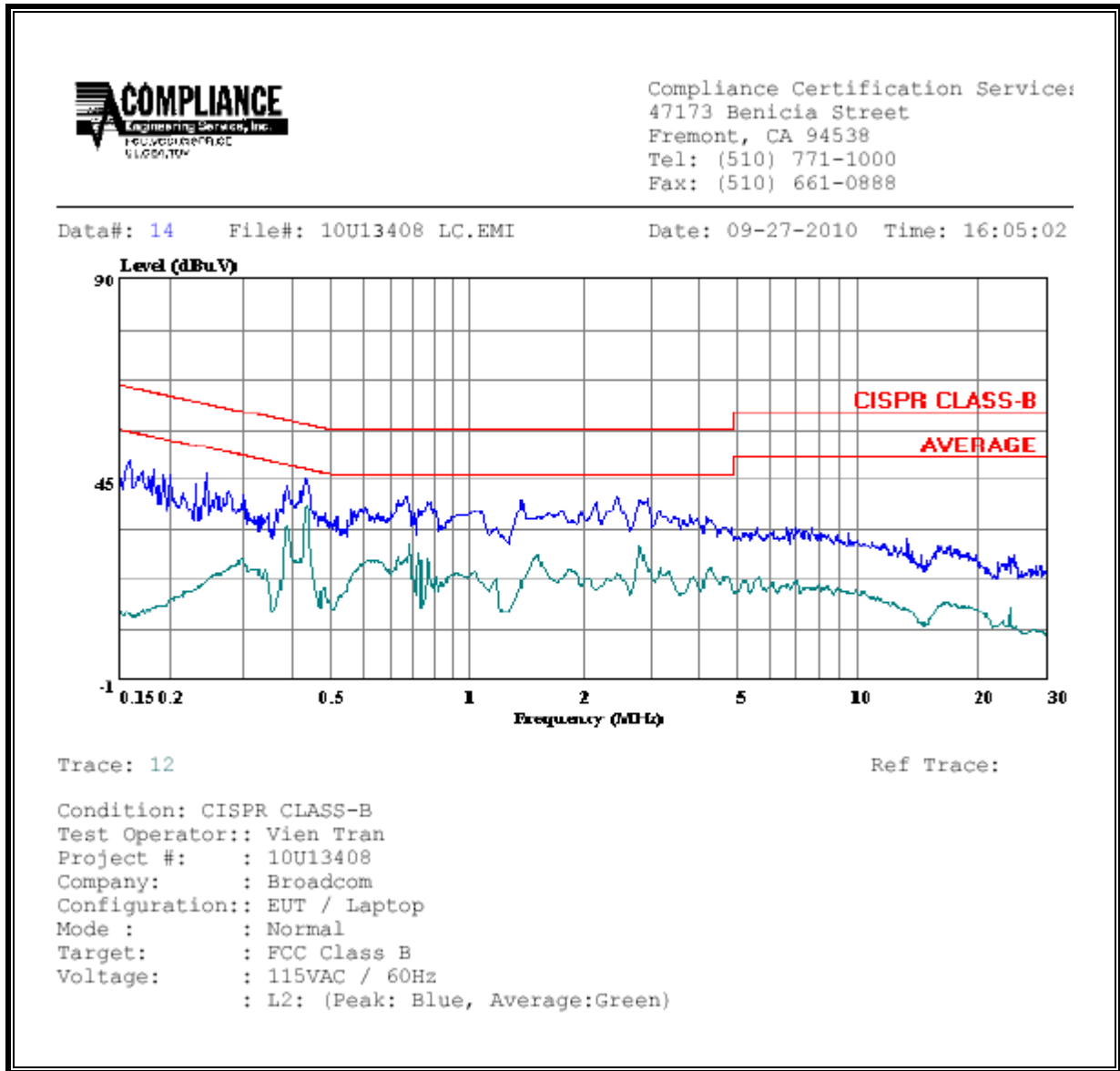

10. MAXIMUM PERMISSIBLE EXPOSURE

FCC RULES

§1.1310 The criteria listed in Table 1 shall be used to evaluate the environmental impact of human exposure to radio-frequency (RF) radiation as specified in §1.1307(b), except in the case of portable devices which shall be evaluated according to the provisions of §2.1093 of this chapter.

TABLE 1—LIMITS FOR MAXIMUM PERMISSIBLE EXPOSURE (MPE)

Frequency range (MHz)	Electric field strength (V/m)	Magnetic field strength (A/m)	Power density (mW/cm ²)	Averaging time (minutes)
(A) Limits for Occupational/Controlled Exposures				
0.3–3.0	614	1.63	*(100)	6
3.0–30	1842/f	4.89/f	*(900/f ²)	6
30–300	61.4	0.163	1.0	6
300–1500	f/300	6
1500–100,000	5	6
(B) Limits for General Population/Uncontrolled Exposure				
0.3–1.34	614	1.63	*(100)	30
1.34–30	824/f	2.19/f	*(180/f ²)	30

TABLE 1—LIMITS FOR MAXIMUM PERMISSIBLE EXPOSURE (MPE)—Continued

Frequency range (MHz)	Electric field strength (V/m)	Magnetic field strength (A/m)	Power density (mW/cm ²)	Averaging time (minutes)
30–300	27.5	0.073	0.2	30
300–1500	f/1500	30
1500–100,000	1.0	30

f = frequency in MHz

* = Plane-wave equivalent power density

NOTE 1 TO TABLE 1: Occupational/controlled limits apply in situations in which persons are exposed as a consequence of their employment provided those persons are fully aware of the potential for exposure and can exercise control over their exposure. Limits for occupational/controlled exposure also apply in situations when an individual is transient through a location where occupational/controlled limits apply provided he or she is made aware of the potential for exposure.

NOTE 2 TO TABLE 1: General population/uncontrolled exposures apply in situations in which the general public may be exposed, or in which persons that are exposed as a consequence of their employment may not be fully aware of the potential for exposure or can not exercise control over their exposure.

IC RULES

IC Safety Code 6, Section 2.2.1 (a) A person other than an RF and microwave exposed worker shall not be exposed to electromagnetic radiation in a frequency band listed in Column 1 of Table 5, if the field strength exceeds the value given in Column 2 or 3 of Table 5, when averaged spatially and over time, or if the power density exceeds the value given in Column 4 of Table 5, when averaged spatially and over time.

**Table 5
 Exposure Limits for Persons Not Classed As RF and Microwave Exposed Workers (Including the General Public)**

1 Frequency (MHz)	2 Electric Field Strength; rms (V/m)	3 Magnetic Field Strength; rms (A/m)	4 Power Density (W/m ²)	5 Averaging Time (min)
0.003–1	280	2.19		6
1–10	280/ <i>f</i>	2.19/ <i>f</i>		6
10–30	28	2.19/ <i>f</i>		6
30–300	28	0.073	2*	6
300–1 500	1.585 <i>f</i> ^{0.5}	0.0042 <i>f</i> ^{0.5}	<i>f</i> /150	6
1 500–15 000	61.4	0.163	10	6
15 000–150 000	61.4	0.163	10	616 000 / <i>f</i> ^{1.2}
150 000–300 000	0.158 <i>f</i> ^{0.5}	4.21 x 10 ⁻⁴ <i>f</i> ^{0.5}	6.67 x 10 ⁻⁵ <i>f</i>	616 000 / <i>f</i> ^{1.2}

* Power density limit is applicable at frequencies greater than 100 MHz.

- Notes:**
1. Frequency, *f*, is in MHz.
 2. A power density of 10 W/m² is equivalent to 1 mW/cm².
 3. A magnetic field strength of 1 A/m corresponds to 1.257 microtesla (μT) or 12.57 milligauss (mG).

EQUATIONS

Power density is given by:

$$S = \text{EIRP} / (4 * \text{Pi} * \text{D}^2)$$

where

- S = Power density in W/m²
- EIRP = Equivalent Isotropic Radiated Power in W
- D = Separation distance in m

Power density in units of W/m² is converted to units of mW/cm² by dividing by 10.

Distance is given by:

$$D = \text{SQRT} (\text{EIRP} / (4 * \text{Pi} * S))$$

where

- D = Separation distance in m
- EIRP = Equivalent Isotropic Radiated Power in W
- S = Power density in W/m²

For multiple colocated transmitters operating simultaneously in frequency bands where the limit is identical, the total power density is calculated using the total EIRP obtained by summing the Power * Gain product (in linear units) of each transmitter.

$$\text{Total EIRP} = (P1 * G1) + (P2 * G2) + \dots + (Pn * Gn)$$

where

- Px = Power of transmitter x
- Gx = Numeric gain of antenna x

In the table(s) below, Power and Gain are entered in units of dBm and dBi respectively and conversions to linear forms are used for the calculations.

LIMITS

From FCC §1.1310 Table 1 (B), the maximum value of S = 1.0 mW/cm²
 From IC Safety Code 6, Section 2.2 Table 5 Column 4, S = 10 W/m²

RESULTS

Band	Mode	Separation Distance (m)	Output Power (dBm)	Antenna Gain (dBi)	IC Power Density (W/m ²)	FCC Power Density (mW/cm ²)
2.4 GHz	WLAN	0.20	23.91	2.40	0.85	0.085