

# SAR Test Report

Product Name : Wireless Printing Upgrade Kit  
Model No. : Q6236A

Applicant : SerComm Corporation  
Address : 8F, No. 3-1, YuanQu St., NanKang, Taipei 115  
Taiwan, R.O.C.

Date of Receipt : 2006/03/10  
Issued Date : 2006/07/04  
Report No. : 067L070-HP-US-P09V01-D

The test results relate only to the samples tested.

The test report shall not be reproduced except in full without the written approval of Quietek Corporation.

## Test Report Certification

Issued Date: 2006/07/04

Report No.:067L070-HP-US-P09V01-D



Product Name : Wireless Printing Upgrade Kit  
Applicant : SerComm Corporation  
Address : 8F, No. 3-1, YuanQu St., NanKang, Taipei 115  
Taiwan, R.O.C.  
Manufacturer : Exclusive Certification Corp.  
Model No. : Q6236A  
Trade Name : HP  
Applicable Standard : FCC Oet65 Supplement C June 2001

Test Result : Max. SAR Measurement (1g)  
802.11b: 0.532 W/kg  
802.11g: 0.363 W/kg

Application Type : Certification

The test results relate only to the samples tested.

The test report shall not be reproduced except in full without the written approval of Quietek Corporation.

Documented By :   
\_\_\_\_\_  
(Alfreda Hsu)

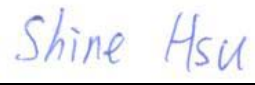
Tested By :   
\_\_\_\_\_  
(Shine Hsu)

Approved By :   
\_\_\_\_\_  
(George Chen)

## TABLE OF CONTENTS

Description	Page
<b>1. General Information.....</b>	<b>5</b>
1.1 EUT Description .....	5
1.2 Test Environment .....	5
<b>2. SAR Measurement System .....</b>	<b>6</b>
2.1 ALSAS-10U System Description .....	6
2.1.1 Applications .....	6
2.1.2 Area Scans.....	6
2.1.3 Zoom Scan (Cube Scan Averaging).....	7
2.1.4 ALSAS-10U Interpolation and Extrapolation Uncertainty.....	7
2.2 Isotropic E-Field Probe .....	7
2.2.1 Isotropic E-Field Probe Specification .....	9
2.3 Boundary Detection Unit and Probe Mounting Device .....	9
2.4 Daq-Paq (Analog to Digital Electronics).....	10
2.5 Axis Articulated Robot .....	10
2.6 ALSAS Universal Workstation.....	11
2.7 Universal Device Positioner.....	11
2.8 Phantom Types.....	11
2.8.1 APREL SAM Phantoms .....	12
2.8.2 APREL Laboratories Universal Phantom .....	12
<b>3. Tissue Simulating Liquid .....</b>	<b>13</b>
3.1 The composition of the tissue simulating liquid .....	13
3.2 Tissue Calibration Result .....	13
3.3 Tissue Dielectric Parameters for Head and Body Phantoms .....	14
<b>4. SAR Measurement Procedure .....</b>	<b>15</b>
4.1 SAR System Validation.....	15
4.1.1 Validation Dipoles.....	15
4.1.2 Validation Result .....	15
4.2 SAR Measurement Procedure .....	16
<b>5. SAR Exposure Limits .....</b>	<b>17</b>
<b>6. Test Equipment List.....</b>	<b>18</b>
<b>7. Measurement Uncertainty .....</b>	<b>19</b>
<b>8. Test Results .....</b>	<b>20</b>
8.1 SAR Test Results Summary .....	20
Appendix A. SAR System Validation Data.....	22
Appendix B. SAR measurement Data.....	22

Appendix C. Test Setup Photographs & EUT Photographs..... 22  
Appendix D. Probe Calibration Data ..... 22  
Appendix E. Dipole Calibration Data ..... 22

## 1. General Information

### 1.1 EUT Description

Product Name	Wireless Printing Upgrade Kit
Trade Name	HP
Model No.	Q6236A
FCC ID	B94RSVLD0604
TX Frequency	2412MHz ~ 2462MHz
Number of Channel	11
Type of Modulation	DSSS/OFDM
Antenna Type	Internal
Device Category	Portable
RF Exposure Environment	Uncontrolled
Transfer Rate	802.11b: 11Mbps 802.11g: 54Mbps
Max. Output Power (Conducted)	802.11b: 19.44dBm 802.11g: 15.3dBm

### 1.2 Test Environment

Ambient conditions in the laboratory:

Items	Required	Actual
Temperature (°C)	18-25	20.2
Humidity (%RH)	30-70	50

## 2. SAR Measurement System

### 2.1 ALSAS-10U System Description

**ALSAS-10-U** is fully compliant with the technical and scientific requirements of IEEE 1528, IEC 62209, CENELEC, ARIB, ACA, and the Federal Communications Commission. The system comprises of a six axes articulated robot which utilizes a dedicated controller.

ALSAS-10U uses the latest methodologies and FDTD modeling to provide a platform which is repeatable with minimum uncertainty.

#### 2.1.1 Applications

Predefined measurement procedures compliant with the guidelines of CENELEC, IEEE, IEC, FCC, etc are utilized during the assessment for the device. Automatic detection for all SAR maxima are embedded within the core architecture for the system, ensuring that peak locations used for centering the zoom scan are within a 1mm resolution and a 0.05mm repeatable position. System operation range currently available up-to 6 GHz in simulated tissue.

#### 2.1.2 Area Scans

Area scans are defined prior to the measurement process being executed with a user defined variable spacing between each measurement point (integral) allowing low uncertainty measurements to be conducted. Scans defined for FCC applications utilize a 10mm<sup>2</sup> step integral, with 1mm interpolation used to locate the peak SAR area used for zoom scan assessments.

Where the system identifies multiple SAR peaks (which are within 25% of peak value) the system will provide the user with the option of assessing each peak location individually for zoom scan averaging.



**2.1.3 Zoom Scan (Cube Scan Averaging)**

The averaging zoom scan volume utilized in the ALSAS-10U software is in the shape of a cube and the side dimension of a 1 g or 10 g mass is dependent on the density of the liquid representing the simulated tissue. A density of 1000 kg/m<sup>3</sup> is used to represent the head and body tissue density and not the phantom liquid density, in order to be consistent with the definition of the liquid dielectric properties, i.e. the side length of the 1 g cube is 10mm, with the side length of the 10 g cube 21,5mm.

When the cube intersects with the surface of the phantom, it is oriented so that 3 vertices touch the surface of the shell or the center of a face is tangent to the surface. The face of the cube closest to the surface is modified in order to conform to the tangent surface.

The zoom scan integer steps can be user defined so as to reduce uncertainty, but normal practice for typical test applications (including FCC) utilize a physical step of 5x5x8 (8mmx8mmx5mm) providing a volume of 32mm in the X & Y axis, and 35mm in the Z axis.

**2.1.4 ALSAS-10U Interpolation and Extrapolation Uncertainty**

The overall uncertainty for the methodology and algorithms the used during the SAR calculation was evaluated using the data from IEEE 1528 based on the example f3 algorithm:

$$f_3(x, y, z) = A \frac{a^2}{\frac{a^2}{4} + x'^2 + y'^2} \cdot \left( e^{-\frac{2z}{a}} + \frac{a^2}{2(a + 2z)^2} \right)$$

**2.2 Isotropic E-Field Probe**

The isotropic E-Field probe has been fully calibrated and assessed for isotropicity, and boundary effect within a controlled environment. Depending on the frequency for which the probe is calibrated the method utilized for calibration will change. A number of methods is used for calibrating probes, and these are outlined in the table below:

Calibration Frequency	Air Calibration	Tissue Calibration
2450MHz	Waveguide	Temperature

The E-Field probe utilizes a triangular sensor arrangement as detailed in the diagram below:

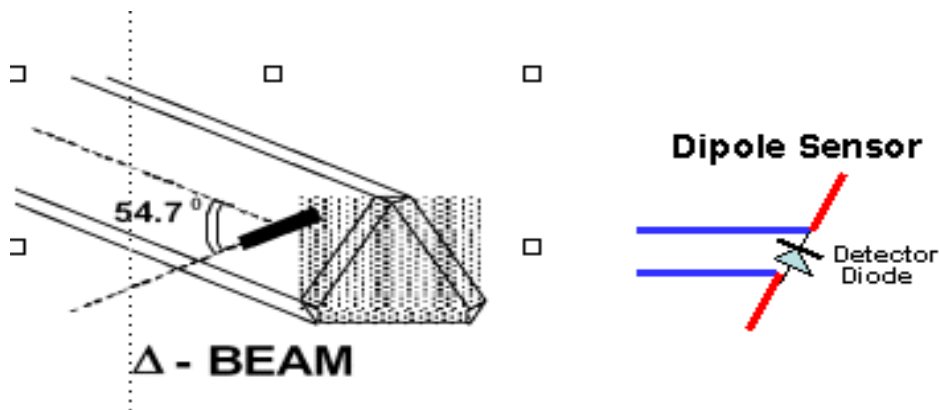

SAR is assessed with a calibrated probe which moves at a default height of 5mm from the center of the diode, which is mounted to the sensor, to the phantom surface (in the Z Axis). The 5mm offset height has been selected so as to minimize any resultant boundary effect due to the probe being in close proximity to the phantom surface.

The following algorithm is an example of the function used by the system for linearization of the output from the probe when measuring complex modulation schemes.

$$V_i = U_i + U_i^2 \cdot \frac{cf}{dcp_i}$$



**2.2.1 Isotropic E-Field Probe Specification**

<b>Calibration in Air</b>	Frequency Dependent Below 2GHz Calibration in air performed in a TEM Cell Above 2GHz Calibration in air performed in waveguide
<b>Sensitivity</b>	0.70 $\mu\text{V}/(\text{V}/\text{m})^2$ to 0.85 $\mu\text{V}/(\text{V}/\text{m})^2$
<b>Dynamic Range</b>	0.0005 W/kg to 100W/kg
<b>Isotropic Response</b>	Better than 0.2dB
<b>Diode Compression point (DCP)</b>	Calibration for Specific Frequency
<b>Probe Tip Radius</b>	< 5mm
<b>Sensor Offset</b>	1.56 (+/- 0.02mm)
<b>Probe Length</b>	290mm
<b>Video Bandwidth</b>	@ 500 Hz: 1dB @1.02 KHz: 3dB
<b>Boundary Effect</b>	Less than 2% for distance greater than 2.4mm
<b>Spatial Resolution</b>	Diameter less than 5mm Compliant with Standards

**2.3 Boundary Detection Unit and Probe Mounting Device**

ALSAS-10U incorporates a boundary detection unit with a sensitivity of 0.05mm for detecting all types of surfaces. The robust design allows for detection during probe tilt (probe normalize) exercises, and utilizes a second stage emergency stop. The signal electronics are fed directly into the robot controller for high accuracy surface detection in lateral and axial detection modes (X, Y, & Z).

The probe is mounted directly onto the Boundary Detection unit for accurate tooling and displacement calculations controlled by the robot kinematics. The probe is connect to an isolated probe interconnect where the output stage of the probe is fed directly into the amplifier stage of the Daq-Paq

**2.4 Daq-Paq (Analog to Digital Electronics)**

ALSAS-10U incorporates a fully calibrated Daq-Paq (analog to digital conversion system) which has a 4 channel input stage, sent via a 2 stage auto-set amplifier module. The input signal is amplified accordingly so as to offer a dynamic range from 5µV to 800mV. Integration of the fields measured is carried out at board level utilizing a Co-Processor which then sends the measured fields down into the main computational module in digitized form via an RS232 communications port. Probe linearity and duty cycle compensation is carried out within the main Daq-Paq module.

<b>ADC</b>	12 Bit
<b>Amplifier Range</b>	20mV to 200mV and 150mV to 800mV
<b>Field Integration</b>	Local Co-Processor utilizing proprietary integration algorithms
<b>Number of Input Channels</b>	4 in total 3 dedicated and 1 spare
<b>Communication</b>	Packet data via RS232

**2.5 Axis Articulated Robot**



ALSAS-10U utilizes a six axis articulated robot, which is controlled using a Pentium based real-time movement controller. The movement kinematics engine utilizes proprietary (Thermo CRS) interpolation and extrapolation algorithms, which allow full freedom of movement for each of the six joints within the working envelope. Utilization of joint 6 allows for full probe rotation with a tolerance better than 0.05mm around the central axis.

<b>Robot/Controller Manufacturer</b>	Thermo CRS
<b>Number of Axis</b>	Six independently controlled axis
<b>Positioning Repeatability</b>	0.05mm
<b>Controller Type</b>	Single phase Pentium based C500C
<b>Robot Reach</b>	710mm
<b>Communication</b>	RS232 and LAN compatible

**2.6 ALSAS Universal Workstation**

ALSAS Universal workstation allows for repeatability and fast adaptability. It allows users to do calibration, testing and measurements using different types of phantoms with one set up, which significantly speeds up the measurement process.

**2.7 Universal Device Positioner**

The universal device positioner allow complete freedom of movement of the EUT. Developed to hold a EUT in a free-space scenario any additional loading attributable to the material used in the construction of the positioner has been eliminated. Repeatability has been enhanced through the linear scales which form the design used to indicate positioning for any given test scenario in all major axes. A 15° tilt indicator is included for the of aid cheek to tilt movements for head SAR analysis. Overall uncertainty for measurements have been reduced due to the design of the Universal device positioner, which allows positioning of a device in as near to a free-space scenario as possible, and by providing the means for complete repeatability.



**2.8 Phantom Types**

The ALSAS-10U allows the integration of multiple phantom types. SAM Phantoms fully compliant with IEEE 1528, Universal Phantom, and Universal Flat.

**2.8.1 APREL SAM Phantoms**

The SAM phantoms developed using the IEEE SAM CAD file. They are fully compliant with the requirements for both IEEE 1528 and FCC Supplement C. Both the left and right SAM phantoms are interchangeable, transparent and include the IEEE 1528 grid with visible NF and MB lines.

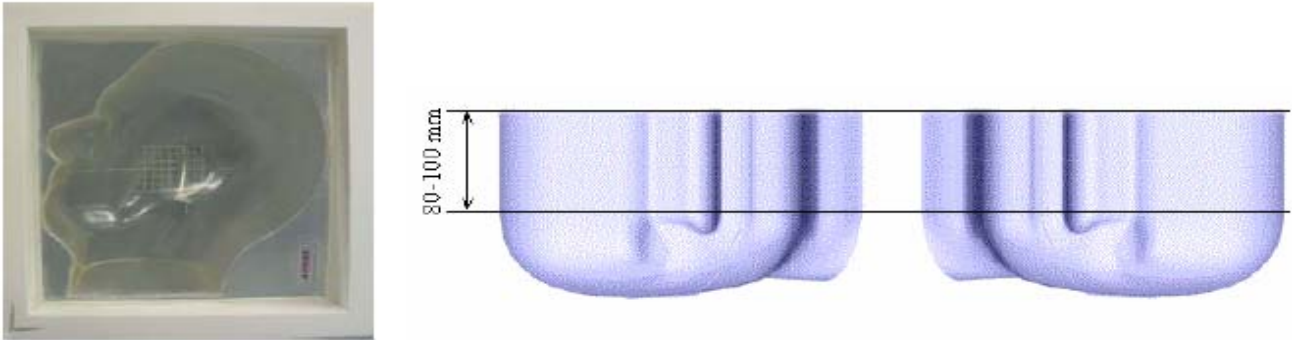

**2.8.2 APREL Laboratories Universal Phantom**

The Universal Phantom is used on the ALSAS-10U as a system validation phantom. The Universal Phantom has been fully validated both experimentally from 800MHz to 6GHz and numerically using XFDTD numerical software. The shell thickness is 2mm overall, with a 4mm spacer located at the NF/MB intersection providing an overall thickness of 6mm in line with the requirements of IEEE-1528.



The design allows for fast and accurate measurements, of handsets, by allowing the conservative SAR to be evaluated at on frequency for both left and right head experiments in one measurement.

### 3. Tissue Simulating Liquid

#### 3.1 The composition of the tissue simulating liquid

INGREDIENT (% Weight)	900MHz Head	1800MHz Head	2450MHz Head	2450MHz Body
<b>Water</b>	--	--	46.7	73.2
<b>Salt</b>	--	--	0.00	0.04
<b>Sugar</b>	--	--	0.00	0.00
<b>HEC</b>	--	--	0.00	0.00
<b>Preventol</b>	--	--	0.00	0.00
<b>DGBE</b>	--	--	53.3	26.7

#### 3.2 Tissue Calibration Result

The dielectric parameters of the liquids were verified prior to the SAR evaluation using APREL Dielectric Probe Kit and Anritsu MS4623B Vector Network Analyzer

Head Tissue Simulant Measurement				
Frequency [MHz]	Description	Dielectric Parameters		Tissue Temp. [°C]
		$\epsilon_r$	$\sigma$ [s/m]	
2450MHz	Reference result $\pm 5\%$ window	39.2 37.24 to 41.16	1.8 1.71 to 1.89	N/A
	14-Mar-06	38.3	1.852	19.7

Body Tissue Simulant Measurement				
Frequency [MHz]	Description	Dielectric Parameters		Tissue Temp. [°C]
		$\epsilon_r$	$\sigma$ [s/m]	
2450MHz	Reference result $\pm 5\%$ window	52.7 50.065 to 55.335	1.95 1.8525 to 2.0475	N/A
	14-Mar-06	51.31	1.979	19.7
2412 MHz	Low channel	51.64	2.009	19.7
2437 MHz	Mid channel	51.42	1.988	19.7
2462 MHz	High channel	51.21	1.968	19.7

**3.3 Tissue Dielectric Parameters for Head and Body Phantoms**

The head tissue dielectric parameters recommended by the IEEE SCC-34/SC-2 in P1528 have been incorporated in the following table. These head parameters are derived from planar layer models simulating the highest expected SAR for the dielectric properties and tissue thickness variations in a human head. Other head and body tissue parameters that have not been specified in P1528 are derived from the tissue dielectric parameters computed from the 4-Cole-Cole equations described in Reference [12] and extrapolated according to the head parameters specified in P1528.

Target Frequency (MHz)	Head		Body	
	$\epsilon_r$	$\sigma$ (S/m)	$\epsilon_r$	$\sigma$ (S/m)
150	52.3	0.76	61.9	0.80
300	45.3	0.87	58.2	0.92
450	43.5	0.87	56.7	0.94
835	41.5	0.90	55.2	0.97
900	41.5	0.97	55.0	1.05
915	41.5	0.98	55.0	1.06
1450	40.5	1.20	54.0	1.30
1610	40.3	1.29	53.8	1.40
1800 – 2000	40.0	1.40	53.3	1.52
2450	39.2	1.80	52.7	1.95
3000	38.5	2.40	52.0	2.73
5800	35.3	5.27	48.2	6.00

( $\epsilon_r$  = relative permittivity,  $\sigma$  = conductivity and  $\rho = 1000 \text{ kg/m}^3$ )

## 4. SAR Measurement Procedure

### 4.1 SAR System Validation

#### 4.1.1 Validation Dipoles

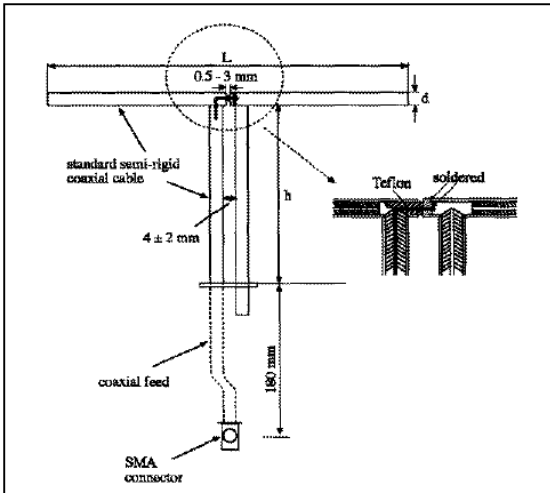

The dipoles used is based on the IEEE-1528 standard, and is complied with mechanical and electrical specifications in line with the requirements of both IEEE and FCC Supplement C. the table below provides details for the mechanical and electrical specifications for the dipoles.

Frequency	L (mm)	h (mm)	d (mm)
2450MHz	53.5	30.4	3.6

#### 4.1.2 Validation Result

System Performance Check at 2450MHz				
Validation Kit: ASL-D-2450-S-2				
Frequency [MHz]	Description	SAR [w/kg] 1g	SAR [w/kg] 10g	Tissue Temp. [°C]
2450 MHz	Reference result ± 5% window	52.4 49.78 to 55.02	24 22.8 to 25.2	N/A
	14-Mar-06	53.092	23.98	19.7
Note: All SAR values are normalized to 1W forward power.				

**4.2 SAR Measurement Procedure**

The ALSAS-10U calculates SAR using the following equation,

$$SAR = \frac{\sigma |E|^2}{\rho}$$

$\sigma$ : represents the simulated tissue conductivity

$\rho$ : represents the tissue density

The EUT is set to transmit at the required power in line with product specification, at each frequency relating to the LOW, MID, and HIGH channel settings.

Pre-scans are made on the device to establish the location for the transmitting antenna, using a large area scan in either air or tissue simulation fluid.

The EUT is placed against the Universal Phantom where the maximum area scan dimensions are larger than the physical size of the resonating antenna. When the scan size is not large enough to cover the peak SAR distribution, it is modified by either extending the area scan size in both the X and Y directions, or the device is shifted within the predefined area.

The area scan is then run to establish the peak SAR location (interpolated resolution set at 1mm<sup>2</sup> )which is then used to orient the center of the zoom scan. The zoom scan is then executed and the 1g and 10g averages are derived from the zoom scan volume (interpolated resolution set at 1mm<sup>3</sup> ).



**5. SAR Exposure Limits**

SAR assessments have been made in line with the requirements of IEEE-1528, FCC Supplement C, and comply with ANSI/IEEE C95.1-1992 “Uncontrolled Environments” limits. These limits apply to a location which is deemed as “Uncontrolled Environment” which can be described as a situation where the general public may be exposed to an RF source with no prior knowledge or control over their exposure.

**Limits for General Population/Uncontrolled Exposure (W/kg)**

<b>Type Exposure</b>	<b>Uncontrolled Environment Limit</b>
Spatial Peak SAR (1g cube tissue for brain or body)	<b>1.60 W/kg</b>
Spatial Average SAR (whole body)	<b>0.08 W/kg</b>
Spatial Peak SAR (10g for hands, feet, ankles and wrist)	<b>4.00 W/kg</b>

## 6. Test Equipment List

Instrument	Manufacturer	Model No.	Serial No.	Last Calibration
Data Acquisition Package	Aprél	ALS-DAQ-PAQ-2	QTK-337	Nov. 2005
Aprél Laboratories Probe	Aprél	ALS-E020	264	Mar. 2005
Aprél Laboratories Probe	Aprél	ALS-E020	265	Mar. 2005
Aprél Reference Dipole 900Mhz	Aprél	ALS-D-900-S-2	QTK-316	Jun. 2004
Aprél Reference Dipole 1800Mhz	Aprél	ALS-D-1800-S-2	QTK-317	Jun. 2004
Aprél Reference Dipole 2450Mhz	Aprél	ALS-D-2450-S-2	QTK-319	Jun. 2004
Boundary Detection Sensor System	Aprél	ALS-PMDPS-2	QTK-336	N/A
Dielectric Probe Kit	Aprél	ALS-PR-DIEL	QTK-296	N/A
Universal Work Station	Aprél	ALS-UWS	QTK-326	N/A
Device Holder 2.0	Aprél	ALS-H-E-SET-2	QTK-294	N/A
Left Ear SAM Phantom	Aprél	ALS-P-SAM-L	QTK-292	N/A
Right Ear SAM Phantom	Aprél	ALS-P-SAM-R	QTK-288	N/A
Universal Phantom	Aprél	ALS-P-UP-1	QTK-246	N/A
Aprél Dipole Spacer	Aprél	ALS-DS-U	QTK-295	N/A
SAR Software	Aprél	ALSAS-10	Ver. 2.3.0	N/A
CRS C500C Controller	Thermo	ALS-C500	RCF0404433	N/A
CRF F3 Robot	Thermo	ALS-F3	RAF0412222	N/A
Power Amplifier	Mini-Circuit	ZHL-42	D051404-20	N/A
Directional Coupler	Agilent	778D-012	50550	N/A
Universal Radio Communication Tester	Rohde & Schwarz	CMU 200	104846	Mar. 2006
Vector Network	Anritsu	MS4623B	992801	Mar 2005
Signal Generator	Anritsu	MG3692A	042319	Jun. 2005
Power Meter	Anritsu	ML2487A	6K00001447	Jan. 2006
Wide Bandwidth Sensor	Anritsu	MA2491	030677	Jan. 2006

## 7. Measurement Uncertainty

### Exposure Assessment Measurement Uncertainty

Source of Uncertainty	Tolerance Value %	Probability Distribution	Divisor	$c_1^1$ (1-g)	$c_1^1$ (10-g)	Standard Uncertainty (1-g) %	Standard Uncertainty (10-g) %
Measurement System							
Probe Calibration	3.5	normal	1	1	1	3.5	3.5
Axial Isotropy	3.7	rectangular	$\sqrt{3}$	$(1-cp)^{1/2}$	$(1-cp)^{1/2}$	1.5	1.5
Hemispherical Isotropy	10.9	rectangular	$\sqrt{3}$	$\sqrt{cp}$	$\sqrt{cp}$	4.4	4.4
Boundary Effect	1.0	rectangular	$\sqrt{3}$	1	1	0.6	0.6
Linearity	4.7	rectangular	$\sqrt{3}$	1	1	2.7	2.7
Detection Limit	1.0	rectangular	$\sqrt{3}$	1	1	0.6	0.6
Readout Electronics	1.0	normal	1	1	1	1.0	1.0
Response Time	0.8	rectangular	$\sqrt{3}$	1	1	0.5	0.5
Integration Time	1.7	rectangular	$\sqrt{3}$	1	1	1.0	1.0
RF Ambient Condition	3.0	rectangular	$\sqrt{3}$	1	1	1.7	1.7
Probe Positioner Mech.	0.4	rectangular	$\sqrt{3}$	1	1	0.2	0.2
Restriction							
Probe Positioning with respect to Phantom Shell	2.9	rectangular	$\sqrt{3}$	1	1	1.7	1.7
Extrapolation and Integration	3.7	rectangular	$\sqrt{3}$	1	1	2.1	2.1
Test Sample Positioning	4.0	normal	1	1	1	4.0	4.0
Device Holder Uncertainty	2.0	normal	1	1	1	2.0	2.0
Drift of Output Power	0.1	rectangular	$\sqrt{3}$	1	1	0.0	0.0
Phantom and Setup							
Phantom Uncertainty(shape & thickness tolerance)	3.4	rectangular	$\sqrt{3}$	1	1	2.0	2.0
Liquid Conductivity(target)	5.0	rectangular	$\sqrt{3}$	0.7	0.5	2.0	1.4
Liquid Conductivity(meas.)	0.1	rectangular	$\sqrt{3}$	0.7	0.5	0.0	0.0
Liquid Permittivity(target)	2.0	rectangular	$\sqrt{3}$	0.6	0.5	0.7	0.6
Liquid Permittivity(meas.)	4.2	rectangular	$\sqrt{3}$	0.6	0.5	1.4	1.2
Combined Uncertainty		RSS				9.2	9.1
Combined Uncertainty (coverage factor=2)		Normal (k=2)				18.4	18.1

## 8. Test Results

### 8.1 SAR Test Results Summary

SAR MEASUREMENT						
Ambient Temperature (°C) : 20.2±2				Relative Humidity (%) : 50		
Liquid Temperature (°C) : 19.7±2				Depth of Liquid (cm):>15		
Product: Wireless Printing Upgrade Kit						
Test Mode: 802.11b						
Test Position Body	Antenna Position	Frequency		Conducted Power (dBm)	SAR 1g (W/kg)	Limit (W/kg)
		Channel	MHz			
Back	Internal	1	2412	19.25	0.216	1.6
Back	Internal	6	2437	19.27	0.204	1.6
Back	Internal	11	2462	19.44	0.286	1.6
Front	Internal	1	2412	19.25	0.421	1.6
Front	Internal	6	2437	19.27	0.441	1.6
Front	Internal	11	2462	19.44	0.532	1.6
Top	Internal	1	2412	19.25	**	1.6
Top	Internal	6	2437	19.27	0.117	1.6
Top	Internal	11	2462	19.44	**	1.6
<p>Note:</p> <p>The SAR measured at the middle channel for this configuration is at least 3 dB lower than SAR limit, testing at the high and low channels is option.</p>						

SAR MEASUREMENT						
Ambient Temperature (°C) : 20.2±2				Relative Humidity (%) : 50		
Liquid Temperature (°C) : 19.7±2				Depth of Liquid (cm):>15		
Product: Wireless Printing Upgrade Kit						
Test Mode: 802.11g						
Test Position	Antenna Position	Frequency		Conducted Power (dBm)	SAR 1g (W/kg)	Limit (W/kg)
		Channel	MHz			
Back	Internal	1	2412	15.2	0.178	1.6
Back	Internal	6	2437	15.3	0.211	1.6
Back	Internal	11	2462	14.95	0.235	1.6
Front	Internal	1	2412	15.2	0.363	1.6
Front	Internal	6	2437	15.3	0.337	1.6
Front	Internal	11	2462	14.95	0.315	1.6
Top	Internal	1	2412	15.2	**	1.6
Top	Internal	6	2437	15.3	**	1.6
Top	Internal	11	2462	14.95	**	1.6

Note:  
The SAR measured at the Top position for this configuration is at least 3 dB lower than SAR limit,

**Appendix A. SAR System Validation Data**

**Appendix B. SAR measurement Data**

**Appendix C. Test Setup Photographs & EUT Photographs**

**Appendix D. Probe Calibration Data**

**Appendix E. Dipole Calibration Data**

**SAR System Validation Data**

ALSAS-10U VER 2.3.0 APREL Laboratories

## SAR Test Report

Validation Date : 14-Mar-2006  
Measurement Date : 14-Mar-2006

## Product Data

Device Name : Dipole-2450  
Type : Dipole  
Frequency : 2450.00 MHz  
Max. Transmit Pwr : 0.25 W  
Drift Time : 0 min(s)  
Length : 51.5 mm  
Width : 3.6 mm  
Depth : 30.4 mm  
Power Drift-Start : 11.274 W/kg  
Power Drift-Finish: 11.414 W/kg  
Power Drift (%) : 1.240

## Phantom Data

Name : APREL-Uni  
Type : Uni-Phantom  
Size (mm) : 280 x 280 x 200  
Location : Center

## Tissue Data

Type : HEAD  
Serial No. : 325-H  
Frequency : 2450.00 MHz  
Last Calib. Date : 14-Mar-2006  
Temperature : 19.70 °C  
Ambient Temp. : 20.20 °C  
Humidity : 50.00 RH%  
Epsilon : 38.30 F/m  
Sigma : 1.852 S/m  
Density : 1000.00 kg/cu. m

## Probe Data

Name : Probe 265  
Model : E020  
Type : E-Field Triangle  
Serial No. : 265  
Last Calib. Date : 23-Mar-2005  
Frequency : 2450.00 MHz  
Duty Cycle Factor: 1  
Conversion Factor: 4.6  
Probe Sensitivity: 1.20 1.20 1.20  $\mu\text{V}/(\text{V}/\text{m})^2$   
Compression Point: 95.00 mV  
Offset : 1.56 mm

Measurement Data

Crest Factor : 1  
 Tissue Temp. : 19.70 °C  
 Ambient Temp. : 20.20 °C  
 Area Scan : 5x5x1 : Measurement x=12mm, y=12mm, z=4mm  
 Zoom Scan : 5x5x8 : Measurement x=8mm, y=8mm, z=4mm  
 Frequency : 2450

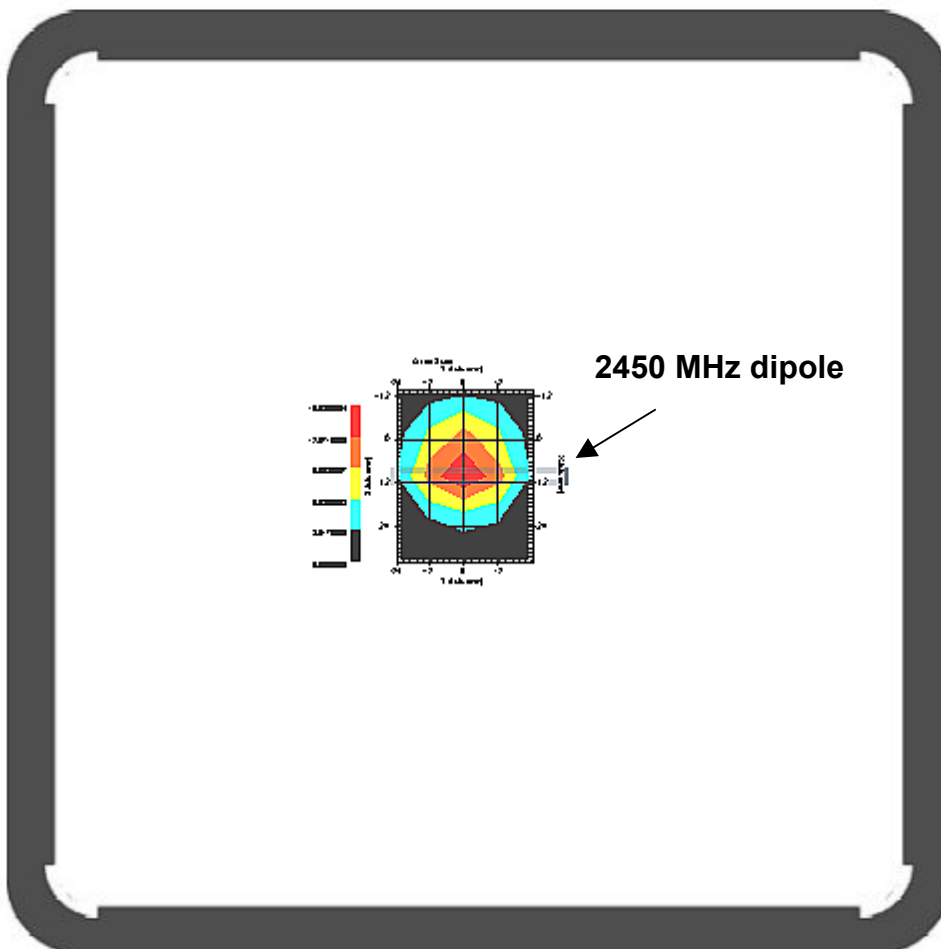

1 gram SAR value : 13.273 W/kg  
 10 gram SAR value : 5.995 W/kg  
 Area Scan Peak SAR : 15.088 W/kg  
 Zoom Scan Peak SAR : 27.623 W/kg



This is previous page plot (zoom in)

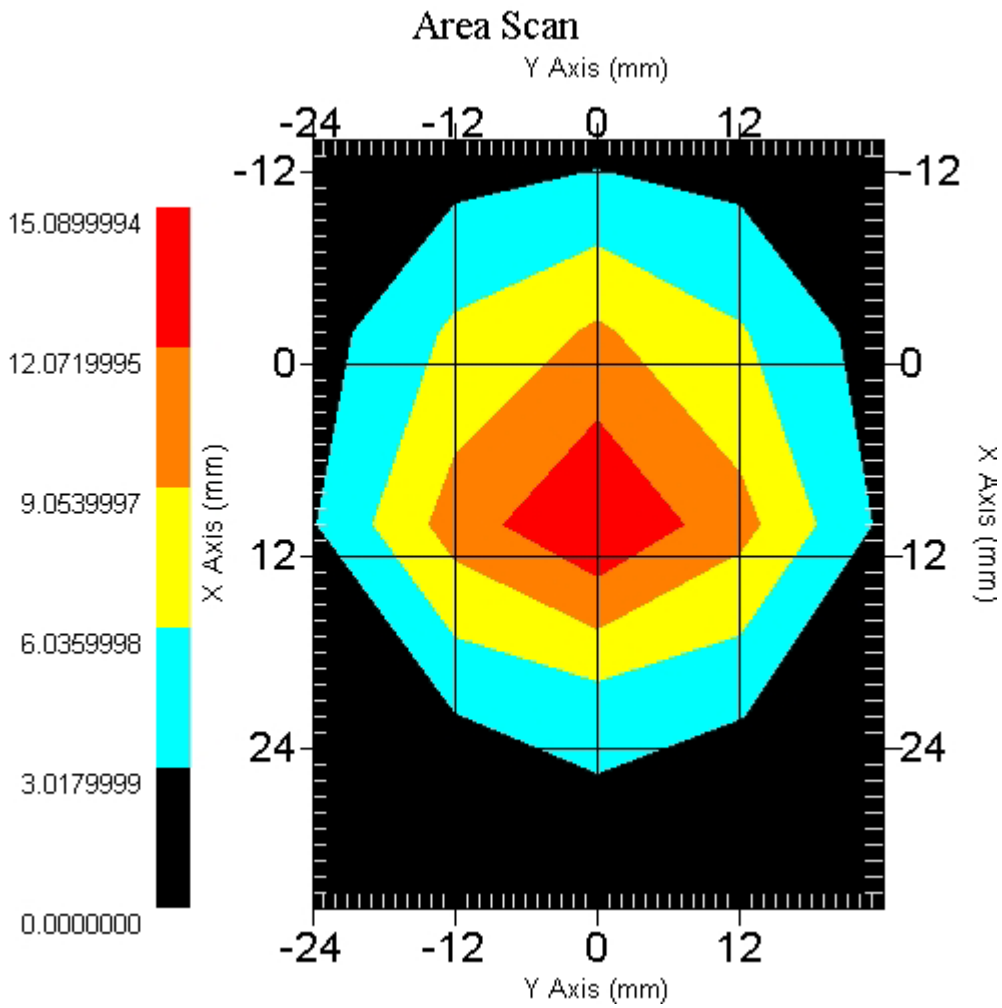

**SAR Measurement Data**

ALSAS-10U VER 2.3.0APREL Laboratories

SAR Test Report(802.11b)

Validation Date : 14-Mar-2006  
Measurement Date : 14-Mar-2006

## Product Data

Device Name : USB wireless  
Model : Q6236A  
Frequency : 2450.00 MHz  
Length : 88 mm  
Width : 26 mm  
Depth : 12 mm  
Antenna Type : Internal

## Phantom Data

Type : Uni-Phantom  
Size (mm) : 280 x 280 x 200  
Location : Center

## Tissue Data

Type : BODY  
Serial No. : 325-B  
Frequency : 2450.00 MHz  
Last Calib. Date : 14-Mar-2005  
Temperature : 20.20 °C  
Ambient Temp. : 19.70 °C  
Humidity : 50.00 RH%  
Epsilon : 51.31 F/m  
Sigma : 1.979 S/m  
Density : 1000.00 kg/cu. m

## Probe Data

Name : Probe 265  
Model : E020  
Type : E-Field Triangle  
Serial No. : 265  
Last Calib. Date : 23-Mar-2005  
Frequency : 2450.00 MHz  
Duty Cycle Factor: 1  
Conversion Factor: 4.7  
Probe Sensitivity: 1.20 1.20 1.20  $\mu\text{V}/(\text{V}/\text{m})^2$   
Compression Point: 95.00 mV  
Offset : 1.56 mm

Measurement Data

Crest Factor : 1  
Tissue Temp. : 20.20 °C  
Ambient Temp. : 19.70 °C  
Area Scan : 6x6x1 : Measurement x=10mm, y=10mm, z=4mm  
Zoom Scan : 7x7x7 : Measurement x=5mm, y=5mm, z=5mm  
Power Drift-Start : 0.178 W/kg  
Power Drift-Finish: 0.175 W/kg  
Power Drift (%) : -1.524

DUT Position : 802.11b-Front  
Channel : 1

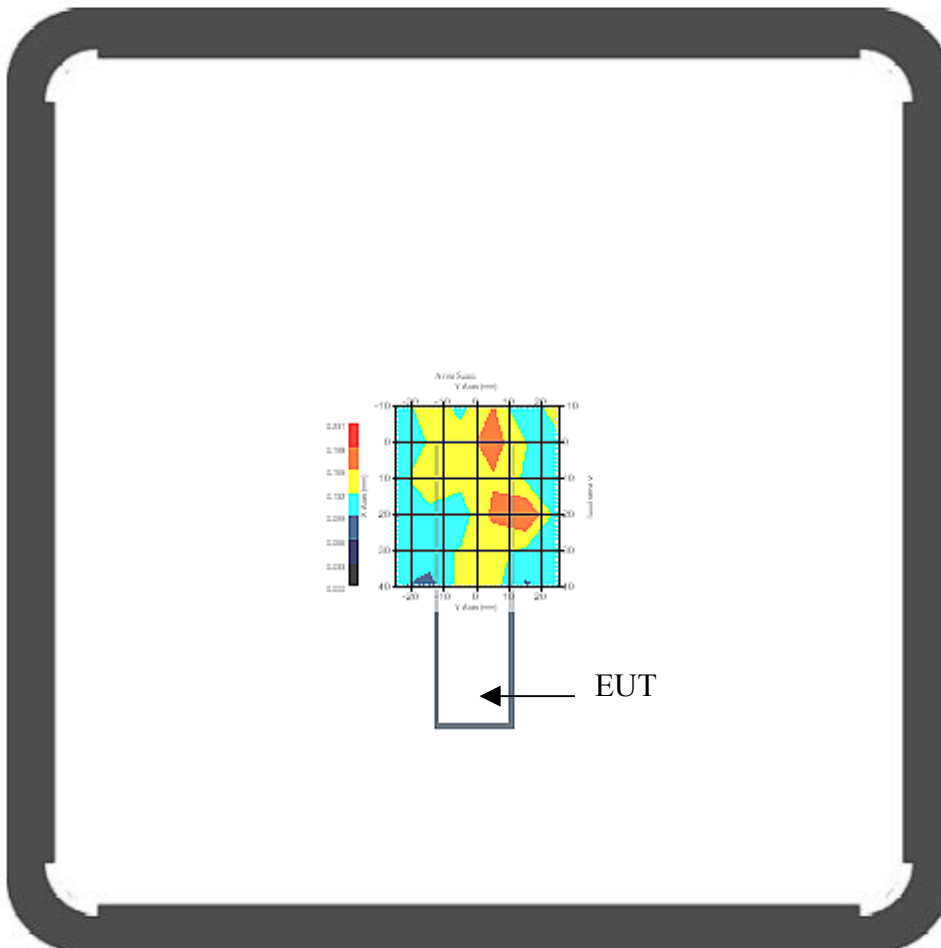

1 gram SAR value : 0.216 W/kg  
10 gram SAR value : 0.171 W/kg  
Area Scan Peak SAR : 0.198 W/kg  
Zoom Scan Peak SAR : 0.230 W/kg

This is previous page plot (zoom in)

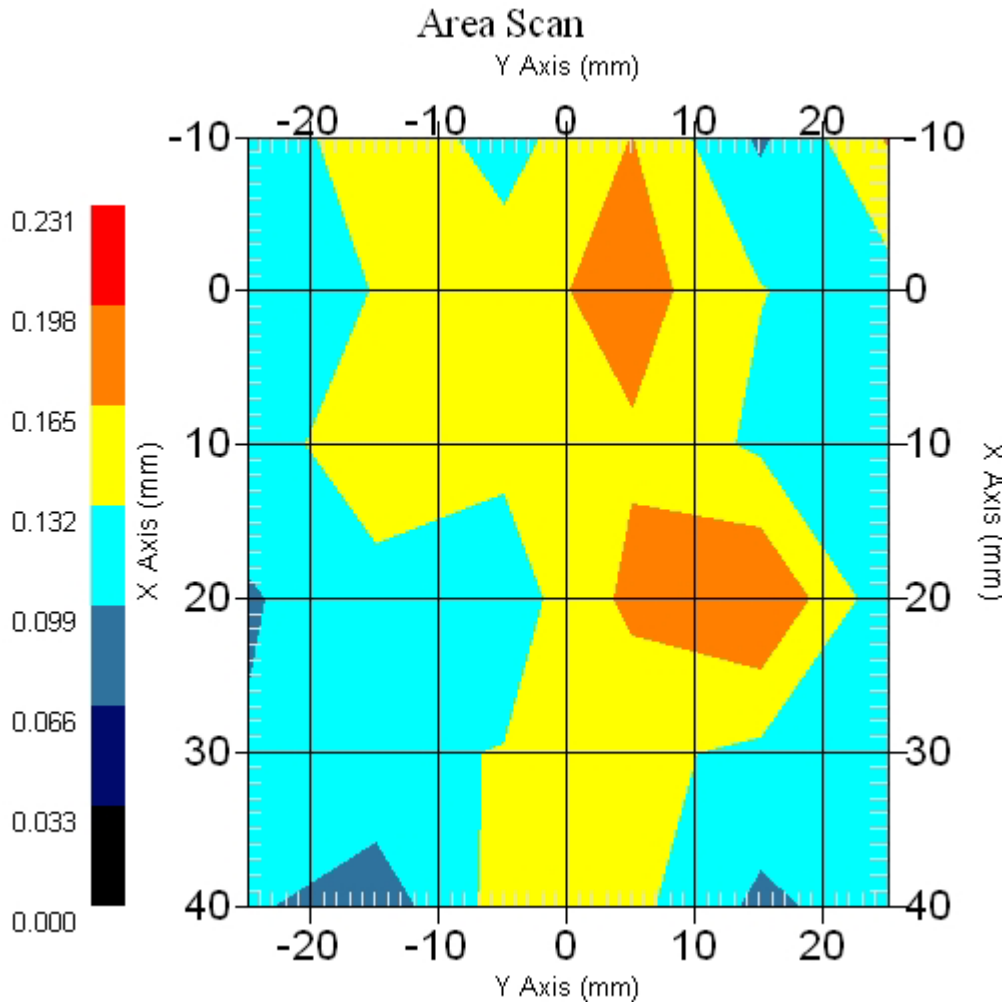

### Measurement Data

Crest Factor : 1  
Tissue Temp. : 20.20 °C  
Ambient Temp. : 19.70 °C  
Area Scan : 6x6x1 : Measurement x=10mm, y=10mm, z=4mm  
Zoom Scan : 7x7x7 : Measurement x=5mm, y=5mm, z=5mm  
Power Drift-Start : 0.236 W/kg  
Power Drift-Finish: 0.232 W/kg  
Power Drift (%) : -1.094  
  
DUT Position : 802.11b-Front  
Channel : 6

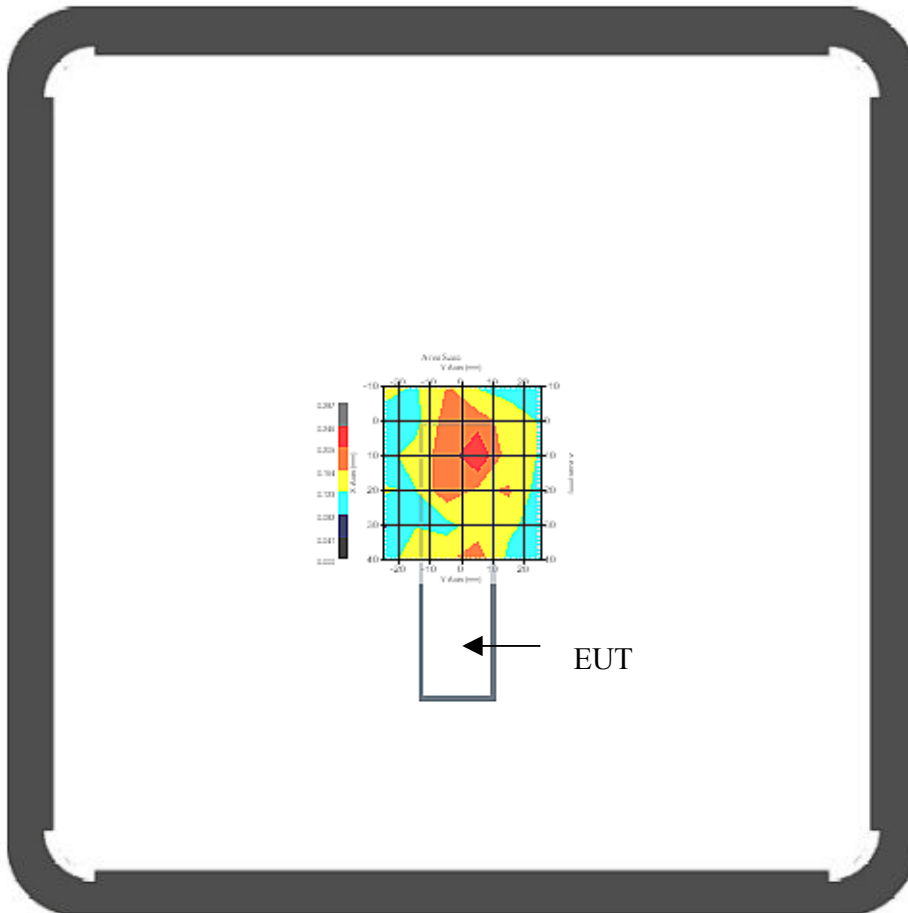

1 gram SAR value : 0.204 W/kg  
10 gram SAR value : 0.138 W/kg  
Area Scan Peak SAR : 0.246 W/kg  
Zoom Scan Peak SAR : 0.490 W/kg

This is previous page plot (zoom in)

Area Scan

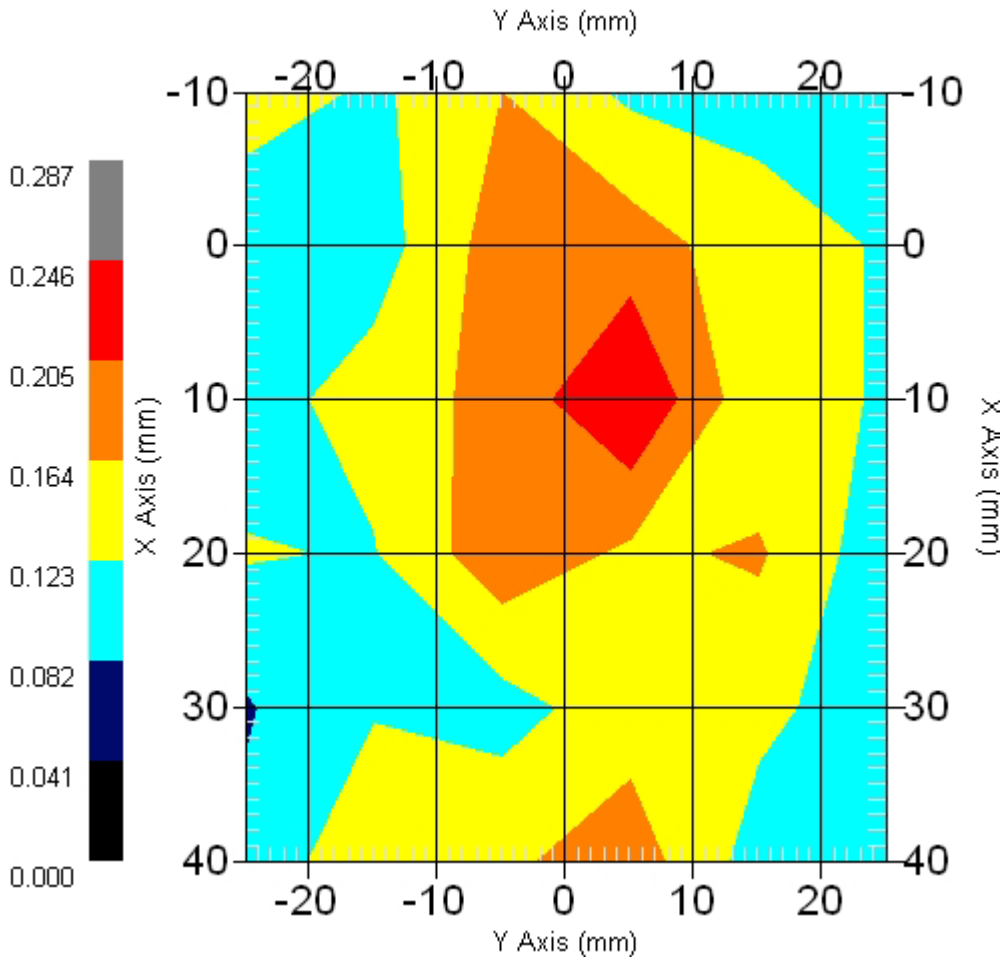

Measurement Data

Crest Factor : 1  
Tissue Temp. : 20.20 °C  
Ambient Temp. : 19.70 °C  
Area Scan : 6x6x1 : Measurement x=10mm, y=10mm, z=4mm  
Zoom Scan : 7x7x7 : Measurement x=5mm, y=5mm, z=5mm  
Power Drift-Start : 0.255 W/kg  
Power Drift-Finish: 0.252 W/kg  
Power Drift (%) : -1.198  
  
DUT Position : 802.11b-Front  
Channel : 11

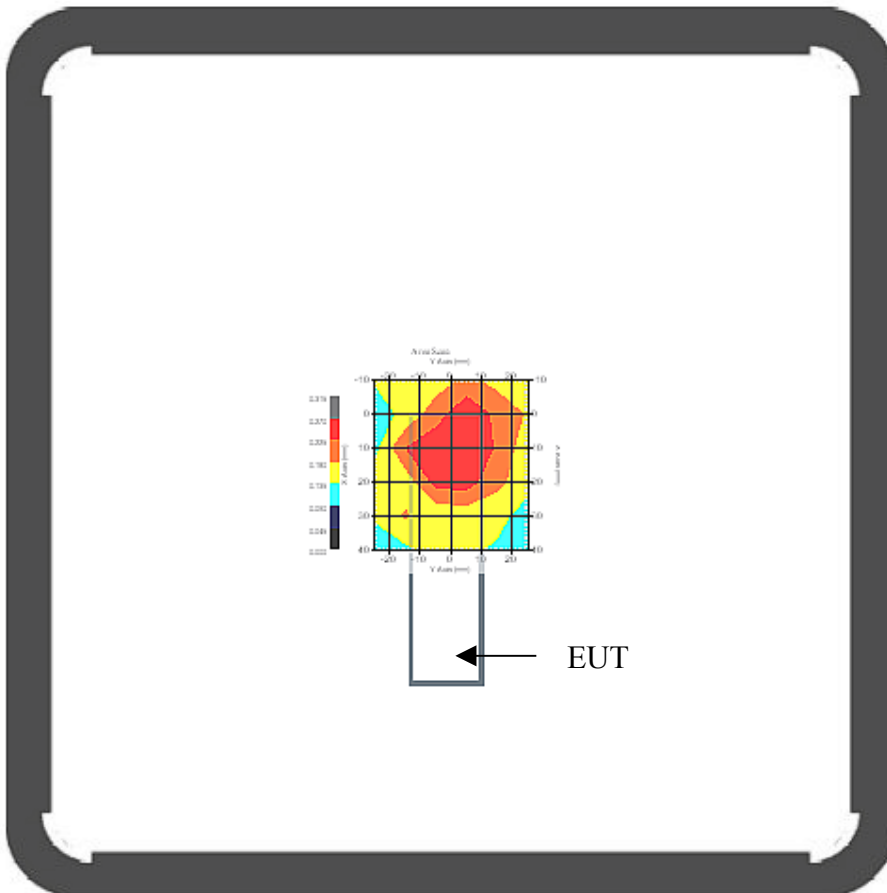

1 gram SAR value : 0.286 W/kg  
10 gram SAR value : 0.211 W/kg  
Area Scan Peak SAR : 0.270 W/kg  
Zoom Scan Peak SAR : 0.460 W/kg

This is previous page plot (zoom in)

Area Scan

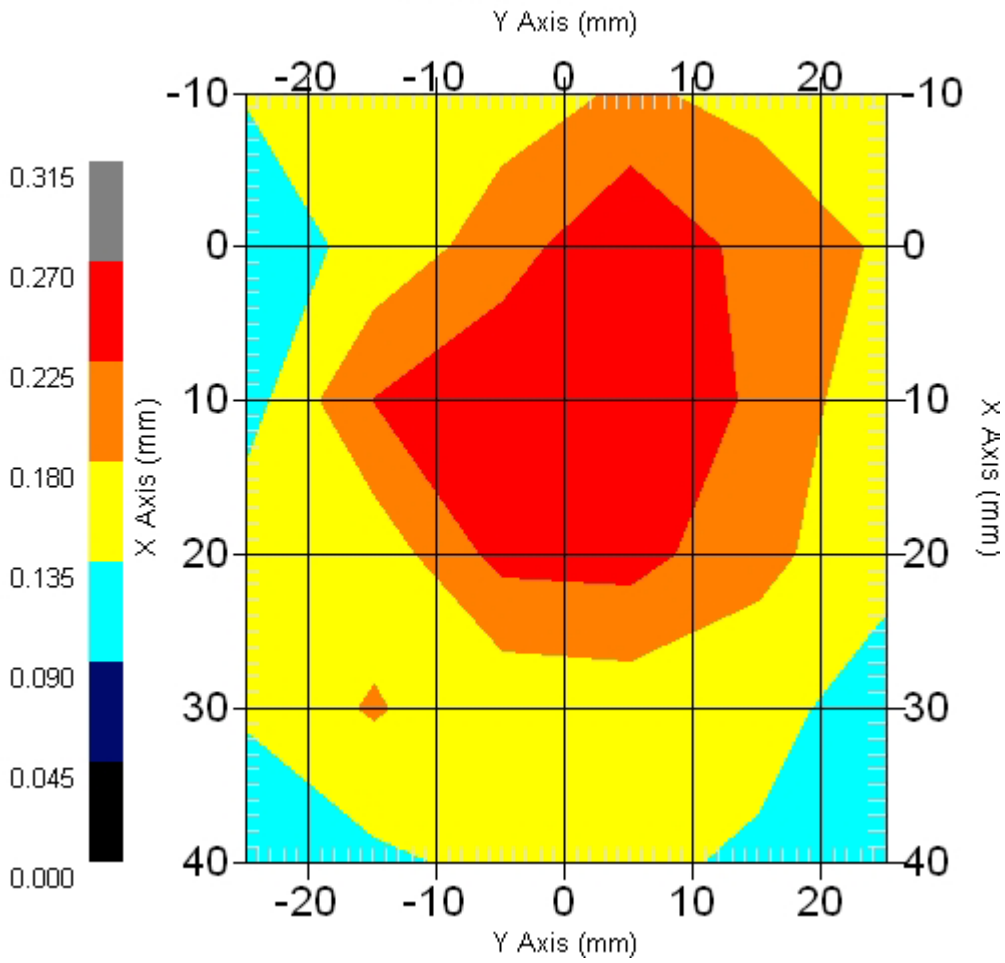



Measurement Data

Crest Factor : 1  
Tissue Temp. : 20.20 °C  
Ambient Temp. : 19.70 °C  
Area Scan : 6x6x1 : Measurement x=10mm, y=10mm, z=4mm  
Zoom Scan : 7x7x7 : Measurement x=5mm, y=5mm, z=5mm  
Power Drift-Start : 0.360 W/kg  
Power Drift-Finish: 0.371 W/kg  
Power Drift (%) : 2.844

DUT Position : 802.11b-Back  
Channel : 1

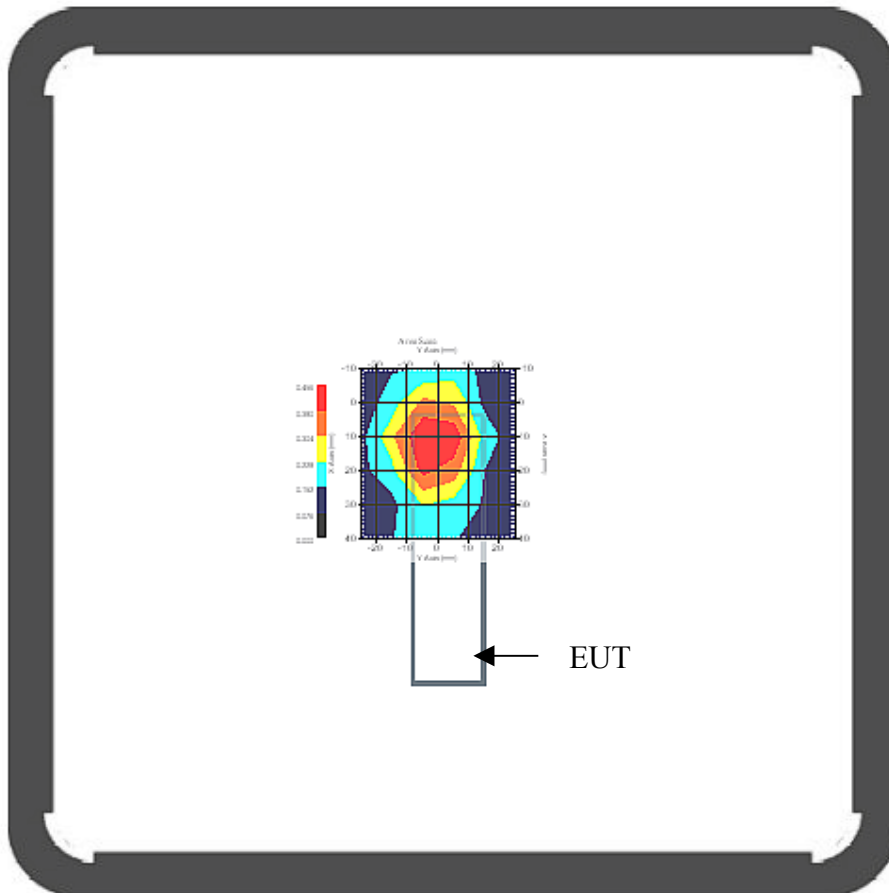

1 gram SAR value : 0.421 W/kg  
10 gram SAR value : 0.246 W/kg  
Area Scan Peak SAR : 0.454 W/kg  
Zoom Scan Peak SAR : 0.660 W/kg

This is previous page plot (zoom in)

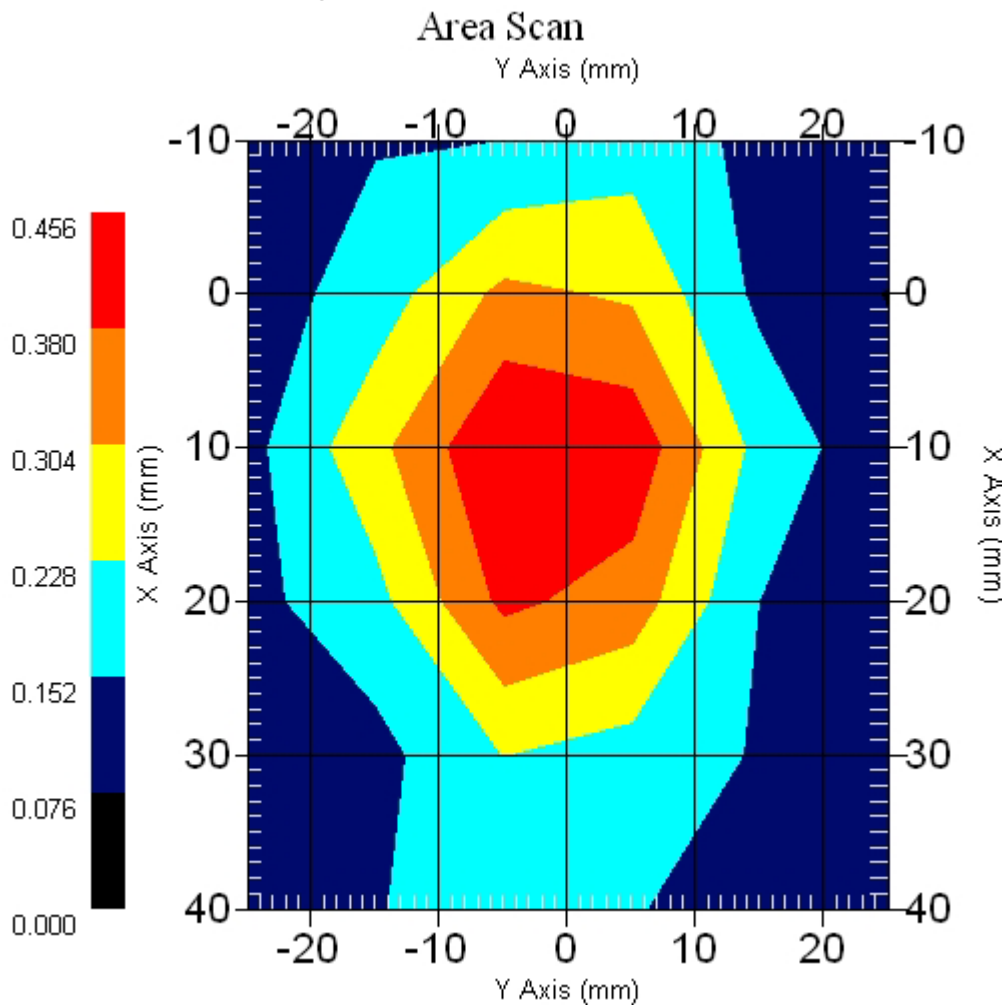

Measurement Data

Crest Factor : 1  
Tissue Temp. : 20.20 °C  
Ambient Temp. : 19.70 °C  
Area Scan : 6x6x1 : Measurement x=10mm, y=10mm, z=4mm  
Zoom Scan : 7x7x7 : Measurement x=5mm, y=5mm, z=5mm  
Power Drift-Start : 0.200 W/kg  
Power Drift-Finish: 0.197 W/kg  
Power Drift (%) : -1.397  
  
DUT Position : 802.11b-Back  
Channel : 6

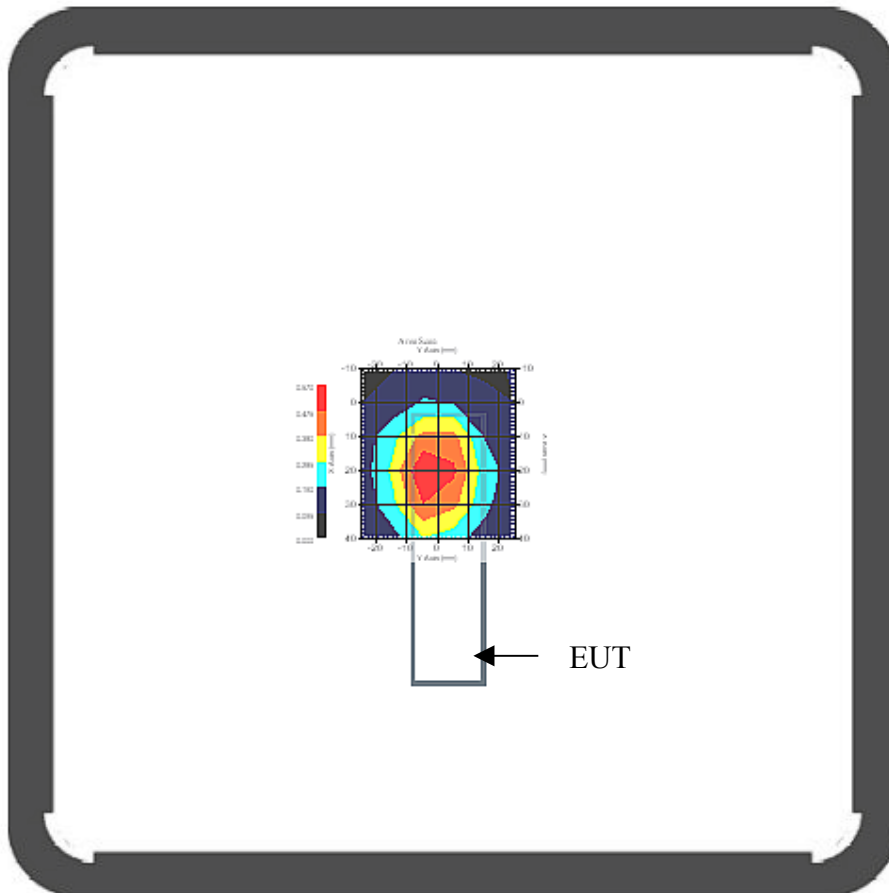

1 gram SAR value : 0.441 W/kg  
10 gram SAR value : 0.250 W/kg  
Area Scan Peak SAR : 0.569 W/kg  
Zoom Scan Peak SAR : 0.850 W/kg

This is previous page plot (zoom in)

Area Scan

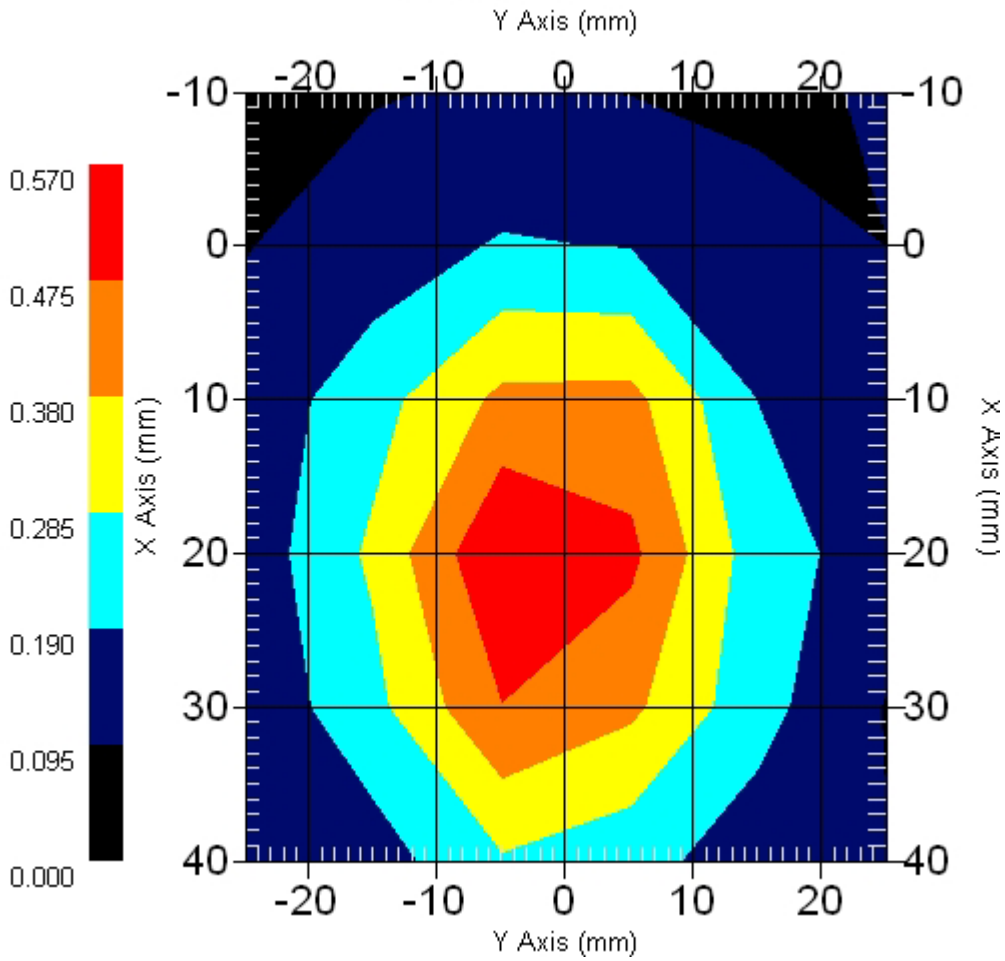

Measurement Data

Crest Factor : 1  
Tissue Temp. : 20.20 °C  
Ambient Temp. : 19.70 °C  
Area Scan : 6x6x1 : Measurement x=10mm, y=10mm, z=4mm  
Zoom Scan : 7x7x7 : Measurement x=5mm, y=5mm, z=5mm  
Power Drift-Start : 0.499 W/kg  
Power Drift-Finish: 0.479 W/kg  
Power Drift (%) : -4.127  
  
DUT Position : 802.11b-Back  
Channel : 11

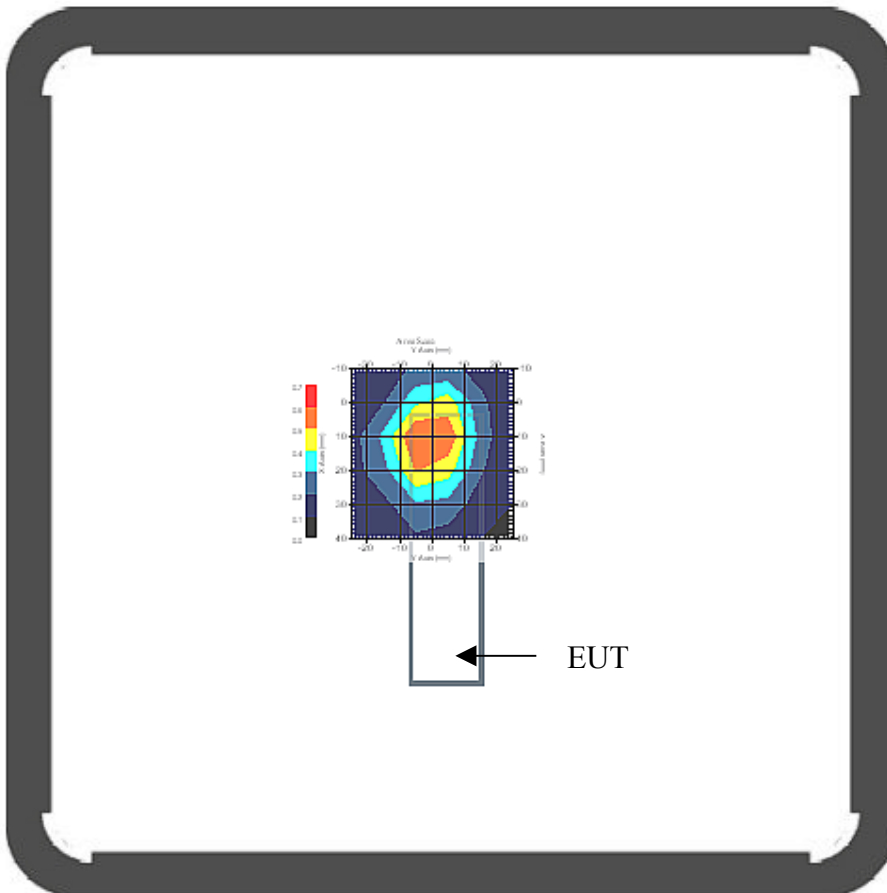

1 gram SAR value : 0.532 W/kg  
10 gram SAR value : 0.299 W/kg  
Area Scan Peak SAR : 0.602 W/kg  
Zoom Scan Peak SAR : 0.920 W/kg

This is previous page plot (zoom in)

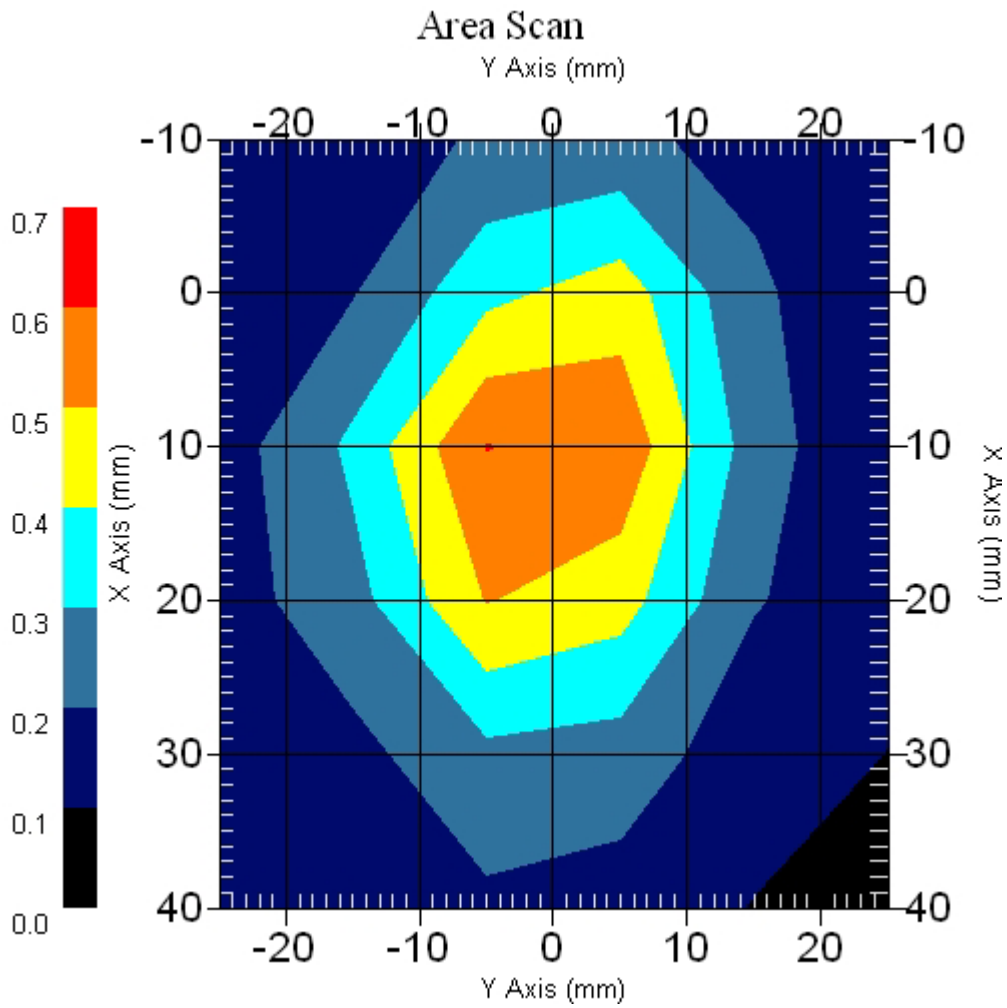

Measurement Data

Crest Factor : 1  
Tissue Temp. : 20.20 °C  
Ambient Temp. : 19.70 °C  
Area Scan : 4x6x1 : Measurement x=10mm, y=10mm, z=4mm  
Zoom Scan : 7x7x7 : Measurement x=5mm, y=5mm, z=5mm  
Power Drift-Start : 0.081 W/kg  
Power Drift-Finish: 0.083 W/kg  
Power Drift (%) : 2.750  
  
DUT Position : 802.11b-Top  
Channel : 6

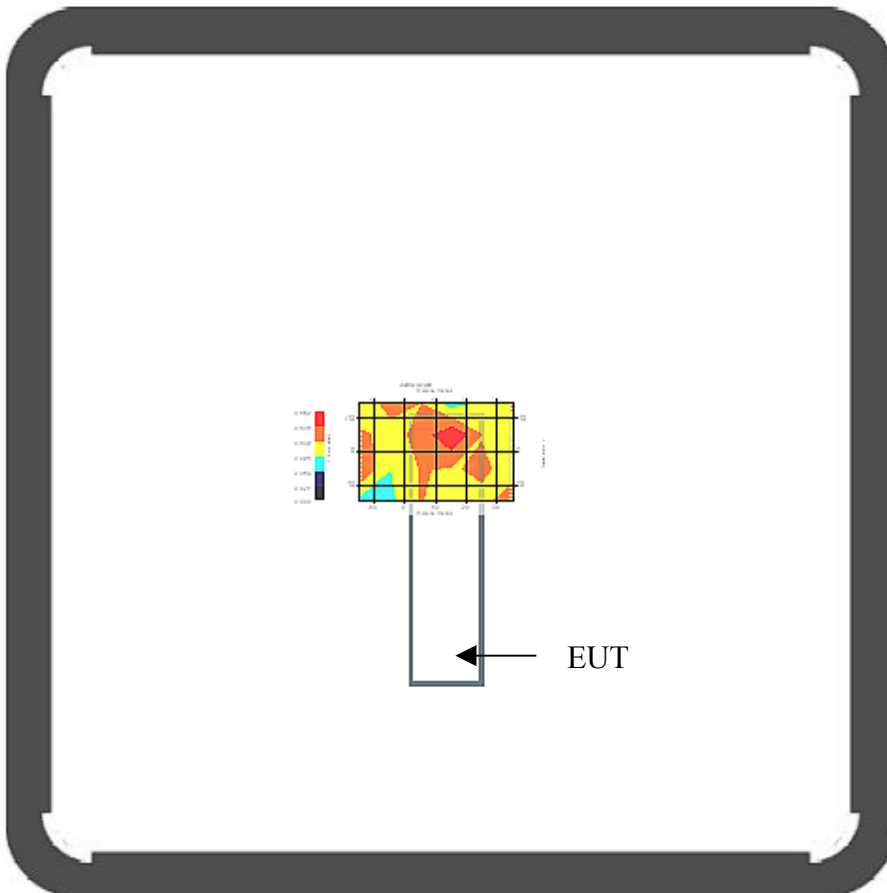

1 gram SAR value : 0.117 W/kg  
10 gram SAR value : 0.105 W/kg  
Area Scan Peak SAR : 0.161 W/kg  
Zoom Scan Peak SAR : 0.220 W/kg

This is previous page plot (zoom in)

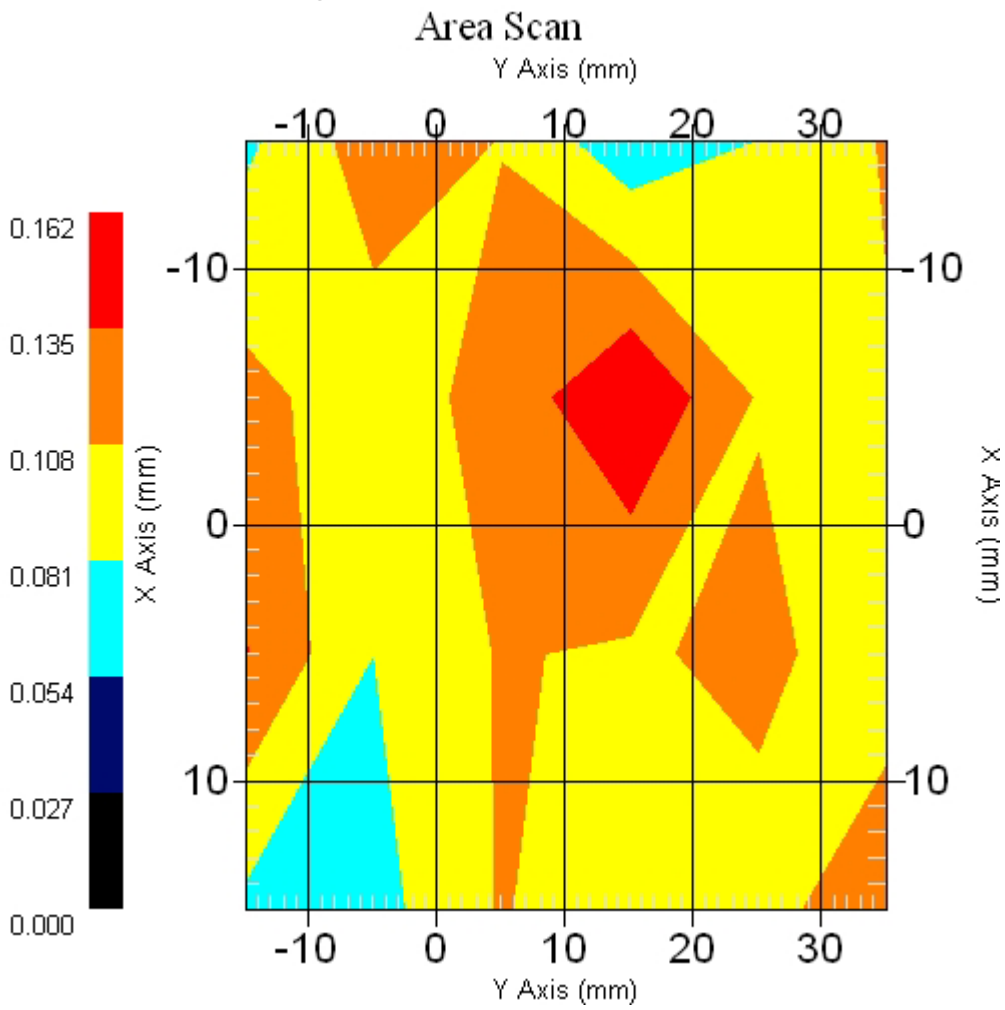



ALSAS-10U VER 2.3.0APREL Laboratories  
SAR Test Report(802.11g)Validation Date : 14-Mar-2006  
Measurement Date : 14-Mar-2006

## Product Data

Device Name : USB wireless  
Model : Q6236A  
Frequency : 2450.00 MHz  
Length : 88 mm  
Width : 26 mm  
Depth : 12 mm  
Antenna Type : Internal

## Phantom Data

Type : Uni-Phantom  
Size (mm) : 280 x 280 x 200  
Location : Center

## Tissue Data

Type : BODY  
Serial No. : 325-B  
Frequency : 2450.00 MHz  
Last Calib. Date : 14-Mar-2005  
Temperature : 20.20 °C  
Ambient Temp. : 19.70 °C  
Humidity : 50.00 RH%  
Epsilon : 51.31 F/m  
Sigma : 1.979 S/m  
Density : 1000.00 kg/cu. m

## Probe Data

Name : Probe 265  
Model : E020  
Type : E-Field Triangle  
Serial No. : 265  
Last Calib. Date : 23-Mar-2005  
Frequency : 2450.00 MHz  
Duty Cycle Factor: 1  
Conversion Factor: 4.7  
Probe Sensitivity: 1.20 1.20 1.20  $\mu\text{V}/(\text{V}/\text{m})^2$   
Compression Point: 95.00 mV  
Offset : 1.56 mm

Measurement Data

Crest Factor : 1  
Tissue Temp. : 20.20 °C  
Ambient Temp. : 19.70 °C  
Area Scan : 6x6x1 : Measurement x=10mm, y=10mm, z=4mm  
Zoom Scan : 7x7x7 : Measurement x=5mm, y=5mm, z=5mm  
Power Drift-Start : 0.145 W/kg  
Power Drift-Finish: 0.139 W/kg  
Power Drift (%) : -3.788

DUT Position : 802.11g-Front  
Channel : 1

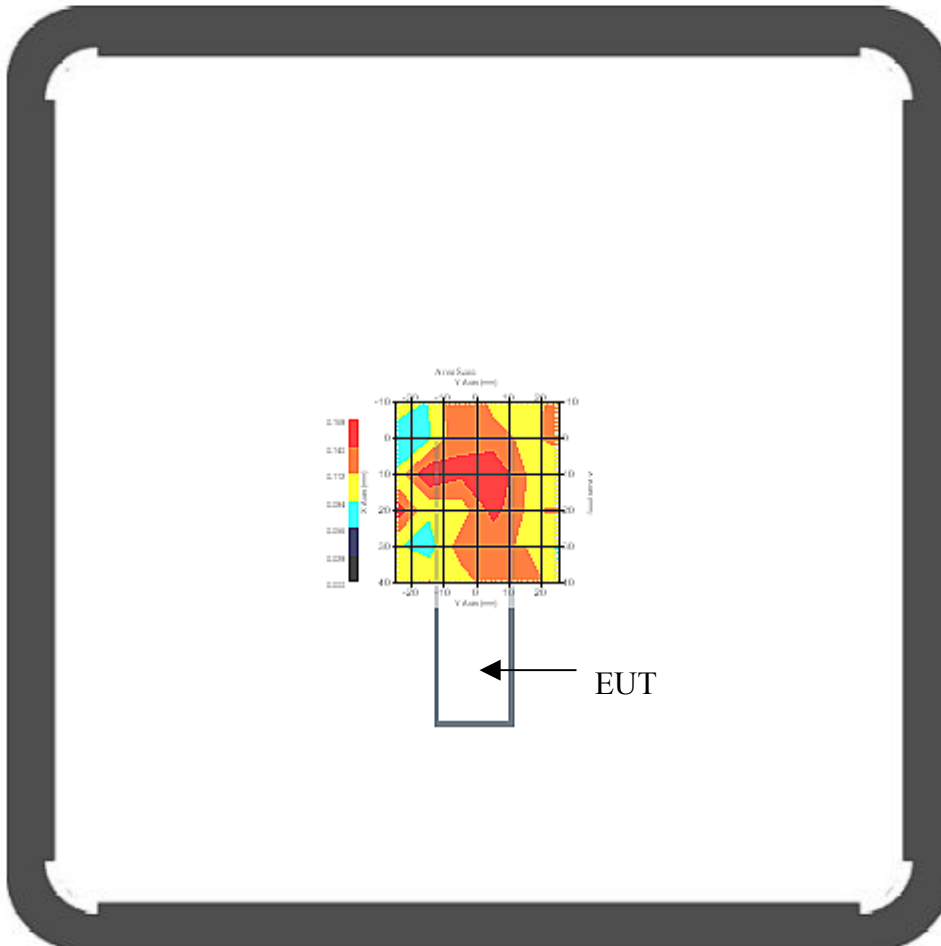

1 gram SAR value : 0.178 W/kg  
10 gram SAR value : 0.136 W/kg  
Area Scan Peak SAR : 0.167 W/kg  
Zoom Scan Peak SAR : 0.230 W/kg

This is previous page plot (zoom in)

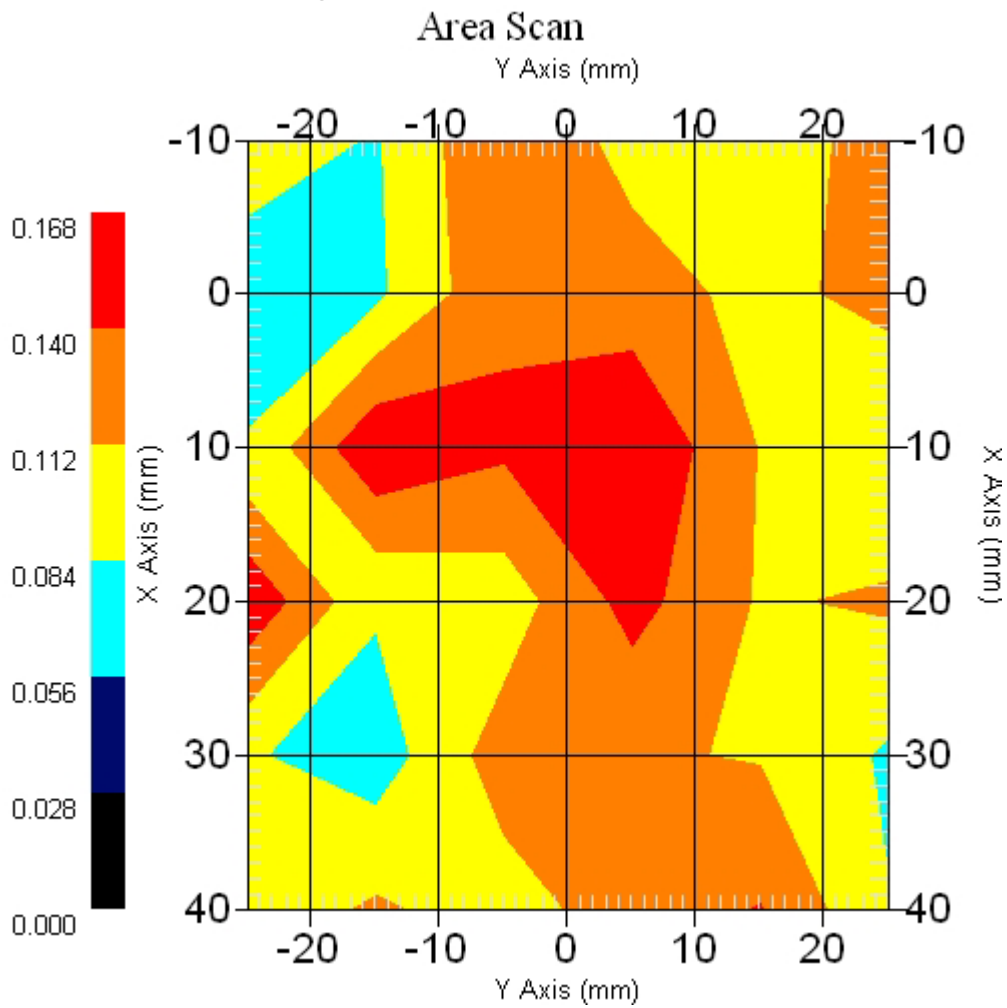

Measurement Data

Crest Factor : 1  
Tissue Temp. : 20.20 °C  
Ambient Temp. : 19.70 °C  
Area Scan : 6x6x1 : Measurement x=10mm, y=10mm, z=4mm  
Zoom Scan : 7x7x7 : Measurement x=5mm, y=5mm, z=5mm  
Power Drift-Start : 0.202 W/kg  
Power Drift-Finish: 0.198 W/kg  
Power Drift (%) : -2.089  
  
DUT Position : 802.11g-Front  
Channel : 6

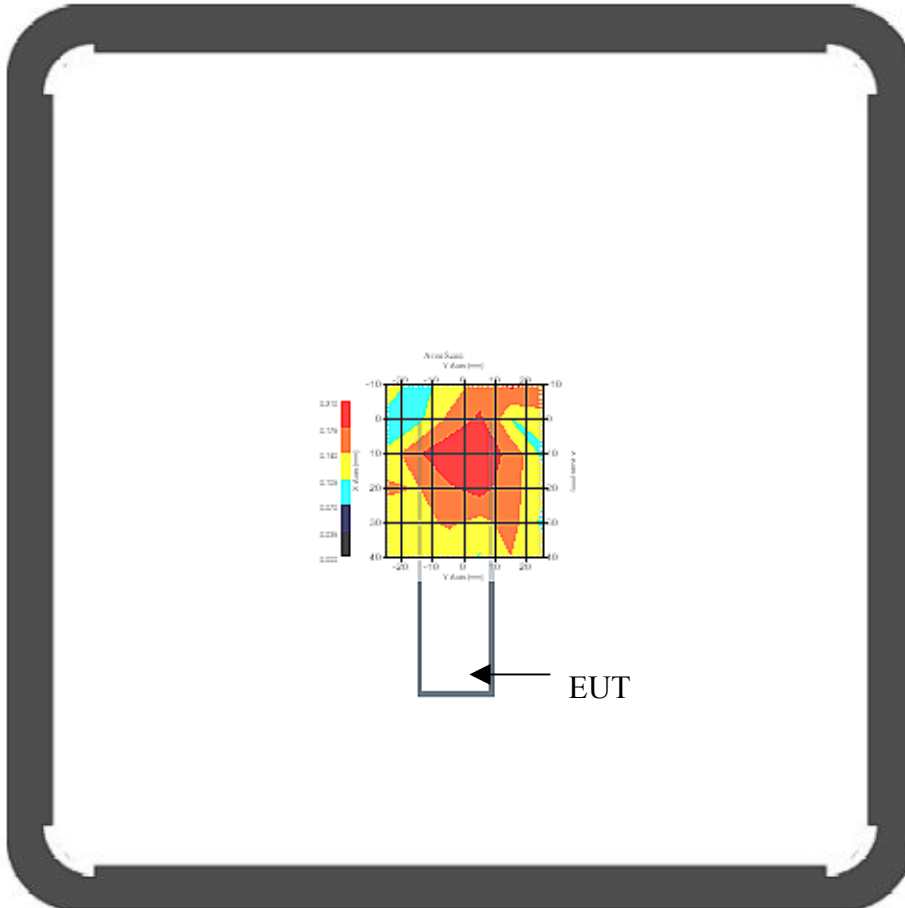

1 gram SAR value : 0.211 W/kg  
10 gram SAR value : 0.149 W/kg  
Area Scan Peak SAR : 0.207 W/kg  
Zoom Scan Peak SAR : 0.300 W/kg

This is previous page plot (zoom in)

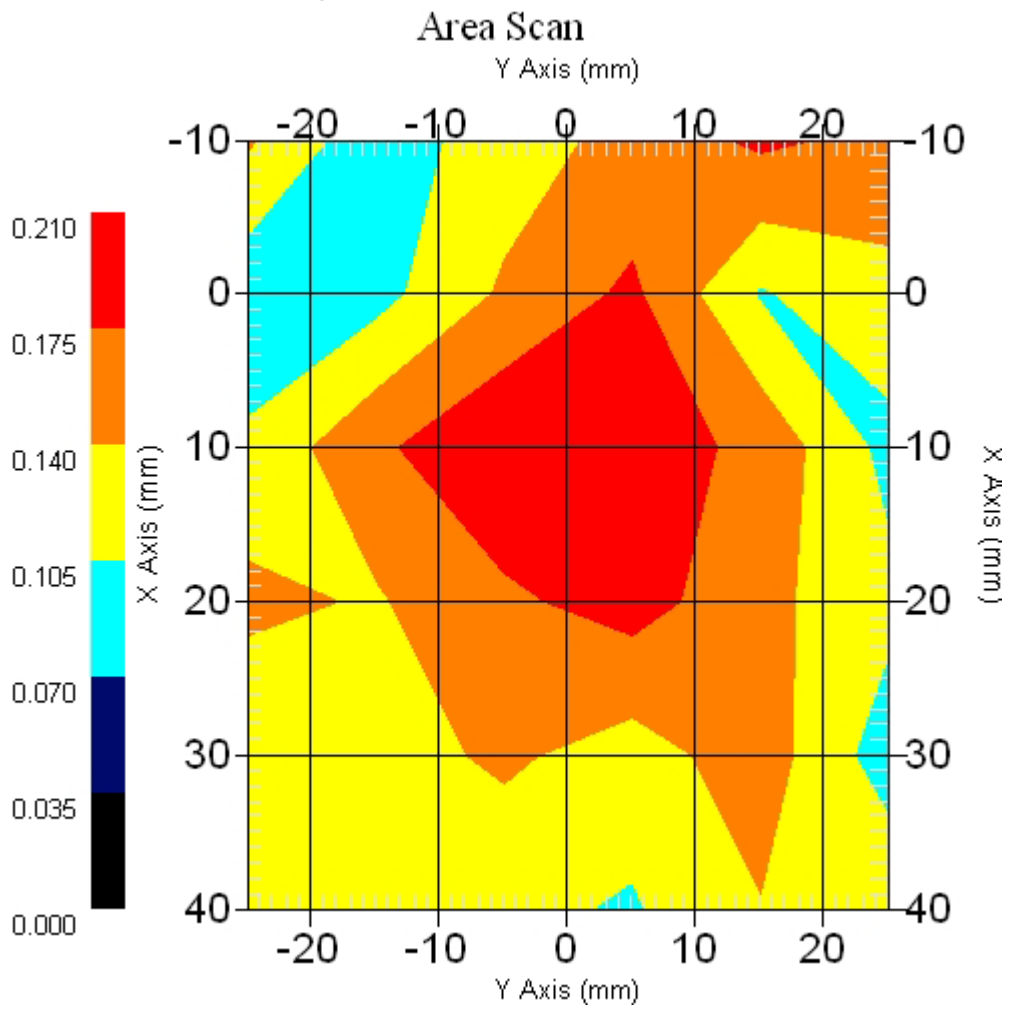

Measurement Data

Crest Factor : 1  
Tissue Temp. : 20.20 °C  
Ambient Temp. : 19.70 °C  
Area Scan : 6x6x1 : Measurement x=10mm, y=10mm, z=4mm  
Zoom Scan : 7x7x7 : Measurement x=5mm, y=5mm, z=5mm  
Power Drift-Start : 0.215 W/kg  
Power Drift-Finish: 0.223 W/kg  
Power Drift (%) : 3.637  
  
DUT Position : 802.11g-Front  
Channel : 11

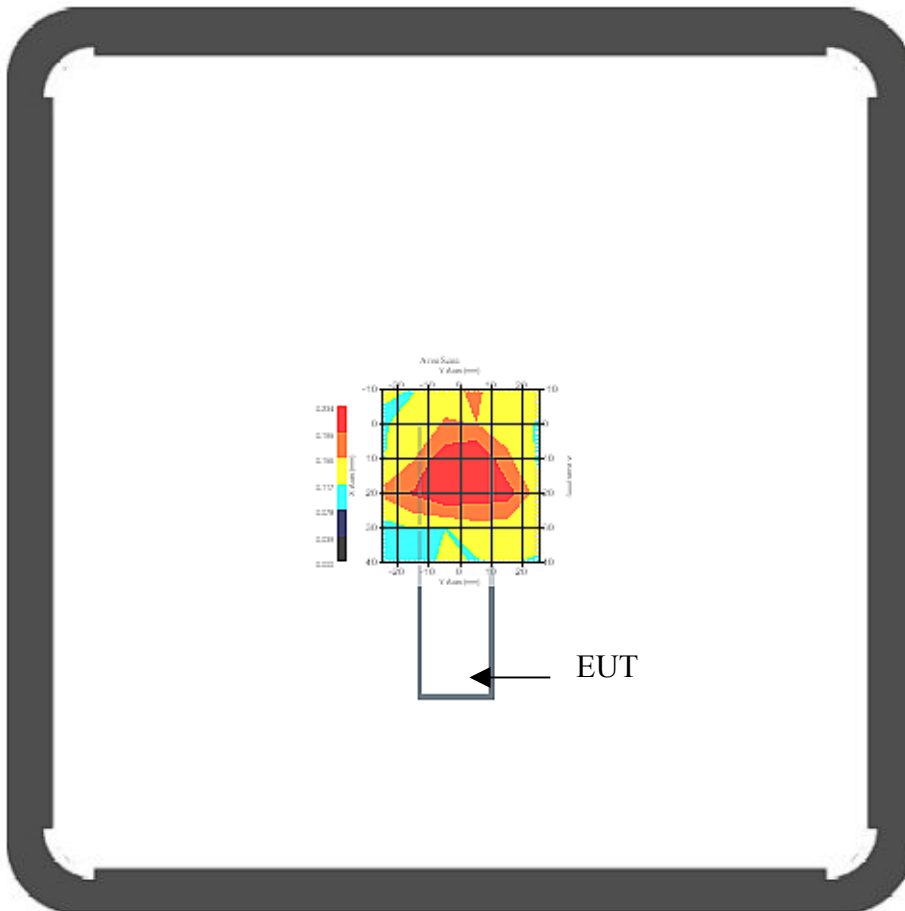

1 gram SAR value : 0.235 W/kg  
10 gram SAR value : 0.190 W/kg  
Area Scan Peak SAR : 0.234 W/kg  
Zoom Scan Peak SAR : 0.390 W/kg

This is previous page plot (zoom in)

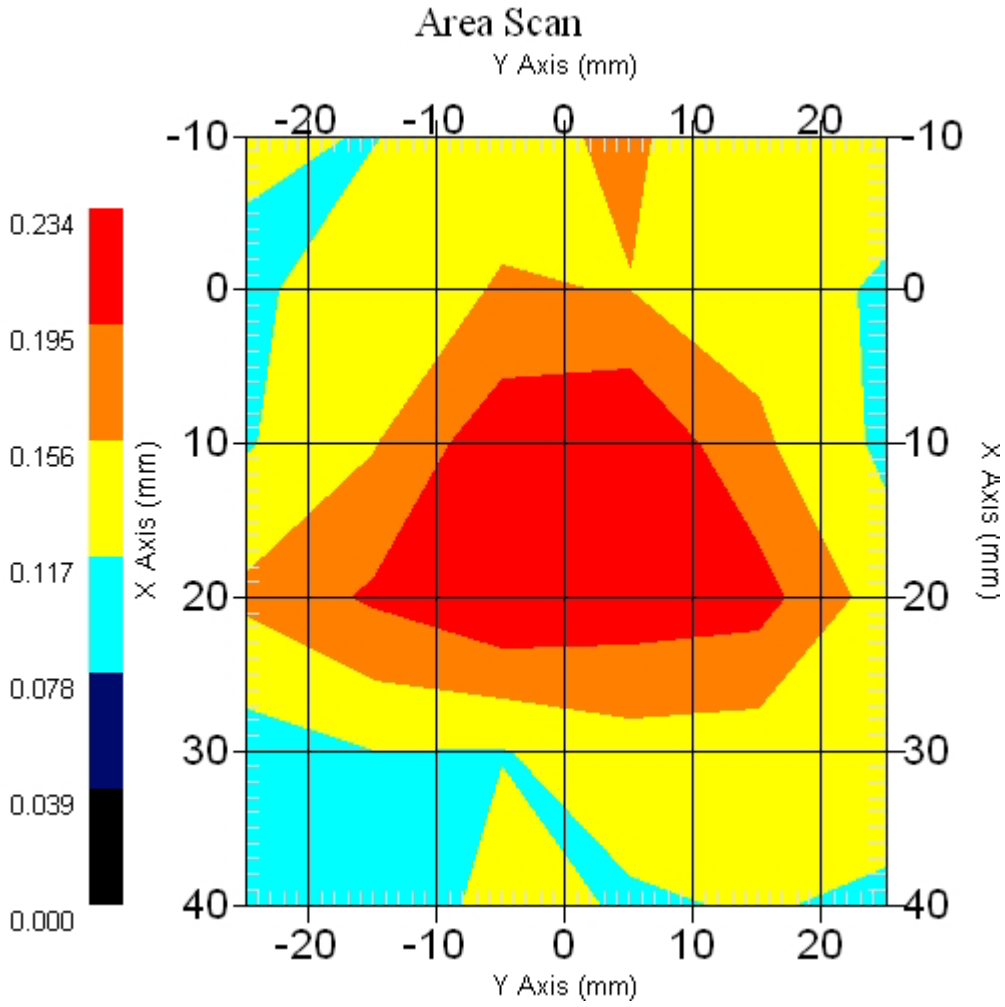

Measurement Data

Crest Factor : 1  
Tissue Temp. : 20.20 °C  
Ambient Temp. : 19.70 °C  
Area Scan : 6x6x1 : Measurement x=10mm, y=10mm, z=4mm  
Zoom Scan : 7x7x7 : Measurement x=5mm, y=5mm, z=5mm  
Power Drift-Start : 0.365 W/kg  
Power Drift-Finish: 0.354 W/kg  
Power Drift (%) : -3.115  
  
DUT Position : 802.11g-Back  
Channel : 1

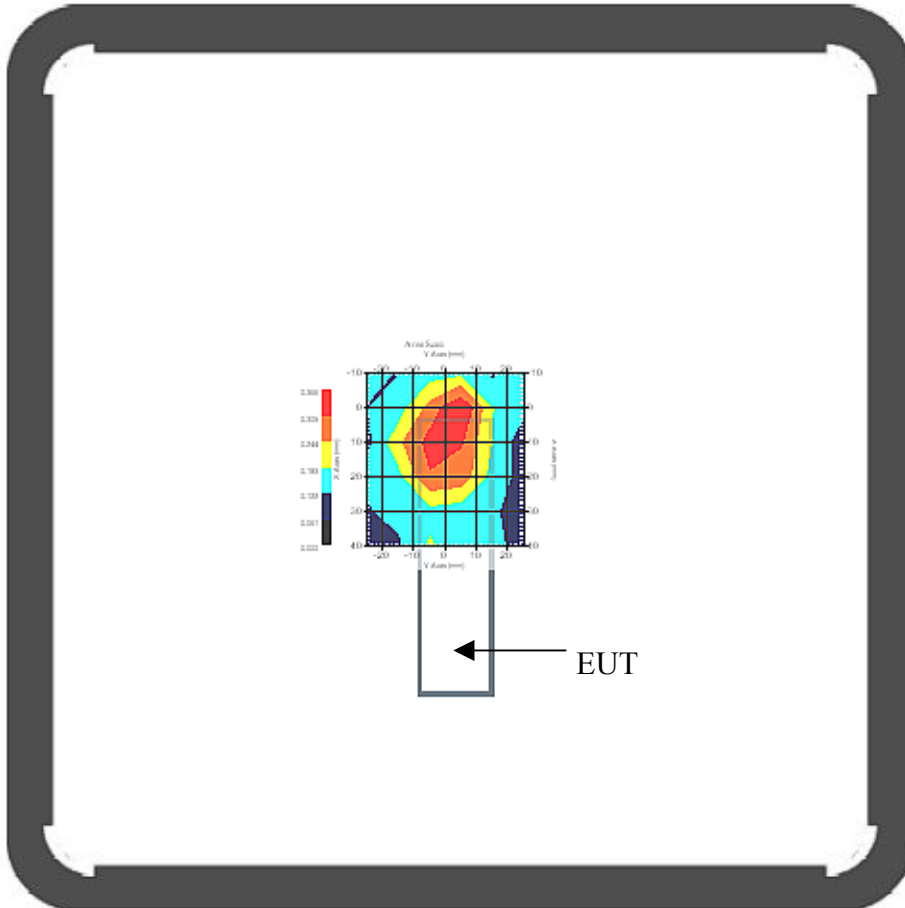

1 gram SAR value : 0.363 W/kg  
10 gram SAR value : 0.224 W/kg  
Area Scan Peak SAR : 0.366 W/kg  
Zoom Scan Peak SAR : 0.620 W/kg



This is previous page plot (zoom in)

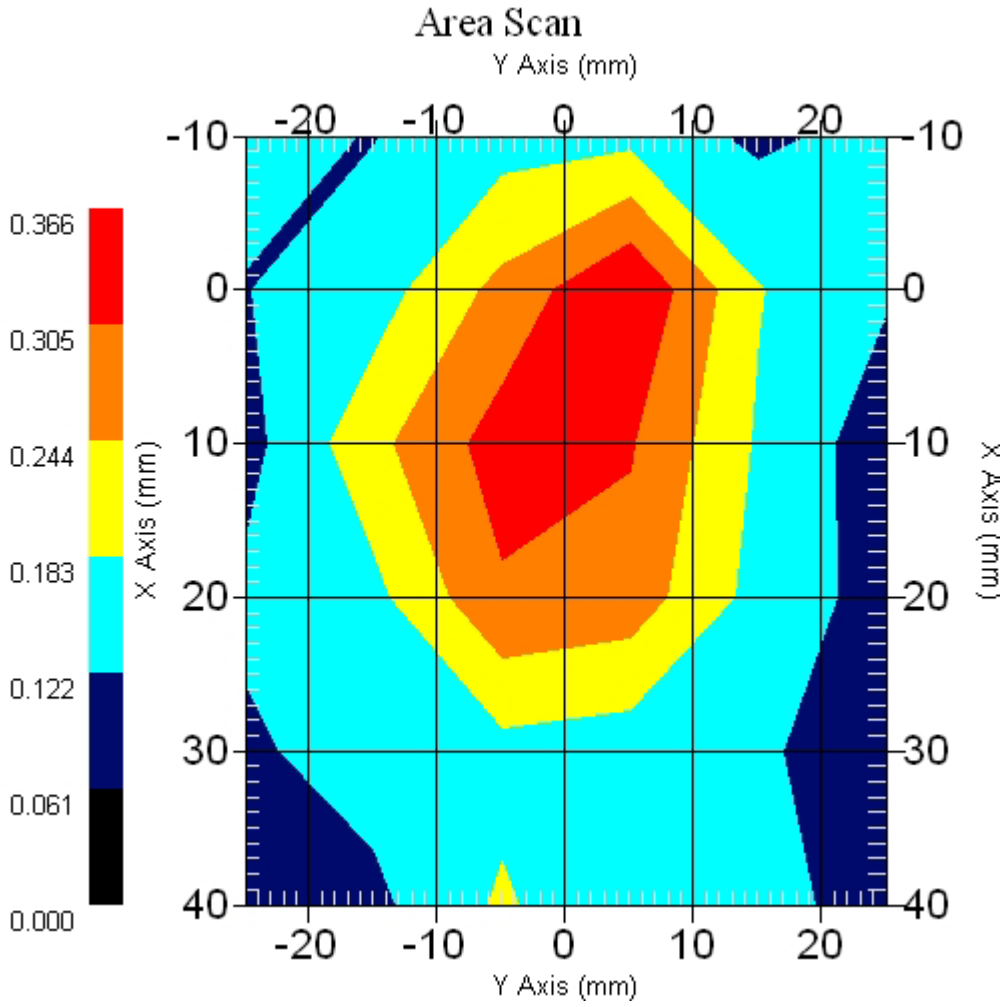

Measurement Data

Crest Factor : 1  
Tissue Temp. : 20.20 °C  
Ambient Temp. : 19.70 °C  
Area Scan : 6x6x1 : Measurement x=10mm, y=10mm, z=4mm  
Zoom Scan : 7x7x7 : Measurement x=5mm, y=5mm, z=5mm  
Power Drift-Start : 0.407 W/kg  
Power Drift-Finish: 0.391 W/kg  
Power Drift (%) : -3.863  
  
DUT Position : 802.11g-Back  
Channel : 6

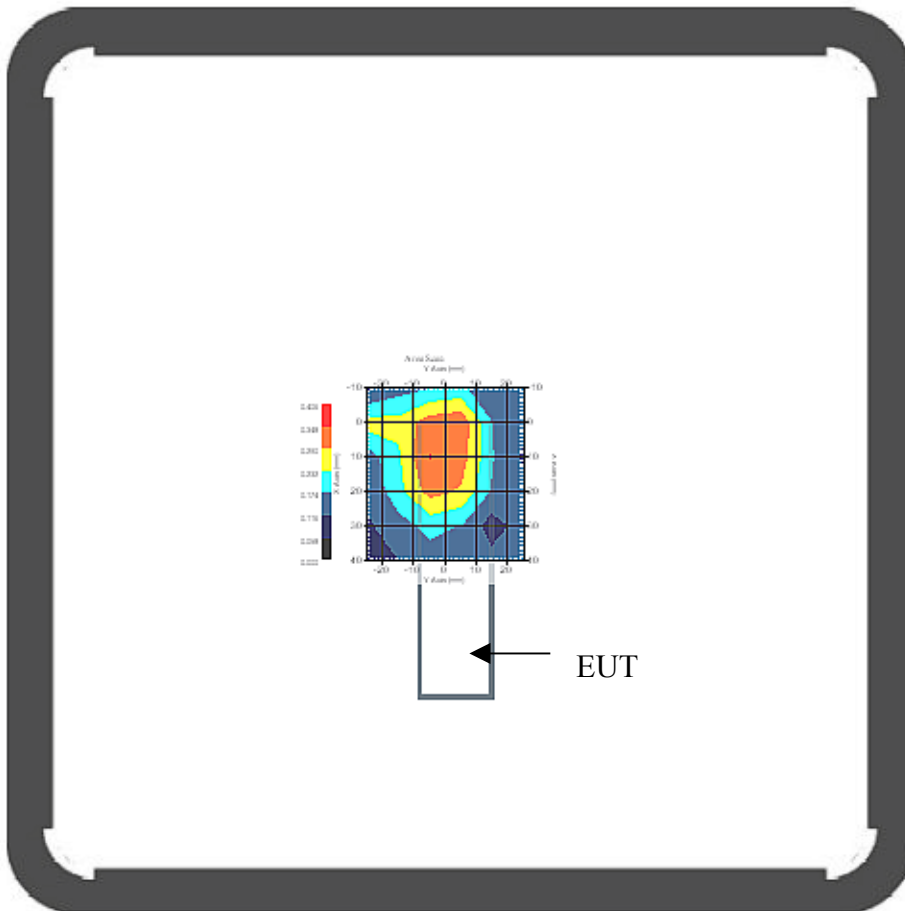

1 gram SAR value : 0.337 W/kg  
10 gram SAR value : 0.210 W/kg  
Area Scan Peak SAR : 0.350 W/kg  
Zoom Scan Peak SAR : 0.410 W/kg

This is previous page plot (zoom in)

Area Scan

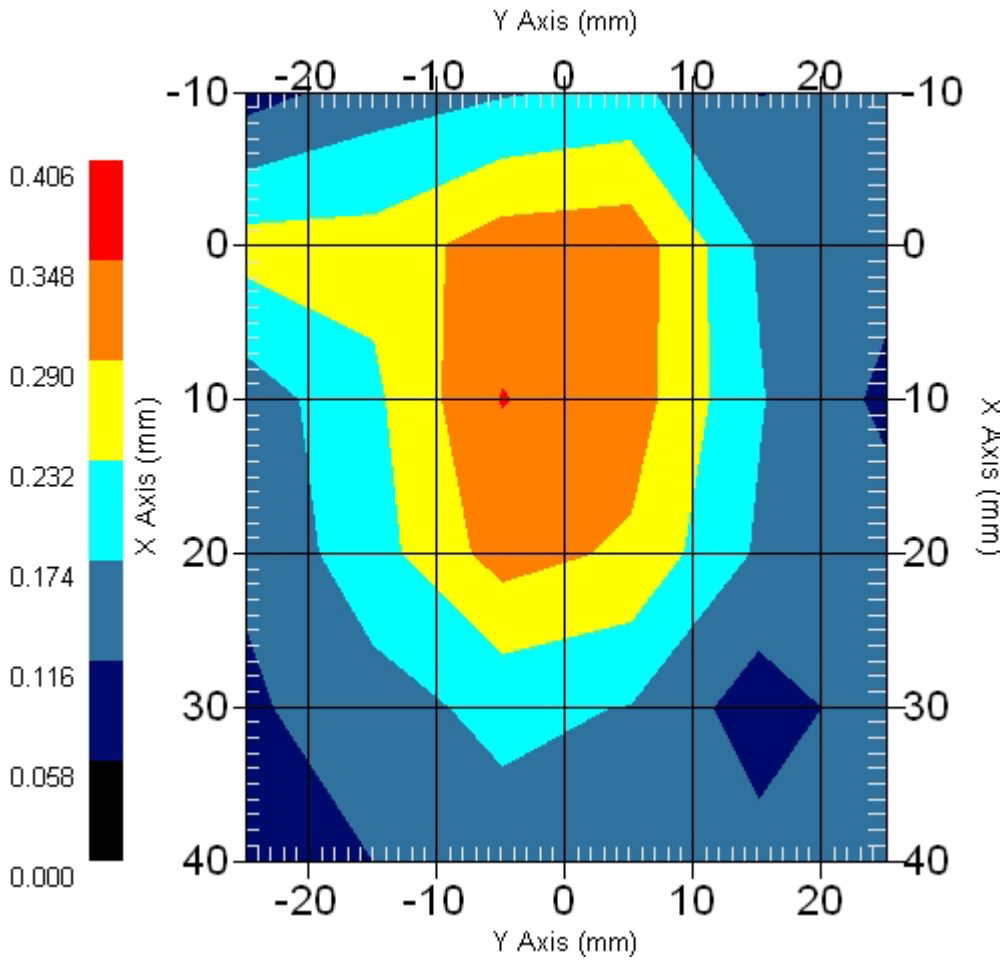

Measurement Data

Crest Factor : 1  
Tissue Temp. : 20.20 °C  
Ambient Temp. : 19.70 °C  
Area Scan : 6x6x1 : Measurement x=10mm, y=10mm, z=4mm  
Zoom Scan : 7x7x7 : Measurement x=5mm, y=5mm, z=5mm  
Power Drift-Start : 0.379 W/kg  
Power Drift-Finish: 0.368 W/kg  
Power Drift (%) : -2.981  
  
DUT Position : 802.11g-Back  
Channel : 11

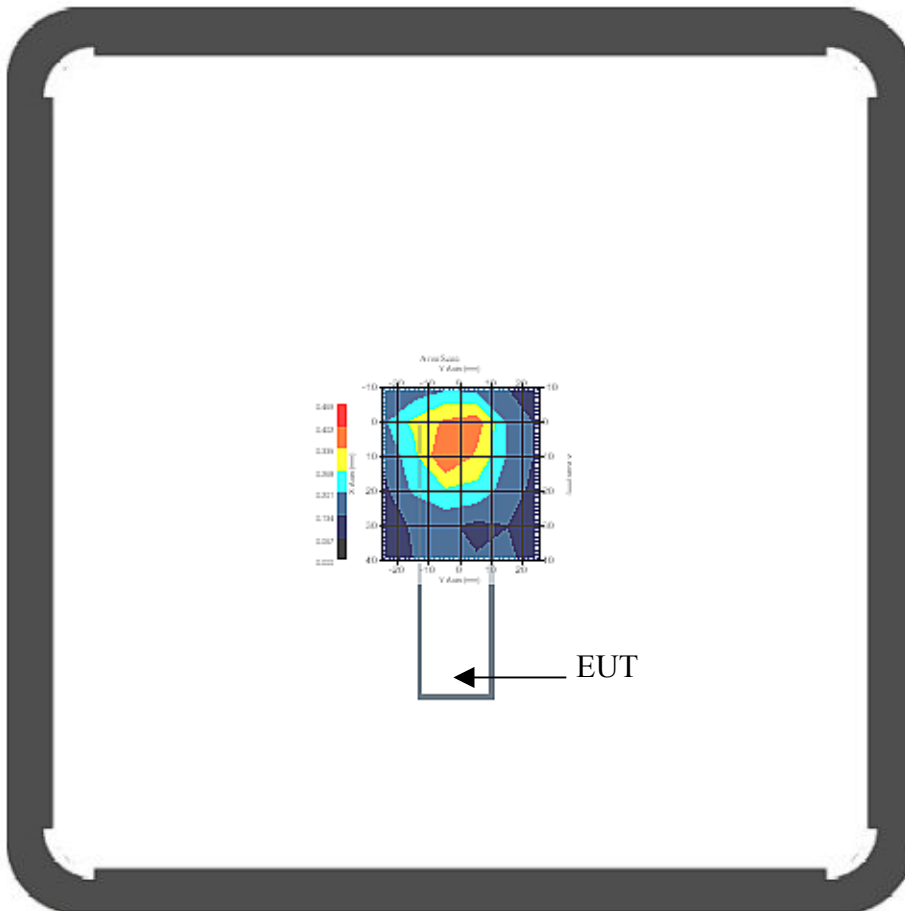

1 gram SAR value : 0.315 W/kg  
10 gram SAR value : 0.221 W/kg  
Area Scan Peak SAR : 0.404 W/kg  
Zoom Scan Peak SAR : 0.560 W/kg

This is previous page plot (zoom in)

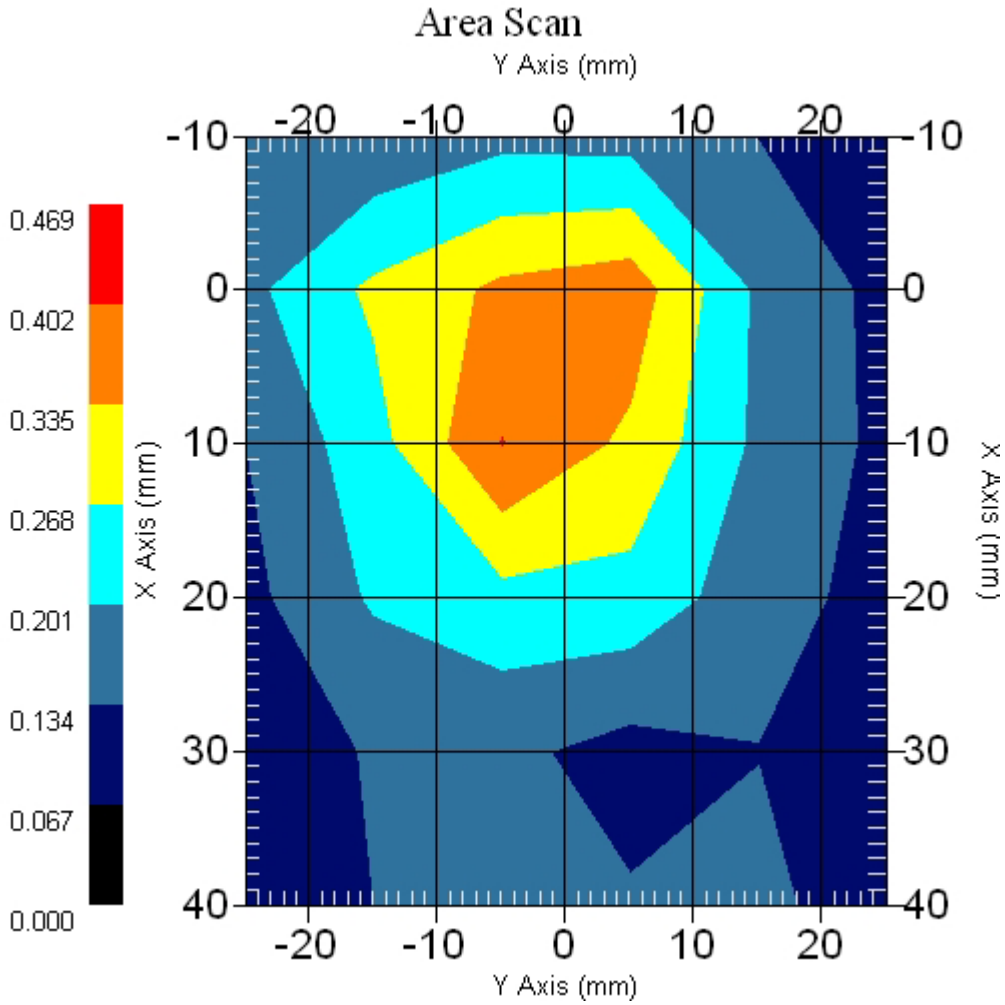

**EUT 2450MHz SAR test Z-Axis plot**  
**(802.11b, Back, Channel 11)**

SAR-Z Axis  
at Hotspot x:10.00 y:-5.00

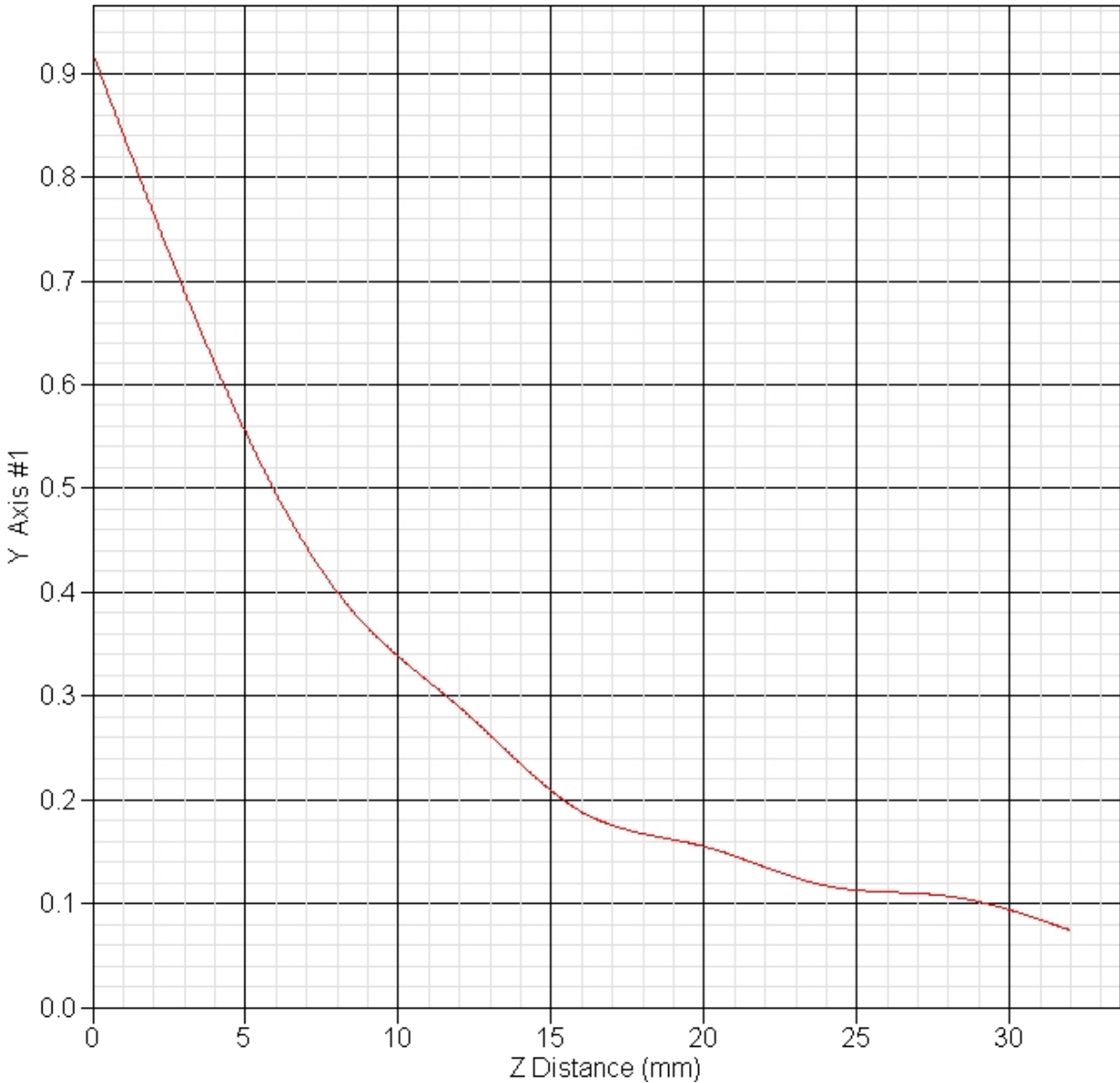

### EUT 2450MHz SAR test Z-Axis plot

(802.11g, Back, Channel 1)

SAR-Z Axis  
at Hotspot x:20.00 y:-5.00

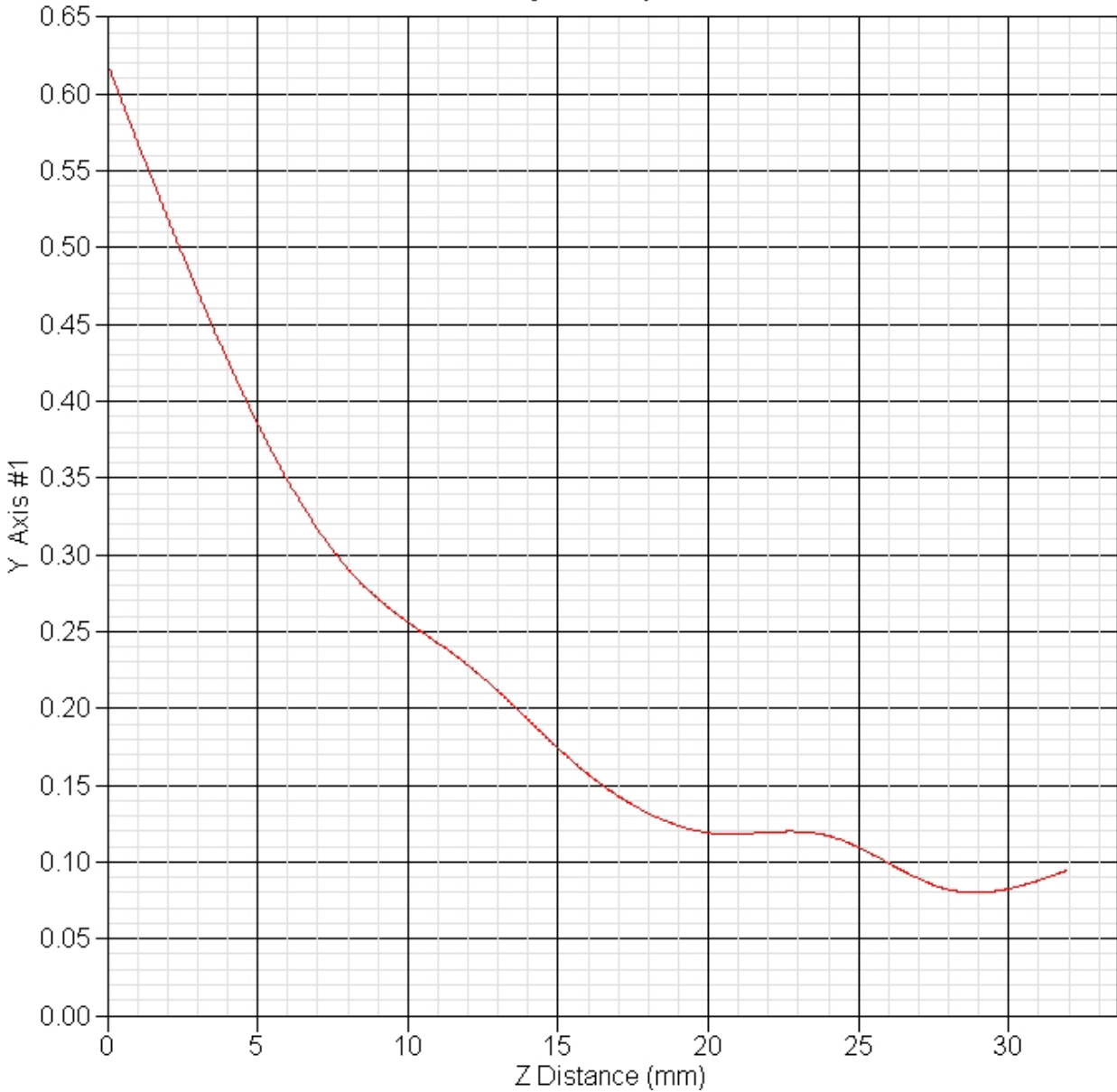

**Test Setup Photographs**

**EUT Back**

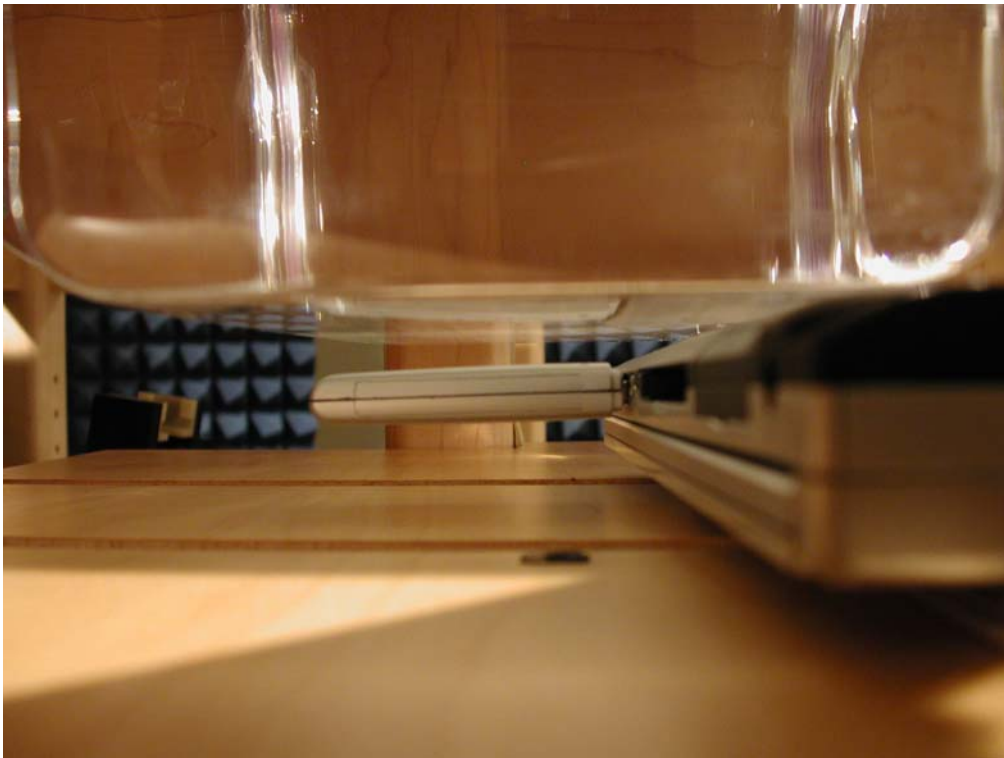

**EUT Front**

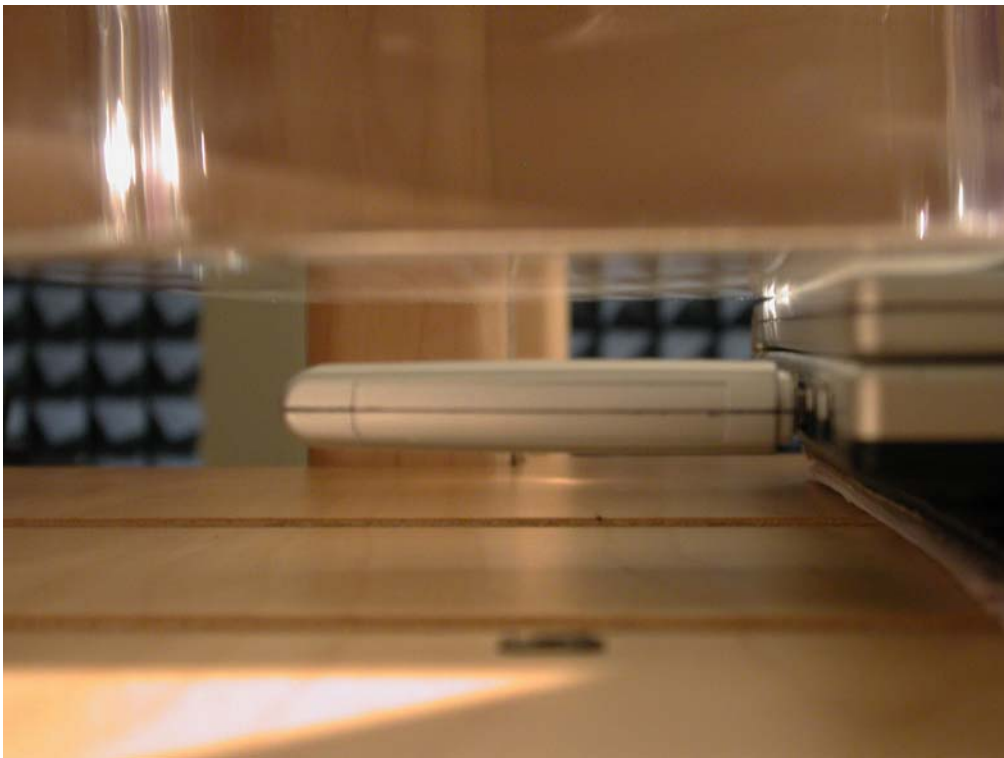



EUT Top



**EUT Photographs**





## **Appendix - Probe Calibration**

**Miniature Isotropic RF Probe**

**M/N: ALS-E-020**

**S/N: 265**

**2450MHz Head Calibration page2~11**

**2450MHz Body Calibration page12~21**

## NCL CALIBRATION LABORATORIES

Calibration File No.: CP-557

Client: QUIETEK

## CERTIFICATE OF CALIBRATION

It is certified that the equipment identified below has been calibrated in the **NCL CALIBRATION LABORATORIES** by qualified personnel following recognized procedures and using transfer standards traceable to NRC/NIST.

Equipment: Miniature Isotropic RF Probe 2450 MHz

Manufacturer: APREL Laboratories

Model No.: ALS-E-020

Serial No.: 265

HEAD Calibration

Calibration Procedure: SSI/DRB-TP-D01-032-E020-V2

Project No: QTKB-ALS-E-020 Probe Cal-5091

Calibrated: 23<sup>rd</sup> March 2005

Released on: 23<sup>rd</sup> March 2005

This Calibration Certificate is incomplete unless accompanied with the Calibration Results Summary

Released By: \_\_\_\_\_

**NCL CALIBRATION LABORATORIES**

51 SPECTRUM WAY  
NEPEAN, ONTARIO  
CANADA K2R 1E6

Division of APREL Lab.  
TEL: (613) 620-4988  
FAX: (613) 620-4161

## NCL Calibration Laboratories

Division of APREL Laboratories.

---

### Introduction

This Calibration Report reproduces the results of the calibration performed in line with the SSI/DRB-TP-D01-032-E020-V2 E-Field Probe Calibration Procedure. The results contained within this report are for APREL E-Field Probe E-020 265.

### References

SSI/DRB-TP-D01-032-E020-V2 E-Field Probe Calibration Procedure  
IEEE 1528 "Recommended Practice for Determining the Peak Spatial-Average Specific Absorption Rate (SAR) in the Human Body Due to Wireless Communications Devices: Experimental Techniques"  
SSI-TP-011 Tissue Calibration Procedure

### Conditions

Probe 265 was a new probe taken from stock prior to calibration.

Ambient Temperature of the Laboratory: 22 °C +/- 0.5°C  
Temperature of the Tissue: 21 °C +/- 0.5°C

We the undersigned attest that to the best of our knowledge the calibration of this probe has been accurately conducted and that all information contained within this report has been reviewed for accuracy.



---

Ron Dulmage



---

Y. Chen

---

Page 2 of 10

This page has been reviewed for content and attested to on Page 2 of this document.

## NCL Calibration Laboratories

Division of APREL Laboratories.

---

### Calibration Results Summary

Probe Type:	E-Field Probe E-020
Serial Number:	265
Frequency:	2450 MHz
Sensor Offset:	1.56 mm
Sensor Length:	2.5 mm
Tip Enclosure:	Ertalyte*
Tip Diameter:	<5 mm
Tip Length:	60 mm
Total Length:	290 mm

\*Resistive to recommended tissue recipes per IEEE-1528

### Sensitivity in Air

Channel X:	1.2 $\mu\text{V}/(\text{V}/\text{m})^2$
Channel Y:	1.2 $\mu\text{V}/(\text{V}/\text{m})^2$
Channel Z:	1.2 $\mu\text{V}/(\text{V}/\text{m})^2$
Diode Compression Point:	95 mV



## NCL Calibration Laboratories

---

Division of APREL Laboratories.

### Sensitivity in Head Tissue

**Frequency:** 2450 MHz

**Epsilon:** 39.2 (+/-5%)

**Sigma:** 1.80 S/m (+/-5%)

### ConvF

**Channel X:** 4.6

**Channel Y:** 4.6

**Channel Z:** 4.6

Tissue sensitivity values were calculated using the load impedance of the APREL Laboratories Daq-Paq.

### Boundary Effect:

Uncertainty resulting from the boundary effect is less than 2% for the distance between the tip of the probe and the tissue boundary, when less than 2.44mm.

### Spatial Resolution:

The measured probe tip diameter is 5 mm (+/- 0.01 mm) and therefore meets the requirements of SSI/DRB-TP-D01-032 for spatial resolution.

## Receiving Pattern 2450 MHz (Air)

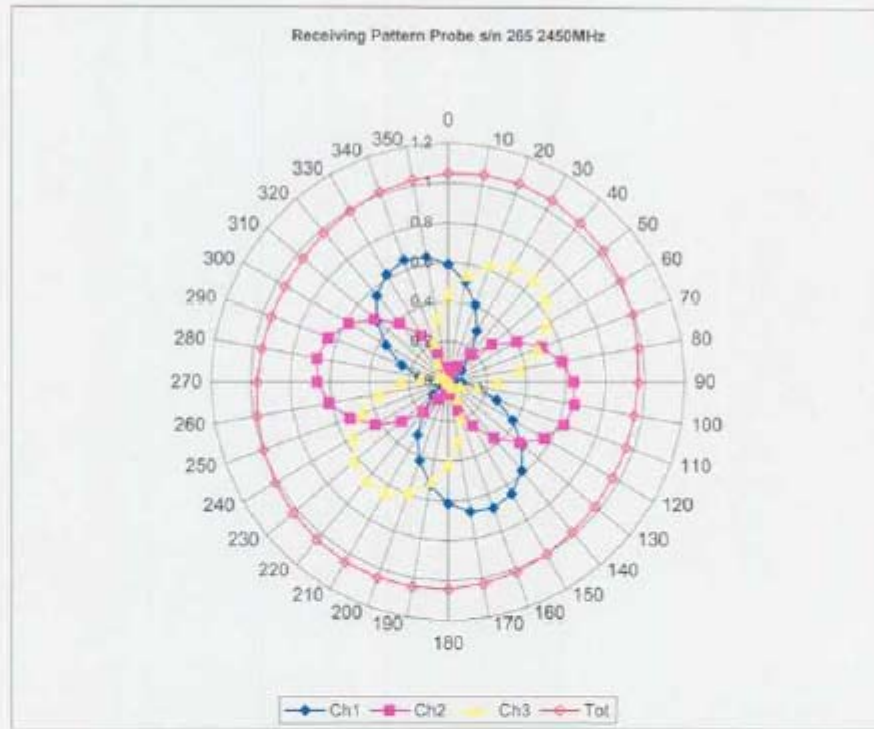



## Isotropy Error 2450 MHz (Air)

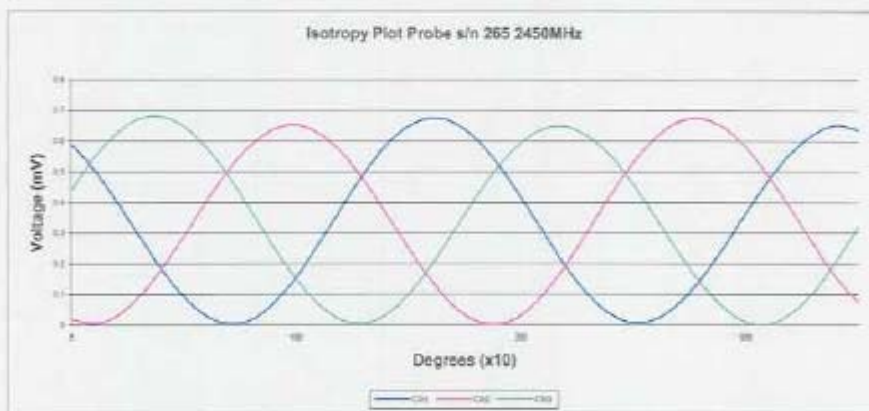
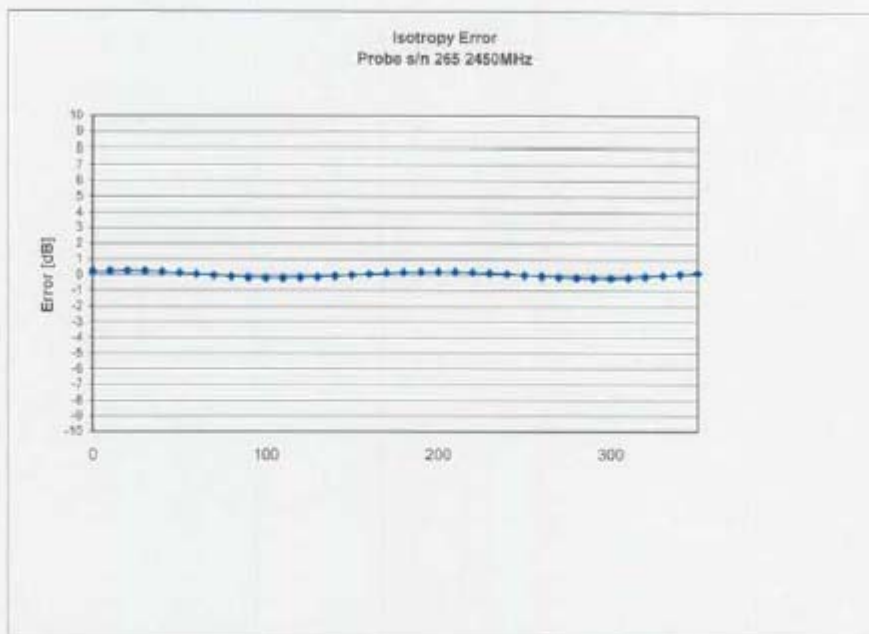

Isotropicity in Tissue:

0.10 dB

## Dynamic Range



## Video Bandwidth

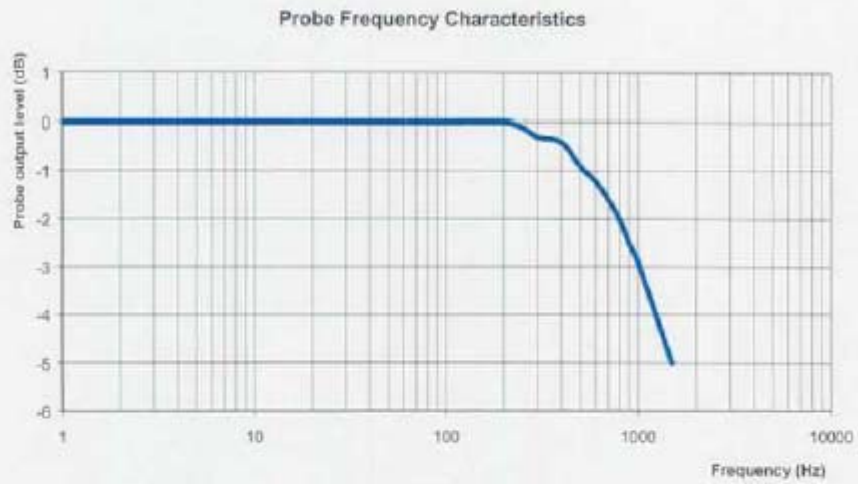

Video Bandwidth at 500 Hz      1 dB  
Video Bandwidth at 1000 Hz    3 dB

## NCL Calibration Laboratories

---

Division of APREL Laboratories

### Conversion Factor Uncertainty Assessment

**Frequency:** 2450MHz  
**Epsilon:** 39.2 (+/-5%)      **Sigma:** 1.80 S/m (+/-5%)

#### ConvF

**Channel X:** 4.6      7%(K=2)  
**Channel Y:** 4.6      7%(K=2)  
**Channel Z:** 4.6      7%(K=2)

To minimize the uncertainty calculation all tissue sensitivity values were calculated using a load impedance of 5 MΩ.

#### Boundary Effect:

For a distance of 2.4mm the evaluated uncertainty (increase in the probe sensitivity) is less than 2%.

## NCL Calibration Laboratories

Division of APREL Laboratories.

---

### **Test Equipment**

The test equipment used during Probe Calibration, manufacturer, model number and, current calibration status are listed and located on the main APREL server R:\NCL\Calibration Equipment\Instrument List May 2004.

---

Page 10 of 10

This page has been reviewed for content and attested to on Page 2 of this document.

## NCL CALIBRATION LABORATORIES

Calibration File No.: CP-558

Client: QUIETEK

## CERTIFICATE OF CALIBRATION

It is certified that the equipment identified below has been calibrated in the **NCL CALIBRATION LABORATORIES** by qualified personnel following recognized procedures and using transfer standards traceable to NRC/NIST.

Equipment: Miniature Isotropic RF Probe 2450 MHz

Manufacturer: APREL Laboratories

Model No.: ALS-E-020

Serial No.: 205

BODY Calibration

Calibration Procedure: SSI/DRB-TP-D01-032-E020-V2

Project No: QTKB-ALS-E-020 Probe Cal-6001

Calibrated: 23<sup>rd</sup> March 2005  
Released on: 23<sup>rd</sup> March 2005

This Calibration Certificate is Incomplete Unless Accompanied with the Calibration Results Summary

Released By: \_\_\_\_\_

**NCL** CALIBRATION LABORATORIES

51 SPECTRUM WAY  
NEPEAN, ONTARIO  
CANADA K2R 1E6

Division of APREL Lab.  
TEL: (613) 820-6966  
FAX: (613) 820-4101

## NCL Calibration Laboratories

Division of APREL Laboratories.

---

### Introduction

This Calibration Report reproduces the results of the calibration performed in line with the SSI/DRB-TP-D01-032-E020-V2 E-Field Probe Calibration Procedure. The results contained within this report are for APREL E-Field Probe E-020 265.

### References

SSI/DRB-TP-D01-032-E020-V2 E-Field Probe Calibration Procedure  
IEEE 1528 "Recommended Practice for Determining the Peak Spatial-Average Specific Absorption Rate (SAR) in the Human Body Due to Wireless Communications Devices: Experimental Techniques"  
SSI-TP-011 Tissue Calibration Procedure

### Conditions

Probe 265 was a new probe taken from stock prior to calibration.

**Ambient Temperature of the Laboratory:** 22 °C +/- 0.5°C

**Temperature of the Tissue:** 21 °C +/- 0.5°C

We the undersigned attest that to the best of our knowledge the calibration of this probe has been accurately conducted and that all information contained within this report has been reviewed for accuracy.



---

Ron Dulmage



---

Y. Chen

---

Page 2 of 10

This page has been reviewed for content and attested to on Page 2 of this document.

## NCL Calibration Laboratories

Division of APREL Laboratories.

---

### Calibration Results Summary

Probe Type:	E-Field Probe E-020
Serial Number:	265
Frequency:	2450 MHz
Sensor Offset:	1.56 mm
Sensor Length:	2.5 mm
Tip Enclosure:	Ertalyte*
Tip Diameter:	<5 mm
Tip Length:	60 mm
Total Length:	290 mm

\*Resistive to recommended tissue recipes per IEEE-1528

### Sensitivity in Air

Channel X:	1.2 $\mu\text{V}/(\text{V}/\text{m})^2$
Channel Y:	1.2 $\mu\text{V}/(\text{V}/\text{m})^2$
Channel Z:	1.2 $\mu\text{V}/(\text{V}/\text{m})^2$
Diode Compression Point:	95 mV

---

Page 3 of 10

This page has been reviewed for content and attested to on Page 2 of this document.



## NCL Calibration Laboratories

---

Division of APREL Laboratories.

### Sensitivity in Body Tissue

**Frequency:** 2450 MHz

**Epsilon:** 52.7 (+/-5%)      **Sigma:** 1.95 S/m (+/-5%)

### ConvF

**Channel X:** 4.7

**Channel Y:** 4.7

**Channel Z:** 4.7

Tissue sensitivity values were calculated using the load impedance of the APREL Laboratories Daq-Paq.

### Boundary Effect:

Uncertainty resulting from the boundary effect is less than 2% for the distance between the tip of the probe and the tissue boundary, when less than 2.44mm.

### Spatial Resolution:

The measured probe tip diameter is 5 mm (+/- 0.01 mm) and therefore meets the requirements of SSI/DRB-TP-D01-032 for spatial resolution.

## Receiving Pattern 2450 MHz (Air)

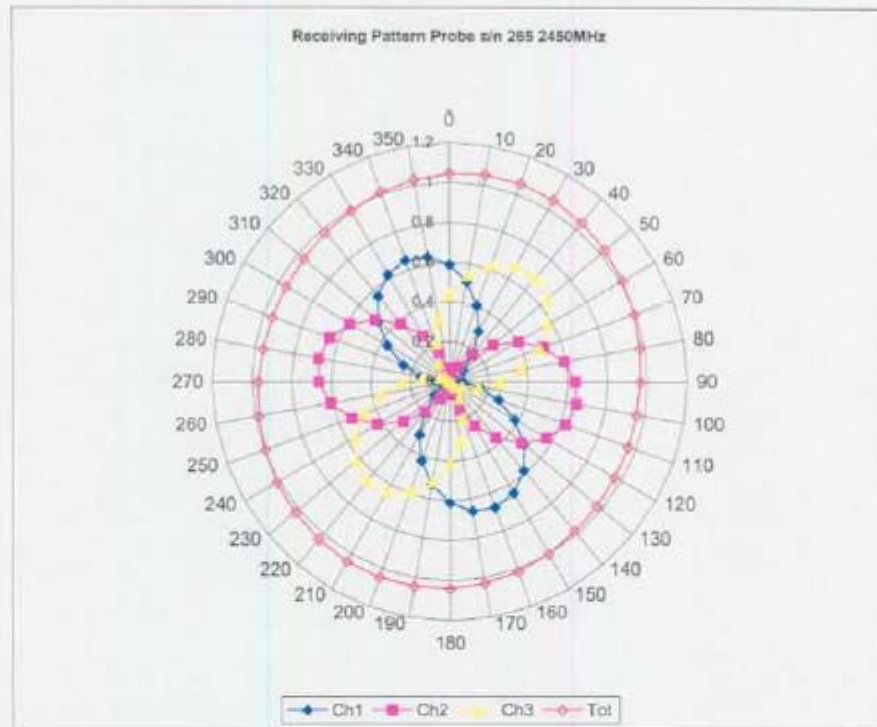

## NCL Calibration Laboratories

Division of APREL Laboratories

### Isotropy Error 2450 MHz (Air)

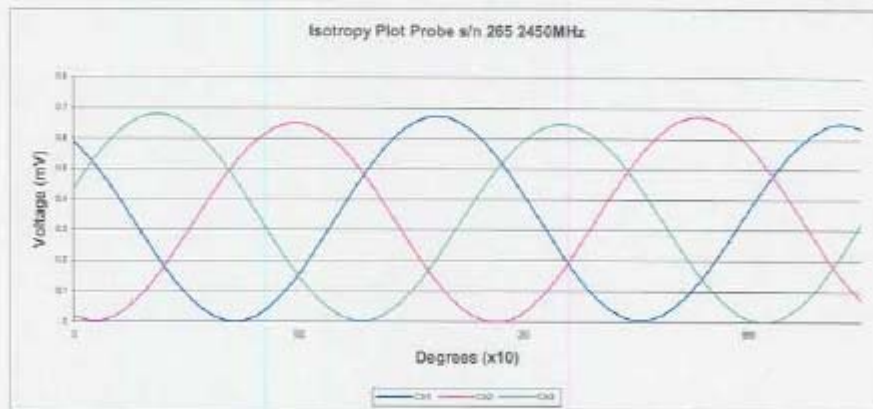
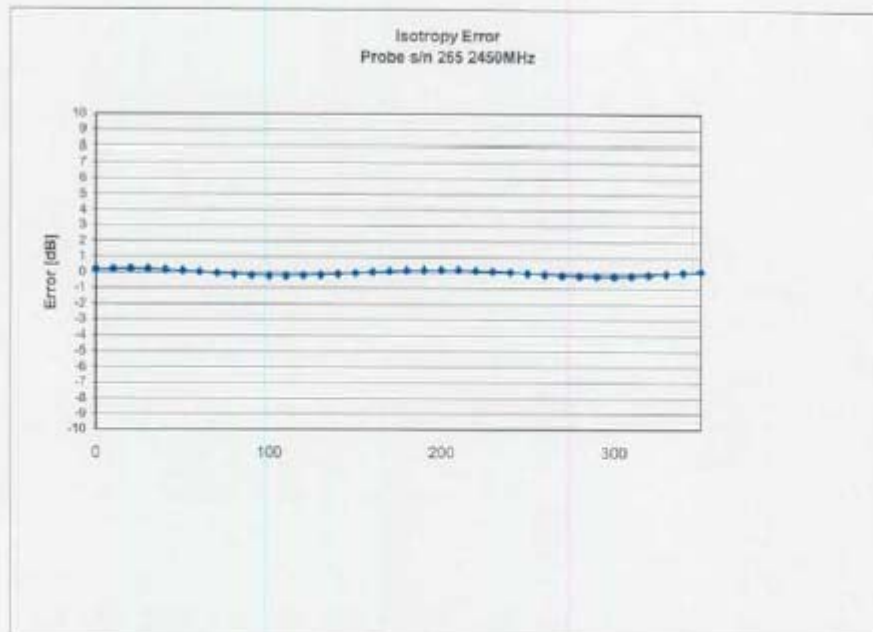

Isotropicity in Tissue:

0.10 dB

## Dynamic Range

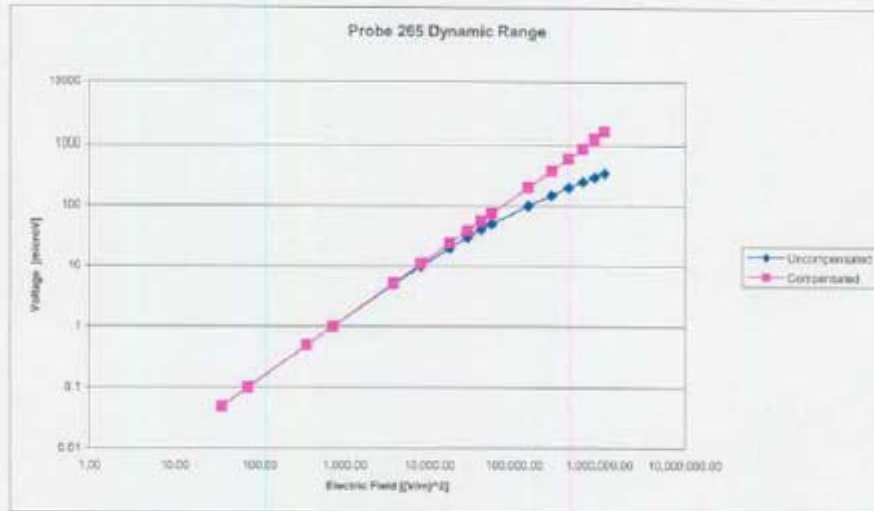

NCL Calibration Laboratories  
Division of APREL Laboratories.

## Video Bandwidth

Probe Frequency Characteristics

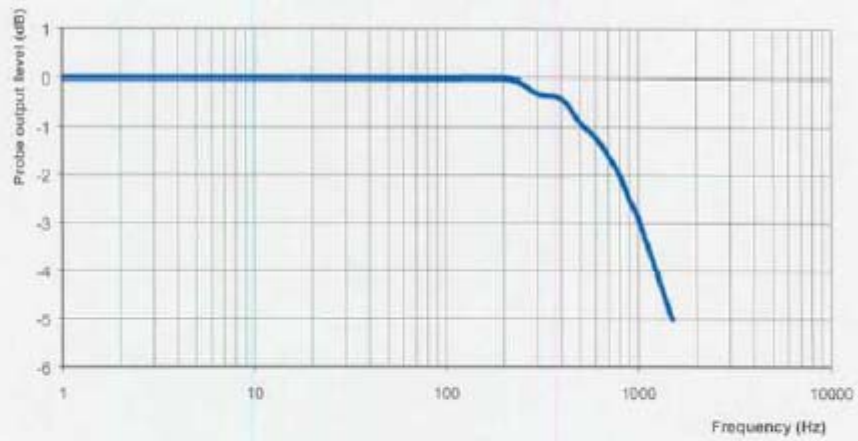

Video Bandwidth at 500 Hz      1 dB  
Video Bandwidth at 1000 Hz    3 dB

## NCL Calibration Laboratories

Division of APREL Laboratories.

---

### Conversion Factor Uncertainty Assessment

Frequency:		2450MHz	
Epsilon:	52.7 (+/-5%)	Sigma:	1.95 S/m (+/-5%)
ConvF			
Channel X:	4.7		7%(K=2)
Channel Y:	4.7		7%(K=2)
Channel Z:	4.7		7%(K=2)

To minimize the uncertainty calculation all tissue sensitivity values were calculated using a load impedance of 5 M $\Omega$ .

#### Boundary Effect:

For a distance of 2.4mm the evaluated uncertainty (increase in the probe sensitivity) is less than 2%.

## NCL Calibration Laboratories

Division of APREL Laboratories.

---

### **Test Equipment**

The test equipment used during Probe Calibration, manufacturer, model number and, current calibration status are listed and located on the main APREL server R:\NCL\Calibration Equipment\Instrument List May 2004.

---

Page 10 of 10

This page has been reviewed for content and attested to on Page 2 of this document.



## **Appendix - Dipole Calibration**

**Validation Dipole 2450MHz**

**P/N: ALS-D-2450-S-2**

**S/N: QTK-319**



**NCL CALIBRATION LABORATORIES**

Calibration File No: DC-409  
Project Number: QTKB-ALSAS-10U-5050

**CERTIFICATE OF CALIBRATION**

It is certified that the equipment identified below has been calibrated in the  
**NCL CALIBRATION LABORATORIES** by qualified personnel following recognized  
procedures and using transfer standards traceable to NRC/NIST.

Quietek Validation Dipole

Manufacturer: APREL Laboratories  
Part number: ALS-D-2450-S-2  
Frequency: 2.45 GHz  
Serial No: QTK-319

Customer: Quietek

Calibrated: 23 June 2004  
Released on: 23 June 2004

Released By: \_\_\_\_\_

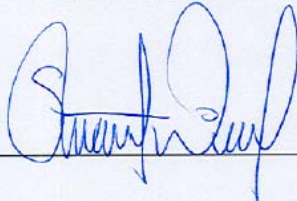

**NCL CALIBRATION LABORATORIES**

51 SPECTRUM WAY  
NEPEAN, ONTARIO  
CANADA K2R 1E6

Division of APREL Lab.  
TEL: (613) 820-4988  
FAX: (613) 820-4161

## NCL Calibration Laboratories

Division of APREL Laboratories.

### Calibration Results Summary

The following results relate the Calibrated Dipole and should be used as a quick reference for the user.

#### Mechanical Dimensions

Length: 53.5 mm  
Height: 30.4 mm

#### Electrical Specification

SWR: 1.19 U  
Return Loss: -20.8 dB  
Impedance: 49.4  $\Omega$

#### System Validation Results

Frequency	1 Gram	10 Gram	Peak
2.45 GHz	48.07	25.65	95.6

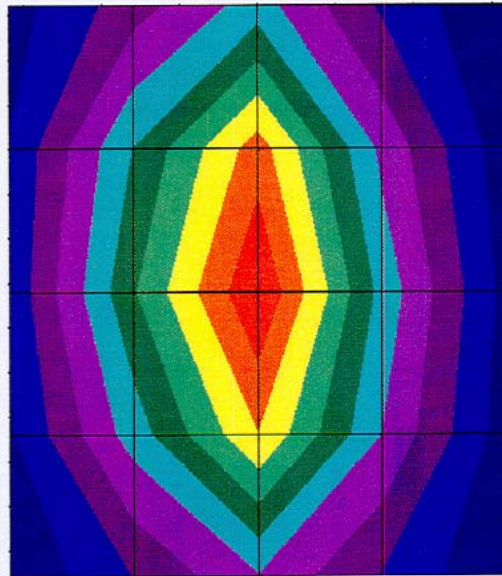

Page 2 of 9

Calibrated by

Approved by

## NCL Calibration Laboratories

Division of APREL Laboratories.

### Introduction

This Calibration Report has been produced in line with the SSI Dipole Calibration Procedure SSI-TP-018-ALSAS. The results contained within this report are for Validation Dipole QTK-319. The calibration routine consisted of a three-step process. Step 1 was a mechanical verification of the dipole to ensure that it meets the IEEE/APREL mechanical specifications. Step 2 was an Electrical Calibration for the Validation Dipole, where the SWR, Impedance, and the Return loss were assessed. Step 3 involved a System Validation using the ALSAS-10U, along with QTK E-020 130 MHz to 26 GHz E-Field Probe Serial Number 212.

### References

SSI-TP-018-ALSAS Dipole Calibration Procedure  
SSI-TP-016 Tissue Calibration Procedure  
IEEE 1528 "Recommended Practice for Determining the Peak Spatial-Average Specific Absorption Rate (SAR) in the Human Body Due to Wireless Communications Devices: Experimental Techniques"

### Conditions

Dipole QTK-319 was new taken from stock.

**Ambient Temperature of the Laboratory:** 22 °C +/- 0.5°C  
**Temperature of the Tissue:** 20 °C +/- 0.5°C



## NCL Calibration Laboratories

Division of APREL Laboratories.

### Dipole Calibration Results

#### Mechanical Verification

IEEE Length	IEEE Height	Measured Length	Measured Height
51.5 mm	30.4 mm	53.5 mm	30.4 mm

#### Tissue Validation

Body Tissue 2450 MHz	Measured
Dielectric constant, $\epsilon_r$	52.5
Conductivity, $\sigma$ [S/m]	1.78

## NCL Calibration Laboratories

Division of APREL Laboratories.

### Electrical Calibration

Test	Result
S11 R/L	-20.8 dB
SWR	1.2 U
Impedance	49.4 $\Omega$

The Following Graphs are the results as displayed on the Vector Network Analyzer.

### S11 Parameter Return Loss

S11 FORWARD REFLECTION

LOG MAGNITUDE

REF = -25.000 dB

5.000 dB/DIV

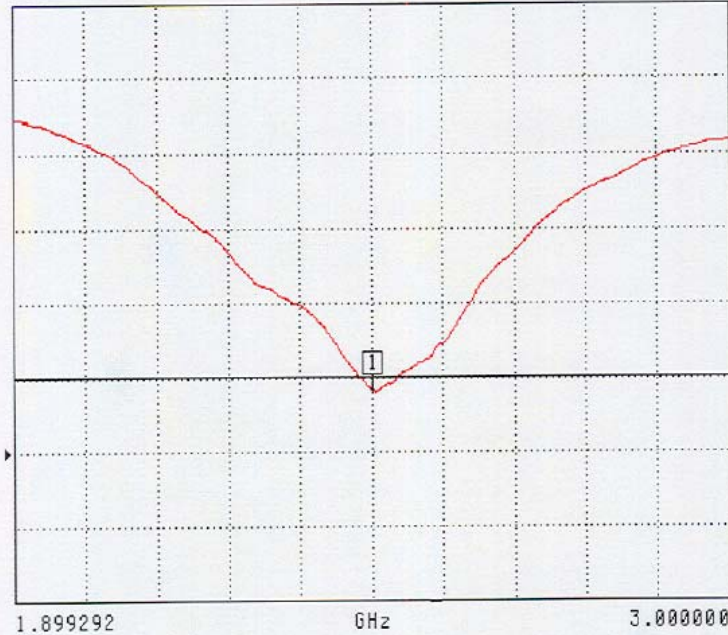

CH 1 - S11  
REFERENCE PLANE  
0.0000 mm

MARKER 1  
2.450046 GHz  
-20.796 dB

MARKER TO MAX  
▶ MARKER TO MIN

MARKER READOUT  
FUNCTIONS

## NCL Calibration Laboratories

Division of APREL Laboratories.

### SWR

S11 FORWARD REFLECTION

SWR REF=500.000 mU 1.000 U/DIV



CH 1 - S11  
REFERENCE PLANE  
0.0000 mm

MARKER 1  
2.450046 GHz  
1.199 U

MARKER TO MAX  
▶ MARKER TO MIN

MARKER READOUT  
FUNCTIONS



## NCL Calibration Laboratories

Division of APREL Laboratories.

### Smith Chart Dipole Impedance

S11 FORWARD REFLECTION  
IMPEDANCE

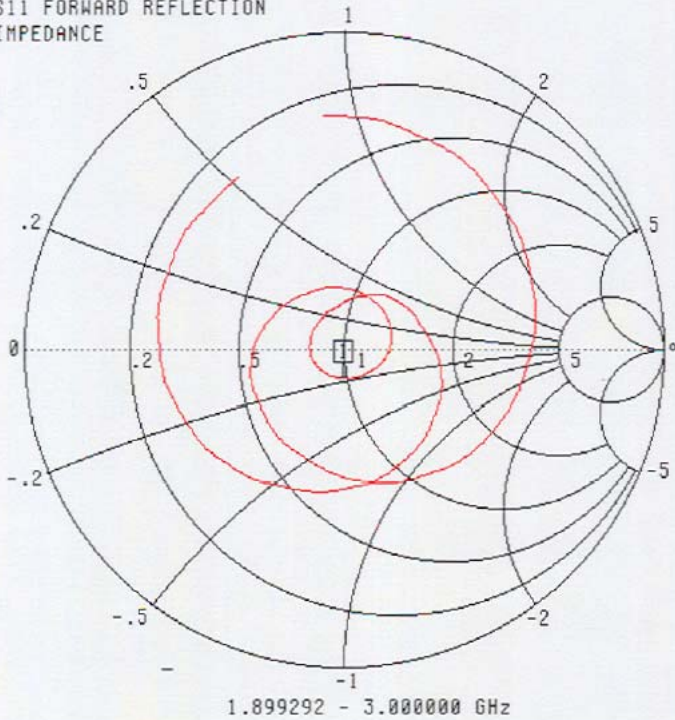

CH 1 - S11  
REFERENCE PLANE  
0.0000 mm

MARKER 1  
2.450046 GHz  
49.365  $\Omega$   
-9.232  $j\Omega$

MARKER TO MAX  
▶ MARKER TO MIN

MARKER READOUT  
FUNCTIONS

## NCL Calibration Laboratories

Division of APREL Laboratories.

### System Validation Results Using the Electrically Calibrated Dipole

Frequency	1 Gram	10 Gram	Peak Above Feed Point
2.45 GHz	48.07	25.65	95.6

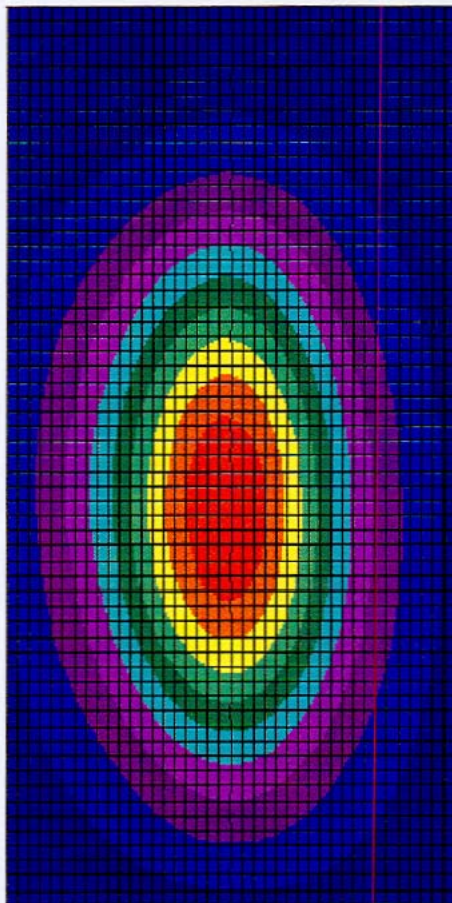



## **NCL Calibration Laboratories**

---

Division of APREL Laboratories.

### **Test Equipment**

The test equipment used during Probe Calibration, manufacturer, model number and, current calibration status are listed and located on the main APREL server R:\NCL\Calibration Equipment\Instrument List May 2003