



FCC RF Test Report

APPLICANT : Fibocom Wireless Inc.
EQUIPMENT : 5G Module
BRAND NAME : Fibocom
MODEL NAME : FM350-GL
FCC ID : ZMOFM350GL
STANDARD : 47 CFR Part 2, 27
CLASSIFICATION : PCS Licensed Transmitter (PCB)

The product was received on May 18, 2020 and completely tested on Mar. 29, 2021. We, Sporton International (ShenZhen) Inc., would like to declare that the tested sample has been evaluated in accordance with the procedures given in ANSI C63.26-2015 and shown compliance with the applicable technical standards.

The test results in this report apply exclusively to the tested model / sample. Without written approval of Sporton International (ShenZhen) Inc., the test report shall not be reproduced except in full.

Reviewed by: Derreck Chen / Supervisor

Approved by: Eric Shih / Manager



Sporton International (ShenZhen) Inc.

1/F, 2/F, Bldg 5, Shiling Industrial Zone, Xinwei Village, Xili, Nanshan, Shenzhen, 518055

People's Republic of China



TABLE OF CONTENTS

REVISION HISTORY... 3
SUMMARY OF TEST RESULT ... 4
1 GENERAL DESCRIPTION ... 5
1.1 Applicant ... 5
1.2 Manufacturer ... 5
1.3 Product Feature of Equipment Under Test ... 5
1.4 Product Specification of Equipment Under Test ... 5
1.5 Modification of EUT ... 6
1.6 Maximum Conducted Power, Frequency Tolerance, and Emission Designator ... 6
1.7 Testing Location ... 14
1.8 Test Software ... 14
1.9 Applicable Standards ... 14
2 TEST CONFIGURATION OF EQUIPMENT UNDER TEST ... 15
2.1 Test Mode ... 15
2.2 Connection Diagram of Test System ... 18
2.3 Support Unit used in test configuration and system ... 18
2.4 Measurement Results Explanation Example ... 18
2.5 Frequency List of Low/Middle/High Channels ... 19
3 CONDUCTED TEST ITEMS ... 22
3.1 Measuring Instruments ... 22
3.2 Test Setup ... 22
3.3 Test Result of Conducted Test ... 22
3.4 Conducted Output Power and ERP/EIRP ... 23
3.5 Peak-to-Average Ratio ... 24
3.6 Occupied Bandwidth ... 25
3.7 Conducted Band Edge ... 26
3.8 Conducted Spurious Emission ... 28
3.9 Frequency Stability ... 29
4 RADIATED TEST ITEMS ... 30
4.1 Measuring Instruments ... 30
4.2 Test Setup ... 30
4.3 Test Result of Radiated Test ... 30
4.4 Radiated Spurious Emission ... 31
5 LIST OF MEASURING EQUIPMENT ... 32
6 UNCERTAINTY OF EVALUATION ... 33
APPENDIX A. TEST RESULTS OF CONDUCTED TEST
APPENDIX B. TEST RESULTS OF RADIATED TEST
APPENDIX C. TEST SETUP PHOTOGRAPHS



REVISION HISTORY

REPORT NO.	VERSION	DESCRIPTION	ISSUED DATE
FG051802I	Rev. 01	Initial issue of report	Apr. 06, 2021



SUMMARY OF TEST RESULT

Report Section	FCC Rule	Description	Limit	Result	Remark
3.4	§2.1046	Conducted Output Power	Reporting Only	PASS	-
	§27.50(c)(10)	Effective Radiated Power (5G NR n71)	ERP < 3 Watt		
	§27.50(h)(2)	Equivalent Isotropic Radiated Power (5G NR n7, n38, n41)	EIRP < 2Watt		
	§27.50(j)(3)	Equivalent Isotropic Radiated Power (5G NR n77, n78)	EIRP < 1Watt		
3.5	§27.50(j)(4)	Peak-to-Average Ratio	<13 dB	PASS	-
3.6	§2.1049	Occupied Bandwidth	Reporting Only	PASS	-
3.7	§2.1051 §27.53(g) §27.53(l)(2)	Conducted Band Edge Measurement (5G NR n71, n77, n78)	< 43+10log ₁₀ (P[Watts])	PASS	-
	§27.53(m)(4)	Conducted Band Edge Measurement (5G NR n7, n38, n41)	§27.53(m)(4)		
3.8	§2.1051 §27.53(g) §27.53(l)(2)	Conducted Spurious Emission (5G NR n71, n77, n78)	< 43+10log ₁₀ (P[Watts])	PASS	-
	§2.1051 §27.53(m)(4)	Conducted Spurious Emission (5G NR n7, n38, n41)	< 55+10log ₁₀ (P[Watts])		
3.9	§27.54	Frequency Stability Temperature & Voltage	Within Authorized Band	PASS	-
4.4	§2.1053 §27.53(g) §27.53(l)(2)	Radiated Spurious Emission (5G NR n71, n77, n78)	< 43+10log ₁₀ (P[Watts])	PASS	Under limit 25.88 dB at 10002.80 MHz
	§2.1053 §27.53(m)(4)	Radiated Spurious Emission (5G NR n7, n38, n41)	< 55+10log ₁₀ (P[Watts])		

Declaration of Conformity:

The test results with all measurement uncertainty excluded are presented in accordance with the regulation limits or requirements declared by manufacturers.

Comments and Explanations:

The declared of product specification for EUT presented in the report are provided by the manufacturer, and the manufacturer takes all the responsibilities for the accuracy of product specification.



1 General Description

1.1 Applicant

Fibocom Wireless Inc.

1101, Tower A, Building 6, Shenzhen International Innovation Valley, Dashi 1st Rd, Nanshan, Shenzhen, China

1.2 Manufacturer

Fibocom Wireless Inc.

1101, Tower A, Building 6, Shenzhen International Innovation Valley, Dashi 1st Rd, Nanshan, Shenzhen, China

1.3 Product Feature of Equipment Under Test

Product Feature	
Equipment	5G Module
Brand Name	Fibocom
Model Name	FM350-GL
FCC ID	ZMOFM350GL
EUT supports Radios application	WCDMA/LTE/5G NR/GNSS
IMEI Code	Conducted: 862146050001310 Radiation: 882146050002276
HW Version	V1.0.6
SW Version	81600.0000.00.09.03.03
EUT Stage	Identical Prototype

1.4 Product Specification of Equipment Under Test

Standards-related Product Specification	
Tx Frequency	5G NR n7 : 2500 MHz ~ 2570 MHz 5G NR n38 : 2570 MHz ~ 2620 MHz 5G NR n41 : 2496 MHz ~ 2690 MHz 5G NR n71 : 663 MHz ~ 698 MHz 5G NR n77 : 3700 MHz ~ 3980 MHz 5G NR n78 : 3700 MHz ~ 3800 MHz
Rx Frequency	5G NR n7 : 2620 MHz ~ 2690 MHz 5G NR n38 : 2570 MHz ~ 2620 MHz 5G NR n41 : 2496 MHz ~ 2690 MHz 5G NR n71 : 617 MHz ~ 652 MHz 5G NR n77 : 3700 MHz ~ 3980 MHz 5G NR n78 : 3700 MHz ~ 3800 MHz
SCS/Bandwidth	SCS: 15kHz: n7, n71, n38: 5MHz / 10MHz / 15MHz / 20MHz n41: 10MHz / 15MHz / 30MHz / 40MHz n77, n78: 10MHz / 15MHz / 20MHz



	SCS: 30kHz: n7, n71, n38: 10MHz / 15MHz / 20MHz n41: 10MHz / 15MHz / 30MHz / 40MHz / 50MHz / 80MHz n77, n78: 10MHz / 15MHz / 20MHz / 40MHz / 50MHz / 60MHz / 80MHz / 100MHz
NR Mode	NSA: n41/n71/n77/n78 SA: n7/n38/n41/n71/n77/n78
Antenna Gain	5G NR n7: 4.0 dBi 5G NR n38: 4.0 dBi 5G NR n41: 4.0 dBi 5G NR n71: 3.0 dBi 5G NR n77: 3.0 dBi 5G NR n78: 3.0 dBi
Type of Modulation	CP-OFDM: QPSK / 16QAM / 64QAM / 256QAM DFT-s-OFDM: PI/2 BPSK / QPSK / 16QAM / 64QAM / 256QAM

1.5 Modification of EUT

No modifications are made to the EUT during all test items.

1.6 Maximum Conducted Power, Frequency Tolerance, and Emission Designator

SA:

5G NR n7-SCS 15k		PI/2 BPSK / QPSK		16QAM / 64QAM / 256QAM	
BW (MHz)	Frequency Range (MHz)	Emission Designator (99%OBW)	Conducted Power(W)	Emission Designator (99%OBW)	Conducted Power(W)
5	2502.5 ~ 2567.5	4M52G7D	0.2109	4M49W7D	0.1570
10	2505.0 ~ 2565.0	9M29G7D	0.2099	9M31W7D	0.1560
15	2507.5 ~ 2562.5	14M2G7D	0.2178	14M2W7D	0.1563
20	2510.0 ~ 2560.0	18M9G7D	0.2143	19M0W7D	0.1570
Frequency Tolerance (ppm)			0.0031		

5G NR n38-SCS 15k		PI/2 BPSK / QPSK		16QAM / 64QAM / 256QAM	
BW (MHz)	Frequency Range (MHz)	Emission Designator (99%OBW)	Conducted Power(W)	Emission Designator (99%OBW)	Conducted Power(W)
5	2572.5 ~ 2617.5	4M48G7D	0.2118	4M51W7D	0.1633
10	2575.0 ~ 2615.0	9M29G7D	0.2104	9M31W7D	0.1683
15	2577.5 ~ 2612.5	14M1G7D	0.2118	14M2W7D	0.1667
20	2580.0 ~ 2610.0	19M1G7D	0.2123	19M0W7D	0.1671
Frequency Tolerance (ppm)			0.0012		



5G NR n41 HPUE-SCS 15k		PI/2 BPSK / QPSK		16QAM / 64QAM / 256QAM	
BW (MHz)	Frequency Range (MHz)	Emission Designator (99%OBW)	Conducted Power(W)	Emission Designator (99%OBW)	Conducted Power(W)
10	2501.01 ~ 2685.00	9M25G7D	0.4375	9M31W7D	0.3548
15	2503.50 ~ 2682.48	14M3G7D	0.4406	14M2W7D	0.3855
30	2511.00 ~ 2674.98	28M6G7D	0.4416	28M5W7D	0.3451
40	2516.01 ~ 2670.00	38M6G7D	0.4426	38M8W7D	0.3581
Frequency Tolerance (ppm)		0.0031			

5G NR n41 HPUE-SCS 30k		PI/2 BPSK / QPSK		16QAM / 64QAM / 256QAM	
BW (MHz)	Frequency Range (MHz)	Emission Designator (99%OBW)	Conducted Power(W)	Emission Designator (99%OBW)	Conducted Power(W)
10	2501.01 ~ 2685.00	8M57G7D	0.4581	8M59W7D	0.3681
15	2503.50 ~ 2682.48	13M6G7D	0.4539	13M6W7D	0.3673
30	2511.00 ~ 2674.98	27M5G7D	0.4467	27M9W7D	0.3396
40	2516.01 ~ 2670.00	38M1G7D	0.4446	38M0W7D	0.3589
50	2521.02 ~ 2664.99	47M3G7D	0.4426	47M9W7D	0.3639
80	2536.02 ~ 2649.99	77M5G7D	0.4539	77M8W7D	0.3459
Frequency Tolerance (ppm)		0.0033			

5G NR n41_UL MIMO HPUE -SCS 15k		QPSK		16QAM / 64QAM / 256QAM	
BW (MHz)	Frequency Range (MHz)	Emission Designator (99%OBW)	Conducted Power(W)	Emission Designator (99%OBW)	Conducted Power(W)
10	2501.01 ~ 2685.00	9M23G7D	0.3227	9M29W7D	0.3071
15	2503.50 ~ 2682.48	14M1G7D	0.3328	14M2W7D	0.2931
30	2511.00 ~ 2674.98	28M5G7D	0.3254	28M6W7D	0.2852
40	2516.01 ~ 2670.00	38M8G7D	0.3380	38M8W7D	0.2765
Frequency Tolerance (ppm)		0.0028			

5G NR n41_UL MIMO HPUE -SCS 30k		QPSK		16QAM / 64QAM / 256QAM	
BW (MHz)	Frequency Range (MHz)	Emission Designator (99%OBW)	Conducted Power(W)	Emission Designator (99%OBW)	Conducted Power(W)



10	2501.01 ~ 2685.00	8M59G7D	0.3802	8M61W7D	0.2520
15	2503.50 ~ 2682.48	13M7G7D	0.3801	13M7W7D	0.2533
30	2511.00 ~ 2674.98	27M9G7D	0.3698	27M9W7D	0.2548
40	2516.01 ~ 2670.00	38M0G7D	0.3808	38M3W7D	0.2551
50	2521.02 ~ 2664.99	47M9G7D	0.3807	47M9W7D	0.2787
80	2536.02 ~ 2649.99	77M7G7D	0.3849	77M7W7D	0.2699
Frequency Tolerance (ppm)			0.0038		

5G NR n71-SCS 15k		PI/2 BPSK / QPSK		16QAM / 64QAM / 256QAM	
BW (MHz)	Frequency Range (MHz)	Emission Designator (99%OBW)	Conducted Power(W)	Emission Designator (99%OBW)	Conducted Power(W)
5	665.5 ~ 695.5	4M48G7D	0.2679	4M50W7D	0.2254
10	668.0 ~ 693.0	9M29G7D	0.2606	9M31W7D	0.2249
15	670.5 ~ 690.5	14M2G7D	0.2692	14M2W7D	0.2259
20	673.0 ~ 688.0	19M0G7D	0.2704	19M0W7D	0.2213
Frequency Tolerance (ppm)			0.0026		

5G NR n77 HPUE-SCS 15k		PI/2 BPSK / QPSK		16QAM / 64QAM / 256QAM	
BW (MHz)	Frequency Range (MHz)	Emission Designator (99%OBW)	Conducted Power(W)	Emission Designator (99%OBW)	Conducted Power(W)
10	3705.00 ~ 3975.00	9M27G7D	0.3724	9M31W7D	0.3141
15	3707.52 ~ 3972.48	14M2G7D	0.3945	14M2W7D	0.3428
20	3710.01 ~ 3969.99	18M9G7D	0.3926	19M0W7D	0.3115
Frequency Tolerance (ppm)			0.0026		

5G NR n77 HPUE-SCS 30k		PI/2 BPSK / QPSK		16QAM / 64QAM / 256QAM	
BW (MHz)	Frequency Range (MHz)	Emission Designator (99%OBW)	Conducted Power(W)	Emission Designator (99%OBW)	Conducted Power(W)
10	3705.00 ~ 3975.00	8M59G7D	0.3945	8M59W7D	0.3148
15	3707.52 ~ 3972.48	13M6G7D	0.3917	13M6W7D	0.3090
20	3710.01 ~ 3969.99	18M2G7D	0.3999	18M3W7D	0.3119
40	3720.00 ~ 3960.00	38M0G7D	0.3873	38M1W7D	0.3097
50	3725.01 ~ 3954.99	47M6G7D	0.3990	48M0W7D	0.3126



60	3730.02 ~ 3949.98	58M0G7D	0.4009	58M0W7D	0.3090
80	3740.01 ~ 3939.99	77M4G7D	0.3724	77M5W7D	0.3076
100	3750.00 ~ 3930.00	97M5G7D	0.3606	97M5W7D	0.3155
Frequency Tolerance (ppm)			0.0031		

5G NR n77_UL MIMO HPUE -SCS 15k		QPSK		16QAM / 64QAM / 256QAM	
BW (MHz)	Frequency Range (MHz)	Emission Designator (99%OBW)	Conducted Power(W)	Emission Designator (99%OBW)	Conducted Power(W)
10	3705.00 ~ 3975.00	9M25G7D	0.2501	9M31W7D	0.2195
15	3707.52 ~ 3972.48	14M2G7D	0.2501	14M2W7D	0.2232
20	3710.01 ~ 3969.99	19M0G7D	0.2495	19M0W7D	0.2231
Frequency Tolerance (ppm)			0.0026		

5G NR n77_UL MIMO HPUE -SCS 30k		QPSK		16QAM / 64QAM / 256QAM	
BW (MHz)	Frequency Range (MHz)	Emission Designator (99%OBW)	Conducted Power(W)	Emission Designator (99%OBW)	Conducted Power(W)
10	3705.00 ~ 3975.00	8M57G7D	0.2501	8M59W7D	0.2321
15	3707.52 ~ 3972.48	13M7G7D	0.2502	13M6W7D	0.2330
20	3710.01 ~ 3969.99	18M3G7D	0.2495	18M3W7D	0.2305
40	3720.00 ~ 3960.00	38M2G7D	0.2448	38M2W7D	0.2261
50	3725.01 ~ 3954.99	47M6G7D	0.2502	47M8W7D	0.2272
60	3730.02 ~ 3949.98	58M4G7D	0.2500	58M1W7D	0.2277
80	3740.01 ~ 3939.99	77M4G7D	0.2467	77M8W7D	0.2243
100	3750.00 ~ 3930.00	96M7G7D	0.2461	97M3W7D	0.2222
Frequency Tolerance (ppm)			0.0025		



5G NR n78 HPUE-SCS 15k		PI/2 BPSK / QPSK		16QAM / 64QAM / 256QAM	
BW (MHz)	Frequency Range (MHz)	Emission Designator (99%OBW)	Conducted Power(W)	Emission Designator (99%OBW)	Conducted Power(W)
10	3705.00 ~ 3795.00	9M29G7D	0.4276	9M31W7D	0.3681
15	3707.52 ~ 3792.495	14M1G7D	0.4487	14M2W7D	0.4009
20	3710.01 ~ 3792.485	18M9G7D	0.4457	19M0W7D	0.3707
Frequency Tolerance (ppm)		0.0029			

5G NR n78 HPUE-SCS 30k		PI/2 BPSK / QPSK		16QAM / 64QAM / 256QAM	
BW (MHz)	Frequency Range (MHz)	Emission Designator (99%OBW)	Conducted Power(W)	Emission Designator (99%OBW)	Conducted Power(W)
10	3705.00 ~ 3795.00	8M61G7D	0.4477	8M59W7D	0.3750
15	3707.52 ~ 3792.495	13M6G7D	0.4519	13M6W7D	0.3837
20	3710.01 ~ 3792.485	18M3G7D	0.4487	18M3W7D	0.3864
40	3720.00 ~ 3780.00	38M0G7D	0.4667	38M1W7D	0.3606
50	3725.01 ~ 3774.99	47M6G7D	0.4457	47M7W7D	0.3648
60	3730.02 ~ 3769.98	57M8G7D	0.4375	58M0W7D	0.3673
80	3740.01 ~ 3759.99	77M2G7D	0.4207	77M5W7D	0.3420
100	3750	97M1G7D	0.3945	97M5W7D	0.3170
Frequency Tolerance (ppm)		0.0035			



5G NR n78_UL MIMO HPUE -SCS 15k		QPSK		16QAM / 64QAM / 256QAM	
BW (MHz)	Frequency Range (MHz)	Emission Designator (99%OBW)	Conducted Power(W)	Emission Designator (99%OBW)	Conducted Power(W)
10	3705.00 ~ 3795.00	9M27G7D	0.2502	9M31W7D	0.2499
15	3707.52 ~ 3792.495	14M2G7D	0.2502	14M2W7D	0.2494
20	3710.01 ~ 3792.485	18M9G7D	0.2495	19M0W7D	0.2502
Frequency Tolerance (ppm)		0.0027			

5G NR n78_UL MIMO HPUE -SCS 30k		QPSK		16QAM / 64QAM / 256QAM	
BW (MHz)	Frequency Range (MHz)	Emission Designator (99%OBW)	Conducted Power(W)	Emission Designator (99%OBW)	Conducted Power(W)
10	3705.00 ~ 3795.00	8M57G7D	0.2502	8M59W7D	0.2495
15	3707.52 ~ 3792.495	13M6G7D	0.2502	13M6W7D	0.2501
20	3710.01 ~ 3792.485	18M3G7D	0.2493	18M5W7D	0.2487
40	3720.00 ~ 3780.00	38M1G7D	0.2502	38M1W7D	0.2501
50	3725.01 ~ 3774.99	48M0G7D	0.2502	47M7W7D	0.2501
60	3730.02 ~ 3769.98	57M9G7D	0.2503	57M8W7D	0.2501
80	3740.01 ~ 3759.99	77M5G7D	0.2501	77M7W7D	0.2495
100	3750	97M5G7D	0.2499	97M3W7D	0.2475
Frequency Tolerance (ppm)		0.0023			



NSA:

5G NR n77 HPUE-SCS 15k (EN DC_2A-n77A)		PI/2 BPSK / QPSK		16QAM / 64QAM / 256QAM	
BW (MHz)	Frequency Range (MHz)	Emission Designator (99%OBW)	Conducted Power(W)	Emission Designator (99%OBW)	Conducted Power(W)
10	3705.00 ~ 3975.00	9M31G7D	0.4315	9M33W7D	0.3657
15	3707.52 ~ 3972.48	14M2G7D	0.4416	14M2W7D	0.3632
20	3710.01 ~ 3969.99	18M9G7D	0.4457	19M1W7D	0.3691
Frequency Tolerance (ppm)		0.0019			

5G NR n77 HPUE-SCS 30k (EN DC_2A-n77A)		PI/2 BPSK / QPSK		16QAM / 64QAM / 256QAM	
BW (MHz)	Frequency Range (MHz)	Emission Designator (99%OBW)	Conducted Power(W)	Emission Designator (99%OBW)	Conducted Power(W)
10	3705.00 ~ 3975.00	8M55G7D	0.4121	8M55W7D	0.2682
15	3707.52 ~ 3972.48	13M6G7D	0.4226	13M7W7D	0.2815
20	3710.01 ~ 3969.99	18M3G7D	0.4227	18M3W7D	0.2745
40	3720.00 ~ 3960.00	38M1G7D	0.4315	38M2W7D	0.2714
50	3725.01 ~ 3954.99	47M7G7D	0.4305	47M6W7D	0.2677
60	3730.02 ~ 3949.98	57M5G7D	0.4295	57M9W7D	0.2726
80	3740.01 ~ 3939.99	77M8G7D	0.4018	77M5W7D	0.2920
100	3750.00 ~ 3930.00	97M5G7D	0.4018	97M5W7D	0.2988
Frequency Tolerance (ppm)		0.0022			



5G NR n78 HPUE-SCS 15k (EN DC_2A-n78A)		PI/2 BPSK / QPSK		16QAM / 64QAM / 256QAM	
BW (MHz)	Frequency Range (MHz)	Emission Designator (99%OBW)	Conducted Power(W)	Emission Designator (99%OBW)	Conducted Power(W)
10	3705.00 ~ 3795.00	9M29G7D	0.4242	9M25W7D	0.3759
15	3707.52 ~ 3792.495	14M2G7D	0.4400	14M1W7D	0.3725
20	3710.01 ~ 3792.485	19M0G7D	0.4340	19M0W7D	0.3750
Frequency Tolerance (ppm)		0.0019			

5G NR n78 HPUE-SCS 30k (EN DC_2A-n78A)		PI/2 BPSK / QPSK		16QAM / 64QAM / 256QAM	
BW (MHz)	Frequency Range (MHz)	Emission Designator (99%OBW)	Conducted Power(W)	Emission Designator (99%OBW)	Conducted Power(W)
10	3705.00 ~ 3795.00	8M57G7D	0.4566	8M61W7D	0.3803
15	3707.52 ~ 3792.495	13M7G7D	0.4402	13M6W7D	0.3794
20	3710.01 ~ 3792.485	18M3G7D	0.4524	18M3W7D	0.3794
40	3720.00 ~ 3780.00	38M1G7D	0.4837	38M0W7D	0.3734
50	3725.01 ~ 3774.99	47M6G7D	0.4860	47M8W7D	0.3785
60	3730.02 ~ 3769.98	57M7G7D	0.4849	58M0W7D	0.3820
80	3740.01 ~ 3759.99	77M7G7D	0.4772	77M5W7D	0.3751
100	3750	96M5G7D	0.4750	96M7W7D	0.3845
Frequency Tolerance (ppm)		0.0011			



1.7 Testing Location

Sporton International (Shenzhen) Inc. is accredited to ISO/IEC 17025:2017 by American Association for Laboratory Accreditation with Certificate Number 5145.01.

Test Firm	Sporton International (Shenzhen) Inc.		
Test Site Location	1/F, 2/F, Bldg 5, Shiling Industrial Zone, Xinwei Village, Xili, Nanshan, Shenzhen, 518055 People’s Republic of China TEL: +86-755-86379589 FAX: +86-755-86379595		
Test Site No.	Sporton Site No.	FCC Designation No.	FCC Test Firm Registration No.
	TH01-SZ	CN1256	421272

Test Firm	Sporton International (Shenzhen) Inc.		
Test Site Location	101, 1st Floor, Block B, Building 1, No. 2, Tengfeng 4th Road, Fenghuang Community, Fuyong Street, Baoan District, Shenzhen City Guangdong Province China 518103 TEL: +86-755-33202398		
Test Site No.	Sporton Site No.	FCC Designation No.	FCC Test Firm Registration No.
	03CH03-SZ	CN1256	421272

1.8 Test Software

Item	Site	Manufacturer	Name	Version
1.	03CH03-SZ	AUDIX	E3	6.2009-8-24

1.9 Applicable Standards

According to the specifications of the manufacturer, the EUT must comply with the requirements of the following standards:

- ♦ 47 CFR Part 2, 27
- ♦ ANSI C63.26-2015
- ♦ FCC KDB 971168 D01 Power Meas License Digital Systems v03r01
- ♦ FCC KDB 412172 D01 Determining ERP and EIRP v01r01

Remark:

All test items were verified and recorded according to the standards and without any deviation during the test.



2 Test Configuration of Equipment Under Test

2.1 Test Mode

Antenna port conducted and radiated test items are performed according to KDB 971168 D01 Power Meas License Digital Systems v03r01 with maximum output power.

For radiated measurement, pre-scanned in three orthogonal panels, X, Y, Z. The worst cases were recorded in this report.

The device is investigated from 30MHz to 10 times of fundamental signal for radiated spurious emission test under different RB size/offset and modulations in exploratory test. Subsequently, only the worst case emissions are reported.

Orthogonal Planes of EUT	X Plane	Y Plane	Z Plane
			

Test Items	5G NR	Bandwidth (MHz)										Modulation					RB #		Test Channel		
		5	10	15	20	30	40	50	60	80	100	PI/2 BPSK	QPSK	16QAM	64QAM	256QAM	1	Full	L	M	H
Max. Output Power	n7	v	v	v	v	-	-	-	-	-	-	v	v	v	v	v	v	v	v	v	v
	n38	v	v	v	v	-	v	-	-	-	-	v	v	v	v	v	v	v	v	v	v
	n41	-	v	v		v	v	v	-	v	-	v	v	v	v	v	v	v	v	v	v
	n71	v	v	v	v	-	-	-	-	-	-	v	v	v	v	v	v	v	v	v	v
	n77	-	v	v	v	-	v	v	v	v	v	v	v	v	v	v	v	v	v	v	v
	n78	-	v	v	v	-	v	v	v	v	v	v	v	v	v	v	v	v	v	v	v
Peak-to-Average Ratio	n7				v	-	-	-	-	-	-	v	v				v	v	v	v	v
	N38				v	-		-	-	-	-	v	v				v	v	v	v	v
	n41	-	v							-	-	v	v				v	v	v	v	v
	n71				v	-	-	-	-	-	-	v	v				v	v	v	v	v
	n77	-	v			-						v	v				v	v	v	v	v
	n78	-	v			-						v	v				v	v	v	v	v
26dB and 99% Bandwidth	n7	v	v	v	v	-	-	-	-	-	-		v	v	v	v		v		v	
	n38	v	v	v	v	-		-	-	-	-		v	v	v	v		v		v	
	n41	-	v	v		v	v	v	-	v	-		v	v	v	v		v		v	
	n71	v	v	v	v	-	-	-	-	-	-		v	v	v	v		v		v	
	n77	-	v	v	v	-	v	v	v	v	v		v	v	v	v		v		v	
	n78	-	v	v	v	-	v	v	v	v	v		v	v	v	v		v		v	



Test Items	5G NR	Bandwidth (MHz)										Modulation					RB #		Test Channel		
		5	10	15	20	30	40	50	60	80	100	PI/2 BPSK	QPSK	16QAM	64QAM	256QAM	1	Full	L	M	H
Conducted Band Edge	n7	v	v		v	-	-	-	-	-	-	v	v				v	v	v		v
	N38	v	v		v	-		-	-	-	-	v	v				v	v	v		v
	n41	-	v				v		-	v	-	v	v				v	v	v		v
	n71	v	v		v	-	-	-	-	-	-	v	v				v	v	v		v
	n77	-	v			-		v				v	v				v	v	v		v
	n78	-	v			-		v				v	v				v	v	v		v
Conducted Spurious Emission	n7	v	v		v	-	-	-	-	-	-	v	v				v		v	v	v
	N38	v	v		v	-		-	-	-	-	v	v				v		v	v	v
	n41	-	v				v		-	v	-	v	v				v		v	v	v
	n71	v	v		v	-	-	-	-	-	-	v	v				v		v	v	v
	n77	-	v			-		v				v	v				v		v	v	v
	n78	-	v			-		v				v	v				v		v	v	v
Frequency Stability	n7				v	-	-	-	-	-	-	v						v		v	
	N38				v	-		-	-	-	-	v						v		v	
	n41	-			v				-		-	v						v		v	
	n71				v	-	-	-	-	-	-	v						v		v	
	n77	-			v	-						v						v		v	
	n78	-			v	-						v						v		v	
E.R.P / E.I.R.P	n7	v	v	v	v	-	-	-	-	-	-	v	v	v	v	v	v	v	v	v	v
	N38	v	v	v	v	-	v	-	-	-	-	v	v	v	v	v	v	v	v	v	v
	n41	-	v	v		v	v	v	-	v	-	v	v	v	v	v	v	v	v	v	v
	n71	v	v	v	v	-	-	-	-	-	-	v	v	v	v	v	v	v	v	v	v
	n77	-	v	v	v	-	v	v	v	v	v	v	v	v	v	v	v	v	v	v	v
	n78	-	v	v	v	-	v	v	v	v	v	v	v	v	v	v	v	v	v	v	v



Test Items	5G NR	Bandwidth (MHz)										Modulation					RB #		Test Channel			
		5	10	15	20	30	40	50	60	80	100	PI/2 BPSK	QPSK	16QAM	64QAM	256QAM	1	Full	L	M	H	
Conducted Band Edge	n7	Worst Case															1	Full	v	v	v	
	N38	Worst Case																		v	v	v
	n41	Worst Case																		v	v	v
	n71	Worst Case																		v	v	v
	n77	Worst Case																		v	v	v
	n78	Worst Case																		v	v	v
Note	<ol style="list-style-type: none"> The mark "v" means that this configuration is chosen for testing The mark "-" means that this bandwidth is not supported. The device is investigated from 30MHz to 10 times of fundamental signal for radiated spurious emission test under different RB size/offset and modulations in exploratory test. Subsequently, only the worst case emissions are reported. Based on engineering evaluation, only the worst modulation test results are shown in the report. 5G NR n41, n77, n78 support UL MIMO mode, and only supports CP-OFDM modulation in UL MIMO mode. 5G NR n41, n77, n78 UL MIMO mode, the conducted power show in the appendix A is the total MIMO power, the gain is the MIMO gain(MIMO Gain = Gain+10log2), and the transmit signals are correlated. 5G NR n41, n77, n78 SA/NSA/UL MIMO supports HPUE. Only EN-DC 41A_n41A supports the power fallback, and the maximum power listed in the report is the value after the fallback. 5G NR supports SCS 15KHz and 30KHz for FDD/TDD band, according to engineering evaluation, for FDD band, only choose the SCS 15KHz (the highest conducted power) perform for all tests; for TDD band, choose the SCS 15KHz and 30kHz(different BW for different SCS) perform for all tests. 5G NR supports SA and NSA mode (refer to the Operation Description). For NSA mode, according to engineering evaluation, only the worst EN-DC combination mode show in the report. 																					

2.2 Connection Diagram of Test System

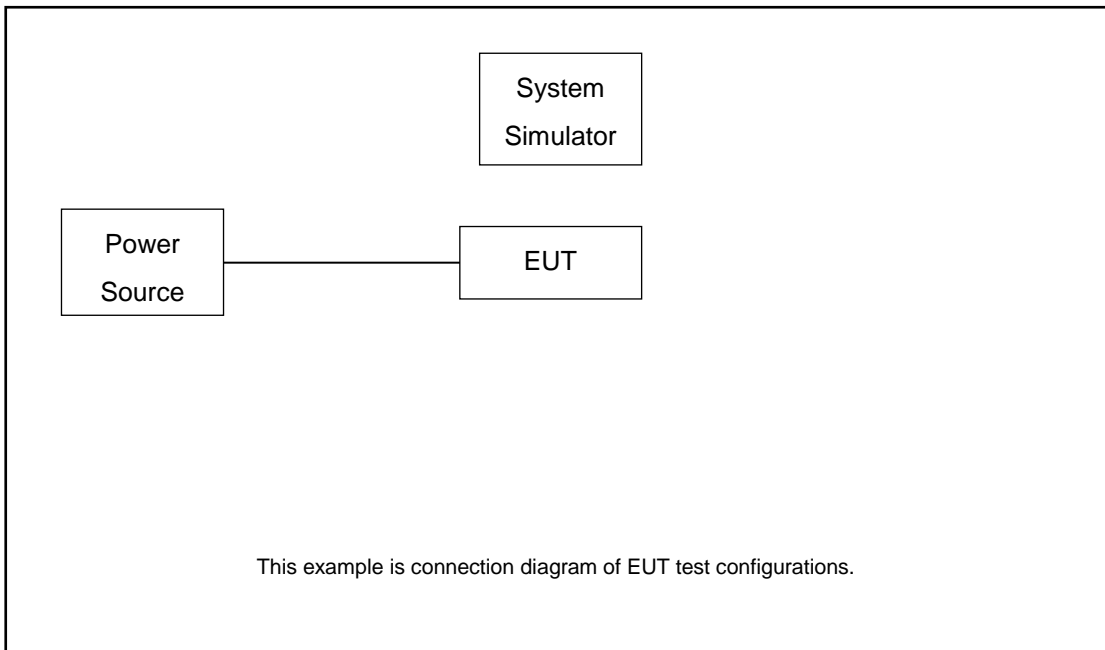

2.3 Support Unit used in test configuration and system

Item	Equipment	Trade Name	Model No.	FCC ID	Data Cable	Power Cord
1.	DC Power Supply	GW	GPS-3030D	N/A	N/A	Unshielded, 1.8 m
2.	LTE Base Station	Anritsu	MT8821C	N/A	N/A	Unshielded, 1.8 m
3.	NR Base Station	Anritsu	MT8000A	N/A	N/A	Unshielded, 1.8 m
4.	Test Jig	N/A	N/A	N/A	N/A	N/A

2.4 Measurement Results Explanation Example

For all conducted test items:

The offset level is set in the spectrum analyzer to compensate the RF cable loss between EUT conducted output port and spectrum analyzer. With the offset compensation, the spectrum analyzer reading level is exactly the EUT RF output level.

The spectrum analyzer offset is derived from RF cable loss.

$Offset = RF\ cable\ loss.$

Following shows an offset computation example with cable loss 4.3 dB.

Example :

$Offset(dB) = RF\ cable\ loss(dB).$

$= 4.3\ (dB)$



2.5 Frequency List of Low/Middle/High Channels

5G NR n7 Channel and Frequency List				
BW [MHz]	Channel/Frequency(MHz)	Lowest	Middle	Highest
20	Channel	502000	507000	512000
	Frequency	2510	2535	2560
15	Channel	501500	507000	512500
	Frequency	2507.5	2535	2562.5
10	Channel	501000	507000	513000
	Frequency	2505	2535	2565
5	Channel	500500	507000	513500
	Frequency	2502.5	2535	2567.5

5G NR n38 Channel and Frequency List				
BW [MHz]	Channel/Frequency(MHz)	Lowest	Middle	Highest
20	Channel	516000	519000	522000
	Frequency	2580	2595	2610
15	Channel	515500	519000	522500
	Frequency	2577.5	2595	2612.5
10	Channel	515000	519000	523000
	Frequency	2575	2595	2615
5	Channel	514500	519000	523500
	Frequency	2572.5	2595	2617.5

5G NR n41 Channel and Frequency List				
BW [MHz]	Channel/Frequency(MHz)	Lowest	Middle	Highest
80	Channel	507204	518598	529998
	Frequency	2536.02	2592.99	2649.99
50	Channel	504204	518598	532998
	Frequency	2521.02	2592.99	2664.99
40	Channel	503202	518598	534000
	Frequency	2516.01	2592.99	2670
30	Channel	502200	518598	534996
	Frequency	2511	2592.99	2674.98
15	Channel	500700	518598	536496
	Frequency	2503.5	2592.99	2682.48



10	Channel	500202	518598	537000
	Frequency	2501.01	2592.99	2685

5G NR n71 Channel and Frequency List				
BW [MHz]	Channel/Frequency(MHz)	Lowest	Middle	Highest
20	Channel	134600	136100	137600
	Frequency	673	680.5	688
15	Channel	134100	136100	138100
	Frequency	670.5	680.5	690.5
10	Channel	133600	136100	138600
	Frequency	668	680.5	693
5	Channel	133100	136100	139100
	Frequency	665.5	680.5	695.5

5G NR n77 Channel and Frequency List				
BW [MHz]	Channel/Frequency(MHz)	Lowest	Middle	Highest
100	Channel	650000	656000	662000
	Frequency	3750	3840	3930
80	Channel	649334	656000	662666
	Frequency	3740.01	3840	3939.99
60	Channel	648668	656000	663332
	Frequency	3730.02	3840	3949.98
50	Channel	648334	656000	663666
	Frequency	3725.01	3840	3954.99
40	Channel	648000	656000	664000
	Frequency	3720	3840	3960
20	Channel	647334	656000	664666
	Frequency	3710.01	3840	3969.99
15	Channel	647168	656000	664832
	Frequency	3707.52	3840	3972.48
10	Channel	647000	656000	665000
	Frequency	3705	3840	3975



5G NR n78 Channel and Frequency List				
BW [MHz]	Channel/Frequency(MHz)	Lowest	Middle	Highest
100	Channel	650000		
	Frequency	3750		
80	Channel	649334	650000	650666
	Frequency	3740.01	3750	3759.99
60	Channel	648668	650000	651332
	Frequency	3730.02	3750	3769.98
50	Channel	648334	650000	651666
	Frequency	3725.01	3750	3774.99
40	Channel	648000	650000	652000
	Frequency	3720	3750	3780
20	Channel	647334	650000	652666
	Frequency	3710.01	3750	3789.99
15	Channel	647168	650000	652833
	Frequency	3707.52	3750	3792.495
10	Channel	647000	650000	653000
	Frequency	3705	3750	3795

3 Conducted Test Items

3.1 Measuring Instruments

See list of measuring instruments of this test report.

3.2 Test Setup

3.2.1 Conducted Output Power



3.2.2 Peak-to-Average Ratio, Occupied Bandwidth, Conducted Band-Edge and Conducted Spurious Emission



3.2.3 Frequency Stability

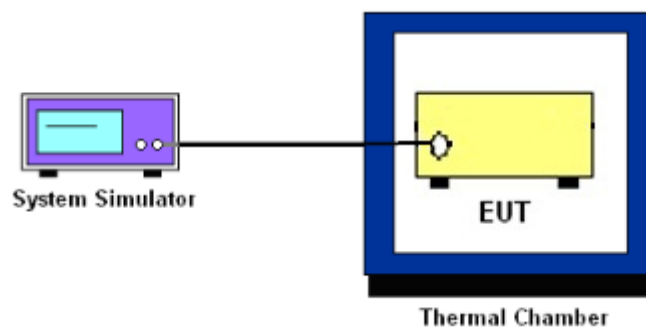

3.3 Test Result of Conducted Test

Please refer to Appendix A.



3.4 Conducted Output Power and ERP/EIRP

3.4.1 Description of the Conducted Output Power Measurement and ERP/EIRP Measurement

A system simulator was used to establish communication with the EUT. Its parameters were set to force the EUT transmitting at maximum output power. The measured power in the radio frequency on the transmitter output terminals shall be reported.

The ERP of mobile transmitters must not exceed 3 Watts for 5G NR n71.

The EIRP of mobile transmitters must not exceed 2 Watts for 5G NR n7, n38 and n41.

The EIRP of mobile transmitters must not exceed 1 Watts for 5G NR n77, n78.

According to KDB 412172 D01 Power Approach,

$EIRP = P_T + G_T - L_C$, $ERP = EIRP - 2.15$, where

P_T = transmitter output power in dBm

G_T = gain of the transmitting antenna in dBi

L_C = signal attenuation in the connecting cable between the transmitter and antenna in dB

3.4.2 Test Procedures

1. The testing follows ANSI C63.26 Section 5.2
2. The transmitter output port was connected to the system simulator.
3. Set EUT at maximum power through the system simulator.
4. Select lowest, middle, and highest channels for each band and different modulation.
5. Measure and record the power level from the system simulator.



3.5 Peak-to-Average Ratio

3.5.1 Description of the PAR Measurement

Power Complementary Cumulative Distribution Function (CCDF) curves provide a means for characterizing the power peaks of a digitally modulated signal on a statistical basis. A CCDF curve depicts the probability of the peak signal amplitude exceeding the average power level. Most contemporary measurement instrumentation include the capability to produce CCDF curves for an input signal provided that the instrument's resolution bandwidth can be set wide enough to accommodate the entire input signal bandwidth. In measuring transmissions in this band using an average power technique, the peak-to-average ratio (PAR) of the transmission may not exceed 13 dB.

3.5.2 Test Procedures

1. The testing follows ANSI C63.26 Section 5.2.3.4 (CCDF).
2. The EUT was connected to spectrum and system simulator via a power divider.
3. Set the CCDF (Complementary Cumulative Distribution Function) option in spectrum analyzer.
4. The highest RF powers were measured and recorded the maximum PAPR level associated with a probability of 0.1 %.
5. Record the deviation as Peak to Average Ratio.



3.6 Occupied Bandwidth

3.6.1 Description of Occupied Bandwidth Measurement

The occupied bandwidth is the width of a frequency band such that, below the lower and above the upper frequency limits, the mean powers emitted are each equal to a specified percentage 0.5% of the total mean transmitted power.

The 26 dB emission bandwidth is defined as the frequency range between two points, one above and one below the carrier frequency, at which the spectral density of the emission is attenuated 26 dB below the maximum in-band spectral density of the modulated signal. Spectral density (power per unit bandwidth) is to be measured with a detector of resolution bandwidth equal to approximately 1.0% of the emission bandwidth.

3.6.2 Test Procedures

1. The testing follows ANSI C63.26 Section 5.4
2. The EUT was connected to spectrum analyzer and system simulator via a power divider.
3. The spectrum analyzer center frequency is set to the nominal EUT channel center frequency. The span range for the spectrum analyzer shall be between two and five times the anticipated OBW.
4. The nominal resolution bandwidth (RBW) shall be in the range of 1 to 5 % of the anticipated OBW, and the VBW shall be at least 3 times the RBW.
5. Set the detection mode to peak, and the trace mode to max hold.
6. Determine the reference value: Set the EUT to transmit a modulated signal. Allow the trace to stabilize. Set the spectrum analyzer marker to the highest level of the displayed trace.
(this is the reference value)
7. Determine the “-26 dB down amplitude” as equal to (Reference Value – X).
8. Place two markers, one at the lowest and the other at the highest frequency of the envelope of the spectral display such that each marker is at or slightly below the “-X dB down amplitude” determined in step 6. If a marker is below this “-X dB down amplitude” value it shall be placed as close as possible to this value. The OBW is the positive frequency difference between the two markers.
9. Use the 99 % power bandwidth function of the spectrum analyzer and report the measured bandwidth.



3.7 Conducted Band Edge

3.7.1 Description of Conducted Band Edge Measurement

27.53 (g)

For operations in the 600MHz band and 698 -746 MHz band, the FCC limit is $43 + 10\log_{10}(P[\text{Watts}])$ dB below the transmitter power P(Watts) in a 100 kHz bandwidth. However, in the 100 kilohertz bands immediately outside and adjacent to a licensee's frequency block, a resolution bandwidth of at least 30 kHz may be employed.

27.53(m)(4)

For mobile digital stations, the attenuation factor shall be not less than $40 + 10 \log (P)$ dB on all frequencies between the channel edge and 5 megahertz from the channel edge, $43 + 10 \log (P)$ dB on all frequencies between 5 megahertz and X megahertz from the channel edge, and $55 + 10 \log (P)$ dB on all frequencies more than X megahertz from the channel edge, where X is the greater of 6 megahertz or the actual emission bandwidth as defined in paragraph (m)(6) of this section. In addition, the attenuation factor shall not be less that $43 + 10 \log (P)$ dB on all frequencies between 2490.5 MHz and 2496 MHz and $55 + 10 \log (P)$ dB at or below 2490.5 MHz. Mobile Satellite Service licensees operating on frequencies below 2495 MHz may also submit a documented interference complaint against BRS licensees operating on channel BRS Channel 1 on the same terms and conditions as adjacent channel BRS or EBS licensees.

27.53(l)(2)

For mobile operations in the 3700-3980 MHz band, the conducted power of any emission outside the licensee's authorized bandwidth shall not exceed -13 dBm/MHz. Compliance with this paragraph is based on the use of measurement instrumentation employing a resolution bandwidth of 1 megahertz or greater. However, in the 1 megahertz bands immediately outside and adjacent to the licensee's frequency block, the minimum resolution bandwidth for the measurement shall be either one percent of the emission bandwidth of the fundamental emission of the transmitter or 350 kHz. In the bands between 1 and 5 MHz removed from the licensee's frequency block, the minimum resolution bandwidth for the measurement shall be 500 kHz.



3.7.2 Test Procedures

1. The testing follows ANSI C63.26 section 5.7
2. The EUT was connected to spectrum analyzer and system simulator via a power divider.
3. The band edges of low and high channels for the highest RF powers were measured.
4. Set RBW \geq 1% EBW in the 1MHz band immediately outside and adjacent to the band edge.
5. Beyond the 1 MHz band from the band edge, RBW=1MHz was used.
6. Set spectrum analyzer with RMS detector.
7. The RF fundamental frequency should be excluded against the limit line in the operating frequency band.
8. Checked that all the results comply with the emission limit line.

Example:

The limit line is derived from $43 + 10\log(P)$ dB below the transmitter power P(Watts)

$$= P(W) - [43 + 10\log(P)] \text{ (dB)}$$

$$= [30 + 10\log(P)] \text{ (dBm)} - [43 + 10\log(P)] \text{ (dB)} = -13\text{dBm}.$$

9. For 5G NR n7/n41, the other 40 dB, and 55 dB have additionally applied same calculation above.



3.8 Conducted Spurious Emission

3.8.1 Description of Conducted Spurious Emission Measurement

The power of any emission outside of the authorized operating frequency ranges must be lower than the transmitter power (P) by a factor of at least $43 + 10 \log (P)$ dB.

For 5G NR n7/n38/n41:

The power of any emission outside of the authorized operating frequency ranges must be lower than the transmitter power (P) by a factor of at least $55 + 10 \log (P)$ dB.

It is measured by means of a calibrated spectrum analyzer and scanned from 30 MHz up to a frequency including its 10th harmonic.

3.8.2 Test Procedures

1. The testing follows ANSI C63.26 section 5.7
2. The EUT was connected to spectrum analyzer and system simulator via a power divider.
3. The RF output of EUT was connected to the spectrum analyzer by RF cable and attenuator. The path loss was compensated to the results for each measurement.
4. The middle channel for the highest RF power within the transmitting frequency was measured.
5. The conducted spurious emission for the whole frequency range was taken.
6. Make the measurement with the spectrum analyzer's RBW = 1MHz, VBW = 3MHz.
7. Set spectrum analyzer with RMS detector.
8. Taking the record of maximum spurious emission.
9. The RF fundamental frequency should be excluded against the limit line in the operating frequency band.
10. The limit line is derived from $43 + 10\log(P)$ dB below the transmitter power P(Watts)
 $= P(W) - [43 + 10\log(P)]$ (dB)
 $= [30 + 10\log(P)]$ (dBm) - $[43 + 10\log(P)]$ (dB)
 $= -13$ dBm.
11. For 5G NR n7/n38/n41
The limit line is derived from $55 + 10\log(P)$ dB below the transmitter power P(Watts)
 $= P(W) - [55 + 10\log(P)]$ (dB)
 $= [30 + 10\log(P)]$ (dBm) - $[55 + 10\log(P)]$ (dB)
 $= -25$ dBm.



3.9 Frequency Stability

3.9.1 Description of Frequency Stability Measurement

The frequency stability shall be measured by variation of ambient temperature and variation of primary supply voltage to ensure that the fundamental emission stays within the authorized frequency block. The frequency stability of the transmitter shall be maintained within $\pm 0.00025\%$ ($\pm 2.5\text{ppm}$) of the center frequency.

3.9.2 Test Procedures for Temperature Variation

1. The testing follows ANSI C63.26 section 5.6.4
2. The EUT was set up in the thermal chamber and connected with the system simulator.
3. With power OFF, the temperature was decreased to -30°C and the EUT was stabilized before testing. Power was applied and the maximum change in frequency was recorded within one minute.
4. With power OFF, the temperature was raised in 10°C step up to 50°C . The EUT was stabilized at each step for at least half an hour. Power was applied and the maximum frequency change was recorded within one minute.

3.9.3 Test Procedures for Voltage Variation

1. The testing follows ANSI C63.26 section 5.6.5
2. The EUT was placed in a temperature chamber at $20\pm 5^{\circ}\text{C}$ and connected with the system simulator.
3. The power supply voltage to the EUT was varied from 85% to 115% of the nominal value for other than hand carried battery equipment.
4. For hand carried, battery powered equipment, reduce the primary ac or dc supply voltage to the battery operating end point, which shall be specified by the manufacturer.
5. The variation in frequency was measured for the worst case.

4 Radiated Test Items

4.1 Measuring Instruments

See list of measuring instruments of this test report.

4.2 Test Setup

4.2.1 For radiated test from 30MHz to 1GHz

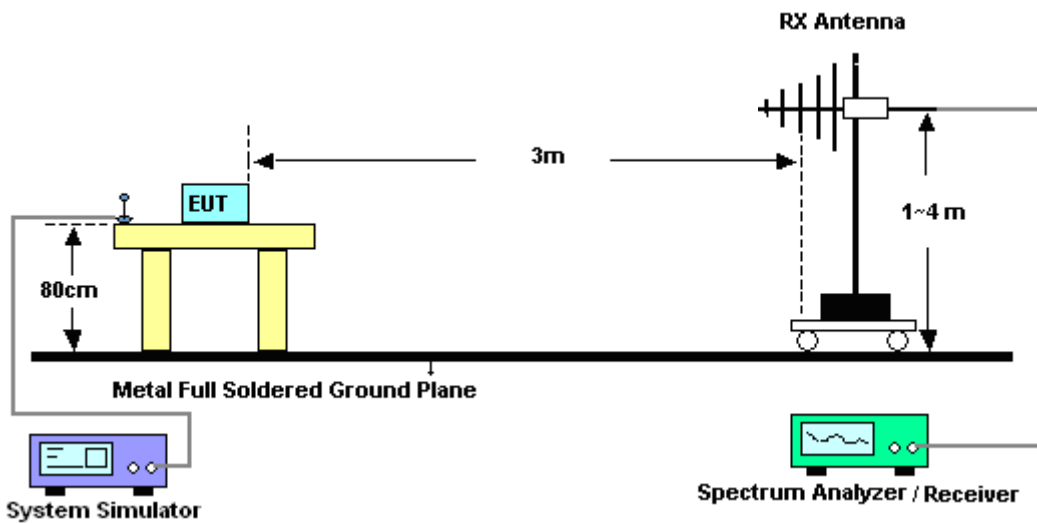

4.2.2 For radiated test above 1GHz

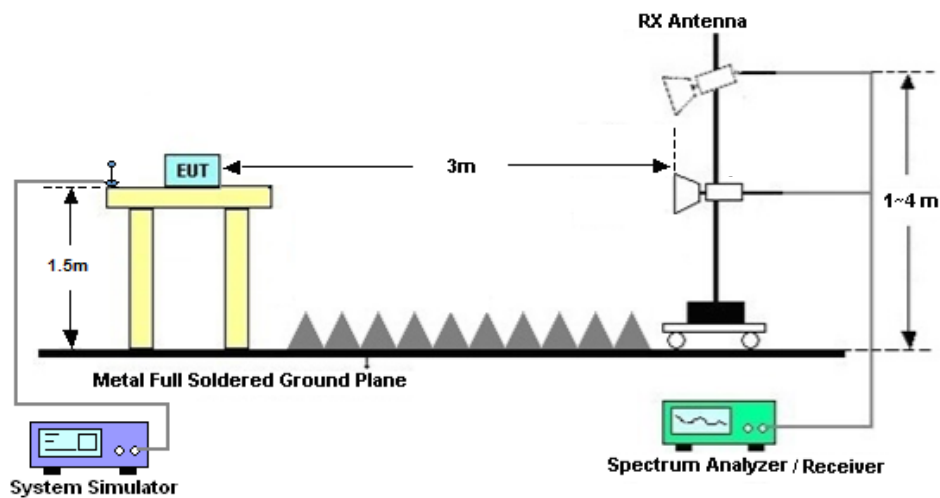

4.3 Test Result of Radiated Test

Please refer to Appendix B.



4.4 Radiated Spurious Emission

4.4.1 Description of Radiated Spurious Emission

The radiated spurious emission was measured by substitution method according to ANSI C63.26. The power of any emission outside of the authorized operating frequency ranges must be attenuated below the transmitter power (P) by a factor of at least $43 + 10 \log (P)$ dB.

For 5G NR n7/n41

The power of any emission outside of the authorized operating frequency ranges must be attenuated below the transmitter power (P) by a factor of at least $55 + 10 \log (P)$ dB.

The spectrum is scanned from 30 MHz up to a frequency including its 10th harmonic.

4.4.2 Test Procedures

1. The testing follows ANSI C63.26 Section 5.5
2. The EUT was placed on a turntable with 0.8 meter height for frequency below 1GHz and 1.5 meter height for frequency above 1GHz respectively above ground.
3. The EUT was set 3 meters from the receiving antenna mounted on the antenna tower.
4. The table was rotated 360 degrees to determine the position of the highest spurious emission.
5. The height of the receiving antenna is varied between 1m to 4m to search the maximum spurious emission for both horizontal and vertical polarizations.
6. During the measurement, the system simulator parameters were set to force the EUT transmitting at maximum output power.
7. Make the measurement with the spectrum analyzer's RBW = 1MHz, VBW = 3MHz, taking the record of maximum spurious emission.
8. A horn antenna was substituted in place of the EUT and was driven by a signal generator.
9. Tune the output power of signal generator to the same emission level with EUT maximum spurious emission.
10. $EIRP (dBm) = S.G. Power - Tx Cable Loss + Tx Antenna Gain$
11. $ERP (dBm) = EIRP - 2.15$
12. The RF fundamental frequency should be excluded against the limit line in the operating frequency band.

The limit line is derived from $43 + 10\log(P)$ dB below the transmitter power P(Watts)
 $= P(W) - [43 + 10\log(P)] (dB)$
 $= [30 + 10\log(P)] (dBm) - [43 + 10\log(P)] (dB)$
 $= -13dBm.$

13. For 5G NR n7/n38/n41:

The limit line is derived from $55 + 10\log(P)$ dB below the transmitter power P(Watts)The limit line is derived from $55 + 10\log(P)$ dB below the transmitter power P(Watts)



5 List of Measuring Equipment

Instrument	Manufacturer	Model No.	Serial No.	Characteristics	Calibration Date	Test Date	Due Date	Remark
Spectrum Analyzer	R&S	FSV40	101078	10Hz~40GHz	Apr. 17, 2020	Jan. 13, 2021~ Mar. 13, 2021	Apr. 16, 2021	Conducted (TH01-SZ)
Thermal Chamber	Ten Billion Hongzhangroup	LP-150U	H201408180 3	-40~+150°C	Jul. 22, 2020	Jan. 13, 2021~ Mar. 13, 2021	Jul. 21, 2021	Conducted (TH01-SZ)
EMI Test Receiver&SA	KEYSIGHT	N9038A	MY5445008 3	20Hz~8.4GHz	Apr. 17, 2020	Jan. 20, 2021~ Mar. 29, 2021	Apr. 16, 2021	Radiation (03CH03-SZ)
EXA Spectrum Analyzer	KEYSIGHT	N9010A	MY5515024 6	10Hz~44GHz;	Apr. 17, 2020	Jan. 20, 2021~ Mar. 29, 2021	Apr. 16, 2021	Radiation (03CH03-SZ)
Bilog Antenna	TeseQ	CBL6112D	35408	30MHz-2GHz	Jun. 22, 2020	Jan. 20, 2021~ Mar. 29, 2021	Jun. 21, 2021	Radiation (03CH03-SZ)
Double Ridge Horn Antenna	SCHWARZBECK	BBHA9120 D	9120D-1355	1GHz~18GHz	Apr. 30, 2020	Jan. 20, 2021~ Mar. 29, 2021	Apr. 29, 2021	Radiation (03CH03-SZ)
Amplifier	Burgeon	BPA-530	102210	0.01Hz ~3000MHz	Oct. 17, 2020	Jan. 20, 2021~ Mar. 29, 2021	Oct. 16, 2021	Radiation (03CH03-SZ)
HF Amplifier	MITEQ	TTA1840-35 -HG	1871923	18GHz~40GHz	Jul. 21, 2020	Jan. 20, 2021~ Mar. 29, 2021	Jul. 20, 2021	Radiation (03CH03-SZ)
SHF-EHF Horn	com-power	AH-840	101071	18Ghz-40GHz	Apr. 23, 2020	Jan. 20, 2021~ Mar. 29, 2021	Apr. 22, 2021	Radiation (03CH03-SZ)
Amplifier	Agilent Technologies	83017A	MY3950130 2	500MHz~26.5G Hz	Dec. 25, 2020	Jan. 20, 2021~ Mar. 29, 2021	Dec. 24, 2021	Radiation (03CH03-SZ)
AC Power Source	Chroma	61601	6160100019 85	N/A	NCR	Jan. 20, 2021~ Mar. 29, 2021	NCR	Radiation (03CH03-SZ)
Turn Table	EM	EM1000	N/A	0~360 degree	NCR	Jan. 20, 2021~ Mar. 29, 2021	NCR	Radiation (03CH03-SZ)
Antenna Mast	EM	EM1000	N/A	1 m~4 m	NCR	Jan. 20, 2021~ Mar. 29, 2021	NCR	Radiation (03CH03-SZ)

NCR: No Calibration Required



6 Uncertainty of Evaluation

The measurement uncertainties shown below were calculated in accordance with the requirements of ANSI 63.26-2015. All the measurement uncertainty value were shown with a coverage K=2 to indicate 95% level of confidence. The measurement data show herein meets or exceeds the CISPR measurement uncertainty values specified in CISPR 16-4-2 and can be compared directly to specified limit to determine compliance.

Uncertainty of Radiated Emission Measurement (30 MHz ~ 1000 MHz)

Measuring Uncertainty for a Level of Confidence of 95% (U = 2Uc(y))	3.0dB
---	-------

Uncertainty of Radiated Emission Measurement (1 GHz ~ 18 GHz)

Measuring Uncertainty for a Level of Confidence of 95% (U = 2Uc(y))	3.6dB
---	-------

Uncertainty of Radiated Emission Measurement (18 GHz ~ 40 GHz)

Measuring Uncertainty for a Level of Confidence of 95% (U = 2Uc(y))	3.8dB
---	-------



Appendix A. Test Results of Conducted Test

Conducted Output Power(Average power and EIRP)

5G NR n7 SA mode:

SCS 15

SA n7 (ANT M) 20MHz (GT - LC = 4 dB)							
Channel	Mode	NR		Conducted		EIRP	
		RB		Power(dBm)	Power(Watts)	EIRP(dBm)	EIRP(W)
		Size	Offset				
Lowest	PI/2 BPSK DFT-s-	1	1	22.86	0.1932	26.86	0.4853
		1	104	23.31	0.2143	27.31	0.5383
		50	25	23.17	0.2075	27.17	0.5212
	QPSK DFT-s- OFDM	1	1	22.94	0.1968	26.94	0.4943
		1	104	23.26	0.2118	27.26	0.5321
		50	25	23.17	0.2075	27.17	0.5212
	16QAM DFT-s- OFDM	1	1	21.62	0.1452	25.62	0.3648
		1	104	21.89	0.1545	25.89	0.3882
		50	25	21.92	0.1556	25.92	0.3908
	64QAM DFT-s- OFDM	1	1	20.18	0.1042	24.18	0.2618
		1	104	20.41	0.1099	24.41	0.2761
		50	25	20.36	0.1086	24.36	0.2729
256QA M DFT-s-	1	1	18.36	0.0685	22.36	0.1722	
	1	104	18.39	0.069	22.39	0.1734	
	50	25	18.35	0.0684	22.35	0.1718	
Middle	PI/2 BPSK DFT-s-	1	1	22.98	0.1986	26.98	0.4989
		1	104	23.17	0.2075	27.17	0.5212
		50	25	23.18	0.208	27.18	0.5224
	QPSK DFT-s- OFDM	1	1	23.01	0.2	27.01	0.5023
		1	104	23.07	0.2028	27.07	0.5093
		50	25	23.21	0.2094	27.21	0.526
	16QAM DFT-s- OFDM	1	1	21.48	0.1406	25.48	0.3532
		1	104	21.83	0.1524	25.83	0.3828
		50	25	21.87	0.1538	25.87	0.3864
	64QAM DFT-s- OFDM	1	1	19.97	0.0993	23.97	0.2495
		1	104	20.19	0.1045	24.19	0.2624
		50	25	20.28	0.1067	24.28	0.2679
	256QA M DFT-s-	1	1	18.63	0.0729	22.63	0.1832
		1	104	18.39	0.069	22.39	0.1734
		50	25	18.26	0.067	22.26	0.1683
QPSK CP-s- OFDM	1	1	21.33	0.1358	25.33	0.3412	
	1	104	21.37	0.1371	25.37	0.3443	
	53	26	21.42	0.1387	25.42	0.3483	
Highest	PI/2 BPSK DFT-s-	1	1	23.12	0.2051	27.12	0.5152
		1	104	22.42	0.1746	26.42	0.4385
		50	25	23.11	0.2046	27.11	0.514
	QPSK DFT-s- OFDM	1	1	23.04	0.2014	27.04	0.5058
		1	104	22.49	0.1774	26.49	0.4457
		50	25	23.10	0.2042	27.10	0.5129
	16QAM DFT-s- OFDM	1	1	21.71	0.1483	25.71	0.3724
		1	104	21.57	0.1435	25.57	0.3606
		50	25	21.96	0.157	25.96	0.3945
	64QAM DFT-s- OFDM	1	1	20.23	0.1054	24.23	0.2649
		1	104	20.13	0.103	24.13	0.2588
		50	25	20.41	0.1099	24.41	0.2761
	256QA M DFT-s-	1	1	18.09	0.0644	22.09	0.1618
		1	104	18.36	0.0685	22.36	0.1722
		50	25	18.33	0.0681	22.33	0.171

SA n7 (ANT) 15MHz (GT - LC = 4 dB)							
Channel	Mode	NR		Conducted		EIRP	
		RB					
		Size	Offset	Power(dBm)	Power(Watts)	EIRP(dBm)	EIRP(W)
Lowest	PI/2 BPSK DFT-s-	1	1	22.86	0.1932	26.86	0.4853
		1	77	23.38	0.2178	27.38	0.547
		36	18	23.19	0.2084	27.19	0.5236
	QPSK DFT-s- OFDM	1	1	23.06	0.2023	27.06	0.5082
		1	77	23.15	0.2065	27.15	0.5188
		36	18	23.21	0.2094	27.21	0.526
	16QAM DFT-s- OFDM	1	1	21.47	0.1403	25.47	0.3524
		1	77	21.93	0.156	25.93	0.3917
		36	18	21.91	0.1552	25.91	0.3899
	64QAM DFT-s- OFDM	1	1	20.32	0.1076	24.32	0.2704
		1	77	20.54	0.1132	24.54	0.2844
		36	18	20.48	0.1117	24.48	0.2805
	256QA M DFT-s-	1	1	18.46	0.0701	22.46	0.1762
		1	77	18.39	0.069	22.39	0.1734
		36	18	18.44	0.0698	22.44	0.1754
Middle	PI/2 BPSK DFT-s-	1	1	23.19	0.2084	27.19	0.5236
		1	77	23.16	0.207	27.16	0.52
		36	18	23.12	0.2051	27.12	0.5152
	QPSK DFT-s- OFDM	1	1	23.08	0.2032	27.08	0.5105
		1	77	23.18	0.208	27.18	0.5224
		36	18	23.14	0.2061	27.14	0.5176
	16QAM DFT-s- OFDM	1	1	21.81	0.1517	25.81	0.3811
		1	77	21.94	0.1563	25.94	0.3926
		36	18	21.88	0.1542	25.88	0.3873
	64QAM DFT-s- OFDM	1	1	20.13	0.103	24.13	0.2588
		1	77	20.31	0.1074	24.31	0.2698
		36	18	20.37	0.1089	24.37	0.2735
	256QA M DFT-s-	1	1	18.72	0.0745	22.72	0.1871
		1	77	18.37	0.0687	22.37	0.1726
		36	18	18.33	0.0681	22.33	0.171
QPSK CP-s- OFDM	1	1	21.41	0.1384	25.41	0.3475	
	1	77	21.47	0.1403	25.47	0.3524	
	39	19	21.37	0.1371	25.37	0.3443	
Highest	PI/2 BPSK DFT-s-	1	1	23.13	0.2056	27.13	0.5164
		1	77	22.66	0.1845	26.66	0.4634
		36	18	23.06	0.2023	27.06	0.5082
	QPSK DFT-s- OFDM	1	1	22.93	0.1963	26.93	0.4932
		1	77	22.53	0.1791	26.53	0.4498
		36	18	23.11	0.2046	27.11	0.514
	16QAM DFT-s- OFDM	1	1	21.68	0.1472	25.68	0.3698
		1	77	21.56	0.1432	25.56	0.3597
		36	18	21.94	0.1563	25.94	0.3926
	64QAM DFT-s- OFDM	1	1	20.31	0.1074	24.31	0.2698
		1	77	20.19	0.1045	24.19	0.2624
		36	18	20.27	0.1064	24.27	0.2673
	256QA M DFT-s-	1	1	18.12	0.0649	22.12	0.1629
		1	77	18.34	0.0682	22.34	0.1714
		36	18	18.26	0.067	22.26	0.1683

SA n7 (ANT) 10MHz (GT - LC = 4 dB)							
Channel	Mode	NR		Conducted		EIRP	
		RB		Power(dBm)	Power(Watts)	EIRP(dBm)	EIRP(W)
		Size	Offset				
Lowest	PI/2 BPSK DFT-s-	1	1	22.77	0.1892	26.77	0.4753
		1	50	23.17	0.2075	27.17	0.5212
		25	12	22.97	0.1982	26.97	0.4977
	QPSK DFT-s- OFDM	1	1	22.91	0.1954	26.91	0.4909
		1	50	23.22	0.2099	27.22	0.5272
		25	12	22.99	0.1991	26.99	0.5
	16QAM DFT-s- OFDM	1	1	21.59	0.1442	25.59	0.3622
		1	50	21.91	0.1552	25.91	0.3899
		25	12	21.81	0.1517	25.81	0.3811
	64QAM DFT-s- OFDM	1	1	20.15	0.1035	24.15	0.26
		1	50	20.47	0.1114	24.47	0.2799
		25	12	20.36	0.1086	24.36	0.2729
	256QA M DFT-s-	1	1	18.35	0.0684	22.35	0.1718
		1	50	18.36	0.0685	22.36	0.1722
		25	12	18.31	0.0678	22.31	0.1702
Middle	PI/2 BPSK DFT-s-	1	1	23.17	0.2075	27.17	0.5212
		1	50	23.06	0.2023	27.06	0.5082
		25	12	23.01	0.2	27.01	0.5023
	QPSK DFT-s- OFDM	1	1	23.21	0.2094	27.21	0.526
		1	50	23.05	0.2018	27.05	0.507
		25	12	23.03	0.2009	27.03	0.5047
	16QAM DFT-s- OFDM	1	1	21.93	0.156	25.93	0.3917
		1	50	21.89	0.1545	25.89	0.3882
		25	12	21.81	0.1517	25.81	0.3811
	64QAM DFT-s- OFDM	1	1	20.03	0.1007	24.03	0.2529
		1	50	20.19	0.1045	24.19	0.2624
		25	12	20.25	0.1059	24.25	0.2661
	256QA M DFT-s-	1	1	18.43	0.0697	22.43	0.175
		1	50	18.32	0.0679	22.32	0.1706
		25	12	18.25	0.0668	22.25	0.1679
QPSK CP-s- OFDM	1	1	21.29	0.1346	25.29	0.3381	
	1	50	21.45	0.1396	25.45	0.3508	
	26	13	21.21	0.1321	25.21	0.3319	
Highest	PI/2 BPSK DFT-s-	1	1	22.71	0.1866	26.71	0.4688
		1	50	22.46	0.1762	26.46	0.4426
		25	12	22.94	0.1968	26.94	0.4943
	QPSK DFT-s- OFDM	1	1	22.81	0.191	26.81	0.4797
		1	50	22.51	0.1782	26.51	0.4477
		25	12	22.91	0.1954	26.91	0.4909
	16QAM DFT-s- OFDM	1	1	21.47	0.1403	25.47	0.3524
		1	50	21.45	0.1396	25.45	0.3508
		25	12	21.74	0.1493	25.74	0.375
	64QAM DFT-s- OFDM	1	1	20.14	0.1033	24.14	0.2594
		1	50	20.08	0.1019	24.08	0.2559
		25	12	20.32	0.1076	24.32	0.2704
	256QA M DFT-s-	1	1	18.39	0.069	22.39	0.1734
		1	50	18.35	0.0684	22.35	0.1718
		25	12	18.25	0.0668	22.25	0.1679

SA n7 (ANT) 5MHz (GT - LC = 4 dB)							
Channel	Mode	NR		Conducted		EIRP	
		RB		Power(dBm)	Power(Watts)	EIRP(dBm)	EIRP(W)
		Size	Offset				
Lowest	PI/2 BPSK DFT-s-	1	1	22.78	0.1897	26.78	0.4764
		1	23	23.01	0.2	27.01	0.5023
		12	6	23.11	0.2046	27.11	0.514
	QPSK DFT-s- OFDM	1	1	22.88	0.1941	26.88	0.4875
		1	23	22.91	0.1954	26.91	0.4909
		12	6	23.16	0.207	27.16	0.52
	16QAM DFT-s- OFDM	1	1	21.55	0.1429	25.55	0.3589
		1	23	21.94	0.1563	25.94	0.3926
		12	6	21.92	0.1556	25.92	0.3908
	64QAM DFT-s- OFDM	1	1	20.16	0.1038	24.16	0.2606
		1	23	20.44	0.1107	24.44	0.278
		12	6	20.31	0.1074	24.31	0.2698
	256QA M DFT-s-	1	1	18.36	0.0685	22.36	0.1722
		1	23	18.39	0.069	22.39	0.1734
		12	6	18.38	0.0689	22.38	0.173
Middle	PI/2 BPSK DFT-s-	1	1	23.09	0.2037	27.09	0.5117
		1	23	23.18	0.208	27.18	0.5224
		12	6	23.13	0.2056	27.13	0.5164
	QPSK DFT-s- OFDM	1	1	23.24	0.2109	27.24	0.5297
		1	23	23.09	0.2037	27.09	0.5117
		12	6	22.93	0.1963	26.93	0.4932
	16QAM DFT-s- OFDM	1	1	21.92	0.1556	25.92	0.3908
		1	23	21.91	0.1552	25.91	0.3899
		12	6	21.96	0.157	25.96	0.3945
	64QAM DFT-s- OFDM	1	1	20.17	0.104	24.17	0.2612
		1	23	20.21	0.105	24.21	0.2636
		12	6	20.23	0.1054	24.23	0.2649
	256QA M DFT-s-	1	1	18.34	0.0682	22.34	0.1714
		1	23	18.31	0.0678	22.31	0.1702
		12	6	18.28	0.0673	22.28	0.169
QPSK CP-s- OFDM	1	1	21.48	0.1406	25.48	0.3532	
	1	23	21.03	0.1268	25.03	0.3184	
	13	6	21.31	0.1352	25.31	0.3396	
Highest	PI/2 BPSK DFT-s-	1	1	22.76	0.1888	26.76	0.4742
		1	23	22.46	0.1762	26.46	0.4426
		12	6	23.09	0.2037	27.09	0.5117
	QPSK DFT-s- OFDM	1	1	22.91	0.1954	26.91	0.4909
		1	23	22.44	0.1754	26.44	0.4406
		12	6	23.09	0.2037	27.09	0.5117
	16QAM DFT-s- OFDM	1	1	21.67	0.1469	25.67	0.369
		1	23	21.42	0.1387	25.42	0.3483
		12	6	21.92	0.1556	25.92	0.3908
	64QAM DFT-s- OFDM	1	1	20.15	0.1035	24.15	0.26
		1	23	20.11	0.1026	24.11	0.2576
		12	6	20.39	0.1094	24.39	0.2748
	256QA M DFT-s-	1	1	18.34	0.0682	22.34	0.1714
		1	23	18.39	0.069	22.39	0.1734
		12	6	18.33	0.0681	22.33	0.171

5G NR n38 SA mode:

SCS 15

SA n38 (ANT M) 20MHz (GT - LC = 4 dB)							
Channel	Mode	NR		Conducted		EIRP	
		RB		Power(dBm)	Power(Watts)	EIRP(dBm)	EIRP(W)
		Size	Offset				
Lowest	PI/2 BPSK DFT-s-OFDM	1	1	22.99	0.1991	26.99	0.5
		1	104	23.04	0.2014	27.04	0.5058
		50	25	23.19	0.2084	27.19	0.5236
	QPSK DFT-s-OFDM	1	1	23.00	0.1995	27.00	0.5012
		1	104	23.03	0.2009	27.03	0.5047
		50	25	23.27	0.2123	27.27	0.5333
	16QAM DFT-s-OFDM	1	1	21.91	0.1552	25.91	0.3899
		1	104	21.90	0.1549	25.90	0.389
		50	25	21.93	0.156	25.93	0.3917
	64QAM DFT-s-OFDM	1	1	20.59	0.1146	24.59	0.2877
		1	104	20.43	0.1104	24.43	0.2773
		50	25	20.54	0.1132	24.54	0.2844
	256QAM DFT-s-OFDM	1	1	18.46	0.0701	22.46	0.1762
		1	104	18.26	0.067	22.26	0.1683
		50	25	18.41	0.0693	22.41	0.1742
Middle	PI/2 BPSK DFT-s-OFDM	1	1	22.98	0.1986	26.98	0.4989
		1	104	23.02	0.2004	27.02	0.5035
		50	25	23.17	0.2075	27.17	0.5212
	QPSK DFT-s-OFDM	1	1	23.06	0.2023	27.06	0.5082
		1	104	23.01	0.2	27.01	0.5023
		50	25	23.25	0.2113	27.25	0.5309
	16QAM DFT-s-OFDM	1	1	22.16	0.1644	26.16	0.413
		1	104	22.13	0.1633	26.13	0.4102
		50	25	22.20	0.166	26.20	0.4169
	64QAM DFT-s-OFDM	1	1	20.59	0.1146	24.59	0.2877
		1	104	20.63	0.1156	24.63	0.2904
		50	25	20.54	0.1132	24.54	0.2844
	256QAM DFT-s-OFDM	1	1	18.26	0.067	22.26	0.1683
		1	104	18.46	0.0701	22.46	0.1762
		50	25	18.35	0.0684	22.35	0.1718
QPSK CP-s-OFDM	1	1	21.51	0.1416	25.51	0.3556	
	1	104	21.56	0.1432	25.56	0.3597	
	53	26	21.49	0.1409	25.49	0.354	
Highest	PI/2 BPSK DFT-s-OFDM	1	1	22.86	0.1932	26.86	0.4853
		1	104	23.02	0.2004	27.02	0.5035
		50	25	23.24	0.2109	27.24	0.5297
	QPSK DFT-s-OFDM	1	1	22.97	0.1982	26.97	0.4977
		1	104	23.10	0.2042	27.10	0.5129
		50	25	23.22	0.2099	27.22	0.5272
	16QAM DFT-s-OFDM	1	1	22.12	0.1629	26.12	0.4093
		1	104	21.92	0.1556	25.92	0.3908
		50	25	22.23	0.1671	26.23	0.4198
	64QAM DFT-s-OFDM	1	1	20.92	0.1236	24.92	0.3105
		1	104	20.74	0.1186	24.74	0.2979
		50	25	20.60	0.1148	24.60	0.2884
	256QAM DFT-s-OFDM	1	1	18.51	0.071	22.51	0.1782
		1	104	18.46	0.0701	22.46	0.1762
		50	25	18.37	0.0687	22.37	0.1726

SA n38 (ANT) 15MHz (GT - LC = 4 dB)								
Channel	Mode	NR		Conducted		EIRP		
		RB		Power(dBm)	Power(Watts)	EIRP(dBm)	EIRP(W)	
		Size	Offset					
Lowest	PI/2 BPSK DFT-s-OFDM	1	1	23.02	0.2004	27.02	0.5035	
		1	77	23.04	0.2014	27.04	0.5058	
		36	18	23.16	0.207	27.16	0.52	
	QPSK DFT-s-OFDM	1	1	23.14	0.2061	27.14	0.5176	
		1	77	23.11	0.2046	27.11	0.514	
		36	18	23.25	0.2113	27.25	0.5309	
	16QAM DFT-s-OFDM	1	1	21.98	0.1578	25.98	0.3963	
		1	77	22.01	0.1589	26.01	0.399	
		36	18	21.91	0.1552	25.91	0.3899	
	64QAM DFT-s-OFDM	1	1	20.42	0.1102	24.42	0.2767	
		1	77	20.61	0.1151	24.61	0.2891	
		36	18	20.47	0.1114	24.47	0.2799	
	256QAM DFT-s-OFDM	1	1	18.29	0.0675	22.29	0.1694	
		1	77	18.37	0.0687	22.37	0.1726	
		36	18	18.34	0.0682	22.34	0.1714	
	Middle	PI/2 BPSK DFT-s-OFDM	1	1	23.06	0.2023	27.06	0.5082
			1	77	23.07	0.2028	27.07	0.5093
			36	18	23.15	0.2065	27.15	0.5188
QPSK DFT-s-OFDM		1	1	23.14	0.2061	27.14	0.5176	
		1	77	23.12	0.2051	27.12	0.5152	
		36	18	23.11	0.2046	27.11	0.514	
16QAM DFT-s-OFDM		1	1	22.15	0.1641	26.15	0.4121	
		1	77	22.11	0.1626	26.11	0.4083	
		36	18	22.22	0.1667	26.22	0.4188	
64QAM DFT-s-OFDM		1	1	20.65	0.1161	24.65	0.2917	
		1	77	20.59	0.1146	24.59	0.2877	
		36	18	20.72	0.118	24.72	0.2965	
256QAM DFT-s-OFDM		1	1	18.32	0.0679	22.32	0.1706	
		1	77	18.43	0.0697	22.43	0.175	
		36	18	18.54	0.0714	22.54	0.1795	
QPSK CP-s-OFDM		1	1	21.52	0.1419	25.52	0.3565	
		1	77	21.57	0.1435	25.57	0.3606	
		39	19	21.50	0.1413	25.50	0.3548	
Highest	PI/2 BPSK DFT-s-OFDM	1	1	22.92	0.1959	26.92	0.492	
		1	77	23.12	0.2051	27.12	0.5152	
		36	18	23.26	0.2118	27.26	0.5321	
	QPSK DFT-s-OFDM	1	1	23.01	0.2	27.01	0.5023	
		1	77	23.14	0.2061	27.14	0.5176	
		36	18	23.21	0.2094	27.21	0.526	
	16QAM DFT-s-OFDM	1	1	22.07	0.1611	26.07	0.4046	
		1	77	22.11	0.1626	26.11	0.4083	
		36	18	22.18	0.1652	26.18	0.415	
	64QAM DFT-s-OFDM	1	1	20.79	0.1199	24.79	0.3013	
		1	77	20.74	0.1186	24.74	0.2979	
		36	18	20.61	0.1151	24.61	0.2891	
	256QAM DFT-s-OFDM	1	1	18.42	0.0695	22.42	0.1746	
		1	77	18.48	0.0705	22.48	0.177	
		36	18	18.46	0.0701	22.46	0.1762	

SA n38 (ANT) 10MHz (GT - LC = 4 dB)							
Channel	Mode	NR		Conducted		EIRP	
		RB		Power(dBm)	Power(Watts)	EIRP(dBm)	EIRP(W)
		Size	Offset				
Lowest	PI/2 BPSK DFT-s-OFDM	1	1	22.84	0.1923	26.84	0.4831
		1	50	22.99	0.1991	26.99	0.5
		25	12	23.23	0.2104	27.23	0.5284
	QPSK DFT-s-OFDM	1	1	23.05	0.2018	27.05	0.507
		1	50	23.14	0.2061	27.14	0.5176
		25	12	23.12	0.2051	27.12	0.5152
	16QAM DFT-s-OFDM	1	1	21.93	0.156	25.93	0.3917
		1	50	21.96	0.157	25.96	0.3945
		25	12	21.93	0.156	25.93	0.3917
	64QAM DFT-s-OFDM	1	1	20.53	0.113	24.53	0.2838
		1	50	20.58	0.1143	24.58	0.2871
		25	12	20.50	0.1122	24.50	0.2818
	256QAM DFT-s-OFDM	1	1	18.21	0.0662	22.21	0.1663
		1	50	18.42	0.0695	22.42	0.1746
		25	12	18.35	0.0684	22.35	0.1718
Middle	PI/2 BPSK DFT-s-OFDM	1	1	22.91	0.1954	26.91	0.4909
		1	50	22.96	0.1977	26.96	0.4966
		25	12	23.05	0.2018	27.05	0.507
	QPSK DFT-s-OFDM	1	1	22.95	0.1972	26.95	0.4955
		1	50	22.90	0.195	26.90	0.4898
		25	12	23.01	0.2	27.01	0.5023
	16QAM DFT-s-OFDM	1	1	22.26	0.1683	26.26	0.4227
		1	50	22.14	0.1637	26.14	0.4111
		25	12	22.25	0.1679	26.25	0.4217
	64QAM DFT-s-OFDM	1	1	20.51	0.1125	24.51	0.2825
		1	50	20.68	0.1169	24.68	0.2938
		25	12	20.69	0.1172	24.69	0.2944
	256QAM DFT-s-OFDM	1	1	18.33	0.0681	22.33	0.171
		1	50	18.25	0.0668	22.25	0.1679
		25	12	18.22	0.0664	22.22	0.1667
QPSK CP-s-OFDM	1	1	21.53	0.1422	25.53	0.3573	
	1	50	21.52	0.1419	25.52	0.3565	
	26	13	21.61	0.1449	25.61	0.3639	
Highest	PI/2 BPSK DFT-s-OFDM	1	1	22.82	0.1914	26.82	0.4808
		1	50	22.99	0.1991	26.99	0.5
		25	12	23.10	0.2042	27.10	0.5129
	QPSK DFT-s-OFDM	1	1	22.89	0.1945	26.89	0.4887
		1	50	23.05	0.2018	27.05	0.507
		25	12	23.14	0.2061	27.14	0.5176
	16QAM DFT-s-OFDM	1	1	22.18	0.1652	26.18	0.415
		1	50	21.88	0.1542	25.88	0.3873
		25	12	22.20	0.166	26.20	0.4169
	64QAM DFT-s-OFDM	1	1	20.91	0.1233	24.91	0.3097
		1	50	20.74	0.1186	24.74	0.2979
		25	12	20.57	0.114	24.57	0.2864
	256QAM DFT-s-OFDM	1	1	18.33	0.0681	22.33	0.171
		1	50	18.30	0.0676	22.30	0.1698
		25	12	18.25	0.0668	22.25	0.1679

SA n38 (ANT) 5MHz (GT - LC = 4 dB)							
Channel	Mode	NR		Conducted		EIRP	
		RB		Power(dBm)	Power(Watts)	EIRP(dBm)	EIRP(W)
		Size	Offset				
Lowest	PI/2 BPSK DFT-s-OFDM	1	1	22.82	0.1914	26.82	0.4808
		1	23	22.89	0.1945	26.89	0.4887
		12	6	23.22	0.2099	27.22	0.5272
	QPSK DFT-s-OFDM	1	1	23.10	0.2042	27.10	0.5129
		1	23	23.18	0.208	27.18	0.5224
		12	6	23.07	0.2028	27.07	0.5093
	16QAM DFT-s-OFDM	1	1	21.98	0.1578	25.98	0.3963
		1	23	21.98	0.1578	25.98	0.3963
		12	6	22.01	0.1589	26.01	0.399
	64QAM DFT-s-OFDM	1	1	20.46	0.1112	24.46	0.2793
		1	23	20.43	0.1104	24.43	0.2773
		12	6	20.50	0.1122	24.50	0.2818
	256QAM DFT-s-OFDM	1	1	18.30	0.0676	22.30	0.1698
		1	23	18.27	0.0671	22.27	0.1687
		12	6	18.48	0.0705	22.48	0.177
Middle	PI/2 BPSK DFT-s-OFDM	1	1	23.04	0.2014	27.04	0.5058
		1	23	22.96	0.1977	26.96	0.4966
		12	6	23.19	0.2084	27.19	0.5236
	QPSK DFT-s-OFDM	1	1	23.03	0.2009	27.03	0.5047
		1	23	22.94	0.1968	26.94	0.4943
		12	6	23.23	0.2104	27.23	0.5284
	16QAM DFT-s-OFDM	1	1	22.13	0.1633	26.13	0.4102
		1	23	22.11	0.1626	26.11	0.4083
		12	6	22.13	0.1633	26.13	0.4102
	64QAM DFT-s-OFDM	1	1	20.52	0.1127	24.52	0.2831
		1	23	20.75	0.1189	24.75	0.2985
		12	6	20.52	0.1127	24.52	0.2831
	256QAM DFT-s-OFDM	1	1	18.32	0.0679	22.32	0.1706
		1	23	18.28	0.0673	22.28	0.169
		12	6	18.40	0.0692	22.40	0.1738
QPSK CP-s-OFDM	1	1	21.55	0.1429	25.55	0.3589	
	1	23	21.61	0.1449	25.61	0.3639	
	13	6	21.56	0.1432	25.56	0.3597	
Highest	PI/2 BPSK DFT-s-OFDM	1	1	23.02	0.2004	27.02	0.5035
		1	23	23.06	0.2023	27.06	0.5082
		12	6	23.26	0.2118	27.26	0.5321
	QPSK DFT-s-OFDM	1	1	23.03	0.2009	27.03	0.5047
		1	23	23.08	0.2032	27.08	0.5105
		12	6	23.21	0.2094	27.21	0.526
	16QAM DFT-s-OFDM	1	1	22.01	0.1589	26.01	0.399
		1	23	22.03	0.1596	26.03	0.4009
		12	6	22.11	0.1626	26.11	0.4083
	64QAM DFT-s-OFDM	1	1	20.88	0.1225	24.88	0.3076
		1	22	20.61	0.1151	24.61	0.2891
		12	6	20.56	0.1138	24.56	0.2858
	256QAM DFT-s-OFDM	1	1	18.55	0.0716	22.55	0.1799
		1	22	18.52	0.0711	22.52	0.1786
		12	6	18.37	0.0687	22.37	0.1726

5G NR n41 HPUE SA mode:
SCS 30

SA n41 (ANT M2) 80MHz (GT - LC = 4 dB)							
Channel	Mode	NR		Conducted		EIRP	
		RB		Power(dBm)	Power(Watts)	EIRP(dBm)	EIRP(W)
		Size	Offset				
Lowest	PI/2 BPSK DFT-s-OFDM	1	1	25.31	0.3396	29.31	0.8531
		1	215	25.83	0.3828	29.83	0.9616
		108	54	26.31	0.4276	30.31	1.074
	QPSK DFT-s-OFDM	1	1	26.01	0.399	30.01	1.0023
		1	215	26.12	0.4093	30.12	1.028
		108	54	26.33	0.4295	30.33	1.0789
	16QAM DFT-s-OFDM	1	1	24.77	0.2999	28.77	0.7534
		1	215	25.03	0.3184	29.03	0.7998
		108	54	25.39	0.3459	29.39	0.869
	64QAM DFT-s-OFDM	1	1	23.75	0.2371	27.75	0.5957
		1	215	23.83	0.2415	27.83	0.6067
		108	54	23.92	0.2466	27.92	0.6194
	256QAM DFT-s-OFDM	1	1	22.24	0.1675	26.24	0.4207
		1	215	21.61	0.1449	25.61	0.3639
		108	54	21.91	0.1552	25.91	0.3899
Middle	PI/2 BPSK DFT-s-OFDM	1	1	25.76	0.3767	29.76	0.9462
		1	215	25.71	0.3724	29.71	0.9354
		108	54	26.14	0.4111	30.14	1.0328
	QPSK DFT-s-OFDM	1	1	25.71	0.3724	29.71	0.9354
		1	215	25.69	0.3707	29.69	0.9311
		108	54	26.13	0.4102	30.13	1.0304
	16QAM DFT-s-OFDM	1	1	24.88	0.3076	28.88	0.7727
		1	215	24.98	0.3148	28.98	0.7907
		108	54	25.21	0.3319	29.21	0.8337
	64QAM DFT-s-OFDM	1	1	23.54	0.2259	27.54	0.5675
		1	215	23.63	0.2307	27.63	0.5794
		108	54	23.54	0.2259	27.54	0.5675
	256QAM DFT-s-OFDM	1	1	21.48	0.1406	25.48	0.3532
		1	215	22.39	0.1734	26.39	0.4355
		108	54	21.67	0.1469	25.67	0.369
QPSK CP-s-OFDM	1	1	24.41	0.2761	28.41	0.6934	
	1	215	25.02	0.3177	29.02	0.798	
	109	54	24.64	0.2911	28.64	0.7311	
Highest	PI/2 BPSK DFT-s-OFDM	1	1	26.17	0.414	30.17	1.0399
		1	215	25.84	0.3837	29.84	0.9638
		108	54	26.30	0.4266	30.30	1.0715
	QPSK DFT-s-OFDM	1	1	26.34	0.4305	30.34	1.0814
		1	215	26.57	0.4539	30.57	1.1402
		108	54	26.33	0.4295	30.33	1.0789
	16QAM DFT-s-OFDM	1	1	25.03	0.3184	29.03	0.7998
		1	215	25.14	0.3266	29.14	0.8204
		108	54	25.35	0.3428	29.35	0.861
	64QAM DFT-s-OFDM	1	1	23.27	0.2123	27.27	0.5333
		1	215	23.73	0.236	27.73	0.5929
		108	54	23.91	0.246	27.91	0.618
	256QAM DFT-s-OFDM	1	1	21.41	0.1384	25.41	0.3475
		1	215	21.77	0.1503	25.77	0.3776
		108	54	21.83	0.1524	25.83	0.3828

SA n41 (ANT M2) 50MHz (GT - LC = 4 dB)							
Channel	Mode	NR		Conducted		EIRP	
		RB					
		Size	Offset	Power(dBm)	Power(Watts)	EIRP(dBm)	EIRP(W)
Lowest	PI/2 BPSK DFT-s-OFDM	1	1	25.96	0.3945	29.96	0.9908
		1	131	26.41	0.4375	30.41	1.099
		64	32	26.43	0.4395	30.43	1.1041
	QPSK DFT-s-OFDM	1	1	25.85	0.3846	29.85	0.9661
		1	131	26.39	0.4355	30.39	1.094
		64	32	26.43	0.4395	30.43	1.1041
	16QAM DFT-s-OFDM	1	1	25.16	0.3281	29.16	0.8241
		1	131	25.42	0.3483	29.42	0.875
		64	32	25.45	0.3508	29.45	0.881
	64QAM DFT-s-OFDM	1	1	23.33	0.2153	27.33	0.5408
		1	131	24.09	0.2564	28.09	0.6442
		64	32	23.89	0.2449	27.89	0.6152
256QAM DFT-s-OFDM	1	1	21.61	0.1449	25.61	0.3639	
	1	131	21.96	0.157	25.96	0.3945	
	64	32	21.92	0.1556	25.92	0.3908	
Middle	PI/2 BPSK DFT-s-OFDM	1	1	26.11	0.4083	30.11	1.0257
		1	131	26.13	0.4102	30.13	1.0304
		64	32	26.31	0.4276	30.31	1.074
	QPSK DFT-s-OFDM	1	1	26.07	0.4046	30.07	1.0162
		1	131	26.11	0.4083	30.11	1.0257
		64	32	26.27	0.4236	30.27	1.0641
	16QAM DFT-s-OFDM	1	1	25.25	0.335	29.25	0.8414
		1	131	25.23	0.3334	29.23	0.8375
		64	32	25.36	0.3436	29.36	0.863
	64QAM DFT-s-OFDM	1	1	23.76	0.2377	27.76	0.597
		1	131	23.79	0.2393	27.79	0.6012
		64	32	23.87	0.2438	27.87	0.6124
	256QAM DFT-s-OFDM	1	1	21.61	0.1449	25.61	0.3639
		1	131	21.84	0.1528	25.84	0.3837
		64	32	21.73	0.1489	25.73	0.3741
	QPSK CP-s-OFDM	1	1	24.56	0.2858	28.56	0.7178
		1	131	24.72	0.2965	28.72	0.7447
		67	33	24.81	0.3027	28.81	0.7603
Highest	PI/2 BPSK DFT-s-OFDM	1	1	26.12	0.4093	30.12	1.028
		1	131	26.33	0.4295	30.33	1.0789
		64	32	26.38	0.4345	30.38	1.0914
	QPSK DFT-s-OFDM	1	1	26.05	0.4027	30.05	1.0116
		1	131	26.29	0.4256	30.29	1.0691
		64	32	26.46	0.4426	30.46	1.1117
	16QAM DFT-s-OFDM	1	1	25.37	0.3443	29.37	0.865
		1	131	25.48	0.3532	29.48	0.8872
		64	32	25.61	0.3639	29.61	0.9141
	64QAM DFT-s-OFDM	1	1	23.74	0.2366	27.74	0.5943
		1	131	23.59	0.2286	27.59	0.5741
		64	32	24.03	0.2529	28.03	0.6353
	256QAM DFT-s-OFDM	1	1	21.57	0.1435	25.57	0.3606
		1	131	21.76	0.15	25.76	0.3767
		64	32	21.92	0.1556	25.92	0.3908

SA n41 (ANT M2) 40MHz (GT - LC = 4 dB)							
Channel	Mode	NR		Conducted		EIRP	
		RB					
		Size	Offset	Power(dBm)	Power(Watts)	EIRP(dBm)	EIRP(W)
Lowest	PI/2 BPSK DFT-s-OFDM	1	1	25.63	0.3656	29.63	0.9183
		1	104	26.05	0.4027	30.05	1.0116
		50	25	26.31	0.4276	30.31	1.074
	QPSK DFT-s-OFDM	1	1	25.57	0.3606	29.57	0.9057
		1	104	25.99	0.3972	29.99	0.9977
		50	25	26.26	0.4227	30.26	1.0617
	16QAM DFT-s-OFDM	1	1	24.87	0.3069	28.87	0.7709
		1	104	25.08	0.3221	29.08	0.8091
		50	25	25.41	0.3475	29.41	0.873
	64QAM DFT-s-OFDM	1	1	23.10	0.2042	27.10	0.5129
		1	104	23.42	0.2198	27.42	0.5521
		50	25	23.89	0.2449	27.89	0.6152
	256QAM DFT-s-OFDM	1	1	21.44	0.1393	25.44	0.3499
		1	104	21.66	0.1466	25.66	0.3681
		50	25	21.88	0.1542	25.88	0.3873
Middle	PI/2 BPSK DFT-s-OFDM	1	1	25.86	0.3855	29.86	0.9683
		1	104	25.80	0.3802	29.80	0.955
		50	25	26.21	0.4178	30.21	1.0495
	QPSK DFT-s-OFDM	1	1	25.84	0.3837	29.84	0.9638
		1	104	25.73	0.3741	29.73	0.9397
		50	25	26.23	0.4198	30.23	1.0544
	16QAM DFT-s-OFDM	1	1	25.05	0.3199	29.05	0.8035
		1	104	24.71	0.2958	28.71	0.743
		50	25	25.34	0.342	29.34	0.859
	64QAM DFT-s-OFDM	1	1	23.52	0.2249	27.52	0.5649
		1	104	23.19	0.2084	27.19	0.5236
		50	25	23.82	0.241	27.82	0.6053
	256QAM DFT-s-OFDM	1	1	21.69	0.1476	25.69	0.3707
		1	104	21.98	0.1578	25.98	0.3963
		50	25	21.97	0.1574	25.97	0.3954
	QPSK CP-s-OFDM	1	1	24.46	0.2793	28.46	0.7015
		1	104	24.31	0.2698	28.31	0.6776
		53	26	24.75	0.2985	28.75	0.7499
Highest	PI/2 BPSK DFT-s-OFDM	1	1	26.16	0.413	30.16	1.0375
		1	104	26.11	0.4083	30.11	1.0257
		50	25	26.48	0.4446	30.48	1.1169
	QPSK DFT-s-OFDM	1	1	26.13	0.4102	30.13	1.0304
		1	104	26.03	0.4009	30.03	1.0069
		50	25	26.44	0.4406	30.44	1.1066
	16QAM DFT-s-OFDM	1	1	25.26	0.3357	29.26	0.8433
		1	104	25.32	0.3404	29.32	0.8551
		50	25	25.55	0.3589	29.55	0.9016
	64QAM DFT-s-OFDM	1	1	23.41	0.2193	27.41	0.5508
		1	104	23.52	0.2249	27.52	0.5649
		50	25	24.06	0.2547	28.06	0.6397
	256QAM DFT-s-OFDM	1	1	21.56	0.1432	25.56	0.3597
		1	104	21.76	0.15	25.76	0.3767
		50	25	21.77	0.1503	25.77	0.3776

SA n41 (ANT M2) 30MHz (GT - LC = 4 dB)							
Channel	Mode	NR		Conducted		EIRP	
		RB					
		Size	Offset	Power(dBm)	Power(Watts)	EIRP(dBm)	EIRP(W)
Lowest	PI/2 BPSK DFT-s-OFDM	1	1	25.93	0.3917	29.93	0.984
		1	76	26.18	0.415	30.18	1.0423
		36	18	26.19	0.4159	30.19	1.0447
	QPSK DFT-s-OFDM	1	1	25.88	0.3873	29.88	0.9727
		1	76	26.17	0.414	30.17	1.0399
		36	18	26.21	0.4178	30.21	1.0495
	16QAM DFT-s-OFDM	1	1	24.93	0.3112	28.93	0.7816
		1	76	25.31	0.3396	29.31	0.8531
		36	18	25.27	0.3365	29.27	0.8453
	64QAM DFT-s-OFDM	1	1	23.37	0.2173	27.37	0.5458
		1	76	23.59	0.2286	27.59	0.5741
		36	18	23.81	0.2404	27.81	0.6039
	256QAM DFT-s-OFDM	1	1	21.63	0.1455	25.63	0.3656
		1	76	21.79	0.151	25.79	0.3793
		36	18	21.94	0.1563	25.94	0.3926
Middle	PI/2 BPSK DFT-s-OFDM	1	1	26.15	0.4121	30.15	1.0351
		1	76	26.10	0.4074	30.10	1.0233
		36	18	26.28	0.4246	30.28	1.0666
	QPSK DFT-s-OFDM	1	1	26.11	0.4083	30.11	1.0257
		1	76	25.99	0.3972	29.99	0.9977
		36	18	26.22	0.4188	30.22	1.052
	16QAM DFT-s-OFDM	1	1	25.23	0.3334	29.23	0.8375
		1	76	25.17	0.3289	29.17	0.826
		36	18	25.24	0.3342	29.24	0.8395
	64QAM DFT-s-OFDM	1	1	23.38	0.2178	27.38	0.547
		1	76	23.65	0.2317	27.65	0.5821
		36	18	23.78	0.2388	27.78	0.5998
	256QAM DFT-s-OFDM	1	1	21.56	0.1432	25.56	0.3597
		1	76	21.87	0.1538	25.87	0.3864
		36	18	21.71	0.1483	25.71	0.3724
QPSK CP-s-OFDM	1	1	24.61	0.2891	28.61	0.7261	
	1	76	24.57	0.2864	28.57	0.7194	
	39	19	24.67	0.2931	28.67	0.7362	
Highest	PI/2 BPSK DFT-s-OFDM	1	1	26.26	0.4227	30.26	1.0617
		1	76	26.36	0.4325	30.36	1.0864
		36	18	26.50	0.4467	30.50	1.122
	QPSK DFT-s-OFDM	1	1	26.22	0.4188	30.22	1.052
		1	76	26.29	0.4256	30.29	1.0691
		36	18	26.41	0.4375	30.41	1.099
	16QAM DFT-s-OFDM	1	1	25.11	0.3243	29.11	0.8147
		1	76	25.17	0.3289	29.17	0.826
		36	18	25.28	0.3373	29.28	0.8472
	64QAM DFT-s-OFDM	1	1	23.53	0.2254	27.53	0.5662
		1	76	23.52	0.2249	27.52	0.5649
		36	18	23.77	0.2382	27.77	0.5984
	256QAM DFT-s-OFDM	1	1	21.58	0.1439	25.58	0.3614
		1	76	21.79	0.151	25.79	0.3793
		36	18	21.93	0.156	25.93	0.3917

SA n41 (ANT M2) 15MHz (GT - LC = 4 dB)							
Channel	Mode	NR		Conducted		EIRP	
		RB					
		Size	Offset	Power(dBm)	Power(Watts)	EIRP(dBm)	EIRP(W)
Lowest	PI/2 BPSK DFT-s-OFDM	1	1	26.03	0.4009	30.03	1.0069
		1	36	26.22	0.4188	30.22	1.052
		18	9	26.13	0.4102	30.13	1.0304
	QPSK DFT-s-OFDM	1	1	25.92	0.3908	29.92	0.9817
		1	36	26.18	0.415	30.18	1.0423
		18	9	26.08	0.4055	30.08	1.0186
	16QAM DFT-s-OFDM	1	1	25.16	0.3281	29.16	0.8241
		1	36	25.26	0.3357	29.26	0.8433
		18	9	25.21	0.3319	29.21	0.8337
	64QAM DFT-s-OFDM	1	1	23.47	0.2223	27.47	0.5585
		1	36	23.56	0.227	27.56	0.5702
		18	9	23.79	0.2393	27.79	0.6012
	256QAM DFT-s-OFDM	1	1	21.56	0.1432	25.56	0.3597
		1	36	21.91	0.1552	25.91	0.3899
		18	9	21.93	0.156	25.93	0.3917
Middle	PI/2 BPSK DFT-s-OFDM	1	1	26.34	0.4305	30.34	1.0814
		1	36	26.25	0.4217	30.25	1.0593
		18	9	26.23	0.4198	30.23	1.0544
	QPSK DFT-s-OFDM	1	1	26.24	0.4207	30.24	1.0568
		1	36	26.22	0.4188	30.22	1.052
		18	9	26.25	0.4217	30.25	1.0593
	16QAM DFT-s-OFDM	1	1	25.25	0.335	29.25	0.8414
		1	36	25.36	0.3436	29.36	0.863
		18	9	25.33	0.3412	29.33	0.857
	64QAM DFT-s-OFDM	1	1	23.72	0.2355	27.72	0.5916
		1	36	23.46	0.2218	27.46	0.5572
		18	9	23.83	0.2415	27.83	0.6067
	256QAM DFT-s-OFDM	1	1	22.97	0.1982	26.97	0.4977
		1	36	22.01	0.1589	26.01	0.399
		18	9	21.73	0.1489	25.73	0.3741
	QPSK CP-s-OFDM	1	1	24.69	0.2944	28.69	0.7396
		1	36	24.74	0.2979	28.74	0.7482
		19	9	24.89	0.3083	28.89	0.7745
Highest	PI/2 BPSK DFT-s-OFDM	1	1	26.41	0.4375	30.41	1.099
		1	36	26.44	0.4406	30.44	1.1066
		18	9	26.57	0.4539	30.57	1.1402
	QPSK DFT-s-OFDM	1	1	26.37	0.4335	30.37	1.0889
		1	36	26.35	0.4315	30.35	1.0839
		18	9	26.52	0.4487	30.52	1.1272
	16QAM DFT-s-OFDM	1	1	25.51	0.3556	29.51	0.8933
		1	36	25.53	0.3573	29.53	0.8974
		18	9	25.65	0.3673	29.65	0.9226
	64QAM DFT-s-OFDM	1	1	23.88	0.2443	27.88	0.6138
		1	36	23.81	0.2404	27.81	0.6039
		18	9	24.14	0.2594	28.14	0.6516
	256QAM DFT-s-OFDM	1	1	21.55	0.1429	25.55	0.3589
		1	36	21.96	0.157	25.96	0.3945
		18	9	21.82	0.1521	25.82	0.3819

SA n41 (ANT M2) 10MHz (GT - LC = 4 dB)							
Channel	Mode	NR		Conducted		EIRP	
		RB					
		Size	Offset	Power(dBm)	Power(Watts)	EIRP(dBm)	EIRP(W)
Lowest	PI/2 BPSK DFT-s-OFDM	1	1	26.17	0.414	30.17	1.0399
		1	22	26.36	0.4325	30.36	1.0864
		12	6	26.14	0.4111	30.14	1.0328
	QPSK DFT-s-OFDM	1	1	26.15	0.4121	30.15	1.0351
		1	22	26.33	0.4295	30.33	1.0789
		12	6	26.09	0.4064	30.09	1.0209
	16QAM DFT-s-OFDM	1	1	25.17	0.3289	29.17	0.826
		1	22	25.29	0.3381	29.29	0.8492
		12	6	25.25	0.335	29.25	0.8414
	64QAM DFT-s-OFDM	1	1	23.63	0.2307	27.63	0.5794
		1	22	23.68	0.2333	27.68	0.5861
		12	6	23.65	0.2317	27.65	0.5821
	256QAM DFT-s-OFDM	1	1	21.55	0.1429	25.55	0.3589
		1	22	21.83	0.1524	25.83	0.3828
		12	6	21.96	0.157	25.96	0.3945
Middle	PI/2 BPSK DFT-s-OFDM	1	1	26.24	0.4207	30.24	1.0568
		1	22	26.16	0.413	30.16	1.0375
		12	6	26.33	0.4295	30.33	1.0789
	QPSK DFT-s-OFDM	1	1	26.20	0.4169	30.20	1.0471
		1	22	26.14	0.4111	30.14	1.0328
		12	6	26.27	0.4236	30.27	1.0641
	16QAM DFT-s-OFDM	1	1	25.37	0.3443	29.37	0.865
		1	22	25.36	0.3436	29.36	0.863
		12	6	25.31	0.3396	29.31	0.8531
	64QAM DFT-s-OFDM	1	1	23.73	0.236	27.73	0.5929
		1	22	23.41	0.2193	27.41	0.5508
		12	6	23.79	0.2393	27.79	0.6012
	256QAM DFT-s-OFDM	1	1	21.71	0.1483	25.71	0.3724
		1	22	21.98	0.1578	25.98	0.3963
		12	6	21.86	0.1535	25.86	0.3855
QPSK CP-s-OFDM	1	1	24.67	0.2931	28.67	0.7362	
	1	22	24.75	0.2985	28.75	0.7499	
	12	6	24.81	0.3027	28.81	0.7603	
Highest	PI/2 BPSK DFT-s-OFDM	1	1	26.57	0.4539	30.57	1.1402
		1	22	26.48	0.4446	30.48	1.1169
		12	6	26.61	0.4581	30.61	1.1508
	QPSK DFT-s-OFDM	1	1	26.56	0.4529	30.56	1.1376
		1	22	26.46	0.4426	30.46	1.1117
		12	6	26.53	0.4498	30.53	1.1298
	16QAM DFT-s-OFDM	1	1	25.66	0.3681	29.66	0.9247
		1	22	25.56	0.3597	29.56	0.9036
		12	6	25.61	0.3639	29.61	0.9141
	64QAM DFT-s-OFDM	1	1	24.11	0.2576	28.11	0.6471
		1	22	24.09	0.2564	28.09	0.6442
		12	6	23.74	0.2366	27.74	0.5943
	256QAM DFT-s-OFDM	1	1	21.54	0.1426	25.54	0.3581
		1	22	21.76	0.15	25.76	0.3767
		12	6	21.92	0.1556	25.92	0.3908

SCS 15

SA n41 (ANT M2) 40MHz (GT - LC = 4 dB)							
Channel	Mode	NR		Conducted		EIRP	
		RB					
		Size	Offset	Power(dBm)	Power(Watts)	EIRP(dBm)	EIRP(W)
Lowest	PI/2 BPSK DFT-s-OFDM	1	1	26.09	0.4064	30.09	1.0209
		1	214	26.17	0.414	30.17	1.0399
		108	54	26.41	0.4375	30.41	1.099
	QPSK DFT-s-OFDM	1	1	25.97	0.3954	29.97	0.9931
		1	214	26.06	0.4036	30.06	1.0139
		108	54	26.46	0.4426	30.46	1.1117
	16QAM DFT-s-OFDM	1	1	24.66	0.2924	28.66	0.7345
		1	214	25.31	0.3396	29.31	0.8531
		108	54	25.33	0.3412	29.33	0.857
	64QAM DFT-s-OFDM	1	1	23.44	0.2208	27.44	0.5546
		1	214	24.01	0.2518	28.01	0.6324
		108	54	23.91	0.246	27.91	0.618
	256QAM DFT-s-OFDM	1	1	20.76	0.1191	24.76	0.2992
		1	214	21.06	0.1276	25.06	0.3206
		108	54	21.92	0.1556	25.92	0.3908
Middle	PI/2 BPSK DFT-s-OFDM	1	1	26.16	0.413	30.16	1.0375
		1	214	26.01	0.399	30.01	1.0023
		108	54	26.32	0.4285	30.32	1.0765
	QPSK DFT-s-OFDM	1	1	26.08	0.4055	30.08	1.0186
		1	214	25.97	0.3954	29.97	0.9931
		108	54	26.34	0.4305	30.34	1.0814
	16QAM DFT-s-OFDM	1	1	24.85	0.3055	28.85	0.7674
		1	214	25.01	0.317	29.01	0.7962
		108	54	25.19	0.3304	29.19	0.8299
	64QAM DFT-s-OFDM	1	1	23.93	0.2472	27.93	0.6209
		1	214	23.47	0.2223	27.47	0.5585
		108	54	23.77	0.2382	27.77	0.5984
	256QAM DFT-s-OFDM	1	1	21.11	0.1291	25.11	0.3243
		1	214	20.94	0.1242	24.94	0.3119
		108	54	21.74	0.1493	25.74	0.375
QPSK CP-s-OFDM	1	1	24.39	0.2748	28.39	0.6902	
	1	214	24.21	0.2636	28.21	0.6622	
	108	54	24.71	0.2958	28.71	0.743	
Highest	PI/2 BPSK DFT-s-OFDM	1	1	26.21	0.4178	30.21	1.0495
		1	214	26.06	0.4036	30.06	1.0139
		108	54	26.42	0.4385	30.42	1.1015
	QPSK DFT-s-OFDM	1	1	26.24	0.4207	30.24	1.0568
		1	214	26.09	0.4064	30.09	1.0209
		108	54	26.44	0.4406	30.44	1.1066
	16QAM DFT-s-OFDM	1	1	25.09	0.3228	29.09	0.811
		1	214	25.18	0.3296	29.18	0.8279
		108	54	25.54	0.3581	29.54	0.8995
	64QAM DFT-s-OFDM	1	1	23.72	0.2355	27.72	0.5916
		1	214	24.15	0.26	28.15	0.6531
		108	54	24.13	0.2588	28.13	0.6501
	256QAM DFT-s-OFDM	1	1	21.17	0.1309	25.17	0.3289
		1	214	21.58	0.1439	25.58	0.3614
		108	54	22.06	0.1607	26.06	0.4036

SA n41 (ANT M2) 30MHz (GT - LC = 4 dB)							
Channel	Mode	NR		Conducted		EIRP	
		RB					
		Size	Offset	Power(dBm)	Power(Watts)	EIRP(dBm)	EIRP(W)
Lowest	PI/2 BPSK DFT-s-OFDM	1	1	26.11	0.4083	30.11	1.0257
		1	158	26.24	0.4207	30.24	1.0568
		80	40	26.45	0.4416	30.45	1.1092
	QPSK DFT-s-OFDM	1	1	26.18	0.415	30.18	1.0423
		1	158	26.27	0.4236	30.27	1.0641
		80	40	26.45	0.4416	30.45	1.1092
	16QAM DFT-s-OFDM	1	1	24.95	0.3126	28.95	0.7852
		1	158	24.76	0.2992	28.76	0.7516
		80	40	25.38	0.3451	29.38	0.867
	64QAM DFT-s-OFDM	1	1	23.71	0.235	27.71	0.5902
		1	158	23.84	0.2421	27.84	0.6081
		80	40	23.91	0.246	27.91	0.618
	256QAM DFT-s-OFDM	1	1	21.64	0.1459	25.64	0.3664
		1	158	21.81	0.1517	25.81	0.3811
		80	40	21.88	0.1542	25.88	0.3873
Middle	PI/2 BPSK DFT-s-OFDM	1	1	26.17	0.414	30.17	1.0399
		1	158	26.18	0.415	30.18	1.0423
		80	40	26.39	0.4355	30.39	1.094
	QPSK DFT-s-OFDM	1	1	26.19	0.4159	30.19	1.0447
		1	158	26.15	0.4121	30.15	1.0351
		80	40	26.34	0.4305	30.34	1.0814
	16QAM DFT-s-OFDM	1	1	24.72	0.2965	28.72	0.7447
		1	158	24.78	0.3006	28.78	0.7551
		80	40	25.10	0.3236	29.10	0.8128
	64QAM DFT-s-OFDM	1	1	23.72	0.2355	27.72	0.5916
		1	158	23.57	0.2275	27.57	0.5715
		80	40	23.52	0.2249	27.52	0.5649
	256QAM DFT-s-OFDM	1	1	21.54	0.1426	25.54	0.3581
		1	158	21.51	0.1416	25.51	0.3556
		80	40	21.53	0.1422	25.53	0.3573
	QPSK CP-s-OFDM	1	1	24.42	0.2767	28.42	0.695
		1	158	24.38	0.2742	28.38	0.6887
		80	40	24.59	0.2877	28.59	0.7228
Highest	PI/2 BPSK DFT-s-OFDM	1	1	26.32	0.4285	30.32	1.0765
		1	158	26.27	0.4236	30.27	1.0641
		80	40	26.41	0.4375	30.41	1.099
	QPSK DFT-s-OFDM	1	1	26.31	0.4276	30.31	1.074
		1	158	26.29	0.4256	30.29	1.0691
		80	40	26.39	0.4355	30.39	1.094
	16QAM DFT-s-OFDM	1	1	25.01	0.317	29.01	0.7962
		1	158	24.69	0.2944	28.69	0.7396
		80	40	25.25	0.335	29.25	0.8414
	64QAM DFT-s-OFDM	1	1	23.61	0.2296	27.61	0.5768
		1	158	23.75	0.2371	27.75	0.5957
		80	40	23.76	0.2377	27.76	0.597
	256QAM DFT-s-OFDM	1	1	21.72	0.1486	25.72	0.3733
		1	158	21.85	0.1531	25.85	0.3846
		80	40	21.69	0.1476	25.69	0.3707

SA n41 (ANT M2) 15MHz (GT - LC = 4 dB)							
Channel	Mode	NR		Conducted		EIRP	
		RB					
		Size	Offset	Power(dBm)	Power(Watts)	EIRP(dBm)	EIRP(W)
Lowest	PI/2 BPSK DFT-s- OFDM	1	1	26.28	0.4246	30.28	1.0666
		1	77	26.36	0.4325	30.36	1.0864
		36	18	26.42	0.4385	30.42	1.1015
	QPSK DFT-s- OFDM	1	1	26.25	0.4217	30.25	1.0593
		1	77	26.36	0.4325	30.36	1.0864
		36	18	26.41	0.4375	30.41	1.099
	16QAM DFT-s- OFDM	1	1	25.09	0.3228	29.09	0.811
		1	77	24.79	0.3013	28.79	0.7568
		36	18	25.33	0.3412	29.33	0.857
	64QAM DFT-s- OFDM	1	1	23.88	0.2443	27.88	0.6138
		1	77	24.07	0.2553	28.07	0.6412
		36	18	23.63	0.2307	27.63	0.5794
	256QAM DFT-s- OFDM	1	1	21.62	0.1452	25.62	0.3648
		1	77	21.56	0.1432	25.56	0.3597
		36	18	21.82	0.1521	25.82	0.3819
Middle	PI/2 BPSK DFT-s- OFDM	1	1	26.26	0.4227	30.26	1.0617
		1	77	26.29	0.4256	30.29	1.0691
		36	18	26.44	0.4406	30.44	1.1066
	QPSK DFT-s- OFDM	1	1	26.24	0.4207	30.24	1.0568
		1	77	26.31	0.4276	30.31	1.074
		36	18	26.42	0.4385	30.42	1.1015
	16QAM DFT-s- OFDM	1	1	25.55	0.3589	29.55	0.9016
		1	77	25.61	0.3639	29.61	0.9141
		36	18	25.28	0.3373	29.28	0.8472
	64QAM DFT-s- OFDM	1	1	24.99	0.3155	28.99	0.7925
		1	77	24.01	0.2518	28.01	0.6324
		36	18	23.68	0.2333	27.68	0.5861
	256QAM DFT-s- OFDM	1	1	21.71	0.1483	25.71	0.3724
		1	77	21.76	0.15	25.76	0.3767
		36	18	21.74	0.1493	25.74	0.375
	QPSK CP-s-OFDM	1	1	24.73	0.2972	28.73	0.7464
		1	77	24.69	0.2944	28.69	0.7396
		39	19	24.74	0.2979	28.74	0.7482
Highest	PI/2 BPSK DFT-s- OFDM	1	1	26.32	0.4285	30.32	1.0765
		1	77	26.36	0.4325	30.36	1.0864
		36	18	26.41	0.4375	30.41	1.099
	QPSK DFT-s- OFDM	1	1	26.33	0.4295	30.33	1.0789
		1	77	26.35	0.4315	30.35	1.0839
		36	18	26.42	0.4385	30.42	1.1015
	16QAM DFT-s- OFDM	1	1	25.03	0.3184	29.03	0.7998
		1	77	25.86	0.3855	29.86	0.9683
		36	18	25.56	0.3597	29.56	0.9036
	64QAM DFT-s- OFDM	1	1	24.27	0.2673	28.27	0.6714
		1	77	24.35	0.2723	28.35	0.6839
		36	18	24.11	0.2576	28.11	0.6471
	256QAM DFT-s- OFDM	1	1	21.82	0.1521	25.82	0.3819
		1	77	21.74	0.1493	25.74	0.375
		36	18	22.24	0.1675	26.24	0.4207

SA n41 (ANT M2) 10MHz (GT - LC = 4 dB)							
Channel	Mode	NR		Conducted		EIRP	
		RB					
		Size	Offset	Power(dBm)	Power(Watts)	EIRP(dBm)	EIRP(W)
Lowest	PI/2 BPSK DFT-s-OFDM	1	1	26.23	0.4198	30.23	1.0544
		1	50	26.28	0.4246	30.28	1.0666
		25	12	26.31	0.4276	30.31	1.074
	QPSK DFT-s-OFDM	1	1	26.24	0.4207	30.24	1.0568
		1	50	26.29	0.4256	30.29	1.0691
		25	12	26.33	0.4295	30.33	1.0789
	16QAM DFT-s-OFDM	1	1	24.91	0.3097	28.91	0.778
		1	50	25.38	0.3451	29.38	0.867
		25	12	25.17	0.3289	29.17	0.826
	64QAM DFT-s-OFDM	1	1	23.79	0.2393	27.79	0.6012
		1	50	23.83	0.2415	27.83	0.6067
		25	12	23.64	0.2312	27.64	0.5808
	256QAM DFT-s-OFDM	1	1	21.85	0.1531	25.85	0.3846
		1	50	21.58	0.1439	25.58	0.3614
		25	12	21.62	0.1452	25.62	0.3648
Middle	PI/2 BPSK DFT-s-OFDM	1	1	26.29	0.4256	30.29	1.0691
		1	50	26.30	0.4266	30.30	1.0715
		25	12	26.35	0.4315	30.35	1.0839
	QPSK DFT-s-OFDM	1	1	26.30	0.4266	30.30	1.0715
		1	50	26.32	0.4285	30.32	1.0765
		25	12	26.36	0.4325	30.36	1.0864
	16QAM DFT-s-OFDM	1	1	25.42	0.3483	29.42	0.875
		1	50	25.22	0.3327	29.22	0.8356
		25	12	25.08	0.3221	29.08	0.8091
	64QAM DFT-s-OFDM	1	1	23.79	0.2393	27.79	0.6012
		1	50	23.82	0.241	27.82	0.6053
		25	12	23.83	0.2415	27.83	0.6067
	256QAM DFT-s-OFDM	1	1	21.62	0.1452	25.62	0.3648
		1	50	21.27	0.134	25.27	0.3365
		25	12	21.63	0.1455	25.63	0.3656
QPSK CP-s-OFDM	1	1	24.57	0.2864	28.57	0.7194	
	1	50	24.54	0.2844	28.54	0.7145	
	26	13	24.58	0.2871	28.58	0.7211	
Highest	PI/2 BPSK DFT-s-OFDM	1	1	26.24	0.4207	30.24	1.0568
		1	50	26.31	0.4276	30.31	1.074
		25	12	26.39	0.4355	30.39	1.094
	QPSK DFT-s-OFDM	1	1	26.26	0.4227	30.26	1.0617
		1	50	26.32	0.4285	30.32	1.0765
		25	12	26.41	0.4375	30.41	1.099
	16QAM DFT-s-OFDM	1	1	25.45	0.3508	29.45	0.881
		1	50	25.50	0.3548	29.50	0.8913
		25	12	25.48	0.3532	29.48	0.8872
	64QAM DFT-s-OFDM	1	1	24.21	0.2636	28.21	0.6622
		1	50	24.25	0.2661	28.25	0.6683
		25	12	23.97	0.2495	27.97	0.6266
	256QAM DFT-s-OFDM	1	1	21.40	0.138	25.40	0.3467
		1	50	22.10	0.1622	26.10	0.4074
		25	12	22.01	0.1589	26.01	0.399

5G NR n41 UL_MIMO HPUE SA mode:

SCS 30

SA n41 (ANT M2+ANT M) 80MHz (GT - LC = 7.01 dB)								
Channel	Mode	NR		Conducted		EIRP		
		RB		Power(dBm)	Power(Watt)	EIRP(dBm)	EIRP(W)	
		Size	Offset					
Lowest	QPSK CP- OFDM	1	1	25.35	0.3428	32.36	1.7221	
		1	215	24.81	0.303	31.82	1.5221	
		109	54	25.85	0.3849	32.86	1.9336	
	16QAM CP-s- OFDM	1	1	23.63	0.2307	30.64	1.1588	
		1	215	23.89	0.2451	30.90	1.2312	
		109	54	24.24	0.2655	31.25	1.3337	
	64QAM CP-s- OFDM	1	1	22.34	0.1715	29.35	0.8614	
		1	215	22.52	0.1786	29.53	0.8973	
		109	54	22.79	0.1902	29.80	0.9556	
	256QA M CP-s-	1	1	19.29	0.085	26.30	0.4267	
		1	215	19.67	0.0927	26.68	0.4657	
		109	54	19.96	0.099	26.97	0.4974	
Middle	QPSK CP- OFDM	1	1	24.90	0.3088	31.91	1.5511	
		1	215	25.36	0.3432	32.37	1.724	
		109	54	25.38	0.3451	32.39	1.7338	
	16QAM CP-s- OFDM	1	1	23.85	0.2427	30.86	1.219	
		1	215	23.99	0.2506	31.00	1.2591	
		109	54	24.20	0.263	31.21	1.3214	
	64QAM CP-s- OFDM	1	1	22.37	0.1727	29.38	0.8675	
		1	215	22.46	0.1762	29.47	0.8851	
		109	54	22.79	0.1901	29.80	0.9551	
	256QA M CP-s-	1	1	19.59	0.0909	26.60	0.4568	
		1	215	19.59	0.091	26.60	0.4571	
		109	54	19.64	0.0921	26.65	0.4629	
	Highest	QPSK CP- OFDM	1	1	25.21	0.3317	32.22	1.6663
			1	215	24.91	0.31	31.92	1.5572
			109	54	25.57	0.3603	32.58	1.8101
		16QAM CP-s- OFDM	1	1	23.86	0.243	30.87	1.2205
			1	215	24.12	0.2585	31.13	1.2986
			109	54	24.31	0.2699	31.32	1.3558
64QAM CP-s- OFDM		1	1	22.23	0.1672	29.24	0.8402	
		1	215	22.35	0.1716	29.36	0.8622	
		109	54	22.85	0.1927	29.86	0.9682	
256QA M CP-s-		1	1	19.23	0.0837	26.24	0.4204	
		1	215	19.39	0.0869	26.40	0.4364	
		109	54	19.93	0.0984	26.94	0.4941	

SA n41 (ANT M2+ANT M) 50MHz (GT - LC = 7.01 dB)							
Channel	Mode	NR		Conducted		EIRP	
		RB		Power(dBm)	Power(Watt)	EIRP(dBm)	EIRP(W)
		Size	Offset				
Lowest	QPSK CP- OFDM	1	1	25.50	0.3548	32.51	1.7821
		1	131	25.48	0.3528	32.49	1.7724
		67	33	25.81	0.3807	32.82	1.9124
	16QAM CP-s- OFDM	1	1	24.11	0.2574	31.12	1.293
		1	131	24.31	0.2695	31.32	1.3537
		67	33	24.20	0.2628	31.21	1.3202
	64QAM CP-s- OFDM	1	1	22.45	0.176	29.46	0.8841
		1	131	22.72	0.1871	29.73	0.94
		67	33	22.65	0.184	29.66	0.9242
	256QA M CP-s-	1	1	19.62	0.0917	26.63	0.4607
		1	131	19.59	0.0911	26.60	0.4575
		67	33	19.75	0.0943	26.76	0.4738
Middle	QPSK CP- OFDM	1	1	25.03	0.3182	32.04	1.5983
		1	131	25.64	0.3661	32.65	1.8393
		67	33	25.42	0.3486	32.43	1.7513
	16QAM CP-s- OFDM	1	1	24.08	0.2557	31.09	1.2845
		1	131	24.30	0.2691	31.31	1.3516
		67	33	24.35	0.272	31.36	1.3663
	64QAM CP-s- OFDM	1	1	22.55	0.1799	29.56	0.9036
		1	131	22.64	0.1837	29.65	0.9228
		67	33	22.74	0.188	29.75	0.9442
	256QA M CP-s-	1	1	19.38	0.0867	26.39	0.4356
		1	131	19.50	0.089	26.51	0.4473
		67	33	19.82	0.096	26.83	0.482
	QPSK CP- OFDM	1	1	25.60	0.3631	32.61	1.8241
		1	131	25.24	0.3343	32.25	1.6793
		67	33	25.33	0.3414	32.34	1.7151
	16QAM CP-s- OFDM	1	1	24.45	0.2787	31.46	1.4
		1	131	24.37	0.2734	31.38	1.3734
		67	33	24.36	0.2729	31.37	1.3708
64QAM CP-s- OFDM	1	1	22.80	0.1906	29.81	0.9573	
	1	131	22.93	0.1962	29.94	0.9858	
	67	33	22.91	0.1956	29.92	0.9828	
256QA M CP-s-	1	1	19.50	0.0891	26.51	0.4475	
	1	131	19.61	0.0913	26.62	0.4588	
	67	33	19.93	0.0985	26.94	0.4946	
Highest	16QAM CP-s- OFDM	1	1	22.80	0.1906	29.81	0.9573
		1	131	22.93	0.1962	29.94	0.9858
		67	33	22.91	0.1956	29.92	0.9828
256QA M CP-s-	1	1	19.50	0.0891	26.51	0.4475	
	1	131	19.61	0.0913	26.62	0.4588	
	67	33	19.93	0.0985	26.94	0.4946	

SA n41 (ANT M2+ANT M) 40MHz (GT - LC = 7.01 dB)								
Channel	Mode	NR		Conducted		EIRP		
		RB						
		Size	Offset	Power(dBm)	Power(Watt)	IRP(dBm)	EIRP(W)	
Lowest	QPSK CP- OFDM	1	1	25.25	0.3346	32.26	1.6809	
		1	104	25.28	0.3376	32.29	1.6959	
		53	26	25.81	0.3808	32.82	1.9129	
	16QAM CP-s- OFDM	1	1	24.06	0.2548	31.07	1.2802	
		1	104	24.00	0.251	31.01	1.2607	
		53	26	24.02	0.2525	31.03	1.2685	
	64QAM CP-s- OFDM	1	1	22.35	0.1719	29.36	0.8635	
		1	104	22.36	0.1723	29.37	0.8657	
		53	26	22.28	0.1689	29.29	0.8486	
	256QA M CP-s-	1	1	19.21	0.0834	26.22	0.419	
		1	104	19.34	0.0858	26.35	0.4313	
		53	26	19.25	0.0841	26.26	0.4223	
Middle	QPSK CP- OFDM	1	1	24.78	0.3009	31.79	1.5115	
		1	104	25.28	0.3376	32.29	1.6961	
		53	26	25.44	0.3501	32.45	1.7589	
	16QAM CP-s- OFDM	1	1	23.93	0.247	30.94	1.2408	
		1	104	24.07	0.2551	31.08	1.2814	
		53	26	24.01	0.2517	31.02	1.2644	
	64QAM CP-s- OFDM	1	1	23.97	0.2497	30.98	1.2544	
		1	104	22.39	0.1732	29.40	0.8701	
		53	26	22.29	0.1693	29.30	0.8506	
	256QA M CP-s-	1	1	22.33	0.1709	29.34	0.8583	
		1	104	19.28	0.0848	26.29	0.4259	
		53	26	19.39	0.0868	26.40	0.4362	
	Highest	QPSK CP- OFDM	1	1	25.25	0.3352	32.26	1.6839
			1	104	25.02	0.3174	32.03	1.5947
			53	26	25.26	0.3355	32.27	1.6854
		16QAM CP-s- OFDM	1	1	23.96	0.2488	30.97	1.2501
			1	104	24.05	0.254	31.06	1.2761
			53	26	24.00	0.2513	31.01	1.2625
64QAM CP-s- OFDM		1	1	22.27	0.1685	29.28	0.8464	
		1	104	22.39	0.1735	29.40	0.8715	
		53	26	22.25	0.1679	29.26	0.8436	
256QA M CP-s-		1	1	19.43	0.0878	26.44	0.441	
		1	104	19.31	0.0854	26.32	0.4289	
		53	26	19.24	0.084	26.25	0.4218	

SA n41 (ANT M2+ANT M) 30MHz (GT - LC = 7.01 dB)							
Channel	Mode	NR		Conducted		EIRP	
		RB		Power(dBm)	Power(Watt)	IRP(dBm)	EIRP(W)
		Size	Offset				
Lowest	QPSK CP- OFDM	1	1	25.50	0.3551	32.51	1.7839
		1	76	25.68	0.3698	32.69	1.8579
		39	19	25.67	0.3688	32.68	1.8524
	16QAM CP-s- OFDM	1	1	23.95	0.2483	30.96	1.2474
		1	76	24.06	0.2548	31.07	1.28
		39	19	23.90	0.2455	30.91	1.2333
	64QAM CP-s- OFDM	1	1	22.30	0.1699	29.31	0.8535
		1	76	22.33	0.1712	29.34	0.86
		39	19	22.42	0.1746	29.43	0.8772
	256QA M CP-s-	1	1	19.40	0.0871	26.41	0.4377
		1	76	19.48	0.0886	26.49	0.4452
		39	19	19.39	0.0869	26.40	0.4364
Middle	QPSK CP- OFDM	1	1	25.02	0.3175	32.03	1.5952
		1	76	25.64	0.3667	32.65	1.8419
		39	19	25.45	0.3511	32.46	1.7638
	16QAM CP-s- OFDM	1	1	24.00	0.2514	31.01	1.2629
		1	76	23.98	0.2502	30.99	1.2571
		39	19	23.95	0.2481	30.96	1.2463
	64QAM CP-s- OFDM	1	1	22.42	0.1744	29.43	0.8761
		1	76	22.35	0.1718	29.36	0.8631
		39	19	22.22	0.1667	29.23	0.8375
	256QA M CP-s-	1	1	19.23	0.0838	26.24	0.4209
		1	76	19.34	0.0859	26.35	0.4317
		39	19	19.45	0.0882	26.46	0.443
	QPSK CP- OFDM	1	1	25.25	0.3348	32.26	1.6818
		1	76	25.20	0.3312	32.21	1.664
		39	19	25.23	0.3337	32.24	1.6765
	16QAM CP-s- OFDM	1	1	23.89	0.245	30.90	1.2309
		1	76	23.98	0.2499	30.99	1.2555
		39	19	24.00	0.2513	31.01	1.2623
64QAM CP-s- OFDM	1	1	22.38	0.1728	29.39	0.8682	
	1	76	22.32	0.1704	29.33	0.8561	
	39	19	22.30	0.1699	29.31	0.8534	
256QA M CP-s-	1	1	19.42	0.0876	26.43	0.4399	
	1	76	19.28	0.0847	26.29	0.4253	
	39	19	19.22	0.0835	26.23	0.4195	
Highest	QPSK CP- OFDM	1	1	25.02	0.3175	32.03	1.5952
		1	76	25.64	0.3667	32.65	1.8419
		39	19	25.45	0.3511	32.46	1.7638
	16QAM CP-s- OFDM	1	1	24.00	0.2514	31.01	1.2629
		1	76	23.98	0.2502	30.99	1.2571
		39	19	23.95	0.2481	30.96	1.2463
	64QAM CP-s- OFDM	1	1	22.42	0.1744	29.43	0.8761
		1	76	22.35	0.1718	29.36	0.8631
		39	19	22.22	0.1667	29.23	0.8375
256QA M CP-s-	1	1	19.23	0.0838	26.24	0.4209	
	1	76	19.34	0.0859	26.35	0.4317	
	39	19	19.45	0.0882	26.46	0.443	
QPSK CP- OFDM	1	1	25.25	0.3348	32.26	1.6818	
	1	76	25.20	0.3312	32.21	1.664	
	39	19	25.23	0.3337	32.24	1.6765	
16QAM CP-s- OFDM	1	1	23.89	0.245	30.90	1.2309	
	1	76	23.98	0.2499	30.99	1.2555	
	39	19	24.00	0.2513	31.01	1.2623	
64QAM CP-s- OFDM	1	1	22.38	0.1728	29.39	0.8682	
	1	76	22.32	0.1704	29.33	0.8561	
	39	19	22.30	0.1699	29.31	0.8534	
256QA M CP-s-	1	1	19.42	0.0876	26.43	0.4399	
	1	76	19.28	0.0847	26.29	0.4253	
	39	19	19.22	0.0835	26.23	0.4195	

SA n41 (ANT M2+ANT M) 15MHz (GT - LC = 7.01 dB)								
Channel	Mode	NR		Conducted		EIRP		
		RB		Power(dBm)	Power(Watt)	EIRP(dBm)	EIRP(W)	
		Size	Offset					
Lowest	QPSK CP- OFDM	1	1	25.64	0.3663	32.65	1.8401	
		1	36	25.80	0.3801	32.81	1.9096	
		19	9	25.78	0.3788	32.79	1.9027	
	16QAM CP-s- OFDM	1	1	23.98	0.25	30.99	1.2557	
		1	36	24.04	0.2533	31.05	1.2723	
		19	9	24.00	0.2511	31.01	1.2615	
	64QAM CP-s- OFDM	1	1	22.25	0.168	29.26	0.8441	
		1	36	22.43	0.1748	29.44	0.8782	
		19	9	22.27	0.1687	29.28	0.8473	
	256QA M CP-s-	1	1	19.41	0.0873	26.42	0.4383	
		1	36	19.29	0.085	26.30	0.427	
		19	9	19.26	0.0842	26.27	0.4232	
Middle	QPSK CP- OFDM	1	1	25.31	0.3395	32.32	1.7057	
		1	36	25.56	0.3599	32.57	1.8077	
		19	9	25.44	0.3499	32.45	1.7578	
	16QAM CP-s- OFDM	1	1	23.91	0.2459	30.92	1.2354	
		1	36	23.98	0.2503	30.99	1.2574	
		19	9	23.92	0.2465	30.93	1.2381	
	64QAM CP-s- OFDM	1	1	22.33	0.1708	29.34	0.8581	
		1	36	22.35	0.1718	29.36	0.8631	
		19	9	22.30	0.1699	29.31	0.8537	
	256QA M CP-s-	1	1	19.29	0.0848	26.30	0.4262	
		1	36	19.34	0.086	26.35	0.432	
		19	9	19.24	0.084	26.25	0.422	
	Highest	QPSK CP- OFDM	1	1	25.30	0.3388	32.31	1.7018
			1	36	25.25	0.3352	32.26	1.6839
			19	9	25.38	0.3454	32.39	1.7352
		16QAM CP-s- OFDM	1	1	23.92	0.2464	30.93	1.2379
			1	36	23.95	0.2482	30.96	1.2467
			19	9	24.01	0.2518	31.02	1.2648
64QAM CP-s- OFDM		1	1	22.36	0.172	29.37	0.8641	
		1	36	22.27	0.1686	29.28	0.8468	
		19	9	22.30	0.1697	29.31	0.8527	
256QA M CP-s-	1	1	19.31	0.0853	26.32	0.4286		
	1	36	19.43	0.0877	26.44	0.4406		
	19	9	19.18	0.0827	26.19	0.4157		

SA n41 (ANT M2+ANT M) 10MHz (GT - LC = 7.01 dB)							
Channel	Mode	NR		Conducted		EIRP	
		RB					
		Size	Offset	Power(dBm)	Power(Watt)	IRP(dBm)	EIRP(W)
Lowest	QPSK CP- OFDM	1	1	25.63	0.3659	32.64	1.8382
		1	22	25.80	0.3802	32.81	1.9098
		12	6	25.71	0.372	32.72	1.8687
	16QAM CP-s- OFDM	1	1	23.95	0.248	30.96	1.2461
		1	22	23.90	0.2457	30.91	1.2341
		12	6	23.92	0.2463	30.93	1.2375
	64QAM CP-s- OFDM	1	1	22.31	0.1703	29.32	0.8553
		1	22	22.29	0.1695	29.30	0.8514
		12	6	22.40	0.1738	29.41	0.8731
	256QA M CP-s-	1	1	19.29	0.0849	26.30	0.4263
		1	22	19.36	0.0863	26.37	0.4337
		12	6	19.46	0.0884	26.47	0.4438
Middle	QPSK CP- OFDM	1	1	25.45	0.3506	32.46	1.7612
		1	22	25.55	0.3593	32.56	1.8048
		12	6	25.44	0.3503	32.45	1.7597
	16QAM CP-s- OFDM	1	1	24.01	0.252	31.02	1.266
		1	22	23.95	0.2486	30.96	1.2487
		12	6	23.94	0.2477	30.95	1.2441
	64QAM CP-s- OFDM	1	1	22.37	0.1726	29.38	0.8671
		1	22	22.28	0.169	29.29	0.849
		12	6	22.33	0.1709	29.34	0.8584
	256QA M CP-s-	1	1	19.32	0.0856	26.33	0.4298
		1	22	19.46	0.0884	26.47	0.4441
		12	6	19.31	0.0853	26.32	0.4283
	QPSK CP- OFDM	1	1	25.35	0.3427	32.36	1.7215
		1	22	25.36	0.3437	32.37	1.7268
		12	6	25.40	0.3471	32.41	1.7436
	16QAM CP-s- OFDM	1	1	23.92	0.2468	30.93	1.2398
		1	22	23.96	0.2491	30.97	1.2515
		12	6	23.99	0.2506	31.00	1.2591
64QAM CP-s- OFDM	1	1	22.31	0.1702	29.32	0.8548	
	1	22	22.35	0.1719	29.36	0.8636	
	12	6	22.25	0.168	29.26	0.8439	
256QA M CP-s-	1	1	19.29	0.0849	26.30	0.4267	
	1	22	19.37	0.0866	26.38	0.435	
	12	6	19.48	0.0888	26.49	0.4459	

SCS 15

SA n41 (ANT M2+ANT M) 40MHz (GT - LC = 7.01 dB)								
Channel	Mode	NR		Conducted		EIRP		
		RB						
		Size	Offset	Power(dBm)	Power(Watt)	IRP(dBm)	EIRP(W)	
Lowest	QPSK CP- OFDM	1	1	24.61	0.2892	31.62	1.4528	
		1	214	25.29	0.338	32.30	1.6977	
		108	54	24.99	0.3158	32.00	1.5862	
	16QAM CP-s- OFDM	1	1	24.15	0.2601	31.16	1.3065	
		1	214	24.30	0.269	31.31	1.3515	
		108	54	24.16	0.2607	31.17	1.3095	
	64QAM CP-s- OFDM	1	1	22.07	0.1611	29.08	0.8092	
		1	214	22.31	0.1703	29.32	0.8554	
		108	54	22.76	0.1888	29.77	0.9483	
256QA M CP-s-	1	1	19.58	0.0907	26.59	0.4557		
	1	214	19.86	0.0968	26.87	0.4864		
	108	54	20.53	0.1131	27.54	0.5681		
Middle	QPSK CP- OFDM	1	1	24.22	0.264	31.23	1.3261	
		1	214	24.20	0.2631	31.21	1.3215	
		108	54	24.48	0.2803	31.49	1.4082	
	16QAM CP-s- OFDM	1	1	23.81	0.2407	30.82	1.2091	
		1	214	24.19	0.2622	31.20	1.3171	
		108	54	24.35	0.2723	31.36	1.3678	
	64QAM CP-s- OFDM	1	1	22.32	0.1704	29.33	0.8562	
		1	214	22.25	0.168	29.26	0.8437	
		108	54	22.78	0.1896	29.79	0.9522	
	256QA M CP-s-	1	1	19.58	0.0908	26.59	0.4564	
		1	214	19.74	0.0943	26.75	0.4735	
		108	54	20.58	0.1143	27.59	0.5744	
	Highest	QPSK CP- OFDM	1	1	24.67	0.293	31.68	1.4718
			1	214	24.72	0.2963	31.73	1.4883
			108	54	24.79	0.3013	31.80	1.5138
16QAM CP-s- OFDM		1	1	24.25	0.2662	31.26	1.3373	
		1	214	24.13	0.2586	31.14	1.2988	
		108	54	24.42	0.2765	31.43	1.3889	
64QAM CP-s- OFDM		1	1	22.29	0.1695	29.30	0.8514	
		1	214	22.25	0.168	29.26	0.8437	
		108	54	22.93	0.1962	29.94	0.9854	
256QA M CP-s-		1	1	20.04	0.1009	27.05	0.5068	
		1	214	19.85	0.0966	26.86	0.4855	
		108	54	20.80	0.1202	27.81	0.6038	

SA n41 (ANT M2+ANT M) 30MHz (GT - LC = 7.01 dB)							
Channel	Mode	NR		Conducted		EIRP	
		RB		Power(dBm)	Power(Watt)	EIRP(dBm)	EIRP(W)
		Size	Offset				
Lowest	QPSK CP- OFDM	1	1	24.78	0.3003	31.79	1.5087
		1	158	24.87	0.3071	31.88	1.5429
		80	40	25.12	0.3254	32.13	1.6348
	16QAM CP-s- OFDM	1	1	24.15	0.26	31.16	1.3061
		1	158	24.41	0.2758	31.42	1.3854
		80	40	24.17	0.261	31.18	1.3111
	64QAM CP-s- OFDM	1	1	22.29	0.1693	29.30	0.8502
		1	158	22.36	0.1722	29.37	0.8648
		80	40	22.68	0.1854	29.69	0.9314
256QA M CP-s-	1	1	20.03	0.1007	27.04	0.5061	
	1	158	19.57	0.0905	26.58	0.4545	
	80	40	20.49	0.112	27.50	0.5626	
Middle	QPSK CP- OFDM	1	1	24.41	0.2762	31.42	1.3874
		1	158	24.76	0.2989	31.77	1.5017
		80	40	24.74	0.2979	31.75	1.4964
	16QAM CP-s- OFDM	1	1	24.40	0.2755	31.41	1.3842
		1	158	24.18	0.2619	31.19	1.3158
		80	40	24.34	0.2718	31.35	1.3656
	64QAM CP-s- OFDM	1	1	22.43	0.1749	29.44	0.8785
		1	158	22.43	0.1748	29.44	0.8782
		80	40	22.88	0.194	29.89	0.9747
	256QA M CP-s-	1	1	20.87	0.1223	27.88	0.6142
		1	158	20.30	0.1071	27.31	0.538
		80	40	20.88	0.1225	27.89	0.6152
	QPSK CP- OFDM	1	1	24.68	0.2938	31.69	1.4759
		1	158	24.67	0.2931	31.68	1.4725
		80	40	24.72	0.2968	31.73	1.4909
16QAM CP-s- OFDM	1	1	24.55	0.2852	31.56	1.4325	
	1	158	24.34	0.2714	31.35	1.3632	
	80	40	24.40	0.2752	31.41	1.3826	
64QAM CP-s- OFDM	1	1	22.72	0.1869	29.73	0.9388	
	1	158	22.64	0.1835	29.65	0.9216	
	80	40	22.93	0.1962	29.94	0.9856	
256QA M CP-s-	1	1	20.10	0.1023	27.11	0.514	
	1	158	19.72	0.0938	26.73	0.471	
	80	40	20.48	0.1116	27.49	0.5604	

SA n41 (ANT M2+ANT M) 15MHz (GT - LC = 7.01 dB)							
Channel	Mode	NR		Conducted		EIRP	
		RB					
		Size	Offset	Power(dBm)	Power(Watt)	IRP(dBm)	EIRP(W)
Lowest	QPSK CP- OFDM	1	1	25.03	0.3185	32.04	1.5998
		1	77	25.22	0.3328	32.23	1.6716
		39	19	25.10	0.3233	32.11	1.6239
	16QAM CP-s- OFDM	1	1	24.50	0.2817	31.51	1.4151
		1	77	24.42	0.2764	31.43	1.3885
		39	19	24.30	0.2692	31.31	1.3522
	64QAM CP-s- OFDM	1	1	22.70	0.1863	29.71	0.936
		1	77	22.81	0.191	29.82	0.9595
		39	19	22.69	0.1858	29.70	0.9333
	256QA M CP-s-	1	1	20.24	0.1056	27.25	0.5303
		1	77	20.83	0.1211	27.84	0.6083
		39	19	20.43	0.1105	27.44	0.5551
Middle	QPSK CP- OFDM	1	1	24.72	0.2968	31.73	1.4907
		1	77	24.98	0.3144	31.99	1.5795
		39	19	24.78	0.3009	31.79	1.5118
	16QAM CP-s- OFDM	1	1	24.44	0.278	31.45	1.3965
		1	77	24.60	0.2881	31.61	1.4473
		39	19	24.49	0.2812	31.50	1.4124
	64QAM CP-s- OFDM	1	1	22.86	0.193	29.87	0.9696
		1	77	22.95	0.1975	29.96	0.992
		39	19	23.03	0.2009	30.04	1.0091
	256QA M CP-s-	1	1	19.98	0.0996	26.99	0.5004
		1	77	20.50	0.1121	27.51	0.5631
		39	19	20.80	0.1203	27.81	0.6046
	QPSK CP- OFDM	1	1	24.76	0.2993	31.77	1.5036
		1	77	24.88	0.3078	31.89	1.5462
		39	19	24.82	0.3033	31.83	1.5236
	16QAM CP-s- OFDM	1	1	24.59	0.2878	31.60	1.4455
		1	77	24.67	0.2931	31.68	1.4724
		39	19	24.51	0.2823	31.52	1.418
64QAM CP-s- OFDM	1	1	22.93	0.1962	29.94	0.9854	
	1	77	22.95	0.1973	29.96	0.9913	
	39	19	22.96	0.1976	29.97	0.9925	
256QA M CP-s-	1	1	20.23	0.1054	27.24	0.5294	
	1	77	20.75	0.1188	27.76	0.5967	
	39	19	20.68	0.1171	27.69	0.5881	

SA n41 (ANT M2+ANT M) 10MHz (GT - LC = 7.01 dB)							
Channel	Mode	NR		Conducted		EIRP	
		RB		Power(dBm)	Power(Watt)	EIRP(dBm)	EIRP(W)
		Size	Offset				
Lowest	QPSK CP- OFDM	1	1	24.81	0.3028	31.82	1.5213
		1	50	25.09	0.3227	32.10	1.6211
		26	13	24.91	0.3094	31.92	1.5544
	16QAM CP-s- OFDM	1	1	24.17	0.261	31.18	1.311
		1	50	24.55	0.2852	31.56	1.4325
		26	13	24.08	0.2556	31.09	1.2839
	64QAM CP-s- OFDM	1	1	22.42	0.1746	29.43	0.8771
		1	50	22.87	0.1936	29.88	0.9725
		26	13	22.58	0.1811	29.59	0.91
	256QA M CP-s-	1	1	20.00	0.1	27.01	0.5022
		1	50	19.96	0.0991	26.97	0.4978
		26	13	20.17	0.1039	27.18	0.5221
Middle	QPSK CP- OFDM	1	1	24.53	0.284	31.54	1.4264
		1	50	24.76	0.2993	31.77	1.5034
		26	13	24.59	0.2874	31.60	1.4439
	16QAM CP-s- OFDM	1	1	24.75	0.2988	31.76	1.5009
		1	50	24.86	0.3064	31.87	1.5393
		26	13	24.36	0.2726	31.37	1.3696
	64QAM CP-s- OFDM	1	1	22.79	0.1903	29.80	0.956
		1	50	23.01	0.2001	30.02	1.0054
		26	13	22.86	0.1934	29.87	0.9716
	256QA M CP-s-	1	1	20.36	0.1087	27.37	0.5461
		1	50	20.66	0.1164	27.67	0.5846
		26	13	20.73	0.1184	27.74	0.5948
	QPSK CP- OFDM	1	1	24.69	0.2943	31.70	1.4783
		1	50	24.79	0.3013	31.80	1.5133
		26	13	24.72	0.2963	31.73	1.4884
	16QAM CP-s- OFDM	1	1	24.50	0.282	31.51	1.4165
		1	50	24.87	0.3071	31.88	1.5427
		26	13	24.36	0.2728	31.37	1.3706
64QAM CP-s- OFDM	1	1	22.76	0.1886	29.77	0.9475	
	1	50	22.96	0.1975	29.97	0.9921	
	26	13	22.89	0.1947	29.90	0.9778	
256QA M CP-s-	1	1	20.14	0.1032	27.15	0.5183	
	1	50	20.06	0.1013	27.07	0.5088	
	26	13	20.70	0.1174	27.71	0.5898	
Highest	QPSK CP- OFDM	1	1	24.53	0.284	31.54	1.4264
		1	50	24.76	0.2993	31.77	1.5034
		26	13	24.59	0.2874	31.60	1.4439
16QAM CP-s- OFDM	1	1	24.75	0.2988	31.76	1.5009	
	1	50	24.86	0.3064	31.87	1.5393	
	26	13	24.36	0.2726	31.37	1.3696	
64QAM CP-s- OFDM	1	1	22.79	0.1903	29.80	0.956	
	1	50	23.01	0.2001	30.02	1.0054	
	26	13	22.86	0.1934	29.87	0.9716	
256QA M CP-s-	1	1	20.36	0.1087	27.37	0.5461	
	1	50	20.66	0.1164	27.67	0.5846	
	26	13	20.73	0.1184	27.74	0.5948	
QPSK CP- OFDM	1	1	24.69	0.2943	31.70	1.4783	
	1	50	24.79	0.3013	31.80	1.5133	
	26	13	24.72	0.2963	31.73	1.4884	
16QAM CP-s- OFDM	1	1	24.50	0.282	31.51	1.4165	
	1	50	24.87	0.3071	31.88	1.5427	
	26	13	24.36	0.2728	31.37	1.3706	
64QAM CP-s- OFDM	1	1	22.76	0.1886	29.77	0.9475	
	1	50	22.96	0.1975	29.97	0.9921	
	26	13	22.89	0.1947	29.90	0.9778	
256QA M CP-s-	1	1	20.14	0.1032	27.15	0.5183	
	1	50	20.06	0.1013	27.07	0.5088	
	26	13	20.70	0.1174	27.71	0.5898	

5G NR n41 HPUE NSA mode:

SCS 30

EN-DC n41 (ANT 2M)+41A (ANT M)Combination 80MHz+20MHz(LTE)(GT - LC = 4 dB)										
Channel	Mode	NR		LTE		Conducted		EIRP		
		RB		RB						
		Size	Offset	Size	Offset	Power(dBm)	Power(Watts)	EIRP(dBm)	EIRP(W)	
Lowest	PI/2 BPSK DFT-s-OFDM	1	1	1	0	8.58	0.0072	12.58	0.0181	
		1	215	1	99	8.82	0.0076	12.82	0.0191	
		108	54	100	0	9.19	0.0083	13.19	0.0208	
	QPSK DFT-s-OFDM	1	1	1	0	8.62	0.0073	12.62	0.0183	
		1	215	1	99	8.85	0.0077	12.85	0.0193	
		108	54	100	0	9.11	0.0082	13.11	0.0205	
	16QAM DFT-s-OFDM	1	1	1	0	8.48	0.007	12.48	0.0177	
		1	215	1	99	8.76	0.0075	12.76	0.0189	
		108	54	100	0	9.12	0.0082	13.12	0.0205	
	64QAM DFT-s-OFDM	1	1	1	0	8.42	0.007	12.42	0.0175	
		1	215	1	99	8.61	0.0073	12.61	0.0183	
		108	54	100	0	9.18	0.0083	13.18	0.0208	
	256QAM DFT-s-OFDM	1	1	1	0	8.71	0.0074	12.71	0.0187	
		1	215	1	99	8.93	0.0078	12.93	0.0196	
		108	54	100	0	9.17	0.0083	13.17	0.0207	
	Highest	PI/2 BPSK DFT-s-OFDM	1	1	1	0	8.52	0.0071	12.52	0.0178
			1	215	1	99	8.77	0.0075	12.77	0.0189
			108	54	100	0	9.03	0.008	13.03	0.0201
QPSK DFT-s-OFDM		1	1	1	0	8.44	0.007	12.44	0.0176	
		1	215	1	99	8.75	0.0075	12.75	0.0188	
		108	54	100	0	9.05	0.008	13.05	0.0202	
16QAM DFT-s-OFDM		1	1	1	0	8.65	0.0073	12.65	0.0184	
		1	215	1	99	8.92	0.0078	12.92	0.0196	
		108	54	100	0	9.02	0.008	13.02	0.02	
64QAM DFT-s-OFDM		1	1	1	0	8.62	0.0073	12.62	0.0183	
		1	215	1	99	8.88	0.0077	12.88	0.0194	
		108	54	100	0	9.03	0.008	13.03	0.0201	
256QAM DFT-s-OFDM		1	1	1	0	8.44	0.007	12.44	0.0176	
		1	215	1	99	8.75	0.0075	12.75	0.0188	
		108	54	100	0	9.05	0.008	13.05	0.0202	

EN-DC n41 (ANT)+41A (ANT)Combination 50MHz+20MHz(LTE)(GT - LC = 4 dB)									
Channel	Mode	NR		LTE		Conducted		EIRP	
		RB		RB					
		Size	Offset	Size	Offset	Power(dBm)	Power(Watts)	EIRP(dBm)	EIRP(W)
Lowest	PI/2 BPSK DFT-s-OFDM	1	1	1	0	8.83	0.0076	12.83	0.0192
		1	131	1	74	9.08	0.0081	13.08	0.0203
		64	32	75	0	9.22	0.0084	13.22	0.021
	QPSK DFT-s-OFDM	1	1	1	0	8.84	0.0076	12.84	0.0192
		1	131	1	74	9.08	0.0081	13.08	0.0203
		64	32	75	0	9.20	0.0083	13.20	0.0209
	16QAM DFT-s-OFDM	1	1	1	0	8.72	0.0075	12.72	0.0187
		1	131	1	74	8.88	0.0077	12.88	0.0194
		64	32	75	0	9.08	0.0081	13.08	0.0203
	64QAM DFT-s-OFDM	1	1	1	0	8.68	0.0074	12.68	0.0185
		1	131	1	74	8.72	0.0075	12.72	0.0187
		64	32	75	0	9.18	0.0083	13.18	0.0208
	256QAM DFT-s-OFDM	1	1	1	0	8.68	0.0074	12.68	0.0185
		1	131	1	74	8.90	0.0078	12.90	0.0195
		64	32	75	0	9.18	0.0083	13.18	0.0208
Highest	PI/2 BPSK DFT-s-OFDM	1	1	1	0	8.50	0.0071	12.50	0.0178
		1	131	1	74	9.11	0.0082	13.11	0.0205
		64	32	75	0	9.01	0.008	13.01	0.02
	QPSK DFT-s-OFDM	1	1	1	0	8.53	0.0071	12.53	0.0179
		1	131	1	74	9.05	0.008	13.05	0.0202
		64	32	75	0	9.02	0.008	13.02	0.0201
	16QAM DFT-s-OFDM	1	1	1	0	8.83	0.0076	12.83	0.0192
		1	131	1	74	9.09	0.0081	13.09	0.0204
		64	32	75	0	8.91	0.0078	12.91	0.0195
	64QAM DFT-s-OFDM	1	1	1	0	8.81	0.0076	12.81	0.0191
		1	131	1	74	8.98	0.0079	12.98	0.0199
		64	32	75	0	8.97	0.0079	12.97	0.0198
	256QAM DFT-s-OFDM	1	1	1	0	8.79	0.0076	12.79	0.019
		1	131	1	74	9.10	0.0081	13.10	0.0204
		64	32	75	0	9.09	0.0081	13.09	0.0204

EN-DC n41 (ANT)+41A (ANT)Combination 40MHz+20MHz(LTE)(GT - LC = 4 dB)									
Channel	Mode	NR		LTE		Conducted		EIRP	
		RB		RB					
		Size	Offset	Size	Offset	Power(dBm)	Power(Watts)	EIRP(dBm)	EIRP(W)
Lowest	PI/2 BPSK DFT-s-OFDM	1	1	1	0	8.76	0.0075	12.76	0.0189
		1	104	1	74	8.87	0.0077	12.87	0.0193
		50	25	75	0	9.23	0.0084	13.23	0.0211
	QPSK DFT-s-OFDM	1	1	1	0	8.76	0.0075	12.76	0.0189
		1	104	1	74	8.85	0.0077	12.85	0.0193
		50	25	75	0	9.26	0.0084	13.26	0.0212
	16QAM DFT-s-OFDM	1	1	1	0	8.90	0.0078	12.90	0.0195
		1	104	1	74	9.15	0.0082	13.15	0.0206
		50	25	75	0	9.09	0.0081	13.09	0.0204
	64QAM DFT-s-OFDM	1	1	1	0	8.86	0.0077	12.86	0.0193
		1	104	1	74	8.75	0.0075	12.75	0.0188
		50	25	75	0	9.25	0.0084	13.25	0.0212
	256QAM DFT-s-OFDM	1	1	1	0	8.72	0.0075	12.72	0.0187
		1	104	1	74	8.92	0.0078	12.92	0.0196
		50	25	75	0	9.19	0.0083	13.19	0.0209
Highest	PI/2 BPSK DFT-s-OFDM	1	1	1	0	8.67	0.0074	12.67	0.0185
		1	104	1	74	8.71	0.0074	12.71	0.0187
		50	25	75	0	9.07	0.0081	13.07	0.0203
	QPSK DFT-s-OFDM	1	1	1	0	8.70	0.0074	12.70	0.0186
		1	104	1	74	8.66	0.0074	12.66	0.0185
		50	25	75	0	9.09	0.0081	13.09	0.0204
	16QAM DFT-s-OFDM	1	1	1	0	8.73	0.0075	12.73	0.0187
		1	104	1	74	8.83	0.0076	12.83	0.0192
		50	25	75	0	8.92	0.0078	12.92	0.0196
	64QAM DFT-s-OFDM	1	1	1	0	8.69	0.0074	12.69	0.0186
		1	104	1	74	9.05	0.008	13.05	0.0202
		50	25	75	0	8.94	0.0078	12.94	0.0197
	256QAM DFT-s-OFDM	1	1	1	0	8.82	0.0076	12.82	0.0191
		1	104	1	74	9.02	0.008	13.02	0.02
		50	25	75	0	9.02	0.008	13.02	0.02

EN-DC n41 (ANT)+41A (ANT)Combination 30MHz+20MHz(LTE)(GT - LC = 4 dB)									
Channel	Mode	NR		LTE		Conducted		EIRP	
		RB		RB					
		Size	Offset	Size	Offset	Power(dBm)	Power(Watts)	EIRP(dBm)	EIRP(W)
Lowest	PI/2 BPSK DFT-s-OFDM	1	1	1	0	8.90	0.0078	12.90	0.0195
		1	76	1	74	8.97	0.0079	12.97	0.0198
		36	18	75	0	7.44	0.0056	11.44	0.0139
	QPSK DFT-s-OFDM	1	1	1	0	8.85	0.0077	12.85	0.0193
		1	76	1	74	8.94	0.0078	12.94	0.0197
		36	18	75	0	9.20	0.0083	13.20	0.0209
	16QAM DFT-s-OFDM	1	1	1	0	8.88	0.0077	12.88	0.0194
		1	76	1	74	9.09	0.0081	13.09	0.0204
		36	18	75	0	8.86	0.0077	12.86	0.0193
	64QAM DFT-s-OFDM	1	1	1	0	8.75	0.0075	12.75	0.0188
		1	76	1	74	9.14	0.0082	13.14	0.0206
		36	18	75	0	8.97	0.0079	12.97	0.0198
	256QAM DFT-s-OFDM	1	1	1	0	8.88	0.0077	12.88	0.0194
		1	76	1	74	8.90	0.0078	12.90	0.0195
		36	18	75	0	9.03	0.008	13.03	0.0201
Highest	PI/2 BPSK DFT-s-OFDM	1	1	1	0	8.89	0.0077	12.89	0.0195
		1	76	1	74	8.90	0.0078	12.90	0.0195
		36	18	75	0	9.13	0.0082	13.13	0.0206
	QPSK DFT-s-OFDM	1	1	1	0	8.84	0.0076	12.84	0.0192
		1	76	1	74	8.83	0.0076	12.83	0.0192
		36	18	75	0	9.04	0.008	13.04	0.0201
	16QAM DFT-s-OFDM	1	1	1	0	8.89	0.0077	12.89	0.0195
		1	76	1	74	8.89	0.0077	12.89	0.0194
		36	18	75	0	9.12	0.0082	13.12	0.0205
	64QAM DFT-s-OFDM	1	1	1	0	8.72	0.0074	12.72	0.0187
		1	76	1	74	8.80	0.0076	12.80	0.019
		36	18	75	0	9.19	0.0083	13.19	0.0208
	256QAM DFT-s-OFDM	1	1	1	0	8.95	0.0078	12.95	0.0197
		1	76	1	74	9.08	0.0081	13.08	0.0203
		36	18	75	0	8.85	0.0077	12.85	0.0193

EN-DC n41 (ANT)+41A (ANT)Combination 15MHz+20MHz(LTE)(GT - LC = 4 dB)										
Channel	Mode	NR		LTE		Conducted		EIRP		
		RB		RB						
		Size	Offset	Size	Offset	Power(dBm)	Power(Watts)	EIRP(dBm)	EIRP(W)	
Lowest	PI/2 BPSK DFT-s-OFDM	1	1	1	0	8.89	0.0077	12.89	0.0195	
		1	36	1	74	9.08	0.0081	13.08	0.0203	
		18	9	75	0	9.09	0.0081	13.09	0.0204	
	QPSK DFT-s-OFDM	1	1	1	0	8.92	0.0078	12.92	0.0196	
		1	36	1	74	9.05	0.008	13.05	0.0202	
		18	9	75	0	9.11	0.0082	13.11	0.0205	
	16QAM DFT-s-OFDM	1	1	1	0	8.64	0.0073	12.64	0.0184	
		1	36	1	74	9.02	0.008	13.02	0.02	
		18	9	75	0	9.04	0.008	13.04	0.0201	
	64QAM DFT-s-OFDM	1	1	1	0	8.70	0.0074	12.70	0.0186	
		1	36	1	74	9.10	0.0081	13.10	0.0204	
		18	9	75	0	8.87	0.0077	12.87	0.0193	
	256QAM DFT-s-OFDM	1	1	1	0	8.85	0.0077	12.85	0.0193	
		1	36	1	74	8.76	0.0075	12.76	0.0189	
		18	9	75	0	8.84	0.0077	12.84	0.0192	
	Highest	PI/2 BPSK DFT-s-OFDM	1	1	1	0	8.89	0.0077	12.89	0.0194
			1	36	1	74	8.96	0.0079	12.96	0.0198
			18	9	75	0	9.11	0.0081	13.11	0.0205
QPSK DFT-s-OFDM		1	1	1	0	8.85	0.0077	12.85	0.0193	
		1	36	1	74	8.90	0.0078	12.90	0.0195	
		18	9	75	0	9.00	0.0079	13.00	0.02	
16QAM DFT-s-OFDM		1	1	1	0	8.77	0.0075	12.77	0.0189	
		1	36	1	74	8.80	0.0076	12.80	0.0191	
		18	9	75	0	8.87	0.0077	12.87	0.0194	
64QAM DFT-s-OFDM		1	1	1	0	8.69	0.0074	12.69	0.0186	
		1	36	1	74	8.80	0.0076	12.80	0.019	
		18	9	75	0	9.06	0.0081	13.06	0.0202	
256QAM DFT-s-OFDM		1	1	1	0	8.73	0.0075	12.73	0.0188	
		1	36	1	74	9.07	0.0081	13.07	0.0203	
		18	9	75	0	8.78	0.0076	12.78	0.019	

EN-DC n41 (ANT)+41A (ANT)Combination 10MHz+20MHz(LTE)(GT - LC = 4 dB)									
Channel	Mode	NR		LTE		Conducted		EIRP	
		RB		RB					
		Size	Offset	Size	Offset	Power(dBm)	Power(Watts)	EIRP(dBm)	EIRP(W)
Lowest	PI/2 BPSK DFT-s-OFDM	1	1	1	0	8.96	0.0079	12.96	0.0198
		1	22	1	74	8.98	0.0079	12.98	0.0199
		12	6	75	0	9.09	0.0081	13.09	0.0204
	QPSK DFT-s-OFDM	1	1	1	0	8.93	0.0078	12.93	0.0196
		1	22	1	74	8.99	0.0079	12.99	0.0199
		12	6	75	0	9.12	0.0082	13.12	0.0205
	16QAM DFT-s-OFDM	1	1	1	0	8.74	0.0075	12.74	0.0188
		1	22	1	74	8.94	0.0078	12.94	0.0197
		12	6	75	0	9.11	0.0082	13.11	0.0205
	64QAM DFT-s-OFDM	1	1	1	0	8.68	0.0074	12.68	0.0185
		1	22	1	74	8.83	0.0076	12.83	0.0192
		12	6	75	0	8.81	0.0076	12.81	0.0191
	256QAM DFT-s-OFDM	1	1	1	0	8.98	0.0079	12.98	0.0198
		1	22	1	74	8.79	0.0076	12.79	0.019
		12	6	75	0	8.79	0.0076	12.79	0.019
Highest	PI/2 BPSK DFT-s-OFDM	1	1	1	0	9.01	0.008	13.01	0.02
		1	22	1	74	9.09	0.0081	13.09	0.0204
		12	6	75	0	9.20	0.0083	13.20	0.0209
	QPSK DFT-s-OFDM	1	1	1	0	9.03	0.008	13.03	0.0201
		1	22	1	74	9.00	0.0079	13.00	0.0199
		12	6	75	0	9.12	0.0082	13.12	0.0205
	16QAM DFT-s-OFDM	1	1	1	0	8.86	0.0077	12.86	0.0193
		1	22	1	74	8.84	0.0077	12.84	0.0192
		12	6	75	0	8.80	0.0076	12.80	0.0191
	64QAM DFT-s-OFDM	1	1	1	0	8.73	0.0075	12.73	0.0188
		1	22	1	74	8.72	0.0074	12.72	0.0187
		12	6	75	0	8.83	0.0076	12.83	0.0192
	256QAM DFT-s-OFDM	1	1	1	0	8.76	0.0075	12.76	0.0189
		1	22	1	74	8.98	0.0079	12.98	0.0199
		12	6	75	0	9.08	0.0081	13.08	0.0203

SCS 15

EN-DC n41 (ANT)+41A (ANT)Combination 40MHz+20MHz(LTE)(GT - LC = 4 dB)									
Channel	Mode	NR		LTE		Conducted		EIRP	
		RB		RB					
		Size	Offset	Size	Offset	Power(dBm)	Power(Watts)	EIRP(dBm)	EIRP(W)
Lowest	PI/2 BPSK DFT-s-OFDM	1	1	1	0	8.72	0.0074	12.72	0.0187
		1	214	1	74	8.69	0.0074	12.69	0.0186
		108	54	75	0	9.13	0.0082	13.13	0.0206
	QPSK DFT-s-OFDM	1	1	1	0	8.75	0.0075	12.75	0.0188
		1	214	1	74	8.73	0.0075	12.73	0.0188
		108	54	75	0	9.19	0.0083	13.19	0.0209
	16QAM DFT-s-OFDM	1	1	1	0	8.84	0.0077	12.84	0.0192
		1	214	1	74	9.14	0.0082	13.14	0.0206
		108	54	75	0	8.87	0.0077	12.87	0.0193
	64QAM DFT-s-OFDM	1	1	1	0	8.74	0.0075	12.74	0.0188
		1	214	1	74	8.88	0.0077	12.88	0.0194
		108	54	75	0	9.16	0.0082	13.16	0.0207
	256QAM DFT-s-OFDM	1	1	1	0	8.71	0.0074	12.71	0.0186
		1	214	1	74	8.89	0.0078	12.89	0.0195
		108	54	75	0	8.79	0.0076	12.79	0.019
Highest	PI/2 BPSK DFT-s-OFDM	1	1	1	0	8.72	0.0074	12.72	0.0187
		1	214	1	74	8.73	0.0075	12.73	0.0188
		108	54	75	0	9.10	0.0081	13.10	0.0204
	QPSK DFT-s-OFDM	1	1	1	0	8.73	0.0075	12.73	0.0187
		1	214	1	74	8.68	0.0074	12.68	0.0185
		108	54	75	0	9.09	0.0081	13.09	0.0204
	16QAM DFT-s-OFDM	1	1	1	0	8.97	0.0079	12.97	0.0198
		1	214	1	74	8.96	0.0079	12.96	0.0197
		108	54	75	0	8.78	0.0076	12.78	0.019
	64QAM DFT-s-OFDM	1	1	1	0	9.02	0.008	13.02	0.02
		1	214	1	74	9.05	0.008	13.05	0.0202
		108	54	75	0	8.73	0.0075	12.73	0.0188
	256QAM DFT-s-OFDM	1	1	1	0	8.90	0.0078	12.90	0.0195
		1	214	1	74	8.77	0.0075	12.77	0.0189
		108	54	75	0	9.09	0.0081	13.09	0.0204

EN-DC n41 (ANT)+41A (ANT)Combination 30MHz+20MHz(LTE)(GT - LC = 4 dB)									
Channel	Mode	NR		LTE		Conducted		EIRP	
		RB		RB					
		Size	Offset	Size	Offset	Power(dBm)	Power(Watts)	EIRP(dBm)	EIRP(W)
Lowest	PI/2 BPSK DFT-s-OFDM	1	1	1	0	8.90	0.0078	12.90	0.0195
		1	158	1	74	9.06	0.0081	13.06	0.0203
		80	40	75	0	9.23	0.0084	13.23	0.021
	QPSK DFT-s-OFDM	1	1	1	0	8.90	0.0078	12.90	0.0195
		1	158	1	74	8.99	0.0079	12.99	0.0199
		80	40	75	0	9.25	0.0084	13.25	0.0211
	16QAM DFT-s-OFDM	1	1	1	0	8.75	0.0075	12.75	0.0188
		1	158	1	74	8.99	0.0079	12.99	0.0199
		80	40	75	0	9.07	0.0081	13.07	0.0203
	64QAM DFT-s-OFDM	1	1	1	0	9.06	0.0081	13.06	0.0202
		1	158	1	74	9.05	0.008	13.05	0.0202
		80	40	75	0	9.09	0.0081	13.09	0.0204
	256QAM DFT-s-OFDM	1	1	1	0	8.69	0.0074	12.69	0.0186
		1	158	1	74	9.19	0.0083	13.19	0.0209
		80	40	75	0	9.01	0.008	13.01	0.02
Highest	PI/2 BPSK DFT-s-OFDM	1	1	1	0	8.90	0.0078	12.90	0.0195
		1	158	1	74	8.92	0.0078	12.92	0.0196
		80	40	75	0	9.00	0.0079	13.00	0.02
	QPSK DFT-s-OFDM	1	1	1	0	8.87	0.0077	12.87	0.0194
		1	158	1	74	8.90	0.0078	12.90	0.0195
		80	40	75	0	9.11	0.0082	13.11	0.0205
	16QAM DFT-s-OFDM	1	1	1	0	8.70	0.0074	12.70	0.0186
		1	158	1	74	9.20	0.0083	13.20	0.0209
		80	40	75	0	8.88	0.0077	12.88	0.0194
	64QAM DFT-s-OFDM	1	1	1	0	8.80	0.0076	12.80	0.019
		1	158	1	74	8.78	0.0076	12.78	0.019
		80	40	75	0	8.96	0.0079	12.96	0.0198
	256QAM DFT-s-OFDM	1	1	1	0	8.84	0.0077	12.84	0.0192
		1	158	1	74	8.84	0.0076	12.84	0.0192
		80	40	75	0	9.07	0.0081	13.07	0.0203

EN-DC n41 (ANT)+41A (ANT)Combination 15MHz+20MHz(LTE)(GT - LC = 4 dB)									
Channel	Mode	NR		LTE		Conducted		EIRP	
		RB		RB					
		Size	Offset	Size	Offset	Power(dBm)	Power(Watts)	EIRP(dBm)	EIRP(W)
Lowest	PI/2 BPSK DFT-s-OFDM	1	1	1	0	8.98	0.0079	12.98	0.0199
		1	77	1	74	9.26	0.0084	13.26	0.0212
		36	18	75	0	9.11	0.0081	13.11	0.0205
	QPSK DFT-s-OFDM	1	1	1	0	8.98	0.0079	12.98	0.0198
		1	77	1	74	9.14	0.0082	13.14	0.0206
		36	18	75	0	9.11	0.0081	13.11	0.0205
	16QAM DFT-s-OFDM	1	1	1	0	8.75	0.0075	12.75	0.0189
		1	77	1	74	8.90	0.0078	12.90	0.0195
		36	18	75	0	9.09	0.0081	13.09	0.0204
	64QAM DFT-s-OFDM	1	1	1	0	8.84	0.0077	12.84	0.0192
		1	77	1	74	9.03	0.008	13.03	0.0201
		36	18	75	0	8.99	0.0079	12.99	0.0199
	256QAM DFT-s-OFDM	1	1	1	0	8.77	0.0075	12.77	0.0189
		1	77	1	74	8.83	0.0076	12.83	0.0192
		36	18	75	0	9.06	0.0081	13.06	0.0202
Highest	PI/2 BPSK DFT-s-OFDM	1	1	1	0	8.99	0.0079	12.99	0.0199
		1	77	1	74	9.15	0.0082	13.15	0.0206
		36	18	75	0	9.08	0.0081	13.08	0.0203
	QPSK DFT-s-OFDM	1	1	1	0	9.00	0.0079	13.00	0.02
		1	77	1	74	9.08	0.0081	13.08	0.0203
		36	18	75	0	9.08	0.0081	13.08	0.0203
	16QAM DFT-s-OFDM	1	1	1	0	8.64	0.0073	12.64	0.0183
		1	77	1	74	8.92	0.0078	12.92	0.0196
		36	18	75	0	9.03	0.008	13.03	0.0201
	64QAM DFT-s-OFDM	1	1	1	0	8.72	0.0074	12.72	0.0187
		1	77	1	74	9.07	0.0081	13.07	0.0203
		36	18	75	0	8.83	0.0076	12.83	0.0192
	256QAM DFT-s-OFDM	1	1	1	0	8.74	0.0075	12.74	0.0188
		1	77	1	74	9.10	0.0081	13.10	0.0204
		36	18	75	0	8.97	0.0079	12.97	0.0198

EN-DC n41 (ANT)+41A (ANT)Combination 10MHz+20MHz(LTE)(GT - LC = 4 dB)									
Channel	Mode	NR		LTE		Conducted		EIRP	
		RB		RB					
		Size	Offset	Size	Offset	Power(dBm)	Power(Watts)	EIRP(dBm)	EIRP(W)
Lowest	PI/2 BPSK DFT-s-OFDM	1	1	1	0	8.90	0.0078	12.90	0.0195
		1	50	1	74	9.07	0.0081	13.07	0.0203
		25	12	75	0	8.99	0.0079	12.99	0.0199
	QPSK DFT-s-OFDM	1	1	1	0	8.88	0.0077	12.88	0.0194
		1	50	1	74	9.04	0.008	13.04	0.0201
		25	12	75	0	9.00	0.0079	13.00	0.02
	16QAM DFT-s-OFDM	1	1	1	0	8.66	0.0073	12.66	0.0185
		1	50	1	74	8.92	0.0078	12.92	0.0196
		25	12	75	0	9.04	0.008	13.04	0.0201
	64QAM DFT-s-OFDM	1	1	1	0	8.86	0.0077	12.86	0.0193
		1	50	1	74	8.81	0.0076	12.81	0.0191
		25	12	75	0	9.06	0.0081	13.06	0.0202
	256QAM DFT-s-OFDM	1	1	1	0	8.77	0.0075	12.77	0.0189
		1	50	1	74	9.04	0.008	13.04	0.0201
		25	12	75	0	8.98	0.0079	12.98	0.0199
Highest	PI/2 BPSK DFT-s-OFDM	1	1	1	0	8.95	0.0079	12.95	0.0197
		1	50	1	74	9.02	0.008	13.02	0.02
		25	12	75	0	8.99	0.0079	12.99	0.0199
	QPSK DFT-s-OFDM	1	1	1	0	8.86	0.0077	12.86	0.0193
		1	50	1	74	8.98	0.0079	12.98	0.0199
		25	12	75	0	9.02	0.008	13.02	0.02
	16QAM DFT-s-OFDM	1	1	1	0	8.65	0.0073	12.65	0.0184
		1	50	1	74	9.01	0.008	13.01	0.02
		25	12	75	0	9.01	0.008	13.01	0.02
	64QAM DFT-s-OFDM	1	1	1	0	8.70	0.0074	12.70	0.0186
		1	50	1	74	8.91	0.0078	12.91	0.0195
		25	12	75	0	9.00	0.0079	13.00	0.02
	256QAM DFT-s-OFDM	1	1	1	0	8.75	0.0075	12.75	0.0188
		1	50	1	74	8.89	0.0077	12.89	0.0195
		25	12	75	0	8.80	0.0076	12.80	0.019

5G NR n71 SA mode:

SCS 15

SA n71 (ANT M) 20MHz (GT - LC = 3 dB)							
Channel	Mode	NR		Conducted		EIRP	
		RB		Power(dBm)	Power(Watts)	EIRP(dBm)	EIRP(W)
		Size	Offset				
Lowest	PI/2 BPSK DFT-s-	1	1	24.09	0.2564	24.94	0.3119
		1	104	24.32	0.2704	25.17	0.3289
		50	25	24.15	0.26	25.00	0.3162
	QPSK DFT-s- OFDM	1	1	24.02	0.2523	24.87	0.3069
		1	104	24.15	0.26	25.00	0.3162
		50	25	24.18	0.2618	25.03	0.3184
	16QAM DFT-s- OFDM	1	1	23.41	0.2193	24.26	0.2667
		1	104	23.44	0.2208	24.29	0.2685
		50	25	23.34	0.2158	24.19	0.2624
	64QAM DFT-s- OFDM	1	1	21.71	0.1483	22.56	0.1803
		1	104	21.74	0.1493	22.59	0.1816
		50	25	21.73	0.1489	22.58	0.1811
	256QAM DFT-s- OFDM	1	1	19.59	0.091	20.44	0.1107
		1	104	19.56	0.0904	20.41	0.1099
		50	25	19.65	0.0923	20.50	0.1122
Middle	PI/2 BPSK DFT-s-	1	1	24.10	0.257	24.95	0.3126
		1	104	24.20	0.263	25.05	0.3199
		50	25	24.28	0.2679	25.13	0.3258
	QPSK DFT-s- OFDM	1	1	24.06	0.2547	24.91	0.3097
		1	104	24.24	0.2655	25.09	0.3228
		50	25	24.27	0.2673	25.12	0.3251
	16QAM DFT-s- OFDM	1	1	23.45	0.2213	24.30	0.2692
		1	104	23.44	0.2208	24.29	0.2685
		50	25	23.37	0.2173	24.22	0.2642
	64QAM DFT-s- OFDM	1	1	21.71	0.1483	22.56	0.1803
		1	104	21.70	0.1479	22.55	0.1799
		50	25	21.75	0.1496	22.60	0.182
	256QAM DFT-s- OFDM	1	1	19.59	0.091	20.44	0.1107
		1	104	19.54	0.0899	20.39	0.1094
		50	25	19.84	0.0964	20.69	0.1172
QPSK CP-OFDM	1	1	22.78	0.1897	23.63	0.2307	
	1	104	22.67	0.1849	23.52	0.2249	
	53	26	22.82	0.1914	23.67	0.2328	
Highest	PI/2 BPSK DFT-s-	1	1	24.12	0.2582	24.97	0.3141
		1	104	24.26	0.2667	25.11	0.3243
		50	25	24.23	0.2649	25.08	0.3221
	QPSK DFT-s- OFDM	1	1	24.16	0.2606	25.01	0.317
		1	104	24.24	0.2655	25.09	0.3228
		50	25	24.28	0.2679	25.13	0.3258
	16QAM DFT-s- OFDM	1	1	23.42	0.2198	24.27	0.2673
		1	104	23.36	0.2168	24.21	0.2636
		50	25	23.29	0.2133	24.14	0.2594
	64QAM DFT-s- OFDM	1	1	21.84	0.1528	22.69	0.1858
		1	104	21.79	0.151	22.64	0.1837
		50	25	21.75	0.1496	22.60	0.182
	256QAM DFT-s- OFDM	1	1	19.69	0.0931	20.54	0.1132
		1	104	19.53	0.0897	20.38	0.1091
		50	25	19.79	0.0953	20.64	0.1159

SA n71 (ANT) 15MHz (GT - LC = 3 dB)							
Channel	Mode	NR		Conducted		EIRP	
		RB		Power(dBm)	Power(Watts)	EIRP(dBm)	EIRP(W)
		Size	Offset				
Lowest	PI/2 BPSK DFT-s-	1	1	24.20	0.263	25.05	0.3199
		1	77	24.24	0.2655	25.09	0.3228
		36	18	24.17	0.2612	25.02	0.3177
	QPSK DFT-s- OFDM	1	1	24.16	0.2606	25.01	0.317
		1	77	24.21	0.2636	25.06	0.3206
		36	18	24.14	0.2594	24.99	0.3155
	16QAM DFT-s- OFDM	1	1	23.54	0.2259	24.39	0.2748
		1	77	23.48	0.2228	24.33	0.271
		36	18	23.31	0.2143	24.16	0.2606
	64QAM DFT-s- OFDM	1	1	21.82	0.1521	22.67	0.1849
		1	77	21.83	0.1524	22.68	0.1854
		36	8	21.77	0.1503	22.62	0.1828
	256QAM DFT-s- OFDM	1	1	19.62	0.0916	20.47	0.1114
		1	77	19.59	0.091	20.44	0.1107
		36	18	19.82	0.0959	20.67	0.1167
Middle	PI/2 BPSK DFT-s-	1	1	24.28	0.2679	25.13	0.3258
		1	77	24.21	0.2636	25.06	0.3206
		36	18	24.23	0.2649	25.08	0.3221
	QPSK DFT-s- OFDM	1	1	24.29	0.2685	25.14	0.3266
		1	77	24.27	0.2673	25.12	0.3251
		36	18	24.30	0.2692	25.15	0.3273
	16QAM DFT-s- OFDM	1	1	23.43	0.2203	24.28	0.2679
		1	77	23.28	0.2128	24.13	0.2588
		36	18	23.32	0.2148	24.17	0.2612
	64QAM DFT-s- OFDM	1	1	21.74	0.1493	22.59	0.1816
		1	77	21.75	0.1496	22.60	0.182
		6	18	21.76	0.15	22.61	0.1824
	256QAM DFT-s- OFDM	1	1	19.64	0.092	20.49	0.1119
		1	77	19.69	0.0931	20.54	0.1132
		36	18	19.83	0.0962	20.68	0.1169
QPSK CP-OFDM	1	1	22.83	0.1919	23.68	0.2333	
	1	77	22.81	0.191	23.66	0.2323	
	39	19	22.79	0.1901	23.64	0.2312	
Highest	PI/2 BPSK DFT-s-	1	1	24.18	0.2618	25.03	0.3184
		1	77	24.29	0.2685	25.14	0.3266
		36	8	24.21	0.2636	25.06	0.3206
	QPSK DFT-s- OFDM	1	1	24.21	0.2636	25.06	0.3206
		1	77	24.28	0.2679	25.13	0.3258
		36	8	24.27	0.2673	25.12	0.3251
	16QAM DFT-s- OFDM	1	1	23.46	0.2218	24.31	0.2698
		1	77	23.41	0.2193	24.26	0.2667
		36	18	23.15	0.2065	24.00	0.2512
	64QAM DFT-s- OFDM	1	1	21.76	0.15	22.61	0.1824
		1	77	21.93	0.156	22.78	0.1897
		36	8	21.71	0.1483	22.56	0.1803
	256QAM DFT-s- OFDM	1	1	19.66	0.0925	20.51	0.1125
		1	77	19.61	0.0914	20.46	0.1112
		36	18	19.76	0.0946	20.61	0.1151

SA n71 (ANT) 10MHz (GT - LC = 3 dB)							
Channel	Mode	NR		Conducted		EIRP	
		RB					
		Size	Offset	Power(dBm)	Power(Watts)	EIRP(dBm)	EIRP(W)
Lowest	PI/2 BPSK DFT-s-	1	1	24.10	0.257	24.95	0.3126
		1	50	24.16	0.2606	25.01	0.317
		25	12	23.99	0.2506	24.84	0.3048
	QPSK DFT-s- OFDM	1	1	24.07	0.2553	24.92	0.3105
		1	50	24.05	0.2541	24.90	0.309
		25	12	24.06	0.2547	24.91	0.3097
	16QAM DFT-s- OFDM	1	1	23.43	0.2203	24.28	0.2679
		1	50	23.52	0.2249	24.37	0.2735
		25	12	23.18	0.208	24.03	0.2529
	64QAM DFT-s- OFDM	1	1	21.82	0.1521	22.67	0.1849
		1	50	21.76	0.15	22.61	0.1824
		25	12	21.77	0.1503	22.62	0.1828
	256QAM DFT-s- OFDM	1	1	19.56	0.0904	20.41	0.1099
		1	50	19.62	0.0916	20.47	0.1114
		25	12	19.58	0.0908	20.43	0.1104
Middle	PI/2 BPSK DFT-s-	1	1	23.99	0.2506	24.84	0.3048
		1	50	24.13	0.2588	24.98	0.3148
		25	12	24.04	0.2535	24.89	0.3083
	QPSK DFT-s- OFDM	1	1	23.92	0.2466	24.77	0.2999
		1	50	24.12	0.2582	24.97	0.3141
		25	12	24.04	0.2535	24.89	0.3083
	16QAM DFT-s- OFDM	1	1	23.29	0.2133	24.14	0.2594
		1	50	23.41	0.2193	24.26	0.2667
		25	12	23.19	0.2084	24.04	0.2535
	64QAM DFT-s- OFDM	1	1	21.63	0.1455	22.48	0.177
		1	50	21.59	0.1442	22.44	0.1754
		25	12	21.64	0.1459	22.49	0.1774
	256QAM DFT-s- OFDM	1	1	19.45	0.0881	20.30	0.1072
		1	50	19.54	0.0899	20.39	0.1094
		25	12	19.58	0.0908	20.43	0.1104
QPSK CP-OFDM	1	1	22.54	0.1795	23.39	0.2183	
	1	50	22.74	0.1879	23.59	0.2286	
	26	13	22.66	0.1845	23.51	0.2244	
Highest	PI/2 BPSK DFT-s-	1	1	23.99	0.2506	24.84	0.3048
		1	50	24.11	0.2576	24.96	0.3133
		25	12	24.06	0.2547	24.91	0.3097
	QPSK DFT-s- OFDM	1	1	23.98	0.25	24.83	0.3041
		1	50	24.08	0.2559	24.93	0.3112
		25	12	24.12	0.2582	24.97	0.3141
	16QAM DFT-s- OFDM	1	1	23.24	0.2109	24.09	0.2564
		1	50	23.19	0.2084	24.04	0.2535
		25	12	22.92	0.1959	23.77	0.2382
	64QAM DFT-s- OFDM	1	1	21.48	0.1406	22.33	0.171
		1	50	21.46	0.14	22.31	0.1702
		25	12	21.55	0.1429	22.40	0.1738
	256QAM DFT-s- OFDM	1	1	19.37	0.0865	20.22	0.1052
		1	50	19.35	0.0861	20.20	0.1047
		25	12	19.36	0.0863	20.21	0.105

SA n71 (ANT) 5MHz (GT - LC = 3 dB)							
Channel	Mode	NR		Conducted		EIRP	
		RB		Power(dBm)	Power(Watts)	EIRP(dBm)	EIRP(W)
		Size	Offset				
Lowest	PI/2 BPSK DFT-s-	1	1	24.23	0.2649	25.08	0.3221
		1	23	24.23	0.2649	25.08	0.3221
		12	6	24.21	0.2636	25.06	0.3206
	QPSK DFT-s- OFDM	1	1	24.18	0.2618	25.03	0.3184
		1	23	24.16	0.2606	25.01	0.317
		12	6	24.18	0.2618	25.03	0.3184
	16QAM DFT-s- OFDM	1	1	23.51	0.2244	24.36	0.2729
		1	23	23.53	0.2254	24.38	0.2742
		12	6	23.41	0.2193	24.26	0.2667
	64QAM DFT-s- OFDM	1	1	21.89	0.1545	22.74	0.1879
		1	23	21.79	0.151	22.64	0.1837
		12	6	21.86	0.1535	22.71	0.1866
	256QAM DFT-s- OFDM	1	1	19.71	0.0935	20.56	0.1138
		1	23	19.65	0.0923	20.50	0.1122
		12	6	19.83	0.0962	20.68	0.1169
Middle	PI/2 BPSK DFT-s-	1	1	24.09	0.2564	24.94	0.3119
		1	23	24.20	0.263	25.05	0.3199
		12	6	24.15	0.26	25.00	0.3162
	QPSK DFT-s- OFDM	1	1	24.10	0.257	24.95	0.3126
		1	23	24.18	0.2618	25.03	0.3184
		12	6	24.21	0.2636	25.06	0.3206
	16QAM DFT-s- OFDM	1	1	23.39	0.2183	24.24	0.2655
		1	23	23.49	0.2234	24.34	0.2716
		12	6	23.27	0.2123	24.12	0.2582
	64QAM DFT-s- OFDM	1	1	21.82	0.1521	22.67	0.1849
		1	23	21.75	0.1496	22.60	0.182
		12	6	21.78	0.1507	22.63	0.1832
	256QAM DFT-s- OFDM	1	1	19.47	0.0885	20.32	0.1076
		1	23	19.61	0.0914	20.46	0.1112
		12	6	19.85	0.0966	20.70	0.1175
QPSK CP-OFDM	1	1	22.75	0.1884	23.60	0.2291	
	1	23	22.82	0.1914	23.67	0.2328	
	13	6	22.84	0.1923	23.69	0.2339	
Highest	PI/2 BPSK DFT-s-	1	1	24.22	0.2642	25.07	0.3214
		1	23	24.18	0.2618	25.03	0.3184
		12	6	24.26	0.2667	25.11	0.3243
	QPSK DFT-s- OFDM	1	1	24.19	0.2624	25.04	0.3192
		1	23	23.25	0.2113	24.10	0.257
		12	6	24.28	0.2679	25.13	0.3258
	16QAM DFT-s- OFDM	1	1	23.34	0.2158	24.19	0.2624
		1	23	23.32	0.2148	24.17	0.2612
		12	6	23.28	0.2128	24.13	0.2588
	64QAM DFT-s- OFDM	1	1	21.62	0.1452	22.47	0.1766
		1	23	21.57	0.1435	22.42	0.1746
		12	6	21.73	0.1489	22.58	0.1811
	256QAM DFT-s- OFDM	1	1	19.49	0.0889	20.34	0.1081
		1	23	19.43	0.0877	20.28	0.1067
		12	6	19.72	0.0938	20.57	0.114

5G NR n71 NSA mode:
SCS 15

EN-DC n71 (ANT M)+2A (ANT M2)Combination 20MHz+20MHz(LTE)(GT - LC = 3 dB)									
Channel	Mode	NR		LTE		Conducted		EIRP	
		RB		RB		Power(dBm)	Power(Watts)	EIRP(dBm)	EIRP(W)
		Size	Offset	Size	Offset				
Lowest	PI/2 BPSK DFT-s-	1	1	1	0	23.53	0.2253	24.38	0.274
		1	104	1	99	23.84	0.2419	24.69	0.2942
		50	25	100	0	23.71	0.2348	24.56	0.2856
	QPSK DFT-s- OFDM	1	1	1	0	23.66	0.2321	24.51	0.2823
		1	104	1	99	23.80	0.2397	24.65	0.2915
		50	25	100	0	23.75	0.237	24.60	0.2882
	16QAM DFT-s- OFDM	1	1	1	0	21.96	0.1569	22.81	0.1908
		1	104	1	99	22.34	0.1716	23.19	0.2087
		50	25	100	0	22.56	0.1804	23.41	0.2194
	64QAM DFT-s- OFDM	1	1	1	0	21.23	0.1327	22.08	0.1614
		1	104	1	99	21.26	0.1337	22.11	0.1626
		50	25	100	0	21.41	0.1384	22.26	0.1683
	256QA M DFT-s-	1	1	1	0	19.16	0.0824	20.01	0.1002
		1	104	1	99	18.99	0.0793	19.84	0.0964
		50	25	100	0	19.29	0.0849	20.14	0.1032
Middle	PI/2 BPSK DFT-s-	1	1	1	0	23.63	0.2305	24.48	0.2804
		1	104	1	99	23.89	0.2447	24.74	0.2976
		50	25	100	0	23.81	0.2403	24.66	0.2922
	QPSK DFT-s- OFDM	1	1	1	0	23.65	0.2316	24.50	0.2817
		1	104	1	99	23.89	0.2447	24.74	0.2976
		50	25	100	0	23.78	0.2386	24.63	0.2902
	16QAM DFT-s- OFDM	1	1	1	0	22.15	0.1639	23.00	0.1993
		1	104	1	99	22.32	0.1708	23.17	0.2077
		50	25	100	0	22.33	0.1711	23.18	0.2081
	64QAM DFT-s- OFDM	1	1	1	0	21.15	0.1303	22.00	0.1585
		1	104	1	99	21.34	0.1361	22.19	0.1656
		50	25	100	0	21.32	0.1355	22.17	0.1648
	256QA M DFT-s-	1	1	1	0	19.19	0.083	20.04	0.1009
		1	104	1	99	19.30	0.0851	20.15	0.1035
		50	25	100	0	18.97	0.0789	19.82	0.096
QPSK CP- OFDM	1	1	1	0	22.39	0.1735	23.24	0.211	
	1	104	1	99	22.19	0.1658	23.04	0.2016	
	53	26	100	0	22.35	0.1719	23.20	0.2091	
Highest	PI/2 BPSK DFT-s-	1	1	1	0	23.75	0.237	24.60	0.2882
		1	104	1	99	23.64	0.2311	24.49	0.281
		50	25	100	0	23.74	0.2365	24.59	0.2876
	QPSK DFT-s- OFDM	1	1	1	0	23.52	0.2248	24.37	0.2734
		1	104	1	99	23.82	0.2408	24.67	0.2929
		50	25	100	0	23.77	0.2381	24.62	0.2895
	16QAM DFT-s- OFDM	1	1	1	0	22.17	0.1646	23.02	0.2002
		1	104	1	99	22.42	0.1747	23.27	0.2125
		50	25	100	0	22.24	0.1676	23.09	0.2039
	64QAM DFT-s- OFDM	1	1	1	0	21.33	0.1358	22.18	0.1652
		1	104	1	99	21.35	0.1365	22.20	0.166
		50	25	100	0	21.16	0.1307	22.01	0.1589
	256QA M DFT-s-	1	1	1	0	19.27	0.0845	20.12	0.1028
		1	104	1	99	19.25	0.0841	20.10	0.1023
		50	25	100	0	19.16	0.0824	20.01	0.1002

EN-DC n71 (ANT)+2A (ANT)Combination 15MHz+20MHz(LTE)(GT - LC = 3 dB)									
Channel	Mode	NR		LTE		Conducted		EIRP	
		RB		RB					
		Size	Offset	Size	Offset	Power(dBm)	Power(Watts)	EIRP(dBm)	EIRP(W)
Lowest	PI/2 BPSK DFT-s-	1	1	1	0	23.57	0.2274	24.42	0.2766
		1	77	1	99	23.74	0.2364	24.59	0.2875
		36	18	100	0	23.66	0.2321	24.51	0.2823
	QPSK DFT-s- OFDM	1	1	1	0	23.66	0.2322	24.51	0.2823
		1	77	1	99	23.83	0.2414	24.68	0.2936
		36	18	100	0	23.68	0.2332	24.53	0.2836
	16QAM DFT-s- OFDM	1	1	1	0	22.14	0.1639	22.99	0.1993
		1	77	1	99	22.07	0.1609	22.92	0.1957
		36	18	100	0	22.24	0.1676	23.09	0.2039
	64QAM DFT-s- OFDM	1	1	1	0	21.23	0.1327	22.08	0.1614
		1	77	1	99	21.21	0.1322	22.06	0.1607
		36	18	100	0	21.20	0.1318	22.05	0.1603
256QA M DFT-s-	1	1	1	0	19.07	0.0807	19.92	0.0982	
	1	77	1	99	19.20	0.0831	20.05	0.1011	
	36	18	100	0	19.33	0.0857	20.18	0.1042	
Middle	PI/2 BPSK DFT-s-	1	1	1	0	23.71	0.2348	24.56	0.2856
		1	77	1	99	23.87	0.2436	24.72	0.2962
		36	18	100	0	23.80	0.2397	24.65	0.2915
	QPSK DFT-s- OFDM	1	1	1	0	23.69	0.2338	24.54	0.2843
		1	77	1	99	23.97	0.2492	24.82	0.3031
		36	18	100	0	23.80	0.2397	24.65	0.2915
	16QAM DFT-s- OFDM	1	1	1	0	22.34	0.1715	23.19	0.2086
		1	77	1	99	22.41	0.1743	23.26	0.212
		36	18	100	0	22.19	0.1658	23.04	0.2016
	64QAM DFT-s- OFDM	1	1	1	0	21.14	0.1301	21.99	0.1582
		1	77	1	99	21.35	0.1364	22.20	0.1659
		36	18	100	0	21.35	0.1365	22.20	0.166
256QA M DFT-s-	1	1	1	0	19.22	0.0836	20.07	0.1016	
	1	77	1	99	19.26	0.0843	20.11	0.1025	
	36	18	100	0	18.98	0.0791	19.83	0.0962	
QPSK CP- OFDM	1	1	1	0	22.36	0.1723	23.21	0.2096	
	1	104	1	99	22.43	0.1751	23.28	0.213	
	53	26	100	0	22.18	0.1654	23.03	0.2011	
Highest	PI/2 BPSK DFT-s-	1	1	1	0	23.56	0.2269	24.41	0.2759
		1	77	1	99	23.49	0.2233	24.34	0.2715
		36	18	100	0	23.74	0.2364	24.59	0.2876
	QPSK DFT-s- OFDM	1	1	1	0	23.63	0.2305	24.48	0.2804
		1	77	1	99	23.83	0.2414	24.68	0.2936
		36	18	100	0	23.83	0.2414	24.68	0.2935
	16QAM DFT-s- OFDM	1	1	1	0	22.22	0.1669	23.07	0.203
		1	77	1	99	22.02	0.1591	22.87	0.1935
		36	18	100	0	22.42	0.1747	23.27	0.2125
	64QAM DFT-s- OFDM	1	1	1	0	21.23	0.1328	22.08	0.1615
		1	77	1	99	21.28	0.1343	22.13	0.1633
		36	18	100	0	21.24	0.133	22.09	0.1618
256QA M DFT-s-	1	1	1	0	19.00	0.0794	19.85	0.0966	
	1	77	1	99	19.14	0.082	19.99	0.0998	
	36	18	100	0	19.20	0.0831	20.05	0.1011	

EN-DC n71 (ANT)+2A (ANT)Combination 10MHz+20MHz(LTE)(GT - LC = 3 dB)									
Channel	Mode	NR		LTE		Conducted		EIRP	
		RB		RB					
		Size	Offset	Size	Offset	Power(dBm)	Power(Watts)	EIRP(dBm)	EIRP(W)
Lowest	PI/2 BPSK DFT-s-	1	1	1	0	23.43	0.2202	24.28	0.2678
		1	50	1	99	23.73	0.2359	24.58	0.2869
		25	12	100	0	23.56	0.2269	24.41	0.2759
	QPSK DFT-s- OFDM	1	1	1	0	23.57	0.2274	24.42	0.2765
		1	50	1	99	23.70	0.2343	24.55	0.285
		25	12	100	0	23.53	0.2253	24.38	0.274
	16QAM DFT-s- OFDM	1	1	1	0	21.99	0.158	22.84	0.1921
		1	50	1	99	22.15	0.1639	23.00	0.1993
		25	12	100	0	21.97	0.1572	22.82	0.1912
	64QAM DFT-s- OFDM	1	1	1	0	21.26	0.1337	22.11	0.1626
		1	50	1	99	21.23	0.1327	22.08	0.1614
		25	12	100	0	21.29	0.1346	22.14	0.1637
256QA M DFT-s-	1	1	1	0	19.15	0.0822	20.00	0.1	
	1	50	1	99	19.10	0.0813	19.95	0.0988	
	25	12	100	0	18.99	0.0793	19.84	0.0964	
Middle	PI/2 BPSK DFT-s-	1	1	1	0	23.49	0.2233	24.34	0.2715
		1	50	1	99	23.77	0.2381	24.62	0.2895
		25	12	100	0	23.63	0.2306	24.48	0.2804
	QPSK DFT-s- OFDM	1	1	1	0	23.56	0.2269	24.41	0.2759
		1	50	1	99	23.76	0.2375	24.61	0.2889
		25	12	100	0	23.63	0.2305	24.48	0.2804
	16QAM DFT-s- OFDM	1	1	1	0	22.47	0.1767	23.32	0.215
		1	50	1	99	22.17	0.1646	23.02	0.2002
		25	12	100	0	22.17	0.1646	23.02	0.2002
	64QAM DFT-s- OFDM	1	1	1	0	21.32	0.1355	22.17	0.1648
		1	50	1	99	21.21	0.1321	22.06	0.1607
		25	12	100	0	21.31	0.1352	22.16	0.1644
	256QA M DFT-s-	1	1	1	0	19.08	0.0809	19.93	0.0984
		1	50	1	99	19.28	0.0847	20.13	0.103
		25	12	100	0	18.97	0.0789	19.82	0.096
QPSK CP- OFDM	1	1	1	0	22.21	0.1665	23.06	0.2025	
	1	50	1	99	22.42	0.1747	23.27	0.2125	
	26	13	100	0	22.26	0.1684	23.11	0.2048	
Highest	PI/2 BPSK DFT-s-	1	1	1	0	23.45	0.2212	24.30	0.2691
		1	50	1	99	23.56	0.2269	24.41	0.2759
		25	12	100	0	23.58	0.2279	24.43	0.2772
	QPSK DFT-s- OFDM	1	1	1	0	23.54	0.2259	24.39	0.2747
		1	50	1	99	23.71	0.2348	24.56	0.2856
		25	12	100	0	23.63	0.2306	24.48	0.2804
	16QAM DFT-s- OFDM	1	1	1	0	22.12	0.1631	22.97	0.1984
		1	50	1	99	22.35	0.1719	23.20	0.2091
		25	12	100	0	22.23	0.1673	23.08	0.2034
	64QAM DFT-s- OFDM	1	1	1	0	21.20	0.1318	22.05	0.1603
		1	50	1	99	21.16	0.1307	22.01	0.1589
		25	12	100	0	21.22	0.1325	22.07	0.1611
	256QA M DFT-s-	1	1	1	0	19.11	0.0815	19.96	0.0991
		1	50	1	99	19.25	0.0841	20.10	0.1023
		25	12	100	0	19.24	0.0839	20.09	0.102

EN-DC n71 (ANT)+2A (ANT)Combination 5MHz+20MHz(LTE)(GT - LC = 3 dB)									
Channel	Mode	NR		LTE		Conducted		EIRP	
		RB		RB					
		Size	Offset	Size	Offset	Power(dBm)	Power(Watts)	EIRP(dBm)	EIRP(W)
Lowest	PI/2 BPSK DFT-s-	1	1	1	0	23.53	0.2253	24.38	0.2741
		1	23	1	99	23.56	0.2269	24.41	0.276
		12	6	100	0	23.60	0.229	24.45	0.2785
	QPSK DFT-s- OFDM	1	1	1	0	23.46	0.2217	24.31	0.2697
		1	23	1	99	23.44	0.2207	24.29	0.2684
		12	6	100	0	23.58	0.2279	24.43	0.2772
	16QAM DFT-s- OFDM	1	1	1	0	22.41	0.1743	23.26	0.212
		1	23	1	99	22.28	0.1692	23.13	0.2058
		12	6	100	0	22.38	0.1731	23.23	0.2106
	64QAM DFT-s- OFDM	1	1	1	0	21.23	0.1327	22.08	0.1614
		1	23	1	99	21.17	0.131	22.02	0.1593
		12	6	100	0	21.18	0.1313	22.03	0.1596
256QA M DFT-s-	1	1	1	0	19.24	0.0839	20.09	0.102	
	1	23	1	99	19.21	0.0833	20.06	0.1013	
	12	6	100	0	19.22	0.0835	20.07	0.1016	
Middle	PI/2 BPSK DFT-s-	1	1	1	0	23.60	0.229	24.45	0.2785
		1	23	1	99	23.80	0.2397	24.65	0.2915
		12	6	100	0	23.68	0.2332	24.53	0.2836
	QPSK DFT-s- OFDM	1	1	1	0	23.63	0.2306	24.48	0.2804
		1	23	1	99	23.76	0.2375	24.61	0.2889
		12	6	100	0	23.71	0.2348	24.56	0.2856
	16QAM DFT-s- OFDM	1	1	1	0	22.01	0.1587	22.86	0.193
		1	23	1	99	22.04	0.1598	22.89	0.1943
		12	6	100	0	22.08	0.1613	22.93	0.1961
	64QAM DFT-s- OFDM	1	1	1	0	21.13	0.1298	21.98	0.1578
		1	23	1	99	21.25	0.1334	22.10	0.1622
		12	6	100	0	21.32	0.1355	22.17	0.1648
	256QA M DFT-s-	1	1	1	0	19.24	0.0839	20.09	0.1021
		1	23	1	99	19.11	0.0815	19.96	0.0991
		12	6	100	0	19.31	0.0853	20.16	0.1037
QPSK CP- OFDM	1	1	1	0	22.37	0.1727	23.22	0.2101	
	1	23	1	99	22.13	0.1631	22.98	0.1984	
	13	6	100	0	22.24	0.1677	23.09	0.2039	
Highest	PI/2 BPSK DFT-s-	1	1	1	0	23.33	0.2152	24.18	0.2618
		1	23	1	99	23.76	0.2375	24.61	0.2889
		12	6	100	0	23.84	0.2419	24.69	0.2942
	QPSK DFT-s- OFDM	1	1	1	0	23.35	0.2162	24.20	0.263
		1	23	1	99	23.75	0.237	24.60	0.2882
		12	6	100	0	23.87	0.2436	24.72	0.2963
	16QAM DFT-s- OFDM	1	1	1	0	22.22	0.1669	23.07	0.203
		1	23	1	99	22.28	0.1692	23.13	0.2058
		12	6	100	0	22.10	0.1624	22.95	0.1975
	64QAM DFT-s- OFDM	1	1	1	0	21.30	0.1349	22.15	0.164
		1	23	1	99	21.27	0.134	22.12	0.1629
		12	6	100	0	21.16	0.1306	22.01	0.1589
	256QA M DFT-s-	1	1	1	0	19.07	0.0807	19.92	0.0982
		1	23	1	99	18.97	0.0789	19.82	0.096
		12	6	100	0	18.98	0.0791	19.83	0.0962

EN-DC n71 (ANT)+66A (ANT)Combination 20MHz+20MHz(LTE)(GT - LC = 3dB)									
Channel	Mode	NR		LTE		Conducted		EIRP	
		RB		RB					
		Size	Offset	Size	Offset	Power(dBm)	Power(Watts)	EIRP(dBm)	EIRP(W)
Lowest	PI/2 BPSK DFT-s-	1	1	1	0	23.59	0.2284	24.44	0.2778
		1	104	1	99	23.85	0.2425	24.70	0.2949
		50	25	100	0	23.71	0.2348	24.56	0.2856
	QPSK DFT-s- OFDM	1	1	1	0	23.65	0.2316	24.50	0.2817
		1	104	1	99	23.76	0.2375	24.61	0.2889
		50	25	100	0	23.75	0.237	24.60	0.2882
Middle	PI/2 BPSK DFT-s-	1	1	1	0	23.63	0.2306	24.48	0.2804
		1	104	1	99	23.87	0.2436	24.72	0.2963
		50	25	100	0	23.82	0.2408	24.67	0.2929
	QPSK DFT-s- OFDM	1	1	1	0	23.64	0.2311	24.49	0.2811
		1	104	1	99	23.87	0.2436	24.72	0.2962
		50	25	100	0	23.64	0.2311	24.49	0.281
Highest	PI/2 BPSK DFT-s-	1	1	1	0	23.39	0.2182	24.24	0.2654
		1	104	1	99	23.64	0.2311	24.49	0.2811
		50	25	100	0	23.71	0.2348	24.56	0.2856
	QPSK DFT-s- OFDM	1	1	1	0	23.53	0.2253	24.38	0.274
		1	104	1	99	23.84	0.2419	24.69	0.2942
		50	25	100	0	23.78	0.2386	24.63	0.2902

SCS 30

EN-DC n71 (ANT)+2A (ANT)Combination 20MHz+20MHz(LTE)(GT - LC = 3 dB)									
Channel	Mode	NR		LTE		Conducted		EIRP	
		RB		RB		Power(dBm)	Power(Watts)	EIRP(dBm)	EIRP(W)
		Size	Offset	Size	Offset				
Lowest	PI/2 BPSK DFT-s-	1	1	1	0	23.46	0.2218	24.31	0.2697
		1	49	1	99	23.66	0.2321	24.51	0.2823
		25	12	100	0	23.73	0.2359	24.58	0.2869
	QPSK DFT-s- OFDM	1	1	1	0	23.43	0.2202	24.28	0.2678
		1	49	1	99	23.67	0.2327	24.52	0.283
		25	12	100	0	23.71	0.2348	24.56	0.2856
	16QAM DFT-s- OFDM	1	1	1	0	22.11	0.1627	22.96	0.1979
		1	104	1	99	22.01	0.159	22.86	0.1934
		50	25	100	0	22.04	0.1598	22.89	0.1943
	64QAM DFT-s- OFDM	1	1	1	0	21.33	0.1358	22.18	0.1652
		1	104	1	99	21.13	0.1298	21.98	0.1578
		50	25	100	0	21.15	0.1304	22.00	0.1585
	256QA M DFT-s-	1	1	1	0	18.96	0.0787	19.81	0.0957
		1	104	1	99	19.30	0.0851	20.15	0.1035
		50	25	100	0	19.00	0.0794	19.85	0.0966
Middle	PI/2 BPSK DFT-s-	1	1	1	0	23.53	0.2253	24.38	0.274
		1	49	1	99	23.71	0.2348	24.56	0.2856
		25	12	100	0	23.76	0.2375	24.61	0.2889
	QPSK DFT-s- OFDM	1	1	1	0	23.48	0.2228	24.33	0.2709
		1	49	1	99	23.72	0.2354	24.57	0.2863
		25	12	100	0	23.78	0.2386	24.63	0.2902
	16QAM DFT-s- OFDM	1	1	1	0	22.40	0.1739	23.25	0.2115
		1	104	1	99	22.28	0.1692	23.13	0.2058
		50	25	100	0	22.11	0.1627	22.96	0.1979
	64QAM DFT-s- OFDM	1	1	1	0	21.14	0.13	21.99	0.1581
		1	104	1	99	21.21	0.1322	22.06	0.1607
		50	25	100	0	21.34	0.1361	22.19	0.1656
	256QA M DFT-s-	1	1	1	0	19.22	0.0835	20.07	0.1016
		1	104	1	99	19.20	0.0831	20.05	0.1011
		50	25	100	0	19.00	0.0794	19.85	0.0966
QPSK CP- OFDM	1	1	1	0	22.12	0.1631	22.97	0.1984	
	1	104	1	99	22.16	0.1646	23.01	0.2002	
	53	26	100	0	22.18	0.1654	23.03	0.2011	
Highest	PI/2 BPSK DFT-s-	1	1	1	0	23.30	0.2137	24.15	0.26
		1	49	1	99	23.52	0.2248	24.37	0.2734
		25	12	100	0	23.76	0.2375	24.61	0.2889
	QPSK DFT-s- OFDM	1	1	1	0	23.07	0.2028	23.92	0.2466
		1	49	1	99	23.23	0.2103	24.08	0.2558
		25	12	100	0	23.73	0.2359	24.58	0.2869
	16QAM DFT-s- OFDM	1	1	1	0	22.01	0.1587	22.86	0.193
		1	104	1	99	22.00	0.1583	22.85	0.1925
		50	25	100	0	22.40	0.1739	23.25	0.2115
	64QAM DFT-s- OFDM	1	1	1	0	21.16	0.1307	22.01	0.1589
		1	104	1	99	21.16	0.1307	22.01	0.1589
		50	25	100	0	21.13	0.1298	21.98	0.1578
	256QA M DFT-s-	1	1	1	0	19.26	0.0843	20.11	0.1025
		1	104	1	99	19.21	0.0833	20.06	0.1013
		50	25	100	0	19.14	0.082	19.99	0.0998

EN-DC n71 (ANT)+2A (ANT)Combination 15MHz+20MHz(LTE)(GT - LC = 3 dB)									
Channel	Mode	NR		LTE		Conducted		EIRP	
		RB		RB					
		Size	Offset	Size	Offset	Power(dBm)	Power(Watts)	EIRP(dBm)	EIRP(W)
Lowest	PI/2 BPSK DFT-s-	1	1	1	0	23.51	0.2243	24.36	0.2728
		1	36	1	99	23.56	0.2269	24.41	0.2759
		18	9	100	0	23.77	0.2381	24.62	0.2895
	QPSK DFT-s- OFDM	1	1	1	0	23.48	0.2228	24.33	0.2709
		1	36	1	99	23.57	0.2274	24.42	0.2765
		18	9	100	0	23.71	0.2348	24.56	0.2856
	16QAM DFT-s- OFDM	1	1	1	0	22.02	0.159	22.87	0.1934
		1	104	1	99	22.43	0.1751	23.28	0.213
		50	25	100	0	22.16	0.1646	23.01	0.2002
	64QAM DFT-s- OFDM	1	1	1	0	21.17	0.1309	22.02	0.1592
		1	104	1	99	21.16	0.1307	22.01	0.1589
		50	25	100	0	21.17	0.131	22.02	0.1593
	256QA M DFT-s-	1	1	1	0	19.34	0.0859	20.19	0.1044
		1	104	1	99	19.00	0.0795	19.85	0.0967
		50	25	100	0	19.14	0.082	19.99	0.0998
Middle	PI/2 BPSK DFT-s-	1	1	1	0	23.56	0.2269	24.41	0.2759
		1	36	1	99	23.81	0.2403	24.66	0.2922
		18	9	100	0	23.83	0.2414	24.68	0.2935
	QPSK DFT-s- OFDM	1	1	1	0	23.54	0.2259	24.39	0.2747
		1	36	1	99	23.70	0.2343	24.55	0.2849
		18	9	100	0	23.78	0.2386	24.63	0.2902
	16QAM DFT-s- OFDM	1	1	1	0	22.17	0.165	23.02	0.2007
		1	104	1	99	22.13	0.1635	22.98	0.1988
		50	25	100	0	22.07	0.1609	22.92	0.1957
	64QAM DFT-s- OFDM	1	1	1	0	21.19	0.1315	22.04	0.16
		1	104	1	99	21.31	0.1352	22.16	0.1644
		50	25	100	0	21.13	0.1298	21.98	0.1578
	256QA M DFT-s-	1	1	1	0	19.00	0.0795	19.85	0.0966
		1	104	1	99	19.25	0.0841	20.10	0.1023
		50	25	100	0	19.35	0.0861	20.20	0.1047
QPSK CP- OFDM	1	1	1	0	22.44	0.1755	23.29	0.2135	
	1	104	1	99	22.33	0.1711	23.18	0.2081	
	53	26	100	0	22.42	0.1747	23.27	0.2125	
Highest	PI/2 BPSK DFT-s-	1	1	1	0	23.51	0.2243	24.36	0.2728
		1	36	1	99	23.54	0.2258	24.39	0.2747
		18	9	100	0	23.83	0.2414	24.68	0.2936
	QPSK DFT-s- OFDM	1	1	1	0	23.37	0.2172	24.22	0.2641
		1	36	1	99	23.34	0.2157	24.19	0.2623
		18	9	100	0	23.79	0.2392	24.64	0.2909
	16QAM DFT-s- OFDM	1	1	1	0	22.14	0.1639	22.99	0.1993
		1	104	1	99	22.47	0.1767	23.32	0.2149
		50	25	100	0	22.41	0.1743	23.26	0.212
	64QAM DFT-s- OFDM	1	1	1	0	21.27	0.134	22.12	0.163
		1	104	1	99	21.33	0.1358	22.18	0.1652
		50	25	100	0	21.16	0.1306	22.01	0.1589
	256QA M DFT-s-	1	1	1	0	19.24	0.0839	20.09	0.1021
		1	104	1	99	19.33	0.0856	20.18	0.1042
		50	25	100	0	19.23	0.0837	20.08	0.1018

EN-DC n71 (ANT)+2A (ANT)Combination 10MHz+20MHz(LTE)(GT - LC = 3 dB)									
Channel	Mode	NR		LTE		Conducted		EIRP	
		RB		RB					
		Size	Offset	Size	Offset	Power(dBm)	Power(Watts)	EIRP(dBm)	EIRP(W)
Lowest	PI/2 BPSK DFT-s-	1	1	1	0	23.56	0.2269	24.41	0.2759
		1	22	1	99	23.67	0.2327	24.52	0.283
		12	6	100	0	23.47	0.2223	24.32	0.2703
	QPSK DFT-s- OFDM	1	1	1	0	23.43	0.2202	24.28	0.2678
		1	22	1	99	23.63	0.2305	24.48	0.2804
		12	6	100	0	23.70	0.2343	24.55	0.2849
	16QAM DFT-s- OFDM	1	1	1	0	22.11	0.1627	22.96	0.1979
		1	50	1	99	22.46	0.1763	23.31	0.2145
		25	12	100	0	22.07	0.1612	22.92	0.1961
	64QAM DFT-s- OFDM	1	1	1	0	21.34	0.1361	22.19	0.1656
		1	50	1	99	21.31	0.1352	22.16	0.1645
		25	12	100	0	21.30	0.1349	22.15	0.164
	256QA M DFT-s-	1	1	1	0	19.11	0.0815	19.96	0.0991
		1	50	1	99	19.33	0.0857	20.18	0.1042
		25	12	100	0	19.02	0.0798	19.87	0.0971
Middle	PI/2 BPSK DFT-s-	1	1	1	0	23.60	0.229	24.45	0.2785
		1	22	1	99	23.74	0.2364	24.59	0.2876
		12	6	100	0	23.79	0.2392	24.64	0.2909
	QPSK DFT-s- OFDM	1	1	1	0	23.53	0.2253	24.38	0.274
		1	22	1	99	23.73	0.2359	24.58	0.2869
		12	6	100	0	23.84	0.2419	24.69	0.2942
	16QAM DFT-s- OFDM	1	1	1	0	22.38	0.1731	23.23	0.2106
		1	50	1	99	22.43	0.1751	23.28	0.213
		25	12	100	0	22.14	0.1639	22.99	0.1993
	64QAM DFT-s- OFDM	1	1	1	0	21.26	0.1337	22.11	0.1626
		1	50	1	99	21.26	0.1337	22.11	0.1626
		25	12	100	0	21.13	0.1297	21.98	0.1578
	256QA M DFT-s-	1	1	1	0	19.20	0.0832	20.05	0.1012
		1	50	1	99	19.28	0.0847	20.13	0.103
		25	12	100	0	19.31	0.0853	20.16	0.1037
QPSK CP- OFDM	1	1	1	0	22.42	0.1747	23.27	0.2125	
	1	50	1	99	22.39	0.1735	23.24	0.211	
	26	13	100	0	22.22	0.1669	23.07	0.203	
Highest	PI/2 BPSK DFT-s-	1	1	1	0	23.69	0.2338	24.54	0.2843
		1	22	1	99	23.71	0.2348	24.56	0.2856
		12	6	100	0	23.76	0.2375	24.61	0.2889
	QPSK DFT-s- OFDM	1	1	1	0	23.63	0.2305	24.48	0.2804
		1	22	1	99	23.65	0.2316	24.50	0.2817
		12	6	100	0	23.81	0.2403	24.66	0.2922
	16QAM DFT-s- OFDM	1	1	1	0	22.29	0.1696	23.14	0.2062
		1	50	1	99	22.27	0.1688	23.12	0.2053
		25	12	100	0	22.19	0.1658	23.04	0.2016
	64QAM DFT-s- OFDM	1	1	1	0	21.26	0.1337	22.11	0.1625
		1	50	1	99	21.28	0.1343	22.13	0.1633
		25	12	100	0	21.16	0.1306	22.01	0.1589
	256QA M DFT-s-	1	1	1	0	19.22	0.0836	20.07	0.1016
		1	50	1	99	19.19	0.083	20.04	0.1009
		25	12	100	0	19.23	0.0837	20.08	0.1018

**5G NR n77 HPUE SA mode:
SCS 30**

SA n77 (ANT M2) 100MHz (GT - LC = 3 dB)							
Channel	Mode	NR		Conducted		EIRP	
		RB		Power(dBm)	Power(Watts)	EIRP(dBm)	EIRP(W)
		Size	Offset				
Lowest	PI/2 BPSK DFT-s- OFDM	1	1	24.06	0.2547	27.06	0.5082
		1	271	24.85	0.3055	27.85	0.6095
		135	67	25.17	0.3289	28.17	0.6561
	QPSK DFT-s- OFDM	1	1	24.09	0.2564	27.09	0.5117
		1	271	24.98	0.3148	27.98	0.6281
		135	67	25.19	0.3304	28.19	0.6592
	16QAM DFT-s- OFDM	1	1	24.23	0.2649	27.23	0.5284
		1	271	24.09	0.2564	27.09	0.5117
		135	67	24.18	0.2618	27.18	0.5224
	64QAM DFT-s- OFDM	1	1	22.65	0.1841	25.65	0.3673
		1	271	22.78	0.1897	25.78	0.3784
		135	67	22.70	0.1862	25.70	0.3715
	256QAM DFT-s- OFDM	1	1	20.75	0.1189	23.75	0.2371
		1	271	20.52	0.1127	23.52	0.2249
		135	67	20.63	0.1156	23.63	0.2307
Middle	PI/2 BPSK DFT-s- OFDM	1	1	24.53	0.2838	27.53	0.5662
		1	271	24.93	0.3112	27.93	0.6209
		135	67	25.45	0.3508	28.45	0.6998
	QPSK DFT-s- OFDM	1	1	24.67	0.2931	27.67	0.5848
		1	271	25.15	0.3273	28.15	0.6531
		135	67	25.51	0.3556	28.51	0.7096
	16QAM DFT-s- OFDM	1	1	24.77	0.2999	27.77	0.5984
		1	271	24.73	0.2972	27.73	0.5929
		135	67	24.77	0.2999	27.77	0.5984
	64QAM DFT-s- OFDM	1	1	23.31	0.2143	26.31	0.4276
		1	271	23.39	0.2183	26.39	0.4355
		135	67	23.38	0.2178	26.38	0.4345
	256QAM DFT-s- OFDM	1	1	21.24	0.133	24.24	0.2655
		1	271	21.21	0.1321	24.21	0.2636
		135	67	21.29	0.1346	24.29	0.2685
QPSK CP-OFDM	1	1	24.31	0.2698	27.31	0.5383	
	1	271	24.26	0.2667	27.26	0.5321	
	137	68	24.29	0.2685	27.29	0.5358	
Highest	PI/2 BPSK DFT-s- OFDM	1	1	24.68	0.2938	27.68	0.5861
		1	271	24.98	0.3148	27.98	0.6281
		135	67	25.55	0.3589	28.55	0.7161
	QPSK DFT-s- OFDM	1	1	24.96	0.3133	27.96	0.6252
		1	271	25.32	0.3404	28.32	0.6792
		135	67	25.57	0.3606	28.57	0.7194
	16QAM DFT-s- OFDM	1	1	24.67	0.2931	27.67	0.5848
		1	271	24.99	0.3155	27.99	0.6295
		135	67	24.86	0.3062	27.86	0.6109
	64QAM DFT-s- OFDM	1	1	23.49	0.2234	26.49	0.4457
		1	271	23.39	0.2183	26.39	0.4355
		135	67	23.37	0.2173	26.37	0.4335
	256QAM DFT-s- OFDM	1	1	21.19	0.1315	24.19	0.2624
		1	271	21.28	0.1343	24.28	0.2679
		135	67	21.14	0.13	24.14	0.2594

SA n77 (ANT) 80MHz (GT - LC = 3 dB)								
Channel	Mode	NR		Conducted		EIRP		
		RB						
		Size	Offset	Power(dBm)	Power(Watts)	EIRP(dBm)	EIRP(W)	
Lowest	PI/2 BPSK DFT-s- OFDM	1	1	24.39	0.2748	27.39	0.5483	
		1	215	24.97	0.3141	27.97	0.6266	
		108	54	25.27	0.3365	28.27	0.6714	
	QPSK DFT-s- OFDM	1	1	24.17	0.2612	27.17	0.5212	
		1	215	25.09	0.3228	28.09	0.6442	
		108	54	25.33	0.3412	28.33	0.6808	
	16QAM DFT-s- OFDM	1	1	24.16	0.2606	27.16	0.52	
		1	215	24.22	0.2642	27.22	0.5272	
		108	54	24.07	0.2553	27.07	0.5093	
	64QAM DFT-s- OFDM	1	1	22.64	0.1837	25.64	0.3664	
		1	215	22.72	0.1871	25.72	0.3733	
		108	54	22.66	0.1845	25.66	0.3681	
	256QAM DFT-s- OFDM	1	1	20.79	0.1199	23.79	0.2393	
		1	215	20.51	0.1125	23.51	0.2244	
		108	54	20.68	0.1169	23.68	0.2333	
	Middle	PI/2 BPSK DFT-s- OFDM	1	1	24.89	0.3083	27.89	0.6152
			1	215	25.19	0.3304	28.19	0.6592
			108	54	25.62	0.3648	28.62	0.7278
QPSK DFT-s- OFDM		1	1	24.94	0.3119	27.94	0.6223	
		1	215	25.24	0.3342	28.24	0.6668	
		108	54	25.63	0.3656	28.63	0.7295	
16QAM DFT-s- OFDM		1	1	24.79	0.3013	27.79	0.6012	
		1	215	24.78	0.3006	27.78	0.5998	
		108	54	24.71	0.2958	27.71	0.5902	
64QAM DFT-s- OFDM		1	1	23.38	0.2178	26.38	0.4345	
		1	215	23.29	0.2133	26.29	0.4256	
		108	54	23.34	0.2158	26.34	0.4305	
256QAM DFT-s- OFDM		1	1	21.15	0.1303	24.15	0.26	
		1	215	21.13	0.1297	24.13	0.2588	
		108	54	21.26	0.1337	24.26	0.2667	
QPSK CP-OFDM		1	1	24.22	0.2642	27.22	0.5272	
		1	215	24.23	0.2649	27.23	0.5284	
		109	54	24.32	0.2704	27.32	0.5395	
Highest	PI/2 BPSK DFT-s- OFDM	1	1	25.05	0.3199	28.05	0.6383	
		1	215	25.21	0.3319	28.21	0.6622	
		108	54	25.65	0.3673	28.65	0.7328	
	QPSK DFT-s- OFDM	1	1	25.08	0.3221	28.08	0.6427	
		1	215	25.27	0.3365	28.27	0.6714	
		108	54	25.71	0.3724	28.71	0.743	
	16QAM DFT-s- OFDM	1	1	24.68	0.2938	27.68	0.5861	
		1	215	24.88	0.3076	27.88	0.6138	
		108	54	24.84	0.3048	27.84	0.6081	
	64QAM DFT-s- OFDM	1	1	23.44	0.2208	26.44	0.4406	
		1	215	23.40	0.2188	26.40	0.4365	
		108	54	23.38	0.2178	26.38	0.4345	
	256QAM DFT-s- OFDM	1	1	21.26	0.1337	24.26	0.2667	
		1	215	21.28	0.1343	24.28	0.2679	
		108	54	21.29	0.1346	24.29	0.2685	

SA n77 (ANT) 60MHz (GT - LC = 3 dB)							
Channel	Mode	NR		Conducted		EIRP	
		RB		Power(dBm)	Power(Watts)	EIRP(dBm)	EIRP(W)
		Size	Offset				
Lowest	PI/2 BPSK DFT-s- OFDM	1	1	24.45	0.2786	27.45	0.5559
		1	160	24.95	0.3126	27.95	0.6237
		81	40	25.26	0.3357	28.26	0.6699
	QPSK DFT-s- OFDM	1	1	24.56	0.2858	27.56	0.5702
		1	160	25.03	0.3184	28.03	0.6353
		81	40	25.16	0.3281	28.16	0.6546
	16QAM DFT-s- OFDM	1	1	24.22	0.2642	27.22	0.5272
		1	160	24.11	0.2576	27.11	0.514
		81	40	24.15	0.26	27.15	0.5188
	64QAM DFT-s- OFDM	1	1	22.71	0.1866	25.71	0.3724
		1	160	22.68	0.1854	25.68	0.3698
		81	40	22.71	0.1866	25.71	0.3724
	256QAM DFT-s- OFDM	1	1	20.52	0.1127	23.52	0.2249
		1	160	20.54	0.1132	23.54	0.2259
		81	40	20.72	0.118	23.72	0.2355
Middle	PI/2 BPSK DFT-s- OFDM	1	1	25.47	0.3524	28.47	0.7031
		1	160	25.75	0.3758	28.75	0.7499
		81	40	25.82	0.3819	28.82	0.7621
	QPSK DFT-s- OFDM	1	1	25.58	0.3614	28.58	0.7211
		1	160	25.78	0.3784	28.78	0.7551
		81	40	25.79	0.3793	28.79	0.7568
	16QAM DFT-s- OFDM	1	1	24.73	0.2972	27.73	0.5929
		1	160	24.76	0.2992	27.76	0.597
		81	40	24.76	0.2992	27.76	0.597
	64QAM DFT-s- OFDM	1	1	23.30	0.2138	26.30	0.4266
		1	160	23.31	0.2143	26.31	0.4276
		81	40	23.38	0.2178	26.38	0.4345
	256QAM DFT-s- OFDM	1	1	21.12	0.1294	24.12	0.2582
		1	160	21.18	0.1312	24.18	0.2618
		81	40	21.19	0.1315	24.19	0.2624
QPSK CP-OFDM	1	1	24.29	0.2685	27.29	0.5358	
	1	160	24.24	0.2655	27.24	0.5297	
	81	40	24.28	0.2679	27.28	0.5346	
Highest	PI/2 BPSK DFT-s- OFDM	1	1	25.64	0.3664	28.64	0.7311
		1	160	25.82	0.3819	28.82	0.7621
		81	40	25.93	0.3917	28.93	0.7816
	QPSK DFT-s- OFDM	1	1	25.56	0.3597	28.56	0.7178
		1	160	25.87	0.3864	28.87	0.7709
		81	40	26.03	0.4009	29.03	0.7998
	16QAM DFT-s- OFDM	1	1	24.61	0.2891	27.61	0.5768
		1	160	24.81	0.3027	27.81	0.6039
		81	40	24.90	0.309	27.90	0.6166
	64QAM DFT-s- OFDM	1	1	23.47	0.2223	26.47	0.4436
		1	160	23.48	0.2228	26.48	0.4446
		81	40	23.32	0.2148	26.32	0.4285
	256QAM DFT-s- OFDM	1	1	21.16	0.1306	24.16	0.2606
		1	160	21.29	0.1346	24.29	0.2685
		81	40	21.25	0.1334	24.25	0.2661

SA n77 (ANT) 50MHz (GT - LC = 3 dB)								
Channel	Mode	NR		Conducted		EIRP		
		RB		Power(dBm)	Power(Watts)	EIRP(dBm)	EIRP(W)	
		Size	Offset					
Lowest	PI/2 BPSK DFT-s-OFDM	1	1	24.88	0.3076	27.88	0.6138	
		1	131	25.31	0.3396	28.31	0.6776	
		64	32	25.28	0.3373	28.28	0.673	
	QPSK DFT-s-OFDM	1	1	24.89	0.3083	27.89	0.6152	
		1	131	25.41	0.3475	28.41	0.6934	
		64	32	25.42	0.3483	28.42	0.695	
	16QAM DFT-s-OFDM	1	1	24.13	0.2588	27.13	0.5164	
		1	131	24.17	0.2612	27.17	0.5212	
		64	32	24.24	0.2655	27.24	0.5297	
	64QAM DFT-s-OFDM	1	1	22.69	0.1858	25.69	0.3707	
		1	131	22.64	0.1837	25.64	0.3664	
		64	32	22.66	0.1845	25.66	0.3681	
	256QAM DFT-s-OFDM	1	1	20.51	0.1125	23.51	0.2244	
		1	131	20.58	0.1143	23.58	0.228	
		64	32	20.70	0.1175	23.70	0.2344	
	Middle	PI/2 BPSK DFT-s-OFDM	1	1	25.52	0.3565	28.52	0.7112
			1	131	25.65	0.3673	28.65	0.7328
			64	32	25.81	0.3811	28.81	0.7603
QPSK DFT-s-OFDM		1	1	25.59	0.3622	28.59	0.7228	
		1	131	25.66	0.3681	28.66	0.7345	
		64	32	25.82	0.3819	28.82	0.7621	
16QAM DFT-s-OFDM		1	1	24.80	0.302	27.80	0.6026	
		1	131	24.79	0.3013	27.79	0.6012	
		64	32	24.74	0.2979	27.74	0.5943	
64QAM DFT-s-OFDM		1	1	23.30	0.2138	26.30	0.4266	
		1	131	23.41	0.2193	26.41	0.4375	
		64	32	23.35	0.2163	26.35	0.4315	
256QAM DFT-s-OFDM		1	1	21.13	0.1297	24.13	0.2588	
		1	131	21.19	0.1315	24.19	0.2624	
		64	32	21.24	0.133	24.24	0.2655	
QPSK CP-OFDM		1	1	24.16	0.2606	27.16	0.52	
		1	131	24.26	0.2667	27.26	0.5321	
		67	33	24.17	0.2612	27.17	0.5212	
Highest	PI/2 BPSK DFT-s-OFDM	1	1	25.51	0.3556	28.51	0.7096	
		1	131	25.58	0.3614	28.58	0.7211	
		64	32	26.01	0.399	29.01	0.7962	
	QPSK DFT-s-OFDM	1	1	25.71	0.3724	28.71	0.743	
		1	131	25.83	0.3828	28.83	0.7638	
		64	32	25.92	0.3908	28.92	0.7798	
	16QAM DFT-s-OFDM	1	1	24.61	0.2891	27.61	0.5768	
		1	131	24.82	0.3034	27.82	0.6053	
		64	32	24.95	0.3126	27.95	0.6237	
	64QAM DFT-s-OFDM	1	1	23.33	0.2153	26.33	0.4295	
		1	131	23.32	0.2148	26.32	0.4285	
		64	32	23.46	0.2218	26.46	0.4426	
	256QAM DFT-s-OFDM	1	1	21.23	0.1327	24.23	0.2649	
		1	131	21.29	0.1346	24.29	0.2685	
		64	32	21.18	0.1312	24.18	0.2618	

SA n77 (ANT) 40MHz (GT - LC = 3 dB)							
Channel	Mode	NR		Conducted		EIRP	
		RB					
		Size	Offset	Power(dBm)	Power(Watts)	EIRP(dBm)	EIRP(W)
Lowest	PI/2 BPSK DFT-s- OFDM	1	1	24.72	0.2965	27.72	0.5916
		1	104	25.03	0.3184	28.03	0.6353
		50	25	25.31	0.3396	28.31	0.6776
	QPSK DFT-s- OFDM	1	1	24.73	0.2972	27.73	0.5929
		1	104	25.11	0.3243	28.11	0.6471
		50	25	25.27	0.3365	28.27	0.6714
	16QAM DFT-s- OFDM	1	1	24.05	0.2541	27.05	0.507
		1	104	24.06	0.2547	27.06	0.5082
		50	25	24.25	0.2661	27.25	0.5309
	64QAM DFT-s- OFDM	1	1	22.71	0.1866	25.71	0.3724
		1	104	22.70	0.1862	25.70	0.3715
		50	25	22.64	0.1837	25.64	0.3664
	256QAM DFT-s- OFDM	1	1	20.54	0.1132	23.54	0.2259
		1	104	20.61	0.1151	23.61	0.2296
		50	25	20.77	0.1194	23.77	0.2382
Middle	PI/2 BPSK DFT-s- OFDM	1	1	25.23	0.3334	28.23	0.6653
		1	104	25.33	0.3412	28.33	0.6808
		50	25	25.76	0.3767	28.76	0.7516
	QPSK DFT-s- OFDM	1	1	25.26	0.3357	28.26	0.6699
		1	104	25.41	0.3475	28.41	0.6934
		50	25	25.83	0.3828	28.83	0.7638
	16QAM DFT-s- OFDM	1	1	24.77	0.2999	27.77	0.5984
		1	104	24.78	0.3006	27.78	0.5998
		50	25	24.79	0.3013	27.79	0.6012
	64QAM DFT-s- OFDM	1	1	23.30	0.2138	26.30	0.4266
		1	104	23.29	0.2133	26.29	0.4256
		50	25	23.40	0.2188	26.40	0.4365
	256QAM DFT-s- OFDM	1	1	21.22	0.1324	24.22	0.2642
		1	104	21.30	0.1349	24.30	0.2692
		50	25	21.29	0.1346	24.29	0.2685
QPSK CP-OFDM	1	1	24.27	0.2673	27.27	0.5333	
	1	104	24.15	0.26	27.15	0.5188	
	53	26	24.17	0.2612	27.17	0.5212	
Highest	PI/2 BPSK DFT-s- OFDM	1	1	25.31	0.3396	28.31	0.6776
		1	104	25.47	0.3524	28.47	0.7031
		50	25	25.88	0.3873	28.88	0.7727
	QPSK DFT-s- OFDM	1	1	25.45	0.3508	28.45	0.6998
		1	104	25.51	0.3556	28.51	0.7096
		50	25	25.84	0.3837	28.84	0.7656
	16QAM DFT-s- OFDM	1	1	24.62	0.2897	27.62	0.5781
		1	104	24.84	0.3048	27.84	0.6081
		50	25	24.91	0.3097	27.91	0.618
	64QAM DFT-s- OFDM	1	1	23.42	0.2198	26.42	0.4385
		1	104	23.42	0.2198	26.42	0.4385
		50	25	23.32	0.2148	26.32	0.4285
	256QAM DFT-s- OFDM	1	1	21.27	0.134	24.27	0.2673
		1	104	21.15	0.1303	24.15	0.26
		50	25	21.26	0.1337	24.26	0.2667

SA n77 (ANT) 20MHz (GT - LC = 3 dB)								
Channel	Mode	NR		Conducted		EIRP		
		RB						
		Size	Offset	Power(dBm)	Power(Watts)	EIRP(dBm)	EIRP(W)	
Lowest	PI/2 BPSK DFT-s- OFDM	1	1	25.06	0.3206	28.06	0.6397	
		1	49	25.14	0.3266	28.14	0.6516	
		25	12	25.28	0.3373	28.28	0.673	
	QPSK DFT-s- OFDM	1	1	25.06	0.3206	28.06	0.6397	
		1	49	25.14	0.3266	28.14	0.6516	
		25	12	25.31	0.3396	28.31	0.6776	
	16QAM DFT-s- OFDM	1	1	24.05	0.2541	27.05	0.507	
		1	49	24.18	0.2618	27.18	0.5224	
		25	12	24.06	0.2547	27.06	0.5082	
	64QAM DFT-s- OFDM	1	1	22.69	0.1858	25.69	0.3707	
		1	49	22.63	0.1832	25.63	0.3656	
		25	12	22.62	0.1828	25.62	0.3648	
	256QAM DFT-s- OFDM	1	1	20.61	0.1151	23.61	0.2296	
		1	49	20.58	0.1143	23.58	0.228	
		25	12	20.59	0.1146	23.59	0.2286	
	Middle	PI/2 BPSK DFT-s- OFDM	1	1	25.52	0.3565	28.52	0.7112
			1	49	25.55	0.3589	28.55	0.7161
			25	12	25.75	0.3758	28.75	0.7499
QPSK DFT-s- OFDM		1	1	25.63	0.3656	28.63	0.7295	
		1	49	25.61	0.3639	28.61	0.7261	
		25	12	25.84	0.3837	28.84	0.7656	
16QAM DFT-s- OFDM		1	1	24.81	0.3027	27.81	0.6039	
		1	49	24.79	0.3013	27.79	0.6012	
		25	12	24.80	0.302	27.80	0.6026	
64QAM DFT-s- OFDM		1	1	23.31	0.2143	26.31	0.4276	
		1	49	23.36	0.2168	26.36	0.4325	
		25	12	23.31	0.2143	26.31	0.4276	
256QAM DFT-s- OFDM		1	1	21.29	0.1346	24.29	0.2685	
		1	49	21.11	0.1291	24.11	0.2576	
		25	12	21.31	0.1352	24.31	0.2698	
QPSK CP-OFDM		1	1	24.29	0.2685	27.29	0.5358	
		1	49	24.31	0.2698	27.31	0.5383	
		25	12	24.29	0.2685	27.29	0.5358	
Highest	PI/2 BPSK DFT-s- OFDM	1	1	25.71	0.3724	28.71	0.743	
		1	49	25.71	0.3724	28.71	0.743	
		25	12	26.02	0.3999	29.02	0.798	
	QPSK DFT-s- OFDM	1	1	25.79	0.3793	28.79	0.7568	
		1	49	25.74	0.375	28.74	0.7482	
		25	12	25.88	0.3873	28.88	0.7727	
	16QAM DFT-s- OFDM	1	1	24.61	0.2891	27.61	0.5768	
		1	49	24.87	0.3069	27.87	0.6124	
		25	12	24.94	0.3119	27.94	0.6223	
	64QAM DFT-s- OFDM	1	1	23.44	0.2208	26.44	0.4406	
		1	49	23.34	0.2158	26.34	0.4305	
		25	12	23.40	0.2188	26.40	0.4365	
	256QAM DFT-s- OFDM	1	1	21.11	0.1291	24.11	0.2576	
		1	49	21.18	0.1312	24.18	0.2618	
		25	12	21.20	0.1318	24.20	0.263	

SA n77 (ANT) 15MHz (GT - LC = 3-2.15 dB)								
Channel	Mode	NR		Conducted		EIRP		
		RB						
		Size	Offset	Power(dBm)	Power(Watts)	EIRP(dBm)	EIRP(W)	
Lowest	PI/2 BPSK DFT-s-OFDM	1	1	25.05	0.3199	28.05	0.6383	
		1	36	25.17	0.3289	28.17	0.6561	
		18	9	25.29	0.3381	28.29	0.6745	
	QPSK DFT-s-OFDM	1	1	25.09	0.3228	28.09	0.6442	
		1	36	25.18	0.3296	28.18	0.6577	
		18	9	25.27	0.3365	28.27	0.6714	
	16QAM DFT-s-OFDM	1	1	24.21	0.2636	27.21	0.526	
		1	36	24.07	0.2553	27.07	0.5093	
		18	9	24.16	0.2606	27.16	0.52	
	64QAM DFT-s-OFDM	1	1	22.65	0.1841	25.65	0.3673	
		1	36	22.79	0.1901	25.79	0.3793	
		18	9	22.78	0.1897	25.78	0.3784	
	256QAM DFT-s-OFDM	1	1	20.57	0.114	23.57	0.2275	
		1	36	20.54	0.1132	23.54	0.2259	
		18	9	20.60	0.1148	23.60	0.2291	
	Middle	PI/2 BPSK DFT-s-OFDM	1	1	25.64	0.3664	28.64	0.7311
			1	36	25.68	0.3698	28.68	0.7379
			18	9	25.81	0.3811	28.81	0.7603
QPSK DFT-s-OFDM		1	1	25.72	0.3733	28.72	0.7447	
		1	36	25.69	0.3707	28.69	0.7396	
		18	9	25.81	0.3811	28.81	0.7603	
16QAM DFT-s-OFDM		1	1	24.78	0.3006	27.78	0.5998	
		1	36	24.77	0.2999	27.77	0.5984	
		18	9	24.73	0.2972	27.73	0.5929	
64QAM DFT-s-OFDM		1	1	23.41	0.2193	26.41	0.4375	
		1	36	23.30	0.2138	26.30	0.4266	
		18	9	23.37	0.2173	26.37	0.4335	
256QAM DFT-s-OFDM		1	1	21.22	0.1324	24.22	0.2642	
		1	36	21.24	0.133	24.24	0.2655	
		18	9	21.16	0.1306	24.16	0.2606	
QPSK CP-OFDM		1	1	24.16	0.2606	27.16	0.52	
		1	36	24.31	0.2698	27.31	0.5383	
		19	9	24.18	0.2618	27.18	0.5224	
Highest	PI/2 BPSK DFT-s-OFDM	1	1	25.77	0.3776	28.77	0.7534	
		1	36	25.71	0.3724	28.71	0.743	
		18	9	25.93	0.3917	28.93	0.7816	
	QPSK DFT-s-OFDM	1	1	25.79	0.3793	28.79	0.7568	
		1	36	25.78	0.3784	28.78	0.7551	
		18	9	25.84	0.3837	28.84	0.7656	
	16QAM DFT-s-OFDM	1	1	24.68	0.2938	27.68	0.5861	
		1	36	24.90	0.309	27.90	0.6166	
		18	9	24.85	0.3055	27.85	0.6095	
	64QAM DFT-s-OFDM	1	1	23.44	0.2208	26.44	0.4406	
		1	36	23.43	0.2203	26.43	0.4395	
		18	9	23.36	0.2168	26.36	0.4325	
	256QAM DFT-s-OFDM	1	1	21.19	0.1315	24.19	0.2624	
		1	36	21.12	0.1294	24.12	0.2582	
		18	9	21.29	0.1346	24.29	0.2685	

SA n77 (ANT) 10MHz (GT - LC = 3 dB)								
Channel	Mode	NR		Conducted		EIRP		
		RB						
		Size	Offset	Power(dBm)	Power(Watts)	EIRP(dBm)	EIRP(W)	
Lowest	PI/2 BPSK DFT-s-OFDM	1	1	25.04	0.3192	28.04	0.6368	
		1	22	25.11	0.3243	28.11	0.6471	
		12	6	25.19	0.3304	28.19	0.6592	
	QPSK DFT-s-OFDM	1	1	25.09	0.3228	28.09	0.6442	
		1	22	25.12	0.3251	28.12	0.6486	
		12	6	25.21	0.3319	28.21	0.6622	
	16QAM DFT-s-OFDM	1	1	24.14	0.2594	27.14	0.5176	
		1	22	24.15	0.26	27.15	0.5188	
		12	6	24.21	0.2636	27.21	0.526	
	64QAM DFT-s-OFDM	1	1	22.74	0.1879	25.74	0.375	
		1	22	22.66	0.1845	25.66	0.3681	
		12	6	22.71	0.1866	25.71	0.3724	
	256QAM DFT-s-OFDM	1	1	20.56	0.1138	23.56	0.227	
		1	22	20.71	0.1178	23.71	0.235	
		12	6	20.73	0.1183	23.73	0.236	
	Middle	PI/2 BPSK DFT-s-OFDM	1	1	25.68	0.3698	28.68	0.7379
			1	22	25.72	0.3733	28.72	0.7447
			12	6	25.79	0.3793	28.79	0.7568
QPSK DFT-s-OFDM		1	1	25.72	0.3733	28.72	0.7447	
		1	22	25.68	0.3698	28.68	0.7379	
		12	6	25.77	0.3776	28.77	0.7534	
16QAM DFT-s-OFDM		1	1	24.78	0.3006	27.78	0.5998	
		1	22	24.77	0.2999	27.77	0.5984	
		12	6	24.78	0.3006	27.78	0.5998	
64QAM DFT-s-OFDM		1	1	23.33	0.2153	26.33	0.4295	
		1	22	23.35	0.2163	26.35	0.4315	
		12	6	23.31	0.2143	26.31	0.4276	
256QAM DFT-s-OFDM		1	1	21.17	0.1309	24.17	0.2612	
		1	22	21.29	0.1346	24.29	0.2685	
		12	6	21.28	0.1343	24.28	0.2679	
QPSK CP-OFDM		1	1	24.18	0.2618	27.18	0.5224	
		1	22	24.23	0.2649	27.23	0.5284	
		12	6	24.32	0.2704	27.32	0.5395	
Highest	PI/2 BPSK DFT-s-OFDM	1	1	25.71	0.3724	28.71	0.743	
		1	22	25.67	0.369	28.67	0.7362	
		12	6	25.96	0.3945	28.96	0.787	
	QPSK DFT-s-OFDM	1	1	25.76	0.3767	28.76	0.7516	
		1	22	25.78	0.3784	28.78	0.7551	
		12	6	25.91	0.3899	28.91	0.778	
	16QAM DFT-s-OFDM	1	1	24.67	0.2931	27.67	0.5848	
		1	22	24.93	0.3112	27.93	0.6209	
		12	6	24.98	0.3148	27.98	0.6281	
	64QAM DFT-s-OFDM	1	1	23.41	0.2193	26.41	0.4375	
		1	22	23.45	0.2213	26.45	0.4416	
		12	6	23.32	0.2148	26.32	0.4285	
	256QAM DFT-s-OFDM	1	1	21.18	0.1312	24.18	0.2618	
		1	22	21.22	0.1324	24.22	0.2642	
		12	6	21.28	0.1343	24.28	0.2679	

SCS 15

SA n77 (ANT) 20MHz (GT - LC = 3 dB)								
Channel	Mode	NR		Conducted		EIRP		
		RB						
		Size	Offset	Power(dBm)	Power(Watts)	EIRP(dBm)	EIRP(W)	
Lowest	PI/2 BPSK DFT-s- OFDM	1	1	25.03	0.3184	28.03	0.6353	
		1	104	25.26	0.3357	28.26	0.6699	
		50	25	25.20	0.3311	28.20	0.6607	
	QPSK DFT-s- OFDM	1	1	25.14	0.3266	28.14	0.6516	
		1	104	25.42	0.3483	28.42	0.695	
		50	25	25.23	0.3334	28.23	0.6653	
	16QAM DFT-s- OFDM	1	1	23.97	0.2495	26.97	0.4977	
		1	49	24.16	0.2606	27.16	0.52	
		25	12	24.36	0.2729	27.36	0.5445	
	64QAM DFT-s- OFDM	1	1	22.46	0.1762	25.46	0.3516	
		1	49	22.65	0.1841	25.65	0.3673	
		25	12	22.78	0.1897	25.78	0.3784	
	256QAM DFT-s- OFDM	1	1	20.49	0.1119	23.49	0.2234	
		1	49	20.56	0.1138	23.56	0.227	
		25	12	20.82	0.1208	23.82	0.241	
	Middle	PI/2 BPSK DFT-s- OFDM	1	1	25.45	0.3508	28.45	0.6998
			1	104	25.48	0.3532	28.48	0.7047
			50	25	25.62	0.3648	28.62	0.7278
QPSK DFT-s- OFDM		1	1	25.56	0.3597	28.56	0.7178	
		1	104	25.68	0.3698	28.68	0.7379	
		50	25	25.71	0.3724	28.71	0.743	
16QAM DFT-s- OFDM		1	1	24.55	0.2851	27.55	0.5689	
		1	104	24.99	0.3155	27.99	0.6295	
		50	25	24.77	0.2999	27.77	0.5984	
64QAM DFT-s- OFDM		1	1	23.23	0.2104	26.23	0.4198	
		1	104	23.21	0.2094	26.21	0.4178	
		50	25	23.31	0.2143	26.31	0.4276	
256QAM DFT-s- OFDM		1	1	21.22	0.1324	24.22	0.2642	
		1	104	21.58	0.1439	24.58	0.2871	
		50	25	21.26	0.1337	24.26	0.2667	
QPSK CP-OFDM		1	1	24.01	0.2518	27.01	0.5023	
		1	104	24.51	0.2825	27.51	0.5636	
		39	19	24.28	0.2679	27.28	0.5346	
Highest	PI/2 BPSK DFT-s- OFDM	1	1	25.58	0.3614	28.58	0.7211	
		1	104	25.64	0.3664	28.64	0.7311	
		50	25	25.84	0.3837	28.84	0.7656	
	QPSK DFT-s- OFDM	1	1	25.68	0.3698	28.68	0.7379	
		1	104	25.84	0.3837	28.84	0.7656	
		50	25	25.94	0.3926	28.94	0.7834	
	16QAM DFT-s- OFDM	1	1	24.76	0.2992	27.76	0.597	
		1	49	24.71	0.2958	27.71	0.5902	
		25	12	24.81	0.3027	27.81	0.6039	
	64QAM DFT-s- OFDM	1	1	23.19	0.2084	26.19	0.4159	
		1	49	23.24	0.2109	26.24	0.4207	
		25	12	23.29	0.2133	26.29	0.4256	
	256QAM DFT-s- OFDM	1	1	21.11	0.1291	24.11	0.2576	
		1	49	21.23	0.1327	24.23	0.2649	
		25	12	21.31	0.1352	24.31	0.2698	

SA n77 (ANT) 15MHz (GT - LC = 3 dB)							
Channel	Mode	NR		Conducted		EIRP	
		RB					
		Size	Offset	Power(dBm)	Power(Watts)	EIRP(dBm)	EIRP(W)
Lowest	PI/2 BPSK DFT-s-OFDM	1	1	25.01	0.317	28.01	0.6324
		1	77	25.22	0.3327	28.22	0.6637
		36	18	25.18	0.3296	28.18	0.6577
	QPSK DFT-s-OFDM	1	1	25.12	0.3251	28.12	0.6486
		1	77	25.32	0.3404	28.32	0.6792
		36	18	25.19	0.3304	28.19	0.6592
	16QAM DFT-s-OFDM	1	1	24.36	0.2729	27.36	0.5445
		1	77	24.58	0.2871	27.58	0.5728
		36	18	24.21	0.2636	27.21	0.526
	64QAM DFT-s-OFDM	1	1	22.65	0.1841	25.65	0.3673
		1	77	23.01	0.2	26.01	0.399
		36	18	22.74	0.1879	25.74	0.375
	256QAM DFT-s-OFDM	1	1	20.45	0.1109	23.45	0.2213
		1	77	20.61	0.1151	23.61	0.2296
		36	18	20.75	0.1189	23.75	0.2371
Middle	PI/2 BPSK DFT-s-OFDM	1	1	25.55	0.3589	28.55	0.7161
		1	77	25.71	0.3724	28.71	0.743
		36	18	25.74	0.375	28.74	0.7482
	QPSK DFT-s-OFDM	1	1	25.46	0.3516	28.46	0.7015
		1	77	25.61	0.3639	28.61	0.7261
		36	18	25.79	0.3793	28.79	0.7568
	16QAM DFT-s-OFDM	1	1	24.69	0.2944	27.69	0.5875
		1	77	25.02	0.3177	28.02	0.6339
		36	18	24.78	0.3006	27.78	0.5998
	64QAM DFT-s-OFDM	1	1	23.16	0.207	26.16	0.413
		1	77	23.25	0.2113	26.25	0.4217
		36	18	23.24	0.2109	26.24	0.4207
	256QAM DFT-s-OFDM	1	1	21.23	0.1327	24.23	0.2649
		1	77	21.59	0.1442	24.59	0.2877
		36	18	21.16	0.1306	24.16	0.2606
QPSK CP-OFDM	1	1	24.49	0.2812	27.49	0.561	
	1	77	24.52	0.2831	27.52	0.5649	
	39	19	24.25	0.2661	27.25	0.5309	
Highest	PI/2 BPSK DFT-s-OFDM	1	1	25.66	0.3681	28.66	0.7345
		1	77	25.75	0.3758	28.75	0.7499
		36	18	25.81	0.3811	28.81	0.7603
	QPSK DFT-s-OFDM	1	1	25.92	0.3908	28.92	0.7798
		1	77	25.96	0.3945	28.96	0.787
		36	18	25.83	0.3828	28.83	0.7638
	16QAM DFT-s-OFDM	1	1	25.28	0.3373	28.28	0.673
		1	77	25.35	0.3428	28.35	0.6839
		36	18	24.94	0.3119	27.94	0.6223
	64QAM DFT-s-OFDM	1	1	23.38	0.2178	26.38	0.4345
		1	77	23.31	0.2143	26.31	0.4276
		36	18	23.34	0.2158	26.34	0.4305
	256QAM DFT-s-OFDM	1	1	21.66	0.1466	24.66	0.2924
		1	77	21.77	0.1503	24.77	0.2999
		36	18	21.41	0.1384	24.41	0.2761

SA n77 (ANT) 10MHz (GT - LC = 3 dB)							
Channel	Mode	NR		Conducted		EIRP	
		RB					
		Size	Offset	Power(dBm)	Power(Watts)	EIRP(dBm)	EIRP(W)
Lowest	PI/2 BPSK DFT-s- OFDM	1	1	25.42	0.3483	28.42	0.695
		1	50	25.53	0.3573	28.53	0.7129
		25	12	25.51	0.3556	28.51	0.7096
	QPSK DFT-s- OFDM	1	1	25.21	0.3319	28.21	0.6622
		1	50	25.35	0.3428	28.35	0.6839
		25	12	25.38	0.3451	28.38	0.6887
	16QAM DFT-s- OFDM	1	1	24.45	0.2786	27.45	0.5559
		1	50	24.62	0.2897	27.62	0.5781
		25	12	24.46	0.2793	27.46	0.5572
	64QAM DFT-s- OFDM	1	1	23.08	0.2032	26.08	0.4055
		1	50	23.28	0.2128	26.28	0.4246
		25	12	22.93	0.1963	25.93	0.3917
	256QAM DFT-s- OFDM	1	1	20.81	0.1205	23.81	0.2404
		1	50	20.98	0.1253	23.98	0.25
		25	12	20.97	0.125	23.97	0.2495
Middle	PI/2 BPSK DFT-s- OFDM	1	1	25.41	0.3475	28.41	0.6934
		1	50	25.62	0.3648	28.62	0.7278
		25	12	25.53	0.3573	28.53	0.7129
	QPSK DFT-s- OFDM	1	1	25.54	0.3581	28.54	0.7145
		1	50	25.64	0.3664	28.64	0.7311
		25	12	25.58	0.3614	28.58	0.7211
	16QAM DFT-s- OFDM	1	1	24.71	0.2958	27.71	0.5902
		1	50	24.81	0.3027	27.81	0.6039
		25	12	24.62	0.2897	27.62	0.5781
	64QAM DFT-s- OFDM	1	1	23.08	0.2032	26.08	0.4055
		1	50	22.97	0.1982	25.97	0.3954
		25	12	23.07	0.2028	26.07	0.4046
	256QAM DFT-s- OFDM	1	1	21.41	0.1384	24.41	0.2761
		1	50	21.01	0.1262	24.01	0.2518
		25	12	21.17	0.1309	24.17	0.2612
QPSK CP-OFDM	1	1	24.01	0.2518	27.01	0.5023	
	1	22	24.04	0.2535	27.04	0.5058	
	12	6	24.97	0.3141	27.97	0.6266	
Highest	PI/2 BPSK DFT-s- OFDM	1	1	25.45	0.3508	28.45	0.6998
		1	50	25.54	0.3581	28.54	0.7145
		25	12	25.62	0.3648	28.62	0.7278
	QPSK DFT-s- OFDM	1	1	25.71	0.3724	28.71	0.743
		1	50	25.64	0.3664	28.64	0.7311
		25	12	25.59	0.3622	28.59	0.7228
	16QAM DFT-s- OFDM	1	1	24.85	0.3055	27.85	0.6095
		1	50	24.61	0.2891	27.61	0.5768
		25	12	24.84	0.3048	27.84	0.6081
	64QAM DFT-s- OFDM	1	1	23.13	0.2056	26.13	0.4102
		1	50	23.40	0.2188	26.40	0.4365
		25	12	23.06	0.2023	26.06	0.4036
	256QAM DFT-s- OFDM	1	1	21.18	0.1312	24.18	0.2618
		1	50	21.01	0.1262	24.01	0.2518
		25	12	21.16	0.1306	24.16	0.2606

5G NR n77 UL_MIMO HPUE SA mode:

SCS 30

SA n77 (ANT M2+ANT M) 100MHz (GT - LC = 6.01 dB)								
Channel	Mode	NR		Conducted		EIRP		
		RB		Power(dBm)	Power(Watts)	EIRP(dBm)	EIRP(W)	
		Size	Offset					
Lowest	QPSK CP-OFDM	1	1	23.03	0.2008	29.04	0.8011	
		1	271	23.39	0.2184	29.40	0.8714	
		137	68	23.61	0.2294	29.62	0.9154	
	16QAM CP-s- OFDM	1	1	22.69	0.186	28.70	0.7421	
		1	271	23.14	0.2059	29.15	0.8217	
		137	68	23.25	0.2114	29.26	0.8434	
	64QAM CP-s- OFDM	1	1	20.91	0.1233	26.92	0.492	
		1	271	21.42	0.1388	27.43	0.5538	
		137	68	21.74	0.1491	27.75	0.5951	
	256QAM CP-s- OFDM	1	1	18.27	0.0672	24.28	0.268	
		1	271	18.75	0.0749	24.76	0.2989	
		137	68	18.73	0.0746	24.74	0.2975	
Middle	QPSK CP-OFDM	1	1	23.16	0.2071	29.17	0.8262	
		1	271	23.43	0.2202	29.44	0.8788	
		137	68	23.91	0.2461	29.92	0.982	
	16QAM CP-s- OFDM	1	1	22.93	0.1962	28.94	0.7828	
		1	271	23.00	0.1994	29.01	0.7956	
		137	68	23.47	0.2222	29.48	0.8868	
	64QAM CP-s- OFDM	1	1	21.18	0.1312	27.19	0.5234	
		1	271	21.30	0.1348	27.31	0.5379	
		137	68	21.97	0.1574	27.98	0.6281	
	256QAM CP-s- OFDM	1	1	18.34	0.0682	24.35	0.2723	
		1	271	18.60	0.0725	24.61	0.2892	
		137	68	18.91	0.0777	24.92	0.3102	
	Highest	QPSK CP-OFDM	1	1	23.30	0.2139	29.31	0.8533
			1	271	23.34	0.2157	29.35	0.8606
			137	68	23.69	0.234	29.70	0.9337
		16QAM CP-s- OFDM	1	1	22.90	0.195	28.91	0.7781
			1	271	23.00	0.1996	29.01	0.7963
			137	68	23.25	0.2112	29.26	0.8429
64QAM CP-s- OFDM		1	1	21.26	0.1335	27.27	0.5328	
		1	271	21.43	0.1389	27.44	0.5541	
		137	68	21.76	0.1499	27.77	0.5979	
256QAM CP-s- OFDM		1	1	18.30	0.0676	24.31	0.2698	
		1	271	18.45	0.07	24.46	0.2794	
		137	68	18.69	0.074	24.70	0.2953	

SA n77 (ANT M2+ANT M) 80MHz (GT - LC = 6.01 dB)							
Channel	Mode	NR		Conducted		EIRP	
		RB					
		Size	Offset	Power(dBm)	Power(Watts)	EIRP(dBm)	EIRP(W)
Lowest	QPSK CP-OFDM	1	1	23.32	0.2148	29.33	0.8572
		1	215	23.52	0.225	29.53	0.8976
		109	54	23.65	0.2315	29.66	0.9239
	16QAM CP-s- OFDM	1	1	23.12	0.205	29.13	0.818
		1	215	23.22	0.2097	29.23	0.8366
		109	54	23.27	0.2124	29.28	0.8476
	64QAM CP-s- OFDM	1	1	21.48	0.1405	27.49	0.5608
		1	215	21.48	0.1405	27.49	0.5605
		109	54	21.79	0.1509	27.80	0.6021
	256QAM CP-s- OFDM	1	1	18.45	0.07	24.46	0.2792
		1	215	18.64	0.0731	24.65	0.2918
		109	54	18.77	0.0753	24.78	0.3003
Middle	QPSK CP-OFDM	1	1	23.44	0.2209	29.45	0.8813
		1	215	23.71	0.2352	29.72	0.9384
		109	54	23.92	0.2467	29.93	0.9845
	16QAM CP-s- OFDM	1	1	23.12	0.2049	29.13	0.8177
		1	215	23.23	0.2104	29.24	0.8397
		109	54	23.51	0.2243	29.52	0.8951
	64QAM CP-s- OFDM	1	1	21.50	0.1414	27.51	0.5641
		1	215	21.60	0.1445	27.61	0.5764
		109	54	22.00	0.1586	28.01	0.6328
	256QAM CP-s- OFDM	1	1	18.62	0.0728	24.63	0.2904
		1	215	18.81	0.0761	24.82	0.3037
		109	54	18.94	0.0783	24.95	0.3125
	QPSK CP-OFDM	1	1	23.49	0.2233	29.50	0.8912
		1	215	23.48	0.223	29.49	0.8898
		109	54	23.76	0.2377	29.77	0.9486
	16QAM CP-s- OFDM	1	1	22.98	0.1984	28.99	0.7916
		1	215	23.23	0.2102	29.24	0.8387
		109	54	23.26	0.2119	29.27	0.8456
64QAM CP-s- OFDM	1	1	21.46	0.14	27.47	0.5588	
	1	215	21.66	0.1466	27.67	0.5849	
	109	54	21.73	0.149	27.74	0.5945	
256QAM CP-s- OFDM	1	1	18.51	0.0709	24.52	0.2829	
	1	215	18.75	0.0749	24.76	0.2989	
	109	54	18.74	0.0748	24.75	0.2983	

SA n77 (ANT M2+ANT M) 60MHz (GT - LC = 6.01 dB)							
Channel	Mode	NR		Conducted		EIRP	
		RB					
		Size	Offset	Power(dBm)	Power(Watts)	EIRP(dBm)	EIRP(W)
Lowest	QPSK CP-OFDM	1	1	23.40	0.2189	29.41	0.8737
		1	160	23.79	0.2394	29.80	0.9551
		81	40	23.62	0.23	29.63	0.9178
	16QAM CP-s- OFDM	1	1	23.14	0.2059	29.15	0.8214
		1	160	23.46	0.222	29.47	0.8859
		81	40	23.28	0.2129	29.29	0.8493
	64QAM CP-s- OFDM	1	1	21.45	0.1395	27.46	0.5567
		1	160	21.88	0.154	27.89	0.6146
		81	40	21.86	0.1533	27.87	0.6117
	256QAM CP-s- OFDM	1	1	18.67	0.0737	24.68	0.2939
		1	160	19.07	0.0807	25.08	0.3222
		81	40	18.76	0.0752	24.77	0.3
Middle	QPSK CP-OFDM	1	1	23.84	0.242	29.85	0.9656
		1	160	23.98	0.25	29.99	0.9977
		81	40	23.97	0.2493	29.98	0.995
	16QAM CP-s- OFDM	1	1	23.44	0.2206	29.45	0.8804
		1	160	23.55	0.2263	29.56	0.9028
		81	40	23.57	0.2277	29.58	0.9084
	64QAM CP-s- OFDM	1	1	21.80	0.1515	27.81	0.6044
		1	160	21.99	0.1581	28.00	0.631
		81	40	22.07	0.1612	28.08	0.6431
	256QAM CP-s- OFDM	1	1	18.82	0.0762	24.83	0.3042
		1	160	19.04	0.0801	25.05	0.3197
		81	40	18.99	0.0793	25.00	0.3165
Highest	QPSK CP-OFDM	1	1	23.62	0.2302	29.63	0.9187
		1	160	23.76	0.2379	29.77	0.9491
		81	40	23.70	0.2345	29.71	0.9359
	16QAM CP-s- OFDM	1	1	23.27	0.2123	29.28	0.8473
		1	160	23.52	0.225	29.53	0.8978
		81	40	23.39	0.2184	29.40	0.8713
	64QAM CP-s- OFDM	1	1	21.67	0.1467	27.68	0.5856
		1	160	21.87	0.1537	27.88	0.6132
		81	40	21.86	0.1535	27.87	0.6125
	256QAM CP-s- OFDM	1	1	18.76	0.0751	24.77	0.2997
		1	160	18.90	0.0776	24.91	0.3096
		81	40	18.81	0.076	24.82	0.3031

SA n77 (ANT M2+ANT M) 50MHz (GT - LC = 6.01 dB)								
Channel	Mode	NR		Conducted		EIRP		
		RB						
		Size	Offset	Power(dBm)	Power(Watts)	EIRP(dBm)	EIRP(W)	
Lowest	QPSK CP-OFDM	1	1	23.50	0.2237	29.51	0.8926	
		1	131	23.79	0.2391	29.80	0.954	
		67	33	23.73	0.2358	29.74	0.9409	
	16QAM CP-s- OFDM	1	1	23.15	0.2067	29.16	0.8249	
		1	131	23.40	0.2185	29.41	0.872	
		67	33	23.26	0.2116	29.27	0.8445	
	64QAM CP-s- OFDM	1	1	21.44	0.1395	27.45	0.5565	
		1	131	21.75	0.1495	27.76	0.5964	
		67	33	21.75	0.1495	27.76	0.5964	
	256QAM CP-s- OFDM	1	1	18.61	0.0725	24.62	0.2895	
		1	131	19.02	0.0798	25.03	0.3185	
		67	33	18.70	0.0742	24.71	0.2959	
Middle	QPSK CP-OFDM	1	1	23.91	0.2461	29.92	0.982	
		1	131	23.98	0.2501	29.99	0.9981	
		67	33	23.98	0.2502	29.99	0.9984	
	16QAM CP-s- OFDM	1	1	23.52	0.2248	29.53	0.897	
		1	131	23.56	0.2272	29.57	0.9068	
		67	33	23.52	0.2251	29.53	0.8984	
	64QAM CP-s- OFDM	1	1	21.89	0.1544	27.90	0.616	
		1	131	21.91	0.1552	27.92	0.6193	
		67	33	22.08	0.1614	28.09	0.6439	
	256QAM CP-s- OFDM	1	1	18.84	0.0765	24.85	0.3054	
		1	131	19.05	0.0803	25.06	0.3203	
		67	33	19.07	0.0807	25.08	0.3218	
	Highest	QPSK CP-OFDM	1	1	23.75	0.2372	29.76	0.9464
			1	131	23.71	0.2347	29.72	0.9366
			67	33	23.78	0.2386	29.79	0.9519
		16QAM CP-s- OFDM	1	1	23.36	0.2167	29.37	0.8646
			1	131	23.49	0.2233	29.50	0.891
			67	33	23.44	0.2208	29.45	0.8812
64QAM CP-s- OFDM		1	1	21.65	0.1461	27.66	0.583	
		1	131	21.85	0.1531	27.86	0.611	
		67	33	21.95	0.1567	27.96	0.6253	
256QAM CP-s- OFDM		1	1	19.05	0.0803	25.06	0.3203	
		1	131	18.99	0.0793	25.00	0.3163	
		67	33	18.88	0.0772	24.89	0.308	

SA n77 (ANT M2+ANT M) 40MHz (GT - LC = 6.01 dB)							
Channel	Mode	NR		Conducted		EIRP	
		RB					
		Size	Offset	Power(dBm)	Power(Watts)	EIRP(dBm)	EIRP(W)
Lowest	QPSK CP-OFDM	1	1	23.20	0.2088	29.21	0.8332
		1	104	23.33	0.215	29.34	0.8581
		53	26	23.61	0.2294	29.62	0.9155
	16QAM CP-s- OFDM	1	1	22.90	0.1951	28.91	0.7784
		1	104	23.08	0.2033	29.09	0.8112
		53	26	23.21	0.2095	29.22	0.8359
	64QAM CP-s- OFDM	1	1	21.19	0.1316	27.20	0.525
		1	104	21.47	0.1402	27.48	0.5593
		53	26	21.77	0.1502	27.78	0.5994
	256QAM CP-s- OFDM	1	1	18.27	0.0671	24.28	0.2678
		1	104	18.76	0.0751	24.77	0.2997
		53	26	18.75	0.075	24.76	0.2993
Middle	QPSK CP-OFDM	1	1	23.62	0.2303	29.63	0.9191
		1	104	23.72	0.2353	29.73	0.939
		53	26	23.89	0.2448	29.90	0.9767
	16QAM CP-s- OFDM	1	1	23.25	0.2112	29.26	0.8425
		1	104	23.31	0.2142	29.32	0.8548
		53	26	23.54	0.2261	29.55	0.9021
	64QAM CP-s- OFDM	1	1	21.63	0.1456	27.64	0.581
		1	104	21.67	0.1468	27.68	0.5858
		53	26	22.03	0.1596	28.04	0.6367
	256QAM CP-s- OFDM	1	1	18.65	0.0733	24.66	0.2925
		1	104	18.84	0.0765	24.85	0.3054
		53	26	19.01	0.0796	25.02	0.3178
	QPSK CP-OFDM	1	1	23.37	0.2173	29.38	0.8671
		1	104	23.48	0.2229	29.49	0.8893
		53	26	23.78	0.2388	29.79	0.953
	16QAM CP-s- OFDM	1	1	23.07	0.2028	29.08	0.8094
		1	104	23.16	0.2069	29.17	0.8254
		53	26	23.33	0.2153	29.34	0.8591
64QAM CP-s- OFDM	1	1	21.34	0.136	27.35	0.5428	
	1	104	21.62	0.1451	27.63	0.5788	
	53	26	21.85	0.153	27.86	0.6103	
256QAM CP-s- OFDM	1	1	18.58	0.0721	24.59	0.2875	
	1	104	18.84	0.0765	24.85	0.3052	
	53	26	18.89	0.0775	24.90	0.3091	

SA n77 (ANT M2+ANT M) 20MHz (GT - LC = 6.01 dB)								
Channel	Mode	NR		Conducted		EIRP		
		RB						
		Size	Offset	Power(dBm)	Power(Watts)	EIRP(dBm)	EIRP(W)	
Lowest	QPSK CP-OFDM	1	1	23.56	0.227	29.57	0.9057	
		1	49	23.55	0.2264	29.56	0.9032	
		25	12	23.66	0.2325	29.67	0.9278	
	16QAM CP-s- OFDM	1	1	23.20	0.2092	29.21	0.8346	
		1	49	23.28	0.213	29.29	0.8501	
		25	12	23.26	0.2119	29.27	0.8455	
	64QAM CP-s- OFDM	1	1	21.60	0.1446	27.61	0.5771	
		1	49	21.59	0.1443	27.60	0.5759	
		25	12	21.73	0.149	27.74	0.5945	
	256QAM CP-s- OFDM	1	1	18.79	0.0756	24.80	0.3017	
		1	49	18.77	0.0753	24.78	0.3003	
		25	12	18.78	0.0755	24.79	0.3014	
Middle	QPSK CP-OFDM	1	1	23.91	0.2462	29.92	0.9825	
		1	49	23.95	0.2481	29.96	0.9901	
		25	12	23.97	0.2495	29.98	0.9955	
	16QAM CP-s- OFDM	1	1	23.44	0.2209	29.45	0.8814	
		1	49	23.63	0.2305	29.64	0.9198	
		25	12	23.55	0.2265	29.56	0.9039	
	64QAM CP-s- OFDM	1	1	21.85	0.1531	27.86	0.6108	
		1	49	21.88	0.1542	27.89	0.6151	
		25	12	22.08	0.1613	28.09	0.6435	
	256QAM CP-s- OFDM	1	1	19.12	0.0817	25.13	0.3259	
		1	49	19.12	0.0817	25.13	0.3261	
		25	12	19.06	0.0806	25.07	0.3216	
	Highest	QPSK CP-OFDM	1	1	23.58	0.2281	29.59	0.91
			1	49	23.78	0.2386	29.79	0.9522
			25	12	23.79	0.2391	29.80	0.9541
		16QAM CP-s- OFDM	1	1	23.38	0.2178	29.39	0.8692
			1	49	23.44	0.2208	29.45	0.8812
			25	12	23.40	0.2186	29.41	0.8721
64QAM CP-s- OFDM		1	1	21.69	0.1474	27.70	0.5882	
		1	49	21.64	0.1459	27.65	0.5821	
		25	12	21.95	0.1565	27.96	0.6246	
256QAM CP-s- OFDM		1	1	18.84	0.0765	24.85	0.3052	
		1	49	19.05	0.0803	25.06	0.3203	
		25	12	18.88	0.0772	24.89	0.308	

SA n77 (ANT M2+ANT M) 15MHz (GT - LC = 6.01 dB)							
Channel	Mode	NR		Conducted		EIRP	
		RB					
		Size	Offset	Power(dBm)	Power(Watts)	EIRP(dBm)	EIRP(W)
Lowest	QPSK CP-OFDM	1	1	23.64	0.2314	29.65	0.9233
		1	36	23.52	0.2248	29.53	0.8972
		19	9	23.66	0.2324	29.67	0.9274
	16QAM CP-s- OFDM	1	1	23.26	0.2117	29.27	0.8446
		1	36	23.27	0.2124	29.28	0.8477
		19	9	23.30	0.2136	29.31	0.8522
	64QAM CP-s- OFDM	1	1	21.65	0.1462	27.66	0.5835
		1	36	21.61	0.145	27.62	0.5785
		19	9	21.77	0.1504	27.78	0.6001
	256QAM CP-s- OFDM	1	1	18.84	0.0765	24.85	0.3053
		1	36	18.89	0.0774	24.90	0.3089
		19	9	18.75	0.075	24.76	0.2992
Middle	QPSK CP-OFDM	1	1	23.97	0.2496	29.98	0.996
		1	36	23.98	0.2502	29.99	0.9985
		19	9	23.98	0.25	29.99	0.9975
	16QAM CP-s- OFDM	1	1	23.67	0.233	29.68	0.9296
		1	36	23.63	0.2304	29.64	0.9195
		19	9	23.59	0.2286	29.60	0.9121
	64QAM CP-s- OFDM	1	1	21.85	0.1531	27.86	0.6107
		1	36	21.96	0.1572	27.97	0.6271
		19	9	22.13	0.1634	28.14	0.6521
	256QAM CP-s- OFDM	1	1	19.04	0.0801	25.05	0.3197
		1	36	19.18	0.0828	25.19	0.3303
		19	9	19.09	0.081	25.10	0.3234
	QPSK CP-OFDM	1	1	23.85	0.2426	29.86	0.9681
		1	36	23.88	0.2441	29.89	0.974
		19	9	23.95	0.2482	29.96	0.9905
	16QAM CP-s- OFDM	1	1	23.51	0.2242	29.52	0.8946
		1	36	23.40	0.2188	29.41	0.8731
		19	9	23.47	0.2224	29.48	0.8872
64QAM CP-s- OFDM	1	1	21.73	0.1489	27.74	0.5943	
	1	36	21.96	0.1569	27.97	0.626	
	19	9	22.04	0.1598	28.05	0.6376	
256QAM CP-s- OFDM	1	1	19.09	0.081	25.10	0.3232	
	1	36	19.11	0.0815	25.12	0.3253	
	19	9	19.01	0.0795	25.02	0.3174	

SA n77 (ANT M2+ANT M) 10MHz (GT - LC = 6.01 dB)							
Channel	Mode	NR		Conducted		EIRP	
		RB					
		Size	Offset	Power(dBm)	Power(Watts)	EIRP(dBm)	EIRP(W)
Lowest	QPSK CP-OFDM	1	1	23.69	0.2337	29.70	0.9326
		1	22	23.53	0.2253	29.54	0.899
		12	6	23.58	0.2282	29.59	0.9108
	16QAM CP-s- OFDM	1	1	23.22	0.2099	29.23	0.8374
		1	22	23.38	0.218	29.39	0.8698
		12	6	23.16	0.2071	29.17	0.8262
	64QAM CP-s- OFDM	1	1	21.43	0.1389	27.44	0.5541
		1	22	21.42	0.1388	27.43	0.5536
		12	6	21.71	0.1482	27.72	0.5912
	256QAM CP-s- OFDM	1	1	18.63	0.073	24.64	0.2911
		1	22	18.81	0.076	24.82	0.3032
		12	6	18.65	0.0732	24.66	0.2923
Middle	QPSK CP-OFDM	1	1	23.97	0.2494	29.98	0.995
		1	22	23.98	0.2501	29.99	0.998
		12	6	23.95	0.2486	29.96	0.992
	16QAM CP-s- OFDM	1	1	23.61	0.2294	29.62	0.9155
		1	22	23.66	0.2321	29.67	0.9261
		12	6	23.56	0.2272	29.57	0.9067
	64QAM CP-s- OFDM	1	1	21.93	0.156	27.94	0.6225
		1	22	21.93	0.156	27.94	0.6227
		12	6	22.16	0.1646	28.17	0.6568
	256QAM CP-s- OFDM	1	1	19.23	0.0837	25.24	0.3341
		1	22	19.22	0.0836	25.23	0.3335
		12	6	19.08	0.0809	25.09	0.3228
Highest	QPSK CP-OFDM	1	1	23.83	0.2414	29.84	0.9633
		1	22	23.74	0.2366	29.75	0.9439
		12	6	23.80	0.2397	29.81	0.9566
	16QAM CP-s- OFDM	1	1	23.46	0.2216	29.47	0.8842
		1	22	23.46	0.2216	29.47	0.8844
		12	6	23.46	0.2219	29.47	0.8853
	64QAM CP-s- OFDM	1	1	21.82	0.1521	27.83	0.6068
		1	22	21.96	0.157	27.97	0.6267
		12	6	22.00	0.1583	28.01	0.6318
	256QAM CP-s- OFDM	1	1	18.92	0.078	24.93	0.3113
		1	22	18.97	0.0789	24.98	0.3147
		12	6	18.90	0.0775	24.91	0.3094

SCS 15

SA n77 (ANT M2+ANT M) 20MHz (GT - LC = 6.01 dB)								
Channel	Mode	NR		Conducted		EIRP		
		RB						
		Size	Offset	Power(dBm)	Power(Watts)	EIRP(dBm)	EIRP(W)	
Lowest	QPSK CP-OFDM	1	1	23.60	0.2291	29.61	0.9142	
		1	104	23.68	0.2334	29.69	0.9312	
		53	26	23.62	0.2302	29.63	0.9184	
	16QAM CP-s- OFDM	1	1	22.92	0.1957	28.93	0.7808	
		1	104	23.19	0.2085	29.20	0.8319	
		53	26	23.12	0.2051	29.13	0.8185	
	64QAM CP-s- OFDM	1	1	21.25	0.1334	27.26	0.5323	
		1	104	21.28	0.1341	27.29	0.5352	
		53	26	21.46	0.14	27.47	0.5586	
	256QAM CP-s- OFDM	1	1	18.57	0.072	24.58	0.2871	
		1	104	18.42	0.0695	24.43	0.2775	
		53	26	18.40	0.0691	24.41	0.2758	
Middle	QPSK CP-OFDM	1	1	23.93	0.2471	29.94	0.9861	
		1	104	23.96	0.2489	29.97	0.9931	
		53	26	23.97	0.2495	29.98	0.9957	
	16QAM CP-s- OFDM	1	1	23.35	0.2163	29.36	0.8632	
		1	104	23.49	0.2231	29.50	0.8903	
		53	26	23.31	0.2141	29.32	0.8544	
	64QAM CP-s- OFDM	1	1	21.56	0.1432	27.57	0.5715	
		1	104	21.73	0.1489	27.74	0.594	
		53	26	21.82	0.152	27.83	0.6067	
	256QAM CP-s- OFDM	1	1	18.74	0.0747	24.75	0.2982	
		1	104	18.68	0.0738	24.69	0.2946	
		53	26	18.86	0.077	24.87	0.3072	
	Highest	QPSK CP-OFDM	1	1	23.60	0.2293	29.61	0.915
			1	104	23.91	0.2458	29.92	0.9808
			53	26	23.72	0.2353	29.73	0.9391
		16QAM CP-s- OFDM	1	1	23.34	0.2159	29.35	0.8617
			1	104	23.37	0.2172	29.38	0.8668
			53	26	23.22	0.2097	29.23	0.8367
64QAM CP-s- OFDM		1	1	21.39	0.1377	27.40	0.5493	
		1	104	21.81	0.1517	27.82	0.6054	
		53	26	21.74	0.1491	27.75	0.5951	
256QAM CP-s- OFDM		1	1	18.74	0.0749	24.75	0.2987	
		1	104	18.94	0.0783	24.95	0.3123	
		53	26	18.69	0.0739	24.70	0.2949	

SA n77 (ANT M2+ANT M) 15MHz (GT - LC = 6.01 dB)								
Channel	Mode	NR		Conducted		EIRP		
		RB						
		Size	Offset	Power(dBm)	Power(Watts)	EIRP(dBm)	EIRP(W)	
Lowest	QPSK CP-OFDM	1	1	23.53	0.2252	29.54	0.8986	
		1	77	23.80	0.2398	29.81	0.957	
		39	19	23.54	0.226	29.55	0.9016	
	16QAM CP-s- OFDM	1	1	23.12	0.2052	29.13	0.8187	
		1	77	23.13	0.2056	29.14	0.8204	
		39	19	22.93	0.1964	28.94	0.7837	
	64QAM CP-s- OFDM	1	1	21.27	0.134	27.28	0.5346	
		1	77	21.43	0.1389	27.44	0.5544	
		39	19	21.45	0.1395	27.46	0.5567	
	256QAM CP-s- OFDM	1	1	18.57	0.0719	24.58	0.2868	
		1	77	18.68	0.0737	24.69	0.2941	
		39	19	18.41	0.0693	24.42	0.2765	
Middle	QPSK CP-OFDM	1	1	23.98	0.25	29.99	0.9975	
		1	77	23.89	0.245	29.90	0.9776	
		39	19	23.96	0.249	29.97	0.9937	
	16QAM CP-s- OFDM	1	1	23.36	0.2169	29.37	0.8654	
		1	77	23.43	0.2203	29.44	0.8791	
		39	19	23.49	0.2232	29.50	0.8908	
	64QAM CP-s- OFDM	1	1	21.58	0.1439	27.59	0.574	
		1	77	21.70	0.1479	27.71	0.59	
		39	19	21.88	0.1541	27.89	0.615	
	256QAM CP-s- OFDM	1	1	18.81	0.0761	24.82	0.3036	
		1	77	19.01	0.0795	25.02	0.3174	
		39	19	18.89	0.0775	24.90	0.3093	
	Highest	QPSK CP-OFDM	1	1	23.88	0.2444	29.89	0.9753
			1	77	23.98	0.2501	29.99	0.9978
			39	19	23.94	0.2478	29.95	0.9886
		16QAM CP-s- OFDM	1	1	23.34	0.216	29.35	0.862
			1	77	23.45	0.2214	29.46	0.8834
			39	19	23.28	0.2128	29.29	0.8493
64QAM CP-s- OFDM		1	1	21.77	0.1503	27.78	0.5999	
		1	77	21.92	0.1556	27.93	0.6209	
		39	19	21.77	0.1502	27.78	0.5991	
256QAM CP-s- OFDM		1	1	18.67	0.0736	24.68	0.2937	
		1	77	18.83	0.0763	24.84	0.3045	
		39	19	18.74	0.0747	24.75	0.2982	

SA n77 (ANT M2+ANT M) 10MHz (GT - LC = 6.01 dB)								
Channel	Mode	NR		Conducted		EIRP		
		RB						
		Size	Offset	Power(dBm)	Power(Watts)	EIRP(dBm)	EIRP(W)	
Lowest	QPSK CP-OFDM	1	1	23.73	0.2361	29.74	0.942	
		1	50	23.73	0.2361	29.74	0.942	
		26	13	23.72	0.2355	29.73	0.9398	
	16QAM CP-s- OFDM	1	1	23.35	0.2161	29.36	0.8621	
		1	50	23.42	0.2195	29.43	0.8761	
		26	13	23.23	0.2102	29.24	0.8386	
	64QAM CP-s- OFDM	1	1	21.86	0.1533	27.87	0.6117	
		1	50	21.97	0.1572	27.98	0.6274	
		26	13	21.60	0.1444	27.61	0.5762	
	256QAM CP-s- OFDM	1	1	18.79	0.0756	24.80	0.3017	
		1	50	18.58	0.0721	24.59	0.2875	
		26	13	18.55	0.0715	24.56	0.2855	
Middle	QPSK CP-OFDM	1	1	23.87	0.2439	29.88	0.9732	
		1	50	23.96	0.249	29.97	0.9934	
		26	13	23.72	0.2353	29.73	0.9389	
	16QAM CP-s- OFDM	1	1	23.37	0.2171	29.38	0.8662	
		1	50	23.16	0.2068	29.17	0.8253	
		26	13	23.29	0.2131	29.30	0.8502	
	64QAM CP-s- OFDM	1	1	21.74	0.1492	27.75	0.5952	
		1	50	21.68	0.1473	27.69	0.5878	
		26	13	21.65	0.1462	27.66	0.5832	
	256QAM CP-s- OFDM	1	1	18.85	0.0768	24.86	0.3063	
		1	50	18.86	0.077	24.87	0.3071	
		26	13	18.62	0.0727	24.63	0.2902	
	Highest	QPSK CP-OFDM	1	1	23.98	0.2501	29.99	0.9979
			1	50	23.89	0.245	29.90	0.9777
			26	13	23.57	0.2275	29.58	0.9078
		16QAM CP-s- OFDM	1	1	23.09	0.2036	29.10	0.8124
			1	50	23.07	0.2026	29.08	0.8084
			26	13	23.04	0.2012	29.05	0.8027
64QAM CP-s- OFDM		1	1	21.35	0.1363	27.36	0.5439	
		1	50	21.48	0.1407	27.49	0.5613	
		26	13	21.50	0.1411	27.51	0.563	
256QAM CP-s- OFDM		1	1	18.62	0.0727	24.63	0.2903	
		1	50	18.74	0.0749	24.75	0.2989	
		26	13	18.49	0.0706	24.50	0.2819	

5G NR n77 HPUE NSA mode:

SCS 30

EN-DC n77 (ANT M2)+2A (ANT M)Combination 100MHz+10MHz(LTE)(GT - LC = 3 dB)									
Channel	Mode	NR		LTE		Conducted		EIRP	
		RB		RB					
		Size	Offset	Size	Offset	Power(dBm)	Power(Watts)	IRP(dBm)	EIRP(W)
Lowest	PI/2 BPSK DFT-s-OFDM	1	1	1	0	24.71	0.2961	27.71	0.5908
		1	271	1	99	25.17	0.3291	28.17	0.6566
		135	67	100	0	25.82	0.382	28.82	0.7622
	QPSK DFT-s-OFDM	1	1	1	0	24.72	0.2968	27.72	0.5921
		1	271	1	99	25.19	0.3306	28.19	0.6596
		135	67	100	0	25.84	0.3838	28.84	0.7657
	16QAM DFT-s-OFDM	1	1	1	0	23.93	0.247	26.93	0.4928
		1	271	1	99	23.28	0.2128	26.28	0.4246
		135	67	100	0	24.66	0.2927	27.66	0.584
	64QAM DFT-s-OFDM	1	1	1	0	22.68	0.1855	25.68	0.3701
		1	271	1	99	22.56	0.1804	25.56	0.36
		135	67	100	0	23.14	0.2061	26.14	0.4112
	256QAM DFT-s-OFDM	1	1	1	0	20.68	0.1168	23.68	0.2331
		1	271	1	99	19.99	0.0998	22.99	0.1992
		135	67	100	0	20.17	0.104	23.17	0.2075
Middle	PI/2 BPSK DFT-s-OFDM	1	1	1	0	25.28	0.3375	28.28	0.6733
		1	271	1	99	25.02	0.3179	28.02	0.6343
		135	67	100	0	25.98	0.3963	28.98	0.7908
	QPSK DFT-s-OFDM	1	1	1	0	25.24	0.3344	28.24	0.6672
		1	271	1	99	25.02	0.3179	28.02	0.6343
		135	67	100	0	26.04	0.4018	29.04	0.8017
	16QAM DFT-s-OFDM	1	1	1	0	23.77	0.2381	26.77	0.4751
		1	271	1	99	23.75	0.237	26.75	0.4729
		135	67	100	0	24.75	0.2988	27.75	0.5962
	64QAM DFT-s-OFDM	1	1	1	0	22.51	0.1784	25.51	0.3559
		1	271	1	99	22.54	0.1796	25.54	0.3584
		135	67	100	0	23.28	0.2128	26.28	0.4246
	256QAM DFT-s-OFDM	1	1	1	0	20.51	0.1124	23.51	0.2242
		1	271	1	99	20.38	0.1091	23.38	0.2177
		135	67	100	0	21.32	0.1355	24.32	0.2704
QPSK CP-OFDM	1	1	1	0	23.35	0.2162	26.35	0.4315	
	1	271	1	99	23.21	0.2094	26.21	0.4178	
	137	68	100	0	24.11	0.2574	27.11	0.5136	
Highest	PI/2 BPSK DFT-s-OFDM	1	1	1	0	25.27	0.3367	28.27	0.6718
		1	271	1	99	25.04	0.3194	28.04	0.6372
		135	67	100	0	25.97	0.3954	28.97	0.789
	QPSK DFT-s-OFDM	1	1	1	0	25.23	0.3336	28.23	0.6656
		1	271	1	99	25.04	0.3194	28.04	0.6372
		135	67	100	0	25.98	0.3963	28.98	0.7908
	16QAM DFT-s-OFDM	1	1	1	0	23.56	0.2269	26.56	0.4527
		1	271	1	99	23.93	0.247	26.93	0.4928
		135	67	100	0	24.53	0.2841	27.53	0.5668
	64QAM DFT-s-OFDM	1	1	1	0	22.29	0.1696	25.29	0.3384
		1	271	1	99	22.67	0.185	25.67	0.3692
		135	67	100	0	23.11	0.2047	26.11	0.4083
	256QAM DFT-s-OFDM	1	1	1	0	20.25	0.1059	23.25	0.2113
		1	271	1	99	20.62	0.1153	23.62	0.23
		135	67	100	0	21.12	0.1295	24.12	0.2584

EN-DC n77 (ANT M2)+2A (ANT M)Combination 80MHz+20MHz(LTE)(GT - LC = 3 dB)									
Channel	Mode	NR		LTE		Conducted		EIRP	
		RB		RB					
		Size	Offset	Size	Offset	Power(dB)	Power(Watts)	IRP(dBm)	EIRP(W)
Lowest	PI/2 BPSK DFT-s-OFDM	1	1	1	0	25.02	0.3179	28.02	0.6344
		1	215	1	99	25.40	0.3469	28.40	0.6922
		108	54	100	0	25.85	0.3847	28.85	0.7675
	QPSK DFT-s-OFDM	1	1	1	0	25.02	0.3179	28.02	0.6343
		1	215	1	99	25.33	0.3414	28.33	0.6811
		108	54	100	0	25.85	0.3847	28.85	0.7675
	16QAM DFT-s-OFDM	1	1	1	0	24.26	0.2664	27.26	0.5316
		1	215	1	99	24.65	0.292	27.65	0.5827
		108	54	100	0	23.87	0.2436	26.87	0.4861
	64QAM DFT-s-OFDM	1	1	1	0	22.95	0.1973	25.95	0.3937
		1	215	1	99	23.34	0.2157	26.34	0.4305
		108	54	100	0	22.35	0.172	25.35	0.3431
256QAM DFT-s-OFDM	1	1	1	0	20.82	0.1209	23.82	0.2413	
	1	215	1	99	21.08	0.1283	24.08	0.256	
	108	54	100	0	20.38	0.1091	23.38	0.2177	
Middle	PI/2 BPSK DFT-s-OFDM	1	1	1	0	25.65	0.3674	28.65	0.7331
		1	215	1	99	25.33	0.3414	28.33	0.6811
		108	54	100	0	26.04	0.4018	29.04	0.8017
	QPSK DFT-s-OFDM	1	1	1	0	25.57	0.3607	28.57	0.7197
		1	215	1	99	25.33	0.3414	28.33	0.6811
		108	54	100	0	26.02	0.4	29.02	0.798
	16QAM DFT-s-OFDM	1	1	1	0	23.54	0.2259	26.54	0.4506
		1	215	1	99	24.42	0.277	27.42	0.5527
		108	54	100	0	24.13	0.2586	27.13	0.5159
	64QAM DFT-s-OFDM	1	1	1	0	22.29	0.1696	25.29	0.3384
		1	215	1	99	23.14	0.2061	26.14	0.4111
		108	54	100	0	22.69	0.1859	25.69	0.3708
	256QAM DFT-s-OFDM	1	1	1	0	20.13	0.103	23.13	0.2056
		1	215	1	99	21.04	0.1271	24.04	0.2536
		108	54	100	0	20.70	0.1176	23.70	0.2347
QPSK CP-OFDM	1	1	1	0	22.95	0.1973	25.95	0.3936	
	1	215	1	99	23.78	0.2386	26.78	0.4761	
	109	54	100	0	23.54	0.2258	26.54	0.4506	
Highest	PI/2 BPSK DFT-s-OFDM	1	1	1	0	24.84	0.305	27.84	0.6086
		1	215	1	99	25.46	0.3517	28.46	0.7017
		108	54	100	0	25.73	0.3742	28.73	0.7466
	QPSK DFT-s-OFDM	1	1	1	0	24.83	0.3044	27.83	0.6073
		1	215	1	99	25.40	0.3469	28.40	0.6921
		108	54	100	0	25.79	0.3794	28.79	0.757
	16QAM DFT-s-OFDM	1	1	1	0	22.96	0.1977	25.96	0.3945
		1	215	1	99	23.81	0.2403	26.81	0.4794
		108	54	100	0	24.06	0.2545	27.06	0.5077
	64QAM DFT-s-OFDM	1	1	1	0	21.64	0.1458	24.64	0.291
		1	215	1	99	22.25	0.1681	25.25	0.3353
		108	54	100	0	22.53	0.1792	25.53	0.3575
	256QAM DFT-s-OFDM	1	1	1	0	19.81	0.0958	22.81	0.1911
		1	215	1	99	20.74	0.1187	23.74	0.2368
		108	54	100	0	20.59	0.1144	23.59	0.2284

EN-DC n77 (ANT M2)+2A (ANT M)Combination 60MHz+20MHz(LTE)(GT - LC = 3 dB)									
Channel	Mode	NR		LTE		Conducted		EIRP	
		RB		RB					
		Size	Offset	Size	Offset	Power(dB)	Power(Watts)	IRP(dBm)	EIRP(W)
Lowest	PI/2 BPSK DFT-s-OFDM	1	1	1	0	25.70	0.3716	28.70	0.7415
		1	160	1	99	26.05	0.4028	29.05	0.8036
		81	40	100	0	26.14	0.4112	29.14	0.8204
	QPSK DFT-s-OFDM	1	1	1	0	25.65	0.3674	28.65	0.733
		1	160	1	99	26.05	0.4027	29.05	0.8035
		81	40	100	0	26.15	0.4121	29.15	0.8223
	16QAM DFT-s-OFDM	1	1	1	0	23.88	0.2442	26.88	0.4872
		1	160	1	99	23.96	0.2487	26.96	0.4962
		81	40	100	0	24.27	0.267	27.27	0.5328
	64QAM DFT-s-OFDM	1	1	1	0	22.49	0.1776	25.49	0.3543
		1	160	1	99	22.47	0.1768	25.47	0.3527
		81	40	100	0	22.77	0.1893	25.77	0.3778
256QAM DFT-s-OFDM	1	1	1	0	20.73	0.1182	23.73	0.2358	
	1	160	1	99	20.70	0.1174	23.70	0.2342	
	81	40	100	0	20.77	0.1195	23.77	0.2385	
Middle	PI/2 BPSK DFT-s-OFDM	1	1	1	0	26.27	0.4236	29.27	0.8452
		1	160	1	99	26.13	0.4102	29.13	0.8185
		81	40	100	0	26.33	0.4295	29.33	0.8569
	QPSK DFT-s-OFDM	1	1	1	0	26.25	0.4217	29.25	0.8414
		1	160	1	99	26.11	0.4084	29.11	0.8148
		81	40	100	0	26.29	0.4256	29.29	0.8492
	16QAM DFT-s-OFDM	1	1	1	0	23.69	0.2338	26.69	0.4664
		1	160	1	99	23.87	0.2436	26.87	0.4861
		81	40	100	0	24.13	0.2586	27.13	0.5159
	64QAM DFT-s-OFDM	1	1	1	0	22.19	0.1654	25.19	0.33
		1	160	1	99	22.34	0.1716	25.34	0.3423
		81	40	100	0	22.58	0.1813	25.58	0.3617
256QAM DFT-s-OFDM	1	1	1	0	20.39	0.1093	23.39	0.2182	
	1	160	1	99	20.60	0.1147	23.60	0.2289	
	81	40	100	0	20.59	0.1145	23.59	0.2284	
QPSK CP-OFDM	1	1	1	0	23.24	0.2109	26.24	0.4207	
	1	160	1	99	23.39	0.2182	26.39	0.4354	
	81	40	100	0	23.60	0.229	26.60	0.4569	
Highest	PI/2 BPSK DFT-s-OFDM	1	1	1	0	25.59	0.3623	28.59	0.723
		1	160	1	99	26.09	0.4064	29.09	0.811
		81	40	100	0	26.03	0.4009	29.03	0.7999
	QPSK DFT-s-OFDM	1	1	1	0	25.51	0.3558	28.51	0.7099
		1	160	1	99	26.07	0.4046	29.07	0.8073
		81	40	100	0	26.02	0.4	29.02	0.798
	16QAM DFT-s-OFDM	1	1	1	0	24.10	0.2568	27.10	0.5124
		1	160	1	99	24.36	0.2726	27.36	0.5439
		81	40	100	0	24.18	0.2616	27.18	0.5219
	64QAM DFT-s-OFDM	1	1	1	0	22.53	0.1792	25.53	0.3575
		1	160	1	99	22.65	0.1842	25.65	0.3675
		81	40	100	0	22.73	0.1876	25.73	0.3743
256QAM DFT-s-OFDM	1	1	1	0	20.50	0.1121	23.50	0.2237	
	1	160	1	99	20.87	0.1223	23.87	0.244	
	81	40	100	0	20.66	0.1163	23.66	0.2321	

EN-DC n77 (ANT M2)+2A (ANT M)Combination 50MHz+10MHz(LTE)(GT - LC = 3 dB)									
Channel	Mode	NR		LTE		Conducted		EIRP	
		RB		RB					
		Size	Offset	Size	Offset	Power(dB)	Power(Watts)	IRP(dBm)	EIRP(W)
Lowest	PI/2 BPSK DFT-s-OFDM	1	1	1	0	25.69	0.3708	28.69	0.7399
		1	131	1	99	26.06	0.4037	29.06	0.8055
		64	32	100	0	26.13	0.4102	29.13	0.8186
	QPSK DFT-s-OFDM	1	1	1	0	25.65	0.3674	28.65	0.7331
		1	131	1	99	26.02	0.4	29.02	0.7981
		64	32	100	0	26.15	0.4121	29.15	0.8223
	16QAM DFT-s-OFDM	1	1	1	0	23.93	0.247	26.93	0.4928
		1	131	1	99	24.05	0.2539	27.05	0.5066
		64	32	100	0	24.28	0.2677	27.28	0.5341
	64QAM DFT-s-OFDM	1	1	1	0	22.45	0.176	25.45	0.3511
		1	131	1	99	22.50	0.178	25.50	0.3551
		64	32	100	0	22.84	0.1924	25.84	0.3839
256QAM DFT-s-OFDM	1	1	1	0	20.75	0.1187	23.75	0.2369	
	1	131	1	99	20.76	0.119	23.76	0.2375	
	64	32	100	0	20.84	0.1215	23.84	0.2424	
Middle	PI/2 BPSK DFT-s-OFDM	1	1	1	0	26.29	0.4256	29.29	0.8492
		1	131	1	99	26.04	0.4018	29.04	0.8018
		64	32	100	0	26.31	0.4276	29.31	0.8531
	QPSK DFT-s-OFDM	1	1	1	0	26.26	0.4227	29.26	0.8434
		1	131	1	99	26.06	0.4037	29.06	0.8055
		64	32	100	0	26.34	0.4305	29.34	0.859
	16QAM DFT-s-OFDM	1	1	1	0	23.78	0.2387	26.78	0.4762
		1	131	1	99	23.80	0.2397	26.80	0.4783
		64	32	100	0	24.14	0.2592	27.14	0.5172
	64QAM DFT-s-OFDM	1	1	1	0	22.31	0.1704	25.31	0.34
		1	131	1	99	22.29	0.1692	25.29	0.3377
		64	32	100	0	22.68	0.1855	25.68	0.3701
	256QAM DFT-s-OFDM	1	1	1	0	20.61	0.115	23.61	0.2295
		1	131	1	99	20.58	0.1142	23.58	0.2279
		64	32	100	0	20.76	0.119	23.76	0.2374
	QPSK CP-OFDM	1	1	1	0	23.38	0.2177	26.38	0.4344
		1	131	1	99	23.37	0.2172	26.37	0.4334
		67	33	100	0	23.67	0.2327	26.67	0.4643
Highest	PI/2 BPSK DFT-s-OFDM	1	1	1	0	25.72	0.3734	28.72	0.745
		1	131	1	99	26.00	0.3982	29.00	0.7945
		64	32	100	0	26.03	0.4009	29.03	0.7999
	QPSK DFT-s-OFDM	1	1	1	0	25.58	0.3615	28.58	0.7214
		1	131	1	99	25.97	0.3954	28.97	0.789
		64	32	100	0	26.04	0.4018	29.04	0.8018
	16QAM DFT-s-OFDM	1	1	1	0	23.96	0.2487	26.96	0.4963
		1	131	1	99	23.95	0.2481	26.95	0.4951
		64	32	100	0	24.15	0.2598	27.15	0.5184
	64QAM DFT-s-OFDM	1	1	1	0	22.43	0.1752	25.43	0.3495
		1	131	1	99	22.51	0.1784	25.51	0.356
		64	32	100	0	22.64	0.1838	25.64	0.3667
	256QAM DFT-s-OFDM	1	1	1	0	20.65	0.1161	23.65	0.2316
		1	131	1	99	20.73	0.1182	23.73	0.2358
		64	32	100	0	20.67	0.1166	23.67	0.2326

EN-DC n77 (ANT M2)+2A (ANT M)Combination 40MHz+10MHz(LTE)(GT - LC = 3 dB)									
Channel	Mode	NR		LTE		Conducted		EIRP	
		RB		RB					
		Size	Offset	Size	Offset	Power(dB)	Power(Watts)	IRP(dBm)	EIRP(W)
Lowest	PI/2 BPSK DFT-s-OFDM	1	1	1	0	25.45	0.351	28.45	0.7003
		1	104	1	99	25.84	0.3838	28.84	0.7659
		50	25	100	0	26.00	0.3982	29.00	0.7945
	QPSK DFT-s-OFDM	1	1	1	0	25.44	0.3502	28.44	0.6987
		1	104	1	99	25.80	0.3803	28.80	0.7589
		50	25	100	0	26.08	0.4056	29.08	0.8093
	16QAM DFT-s-OFDM	1	1	1	0	23.66	0.2322	26.66	0.4633
		1	104	1	99	23.89	0.2447	26.89	0.4883
		50	25	100	0	24.34	0.2714	27.34	0.5414
	64QAM DFT-s-OFDM	1	1	1	0	22.20	0.1658	25.20	0.3308
		1	104	1	99	22.25	0.1677	25.25	0.3346
		50	25	100	0	22.77	0.1893	25.77	0.3778
256QAM DFT-s-OFDM	1	1	1	0	20.45	0.1109	23.45	0.2212	
	1	104	1	99	20.48	0.1116	23.48	0.2227	
	50	25	100	0	20.76	0.119	23.76	0.2374	
Middle	PI/2 BPSK DFT-s-OFDM	1	1	1	0	25.99	0.3973	28.99	0.7927
		1	104	1	99	25.87	0.3865	28.87	0.7712
		50	25	100	0	26.35	0.4315	29.35	0.861
	QPSK DFT-s-OFDM	1	1	1	0	25.96	0.3945	28.96	0.7872
		1	104	1	99	25.84	0.3839	28.84	0.7659
		50	25	100	0	26.30	0.4266	29.30	0.8512
	16QAM DFT-s-OFDM	1	1	1	0	23.66	0.2322	26.66	0.4633
		1	104	1	99	23.57	0.2274	26.57	0.4538
		50	25	100	0	24.15	0.2598	27.15	0.5184
	64QAM DFT-s-OFDM	1	1	1	0	22.04	0.1598	25.04	0.3189
		1	104	1	99	22.08	0.1613	25.08	0.3218
		50	25	100	0	22.71	0.1868	25.71	0.3726
	256QAM DFT-s-OFDM	1	1	1	0	20.33	0.1079	23.33	0.2152
		1	104	1	99	20.35	0.1084	23.35	0.2162
		50	25	100	0	20.65	0.116	23.65	0.2315
	QPSK CP-OFDM	1	1	1	0	23.18	0.208	26.18	0.415
		1	104	1	99	23.20	0.2089	26.20	0.4169
		53	26	100	0	23.64	0.2311	26.64	0.4612
Highest	PI/2 BPSK DFT-s-OFDM	1	1	1	0	25.54	0.3583	28.54	0.7149
		1	104	1	99	25.88	0.3874	28.88	0.7729
		50	25	100	0	26.07	0.4047	29.07	0.8074
	QPSK DFT-s-OFDM	1	1	1	0	25.50	0.355	28.50	0.7084
		1	104	1	99	25.83	0.383	28.83	0.7641
		50	25	100	0	26.08	0.4056	29.08	0.8093
	16QAM DFT-s-OFDM	1	1	1	0	23.71	0.2349	26.71	0.4686
		1	104	1	99	23.79	0.2392	26.79	0.4773
		50	25	100	0	24.16	0.2604	27.16	0.5196
	64QAM DFT-s-OFDM	1	1	1	0	22.18	0.165	25.18	0.3293
		1	104	1	99	22.34	0.1712	25.34	0.3416
		50	25	100	0	22.69	0.1859	25.69	0.371
	256QAM DFT-s-OFDM	1	1	1	0	20.37	0.1089	23.37	0.2173
		1	104	1	99	20.47	0.1114	23.47	0.2223
		50	25	100	0	20.65	0.1161	23.65	0.2316

EN-DC n77 (ANT M2)+2A (ANT M)Combination 20MHz+10MHz(LTE)(GT - LC = 3 dB)									
Channel	Mode	NR		LTE		Conducted		EIRP	
		RB		RB					
		Size	Offset	Size	Offset	Power(dBm)	Power(Watts)	IRP(dBm)	EIRP(W)
Lowest	PI/2 BPSK DFT-s-OFDM	1	1	1	0	25.70	0.3717	28.70	0.7416
		1	49	1	99	25.92	0.3909	28.92	0.78
		25	12	100	0	25.94	0.3928	28.94	0.7836
	QPSK DFT-s-OFDM	1	1	1	0	25.75	0.376	28.75	0.7502
		1	49	1	99	25.95	0.3937	28.95	0.7854
		25	12	100	0	25.93	0.3919	28.93	0.7818
	16QAM DFT-s-OFDM	1	1	1	0	24.18	0.2616	27.18	0.522
		1	49	1	99	24.23	0.2646	27.23	0.528
		25	12	100	0	24.39	0.2745	27.39	0.5478
	64QAM DFT-s-OFDM	1	1	1	0	22.73	0.1877	25.73	0.3744
		1	49	1	99	22.83	0.192	25.83	0.3831
		25	12	100	0	22.94	0.1969	25.94	0.3928
256QAM DFT-s-OFDM	1	1	1	0	20.57	0.114	23.57	0.2274	
	1	49	1	99	20.67	0.1166	23.67	0.2327	
	25	12	100	0	20.92	0.1235	23.92	0.2463	
Middle	PI/2 BPSK DFT-s-OFDM	1	1	1	0	26.14	0.4112	29.14	0.8205
		1	49	1	99	25.98	0.3964	28.98	0.7909
		25	12	100	0	26.26	0.4227	29.26	0.8435
	QPSK DFT-s-OFDM	1	1	1	0	26.15	0.4122	29.15	0.8224
		1	49	1	99	26.02	0.4	29.02	0.7982
		25	12	100	0	26.25	0.4217	29.25	0.8415
	16QAM DFT-s-OFDM	1	1	1	0	24.05	0.254	27.05	0.5067
		1	49	1	99	24.03	0.2528	27.03	0.5044
		25	12	100	0	24.29	0.2683	27.29	0.5354
	64QAM DFT-s-OFDM	1	1	1	0	22.55	0.1801	25.55	0.3593
		1	49	1	99	22.49	0.1772	25.49	0.3536
		25	12	100	0	22.79	0.1902	25.79	0.3796
	256QAM DFT-s-OFDM	1	1	1	0	20.75	0.1188	23.75	0.237
		1	49	1	99	20.68	0.1169	23.68	0.2332
		25	12	100	0	20.82	0.1207	23.82	0.2408
	QPSK CP-OFDM	1	1	1	0	23.58	0.228	26.58	0.4549
		1	49	1	99	23.59	0.2285	26.59	0.456
		25	12	100	0	23.78	0.2387	26.78	0.4763
Highest	PI/2 BPSK DFT-s-OFDM	1	1	1	0	25.73	0.3743	28.73	0.7467
		1	49	1	99	25.90	0.3892	28.90	0.7765
		25	12	100	0	26.05	0.4028	29.05	0.8037
	QPSK DFT-s-OFDM	1	1	1	0	25.84	0.3839	28.84	0.7659
		1	49	1	99	25.95	0.3936	28.95	0.7854
		25	12	100	0	26.08	0.4056	29.08	0.8093
	16QAM DFT-s-OFDM	1	1	1	0	23.93	0.247	26.93	0.4929
		1	49	1	99	23.94	0.2476	26.94	0.4941
		25	12	100	0	24.16	0.2604	27.16	0.5196
	64QAM DFT-s-OFDM	1	1	1	0	22.47	0.1764	25.47	0.352
		1	49	1	99	22.49	0.1772	25.49	0.3536
		25	12	100	0	22.69	0.1859	25.69	0.371
	256QAM DFT-s-OFDM	1	1	1	0	20.63	0.1156	23.63	0.2306
		1	49	1	99	20.73	0.1182	23.73	0.2359
		25	12	100	0	20.75	0.1188	23.75	0.237

EN-DC n77 (ANT M2)+2A (ANT M)Combination 15MHz+20MHz(LTE)(GT - LC = 3 dB)									
Channel	Mode	NR		LTE		Conducted		EIRP	
		RB		RB					
		Size	Offset	Size	Offset	Power(dBm)	Power(Watts)	IRP(dBm)	EIRP(W)
Lowest	PI/2 BPSK DFT-s-OFDM	1	1	1	0	25.75	0.3759	28.75	0.7501
		1	36	1	99	25.87	0.3864	28.87	0.771
		18	9	100	0	25.90	0.3891	28.90	0.7764
	QPSK DFT-s-OFDM	1	1	1	0	25.76	0.3768	28.76	0.7518
		1	36	1	99	25.80	0.3803	28.80	0.7587
		18	9	100	0	25.93	0.3918	28.93	0.7817
	16QAM DFT-s-OFDM	1	1	1	0	24.38	0.2739	27.38	0.5464
		1	36	1	99	24.25	0.2658	27.25	0.5303
		18	9	100	0	24.49	0.2815	27.49	0.5616
	64QAM DFT-s-OFDM	1	1	1	0	22.85	0.1928	25.85	0.3847
		1	36	1	99	22.75	0.1885	25.75	0.376
		18	9	100	0	22.95	0.1973	25.95	0.3936
	256QAM DFT-s-OFDM	1	1	1	0	20.66	0.1163	23.66	0.232
		1	36	1	99	20.65	0.116	23.65	0.2315
		18	9	100	0	20.96	0.1248	23.96	0.2491
Middle	PI/2 BPSK DFT-s-OFDM	1	1	1	0	26.14	0.4111	29.14	0.8203
		1	36	1	99	26.05	0.4027	29.05	0.8036
		18	9	100	0	26.22	0.4188	29.22	0.8356
	QPSK DFT-s-OFDM	1	1	1	0	26.13	0.4102	29.13	0.8185
		1	36	1	99	26.09	0.4065	29.09	0.811
		18	9	100	0	26.26	0.4226	29.26	0.8433
	16QAM DFT-s-OFDM	1	1	1	0	24.10	0.2568	27.10	0.5124
		1	36	1	99	24.09	0.2562	27.09	0.5112
		18	9	100	0	24.36	0.2726	27.36	0.5439
	64QAM DFT-s-OFDM	1	1	1	0	22.61	0.1825	25.61	0.3641
		1	36	1	99	22.63	0.1833	25.63	0.3658
		18	9	100	0	22.81	0.1911	25.81	0.3812
	256QAM DFT-s-OFDM	1	1	1	0	20.80	0.1204	23.80	0.2401
		1	36	1	99	20.82	0.1209	23.82	0.2412
		18	9	100	0	20.78	0.1198	23.78	0.239
QPSK CP-OFDM	1	1	1	0	23.73	0.2359	26.73	0.4707	
	1	36	1	99	23.64	0.2311	26.64	0.4611	
		19	9	100	0	23.86	0.243	26.86	0.4849
Highest	PI/2 BPSK DFT-s-OFDM	1	1	1	0	25.80	0.3803	28.80	0.7587
		1	36	1	99	25.92	0.3909	28.92	0.7799
		18	9	100	0	26.06	0.4037	29.06	0.8054
	QPSK DFT-s-OFDM	1	1	1	0	25.83	0.3829	28.83	0.7639
		1	36	1	99	25.94	0.3927	28.94	0.7835
		18	9	100	0	26.03	0.4009	29.03	0.7999
	16QAM DFT-s-OFDM	1	1	1	0	23.89	0.2447	26.89	0.4883
		1	36	1	99	24.05	0.2539	27.05	0.5066
		18	9	100	0	24.26	0.2664	27.26	0.5316
	64QAM DFT-s-OFDM	1	1	1	0	22.45	0.1759	25.45	0.351
		1	36	1	99	22.51	0.1784	25.51	0.3559
		18	9	100	0	22.73	0.1876	25.73	0.3743
	256QAM DFT-s-OFDM	1	1	1	0	20.69	0.1171	23.69	0.2336
		1	36	1	99	20.81	0.1206	23.81	0.2407
		18	9	100	0	20.68	0.1168	23.68	0.2331

EN-DC n77 (ANT M2)+2A (ANT M)Combination 10MHz+20MHz(LTE)(GT - LC = 3 dB)									
Channel	Mode	NR		LTE		Conducted		EIRP	
		RB		RB					
		Size	Offset	Size	Offset	Power(dB)	Power(Watts)	IRP(dBm)	EIRP(W)
Lowest	PI/2 BPSK DFT-s-OFDM	1	1	1	0	25.69	0.3708	28.69	0.7399
		1	22	1	99	25.74	0.3751	28.74	0.7484
		12	6	100	0	25.82	0.3821	28.82	0.7623
	QPSK DFT-s-OFDM	1	1	1	0	25.73	0.3743	28.73	0.7467
		1	22	1	99	25.77	0.3777	28.77	0.7536
		12	6	100	0	25.86	0.3856	28.86	0.7693
	16QAM DFT-s-OFDM	1	1	1	0	24.28	0.2676	27.28	0.534
		1	22	1	99	24.25	0.2658	27.25	0.5303
		12	6	100	0	24.12	0.258	27.12	0.5147
	64QAM DFT-s-OFDM	1	1	1	0	22.73	0.1876	25.73	0.3743
		1	22	1	99	22.80	0.1906	25.80	0.3803
		12	6	100	0	22.82	0.1915	25.82	0.3821
	256QAM DFT-s-OFDM	1	1	1	0	20.73	0.1184	23.73	0.2363
		1	22	1	99	20.78	0.1198	23.78	0.239
		12	6	100	0	20.80	0.1203	23.80	0.2401
Middle	PI/2 BPSK DFT-s-OFDM	1	1	1	0	26.03	0.401	29.03	0.8
		1	22	1	99	26.02	0.4	29.02	0.7982
		12	6	100	0	26.15	0.4121	29.15	0.8223
	QPSK DFT-s-OFDM	1	1	1	0	26.08	0.4056	29.08	0.8092
		1	22	1	99	26.05	0.4028	29.05	0.8036
		12	6	100	0	26.14	0.4112	29.14	0.8205
	16QAM DFT-s-OFDM	1	1	1	0	24.27	0.267	27.27	0.5327
		1	22	1	99	24.10	0.2568	27.10	0.5124
		12	6	100	0	24.18	0.2615	27.18	0.5219
	64QAM DFT-s-OFDM	1	1	1	0	22.79	0.1902	25.79	0.3795
		1	22	1	99	22.77	0.1893	25.77	0.3777
		12	6	100	0	22.64	0.1838	25.64	0.3667
	256QAM DFT-s-OFDM	1	1	1	0	20.75	0.119	23.75	0.2374
		1	22	1	99	20.82	0.1209	23.82	0.2412
		12	6	100	0	20.76	0.1192	23.76	0.2379
QPSK CP-OFDM	1	1	1	0	23.64	0.2311	26.64	0.4611	
	1	22	1	99	23.82	0.2408	26.82	0.4805	
	12	6	100	0	23.74	0.2365	26.74	0.4718	
Highest	PI/2 BPSK DFT-s-OFDM	1	1	1	0	25.93	0.3918	28.93	0.7818
		1	22	1	99	25.95	0.3936	28.95	0.7854
		12	6	100	0	26.08	0.4056	29.08	0.8092
	QPSK DFT-s-OFDM	1	1	1	0	26.00	0.3982	29.00	0.7945
		1	22	1	99	26.07	0.4047	29.07	0.8074
		12	6	100	0	26.10	0.4074	29.10	0.8129
	16QAM DFT-s-OFDM	1	1	1	0	24.09	0.2562	27.09	0.5112
		1	22	1	99	24.24	0.2652	27.24	0.5291
		12	6	100	0	24.29	0.2682	27.29	0.5352
	64QAM DFT-s-OFDM	1	1	1	0	22.82	0.1915	25.82	0.3821
		1	22	1	99	22.82	0.1915	25.82	0.3821
		12	6	100	0	22.80	0.1906	25.80	0.3803
	256QAM DFT-s-OFDM	1	1	1	0	20.83	0.1212	23.83	0.2418
		1	22	1	99	20.76	0.1192	23.76	0.2379
		12	6	100	0	20.73	0.1184	23.73	0.2363

SCS 15

EN-DC n77 (ANT M2)+2A (ANT M)Combination 20MHz+10MHz(LTE)(GT - LC = 3 dB)									
Channel	Mode	NR		LTE		Conducted		EIRP	
		RB		RB					
		Size	Offset	Size	Offset	Power(dBm)	Power(Watts)	IRP(dBm)	EIRP(W)
Lowest	PI/2 BPSK DFT-s-OFDM	1	1	1	0	25.97	0.3955	28.97	0.7892
		1	104	1	99	26.23	0.4199	29.23	0.8377
		50	25	100	0	26.18	0.4151	29.18	0.8282
	QPSK DFT-s-OFDM	1	1	1	0	25.93	0.3919	28.93	0.7819
		1	104	1	99	26.18	0.4151	29.18	0.8282
		50	25	100	0	26.15	0.4122	29.15	0.8224
	16QAM DFT-s-OFDM	1	1	1	0	25.16	0.3283	28.16	0.655
		1	104	1	99	25.34	0.3421	28.34	0.6827
		50	25	100	0	25.46	0.3517	28.46	0.7018
	64QAM DFT-s-OFDM	1	1	1	0	24.11	0.2574	27.11	0.5136
		1	104	1	99	24.17	0.261	27.17	0.5207
		50	25	100	0	24.05	0.2539	27.05	0.5066
	256QAM DFT-s-OFDM	1	1	1	0	21.75	0.1496	24.75	0.2984
		1	104	1	99	21.91	0.1551	24.91	0.3095
		50	25	100	0	22.04	0.1598	25.04	0.3188
Middle	PI/2 BPSK DFT-s-OFDM	1	1	1	0	26.30	0.4267	29.30	0.8513
		1	104	1	99	26.27	0.4237	29.27	0.8455
		50	25	100	0	26.47	0.4437	29.47	0.8852
	QPSK DFT-s-OFDM	1	1	1	0	26.35	0.4316	29.35	0.8612
		1	104	1	99	26.33	0.4296	29.33	0.8572
		50	25	100	0	26.49	0.4457	29.49	0.8893
	16QAM DFT-s-OFDM	1	1	1	0	25.46	0.3517	28.46	0.7017
		1	104	1	99	25.44	0.3501	28.44	0.6985
		50	25	100	0	25.67	0.3691	28.67	0.7364
	64QAM DFT-s-OFDM	1	1	1	0	24.17	0.261	27.17	0.5207
		1	104	1	99	24.23	0.2646	27.23	0.5279
		50	25	100	0	24.17	0.2609	27.17	0.5207
	256QAM DFT-s-OFDM	1	1	1	0	21.88	0.1541	24.88	0.3074
		1	104	1	99	21.75	0.1495	24.75	0.2984
		50	25	100	0	22.19	0.1654	25.19	0.33
QPSK CP-OFDM	1	1	1	0	24.84	0.305	27.84	0.6086	
	1	104	1	99	24.73	0.2974	27.73	0.5935	
	53	26	100	0	25.00	0.3164	28.00	0.6314	
Highest	PI/2 BPSK DFT-s-OFDM	1	1	1	0	25.96	0.3946	28.96	0.7874
		1	104	1	99	26.22	0.4189	29.22	0.8358
		50	25	100	0	26.26	0.4228	29.26	0.8435
	QPSK DFT-s-OFDM	1	1	1	0	26.04	0.4019	29.04	0.802
		1	104	1	99	26.24	0.4208	29.24	0.8397
		50	25	100	0	26.28	0.4247	29.28	0.8474
	16QAM DFT-s-OFDM	1	1	1	0	25.22	0.3329	28.22	0.6642
		1	104	1	99	25.30	0.339	28.30	0.6764
		50	25	100	0	25.44	0.3501	28.44	0.6986
	64QAM DFT-s-OFDM	1	1	1	0	24.05	0.2539	27.05	0.5066
		1	104	1	99	24.10	0.2568	27.10	0.5124
		50	25	100	0	24.03	0.2527	27.03	0.5043
	256QAM DFT-s-OFDM	1	1	1	0	21.53	0.1422	24.53	0.2837
		1	104	1	99	21.79	0.1509	24.79	0.3011
		50	25	100	0	21.98	0.1576	24.98	0.3145

EN-DC n77 (ANT M2)+2A (ANT M)Combination 15MHz+20MHz(LTE)(GT - LC = 3 dB)									
Channel	Mode	NR		LTE		Conducted		EIRP	
		RB		RB					
		Size	Offset	Size	Offset	Power(dBm)	Power(Watts)	IRP(dBm)	EIRP(W)
Lowest	PI/2 BPSK DFT-s-OFDM	1	1	1	0	26.02	0.4001	29.02	0.7983
		1	77	1	99	26.18	0.4151	29.18	0.8281
		36	18	100	0	26.13	0.4103	29.13	0.8187
	QPSK DFT-s-OFDM	1	1	1	0	25.97	0.3955	28.97	0.7892
		1	77	1	99	26.14	0.4113	29.14	0.8206
		36	18	100	0	26.05	0.4029	29.05	0.8038
	16QAM DFT-s-OFDM	1	1	1	0	25.27	0.3367	28.27	0.6718
		1	77	1	99	25.21	0.3321	28.21	0.6626
		36	18	100	0	25.44	0.3501	28.44	0.6985
	64QAM DFT-s-OFDM	1	1	1	0	23.96	0.2487	26.96	0.4963
		1	77	1	99	24.08	0.2556	27.08	0.51
		36	18	100	0	24.06	0.2545	27.06	0.5077
	256QAM DFT-s-OFDM	1	1	1	0	21.54	0.1426	24.54	0.2844
		1	77	1	99	21.85	0.153	24.85	0.3053
		36	18	100	0	21.97	0.1573	24.97	0.3138
Middle	PI/2 BPSK DFT-s-OFDM	1	1	1	0	26.34	0.4306	29.34	0.8592
		1	77	1	99	26.32	0.4286	29.32	0.8552
		36	18	100	0	26.45	0.4416	29.45	0.8811
	QPSK DFT-s-OFDM	1	1	1	0	26.35	0.4316	29.35	0.8612
		1	77	1	99	26.36	0.4326	29.36	0.8631
		36	18	100	0	26.42	0.4386	29.42	0.8751
	16QAM DFT-s-OFDM	1	1	1	0	25.48	0.3533	28.48	0.7049
		1	77	1	99	25.43	0.3493	28.43	0.6969
		36	18	100	0	25.60	0.3632	28.60	0.7247
	64QAM DFT-s-OFDM	1	1	1	0	24.14	0.2592	27.14	0.5171
		1	77	1	99	24.15	0.2598	27.15	0.5183
		36	18	100	0	24.08	0.2556	27.08	0.5101
	256QAM DFT-s-OFDM	1	1	1	0	21.84	0.1526	24.84	0.3046
		1	77	1	99	21.69	0.1475	24.69	0.2943
		36	18	100	0	22.11	0.1624	25.11	0.324
QPSK CP-OFDM	1	1	1	0	24.79	0.3016	27.79	0.6017	
	1	77	1	99	24.71	0.2961	27.71	0.5907	
	39	19	100	0	24.99	0.3157	27.99	0.6299	
Highest	PI/2 BPSK DFT-s-OFDM	1	1	1	0	26.03	0.401	29.03	0.8001
		1	77	1	99	26.20	0.417	29.20	0.832
		36	18	100	0	26.19	0.416	29.19	0.8301
	QPSK DFT-s-OFDM	1	1	1	0	26.05	0.4029	29.05	0.8038
		1	77	1	99	26.25	0.4218	29.25	0.8416
		36	18	100	0	26.15	0.4122	29.15	0.8225
	16QAM DFT-s-OFDM	1	1	1	0	25.14	0.3268	28.14	0.652
		1	77	1	99	25.32	0.3406	28.32	0.6795
		36	18	100	0	25.42	0.3485	28.42	0.6953
	64QAM DFT-s-OFDM	1	1	1	0	24.07	0.255	27.07	0.5089
		1	77	1	99	24.08	0.2556	27.08	0.51
		36	18	100	0	24.07	0.2551	27.07	0.5089
	256QAM DFT-s-OFDM	1	1	1	0	21.65	0.1462	24.65	0.2917
		1	77	1	99	21.82	0.1519	24.82	0.3032
		36	18	100	0	22.02	0.1591	25.02	0.3174

EN-DC n77 (ANT M2)+2A (ANT M)Combination 10MHz+20MHz(LTE)(GT - LC = 3 dB)									
Channel	Mode	NR		LTE		Conducted		EIRP	
		RB		RB					
		Size	Offset	Size	Offset	Power(dBm)	Power(Watts)	IRP(dBm)	EIRP(W)
Lowest	PI/2 BPSK DFT-s-OFDM	1	1	1	0	25.93	0.3918	28.93	0.7817
		1	50	1	99	26.03	0.4009	29.03	0.7999
		25	12	100	0	26.02	0.4001	29.02	0.7983
	QPSK DFT-s-OFDM	1	1	1	0	25.89	0.3883	28.89	0.7748
		1	50	1	99	26.02	0.4001	29.02	0.7983
		25	12	100	0	25.98	0.3964	28.98	0.791
	16QAM DFT-s-OFDM	1	1	1	0	25.07	0.3216	28.07	0.6416
		1	50	1	99	25.20	0.3313	28.20	0.6611
		25	12	100	0	25.38	0.3453	28.38	0.689
	64QAM DFT-s-OFDM	1	1	1	0	23.94	0.2476	26.94	0.4939
		1	50	1	99	24.07	0.255	27.07	0.5089
		25	12	100	0	24.04	0.2533	27.04	0.5054
	256QAM DFT-s-OFDM	1	1	1	0	21.61	0.1448	24.61	0.2889
		1	50	1	99	21.81	0.1516	24.81	0.3025
		25	12	100	0	21.95	0.1565	24.95	0.3123
Middle	PI/2 BPSK DFT-s-OFDM	1	1	1	0	26.23	0.4197	29.23	0.8375
		1	50	1	99	26.30	0.4265	29.30	0.8511
		25	12	100	0	26.35	0.4315	29.35	0.8609
	QPSK DFT-s-OFDM	1	1	1	0	26.23	0.4197	29.23	0.8375
		1	50	1	99	26.28	0.4246	29.28	0.8471
		25	12	100	0	26.32	0.4285	29.32	0.8549
	16QAM DFT-s-OFDM	1	1	1	0	25.32	0.3406	28.32	0.6796
		1	50	1	99	25.39	0.3461	28.39	0.6905
		25	12	100	0	25.63	0.3657	28.63	0.7297
	64QAM DFT-s-OFDM	1	1	1	0	24.10	0.2568	27.10	0.5124
		1	50	1	99	24.10	0.2568	27.10	0.5124
		25	12	100	0	24.10	0.2568	27.10	0.5124
	256QAM DFT-s-OFDM	1	1	1	0	21.75	0.1495	24.75	0.2984
		1	50	1	99	21.75	0.1495	24.75	0.2984
		25	12	100	0	22.07	0.1609	25.07	0.321
QPSK CP-OFDM	1	1	1	0	24.77	0.3002	27.77	0.5989	
	1	50	1	99	24.70	0.2954	27.70	0.5894	
	26	13	100	0	24.92	0.3107	27.92	0.6199	
Highest	PI/2 BPSK DFT-s-OFDM	1	1	1	0	26.00	0.3981	29.00	0.7943
		1	50	1	99	25.98	0.3963	28.98	0.7907
		25	12	100	0	26.20	0.4169	29.20	0.8317
	QPSK DFT-s-OFDM	1	1	1	0	26.04	0.4018	29.04	0.8017
		1	50	1	99	26.25	0.4217	29.25	0.8413
		25	12	100	0	26.15	0.4121	29.15	0.8222
	16QAM DFT-s-OFDM	1	1	1	0	25.20	0.3313	28.20	0.661
		1	50	1	99	25.30	0.339	28.30	0.6764
		25	12	100	0	25.45	0.3509	28.45	0.7001
	64QAM DFT-s-OFDM	1	1	1	0	23.98	0.2499	26.98	0.4985
		1	50	1	99	24.05	0.2539	27.05	0.5066
		25	12	100	0	24.04	0.2533	27.04	0.5054
	256QAM DFT-s-OFDM	1	1	1	0	21.64	0.1458	24.64	0.291
		1	50	1	99	21.83	0.1523	24.83	0.3039
		25	12	100	0	21.93	0.1558	24.93	0.3109

**5G NR n78 HPUE SA mode:
SCS 30**

SA n78 (ANT M2) 100MHz (GT - LC = 3 dB)							
Channel	Mode	NR		Conducted		EIRP	
		RB		Power(dBm)	Power(Watts)	EIRP(dBm)	EIRP(W)
		Size	Offset				
Middle	PI/2 BPSK DFT-s- OFDM	1	1	24.85	0.3055	27.85	0.6095
		1	271	25.45	0.3508	28.45	0.6998
		135	67	25.92	0.3908	28.92	0.7798
	QPSK DFT-s- OFDM	1	1	24.95	0.3126	27.95	0.6237
		1	271	25.69	0.3707	28.69	0.7396
		135	67	25.96	0.3945	28.96	0.787
	16QAM DFT-s- OFDM	1	1	24.19	0.2624	27.19	0.5236
		1	271	24.66	0.2924	27.66	0.5834
		135	67	25.01	0.317	28.01	0.6324
	64QAM DFT-s- OFDM	1	1	22.78	0.1897	25.78	0.3784
		1	271	23.45	0.2213	26.45	0.4416
		135	67	23.63	0.2307	26.63	0.4603
	256QAM DFT-s- OFDM	1	1	20.36	0.1086	23.36	0.2168
		1	271	20.96	0.1247	23.96	0.2489
		135	67	21.51	0.1416	24.51	0.2825
	QPSK CP-OFDM	1	1	23.52	0.2249	26.52	0.4487
		1	271	24.26	0.2667	27.26	0.5321
		137	68	24.61	0.2891	27.61	0.5768

SA n78 (ANT) 80MHz (GT - LC = 3 dB)							
Channel	Mode	NR		Conducted		EIRP	
		RB		Power(dBm)	Power(Watts)	EIRP(dBm)	EIRP(W)
		Size	Offset				
Lowest	PI/2 BPSK DFT-s-OFDM	1	1	25.34	0.342	28.34	0.6823
		1	215	25.84	0.3837	28.84	0.7656
		108	54	26.19	0.4159	29.19	0.8299
	QPSK DFT-s-OFDM	1	1	25.38	0.3451	28.38	0.6887
		1	215	25.76	0.3767	28.76	0.7516
		108	54	26.17	0.414	29.17	0.826
	16QAM DFT-s-OFDM	1	1	24.53	0.2838	27.53	0.5662
		1	215	24.98	0.3148	27.98	0.6281
		108	54	25.31	0.3396	28.31	0.6776
	64QAM DFT-s-OFDM	1	1	23.11	0.2046	26.11	0.4083
		1	215	23.51	0.2244	26.51	0.4477
		108	54	23.77	0.2382	26.77	0.4753
	256QAM DFT-s-OFDM	1	1	21.16	0.1306	24.16	0.2606
		1	215	21.46	0.14	24.46	0.2793
		108	54	21.75	0.1496	24.75	0.2985
Middle	PI/2 BPSK DFT-s-OFDM	1	1	25.38	0.3451	28.38	0.6887
		1	215	25.87	0.3864	28.87	0.7709
		108	54	26.16	0.413	29.16	0.8241
	QPSK DFT-s-OFDM	1	1	25.44	0.3499	28.44	0.6982
		1	215	25.79	0.3793	28.79	0.7568
		108	54	26.21	0.4178	29.21	0.8337
	16QAM DFT-s-OFDM	1	1	24.52	0.2831	27.52	0.5649
		1	215	24.93	0.3112	27.93	0.6209
		108	54	25.28	0.3373	28.28	0.673
	64QAM DFT-s-OFDM	1	1	23.05	0.2018	26.05	0.4027
		1	215	23.46	0.2218	26.46	0.4426
		108	54	23.79	0.2393	26.79	0.4775
	256QAM DFT-s-OFDM	1	1	21.14	0.13	24.14	0.2594
		1	215	21.45	0.1396	24.45	0.2786
		108	54	21.73	0.1489	24.73	0.2972
QPSK CP-OFDM	1	1	24.01	0.2518	27.01	0.5023	
	1	215	24.33	0.271	27.33	0.5408	
	109	54	24.76	0.2992	27.76	0.597	
Highest	PI/2 BPSK DFT-s-OFDM	1	1	25.52	0.3565	28.52	0.7112
		1	215	25.93	0.3917	28.93	0.7816
		108	54	26.16	0.413	29.16	0.8241
	QPSK DFT-s-OFDM	1	1	25.41	0.3475	28.41	0.6934
		1	215	25.82	0.3819	28.82	0.7621
		108	54	26.24	0.4207	29.24	0.8395
	16QAM DFT-s-OFDM	1	1	24.58	0.2871	27.58	0.5728
		1	215	25.18	0.3296	28.18	0.6577
		108	54	25.34	0.342	28.34	0.6823
	64QAM DFT-s-OFDM	1	1	23.16	0.207	26.16	0.413
		1	215	23.57	0.2275	26.57	0.4539
		108	54	23.84	0.2421	26.84	0.4831
	256QAM DFT-s-OFDM	1	1	21.13	0.1297	24.13	0.2588
		1	215	21.54	0.1426	24.54	0.2844
		108	54	21.79	0.151	24.79	0.3013

SA n78 (ANT) 60MHz (GT - LC = 3 dB)							
Channel	Mode	NR		Conducted		EIRP	
		RB		Power(dBm)	Power(Watts)	EIRP(dBm)	EIRP(W)
		Size	Offset				
Lowest	PI/2 BPSK DFT-s-OFDM	1	1	25.91	0.3899	28.91	0.778
		1	160	26.32	0.4285	29.32	0.8551
		81	40	26.29	0.4256	29.29	0.8492
	QPSK DFT-s-OFDM	1	1	25.84	0.3837	28.84	0.7656
		1	160	26.09	0.4064	29.09	0.811
		81	40	26.31	0.4276	29.31	0.8531
	16QAM DFT-s-OFDM	1	1	25.02	0.3177	28.02	0.6339
		1	160	25.24	0.3342	28.24	0.6668
		81	40	25.39	0.3459	28.39	0.6902
	64QAM DFT-s-OFDM	1	1	23.57	0.2275	26.57	0.4539
		1	160	24.01	0.2518	27.01	0.5023
		81	40	23.94	0.2477	26.94	0.4943
	256QAM DFT-s-OFDM	1	1	21.33	0.1358	24.33	0.271
		1	160	21.84	0.1528	24.84	0.3048
		81	40	21.92	0.1556	24.92	0.3105
Middle	PI/2 BPSK DFT-s-OFDM	1	1	25.98	0.3963	28.98	0.7907
		1	160	26.34	0.4305	29.34	0.859
		81	40	26.31	0.4276	29.31	0.8531
	QPSK DFT-s-OFDM	1	1	26.05	0.4027	29.05	0.8035
		1	160	26.32	0.4285	29.32	0.8551
		81	40	26.32	0.4285	29.32	0.8551
	16QAM DFT-s-OFDM	1	1	25.12	0.3251	28.12	0.6486
		1	160	25.32	0.3404	28.32	0.6792
		81	40	25.43	0.3491	28.43	0.6966
	64QAM DFT-s-OFDM	1	1	23.72	0.2355	26.72	0.4699
		1	160	24.12	0.2582	27.12	0.5152
		81	40	24.01	0.2518	27.01	0.5023
	256QAM DFT-s-OFDM	1	1	21.37	0.1371	24.37	0.2735
		1	160	21.85	0.1531	24.85	0.3055
		81	40	22.02	0.1592	25.02	0.3177
QPSK CP-OFDM	1	1	24.57	0.2864	27.57	0.5715	
	1	160	25.02	0.3177	28.02	0.6339	
	81	40	25.01	0.317	28.01	0.6324	
Highest	PI/2 BPSK DFT-s-OFDM	1	1	26.08	0.4055	29.08	0.8091
		1	160	26.41	0.4375	29.41	0.873
		81	40	26.39	0.4355	29.39	0.869
	QPSK DFT-s-OFDM	1	1	26.04	0.4018	29.04	0.8017
		1	160	26.37	0.4335	29.37	0.865
		81	40	26.36	0.4325	29.36	0.863
	16QAM DFT-s-OFDM	1	1	25.06	0.3206	28.06	0.6397
		1	160	25.65	0.3673	28.65	0.7328
		81	40	25.55	0.3589	28.55	0.7161
	64QAM DFT-s-OFDM	1	1	23.79	0.2393	26.79	0.4775
		1	160	24.22	0.2642	27.22	0.5272
		81	40	24.11	0.2576	27.11	0.514
	256QAM DFT-s-OFDM	1	1	21.52	0.1419	24.52	0.2831
		1	160	21.89	0.1545	24.89	0.3083
		81	40	22.07	0.1611	25.07	0.3214

SA n78 (ANT) 50MHz (GT - LC = 3 dB)								
Channel	Mode	NR		Conducted		EIRP		
		RB		Power(dBm)	Power(Watts)	EIRP(dBm)	EIRP(W)	
		Size	Offset					
Lowest	PI/2 BPSK DFT-s-OFDM	1	1	25.87	0.3864	28.87	0.7709	
		1	131	26.23	0.4198	29.23	0.8375	
		64	32	26.25	0.4217	29.25	0.8414	
	QPSK DFT-s-OFDM	1	1	25.91	0.3899	28.91	0.778	
		1	131	26.21	0.4178	29.21	0.8337	
		64	32	26.19	0.4159	29.19	0.8299	
	16QAM DFT-s-OFDM	1	1	24.81	0.3027	27.81	0.6039	
		1	131	25.24	0.3342	28.24	0.6668	
		64	32	25.22	0.3327	28.22	0.6637	
	64QAM DFT-s-OFDM	1	1	23.49	0.2234	26.49	0.4457	
		1	131	23.76	0.2377	26.76	0.4742	
		64	32	23.75	0.2371	26.75	0.4732	
	256QAM DFT-s-OFDM	1	1	21.66	0.1466	24.66	0.2924	
		1	131	21.93	0.156	24.93	0.3112	
		64	32	21.78	0.1507	24.78	0.3006	
	Middle	PI/2 BPSK DFT-s-OFDM	1	1	26.07	0.4046	29.07	0.8072
			1	131	26.28	0.4246	29.28	0.8472
			64	32	26.36	0.4325	29.36	0.863
QPSK DFT-s-OFDM		1	1	26.11	0.4083	29.11	0.8147	
		1	131	26.26	0.4227	29.26	0.8433	
		64	32	26.31	0.4276	29.31	0.8531	
16QAM DFT-s-OFDM		1	1	25.31	0.3396	28.31	0.6776	
		1	131	25.47	0.3524	28.47	0.7031	
		64	32	25.26	0.3357	28.26	0.6699	
64QAM DFT-s-OFDM		1	1	23.59	0.2286	26.59	0.456	
		1	131	23.97	0.2495	26.97	0.4977	
		64	32	23.77	0.2382	26.77	0.4753	
256QAM DFT-s-OFDM		1	1	21.32	0.1355	24.32	0.2704	
		1	131	21.51	0.1416	24.51	0.2825	
		64	32	21.88	0.1542	24.88	0.3076	
QPSK CP-OFDM		1	1	24.45	0.2786	27.45	0.5559	
		1	131	24.93	0.3112	27.93	0.6209	
		67	33	24.71	0.2958	27.71	0.5902	
Highest	PI/2 BPSK DFT-s-OFDM	1	1	26.11	0.4083	29.11	0.8147	
		1	131	26.34	0.4305	29.34	0.859	
		64	32	26.46	0.4426	29.46	0.8831	
	QPSK DFT-s-OFDM	1	1	26.13	0.4102	29.13	0.8185	
		1	131	26.31	0.4276	29.31	0.8531	
		64	32	26.49	0.4457	29.49	0.8892	
	16QAM DFT-s-OFDM	1	1	25.22	0.3327	28.22	0.6637	
		1	131	25.61	0.3639	28.61	0.7261	
		64	32	25.62	0.3648	28.62	0.7278	
	64QAM DFT-s-OFDM	1	1	23.68	0.2333	26.68	0.4656	
		1	131	23.98	0.25	26.98	0.4989	
		64	32	24.10	0.257	27.10	0.5129	
	256QAM DFT-s-OFDM	1	1	21.85	0.1531	24.85	0.3055	
		1	131	22.18	0.1652	25.18	0.3296	
		64	32	22.07	0.1611	25.07	0.3214	

SA n78 (ANT) 40MHz (GT - LC = 3 dB)							
Channel	Mode	NR		Conducted		EIRP	
		RB		Power(dBm)	Power(Watts)	EIRP(dBm)	EIRP(W)
		Size	Offset				
Lowest	PI/2 BPSK DFT-s-OFDM	1	1	26.69	0.4667	29.69	0.9311
		1	104	25.98	0.3963	28.98	0.7907
		50	25	26.26	0.4227	29.26	0.8433
	QPSK DFT-s-OFDM	1	1	25.71	0.3724	28.71	0.743
		1	104	26.01	0.399	29.01	0.7962
		50	25	26.31	0.4276	29.31	0.8531
	16QAM DFT-s-OFDM	1	1	24.85	0.3055	27.85	0.6095
		1	104	24.91	0.3097	27.91	0.618
		50	25	25.29	0.3381	28.29	0.6745
	64QAM DFT-s-OFDM	1	1	23.29	0.2133	26.29	0.4256
		1	104	23.42	0.2198	26.42	0.4385
		50	25	23.77	0.2382	26.77	0.4753
	256QAM DFT-s-OFDM	1	1	21.16	0.1306	24.16	0.2606
		1	104	21.61	0.1449	24.61	0.2891
		50	25	21.74	0.1493	24.74	0.2979
Middle	PI/2 BPSK DFT-s-OFDM	1	1	25.83	0.3828	28.83	0.7638
		1	104	26.04	0.4018	29.04	0.8017
		50	25	26.34	0.4305	29.34	0.859
	QPSK DFT-s-OFDM	1	1	25.87	0.3864	28.87	0.7709
		1	104	26.07	0.4046	29.07	0.8072
		50	25	26.30	0.4266	29.30	0.8511
	16QAM DFT-s-OFDM	1	1	24.73	0.2972	27.73	0.5929
		1	104	25.09	0.3228	28.09	0.6442
		50	25	25.23	0.3334	28.23	0.6653
	64QAM DFT-s-OFDM	1	1	23.29	0.2133	26.29	0.4256
		1	104	23.63	0.2307	26.63	0.4603
		50	25	23.83	0.2415	26.83	0.4819
	256QAM DFT-s-OFDM	1	1	21.49	0.1409	24.49	0.2812
		1	104	21.47	0.1403	24.47	0.2799
		50	25	21.79	0.151	24.79	0.3013
	QPSK CP-OFDM	1	1	24.48	0.2805	27.48	0.5598
		1	104	25.01	0.317	28.01	0.6324
		53	26	24.73	0.2972	27.73	0.5929
Highest	PI/2 BPSK DFT-s-OFDM	1	1	25.90	0.389	28.90	0.7762
		1	104	26.10	0.4074	29.10	0.8128
		50	25	26.37	0.4335	29.37	0.865
	QPSK DFT-s-OFDM	1	1	25.87	0.3864	28.87	0.7709
		1	104	26.08	0.4055	29.08	0.8091
		50	25	26.34	0.4305	29.34	0.859
	16QAM DFT-s-OFDM	1	1	24.88	0.3076	27.88	0.6138
		1	104	25.28	0.3373	28.28	0.673
		50	25	25.57	0.3606	28.57	0.7194
	64QAM DFT-s-OFDM	1	1	23.46	0.2218	26.46	0.4426
		1	104	23.81	0.2404	26.81	0.4797
		50	25	24.10	0.257	27.10	0.5129
	256QAM DFT-s-OFDM	1	1	21.55	0.1429	24.55	0.2851
		1	104	21.72	0.1486	24.72	0.2965
		50	25	22.01	0.1589	25.01	0.317

SA n78 (ANT) 20MHz (GT - LC = 3 dB)							
Channel	Mode	NR		Conducted		EIRP	
		RB		Power(dBm)	Power(Watts)	EIRP(dBm)	EIRP(W)
		Size	Offset				
Lowest	PI/2 BPSK DFT-s-OFDM	1	1	26.05	0.4027	29.05	0.8035
		1	49	26.15	0.4121	29.15	0.8222
		25	12	26.28	0.4246	29.28	0.8472
	QPSK DFT-s-OFDM	1	1	26.01	0.399	29.01	0.7962
		1	49	26.17	0.414	29.17	0.826
		25	12	26.38	0.4345	29.38	0.867
	16QAM DFT-s-OFDM	1	1	25.37	0.3443	28.37	0.6871
		1	49	25.25	0.335	28.25	0.6683
		25	12	25.41	0.3475	28.41	0.6934
	64QAM DFT-s-OFDM	1	1	23.78	0.2388	26.78	0.4764
		1	49	23.87	0.2438	26.87	0.4864
		25	12	23.82	0.241	26.82	0.4808
	256QAM DFT-s-OFDM	1	1	21.36	0.1368	24.36	0.2729
		1	49	21.39	0.1377	24.39	0.2748
		25	12	21.82	0.1521	24.82	0.3034
Middle	PI/2 BPSK DFT-s-OFDM	1	1	26.23	0.4198	29.23	0.8375
		1	49	26.24	0.4207	29.24	0.8395
		25	12	26.44	0.4406	29.44	0.879
	QPSK DFT-s-OFDM	1	1	26.19	0.4159	29.19	0.8299
		1	49	26.23	0.4198	29.23	0.8375
		25	12	26.39	0.4355	29.39	0.869
	16QAM DFT-s-OFDM	1	1	25.48	0.3532	28.48	0.7047
		1	49	25.64	0.3664	28.64	0.7311
		25	12	25.42	0.3483	28.42	0.695
	64QAM DFT-s-OFDM	1	1	23.81	0.2404	26.81	0.4797
		1	49	23.95	0.2483	26.95	0.4955
		25	12	24.03	0.2529	27.03	0.5047
	256QAM DFT-s-OFDM	1	1	21.47	0.1403	24.47	0.2799
		1	49	21.58	0.1439	24.58	0.2871
		25	12	22.07	0.1611	25.07	0.3214
QPSK CP-OFDM	1	1	24.81	0.3027	27.81	0.6039	
	1	49	24.69	0.2944	27.69	0.5875	
	25	12	24.95	0.3126	27.95	0.6237	
Highest	PI/2 BPSK DFT-s-OFDM	1	1	26.24	0.4207	29.24	0.8395
		1	49	26.40	0.4365	29.40	0.871
		25	12	26.49	0.4457	29.49	0.8892
	QPSK DFT-s-OFDM	1	1	26.27	0.4236	29.27	0.8453
		1	49	26.39	0.4355	29.39	0.869
		25	12	26.52	0.4487	29.52	0.8954
	16QAM DFT-s-OFDM	1	1	25.73	0.3741	28.73	0.7464
		1	49	25.87	0.3864	28.87	0.7709
		25	12	25.72	0.3733	28.72	0.7447
	64QAM DFT-s-OFDM	1	1	24.12	0.2582	27.12	0.5152
		1	49	24.17	0.2612	27.17	0.5212
		25	12	24.19	0.2624	27.19	0.5236
	256QAM DFT-s-OFDM	1	1	21.78	0.1507	24.78	0.3006
		1	49	21.97	0.1574	24.97	0.3141
		25	12	22.31	0.1702	25.31	0.3396

SA n78 (ANT) 15MHz (GT - LC = 3 dB)							
Channel	Mode	NR		Conducted		EIRP	
		RB		Power(dBm)	Power(Watts)	EIRP(dBm)	EIRP(W)
		Size	Offset				
Lowest	PI/2 BPSK DFT-s-OFDM	1	1	26.02	0.3999	29.02	0.798
		1	36	26.14	0.4111	29.14	0.8204
		18	9	26.24	0.4207	29.24	0.8395
	QPSK DFT-s-OFDM	1	1	26.07	0.4046	29.07	0.8072
		1	36	26.17	0.414	29.17	0.826
		18	9	26.21	0.4178	29.21	0.8337
	16QAM DFT-s-OFDM	1	1	25.25	0.335	28.25	0.6683
		1	36	25.41	0.3475	28.41	0.6934
		18	9	25.31	0.3396	28.31	0.6776
	64QAM DFT-s-OFDM	1	1	23.88	0.2443	26.88	0.4875
		1	36	23.92	0.2466	26.92	0.492
		18	9	23.84	0.2421	26.84	0.4831
	256QAM DFT-s-OFDM	1	1	21.42	0.1387	24.42	0.2767
		1	36	21.54	0.1426	24.54	0.2844
		18	9	21.84	0.1528	24.84	0.3048
Middle	PI/2 BPSK DFT-s-OFDM	1	1	26.28	0.4246	29.28	0.8472
		1	36	26.31	0.4276	29.31	0.8531
		18	9	26.41	0.4375	29.41	0.873
	QPSK DFT-s-OFDM	1	1	26.29	0.4256	29.29	0.8492
		1	36	26.27	0.4236	29.27	0.8453
		18	9	26.39	0.4355	29.39	0.869
	16QAM DFT-s-OFDM	1	1	25.56	0.3597	28.56	0.7178
		1	36	25.63	0.3656	28.63	0.7295
		18	9	25.46	0.3516	28.46	0.7015
	64QAM DFT-s-OFDM	1	1	23.97	0.2495	26.97	0.4977
		1	36	23.96	0.2489	26.96	0.4966
		18	9	24.01	0.2518	27.01	0.5023
	256QAM DFT-s-OFDM	1	1	21.55	0.1429	24.55	0.2851
		1	36	21.71	0.1483	24.71	0.2958
		18	9	22.02	0.1592	25.02	0.3177
QPSK CP-OFDM	1	1	24.81	0.3027	27.81	0.6039	
	1	36	24.85	0.3055	27.85	0.6095	
	19	9	24.57	0.2864	27.57	0.5715	
Highest	PI/2 BPSK DFT-s-OFDM	1	1	26.42	0.4385	29.42	0.875
		1	36	26.47	0.4436	29.47	0.8851
		18	9	26.55	0.4519	29.55	0.9016
	QPSK DFT-s-OFDM	1	1	26.41	0.4375	29.41	0.873
		1	36	26.44	0.4406	29.44	0.879
		18	9	26.49	0.4457	29.49	0.8892
	16QAM DFT-s-OFDM	1	1	25.82	0.3819	28.82	0.7621
		1	36	25.84	0.3837	28.84	0.7656
		18	9	25.72	0.3733	28.72	0.7447
	64QAM DFT-s-OFDM	1	1	24.27	0.2673	27.27	0.5333
		1	36	24.42	0.2767	27.42	0.5521
		18	9	24.27	0.2673	27.27	0.5333
	256QAM DFT-s-OFDM	1	1	21.96	0.157	24.96	0.3133
		1	36	20.22	0.1052	23.22	0.2099
		18	9	22.39	0.1734	25.39	0.3459

SA n78 (ANT) 10MHz (GT - LC = 3 dB)							
Channel	Mode	NR		Conducted		EIRP	
		RB		Power(dBm)	Power(Watts)	EIRP(dBm)	EIRP(W)
		Size	Offset				
Lowest	PI/2 BPSK DFT-s-OFDM	1	1	26.07	0.4046	29.07	0.8072
		1	22	26.15	0.4121	29.15	0.8222
		12	6	26.21	0.4178	29.21	0.8337
	QPSK DFT-s-OFDM	1	1	26.09	0.4064	29.09	0.811
		1	22	26.19	0.4159	29.19	0.8299
		12	6	26.25	0.4217	29.25	0.8414
	16QAM DFT-s-OFDM	1	1	25.27	0.3365	28.27	0.6714
		1	22	25.19	0.3304	28.19	0.6592
		12	6	25.26	0.3357	28.26	0.6699
	64QAM DFT-s-OFDM	1	1	23.73	0.236	26.73	0.471
		1	22	23.99	0.2506	26.99	0.5
		12	6	23.77	0.2382	26.77	0.4753
	256QAM DFT-s-OFDM	1	1	21.53	0.1422	24.53	0.2838
		1	22	21.91	0.1552	24.91	0.3097
		12	6	21.81	0.1517	24.81	0.3027
Middle	PI/2 BPSK DFT-s-OFDM	1	1	26.31	0.4276	29.31	0.8531
		1	22	26.36	0.4325	29.36	0.863
		12	6	26.47	0.4436	29.47	0.8851
	QPSK DFT-s-OFDM	1	1	26.27	0.4236	29.27	0.8453
		1	22	26.34	0.4305	29.34	0.859
		12	6	26.43	0.4395	29.43	0.877
	16QAM DFT-s-OFDM	1	1	25.28	0.3373	28.28	0.673
		1	22	25.51	0.3556	28.51	0.7096
		12	6	25.47	0.3524	28.47	0.7031
	64QAM DFT-s-OFDM	1	1	23.92	0.2466	26.92	0.492
		1	22	23.94	0.2477	26.94	0.4943
		12	6	24.02	0.2523	27.02	0.5035
	256QAM DFT-s-OFDM	1	1	22.01	0.1589	25.01	0.317
		1	22	21.86	0.1535	24.86	0.3062
		12	6	22.09	0.1618	25.09	0.3228
QPSK CP-OFDM	1	1	25.38	0.3451	28.38	0.6887	
	1	22	25.64	0.3664	28.64	0.7311	
	12	6	24.45	0.2786	27.45	0.5559	
Highest	PI/2 BPSK DFT-s-OFDM	1	1	26.29	0.4256	29.29	0.8492
		1	22	26.35	0.4315	29.35	0.861
		12	6	26.51	0.4477	29.51	0.8933
	QPSK DFT-s-OFDM	1	1	26.32	0.4285	29.32	0.8551
		1	22	26.34	0.4305	29.34	0.859
		12	6	26.49	0.4457	29.49	0.8892
	16QAM DFT-s-OFDM	1	1	25.53	0.3573	28.53	0.7129
		1	22	25.72	0.3733	28.72	0.7447
		12	6	25.74	0.375	28.74	0.7482
	64QAM DFT-s-OFDM	1	1	24.39	0.2748	27.39	0.5483
		1	22	24.16	0.2606	27.16	0.52
		12	6	24.13	0.2588	27.13	0.5164
	256QAM DFT-s-OFDM	1	1	22.24	0.1675	25.24	0.3342
		1	22	22.09	0.1618	25.09	0.3228
		12	6	22.26	0.1683	25.26	0.3357

SCS 15

SA n78 (ANT) 20MHz (GT - LC = 3 dB)							
Channel	Mode	NR		Conducted		EIRP	
		RB		Power(dBm)	Power(Watts)	EIRP(dBm)	EIRP(W)
		Size	Offset				
Lowest	PI/2 BPSK DFT-s-OFDM	1	1	25.96	0.3945	28.96	0.787
		1	104	26.10	0.4074	29.10	0.8128
		50	25	26.21	0.4178	29.21	0.8337
	QPSK DFT-s-OFDM	1	1	25.99	0.3972	28.99	0.7925
		1	104	26.07	0.4046	29.07	0.8072
		50	25	26.18	0.415	29.18	0.8279
	16QAM DFT-s-OFDM	1	1	25.41	0.3475	28.41	0.6934
		1	104	25.26	0.3357	28.26	0.6699
		50	25	25.31	0.3396	28.31	0.6776
	64QAM DFT-s-OFDM	1	1	23.87	0.2438	26.87	0.4864
		1	104	24.36	0.2729	27.36	0.5445
		50	25	23.78	0.2388	26.78	0.4764
	256QAM DFT-s-OFDM	1	1	21.62	0.1452	24.62	0.2897
		1	104	21.77	0.1503	24.77	0.2999
		50	25	21.82	0.1521	24.82	0.3034
Middle	PI/2 BPSK DFT-s-OFDM	1	1	26.21	0.4178	29.21	0.8337
		1	104	26.25	0.4217	29.25	0.8414
		50	25	26.28	0.4246	29.28	0.8472
	QPSK DFT-s-OFDM	1	1	26.18	0.415	29.18	0.8279
		1	104	26.21	0.4178	29.21	0.8337
		50	25	26.26	0.4227	29.26	0.8433
	16QAM DFT-s-OFDM	1	1	25.45	0.3508	28.45	0.6998
		1	104	25.58	0.3614	28.58	0.7211
		50	25	25.04	0.3192	28.04	0.6368
	64QAM DFT-s-OFDM	1	1	23.98	0.25	26.98	0.4989
		1	104	24.13	0.2588	27.13	0.5164
		50	25	23.84	0.2421	26.84	0.4831
	256QAM DFT-s-OFDM	1	1	21.31	0.1352	24.31	0.2698
		1	104	21.45	0.1396	24.45	0.2786
		50	25	21.94	0.1563	24.94	0.3119
QPSK CP-OFDM	1	1	24.81	0.3027	27.81	0.6039	
	1	104	24.91	0.3097	27.91	0.618	
	53	26	24.46	0.2793	27.46	0.5572	
Highest	PI/2 BPSK DFT-s-OFDM	1	1	26.24	0.4207	29.24	0.8395
		1	104	26.36	0.4325	29.36	0.863
		50	25	26.49	0.4457	29.49	0.8892
	QPSK DFT-s-OFDM	1	1	26.27	0.4236	29.27	0.8453
		1	104	26.31	0.4276	29.31	0.8531
		50	25	26.46	0.4426	29.46	0.8831
	16QAM DFT-s-OFDM	1	1	25.52	0.3565	28.52	0.7112
		1	49	25.69	0.3707	28.69	0.7396
		25	12	25.58	0.3614	28.58	0.7211
	64QAM DFT-s-OFDM	1	1	24.61	0.2891	27.61	0.5768
		1	49	24.39	0.2748	27.39	0.5483
		25	12	24.22	0.2642	27.22	0.5272
	256QAM DFT-s-OFDM	1	1	21.59	0.1442	24.59	0.2877
		1	49	21.75	0.1496	24.75	0.2985
		25	12	22.11	0.1626	25.11	0.3243

SA n78 (ANT) 15MHz (GT - LC = 3 dB)								
Channel	Mode	NR		Conducted		EIRP		
		RB		Power(dBm)	Power(Watts)	EIRP(dBm)	EIRP(W)	
		Size	Offset					
Lowest	PI/2 BPSK DFT-s-OFDM	1	1	26.05	0.4027	29.05	0.8035	
		1	77	26.23	0.4198	29.23	0.8375	
		36	18	26.21	0.4178	29.21	0.8337	
	QPSK DFT-s-OFDM	1	1	26.02	0.3999	29.02	0.798	
		1	77	26.19	0.4159	29.19	0.8299	
		36	18	26.17	0.414	29.17	0.826	
	16QAM DFT-s-OFDM	1	1	24.61	0.2891	27.61	0.5768	
		1	77	25.31	0.3396	28.31	0.6776	
		36	18	25.22	0.3327	28.22	0.6637	
	64QAM DFT-s-OFDM	1	1	24.29	0.2685	27.29	0.5358	
		1	77	24.03	0.2529	27.03	0.5047	
		36	18	23.67	0.2328	26.67	0.4645	
	256QAM DFT-s-OFDM	1	1	21.66	0.1466	24.66	0.2924	
		1	77	21.38	0.1374	24.38	0.2742	
		36	18	21.75	0.1496	24.75	0.2985	
	Middle	PI/2 BPSK DFT-s-OFDM	1	1	26.24	0.4207	29.24	0.8395
			1	77	26.29	0.4256	29.29	0.8492
			36	18	26.33	0.4295	29.33	0.857
QPSK DFT-s-OFDM		1	1	26.21	0.4178	29.21	0.8337	
		1	77	26.26	0.4227	29.26	0.8433	
		36	18	26.29	0.4256	29.29	0.8492	
16QAM DFT-s-OFDM		1	1	25.52	0.3565	28.52	0.7112	
		1	77	25.24	0.3342	28.24	0.6668	
		36	18	25.62	0.3648	28.62	0.7278	
64QAM DFT-s-OFDM		1	1	24.01	0.2518	27.01	0.5023	
		1	77	24.13	0.2588	27.13	0.5164	
		36	18	23.87	0.2438	26.87	0.4864	
256QAM DFT-s-OFDM		1	1	21.44	0.1393	24.44	0.278	
		1	77	21.95	0.1567	24.95	0.3126	
		36	18	21.93	0.156	24.93	0.3112	
QPSK CP-OFDM		1	1	24.93	0.3112	27.93	0.6209	
		1	77	25.01	0.317	28.01	0.6324	
		39	19	24.79	0.3013	27.79	0.6012	
Highest	PI/2 BPSK DFT-s-OFDM	1	1	26.36	0.4325	29.36	0.863	
		1	77	26.47	0.4436	29.47	0.8851	
		36	18	26.49	0.4457	29.49	0.8892	
	QPSK DFT-s-OFDM	1	1	26.31	0.4276	29.31	0.8531	
		1	77	26.45	0.4416	29.45	0.881	
		36	18	26.52	0.4487	29.52	0.8954	
	16QAM DFT-s-OFDM	1	1	25.41	0.3475	28.41	0.6934	
		1	77	26.03	0.4009	29.03	0.7998	
		36	18	25.72	0.3733	28.72	0.7447	
	64QAM DFT-s-OFDM	1	1	24.35	0.2723	27.35	0.5433	
		1	77	24.53	0.2838	27.53	0.5662	
		36	18	24.24	0.2655	27.24	0.5297	
	256QAM DFT-s-OFDM	1	1	21.71	0.1483	24.71	0.2958	
		1	77	22.32	0.1706	25.32	0.3404	
		36	18	22.27	0.1687	25.27	0.3365	

SA n78 (ANT) 10MHz (GT - LC = 3 dB)								
Channel	Mode	NR		Conducted		EIRP		
		RB		Power(dBm)	Power(Watts)	EIRP(dBm)	EIRP(W)	
		Size	Offset					
Lowest	PI/2 BPSK DFT-s-OFDM	1	1	26.17	0.414	29.17	0.826	
		1	50	26.26	0.4227	29.26	0.8433	
		25	12	26.24	0.4207	29.24	0.8395	
	QPSK DFT-s-OFDM	1	1	26.24	0.4207	29.24	0.8395	
		1	50	26.23	0.4198	29.23	0.8375	
		25	12	26.21	0.4178	29.21	0.8337	
	16QAM DFT-s-OFDM	1	1	25.22	0.3327	28.22	0.6637	
		1	50	25.17	0.3289	28.17	0.6561	
		25	12	25.27	0.3365	28.27	0.6714	
	64QAM DFT-s-OFDM	1	1	24.01	0.2518	27.01	0.5023	
		1	50	23.72	0.2355	26.72	0.4699	
		25	12	23.86	0.2432	26.86	0.4853	
	256QAM DFT-s-OFDM	1	1	21.47	0.1403	24.47	0.2799	
		1	50	21.64	0.1459	24.64	0.2911	
		25	12	21.81	0.1517	24.81	0.3027	
	Middle	PI/2 BPSK DFT-s-OFDM	1	1	26.15	0.4121	29.15	0.8222
			1	50	26.21	0.4178	29.21	0.8337
			25	12	26.08	0.4055	29.08	0.8091
QPSK DFT-s-OFDM		1	1	26.17	0.414	29.17	0.826	
		1	50	26.23	0.4198	29.23	0.8375	
		25	12	26.16	0.413	29.16	0.8241	
16QAM DFT-s-OFDM		1	1	25.20	0.3311	28.20	0.6607	
		1	50	25.32	0.3404	28.32	0.6792	
		25	12	25.11	0.3243	28.11	0.6471	
64QAM DFT-s-OFDM		1	1	23.91	0.246	26.91	0.4909	
		1	50	23.98	0.25	26.98	0.4989	
		25	12	23.69	0.2339	26.69	0.4667	
256QAM DFT-s-OFDM		1	1	21.27	0.134	24.27	0.2673	
		1	50	21.49	0.1409	24.49	0.2812	
		25	12	21.77	0.1503	24.77	0.2999	
QPSK CP-OFDM		1	1	24.77	0.2999	27.77	0.5984	
		1	50	24.89	0.3083	27.89	0.6152	
		25	12	24.69	0.2944	27.69	0.5875	
Highest	PI/2 BPSK DFT-s-OFDM	1	1	26.19	0.4159	29.19	0.8299	
		1	50	26.27	0.4236	29.27	0.8453	
		25	12	26.31	0.4276	29.31	0.8531	
	QPSK DFT-s-OFDM	1	1	26.16	0.413	29.16	0.8241	
		1	50	26.24	0.4207	29.24	0.8395	
		25	12	26.27	0.4236	29.27	0.8453	
	16QAM DFT-s-OFDM	1	1	25.66	0.3681	28.66	0.7345	
		1	50	25.48	0.3532	28.48	0.7047	
		25	12	25.63	0.3656	28.63	0.7295	
	64QAM DFT-s-OFDM	1	1	24.54	0.2844	27.54	0.5675	
		1	50	24.71	0.2958	27.71	0.5902	
		25	12	24.07	0.2553	27.07	0.5093	
	256QAM DFT-s-OFDM	1	1	21.53	0.1422	24.53	0.2838	
		1	50	22.34	0.1714	25.34	0.342	
		25	12	22.07	0.1611	25.07	0.3214	

5G NR n78 UL_MIMO HPUE SA mode:

SCS 30

SA n78 (ANT M2+ANT M) 100MHz (GT - LC = 6.01 dB)							
Channel	Mode	NR		Conducted		EIRP	
		RB		Power(dBm)	Power(Watts)	EIRP(dBm)	EIRP(W)
		Size	Offset				
Middle	QPSK DFT-s-OFDM	1	1	23.54	0.2258	29.55	0.9009
		1	271	23.89	0.2449	29.90	0.9774
		137	68	23.98	0.2499	29.99	0.9971
	16QAM DFT-s-OFDM	1	1	22.93	0.1962	28.94	0.7827
		1	271	23.50	0.2241	29.51	0.894
		137	68	23.94	0.2475	29.95	0.9875
	64QAM DFT-s-OFDM	1	1	22.01	0.159	28.02	0.6345
		1	271	22.57	0.1808	28.58	0.7214
		137	68	22.63	0.1833	28.64	0.7313
	256QAM DFT-s-OFDM	1	1	18.95	0.0785	24.96	0.3133
		1	271	19.64	0.092	25.65	0.367
		137	68	19.81	0.0958	25.82	0.3822

SA n78 (ANT M2+ANT M) 80MHz (GT - LC = 6.01 dB)								
Channel	Mode	NR		Conducted		EIRP		
		RB		Power(dBm)	Power(Watts)	EIRP(dBm)	EIRP(W)	
		Size	Offset					
Lowest	QPSK DFT-s-OFDM	1	1	23.79	0.2392	29.80	0.9544	
		1	215	23.96	0.2489	29.97	0.9931	
		109	54	23.98	0.2501	29.99	0.9978	
	16QAM DFT-s-OFDM	1	1	23.30	0.2136	29.31	0.8524	
		1	215	23.63	0.2305	29.64	0.9196	
		109	54	23.94	0.2478	29.95	0.9888	
	64QAM DFT-s-OFDM	1	1	22.13	0.1634	28.14	0.6521	
		1	215	22.71	0.1868	28.72	0.7454	
		109	54	22.68	0.1855	28.69	0.7403	
	256QAM DFT-s-OFDM	1	1	19.19	0.083	25.20	0.3311	
		1	215	19.65	0.0922	25.66	0.3678	
		109	54	19.65	0.0923	25.66	0.3683	
Middle	QPSK DFT-s-OFDM	1	1	23.82	0.2409	29.83	0.9613	
		1	215	23.64	0.2311	29.65	0.9222	
		109	54	23.96	0.249	29.97	0.9934	
	16QAM DFT-s-OFDM	1	1	23.31	0.2143	29.32	0.8552	
		1	215	23.61	0.2295	29.62	0.9158	
		109	54	23.97	0.2495	29.98	0.9957	
	64QAM DFT-s-OFDM	1	1	22.05	0.1602	28.06	0.6391	
		1	215	22.76	0.1889	28.77	0.7536	
		109	54	22.70	0.1863	28.71	0.7434	
	256QAM DFT-s-OFDM	1	1	19.13	0.0819	25.14	0.3269	
		1	215	19.76	0.0947	25.77	0.3777	
		109	54	19.49	0.0889	25.50	0.3547	
	Highest	QPSK DFT-s-OFDM	1	1	23.85	0.2425	29.86	0.9675
			1	215	23.98	0.2498	29.99	0.9969
			109	54	23.98	0.2498	29.99	0.9966
		16QAM DFT-s-OFDM	1	1	23.34	0.2158	29.35	0.8612
			1	215	23.74	0.2365	29.75	0.9438
			109	54	23.94	0.2478	29.95	0.9888
64QAM DFT-s-OFDM		1	1	22.07	0.1611	28.08	0.6427	
		1	215	22.71	0.1868	28.72	0.7454	
		109	54	22.72	0.1869	28.73	0.7457	
256QAM DFT-s-OFDM		1	1	19.25	0.0841	25.26	0.3356	
		1	215	19.78	0.0951	25.79	0.3796	
		109	54	19.72	0.0937	25.73	0.3738	

SA n78 (ANT M2+ANT M) 60MHz (GT - LC = 6.01 dB)							
Channel	Mode	NR		Conducted		EIRP	
		RB		Power(dBm)	Power(Watts)	EIRP(dBm)	EIRP(W)
		Size	Offset				
Lowest	QPSK DFT-s- OFDM	1	1	23.93	0.2474	29.94	0.987
		1	160	23.98	0.2502	29.99	0.9985
		81	40	23.98	0.2501	29.99	0.9981
	16QAM DFT-s- OFDM	1	1	23.86	0.243	29.87	0.9696
		1	160	23.91	0.2459	29.92	0.981
		81	40	23.93	0.2472	29.94	0.9865
	64QAM DFT-s- OFDM	1	1	22.41	0.1742	28.42	0.6952
		1	160	22.83	0.1917	28.84	0.765
		81	40	22.61	0.1823	28.62	0.7276
	256QAM DFT-s- OFDM	1	1	19.41	0.0874	25.42	0.3486
		1	160	19.78	0.0951	25.79	0.3796
		81	40	19.59	0.0909	25.60	0.3627
Middle	QPSK DFT-s- OFDM	1	1	23.96	0.2487	29.97	0.9924
		1	160	23.98	0.2503	29.99	0.9988
		81	40	23.98	0.2502	29.99	0.9982
	16QAM DFT-s- OFDM	1	1	23.83	0.2413	29.84	0.9629
		1	160	23.98	0.2499	29.99	0.9971
		81	40	23.98	0.2501	29.99	0.9978
	64QAM DFT-s- OFDM	1	1	22.43	0.1751	28.44	0.6989
		1	160	23.01	0.1998	29.02	0.7972
		81	40	22.72	0.1872	28.73	0.747
	256QAM DFT-s- OFDM	1	1	19.47	0.0884	25.48	0.3528
		1	160	20.00	0.1	26.01	0.3988
		81	40	19.63	0.0918	25.64	0.3664
	QPSK DFT-s- OFDM	1	1	23.84	0.2419	29.85	0.9653
		1	160	23.94	0.2475	29.95	0.9875
		81	40	23.96	0.249	29.97	0.9934
	16QAM DFT-s- OFDM	1	1	23.84	0.2419	29.85	0.9652
		1	160	23.97	0.2495	29.98	0.9954
		81	40	23.95	0.2481	29.96	0.9899
64QAM DFT-s- OFDM	1	1	22.44	0.1755	28.45	0.7002	
	1	160	22.81	0.1912	28.82	0.7628	
	81	40	22.58	0.1813	28.59	0.7235	
256QAM DFT-s- OFDM	1	1	19.50	0.089	25.51	0.3553	
	1	160	19.74	0.0941	25.75	0.3757	
	81	40	19.55	0.0902	25.56	0.3598	

SA n78 (ANT M2+ANT M) 50MHz (GT - LC = 6.01 dB)							
Channel	Mode	NR		Conducted		EIRP	
		RB		Power(dBm)	Power(Watts)	EIRP(dBm)	EIRP(W)
		Size	Offset				
Lowest	QPSK DFT-s-OFDM	1	1	23.97	0.2495	29.98	0.9955
		1	131	23.98	0.2502	29.99	0.9983
		67	33	23.98	0.2499	29.99	0.9973
	16QAM DFT-s-OFDM	1	1	23.70	0.2345	29.71	0.9358
		1	131	23.93	0.2472	29.94	0.9862
		67	33	23.97	0.2493	29.98	0.995
	64QAM DFT-s-OFDM	1	1	22.36	0.1721	28.37	0.6869
		1	131	22.74	0.1879	28.75	0.7498
		67	33	22.64	0.1835	28.65	0.7324
	256QAM DFT-s-OFDM	1	1	19.32	0.0855	25.33	0.3413
		1	131	19.65	0.0923	25.66	0.3683
		67	33	19.45	0.0881	25.46	0.3514
Middle	QPSK DFT-s-OFDM	1	1	23.98	0.2499	29.99	0.9973
		1	131	23.98	0.2501	29.99	0.9979
		67	33	23.95	0.2484	29.96	0.9913
	16QAM DFT-s-OFDM	1	1	23.82	0.2411	29.83	0.9621
		1	131	23.92	0.2463	29.93	0.9829
		67	33	23.98	0.2501	29.99	0.9978
	64QAM DFT-s-OFDM	1	1	22.75	0.1882	28.76	0.7508
		1	131	22.82	0.1915	28.83	0.7639
		67	33	22.80	0.1905	28.81	0.7601
	256QAM DFT-s-OFDM	1	1	19.50	0.0892	25.51	0.3558
		1	131	19.83	0.0961	25.84	0.3836
		67	33	19.62	0.0917	25.63	0.3659
Highest	QPSK DFT-s-OFDM	1	1	23.97	0.2495	29.98	0.9956
		1	131	23.96	0.2489	29.97	0.9931
		67	33	23.97	0.2496	29.98	0.9959
	16QAM DFT-s-OFDM	1	1	23.96	0.249	29.97	0.9934
		1	131	23.98	0.2499	29.99	0.9973
		67	33	23.98	0.2499	29.99	0.9972
	64QAM DFT-s-OFDM	1	1	22.62	0.1827	28.63	0.7292
		1	131	23.06	0.2023	29.07	0.8071
		67	33	23.02	0.2004	29.03	0.7997
	256QAM DFT-s-OFDM	1	1	19.70	0.0932	25.71	0.372
		1	131	20.08	0.1019	26.09	0.4068
		67	33	19.89	0.0975	25.90	0.3889

SA n78 (ANT M2+ANT M) 40MHz (GT - LC = 6.01 dB)							
Channel	Mode	NR		Conducted		EIRP	
		RB					
		Size	Offset	Power(dBm)	Power(Watts)	EIRP(dBm)	EIRP(W)
Lowest	QPSK DFT-s-OFDM	1	1	23.84	0.2418	29.85	0.965
		1	104	23.96	0.2486	29.97	0.9921
		53	26	23.97	0.2492	29.98	0.9944
	16QAM DFT-s-OFDM	1	1	23.62	0.2303	29.63	0.9188
		1	104	23.98	0.2501	29.99	0.9981
		53	26	23.98	0.2501	29.99	0.9978
	64QAM DFT-s-OFDM	1	1	22.33	0.1712	28.34	0.683
		1	104	22.48	0.1771	28.49	0.7067
		53	26	22.73	0.1875	28.74	0.7484
	256QAM DFT-s-OFDM	1	1	19.12	0.0817	25.13	0.3259
		1	104	19.49	0.0889	25.50	0.3549
		53	26	19.64	0.092	25.65	0.367
Middle	QPSK DFT-s-OFDM	1	1	23.98	0.2502	29.99	0.9985
		1	104	23.98	0.2502	29.99	0.9983
		53	26	23.96	0.2492	29.97	0.9942
	16QAM DFT-s-OFDM	1	1	23.84	0.2421	29.85	0.966
		1	104	23.97	0.2493	29.98	0.9947
		53	26	23.96	0.2489	29.97	0.9933
	64QAM DFT-s-OFDM	1	1	22.18	0.1652	28.19	0.6592
		1	104	22.46	0.1761	28.47	0.7025
		53	26	22.76	0.189	28.77	0.754
	256QAM DFT-s-OFDM	1	1	19.33	0.0857	25.34	0.3422
		1	104	19.62	0.0916	25.63	0.3654
		53	26	19.71	0.0935	25.72	0.3731
	QPSK DFT-s-OFDM	1	1	23.94	0.2478	29.95	0.9889
		1	104	23.96	0.2492	29.97	0.9942
		53	26	23.95	0.2483	29.96	0.9908
	16QAM DFT-s-OFDM	1	1	23.67	0.2327	29.68	0.9286
		1	104	23.95	0.248	29.96	0.9897
		53	26	23.98	0.2499	29.99	0.9971
64QAM DFT-s-OFDM	1	1	22.42	0.1746	28.43	0.6968	
	1	104	22.76	0.189	28.77	0.7541	
	53	26	22.12	0.1627	28.13	0.6494	
256QAM DFT-s-OFDM	1	1	19.45	0.0882	25.46	0.3519	
	1	104	19.75	0.0943	25.76	0.3763	
	53	26	19.85	0.0965	25.86	0.3851	

SA n78 (ANT M2+ANT M) 20MHz (GT - LC = 6.01 dB)							
Channel	Mode	NR		Conducted		EIRP	
		RB					
		Size	Offset	Power(dBm)	Power(Watts)	EIRP(dBm)	EIRP(W)
Lowest	QPSK CP-OFDM	1	1	23.93	0.2473	29.94	0.9866
		1	49	23.96	0.2489	29.97	0.9934
		25	12	23.94	0.2476	29.95	0.9878
	16QAM CP-s- OFDM	1	1	23.93	0.247	29.94	0.9854
		1	49	23.93	0.2469	29.94	0.9854
		25	12	23.95	0.2483	29.96	0.9909
	64QAM CP-s- OFDM	1	1	22.62	0.183	28.63	0.7303
		1	49	22.63	0.1832	28.64	0.7309
		25	12	22.69	0.1859	28.70	0.7418
	256QAM CP-s- OFDM	1	1	19.52	0.0895	25.53	0.3573
		1	49	19.61	0.0915	25.62	0.365
		25	12	19.57	0.0905	25.58	0.3613
Middle	QPSK CP-OFDM	1	1	23.96	0.2488	29.97	0.9928
		1	49	23.95	0.2482	29.96	0.9906
		25	12	23.96	0.2489	29.97	0.993
	16QAM CP-s- OFDM	1	1	23.85	0.2426	29.86	0.968
		1	49	23.88	0.2445	29.89	0.9756
		25	12	23.95	0.2484	29.96	0.9911
	64QAM CP-s- OFDM	1	1	22.67	0.1851	28.68	0.7387
		1	49	22.73	0.1876	28.74	0.7487
		25	12	22.89	0.1946	28.90	0.7766
	256QAM CP-s- OFDM	1	1	19.64	0.0921	25.65	0.3674
		1	49	19.78	0.0951	25.79	0.3794
		25	12	19.73	0.094	25.74	0.3752
	QPSK CP-OFDM	1	1	23.96	0.249	29.97	0.9934
		1	49	23.97	0.2493	29.98	0.9947
		25	12	23.97	0.2492	29.98	0.9946
	16QAM CP-s- OFDM	1	1	23.89	0.2451	29.90	0.9778
		1	49	23.95	0.2484	29.96	0.9911
		25	12	23.96	0.2487	29.97	0.9925
64QAM CP-s- OFDM	1	1	22.98	0.1988	28.99	0.7933	
	1	49	22.99	0.1993	29.00	0.7952	
	25	12	23.16	0.2069	29.17	0.8256	
256QAM CP-s- OFDM	1	1	19.91	0.0979	25.92	0.3907	
	1	49	20.00	0.1	26.01	0.399	
	25	12	20.01	0.1002	26.02	0.3999	

SA n78 (ANT M2+ANT M) 15MHz (GT - LC = 6.01 dB)							
Channel	Mode	NR		Conducted		EIRP	
		RB		Power(dBm)	Power(Watts)	EIRP(dBm)	EIRP(W)
		Size	Offset				
Lowest	QPSK CP-OFDM	1	1	23.96	0.249	29.97	0.9934
		1	36	23.98	0.2499	29.99	0.9973
		19	9	23.98	0.2502	29.99	0.9984
	16QAM CP-s- OFDM	1	1	23.97	0.2496	29.98	0.9958
		1	36	23.94	0.2475	29.95	0.9877
		19	9	23.93	0.2473	29.94	0.9867
	64QAM CP-s- OFDM	1	1	22.74	0.188	28.75	0.75
		1	36	22.82	0.1914	28.83	0.7638
		19	9	22.76	0.189	28.77	0.7542
	256QAM CP-s- OFDM	1	1	19.66	0.0925	25.67	0.3693
		1	36	19.68	0.0929	25.69	0.3706
		19	9	19.57	0.0906	25.58	0.3615
Middle	QPSK CP-OFDM	1	1	23.96	0.2489	29.97	0.9931
		1	36	23.98	0.2502	29.99	0.9985
		19	9	23.97	0.2496	29.98	0.9959
	16QAM CP-s- OFDM	1	1	23.95	0.2484	29.96	0.9911
		1	36	23.91	0.2458	29.92	0.9809
		19	9	23.97	0.2492	29.98	0.9944
	64QAM CP-s- OFDM	1	1	22.71	0.1868	28.72	0.7455
		1	36	22.75	0.1884	28.76	0.7517
		19	9	22.83	0.1917	28.84	0.7651
	256QAM CP-s- OFDM	1	1	19.77	0.0948	25.78	0.3781
		1	36	19.79	0.0952	25.80	0.38
		19	9	19.70	0.0934	25.71	0.3726
	QPSK CP-OFDM	1	1	23.98	0.2498	29.99	0.9968
		1	36	23.96	0.249	29.97	0.9936
		19	9	23.97	0.2492	29.98	0.9946
	16QAM CP-s- OFDM	1	1	23.96	0.2487	29.97	0.9923
		1	36	23.98	0.2501	29.99	0.9978
		19	9	23.94	0.2475	29.95	0.9877
64QAM CP-s- OFDM	1	1	23.05	0.202	29.06	0.8061	
	1	36	23.19	0.2086	29.20	0.8323	
	19	9	23.16	0.2068	29.17	0.8254	
256QAM CP-s- OFDM	1	1	20.08	0.1018	26.09	0.406	
	1	36	20.17	0.104	26.18	0.4151	
	19	9	20.05	0.1013	26.06	0.4041	

SA n78 (ANT M2+ANT M) 10MHz (GT - LC = 6.01 dB)							
Channel	Mode	NR		Conducted		EIRP	
		RB					
		Size	Offset	Power(dBm)	Power(Watts)	EIRP(dBm)	EIRP(W)
Lowest	QPSK CP-OFDM	1	1	23.94	0.2475	29.95	0.9877
		1	22	23.93	0.2473	29.94	0.9867
		12	6	23.98	0.2499	29.99	0.997
	16QAM CP-s- OFDM	1	1	23.97	0.2492	29.98	0.9946
		1	22	23.90	0.2454	29.91	0.9794
		12	6	23.95	0.2484	29.96	0.991
	64QAM CP-s- OFDM	1	1	22.59	0.1815	28.60	0.7244
		1	22	22.56	0.1805	28.57	0.7202
		12	6	22.64	0.1835	28.65	0.732
	256QAM CP-s- OFDM	1	1	19.54	0.0899	25.55	0.3587
		1	22	19.49	0.0889	25.50	0.3548
		12	6	19.56	0.0903	25.57	0.3605
Middle	QPSK CP-OFDM	1	1	23.96	0.249	29.97	0.9934
		1	22	23.98	0.2499	29.99	0.9973
		12	6	23.97	0.2496	29.98	0.996
	16QAM CP-s- OFDM	1	1	23.97	0.2495	29.98	0.9955
		1	22	23.96	0.2486	29.97	0.9922
		12	6	23.95	0.2481	29.96	0.9901
	64QAM CP-s- OFDM	1	1	22.85	0.1927	28.86	0.769
		1	22	22.86	0.1934	28.87	0.7717
		12	6	22.90	0.195	28.91	0.7779
	256QAM CP-s- OFDM	1	1	19.83	0.0962	25.84	0.3839
		1	22	19.88	0.0973	25.89	0.3883
		12	6	19.80	0.0954	25.81	0.3807
	QPSK CP-OFDM	1	1	23.97	0.2493	29.98	0.9949
		1	22	23.98	0.2502	29.99	0.9984
		12	6	23.98	0.2502	29.99	0.9983
	16QAM CP-s- OFDM	1	1	23.89	0.2448	29.90	0.9767
		1	22	23.92	0.2464	29.93	0.9833
		12	6	23.97	0.2492	29.98	0.9945
64QAM CP-s- OFDM	1	1	22.97	0.1983	28.98	0.7914	
	1	22	23.02	0.2005	29.03	0.8001	
	12	6	23.09	0.2037	29.10	0.8128	
256QAM CP-s- OFDM	1	1	20.07	0.1017	26.08	0.4058	
	1	22	19.99	0.0998	26.00	0.3983	
	12	6	20.03	0.1007	26.04	0.4018	

SCS 15

SA n78 (ANT M2+ANT M) 20MHz (GT - LC = 6.01 dB)							
Channel	Mode	NR		Conducted		EIRP	
		RB		Power(dBm)	Power(Watts)	EIRP(dBm)	EIRP(W)
		Size	Offset				
Lowest	QPSK CP-OFDM	1	1	23.97	0.2493	29.98	0.9946
		1	104	23.93	0.2473	29.94	0.9867
		53	26	23.93	0.247	29.94	0.9855
	16QAM CP-s- OFDM	1	1	23.66	0.2325	29.67	0.9276
		1	104	23.73	0.236	29.74	0.9416
		53	26	23.95	0.2485	29.96	0.9917
	64QAM CP-s- OFDM	1	1	22.42	0.1747	28.43	0.697
		1	104	22.42	0.1745	28.43	0.6963
		53	26	22.49	0.1776	28.50	0.7087
	256QAM CP-s- OFDM	1	1	18.99	0.0792	25.00	0.3159
		1	104	19.01	0.0796	25.02	0.3176
		53	26	19.11	0.0815	25.12	0.3251
Middle	QPSK CP-OFDM	1	1	23.92	0.2467	29.93	0.9843
		1	104	23.96	0.249	29.97	0.9934
		53	26	23.97	0.2495	29.98	0.9957
	16QAM CP-s- OFDM	1	1	23.92	0.2465	29.93	0.9835
		1	104	23.98	0.2502	29.99	0.9984
		53	26	23.96	0.2489	29.97	0.9933
	64QAM CP-s- OFDM	1	1	22.52	0.1785	28.53	0.7122
		1	104	22.73	0.1876	28.74	0.7486
		53	26	22.62	0.1829	28.63	0.7298
	256QAM CP-s- OFDM	1	1	19.18	0.0829	25.19	0.3307
		1	104	19.27	0.0845	25.28	0.3372
		53	26	19.30	0.0851	25.31	0.3394
Highest	QPSK CP-OFDM	1	1	23.96	0.2486	29.97	0.9921
		1	104	23.94	0.2478	29.95	0.9888
		53	26	23.97	0.2492	29.98	0.9946
	16QAM CP-s- OFDM	1	1	23.82	0.2412	29.83	0.9626
		1	104	23.89	0.2448	29.90	0.9767
		53	26	23.91	0.2461	29.92	0.9821
	64QAM CP-s- OFDM	1	1	22.71	0.1868	28.72	0.7455
		1	104	22.91	0.1953	28.92	0.7792
		53	26	22.89	0.1944	28.90	0.7757
	256QAM CP-s- OFDM	1	1	19.12	0.0817	25.13	0.326
		1	104	19.51	0.0893	25.52	0.3563
		53	26	19.47	0.0886	25.48	0.3535

SA n78 (ANT M2+ANT M) 15MHz (GT - LC = 6.01 dB)							
Channel	Mode	NR		Conducted		EIRP	
		RB		Power(dBm)	Power(Watts)	EIRP(dBm)	EIRP(W)
		Size	Offset				
Lowest	QPSK CP-OFDM	1	1	23.98	0.2499	29.99	0.9973
		1	77	23.97	0.2496	29.98	0.9959
		39	19	23.98	0.2499	29.99	0.9971
	16QAM CP-s- OFDM	1	1	23.76	0.2378	29.77	0.9487
		1	77	23.72	0.2355	29.73	0.9395
		39	19	23.93	0.247	29.94	0.9857
	64QAM CP-s- OFDM	1	1	22.52	0.1785	28.53	0.7124
		1	77	22.54	0.1796	28.55	0.7165
		39	19	22.48	0.1769	28.49	0.706
	256QAM CP-s- OFDM	1	1	18.74	0.0749	24.75	0.2987
		1	77	19.09	0.0812	25.10	0.3238
		39	19	19.16	0.0824	25.17	0.3288
Middle	QPSK CP-OFDM	1	1	23.98	0.2502	29.99	0.9982
		1	77	23.98	0.2501	29.99	0.9981
		39	19	23.98	0.2502	29.99	0.9984
	16QAM CP-s- OFDM	1	1	23.96	0.2489	29.97	0.9932
		1	77	23.96	0.2488	29.97	0.9927
		39	19	23.91	0.2459	29.92	0.981
	64QAM CP-s- OFDM	1	1	22.62	0.1828	28.63	0.7296
		1	77	22.78	0.1897	28.79	0.7569
		39	19	22.65	0.1839	28.66	0.7338
	256QAM CP-s- OFDM	1	1	19.19	0.083	25.20	0.3313
		1	77	19.35	0.086	25.36	0.3433
		39	19	19.35	0.086	25.36	0.3433
Highest	QPSK CP-OFDM	1	1	23.98	0.2502	29.99	0.9982
		1	77	23.95	0.2481	29.96	0.9899
		39	19	23.96	0.2487	29.97	0.9925
	16QAM CP-s- OFDM	1	1	23.95	0.2485	29.96	0.9918
		1	77	23.97	0.2494	29.98	0.9952
		39	19	23.96	0.2489	29.97	0.993
	64QAM CP-s- OFDM	1	1	23.12	0.2053	29.13	0.8193
		1	77	23.16	0.2072	29.17	0.8267
		39	19	22.99	0.1989	29.00	0.7936
	256QAM CP-s- OFDM	1	1	19.50	0.089	25.51	0.3553
		1	77	19.64	0.0921	25.65	0.3674
		39	19	19.65	0.0923	25.66	0.3685

SA n78 (ANT M2+ANT M) 10MHz (GT - LC = 6.01 dB)							
Channel	Mode	NR		Conducted		EIRP	
		RB					
		Size	Offset	Power(dBm)	Power(Watts)	EIRP(dBm)	EIRP(W)
Lowest	QPSK CP-OFDM	1	1	23.98	0.2499	29.99	0.997
		1	50	23.97	0.2495	29.98	0.9957
		26	13	23.95	0.2481	29.96	0.9899
	16QAM CP-s- OFDM	1	1	23.92	0.2467	29.93	0.9843
		1	50	23.97	0.2495	29.98	0.9956
		26	13	23.95	0.2484	29.96	0.991
	64QAM CP-s- OFDM	1	1	22.93	0.1964	28.94	0.7838
		1	50	23.06	0.2024	29.07	0.8075
		26	13	22.85	0.1928	28.86	0.7692
	256QAM CP-s- OFDM	1	1	19.75	0.0944	25.76	0.3769
		1	50	19.91	0.098	25.92	0.3911
		26	13	19.79	0.0954	25.80	0.3805
Middle	QPSK CP-OFDM	1	1	23.93	0.247	29.94	0.9855
		1	50	23.93	0.247	29.94	0.9854
		26	13	23.95	0.2481	29.96	0.9902
	16QAM CP-s- OFDM	1	1	23.79	0.2394	29.80	0.9552
		1	50	23.92	0.2467	29.93	0.9845
		26	13	23.97	0.2497	29.98	0.9962
	64QAM CP-s- OFDM	1	1	22.43	0.1751	28.44	0.6987
		1	50	22.79	0.1903	28.80	0.7592
		26	13	22.60	0.1822	28.61	0.7269
	256QAM CP-s- OFDM	1	1	19.18	0.0828	25.19	0.3303
		1	50	19.23	0.0838	25.24	0.3344
		26	13	19.24	0.0839	25.25	0.3348
	QPSK CP-OFDM	1	1	23.98	0.2502	29.99	0.9984
		1	50	23.98	0.2501	29.99	0.9979
		26	13	23.95	0.2481	29.96	0.99
	16QAM CP-s- OFDM	1	1	23.98	0.2499	29.99	0.9973
		1	50	23.93	0.2469	29.94	0.9852
		26	13	23.98	0.2499	29.99	0.9971
64QAM CP-s- OFDM	1	1	22.64	0.1835	28.65	0.7323	
	1	50	22.84	0.1922	28.85	0.7668	
	26	13	22.81	0.1908	28.82	0.7612	
256QAM CP-s- OFDM	1	1	19.35	0.0861	25.36	0.3434	
	1	50	19.44	0.0879	25.45	0.3509	
	26	13	19.45	0.0881	25.46	0.3515	

5G NR n78 HPUE NSA mode:

SCS 30

EN-DC n78 (ANT M2)+2A (ANT M)Combination 100MHz+20MHz(LTE)(GT - LC = 3 dB)									
Channel	Mode	NR		LTE		Conducted		EIRP	
		RB		RB					
		Size	Offset	Size	Offset	Power(dBm)	Power(Watt)	IRP(dBm)	EIRP(W)
Middle	PI/2 BPSK DFT-s-OFDM	1	1	1	0	26.34	0.4302	29.34	0.8583
		1	271	1	99	26.10	0.4071	29.10	0.8123
		135	67	100	0	26.72	0.4695	29.72	0.9368
	QPSK DFT-s-OFDM	1	1	1	0	26.43	0.4393	29.43	0.8765
		1	271	1	99	26.26	0.4224	29.26	0.8429
		135	67	100	0	26.77	0.475	29.77	0.9477
	16QAM DFT-s-OFDM	1	1	1	0	25.40	0.3467	28.40	0.6918
		1	271	1	49	25.28	0.3373	28.28	0.6729
		135	67	50	0	25.85	0.3845	28.85	0.7671
	64QAM DFT-s-OFDM	1	1	1	0	23.98	0.2502	26.98	0.4992
		1	271	1	49	23.87	0.244	26.87	0.4868
		135	67	50	0	24.34	0.2718	27.34	0.5423
	256QAM DFT-s-OFDM	1	1	1	0	21.99	0.1582	24.99	0.3156
		1	271	1	49	21.69	0.1476	24.69	0.2946
		135	67	50	0	22.31	0.1702	25.31	0.3396
	QPSK CP-OFDM	1	1	1	0	24.86	0.3062	27.86	0.611
		1	271	1	49	24.55	0.2852	27.55	0.569
		137	68	50	0	25.32	0.3404	28.32	0.6792

EN-DC n78 (ANT M2)+2A (ANT M)Combination 80MHz+20MHz(LTE)(GT - LC = 3 dB)									
Channel	Mode	NR		LTE		Conducted		EIRP	
		RB		RB					
		Size	Offset	Size	Offset	Power(dBm)	Power(Watt)	IRP(dBm)	EIRP(W)
Lowest	PI/2 BPSK DFT-s-OFDM	1	1	1	0	26.52	0.4485	29.52	0.8949
		1	215	1	99	26.38	0.4343	29.38	0.8665
		108	54	100	0	26.73	0.4706	29.73	0.939
	QPSK DFT-s-OFDM	1	1	1	0	26.63	0.4599	29.63	0.9177
		1	215	1	99	26.55	0.4516	29.55	0.901
		108	54	100	0	26.72	0.4696	29.72	0.9369
	16QAM DFT-s-OFDM	1	1	1	0	24.97	0.3143	27.97	0.6271
		1	215	1	49	25.04	0.3194	28.04	0.6372
		108	54	50	0	25.73	0.3742	28.73	0.7466
	64QAM DFT-s-OFDM	1	1	1	0	23.55	0.2264	26.55	0.4517
		1	215	1	49	23.70	0.2343	26.70	0.4675
		108	54	50	0	24.20	0.2628	27.20	0.5243
256QAM DFT-s-OFDM	1	1	1	0	21.44	0.1393	24.44	0.2779	
	1	215	1	49	21.56	0.1432	24.56	0.2857	
	108	54	50	0	22.16	0.1643	25.16	0.3278	
Middle	PI/2 BPSK DFT-s-OFDM	1	1	1	0	26.42	0.4382	29.42	0.8743
		1	215	1	99	26.38	0.4342	29.38	0.8663
		108	54	100	0	26.79	0.4771	29.79	0.9519
	QPSK DFT-s-OFDM	1	1	1	0	26.56	0.4526	29.56	0.9031
		1	215	1	99	26.52	0.4484	29.52	0.8946
		108	54	100	0	26.78	0.476	29.78	0.9498
	16QAM DFT-s-OFDM	1	1	1	0	25.02	0.3179	28.02	0.6343
		1	215	1	49	25.15	0.3276	28.15	0.6536
		108	54	50	0	25.74	0.3751	28.74	0.7484
	64QAM DFT-s-OFDM	1	1	1	0	23.69	0.2338	26.69	0.4664
		1	215	1	49	23.92	0.2464	26.92	0.4916
		108	54	50	0	24.24	0.2652	27.24	0.5291
	256QAM DFT-s-OFDM	1	1	1	0	21.44	0.1393	24.44	0.278
		1	215	1	49	21.59	0.1442	24.59	0.2877
		108	54	50	0	22.11	0.1627	25.11	0.3247
QPSK CP-OFDM	1	1	1	0	24.54	0.2847	27.54	0.5681	
	1	215	1	49	24.59	0.288	27.59	0.5747	
	109	54	50	0	25.27	0.3367	28.27	0.6718	
Highest	PI/2 BPSK DFT-s-OFDM	1	1	1	0	26.25	0.4214	29.25	0.8407
		1	215	1	99	26.30	0.4263	29.30	0.8507
		108	54	100	0	26.73	0.4707	29.73	0.9391
	QPSK DFT-s-OFDM	1	1	1	0	26.37	0.4332	29.37	0.8643
		1	215	1	99	26.40	0.4362	29.40	0.8704
		108	54	100	0	26.79	0.4772	29.79	0.9521
	16QAM DFT-s-OFDM	1	1	1	0	24.94	0.3121	27.94	0.6228
		1	215	1	49	25.08	0.3223	28.08	0.6431
		108	54	50	0	25.65	0.3674	28.65	0.733
	64QAM DFT-s-OFDM	1	1	1	0	23.79	0.2392	26.79	0.4772
		1	215	1	49	23.73	0.2359	26.73	0.4707
		108	54	50	0	24.12	0.258	27.12	0.5148
	256QAM DFT-s-OFDM	1	1	1	0	21.48	0.1406	24.48	0.2805
		1	215	1	49	21.62	0.1452	24.62	0.2896
		108	54	50	0	22.07	0.1609	25.07	0.321

EN-DC n78 (ANT M2)+2A (ANT M)Combination 60MHz+20MHz(LTE)(GT - LC = 3 dB)									
Channel	Mode	NR		LTE		Conducted		EIRP	
		RB		RB					
		Size	Offset	Size	Offset	Power(dBm)	Power(Watt)	EIRP(dBm)	EIRP(W)
Lowest	PI/2 BPSK DFT-s-OFDM	1	1	1	0	26.66	0.4631	29.66	0.924
		1	160	1	99	26.49	0.4453	29.49	0.8885
		81	40	100	0	26.75	0.4728	29.75	0.9434
	QPSK DFT-s-OFDM	1	1	1	0	26.86	0.4848	29.86	0.9673
		1	160	1	99	26.62	0.4588	29.62	0.9154
		81	40	100	0	26.79	0.4772	29.79	0.9522
	16QAM DFT-s-OFDM	1	1	1	0	24.90	0.3093	27.90	0.6171
		1	160	1	49	25.07	0.3216	28.07	0.6416
		81	40	50	0	25.70	0.3716	28.70	0.7415
	64QAM DFT-s-OFDM	1	1	1	0	23.75	0.237	26.75	0.4729
		1	160	1	49	23.75	0.237	26.75	0.4729
		81	40	50	0	24.29	0.2682	27.29	0.5352
	256QAM DFT-s-OFDM	1	1	1	0	21.55	0.1428	24.55	0.285
		1	160	1	49	21.61	0.1448	24.61	0.289
		81	40	50	0	22.09	0.1616	25.09	0.3225
Middle	PI/2 BPSK DFT-s-OFDM	1	1	1	0	26.56	0.4526	29.56	0.9031
		1	160	1	99	26.68	0.4653	29.68	0.9283
		81	40	100	0	26.73	0.4705	29.73	0.9389
	QPSK DFT-s-OFDM	1	1	1	0	26.70	0.4674	29.70	0.9325
		1	160	1	99	26.84	0.4826	29.84	0.9629
		81	40	100	0	26.76	0.4738	29.76	0.9454
	16QAM DFT-s-OFDM	1	1	1	0	24.91	0.31	27.91	0.6185
		1	160	1	49	25.10	0.3238	28.10	0.646
		81	40	50	0	25.82	0.382	28.82	0.7622
	64QAM DFT-s-OFDM	1	1	1	0	23.76	0.2375	26.76	0.474
		1	160	1	49	23.82	0.2408	26.82	0.4805
		81	40	50	0	24.22	0.264	27.22	0.5267
	256QAM DFT-s-OFDM	1	1	1	0	21.46	0.1399	24.46	0.2792
		1	160	1	49	21.61	0.1448	24.61	0.289
		81	40	50	0	22.16	0.1643	25.16	0.3278
QPSK CP-OFDM	1	1	1	0	24.46	0.2796	27.46	0.5578	
	1	160	1	49	24.62	0.29	27.62	0.5787	
	81	40	50	0	25.21	0.3321	28.21	0.6626	
Highest	PI/2 BPSK DFT-s-OFDM	1	1	1	0	26.33	0.4293	29.33	0.8565
		1	160	1	99	26.54	0.4505	29.54	0.8989
		81	40	100	0	26.84	0.4826	29.84	0.9629
	QPSK DFT-s-OFDM	1	1	1	0	26.49	0.4454	29.49	0.8886
		1	160	1	99	26.75	0.4728	29.75	0.9434
		81	40	100	0	26.86	0.4849	29.86	0.9675
	16QAM DFT-s-OFDM	1	1	1	0	24.96	0.3136	27.96	0.6256
		1	160	1	49	25.07	0.3216	28.07	0.6416
		81	40	50	0	25.72	0.3733	28.72	0.7449
	64QAM DFT-s-OFDM	1	1	1	0	23.79	0.2392	26.79	0.4772
		1	160	1	49	23.67	0.2327	26.67	0.4643
		81	40	50	0	24.13	0.2586	27.13	0.5159
	256QAM DFT-s-OFDM	1	1	1	0	21.53	0.1422	24.53	0.2838
		1	160	1	49	21.63	0.1455	24.63	0.2903
		81	40	50	0	22.08	0.1613	25.08	0.3218

EN-DC n78(ANT M2)+2A (ANT M)Combination 50MHz+20MHz(LTE)(GT - LC = 3 dB)									
Channel	Mode	NR		LTE		Conducted		EIRP	
		RB		RB					
		Size	Offset	Size	Offset	Power(dBm)	Power(Watt)	Power(dBm)	Power(Watt)
Lowest	PI/2 BPSK DFT-s-OFDM	1	1	1	0	26.70	0.4673	29.70	0.9324
		1	131	1	99	26.35	0.4312	29.35	0.8603
		64	32	100	0	26.82	0.4804	29.82	0.9586
	QPSK DFT-s-OFDM	1	1	1	0	26.87	0.486	29.87	0.9697
		1	131	1	99	26.52	0.4484	29.52	0.8947
		64	32	100	0	26.86	0.4849	29.86	0.9674
	16QAM DFT-s-OFDM	1	1	1	0	24.90	0.3093	27.90	0.617
		1	131	1	49	24.95	0.3129	27.95	0.6242
		64	32	50	0	25.76	0.3768	28.76	0.7518
	64QAM DFT-s-OFDM	1	1	1	0	23.68	0.2332	26.68	0.4653
		1	131	1	49	23.80	0.2397	26.80	0.4783
		64	32	50	0	24.16	0.2604	27.16	0.5195
256QAM DFT-s-OFDM	1	1	1	0	21.52	0.1419	24.52	0.2831	
	1	131	1	49	21.59	0.1442	24.59	0.2877	
	64	32	50	0	22.16	0.1643	25.16	0.3277	
Middle	PI/2 BPSK DFT-s-OFDM	1	1	1	0	26.54	0.4504	29.54	0.8987
		1	131	1	99	26.64	0.461	29.64	0.9197
		64	32	100	0	26.75	0.4728	29.75	0.9434
	QPSK DFT-s-OFDM	1	1	1	0	26.65	0.462	29.65	0.9218
		1	131	1	99	26.70	0.4674	29.70	0.9326
		64	32	100	0	26.80	0.4783	29.80	0.9544
	16QAM DFT-s-OFDM	1	1	1	0	25.03	0.3187	28.03	0.6358
		1	131	1	49	25.04	0.3194	28.04	0.6372
		64	32	50	0	25.78	0.3785	28.78	0.7553
	64QAM DFT-s-OFDM	1	1	1	0	23.74	0.2365	26.74	0.4718
		1	131	1	49	23.76	0.2375	26.76	0.474
		64	32	50	0	24.25	0.2658	27.25	0.5304
	256QAM DFT-s-OFDM	1	1	1	0	21.48	0.1406	24.48	0.2805
		1	131	1	49	21.63	0.1455	24.63	0.2903
		64	32	50	0	22.08	0.1613	25.08	0.3218
QPSK CP-OFDM	1	1	1	0	24.46	0.2796	27.46	0.5578	
	1	131	1	49	24.66	0.2927	27.66	0.584	
	67	33	50	0	25.29	0.3382	28.29	0.6748	
Highest	PI/2 BPSK DFT-s-OFDM	1	1	1	0	26.34	0.4303	29.34	0.8586
		1	131	1	99	26.45	0.4413	29.45	0.8806
		64	32	100	0	26.83	0.4815	29.83	0.9607
	QPSK DFT-s-OFDM	1	1	1	0	26.52	0.4484	29.52	0.8948
		1	131	1	99	26.62	0.4588	29.62	0.9155
		64	32	100	0	26.86	0.4849	29.86	0.9676
	16QAM DFT-s-OFDM	1	1	1	0	25.04	0.3194	28.04	0.6372
		1	131	1	49	25.09	0.3231	28.09	0.6446
		64	32	50	0	25.67	0.3691	28.67	0.7364
	64QAM DFT-s-OFDM	1	1	1	0	23.78	0.2386	26.78	0.4761
		1	131	1	49	23.69	0.2338	26.69	0.4664
		64	32	50	0	24.10	0.2568	27.10	0.5124
	256QAM DFT-s-OFDM	1	1	1	0	21.53	0.1422	24.53	0.2837
		1	131	1	49	21.62	0.1452	24.62	0.2897
		64	32	50	0	22.05	0.1602	25.05	0.3196

EN-DC n78 (ANT M2)+2A (ANT M)Combination 40MHz+20MHz(LTE)(GT - LC = 3 dB)									
Channel	Mode	NR		LTE		Conducted		EIRP	
		RB		RB					
		Size	Offset	Size	Offset	Power(dBm)	Power(Watt)	IRP(dBm)	EIRP(W)
Lowest	PI/2 BPSK DFT-s-OFDM	1	1	1	0	26.46	0.4422	29.46	0.8824
		1	104	1	99	26.14	0.411	29.14	0.82
		50	25	100	0	26.82	0.4805	29.82	0.9586
	QPSK DFT-s-OFDM	1	1	1	0	26.58	0.4546	29.58	0.907
		1	104	1	99	26.25	0.4215	29.25	0.841
		50	25	100	0	26.85	0.4837	29.85	0.9651
	16QAM DFT-s-OFDM	1	1	1	0	24.92	0.3107	27.92	0.6199
		1	104	1	49	24.94	0.3121	27.94	0.6228
		50	25	50	0	25.68	0.3699	28.68	0.7381
	64QAM DFT-s-OFDM	1	1	1	0	23.75	0.237	26.75	0.4728
		1	104	1	49	23.89	0.2448	26.89	0.4883
		50	25	50	0	24.20	0.2628	27.20	0.5243
	256QAM DFT-s-OFDM	1	1	1	0	21.55	0.1429	24.55	0.2851
		1	104	1	49	21.64	0.1458	24.64	0.291
		50	25	50	0	22.06	0.1605	25.06	0.3203
Middle	PI/2 BPSK DFT-s-OFDM	1	1	1	0	26.26	0.4223	29.26	0.8427
		1	104	1	99	26.39	0.4352	29.39	0.8683
		50	25	100	0	26.73	0.4707	29.73	0.9391
	QPSK DFT-s-OFDM	1	1	1	0	26.35	0.4312	29.35	0.8603
		1	104	1	99	26.54	0.4505	29.54	0.8988
		50	25	100	0	26.75	0.4728	29.75	0.9433
	16QAM DFT-s-OFDM	1	1	1	0	25.04	0.3194	28.04	0.6372
		1	104	1	49	25.06	0.3209	28.06	0.6402
		50	25	50	0	25.72	0.3734	28.72	0.745
	64QAM DFT-s-OFDM	1	1	1	0	23.81	0.2403	26.81	0.4794
		1	104	1	49	23.74	0.2365	26.74	0.4718
		50	25	50	0	24.25	0.2658	27.25	0.5304
	256QAM DFT-s-OFDM	1	1	1	0	21.56	0.1432	24.56	0.2857
		1	104	1	49	21.64	0.1458	24.64	0.2909
		50	25	50	0	22.14	0.1635	25.14	0.3263
QPSK CP-OFDM	1	1	1	0	24.49	0.2815	27.49	0.5616	
	1	104	1	49	24.66	0.2927	27.66	0.584	
	53	26	50	0	25.28	0.3375	28.28	0.6734	
Highest	PI/2 BPSK DFT-s-OFDM	1	1	1	0	26.20	0.4166	29.20	0.8312
		1	104	1	99	26.27	0.4234	29.27	0.8449
		50	25	100	0	26.80	0.4782	29.80	0.9541
	QPSK DFT-s-OFDM	1	1	1	0	26.34	0.4302	29.34	0.8584
		1	104	1	99	26.38	0.4342	29.38	0.8664
		50	25	100	0	26.84	0.4827	29.84	0.9632
	16QAM DFT-s-OFDM	1	1	1	0	24.96	0.3136	27.96	0.6257
		1	104	1	49	25.00	0.3165	28.00	0.6314
		50	25	50	0	25.63	0.3657	28.63	0.7296
	64QAM DFT-s-OFDM	1	1	1	0	23.81	0.2403	26.81	0.4795
		1	104	1	49	23.78	0.2386	26.78	0.4761
		50	25	50	0	24.05	0.2539	27.05	0.5065
	256QAM DFT-s-OFDM	1	1	1	0	21.48	0.1406	24.48	0.2805
		1	104	1	49	21.59	0.1442	24.59	0.2876
		50	25	50	0	22.06	0.1605	25.06	0.3203

EN-DC n78 (ANT M2)+2A (ANT M)Combination 20MHz+20MHz(LTE)(GT - LC = 3 dB)									
Channel	Mode	NR		LTE		Conducted		EIRP	
		RB		RB					
		Size	Offset	Size	Offset	Power(dBm)	Power(Watt)	Power(dBm)	Power(Watt)
Lowest	PI/2 BPSK DFT-s-OFDM	1	1	1	0	25.94	0.3923	28.94	0.7827
		1	49	1	99	26.03	0.4006	29.03	0.7992
		25	12	100	0	26.36	0.4321	29.36	0.8622
	QPSK DFT-s-OFDM	1	1	1	0	25.85	0.3842	28.85	0.7666
		1	49	1	99	25.92	0.3905	28.92	0.7791
		25	12	100	0	26.37	0.433	29.37	0.864
	16QAM DFT-s-OFDM	1	1	1	0	24.92	0.3107	27.92	0.6199
		1	49	1	49	25.03	0.3186	28.03	0.6358
		25	12	50	0	25.78	0.3785	28.78	0.7552
	64QAM DFT-s-OFDM	1	1	1	0	23.63	0.2305	26.63	0.46
		1	49	1	49	23.73	0.2359	26.73	0.4707
		25	12	50	0	24.24	0.2652	27.24	0.5291
256QAM DFT-s-OFDM	1	1	1	0	21.50	0.1412	24.50	0.2818	
	1	49	1	49	21.64	0.1458	24.64	0.2909	
	25	12	50	0	22.04	0.1598	25.04	0.3189	
Middle	PI/2 BPSK DFT-s-OFDM	1	1	1	0	26.03	0.4005	29.03	0.7991
		1	49	1	99	26.10	0.407	29.10	0.8122
		25	12	100	0	26.55	0.4514	29.55	0.9007
	QPSK DFT-s-OFDM	1	1	1	0	26.20	0.4165	29.20	0.831
		1	49	1	99	26.23	0.4193	29.23	0.8366
		25	12	100	0	26.56	0.4524	29.56	0.9028
	16QAM DFT-s-OFDM	1	1	1	0	24.96	0.3136	27.96	0.6256
		1	49	1	49	25.13	0.326	28.13	0.6505
		25	12	50	0	25.79	0.3794	28.79	0.757
	64QAM DFT-s-OFDM	1	1	1	0	23.59	0.2285	26.59	0.4558
		1	49	1	49	23.84	0.2419	26.84	0.4827
		25	12	50	0	24.17	0.261	27.17	0.5207
	256QAM DFT-s-OFDM	1	1	1	0	21.48	0.1406	24.48	0.2805
		1	49	1	49	21.62	0.1451	24.62	0.2896
		25	12	50	0	22.11	0.1624	25.11	0.324
QPSK CP-OFDM	1	1	1	0	24.54	0.2847	27.54	0.5681	
	1	49	1	49	24.66	0.2927	27.66	0.584	
	25	12	50	0	25.27	0.3367	28.27	0.6718	
Highest	PI/2 BPSK DFT-s-OFDM	1	1	1	0	25.74	0.3747	28.74	0.7476
		1	49	1	99	25.82	0.3816	28.82	0.7614
		25	12	100	0	26.51	0.4473	29.51	0.8925
	QPSK DFT-s-OFDM	1	1	1	0	26.13	0.4099	29.13	0.8178
		1	49	1	99	26.14	0.4107	29.14	0.8195
		25	12	100	0	26.54	0.4503	29.54	0.8985
	16QAM DFT-s-OFDM	1	1	1	0	25.00	0.3164	28.00	0.6314
		1	49	1	49	25.00	0.3165	28.00	0.6314
		25	12	50	0	25.72	0.3733	28.72	0.7449
	64QAM DFT-s-OFDM	1	1	1	0	23.78	0.2387	26.78	0.4762
		1	49	1	49	23.68	0.2332	26.68	0.4654
		25	12	50	0	24.12	0.258	27.12	0.5148
	256QAM DFT-s-OFDM	1	1	1	0	21.55	0.1429	24.55	0.2851
		1	49	1	49	21.64	0.1458	24.64	0.2909
		25	12	50	0	22.09	0.1616	25.09	0.3225

EN-DC n78(ANT M2)+2A (ANT M)Combination 15MHz+20MHz(LTE)(GT - LC = 3 dB)									
Channel	Mode	NR		LTE		Conducted		EIRP	
		RB		RB					
		Size	Offset	Size	Offset	Power(dBm)	Power(Watt)	Power(dBm)	Power(W)
Lowest	PI/2 BPSK DFT-s-OFDM	1	1	1	0	25.84	0.3834	28.84	0.765
		1	36	1	99	25.85	0.3843	28.85	0.7667
		18	9	100	0	26.36	0.432	29.36	0.862
	QPSK DFT-s-OFDM	1	1	1	0	26.00	0.3977	29.00	0.7936
		1	36	1	99	26.13	0.4099	29.13	0.8178
		18	9	100	0	26.29	0.4251	29.29	0.8483
	16QAM DFT-s-OFDM	1	1	1	0	24.99	0.3157	27.99	0.63
		1	36	1	49	24.94	0.3121	27.94	0.6227
		18	9	50	0	25.75	0.3759	28.75	0.75
	64QAM DFT-s-OFDM	1	1	1	0	23.58	0.2279	26.58	0.4548
		1	36	1	49	23.89	0.2447	26.89	0.4883
		18	9	50	0	24.18	0.2616	27.18	0.5219
	256QAM DFT-s-OFDM	1	1	1	0	21.45	0.1396	24.45	0.2786
		1	36	1	49	21.61	0.1449	24.61	0.289
		18	9	50	0	22.13	0.1631	25.13	0.3255
Middle	PI/2 BPSK DFT-s-OFDM	1	1	1	0	26.14	0.4107	29.14	0.8195
		1	36	1	99	26.20	0.4164	29.20	0.8309
		18	9	100	0	26.37	0.4331	29.37	0.8642
	QPSK DFT-s-OFDM	1	1	1	0	26.08	0.4051	29.08	0.8083
		1	36	1	99	26.19	0.4155	29.19	0.829
		18	9	100	0	26.44	0.4402	29.44	0.8782
	16QAM DFT-s-OFDM	1	1	1	0	25.03	0.3186	28.03	0.6358
		1	36	1	49	25.17	0.3291	28.17	0.6566
		18	9	50	0	25.79	0.3794	28.79	0.757
	64QAM DFT-s-OFDM	1	1	1	0	23.76	0.2375	26.76	0.474
		1	36	1	49	23.97	0.2492	26.97	0.4973
		18	9	50	0	24.15	0.2598	27.15	0.5183
	256QAM DFT-s-OFDM	1	1	1	0	21.44	0.1393	24.44	0.278
		1	36	1	49	21.64	0.1458	24.64	0.291
		18	9	50	0	22.15	0.1642	25.15	0.3277
QPSK CP-OFDM	1	1	1	0	24.45	0.2789	27.45	0.5565	
	1	36	1	49	24.60	0.2887	27.60	0.576	
	19	9	50	0	25.29	0.3382	28.29	0.6749	
Highest	PI/2 BPSK DFT-s-OFDM	1	1	1	0	25.95	0.3932	28.95	0.7846
		1	36	1	99	26.04	0.4015	29.04	0.801
		18	9	100	0	26.03	0.4006	29.03	0.7992
	QPSK DFT-s-OFDM	1	1	1	0	26.05	0.4023	29.05	0.8027
		1	36	1	99	26.08	0.4051	29.08	0.8083
		18	9	100	0	26.11	0.408	29.11	0.8141
	16QAM DFT-s-OFDM	1	1	1	0	24.99	0.3157	27.99	0.63
		1	36	1	49	25.12	0.3253	28.12	0.649
		18	9	50	0	25.71	0.3725	28.71	0.7432
	64QAM DFT-s-OFDM	1	1	1	0	23.85	0.2425	26.85	0.4839
		1	36	1	49	23.78	0.2386	26.78	0.4761
		18	9	50	0	24.09	0.2562	27.09	0.5112
	256QAM DFT-s-OFDM	1	1	1	0	21.44	0.1393	24.44	0.278
		1	36	1	49	21.66	0.1465	24.66	0.2923
		18	9	50	0	22.04	0.1598	25.04	0.3189

EN-DC n78(ANT M2)+2A (ANT M)Combination 10MHz+20MHz(LTE)(GT - LC = 3 dB)									
Channel	Mode	NR		LTE		Conducted		EIRP	
		RB		RB					
		Size	Offset	Size	Offset	Power(dBm)	Power(Watt)	IRP(dBm)	EIRP(W)
Lowest	PI/2 BPSK DFT-s-OFDM	1	1	1	0	25.77	0.3773	28.77	0.7528
		1	22	1	99	25.92	0.3905	28.92	0.7792
		12	6	100	0	26.24	0.4203	29.24	0.8386
	QPSK DFT-s-OFDM	1	1	1	0	25.91	0.3897	28.91	0.7775
		1	22	1	99	26.60	0.4566	29.60	0.911
		12	6	100	0	26.40	0.436	29.40	0.87
	16QAM DFT-s-OFDM	1	1	1	0	24.95	0.3128	27.95	0.6242
		1	22	1	49	24.95	0.3128	27.95	0.6242
		12	6	50	0	25.70	0.3717	28.70	0.7415
	64QAM DFT-s-OFDM	1	1	1	0	23.66	0.2322	26.66	0.4632
		1	22	1	49	23.83	0.2414	26.83	0.4817
		12	6	50	0	24.19	0.2622	27.19	0.5231
256QAM DFT-s-OFDM	1	1	1	0	21.48	0.1406	24.48	0.2805	
	1	22	1	49	21.58	0.1438	24.58	0.287	
	12	6	50	0	22.09	0.1616	25.09	0.3225	
Middle	PI/2 BPSK DFT-s-OFDM	1	1	1	0	26.22	0.4184	29.22	0.8348
		1	22	1	99	26.19	0.4155	29.19	0.829
		12	6	100	0	26.52	0.4483	29.52	0.8944
	QPSK DFT-s-OFDM	1	1	1	0	26.19	0.4155	29.19	0.8291
		1	22	1	99	26.31	0.4271	29.31	0.8522
		12	6	100	0	26.48	0.4441	29.48	0.8862
	16QAM DFT-s-OFDM	1	1	1	0	24.94	0.3121	27.94	0.6228
		1	22	1	49	25.17	0.3291	28.17	0.6566
		12	6	50	0	25.80	0.3803	28.80	0.7588
	64QAM DFT-s-OFDM	1	1	1	0	23.63	0.2306	26.63	0.4601
		1	22	1	49	23.81	0.2403	26.81	0.4794
		12	6	50	0	24.16	0.2604	27.16	0.5195
	256QAM DFT-s-OFDM	1	1	1	0	21.44	0.1393	24.44	0.2779
		1	22	1	49	21.65	0.1462	24.65	0.2916
		12	6	50	0	22.14	0.1635	25.14	0.3262
QPSK CP-OFDM	1	1	1	0	24.51	0.2828	27.51	0.5643	
	1	22	1	49	24.66	0.2927	27.66	0.584	
	12	6	50	0	25.29	0.3382	28.29	0.6748	
Highest	PI/2 BPSK DFT-s-OFDM	1	1	1	0	25.81	0.3807	28.81	0.7596
		1	22	1	99	25.91	0.3896	28.91	0.7773
		12	6	100	0	26.53	0.4493	29.53	0.8964
	QPSK DFT-s-OFDM	1	1	1	0	26.09	0.4061	29.09	0.8102
		1	22	1	99	26.36	0.432	29.36	0.862
		12	6	100	0	26.48	0.4442	29.48	0.8863
	16QAM DFT-s-OFDM	1	1	1	0	24.94	0.3121	27.94	0.6228
		1	22	1	49	25.12	0.3253	28.12	0.649
		12	6	50	0	25.70	0.3716	28.70	0.7415
	64QAM DFT-s-OFDM	1	1	1	0	23.78	0.2387	26.78	0.4762
		1	22	1	49	23.72	0.2354	26.72	0.4696
		12	6	50	0	24.08	0.2556	27.08	0.5101
	256QAM DFT-s-OFDM	1	1	1	0	21.46	0.1399	24.46	0.2792
		1	22	1	49	21.62	0.1452	24.62	0.2897
		12	6	50	0	22.09	0.1617	25.09	0.3226

SCS 15

EN-DC n78(ANT M2)+2A (ANT M)Combination 20MHz+20MHz(LTE)(GT - LC = 3 dB)									
Channel	Mode	NR		LTE		Conducted		EIRP	
		RB		RB					
		Size	Offset	Size	Offset	Power(dBm)	Power(Watt)	IRP(dBm)	EIRP(W)
Lowest	PI/2 BPSK DFT-s-OFDM	1	1	1	0	26.04	0.4015	29.04	0.801
		1	104	1	99	26.23	0.4193	29.23	0.8366
		50	25	100	0	26.30	0.4262	29.30	0.8504
	QPSK DFT-s-OFDM	1	1	1	0	25.98	0.396	28.98	0.7901
		1	104	1	99	26.15	0.4117	29.15	0.8215
		50	25	100	0	26.20	0.4165	29.20	0.8309
	16QAM DFT-s-OFDM	1	1	1	0	25.19	0.3306	28.19	0.6596
		1	49	1	49	25.41	0.3477	28.41	0.6937
		25	12	50	0	25.56	0.3599	28.56	0.7181
	64QAM DFT-s-OFDM	1	1	1	0	24.08	0.2557	27.08	0.5101
		1	49	1	49	24.23	0.2646	27.23	0.5279
		25	12	50	0	24.06	0.2545	27.06	0.5078
	256QAM DFT-s-OFDM	1	1	1	0	21.76	0.1499	24.76	0.2991
		1	49	1	49	21.95	0.1566	24.95	0.3124
		25	12	50	0	22.14	0.1639	25.14	0.3269
Middle	PI/2 BPSK DFT-s-OFDM	1	1	1	0	26.15	0.4117	29.15	0.8215
		1	104	1	99	26.38	0.434	29.38	0.866
		50	25	100	0	26.38	0.434	29.38	0.866
	QPSK DFT-s-OFDM	1	1	1	0	26.13	0.4098	29.13	0.8177
		1	104	1	99	26.23	0.4193	29.23	0.8366
		50	25	100	0	26.35	0.4311	29.35	0.8601
	16QAM DFT-s-OFDM	1	1	1	0	25.56	0.3599	28.56	0.718
		1	49	1	49	25.45	0.3509	28.45	0.7001
		25	12	50	0	25.74	0.375	28.74	0.7483
	64QAM DFT-s-OFDM	1	1	1	0	24.18	0.2616	27.18	0.5219
		1	49	1	49	24.27	0.267	27.27	0.5328
		25	12	50	0	24.17	0.2609	27.17	0.5207
	256QAM DFT-s-OFDM	1	1	1	0	21.93	0.1558	24.93	0.3109
		1	49	1	49	21.79	0.1509	24.79	0.3011
		25	12	50	0	22.19	0.1654	25.19	0.33
QPSK CP-OFDM	1	1	1	0	24.85	0.3057	27.85	0.61	
	1	49	1	49	24.76	0.2995	27.76	0.5976	
	25	12	50	0	25.05	0.3201	28.05	0.6387	
Highest	PI/2 BPSK DFT-s-OFDM	1	1	1	0	26.18	0.4146	29.18	0.8272
		1	104	1	99	26.30	0.4261	29.30	0.8502
		50	25	100	0	26.32	0.4282	29.32	0.8543
	QPSK DFT-s-OFDM	1	1	1	0	26.18	0.4146	29.18	0.8273
		1	104	1	99	26.20	0.4165	29.20	0.831
		50	25	100	0	26.24	0.4203	29.24	0.8387
	16QAM DFT-s-OFDM	1	1	1	0	25.34	0.3422	28.34	0.6827
		1	49	1	49	25.42	0.3485	28.42	0.6953
		25	12	50	0	25.56	0.3599	28.56	0.7181
	64QAM DFT-s-OFDM	1	1	1	0	24.17	0.261	27.17	0.5207
		1	49	1	49	24.22	0.264	27.22	0.5267
		25	12	50	0	24.15	0.2598	27.15	0.5183
	256QAM DFT-s-OFDM	1	1	1	0	21.65	0.1462	24.65	0.2916
		1	49	1	49	21.91	0.1551	24.91	0.3095
		25	12	50	0	22.10	0.162	25.10	0.3233

EN-DC n78 (ANT M2)+2A (ANT M)Combination 15MHz+20MHz(LTE)(GT - LC = 3 dB)									
Channel	Mode	NR		LTE		Conducted		EIRP	
		RB		RB					
		Size	Offset	Size	Offset	Power(dBm)	Power(Watt)	EIRP(dBm)	EIRP(W)
Lowest	PI/2 BPSK DFT-s-OFDM	1	1	1	0	26.08	0.4051	29.08	0.8084
		1	77	1	99	26.27	0.4232	29.27	0.8444
		36	18	100	0	26.12	0.4088	29.12	0.8157
	QPSK DFT-s-OFDM	1	1	1	0	25.95	0.3932	28.95	0.7845
		1	77	1	99	26.11	0.4079	29.11	0.8139
		36	18	100	0	26.15	0.4117	29.15	0.8214
	16QAM DFT-s-OFDM	1	1	1	0	25.38	0.3453	28.38	0.6889
		1	36	1	49	25.32	0.3406	28.32	0.6796
		18	9	50	0	25.55	0.359	28.55	0.7164
	64QAM DFT-s-OFDM	1	1	1	0	24.07	0.2551	27.07	0.5089
		1	36	1	49	24.19	0.2622	27.19	0.5231
		18	9	50	0	24.17	0.261	27.17	0.5207
256QAM DFT-s-OFDM	1	1	1	0	21.65	0.1462	24.65	0.2917	
	1	36	1	49	21.96	0.1569	24.96	0.313	
	18	9	50	0	22.08	0.1613	25.08	0.3218	
Middle	PI/2 BPSK DFT-s-OFDM	1	1	1	0	26.28	0.4242	29.28	0.8463
		1	77	1	99	26.44	0.44	29.44	0.878
		36	18	100	0	26.38	0.4341	29.38	0.8662
	QPSK DFT-s-OFDM	1	1	1	0	26.16	0.4127	29.16	0.8234
		1	77	1	99	26.26	0.4222	29.26	0.8425
		36	18	100	0	26.28	0.4242	29.28	0.8464
	16QAM DFT-s-OFDM	1	1	1	0	25.59	0.3623	28.59	0.723
		1	36	1	49	25.54	0.3582	28.54	0.7147
		18	9	50	0	25.71	0.3725	28.71	0.7432
	64QAM DFT-s-OFDM	1	1	1	0	24.25	0.2658	27.25	0.5303
		1	36	1	49	24.26	0.2664	27.26	0.5315
		18	9	50	0	24.19	0.2622	27.19	0.5231
	256QAM DFT-s-OFDM	1	1	1	0	21.95	0.1565	24.95	0.3123
		1	36	1	49	21.80	0.1513	24.80	0.3018
		18	9	50	0	22.21	0.1665	25.21	0.3323
	QPSK CP-OFDM	1	1	1	0	24.90	0.3093	27.90	0.6171
		1	36	1	49	24.82	0.3036	27.82	0.6058
		19	9	50	0	25.10	0.3238	28.10	0.646
Highest	PI/2 BPSK DFT-s-OFDM	1	1	1	0	26.25	0.4213	29.25	0.8406
		1	77	1	99	26.38	0.4341	29.38	0.8661
		36	18	100	0	26.28	0.4242	29.28	0.8463
	QPSK DFT-s-OFDM	1	1	1	0	26.09	0.4061	29.09	0.8103
		1	77	1	99	26.26	0.4222	29.26	0.8424
		36	18	100	0	26.24	0.4203	29.24	0.8386
	16QAM DFT-s-OFDM	1	1	1	0	25.25	0.3351	28.25	0.6687
		1	36	1	49	25.43	0.3493	28.43	0.6969
		18	9	50	0	25.53	0.3574	28.53	0.7131
	64QAM DFT-s-OFDM	1	1	1	0	24.18	0.2616	27.18	0.5219
		1	36	1	49	24.19	0.2621	27.19	0.5231
		18	9	50	0	24.18	0.2616	27.18	0.5219
	256QAM DFT-s-OFDM	1	1	1	0	21.76	0.1499	24.76	0.2991
		1	36	1	49	21.93	0.1558	24.93	0.3109
		18	9	50	0	22.13	0.1631	25.13	0.3255

EN-DC n78 (ANT M2)+2A (ANT M))Combination 10MHz+20MHz(LTE)(GT - LC = 3 dB)									
Channel	Mode	NR		LTE		Conducted		EIRP	
		RB		RB					
		Size	Offset	Size	Offset	Power(dBm)	Power(Watt)	ERP(dBm)	EIRP(W)
Lowest	PI/2 BPSK DFT-s-OFDM	1	1	1	0	25.91	0.3896	28.91	0.7773
		1	50	1	99	26.06	0.4033	29.06	0.8047
		25	12	100	0	25.94	0.3923	28.94	0.7828
	QPSK DFT-s-OFDM	1	1	1	0	25.82	0.3816	28.82	0.7615
		1	50	1	99	26.00	0.3977	29.00	0.7936
		25	12	100	0	25.90	0.3887	28.90	0.7756
	16QAM DFT-s-OFDM	1	1	1	0	25.19	0.3306	28.19	0.6596
		1	22	1	49	25.32	0.3406	28.32	0.6795
		12	6	50	0	25.50	0.355	28.50	0.7082
	64QAM DFT-s-OFDM	1	1	1	0	24.06	0.2545	27.06	0.5077
		1	22	1	49	24.19	0.2622	27.19	0.5231
		12	6	50	0	24.16	0.2604	27.16	0.5195
256QAM DFT-s-OFDM	1	1	1	0	21.73	0.1488	24.73	0.297	
	1	22	1	49	21.93	0.1558	24.93	0.3109	
	12	6	50	0	22.07	0.1609	25.07	0.321	
Middle	PI/2 BPSK DFT-s-OFDM	1	1	1	0	26.19	0.4155	29.19	0.829
		1	50	1	99	26.28	0.4242	29.28	0.8464
		25	12	100	0	26.06	0.4033	29.06	0.8047
	QPSK DFT-s-OFDM	1	1	1	0	26.03	0.4005	29.03	0.7991
		1	50	1	99	26.16	0.4127	29.16	0.8234
		25	12	100	0	26.04	0.4014	29.04	0.801
	16QAM DFT-s-OFDM	1	1	1	0	25.44	0.3501	28.44	0.6986
		1	22	1	49	25.51	0.3558	28.51	0.7098
		12	6	50	0	25.75	0.3759	28.75	0.7501
	64QAM DFT-s-OFDM	1	1	1	0	24.22	0.264	27.22	0.5267
		1	22	1	49	24.22	0.264	27.22	0.5267
		12	6	50	0	24.22	0.264	27.22	0.5267
	256QAM DFT-s-OFDM	1	1	1	0	21.87	0.1537	24.87	0.3067
		1	22	1	49	21.87	0.1537	24.87	0.3067
		12	6	50	0	22.18	0.1654	25.18	0.33
	QPSK CP-OFDM	1	1	1	0	24.89	0.3085	27.89	0.6156
		1	22	1	49	24.82	0.3036	27.82	0.6058
		12	6	50	0	25.04	0.3194	28.04	0.6373
Highest	PI/2 BPSK DFT-s-OFDM	1	1	1	0	26.13	0.4099	29.13	0.8178
		1	50	1	99	26.21	0.4175	29.21	0.8329
		25	12	100	0	25.99	0.3969	28.99	0.7918
	QPSK DFT-s-OFDM	1	1	1	0	25.86	0.3852	28.86	0.7686
		1	50	1	99	26.04	0.4014	29.04	0.8009
		25	12	100	0	26.00	0.3977	29.00	0.7935
	16QAM DFT-s-OFDM	1	1	1	0	25.32	0.3406	28.32	0.6795
		1	22	1	49	25.42	0.3485	28.42	0.6953
		12	6	50	0	25.57	0.3607	28.57	0.7197
	64QAM DFT-s-OFDM	1	1	1	0	24.10	0.2568	27.10	0.5124
		1	22	1	49	24.17	0.261	27.17	0.5207
		12	6	50	0	24.16	0.2604	27.16	0.5195
	256QAM DFT-s-OFDM	1	1	1	0	21.76	0.1499	24.76	0.2991
		1	22	1	49	21.95	0.1566	24.95	0.3124
		12	6	50	0	22.05	0.1602	25.05	0.3195



5G NR n7 SA

Peak-to-Average Ratio

Mode	FR1 n7 / 20MHz / DFT-S OFDM				
Mod.	PI/2 BPSK	PI/2 BPSK	QPSK	QPSK	Limit: 13dB
RB Size	1RB	Full RB	1RB	Full RB	Result
Lowest CH	3.68	4.00	5.77	5.48	PASS
Middle CH	3.19	3.97	5.54	5.42	
Highest CH	3.86	3.86	6.52	5.33	



FR1 n7 / 20MHz / DFT-S OFDM

PI/2 BPSK

QPSK

Lowest Channel / 1RB

Lowest Channel / 1RB

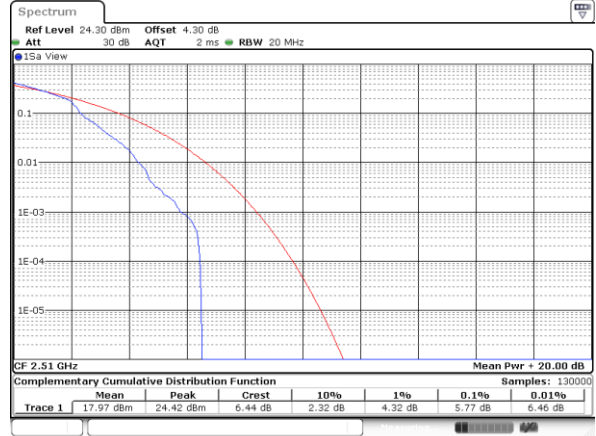
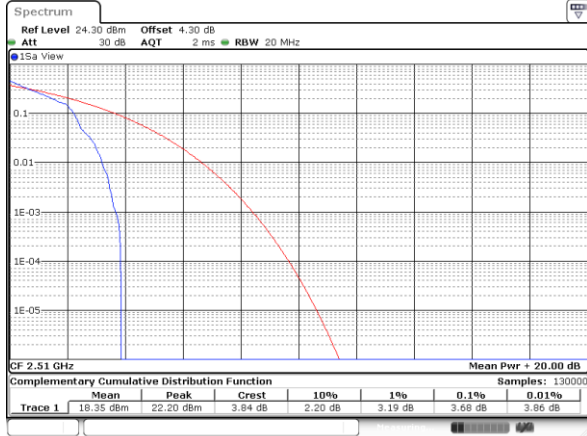

Date: 13_JAN.2021 05:22:48

Date: 13_JAN.2021 05:22:59

Middle Channel / 1 RB

Middle Channel / 1 RB

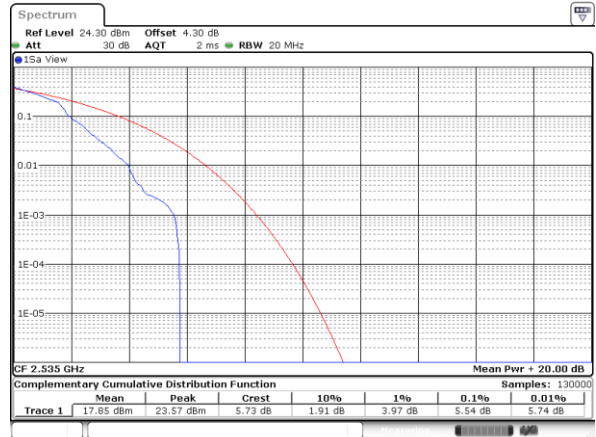
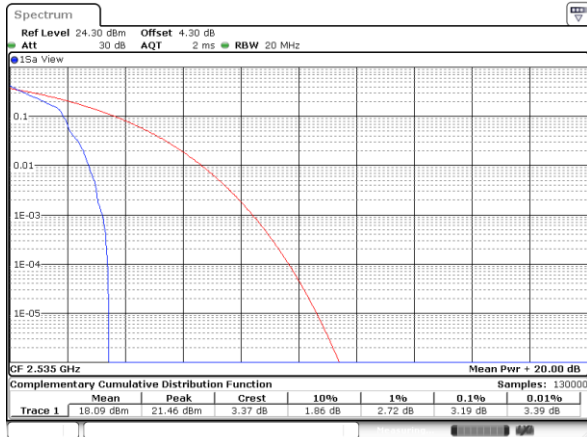

Date: 13_JAN.2021 05:26:37

Date: 13_JAN.2021 05:26:19

Highest Channel / 1 RB

Highest Channel / 1 RB

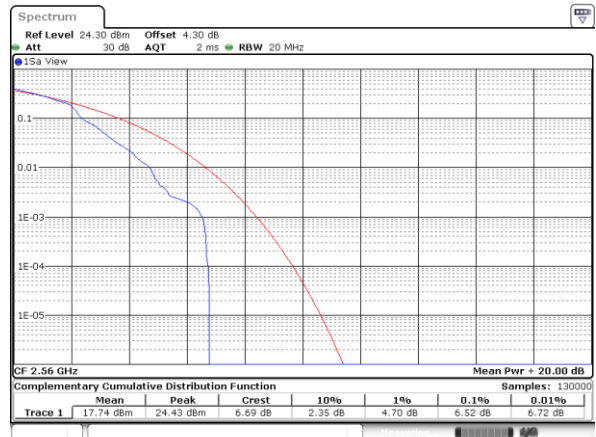
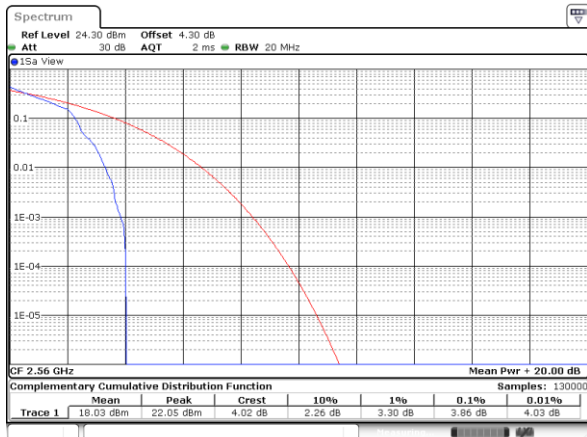

Date: 13_JAN.2021 05:27:11

Date: 13_JAN.2021 05:27:24



FR1 n7 / 20MHz / DFT-S OFDM

PI/2 BPSK

QPSK

Lowest Channel / Full RB

Lowest Channel / Full RB

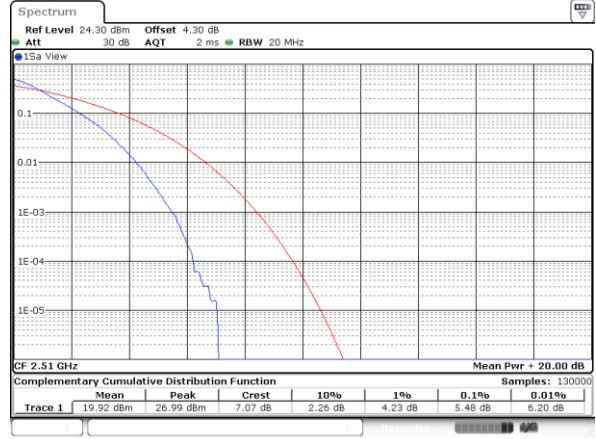
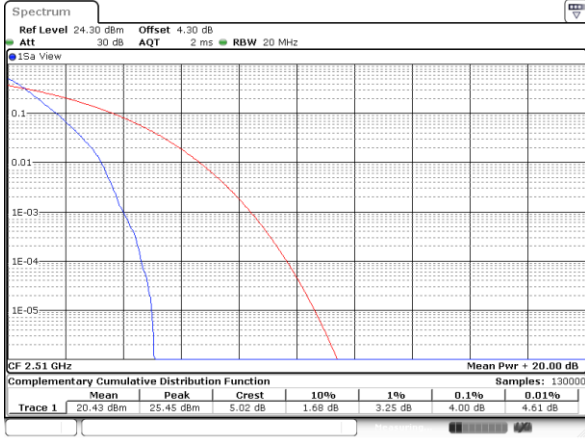

Date: 13_JAN_2021 05:23:40

Date: 13_JAN_2021 05:23:15

Middle Channel / Full RB

Middle Channel / Full RB

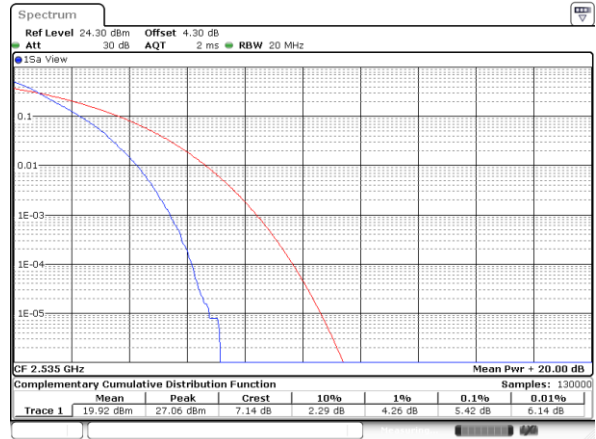
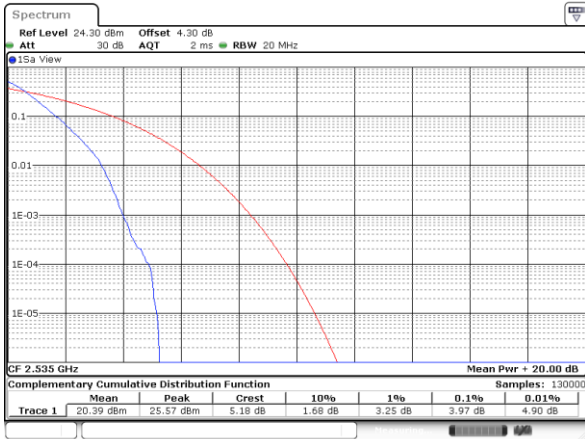

Date: 13_JAN_2021 05:24:28

Date: 13_JAN_2021 05:24:52

Highest Channel / Full RB

Highest Channel / Full RB

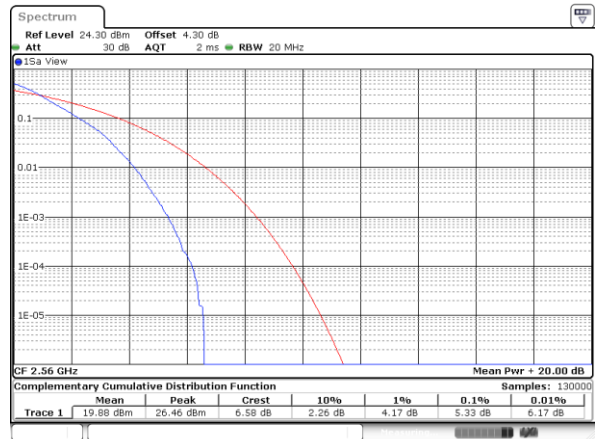
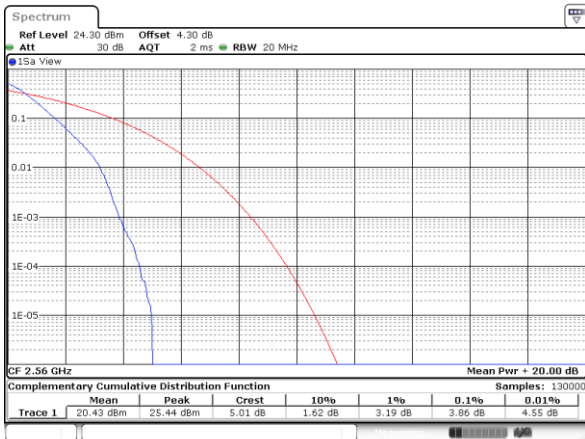

Date: 13_JAN_2021 05:28:13

Date: 13_JAN_2021 05:27:47



26dB Bandwidth

Mode	FR1 n7 : 26dB BW(MHz) / CP-OFDM							
BW	5MHz	5MHz	5MHz	5MHz				
Mod.	QPSK	16QAM	64QAM	256QAM				
Middle CH	4.83	4.91	4.88	4.86				

Mode	FR1 n7 : 26dB BW(MHz) / CP-OFDM							
BW	10MHz	10MHz	10MHz	10MHz				
Mod.	QPSK	16QAM	64QAM	256QAM				
Middle CH	9.79	9.77	9.83	9.67				

Mode	FR1 n7 : 26dB BW(MHz) / CP-OFDM							
BW	15MHz	15MHz	15MHz	15MHz				
Mod.	QPSK	16QAM	64QAM	256QAM				
Middle CH	14.87	14.93	14.93	14.98				

Mode	FR1 n7 : 26dB BW(MHz) / CP-OFDM							
BW	20MHz	20MHz	20MHz	20MHz				
Mod.	QPSK	16QAM	64QAM	256QAM				
Middle CH	19.90	19.82	19.86	20.10				

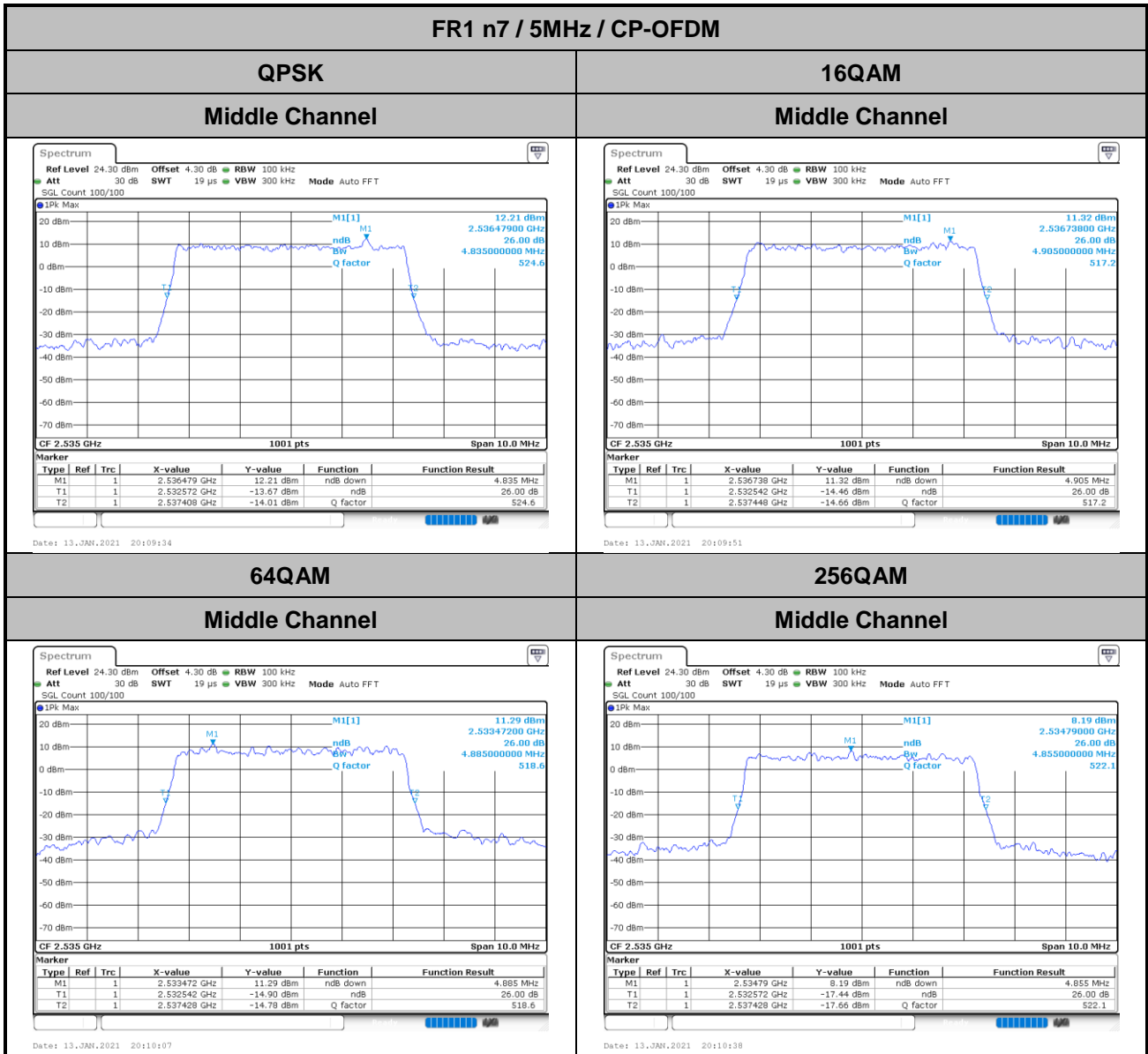

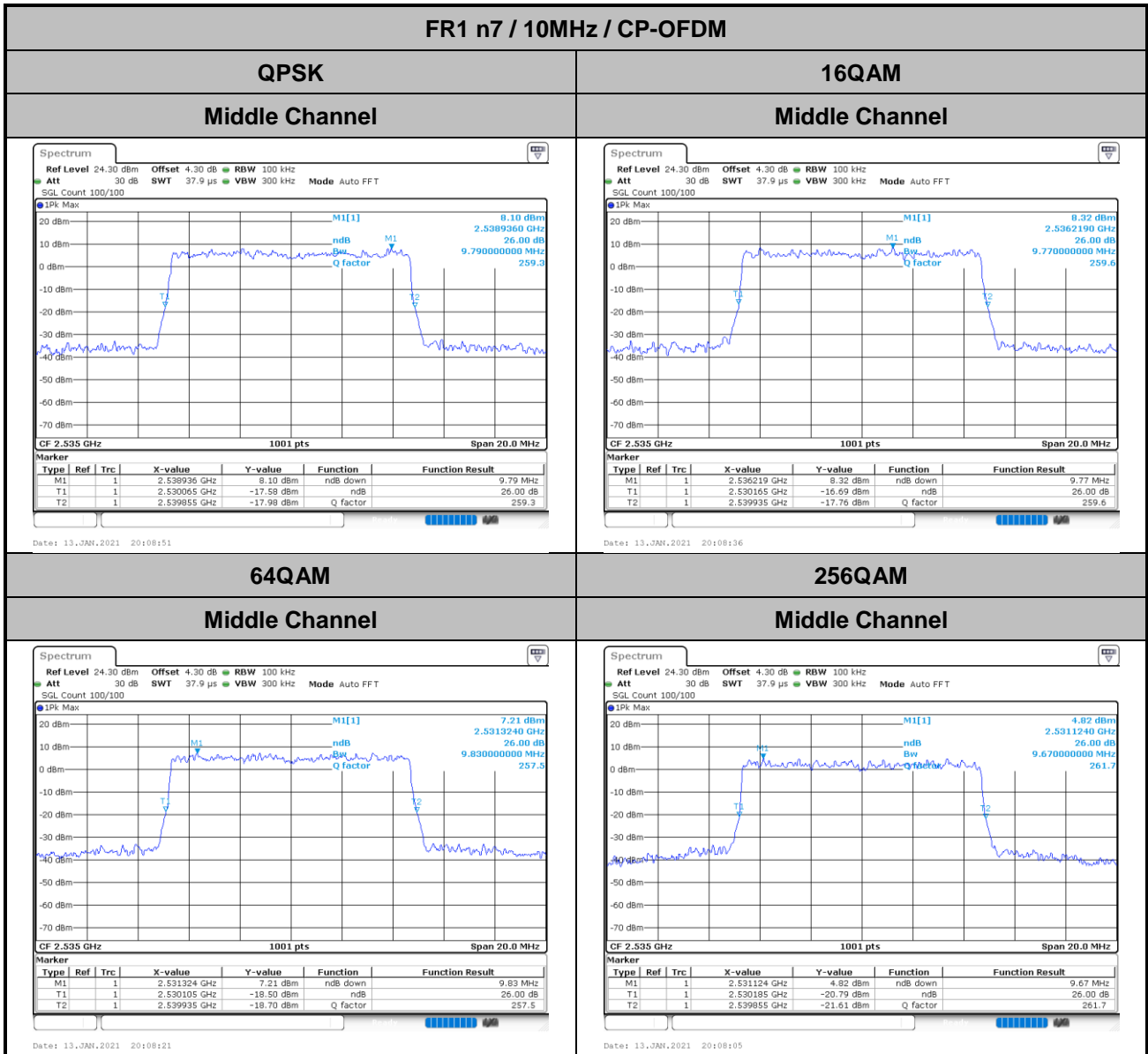



FR1 n7 / 15MHz / CP-OFDM

QPSK

16QAM

Middle Channel

Middle Channel

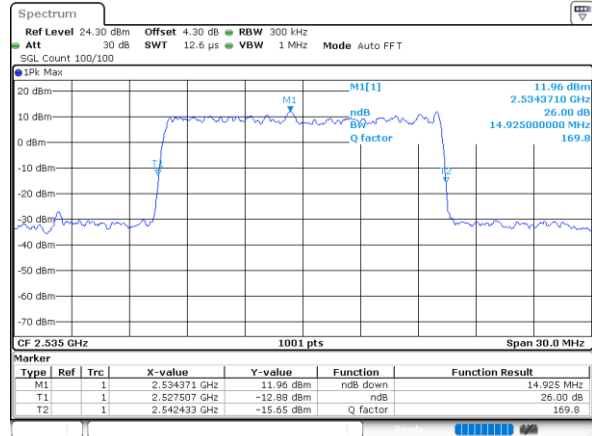
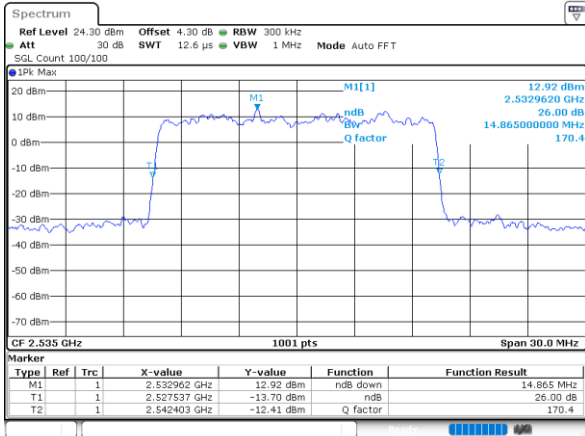

Date: 13.JAN.2021 19:59:14

Date: 13.JAN.2021 19:59:30

64QAM

256QAM

Middle Channel

Middle Channel

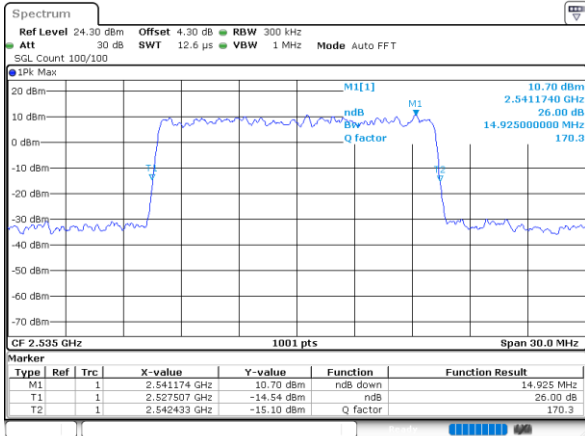

Date: 13.JAN.2021 19:59:46

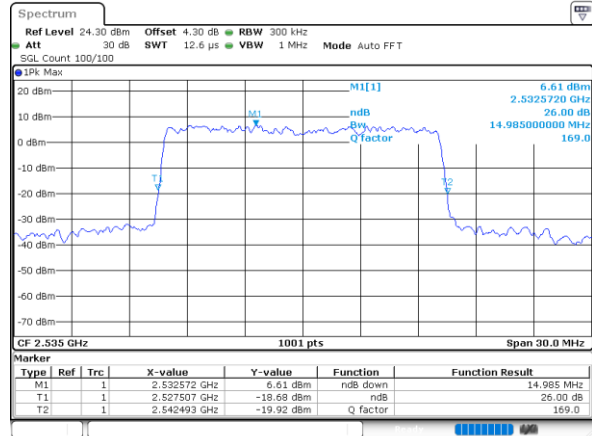

Date: 13.JAN.2021 20:00:02



FR1 n7 / 20MHz / CP-OFDM

QPSK

16QAM

Middle Channel

Middle Channel

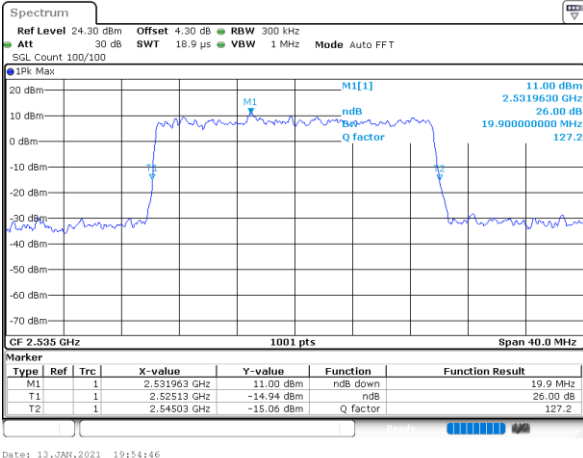

Date: 13.JAN.2021 19:54:46

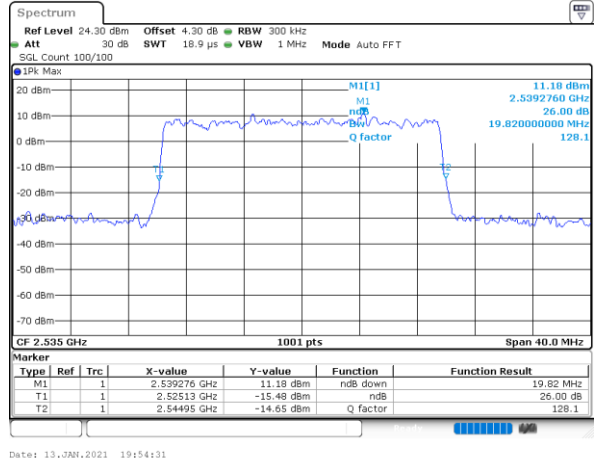

Date: 13.JAN.2021 19:54:31

64QAM

256QAM

Middle Channel

Middle Channel

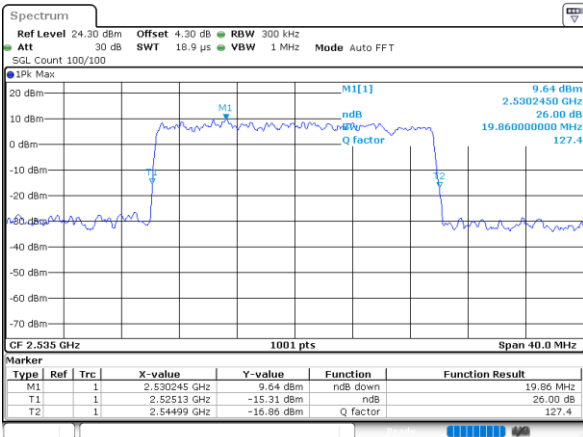

Date: 13.JAN.2021 19:54:16

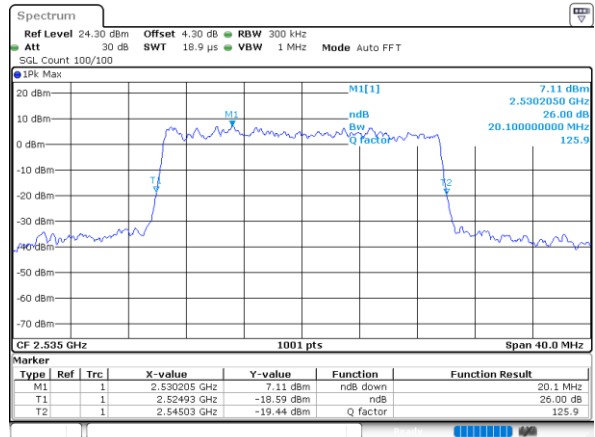

Date: 13.JAN.2021 19:53:58



Occupied Bandwidth

Mode	FR1 n7 : OBW(MHz) / CP-OFDM							
BW	5MHz	5MHz	5MHz	5MHz				
Mod.	QPSK	16QAM	64QAM	256QAM				
Middle CH	4.52	4.46	4.48	4.49				

Mode	FR1 n7 : OBW(MHz) / CP-OFDM							
BW	10MHz	10MHz	10MHz	10MHz				
Mod.	QPSK	16QAM	64QAM	256QAM				
Middle CH	9.29	9.27	9.29	9.31				

Mode	FR1 n7 : OBW(MHz) / CP-OFDM							
BW	15MHz	15MHz	15MHz	15MHz				
Mod.	QPSK	16QAM	64QAM	256QAM				
Middle CH	14.15	14.15	14.15	14.12				

Mode	FR1 n7 : OBW(MHz) / CP-OFDM							
BW	20MHz	20MHz	20MHz	20MHz				
Mod.	QPSK	16QAM	64QAM	256QAM				
Middle CH	18.94	18.90	18.98	18.98				

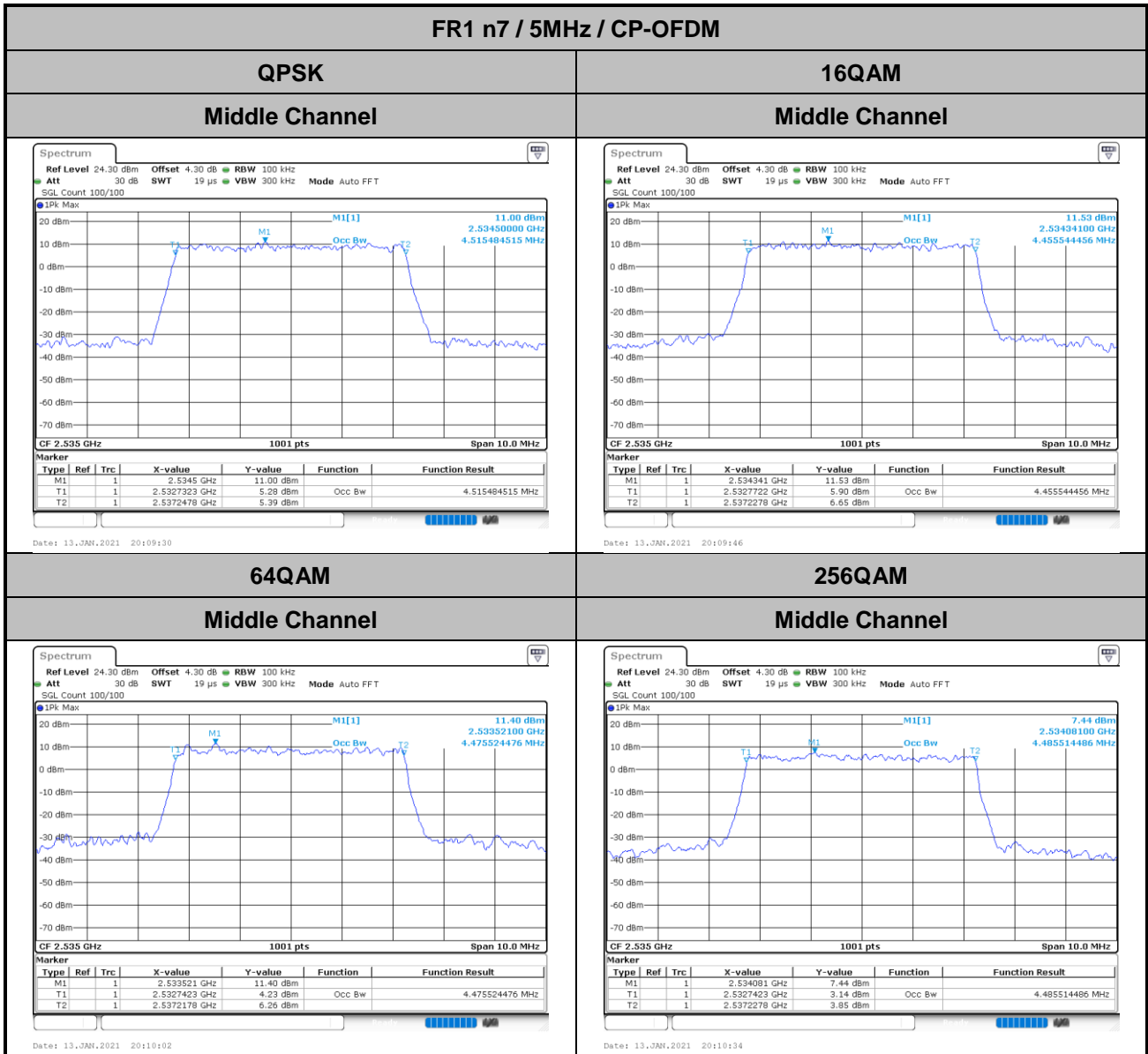

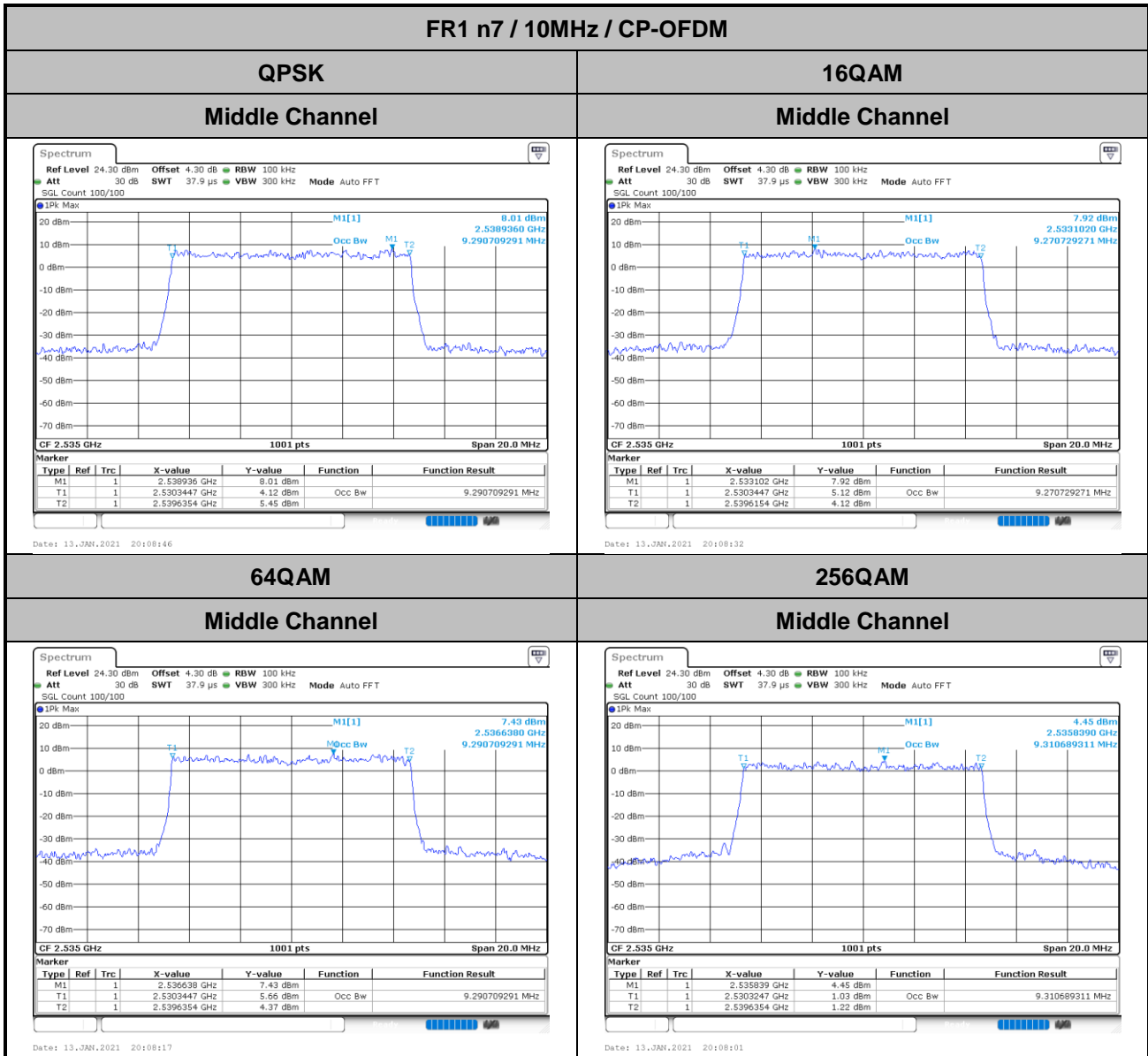

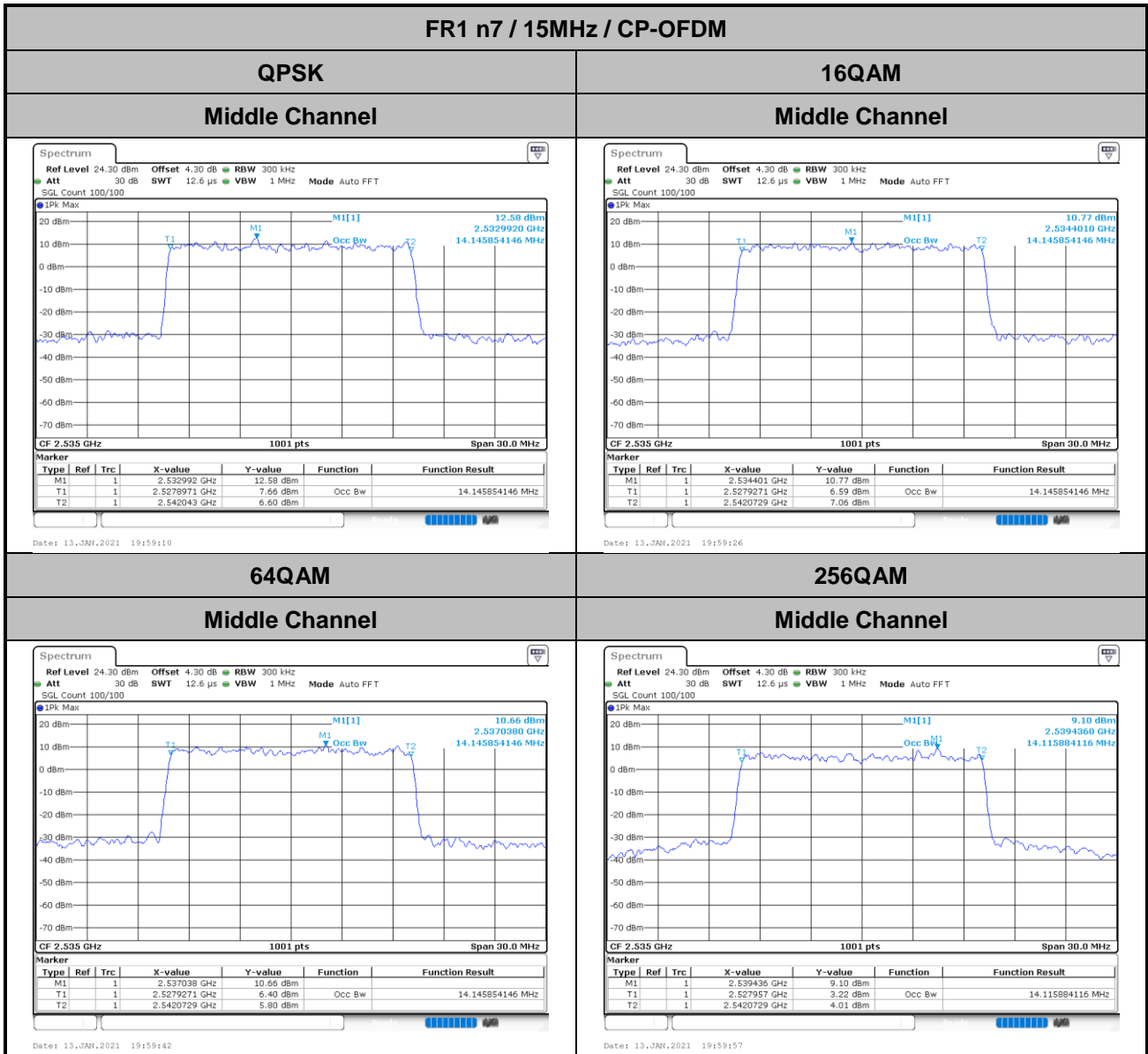



FR1 n7 / 20MHz / CP-OFDM

QPSK

16QAM

Middle Channel

Middle Channel

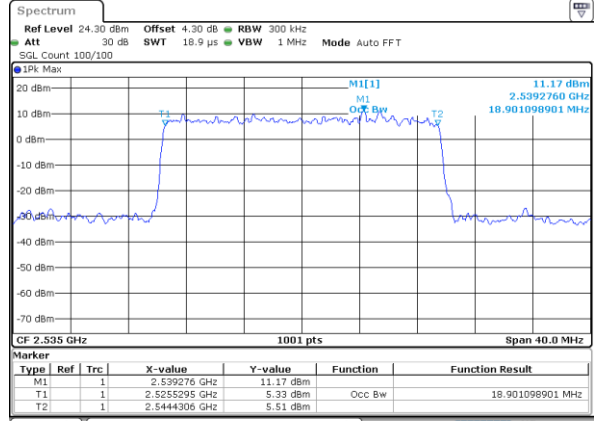
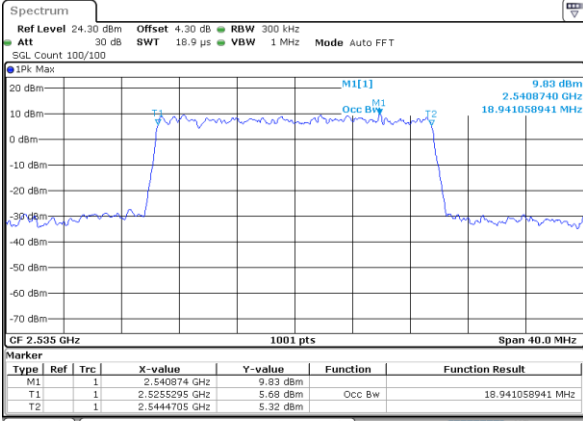

Date: 13, JAN, 2021 19:54:41

Date: 13, JAN, 2021 19:54:27

64QAM

256QAM

Middle Channel

Middle Channel

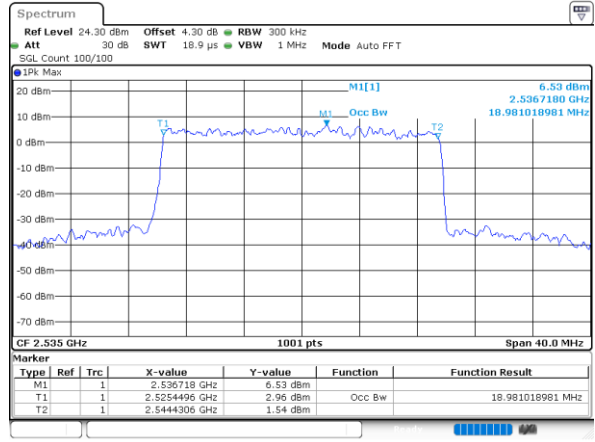
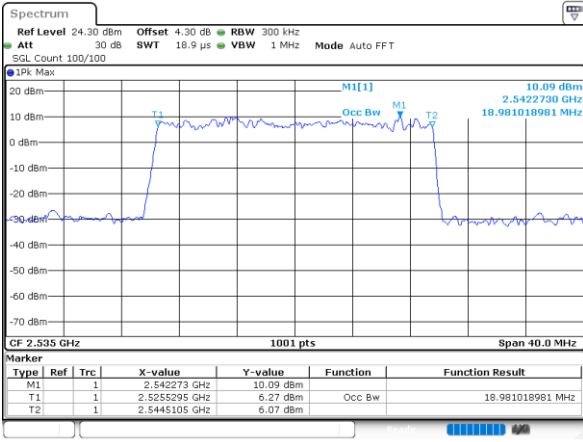

Date: 13, JAN, 2021 19:54:12

Date: 13, JAN, 2021 19:53:52



Conducted Band Edge

FR1 n7 / 5MHz / DFT-S OFDM BPSK

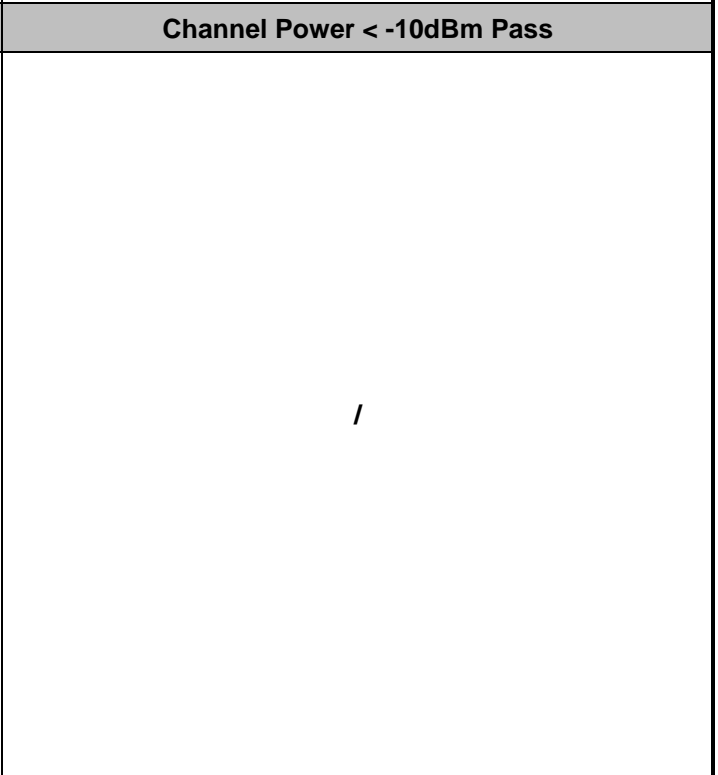
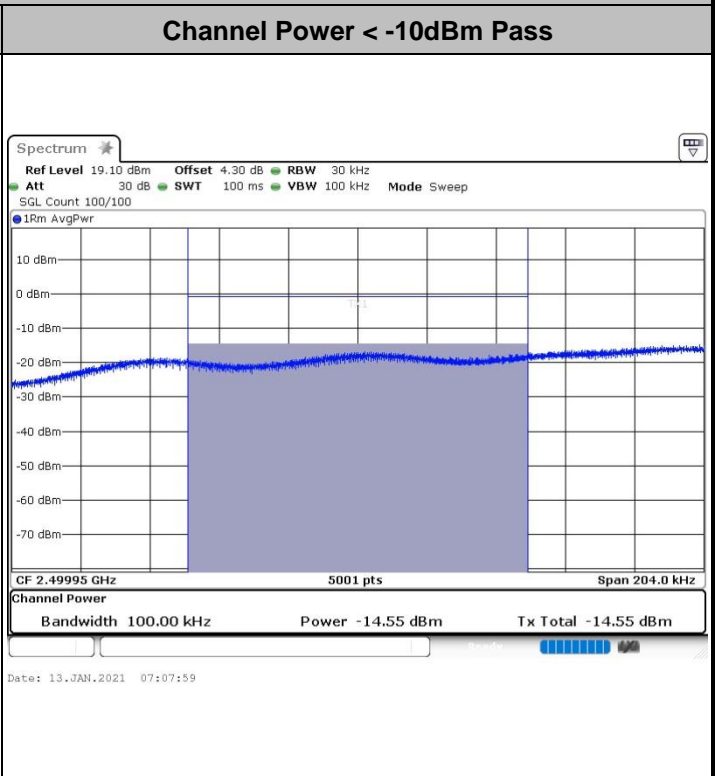
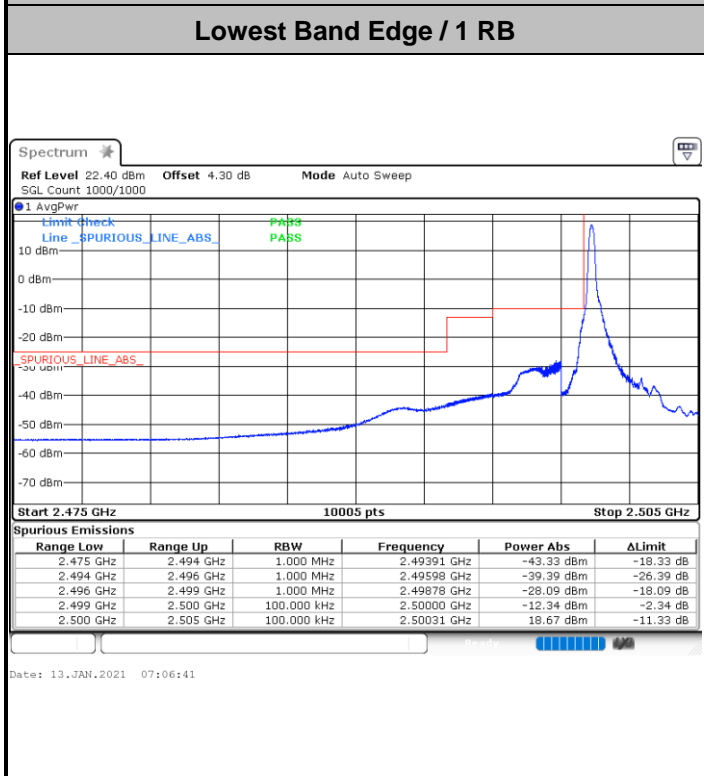



FR1 n7 / 5MHz / DFT-S OFDM BPSK

Highest Band Edge / 1 RB

Channel Power < -10dBm Pass

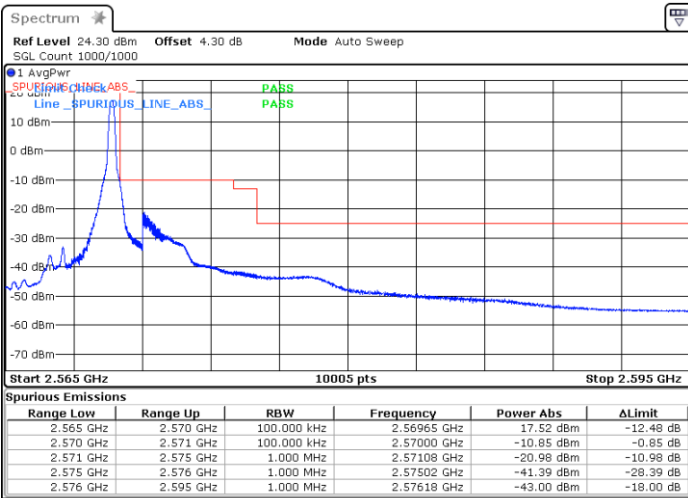

Date: 3.FEB.2021 11:19:21

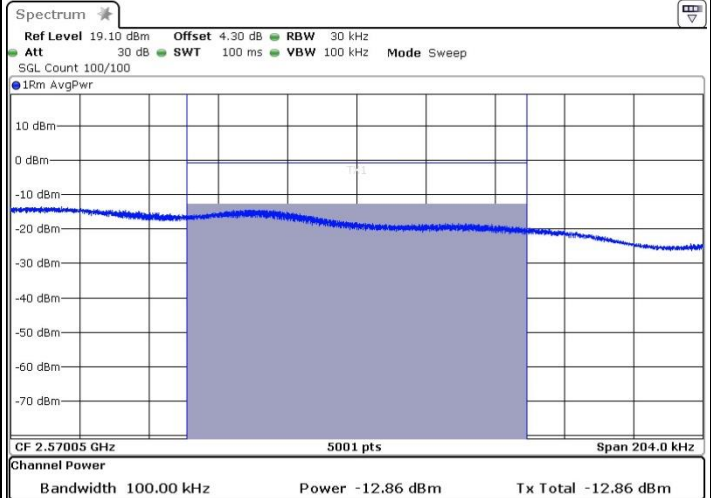

Date: 3.FEB.2021 11:20:18

Highest Band Edge / Full RB

Channel Power < -10dBm Pass

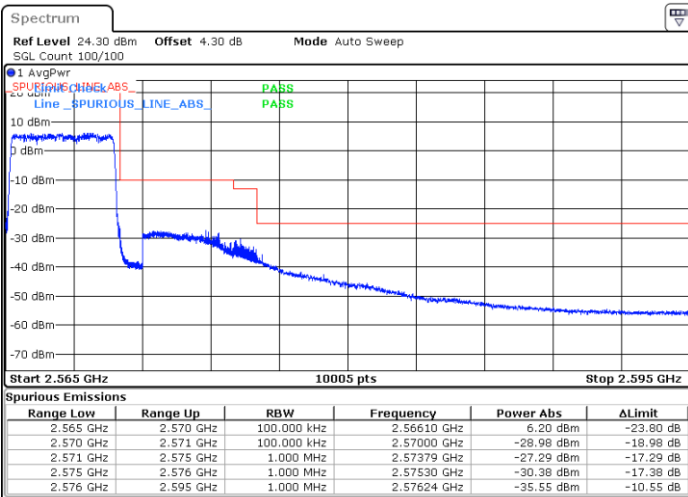

Date: 13.JAN.2021 07:40:41



FR1 n7 / 5MHz / DFT-S OFDM QPSK

Lowest Band Edge / 1 RB

Channel Power < -10dBm Pass

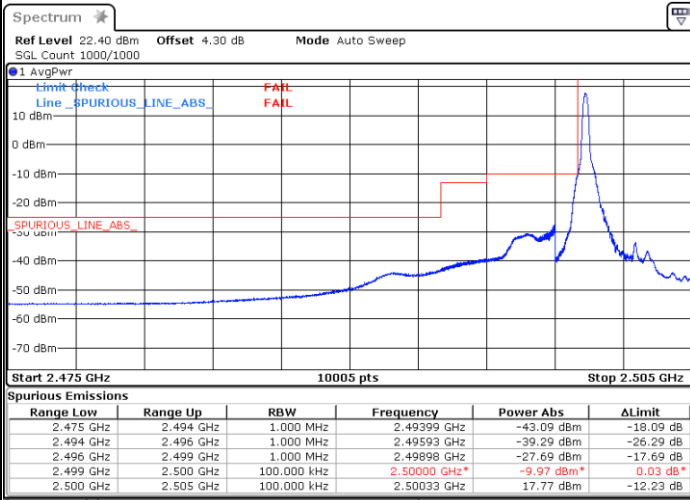

Date: 3.FEB.2021 10:13:11

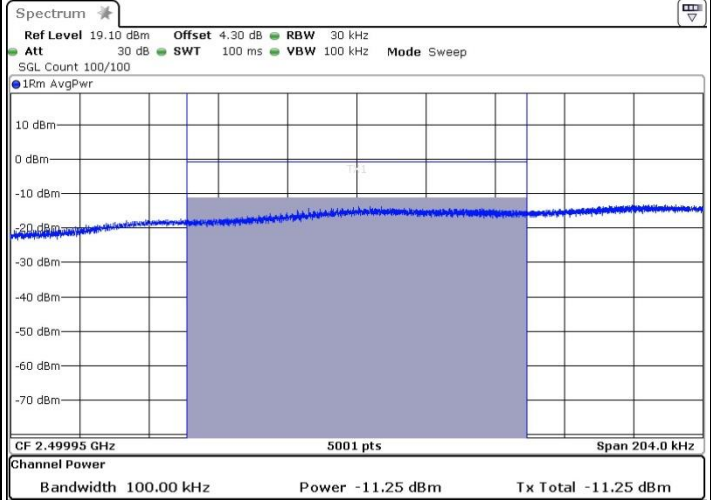

Date: 3.FEB.2021 10:33:49

Lowest Band Edge / Full RB

Channel Power < -10dBm Pass

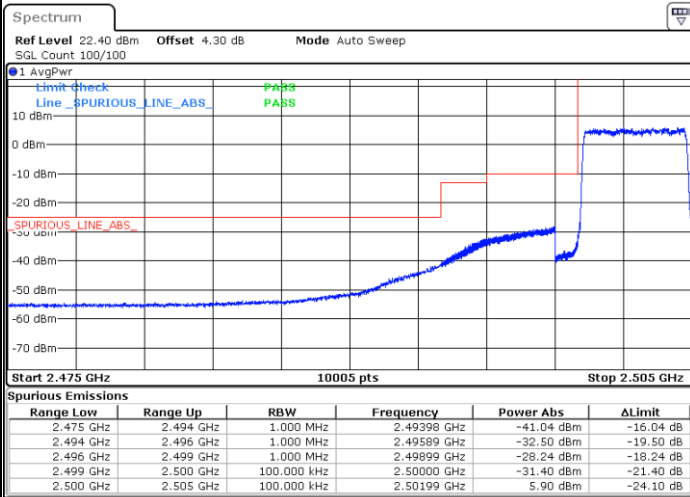

Date: 13.JAN.2021 07:01:31

/



FR1 n7 / 5MHz / DFT-S OFDM QPSK

Highest Band Edge / 1 RB

Channel Power < -10dBm Pass

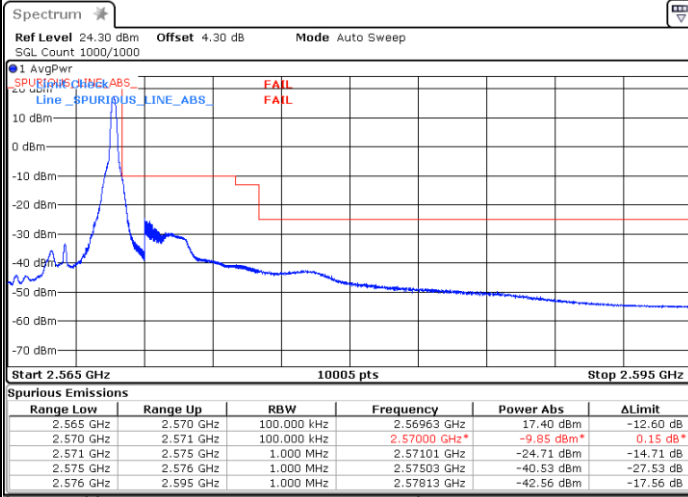

Date: 3.FEB.2021 11:17:12

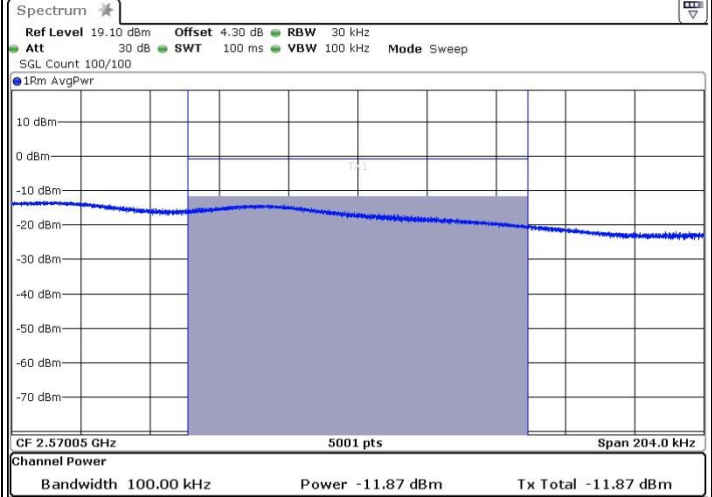

Date: 3.FEB.2021 11:18:13

Highest Band Edge / Full RB

Channel Power < -10dBm Pass

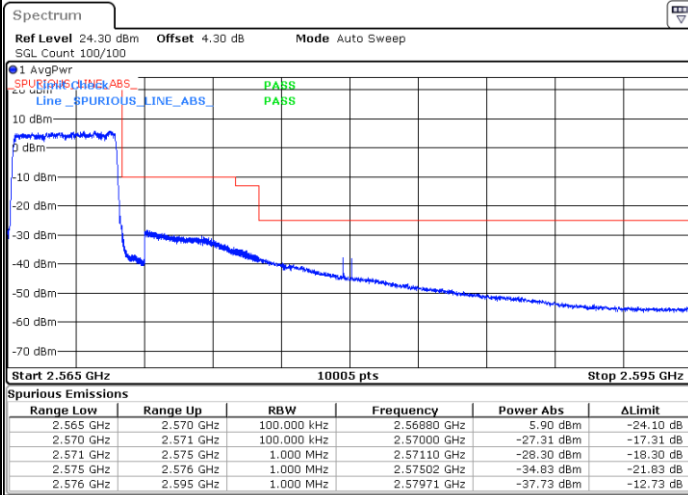

Date: 13.JAN.2021 07:41:03



FR1 n7 / 10MHz / DFT-S OFDM BPSK

Lowest Band Edge / 1 RB

Channel Power < -10dBm Pass

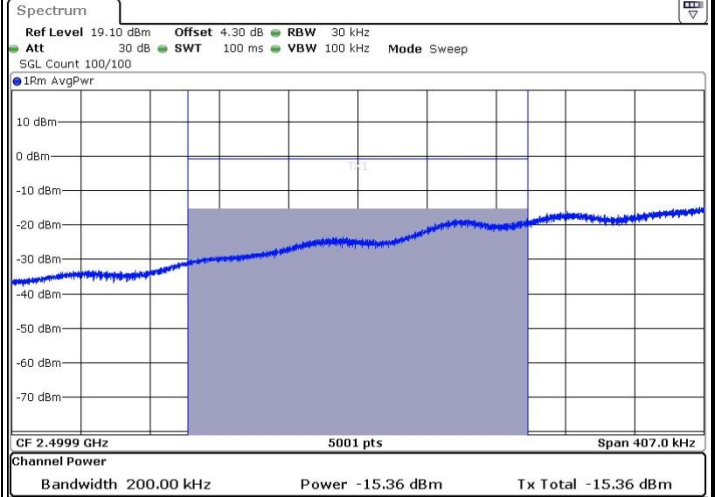
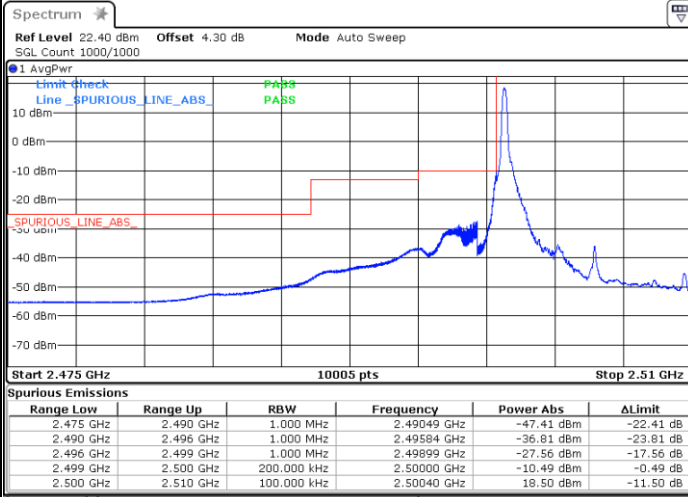

Date: 13.JAN.2021 05:33:46

Date: 13.JAN.2021 05:35:55

Lowest Band Edge / Full RB

Channel Power < -13dBm Pass

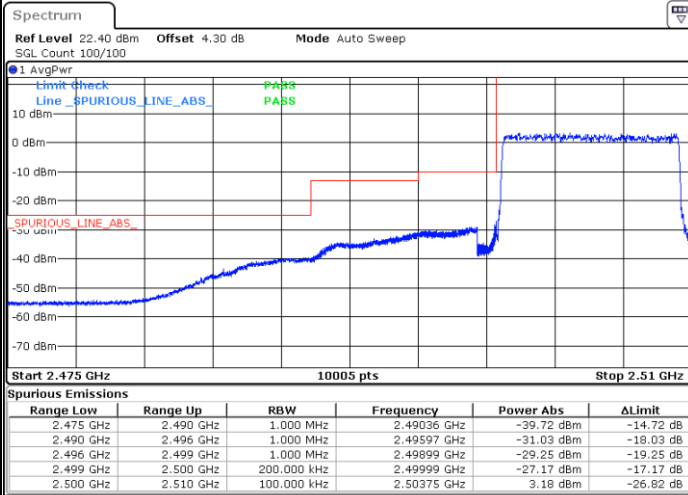

Date: 13.JAN.2021 05:29:32



FR1 n7 / 10MHz / DFT-S OFDM BPSK

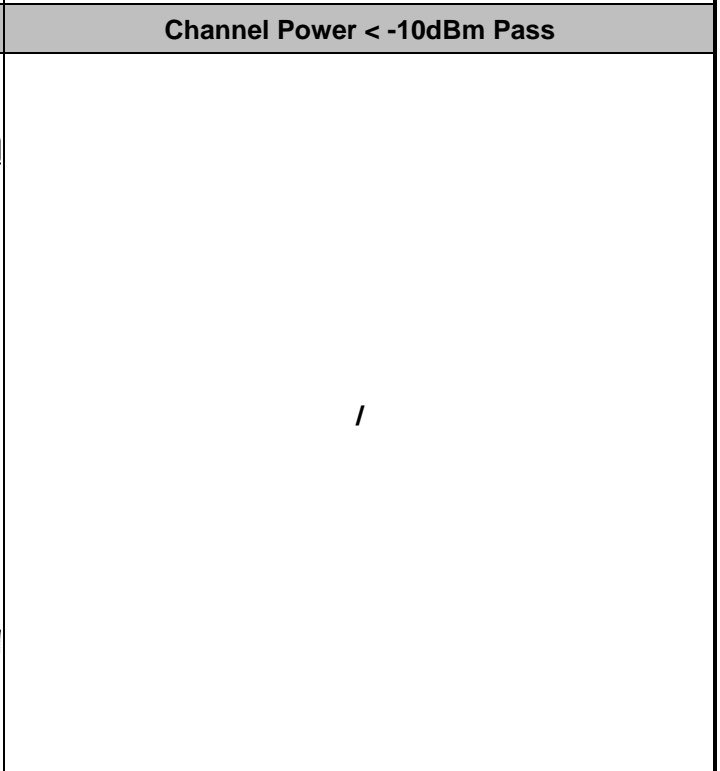
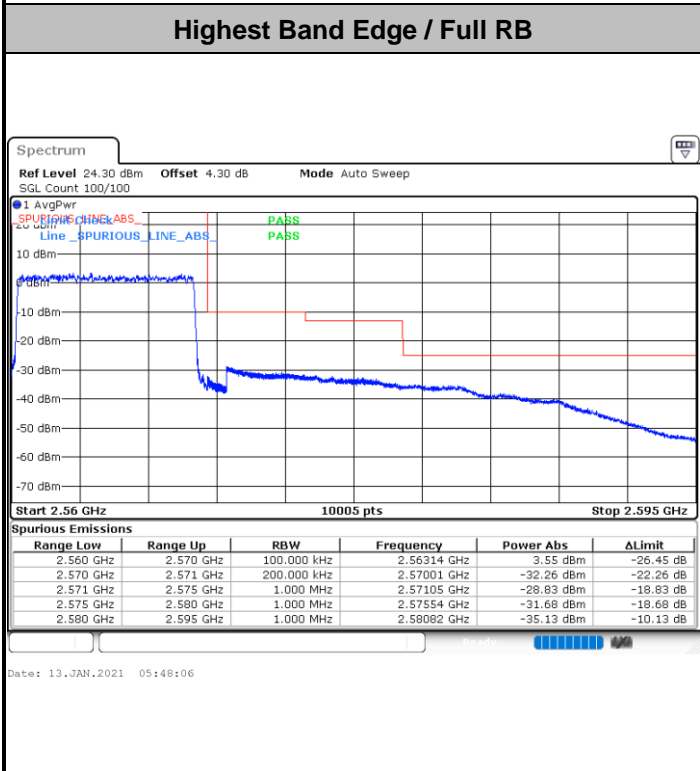
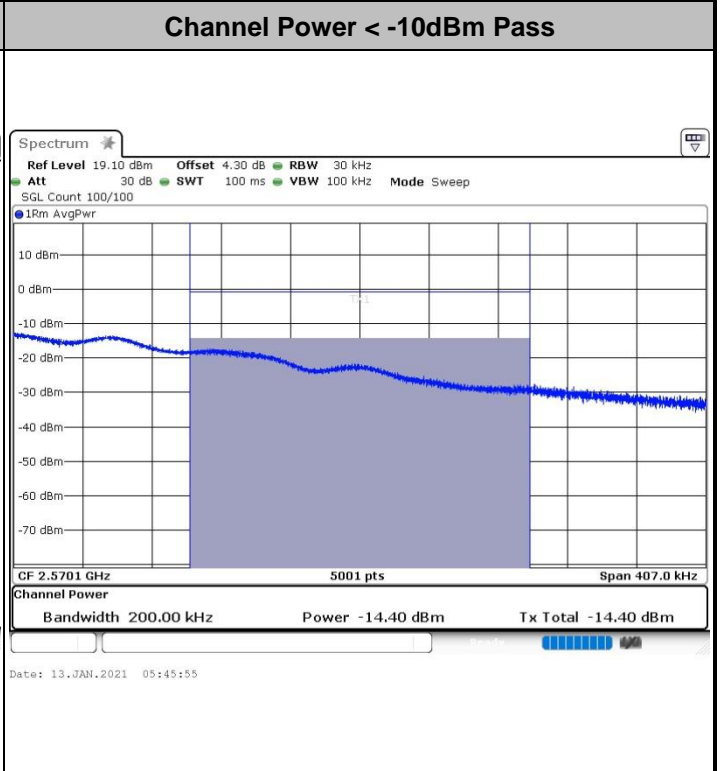



FR1 n7 / 10MHz / DFT-S OFDM QPSK

Lowest Band Edge / 1 RB

Channel Power < -10dBm Pass

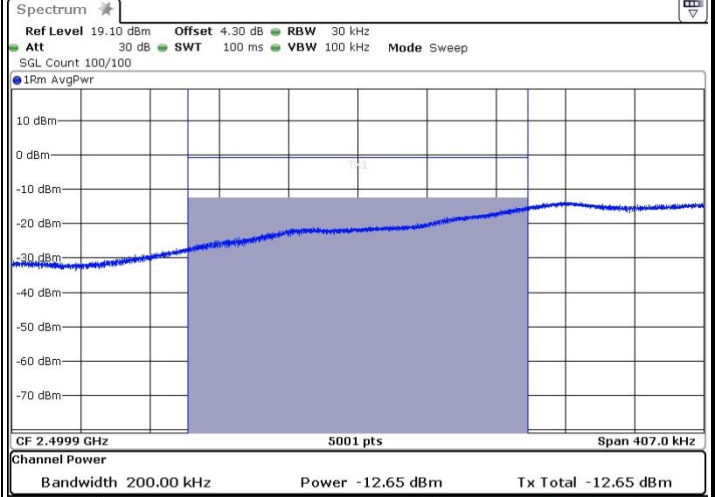
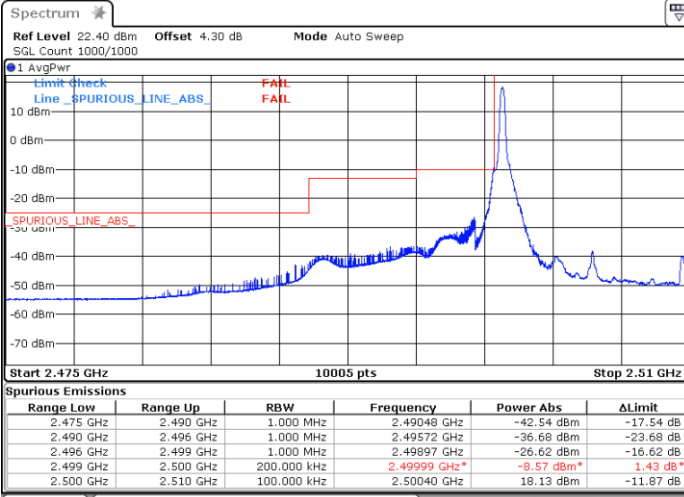

Date: 3.FEB.2021 03:18:10

Date: 3.FEB.2021 03:19:41

Lowest Band Edge / Full RB

Channel Power < -10dBm Pass

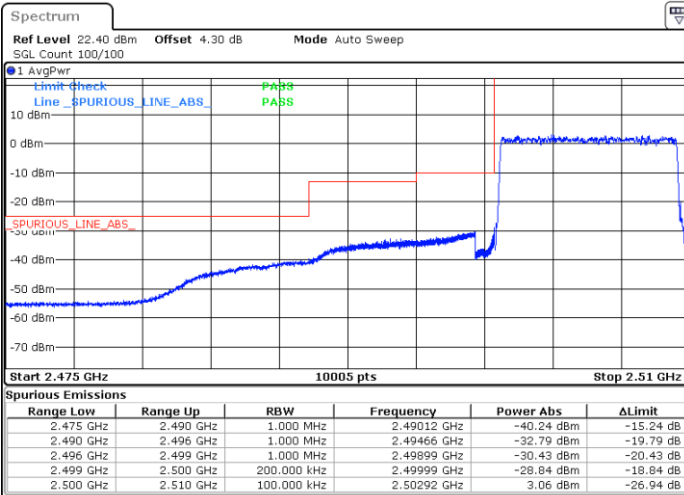

Date: 13.JAN.2021 05:30:38

/



FR1 n7 / 10MHz / DFT-S OFDM QPSK

Highest Band Edge / 1 RB

Channel Power < -10dBm Pass

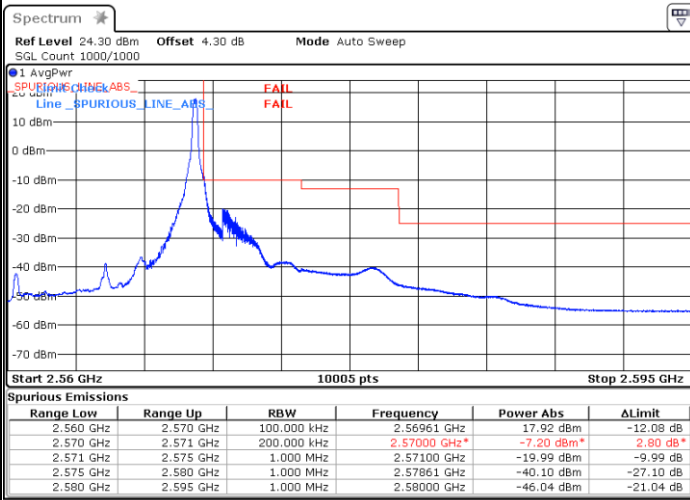

Date: 3.FEB.2021 03:22:47

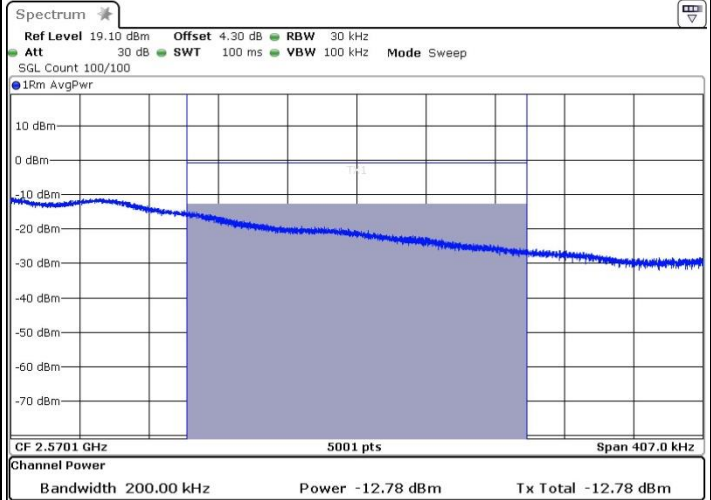

Date: 3.FEB.2021 03:21:54

Highest Band Edge / Full RB

Channel Power < -10dBm Pass

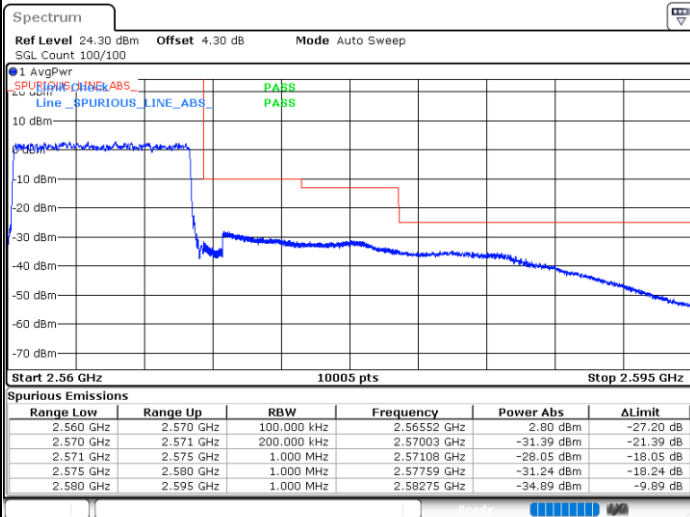

Date: 13.JAN.2021 05:47:23



FR1 n7 / 20MHz / DFT-S OFDM BPSK

Lowest Band Edge / 1 RB

Channel Power < -10dBm Pass

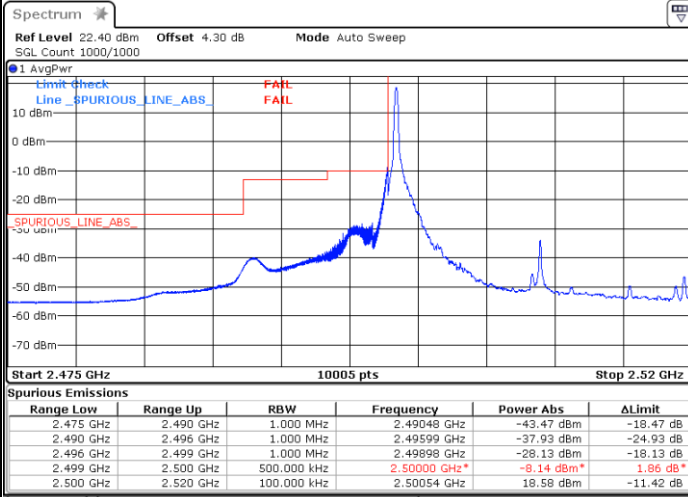

Date: 13.JAN.2021 05:01:09

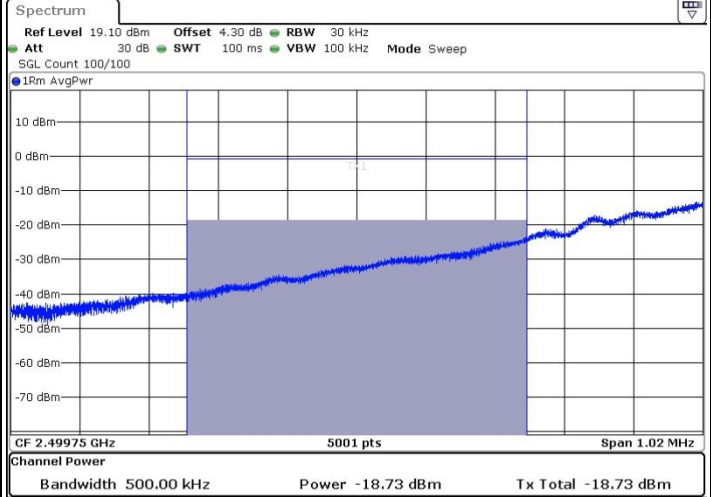

Date: 13.JAN.2021 05:05:00

Lowest Band Edge / Full RB

Channel Power < -10dBm Pass

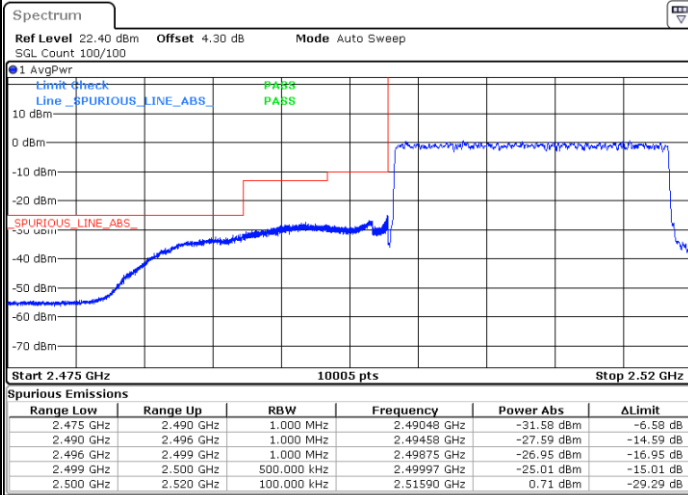

Date: 13.JAN.2021 04:59:46

/



FR1 n7 / 20MHz / DFT-S OFDM BPSK

Highest Band Edge / 1 RB

Channel Power < -10dBm Pass



Date: 13.JAN.2021 05:06:41

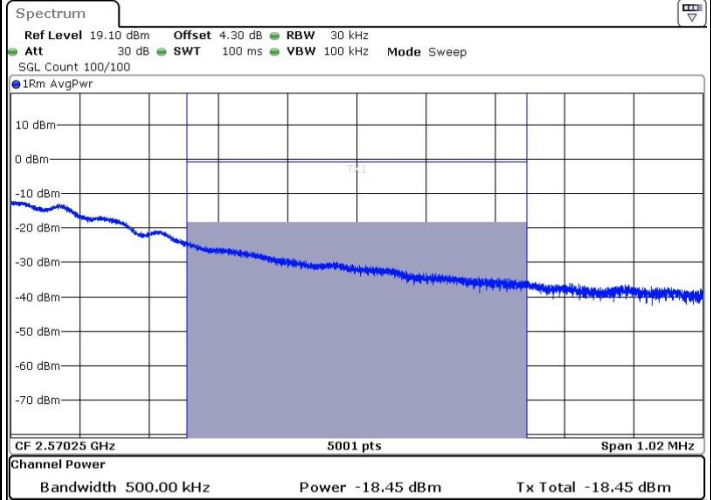

Date: 13.JAN.2021 05:09:53

Highest Band Edge / Full RB

Channel Power < -10dBm Pass

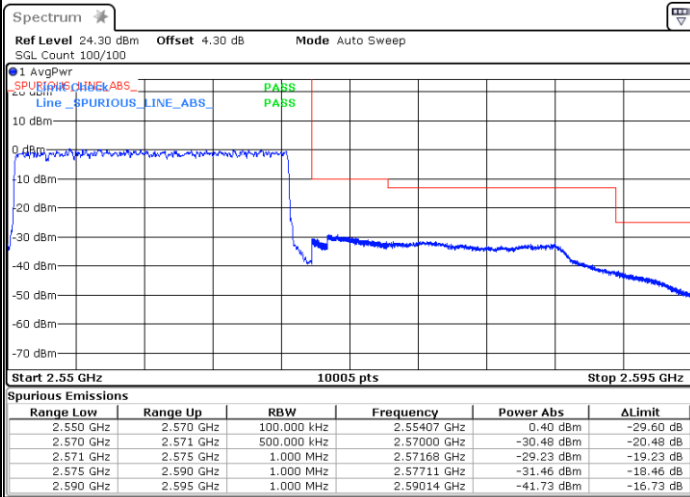

Date: 13.JAN.2021 05:10:24

/



FR1 n7 / 20MHz / DFT-S OFDM QPSK

Lowest Band Edge / 1 RB

Channel Power < -10dBm Pass

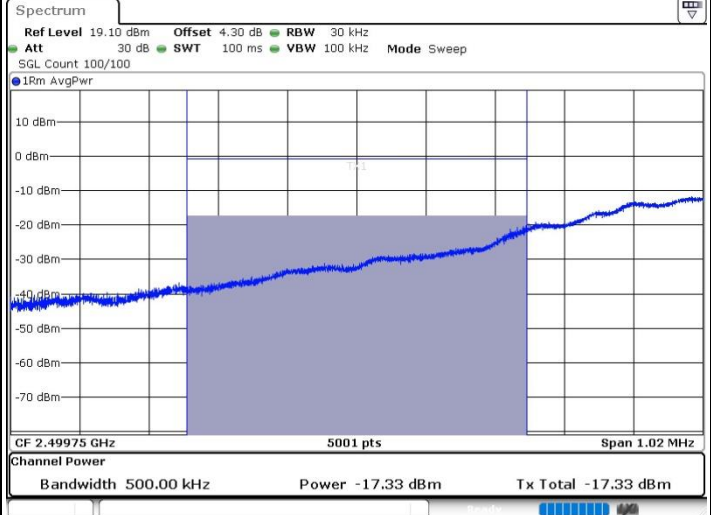
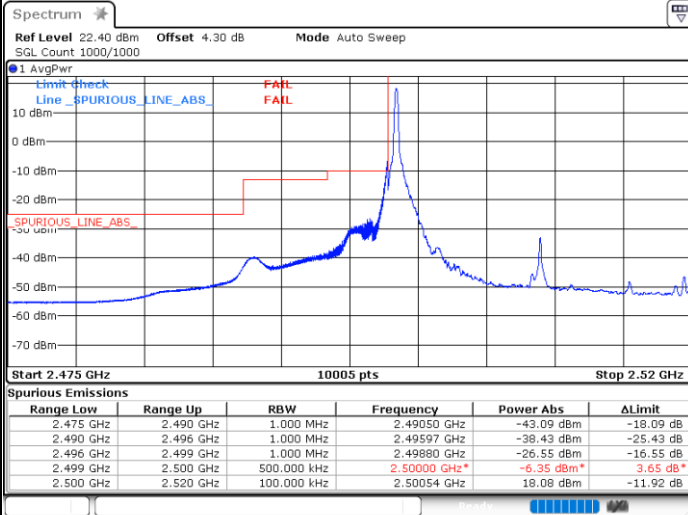

Lowest Band Edge / Full RB

Channel Power < -10dBm Pass

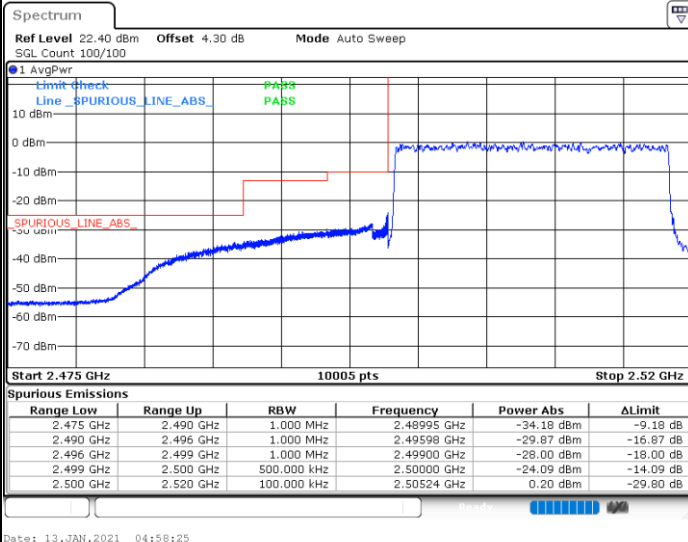

/