

# FCC SAR TEST REPORT

**FCC ID** : B94QCNFA765L434  
**Equipment** : Notebook Computer  
**Brand Name** : HP  
**Model Name** : HSN-I43C-4  
**Applicant** : HP Inc.  
1501 Page Mill Road, CA 94304, Palo Alto, USA  
**Standard** : FCC 47 CFR Part 2 (2.1093)

The product was installed into Notebook Computer (Brand Name HP, Model Name: HSN-I43C-4) during test.

The product was received on Apr. 23, 2021 and testing was started from Apr. 25, 2021 and completed on May 08, 2021. We, SPORTON INTERNATIONAL INC., would like to declare that the tested sample provide by manufacturer and the test data has been evaluated in accordance with the test procedures given in 47 CFR Part 2.1093 and FCC KDB and has been pass the FCC requirement.

The test results in this report apply exclusively to the tested model / sample. Without written approval of SPORTON INTERNATIONAL INC. EMC & Wireless Communications Laboratory, the test report shall not be reproduced except in full.

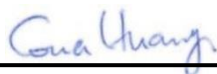

Approved by: Cona Huang / Deputy Manager



**Sporton International Inc. EMC & Wireless Communications Laboratory**  
No.52, Huaya 1st Rd., Guishan Dist., Taoyuan City 333, Taiwan



Table of Contents

1. Statement of Compliance ..... 4
2. Guidance Applied..... 4
3. Equipment Under Test (EUT) Information ..... 5
3.1 General Information ..... 5
4. RF Exposure Limits..... 6
4.1 Uncontrolled Environment..... 6
4.2 Controlled Environment..... 6
4.3 RF Exposure limit for above 6GHz..... 7
5. Specific Absorption Rate (SAR)..... 8
5.1 Introduction ..... 8
5.2 SAR Definition..... 8
6. System Description and Setup ..... 9
6.1 Test Site Location..... 9
6.2 E-Field Probe ..... 10
6.3 Data Acquisition Electronics (DAE) ..... 10
6.4 Phantom..... 11
6.5 Device Holder..... 12
7. Measurement Procedures ..... 13
7.1 Spatial Peak SAR Evaluation..... 13
7.2 Power Reference Measurement..... 14
7.3 Area Scan ..... 14
7.4 Zoom Scan..... 15
7.5 Volume Scan Procedures..... 15
7.6 Power Drift Monitoring..... 15
8. Test Equipment List ..... 16
9. System Verification ..... 17
9.1 Tissue Verification ..... 17
9.2 System Performance Check Results..... 17
9.3 PD System Performance Check Results..... 18
10. WiFi/Bluetooth Output Power (Unit: dBm)..... 19
11. Antenna Location ..... 31
12. RF Exposure Test Results ..... 32
12.1 2.4G/5GHz WLAN/Bluetooth SAR Test Result..... 33
12.2 6GHz WLAN SAR Test Result..... 37
12.3 6GHz PD Test Result ..... 38
12.4 Repeated SAR Measurement ..... 38
13. Simultaneous Transmission Analysis ..... 39
13.1 Body Exposure Conditions ..... 39
14. Uncertainty Assessment ..... 40
15. References ..... 43
Appendix A. Plots of SAR System Performance Check
Appendix B. Plots of PD System Performance Check
Appendix C. Plots of High SAR Measurement
Appendix D. Plots of High PD Measurement
Appendix E. DASY Calibration Certificate
Appendix D. Test Setup Photos



### History of this test report

Report No.	Version	Description	Issued Date
FA0N0903-06	01	Initial issue of report	Jul. 08, 2021
FA0N0903-06	02	Updated section 12.2 and 12.3	Jul. 21, 2021
FA0N0903-06	03	Updated section 12.2 and 12.3	Jul. 26, 2021



1. Statement of Compliance

The maximum results of Specific Absorption Rate (SAR) found during testing for HP Inc., Notebook Computer, HSN-I43C-4, are as follows.

Table with 4 columns: Equipment Class, Frequency Band, Highest SAR Summary (Body 1g SAR (W/kg)), and Highest Simultaneous Transmission 1g SAR (W/kg). Rows include DTS, NII, DSS for WLAN and Bluetooth bands.

Table with 5 columns: Equipment Class, Frequency Band, Reported SAR (Body 1g SAR (W/kg)), APD (Body (W/m^2)), and Reported PD (Body (mW/cm^2)). Row includes NII for 6GHz WLAN band.

Sporton Lab is accredited to ISO 17025 by Taiwan Accreditation Foundation (TAF code: 1190) and the FCC designation No. TW1190 under the FCC 2.948(e) by Mutual Recognition Agreement (MRA) in FCC test. This device is in compliance with Specific Absorption Rate (SAR) for general population/uncontrolled exposure limits (1.6 W/kg for Partial-Body 1g SAR) specified in FCC 47 CFR part 2 (2.1093) and ANSI/IEEE C95.1-1992, and had been tested in accordance with the measurement methods and procedures specified in IEEE 1528-2013 and FCC KDB publications.

Reviewed by: Jason Wang
Report Producer: Paula Chen

2. Guidance Applied

The Specific Absorption Rate (SAR) testing specification, method, and procedure for this device is in accordance with the following standards, the below KDB standard may not including in the TAF code without accreditation.

- FCC 47 CFR Part 2 (2.1093)
ANSI/IEEE C95.1-1992
IEEE 1528-2013
FCC KDB 865664 D01 SAR Measurement 100 MHz to 6 GHz v01r04
FCC KDB 865664 D02 SAR Reporting v01r02
FCC KDB 447498 D01 General RF Exposure Guidance v06
FCC KDB 248227 D01 802.11 Wi-Fi SAR v02r02
FCC KDB 616217 D04 SAR for laptop and tablets v01r02
SPEAG DASY6 System Handbook
SPEAG DASY6 Application Note (Interim Procedure for Device Operation at 6GHz-10GHz)
IEC TE63170:2018
IEC 62479:2010



### 3. Equipment Under Test (EUT) Information

#### 3.1 General Information

Product Feature & Specification	
Equipment Name	Notebook Computer
Brand Name	HP
Model Name	HSN-I43C-4
FCC ID	B94QCNFA765L434
Integrated WLAN Module	Brand Name: Qualcomm Model Name: QCNFA765
Wireless Technology and Frequency Range	WLAN 2.4GHz Band: 2400 MHz ~ 2483.5 MHz WLAN U-NII 1: 5150 MHz ~ 5250 MHz WLAN U-NII 2: 5250 MHz ~ 5350 MHz WLAN U-NII 3: 5470 MHz ~ 5725 MHz WLAN U-NII 4: 5725 MHz ~ 5825 MHz WLAN U-NII 5: 5925 MHz ~ 6425 MHz WLAN U-NII 6: 6425 MHz ~ 6525 MHz WLAN U-NII 7: 6525 MHz ~ 6875 MHz WLAN U-NII 8: 6875 MHz ~ 7125 MHz Bluetooth: 2400 MHz ~ 2483.5 MHz
Mode	WLAN: 802.11a/b/g/n/ac/ax HT20/HT40/VHT20/VHT40/VHT80/VHT160/HE20/HE40/HE80/HE160 Bluetooth BR/EDR/LE
<b>Remark:</b>	
1. This product will be integrated into the WLAN only and WWAN+WLAN sku as below sample list, the RF exposure evaluation is selected Sample 1 as the main testing and Sample 2, 3, 4, 5 and 6 will select worst case found in Sample 1 performs.	
2. The device support DBS (Dual Band Simultaneous) function, when the device 2.4GHz and 5GHz transmit at the same time the module will limit different output power for simultaneous transmission compliance.	

Host Information	
Equipment Name	Notebook Computer
Brand Name	HP
Model Name	HSN-I43C-4
EUT Stage	Production Unit

Sample	SKU	Antenna Vendor
Sample 1	WLAN	AWAN
Sample 2	WLAN	WNC
Sample 3	WLAN	HB
Sample 4	WWAN+WLAN	AWAN
Sample 5	WWAN+WLAN	WNC
Sample 6	WWAN+WLAN	HB

Antenna Information										
1	Ant. Type	PIFA				2	Ant. Type	PIFA		
		Peak Gain (dBi)						Peak Gain (dBi)		
6036B0281001 (AUP6Y-100071) AWAN	2400~2483.5MHz	-1.592	5470~5725MHz	-1.752	6036B0281101 (AUP6Y-100072) AWAN	2400~2483.5MHz	-1.631	5470~5725MHz	-0.755	
	5150~5250MHz	-0.150	5725~5850MHz	-3.090		5150~5250MHz	1.59	5725~5850MHz	-4.02	
	5250~5350MHz	-0.150	5925~7125MHz	-0.876		5250~5350MHz	1.59	5925~7125MHz	-1.585	
6036B0277001 (81EABD15.G06) WNC	2400~2483.5MHz	-1.09	5470~5725MHz	-1.37	6036B0277501 (81EABD15.G05) WNC	2400~2483.5MHz	-1.29	5470~5725MHz	-0.15	
	5150~5250MHz	-0.50	5725~5850MHz	-1.81		5150~5250MHz	-1.64	5725~5850MHz	-1.07	
	5250~5350MHz	-0.50	5925~7125MHz	-2.04		5250~5350MHz	-1.64	5925~7125MHz	-0.75	
6036B0278201 (260-27442) Hong-Bo	2400~2483.5MHz	0.25	5470~5725MHz	-1.21	6036B0278301 (260-27441) Hong-Bo	2400~2483.5MHz	0.63	5470~5725MHz	-1.90	
	5150~5250MHz	-0.89	5725~5850MHz	-1.60		5150~5250MHz	-2.13	5725~5850MHz	-0.99	
	5250~5350MHz	-0.89	5925~7125MHz	-2.19		5250~5350MHz	-2.13	5925~7125MHz	-2.07	



### 4. RF Exposure Limits

#### 4.1 Uncontrolled Environment

Uncontrolled Environments are defined as locations where there is the exposure of individuals who have no knowledge or control of their exposure. The general population/uncontrolled exposure limits are applicable to situations in which the general public may be exposed or in which persons who are exposed as a consequence of their employment may not be made fully aware of the potential for exposure or cannot exercise control over their exposure. Members of the general public would come under this category when exposure is not employment-related; for example, in the case of a wireless transmitter that exposes persons in its vicinity.

#### 4.2 Controlled Environment

Controlled Environments are defined as locations where there is exposure that may be incurred by persons who are aware of the potential for exposure, (i.e. as a result of employment or occupation). In general, occupational/controlled exposure limits are applicable to situations in which persons are exposed as a consequence of their employment, who have been made fully aware of the potential for exposure and can exercise control over their exposure. The exposure category is also applicable when the exposure is of a transient nature due to incidental passage through a location where the exposure levels may be higher than the general population/uncontrolled limits, but the exposed person is fully aware of the potential for exposure and can exercise control over his or her exposure by leaving the area or by some other appropriate means.

Limits for Occupational/Controlled Exposure (W/kg)

Whole-Body	Partial-Body	Hands, Wrists, Feet and Ankles
0.4	8.0	20.0

Limits for General Population/Uncontrolled Exposure (W/kg)

Whole-Body	Partial-Body	Hands, Wrists, Feet and Ankles
0.08	1.6	4.0

1. Whole-Body SAR is averaged over the entire body, partial-body SAR is averaged over any 1gram of tissue defined as a tissue volume in the shape of a cube. SAR for hands, wrists, feet and ankles is averaged over any 10 grams of tissue defined as a tissue volume in the shape of a cube.



**4.3 RF Exposure limit for above 6GHz**

According to ANSI/IEEE C95.1-1992, the criteria listed in Table 1 shall be used to evaluate the environmental impact of human exposure to radio frequency (RF) radiation as specified in §1.1310.

Peak Spatially Averaged Power Density was evaluated over a circular area of 4cm<sup>2</sup> per interim FCC Guidance for near-field power density evaluations per October 2018 TCB Workshop notes

Frequency range (MHz)	Electric field strength (V/m)	Magnetic field strength (A/m)	Power density (mW/cm <sup>2</sup> )	Averaging time (minutes)
<b>(A) Limits for Occupational/Controlled Exposures</b>				
0.3-3.0	614	1.63	*(100)	6
3.0-30	1842/f	4.89/f	*(900/f <sup>2</sup> )	6
30-300	61.4	0.163	1.0	6
300-1500			f/300	6
1500-100,000			5	6
<b>(B) Limits for General Population/Uncontrolled Exposure</b>				
0.3-1.34	614	1.63	*(100)	30
1.34-30	824/f	2.19/f	*(180/f <sup>2</sup> )	30
30-300	27.5	0.073	0.2	30
300-1500			f/1500	30
1500-100,000			1.0	30

## **5. Specific Absorption Rate (SAR)**

### **5.1 Introduction**

SAR is related to the rate at which energy is absorbed per unit mass in an object exposed to a radio field. The SAR distribution in a biological body is complicated and is usually carried out by experimental techniques or numerical modeling. The standard recommends limits for two tiers of groups, occupational/controlled and general population/uncontrolled, based on a person's awareness and ability to exercise control over his or her exposure. In general, occupational/controlled exposure limits are higher than the limits for general population/uncontrolled.

### **5.2 SAR Definition**

The SAR definition is the time derivative (rate) of the incremental energy (dW) absorbed by (dissipated in) an incremental mass (dm) contained in a volume element (dv) of a given density ( $\rho$ ). The equation description is as below:

$$SAR = \frac{d}{dt} \left( \frac{dW}{dm} \right) = \frac{d}{dt} \left( \frac{dW}{\rho dv} \right)$$

SAR is expressed in units of Watts per kilogram (W/kg)

$$SAR = \frac{\sigma |E|^2}{\rho}$$

Where:  $\sigma$  is the conductivity of the tissue,  $\rho$  is the mass density of the tissue and E is the RMS electrical field strength.



## 6. System Description and Setup

The DASY system used for performing compliance tests consists of the following items:

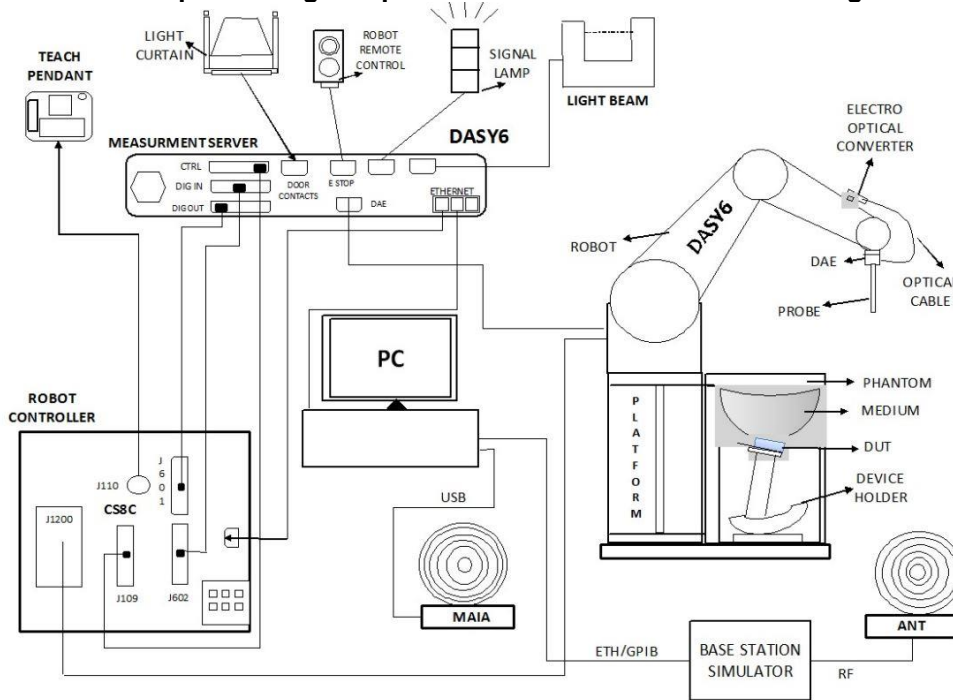

- A standard high precision 6-axis robot with controller, teach pendant and software. An arm extension for accommodating the data acquisition electronics (DAE).
- An isotropic Field probe optimized and calibrated for the targeted measurement.
- A data acquisition electronics (DAE) which performs the signal amplification, signal multiplexing, AD-conversion, offset measurements, mechanical surface detection, collision detection, etc. The unit is battery powered with standard or rechargeable batteries. The signal is optically transmitted to the EOC.
- The Electro-optical converter (EOC) performs the conversion from optical to electrical signals for the digital communication to the DAE. To use optical surface detection, a special version of the EOC is required. The EOC signal is transmitted to the measurement server.
- The function of the measurement server is to perform the time critical tasks such as signal filtering, control of the robot operation and fast movement interrupts.
- The Light Beam used is for probe alignment. This improves the (absolute) accuracy of the probe positioning.
- A computer running Windows 10 and the DASY6 software.
- Remote control and teach pendant as well as additional circuitry for robot safety such as warning lamps, etc.
- The phantom, the device holder and other accessories according to the targeted measurement.

### 6.1 Test Site Location

The SAR measurement facilities used to collect data are within both Sporton Lab list below test site location are accredited to ISO 17025 by Taiwan Accreditation Foundation (TAF code: 1190 and 3786) and the FCC designation No.TW1190 and TW3786 under the FCC 2.948(e) by Mutual Recognition Agreement (MRA) in FCC test.

Test Site	EMC & Wireless Communications Laboratory		Wensan Laboratory		
Test Site Location	TW1190 No.52, Huaya 1st Rd., Guishan Dist., Taoyuan City 333, Taiwan		TW3786 No.58, Aly. 75, Ln. 564, Wenhua 3rd, Rd., Guishan Dist., Taoyuan City 333010, Taiwan		
Test Site No.	SAR01-HY	SAR03-HY	SAR08-HY	SAR09-HY	SAR15-HY
	SAR04-HY	SAR05-HY	SAR11-HY	SAR12-HY	
	SAR06-HY	SAR10-HY	SAR13-HY	SAR14-HY	

**6.2 E-Field Probe**

The SAR measurement is conducted with the dosimetric probe (manufactured by SPEAG).The probe is specially designed and calibrated for use in liquid with high permittivity. The dosimetric probe has special calibration in liquid at different frequency. This probe has a built in optical surface detection system to prevent from collision with phantom.

**<ES3DV3 Probe>**

<b>Construction</b>	Symmetric design with triangular core Interleaved sensors Built-in shielding against static charges PEEK enclosure material (resistant to organic solvents, e.g., DGBE)	
<b>Frequency</b>	10 MHz – 4 GHz; Linearity: $\pm 0.2$ dB (30 MHz – 4 GHz)	
<b>Directivity</b>	$\pm 0.2$ dB in TSL (rotation around probe axis) $\pm 0.3$ dB in TSL (rotation normal to probe axis)	
<b>Dynamic Range</b>	5 $\mu$ W/g – >100 mW/g; Linearity: $\pm 0.2$ dB	
<b>Dimensions</b>	Overall length: 337 mm (tip: 20 mm) Tip diameter: 3.9 mm (body: 12 mm) Distance from probe tip to dipole centers: 3.0 mm	

**<EX3DV4 Probe>**

<b>Construction</b>	Symmetric design with triangular core Built-in shielding against static charges PEEK enclosure material (resistant to organic solvents, e.g., DGBE)	
<b>Frequency</b>	10 MHz – >6 GHz Linearity: $\pm 0.2$ dB (30 MHz – 6 GHz)	
<b>Directivity</b>	$\pm 0.3$ dB in TSL (rotation around probe axis) $\pm 0.5$ dB in TSL (rotation normal to probe axis)	
<b>Dynamic Range</b>	10 $\mu$ W/g – >100 mW/g Linearity: $\pm 0.2$ dB (noise: typically <1 $\mu$ W/g)	
<b>Dimensions</b>	Overall length: 337 mm (tip: 20 mm) Tip diameter: 2.5 mm (body: 12 mm) Typical distance from probe tip to dipole centers: 1 mm	

**6.3 Data Acquisition Electronics (DAE)**

The data acquisition electronics (DAE) consists of a highly sensitive electrometer-grade preamplifier with auto-zeroing, a channel and gain-switching multiplexer, a fast 16 bit AD-converter and a command decoder and control logic unit. Transmission to the measurement server is accomplished through an optical downlink for data and status information as well as an optical uplink for commands and the clock.

The input impedance of the DAE is 200 MOhm; the inputs are symmetrical and floating. Common mode rejection is above 80 dB.



**Fig 5.1 Photo of DAE**

**6.4 Phantom**

**<SAM Twin Phantom>**

<b>Shell Thickness</b>	2 ± 0.2 mm; Center ear point: 6 ± 0.2 mm	
<b>Filling Volume</b>	Approx. 25 liters	
<b>Dimensions</b>	Length: 1000 mm; Width: 500 mm; Height: adjustable feet	
<b>Measurement Areas</b>	Left Hand, Right Hand, Flat Phantom	

The bottom plate contains three pair of bolts for locking the device holder. The device holder positions are adjusted to the standard measurement positions in the three sections. A white cover is provided to tap the phantom during off-periods to prevent water evaporation and changes in the liquid parameters. On the phantom top, three reference markers are provided to identify the phantom position with respect to the robot.

**<ELI Phantom>**

<b>Shell Thickness</b>	2 ± 0.2 mm (sagging: <1%)	
<b>Filling Volume</b>	Approx. 30 liters	
<b>Dimensions</b>	Major ellipse axis: 600 mm Minor axis: 400 mm	

The ELI phantom is intended for compliance testing of handheld and body-mounted wireless devices in the frequency range of 30 MHz to 6 GHz. ELI4 is fully compatible with standard and all known tissue simulating liquids.

## **6.5 Device Holder**

### **<Mounting Device for Hand-Held Transmitter>**

In combination with the Twin SAM V5.0/V5.0c or ELI phantoms, the Mounting Device for Hand-Held Transmitters enables rotation of the mounted transmitter device to specified spherical coordinates. At the heads, the rotation axis is at the ear opening. Transmitter devices can be easily and accurately positioned according to IEC 62209-1, IEEE 1528, FCC, or other specifications. The device holder can be locked for positioning at different phantom sections (left head, right head, flat). And upgrade kit to Mounting Device to enable easy mounting of wider devices like big smart-phones, e-books, small tablets, etc. It holds devices with width up to 140 mm.



Mounting Device for Hand-Held Transmitters



Mounting Device Adaptor for Wide-Phones

### **<Mounting Device for Laptops and other Body-Worn Transmitters>**

The extension is lightweight and made of POM, acrylic glass and foam. It fits easily on the upper part of the mounting device in place of the phone positioned. The extension is fully compatible with the SAM Twin and ELI phantoms.



Mounting Device for Laptops

## **7. Measurement Procedures**

The measurement procedures are as follows:

### <Conducted power measurement>

- (a) For WWAN power measurement, use base station simulator to configure EUT WWAN transmission in conducted connection with RF cable, at maximum power in each supported wireless interface and frequency band.
- (b) Read the WWAN RF power level from the base station simulator.
- (c) For WLAN/BT power measurement, use engineering software to configure EUT WLAN/BT continuously transmission, at maximum RF power in each supported wireless interface and frequency band
- (d) Connect EUT RF port through RF cable to the power meter, and measure WLAN/BT output power

### <SAR measurement>

- (a) Use base station simulator to configure EUT WWAN transmission in radiated connection, and engineering software to configure EUT WLAN/BT continuously transmission, at maximum RF power, in the highest power channel.
- (b) Place the EUT in the positions as Appendix D demonstrates.
- (c) Set scan area, grid size and other setting on the DASY software.
- (d) Measure SAR results for the highest power channel on each testing position.
- (e) Find out the largest SAR result on these testing positions of each band
- (f) Measure SAR results for other channels in worst SAR testing position if the reported SAR of highest power channel is larger than 0.8 W/kg

According to the test standard, the recommended procedure for assessing the peak spatial-average SAR value consists of the following steps:

- (a) Power reference measurement
- (b) Area scan
- (c) Zoom scan
- (d) Power drift measurement

### **7.1 Spatial Peak SAR Evaluation**

The procedure for spatial peak SAR evaluation has been implemented according to the test standard. It can be conducted for 1g and 10g, as well as for user-specific masses. The DASY software includes all numerical procedures necessary to evaluate the spatial peak SAR value.

The base for the evaluation is a "cube" measurement. The measured volume must include the 1g and 10g cubes with the highest averaged SAR values. For that purpose, the center of the measured volume is aligned to the interpolated peak SAR value of a previously performed area scan.

The entire evaluation of the spatial peak values is performed within the post-processing engine (SEMCAD). The system always gives the maximum values for the 1g and 10g cubes. The algorithm to find the cube with highest averaged SAR is divided into the following stages:

- (a) Extraction of the measured data (grid and values) from the Zoom Scan
- (b) Calculation of the SAR value at every measurement point based on all stored data (A/D values and measurement parameters)
- (c) Generation of a high-resolution mesh within the measured volume
- (d) Interpolation of all measured values from the measurement grid to the high-resolution grid
- (e) Extrapolation of the entire 3-D field distribution to the phantom surface over the distance from sensor to surface
- (f) Calculation of the averaged SAR within masses of 1g and 10g



**7.2 Power Reference Measurement**

The Power Reference Measurement and Power Drift Measurements are for monitoring the power drift of the device under test in the batch process. The minimum distance of probe sensors to surface determines the closest measurement point to phantom surface. This distance cannot be smaller than the distance of sensor calibration points to probe tip as defined in the probe properties.

**7.3 Area Scan**

The area scan is used as a fast scan in two dimensions to find the area of high field values, before doing a fine measurement around the hot spot. The sophisticated interpolation routines implemented in DASY software can find the maximum found in the scanned area, within a range of the global maximum. The range (in dB0) is specified in the standards for compliance testing. For example, a 2 dB range is required in IEEE standard 1528 and IEC 62209 standards, whereby 3 dB is a requirement when compliance is assessed in accordance with the ARIB standard (Japan), if only one zoom scan follows the area scan, then only the absolute maximum will be taken as reference. For cases where multiple maximums are detected, the number of zoom scans has to be increased accordingly.

Area scan parameters extracted from FCC KDB 865664 D01v01r04 SAR measurement 100 MHz to 6 GHz.

	≤ 3 GHz	> 3 GHz
Maximum distance from closest measurement point (geometric center of probe sensors) to phantom surface	5 ± 1 mm	$\frac{1}{2} \cdot \delta \cdot \ln(2) \pm 0.5$ mm
Maximum probe angle from probe axis to phantom surface normal at the measurement location	30° ± 1°	20° ± 1°
Maximum area scan spatial resolution: $\Delta x_{Area}$ , $\Delta y_{Area}$	≤ 2 GHz: ≤ 15 mm 2 – 3 GHz: ≤ 12 mm	3 – 4 GHz: ≤ 12 mm 4 – 6 GHz: ≤ 10 mm
	When the x or y dimension of the test device, in the measurement plane orientation, is smaller than the above, the measurement resolution must be ≤ the corresponding x or y dimension of the test device with at least one measurement point on the test device.	

**7.4 Zoom Scan**

Zoom scans are used assess the peak spatial SAR values within a cubic averaging volume containing 1 gram and 10 gram of simulated tissue. The zoom scan measures points (refer to table below) within a cube shoes base faces are centered on the maxima found in a preceding area scan job within the same procedure. When the measurement is done, the zoom scan evaluates the averaged SAR for 1 gram and 10 gram and displays these values next to the job's label.

Zoom scan parameters extracted from FCC KDB 865664 D01v01r04 SAR measurement 100 MHz to 6 GHz.

		≤ 3 GHz	> 3 GHz	
Maximum zoom scan spatial resolution: $\Delta x_{Zoom}, \Delta y_{Zoom}$		$\leq 2$ GHz: $\leq 8$ mm 2 – 3 GHz: $\leq 5$ mm*	3 – 4 GHz: $\leq 5$ mm* 4 – 6 GHz: $\leq 4$ mm*	
Maximum zoom scan spatial resolution, normal to phantom surface	uniform grid: $\Delta z_{Zoom}(n)$	$\leq 5$ mm	3 – 4 GHz: $\leq 4$ mm 4 – 5 GHz: $\leq 3$ mm 5 – 6 GHz: $\leq 2$ mm	
	graded grid	$\Delta z_{Zoom}(1)$ : between 1 <sup>st</sup> two points closest to phantom surface	$\leq 4$ mm	3 – 4 GHz: $\leq 3$ mm 4 – 5 GHz: $\leq 2.5$ mm 5 – 6 GHz: $\leq 2$ mm
		$\Delta z_{Zoom}(n>1)$ : between subsequent points	$\leq 1.5 \cdot \Delta z_{Zoom}(n-1)$	
Minimum zoom scan volume	x, y, z	$\geq 30$ mm	3 – 4 GHz: $\geq 28$ mm 4 – 5 GHz: $\geq 25$ mm 5 – 6 GHz: $\geq 22$ mm	
Note: $\delta$ is the penetration depth of a plane-wave at normal incidence to the tissue medium; see draft standard IEEE P1528-2011 for details. * When zoom scan is required and the <i>reported</i> SAR from the <i>area scan based 1-g SAR estimation</i> procedures of KDB 447498 is $\leq 1.4$ W/kg, $\leq 8$ mm, $\leq 7$ mm and $\leq 5$ mm zoom scan resolution may be applied, respectively, for 2 GHz to 3 GHz, 3 GHz to 4 GHz and 4 GHz to 6 GHz.				

**7.5 Volume Scan Procedures**

The volume scan is used for assess overlapping SAR distributions for antennas transmitting in different frequency bands. It is equivalent to an oversized zoom scan used in standalone measurements. The measurement volume will be used to enclose all the simultaneous transmitting antennas. For antennas transmitting simultaneously in different frequency bands, the volume scan is measured separately in each frequency band. In order to sum correctly to compute the 1g aggregate SAR, the EUT remain in the same test position for all measurements and all volume scan use the same spatial resolution and grid spacing. When all volume scan were completed, the software, SEMCAD postprocessor can combine and subsequently superpose these measurement data to calculating the multiband SAR.

**7.6 Power Drift Monitoring**

All SAR testing is under the EUT install full charged battery and transmit maximum output power. In DASy measurement software, the power reference measurement and power drift measurement procedures are used for monitoring the power drift of EUT during SAR test. Both these procedures measure the field at a specified reference position before and after the SAR testing. The software will calculate the field difference in dB. If the power drifts more than 5%, the SAR will be retested.



### 8. Test Equipment List

Manufacturer	Name of Equipment	Type/Model	Serial Number	Calibration	
				Last Cal.	Due Date
SPEAG	2450MHz System Validation Kit <sup>(2)</sup>	D2450V2	736	Aug. 31, 2018	Aug. 28, 2021
SPEAG	5GHz System Validation Kit <sup>(2)</sup>	D5GHZV2	1006	Sep. 27, 2018	Sep. 24, 2021
SPEAG	6500MHz System Validation Kit <sup>(2)</sup>	D6500V2	1003	Feb. 04, 2020	Feb. 02, 2022
SPEAG	5G Verification Source	10 GHz	1020	Jan. 18, 2021	Jan. 17, 2022
SPEAG	Data Acquisition Electronics	DAE4	656	Jan. 22, 2021	Jan. 21, 2022
SPEAG	Dosimetric E-Field Probe	EX3DV4	7439	Feb. 23, 2021	Feb. 22, 2022
SPEAG	EUmmWV Probe Tip Protection	EUmmWV4	9441	Nov. 24, 2020	Nov. 23, 2021
RCPTWN	Thermometer	HTC-1	TM560-2	Nov. 10, 2020	Nov. 09, 2021
Testo	Hygro meter	608-H1	45196600	Nov. 10, 2020	Nov. 09, 2021
R&S	BT Base Station	CBT32	100519	Jun. 04, 2020	Jun. 03, 2021
SPEAG	Device Holder	N/A	N/A	N/A	N/A
Anritsu	Signal Generator	MG3710A	6201502524	Nov. 11, 2020	Nov. 10, 2021
Keysight	ENA Network Analyzer	E5071C	MY46101588	Jun. 10, 2020	Jun. 09, 2021
SPEAG	Dielectric Probe Kit	DAK-3.5	1126	Sep. 16, 2020	Sep. 15, 2021
LINE SEIKI	Digital Thermometer	DTM3000-spezial	2942	Nov. 06, 2020	Nov. 05, 2021
Anritsu	Power Meter	ML2495A	1419002	Aug. 19, 2020	Aug. 18, 2021
Anritsu	Power Sensor	MA2411B	1911176	Aug. 18, 2020	Aug. 17, 2021
Anritsu	Power Meter	ML2495A	1804003	Oct. 21, 2020	Oct. 20, 2021
Anritsu	Power Sensor	MA2411B	1726150	Oct. 21, 2020	Oct. 20, 2021
Anritsu	Spectrum Analyzer	MS2830A	6201396378	Jun. 30, 2020	Jun. 29, 2021
Anritsu	Spectrum Analyzer	N9010A	MY53470118	Jan. 15, 2021	Jan. 14, 2022
Mini-Circuits	Power Amplifier	ZVE-8G+	6418	Oct. 21, 2020	Oct. 20, 2021
Mini-Circuits	Power Amplifier	ZVE-8G+	479102029	Aug. 26, 2020	Aug. 25, 2021
Custom Microwave	Standard Horn antenna	M15RH	V91113-A	NCR	NCR
ATM	Dual Directional Coupler	C122H-10	P610410z-02	Note 1	
Woken	Attenuator 1	WK0602-XX	N/A	Note 1	
PE	Attenuator 2	PE7005-10	N/A	Note 1	
PE	Attenuator 3	PE7005- 3	N/A	Note 1	

**General Note:**

1. Prior to system verification and validation, the path loss from the signal generator to the system check source and the power meter, which includes the amplifier, cable, attenuator and directional coupler, was measured by the network analyzer. The reading of the power meter was offset by the path loss difference between the path to the power meter and the path to the system check source to monitor the actual power level fed to the system check source.
2. The dipole calibration interval can be extended to 3 years with justification according to KDB 865664 D01. The dipoles are also not physically damaged, or repaired during the interval. The justification data in appendix C can be found which the return loss is < -20dB, within 20% of prior calibration, the impedance is within 5 ohm of prior calibration for each dipole.



## 9. System Verification

### 9.1 Tissue Verification

The tissue dielectric parameters of tissue-equivalent media used for SAR measurements must be characterized within a temperature range of 18°C to 25°C, measured with calibrated instruments and apparatuses, such as network analyzers and temperature probes. The temperature of the tissue-equivalent medium during SAR measurement must also be within 18°C to 25°C and within ± 2°C of the temperature when the tissue parameters are characterized. The tissue dielectric measurement system must be calibrated before use. The dielectric parameters must be measured before the tissue-equivalent medium is used in a series of SAR measurements.

The liquid tissue depth was at least 15cm in the phantom for all SAR testing

#### <Tissue Dielectric Parameter Check Results>

Frequency (MHz)	Liquid Temp. (°C)	Conductivity (σ)	Permittivity (ε <sub>r</sub> )	Conductivity Target (σ)	Permittivity Target (ε <sub>r</sub> )	Delta (σ) (%)	Delta (ε <sub>r</sub> ) (%)	Limit (%)	Date
2450	22.2	1.791	40.493	1.80	39.20	-0.50	3.30	±5	2021/5/5
2450	22.5	1.785	39.917	1.80	39.20	-0.83	1.83	±5	2021/5/7
5250	22.2	4.516	37.141	4.71	35.95	-4.12	3.31	±5	2021/5/5
5600	22.3	5.067	36.805	5.07	35.50	-0.06	3.68	±5	2021/5/6
5750	22.3	5.222	36.347	5.22	35.35	0.04	2.82	±5	2021/5/6
6500	22.5	6.070	35.300	6.07	34.50	0.00	2.32	±5	2021/5/8

### 9.2 System Performance Check Results

Comparing to the original SAR value provided by SPEAG, the verification data should be within its specification of 10 %. Below table shows the target SAR and measured SAR after normalized to 1W input power. The table below indicates the system performance check can meet the variation criterion and the plots can be referred to Appendix A of this report.

Test Site	Date	Frequency (MHz)	Input Power (mW)	Dipole S/N	Probe S/N	DAE S/N	Measured 1g SAR (W/kg)	Targeted 1g SAR (W/kg)	Normalized 1g SAR (W/kg)	Deviation (%)
SAR05	2021/5/5	2450	50	D2450V2-736	EX3DV4 - SN7439	DAE4 Sn656	2.56	52.70	51.2	-2.85
SAR05	2021/5/7	2450	50	D2450V2-736	EX3DV4 - SN7439	DAE4 Sn656	2.62	52.70	52.4	-0.57
SAR05	2021/5/5	5250	50	D5GHzV2-1006-5250	EX3DV4 - SN7439	DAE4 Sn656	3.89	80.70	77.8	-3.59
SAR05	2021/5/6	5600	50	D5GHzV2-1006-5600	EX3DV4 - SN7439	DAE4 Sn656	4.49	83.30	89.8	7.80
SAR05	2021/5/6	5750	50	D5GHzV2-1006-5750	EX3DV4 - SN7439	DAE4 Sn656	3.93	80.40	78.6	-2.24
SAR06	2021/5/8	6500	100	D6500HzV2-1003	EX3DV4 - SN7439	DAE4 Sn656	29.60	299.00	296	-1.00

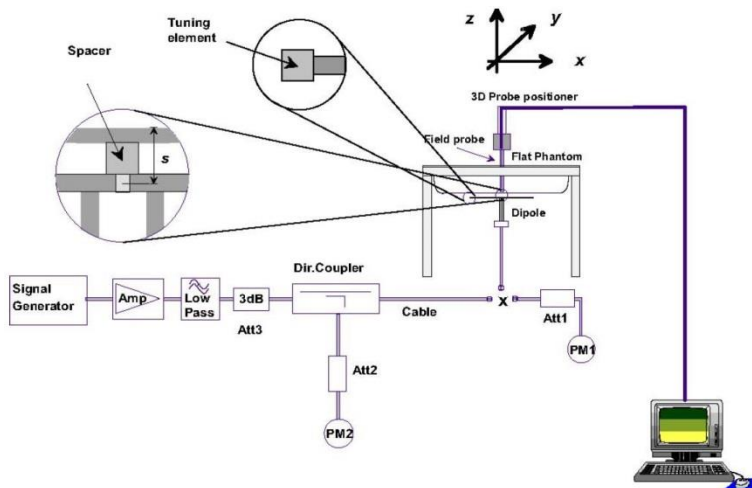

Fig 8.3.1 System Performance Check Setup

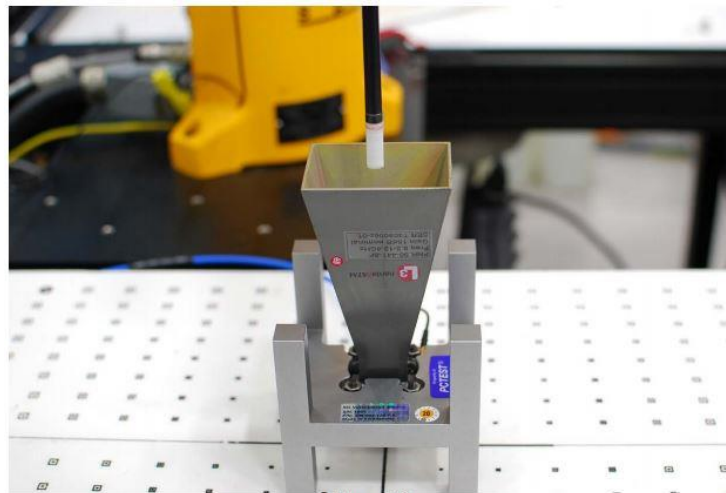

Fig 8.3.2 Setup Photo

**9.3 PD System Performance Check Results**

The system was verified to be within  $\pm 0.66$  dB of the power density targets on the calibration certificate according to the test system specification in the user’s manual and calibration facility recommendation. The 0.66 dB deviation threshold represents the expanded uncertainty for system performance checks using SPEAG’s mmWave verification sources. The same spatial resolution and measurement region used in the source calibration was applied during the system check. The measured power density distribution of verification source was also confirmed through visual inspection to have no noticeable differences, both spatially (shape) and numerically (level) from the distribution provided by the manufacturer, per November 2017 TCBC Workshop Notes

Frequency (GHz)	5G Verification Source	Probe S/N	DAE S/N	Distance (mm)	Measured 4 cm <sup>2</sup> (W/m <sup>2</sup> )	Targeted 4 cm <sup>2</sup> (W/m <sup>2</sup> )	Deviation (dB)	Date
10	10GHz_1012	9441	656	10	39.6	41.5	-0.20	2021/4/25



**Figure 4-3**  
System Verification Setup Photo

**System Performance Check Setup**



## 10. WiFi/Bluetooth Output Power (Unit: dBm)

### General Note:

1. All of the wireless technology of this device only supports MIMO mode operation.
2. The maximum output power specified for production units are determined for all applicable 802.11 transmission modes in each standalone and aggregated frequency band. Maximum output power is measured for the highest maximum output power configuration(s) in each frequency band according to the default power measurement procedures. For "Not required", SAR Test reduction was applied from KDB 248227 guidance, Sec. 2.1, b), 1) when the same maximum power is specified for multiple transmission modes in a frequency band, the largest channel bandwidth, lowest order modulation, lowest data rate and lowest order 802.11a/g/n/ac mode is used for SAR measurement, on the highest measured output power channel in the initial test configuration, for each frequency band or when MIMO mode was not performed, due to for each antenna, transmit power in SISO operation is larger than (or equal to) the power in MIMO operation, RF exposure compliance of MIMO mode can be deduced from the compliance simultaneous transmission of antennas operating in SISO mode. Additional output power measurements were not necessary.
3. Per KDB 248227 D01v02r02, SAR test reduction is determined according to 802.11 transmission mode configurations and certain exposure conditions with multiple test positions. In the 2.4 GHz band, separate SAR procedures are applied to DSSS and OFDM configurations to simplify DSSS test requirements. For OFDM, in both 2.4 and 5 GHz bands, an initial test configuration must be determined for each standalone and aggregated frequency band, according to the transmission mode configuration with the highest maximum output power specified for production units to perform SAR measurements. If the same highest maximum output power applies to different combinations of channel bandwidths, modulations and data rates, additional procedures are applied to determine which test configurations require SAR measurement. When applicable, an initial test position may be applied to reduce the number of SAR measurements required for next to the ear, UMPC mini-tablet or hotspot mode configurations with multiple test positions.
4. For 2.4 GHz 802.11b DSSS, either the initial test position procedure for multiple exposure test positions or the DSSS procedure for fixed exposure position is applied; these are mutually exclusive. For 2.4 GHz and 5 GHz OFDM configurations, the initial test configuration is applied to measure SAR using either the initial test position procedure for multiple exposure test position configurations or the initial test configuration procedures for fixed exposure test conditions. Based on the reported SAR of the measured configurations and maximum output power of the transmission mode configurations that are not included in the initial test configuration, the subsequent test configuration and initial test position procedures are applied to determine if SAR measurements are required for the remaining OFDM transmission configurations. In general, the number of test channels that require SAR measurement is minimized based on maximum output power measured for the test sample(s).
5. For OFDM transmission configurations in the 2.4 GHz and 5 GHz bands, When the same maximum power is specified for multiple transmission modes in a frequency band, the largest channel bandwidth, lowest order modulation, lowest data rate and lowest order 802.11a/g/n/ac mode is used for SAR measurement, on the highest measured output power channel for each frequency band.
6. DSSS and OFDM configurations are considered separately according to the required SAR procedures. SAR is measured in the initial test position using the 802.11 transmission mode configuration required by the DSSS procedure or initial test configuration and subsequent test configuration(s) according to the OFDM procedures.18 The initial test position procedure is described in the following:
  - a. When the reported SAR of the initial test position is  $\leq 0.4$  W/kg, further SAR measurement is not required for the other test positions in that exposure configuration and 802.11 transmission mode combinations within the frequency band or aggregated band.
  - b. When the reported SAR of the test position is  $> 0.4$  W/kg, SAR is repeated for the 802.11 transmission mode configuration tested in the initial test position to measure the subsequent next closest/smallest test separation distance and maximum coupling test position on the highest maximum output power channel, until the report SAR is  $\leq 0.8$  W/kg or all required test position are tested.
  - c. For all positions/configurations, when the reported SAR is  $> 0.8$  W/kg, SAR is measured for these test positions/configurations on the subsequent next highest measured output power channel(s) until the reported SAR is  $\leq 1.2$  W/kg or all required channels are tested.
7. Per 201904 TCBC workshops, General principles of FCC KDB Publication 248227 D01 can be applied to determine the SAR Initial Test Configurations and test reduction for 802.11ax SAR testing. For the table below the 802.11ax maximum power is SU (non-OFDMA), and the SU maximum power also higher than RU (OFDMA)
8. In applying the test guidance, the IEEE 802.11 mode with the maximum output power (out of all modes) should be considered for testing
9. For modes with the same maximum output power, the guidance from section 5.3.2 a) of FCC KDB Publication 248227 D01 should be applied, with 802.11ax being considered as the highest 802.11 mode for the appropriate frequency bands
10. When SAR testing for 802.11ax is required
  - a. If the maximum output power is highest for OFDMA scenarios, choose the tone size with the maximum number of tones and the highest maximum output power
  - b. Otherwise, consider the fully allocated channel for SAR testing
  - c. When SAR testing is required on RU sizes less than the fully allocated channel, use the RU number closest to the middle of the channel, choosing the higher RU number when two RUs are equidistant to the middle of the channel



<Non-DBS>

2.4GHz WLAN				Ant 1+2 (1)		Ant 1+2 (2)		Ant 1+2		
Mode	Channel	Frequency (MHz)	Average power (dBm)	Tune-Up Limit	Average power (dBm)	Tune-Up Limit	Average power (dBm)	Tune-Up Limit	Duty Cycle %	
802.11b 1Mbps	1	2412	18.30	18.50	17.70	18.50	21.02	21.50	98.20	
	6	2437	17.90	18.50	17.60	18.50	20.76	21.50		
	11	2462	18.40	18.50	18.00	18.50	21.21	21.50		
	12	2467	18.30	18.50	17.80	18.50	21.07	21.50		
	13	2472	15.80	16.00	14.80	16.00	18.34	19.00		
802.11g 6Mbps	1	2412	Not Required	18.00	Not Required	18.00	Not Required	21.00	Not Required	
	6	2437		18.50		18.50				
	11	2462		18.00		18.00				
	12	2467		16.00		16.00				
	13	2472		4.00		4.00				
802.11n-HT20 MCS0	1	2412	Not Required	17.50	Not Required	17.50	Not Required	20.50	Not Required	
	6	2437		18.50		18.50				
	11	2462		16.00		16.00				
	12	2467		15.00		15.00				
	13	2472		3.50		3.50				
802.11n-HT40 MCS0	3	2422	Not Required	15.50	Not Required	15.50	Not Required	18.50	Not Required	
	6	2437		16.00		16.00				
	9	2452		15.00		15.00				
	10	2457		14.00		14.00				
	11	2462		5.50		5.50				
802.11ac-VHT20 MCS0	1	2412	Not Required	17.50	Not Required	17.50	Not Required	20.50	Not Required	
	6	2437		18.50		18.50				
	11	2462		16.00		16.00				
	12	2467		15.00		15.00				
	13	2472		3.50		3.50				
802.11ac-VHT40 MCS0	3	2422	Not Required	15.50	Not Required	15.50	Not Required	18.50	Not Required	
	6	2437		16.00		16.00				
	9	2452		15.00		15.00				
	10	2457		14.00		14.00				
	11	2462		5.50		5.50				
802.11ax-HE20 MCS0	1	2412	Not Required	17.50	Not Required	17.50	Not Required	20.50	Not Required	
	6	2437		18.50		18.50				
	11	2462		16.00		16.00				
	12	2467		15.00		15.00				
	13	2472		3.50		3.50				
802.11ax-HE40 MCS0	3	2422	Not Required	15.50	Not Required	15.50	Not Required	18.50	Not Required	
	6	2437		16.00		16.00				
	9	2452		15.00		15.00				
	10	2457		14.00		14.00				
	11	2462		5.50		5.50				



**FCC SAR TEST REPORT**

**Report No. : FA0N0903-06**

5.2GHz WLAN				Ant 1+2 (1)		Ant 1+2 (2)		Ant 1+2			
5.2GHz WLAN	Mode	Channel	Frequency (MHz)	Average power (dBm)	Tune-Up Limit	Average power (dBm)	Tune-Up Limit	Average power (dBm)	Tune-Up Limit	Duty Cycle %	
	802.11a 6Mbps	36	5180	Not Required	Not Required	Not Required	Not Required	Not Required	Not Required	17.50	Not Required
		40	5200							17.50	
		44	5220							17.50	
		48	5240							17.50	
	802.11n-HT20 MCS0	36	5180							17.50	
		40	5200							17.50	
		44	5220							17.50	
		48	5240							17.50	
	802.11n-HT40 MCS0	38	5190							18.00	
		46	5230							18.00	
	802.11ac-VHT20 MCS0	36	5180							17.50	
		40	5200							17.50	
		44	5220							17.50	
	802.11ac-VHT40 MCS0	38	5190							18.00	
		46	5230							18.00	
	802.11ac-VHT80 MCS0	42	5210							16.00	
802.11ax-HE20 MCS0	36	5180	17.50								
	40	5200	17.50								
	44	5220	17.50								
	48	5240	17.50								
802.11ax-HE40 MCS0	38	5190	18.00								
	46	5230	18.00								
802.11ax-HE80 MCS0	42	5210	16.00								



5.3GHz WLAN				Ant 1+2 (1)		Ant 1+2 (2)		Ant 1+2		
	Mode	Channel	Frequency (MHz)	Average power (dBm)	Tune-Up Limit	Average power (dBm)	Tune-Up Limit	Average power (dBm)	Tune-Up Limit	Duty Cycle %
5.3GHz WLAN	802.11a 6Mbps	52	5260	Not Required	15.00	Not Required	15.00	Not Required	18.00	Not Required
		56	5280		15.00		15.00		18.00	
		60	5300		15.00		15.00		18.00	
		64	5320		15.00		15.00		18.00	
	802.11n-HT20 MCS0	52	5260	Not Required	15.00	Not Required	15.00	Not Required	18.00	Not Required
		56	5280		15.00		15.00		18.00	
		60	5300		15.00		15.00		18.00	
		64	5320		15.00		15.00		18.00	
	802.11n-HT40 MCS0	54	5270	14.30	15.00	14.80	15.00	17.57	18.00	99.70
		62	5310	14.60	15.00	14.60	15.00	17.61	18.00	
	802.11ac-VHT20 MCS0	52	5260	Not Required	15.00	Not Required	15.00	Not Required	18.00	Not Required
		56	5280		15.00		15.00		18.00	
		60	5300		15.00		15.00		18.00	
		64	5320		15.00		15.00		18.00	
	802.11ac-VHT40 MCS0	54	5270	Not Required	15.00	Not Required	15.00	Not Required	18.00	Not Required
		62	5310		15.00		15.00		18.00	
	802.11ac-VHT80 MCS0	58	5290	Not Required	14.00	Not Required	14.00	Not Required	17.00	Not Required
	802.11ac-VHT160 MCS0	50	5250	Not Required	11.50	Not Required	11.50	Not Required	14.50	Not Required
	802.11ax-HE20 MCS0	52	5260	Not Required	15.00	Not Required	15.00	Not Required	18.00	Not Required
		56	5280		15.00		15.00		18.00	
		60	5300		15.00		15.00		18.00	
		64	5320		15.00		15.00		18.00	
	802.11ax-HE40 MCS0	54	5270	Not Required	15.00	Not Required	15.00	Not Required	18.00	Not Required
		62	5310		15.00		15.00		18.00	
802.11ax-HE80 MCS0	58	5290	Not Required	14.00	Not Required	14.00	Not Required	17.00	Not Required	
802.11ax-HE160 MCS0	50	5250	Not Required	11.50	Not Required	11.50	Not Required	14.50	Not Required	



5.5GHz WLAN				Ant 1+2 (1)		Ant 1+2 (2)		Ant 1+2		
Mode	Channel	Frequency (MHz)	Average power (dBm)	Tune-Up Limit	Average power (dBm)	Tune-Up Limit	Average power (dBm)	Tune-Up Limit	Duty Cycle %	
802.11a 6Mbps	100	5500	Not Required	15.50	Not Required	15.50	Not Required	18.50	Not Required	
	116	5580		15.50		15.50				
	124	5620		15.50		15.50				
	132	5660		15.50		15.50				
	144	5720		15.50		15.50				
802.11n-HT20 MCS0	100	5500	Not Required	15.50	Not Required	15.50	Not Required	18.50	Not Required	
	116	5580		15.50		15.50				
	124	5620		15.50		15.50				
	132	5660		15.50		15.50				
	144	5720		15.50		15.50				
802.11n-HT40 MCS0	102	5510	13.60	15.50	15.10	15.50	17.42	99.70		
	110	5550	13.50	15.50	15.20	15.50	17.44			
	126	5630	14.20	15.50	15.50	15.50	18.00			
	134	5670	13.50	15.50	14.00	15.50	16.77			
	142	5710	13.50	15.50	13.80	15.50	16.66			
802.11ac-VHT20 MCS0	100	5500	Not Required	15.50	Not Required	15.50	Not Required	18.50	Not Required	
	116	5580		15.50		15.50				
	124	5620		15.50		15.50				
	132	5660		15.50		15.50				
	144	5720		15.50		15.50				
802.11ac-VHT40 MCS0	102	5510	Not Required	15.50	Not Required	15.50	Not Required	18.50	Not Required	
	110	5550		15.50		15.50				
	126	5630		15.50		15.50				
	134	5670		15.50		15.50				
	142	5710		15.50		15.50				
802.11ac-VHT80 MCS0	106	5530	13.30	15.00	14.90	15.00	17.18	99.60		
	122	5610	13.70	15.00	14.80	15.00	17.30			
	138	5690	13.90	15.50	15.40	15.50	17.72			
802.11ac-VHT160 MCS0	114	5570	Not Required	12.50	Not Required	12.50	Not Required	15.50	Not Required	
802.11ax-HE20 MCS0	100	5500		15.50		15.50				
	116	5580		15.50		15.50				
	124	5620		15.50		15.50				
	132	5660		15.50		15.50				
	144	5720		15.50		15.50				
802.11ax-HE40 MCS0	102	5510		15.50		15.50				
	110	5550		15.50		15.50				
	126	5630		15.50		15.50				
	134	5670		15.50		15.50				
802.11ax-HE80 MCS0	106	5530		15.00		15.00				
	122	5610		15.00		15.00				
	138	5690		15.50		15.50				
802.11ax-HE160 MCS0	114	5570		12.50		12.50				



5.8GHz WLAN				Ant 1+2 (1)		Ant 1+2 (2)		Ant 1+2						
5.8GHz WLAN	Mode	Channel	Frequency (MHz)	Average power (dBm)	Tune-Up Limit	Average power (dBm)	Tune-Up Limit	Average power (dBm)	Tune-Up Limit	Duty Cycle %				
	802.11a 6Mbps	149	5745	Not Required	16.00	16.00	Not Required	16.00	Not Required	19.00	Not Required			
		157	5785									16.00	16.00	19.00
		165	5825									16.00	16.00	19.00
	802.11n-HT20 MCS0	149	5745	Not Required	16.00	16.00	Not Required	16.00	Not Required	19.00	Not Required			
		157	5785									16.00	16.00	19.00
		165	5825									16.00	16.00	19.00
	802.11n-HT40 MCS0	151	5755	14.00	16.00	15.10	16.00	17.60	19.00	99.70				
		159	5795	14.70	16.00	16.00	16.00	18.41	19.00					
	802.11ac-VHT20 MCS0	149	5745	Not Required	16.00	Not Required	16.00	Not Required	Not Required	19.00	Not Required			
157		5785	16.00									16.00	19.00	
165		5825	16.00									16.00	19.00	
802.11ac-VHT40 MCS0	151	5755	Not Required	16.00	Not Required	16.00	Not Required	Not Required	19.00	Not Required				
	159	5795									16.00	16.00	19.00	
802.11ac-VHT80 MCS0	155	5775	14.70	16.00	16.00	16.00	18.41	19.00	99.60					
802.11ax-HE20 MCS0	149	5745	Not Required	16.00	Not Required	16.00	Not Required	Not Required	19.00	Not Required				
	157	5785									16.00	16.00	19.00	
	165	5825									16.00	16.00	19.00	
802.11ax-HE40 MCS0	151	5755	Not Required	16.00	Not Required	16.00	Not Required	Not Required	19.00	Not Required				
	159	5795									16.00	16.00	19.00	
802.11ax-HE80 MCS0	155	5775	Not Required	16.00	Not Required	16.00	Not Required	Not Required	19.00	Not Required				





<DBS>

2.4GHz WLAN				Ant 1+2 (1)		Ant 1+2 (2)		Ant 1+2		
Mode	Channel	Frequency (MHz)	Average power (dBm)	Tune-Up Limit	Average power (dBm)	Tune-Up Limit	Average power (dBm)	Tune-Up Limit	Duty Cycle %	
802.11b 1Mbps	1	2412	14.90	15.00	14.40	15.00	17.67	18.00	98.20	
	6	2437	13.60	15.00	13.90	15.00	16.76	18.00		
	11	2462	14.90	15.00	14.60	15.00	17.76	18.00		
	12	2467	14.60	15.00	14.50	15.00	17.56	18.00		
	13	2472	14.60	15.00	14.50	15.00	17.56	18.00		
802.11g 6Mbps	1	2412	Not Required	15.00	Not Required	15.00	Not Required	18.00	Not Required	
	6	2437		15.00		15.00		18.00		
	11	2462		15.00		15.00		18.00		
	12	2467		15.00		15.00		18.00		
	13	2472		4.00		4.00		7.00		
802.11n-HT20 MCS0	1	2412	Not Required	15.00	Not Required	15.00	Not Required	18.00	Not Required	
	6	2437		15.00		15.00		18.00		
	11	2462		15.00		15.00		18.00		
	12	2467		15.00		15.00		18.00		
	13	2472		3.50		3.50		6.50		
802.11n-HT40 MCS0	3	2422	Not Required	15.00	Not Required	15.00	Not Required	18.00	Not Required	
	6	2437		15.00		15.00		18.00		
	9	2452		15.00		15.00		18.00		
	10	2457		14.00		14.00		17.00		
	11	2462		5.50		5.50		8.50		
802.11ac-VHT20 MCS0	1	2412	Not Required	15.00	Not Required	15.00	Not Required	18.00	Not Required	
	6	2437		15.00		15.00		18.00		
	11	2462		15.00		15.00		18.00		
	12	2467		15.00		15.00		18.00		
	13	2472		3.50		3.50		6.50		
802.11ac-VHT40 MCS0	3	2422	Not Required	15.00	Not Required	15.00	Not Required	18.00	Not Required	
	6	2437		15.00		15.00		18.00		
	9	2452		15.00		15.00		18.00		
	10	2457		14.00		14.00		17.00		
	11	2462		5.50		5.50		8.50		
802.11ax-HE20 MCS0	1	2412	Not Required	15.00	Not Required	15.00	Not Required	18.00	Not Required	
	6	2437		15.00		15.00		18.00		
	11	2462		15.00		15.00		18.00		
	12	2467		15.00		15.00		18.00		
	13	2472		3.50		3.50		6.50		
802.11ax-HE40 MCS0	3	2422	Not Required	15.00	Not Required	15.00	Not Required	18.00	Not Required	
	6	2437		15.00		15.00		18.00		
	9	2452		15.00		15.00		18.00		
	10	2457		14.00		14.00		17.00		
	11	2462		5.50		5.50		8.50		



# FCC SAR TEST REPORT

Report No. : FA0N0903-06

5.2GHz WLAN				Ant 1+2 (1)		Ant 1+2 (2)		Ant 1+2			
5.2GHz WLAN	Mode	Channel	Frequency (MHz)	Average power (dBm)	Tune-Up Limit	Average power (dBm)	Tune-Up Limit	Average power (dBm)	Tune-Up Limit	Duty Cycle %	
	802.11a 6Mbps	36	5180	Not Required	Not Required	Not Required	Not Required	Not Required	Not Required	15.00	Not Required
		40	5200							15.00	
		44	5220							15.00	
		48	5240							15.00	
	802.11n-HT20 MCS0	36	5180							15.00	
		40	5200							15.00	
		44	5220							15.00	
		48	5240							15.00	
	802.11n-HT40 MCS0	38	5190							15.00	
		46	5230							15.00	
	802.11ac-VHT20 MCS0	36	5180							15.00	
		40	5200							15.00	
		44	5220							15.00	
	802.11ac-VHT40 MCS0	38	5190							15.00	
46		5230	15.00								
802.11ac-VHT80 MCS0	42	5210	15.00								
802.11ax-HE20 MCS0	36	5180	15.00								
	40	5200	15.00								
	44	5220	15.00								
	48	5240	15.00								
802.11ax-HE40 MCS0	38	5190	15.00								
	46	5230	15.00								
802.11ax-HE80 MCS0	42	5210	15.00								

5.3GHz WLAN				Ant 1+2 (1)		Ant 1+2 (2)		Ant 1+2						
5.3GHz WLAN	Mode	Channel	Frequency (MHz)	Average power (dBm)	Tune-Up Limit	Average power (dBm)	Tune-Up Limit	Average power (dBm)	Tune-Up Limit	Duty Cycle %				
	802.11a 6Mbps	52	5260	Not Required	11.60	11.80	14.71	12.00	15.00					
		56	5280					12.00	15.00					
		60	5300					12.00	15.00					
		64	5320					12.00	15.00					
	802.11n-HT20 MCS0	52	5260					12.00	15.00					
		56	5280					12.00	15.00					
		60	5300					12.00	15.00					
	802.11n-HT40 MCS0	54	5270					12.00	15.00					
		62	5310					12.00	15.00					
	802.11ac-VHT20 MCS0	52	5260					12.00	15.00					
		56	5280					12.00	15.00					
		60	5300					12.00	15.00					
		64	5320					12.00	15.00					
	802.11ac-VHT40 MCS0	54	5270					12.00	15.00					
		62	5310					12.00	15.00					
	802.11ac-VHT80 MCS0	58	5290					11.60	12.00	11.80	12.00	14.71	15.00	99.60
	802.11ac-VHT160 MCS0	50	5250					11.50	11.50	11.50	11.50	14.50		
802.11ax-HE20 MCS0	52	5260	Not Required					12.00	Not Required	12.00	Not Required	15.00	Not Required	
	56	5280		12.00	15.00									
	60	5300		12.00	15.00									
	64	5320		12.00	15.00									
802.11ax-HE40 MCS0	54	5270		12.00	15.00									
	62	5310		12.00	15.00									
802.11ax-HE80 MCS0	58	5290		12.00	12.00	12.00	12.00					15.00		
802.11ax-HE160 MCS0	50	5250		11.50	11.50	11.50	11.50					14.50		



**FCC SAR TEST REPORT**

**Report No. : FA0N0903-06**

5.5GHz WLAN				Ant 1+2 (1)		Ant 1+2 (2)		Ant 1+2		
5.5GHz WLAN	Mode	Channel	Frequency (MHz)	Average power (dBm)	Tune-Up Limit	Average power (dBm)	Tune-Up Limit	Average power (dBm)	Tune-Up Limit	Duty Cycle %
	802.11a 6Mbps		100	5500	Not Required	13.00	Not Required	13.00	Not Required	16.00
		116	5580	13.00		13.00				
		124	5620	13.00		13.00				
		132	5660	13.00		13.00				
		144	5720	13.00		13.00				
802.11n-HT20 MCS0		100	5500	Not Required	13.00	Not Required	13.00	Not Required	16.00	Not Required
		116	5580		13.00		13.00			
		124	5620		13.00		13.00			
		132	5660		13.00		13.00			
		144	5720		13.00		13.00			
802.11n-HT40 MCS0		102	5510	Not Required	13.00	Not Required	13.00	Not Required	16.00	Not Required
		110	5550		13.00		13.00			
		126	5630		13.00		13.00			
		134	5670		13.00		13.00			
802.11ac-VHT20 MCS0		100	5500	Not Required	13.00	Not Required	13.00	Not Required	16.00	Not Required
		116	5580		13.00		13.00			
		124	5620		13.00		13.00			
		132	5660		13.00		13.00			
802.11ac-VHT40 MCS0		102	5510	Not Required	13.00	Not Required	13.00	Not Required	16.00	Not Required
		110	5550		13.00		13.00			
		126	5630		13.00		13.00			
		134	5670		13.00		13.00			
802.11ac-VHT80 MCS0		106	5530	11.40	13.00	12.80	13.00	15.17	16.00	99.60
		122	5610	12.20	13.00	13.00	13.00	15.63	16.00	
		138	5690	11.00	13.00	12.70	13.00	14.94	16.00	
802.11ac-VHT160 MCS0		114	5570	Not Required	12.50	Not Required	12.50	Not Required	15.50	Not Required
802.11ax-HE20 MCS0		100	5500		13.00		13.00			
		116	5580		13.00		13.00			
		124	5620		13.00		13.00			
		132	5660		13.00		13.00			
		144	5720		13.00		13.00			
802.11ax-HE40 MCS0		102	5510		13.00		13.00			
		110	5550		13.00		13.00			
		126	5630		13.00		13.00			
		134	5670		13.00		13.00			
802.11ax-HE80 MCS0		102	5510		13.00		13.00			
		110	5550		13.00		13.00			
		126	5630		13.00		13.00			
802.11ax-HE160 MCS0		106	5530		13.00		13.00			
		122	5610		13.00		13.00			
	138	5690	13.00	13.00						
	114	5570	12.50	12.50						



5.8GHz WLAN				Ant 1+2 (1)		Ant 1+2 (2)		Ant 1+2			
5.8GHz WLAN	Mode	Channel	Frequency (MHz)	Average power (dBm)	Tune-Up Limit	Average power (dBm)	Tune-Up Limit	Average power (dBm)	Tune-Up Limit	Duty Cycle %	
	802.11a 6Mbps	149	5745	Not Required	13.50	Not Required	13.50	Not Required	16.50	Not Required	
		157	5785								13.50
		165	5825								13.50
	802.11n-HT20 MCS0	149	5745								13.50
		157	5785								13.50
		165	5825								13.50
	802.11n-HT40 MCS0	151	5755								13.50
		159	5795								13.50
	802.11ac-VHT20 MCS0	149	5745								13.50
157		5785	13.50								
165		5825	13.50								
802.11ac-VHT40 MCS0	151	5755	13.50								
	159	5795	13.50								
802.11ac-VHT80 MCS0	155	5775	12.80	13.50	13.10	13.50	15.96	16.50	99.60		
802.11ax-HE20 MCS0	149	5745	Not Required	13.50	Not Required	13.50	Not Required	16.50	Not Required		
	157	5785								13.50	
	165	5825								13.50	
802.11ax-HE40 MCS0	151	5755								13.50	
	159	5795								13.50	
802.11ax-HE80 MCS0	155	5775								13.50	



<WiFi 6E>

6GHz WLAN				Ant 1+2 (1)		Ant 1+2 (2)		Ant 1+2		Duty Cycle %
Mode	Channel	Frequency (MHz)	Average power (dBm)	Tune-Up Limit	Average power (dBm)	Tune-Up Limit	Average power (dBm)	Tune-Up Limit		
WiFi 6E	802.11a 6Mbps	1	5955	Not Required	1.50	Not Required	1.50	Not Required	4.50	Not Required
		57	6235		1.50		1.50		4.50	
		113	6515		1.50		1.50		4.50	
		173	6815		1.50		1.50		4.50	
		233	7115		1.00		1.00		4.00	
	802.11ax-HE20 MCS0	1	5955		3.50		3.50		6.50	
		57	6235		3.50		3.50		6.50	
		113	6515		3.50		3.50		6.50	
		173	6815		3.50		3.50		6.50	
		233	7115		-7.00		-7.00		-4.00	
	802.11ax-HE40 MCS0	3	5965		6.50		6.50		9.50	
		59	6245		6.50		6.50		9.50	
		107	6485		6.50		6.50		9.50	
		171	6805		6.50		6.50		9.50	
		227	7085		6.50		6.50		9.50	
	802.11ax-HE80 MCS0	7	5985		9.50		9.50		12.50	
		71	6305		9.50		9.50		12.50	
		119	6545		9.50		9.50		12.50	
		167	6785		9.50		9.50		12.50	
		215	7025		9.50		9.50		12.50	
802.11ax-HE160 MCS0	15	6025	11.76	12.00	10.89	12.00	14.36	15.00	99.10	
	47	6185	11.93	12.00	10.47	12.00	14.27	15.00		
	111	6505	11.48	12.00	11.78	12.00	14.64	15.00		
	175	6825	10.58	12.00	11.61	12.00	14.14	15.00		
	207	6985	10.34	12.00	11.66	12.00	14.06	15.00		



<2.4GHz Bluetooth>

Mode	Channel	Frequency (MHz)	Average power (dBm)		
			1Mbps	2Mbps	3Mbps
BR / EDR	CH 00	2402	15.92	11.82	11.88
	CH 39	2441	15.97	11.98	11.99
	CH 78	2480	15.52	11.52	11.55
Tune-up Limit			16	12	12

Mode	Channel	Frequency (MHz)	Average power (dBm)	
			1Mbps	2Mbps
LE	CH 00	2402	5.10	5.10
	CH 19	2440	5.40	5.40
	CH 39	2480	5.60	5.60
Tune-up Limit			7	7

General Note:

- For 2.4GHz Bluetooth SAR testing was selected 1Mbps due to its highest average power and duty cycle is 76.83% considered in SAR testing, and the duty cycle would be scaled to theoretical 83.3% in reported SAR calculation.

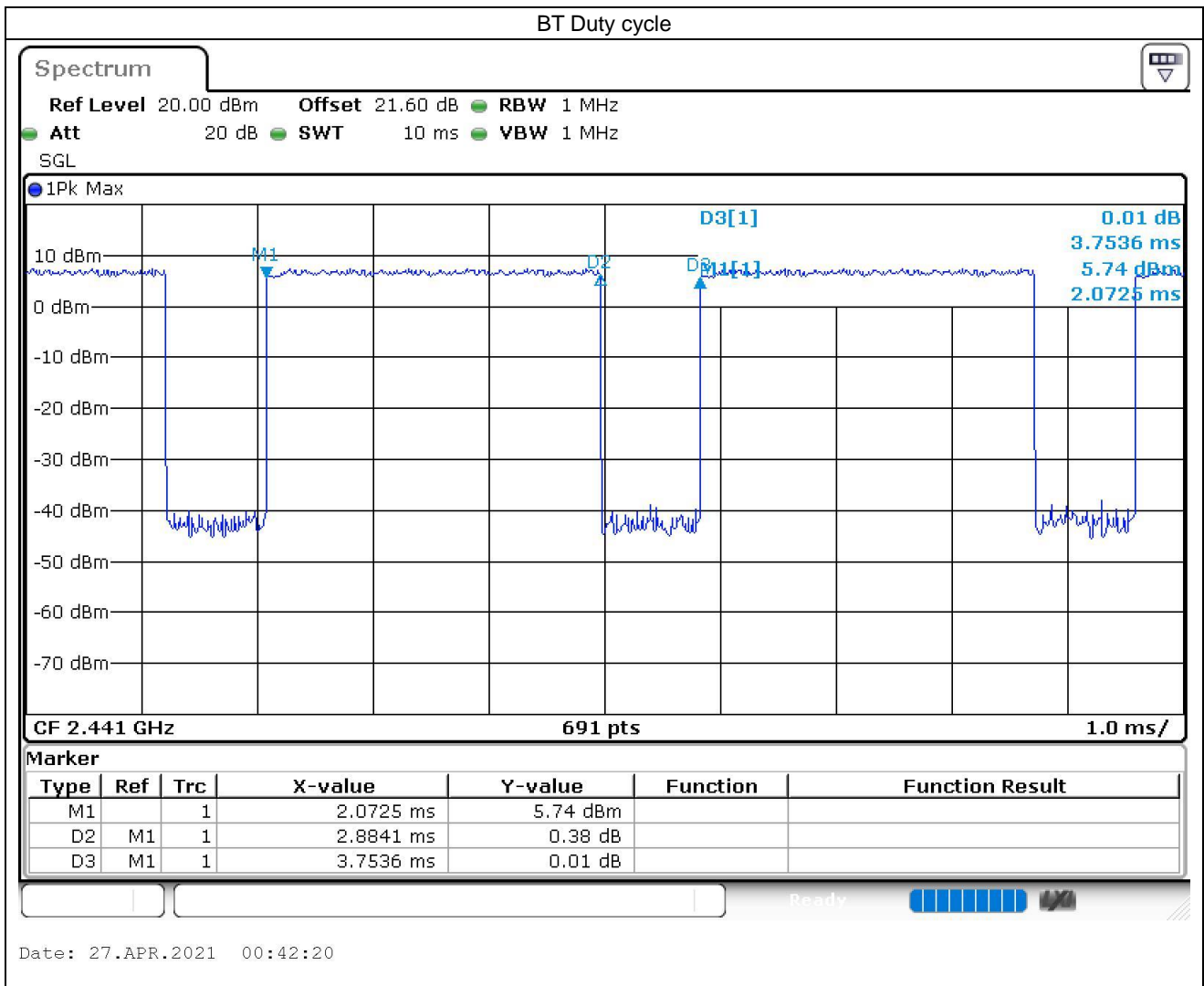

### 11. Antenna Location

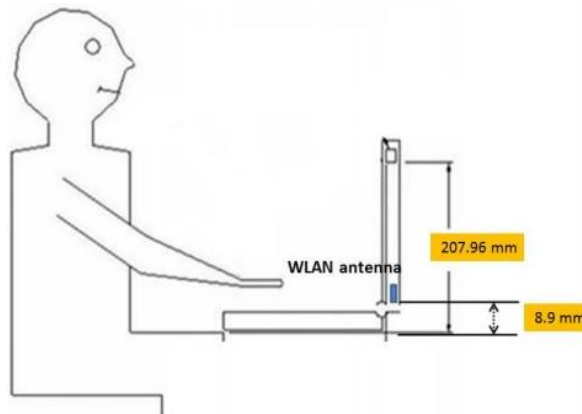
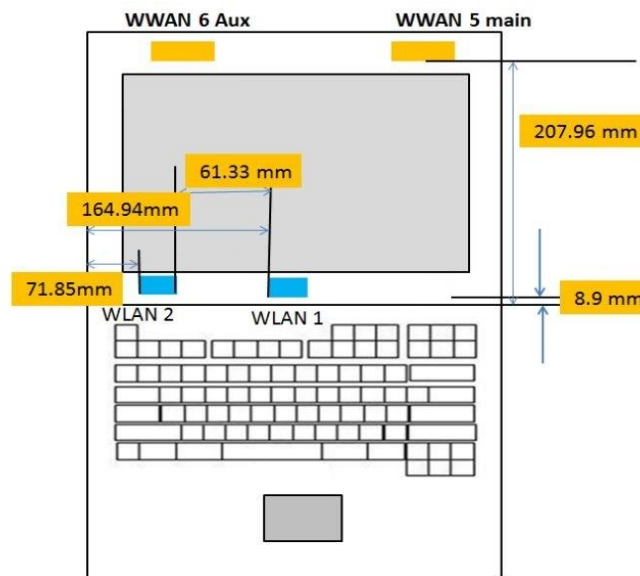

The separation distance for antenna to edge:

Antenna	To Bottom of Laptop (mm)
WLAN/BT Antenna 1	8.9
WLAN Antenna 2	8.9



## 12. RF Exposure Test Results

### General Note:

1. Per KDB 447498 D01v06, the reported SAR is the measured SAR value adjusted for maximum tune-up tolerance.
  - a. Tune-up scaling Factor = tune-up limit power (mW) / EUT RF power (mW), where tune-up limit is the maximum rated power among all production units.
  - b. For SAR testing of WLAN signal with non-100% duty cycle, the measured SAR is scaled-up by the duty cycle scaling factor which is equal to "1/(duty cycle)"
  - c. For WLAN/Bluetooth: Reported SAR(W/kg)= Measured SAR(W/kg)\* Duty Cycle scaling factor \* Tune-up scaling factor
2. Per KDB 447498 D01v06, for each exposure position, testing of other required channels within the operating mode of a frequency band is not required when the *reported* 1-g or 10-g SAR for the mid-band or highest output power channel is:
  - $\leq 0.8$  W/kg or 2.0 W/kg, for 1-g or 10-g respectively, when the transmission band is  $\leq 100$  MHz
  - $\leq 0.6$  W/kg or 1.5 W/kg, for 1-g or 10-g respectively, when the transmission band is between 100 MHz and 200 MHz
  - $\leq 0.4$  W/kg or 1.0 W/kg, for 1-g or 10-g respectively, when the transmission band is  $\geq 200$  MHz
3. Per KDB 865664 D01v01r04, for each frequency band, repeated SAR measurement is required only when the measured SAR is  $\geq 0.8$ W/kg.

### WLAN Note:

1. Per KDB 248227 D01v02r02, for 2.4GHz 802.11g/n SAR testing is not required when the highest reported SAR for DSSS is adjusted by the ratio of OFDM to DSSS specified maximum output power and the adjusted SAR is  $\leq 1.2$  W/kg.
2. Per KDB 248227 D01v02r02, U-NII-1 SAR testing is not required when the U-NII-2A band highest reported SAR for a test configuration is  $\leq 1.2$  W/kg, SAR is not required for U-NII-1 band.
3. When the reported SAR of the test position is  $> 0.4$  W/kg, SAR is repeated for the 802.11 transmission mode configuration tested in the initial test position to measure the subsequent next closet/smallest test separation distance and maximum coupling test position on the highest maximum output power channel, until the report SAR is  $\leq 0.8$  W/kg or all required test position are tested.
4. For all positions / configurations, when the reported SAR is  $> 0.8$  W/kg, SAR is measured for these test positions / configurations on the subsequent next highest measured output power channel(s) until the reported SAR is  $\leq 1.2$  W/kg or all required channels are tested.
5. Per October 2020 TCB Workshop Interim procedures, start instead with a minimum of 5 test channels across the full band for 6GHz WLAN.
6. During SAR testing the WLAN transmission was verified using a spectrum analyzer.
7. When SAR testing for 802.11ax is required
  - a. If the maximum output power is highest for OFDMA scenarios, choose the tone size with the maximum number of tones and the highest maximum output power
  - b. Otherwise, consider the fully allocated channel for SAR testing
  - c. When SAR testing is required on RU sizes less than the fully allocated channel, use the RU number closest to the middle of the channel, choosing the higher RU number when two RUs are equidistant to the middle of the channel.

### WLAN PD Note:

1. The manufacturer has confirmed that the devices tested have the same physical, mechanical and thermal characteristics and are within operational tolerances expected for production units.
2. Batteries are fully charged at the beginning of the measurements. The DUT was connected to a wall charger for some measurements due to the test duration. It was confirmed that the charger plugged into this DUT did not impact the near-field PD test results.
3. Absorbed power density (APD) using a 4cm<sup>2</sup> averaging area is reported based on SAR measurements.
4. Power density was calculated by repeated E-field measurements on two measurement planes separated by  $\lambda/4$ .
5. The device was configured to transmit continuously at the required data rate, channel bandwidth and signal modulation, using the highest transmission duty factor supported by the test mode tools.
6. Per FCC guidance and equipment manufacturer guidance, power density results were scaled according to IEC 62479:2010 for the portion of the measurement uncertainty  $> 30\%$ . Total expanded uncertainty of 2.68 dB (85.4%) was used to determine the psPD measurement scaling factor.
7. Per equipment manufacturer guidance, power density was measured at  $d=2$ mm and  $d=\lambda/5$  mm using the corresponding grid size and grid step size for some frequencies, surfaces and each antennas. The integrated Power Density (iPD) was calculated based on these measurements. Since iPD ratio between the two distances is  $< 1$ dB, the grid step (0.15) was sufficient for determining compliance at  $d=2$ mm.





12.1 2.4G/5GHz WLAN/Bluetooth SAR Test Result

<Non-DBS>

Plot No.	Band	Mode	Test Position	Gap (mm)	Sample	Antenna	Ch.	Freq. (MHz)	Average Power (dBm)	Tune-Up Limit (dBm)	Tune-up Scaling Factor	Duty Cycle %	Duty Cycle Scaling Factor	Power Drift (dB)	Measured 1g SAR (W/kg)	Reported 1g SAR (W/kg)
	WLAN2.4GHz	802.11b 1Mbps	Bottom of Laptop	0mm	Sample 1	Ant 1+2 (1)	11	2462	18.40	18.50	1.023	98.2	1.018	-0.15	0.476	0.496
						Ant 1+2 (2)			18.00	18.50	1.122	98.2	1.018	-0.15	0.329	0.376
	WLAN2.4GHz	802.11b 1Mbps	Bottom of Laptop	0mm	Sample 1	Ant 1+2 (1)	1	2412	18.30	18.50	1.047	98.2	1.018	0	0.544	0.580
						Ant 1+2 (2)			17.70	18.50	1.202	98.2	1.018	0	0.390	0.477
	WLAN2.4GHz	802.11b 1Mbps	Bottom of Laptop	0mm	Sample 1	Ant 1+2 (1)	6	2437	17.90	18.50	1.148	98.2	1.018	-0.18	0.657	0.768
						Ant 1+2 (2)			17.60	18.50	1.230	98.2	1.018	-0.18	0.472	0.591
	WLAN2.4GHz	802.11b 1Mbps	Bottom of Laptop	0mm	Sample 1	Ant 1+2 (1)	12	2467	18.30	18.50	1.047	98.2	1.018	0.05	0.612	0.652
						Ant 1+2 (2)			17.80	18.50	1.175	98.2	1.018	0.05	0.442	0.529
	WLAN2.4GHz	802.11b 1Mbps	Bottom of Laptop	0mm	Sample 1	Ant 1+2 (1)	13	2472	15.80	16.00	1.047	98.2	1.018	0.01	0.398	0.424
						Ant 1+2 (2)			14.80	16.00	1.318	98.2	1.018	0.01	0.295	0.396
	WLAN2.4GHz	802.11b 1Mbps	Bottom of Laptop	0mm	Sample 2	Ant 1+2 (1)	6	2437	17.90	18.50	1.148	98.2	1.018	0.01	0.651	0.761
						Ant 1+2 (2)			17.60	18.50	1.230	98.2	1.018	0.01	0.464	0.582
	WLAN2.4GHz	802.11b 1Mbps	Bottom of Laptop	0mm	Sample 3	Ant 1+2 (1)	6	2437	17.90	18.50	1.148	98.2	1.018	-0.12	0.616	0.720
						Ant 1+2 (2)			17.60	18.50	1.230	98.2	1.018	-0.12	0.296	0.371
	WLAN2.4GHz	802.11b 1Mbps	Bottom of Laptop	0mm	Sample 4	Ant 1+2 (1)	6	2437	17.90	18.50	1.148	98.2	1.018	0.15	0.902	1.054
						Ant 1+2 (2)			17.60	18.50	1.230	98.2	1.018	0.15	0.491	0.615
	WLAN2.4GHz	802.11b 1Mbps	Bottom of Laptop	0mm	Sample 4	Ant 1+2 (1)	1	2412	18.30	18.50	1.047	98.2	1.018	0.06	0.712	0.759
						Ant 1+2 (2)			17.70	18.50	1.202	98.2	1.018	0.06	0.556	0.680
	WLAN2.4GHz	802.11b 1Mbps	Bottom of Laptop	0mm	Sample 4	Ant 1+2 (1)	11	2462	18.40	18.50	1.023	98.2	1.018	-0.02	0.763	0.795
						Ant 1+2 (2)			18.00	18.50	1.122	98.2	1.018	-0.02	0.596	0.681
	WLAN2.4GHz	802.11b 1Mbps	Bottom of Laptop	0mm	Sample 4	Ant 1+2 (1)	12	2467	18.30	18.50	1.047	98.2	1.018	0.13	0.744	0.793
						Ant 1+2 (2)			17.80	18.50	1.175	98.2	1.018	0.13	0.584	0.698
	WLAN2.4GHz	802.11b 1Mbps	Bottom of Laptop	0mm	Sample 4	Ant 1+2 (1)	13	2472	15.80	16.00	1.047	98.2	1.018	0.07	0.445	0.474
						Ant 1+2 (2)			14.80	16.00	1.318	98.2	1.018	0.07	0.341	0.458
01	WLAN2.4GHz	802.11b 1Mbps	Bottom of Laptop	0mm	Sample 5	Ant 1+2 (1)	6	2437	17.90	18.50	1.148	98.2	1.018	-0.01	0.948	1.108
						Ant 1+2 (2)			17.60	18.50	1.230	98.2	1.018	-0.01	0.632	0.792
	WLAN2.4GHz	802.11b 1Mbps	Bottom of Laptop	0mm	Sample 5	Ant 1+2 (1)	1	2412	18.30	18.50	1.047	98.2	1.018	0.15	0.742	0.791
						Ant 1+2 (2)			17.70	18.50	1.202	98.2	1.018	0.15	0.584	0.715
	WLAN2.4GHz	802.11b 1Mbps	Bottom of Laptop	0mm	Sample 5	Ant 1+2 (1)	11	2462	18.40	18.50	1.023	98.2	1.018	-0.06	0.772	0.804
						Ant 1+2 (2)			18.00	18.50	1.122	98.2	1.018	-0.06	0.603	0.689
	WLAN2.4GHz	802.11b 1Mbps	Bottom of Laptop	0mm	Sample 5	Ant 1+2 (1)	12	2467	18.30	18.50	1.047	98.2	1.018	0.14	0.781	0.833
						Ant 1+2 (2)			17.80	18.50	1.175	98.2	1.018	0.14	0.622	0.744
	WLAN2.4GHz	802.11b 1Mbps	Bottom of Laptop	0mm	Sample 5	Ant 1+2 (1)	13	2472	15.80	16.00	1.047	98.2	1.018	0.09	0.458	0.488
						Ant 1+2 (2)			14.80	16.00	1.318	98.2	1.018	0.09	0.362	0.486
	WLAN2.4GHz	802.11b 1Mbps	Bottom of Laptop	0mm	Sample 6	Ant 1+2 (1)	6	2437	17.90	18.50	1.148	98.2	1.018	0.05	0.605	0.707
						Ant 1+2 (2)			17.60	18.50	1.230	98.2	1.018	0.05	0.394	0.494



**FCC SAR TEST REPORT**

Report No. : FA0N0903-06

Plot No.	Band	Mode	Test Position	Gap (mm)	Sample	Antenna	Ch.	Freq. (MHz)	Average Power (dBm)	Tune-Up Limit (dBm)	Tune-up Scaling Factor	Duty Cycle %	Duty Cycle Scaling Factor	Power Drift (dB)	Measured 1g SAR (W/kg)	Reported 1g SAR (W/kg)
02	WLAN5GHz	802.11n-HT40 MCS0	Bottom of Laptop	0mm	Sample 1	Ant 1+2 (1)	62	5310	14.60	15.00	1.096	99.7	1.003	0.01	0.329	0.362
						Ant 1+2 (2)			14.60	15.00	1.096	99.7	1.003	0.01	0.826	0.908
	WLAN5GHz	802.11n-HT40 MCS0	Bottom of Laptop	0mm	Sample 1	Ant 1+2 (1)	54	5270	14.30	15.00	1.175	99.7	1.003	0.04	0.334	0.394
						Ant 1+2 (2)			14.80	15.00	1.047	99.7	1.003	0.04	0.772	0.811
	WLAN5GHz	802.11n-HT40 MCS0	Bottom of Laptop	0mm	Sample 2	Ant 1+2 (1)	62	5310	14.60	15.00	1.096	99.7	1.003	-0.17	0.508	0.559
						Ant 1+2 (2)			14.60	15.00	1.096	99.7	1.003	-0.17	0.412	0.453
	WLAN5GHz	802.11n-HT40 MCS0	Bottom of Laptop	0mm	Sample 3	Ant 1+2 (1)	62	5310	14.60	15.00	1.096	99.7	1.003	-0.14	0.564	0.620
						Ant 1+2 (2)			14.60	15.00	1.096	99.7	1.003	-0.14	0.628	0.691
	WLAN5GHz	802.11n-HT40 MCS0	Bottom of Laptop	0mm	Sample 4	Ant 1+2 (1)	62	5310	14.60	15.00	1.096	99.7	1.003	-0.12	0.240	0.264
						Ant 1+2 (2)			14.60	15.00	1.096	99.7	1.003	-0.12	0.540	0.594
	WLAN5GHz	802.11n-HT40 MCS0	Bottom of Laptop	0mm	Sample 5	Ant 1+2 (1)	62	5310	14.60	15.00	1.096	99.7	1.003	0.16	0.316	0.348
						Ant 1+2 (2)			14.60	15.00	1.096	99.7	1.003	0.16	0.300	0.330
	WLAN5GHz	802.11n-HT40 MCS0	Bottom of Laptop	0mm	Sample 6	Ant 1+2 (1)	62	5310	14.60	15.00	1.096	99.7	1.003	0.19	0.456	0.501
						Ant 1+2 (2)			14.60	15.00	1.096	99.7	1.003	0.19	0.472	0.519
	WLAN5GHz	802.11ac-VHT80 MCS0	Bottom of Laptop	0mm	Sample 1	Ant 1+2 (1)	138	5690	13.90	15.50	1.445	99.6	1.004	0.04	0.286	0.415
						Ant 1+2 (2)			15.40	15.50	1.023	99.6	1.004	0.04	0.874	0.898
	WLAN5GHz	802.11ac-VHT80 MCS0	Bottom of Laptop	0mm	Sample 1	Ant 1+2 (1)	106	5530	13.30	15.00	1.479	99.6	1.004	-0.1	0.330	0.490
						Ant 1+2 (2)			14.90	15.00	1.023	99.6	1.004	-0.1	0.568	0.584
	WLAN5GHz	802.11ac-VHT80 MCS0	Bottom of Laptop	0mm	Sample 1	Ant 1+2 (1)	122	5610	13.70	15.00	1.349	99.6	1.004	-0.06	0.427	0.579
						Ant 1+2 (2)			14.80	15.00	1.047	99.6	1.004	-0.06	0.845	0.889
03	WLAN5GHz	802.11n-HT40 MCS0	Bottom of Laptop	0mm	Sample 1	Ant 1+2 (1)	126	5630	14.20	15.50	1.349	99.7	1.003	-0.03	0.515	0.697
						Ant 1+2 (2)			15.50	15.50	1.000	99.7	1.003	-0.03	1.010	1.013
	WLAN5GHz	802.11n-HT40 MCS0	Bottom of Laptop	0mm	Sample 2	Ant 1+2 (1)	126	5630	14.20	15.50	1.349	99.7	1.003	-0.17	0.465	0.629
						Ant 1+2 (2)			15.50	15.50	1.000	99.7	1.003	-0.17	0.516	0.518
	WLAN5GHz	802.11n-HT40 MCS0	Bottom of Laptop	0mm	Sample 3	Ant 1+2 (1)	126	5630	14.20	15.50	1.349	99.7	1.003	0.02	0.452	0.612
						Ant 1+2 (2)			15.50	15.50	1.000	99.7	1.003	0.02	0.616	0.618
	WLAN5GHz	802.11n-HT40 MCS0	Bottom of Laptop	0mm	Sample 4	Ant 1+2 (1)	126	5630	14.20	15.50	1.349	99.7	1.003	-0.17	0.345	0.466
						Ant 1+2 (2)			15.50	15.50	1.000	99.7	1.003	-0.17	0.430	0.431
	WLAN5GHz	802.11n-HT40 MCS0	Bottom of Laptop	0mm	Sample 5	Ant 1+2 (1)	126	5630	14.20	15.50	1.349	99.7	1.003	0.14	0.526	0.712
						Ant 1+2 (2)			15.50	15.50	1.000	99.7	1.003	0.14	0.677	0.679
	WLAN5GHz	802.11n-HT40 MCS0	Bottom of Laptop	0mm	Sample 6	Ant 1+2 (1)	126	5630	14.20	15.50	1.349	99.7	1.003	0.13	0.390	0.527
						Ant 1+2 (2)			15.50	15.50	1.000	99.7	1.003	0.13	0.570	0.572
04	WLAN5GHz	802.11ac-VHT80 MCS0	Bottom of Laptop	0mm	Sample 1	Ant 1+2 (1)	155	5775	14.70	16.00	1.349	99.6	1.004	0.02	0.427	0.578
						Ant 1+2 (2)			16.00	16.00	1.000	99.6	1.004	0.02	0.909	0.913
	WLAN5GHz	802.11n-HT40 MCS0	Bottom of Laptop	0mm	Sample 1	Ant 1+2 (1)	159	5795	14.70	16.00	1.349	99.7	1.003	0.05	0.287	0.388
						Ant 1+2 (2)			16.00	16.00	1.000	99.7	1.003	0.05	0.840	0.843
	WLAN5GHz	802.11ac-VHT80 MCS0	Bottom of Laptop	0mm	Sample 2	Ant 1+2 (1)	155	5775	14.70	16.00	1.349	99.6	1.004	-0.03	0.410	0.555
						Ant 1+2 (2)			16.00	16.00	1.000	99.6	1.004	-0.03	0.828	0.831
	WLAN5GHz	802.11ac-VHT80 MCS0	Bottom of Laptop	0mm	Sample 3	Ant 1+2 (1)	155	5775	14.70	16.00	1.349	99.6	1.004	0.06	0.387	0.524
						Ant 1+2 (2)			16.00	16.00	1.000	99.6	1.004	0.06	0.666	0.669
	WLAN5GHz	802.11ac-VHT80 MCS0	Bottom of Laptop	0mm	Sample 4	Ant 1+2 (1)	155	5775	14.70	16.00	1.349	99.6	1.004	0.14	0.340	0.461
						Ant 1+2 (2)			16.00	16.00	1.000	99.6	1.004	0.14	0.467	0.469
	WLAN5GHz	802.11ac-VHT80 MCS0	Bottom of Laptop	0mm	Sample 5	Ant 1+2 (1)	155	5775	14.70	16.00	1.349	99.6	1.004	-0.11	0.388	0.526
						Ant 1+2 (2)			16.00	16.00	1.000	99.6	1.004	-0.11	0.403	0.405
	WLAN5GHz	802.11ac-VHT80 MCS0	Bottom of Laptop	0mm	Sample 6	Ant 1+2 (1)	155	5775	14.70	16.00	1.349	99.6	1.004	-0.17	0.379	0.514
						Ant 1+2 (2)			16.00	16.00	1.000	99.6	1.004	-0.17	0.654	0.657



<DBS>

Plot No.	Band	Mode	Test Position	Gap (mm)	Sample	Antenna	Ch.	Freq. (MHz)	Average Power (dBm)	Tune-Up Limit (dBm)	Tune-up Scaling Factor	Duty Cycle %	Duty Cycle Scaling Factor	Power Drift (dB)	Measured 1g SAR (W/kg)	Reported 1g SAR (W/kg)
	WLAN2.4GHz	802.11b 1Mbps	Bottom of Laptop	0mm	Sample 1	Ant 1+2 (1)	11	2462	14.90	15.00	1.023	98.2	1.018	0.1	0.254	0.264
						Ant 1+2 (2)			14.60	15.00	1.096	98.2	1.018	0.1	0.182	0.203
	WLAN2.4GHz	802.11b 1Mbps	Bottom of Laptop	0mm	Sample 1	Ant 1+2 (1)	1	2412	14.90	15.00	1.023	98.2	1.018	0.15	0.210	0.219
						Ant 1+2 (2)			14.40	15.00	1.148	98.2	1.018	0.15	0.151	0.176
	WLAN2.4GHz	802.11b 1Mbps	Bottom of Laptop	0mm	Sample 1	Ant 1+2 (1)	6	2437	13.60	15.00	1.380	98.2	1.018	0.09	0.194	0.273
						Ant 1+2 (2)			13.90	15.00	1.288	98.2	1.018	0.09	0.138	0.181
	WLAN2.4GHz	802.11b 1Mbps	Bottom of Laptop	0mm	Sample 1	Ant 1+2 (1)	12	2467	14.60	15.00	1.096	98.2	1.018	0.04	0.222	0.248
						Ant 1+2 (2)			14.50	15.00	1.122	98.2	1.018	0.04	0.157	0.179
	WLAN2.4GHz	802.11b 1Mbps	Bottom of Laptop	0mm	Sample 1	Ant 1+2 (1)	13	2472	14.60	15.00	1.096	98.2	1.018	0.12	0.213	0.238
						Ant 1+2 (2)			14.50	15.00	1.122	98.2	1.018	0.12	0.151	0.172
	WLAN2.4GHz	802.11b 1Mbps	Bottom of Laptop	0mm	Sample 2	Ant 1+2 (1)	6	2437	13.60	15.00	1.380	98.2	1.018	0.16	0.261	0.366
						Ant 1+2 (2)			13.90	15.00	1.288	98.2	1.018	0.16	0.179	0.235
	WLAN2.4GHz	802.11b 1Mbps	Bottom of Laptop	0mm	Sample 3	Ant 1+2 (1)	6	2437	13.60	15.00	1.380	98.2	1.018	0.17	0.238	0.334
						Ant 1+2 (2)			13.90	15.00	1.288	98.2	1.018	0.17	0.114	0.150
	WLAN2.4GHz	802.11b 1Mbps	Bottom of Laptop	0mm	Sample 4	Ant 1+2 (1)	6	2437	13.60	15.00	1.380	98.2	1.018	0.14	0.348	0.489
						Ant 1+2 (2)			13.90	15.00	1.288	98.2	1.018	0.14	0.189	0.248
	WLAN2.4GHz	802.11b 1Mbps	Bottom of Laptop	0mm	Sample 5	Ant 1+2 (1)	6	2437	13.60	15.00	1.380	98.2	1.018	-0.13	0.366	0.514
						Ant 1+2 (2)			13.90	15.00	1.288	98.2	1.018	-0.13	0.264	0.346
	WLAN2.4GHz	802.11b 1Mbps	Bottom of Laptop	0mm	Sample 6	Ant 1+2 (1)	6	2437	13.60	15.00	1.380	98.2	1.018	0	0.233	0.328
						Ant 1+2 (2)			13.90	15.00	1.288	98.2	1.018	0	0.152	0.200



**FCC SAR TEST REPORT**

**Report No. : FA0N0903-06**

Plot No.	Band	Mode	Test Position	Gap (mm)	Sample	Antenna	Ch.	Freq. (MHz)	Average Power (dBm)	Tune-Up Limit (dBm)	Tune-up Scaling Factor	Duty Cycle %	Duty Cycle Scaling Factor	Power Drift (dB)	Measured 1g SAR (W/kg)	Reported 1g SAR (W/kg)
	WLAN5GHz	802.11ac-VHT80 MCS0	Bottom of Laptop	0mm	Sample 1	Ant 1+2 (1)	58	5290	11.60	12.00	1.096	99.6	1.004	-0.05	0.170	0.187
						Ant 1+2 (2)			11.80	12.00	1.047	99.6	1.004	-0.05	0.405	0.426
	WLAN5GHz	802.11ac-VHT80 MCS0	Bottom of Laptop	0mm	Sample 2	Ant 1+2 (1)	58	5290	11.60	12.00	1.096	99.6	1.004	0.17	0.249	0.274
						Ant 1+2 (2)			11.80	12.00	1.047	99.6	1.004	0.17	0.202	0.212
	WLAN5GHz	802.11ac-VHT80 MCS0	Bottom of Laptop	0mm	Sample 3	Ant 1+2 (1)	58	5290	11.60	12.00	1.096	99.6	1.004	0.13	0.276	0.304
						Ant 1+2 (2)			11.80	12.00	1.047	99.6	1.004	0.13	0.308	0.324
	WLAN5GHz	802.11ac-VHT80 MCS0	Bottom of Laptop	0mm	Sample 4	Ant 1+2 (1)	58	5290	11.60	12.00	1.096	99.6	1.004	0.01	0.117	0.129
						Ant 1+2 (2)			11.80	12.00	1.047	99.6	1.004	0.01	0.265	0.278
	WLAN5GHz	802.11ac-VHT80 MCS0	Bottom of Laptop	0mm	Sample 5	Ant 1+2 (1)	58	5290	11.60	12.00	1.096	99.6	1.004	0.04	0.155	0.171
						Ant 1+2 (2)			11.80	12.00	1.047	99.6	1.004	0.04	0.147	0.155
	WLAN5GHz	802.11ac-VHT80 MCS0	Bottom of Laptop	0mm	Sample 6	Ant 1+2 (1)	58	5290	11.60	12.00	1.096	99.6	1.004	0.11	0.223	0.246
						Ant 1+2 (2)			11.80	12.00	1.047	99.6	1.004	0.11	0.231	0.243
	WLAN5GHz	802.11ac-VHT80 MCS0	Bottom of Laptop	0mm	Sample 1	Ant 1+2 (1)	122	5610	12.20	13.00	1.202	99.6	1.004	-0.04	0.292	0.352
						Ant 1+2 (2)			13.00	13.00	1.000	99.6	1.004	-0.04	0.588	0.590
	WLAN5GHz	802.11ac-VHT80 MCS0	Bottom of Laptop	0mm	Sample 1	Ant 1+2 (1)	106	5530	11.40	13.00	1.445	99.6	1.004	-0.14	0.192	0.279
						Ant 1+2 (2)			12.80	13.00	1.047	99.6	1.004	-0.14	0.331	0.348
	WLAN5GHz	802.11ac-VHT80 MCS0	Bottom of Laptop	0mm	Sample 1	Ant 1+2 (1)	138	5690	11.00	13.00	1.585	99.6	1.004	-0.14	0.216	0.344
						Ant 1+2 (2)			12.70	13.00	1.072	99.6	1.004	-0.14	0.509	0.547
	WLAN5GHz	802.11ac-VHT80 MCS0	Bottom of Laptop	0mm	Sample 2	Ant 1+2 (1)	122	5610	12.20	13.00	1.202	99.6	1.004	-0.12	0.271	0.327
						Ant 1+2 (2)			13.00	13.00	1.000	99.6	1.004	-0.12	0.300	0.301
	WLAN5GHz	802.11ac-VHT80 MCS0	Bottom of Laptop	0mm	Sample 3	Ant 1+2 (1)	122	5610	12.20	13.00	1.202	99.6	1.004	-0.12	0.263	0.318
						Ant 1+2 (2)			13.00	13.00	1.000	99.6	1.004	-0.12	0.359	0.360
	WLAN5GHz	802.11ac-VHT80 MCS0	Bottom of Laptop	0mm	Sample 4	Ant 1+2 (1)	122	5610	12.20	13.00	1.202	99.6	1.004	0.1	0.201	0.242
						Ant 1+2 (2)			13.00	13.00	1.000	99.6	1.004	0.1	0.215	0.216
	WLAN5GHz	802.11ac-VHT80 MCS0	Bottom of Laptop	0mm	Sample 5	Ant 1+2 (1)	122	5610	12.20	13.00	1.202	99.6	1.004	-0.13	0.306	0.369
						Ant 1+2 (2)			13.00	13.00	1.000	99.6	1.004	-0.13	0.161	0.162
	WLAN5GHz	802.11ac-VHT80 MCS0	Bottom of Laptop	0mm	Sample 6	Ant 1+2 (1)	122	5610	12.20	13.00	1.202	99.6	1.004	0.19	0.227	0.274
						Ant 1+2 (2)			13.00	13.00	1.000	99.6	1.004	0.19	0.332	0.333
	WLAN5GHz	802.11ac-VHT80 MCS0	Bottom of Laptop	0mm	Sample 1	Ant 1+2 (1)	155	5775	12.80	13.50	1.175	99.6	1.004	-0.02	0.234	0.276
						Ant 1+2 (2)			13.10	13.50	1.096	99.6	1.004	-0.02	0.500	0.550
	WLAN5GHz	802.11ac-VHT80 MCS0	Bottom of Laptop	0mm	Sample 2	Ant 1+2 (1)	155	5775	12.80	13.50	1.175	99.6	1.004	-0.19	0.223	0.263
						Ant 1+2 (2)			13.10	13.50	1.096	99.6	1.004	-0.19	0.451	0.497
	WLAN5GHz	802.11ac-VHT80 MCS0	Bottom of Laptop	0mm	Sample 3	Ant 1+2 (1)	155	5775	12.80	13.50	1.175	99.6	1.004	0.15	0.211	0.249
						Ant 1+2 (2)			13.10	13.50	1.096	99.6	1.004	0.15	0.363	0.400
	WLAN5GHz	802.11ac-VHT80 MCS0	Bottom of Laptop	0mm	Sample 4	Ant 1+2 (1)	155	5775	12.80	13.50	1.175	99.6	1.004	0.1	0.185	0.219
						Ant 1+2 (2)			13.10	13.50	1.096	99.6	1.004	0.1	0.255	0.280
	WLAN5GHz	802.11ac-VHT80 MCS0	Bottom of Laptop	0mm	Sample 5	Ant 1+2 (1)	155	5775	12.80	13.50	1.175	99.6	1.004	0.19	0.212	0.250
						Ant 1+2 (2)			13.10	13.50	1.096	99.6	1.004	0.19	0.220	0.242
	WLAN5GHz	802.11ac-VHT80 MCS0	Bottom of Laptop	0mm	Sample 6	Ant 1+2 (1)	155	5775	12.80	13.50	1.175	99.6	1.004	0.09	0.207	0.244
						Ant 1+2 (2)			13.10	13.50	1.096	99.6	1.004	0.09	0.356	0.392



<Bluetooth SAR>

Plot No.	Band	Mode	Test Position	Gap (mm)	Sample	Antenna	Ch.	Freq. (MHz)	Average Power (dBm)	Tune-Up Limit (dBm)	Tune-up Scaling Factor	Duty Cycle %	Duty Cycle Scaling Factor	Power Drift (dB)	Measured 1g SAR (W/kg)	Reported 1g SAR (W/kg)
05	Bluetooth	1Mbps	Bottom of Laptop	0mm	Sample 1	Ant 1	39	2441	15.97	16.00	1.007	76.83	1.084	-0.17	0.148	0.162
	Bluetooth	1Mbps	Bottom of Laptop	0mm	Sample 1	Ant 1	0	2402	15.92	16.00	1.019	76.83	1.084	0.17	0.120	0.132
	Bluetooth	1Mbps	Bottom of Laptop	0mm	Sample 1	Ant 1	78	2480	15.52	16.00	1.117	76.83	1.084	0.14	0.112	0.136
	Bluetooth	1Mbps	Bottom of Laptop	0mm	Sample 2	Ant 1	39	2441	15.97	16.00	1.007	76.83	1.084	-0.05	0.132	0.144
	Bluetooth	1Mbps	Bottom of Laptop	0mm	Sample 3	Ant 1	39	2441	15.97	16.00	1.007	76.83	1.084	0.08	0.137	0.150
	Bluetooth	1Mbps	Bottom of Laptop	0mm	Sample 4	Ant 1	39	2441	15.97	16.00	1.007	76.83	1.084	-0.16	0.107	0.117
	Bluetooth	1Mbps	Bottom of Laptop	0mm	Sample 5	Ant 1	39	2441	15.97	16.00	1.007	76.83	1.084	0.13	0.142	0.155
	Bluetooth	1Mbps	Bottom of Laptop	0mm	Sample 6	Ant 1	39	2441	15.97	16.00	1.007	76.83	1.084	-0.09	0.125	0.136

12.2 6GHz WLAN SAR Test Result

Plot No.	Band	Mode	Test Position	Gap (mm)	Sample	Antenna	Ch.	Freq. (MHz)	Average Power (dBm)	Tune-Up Limit (dBm)	Duty Cycle %	Duty Cycle Scaling Factor	Power Drift (dB)	Measured 1g SAR (W/kg)	Reported 1g SAR (W/kg)	Measured APD W/m <sup>2</sup> (4cm <sup>2</sup> )
	WLAN 6E	802.11ax-HE160 MCS0	Bottom of Laptop	0mm	Sample 1	Ant 1+2 (1)	111	6505	11.48	12.00	99.1	1.009	-0.09	0.141	0.160	3.533
						Ant 1+2 (2)			11.78	12.00	99.1	1.009	-0.09	0.136	0.144	3.408
	WLAN 6E	802.11ax-HE160 MCS0	Bottom of Laptop	0mm	Sample 1	Ant 1+2 (1)	15	6025	11.76	12.00	99.1	1.009	0.05	0.168	0.179	4.210
						Ant 1+2 (2)			10.89	12.00	99.1	1.009	0.05	0.193	0.251	4.837
06	WLAN 6E	802.11ax-HE160 MCS0	Bottom of Laptop	0mm	Sample 1	Ant 1+2 (1)	47	6185	11.93	12.00	99.1	1.009	-0.18	0.211	0.216	5.288
						Ant 1+2 (2)			10.47	12.00	99.1	1.009	-0.18	0.241	0.346	6.039
	WLAN 6E	802.11ax-HE160 MCS0	Bottom of Laptop	0mm	Sample 1	Ant 1+2 (1)	175	6825	10.58	12.00	99.1	1.009	0.14	0.166	0.232	4.160
						Ant 1+2 (2)			11.61	12.00	99.1	1.009	0.14	0.078	0.086	1.955
	WLAN 6E	802.11ax-HE160 MCS0	Bottom of Laptop	0mm	Sample 1	Ant 1+2 (1)	207	6985	10.34	12.00	99.1	1.009	0.04	0.143	0.211	3.584
						Ant 1+2 (2)			11.66	12.00	99.1	1.009	0.04	0.095	0.104	2.381
	WLAN 6E	802.11ax-HE160 MCS0	Bottom of Laptop	0mm	Sample 2	Ant 1+2 (1)	47	6185	11.93	12.00	99.1	1.009	0.02	0.187	0.192	4.686
						Ant 1+2 (2)			10.47	12.00	99.1	1.009	0.02	0.221	0.317	5.538
	WLAN 6E	802.11ax-HE160 MCS0	Bottom of Laptop	0mm	Sample 3	Ant 1+2 (1)	47	6185	11.93	12.00	99.1	1.009	-0.06	0.153	0.157	3.834
						Ant 1+2 (2)			10.47	12.00	99.1	1.009	-0.06	0.198	0.284	4.962
	WLAN 6E	802.11ax-HE160 MCS0	Bottom of Laptop	0mm	Sample 4	Ant 1+2 (1)	47	6185	11.93	12.00	99.1	1.009	0.07	0.102	0.105	2.556
						Ant 1+2 (2)			10.47	12.00	99.1	1.009	0.07	0.132	0.189	3.308
	WLAN 6E	802.11ax-HE160 MCS0	Bottom of Laptop	0mm	Sample 5	Ant 1+2 (1)	47	6185	11.93	12.00	99.1	1.009	0.05	0.112	0.115	2.807
						Ant 1+2 (2)			10.47	12.00	99.1	1.009	0.05	0.157	0.225	3.934
	WLAN 6E	802.11ax-HE160 MCS0	Bottom of Laptop	0mm	Sample 6	Ant 1+2 (1)	47	6185	11.93	12.00	99.1	1.009	-0.11	0.144	0.148	3.609
						Ant 1+2 (2)			10.47	12.00	99.1	1.009	-0.11	0.106	0.152	2.656

12.3 6GHz PD Test Result

Band	Mode	Test Position	Gap (mm)	Antenna	Sample	Ch.	Freq. (MHz)	Average Power (dBm)	Grip Step (A)	iPD (W/m <sup>2</sup> )	iPD ratio (<1dB)	Scaling Factor for Measurement Uncertainty	Measured Normal psPD	Measured Total psPD
													W/m <sup>2</sup> (4cm <sup>2</sup> )	W/m <sup>2</sup> (4cm <sup>2</sup> )
WLAN6GHz	802.11ax-HE160 MCS0	Bottom of Laptop	2mm	Ant 1+2 (2)	Sample 1	15	6025	10.89	0.15	469.57993		1.5535	2.52	3.15
WLAN6GHz	802.11ax-HE160 MCS0	Bottom of Laptop	10mm	Ant 1+2 (2)	Sample 1	15	6025	10.89	0.25	173.56664	-0.1145422	1.5535	1.31	1.47
WLAN6GHz	802.11ax-HE160 MCS0	Bottom of Laptop	2mm	Ant 1+2 (1)	Sample 1	207	6985	10.34	0.15	267.48996		1.5535	0.915	1.02
WLAN6GHz	802.11ax-HE160 MCS0	Bottom of Laptop	8.59mm	Ant 1+2 (2)	Sample 1	207	6985	11.66	0.25	105.07229	-0.3787819	1.5535	0.35	0.393

Plot No.	Band	Mode	Test Position	Gap (mm)	Antenna	Sample	Ch.	Freq. (MHz)	Average Power (dBm)	Tune-Up Limit (dBm)	Tune-up Scaling Factor	Duty Cycle %	Duty Cycle Scaling Factor	Grip Step (A)	Scaling Factor for Measurement Uncertainty	Power Drift (dB)	Measured Normal psPD	Reported Normal psPD	Measured Total psPD	Reported Total psPD
																	W/m <sup>2</sup> (4cm <sup>2</sup> )	W/m <sup>2</sup> (4cm <sup>2</sup> )	W/m <sup>2</sup> (4cm <sup>2</sup> )	W/m <sup>2</sup> (4cm <sup>2</sup> )
	WLAN6GHz	802.11ax-HE160 MCS0	Bottom of Laptop	2mm	Ant 1+2 (2)	Sample 1	15	6025	10.89	12.00	1.291	99.10	1.009	0.15	1.5535	0.11	2.52	5.10	3.15	6.38
01	WLAN6GHz	802.11ax-HE160 MCS0	Bottom of Laptop	2mm	Ant 1+2 (2)	Sample 1	47	6185	10.47	12.00	1.422	99.10	1.009	0.15	1.5535	0.08	2.75	6.13	2.93	6.53
	WLAN6GHz	802.11ax-HE160 MCS0	Bottom of Laptop	2mm	Ant 1+2 (2)	Sample 1	111	6505	11.78	12.00	1.052	99.10	1.009	0.15	1.5535	-0.04	1.24	2.04	1.41	2.32
	WLAN6GHz	802.11ax-HE160 MCS0	Bottom of Laptop	2mm	Ant 1+2 (1)	Sample 1	175	6825	10.58	12.00	1.387	99.10	1.009	0.15	1.5535	-0.13	0.992	2.16	1.27	2.76
	WLAN6GHz	802.11ax-HE160 MCS0	Bottom of Laptop	2mm	Ant 1+2 (1)	Sample 1	207	6985	10.34	12.00	1.466	99.10	1.009	0.15	1.5535	0.04	0.915	2.10	1.02	2.34
	WLAN6GHz	802.11ax-HE160 MCS0	Bottom of Laptop	2mm	Ant 1+2 (2)	Sample 2	47	6185	10.47	12.00	1.422	99.10	1.009	0.15	1.5535	0.12	2.35	5.24	2.57	5.73
	WLAN6GHz	802.11ax-HE160 MCS0	Bottom of Laptop	2mm	Ant 1+2 (2)	Sample 3	47	6185	10.47	12.00	1.422	99.10	1.009	0.15	1.5535	-0.08	2.29	5.11	2.72	6.06
	WLAN6GHz	802.11ax-HE160 MCS0	Bottom of Laptop	2mm	Ant 1+2 (1)	Sample 4	47	6185	11.93	12.00	1.016	99.10	1.009	0.15	1.5535	-0.13	2.14	3.41	2.4	3.82
	WLAN6GHz	802.11ax-HE160 MCS0	Bottom of Laptop	2mm	Ant 1+2 (1)	Sample 5	47	6185	11.93	12.00	1.016	99.10	1.009	0.15	1.5535	-0.03	2.21	3.52	2.42	3.85
	WLAN6GHz	802.11ax-HE160 MCS0	Bottom of Laptop	2mm	Ant 1+2 (2)	Sample 6	47	6185	10.47	12.00	1.422	99.10	1.009	0.15	1.5535	-0.05	1.39	3.10	1.56	3.48

12.4 Repeated SAR Measurement

No.	Band	Mode	Test Position	Gap (mm)	Sample	Antenna	Ch.	Freq. (MHz)	Average Power (dBm)	Tune-Up Limit (dBm)	Tune-up Scaling Factor	Duty Cycle %	Duty Cycle Scaling Factor	Power Drift (dB)	Measured 1g SAR (W/kg)	Ratio	Reported 1g SAR (W/kg)
1st	WLAN2.4GHz	802.11b 1Mbps	Bottom of Laptop	0mm	Sample 5	Ant 1+2 (1)	6	2437	17.90	18.50	1.148	98.2	1.018	-0.01	0.948	-	1.108
									17.60	18.50	1.230	98.2	1.018	-0.01	0.632	-	0.792
2nd	WLAN2.4GHz	802.11b 1Mbps	Bottom of Laptop	0mm	Sample 5	Ant 1+2 (1)	6	2437	17.90	18.50	1.148	98.2	1.018	-0.07	0.933	1.016	1.091
									17.60	18.50	1.230	98.2	1.018	-0.07	0.613	1.031	0.768
1st	WLAN5GHz	802.11n-HT40 MCS0	Bottom of Laptop	0mm	Sample 1	Ant 1+2 (1)	62	5310	14.60	15.00	1.096	99.7	1.003	0.01	0.329	-	0.362
									14.60	15.00	1.096	99.7	1.003	0.01	0.826	-	0.908
2nd	WLAN5GHz	802.11n-HT40 MCS0	Bottom of Laptop	0mm	Sample 1	Ant 1+2 (1)	62	5310	14.60	15.00	1.096	99.7	1.003	0.06	0.322	1.022	0.354
									14.60	15.00	1.096	99.7	1.003	0.06	0.809	1.021	0.890
1st	WLAN5GHz	802.11n-HT40 MCS0	Bottom of Laptop	0mm	Sample 1	Ant 1+2 (1)	126	5630	14.20	15.50	1.349	99.7	1.003	-0.03	0.515	-	0.697
									15.50	15.50	1.000	99.7	1.003	-0.03	1.010	-	1.013
2nd	WLAN5GHz	802.11n-HT40 MCS0	Bottom of Laptop	0mm	Sample 1	Ant 1+2 (1)	126	5630	14.20	15.50	1.349	99.7	1.003	0.14	0.507	1.016	0.686
									15.50	15.50	1.000	99.7	1.003	0.14	0.996	1.014	0.999
1st	WLAN5GHz	802.11ac-VHT80 MCS0	Bottom of Laptop	0mm	Sample 1	Ant 1+2 (1)	155	5775	14.70	16.00	1.349	99.6	1.004	0.02	0.427	-	0.578
									16.00	16.00	1.000	99.6	1.004	0.02	0.909	-	0.913
2nd	WLAN5GHz	802.11ac-VHT80 MCS0	Bottom of Laptop	0mm	Sample 1	Ant 1+2 (1)	155	5775	14.70	16.00	1.349	99.6	1.004	0.12	0.422	1.012	0.572
									16.00	16.00	1.000	99.6	1.004	0.12	0.884	1.028	0.888

General Note:

- Per KDB 865664 D01v01r04, for each frequency band, repeated SAR measurement is required only when the measured SAR is  $\geq 0.8W/kg$ .
- Per KDB 865664 D01v01r04, if the ratio among the repeated measurement is  $\leq 1.2$  and the measured SAR  $< 1.45W/kg$ , only one repeated measurement is required.
- The ratio is the difference in percentage between original and repeated *measured SAR*.
- All measurement SAR result is scaled-up to account for tune-up tolerance and is compliant.

### 13. Simultaneous Transmission Analysis

NO.	Simultaneous Transmission Configurations	Support	Note
<b>Non-DBS</b>			
1.	WLAN 2.4GHz ANT 1 + WLAN 2.4GHz ANT 2	√	
2.	WLAN 5GHz ANT 1 + WLAN 5GHz ANT 2	√	Covered by NO.4
3.	WLAN 6GHz ANT 1 + WLAN 6GHz ANT 2	√	Covered by NO.5
4.	WLAN 5GHz ANT 1 + WLAN 5GHz ANT 2 + Bluetooth ANT 1	√	
5.	WLAN 6GHz ANT 1 + WLAN 6GHz ANT 2 + Bluetooth ANT 1	√	
<b>DBS</b>			
6.	WLAN 5GHz ANT 1 + WLAN 2.4GHz ANT 2	√	Covered by NO.10
7.	WLAN 5GHz ANT 2 + WLAN 2.4GHz ANT 2	√	Covered by NO.10
8.	WLAN 2.4GHz ANT 2 + WLAN 6GHz ANT 2	√	Covered by NO.11
9.	WLAN 6GHz ANT 1 + WLAN 2.4GHz ANT 2	√	Covered by NO.11
10.	WLAN 2.4GHz ANT 1 + WLAN 5GHz ANT 1 + WLAN 2.4GHz ANT 2 + WLAN 5GHz ANT 2	√	
11.	WLAN 2.4GHz ANT 1 + WLAN 6GHz ANT 1 + WLAN 2.4GHz ANT 2 + WLAN 6GHz ANT 2	√	

**General Note:**

- The device may collocate with WWAN operation, but the WWAN was test exclusion by KDB 447498 D01, and the estimated as 1-g SAR 0.4W/kg when the distance is > 50mm according to KDB 447498 D01, also according to KDB 388624 D02 for over6G the SAR total algebraic summation from transmitter is < 1.45W/kg.
- Per KDB 447498 D01v06, simultaneous transmission SAR is compliant if,
  - Scalar SAR summation < 1.6W/kg.
  - $SPLSR = (SAR1 + SAR2)^{1.5} / (\text{min. separation distance, mm})$ , and the peak separation distance is determined from the square root of  $[(x1-x2)^2 + (y1-y2)^2 + (z1-z2)^2]$ , where (x1, y1, z1) and (x2, y2, z2) are the coordinates of the extrapolated peak SAR locations in the zoom scan.
  - If  $SPLSR \leq 0.04$ , simultaneously transmission SAR measurement is not necessary.
  - Simultaneously transmission SAR measurement, and the reported multi-band SAR < 1.6W/kg.

#### 13.1 Body Exposure Conditions

**Non-DBS**

Exposure Position	1	2	3	4	2+3 Summed 1g SAR (W/kg)	3+4 Summed 1g SAR (W/kg)
	2.4GHz WLAN Ant 1+2 1g SAR (W/kg)	5GHz WLAN Ant 1+2 1g SAR (W/kg)	Bluetooth Ant 1 1g SAR (W/kg)	WLAN 6E Ant 1+2 Ant 2 1g SAR (W/kg)		
Bottom of Laptop at 0mm	1.108	1.013	0.162	0.346	1.175	0.508

**DBS**

Exposure Position	1	2	3	4	1+2 Summed 1g SAR (W/kg)	1+4 Summed 1g SAR (W/kg)
	2.4GHz WLAN Ant 1+2 1g SAR (W/kg)	5GHz WLAN Ant 1+2 1g SAR (W/kg)	Bluetooth Ant 1 1g SAR (W/kg)	WLAN 6E Ant 1+2 Ant 2 1g SAR (W/kg)		
Bottom of Laptop at 0mm	0.514	0.590	0.162	0.346	1.104	0.860

Test Engineer : Lemon Su and Mood Huang

## **14. Uncertainty Assessment**

**Declaration of Conformity:**

The test results with all measurement uncertainty excluded is presented in accordance with the regulation limits or requirements declared by manufacturers.

**Comments and Explanations:**

The declared of product specification for EUT presented in the report are provided by the manufacturer, and the manufacturer takes all the responsibilities for the accuracy of product specification.

The component of uncertainty may generally be categorized according to the methods used to evaluate them. The evaluation of uncertainty by the statistical analysis of a series of observations is termed a Type A evaluation of uncertainty. The evaluation of uncertainty by means other than the statistical analysis of a series of observation is termed a Type B evaluation of uncertainty. Each component of uncertainty, however evaluated, is represented by an estimated standard deviation, termed standard uncertainty, which is determined by the positive square root of the estimated variance.

A Type A evaluation of standard uncertainty may be based on any valid statistical method for treating data. This includes calculating the standard deviation of the mean of a series of independent observations; using the method of least squares to fit a curve to the data in order to estimate the parameter of the curve and their standard deviations; or carrying out an analysis of variance in order to identify and quantify random effects in certain kinds of measurement.

A type B evaluation of standard uncertainty is typically based on scientific judgment using all of the relevant information available. These may include previous measurement data, experience, and knowledge of the behavior and properties of relevant materials and instruments, manufacture’s specification, data provided in calibration reports and uncertainties assigned to reference data taken from handbooks. Broadly speaking, the uncertainty is either obtained from an outdoor source or obtained from an assumed distribution, such as the normal distribution, rectangular or triangular distributions indicated in table below.

<b>Uncertainty Distributions</b>	<b>Normal</b>	<b>Rectangular</b>	<b>Triangular</b>	<b>U-Shape</b>
Multi-plying Factor <sup>(a)</sup>	1/k <sup>(b)</sup>	1/√3	1/√6	1/√2

(a) standard uncertainty is determined as the product of the multiplying factor and the estimated range of variations in the measured quantity

(b)  $\kappa$  is the coverage factor

### **Standard Uncertainty for Assumed Distribution**

The combined standard uncertainty of the measurement result represents the estimated standard deviation of the result. It is obtained by combining the individual standard uncertainties of both Type A and Type B evaluation using the usual “root-sum-squares” (RSS) methods of combining standard deviations by taking the positive square root of the estimated variances.

Expanded uncertainty is a measure of uncertainty that defines an interval about the measurement result within which the measured value is confidently believed to lie. It is obtained by multiplying the combined standard uncertainty by a coverage factor. Typically, the coverage factor ranges from 2 to 3. Using a coverage factor allows the true value of a measured quantity to be specified with a defined probability within the specified uncertainty range. For purpose of this document, a coverage factor two is used, which corresponds to confidence interval of about 95 %. The DASY uncertainty Budget is shown in the following tables.

The judgment of conformity in the report is based on the measurement results excluding the measurement uncertainty.





DASY6 Uncertainty Budget (Frequency band: 4 MHz - 10 GHz range)							
Error Description	Uncertainty Value (±%)	Probability	Divisor	(Ci) 1g	(Ci) 10g	Standard Uncertainty (1g) (±%)	Standard Uncertainty (10g) (±%)
<b>Measurement System</b>							
Probe Calibration	18.60	N	2	1	1	9.3	9.3
Probe Calibration Drift	1.00	N	1	1	1	1.0	1.0
Probe Linearity	4.70	R	1.732	1	1	2.7	2.7
Broadband Signal	3.00	N	1	1	1	3.0	3.0
Probe Isotropy	7.60	R	2	1	1	3.8	3.8
Data Acquisition	0.30	N	1.732	1	1	0.2	0.2
RF Ambient	1.80	N	1	1	1	1.8	1.8
Probe Positioning	0.20	N	1	0.33	0.33	0.1	0.1
Data Processing	3.50	N	1	1	1	3.5	3.5
<b>Phantom and Device Errors</b>							
Conductivity (meas.) DAK	2.50	N	1	0.78	0.71	2.0	1.8
Conductivity (temp.) BB	5.40	R	1.732	0.78	0.71	2.4	2.2
Phantom Permittivity	14.00	R	1.732	0.5	0.5	4.0	4.0
Distance DUT - TSL	2.00	N	1	2	2	4.0	4.0
Device Holder	3.60	N	1	1	1	3.6	3.6
DUT Modulationm	2.40	R	1.732	1	1	1.4	1.4
Time-average SAR	2.60	R	1.732	1	1	1.5	1.5
DUT drift	5.00	N	1	1	1	5.0	5.0
<b>Correction to the SAR results</b>							
Deviation to Target	1.90	N	1	1	0.84	1.9	1.6
SAR scalingp	0.00	R	1.732	1	1	0.0	0.0
<b>Combined Std. Uncertainty</b>						14.9%	14.8%
<b>Coverage Factor for 95 %</b>						K=2	K=2
<b>Expanded STD Uncertainty</b>						29.8%	29.6%

**SAR Uncertainty Budget for frequency range 4MHz to 10GHz**



<b>cDASY6 Module mmWave Uncertainty Budget</b> <b>Evaluation Distances to the Antennas &gt; <math>\lambda/2\pi</math></b> <b>In Compliance with IEC/IEEE 63195</b>					
<b>Error Description</b>	<b>Uncertainty Value (<math>\pm</math>dB)</b>	<b>Probability</b>	<b>Divisor</b>	<b>(Ci)</b>	<b>Standard Uncertainty (<math>\pm</math>dB)</b>
<b>Uncertainty terms dependent on the measurement system</b>					
Probe Calibration	0.49	N	1	1	0.49
Probe correction	0.00	R	1.732	1	0.00
Frequency response (BW $\leq$ 1 GHz)	0.20	R	1.732	1	0.12
Sensor cross coupling	0.00	R	1.732	1	0.00
Isotropy	0.50	R	1.732	1	0.29
Linearity	0.20	R	1.732	1	0.12
Probe scattering	0.00	R	1.732	1	0.00
Probe positioning offset	0.30	R	1.732	1	0.17
Probe positioning repeatability	0.04	R	1.732	1	0.02
Sensor mechanical offset	0.00	R	1.732	1	0.00
Probe spatial resolution	0.00	R	1.732	1	0.00
Field impedance dependance	0.00	R	1.732	1	0.00
Amplitude and phase drift	0.00	R	1.732	1	0.00
Amplitude and phase noise	0.04	R	1.732	1	0.02
Measurement area truncation	0.00	R	1.732	1	0.00
Data acquisition	0.03	N	1	1	0.03
Sampling	0.00	R	1.732	1	0.00
Field reconstruction	2.00	R	1.732	1	1.15
Forward transformation	0.00	R	1.732	1	0.00
Power density scaling	0.00	R	1.732	1	0.00
Spatial averaging	0.10	R	1.732	1	0.06
System detection limit	0.04	R	1.732	1	0.02
<b>Uncertainty terms dependent on the DUT and environmental factors</b>					
Probe coupling with DUT	0.00	R	1.732	1	0.0
Modulation response	0.40	R	1.732	1	0.2
Integration time	0.00	R	1.732	1	0.0
Response time	0.00	R	1.732	1	0.0
Device holder influence	0.10	R	1.732	1	0.1
DUT alignment	0.00	R	1.732	1	0.0
RF ambient conditions	0.04	R	1.732	1	0.0
Ambient reflections	0.04	R	1.732	1	0.0
Immunity / secondary reception	0.00	R	1.732	1	0.0
Drift of the DUT		R	1.732	1	
<b>Combined Std. Uncertainty</b>					<b>1.34</b>
<b>Expanded STD Uncertainty (95%)</b>					<b>2.68</b>

**PD Uncertainty Budget**



## **15. References**

- [1] FCC 47 CFR Part 2 "Frequency Allocations and Radio Treaty Matters; General Rules and Regulations"
- [2] ANSI/IEEE Std. C95.1-1992, "IEEE Standard for Safety Levels with Respect to Human Exposure to Radio Frequency Electromagnetic Fields, 3 kHz to 300 GHz", September 1992
- [3] IEEE Std. 1528-2013, "IEEE Recommended Practice for Determining the Peak Spatial-Average Specific Absorption Rate (SAR) in the Human Head from Wireless Communications Devices: Measurement Techniques", Sep 2013
- [4] SPEAG DASY System Handbook
- [5] FCC KDB 248227 D01 v02r02, "SAR Guidance for IEEE 802.11 (WiFi) Transmitters", Oct 2015.
- [6] FCC KDB 447498 D01 v06, "Mobile and Portable Device RF Exposure Procedures and Equipment Authorization Policies", Oct 2015
- [7] FCC KDB 616217 D04 v01r02, "SAR Evaluation Considerations for Laptop, Notebook, Netbook and Tablet Computers", Oct 2015
- [8] FCC KDB 865664 D01 v01r04, "SAR Measurement Requirements for 100 MHz to 6 GHz", Aug 2015.
- [9] FCC KDB 865664 D02 v01r02, "RF Exposure Compliance Reporting and Documentation Considerations" Oct 2015.