



FCC DFS Test Report

Equipment : 802.11ac WLAN Radio Module
Brand Name : HP
Model No. : MRLBB-1301
FCC ID : B94MRLBB1301
Standard : 47 CFR FCC Part 15.407
Frequency Range : 5250 MHz – 5350 MHz
5470 MHz – 5725 MHz
Applicant : Hewlett-Packard Company
3000 Hanover Street Palo Alto, California 94304 U.S.A.
Manufacturer : Joy Technology (ShenZhen) Corporation
Building A,B,C,D, HengKeng Ind., Shangpai,
Shangwu,Aiqun Rd., Shiyan Town,Shenzhen 518135
China
Operate Mode : Client without radar detection

The product sample received on Jun. 28, 2013 and completely tested on Apr. 01, 2015. We, SPORTON, would like to declare that the tested sample has been evaluated in accordance with the procedures given in FCC 06-96 Appendix & FCC KDB 905462 D02 UNII DFS Compliance Procedures New Rules v01r01 and shown compliance with the applicable technical standards. The test results in this report apply exclusively to the tested model / sample. Without written approval of SPORTON INTERNATIONAL INC., the test report shall not be reproduced except in full.

Sam Chen
SPORTON INTERNATIONAL INC.





Table of Contents

1	GENERAL DESCRIPTION	5
1.1	Information.....	5
1.2	Accessories	18
1.3	Support Equipment.....	18
1.4	Testing Applied Standards	18
1.5	Testing Location Information	18
2	TEST CONFIGURATION OF EUT	19
2.1	Test Channel Frequencies Configuration.....	19
2.2	The Worst Case Measurement Configuration.....	19
3	DYNAMIC FREQUENCY SELECTION (DFS) TEST RESULT	20
3.1	General DFS Information	20
3.2	Radar Test Waveform Calibration	23
3.3	In-service Monitoring	34
4	TEST EQUIPMENT AND CALIBRATION DATA	47
5	MEASUREMENT UNCERTAINTY	48
	APPENDIX A. TEST PHOTOS	A1 ~ A2



Summary of Test Result

Conformance Test Specifications (FCC 06-96 Appendix)				
Report Clause	Ref. Std. Clause	Description	Limit	Result
3.3	7.8.3	DFS: In-Service Monitoring for Channel Move Time (CMT)	CMT ≤ 10sec	Complied
3.3	7.8.3	DFS: In-Service Monitoring for Channel Closing Transmission Time (CCTT)	CCTT ≤ 60 ms starting at CMT 200ms	Complied
3.3	7.8.3	DFS: In-Service Monitoring for Non-Occupancy Period (NOP)	NOP ≥ 30 min	Complied

Note: Since the product is client without radar detection function, only Channel Move Time, Channel Closing Transmission Time and Non-Occupancy Period are required to be performed.



Revision History

Report No.	Version	Description	Issued Date
FZ321924-07	Rev. 01	Initial issue of report	Apr. 29, 2015



1 General Description

1.1 Information

1.1.1 RF General Information

Specification Items	Description
Product Type	WLAN (3TX, 3RX)
Radio Type	Intentional Transceiver
Power Type	From host system
Modulation	see the below table for 802.11n/ac OFDM (BPSK / QPSK / 16QAM / 64QAM) for IEEE 802.11a
Data Rate (Mbps)	see the below table for 802.11n/ac OFDM (6/9/12/18/24/36/48/54) for IEEE 802.11a
Channel Bandwidth	20/40/80 MHz operating channel bandwidth
Operating Mode	<input type="checkbox"/> Master
	<input type="checkbox"/> Slave with radar detection
	<input checked="" type="checkbox"/> Slave without radar detection
Communication Mode	<input checked="" type="checkbox"/> IP Based (Load Based) <input type="checkbox"/> Frame Based
TPC Function	<input checked="" type="checkbox"/> With TPC <input type="checkbox"/> Without TPC
Weather Band (5600~5650MHz)	<input checked="" type="checkbox"/> With 5600~5650MHz <input type="checkbox"/> Without 5600~5650MHz



Max. Con. Power (DFS band)	<p><u>Mode 1 (Ant. 1 Dipole antenna / 1dBi)</u></p> <p>Band 2:</p> <p>IEEE 802.11a: 23.91 dBm</p> <p>IEEE 802.11ac MCS0/Nss1 (VHT20): 23.90 dBm</p> <p>IEEE 802.11ac MCS0/Nss3 (VHT20): 23.82 dBm</p> <p>IEEE 802.11ac MCS0/Nss1 (VHT40): 22.68 dBm</p> <p>IEEE 802.11ac MCS0/Nss3 (VHT40): 23.97 dBm</p> <p>IEEE 802.11ac MCS0/Nss1 (VHT80): 16.86 dBm</p> <p>IEEE 802.11ac MCS0/Nss3 (VHT80): 17.66 dBm</p> <p>Band 3:</p> <p>IEEE 802.11a: 23.93 dBm</p> <p>IEEE 802.11ac MCS0/Nss1 (VHT20): 23.85 dBm</p> <p>IEEE 802.11ac MCS0/Nss3 (VHT20): 23.90 dBm</p> <p>IEEE 802.11ac MCS0/Nss1 (VHT40): 23.87 dBm</p> <p>IEEE 802.11ac MCS0/Nss3 (VHT40): 23.94 dBm</p> <p>IEEE 802.11ac MCS0/Nss1 (VHT80): 21.96 dBm</p> <p>IEEE 802.11ac MCS0/Nss3 (VHT80): 21.73 dBm</p> <p><u>Mode 2 (Ant. 3 Omnidirectional antenna / 6.7dBi)</u></p> <p>Band 2:</p> <p>IEEE 802.11a: 18.78 dBm</p> <p>IEEE 802.11ac MCS0/Nss1 (VHT20): 19.11 dBm</p> <p>IEEE 802.11ac MCS0/Nss3 (VHT20): 23.17 dBm</p> <p>IEEE 802.11ac MCS0/Nss1 (VHT40): 21.97 dBm</p> <p>IEEE 802.11ac MCS0/Nss3 (VHT40): 23.11 dBm</p> <p>IEEE 802.11ac MCS0/Nss1 (VHT80): 16.45 dBm</p> <p>IEEE 802.11ac MCS0/Nss3 (VHT80): 17.10 dBm</p> <p>Band 3:</p> <p>IEEE 802.11a: 19.03 dBm</p> <p>IEEE 802.11ac MCS0/Nss1 (VHT20): 19.29 dBm</p> <p>IEEE 802.11ac MCS0/Nss3 (VHT20): 23.12 dBm</p> <p>IEEE 802.11ac MCS0/Nss1 (VHT40): 21.92 dBm</p> <p>IEEE 802.11ac MCS0/Nss3 (VHT40): 22.73 dBm</p> <p>IEEE 802.11ac MCS0/Nss1 (VHT80): 22.56 dBm</p> <p>IEEE 802.11ac MCS0/Nss3 (VHT80): 22.70 dBm</p>
-----------------------------------	--



<p><u>Mode 3 (Ant. 4 Panel antenna / 9.2dBi)</u></p> <p>Band 2:</p> <p>IEEE 802.11a: 16.55 dBm</p> <p>IEEE 802.11ac MCS0/Nss1 (VHT20): 16.79 dBm</p> <p>IEEE 802.11ac MCS0/Nss3 (VHT20): 20.64 dBm</p> <p>IEEE 802.11ac MCS0/Nss1 (VHT40): 19.56 dBm</p> <p>IEEE 802.11ac MCS0/Nss3 (VHT40): 20.48 dBm</p> <p>IEEE 802.11ac MCS0/Nss1 (VHT80): 14.94 dBm</p> <p>IEEE 802.11ac MCS0/Nss3 (VHT80): 15.94 dBm</p> <p>Band 3:</p> <p>IEEE 802.11a: 16.47 dBm</p> <p>IEEE 802.11ac MCS0/Nss1 (VHT20): 16.79 dBm</p> <p>IEEE 802.11ac MCS0/Nss3 (VHT20): 20.57 dBm</p> <p>IEEE 802.11ac MCS0/Nss1 (VHT40): 19.36 dBm</p> <p>IEEE 802.11ac MCS0/Nss3 (VHT40): 20.56 dBm</p> <p>IEEE 802.11ac MCS0/Nss1 (VHT80): 20.74 dBm</p> <p>IEEE 802.11ac MCS0/Nss3 (VHT80): 20.79 dBm</p> <p><u>Mode 4 (Ant. 5 PCB antenna / 5.74dBi)</u></p> <p>Band 2:</p> <p>IEEE 802.11a: 19.54 dBm</p> <p>IEEE 802.11ac MCS0/Nss1 (VHT20): 19.99 dBm</p> <p>IEEE 802.11ac MCS0/Nss3 (VHT20): 23.91 dBm</p> <p>IEEE 802.11ac MCS0/Nss1 (VHT40): 23.06 dBm</p> <p>IEEE 802.11ac MCS0/Nss3 (VHT40): 23.70 dBm</p> <p>IEEE 802.11ac MCS0/Nss1 (VHT80): 18.08 dBm</p> <p>IEEE 802.11ac MCS0/Nss3 (VHT80): 18.28 dBm</p> <p>Band 3:</p> <p>IEEE 802.11a: 20.04 dBm</p> <p>IEEE 802.11ac MCS0/Nss1 (VHT20): 20.19 dBm</p> <p>IEEE 802.11ac MCS0/Nss3 (VHT20): 23.91 dBm</p> <p>IEEE 802.11ac MCS0/Nss1 (VHT40): 22.97 dBm</p> <p>IEEE 802.11ac MCS0/Nss3 (VHT40): 23.77 dBm</p> <p>IEEE 802.11ac MCS0/Nss1 (VHT80): 22.96 dBm</p> <p>IEEE 802.11ac MCS0/Nss3 (VHT80): 22.87 dBm</p>
--



Min. Con. Power (DFS band)	<p><u>Mode 1 (Ant. 1 Dipole antenna / 1dBi)</u></p> <p>Band 2:</p> <p>IEEE 802.11a: 17.91 dBm</p> <p>IEEE 802.11ac MCS0/Nss1 (VHT20): 17.90 dBm</p> <p>IEEE 802.11ac MCS0/Nss3 (VHT20): 17.82 dBm</p> <p>IEEE 802.11ac MCS0/Nss1 (VHT40): 16.68 dBm</p> <p>IEEE 802.11ac MCS0/Nss3 (VHT40): 17.97 dBm</p> <p>IEEE 802.11ac MCS0/Nss1 (VHT80): 10.86 dBm</p> <p>IEEE 802.11ac MCS0/Nss3 (VHT80): 11.66 dBm</p> <p>Band 3:</p> <p>IEEE 802.11a: 17.93 dBm</p> <p>IEEE 802.11ac MCS0/Nss1 (VHT20): 17.85 dBm</p> <p>IEEE 802.11ac MCS0/Nss3 (VHT20): 17.90 dBm</p> <p>IEEE 802.11ac MCS0/Nss1 (VHT40): 17.87 dBm</p> <p>IEEE 802.11ac MCS0/Nss3 (VHT40): 17.94 dBm</p> <p>IEEE 802.11ac MCS0/Nss1 (VHT80): 15.96 dBm</p> <p>IEEE 802.11ac MCS0/Nss3 (VHT80): 15.73 dBm</p> <p><u>Mode 2 (Ant. 3 Omnidirectional antenna / 6.7dBi)</u></p> <p>Band 2:</p> <p>IEEE 802.11a: 12.78 dBm</p> <p>IEEE 802.11ac MCS0/Nss1 (VHT20): 13.11 dBm</p> <p>IEEE 802.11ac MCS0/Nss3 (VHT20): 17.17 dBm</p> <p>IEEE 802.11ac MCS0/Nss1 (VHT40): 15.97 dBm</p> <p>IEEE 802.11ac MCS0/Nss3 (VHT40): 17.11 dBm</p> <p>IEEE 802.11ac MCS0/Nss1 (VHT80): 10.45 dBm</p> <p>IEEE 802.11ac MCS0/Nss3 (VHT80): 11.10 dBm</p> <p>Band 3:</p> <p>IEEE 802.11a: 13.03 dBm</p> <p>IEEE 802.11ac MCS0/Nss1 (VHT20): 13.29 dBm</p> <p>IEEE 802.11ac MCS0/Nss3 (VHT20): 17.12 dBm</p> <p>IEEE 802.11ac MCS0/Nss1 (VHT40): 15.92 dBm</p> <p>IEEE 802.11ac MCS0/Nss3 (VHT40): 16.73 dBm</p> <p>IEEE 802.11ac MCS0/Nss1 (VHT80): 16.56 dBm</p> <p>IEEE 802.11ac MCS0/Nss3 (VHT80): 16.70 dBm</p>
-----------------------------------	--



<p><u>Mode 3 (Ant. 4 Panel antenna / 9.2dBi)</u></p> <p>Band 2:</p> <p>IEEE 802.11a: 10.55 dBm</p> <p>IEEE 802.11ac MCS0/Nss1 (VHT20): 10.79 dBm</p> <p>IEEE 802.11ac MCS0/Nss3 (VHT20): 14.64 dBm</p> <p>IEEE 802.11ac MCS0/Nss1 (VHT40): 13.56 dBm</p> <p>IEEE 802.11ac MCS0/Nss3 (VHT40): 14.48 dBm</p> <p>IEEE 802.11ac MCS0/Nss1 (VHT80): 8.94 dBm</p> <p>IEEE 802.11ac MCS0/Nss3 (VHT80): 9.94 dBm</p> <p>Band 3:</p> <p>IEEE 802.11a: 10.47 dBm</p> <p>IEEE 802.11ac MCS0/Nss1 (VHT20): 10.79 dBm</p> <p>IEEE 802.11ac MCS0/Nss3 (VHT20): 14.57 dBm</p> <p>IEEE 802.11ac MCS0/Nss1 (VHT40): 13.36 dBm</p> <p>IEEE 802.11ac MCS0/Nss3 (VHT40): 14.56 dBm</p> <p>IEEE 802.11ac MCS0/Nss1 (VHT80): 14.74 dBm</p> <p>IEEE 802.11ac MCS0/Nss3 (VHT80): 14.79 dBm</p> <p><u>Mode 4 (Ant. 5 PCB antenna / 5.74dBi)</u></p> <p>Band 2:</p> <p>IEEE 802.11a: 13.54 dBm</p> <p>IEEE 802.11ac MCS0/Nss1 (VHT20): 13.99 dBm</p> <p>IEEE 802.11ac MCS0/Nss3 (VHT20): 17.91 dBm</p> <p>IEEE 802.11ac MCS0/Nss1 (VHT40): 17.06 dBm</p> <p>IEEE 802.11ac MCS0/Nss3 (VHT40): 17.70 dBm</p> <p>IEEE 802.11ac MCS0/Nss1 (VHT80): 12.08 dBm</p> <p>IEEE 802.11ac MCS0/Nss3 (VHT80): 12.28 dBm</p> <p>Band 3:</p> <p>IEEE 802.11a: 14.04 dBm</p> <p>IEEE 802.11ac MCS0/Nss1 (VHT20): 14.19 dBm</p> <p>IEEE 802.11ac MCS0/Nss3 (VHT20): 17.91 dBm</p> <p>IEEE 802.11ac MCS0/Nss1 (VHT40): 16.97 dBm</p> <p>IEEE 802.11ac MCS0/Nss3 (VHT40): 17.77 dBm</p> <p>IEEE 802.11ac MCS0/Nss1 (VHT80): 16.96 dBm</p> <p>IEEE 802.11ac MCS0/Nss3 (VHT80): 16.87 dBm</p>
--



Max. EIRP Power (DFS band)	<p><u>Mode 1 (Ant. 1 Dipole antenna / 1dBi)</u></p> <p>Band 2:</p> <p>IEEE 802.11a: 24.91 dBm</p> <p>IEEE 802.11ac MCS0/Nss1 (VHT20): 24.90 dBm</p> <p>IEEE 802.11ac MCS0/Nss3 (VHT20): 24.82 dBm</p> <p>IEEE 802.11ac MCS0/Nss1 (VHT40): 23.68 dBm</p> <p>IEEE 802.11ac MCS0/Nss3 (VHT40): 24.97 dBm</p> <p>IEEE 802.11ac MCS0/Nss1 (VHT80): 17.86 dBm</p> <p>IEEE 802.11ac MCS0/Nss3 (VHT80): 18.66 dBm</p> <p>Band 3:</p> <p>IEEE 802.11a: 24.93 dBm</p> <p>IEEE 802.11ac MCS0/Nss1 (VHT20): 24.85 dBm</p> <p>IEEE 802.11ac MCS0/Nss3 (VHT20): 24.90 dBm</p> <p>IEEE 802.11ac MCS0/Nss1 (VHT40): 24.87 dBm</p> <p>IEEE 802.11ac MCS0/Nss3 (VHT40): 24.94 dBm</p> <p>IEEE 802.11ac MCS0/Nss1 (VHT80): 22.96 dBm</p> <p>IEEE 802.11ac MCS0/Nss3 (VHT80): 22.73 dBm</p> <p><u>Mode 2 (Ant. 3 Omnidirectional antenna / 6.7dBi)</u></p> <p>Band 2:</p> <p>IEEE 802.11a: 25.48 dBm</p> <p>IEEE 802.11ac MCS0/Nss1 (VHT20): 25.81 dBm</p> <p>IEEE 802.11ac MCS0/Nss3 (VHT20): 29.87 dBm</p> <p>IEEE 802.11ac MCS0/Nss1 (VHT40): 28.67 dBm</p> <p>IEEE 802.11ac MCS0/Nss3 (VHT40): 29.81 dBm</p> <p>IEEE 802.11ac MCS0/Nss1 (VHT80): 23.15 dBm</p> <p>IEEE 802.11ac MCS0/Nss3 (VHT80): 23.80 dBm</p> <p>Band 3:</p> <p>IEEE 802.11a: 25.73 dBm</p> <p>IEEE 802.11ac MCS0/Nss1 (VHT20): 25.99 dBm</p> <p>IEEE 802.11ac MCS0/Nss3 (VHT20): 29.82 dBm</p> <p>IEEE 802.11ac MCS0/Nss1 (VHT40): 28.62 dBm</p> <p>IEEE 802.11ac MCS0/Nss3 (VHT40): 29.43 dBm</p> <p>IEEE 802.11ac MCS0/Nss1 (VHT80): 29.26 dBm</p> <p>IEEE 802.11ac MCS0/Nss3 (VHT80): 29.40 dBm</p>
-----------------------------------	--



<p><u>Mode 3 (Ant. 4 Panel antenna / 9.2dBi)</u></p> <p>Band 2:</p> <p>IEEE 802.11a: 25.75 dBm</p> <p>IEEE 802.11ac MCS0/Nss1 (VHT20): 25.99 dBm</p> <p>IEEE 802.11ac MCS0/Nss3 (VHT20): 29.84 dBm</p> <p>IEEE 802.11ac MCS0/Nss1 (VHT40): 28.76 dBm</p> <p>IEEE 802.11ac MCS0/Nss3 (VHT40): 29.68 dBm</p> <p>IEEE 802.11ac MCS0/Nss1 (VHT80): 24.14 dBm</p> <p>IEEE 802.11ac MCS0/Nss3 (VHT80): 25.14 dBm</p> <p>Band 3:</p> <p>IEEE 802.11a: 25.67 dBm</p> <p>IEEE 802.11ac MCS0/Nss1 (VHT20): 25.99 dBm</p> <p>IEEE 802.11ac MCS0/Nss3 (VHT20): 29.77 dBm</p> <p>IEEE 802.11ac MCS0/Nss1 (VHT40): 28.56 dBm</p> <p>IEEE 802.11ac MCS0/Nss3 (VHT40): 29.76 dBm</p> <p>IEEE 802.11ac MCS0/Nss1 (VHT80): 29.94 dBm</p> <p>IEEE 802.11ac MCS0/Nss3 (VHT80): 29.99 dBm</p> <p><u>Mode 4 (Ant. 5 PCB antenna / 5.74dBi)</u></p> <p>Band 2:</p> <p>IEEE 802.11a: 22.28 dBm</p> <p>IEEE 802.11ac MCS0/Nss1 (VHT20): 25.73 dBm</p> <p>IEEE 802.11ac MCS0/Nss3 (VHT20): 29.65 dBm</p> <p>IEEE 802.11ac MCS0/Nss1 (VHT40): 28.80 dBm</p> <p>IEEE 802.11ac MCS0/Nss3 (VHT40): 29.44 dBm</p> <p>IEEE 802.11ac MCS0/Nss1 (VHT80): 23.82 dBm</p> <p>IEEE 802.11ac MCS0/Nss3 (VHT80): 24.02 dBm</p> <p>Band 3:</p> <p>IEEE 802.11a: 25.78 dBm</p> <p>IEEE 802.11ac MCS0/Nss1 (VHT20): 25.93 dBm</p> <p>IEEE 802.11ac MCS0/Nss3 (VHT20): 29.65 dBm</p> <p>IEEE 802.11ac MCS0/Nss1 (VHT40): 28.71 dBm</p> <p>IEEE 802.11ac MCS0/Nss3 (VHT40): 29.51 dBm</p> <p>IEEE 802.11ac MCS0/Nss1 (VHT80): 28.70 dBm</p> <p>IEEE 802.11ac MCS0/Nss3 (VHT80): 28.61 dBm</p>
--



Min. EIRP Power (DFS band)	<p><u>Mode 1 (Ant. 1 Dipole antenna / 1dBi)</u></p> <p>Band 2:</p> <p>IEEE 802.11a: 18.91 dBm</p> <p>IEEE 802.11ac MCS0/Nss1 (VHT20): 18.90 dBm</p> <p>IEEE 802.11ac MCS0/Nss3 (VHT20): 18.82 dBm</p> <p>IEEE 802.11ac MCS0/Nss1 (VHT40): 17.68 dBm</p> <p>IEEE 802.11ac MCS0/Nss3 (VHT40): 18.97 dBm</p> <p>IEEE 802.11ac MCS0/Nss1 (VHT80): 11.86 dBm</p> <p>IEEE 802.11ac MCS0/Nss3 (VHT80): 12.66 dBm</p> <p>Band 3:</p> <p>IEEE 802.11a: 18.93 dBm</p> <p>IEEE 802.11ac MCS0/Nss1 (VHT20): 18.85 dBm</p> <p>IEEE 802.11ac MCS0/Nss3 (VHT20): 18.90 dBm</p> <p>IEEE 802.11ac MCS0/Nss1 (VHT40): 18.87 dBm</p> <p>IEEE 802.11ac MCS0/Nss3 (VHT40): 18.94 dBm</p> <p>IEEE 802.11ac MCS0/Nss1 (VHT80): 16.96 dBm</p> <p>IEEE 802.11ac MCS0/Nss3 (VHT80): 16.73 dBm</p> <p><u>Mode 2 (Ant. 3 Omnidirectional antenna / 6.7dBi)</u></p> <p>Band 2:</p> <p>IEEE 802.11a: 19.48 dBm</p> <p>IEEE 802.11ac MCS0/Nss1 (VHT20): 19.81 dBm</p> <p>IEEE 802.11ac MCS0/Nss3 (VHT20): 23.87 dBm</p> <p>IEEE 802.11ac MCS0/Nss1 (VHT40): 22.67 dBm</p> <p>IEEE 802.11ac MCS0/Nss3 (VHT40): 23.81 dBm</p> <p>IEEE 802.11ac MCS0/Nss1 (VHT80): 17.15 dBm</p> <p>IEEE 802.11ac MCS0/Nss3 (VHT80): 17.80 dBm</p> <p>Band 3:</p> <p>IEEE 802.11a: 19.73 dBm</p> <p>IEEE 802.11ac MCS0/Nss1 (VHT20): 19.99 dBm</p> <p>IEEE 802.11ac MCS0/Nss3 (VHT20): 23.82 dBm</p> <p>IEEE 802.11ac MCS0/Nss1 (VHT40): 22.62 dBm</p> <p>IEEE 802.11ac MCS0/Nss3 (VHT40): 23.43 dBm</p> <p>IEEE 802.11ac MCS0/Nss1 (VHT80): 23.26 dBm</p> <p>IEEE 802.11ac MCS0/Nss3 (VHT80): 23.40 dBm</p>
-----------------------------------	--



	<p><u>Mode 3 (Ant. 4 Panel antenna / 9.2dBi)</u></p> <p>Band 2:</p> <p>IEEE 802.11a: 19.75 dBm</p> <p>IEEE 802.11ac MCS0/Nss1 (VHT20): 19.99 dBm</p> <p>IEEE 802.11ac MCS0/Nss3 (VHT20): 23.84 dBm</p> <p>IEEE 802.11ac MCS0/Nss1 (VHT40): 22.76 dBm</p> <p>IEEE 802.11ac MCS0/Nss3 (VHT40): 23.68 dBm</p> <p>IEEE 802.11ac MCS0/Nss1 (VHT80): 18.14 dBm</p> <p>IEEE 802.11ac MCS0/Nss3 (VHT80): 19.14 dBm</p> <p>Band 3:</p> <p>IEEE 802.11a: 19.67 dBm</p> <p>IEEE 802.11ac MCS0/Nss1 (VHT20): 19.99 dBm</p> <p>IEEE 802.11ac MCS0/Nss3 (VHT20): 23.77 dBm</p> <p>IEEE 802.11ac MCS0/Nss1 (VHT40): 22.56 dBm</p> <p>IEEE 802.11ac MCS0/Nss3 (VHT40): 23.76 dBm</p> <p>IEEE 802.11ac MCS0/Nss1 (VHT80): 23.94 dBm</p> <p>IEEE 802.11ac MCS0/Nss3 (VHT80): 23.99 dBm</p> <p><u>Mode 4 (Ant. 5 PCB antenna / 5.74dBi)</u></p> <p>Band 2:</p> <p>IEEE 802.11a: 16.28 dBm</p> <p>IEEE 802.11ac MCS0/Nss1 (VHT20): 19.73 dBm</p> <p>IEEE 802.11ac MCS0/Nss3 (VHT20): 23.65 dBm</p> <p>IEEE 802.11ac MCS0/Nss1 (VHT40): 22.80 dBm</p> <p>IEEE 802.11ac MCS0/Nss3 (VHT40): 23.44 dBm</p> <p>IEEE 802.11ac MCS0/Nss1 (VHT80): 17.82 dBm</p> <p>IEEE 802.11ac MCS0/Nss3 (VHT80): 18.02 dBm</p> <p>Band 3:</p> <p>IEEE 802.11a: 19.78 dBm</p> <p>IEEE 802.11ac MCS0/Nss1 (VHT20): 19.93 dBm</p> <p>IEEE 802.11ac MCS0/Nss3 (VHT20): 23.65 dBm</p> <p>IEEE 802.11ac MCS0/Nss1 (VHT40): 22.71 dBm</p> <p>IEEE 802.11ac MCS0/Nss3 (VHT40): 23.51 dBm</p> <p>IEEE 802.11ac MCS0/Nss1 (VHT80): 22.70 dBm</p> <p>IEEE 802.11ac MCS0/Nss3 (VHT80): 22.61 dBm</p>
Power-on cycle	NA (No Channel Availability Check Function)
Software / Firmware Version	6.30.150.0



Note: EUT employ a TPC mechanism and TPC have the capability to operate at least 6 dB below highest RF output power.

Antenna & Band width

Antenna	Three (TX)		
	20 MHz	40 MHz	80MHz
IEEE 802.11a	V	X	X
IEEE 802.11n	V	V	X
IEEE 802.11ac	V	V	V

IEEE 11n/ac Spec.

Protocol	Number of Transmit Chains (NTX)	Data Rate / MCS
802.11n (HT20)	3	MCS 0-23
802.11n (HT40)	3	MCS 0-23
802.11ac (VHT20)	3	MCS 0-9/Nss1-3
802.11ac (VHT40)	3	MCS 0-9/Nss1-3
802.11ac (VHT80)	3	MCS 0-9/Nss1-3

Note 1: IEEE Std. 802.11n modulation consists of HT20 and HT40 (HT: High Throughput). Then EUT support HT20 and HT40.

Note 2: IEEE Std. 802.11ac modulation consists of VHT20, VHT40, VHT80 and VHT160 (VHT: Very High Throughput). Then EUT support VHT20, VHT40 and VHT80.

Note 3: Modulation modes consist of below configuration:

11a: IEEE 802.11a, HT20/HT40: IEEE 802.11n, VHT20/VHT40/VHT80: IEEE 802.11ac

1.1.2 Antenna Information

Ant	Brand	Model No.	Type	Connector	Ant. Gain (dBi)		Cable Loss (dBm)		True Gain (dBi)		Remark
					2.4G	5G	2.4G	5G	2.4G	5G	
1	HP	5188-9334	Dipole Antenna	Reversed-SMA	1.8	2	0.6	1	1.2	1	P to M
2	HP	J9719A	Element Antenna	N Type	6	-	0.8	-	5.2	-	P to M
3	HP	J9720A	Omnidirectional Antenna	N Type	-	8	-	1.3	-	6.7	P to M
4	HP	J9170A	Panel Antenna	N Type	10.9	13.5	3.8	4.3	7.1	9.2	P to P
5	HP	5066-3481	PCB Antenna	I-PEX	4.94	5.74	0	0	4.94	5.74	P to M

Note: There are five sets of antenna provided to this EUT and all of them can be used as transmitting and receiving antenna

For 2.4GHz function:

For IEEE 802.11b/g/n mode (3TX/3RX)

Chain 1, Chain 2 and Chain 3 could transmit/receive simultaneously.

For 5GHz function:

For IEEE 802.11a/n/ac mode (3TX/3RX)

Chain 1, Chain 2 and Chain 3 could transmit/receive simultaneously.

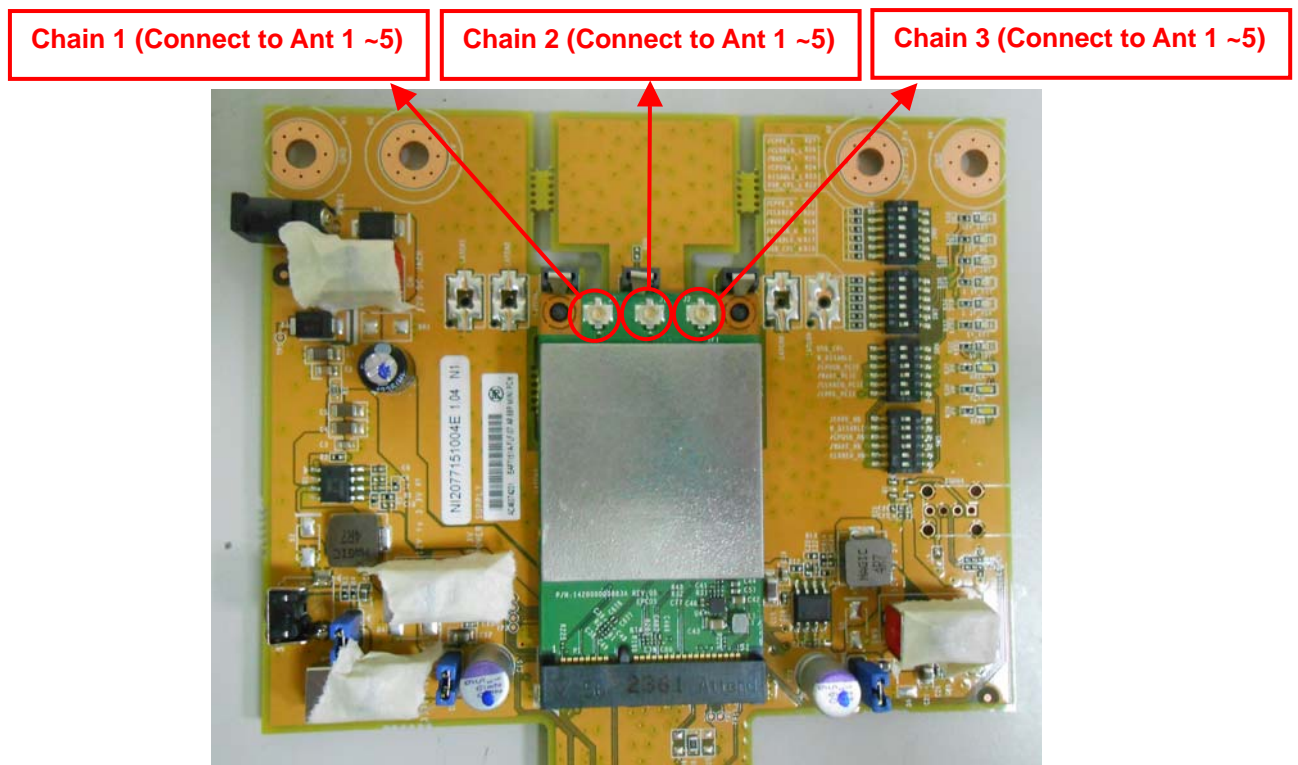



1.1.3 DFS Band Carrier Frequencies

There are three bandwidth systems.

For 20MHz bandwidth systems, use Channel 52, 56, 60, 64, 100, 104, 108, 112, 116, 120, 124, 128, 132, 136, 140, 144.

For 40MHz bandwidth systems, use Channel 54, 62, 102, 110, 118, 126, 134, 142.

For 80MHz bandwidth systems, use Channel 58, 106, 122, 138.

Frequency Band	Channel No.	Frequency	Channel No.	Frequency
5250~5350 MHz Band 2	52	5260 MHz	60	5300 MHz
	54	5270 MHz	62	5310 MHz
	56	5280 MHz	64	5320 MHz
	58	5290 MHz	-	-
5470~5725 MHz Band 3	100	5500 MHz	124	5620 MHz
	102	5510 MHz	126	5630 MHz
	104	5520 MHz	128	5640 MHz
	106	5530 MHz	132	5660 MHz
	108	5540 MHz	134	5670 MHz
	110	5550 MHz	136	5680 MHz
	112	5560 MHz	138	5690 MHz
	116	5580 MHz	140	5700 MHz
	118	5590 MHz	142	5710 MHz
	120	5600 MHz	144	5720 MHz
	122	5610 MHz	-	-



1.1.4 Table for Class II Change

This product is an extension of original one reported under Sporton project number: FZ321924-02

Below is the table for the change of the product with respect to the original one.

Modifications
1. Updating test rule of 5GHz band 1~4 (5150~5350MHz / 5470~5725MHz / 5725~5850 MHz) to "New Rules" from "Old Rules".
2. Adding weather band (5600~5650MHz) for this device.
Performance Checking
DFS test.



1.2 Accessories

N/A

1.3 Support Equipment

Support Equipment				
No.	Equipment	Brand Name	Model Name	FCC ID
1	Notebook	DELL	E4300	DoC
2	Notebook	DELL	D400	E2K24GBRL
3	Wireless AP	D-link	DIR-860L	KA2IR860LA1

1.4 Testing Applied Standards

According to the specifications of the manufacturer, the EUT must comply with the requirements of the following standards:

- ◆ FCC 06-96 Appendix
- ◆ FCC KDB 905462 D02 UNII DFS Compliance Procedures New Rules v01r01
- ◆ FCC KDB 443999 D01 Approval of DFS UNII Devices v01r03

1.5 Testing Location Information

Testing Location				
<input type="checkbox"/>	HWA YA	ADD : No. 52, Hwa Ya 1st Rd., Kwei-Shan Hsiang, Tao Yuan Hsien, Taiwan, R.O.C. TEL : 886-3-327-3456 FAX : 886-3-327-0973		
<input checked="" type="checkbox"/>	JHUBEI	ADD : No.8, Lane 724, Bo-ai St., Jhubei City, HsinChu County 302, Taiwan, R.O.C. TEL : 886-3-656-9065 FAX : 886-3-656-9085		
Test Condition	Test Site No.	Test Engineer	Test Environment	Test Date
DFS Site	DF01-CB	Taka Hsu	19°C / 60%	31-Mar-15 ~ 01-Apr-15

2 Test Configuration of EUT

2.1 Test Channel Frequencies Configuration

Test Channel Frequencies Configuration	
IEEE Std.	Test Channel Freq. (MHz)
802.11n (HT20)	5500 MHz
802.11ac (VHT40)	5510 MHz
802.11ac (VHT80)	5530 MHz

2.2 The Worst Case Measurement Configuration

The Worst Case Mode for Following Conformance Tests	
Tests Item	Dynamic Frequency Selection (DFS)
Test Condition	Radiated measurement The EUT shall be configured to operate at the highest transmitter output power setting. If more than one antenna assembly is intended for this power setting, the gain of the antenna assembly with the lowest gain shall be used. The DFS radar test signals have been aligned to the direction corresponding to the EUT's maximum antenna gain.
Modulation Mode	802.11n (HT20), 802.11ac (VHT40), 802.11ac (VHT80)



3 Dynamic Frequency Selection (DFS) Test Result

3.1 General DFS Information

3.1.1 DFS Parameters

Table D.1: DFS requirement values	
Parameter	Value
Non-occupancy period	Minimum 30 minutes
Channel Availability Check Time	60 seconds
Channel Move Time	10 seconds (Note 1).
Channel Closing Transmission Time	200 milliseconds + an aggregate of 60 milliseconds over remaining 10 second periods. (Notes 1 and 2).
U-NII Detection Bandwidth	Minimum 100% of the 99% power bandwidth (Note 3).

Note 1: Channel Move Time and the Channel Closing Transmission Time should be performed with Radar Type 0. The measurement timing begins at the end of the Radar Type 0 burst.

Note 2: The Channel Closing Transmission Time is comprised of 200 milliseconds starting at the beginning of the Channel Move Time plus any additional intermittent control signals required to facilitate Channel changes (an aggregate of 60 milliseconds) during the remainder of the 10 second period. The aggregate duration of control signals will not count quiet periods in between transmissions.

Note 3: During the U-NII Detection Bandwidth detection test, radar type 1 is used and for each frequency step the minimum percentage of detection is 90%. Measurements are performed with no data traffic.

Table D.2: Interference threshold values	
Maximum Transmit Power	Value (see note)
EIRP ≥ 200 mW	-64 dBm
EIRP < 200 mW and PSD < 10dBm/MHz	-62 dBm
EIRP < 200 mW and PSD ≥ 10dBm/MHz	-64 dBm

Note 1: This is the level at the input of the receiver assuming a 0 dBi receive antenna.

Note 2: Throughout these test procedures an additional 1 dB has been added to the amplitude of the test transmission waveforms to account for variations in measurement equipment. This will ensure that the test signal is at or above the detection threshold level to trigger a DFS response.

Note3: EIRP is based on the highest antenna gain. For MIMO devices refer to KDB Publication 662911D01.



3.1.2 Applicability of DFS Requirements Prior to Use of a Channel

Requirement	DFS Operational mode		
	Master	Client without radar detection	Client with radar detection
<i>Non-Occupancy Period</i>	Yes	Not required	Yes
<i>DFS Detection Threshold</i>	Yes	Not required	Yes
<i>Channel Availability Check Time</i>	Yes	Not required	Not required
<i>U-NII Detection Bandwidth</i>	Yes	Not required	Yes

3.1.3 Applicability of DFS Requirements during Normal Operation

Requirement	DFS Operational mode		
	Master	Client without radar detection	Client with radar detection
<i>DFS Detection Threshold</i>	Yes	Not required	Yes
<i>Channel Closing Transmission Time</i>	Yes	Yes	Yes
<i>Channel Move Time</i>	Yes	Yes	Yes
<i>U-NII Detection Bandwidth</i>	Yes	Not required	Yes

Additional requirements for devices with multiple bandwidth modes	Master Device or Client with Radar Detection	Client Without Radar Detection
U-NII Detection Bandwidth and Statistical Performance Check	All BW modes must be tested	Not required
Channel Move Time and Channel Closing Transmission Time	Test using widest BW mode available	Test using the widest BW mode available for the link
All other tests	Any single BW mode	Not required

Note: Frequencies selected for statistical performance check (Section 7.8.4) should include several frequencies within the radar detection bandwidth and frequencies near the edge of the radar detection bandwidth. For 802.11 devices it is suggested to select frequencies in each of the bonded 20 MHz channels and the channel center frequency.



3.1.4 Channel Loading/Data Streaming

<input checked="" type="checkbox"/>	IP Based (Load Based) - stream the test file from the Master to the Client.
<input type="checkbox"/>	The data file (MPEG-4) has been transmitting in a streaming mode.
<input type="checkbox"/>	Software to ping the client is permitted to simulate data transfer with random ping intervals.
<input checked="" type="checkbox"/>	Minimum channel loading of approximately 17%.
<input type="checkbox"/>	Unicast protocol has been used.
<input type="checkbox"/>	Frame Based - stream the test file from the Master to the Client.
<input type="checkbox"/>	fixed talk/listen ratio, set the ratio to 45%/55%

3.2 Radar Test Waveform Calibration

3.2.1 Short Pulse Radar Test Waveforms

Radar Type	Pulse Width (µsec)	PRI (µsec)	Number of Pulses	Minimum Percentage of Successful Detection	Minimum Trials
0	1	1428	18	See Note 1	See Note 1
1A	1	15 unique PRI in KDB 905462 D02 Table 5a	$\text{Roundup}\left\{\left(\frac{1}{360}\right) \times \left(\frac{19 \times 10^6}{PRI}\right)\right\}$	60%	15
1B	1	15 unique PRI within 518-3066, Excluding 1A PRI		60%	15
2	1-5	150-230	23-29	60%	30
3	6-10	200-500	16-18	60%	30
4	11-20	200-500	12-16	60%	30
Aggregate (Radar Types 1-4)				80%	120
Note 1: Short Pulse Radar Type 0 should be used for the detection bandwidth test, channel move time, and channel closing time tests.					

A minimum of 30 unique waveforms are required for each of the short pulse radar types 2 through 4. For short pulse radar type 1, the same waveform is used a minimum of 30 times. If more than 30 waveforms are used for short pulse radar types 2 through 4, then each additional waveform must also be unique and not repeated from the previous waveforms. The aggregate is the average of the percentage of successful detections of short pulse radar types 1-4.

3.2.2 Long Pulse Radar Test Waveform

Radar Type	Pulse Width (µsec)	Chirp Width (MHz)	PRI (µsec)	Number of Pulses per Burst	Number of Bursts	Minimum Percentage of Successful Detection	Minimum Trials
5	50-100	5-20	1000-2000	1-3	8-20	80%	30

Each waveform is defined as follows:

- The transmission period for the Long Pulse Radar test signal is 12 seconds.
- There are a total of 8 to 20 Bursts in the 12 second period, with the number of Bursts being randomly chosen. This number is Burst_Count.
- Each Burst consists of 1 to 3 pulses, with the number of pulses being randomly chosen. Each Burst within the 12 second sequence may have a different number of pulses.
- The pulse width is between 50 and 100 microseconds, with the pulse width being randomly chosen. Each pulse within a Burst will have the same pulse width. Pulses in different Bursts may have different pulse widths.
- Each pulse has a linear FM chirp between 5 and 20 MHz, with the chirp width being randomly chosen. Each pulse within a Burst will have the same chirp width. Pulses in different Bursts may have different chirp widths. The chirp is centered on the pulse. For example, with a radar frequency of 5300 MHz and a 20 MHz chirped signal, the chirp starts at 5290 MHz and ends at 5310 MHz.
- If more than one pulse is present in a Burst, the time between the pulses will be between 1000 and 2000

microseconds, with the time being randomly chosen. If three pulses are present in a Burst, the time between the first and second pulses is chosen independently of the time between the second and third pulses.

- The 12 second transmission period is divided into even intervals. The number of intervals is equal to Burst_Count. Each interval is of length (12,000,000 / Burst_Count) microseconds. Each interval contains one Burst. The start time for the Burst, relative to the beginning of the interval, is between 1 and [(12,000,000 / Burst_Count) – (Total Burst Length) + (One Random PRI Interval)] microseconds, with the start time being randomly chosen. The step interval for the start time is 1 microsecond. The start time for each Burst is chosen independently.

3.2.3 Frequency Hopping Radar Test Waveform

Radar Type	Pulse Width (µsec)	PRI (µsec)	Pulses per Hop	Hopping Rate (kHz)	Hopping Sequence Length (ms)	Minimum Percentage of Successful Detection	Minimum Trials
6	1	333	9	0.333	300	70%	30

The FCC Type 6 waveform uses a static waveform with 100 bursts in the instruments ARB. In addition, the RF list mode is operated with a list containing 100 frequencies from a randomly generated list and it had be ensured that at least one of the random frequencies falls into the UNII Detection Bandwidth of the DUT. Each burst from the waveform file initiates a trigger pulse at the beginning that switches the RF list from one item to the next one.

3.2.4 DFS Threshold Level

DFS Threshold Level	
DFS Threshold level: -63 dBm	<input checked="" type="checkbox"/> at the antenna connector
	<input type="checkbox"/> in front of the antenna
The Interference Radar Detection Threshold Level is is $-64 \text{ dBm} + 0 [dBi] + 1 \text{ dB} = -63 \text{ dBm}$. That had been taken into account the output power range and antenna gain.	

3.2.5 Calibration Setup

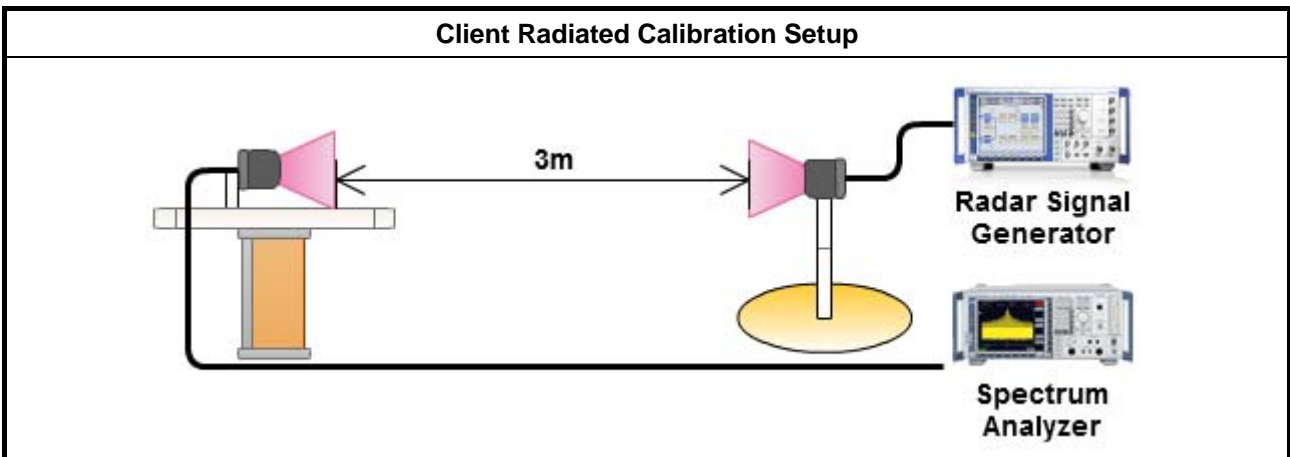



3.2.6 Radar Waveform calibration Plot

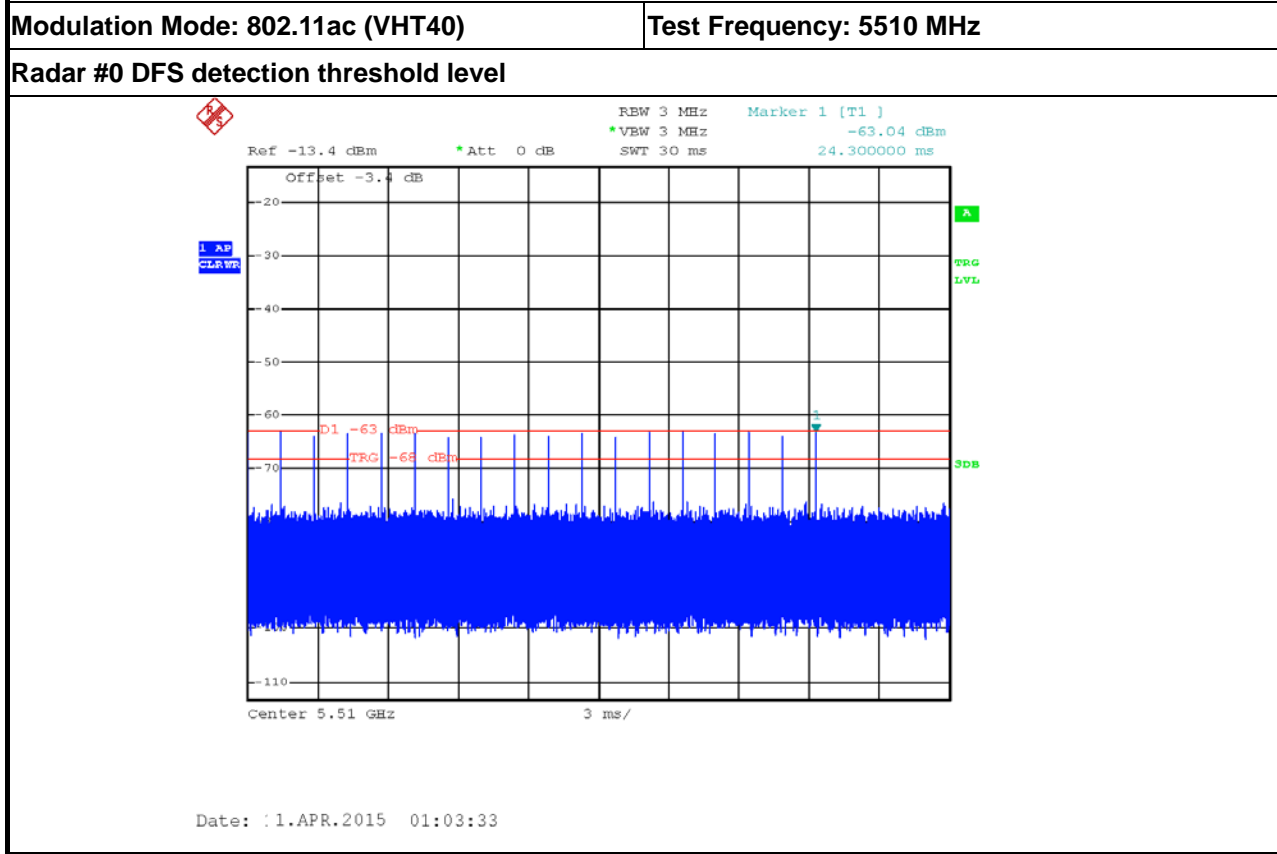
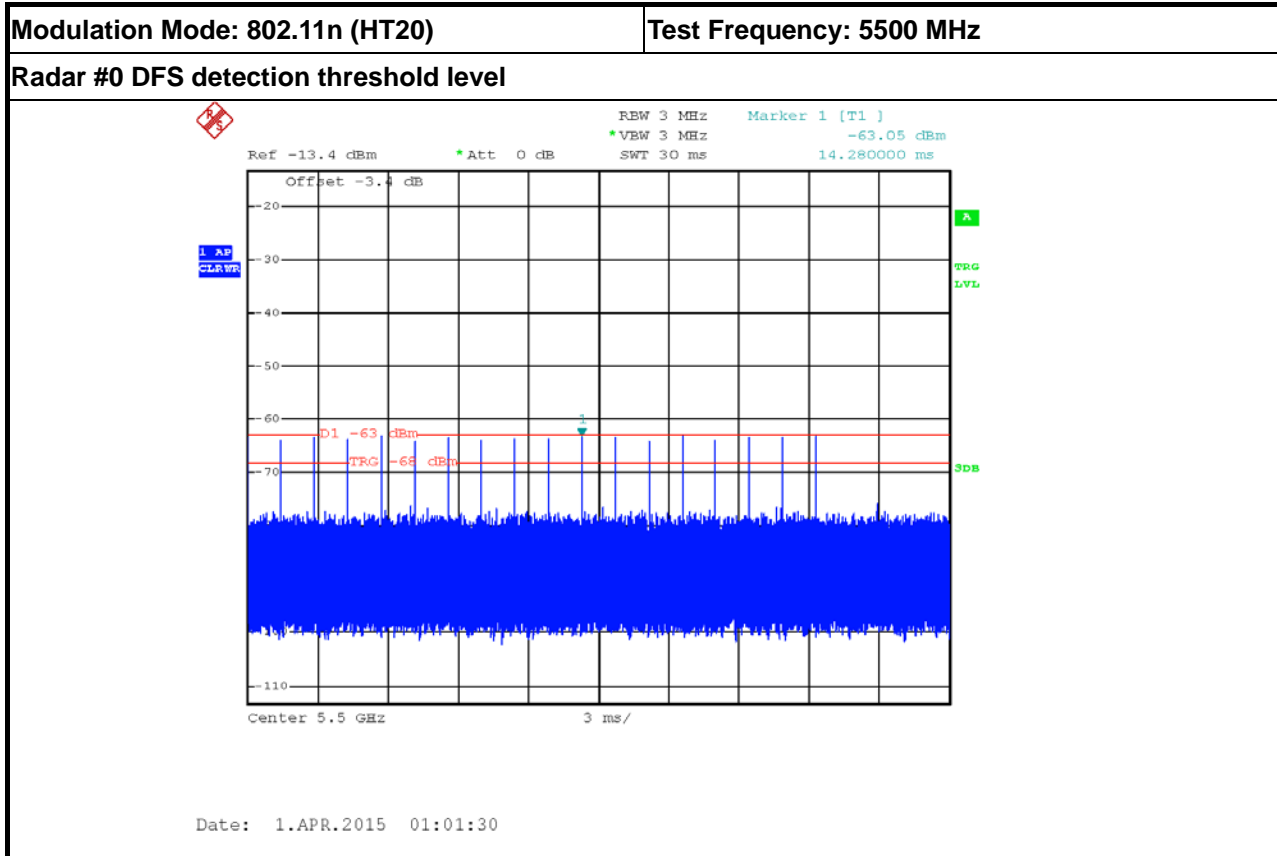

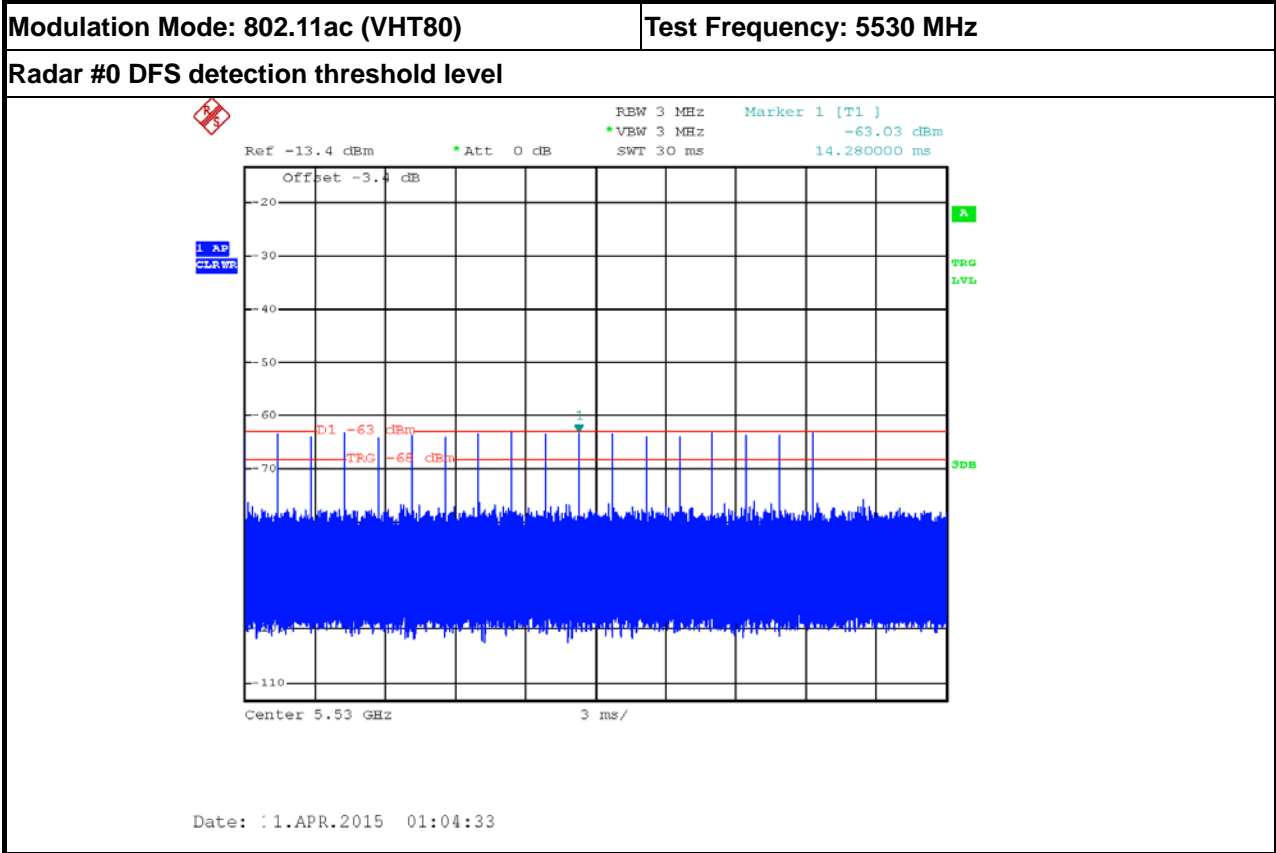

3.2.7 Test Setup

A spectrum analyzer is used as a monitor to verify that the EUT has vacated the Channel within the (Channel Closing Transmission Time and Channel Move Time, and does not transmit on a Channel during the Non-Occupancy Period after the detection and Channel move.

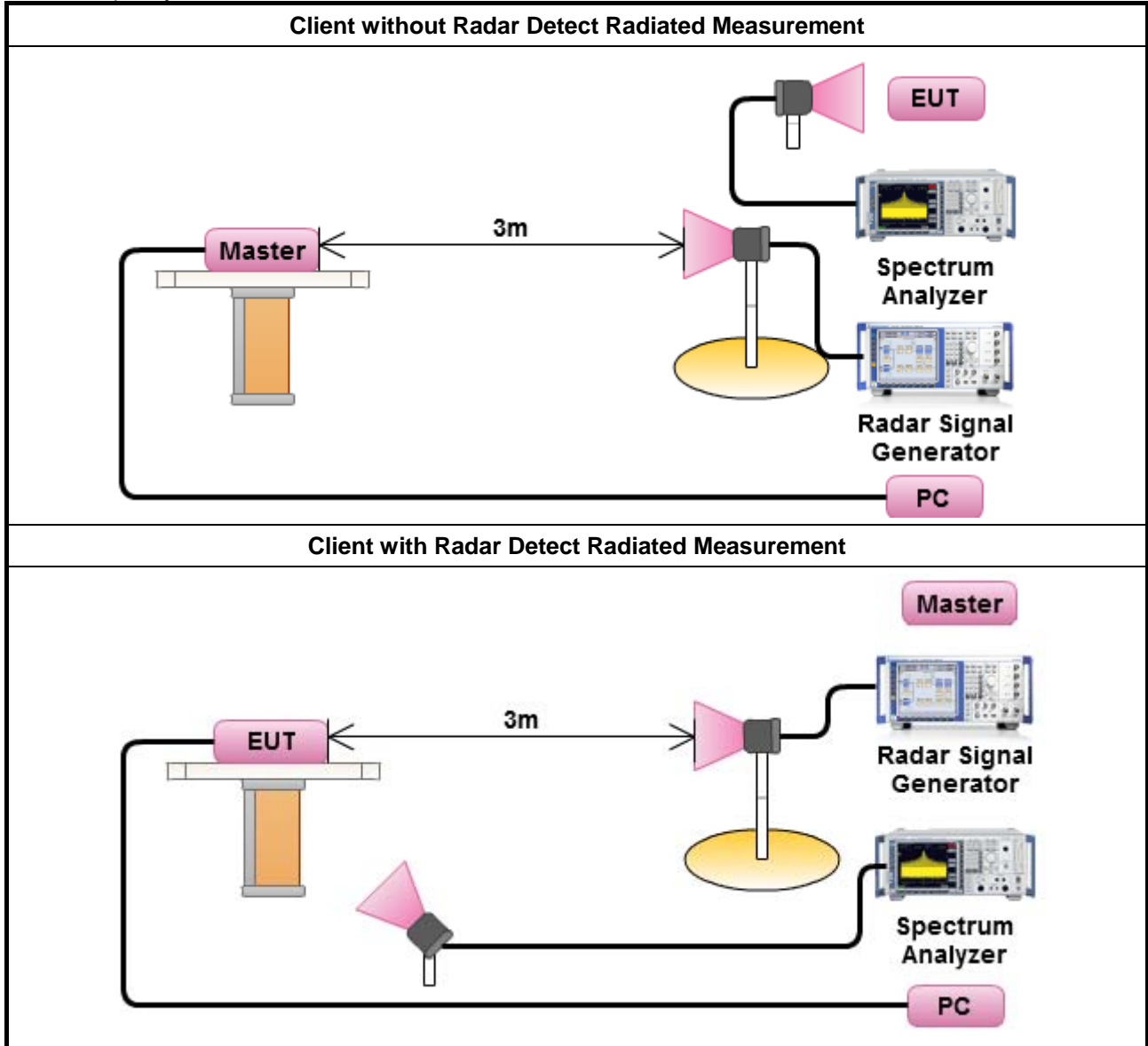



3.2.8 Data traffic Plot

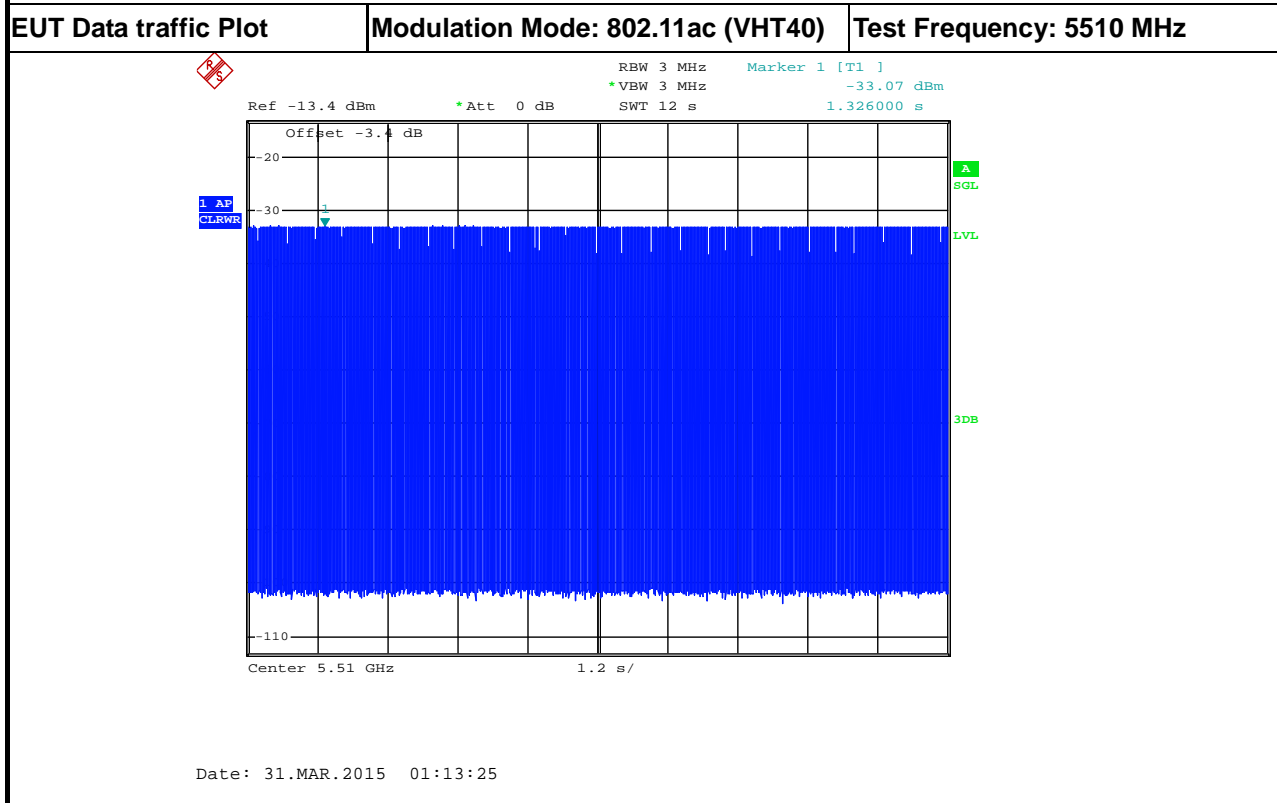
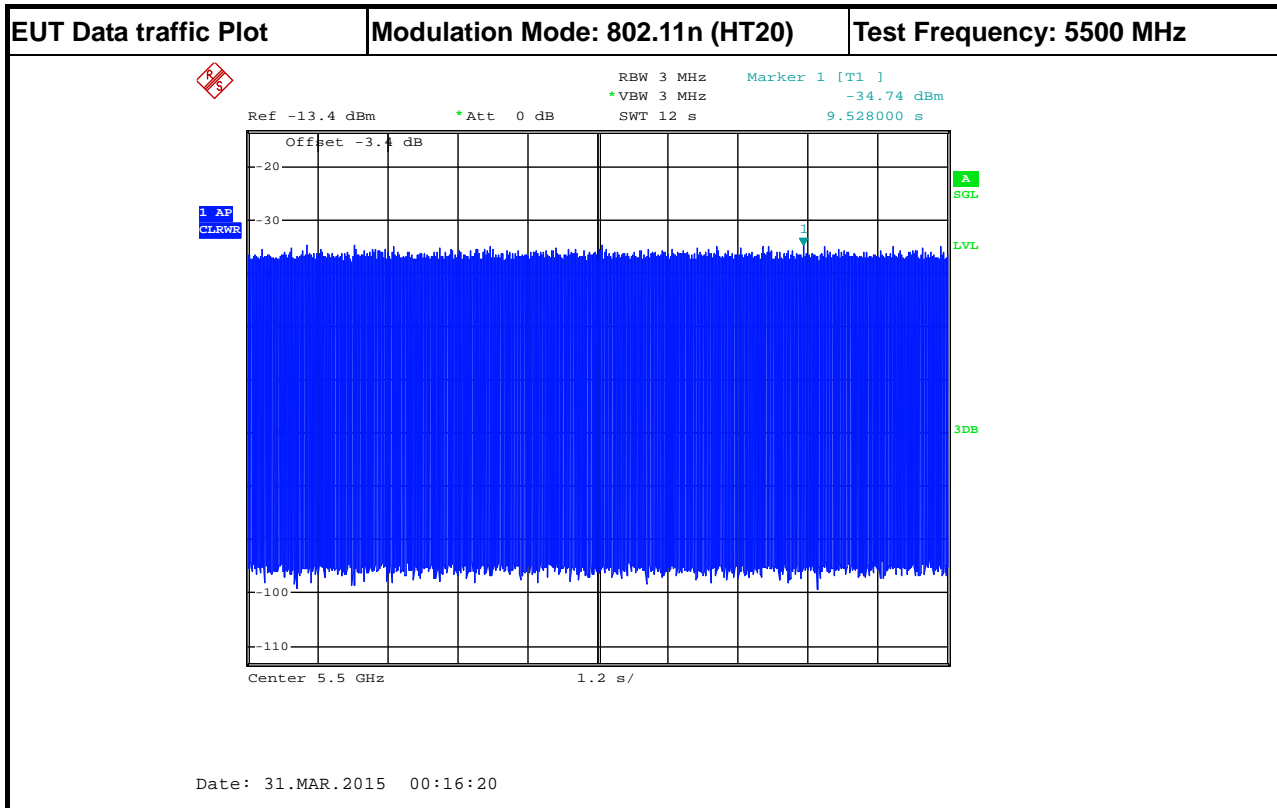

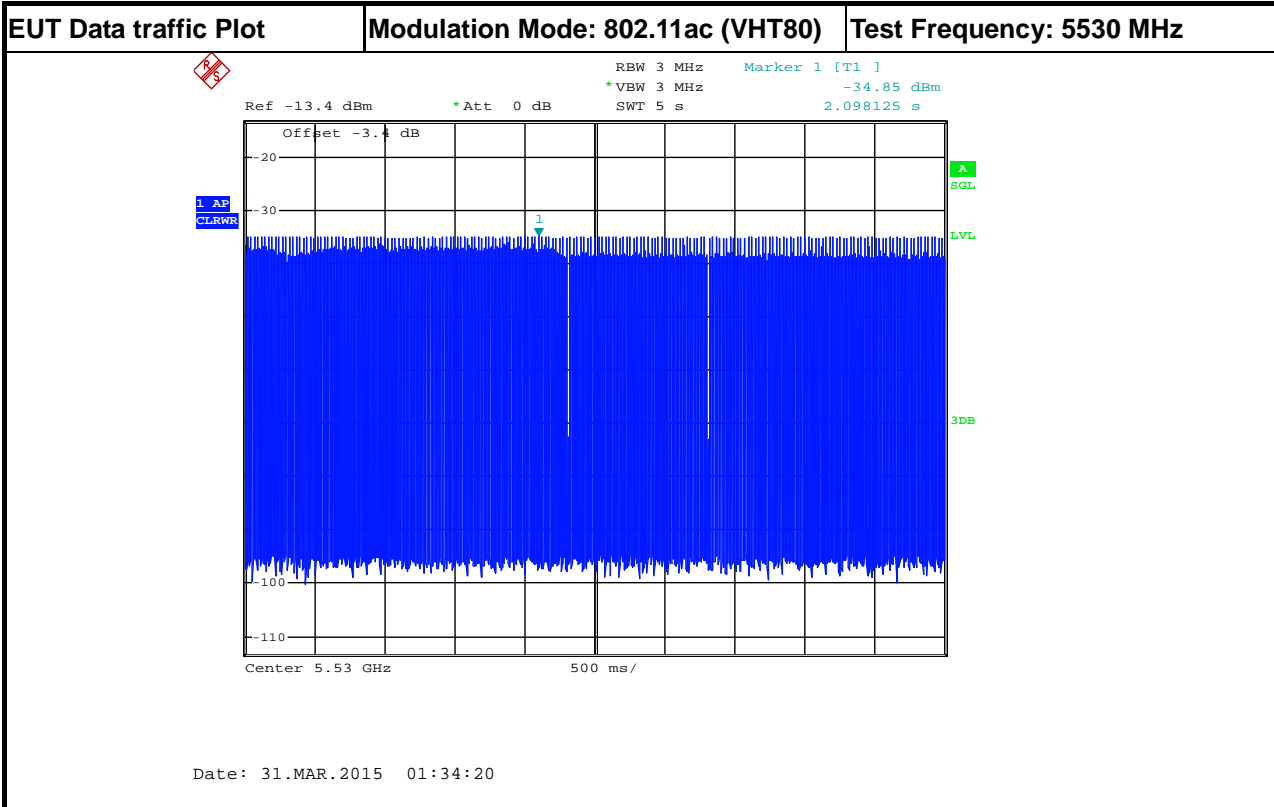

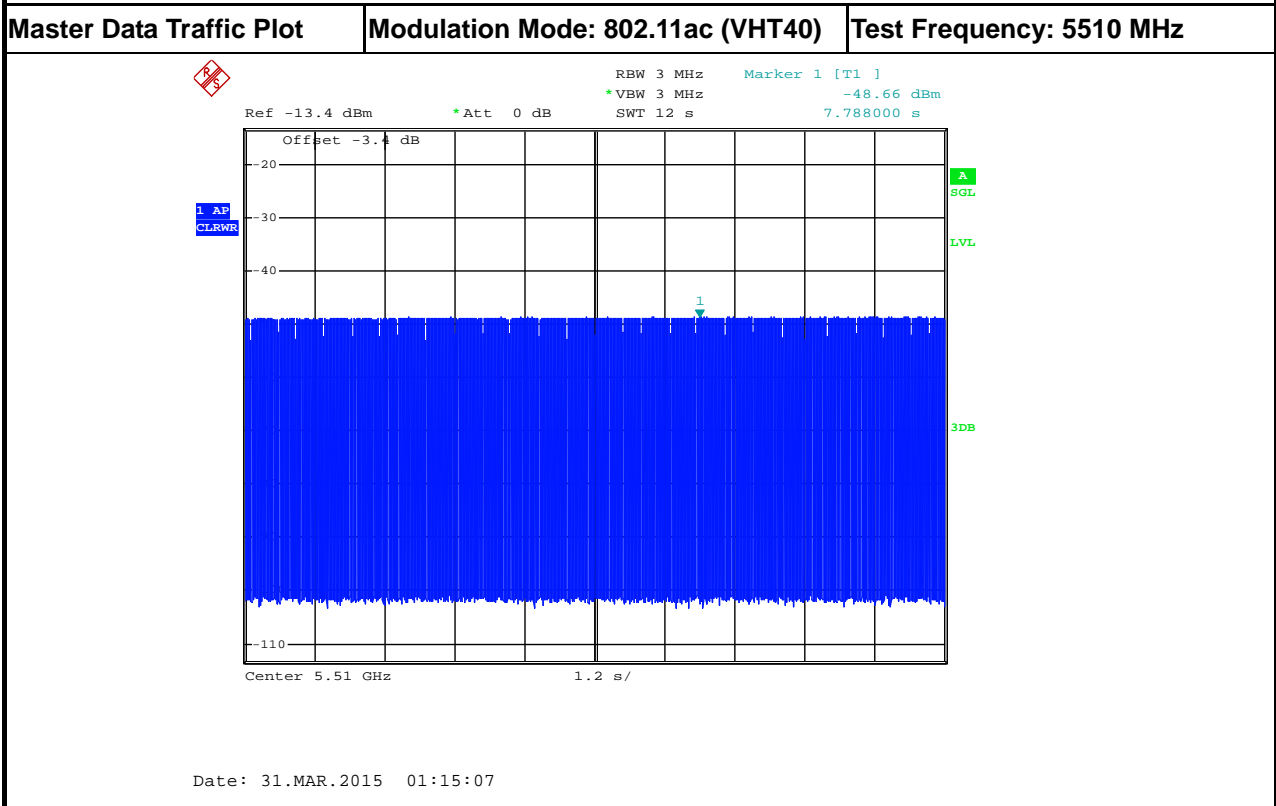
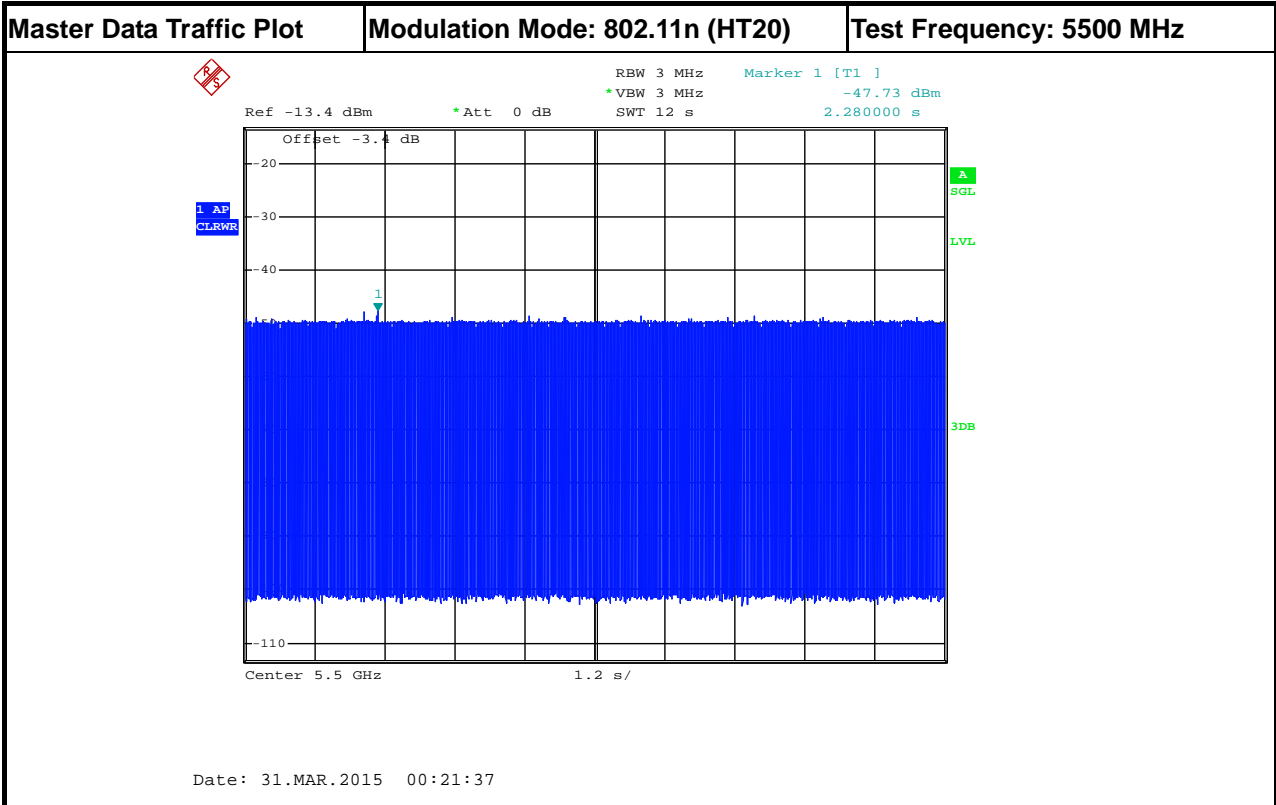

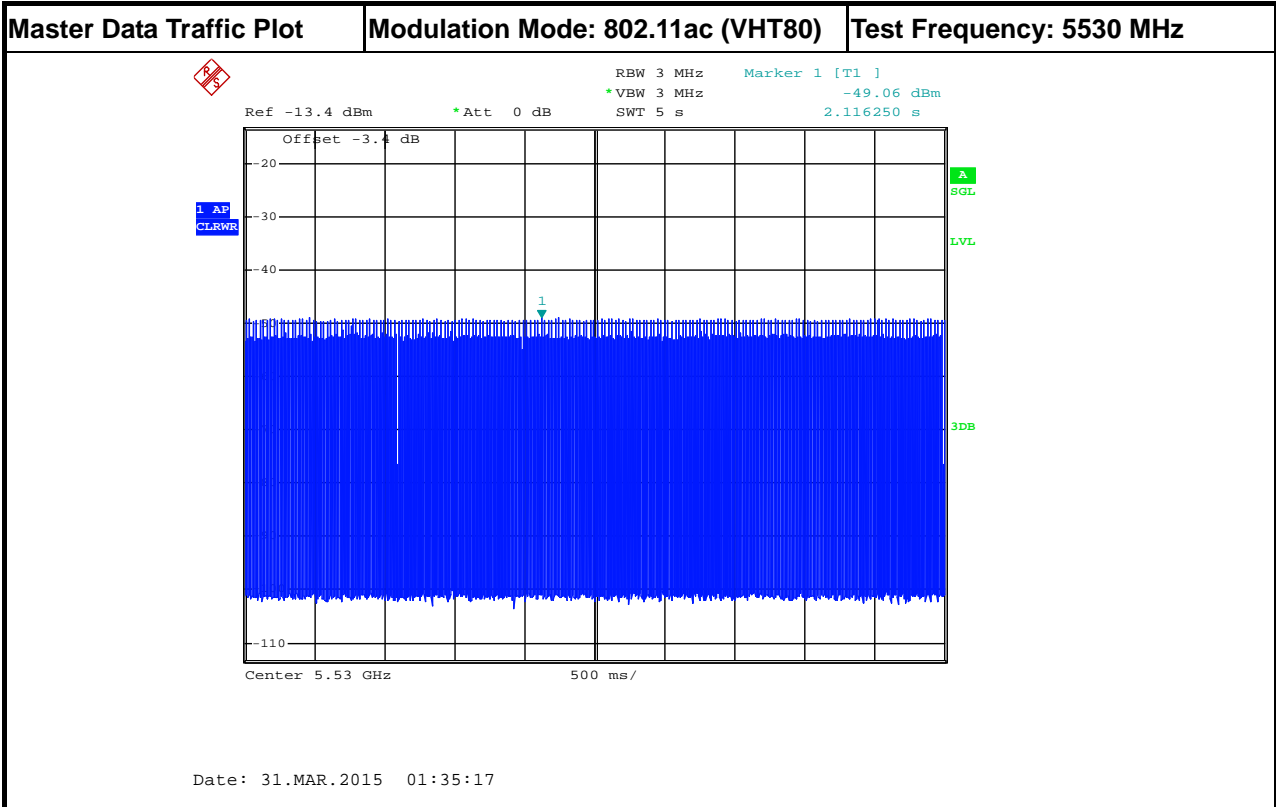

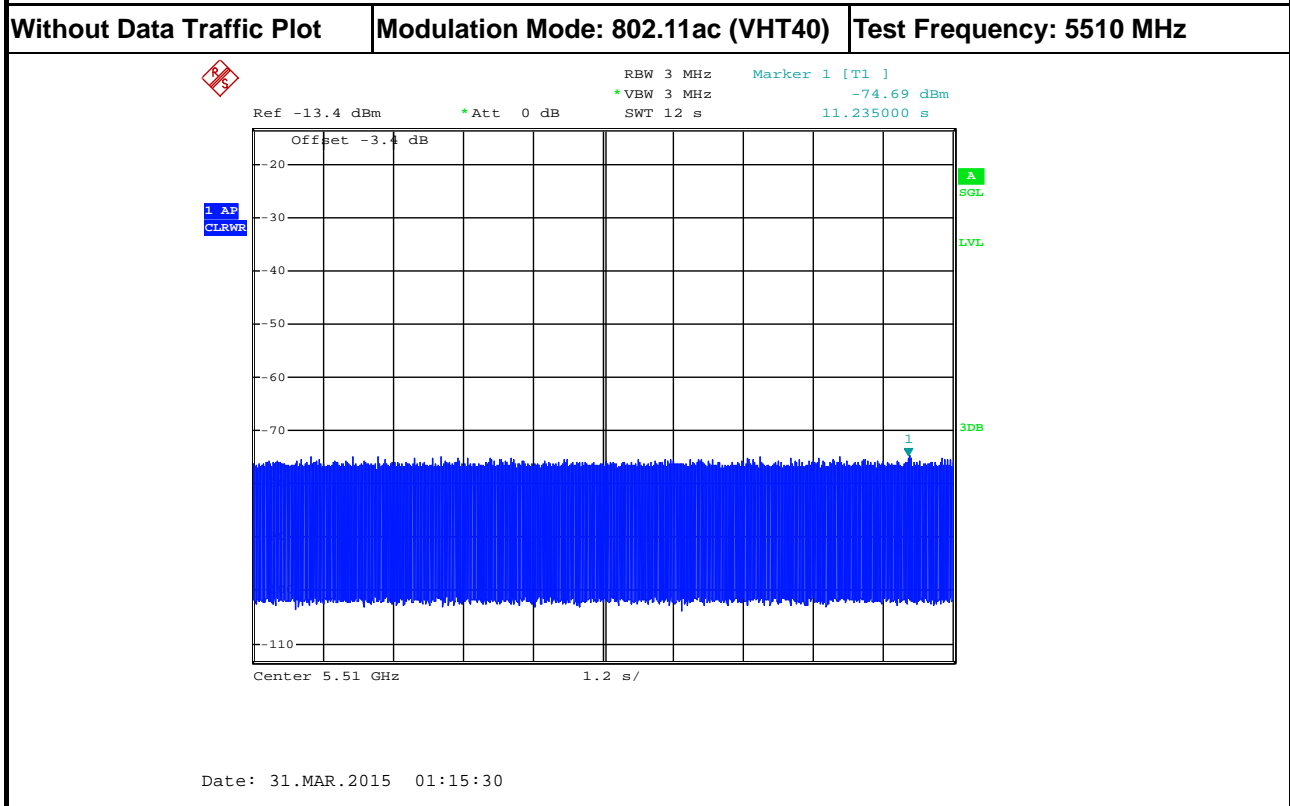
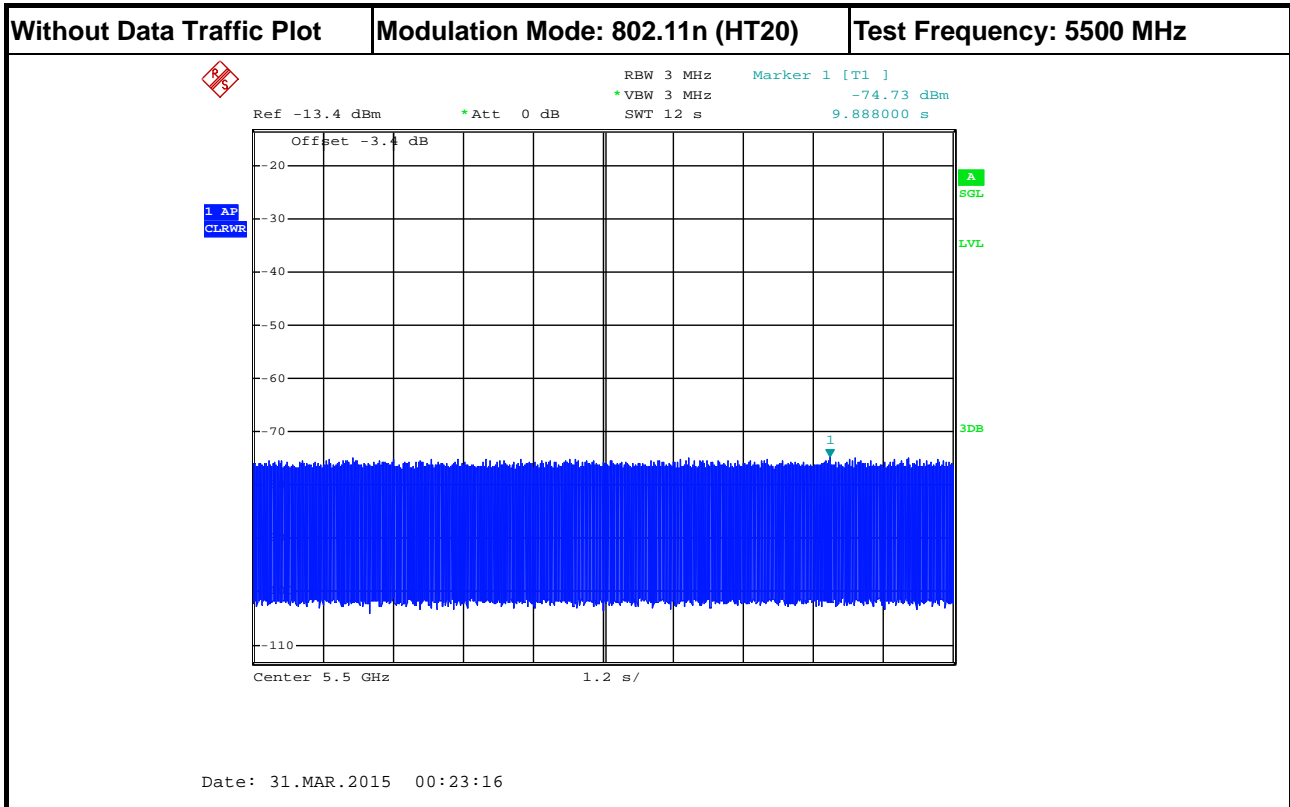

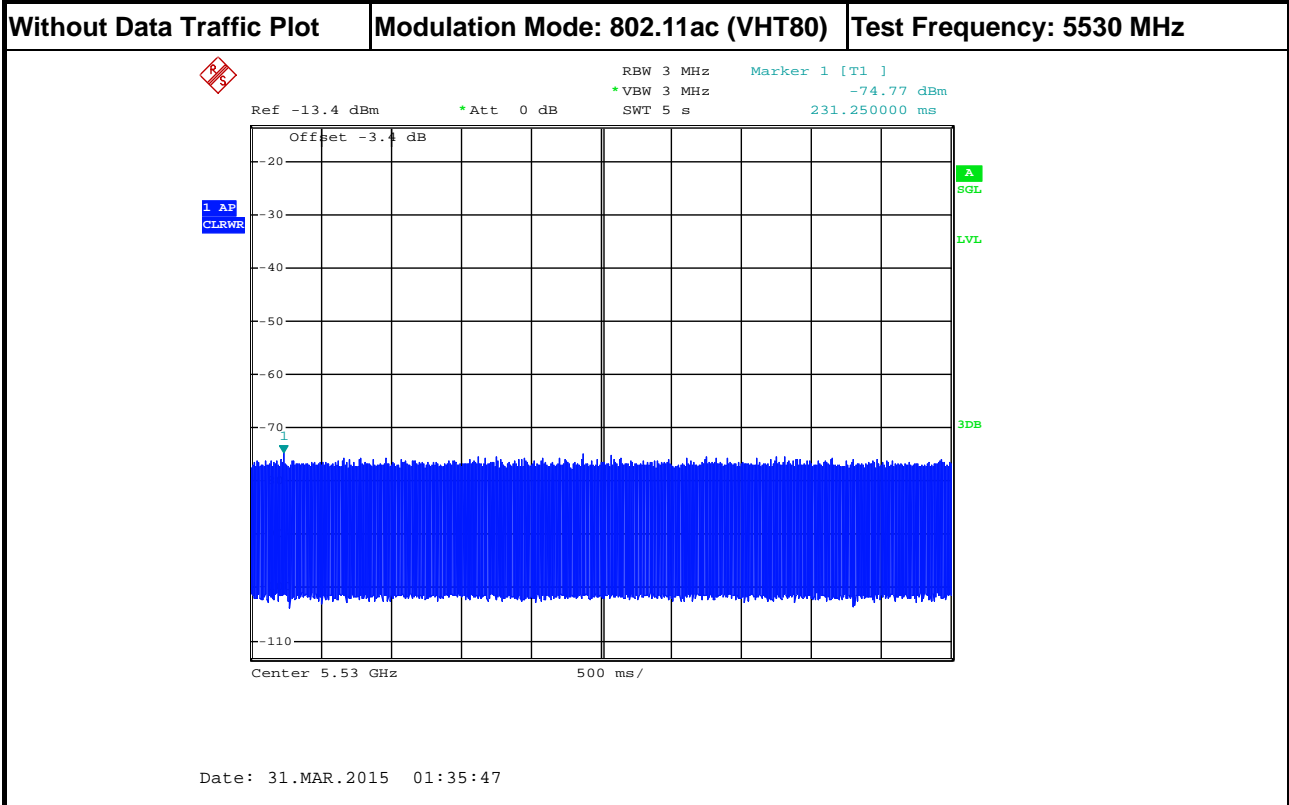



3.3 In-service Monitoring

3.3.1 In-service Monitoring Limit

In-service Monitoring Limit	
Channel Move Time	10 sec
Channel Closing Transmission Time	200 ms + an aggregate of 60 ms over remaining 10 sec periods.
Non-occupancy period	Minimum 30 minutes

3.3.2 Measuring Instruments

Refer a test equipment and calibration data table in this test report.

3.3.3 Test Procedures

Test Method
<input checked="" type="checkbox"/> Refer as FCC 06-96 Appendix, clause 7.8.3 verified during In-Service Monitoring; Channel Closing Transmission Time, Channel Move Time. Client Device will associate with the EUT. Observe the transmissions of the EUT at the end of the radar Burst on the Operating Channel for duration greater than 10 seconds. Measure and record the transmissions from the EUT during the observation time (Channel Move Time). Compare the Channel Move Time and Channel Closing Transmission Time limits.
<input checked="" type="checkbox"/> Refer as FCC 06-96 Appendix, clause 8.3 verified during In-Service Monitoring; Channel Closing Transmission Time, Channel Move Time. One 12 sec plot needs to be reported for the Short Pulse Radar Types 0. And zoom-in a 600 ms plot verified channel closing time for the aggregate transmission time starting from 200ms after the end of the radar signal to the completion of the channel move.
<input checked="" type="checkbox"/> Refer as FCC 06-96 Appendix, clause 7.8.3 verified during In-Service Monitoring; Non-Occupancy Period. Client Device will associate with the EUT. Observe the transmissions of the EUT at the end of the radar Burst on the Operating Channel for duration greater than 10 seconds. Measure and record the transmissions from the EUT during the observation time (Non-Occupancy Period). Compare the Non-Occupancy Period limits.



3.3.4 Test Result of In-service Monitoring

Modulation Mode: 802.11n (HT20)

Parameter	Test Result	Limit
	Type 0	
Test Channel (MHz)	5500 MHz	-
Channel Move Time (sec.)	3.984	< 10s
Channel Closing Transmission Time (ms) (Note)	26.875	< 60ms
Non-Occupancy Period (min.)	≥ 30	≥ 30 min

Note: The Channel Closing Transmission Time is comprised of 200 milliseconds starting at the beginning of the Channel Move Time plus any additional intermittent control signals required to facilitate a Channel move (an aggregate of 60 milliseconds) during the remainder of the 10 seconds period. The aggregate duration of control signals will not count quiet periods in between transmissions.

Modulation Mode: 802.11ac (VHT40)

Parameter	Test Result	Limit
	Type 0	
Test Channel (MHz)	5510 MHz	-
Channel Move Time (sec.)	4.146	< 10s
Channel Closing Transmission Time (ms) (Note)	25.625	< 60ms
Non-Occupancy Period (min.)	≥ 30	≥ 30 min

Note: The Channel Closing Transmission Time is comprised of 200 milliseconds starting at the beginning of the Channel Move Time plus any additional intermittent control signals required to facilitate a Channel move (an aggregate of 60 milliseconds) during the remainder of the 10 seconds period. The aggregate duration of control signals will not count quiet periods in between transmissions.

Modulation Mode: 802.11ac (VHT80)

Parameter	Test Result	Limit
	Type 0	
Test Channel (MHz)	5530 MHz	-
Channel Move Time (sec.)	4.0305	< 10s
Channel Closing Transmission Time (ms) (Note)	27.500	< 60ms
Non-Occupancy Period (min.)	≥ 30	≥ 30 min

Note: The Channel Closing Transmission Time is comprised of 200 milliseconds starting at the beginning of the Channel Move Time plus any additional intermittent control signals required to facilitate a Channel move (an aggregate of 60 milliseconds) during the remainder of the 10 seconds period. The aggregate duration of control signals will not count quiet periods in between transmissions.

3.3.5 Test Plot of In-Service Monitoring for Channel Move Time

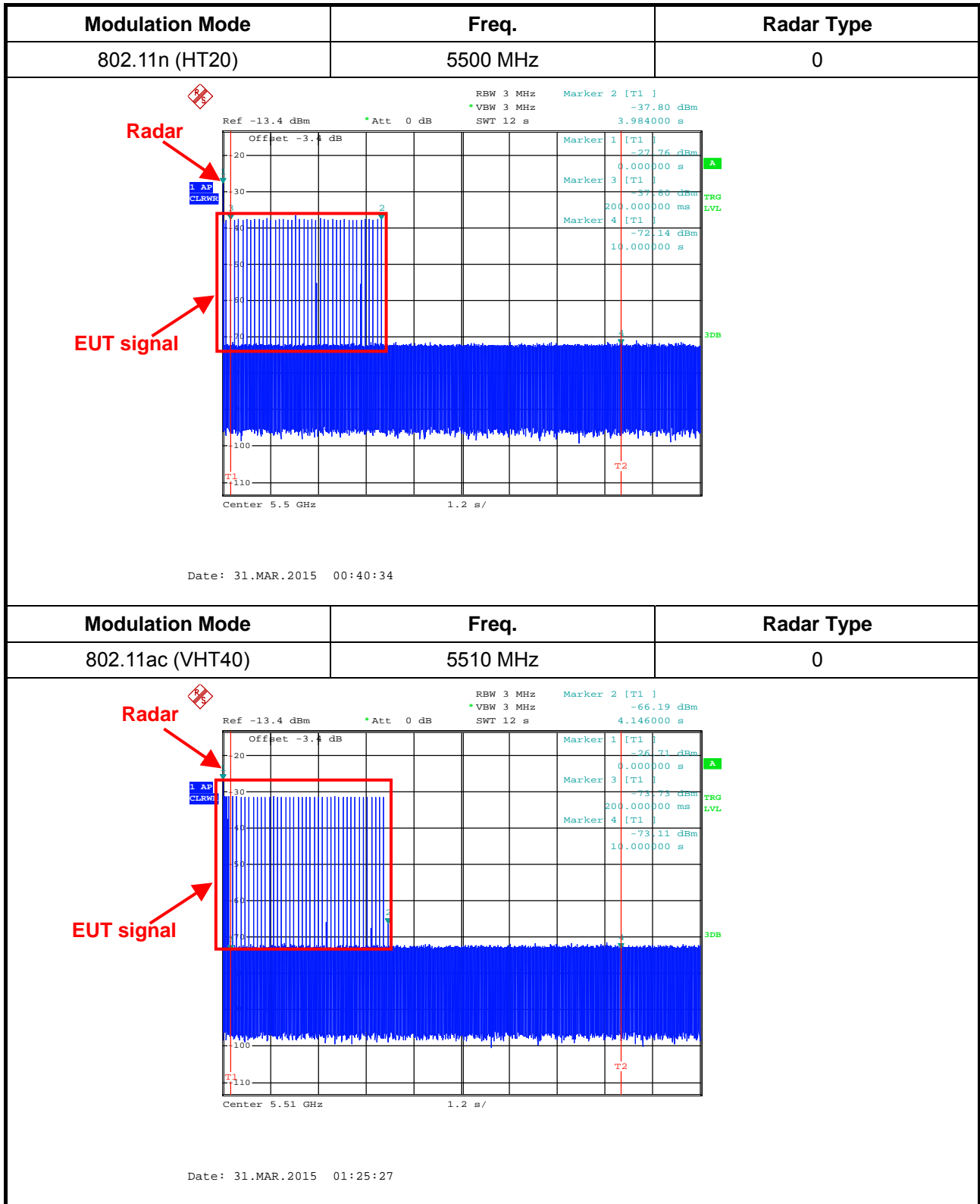

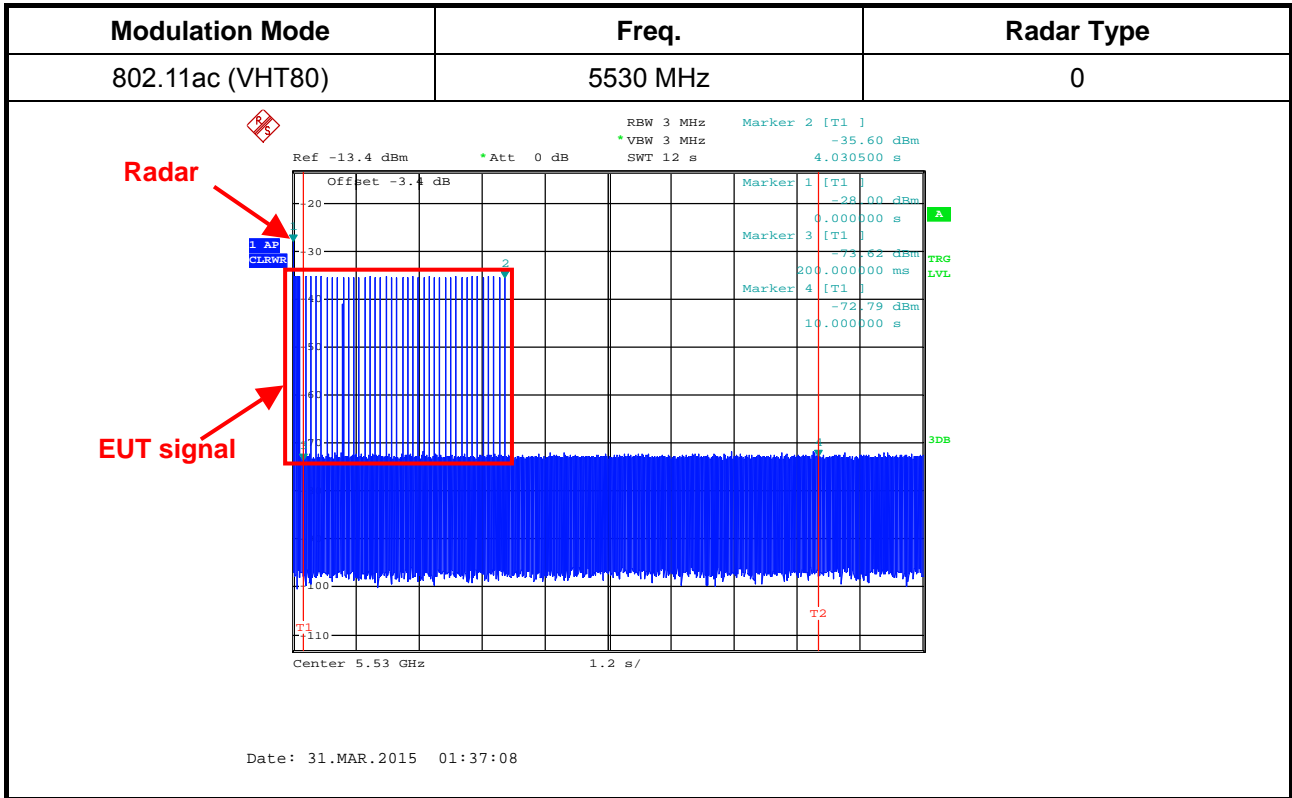

3.3.6 Test Plot of In-Service Monitoring for Channel Closing Transmission Time

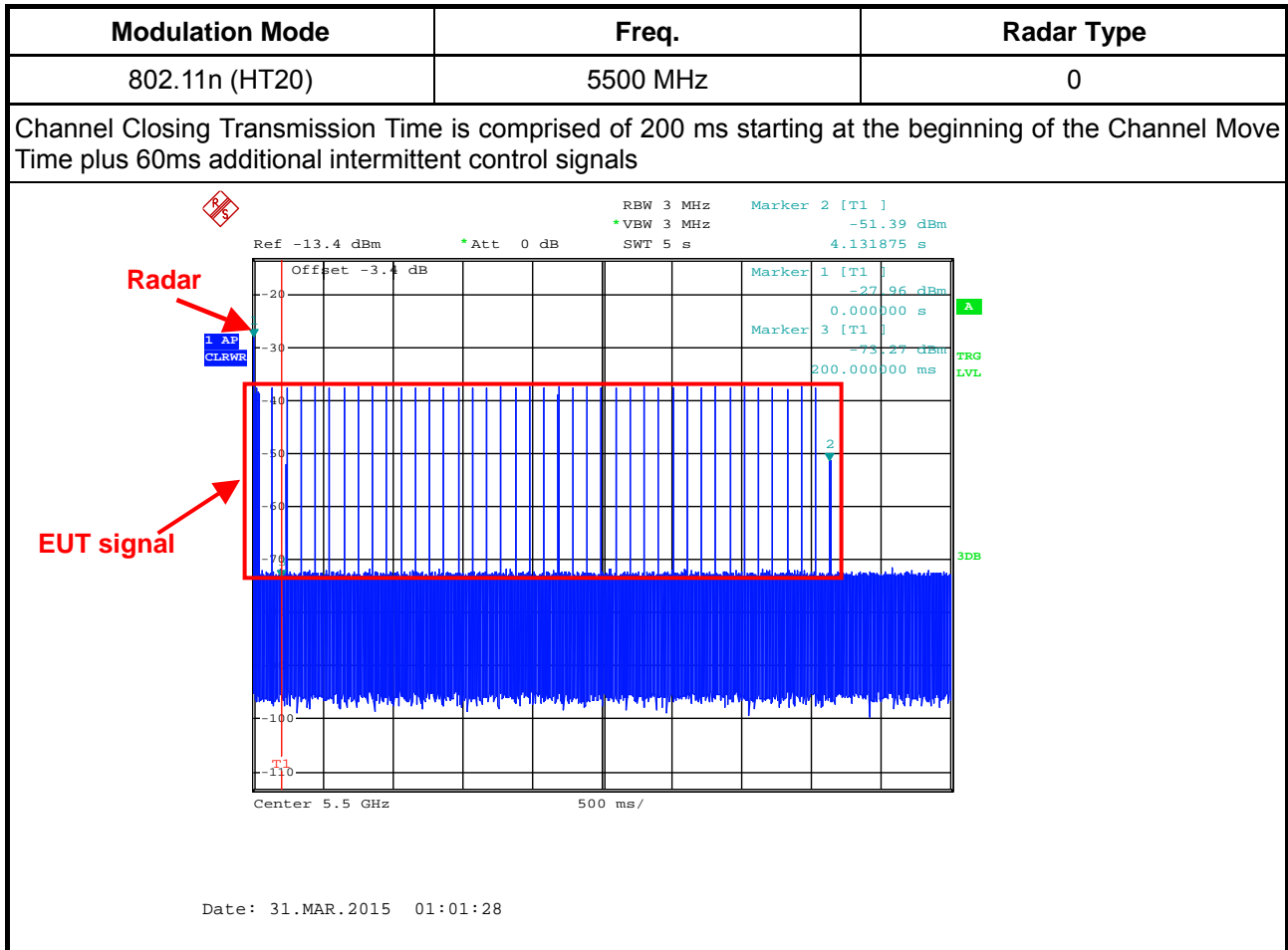

Dwell is the dwell time per spectrum analyzer sampling bin.

S is the sweep time

B is the number of spectrum analyzer sampling bins

C is the intermittent control signals of Channel Closing Transmission Time

N is the number of spectrum analyzer sampling bins (intermittent control signals) showing a U-NII transmission

$$\text{Dwell (0.625 ms)} = S (5000 \text{ ms}) / B (8000)$$

$$C (26.875 \text{ ms}) = N (43) \times \text{Dwell (0.625 ms)}$$

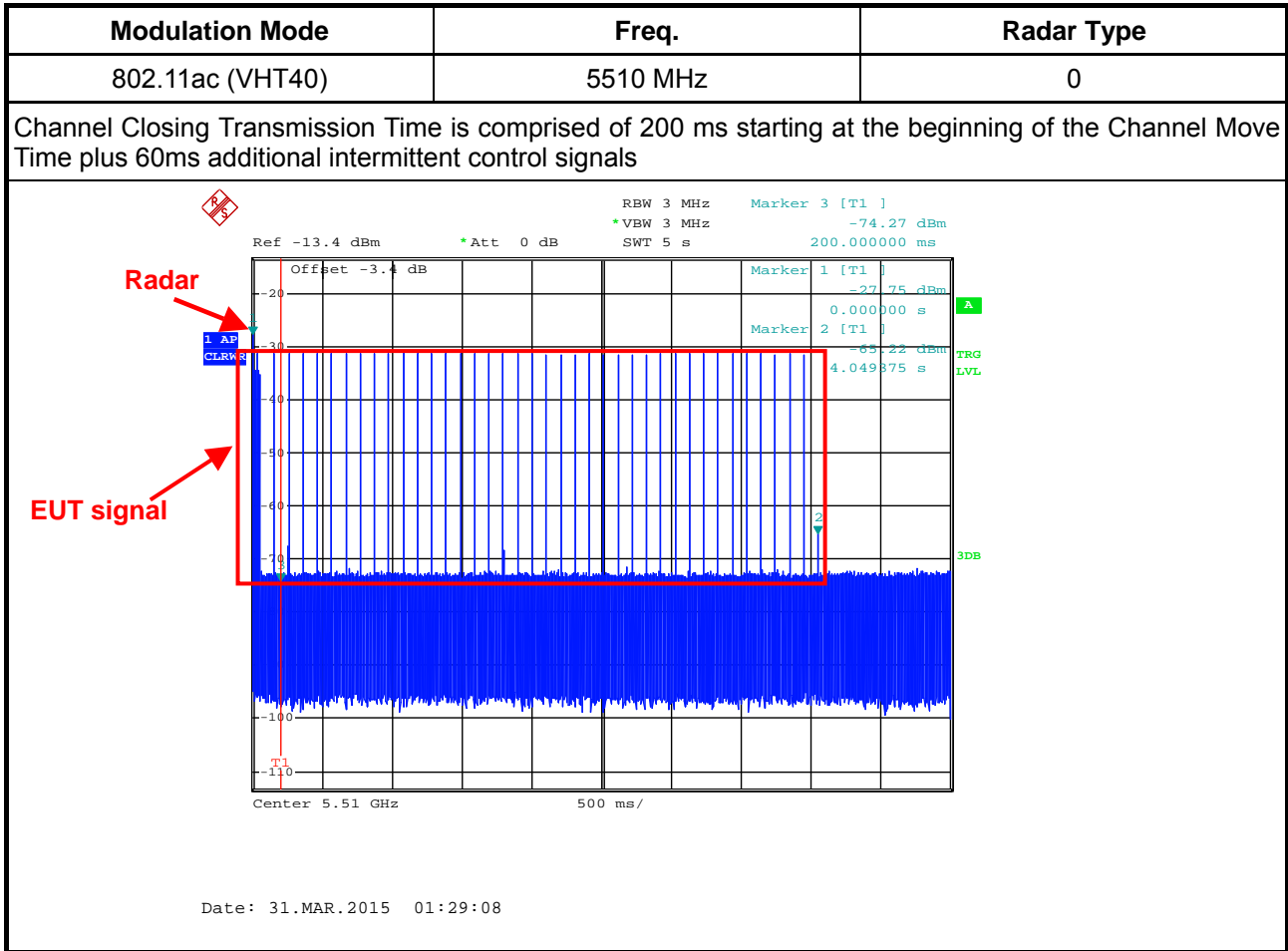

Dwell is the dwell time per spectrum analyzer sampling bin.

S is the sweep time

B is the number of spectrum analyzer sampling bins

C is the intermittent control signals of Channel Closing Transmission Time

N is the number of spectrum analyzer sampling bins (intermittent control signals) showing a U-NII transmission

$$\text{Dwell (0.625 ms)} = S (5000 \text{ ms}) / B (8000)$$

$$C (25.625 \text{ ms}) = N (41) \times \text{Dwell (0.625 ms)}$$

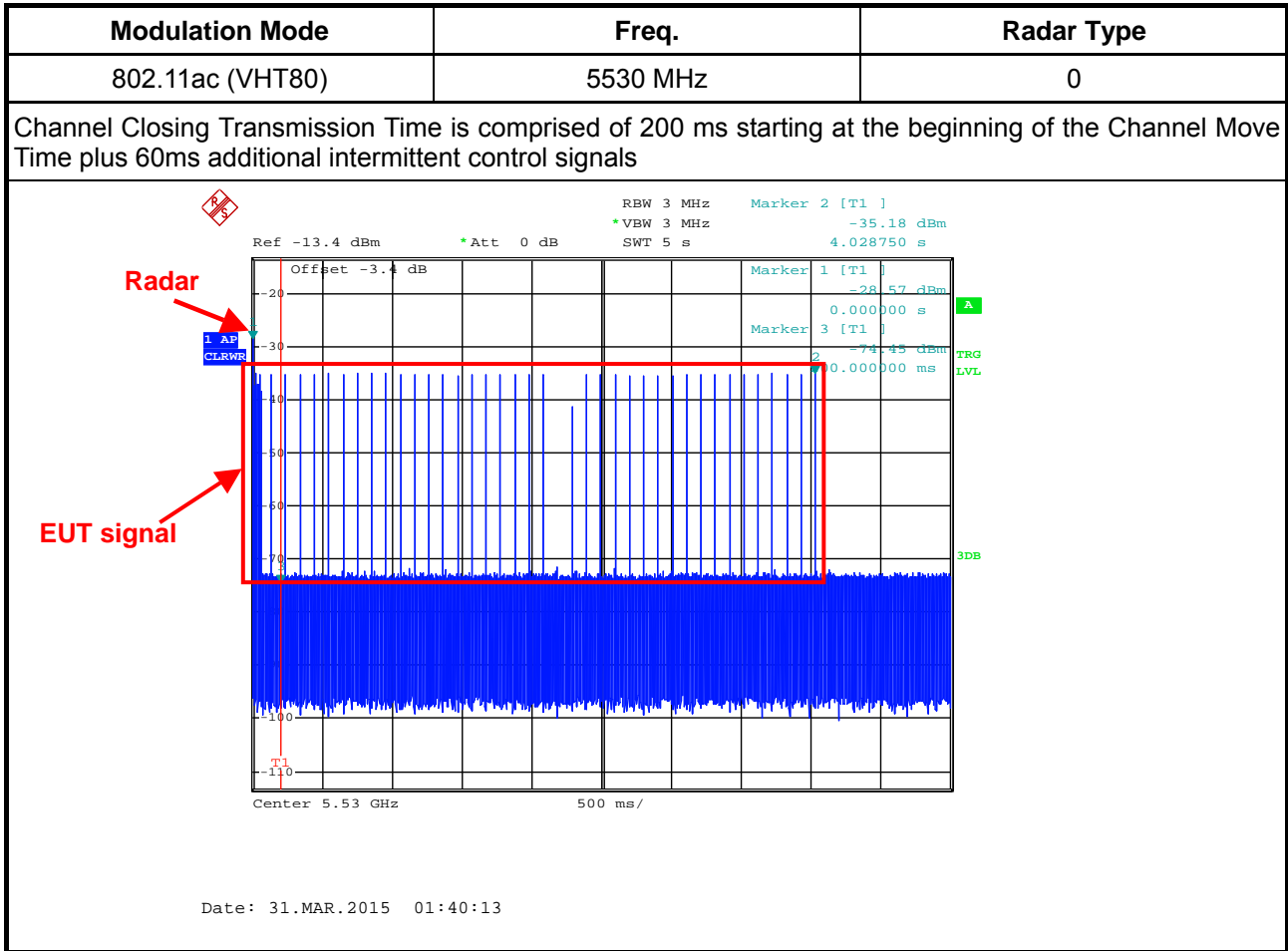

Dwell is the dwell time per spectrum analyzer sampling bin.

S is the sweep time

B is the number of spectrum analyzer sampling bins

C is the intermittent control signals of Channel Closing Transmission Time

N is the number of spectrum analyzer sampling bins (intermittent control signals) showing a U-NII transmission

$$\text{Dwell (0.625 ms)} = \text{S (5000 ms)} / \text{B (8000)}$$

$$\text{C (27.500 ms)} = \text{N (44)} \times \text{Dwell (0.625 ms)}$$



3.3.7 Test Plot of In-Service Monitoring for Non-Occupancy Period

Modulation Mode	Freq.
802.11n (HT20)	5500 MHz

Non-Occupancy Period

During the 30 minutes observation time, UUT did not make any transmissions on a channel after a radar signal was detected on that channel by either the Channel Availability Check or the In-Service Monitoring.

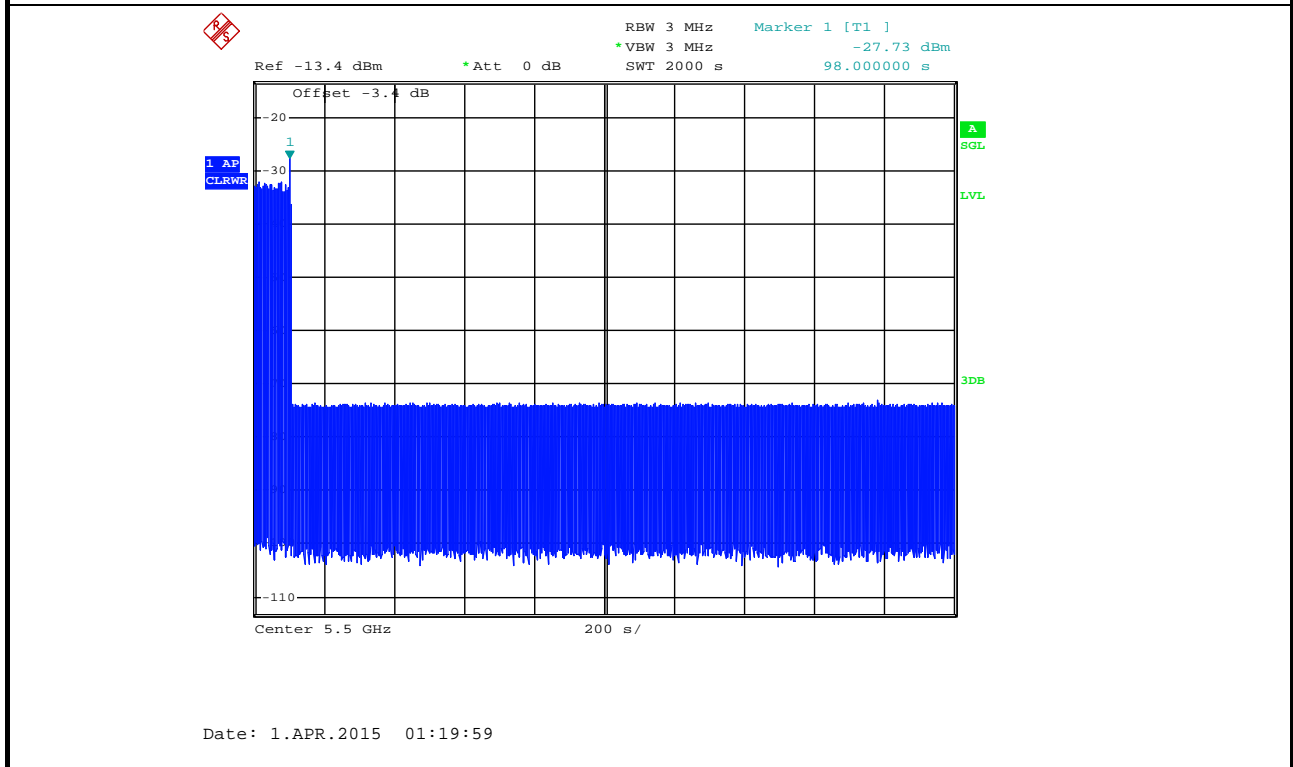



Non-associated test

Master was off.

During the 30 minutes observation time, The UUT did not make any transmissions in the DFS band after UUT power up.

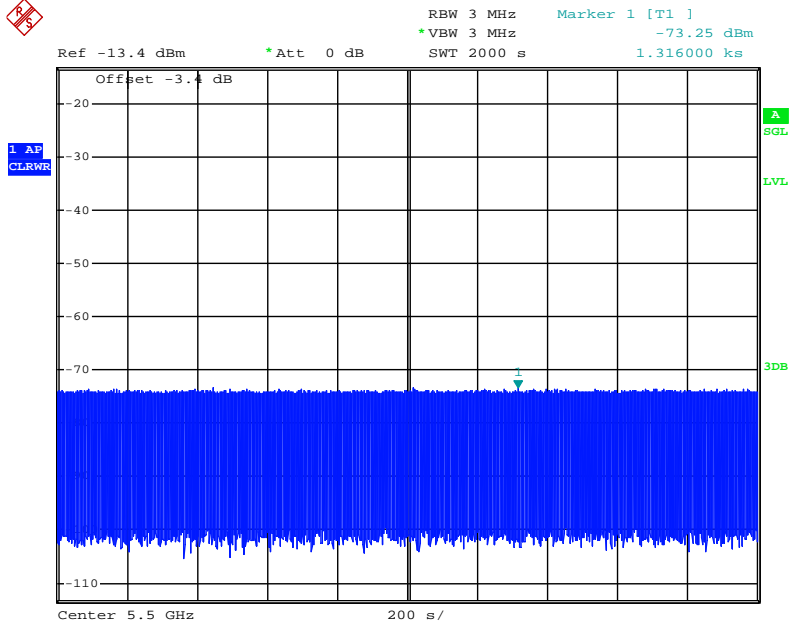

Date: 1.APR.2015 01:56:24



Modulation Mode	Freq.
802.11ac (VHT40)	5510 MHz

Non-Occupancy Period

During the 30 minutes observation time, UUT did not make any transmissions on a channel after a radar signal was detected on that channel by either the Channel Availability Check or the In-Service Monitoring.

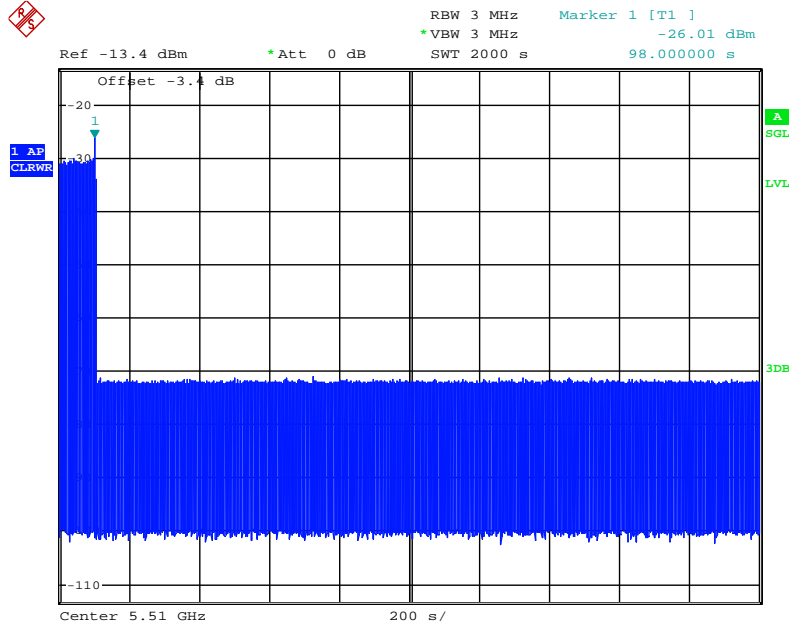

Date: 1.APR.2015 03:21:35



Non-associated test

Master was off.

During the 30 minutes observation time, The UUT did not make any transmissions in the DFS band after UUT power up.

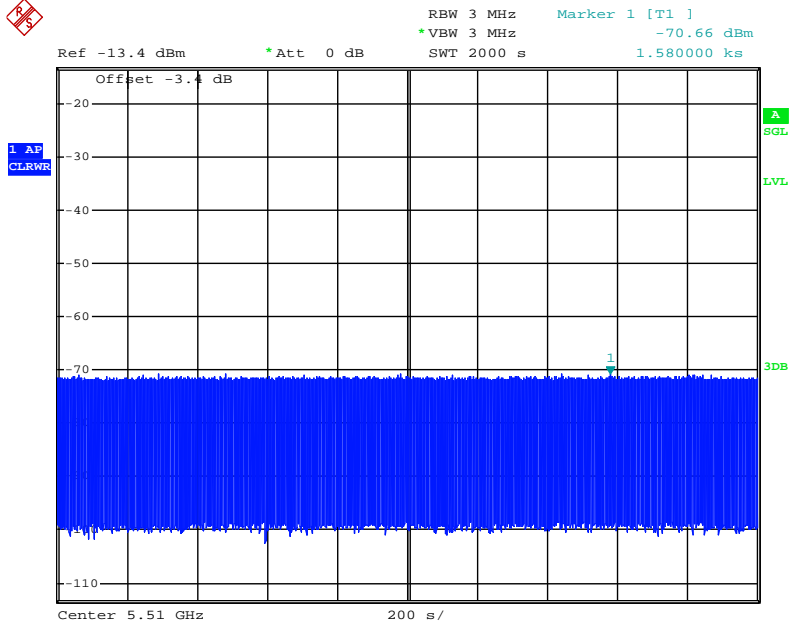

Date: 31.MAR.2015 03:38:13



Modulation Mode	Freq.
802.11ac (VHT80)	5530 MHz

Non-Occupancy Period

During the 30 minutes observation time, UUT did not make any transmissions on a channel after a radar signal was detected on that channel by either the Channel Availability Check or the In-Service Monitoring.

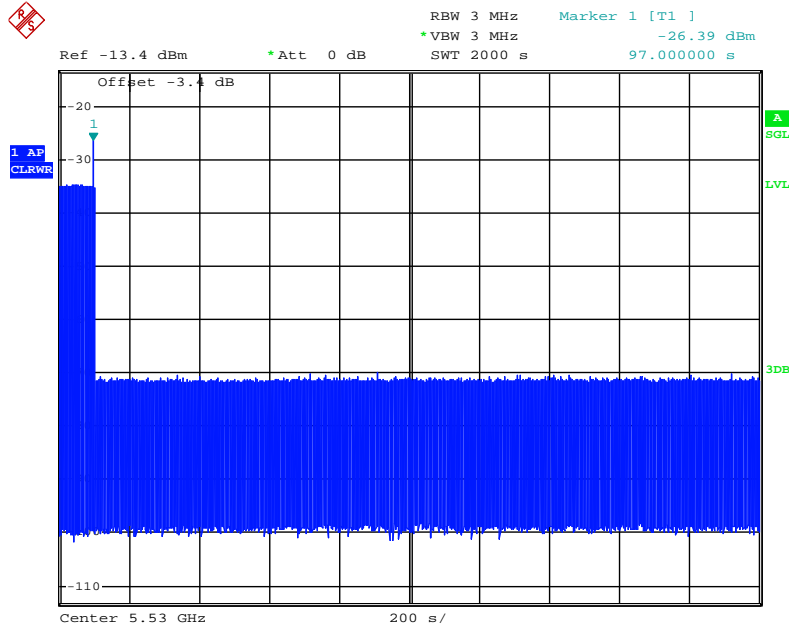

Date: 31.MAR.2015 02:18:03



Non-associated test

Master was off.

During the 30 minutes observation time, The UUT did not make any transmissions in the DFS band after UUT power up.

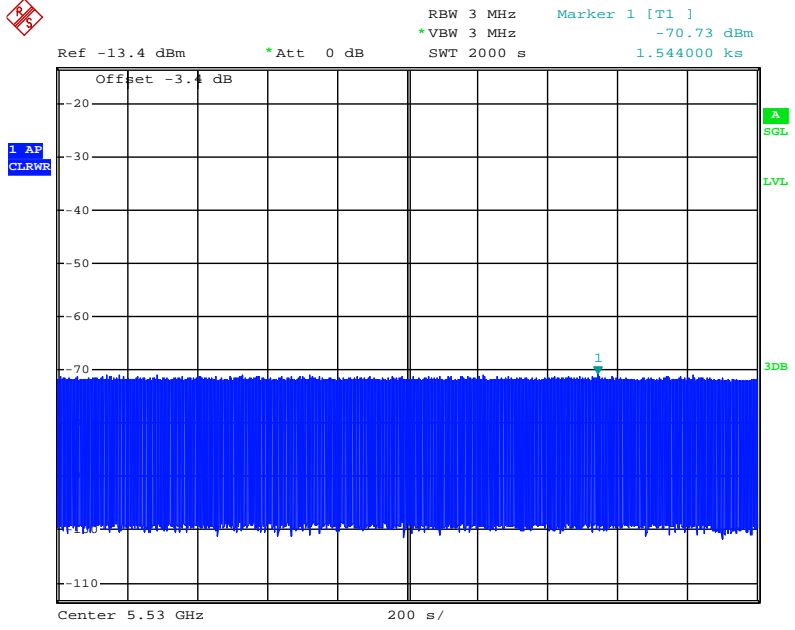

Date: 31.MAR.2015 02:54:05



4 Test Equipment and Calibration Data

Instrument	Manufacturer	Model No.	Serial No.	Characteristics	Calibration Date	Remark
Spectrum analyzer	R&S	FSP40	100142	9kHz~40GHz	Oct.15, 2014	Conducted (DF01-CB)
Signal generator	R&S	SMU200A	102782	25MHz-6GHz	Nov. 29, 2014	Conducted (DF01-CB)
RF Power Divider	ANAREN	2 Way	DFS-01-DV-02	1GHz ~ 6GHz	Jan. 10, 2015	Conducted (DF01-CB)
RF Power Divider	MTJ	2Way	DFS-01-DV-03	1GHz ~ 6GHz	Jan. 10, 2015	Conducted (DF01-CB)
RF Power Divider	ANAREN	4 Way	DFS-01-DV-01	1GHz ~ 6GHz	Jan. 10, 2015	Conducted (DF01-CB)
Horn Antenna	COM-POWER	AH-118	071187	1GHz – 18GHz	Aug. 26, 2014	Conducted (DF01-CB)
Horn Antenna	COM-POWER	AH-118	071042	1GHz – 18GHz	Dec. 03, 2014	Conducted (DF01-CB)
RF Cable-high	Woken	RG402	High Cable-53	1 GHz –18 GHz	Nov. 15, 2014	Conducted (DF01-CB)
RF Cable-high	Woken	RG402	High Cable-54	1 GHz –18 GHz	Nov. 15, 2014	Conducted (DF01-CB)
RF Cable-high	Woken	RG402	High Cable-56	1 GHz –18 GHz	Nov. 15, 2014	Conducted (DF01-CB)
RF Cable-high	Woken	RG402	High Cable-57	1 GHz –18 GHz	Nov. 15, 2014	Conducted (DF01-CB)
RF Cable-high	Woken	RG402	High Cable-58	1 GHz –18 GHz	Nov. 15, 2014	Conducted (DF01-CB)
RF Cable-high	Woken	RG402	High Cable-60	1 GHz –18 GHz	Nov. 15, 2014	Conducted (DF01-CB)
Thermometer	HTC-1	HTC-1	TP-11	-50°C~70°C	Mar. 05, 2015	Conducted (DF01-CB)

Note: Calibration Interval of instruments listed above is one year.



5 Measurement Uncertainty

Test Items	Uncertainty	Remark
Radiated Emission	2.9 dB	Confidence levels of 95%