



User Guide

© Copyright 2018 HP Development Company, L.P.

AMD is a trademark of Advanced Micro Devices, Inc. Bluetooth is a trademark owned by its proprietor and used by HP Inc. under license. Intel, Celeron, and Pentium are trademarks of Intel Corporation in the U.S. and other countries. Windows is either a registered trademark or trademark of Microsoft Corporation in the United States and/or other countries.

The information contained herein is subject to change without notice. The only warranties for HP products and services are set forth in the express warranty statements accompanying such products and services. Nothing herein should be construed as constituting an additional warranty. HP shall not be liable for technical or editorial errors or omissions contained herein.

First Edition: August 2018

Document Part Number: L11079-001

Product notice

This user guide describes features that are common to most models. Some features may not be available on your computer.

Not all features are available in all editions or versions of Windows. Systems may require upgraded and/or separately purchased hardware, drivers, software or BIOS update to take full advantage of Windows functionality. Windows 10 is automatically updated, which is always enabled. ISP fees may apply and additional requirements may apply over time for updates. See <http://www.microsoft.com>.

To access the latest user guides, go to <http://www.hp.com/support>, and follow the instructions to find your product. Then select **User Guides**.

Software terms

By installing, copying, downloading, or otherwise using any software product preinstalled on this computer, you agree to be bound by the terms of the HP End User License Agreement (EULA). If you do not accept these license terms, your sole remedy is to return the entire unused product (hardware and software) within 14 days for a full refund subject to the refund policy of your seller.

For any further information or to request a full refund of the price of the computer, please contact your seller.

Safety warning notice

 **WARNING!** To reduce the possibility of heat-related injuries or of overheating the computer, do not place the computer directly on your lap or obstruct the computer air vents. Use the computer only on a hard, flat surface. Do not allow another hard surface, such as an adjoining optional printer, or a soft surface, such as pillows or rugs or clothing, to block airflow. Also, do not allow the AC adapter to come into contact with the skin or a soft surface, such as pillows or rugs or clothing, during operation. The computer and the AC adapter comply with the user-accessible surface temperature limits defined by the International Standard for Safety of Information Technology Equipment (IEC 60950-1).

Processor configuration setting (select products only)

 **IMPORTANT:** Select computer products are configured with an Intel® Pentium® N35xx/N37xx series or a Celeron® N28xx/N29xx/N30xx/N31xx series processor and a Windows® operating system. **If your computer is configured as described, do not change the processor configuration setting in msconfig.exe from 4 or 2 processors to 1 processor.** If you do so, your computer will not restart. You will have to perform a factory reset to restore the original settings.

Table of contents

1 Welcome	1
Finding information	2
2 Components	3
Locating hardware	3
Locating software	3
Labels	4
3 Network connections	6
Connecting to a wireless network	6
Using the wireless controls	6
Wireless button	6
Operating system controls	6
Connecting to a WLAN	7
Using HP Mobile Broadband (select products only)	7
Using GPS (select products only)	8
Using Bluetooth wireless devices (select products only)	8
Connecting Bluetooth devices	8
Using NFC to share information (select products only)	8
Sharing	9
Connecting to a wired network	9
Connecting to a local area network (LAN) (select products only)	9
Using HP LAN-Wireless Protection (select products only)	10
Turning on and customizing HP LAN-Wireless Protection	10
Using HP MAC Address Pass Through to identify your computer on a network (select products only)	11
Customizing MAC Address Pass Through	11
4 Navigating the screen	12
Using TouchPad and touch screen gestures	12
Tap	12
Two-finger pinch zoom	13
Two-finger slide (TouchPad only)	13
Two-finger tap (TouchPad only)	13
Four-finger tap (TouchPad only)	13
Three-finger swipe (TouchPad only)	14
One-finger slide (touch screen only)	15

Using an optional keyboard or mouse	15
Using an on-screen keyboard (select products only)	15
5 Entertainment features	16
Using a camera (select products only)	16
Using audio	16
Connecting speakers	16
Connecting headphones	16
Connecting a microphone	16
Connecting headsets	17
Using sound settings	17
Using video	17
Connecting a DisplayPort device using a USB Type-C cable (select products only)	17
Connecting a Thunderbolt device using a USB Type-C cable (select products only)	18
Connecting video devices by using a VGA cable (select products only)	19
Connecting video devices using an HDMI cable (select products only)	20
Setting up HDMI audio	21
Connecting a Thunderbolt DisplayPort device	21
Discovering and connecting wired displays using MultiStream Transport	22
Connect displays to computers with AMD or Nvidia graphics (with an optional hub) ...	22
Connect displays to computers with Intel graphics (with an optional hub)	23
Connect displays to computers with Intel graphics (with a built-in hub)	23
Discovering and connecting to Miracast-compatible wireless displays (select products only)	24
Discovering and connecting to Intel WiDi certified displays (select Intel products only)	24
Using data transfer	24
Connecting devices to a USB Type-C port (select products only)	24
6 Managing power	26
Using Sleep and Hibernation	26
Initiating and exiting Sleep	26
Initiating and exiting Hibernation (select products only)	27
Shutting down (turning off) the computer	27
Using the Power icon and Power Options	28
Running on battery power	28
Using HP Fast Charge (select products only)	28
Displaying battery charge	29
Finding battery information in HP Support Assistant (select products only)	29
Conserving battery power	29
Identifying low battery levels	29
Resolving a low battery level	30
Resolving a low battery level when external power is available	30

Resolving a low battery level when no power source is available	30
Resolving a low battery level when the computer cannot exit Hibernation	30
7 Security	31
Protecting the computer	31
Using passwords	31
Setting passwords in Windows	32
Setting passwords in Computer Setup	33
Managing a BIOS administrator password	33
Entering a BIOS administrator password	34
Using DriveLock Security Options	35
Selecting Automatic DriveLock (select products only)	35
Enabling Automatic DriveLock	35
Disabling Automatic DriveLock	35
Entering an Automatic DriveLock password	36
Selecting manual DriveLock	36
Setting a DriveLock master password	37
Enabling DriveLock and setting a DriveLock user password	37
Disabling DriveLock	38
Entering a DriveLock password	38
Changing a DriveLock password	38
Windows Hello (select products only)	39
Using antivirus software	39
Using firewall software	39
Installing software updates	40
Using HP Client Security (select products only)	40
Using HP Device as a Service (HP DaaS) (select products only)	40
Using an optional security cable (select products only)	40
Using a fingerprint reader (select products only)	41
Locating the fingerprint reader	41
8 Maintenance	42
Improving performance	42
Using Disk Defragmenter	42
Using Disk Cleanup	42
Using HP 3D DriveGuard (select products only)	43
Identifying HP 3D DriveGuard status	43
Updating programs and drivers	43
Cleaning your computer	43
Cleaning procedures	44
Cleaning the display	44



Cleaning the sides or cover	44
Cleaning the TouchPad, keyboard, or mouse (select products only)	44
Traveling with or shipping your computer	44
9 Backing up, restoring, and recovering	46
Using Windows tools	46
Creating HP Recovery media (select products only)	46
Using HP Recovery Manager to create recovery media	47
Before you begin	47
Creating the recovery media	47
Using the HP Cloud Recovery Download Tool to create recovery media	48
Restoring and recovery	48
Restoring, resetting, and refreshing using Windows tools	48
Restoring using HP Recovery Manager and the HP Recovery partition	48
Recovering using HP Recovery Manager	48
Recovering using the HP Recovery partition (select products only)	49
Recovering using HP Recovery media	49
Changing the computer boot order	50
Removing the HP Recovery partition (select products only)	50
10 Computer Setup (BIOS), TPM, and HP Sure Start	51
Using Computer Setup	51
Starting Computer Setup	51
Navigating and selecting in Computer Setup	51
Restoring factory settings in Computer Setup	51
Updating the BIOS	52
Determining the BIOS version	52
Downloading a BIOS update	52
Changing the boot order using the f9 prompt	53
TPM BIOS settings (select products only)	53
Using HP Sure Start (select products only)	54
11 Using HP PC Hardware Diagnostics	55
Using HP PC Hardware Diagnostics Windows (select products only)	55
Downloading HP PC Hardware Diagnostics Windows	55
Downloading the latest HP PC Hardware Diagnostics Windows version	56
Downloading HP Hardware Diagnostics Windows by product name or number (select products only)	56
Installing HP PC Hardware Diagnostics Windows	56
Using HP PC Hardware Diagnostics UEFI	56

Starting HP PC Hardware Diagnostics UEFI	57
Downloading HP PC Hardware Diagnostics UEFI to a USB flash drive	57
Downloading the latest HP PC Hardware Diagnostics UEFI version	57
Downloading HP PC Hardware Diagnostics UEFI by product name or number (select products only)	57
Using Remote HP PC Hardware Diagnostics UEFI settings (select products only)	58
Downloading Remote HP PC Hardware Diagnostics UEFI	58
Downloading the latest Remote HP PC Hardware Diagnostics UEFI version	58
Downloading Remote HP PC Hardware Diagnostics UEFI by product name or number	58
Customizing Remote HP PC Hardware Diagnostics UEFI settings	58
12 Specifications	60
Input power	60
Operating environment	61
13 Electrostatic Discharge	62
14 Accessibility	63
Accessibility	63
Finding the technology tools you need	63
Our commitment	63
International Association of Accessibility Professionals (IAAP)	63
Finding the best assistive technology	64
Assessing your needs	64
Accessibility for HP products	64
Standards and legislation	65
Standards	65
Mandate 376 – EN 301 549	65
Web Content Accessibility Guidelines (WCAG)	65
Legislation and regulations	65
United States	66
21st Century Communications and Video Accessibility Act (CVAA)	66
Canada	66
Europe	67
United Kingdom	67
Australia	67
Worldwide	67
Useful accessibility resources and links	68
Organizations	68
Educational institutions	68

Other disability resources	68
HP links	68
Contacting support	69

1 Welcome

After you set up and register the computer, we recommend the following steps to get the most out of your smart investment:

-  **TIP:** To quickly return to the computer Start screen from an open app or the Windows desktop, press the Windows key  on your keyboard. Pressing the Windows key again will return you to the previous screen.
- **Connect to the Internet**—Set up your wired or wireless network so that you can connect to the Internet. For more information, see [Network connections on page 6](#).
- **Update your antivirus software**—Protect your computer from damage caused by viruses. The software is preinstalled on the computer. For more information, see [Using antivirus software on page 39](#).
- **Get to know your computer**—Learn about your computer features. See [Components on page 3](#) and [Navigating the screen on page 12](#) for additional information.
- **Find installed software**—Access a list of the software preinstalled on the computer:
Select the **Start** button.
– or –
Right-click the **Start** button, and then select **Apps and Features**.
- Back up your hard drive by creating recovery discs or a recovery USB flash drive. See [Backing up, restoring, and recovering on page 46](#).

Finding information

To locate resources that provide product details, how-to information, and more, use this table.

Resource	Contents
<i>Setup Instructions</i>	<ul style="list-style-type: none">• Overview of computer setup and features
HP support For HP support, go to http://www.hp.com/support , and follow the instructions to find your product.	<ul style="list-style-type: none">• Online chat with an HP technician• Support telephone numbers• Replacement parts videos (select products only)• Maintenance and service guides• HP service center locations
<i>Safety & Comfort Guide</i> To access this guide: ▲ Select the Start button, select HP Help and Support , and then select HP Documentation . – or – ▲ Go to http://www.hp.com/ergo . IMPORTANT: You must be connected to the Internet to access the latest version of the user guide.	<ul style="list-style-type: none">• Proper workstation setup• Guidelines for posture and work habits that increase your comfort and decrease your risk of injury• Electrical and mechanical safety information
<i>Regulatory, Safety and Environmental Notices</i> To access this document: ▲ Select the Start button, select HP Help and Support , and then select HP Documentation .	<ul style="list-style-type: none">• Important regulatory notices, including information about proper battery disposal, if needed.
<i>Limited Warranty*</i> To access this document: ▲ Select the Start button, select HP Help and Support , and then select HP Documentation . – or – ▲ Go to http://www.hp.com/go/orderdocuments . IMPORTANT: You must be connected to the Internet to access the latest version of the user guide.	<ul style="list-style-type: none">• Specific warranty information about this computer
<p>*You can find your HP Limited Warranty located with the user guides on your product and/or on the CD or DVD provided in the box. In some countries or regions, HP may provide a printed warranty in the box. For countries or regions where the warranty is not provided in printed format, you can request a copy from http://www.hp.com/go/orderdocuments. For products purchased in Asia Pacific, you can write to HP at POD, PO Box 161, Kitchener Road Post Office, Singapore 912006. Include your product name, and your name, phone number, and postal address.</p>	

2 Components

Locating hardware

To find out what hardware is installed on your computer:

- ▲ Type `device manager` in the taskbar search box, and then select the **Device Manager** app.

A list displays all the devices installed on your computer.

For information about system hardware components and the system BIOS version number, press `fn+esc` (select products only).

Locating software

To find out what software is installed on your computer:

- ▲ Select the **Start** button.

– or –

Right-click the **Start** button, and then select **Apps and Features**.

Labels

The labels affixed to the computer provide information you may need when you troubleshoot system problems or travel internationally with the computer. Labels may be in paper form or imprinted on the product.

 **IMPORTANT:** Check the following locations for the labels described in this section: the bottom of the computer, inside the battery bay, under the service door, on the back of the display, or on the bottom of a tablet kickstand.

- **Service label**—Provides important information to identify your computer. When contacting support, you may be asked for the serial number, the product number, or the model number. Locate this information before you contact support.

Your service label will resemble one of the examples shown below. Refer to the illustration that most closely matches the service label on your computer.

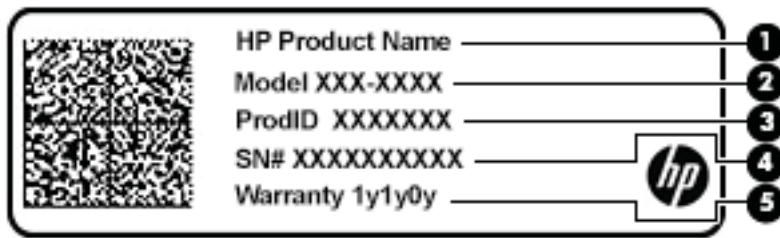

Component

- (1) HP product name
 - (2) Model number
 - (3) Product ID
 - (4) Serial number
 - (5) Warranty period
-

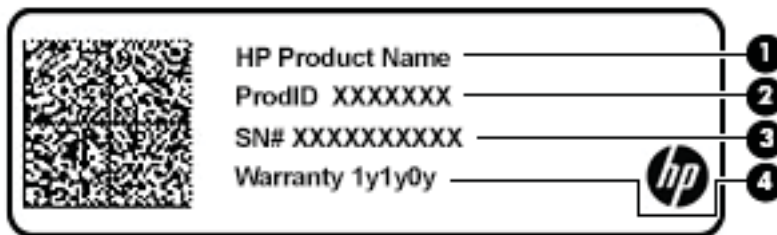

Component

- (1) HP product name
 - (2) Product ID
-

Component

(3) Serial number

(4) Warranty period

- Regulatory label(s)—Provide(s) regulatory information about the computer.
- Wireless certification label(s)—Provide(s) information about optional wireless devices and the approval markings for the countries or regions in which the devices have been approved for use.

3 Network connections

Your computer can travel with you wherever you go. But even at home, you can explore the globe and access information from millions of websites using your computer and a wired or wireless network connection. This chapter will help you get connected to that world.

Connecting to a wireless network

Your computer may be equipped with one or more of the following wireless devices:

- **WLAN device**—Connects the computer to wireless local area networks (commonly referred to as Wi-Fi networks, wireless LANs, or WLANs) in corporate offices, your home, and public places such as airports, restaurants, coffee shops, hotels, and universities. In a WLAN, the mobile wireless device in your computer communicates with a wireless router or a wireless access point.
- **HP Mobile Broadband Module (select products only)**—A wireless wide area network (WWAN) device that gives you wireless connectivity over a much larger area. Mobile network operators install base stations (similar to cell phone towers) throughout large geographic areas, effectively providing coverage across entire states, regions, or even countries.
- **Bluetooth® device**—Creates a personal area network (PAN) to connect to other Bluetooth-enabled devices such as computers, phones, printers, headsets, speakers, and cameras. In a PAN, each device communicates directly with other devices, and devices must be relatively close together—typically within 10 meters (approximately 33 feet) of each other.

Using the wireless controls

You can control the wireless devices in your computer using one or more of these features:

- **Wireless button (also called airplane mode key or wireless key)** (referred to in this chapter as wireless button)
- **Operating system controls**

Wireless button

The computer may have a wireless button, one or more wireless devices, and one or two wireless lights. All the wireless devices on your computer are enabled at the factory.

The wireless light indicates the overall power state of your wireless devices, not the status of individual devices.

Operating system controls

The Network and Sharing Center allows you to set up a connection or network, connect to a network, and diagnose and repair network problems.

To use operating system controls:

1. Type `control panel` in the taskbar search box, and then select **Control Panel**.
2. Select **Network and Internet**, and then select **Network and Sharing Center**.

– or –

- ▲ On the taskbar, select the network status icon, and then select **Network & Internet settings**.

Connecting to a WLAN

 **NOTE:** When you are setting up Internet access in your home, you must establish an account with an Internet service provider (ISP). To purchase Internet service and a modem, contact a local ISP. The ISP will help set up the modem, install a network cable to connect your wireless router to the modem, and test the Internet service.

To connect to a WLAN, follow these steps:

1. Be sure that the WLAN device is on.
2. On the taskbar, select the network status icon, and then connect to one of the available networks.

If the WLAN is a security-enabled WLAN, you are prompted to enter a security code. Enter the code, and then select **Next** to complete the connection.

 **NOTE:** If no WLANs are listed, you may be out of range of a wireless router or access point.

 **NOTE:** If you do not see the WLAN you want to connect to:

1. On the taskbar, right-click the network status icon, and then select **Open Network & Internet settings**.

– or –

On the taskbar, select the network status icon, and then select **Network & Internet settings**.

2. Under the **Network & Internet Status** section, select **Network and Sharing Center**.
3. Select **Set up a new connection or network**.

A list of options is displayed, allowing you to manually search for and connect to a network or to create a new network connection.

3. Follow the on-screen instructions to complete the connection.

After the connection is made, select the network status icon at the far right of the taskbar, to verify the name and status of the connection.

 **NOTE:** The functional range (how far your wireless signals travel) depends on WLAN implementation, router manufacturer, and interference from other electronic devices or structural barriers such as walls and floors.

Using HP Mobile Broadband (select products only)

Your HP Mobile Broadband computer has built-in support for mobile broadband service. Your new computer, when used with a mobile operator's network, gives you the freedom to connect to the Internet, send e-mail, or connect to your corporate network without the need for Wi-Fi hotspots.

You might need the HP Mobile Broadband Module IMEI and/or MEID number to activate mobile broadband service. The number may be printed on a label located on the bottom of your computer, inside the battery bay, under the service door, or on the back of the display.

– or –

1. On the taskbar, select the network status icon.
2. Select **Network & Internet settings**.
3. Under the **Network & Internet** section, select **Cellular**, and then select **Advanced Options**.

Some mobile network operators require the use of a SIM card. A SIM card contains basic information about you, such as a personal identification number (PIN), as well as network information. Some computers include a SIM card that is preinstalled. If the SIM card is not preinstalled, it may be provided in the HP Mobile Broadband information provided with your computer or the mobile network operator may provide it separately from the computer.

For information about HP Mobile Broadband and how to activate service with a preferred mobile network operator, see the HP Mobile Broadband information included with your computer.

Using GPS (select products only)

Your computer may be equipped with a Global Positioning System (GPS) device. GPS satellites deliver location, speed, and direction information to GPS-equipped systems.

To enable GPS, make sure location is enabled under the Windows privacy setting.

1. Type `location` in the taskbar search box, and then select **Location privacy settings**.
2. Follow the on-screen instructions for using location settings.

Using Bluetooth wireless devices (select products only)

A Bluetooth device provides short-range wireless communications that replace the physical cable connections that traditionally link electronic devices such as the following:

- Computers (desktop, notebook)
- Phones (cellular, cordless, smartphone)
- Imaging devices (printer, camera)
- Audio devices (headset, speakers)
- Mouse
- External keyboard

Connecting Bluetooth devices

Before you can use a Bluetooth device, you must establish a Bluetooth connection.

1. Type `bluetooth` in the taskbar search box, and then select **Bluetooth and other devices settings**.
2. Turn on Bluetooth, if it is not already turned on.
3. Select **Add Bluetooth or other device**, and then in the **Add a device** dialog box, select **Bluetooth**.
4. Select your device from the list, and then follow the on-screen instructions.

 **NOTE:** If the device requires verification, a pairing code is displayed. On the device you are adding, follow the on-screen instructions to verify that the code on your device matches the pairing code. For more information, refer to the documentation provided with the device.

 **NOTE:** If your device does not appear in the list, be sure that Bluetooth on that device is turned on. Some devices may have additional requirements; refer to the documentation provided with the device.

Using NFC to share information (select products only)

Your computer supports Near Field Communication (NFC), which allows you to wirelessly share information between two NFC-enabled devices. Information is transferred by tapping the tapping area (antenna) of the

computer with the antenna of your phone or other device. With NFC and supported apps, you can share websites, transfer contact information, transfer payments, and print on NFC-enabled printers.



NOTE: To locate the tapping area on your computer, see [Components on page 3](#).

Sharing

1. Confirm that the NFC function is enabled.
 - a. Type `wireless` in the taskbar search box, and then select **Turn wireless devices on or off**.
 - b. Confirm that the selection for NFC is **On**.
2. Tap the NFC tapping area with an NFC-enabled device. You may hear a sound when the devices connect.



NOTE: To find the location of the antenna on the other NFC device, refer to your device instructions.

3. Follow any on-screen instructions to continue.

Connecting to a wired network

Select products may allow wired connections: local area network (LAN) and modem connection. A LAN connection uses a network cable and is much faster than a modem, which uses a telephone cable. Both cables are sold separately.



WARNING! To reduce the risk of electric shock, fire, or damage to the equipment, do not plug a modem cable or telephone cable into an RJ-45 (network) jack.

Connecting to a local area network (LAN) (select products only)

Use a LAN connection if you want to connect the computer directly to a router in your home (instead of working wirelessly), or if you want to connect to an existing network at your office.



NOTE: A feature called HP LAN-Wireless Protection may be enabled on your computer. It closes your wireless (Wi-Fi) or WWAN connection when you connect directly to a LAN. For more information about HP LAN-Wireless Protection, see [Using HP LAN-Wireless Protection \(select products only\) on page 10](#).

If there is no RJ-45 port on the computer, connecting to a LAN requires an 8-pin, RJ-45 network cable or an optional docking device or expansion product.

To connect the network cable, follow these steps:

1. Plug the network cable into the network jack **(1)** on the computer or on an optional docking device or expansion product.

2. Plug the other end of the network cable into a network wall jack **(2)** or router.

 **NOTE:** If the network cable contains noise suppression circuitry **(3)**, which prevents interference from TV and radio reception, orient the circuitry end of the cable toward the computer.

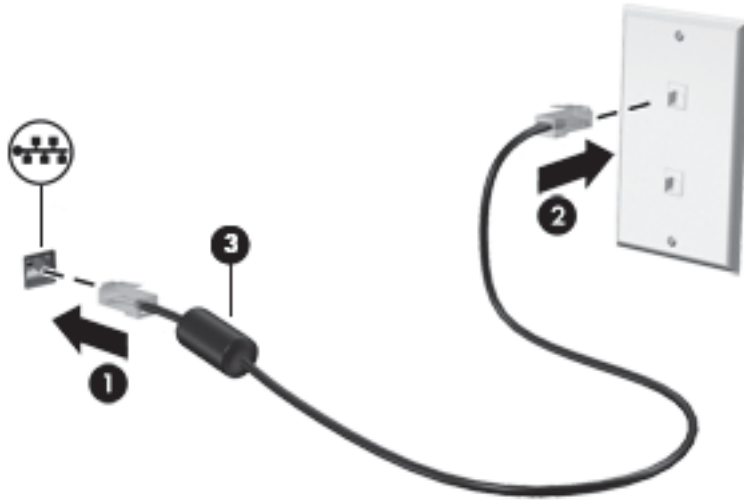

Using HP LAN-Wireless Protection (select products only)

In a LAN environment, you can set HP LAN-Wireless Protection to safeguard your LAN network from unauthorized wireless access. When HP LAN-Wireless Protection is enabled, the WLAN (Wi-Fi) or WWAN connection is turned off when the computer is connected directly to a LAN.

Turning on and customizing HP LAN-Wireless Protection

1. Connect a network cable to the network jack on the computer, or on an optional docking device or expansion product.
2. Start Computer Setup (BIOS).
 - Computers or tablets with keyboards:
 - ▲ Turn on or restart the computer, and when the HP logo appears, press **f10** to enter Computer Setup.
 - Tablets without keyboards:
 - ▲ Turn on or restart the tablet, and then quickly hold down the volume down button until the Startup menu is displayed. Tap **f10** to enter Computer Setup.
3. Select **Advanced**, and then select **Built-in Device Options**.
4. Select the check box for **LAN/WLAN Auto Switching** and/or **LAN/WWAN Auto Switching** to turn off WLAN and/or WWAN connections when connected to a LAN network.
5. To save your changes and exit Computer Setup, select **Main**, select **Save Changes and Exit**, and then select **Yes**.

 **NOTE:** If you are using arrow keys to highlight your choice, you must then press **enter**.

Your changes go into effect when the computer restarts.

Using HP MAC Address Pass Through to identify your computer on a network (select products only)

MAC Address Pass Through provides a customizable way of identifying your computer and its communications on networks. This system MAC address provides unique identification even when your computer is connected through an Ethernet adapter. This address is enabled by default.

Customizing MAC Address Pass Through

1. Start Computer Setup (BIOS).
 - Computers or tablets with keyboards:
 - ▲ Turn on or restart the computer, and when the HP logo appears, press **f10** to enter Computer Setup.
 - Tablets without keyboards:
 - ▲ Turn on or restart the tablet, and then quickly hold down the volume down button until the Startup menu is displayed. Tap **f10** to enter Computer Setup.
2. Select **Advanced**, and then select **MAC Address Pass Through**.
3. In the box to the right of **Host Based MAC Address**, select either **System Address** to enable MAC address Pass Through or **Custom Address** to customize the address.
4. If you selected Custom, select **MAC ADDRESS**, enter your customized system MAC address, and then press **enter** to save the address.
5. If the computer has an embedded LAN and you would like to use the embedded MAC address as the system MAC address, select **Reuse Embedded LAN Address**.

– or –

Select **Main**, select **Save Changes and Exit**, and then select **Yes**.



NOTE: If you are using arrow keys to highlight your choice, you must then press **enter**.

Your changes go into effect when the computer restarts.

4 Navigating the screen

You can navigate the computer screen in one or more of the following ways:

- Use touch gestures directly on the computer screen
- Use touch gestures on the TouchPad
- Use an optional mouse or keyboard (purchased separately)
- Use an on-screen keyboard
- Use a pointing stick

Using TouchPad and touch screen gestures

The TouchPad helps you navigate the computer screen and control the pointer using simple touch gestures. You can also use the left and right TouchPad buttons as you would use the corresponding buttons on an external mouse. To navigate a touch screen (select products only), touch the screen directly using gestures described in this chapter.

You can also customize gestures and view demonstrations of how they work. Type `control panel` in the taskbar search box, select **Control Panel**, and then select **Hardware and Sound**. Under **Devices and Printers**, select **Mouse**.



NOTE: Unless noted, gestures can be used on the TouchPad or a touch screen (select products only).

Tap

Use the tap/double-tap gesture to select or open an item on the screen.

- Point to an item on the screen, and then tap one finger on the TouchPad zone or touch screen to select the item. Double-tap an item to open it.



Two-finger pinch zoom

Use the two-finger pinch zoom to zoom out or in on images or text.

- Zoom out by placing two fingers apart on the TouchPad zone or touch screen and then moving your fingers together.
- Zoom in by placing two fingers together on the TouchPad zone or touch screen and then moving your fingers apart.



Two-finger slide (TouchPad only)

Use the two-finger slide to move up, down, or sideways on a page or image.

- Place two fingers slightly apart on the TouchPad zone and then drag them up, down, left, or right.

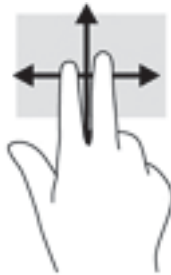

Two-finger tap (TouchPad only)

Use the two-finger tap to open the menu for an object on the screen.

 **NOTE:** The two-finger tap performs the same function as right-clicking with the mouse.

- Tap two fingers on the TouchPad zone to open the options menu for the selected object.



Four-finger tap (TouchPad only)

Use the four-finger tap to open the action center.

- Tap four fingers on the Touchpad to open the action center and view current settings and notifications.



Three-finger swipe (TouchPad only)

Use the three-finger swipe to view open windows and to switch between open windows and the desktop.

- Swipe 3 fingers away from you to see all open windows.
- Swipe 3 fingers toward you to show the desktop.
- Swipe 3 fingers left or right to switch between open windows.



One-finger slide (touch screen only)

Use the one-finger slide to pan or scroll through lists and pages, or to move an object.

- To scroll across the screen, lightly slide one finger across the screen in the direction you want to move.
- To move an object, press and hold your finger on an object, and then drag your finger to move the object.

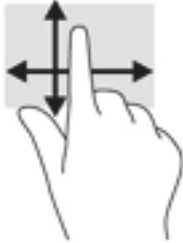

Using an optional keyboard or mouse

An optional keyboard or mouse allows you to type, select items, scroll, and perform the same functions as you do using touch gestures. The keyboard also allows you to use action keys and hot keys to perform specific functions.

Using an on-screen keyboard (select products only)

1. To display an on-screen keyboard, tap the keyboard icon in the notification area, at the far right of the taskbar.
2. Begin typing.



NOTE: Suggested words may be displayed above the on-screen keyboard. Tap a word to select it.



NOTE: Action keys and hot keys do not display or function on the on-screen keyboard.

5 Entertainment features

Use your HP computer for business or pleasure to meet with others via the camera, mix audio and video, or connect external devices like a projector, monitor, TV, or speakers. See [Components on page 3](#) to locate the audio, video and camera features on your computer.

Using a camera (select products only)

Your computer has a camera (integrated camera) that records video and captures photographs. Some models allow you to video conference and chat online using streaming video.

- ▲ To access the camera, type `camera` in the taskbar search box, and then select **Camera** from the list of applications.

Using audio

You can download and listen to music, stream audio content (including radio) from the web, record audio, or mix audio and video to create multimedia. You can also play music CDs on the computer (on select models) or attach an external optical drive to play CDs. To enhance your listening enjoyment, attach headphones or speakers.

Connecting speakers

You can attach wired speakers to your computer by connecting them to a USB port or to the audio-out (headphone)/audio-in (microphone) combo jack on your computer or on a docking station.

To connect wireless speakers to your computer, follow the device manufacturer's instructions. To connect high-definition speakers to the computer, see [Setting up HDMI audio on page 21](#). Before connecting speakers, lower the volume setting.

Connecting headphones

 **WARNING!** To reduce the risk of personal injury, lower the volume setting before putting on headphones, earbuds, or a headset. For additional safety information, see the *Regulatory, Safety and Environmental Notices*.

To access this guide:

- ▲ Select the **Start** button, select **HP**, and then select **HP Documentation**.
-

You can connect wired headphones to the headphone jack or to the audio-out (headphone)/audio-in (microphone) combo jack on your computer.

To connect wireless headphones to your computer, follow the device manufacturer's instructions.

Connecting a microphone

To record audio, connect a microphone to the microphone jack on the computer. For best results when recording, speak directly into the microphone and record sound in a setting free of background noise.

Connecting headsets

 **WARNING!** To reduce the risk of personal injury, lower the volume setting before putting on headphones, earbuds, or a headset. For additional safety information, see the *Regulatory, Safety and Environmental Notices*.

To access this guide:

- ▲ Select the **Start** button, select **HP Help and Support**, and then select **HP Documentation**.

Headphones combined with a microphone are called headsets. You can connect wired headsets to the audio-out (headphone)/audio-in (microphone) combo jack on your computer.

To connect wireless headsets to your computer, follow the device manufacturer's instructions.

Using sound settings

Use sound settings to adjust system volume, change system sounds, or manage audio devices.

To view or change sound settings:

- ▲ Type `control panel` in the taskbar search box, select **Control Panel**, select **Hardware and Sound**, and then select **Sound**.

Your computer may include an enhanced sound system by Bang & Olufsen, DTS, Beats audio, or another provider. As a result, your computer may include advanced audio features that can be controlled through an audio control panel specific to your audio system.

Use the audio control panel to view and control audio settings.

- ▲ Type `control panel` in the taskbar search box, select **Control Panel**, select **Hardware and Sound**, and then select the audio control panel specific to your system.

Using video

Your computer is a powerful video device that enables you to watch streaming video from your favorite websites and download video and movies to watch on your computer when you are not connected to a network.

To enhance your viewing enjoyment, use one of the video ports on the computer to connect an external monitor, projector, or TV.

 **IMPORTANT:** Be sure that the external device is connected to the correct port on the computer, using the correct cable. Follow the device manufacturer's instructions.

For information on using your video features, refer to HP Support Assistant.

Connecting a DisplayPort device using a USB Type-C cable (select products only)

 **NOTE:** To connect a USB Type-C DisplayPort device to your computer, you need a USB Type-C cable, purchased separately.

To see video or high-resolution display output on an external DisplayPort device, connect the DisplayPort device according to the following instructions:

1. Connect one end of the USB Type-C cable to the USB SuperSpeed and DisplayPort port on the computer.

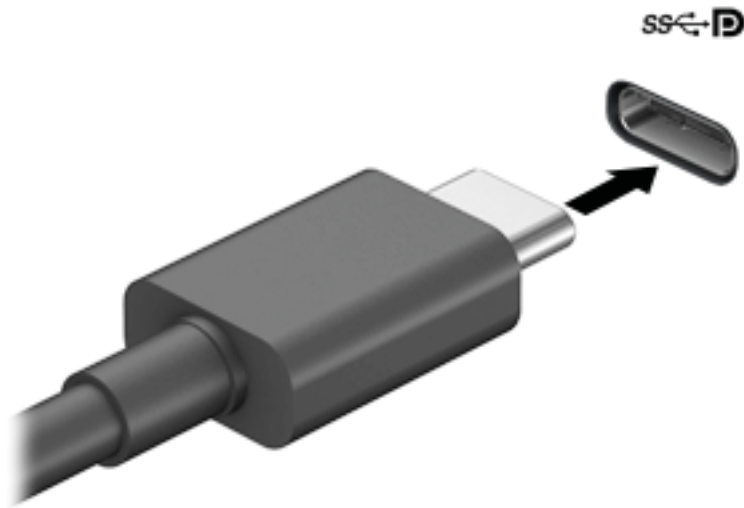

2. Connect the other end of the cable to the external DisplayPort device.
3. Press **f1** to alternate the computer screen image between 4 display states:
 - **PC screen only:** View the screen image on the computer only.
 - **Duplicate:** View the screen image simultaneously on both the computer and external device.
 - **Extend:** View the screen image extended across both the computer and external device.
 - **Second screen only:** View the screen image on the external device only.

Each time you press **f1** the display state changes.

 **NOTE:** For best results, especially if you choose the "Extend" option, increase the screen resolution of the external device, as follows. Select the **Start** button, select **Settings**, and then select **System**. Under **Display**, select the appropriate resolution, and then select **Keep changes**.

Connecting a Thunderbolt device using a USB Type-C cable (select products only)

 **NOTE:** To connect a USB Type-C Thunderbolt™ device to your computer, you need a USB Type-C cable, purchased separately.

To see video or high-resolution display output on an external Thunderbolt device, connect the Thunderbolt device according to the following instructions:

1. Connect one end of the USB Type-C cable to the USB Type-C Thunderbolt port on the computer.

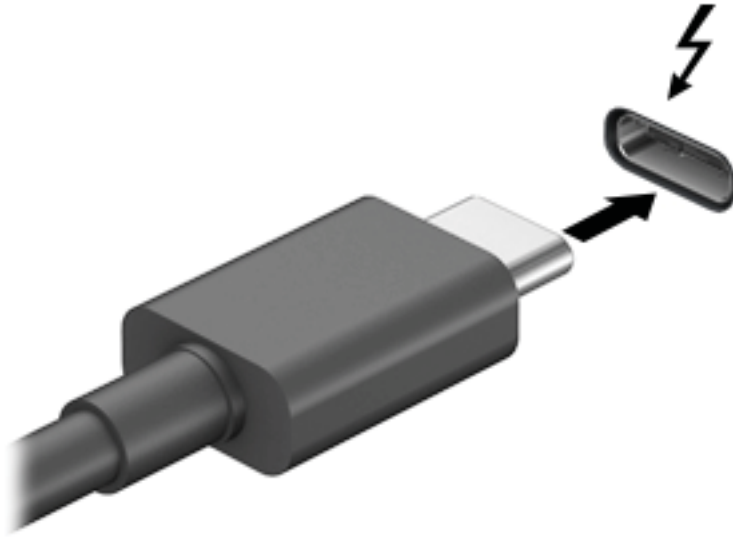

2. Connect the other end of the cable to the external Thunderbolt device.
3. Press **fn+f4** to alternate the computer screen image between 4 display states:
 - **PC screen only:** View the screen image on the computer only.
 - **Duplicate:** View the screen image simultaneously on both the computer and external device.
 - **Extend:** View the screen image extended across both the computer and external device.
 - **Second screen only:** View the screen image on the external device only.

Each time you press **fn+f4** the display state changes.

 **NOTE:** For best results, especially if you choose the "Extend" option, increase the screen resolution of the external device, as follows. Select the **Start** button, select **Settings**, and then select **System**. Under **Display**, select the appropriate resolution, and then select **Keep changes**.

Connecting video devices by using a VGA cable (select products only)

 **NOTE:** To connect a VGA video device to your computer, you need a VGA cable, purchased separately.

To see the computer screen image on an external VGA monitor or projected for a presentation, connect a monitor or projector to the computer's VGA port.

1. Connect the VGA cable from the monitor or projector to the VGA port on the computer as shown.

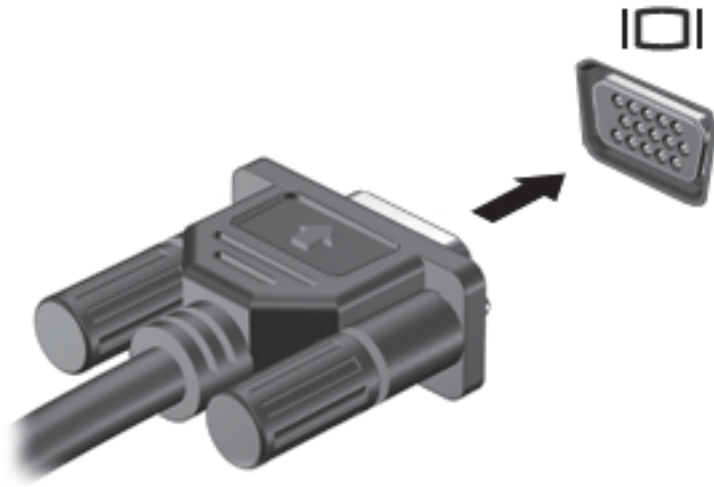

2. Press **f4** to alternate the screen image between 4 display states:
 - **PC screen only:** View the screen image on the computer only.
 - **Duplicate:** View the screen image simultaneously on both the computer and the external device.
 - **Extend:** View the screen image extended across both the computer and the external device.
 - **Second screen only:** View the screen image on the external device only.

Each time you press **f4**, the display state changes.

 **NOTE:** For best results, especially if you choose the "Extend" option, increase the screen resolution of the external device, as follows. Select the **Start** button, select **Settings**, and then select **System**. Under **Display**, select the appropriate resolution, and then select **Keep changes**.

Connecting video devices using an HDMI cable (select products only)

 **NOTE:** To connect an HDMI device to your computer, you need an HDMI cable, purchased separately.

To see the computer screen image on a high-definition TV or monitor, connect the high-definition device according to the following instructions:

1. Connect one end of the HDMI cable to the HDMI port on the computer.

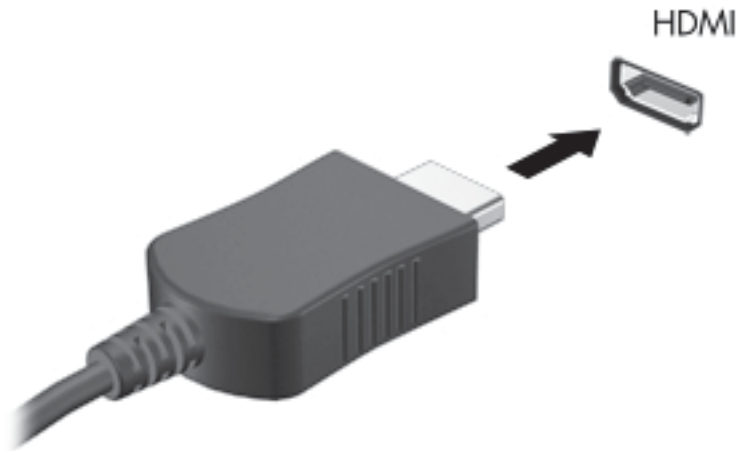

2. Connect the other end of the cable to the high-definition TV or monitor.
3. Press **f4** to alternate the computer screen image between 4 display states:
 - **PC screen only:** View the screen image on the computer only.
 - **Duplicate:** View the screen image simultaneously on both the computer and the external device.
 - **Extend:** View the screen image extended across both the computer and the external device.
 - **Second screen only:** View the screen image on the external device only.

Each time you press **f4**, the display state changes.

 **NOTE:** For best results, especially if you choose the "Extend" option, increase the screen resolution of the external device, as follows. Select the **Start** button, select **Settings**, and then select **System**. Under **Display**, select the appropriate resolution, and then select **Keep changes**.

Setting up HDMI audio

HDMI is the only video interface that supports high-definition video and audio. After you connect an HDMI TV to the computer, you can then turn on HDMI audio by following these steps:

1. Right-click the **Speakers** icon in the notification area, at the far right of the taskbar, and then select **Playback devices**.
2. On the **Playback** tab, select the name of the digital output device.
3. Click **Set Default**, and then click **OK**.

To return the audio stream to the computer speakers:

1. Right-click the **Speakers** icon in the notification area, at the far right of the taskbar, and then click **Playback devices**.
2. On the Playback tab, click **Speakers**.
3. Click **Set Default**, and then click **OK**.

Connecting a Thunderbolt DisplayPort device

The Thunderbolt™ DisplayPort connects an optional high-resolution display device or a high-performance data device. This port delivers higher performance than the VGA external monitor port and improves digital connectivity.

 **NOTE:** Install all the latest drivers for your Thunderbolt device before connecting the device to the Thunderbolt DisplayPort. Thunderbolt cable and Thunderbolt device (sold separately) must be compatible with Windows. To determine whether your device is Thunderbolt Certified for Windows, go to <https://thunderbolttechnology.net/products>.

1. Connect one end of the Thunderbolt DisplayPort cable to the Thunderbolt DisplayPort on the computer.

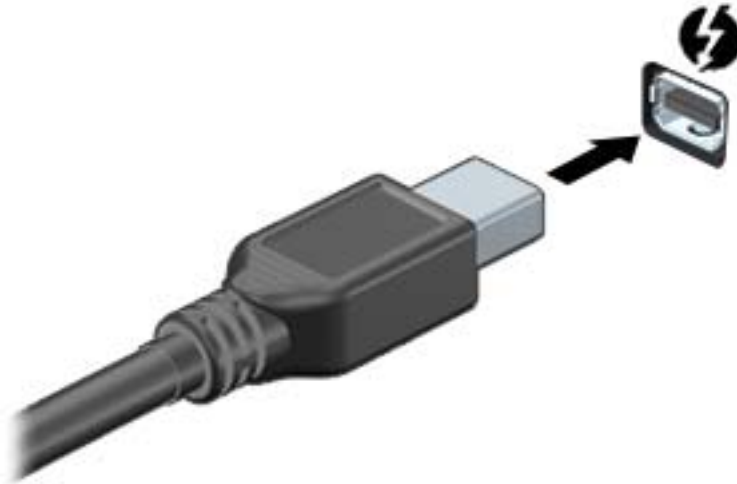

2. Connect the other end of the cable to the digital display device.
3. Press **f4** to alternate the computer screen image between 4 display states:
 - **PC screen only:** View the screen image on the computer only.
 - **Duplicate:** View the screen image simultaneously on both the computer and external device.
 - **Extend:** View the screen image extended across both the computer and external device.
 - **Second screen only:** View the screen image on the external device only.

Each time you press **f4** the display state changes.

 **NOTE:** For best results, especially if you choose the "Extend" option, increase the screen resolution of the external device, as follows. Select the **Start** button, select **Settings**, and then select **System**. Under **Display**, select the appropriate resolution, and then select **Keep changes**.

Discovering and connecting wired displays using MultiStream Transport

MultiStream Transport (MST) allows you to connect multiple wired display devices to your computer by connecting to the VGA or DisplayPorts on your computer and also to the VGA or DisplayPorts on a hub or an external docking station. You can connect in several ways, depending on the type of graphics controller installed on your computer and whether or not your computer includes a built-in hub. Go to Device Manager to find out what hardware is installed on your computer.

- ▲ Type `device manager` in the taskbar search box, and then select the **Device Manager** app. A list displays all the devices installed on your computer.

Connect displays to computers with AMD or Nvidia graphics (with an optional hub)

 **NOTE:** With an AMD graphics controller and optional hub, you can connect up to 6 external display devices.

 **NOTE:** With an Nvidia graphics controller and optional hub, you can connect up to 4 external display devices.

To set up multiple display devices, follow these steps:

1. Connect an external hub (purchased separately) to the DisplayPort on your computer, using a DP-to-DP cable (purchased separately). Be sure that the hub power adapter is connected to AC power.
2. Connect your external display devices to the VGA ports or DisplayPorts on the hub.
3. To see all of your connected display devices, type `device manager` in the taskbar search box, and then select the **Device Manager** app. If you don't see all of your connected displays, be sure that each is connected to the correct port on the hub.



NOTE: Multiple display choices include **Duplicate**, which mirrors your computer screen on all enabled display devices, or **Extend**, which spans your computer screen across all enabled display devices.

Connect displays to computers with Intel graphics (with an optional hub)



NOTE: With an Intel graphics controller and optional hub, you can connect up to 3 display devices.

To set up multiple display devices, follow these steps:

1. Connect an external hub (purchased separately) to the DisplayPort on your computer, using a DP-to-DP cable (purchased separately). Be sure that the hub power adapter is connected to AC power.
2. Connect your external display devices to the VGA ports or DisplayPorts on the hub.
3. When Windows detects a monitor connected to the DP hub, the **DisplayPort Topology Notification** dialog box is displayed. Click the appropriate options to configure your displays. Multiple display choices include **Duplicate**, which mirrors your computer screen on all enabled display devices, or **Extend**, which extends the screen image across all enabled display devices.



NOTE: If this dialog box does not appear, be sure that each external display device is connected to the correct port on the hub. Select the **Start** button, select **Settings**, and then select **System**. Under **Display**, select the appropriate resolution, and then select **Keep changes**.

Connect displays to computers with Intel graphics (with a built-in hub)

With your internal hub and Intel graphics controller, you can connect up to 3 display devices in the following configurations:

- Two 1920 x 1200 DP monitors connected to the computer + one 1920 x 1200 VGA monitor connected to an optional docking station
- One 2560 x 1600 DP monitor connected to the computer + one 1920 x 1200 VGA monitor connected to an optional docking station

To set up multiple display devices, follow these steps:

1. Connect your external display devices to the VGA ports or DisplayPorts (DP) on the computer base or the docking station.
2. When Windows detects a monitor connected to the DP hub, the **DisplayPort Topology Notification** dialog box is displayed. Click the appropriate options to configure your displays. Multiple display choices include **Duplicate**, which mirrors your computer screen on all enabled display devices, or **Extend**, which extends the screen image across all enabled display devices.



NOTE: If this dialog box does not appear, be sure that each external display device is connected to the correct port on the hub. Select the **Start** button, select **Settings**, and then select **System**. Under **Display**, select the appropriate resolution, and then select **Keep changes**.

Discovering and connecting to Miracast-compatible wireless displays (select products only)

 **NOTE:** To learn what type of display you have (Miracast-compatible or Intel WiDi), refer to the documentation that came with your TV or secondary display.

To discover and connect to Miracast-compatible wireless displays without leaving your current apps, follow the steps below.

To open Miracast:

- ▲ Type `project` in the taskbar search box, and then click **Project to a second screen**. Click **Connect to a wireless display**, and then follow the on-screen instructions.

Discovering and connecting to Intel WiDi certified displays (select Intel products only)

Use Intel WiDi to wirelessly project individual files such as photos, music, or videos, or to duplicate your entire computer screen to a TV or a secondary display device.

Intel WiDi, a premium Miracast solution, makes it easy and seamless to pair your secondary display device; provides for full-screen duplication; and improves speed, quality, and scaling.

To connect to Intel WiDi certified displays:

- ▲ Type `project` in the taskbar search box, and then click **Project to a second screen**. Click **Connect to a wireless display**, and then follow the on-screen instructions.

To open Intel WiDi:

- ▲ Type `Intel WiDi` in the taskbar search box, and then click **Intel WiDi**.

Using data transfer

Your computer is a powerful entertainment device that enables you to transfer photos, videos, and movies from your USB devices to view on your computer.

To enhance your viewing enjoyment, use one of the USB Type-C ports on the computer to connect a USB device, such as a cell phone, camera, activity tracker, or smartwatch, and transfer the files to your computer.

 **IMPORTANT:** Be sure that the external device is connected to the correct port on the computer, using the correct cable. Follow the device manufacturer's instructions.

For information on using your USB Type-C features, refer to HP Support Assistant.

Connecting devices to a USB Type-C port (select products only)

 **NOTE:** To connect a USB Type-C device to your computer, you need a USB Type-C cable, purchased separately.

1. Connect one end of the USB Type-C cable to the USB Type-C port on the computer.

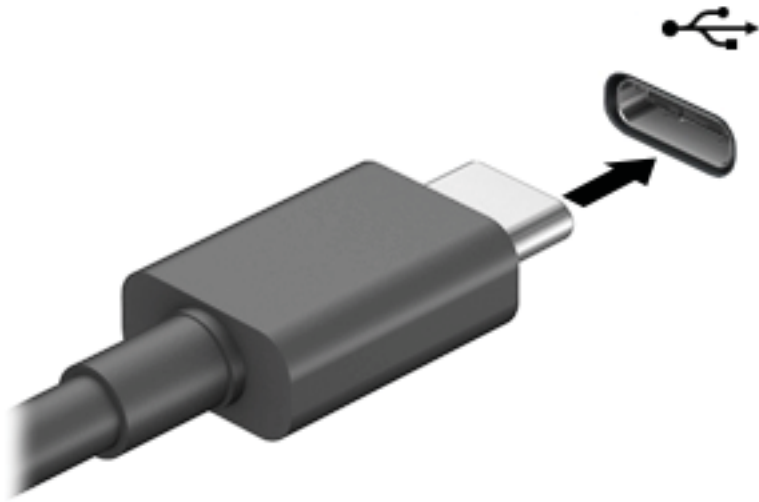

2. Connect the other end of the cable to the external device.

6 Managing power

Your computer can operate on either battery power or external power. When the computer is running on battery power and an external power source is not available to charge the battery, it is important to monitor and conserve the battery charge.

Some power management features described in this chapter may not be available on your computer.

Using Sleep and Hibernation

 **CAUTION:** Several well-known vulnerabilities exist when a computer is in the Sleep state. To prevent an unauthorized user from accessing data on your computer, even encrypted data, HP recommends that you always initiate Hibernation instead of Sleep anytime the computer will be out of your physical possession. This practice is particularly important when you travel with your computer.

CAUTION: To reduce the risk of possible audio and video degradation, loss of audio or video playback functionality, or loss of information, do not initiate Sleep while reading from or writing to a disc or an external media card.

Windows has two power-saving states, Sleep and Hibernation.

- Sleep—The Sleep state is automatically initiated after a period of inactivity. Your work is saved to memory, allowing you to resume your work very quickly. You can also initiate Sleep manually. For more information, see [Initiating and exiting Sleep on page 26](#).
- Hibernation—The Hibernation state is automatically initiated if the battery reaches a critical level or the computer has been in the Sleep state for an extended period of time. In the Hibernation state, your work is saved to a hibernation file and the computer powers down. You can also initiate Hibernation manually. For more information, see [Initiating and exiting Hibernation \(select products only\) on page 27](#).

Initiating and exiting Sleep

You can initiate Sleep in any of the following ways:

- Select the **Start** button, select the **Power** icon, and then select **Sleep**.
- Close the display (select products only).
- Press the Sleep hot key (select products only); for example, **fn+f1** or **fn+f12**.
- Briefly press the power button (select products only).

You can exit Sleep in any of the following ways:

- Briefly press the power button.
- If the computer is closed, raise the display (select products only).
- Press a key on the keyboard (select products only).
- Tap the TouchPad (select products only).

When the computer exits Sleep, your work returns to the screen.

 **NOTE:** If you have set a password to be required on exiting Sleep, you must enter your Windows password before your work returns to the screen.

Initiating and exiting Hibernation (select products only)

You can enable user-initiated Hibernation and change other power settings and timeouts using Power Options.

1. Right-click the **Power** icon , and then select **Power Options**.
2. In the left pane, select **Choose what the power buttons do** (wording may vary by product).
3. Depending on your product, you can enable Hibernation for battery power or external power in any of the following ways:
 - **Power button**—Under **Power and sleep buttons and lid settings** (wording may vary by product), select **When I press the power button**, and then select **Hibernate**.
 - **Sleep button** (select products only)—Under **Power and sleep buttons and lid settings** (wording may vary by product), select **When I press the sleep button**, and then select **Hibernate**.
 - **Lid** (select products only)—Under **Power and sleep buttons and lid settings** (wording may vary by product), select **When I close the lid**, and then select **Hibernate**.
 - **Power menu**—Select **Change Settings that are currently unavailable**, and then, under **Shutdown settings**, select the **Hibernate** check box.

The Power menu can be accessed by selecting the **Start** button.
4. Select **Save changes**.
 - ▲ To initiate Hibernation, use the method that you enabled in step 3.
 - ▲ To exit Hibernation, briefly press the power button.

 **NOTE:** If you have set a password to be required on exiting Hibernation, you must enter your Windows password before your work returns to the screen.

Shutting down (turning off) the computer

 **CAUTION:** Unsaved information is lost when the computer shuts down. Be sure to save your work before shutting down the computer.

The Shut down command closes all open programs, including the operating system, and then turns off the display and the computer.

Shut down the computer when it will be unused and disconnected from external power for an extended period.

The recommended procedure is to use the Windows Shut down command.

 **NOTE:** If the computer is in the Sleep state or in Hibernation, first exit Sleep or Hibernation by briefly pressing the power button.



1. Save your work and close all open programs.
2. Select the **Start** button, select the **Power** icon, and then select **Shut down**.

If the computer is unresponsive and you are unable to use the preceding shutdown procedures, try the following emergency procedures in the sequence provided:

- Press **ctrl+alt+delete**, select the **Power** icon, and then select **Shut down**.
- Press and hold the power button for at least 10 seconds.
- If your computer has a user-replaceable battery (select products only), disconnect the computer from external power, and then remove the battery.

Using the Power icon and Power Options

The Power icon  is located on the Windows taskbar. The Power icon allows you to quickly access power settings and view the remaining battery charge.

- To view the percentage of remaining battery charge, place the mouse pointer over the **Power** icon .
- To use Power Options, right-click the **Power** icon , and then select **Power Options**.

Different Power icons indicate whether the computer is running on battery or external power. Placing the mouse pointer over the icon reveals a message if the battery has reached a low or critical battery level.

Running on battery power

 **WARNING!** To reduce potential safety issues, use only the battery provided with the computer, a replacement battery provided by HP, or a compatible battery purchased from HP.

When a charged battery is in the computer and the computer is not plugged into external power, the computer runs on battery power. When the computer is off and unplugged from external power, the battery in the computer slowly discharges. The computer displays a message when the battery reaches a low or critical battery level.

Computer battery life varies, depending on power management settings, programs running on the computer, screen brightness, external devices connected to the computer, and other factors.

 **NOTE:** When you disconnect external power, the display brightness is automatically decreased to conserve battery charge. Select computer products can switch between graphic controllers to conserve battery charge.

Using HP Fast Charge (select products only)

The HP Fast Charge feature allows you to quickly charge your computer battery. Charging time may vary by +/- 10%. Depending on your computer model and the HP AC adapter provided with your computer, HP Fast Charge operates in one or more of the following ways:

- When the remaining battery charge is between zero and 50%, the battery will charge to 50% of full capacity in no more than 30 to 45 minutes, depending on your computer model.
- When the remaining battery charge is between zero and 90%, the battery will charge to 90% of full capacity in no more than 90 minutes.

To use HP Fast Charge, shut down your computer, and then connect the AC adapter to your computer and to external power.

Displaying battery charge

To view the percentage of remaining battery charge, place the mouse pointer over the **Power** icon .

Finding battery information in HP Support Assistant (select products only)

To access battery information:

1. Type `support` in the taskbar search box, and then select the **HP Support Assistant** app.
– or –
Select the question mark icon in the taskbar.
2. Select **Troubleshooting and fixes**, and then in the **Diagnostics** section, select **HP Battery Check**. If HP Battery Check indicates that your battery should be replaced, contact support.

HP Support Assistant provides the following tools and information about the battery:

- HP Battery Check
- Information about battery types, specifications, life cycles, and capacity

Conserving battery power

To conserve battery power and maximize battery life:

- Lower the brightness of the display.
- Select the **Power saver** setting in Power Options.
- Turn off wireless devices when you are not using them.
- Disconnect unused external devices that are not plugged into an external power source, such as an external hard drive connected to a USB port.
- Stop, disable, or remove any external media cards that you are not using.
- Before you leave your work, initiate Sleep or shut down the computer.

Identifying low battery levels

When a battery that is the sole power source for the computer reaches a low or critical battery level, the following behavior occurs:

- The battery light (select products only) indicates a low or critical battery level.
– or –
- The Power icon  shows a low or critical battery notification.



NOTE: For additional information about the Power icon, see [Using the Power icon and Power Options on page 28](#).

The computer takes the following actions for a critical battery level:

- If Hibernation is disabled and the computer is on or in the Sleep state, the computer remains briefly in the Sleep state and then shuts down and loses any unsaved information.
- If Hibernation is enabled and the computer is on or in the Sleep state, the computer initiates Hibernation.

Resolving a low battery level

Resolving a low battery level when external power is available

Connect one of the following to the computer and to external power:

- AC adapter
- Optional docking device or expansion product
- Optional power adapter purchased as an accessory from HP

Resolving a low battery level when no power source is available

Save your work and shut down the computer.

Resolving a low battery level when the computer cannot exit Hibernation

1. Connect the AC adapter to the computer and to external power.
2. Exit Hibernation by pressing the power button.

7 Security

Protecting the computer

Standard security features provided by the Windows operating system and the Windows Computer Setup utility (BIOS, which runs under any operating system) can protect your personal settings and data from a variety of risks.

 **NOTE:** Security solutions are designed to act as deterrents. These deterrents may not prevent a product from being mishandled or stolen.

 **NOTE:** Before you send your computer for service, back up and delete confidential files, and remove all password settings.

 **NOTE:** Some features listed in this chapter may not be available on your computer.

 **NOTE:** Your computer supports Computrace, which is an online security-based tracking and recovery service available in select regions. If the computer is stolen, Computrace can track the computer if the unauthorized user accesses the Internet. You must purchase the software and subscribe to the service in order to use Computrace. For information about ordering the Computrace software, go to <http://www.hp.com>.

Computer risk	Security feature
Unauthorized use of the computer	<ul style="list-style-type: none">• HP Client Security software, in combination with a password, smart card, contactless card, registered fingerprints, or other authentication credential• BIOS power-on password
Unauthorized access to Computer Setup (BIOS)	BIOS administrator password in Computer Setup*
Unauthorized access to the contents of a hard drive	DriveLock password (select products only) in Computer Setup*
Unauthorized startup from an optional external optical drive (select products only), optional external hard drive (select products only), or internal network adapter	Boot options feature in Computer Setup*
Unauthorized access to a Windows user account	Windows user password
Unauthorized access to data	Windows BitLocker
Unauthorized removal of the computer	Security cable slot (used with an optional security cable on select products only)

*Computer Setup is an embedded, ROM-based utility that can be used even when the operating system is not working or will not load. You can use a pointing device (TouchPad, pointing stick, or USB mouse) or the keyboard to navigate and make selections in Computer Setup.

NOTE: On tablets without keyboards, you can use the touch screen.

Using passwords

A password is a group of characters that you choose to secure your computer information. Several types of passwords can be set, depending on how you want to control access to your information. Passwords can be set in Windows or in Computer Setup, which is preinstalled on the computer.

- BIOS administrator, power-on, and DriveLock passwords are set in Computer Setup and are managed by the system BIOS.
- Windows passwords are set only in the Windows operating system.
- If you forget both the DriveLock user password and the DriveLock master password set in Computer Setup, the hard drive that is protected by the passwords is permanently locked and can no longer be used.

You can use the same password for a Computer Setup feature and for a Windows security feature.

Use the following tips for creating and saving passwords:

- When creating passwords, follow requirements set by the program.
- Do not use the same password for multiple applications or websites, and do not reuse your Windows password for any other application or website.
- Use the Password Manager feature of HP Client Security to store your user names and passwords for your websites and applications. You can securely read them in the future if they cannot be remembered.
- Do not store passwords in a file on the computer.

The following tables list commonly used Windows and BIOS administrator passwords and describe their functions.

Setting passwords in Windows

Password	Function
Administrator password*	Protects access to a Windows administrator-level account. NOTE: Setting the Windows administrator password does not set the BIOS administrator password.
User password*	Protects access to a Windows user account.

*For information about setting a Windows administrator password or a Windows user password, type `support` in the taskbar search box, and then select the **HP Support Assistant** app.

Setting passwords in Computer Setup

Password	Function
BIOS administrator password*	Protects access to Computer Setup. NOTE: If features have been enabled to prevent removing the BIOS administrator password, you may not be able to remove it until those features have been disabled.
Power-on password	<ul style="list-style-type: none">• Must be entered each time you turn on or restart the computer.• If you forget your power-on password, you cannot turn on or restart the computer.
DriveLock master password*	Protects access to the internal hard drive that is protected by DriveLock, and is set under DriveLock Passwords during the enable process. This password is also used to remove DriveLock protection.
DriveLock user password*	Protects access to the internal hard drive that is protected by DriveLock, and is set under DriveLock Passwords during the enable process.

*For details about each of these passwords, see the following topics.

Managing a BIOS administrator password

To set, change, or delete this password, follow these steps:

Setting a new BIOS administrator password

1. Start Computer Setup.
 - Computers or tablets with keyboards:
 - ▲ Turn on or restart the computer, and when the HP logo appears, press **f10** to enter Computer Setup.
 - Tablets without keyboards:
 - ▲ Turn off the tablet. Press the power button in combination with the volume down button until the Startup menu is displayed, and then tap **f10** to enter Computer Setup.
2. Select **Security**, select **Create BIOS administrator password** or **Set Up BIOS administrator Password** (select products only), and then press **enter**.
3. When prompted, type a password.
4. When prompted, type the new password again to confirm.
5. To save your changes and exit Computer Setup, select **Main**, select **Save Changes and Exit**, and then select **Yes**.



NOTE: If you are using arrow keys to highlight your choice, you must then press **enter**.

Your changes go into effect when the computer restarts.

Changing a BIOS administrator password

1. Start Computer Setup.
 - Computers or tablets with keyboards:

- ▲ Turn on or restart the computer, and when the HP logo appears, press **f10** to enter Computer Setup.
 - Tablets without keyboards:
 - ▲ Turn off the tablet. Press the power button in combination with the volume down button until the Startup menu is displayed, and then tap **f10** to enter Computer Setup.
2. Enter your current BIOS administrator password.
 3. Select **Security**, select **Change BIOS administrator Password** or **Change Password** (select products only), and then press **enter**.
 4. When prompted, type your current password.
 5. When prompted, type your new password.
 6. When prompted, type your new password again to confirm.
 7. To save your changes and exit Computer Setup, select **Main**, select **Save Changes and Exit**, and then select **Yes**.



NOTE: If you are using arrow keys to highlight your choice, you must then press **enter**.

Your changes go into effect when the computer restarts.

Deleting a BIOS administrator password

1. Start Computer Setup.
 - Computers or tablets with keyboards:
 - ▲ Turn on or restart the computer, and when the HP logo appears, press **f10** to enter Computer Setup.
 - Tablets without keyboards:
 - ▲ Turn off the tablet. Press the power button in combination with the volume down button until the Startup menu is displayed, and then tap **f10** to enter Computer Setup.
2. Enter your current BIOS administrator password.
3. Select **Security**, select **Change BIOS administrator Password** or **Change Password** (select products only), and then press **enter**.
4. When prompted, type your current password.
5. When prompted for the new password, leave the field empty, and then press **enter**.
6. When prompted to type your new password again, leave the field empty, and then press **enter**.
7. To save your changes and exit Computer Setup, select **Main**, select **Save Changes and Exit**, and then select **Yes**.



NOTE: If you are using arrow keys to highlight your choice, you must then press **enter**.

Your changes go into effect when the computer restarts.

Entering a BIOS administrator password

At the **BIOS administrator password** prompt, type your password (using the same kind of keys you used to set the password), and then press **enter**. After two unsuccessful attempts to enter the BIOS administrator password, you must restart the computer and try again.

Using DriveLock Security Options

DriveLock protection prevents unauthorized access to the contents of a hard drive. DriveLock can be applied only to the internal hard drive(s) of the computer. After DriveLock protection is applied to a drive, the appropriate password must be entered to access the drive. The drive must be inserted into the computer or an advanced port replicator in order for it to be unlocked.

DriveLock Security Options offers the following features:

- **Automatic DriveLock**—See [Selecting Automatic DriveLock \(select products only\) on page 35](#).
- **Set DriveLock Master Password**—See [Selecting manual DriveLock on page 36](#).
- **Enable DriveLock**—See [Enabling DriveLock and setting a DriveLock user password on page 37](#).

Selecting Automatic DriveLock (select products only)

A BIOS administrator password must be set before you can enable Automatic DriveLock. When Automatic DriveLock is enabled, a random DriveLock user password and a DriveLock master password derived from the BIOS administrator password are created. When the computer is turned on, the random user password automatically unlocks the drive. If the drive is moved to another computer, you must enter the BIOS administrator password for the original computer at the DriveLock password prompt to unlock the drive.

Enabling Automatic DriveLock

To enable Automatic DriveLock, follow these steps:

1. Start Computer Setup.
 - Computers or tablets with keyboards:
 1. Turn off the computer.
 2. Press the power button, and when the HP logo appears, press **f10** to enter Computer Setup.
 - Tablets without keyboards:
 1. Turn off the tablet.
 2. Press the power button in combination with the volume down button until the Startup menu is displayed, and then tap **f10** to enter Computer Setup.
2. At the BIOS administrator password prompt, enter the BIOS administrator password, and then press **enter**.
3. Select **Security**, select **Hard Drive Utilities**, select **DriveLock/Automatic DriveLock**, and then press **enter**.
4. Use the **enter** key, left mouse click, or touch screen to select the **Automatic DriveLock** check box.
5. To save your changes and exit Computer Setup, select **Main**, select **Save Changes and Exit**, and then select **Yes**.



NOTE: If you are using arrow keys to highlight your choice, you must then press **enter**.

Disabling Automatic DriveLock

To disable Automatic DriveLock, follow these steps:

1. Start Computer Setup.
 - Computers or tablets with keyboards:

1. Turn off the computer.
2. Press the power button, and when the HP logo appears, press **f10** to enter Computer Setup.
- Tablets without keyboards:
 1. Turn off the tablet.
 2. Press the power button in combination with the volume down button until the Startup menu is displayed, and then tap **f10** to enter Computer Setup.
2. At the BIOS administrator password prompt, enter the BIOS administrator password, and then press **enter**.
3. Select **Security**, select **Hard Drive Utilities**, select **DriveLock/Automatic DriveLock**, and then press **enter**.
4. Select an internal hard drive, and then press **enter**.
5. Use the **enter** key, left mouse click, or touch screen to clear the **Automatic DriveLock** check box.
6. To save your changes and exit Computer Setup, select **Main**, select **Save Changes and Exit**, and then select **Yes**.



NOTE: If you are using arrow keys to highlight your choice, you must then press **enter**.

Entering an Automatic DriveLock password

While Automatic DriveLock is enabled and the drive remains attached to the original computer, you will not be prompted to enter a DriveLock password to unlock the drive. However, if the drive is moved to another computer, or the system board is replaced on the original computer, you will be prompted to provide the DriveLock password.

If this happens, at the **DriveLock Password** prompt, type the BIOS administrator password for the original computer (using the same kind of keys you used to set the password), and then press **enter** to unlock the drive.

After three incorrect attempts to enter the password, you must shut down the computer and try again.

Selecting manual DriveLock



CAUTION: To prevent a DriveLock-protected hard drive from becoming permanently unusable, record the DriveLock user password and the DriveLock master password in a safe place away from your computer. If you forget both DriveLock passwords, the hard drive will be permanently locked and can no longer be used.

To manually apply DriveLock protection to an internal hard drive, a master password must be set, and DriveLock must be enabled in Computer Setup. Note the following considerations about using DriveLock protection:

- After DriveLock protection is applied to a hard drive, the hard drive can be accessed only by entering either the DriveLock user password or the master password.
- The owner of the DriveLock user password should be the day-to-day user of the protected hard drive. The owner of the DriveLock master password may be either a system administrator or the day-to-day user.
- The DriveLock user password and the DriveLock master password can be identical.

Setting a DriveLock master password

To set a DriveLock master password, follow these steps:

1. Start Computer Setup.
 - Computers or tablets with keyboards:
 1. Turn off the computer.
 2. Press the power button, and when the HP logo appears, press **f10** to enter Computer Setup.
 - Tablets without keyboards:
 1. Turn off the tablet.
 2. Press the power button in combination with the volume down button until the Startup menu is displayed, and then tap **f10** to enter Computer Setup.
2. Select **Security**, make the selection for **Hard Drive Utilities**, select **DriveLock/Automatic DriveLock**, and then press **enter**.
3. Select the hard drive you want to protect, and then press **enter**.
4. Select **Set DriveLock Master Password**, and then press **enter**.
5. Carefully read the warning.
6. Follow the on-screen instructions to set a DriveLock master password.



NOTE: You can enable DriveLock and set a DriveLock user password before exiting from Computer Setup. For more information, see [Enabling DriveLock and setting a DriveLock user password on page 37](#).

7. To save your changes and exit Computer Setup, select **Main**, select **Save Changes and Exit**, and then select **Yes**.



NOTE: If you are using arrow keys to highlight your choice, you must then press **enter**.

Enabling DriveLock and setting a DriveLock user password

To enable DriveLock, and set a DriveLock user password, follow these steps:

1. Start Computer Setup.
 - Computers or tablets with keyboards:
 1. Turn off the computer.
 2. Press the power button, and when the HP logo appears, press **f10** to enter Computer Setup.
 - Tablets without keyboards:
 1. Turn off the tablet.
 2. Press the power button in combination with the volume down button until the Startup menu is displayed, and then tap **f10** to enter Computer Setup.
2. Select **Security**, select **Hard Drive Utilities**, select **DriveLock/Automatic DriveLock**, and then press **enter**.
3. Select the hard drive you want to protect, and then press **enter**.
4. Select **Enable DriveLock** and then press **enter**.

5. Carefully read the warning.
6. Follow the on-screen instructions to set a DriveLock user password and enable DriveLock.
7. To save your changes and exit Computer Setup, select **Main**, select **Save Changes and Exit**, and then select **Yes**.



NOTE: If you are using arrow keys to highlight your choice, you must then press **enter**.

Disabling DriveLock

1. Start Computer Setup.
 - Computers or tablets with keyboards:
 1. Turn off the computer.
 2. Press the power button, and when the HP logo appears, press **f10** to enter Computer Setup.
 - Tablets without keyboards:
 1. Turn off the tablet.
 2. Press the power button in combination with the volume down button until the Startup menu is displayed, and then tap **f10** to enter Computer Setup.
2. Select **Security**, select **Hard Drive Utilities**, select **DriveLock/Automatic DriveLock**, and then press **enter**.
3. Select the hard drive you want to manage, and then press **enter**.
4. Select **Disable DriveLock**, and then press **enter**.
5. Follow the on-screen instructions to disable DriveLock.
6. To save your changes and exit Computer Setup, select **Main**, select **Save Changes and Exit**, and then select **Yes**.



NOTE: If you are using arrow keys to highlight your choice, you must then press **enter**.

Entering a DriveLock password

Be sure that the hard drive is inserted into the computer (not into an optional docking device or external MultiBay).

At the **DriveLock Password** prompt, type your DriveLock user or master password (using the same kind of keys you used to set the password), and then press **enter**.

After three incorrect attempts to enter the password, you must shut down the computer and try again.

Changing a DriveLock password

To change a DriveLock password in Computer Setup, follow these steps:

1. Turn off the computer.
2. Press the power button.
3. At the **DriveLock Password** prompt, type the current DriveLock user password or master password that you are changing, press **enter**, and then press or tap **f10** to enter Computer Setup.
4. Select **Security**, select **Hard Drive Utilities**, select **DriveLock/Automatic DriveLock**, and then press **enter**.

5. Select the hard drive you want to manage, and then press **enter**.
6. Make the selection for the DriveLock password that you want to change, and then follow the on-screen instructions to enter passwords.

 **NOTE:** The **Change DriveLock Master Password** option is visible only if the DriveLock master password was provided at the DriveLock Password prompt in step 3.

7. To save your changes and exit Computer Setup, select **Main**, select **Save Changes and Exit**, and then select **Yes**.

 **NOTE:** If you are using arrow keys to highlight your choice, you must then press **enter**.

Windows Hello (select products only)

On products equipped with a fingerprint reader or an infrared camera, you can use Windows Hello to sign in by swiping your finger or looking at the camera.

To set up Windows Hello:

1. Select the **Start** button, select **Settings**, select **Accounts**, and then select **Sign-in options**.
2. To add a password, select **Add**.
3. Select **Get Started**, and then follow the on-screen instructions enroll your fingerprint or facial ID and set up a PIN.

 **NOTE:** The PIN is not limited in length, but it must consist of numbers only. To include alphabetic or special characters, select the **include letters and symbols** checkbox.

Using antivirus software

When you use the computer to access e-mail, a network, or the Internet, you potentially expose it to computer viruses. Computer viruses can disable the operating system, programs, or utilities, or cause them to function abnormally.

Antivirus software can detect most viruses, destroy them, and, in most cases, repair any damage they have caused. To provide ongoing protection against newly discovered viruses, antivirus software must be kept up to date.

Windows Defender is preinstalled on your computer. It is strongly recommended that you continue to use an antivirus program in order to fully protect your computer.

For more information about computer viruses, access the HP Support Assistant.

Using firewall software

Firewalls are designed to prevent unauthorized access to a system or network. A firewall can be a software program you install on your computer and/or network, or it can be a solution made up of both hardware and software.

There are two types of firewalls to consider:

- Host-based firewalls—Software that protects only the computer it is installed on.
- Network-based firewalls—Installed between your DSL or cable modem and your home network to protect all the computers on the network.

When a firewall is installed on a system, all data sent to and from the system is monitored and compared with a set of user-defined security criteria. Any data that does not meet those criteria is blocked.

Your computer or networking equipment may already have a firewall installed. If not, firewall software solutions are available.

 **NOTE:** Under some circumstances a firewall can block access to Internet games, interfere with printer or file sharing on a network, or block authorized e-mail attachments. To temporarily resolve the problem, disable the firewall, perform the task that you want to perform, and then reenable the firewall. To permanently resolve the problem, reconfigure the firewall.

Installing software updates

HP, Windows, and third-party software installed on your computer should be regularly updated to correct security problems and improve software performance.

 **IMPORTANT:** Microsoft sends out alerts regarding Windows updates, which may include security updates. To protect the computer from security breaches and computer viruses, install all updates from Microsoft as soon as you receive an alert.

You can install these updates automatically.

To view or change the settings:

1. Select the **Start** button, select **Settings**, and then select **Update & Security**.
2. Select **Windows Update**, and then follow the on-screen instructions.
3. To schedule a time for installing updates, select **Advanced Options**, and then follow the on-screen instructions.

Using HP Client Security (select products only)

HP Client Security software is preinstalled on your computer. This software can be accessed through the HP Client Security icon at the far right of the taskbar or Windows Control Panel. It provides security features that help protect against unauthorized access to the computer, networks, and critical data. For more information, see the HP Client Security software Help.

Using HP Device as a Service (HP DaaS) (select products only)

HP DaaS is a cloud-based IT solution that enables businesses to effectively manage and secure their company assets. HP DaaS helps protect devices against malware and other attacks, monitors device health, and helps reduce time spent solving device and security issues. You can quickly download and install the software, which is highly cost effective relative to traditional in-house solutions. For more information, go to <https://www.hptouchpointmanager.com/>.

Using an optional security cable (select products only)

A security cable (purchased separately) is designed to act as a deterrent, but it may not prevent the computer from being mishandled or stolen. To connect a security cable to your computer, follow the device manufacturer's instructions.

Using a fingerprint reader (select products only)

Integrated fingerprint readers are available on select products. In order to use the fingerprint reader, you must enroll your fingerprints in HP Client Security's Credential Manager. Refer to the HP Client Security software Help.

After you enroll your fingerprints in Credential Manager, you can use HP Client Security's Password Manager to store and fill in your user names and passwords in supported websites and applications.

Locating the fingerprint reader

The fingerprint reader is a small metallic sensor that is located in one of the following areas of your computer:

- Near the bottom of the TouchPad
- On the right side of the keyboard
- On the upper-right side of the display
- On the left side of the display
- On the back of the display

Depending on your product, the reader may be oriented horizontally or vertically.

8 Maintenance

It is important to perform regular maintenance to keep your computer in optimal condition. This chapter explains how to use tools like Disk Defragmenter and Disk Cleanup. It also provides instructions for updating programs and drivers, steps to clean the computer, and tips for traveling with (or shipping) the computer.

Improving performance

You can improve the performance of your computer by performing regular maintenance tasks with tools such as Disk Defragmenter and Disk Cleanup.

Using Disk Defragmenter

HP recommends using Disk Defragmenter to defragment your hard drive at least once a month.



NOTE: It is not necessary to run Disk Defragmenter on solid-state drives.

To run Disk Defragmenter:

1. Connect the computer to AC power.
2. Type `defragment` in the taskbar search box, and then select **Defragment and optimize your drives**.
3. Follow the on-screen instructions.

For additional information, access the Disk Defragmenter software Help.

Using Disk Cleanup

Use Disk Cleanup to search the hard drive for unnecessary files that you can safely delete to free up disk space and help the computer run more efficiently.

To run Disk Cleanup:

1. Type `disk` in the taskbar search box, and then select **Disk Cleanup**.
2. Follow the on-screen instructions.

Using HP 3D DriveGuard (select products only)

HP 3D DriveGuard protects a hard drive by parking the drive and halting data requests under either of the following conditions:

- You drop the computer.
- You move the computer with the display closed while the computer is running on battery power.

A short time after the end of one of these events, HP 3D DriveGuard returns the hard drive to normal operation.



NOTE: Only internal hard drives are protected by HP 3D DriveGuard. A hard drive installed in an optional docking device or connected to a USB port is not protected by HP 3D DriveGuard.



NOTE: Because solid-state drives (SSDs) lack moving parts, HP 3D DriveGuard is unnecessary for these drives.

Identifying HP 3D DriveGuard status

The hard drive light on the computer changes color to show that the drive in a primary hard drive bay and/or the drive in a secondary hard drive bay (select products only) is parked.

Updating programs and drivers

HP recommends that you update your programs and drivers on a regular basis. Updates can resolve issues and bring new features and options to your computer. For example, older graphics components might not work well with the most recent gaming software. Without the latest driver, you would not be getting the most out of your equipment.

Go to <http://www.hp.com/support> to download the latest versions of HP programs and drivers. In addition, register to receive automatic notifications when updates become available.

If you would like to update your programs and drivers, follow these instructions:

1. Type `support` in the taskbar search box, and then select the **HP Support Assistant** app.
– or –
Select the question mark icon in the taskbar.
2. Select **My notebook**, select the **Updates** tab, and then select **Check for updates and messages**.
3. Follow the on-screen instructions.

Cleaning your computer

Use the following products to safely clean your computer:

- Alcohol-free glass-cleaning fluid
- Solution of water and mild soap
- Dry microfiber cleaning cloth or a chamois (static-free cloth without oil)
- Static-free cloth wipes

⚠ CAUTION: Avoid strong cleaning solvents or germicidal wipes that can permanently damage your computer. If you are not sure that a cleaning product is safe for your computer, check the product contents to make sure that ingredients such as alcohol, acetone, ammonium chloride, methylene chloride, and hydrocarbons are not included in the product.

Fibrous materials, such as paper towels, can scratch the computer. Over time, dirt particles and cleaning agents can get trapped in the scratches.

Cleaning procedures

Follow the procedures in this section to safely clean your computer.

⚠ WARNING! To prevent electric shock or damage to components, do not attempt to clean your computer while it is on.

1. Turn off the computer.
2. Disconnect AC power.
3. Disconnect all powered external devices.

⚠ CAUTION: To prevent damage to internal components, do not spray cleaning agents or liquids directly on any computer surface. Liquids dripped on the surface can permanently damage internal components.

Cleaning the display

Gently wipe the display using a soft, lint-free cloth moistened with an alcohol-free glass cleaner. Be sure that a display is dry before you close the computer.

Cleaning the sides or cover

To clean the sides or cover, use a soft microfiber cloth or chamois moistened with one of the cleaning solutions listed previously, or use an acceptable disposable wipe.

📝 NOTE: When cleaning the cover of the computer, use a circular motion to aid in removing dirt and debris.

Cleaning the TouchPad, keyboard, or mouse (select products only)

⚠ WARNING! To reduce the risk of electric shock or damage to internal components, do not use a vacuum cleaner attachment to clean the keyboard. A vacuum cleaner can deposit household debris on the keyboard surface.

⚠ CAUTION: To prevent damage to internal components, do not allow liquids to drip between the keys.

- To clean the TouchPad, keyboard, or mouse, use a soft microfiber cloth or a chamois moistened with one of the cleaning solutions listed previously.
- To prevent keys from sticking and to remove dust, lint, and particles from the keyboard, use a can of compressed air with a straw extension.

Traveling with or shipping your computer

If you have to travel with or ship your computer, follow these tips to keep your equipment safe.

- Prepare the computer for traveling or shipping:
 - Back up your information to an external drive.
 - Remove all discs and all external media cards, such as memory cards.

- Turn off and then disconnect all external devices.
- Shut down the computer.
- Take along a backup of your information. Keep the backup separate from the computer.
- When traveling by air, carry the computer as hand luggage; do not check it in with the rest of your luggage.

⚠ CAUTION: Avoid exposing a drive to magnetic fields. Security devices with magnetic fields include airport walk-through devices and security wands. Airport conveyer belts and similar security devices that check carry-on baggage use X-rays instead of magnetism and do not damage drives.

- If you plan to use the computer during a flight, listen for the in-flight announcement that tells you when you are allowed to use your computer. In-flight computer use is at the discretion of the airline.
- If you are shipping the computer or a drive, use suitable protective packaging and label the package “FRAGILE.”
- The use of wireless devices may be restricted in some environments. Such restrictions may apply aboard aircraft, in hospitals, near explosives, and in hazardous locations. If you are uncertain of the policy that applies to the use of a wireless device in your computer, ask for authorization to use your computer before you turn it on.
- If you are traveling internationally, follow these suggestions:
 - Check the computer-related customs regulations for each country or region on your itinerary.
 - Check the power cord and adapter requirements for each location in which you plan to use the computer. Voltage, frequency, and plug configurations vary.

⚠ WARNING! To reduce the risk of electric shock, fire, or damage to the equipment, do not attempt to power the computer with a voltage converter kit sold for appliances.

9 Backing up, restoring, and recovering

This chapter provides information about the following processes, which are standard procedure for most products:

- **Backing up your personal information**—You can use Windows tools to back up your personal information (see [Using Windows tools on page 46](#)).
- **Creating a restore point**—You can use Windows tools to create a restore point (see [Using Windows tools on page 46](#)).
- **Creating recovery media** (select products only)—You can use HP Recovery Manager or HP Cloud Recovery Download Tool (select products only) to create recovery media (see [Creating HP Recovery media \(select products only\) on page 46](#)).
- **Restoring and recovery**—Windows offers several options for restoring from backup, refreshing the computer, and resetting the computer to its original state (see [Using Windows tools on page 46](#)).
- **Removing the Recovery Partition**—To remove the Recovery partition to reclaim hard drive space (select products only), select the **Remove Recovery Partition** option of HP Recovery Manager. For more information, see [Removing the HP Recovery partition \(select products only\) on page 50](#).

Using Windows tools

 **IMPORTANT:** Windows is the only option that allows you to back up your personal information. Schedule regular backups to avoid information loss.

You can use Windows tools to back up personal information and create system restore points and recovery media, allowing you to restore from backup, refresh the computer, and reset the computer to its original state.

 **NOTE:** If computer storage is 32 GB or less, Microsoft System Restore is disabled by default.

For more information and steps, see the Get Help app.

1. Select the **Start** button, and then select the **Get Help** app.
2. Enter the task you want to perform.

 **NOTE:** You must be connected to the Internet to access the Get Help app.

Creating HP Recovery media (select products only)

After you have successfully set up the computer, use HP Recovery Manager to create a backup of the HP Recovery partition on the computer. This backup is called HP Recovery media. In cases where the hard drive is corrupted or has been replaced, the HP Recovery media can be used to reinstall the original operating system.

To check for the presence of the Recovery partition in addition to the Windows partition, right-click the **Start** button, select **File Explorer**, and then select **This PC**.

 **NOTE:** If your computer does not list the Recovery partition in addition to the Windows partition, contact support to obtain recovery discs. Go to <http://www.hp.com/support>, select your country or region, and then follow the on-screen instructions.

On select products, you can use the HP Cloud Recovery Download Tool to create HP Recovery media on a bootable USB flash drive. For more information, see [Using the HP Cloud Recovery Download Tool to create recovery media on page 48](#).

Using HP Recovery Manager to create recovery media

 **NOTE:** If you cannot create recovery media yourself, contact support to obtain recovery discs. Go to <http://www.hp.com/support>, select your country or region, and then follow the on-screen instructions.

Before you begin

Before you begin, note the following:

- Only one set of recovery media can be created. Handle these recovery tools carefully, and keep them in a safe place.
- HP Recovery Manager examines the computer and determines the required media storage capacity.
- To create recovery media, use one of the following options:

 **NOTE:** If the computer does not have a recovery partition, HP Recovery Manager displays the Windows Create a Recovery Drive feature. Follow the on-screen instructions to create a recovery image on a blank USB flash drive or hard drive.

- If your computer has an optical drive with DVD writer capability, be sure to use only high-quality blank DVD-R, DVD+R, DVD-R DL, or DVD+R DL discs. Do not use rewritable discs such as CD±RW, DVD±RW, double-layer DVD±RW, or BD-RE (rewritable Blu-ray) discs, which are not compatible with HP Recovery Manager software.
- If your computer does not include an integrated optical drive with DVD writer capability, you can use an external optical drive (purchased separately) to create recovery discs, as described above. If an external optical drive is used, you must connect it directly to a USB port on the computer. It cannot be connected to a USB port on an external device, such as a USB hub.
- To create a recovery USB flash drive, use a high-quality blank USB flash drive.
- Be sure that the computer is connected to AC power before you begin creating the recovery media.
- The creation process can take an hour or more. Do not interrupt this process.
- If necessary, you can exit the program before you have finished creating all of the recovery media. HP Recovery Manager will finish the current DVD or USB flash drive. The next time you start HP Recovery Manager, you will be prompted to continue.

Creating the recovery media

To create HP Recovery media using HP Recovery Manager:

 **IMPORTANT:** For a tablet with a detachable keyboard, connect the tablet to the keyboard base before beginning these steps.

1. Type `recovery` in the taskbar search box, and then select **HP Recovery Manager**.
2. Select **Create recovery media**, and then follow the on-screen instructions.

If you need to recover the system, see [Recovering using HP Recovery Manager on page 48](#).

Using the HP Cloud Recovery Download Tool to create recovery media

To create HP Recovery media using the HP Cloud Recovery Download Tool:

1. Go to <http://www.hp.com/support>.
2. Select **Software and Drivers**, and then follow the on-screen instructions.

Restoring and recovery

Restoring and recovery can be performed using one or more of the following options: Windows tools, HP Recovery Manager, or the HP Recovery partition.

 **IMPORTANT:** Not all methods are available on all products.

Restoring, resetting, and refreshing using Windows tools

Windows offers several options for restoring, resetting, and refreshing the computer. For details, see [Using Windows tools on page 46](#).

Restoring using HP Recovery Manager and the HP Recovery partition

You can use HP Recovery Manager and the HP Recovery partition (select products only) to restore the computer to the original factory state:

- **Resolving problems with preinstalled applications or drivers**—To correct a problem with a preinstalled application or driver:
 1. Type `recovery` in the taskbar search box, and then select **HP Recovery Manager**.
 2. Select **Reinstall drivers and/or applications**, and then follow the on-screen instructions.
- **Using System Recovery**—To recover the Windows partition to original factory content, select the **System Recovery** option from the HP Recovery partition (select products only) or use the HP Recovery media. For more information, see [Recovering using HP Recovery Manager on page 48](#). If you have not already created recovery media, see [Creating HP Recovery media \(select products only\) on page 46](#).
- **Using Factory Reset** (select products only)—Restores the computer to its original factory state by deleting all information from the hard drive and recreating the partitions and then reinstalling the operating system and the software that was installed at the factory (select products only). To use the **Factory Reset** option, you must use HP Recovery media. If you have not already created recovery media, see [Creating HP Recovery media \(select products only\) on page 46](#).

 **NOTE:** If you have replaced the hard drive in the computer, you can use the Factory Reset option to install the operating system and the software that was installed at the factory.

Recovering using HP Recovery Manager

You can use HP Recovery Manager software to recover the computer to its original factory state by using the HP Recovery media that you either created or that you obtained from HP, or by using the HP Recovery partition (select products only).

If you have not already created HP Recovery media, see [Creating HP Recovery media \(select products only\) on page 46](#).

 **IMPORTANT:** HP Recovery Manager does not automatically provide backups of your personal data. Before beginning recovery, back up any personal data that you want to retain. See [Using Windows tools on page 46](#).

IMPORTANT: Recovery through HP Recovery Manager should be used as a final attempt to correct computer issues.

 **NOTE:** When you start the recovery process, only the options available for your computer are displayed.

Before you begin, note the following:

- HP Recovery Manager recovers only software that was installed at the factory. For software not provided with this computer, you must either download the software from the manufacturer's website or reinstall the software from the media provided by the manufacturer.
- If the computer hard drive fails, HP Recovery media must be used. This media is created using HP Recovery Manager. See [Creating HP Recovery media \(select products only\) on page 46](#).
- If your computer does not allow the creation of HP Recovery media or if the HP Recovery media does not work, contact support to obtain recovery media. Go to <http://www.hp.com/support>, select your country or region, and then follow the on-screen instructions.

Recovering using the HP Recovery partition (select products only)

The HP Recovery partition allows you to perform a system recovery without recovery discs or a recovery USB flash drive. This type of recovery can be used only if the hard drive is still working.

The HP Recovery partition (select products only) allows System Recovery only.

To start HP Recovery Manager from the HP Recovery partition:

 **IMPORTANT:** For a tablet with a detachable keyboard, connect the tablet to the keyboard base before beginning these steps (select products only).

1. Type `recovery` in the taskbar search box, select **HP Recovery Manager**, and then select **Windows Recovery Environment**.

– or –

For computers or tablets with keyboards attached:

- ▲ Press **f11** while the computer boots, or press and hold **f11** as you press the power button.

For tablets without keyboards:

- ▲ Turn on or restart the tablet, quickly hold down the volume up button, and then select **f11**.

2. Select **Troubleshoot** from the boot options menu.
3. Select **Recovery Manager**, and then follow the on-screen instructions.

 **NOTE:** If your computer does not automatically restart in HP Recovery Manager, change the computer boot order, and then follow the on-screen instructions. See [Changing the computer boot order on page 50](#).

Recovering using HP Recovery media

If your computer does not have an HP Recovery partition or if the hard drive is not working properly, you can use HP Recovery media to recover the original operating system and software programs that were installed at the factory.

- ▲ Insert the HP Recovery media, and then restart the computer.

 **NOTE:** If your computer does not automatically restart in HP Recovery Manager, change the computer boot order, and then follow the on-screen instructions. See [Changing the computer boot order on page 50](#).

Changing the computer boot order

If your computer does not restart in HP Recovery Manager, you can change the computer boot order. This is the order of devices listed in BIOS where the computer looks for startup information. You can change the selection to an optical drive or a USB flash drive, depending on the location of your HP Recovery media.

To change the boot order:

 **IMPORTANT:** For a tablet with a detachable keyboard, connect the tablet to the keyboard base before beginning these steps.

1. Insert the HP Recovery media.
2. Access the system **Startup** menu.

For computers or tablets with keyboards attached:

- ▲ Turn on or restart the computer, quickly press **esc**, and then press **f9** for boot options.

For tablets without keyboards:

- ▲ Turn on or restart the tablet, quickly hold down the volume up button, and then select **f9**.

– or –

Turn on or restart the tablet, quickly hold down the volume down button, and then select **f9**.

3. Select the optical drive or USB flash drive from which you want to boot, and then follow the on-screen instructions.

Removing the HP Recovery partition (select products only)

HP Recovery Manager software allows you to remove the HP Recovery partition (select products only) to free up hard drive space.

 **IMPORTANT:** After you remove the HP Recovery partition, you will not be able to perform System Recovery or create HP Recovery media. Before removing the Recovery partition, create HP Recovery media. See [Creating HP Recovery media \(select products only\) on page 46](#).

Follow these steps to remove the HP Recovery partition:

1. Type `recovery` in the taskbar search box, and then select **HP Recovery Manager**.
2. Select **Remove Recovery Partition**, and then follow the on-screen instructions.

10 Computer Setup (BIOS), TPM, and HP Sure Start

Using Computer Setup

Computer Setup, or Basic Input/Output System (BIOS), controls communication between all the input and output devices on the system (such as disk drives, display, keyboard, mouse, and printer). Computer Setup includes settings for the types of devices installed, the startup sequence of the computer, and the amount of system and extended memory.

 **NOTE:** Use extreme care when making changes in Computer Setup. Errors can prevent the computer from operating properly.

Starting Computer Setup

- ▲ Turn on or restart the computer, and when the HP logo appears, press **F10** to enter Computer Setup.

Navigating and selecting in Computer Setup

- To select a menu or a menu item, use the **tab** key and the keyboard arrow keys and then press **enter**, or use a pointing device to select the item.
- To scroll up and down, select the up arrow or the down arrow in the upper-right corner of the screen, or use the up arrow key or the down arrow key on the keyboard.
- To close open dialog boxes and return to the main Computer Setup screen, press **esc**, and then follow the on-screen instructions.

To exit Computer Setup, choose one of the following methods:

- To exit Computer Setup menus without saving your changes, select **Main**, select **Ignore Changes and Exit**, and then select **Yes**.

 **NOTE:** If you are using arrow keys to highlight your choice, you must then press **enter**.

- To save your changes and exit Computer Setup menus, select **Main**, select **Save Changes and Exit**, and then select **Yes**.

 **NOTE:** If you are using arrow keys to highlight your choice, you must then press **enter**.

Your changes go into effect when the computer restarts.

Restoring factory settings in Computer Setup

 **NOTE:** Restoring defaults will not change the hard drive mode.

To return all settings in Computer Setup to the values that were set at the factory, follow these steps:

1. Start Computer Setup. See [Starting Computer Setup on page 51](#).
2. Select **Main**, select **Apply Factory Defaults and Exit**, and then select **Yes**.

 **NOTE:** If you are using arrow keys to highlight your choice, you must then press **enter**.

 **NOTE:** On select products, the selections may display **Restore Defaults** instead of **Apply Factory Defaults and Exit**.

Your changes go into effect when the computer restarts.

 **NOTE:** Your password settings and security settings are not changed when you restore the factory settings.

Updating the BIOS

Updated versions of the BIOS may be available on the HP website.

Most BIOS updates on the HP website are packaged in compressed files called *SoftPaqs*.

Some download packages contain a file named *Readme.txt*, which contains information regarding installing and troubleshooting the file.

Determining the BIOS version

To decide whether you need to update Computer Setup (BIOS), first determine the BIOS version on your computer.

BIOS version information (also known as *ROM date* and *System BIOS*) can be accessed by pressing **fn+esc** (if you are already in Windows) or by using Computer Setup.

1. Start Computer Setup. See [Starting Computer Setup on page 51](#).
2. Select **Main**, and then select **System Information**.
3. To exit Computer Setup menus without saving your changes, select **Main**, select **Ignore Changes and Exit**, and then select **Yes**.

 **NOTE:** If you are using arrow keys to highlight your choice, you must then press **enter**.

To check for later BIOS versions, see [Downloading a BIOS update on page 52](#).

Downloading a BIOS update

 **CAUTION:** To reduce the risk of damage to the computer or an unsuccessful installation, download and install a BIOS update only when the computer is connected to reliable external power using the AC adapter. Do not download or install a BIOS update while the computer is running on battery power, docked in an optional docking device, or connected to an optional power source. During the download and installation, follow these instructions:

Do not disconnect power on the computer by unplugging the power cord from the AC outlet.

Do not shut down the computer or initiate Sleep.

Do not insert, remove, connect, or disconnect any device, cable, or cord.

1. Type `support` in the taskbar search box, and then select the HP Support Assistant app.
– or –
Select the question mark icon in the taskbar.
2. Select **Updates**, and then select **Check for updates and messages**.
3. Follow the on-screen instructions.
4. At the download area, follow these steps:

- a. Identify the most recent BIOS update and compare it to the BIOS version currently installed on your computer. Make a note of the date, name, or other identifier. You may need this information to locate the update later, after it has been downloaded to your hard drive.
- b. Follow the on-screen instructions to download your selection to the hard drive.

Make a note of the path to the location on your hard drive where the BIOS update is downloaded. You will need to access this path when you are ready to install the update.

 **NOTE:** If you connect your computer to a network, consult the network administrator before installing any software updates, especially system BIOS updates.

BIOS installation procedures vary. Follow any instructions that are displayed on the screen after the download is complete. If no instructions are displayed, follow these steps:

1. Type `file` in the taskbar search box, and then select **File Explorer**.
2. Select your hard drive designation. The hard drive designation is typically Local Disk (C:).
3. Using the hard drive path you recorded earlier, open the folder that contains the update.
4. Double-click the file that has an `.exe` extension (for example, `filename.exe`).

The BIOS installation begins.

5. Complete the installation by following the on-screen instructions.

 **NOTE:** After a message on the screen reports a successful installation, you can delete the downloaded file from your hard drive.

Changing the boot order using the f9 prompt

To dynamically choose a boot device for the current startup sequence, follow these steps:

1. Access the Boot Device Options menu:
 - Turn on or restart the computer, and when the HP logo appears, press **f9** to enter the Boot Device Options menu.
2. Select a boot device, press **enter**, and then follow the on-screen instructions.

TPM BIOS settings (select products only)

 **IMPORTANT:** Before enabling Trusted Platform Module (TPM) functionality on this system, you must ensure that your intended use of TPM complies with relevant local laws, regulations and policies, and approvals or licenses must be obtained if applicable. For any compliance issues arising from your operation/usage of TPM which violates the above mentioned requirement, you shall bear all the liabilities wholly and solely. HP will not be responsible for any related liabilities.

TPM provides additional security for your computer. You can modify the TPM settings in Computer Setup (BIOS).

 **NOTE:** If you change the TPM setting to Hidden, TPM is not visible in the operating system.

To access TPM settings in Computer Setup:

1. Start Computer Setup. See [Starting Computer Setup on page 51](#).
2. Select **Security**, select **TPM Embedded Security**, and then follow the on-screen instructions.

Using HP Sure Start (select products only)

Select computer models are configured with HP Sure Start, a technology that monitors the computer's BIOS for attacks or corruption. If the BIOS becomes corrupted or is attacked, HP Sure Start automatically restores the BIOS to its previously safe state, without user intervention.

HP Sure Start is configured and already enabled so that most users can use the HP Sure Start default configuration. The default configuration can be customized by advanced users.

To access the latest documentation on HP Sure Start, go to <http://www.hp.com/support>. Select **Find your product**, and then follow the on-screen instructions.

11 Using HP PC Hardware Diagnostics

Using HP PC Hardware Diagnostics Windows (select products only)

HP PC Hardware Diagnostics Windows is a Windows-based utility that allows you to run diagnostic tests to determine whether the computer hardware is functioning properly. The tool runs within the Windows operating system in order to diagnose hardware failures.

If HP PC Hardware Diagnostics Windows is not installed on your computer, first you must download and install it. To download HP PC Hardware Diagnostics Windows, see [Downloading HP PC Hardware Diagnostics Windows on page 55](#).

After HP PC Hardware Diagnostics Windows is installed, follow these steps to access it from HP Help and Support or HP Support Assistant.

1. To access HP PC Hardware Diagnostics Windows from HP Help and Support:
 - a. Select the **Start** button, and then select **HP Help and Support**.
 - b. Right-click **HP PC Hardware Diagnostics Windows**, select **More**, and then select **Run as administrator**.

– or –

To access HP PC Hardware Diagnostics Windows from HP Support Assistant:

- a. Type `support` in the taskbar search box, and then select the **HP Support Assistant** app.
 - or –
 - Select the question mark icon in the taskbar.
 - b. Select **Troubleshooting and fixes**.
 - c. Select **Diagnostics**, and then select **HP PC Hardware Diagnostics Windows**.
2. When the tool opens, select the type of diagnostic test you want to run, and then follow the on-screen instructions.



NOTE: If you need to stop a diagnostic test at any time, select **Cancel**.

3. When HP PC Hardware Diagnostics Windows detects a failure that requires hardware replacement, a 24-digit Failure ID code is generated. For assistance in correcting the problem, contact support, and then provide the Failure ID code.

Downloading HP PC Hardware Diagnostics Windows

- The HP PC Hardware Diagnostics Windows download instructions are provided in English only.
- You must use a Windows computer to download this tool because only .exe files are provided.

Downloading the latest HP PC Hardware Diagnostics Windows version

To download HP PC Hardware Diagnostics Windows, follow these steps:

1. Go to <http://www.hp.com/go/techcenter/pcdiags>. The HP PC Diagnostics home page is displayed.
2. In the **HP PC Hardware Diagnostics** section, select **Download**, and then select a location on your computer or a USB flash drive.

The tool is downloaded to the selected location.

Downloading HP Hardware Diagnostics Windows by product name or number (select products only)

 **NOTE:** For some products, it may be necessary to download the software to a USB flash drive by using the product name or number.

To download HP PC Hardware Diagnostics Windows by product name or number, follow these steps:

1. Go to <http://www.hp.com/support>.
2. Select **Get software and drivers**, select your type of product, and then enter the product name or number in the search box that is displayed.
3. In the **HP PC Hardware Diagnostics** section, select **Download**, and then select a location on your computer or a USB flash drive.

The tool is downloaded to the selected location.

Installing HP PC Hardware Diagnostics Windows

To install HP PC Hardware Diagnostics Windows, follow these steps:

- ▲ Navigate to the folder on your computer or the USB flash drive where the .exe file was downloaded, double-click the .exe file, and then follow the on-screen instructions.

Using HP PC Hardware Diagnostics UEFI

 **NOTE:** For Windows 10 S computers, you must use a Windows computer and a USB flash drive to download and create the HP UEFI support environment because only .exe files are provided. For more information, see [Downloading HP PC Hardware Diagnostics UEFI to a USB flash drive on page 57](#).

HP PC Hardware Diagnostics UEFI (Unified Extensible Firmware Interface) allows you to run diagnostic tests to determine whether the computer hardware is functioning properly. The tool runs outside the operating system so that it can isolate hardware failures from issues that are caused by the operating system or other software components.

If your PC will not boot into Windows, you can use HP PC Hardware Diagnostics UEFI to diagnose hardware issues.

When HP PC Hardware Diagnostics UEFI detects a failure that requires hardware replacement, a 24-digit Failure ID code is generated. For assistance in correcting the problem, contact support, and provide the Failure ID code.

 **NOTE:** To start diagnostics on a convertible computer, your computer must be in notebook mode, and you must use the attached keyboard.

 **NOTE:** If you need to stop a diagnostic test, press **esc**.

Starting HP PC Hardware Diagnostics UEFI

To start HP PC Hardware Diagnostics UEFI, follow these steps:

1. Turn on or restart the computer, and quickly press **esc**.
2. Press **f2**.

The BIOS searches three places for the diagnostic tools, in the following order:

- a. Connected USB flash drive



NOTE: To download the HP PC Hardware Diagnostics UEFI tool to a USB flash drive, see [Downloading the latest HP PC Hardware Diagnostics UEFI version on page 57](#).

- b. Hard drive
- c. BIOS

3. When the diagnostic tool opens, select a language, select the type of diagnostic test you want to run, and then follow the on-screen instructions.

Downloading HP PC Hardware Diagnostics UEFI to a USB flash drive

Downloading HP PC Hardware Diagnostics UEFI to a USB flash drive can be useful in the following situations:

- HP PC Hardware Diagnostics UEFI is not included in the preinstall image.
- HP PC Hardware Diagnostics UEFI is not included in the HP Tool partition.
- The hard drive is damaged.



NOTE: The HP PC Hardware Diagnostics UEFI download instructions are provided in English only, and you must use a Windows computer to download and create the HP UEFI support environment because only .exe files are provided.

Downloading the latest HP PC Hardware Diagnostics UEFI version

To download the latest HP PC Hardware Diagnostics UEFI version to a USB flash drive:

1. Go to <http://www.hp.com/go/techcenter/pcdiags>. The HP PC Diagnostics home page is displayed.
2. In the **HP PC Hardware Diagnostics UEFI** section, select **Download UEFI Diagnostics**, and then select **Run**.

Downloading HP PC Hardware Diagnostics UEFI by product name or number (select products only)



NOTE: For some products, it may be necessary to download the software to a USB flash drive by using the product name or number.

To download HP PC Hardware Diagnostics UEFI by product name or number (select products only) to a USB flash drive:

1. Go to <http://www.hp.com/support>.
2. Enter the product name or number, select your computer, and then select your operating system.
3. In the **Diagnostics** section, follow the on-screen instructions to select and download the specific UEFI Diagnostics version for your computer.

Using Remote HP PC Hardware Diagnostics UEFI settings (select products only)

Remote HP PC Hardware Diagnostics UEFI is a firmware (BIOS) feature that downloads HP PC Hardware Diagnostics UEFI to your computer. It can then execute the diagnostics on your computer, and it may upload results to a preconfigured server. For more information on Remote HP PC Hardware Diagnostics UEFI, go to <http://www.hp.com/go/techcenter/pcdiags>, and then select **Find out more**.

Downloading Remote HP PC Hardware Diagnostics UEFI

 **NOTE:** HP Remote PC Hardware Diagnostics UEFI is also available as a Softpaq that can be downloaded to a server.

Downloading the latest Remote HP PC Hardware Diagnostics UEFI version

To download the latest Remote HP PC Hardware Diagnostics UEFI version, follow these steps:

1. Go to <http://www.hp.com/go/techcenter/pcdiags>. The HP PC Diagnostics home page is displayed.
2. In the **HP PC Hardware Diagnostics UEFI** section, select **Download Remote Diagnostics**, and then select **Run**.

Downloading Remote HP PC Hardware Diagnostics UEFI by product name or number

 **NOTE:** For some products, it may be necessary to download the software by using the product name or number.

To download HP Remote PC Hardware Diagnostics UEFI by product name or number, follow these steps:

1. Go to <http://www.hp.com/support>.
2. Select **Get software and drivers**, select your type of product, enter the product name or number in the search box that is displayed, select your computer, and then select your operating system.
3. In the **Diagnostics** section, follow the on-screen instructions to select and download the **Remote UEFI** version for the product.

Customizing Remote HP PC Hardware Diagnostics UEFI settings

Using the Remote HP PC Hardware Diagnostics setting in Computer Setup (BIOS), you can perform the following customizations:

- Set a schedule for running diagnostics unattended. You can also start diagnostics immediately in interactive mode by selecting **Execute Remote HP PC Hardware Diagnostics**.
- Set the location for downloading the diagnostic tools. This feature provides access to the tools from the HP website or from a server that has been preconfigured for use. Your computer does not require the traditional local storage (such as a disk drive or USB flash drive) to run remote diagnostics.
- Set a location for storing the test results. You can also set the user name and password settings used for uploads.
- Display status information about the diagnostics run previously.

To customize Remote HP PC Hardware Diagnostics UEFI settings, follow these steps:

1. Turn on or restart the computer, and when the HP logo appears, press **f10** to enter Computer Setup.
2. Select **Advanced**, and then select **Settings**.

3. Make your customization selections.
4. Select **Main**, and then **Save Changes and Exit** to save your settings.

Your changes take effect when the computer restarts.

12 Specifications

Input power

The power information in this section may be helpful if you plan to travel internationally with the computer.

The computer operates on DC power, which can be supplied by an AC or a DC power source. The AC power source must be rated at 100–240 V, 50–60 Hz. Although the computer can be powered from a standalone DC power source, it should be powered only with an AC adapter or a DC power source supplied and approved by HP for use with this computer.

The computer can operate on DC power within the following specifications. The voltage and current for your computer is located on the regulatory label.

Input Power	Rating
Operating voltage and current	5 V dc @ 2 A / 12 V dc @ 3 A / 15 V dc @ 3 A – 45 W USB-C
	5 V dc @ 3 A / 9 V dc @ 3 A / 12 V dc @ 3.75 A / 15 V dc @ 3 A – 45 W USB-C
	5 V dc @ 3 A / 9 V dc @ 3 A / 10 V dc @ 3.75 A / 12 V dc @ 3.75 A / 15 V dc @ 3 A / 20 V dc @ 2.25 A – 45 W USB-C
	5 V dc @ 3 A / 9 V dc @ 3 A / 12 V dc @ 5 A / 15 V dc @ 4.33 A / 20 V dc @ 3.25 A – 65 W USB-C
	5 V dc @ 3 A / 9 V dc @ 3 A / 10 V dc @ 5 A / 12 V dc @ 5 A / 15 V dc @ 4.33 A / 20 V dc @ 3.25 A – 65 W USB-C
	5 V dc @ 3 A / 9 V dc @ 3 A / 10 V dc @ 5 A / 12 V dc @ 5 A / 15 V dc @ 5 A / 20 V dc @ 4.5 A – 90 W USB-C
	19.5 V dc @ 2.31 A – 45 W
	19.5 V dc @ 3.33 A – 65 W
	19.5 V dc @ 4.62 A – 90 W
	19.5 V dc @ 6.15 A – 120 W
	19.5 V dc @ 6.9 A – 135 W
	19.5 V dc @ 7.70 A – 150 W
	19.5 V dc @ 10.3 A – 200 W
19.5 V dc @ 11.8 A – 230 W	
19.5 V dc @ 16.92 A – 330 W	



NOTE: This product is designed for IT power systems in Norway with phase-to-phase voltage not exceeding 240 V rms.

Operating environment

Factor	Metric	U.S.
Temperature		
Operating (writing to optical disc)	5°C to 35°C	41°F to 95°F
Nonoperating	-20°C to 60°C	-4°F to 140°F
Relative humidity (noncondensing)		
Operating	10% to 90%	10% to 90%
Nonoperating	5% to 95%	5% to 95%
Maximum altitude (unpressurized)		
Operating	-15 m to 3,048 m	-50 ft to 10,000 ft
Nonoperating	-15 m to 12,192 m	-50 ft to 40,000 ft

13 Electrostatic Discharge

Electrostatic discharge is the release of static electricity when two objects come into contact—for example, the shock you receive when you walk across the carpet and touch a metal door knob.

A discharge of static electricity from fingers or other electrostatic conductors may damage electronic components.

To prevent damage to the computer, damage to a drive, or loss of information, observe these precautions:

- If removal or installation instructions direct you to unplug the computer, first be sure that it is properly grounded.
- Keep components in their electrostatic-safe containers until you are ready to install them.
- Avoid touching pins, leads, and circuitry. Handle electronic components as little as possible.
- Use nonmagnetic tools.
- Before handling components, discharge static electricity by touching an unpainted metal surface.
- If you remove a component, place it in an electrostatic-safe container.

14 Accessibility

Accessibility

HP is working to weave diversity, inclusion and work/life into the fabric of our company, so it is reflected in everything we do. Here are some examples of how we are putting differences to work to create an inclusive environment focused on connecting people to the power of technology throughout the world.

Finding the technology tools you need

Technology can unleash your human potential. Assistive technology removes barriers and helps you create independence at home, at work, and in the community. Assistive technology helps increase, maintain, and improve the functional capabilities of electronic and information technology. For more information, see [Finding the best assistive technology on page 64](#).

Our commitment

HP is committed to providing products and services that are accessible for people with disabilities. This commitment supports our company's diversity objectives and helps us ensure that the benefits of technology are available to all.

Our accessibility goal is to design, produce, and market products and services that can be effectively used by everyone, including people with disabilities, either on a stand-alone basis or with appropriate assistive devices.

To achieve our goal, this Accessibility Policy establishes seven key objectives to guide our actions as a company. All HP managers and employees are expected to support these objectives and their implementation in accordance with their roles and responsibilities:

- Raise the level of awareness of accessibility issues within our company, and provide our employees with the training they need to design, produce, market, and deliver accessible products and services.
- Develop accessibility guidelines for products and services, and hold product development groups accountable for implementing these guidelines where competitively, technically, and economically feasible.
- Involve people with disabilities in the development of accessibility guidelines, and in the design and testing of products and services.
- Document accessibility features and make information about our products and services publicly available in an accessible form.
- Establish relationships with leading assistive technology and solution providers.
- Support internal and external research and development that will improve assistive technology relevant to our products and services.
- Support and contribute to industry standards and guidelines for accessibility.

International Association of Accessibility Professionals (IAAP)

IAAP is a not-for-profit association focused on advancing the accessibility profession through networking, education, and certification. The objective is to help accessibility professionals develop and advance their careers and to better enable organizations to integrate accessibility into their products and infrastructure.

HP is a founding member, and we joined to participate with other organizations to advance the field of accessibility. This commitment supports our company's accessibility goal of designing, producing, and marketing products and services that can be effectively used by people with disabilities.

IAAP will make our profession strong by globally connecting individuals, students, and organizations to learn from one another. If you are interested in learning more, go to <http://www.accessibilityassociation.org> to join the online community, sign up for newsletters, and learn about membership options.

Finding the best assistive technology

Everyone, including people with disabilities or age-related limitations, should be able to communicate, express themselves, and connect with the world using technology. HP is committed to increasing accessibility awareness within HP and with our customers and partners. Whether it's large fonts that are easy on the eyes, voice recognition that lets you give your hands a rest, or any other assistive technology to help with your specific situation—a variety of assistive technologies make HP products easier to use. How do you choose?

Assessing your needs

Technology can unleash your potential. Assistive technology removes barriers and helps you create independence at home, at work, and in the community. Assistive technology (AT) helps increase, maintain, and improve the functional capabilities of electronic and information technology.

You may choose from many AT products. Your AT assessment should allow you to evaluate several products, answer your questions, and facilitate your selection of the best solution for your situation. You will find that professionals qualified to do AT assessments come from many fields, including those licensed or certified in physical therapy, occupational therapy, speech/language pathology, and other areas of expertise. Others, while not certified or licensed, may also provide evaluation information. You will want to ask about the individual's experience, expertise, and fees to determine if they are appropriate for your needs.

Accessibility for HP products

The following links provide information on accessibility features and assistive technology, if applicable, included in various HP products. These resources will help you select the specific assistive technology features and product(s) most appropriate for your situation.

- [HP Elite x3—Accessibility Options \(Windows 10 Mobile\)](#)
- [HP PCs—Windows 7 Accessibility Options](#)
- [HP PCs—Windows 8 Accessibility Options](#)
- [HP PC's—Windows 10 Accessibility Options](#)
- [HP Slate 7 Tablets—Enabling Accessibility Features on Your HP Tablet \(Android 4.1/Jelly Bean\)](#)
- [HP SlateBook PCs—Enabling Accessibility Features \(Android 4.3,4.2/Jelly Bean\)](#)
- [HP Chromebook PCs—Enabling Accessibility Features on Your HP Chromebook or Chromebox \(Chrome OS\)](#)
- [HP Shopping—peripherals for HP products](#)

If you need additional support with the accessibility features on your HP product, see [Contacting support on page 69](#).

Additional links to external partners and suppliers that may provide additional assistance:

- [Microsoft Accessibility information \(Windows 7, Windows 8, Windows 10, Microsoft Office\)](#)
- [Google Products accessibility information \(Android, Chrome, Google Apps\)](#)

- [Assistive Technologies sorted by impairment type](#)
- [Assistive Technologies sorted by product type](#)
- [Assistive Technology vendors with product descriptions](#)
- [Assistive Technology Industry Association \(ATIA\)](#)

Standards and legislation

Standards

Section 508 of the Federal Acquisition Regulation (FAR) standards was created by the US Access Board to address access to information and communication technology (ICT) for people with physical, sensory, or cognitive disabilities. The standards contain technical criteria specific to various types of technologies, as well as performance-based requirements which focus on functional capabilities of covered products. Specific criteria cover software applications and operating systems, web-based information and applications, computers, telecommunications products, video and multi-media, and self-contained closed products.

Mandate 376 – EN 301 549

The EN 301 549 standard was created by the European Union within Mandate 376 as the basis for an online toolkit for public procurement of ICT products. The standard specifies the functional accessibility requirements applicable to ICT products and services, together with a description of the test procedures and evaluation methodology for each accessibility requirement.

Web Content Accessibility Guidelines (WCAG)

Web Content Accessibility Guidelines (WCAG) from the W3C's Web Accessibility Initiative (WAI) helps web designers and developers create sites that better meet the needs of people with disabilities or age-related limitations. WCAG advances accessibility across the full range of web content (text, images, audio, and video) and web applications. WCAG can be precisely tested, is easy to understand and use, and allows web developers flexibility for innovation. WCAG 2.0 has also been approved as [ISO/IEC 40500:2012](#).

WCAG specifically addresses barriers to accessing the web experienced by people with visual, auditory, physical, cognitive, and neurological disabilities, and by older web users with accessibility needs. WCAG 2.0 provides characteristics of accessible content:

- **Perceivable** (for instance, by addressing text alternatives for images, captions for audio, adaptability of presentation, and color contrast)
- **Operable** (by addressing keyboard access, color contrast, timing of input, seizure avoidance, and navigability)
- **Understandable** (by addressing readability, predictability, and input assistance)
- **Robust** (for instance, by addressing compatibility with assistive technologies)

Legislation and regulations

Accessibility of IT and information has become an area of increasing legislative importance. This section provides links to information on key legislation, regulations, and standards.

- [United States](#)
- [Canada](#)
- [Europe](#)

- [United Kingdom](#)
- [Australia](#)
- [Worldwide](#)

United States

Section 508 of the Rehabilitation Act specifies that agencies must identify which standards apply to the procurement of ICT, perform market research to determine the availability of accessible products and services, and document the results of their market research. The following resources provide assistance in meeting Section 508 requirements:

- www.section508.gov
- [Buy Accessible](#)

The U.S. Access Board is currently updating the Section 508 standards. This effort will address new technologies and other areas where the standards need to be modified. For more information, go to [Section 508 Refresh](#).

Section 255 of the Telecommunications Act requires telecommunications products and services to be accessible to people with disabilities. FCC rules cover all hardware and software telephone network equipment and telecommunications equipment used in the home or office. Such equipment includes telephones, wireless handsets, fax machines, answering machines, and pagers. FCC rules also cover basic and special telecommunications services, including regular telephone calls, call waiting, speed dialing, call forwarding, computer-provided directory assistance, call monitoring, caller identification, call tracing, and repeat dialing, as well as voice mail and interactive voice response systems that provide callers with menus of choices. For more information, go to [Federal Communication Commission Section 255 information](#).

21st Century Communications and Video Accessibility Act (CVAA)

The CVAA updates federal communications law to increase the access of persons with disabilities to modern communications, updating accessibility laws enacted in the 1980s and 1990s to include new digital, broadband, and mobile innovations. Regulations are enforced by the FCC and documented as 47 CFR Part 14 and Part 79.

- [FCC Guide on the CVAA](#)

Other U.S. legislation and initiatives

- [Americans with Disabilities Act \(ADA\), Telecommunications Act, the Rehabilitation Act and others](#)

Canada

The Accessibility for Ontarians with Disabilities Act was established to develop and implement accessibility standards to make goods, services, and facilities accessible to Ontarians with disabilities and to provide for the involvement of persons with disabilities in the development of the accessibility standards. The first standard of the AODA is the customer service standard; however, standards for transportation, employment, and information and communication are also being developed. The AODA applies to the Government of Ontario, the Legislative Assembly, every designated public sector organization, and to every other person or organization that provides goods, services, or facilities to the public or other third parties and that has at least one employee in Ontario; and accessibility measures must be implemented on or before January 1, 2025. For more information, go to [Accessibility for Ontarians with Disability Act \(AODA\)](#).

Europe

EU Mandate 376 ETSI Technical Report ETSI DTR 102 612: "Human Factors (HF); European accessibility requirements for public procurement of products and services in the ICT domain (European Commission Mandate M 376, Phase 1)" has been released.

Background: The three European Standardization Organizations have set up two parallel project teams to carry out the work specified in the European Commission "Mandate 376 to CEN, CENELEC and ETSI, in Support of Accessibility Requirements for Public Procurement of Products and Services in the ICT Domain."

ETSI TC Human Factors Specialist Task Force 333 has developed ETSI DTR 102 612. Further details about the work performed by STF333 (e.g., Terms of Reference, specification of the detailed work tasks, time plan for the work, previous drafts, listing of comments received and means to contact the task force) can be found at the [Special Task Force 333](#).

The parts relating to the assessment of suitable testing and conformity schemes were carried out by a parallel project, detailed in CEN BT/WG185/PT. For further information, go to the CEN project team website. The two projects are closely coordinated.

- [CEN project team](#)
- [European Commission mandate for e-accessibility \(PDF 46KB\)](#)
- [Commission takes low profile on e-accessibility](#)

United Kingdom

The Disability Discrimination Act of 1995 (DDA) was enacted to ensure that websites are accessible to blind and disabled users in the United Kingdom.

- [W3C UK Policies](#)

Australia

The Australian government has announced their plan to implement [Web Content Accessibility Guidelines 2.0](#).

All Australian government websites will require Level A compliance by 2012, and Double A by 2015. The new standard replaces WCAG 1.0, which was introduced as a mandated requirement for agencies in 2000.

Worldwide

- [JTC1 Special Working Group on Accessibility \(SWG-A\)](#)
- [G3ict: The Global Initiative for Inclusive ICT](#)
- [Italian accessibility legislation](#)
- [W3C Web Accessibility Initiative \(WAI\)](#)

Useful accessibility resources and links

The following organizations may be good resources for information about disabilities and age-related limitations.



NOTE: This is not an exhaustive list. These organizations are provided for informational purposes only. HP assumes no responsibility for information or contacts you may encounter on the Internet. Listing on this page does not imply endorsement by HP.

Organizations

- American Association of People with Disabilities (AAPD)
- The Association of Assistive Technology Act Programs (ATAP)
- Hearing Loss Association of America (HLAA)
- Information Technology Technical Assistance and Training Center (ITTATC)
- Lighthouse International
- National Association of the Deaf
- National Federation of the Blind
- Rehabilitation Engineering & Assistive Technology Society of North America (RESNA)
- Telecommunications for the Deaf and Hard of Hearing, Inc. (TDI)
- W3C Web Accessibility Initiative (WAI)

Educational institutions

- California State University, Northridge, Center on Disabilities (CSUN)
- University of Wisconsin - Madison, Trace Center
- University of Minnesota computer accommodations program

Other disability resources

- ADA (Americans with Disabilities Act) Technical Assistance Program
- Business & Disability network
- EnableMart
- European Disability Forum
- Job Accommodation Network
- Microsoft Enable
- U.S. Department of Justice - A Guide to disability rights Laws

HP links

[Our contact webform](#)

[HP comfort and safety guide](#)

[HP public sector sales](#)

Contacting support

 **NOTE:** Support is in English only.

- Customers who are deaf or hard of hearing that have questions about technical support or accessibility of HP products:
 - Use TRS/VRS/WebCapTel to call (877) 656-7058 Monday through Friday, 6 a.m. to 9 p.m. Mountain Time.
- Customers with other disabilities or age-related limitations who have questions about technical support or accessibility of HP products, choose one of the following options:
 - Call (888) 259-5707 Monday through Friday, 6 a.m. to 9 p.m. Mountain Time.
 - Complete the [Contact form for people with disabilities or age-related limitations](#).



Informations sur les réglementations, la sécurité et les conditions d'utilisation

Manuel de l'utilisateur

© Copyright 2018, 2019 HP Development Company, L.P.

Bluetooth est une marque détenue par son propriétaire et utilisée sous licence par HP Inc. ENERGY STAR et la marque de ENERGY STAR sont des marques déposées aux États-Unis. Java est une marque déposée d'Oracle et/ou de ses filiales.

Les informations contenues dans ce document peuvent être modifiées sans préavis. Les garanties relatives aux produits et aux services HP sont décrites dans les déclarations de garantie limitée expresse qui les accompagnent. Aucun élément du présent document ne peut être interprété comme constituant une garantie supplémentaire. HP ne saurait être tenu pour responsable des erreurs ou omissions de nature technique ou rédactionnelle qui pourraient subsister dans le présent document.

Quatrième édition : avril 2019





Première édition : mars 2018

Référence du document : L25269-054

À propos de ce manuel

Ce manuel fournit des informations sur les réglementations, la sécurité et les conditions d'utilisation en conformité avec les réglementations américaines, canadiennes et internationales en matière d'ordinateurs portables, de tablettes, d'ordinateurs de bureau, de clients légers, de stations de travail personnelles, de tout-en-un et de terminaux de point de vente.

Pour accéder aux derniers manuels de l'utilisateur, ouvrez la page <http://www.hp.com/support>, et suivez les instructions pour retrouver votre produit. Puis, sélectionnez **Guides de l'utilisateur**.

-
-  **AVERTISSEMENT !** Signale une situation dangereuse qui, si elle n'est pas évitée, **peut** entraîner des blessures graves voire mortelles.
 -  **ATTENTION :** Signale une situation dangereuse qui, si elle n'est pas évitée, **peut** entraîner des blessures légères ou modérées.
 -  **IMPORTANT :** Signale des informations considérées comme importantes mais n'impliquant aucun danger (par exemple, des messages liés à des dommages matériels). Des avertissements signalent à l'utilisateur que tout non-respect scrupuleux d'une procédure peut entraîner une perte de données ou une détérioration du matériel ou des logiciels. Contient également des informations essentielles pour expliquer un concept ou pour accomplir une tâche.
 -  **REMARQUE :** Contient des informations supplémentaires qui soulignent ou complètent les points importants du texte principal.
 -  **CONSEIL :** Fournit des conseils utiles pour accomplir une tâche.
-

Sommaire

1 Avis de conformité	1
Accès aux étiquettes de conformité	1
Avis de la FCC	2
Modifications	2
Câbles	2
Produits avec appareils sans fil LAN ou modules mobiles à large bande HP	3
Avis de réglementation pour la Biélorussie	3
Avis pour le Brésil	3
Avis pour le Canada	3
Avis pour l'Union européenne	4
Déclaration de conformité	4
Produits équipés de fonctionnalité radio	5
Restrictions pour les produits équipés de fonctionnalité radio (certains produits uniquement)	5
Bandes de fréquences radio et niveaux de puissance maximale (certains produits et pays uniquement)	5
Avis sur l'ergonomie	5
Déclaration relative au réseau téléphonique européen (modem/fax)	6
Avis pour l'Australie et la Nouvelle-Zélande	6
Avis WWAN pour la Chine	6
Avis sur les équipements radio pour la Chine	6
Avis pour le Japon	7
Marques de certification des périphériques WLAN, WWAN et Bluetooth®	7
Avis pour le Mexique	7
Avis sur les appareils sans fil pour Singapour	8
Avis pour la Corée du Sud	8
Avis sur les périphériques sans fil pour la Thaïlande	8
Avis de la NCC pour Taïwan	9
Périphériques WLAN 802.11a	9
Périphériques sans fil LAN 802.11/Périphériques Bluetooth/Périphériques à courte portée	9
Avis sur les utilisations en vol	9
Avis sur les batteries remplaçables par l'utilisateur	9
Avis sur les batteries scellées en usine	10
Conformité du laser	10
Homologations du périphérique de télécommunication	11
Avis sur les modems	11
Avis sur les modems pour les États-Unis	11

Déclarations sur les modems pour les États-Unis	13
Avis sur les modems pour le Canada	14
Avis sur les modems pour le Japon	14
Déclarations sur les modems pour la Nouvelle-Zélande	15
Prise en charge vocale	15
Avis de Macrovision Corporation	15
2 Avis relatifs à la sécurité	16
Informations importantes relatives à la sécurité	16
Notice d'avertissement relative à la sécurité liée à la chaleur	17
Avis sur les risques liés à la sécurité	17
Conditions d'installation	17
Avis sur l'acoustique	18
Avis relatif aux batteries	18
Avis sur le ventilateur	19
Avis sur le niveau du volume du casque et des écouteurs	19
Sécurité des lasers	19
Exigences relatives au bloc d'alimentation et au cordon d'alimentation	19
Exigences relatives à la mise à la terre des alimentations de classe 1	19
Avis pour le Brésil	20
Danemark	20
Finlande	20
Norvège	20
Suède	20
Exigences relatives au bloc d'alimentation	20
Pour une utilisation en Norvège	20
Exigences relatives au cordon d'alimentation	20
Informations sur le cordon d'alimentation	22
prise CC de la source d'alimentation externe HP	22
Avis sur les cordons d'alimentation pour le Japon	22
Spécifications du cordon d'alimentation pour le Japon	22
Risque de pincement	22
Protection des connecteurs de l'antenne TV	22
Mise à la terre d'une antenne de télévision externe	22
Protection contre la foudre	23
Remarque destinée aux installateurs de systèmes de télévision par câble	23
Avis sur les déplacements	23
Avis de sécurité pour la Chine	24
Chine : avis sur l'altitude	24
Chine : avis sur une utilisation dans des conditions tropicales	24
Norvège et Suède : Avis de mise à la terre des câbles pour les produits équipés d'une carte TV	25

使用過度恐傷害視力	25
3 Avis des agences environnementales	26
Recyclage du matériel électronique, de l'emballage et de la batterie	26
Mise au rebut des équipements par les utilisateurs	26
Mise au rebut des batteries alcalines au Brésil	26
Informations sur le recyclage du matériel au Brésil	26
Informations de recyclage de la pile pour Taiwan	27
Certification ENERGY STAR® (certains produits uniquement)	27
Substances chimiques	28
Avis sur le mercure	28
Matériau composé de perchlorate : une manipulation particulière peut être nécessaire	29
Avis sur l'environnement pour la Chine	29
Étiquette de consommation énergétique des ordinateurs pour la Chine	29
Restrictions d'utilisation de substances dangereuses (RoHS) pour les ordinateurs portables et les tablettes en Chine	32
Tableau des substances/composants dangereux et leur contenu	32
笔记本电脑和平板电脑产品中有害物质或元素的名称及含量	33
Restrictions d'utilisation de substances dangereuses pour la Chine (ROHS) pour les ordinateurs de bureau, clients légers, stations de travail personnelles, tout-en-un et les terminaux de point de vente	34
Tableau des substances/composants dangereux et leur contenu	34
台式机、瘦客户端、个人工作站、一体机和销售点终端产品中有害物质或元素的名称及含量 (ROHS)	36
台灣針對筆記型電腦和平板電腦的有害物質限制使用管理辦法 (RoHS)	38
限用物質含有情況標示聲明書	38
台灣針對桌上型電腦、精簡型電腦、個人工作站、一體成形電腦及銷售點終端機的有害物質限制 使用管理辦法 (RoHS)	39
限用物質含有情況標示聲明書	39
Avis sur la restriction des substances dangereuses pour l'Inde (RoHS)	40
Informations sur le règlement 1275/2008 de la Commission européenne	40
Déclarations IT ECO	40
Avis sur la restriction des substances dangereuses pour le Japon (RoHS)	40
Ley para el Aprovechamiento Sustentable de la Energía de México	41
Réglementation WEEE de la Turquie	41
Certifié TCO	42
TCO Certified Edge	43
Index	44

1 Avis de conformité

Ce chapitre fournit des avis de réglementation spécifiques à des pays et à des régions concernant les produits filaires et sans fil, ainsi que des informations de conformité concernant l'ordinateur. Certains de ces avis peuvent ne pas s'appliquer à votre produit.

Un ou plusieurs appareils sans fil intégrés peuvent être installés. Dans certains environnements, l'utilisation d'appareils sans fil peut être limitée. Ces restrictions peuvent s'appliquer à bord des avions, dans les hôpitaux, dans les lieux à proximité d'explosifs, dans les environnements dangereux, etc. Si vous ne connaissez pas la politique relative à l'utilisation de ce produit, demandez l'autorisation de l'utiliser avant de le mettre sous tension.

Accès aux étiquettes de conformité

Les étiquettes de conformité, qui fournissent des informations sur les réglementations de votre pays ou région (par exemple, l'ID FCC), peuvent être situées physiquement sous l'ordinateur, à l'intérieur du compartiment de la batterie (certains produits uniquement), sous le cache de service amovible (certains produits uniquement), à l'arrière de l'écran ou sur le module du modem ou de l'appareil sans fil.

Certains produits peuvent également fournir des étiquettes de réglementation électroniques (e-étiquettes) accessibles via le système BIOS.

 **REMARQUE :** Les étiquettes électroniques ne sont pas disponibles sur tous les produits.

 **REMARQUE :** Les appareils qui ne sont pas destinés à la vente ou à une utilisation aux États-Unis ne possèdent peut-être pas d'ID FCC.

Pour afficher les étiquettes de conformité électroniques :

1. Mettez l'ordinateur sous tension ou redémarrez-le.
2. Appuyez sur **Échap** ou **F10** pour accéder à Computer Setup.
3. À l'aide d'un périphérique de pointage ou des touches de direction, sélectionnez **Advanced** (Avancé), **Electronic Labels** (Étiquettes de conformité), puis appuyez sur la touche **entrée**.
4. Pour afficher une étiquette électronique, utilisez un périphérique de pointage ou les touches de direction pour sélectionner un des éléments de la liste, puis appuyez sur **OK**.

 **REMARQUE :** La liste des éléments d'étiquette électronique disponibles varie en fonction du modèle d'ordinateur et des périphériques installés.

5. Pour quitter les menus de Computer Setup sans effectuer de modification :

Sélectionnez l'icône **Exit** (Quitter) dans le coin inférieur droit de l'écran, puis suivez les instructions à l'écran.

– ou –

Utilisez les touches de direction pour sélectionner **Main** (Principal), **Ignore Changes and Exit** (Ignorer les modifications et quitter), puis appuyez sur la touche **entrée**.

Avis de la FCC

Le présent équipement a été testé et déclaré conforme aux limites d'un appareil numérique de Classe B, telles que définies dans l'article 15 des réglementations FCC. Ces limites sont conçues pour fournir une protection raisonnable contre les interférences préjudiciables dans un environnement résidentiel. Le présent équipement génère, utilise et peut émettre une énergie de radiofréquence et, s'il n'est pas installé et utilisé conformément aux instructions, peut entraîner des interférences préjudiciables pour les radiocommunications. Cependant, tout risque d'interférences ne peut être totalement exclu dans certains environnements spécifiques.

Si cet équipement entraîne des interférences en matière de réception radio ou télévision, ce qui peut être vérifié en éteignant et en rallumant l'équipement, il est recommandé à l'utilisateur d'essayer de corriger les interférences en suivant une ou plusieurs des mesures suivantes :

- Réorienter ou déplacer l'antenne de réception.
- Augmenter la distance entre l'équipement et le récepteur.
- Brancher l'équipement sur un autre circuit que celui du récepteur.
- Demander conseil à votre revendeur ou à un technicien radio ou télévision expérimenté.

Cet appareil est conforme à l'article 15 des réglementations FCC. Son fonctionnement est soumis à deux conditions :

1. Cet appareil ne doit pas provoquer des interférences nuisibles, et
2. Cet appareil doit accepter toute interférence reçue, notamment des interférences pouvant provoquer un fonctionnement non voulu.

Pour toute question concernant ce produit :

- Écrivez à :
HP Inc.
1501 Page Mill Road
Palo Alto, CA 94304
- Appelez HP au 650-857-1501
–ou–
- Envoyez un courrier électronique à techregshelp@hp.com

Pour identifier ce produit, reportez-vous à la référence de pièce, de gamme ou de modèle indiquée sur le produit.

Modifications

La FCC stipule que l'utilisateur doit être informé que toute modification opérée sur l'appareil, n'ayant pas été expressément approuvée par HP, peut entraîner l'annulation des droits d'exploitation du produit dont bénéficie l'utilisateur.

Câbles

Pour être conformes à la réglementation de la FCC, les connexions d'entrée de l'appareil doivent être établies avec des câbles blindés munis d'embouts de connecteurs RFI/EMI métalliques.

Produits avec appareils sans fil LAN ou modules mobiles à large bande HP

Cet appareil ne doit pas être placé à côté ou fonctionner avec une autre antenne ou un autre émetteur.

⚠ AVERTISSEMENT ! Exposition aux radiations de fréquence radio La puissance de rayonnement de cet appareil est inférieure aux limites d'exposition aux radiations émises par les fréquences radio FCC. Toutefois, l'appareil doit être utilisé d'une manière conforme avec l'utilisation normale attendue.

Avis de réglementation pour la Biélorussie

Le produit est conforme à la réglementation technique nationale relative aux télécommunications/radio pour la Biélorussie TR 2018/024/BY.



Avis pour le Brésil

Este equipamento opera em caráter secundário, isto é, não tem direito a proteção contra interferência prejudicial, mesmo de estações do mesmo tipo, e não pode causar interferência a sistemas operando em caráter primário.

Este equipamento atende aos limites de Taxa de Absorção Específica referente à exposição a campos elétricos, magnéticos e eletromagnéticos de radiofrequências adotados pela ANATEL.

Ao operar o dispositivo a uma distância muito próxima do seu corpo, utilize um acessório de armazenamento não metálico para posicionar o dispositivo a uma distância mínima de 1,5 cm do corpo.

🔌 IMPORTANT : A alimentação de energia é predefinida para 220/230Vv. Se você possuir tomada elétrica de 110/115Vv, por favor, altere a chave na parte traseira do seu computador para a tensão correta.

Avis pour le Canada

Cet appareil numérique de Classe B respecte toutes les exigences des réglementations canadiennes sur les équipements pouvant causer des interférences, CAN ICES-3(B)/NMB-3(B). Si cet appareil est équipé de fonctions WLAN ou Bluetooth, il est conforme aux normes RSS exemptes de licence édictées par Industrie Canada. Son fonctionnement est soumis à deux conditions : (1) cet appareil ne doit pas générer d'interférence et (2) cet appareil doit supporter toutes les interférences reçues, y compris les interférences qui pourraient entraîner un dysfonctionnement de l'appareil.

⚠ AVERTISSEMENT ! Exposition aux radiations de fréquence radio : la puissance de rayonnement de cet appareil est inférieure aux limites d'exposition aux radiations émises par les fréquences radio édictées par Industrie Canada. Toutefois, l'appareil doit être utilisé d'une manière conforme avec l'utilisation normale attendue.

 **IMPORTANT :** Lorsque vous utilisez un réseau local sans fil IEEE 802.11 a, n ou ac, abstenez-vous d'utiliser ce matériel à l'extérieur. En effet, il fonctionne dans la plage de fréquences allant de 5,15 à 5,25 GHz. Industrie Canada exige que ce produit soit utilisé à l'intérieur d'un bâtiment pour la plage de fréquence allant de 5,15 à 5,25 GHz afin de réduire le risque d'interférences préjudiciables pour les systèmes de satellites mobiles utilisant le même canal. Les plages de 5,25 à 5,35 GHz et de 5,65 à 5,85 GHz sont allouées prioritairement aux radars haute puissance. Ces stations radar peuvent provoquer des interférences avec cet appareil ou l'endommager.

Les antennes de ce périphérique ne sont pas remplaçables. Toute tentative d'accès par l'utilisateur endommagera l'ordinateur.

Avis pour l'Union européenne

Déclaration de conformité

Les produits portant le marquage CE ont été conçus de façon à pouvoir fonctionner au moins dans un pays membre de l'UE et sont conformes à une ou plusieurs des directives de l'UE suivantes, le cas échéant :

RED 2014/53/EU ; Directive relative à la basse tension 2014/35/EU ; Directive EMC 2014/30/EU ; Directive Ecodesign 2009/125/CE ; Directive RoHS 2011/65/CE.

La conformité à ces directives est évaluée à l'aide des normes harmonisées européennes applicables.

L'intégralité de la déclaration de conformité est disponible sur le site Web suivant : <http://www.hp.eu/certificates> (recherchez le nom de modèle du produit ou son numéro de modèle réglementaire (RMN), qui est indiqué sur l'étiquette de conformité).

Pour toute question portant sur les réglementations, envoyez un courrier à : HP Deutschland GmbH, HQ-TRE, 71025, Boeblingen, Allemagne. Envoyez un courrier électronique à techregshelp@hp.com

Produits équipés de fonctionnalité radio

Ce produit intègre un appareil de transmission et réception radioélectrique. Lors d'une utilisation standard d'un ordinateur portable, l'observation d'une distance de séparation de 20 cm permet aux niveaux d'exposition des fréquences radio de respecter la conformité des normes de l'UE. Les produits conçus pour une utilisation en deçà de cette distance, tels que les tablettes, respectent la conformité aux normes de l'UE applicables dans les positions de fonctionnement standard. Les produits peuvent être utilisés sans garder une distance de séparation, sauf indication contraire dans les instructions spécifiques au produit.

Restrictions pour les produits équipés de fonctionnalité radio (certains produits uniquement)



AT	BE	BG	CH	CY
CZ	DE	DK	EE	EL
ES	FI	FR	HR	HU
IE	IS	IT	LI	LT
LU	LV	MT	NL	NO
PL	PT	RO	RS	SE
SI	SK	TR	UK	

IMPORTANT : Le LAN sans fil IEEE 802,11x avec une bande de fréquence de 5,15 à 5,35 GHz est limité à une utilisation intérieure uniquement dans l'ensemble des pays listés dans la matrice. L'utilisation de cette application WLAN en extérieur peut engendrer des problèmes d'interférences avec les services radio existants.

IMPORTANT : Les installations extérieures fixes pour l'application WiGig (bande de fréquence 57–66 GHz) sont exclues pour l'ensemble des pays listés dans la matrice.

Bandes de fréquences radio et niveaux de puissance maximale (certains produits et pays uniquement)

Technologie Radio	Puissance maximale de transmission PIRE (mW)
Bluetooth ; 2,4 GHz	100
NFC ; 13,56 MHz	10
RFID ; 125 kHz/13,56 MHz	Moins de 1
WLAN Wi-Fi 802.11 x ; 2,4 GHz	100
WLAN Wi-Fi 802.11 x ; 5 GHz	200
WWAN 4G LTE ; 700/800/900/1800/2100/2300/2600/3500 MHz	200
WWAN 3G UTMS ; 900/2100 MHz	250
WWAN 2G GSM GPRS EDGE ; 900 MHz	2000
WWAN 2G GSM GPRS EDGE ; 1800 MHz	1000
WiGig 802.11ad ; 60 GHz	316

REMARQUE : Utiliser uniquement les pilotes logiciels compatibles HP et corriger les paramètres régionaux pour assurer la conformité.

Avis sur l'ergonomie

Lorsqu'un ordinateur portable est utilisé sur une station de travail professionnelle dans le cadre d'un travail sur écran de visualisation où la directive 90/270/CEE relative aux écrans de visualisation est applicable, un clavier externe adapté est recommandé. Selon l'application et le travail réalisé, un moniteur externe adapté peut également être nécessaire pour obtenir des conditions de travail comparables à celles d'une station de travail.

Réf : EK1-ITB 2000 (certification GS volontaire)

Les ordinateurs portables portant la marque d'homologation « GS » sont conformes aux exigences en matière d'ergonomie. Sans clavier externe, ils sont uniquement adaptés aux tâches ponctuelles sur écran de visualisation.

Une utilisation mobile dans de mauvaises conditions de luminosité (par exemple, lumière directe du soleil) peut occasionner des reflets et donc réduire la lisibilité.

Un système informatique composé de produits de la marque HP respecte les exigences applicables relatives à l'ergonomie si tous les produits inclus concernés portent la marque de conformité « GS », par exemple un ordinateur de bureau professionnel, un clavier, une souris et un moniteur.

Déclaration relative au réseau téléphonique européen (modem/fax)

Le produit ci-joint est conforme aux spécifications de la directive applicable et porte en conséquence la marque CE. Cependant, des différences existant entre les réseaux téléphoniques publics commutés (RTPC) nationaux présents dans les différents pays/régions, cette homologation en elle-même ne garantit pas la réussite de toutes les opérations sur tous les points de terminaison du RTPC. En cas de problème, prenez contact avec le fournisseur auprès duquel vous vous êtes procuré votre équipement.

Avis pour l'Australie et la Nouvelle-Zélande

Cet équipement intègre un appareil de transmission et réception radioélectrique. Lors d'une utilisation standard, l'observation d'une distance de séparation de 20 cm permet aux niveaux d'exposition des fréquences radio de respecter la conformité des normes australiennes et néo-zélandaises.

L'ordinateur doit être connecté au réseau de télécommunications par un câble répondant aux critères de la norme AS/CA S008.

⚠ AVERTISSEMENT ! Les modems sans connecteur RJ11 intégral qui sont livrés avec cet ordinateur ne doivent pas être installés dans un autre périphérique.

Avis WWAN pour la Chine

重要信息：本公司建议用户通过官方渠道进行系统更新，非官方渠道的更新可能会带来安全风险。

Avis sur les équipements radio pour la Chine

型号核准代码显示在产品本体的铭牌上

Avis pour le Japon

V2 規定適合の場合

この装置は、クラスB情報技術装置です。この装置は、家庭環境で使用することを目的としていますが、この装置がラジオやテレビジョン受信機に近接して使用されると、受信障害を引き起こすことがあります。

取扱説明書に従って正しい取り扱いをして下さい。 VCCI-B

VCCI321 規定適合の場合

この装置は、クラスB機器です。この装置は、住宅環境で使用することを目的としていますが、この装置がラジオやテレビジョン受信機に近接して使用されると、受信障害を引き起こすことがあります。

取扱説明書に従って正しい取り扱いをして下さい。 VCCI-B

5GHz帯を使用する特定無線設備は屋内使用に限られています。この機器を屋外で使用することは電波法で禁じられています。

Marques de certification des périphériques WLAN, WWAN et Bluetooth®

この機器は、技術基準適合証明または工事設計認証を受けた無線設備を搭載しています
This product contains certified radio equipment.



Some products may use electronic regulatory labels (e-labels). To view the certification mark and numbers on an e-label, please refer to the previous “Accessing regulatory labels” section.

一部の製品では、電子規定ラベル(eラベル)が使用されています。eラベルの技適マークと認証番号を確認するには、「規定ラベルの確認」の項目をご覧ください

Avis pour le Mexique

Declaración para México

La operación de este equipo está sujeta a las siguientes dos condiciones: (1) es posible que este equipo o dispositivo no cause interferencia perjudicial y (2) este equipo o dispositivo debe aceptar cualquier interferencia, incluyendo la que pueda causar su operación no deseada. El número de modelo reglamentario de este producto está en la etiqueta normativa.

Si votre produit est fourni avec des accessoires sans fil, tels qu'un clavier ou une souris, et si vous devez identifier le modèle de l'accessoire, reportez-vous à l'étiquette apposée sur cet accessoire. Le numéro de modèle réglementaire de ce produit se trouve sur l'étiquette réglementaire.

Avis sur les appareils sans fil pour Singapour

Mettez hors tension tout appareil réseau large bande sans fil (WWAN) lorsque vous êtes à bord d'un avion. L'utilisation de tels appareils à bord d'un avion est illégale, peut être dangereuse pour le fonctionnement de l'avion et peut perturber le réseau cellulaire. Le non-respect de cette instruction peut entraîner la suspension ou le refus de services cellulaires au contrevenant, ou des actions juridiques, ou les deux.

Les utilisateurs doivent limiter l'emploi d'équipement radio dans des dépôts de carburant, usines chimiques et là où des explosions sont en cours.

Comme pour les autres équipements mobiles de transmission par fréquences radioélectriques, il est recommandé aux utilisateurs, pour le bon fonctionnement de leur équipement et pour la sécurité du personnel, de ne pas trop approcher les antennes du corps humain au cours du fonctionnement de l'équipement.

Ce périphérique a été conçu pour être conforme aux exigences applicables pour l'exposition aux ondes radio, en fonction de normes scientifiques qui comprennent des plages destinées à assurer la sécurité de tout le monde, quel que soit l'âge et l'état de santé. Ces règles d'exposition aux ondes radio utilisent une unité de mesure appelée taux d'absorption spécifique (SAR - Specific Absorption Rate). Les tests relatifs aux taux d'absorption sont menés à l'aide de méthodes standardisées, le téléphone transmettant à son niveau certifié le plus élevé dans toutes les bandes de fréquences utilisées. Les informations de données SAR se basent sur les normes EN50360 et EN50361 de CENELEC, qui utilisent la limite de 2 watts par kilogramme, sur une moyenne de 10 grammes de tissu.

Avis pour la Corée du Sud

무선적용제품

해당 무선설비가 전파혼신 가능성이 있으므로 인명안전과 관련된 서비스는 할 수 없음 (무선모듈 제품이 설치되어 있는 경우).

몸 가까이에서 장치를 작동할 경우, 비금속 저장 액세스리를 사용하여 장치와 몸 사이에 2.5cm 이상의 거리를 유지하십시오.

Avis sur les périphériques sans fil pour la Thaïlande

เครื่องโทรคมนาคมและอุปกรณ์นี้ มีความสอดคล้องตามมาตรฐานหรือข้อกำหนดของ กสทช.

(Cet équipement de télécommunication se conforme aux exigences NBTC.)

เครื่องวิทยุคมนาคมนี้มีระดับการแผ่คลื่นแม่เหล็กไฟฟ้าสอดคล้องตามมาตรฐานความปลอดภัยต่อสุขภาพของมนุษย์จากการใช้เครื่องวิทยุคมนาคมที่คณะกรรมการกิจการโทรคมนาคมแห่งชาติประกาศกำหนด

Cet équipement de communication radio possède une force de champ électromagnétique conforme à la norme de sécurité pour l'utilisation d'équipement de communication radio vis-à-vis de la santé des personnes annoncée par la Commission nationale des télécommunications.

Avis de la NCC pour Taïwan

Périphériques WLAN 802.11a

在 5.25G~5.35G 頻帶內操作之無線
資訊傳輸設備僅適於室內使用

應避免影響附近雷達系統之操作。

Périphériques sans fil LAN 802.11/Périphériques Bluetooth/Périphériques à courte portée

低功率電波輻射性電機管理辦法

第十二條 經型式認證合格之低功率射頻電機，非經許可，公司、商號或使用者均不得擅自變更頻率、加大功率或變更原設計之特性及功能。

第十四條 低功率射頻電機之使用不得影響飛航安全及干擾合法通信；經發現有干擾現象時，應立即停用，並改善至無干擾時方得繼續使用。

前項合法通信，指依電信法規定作業之無線電通信。低功率射頻電機須忍受合法通信或工業、科學及醫療用電波輻射性電機設備之干擾。

Avis sur les utilisations en vol

L'utilisation d'appareils électroniques à bord des avions de ligne est laissée à l'appréciation de la compagnie aérienne.

Avis sur les batteries remplaçables par l'utilisateur

Ne jetez pas les batteries ayant atteint leur durée de vie utile avec les ordures ménagères. Appliquez les lois et réglementations locales en matière de mise au rebut des batteries d'ordinateur.

HP encourage ses clients à recycler le matériel électronique usagé, les cartouches d'impression d'origine HP et les piles rechargeables. Pour plus d'informations sur les programmes de recyclage, consultez le site Web HP à l'adresse <http://www.hp.com/recycle>.

Pour des informations sur le retrait d'une batterie remplaçable par l'utilisateur, reportez-vous au manuel de l'utilisateur livré avec le produit.

Avis sur les batteries scellées en usine

La ou les batteries de ce produit ne peuvent pas être facilement remplacées par les utilisateurs. Le retrait ou le remplacement de la batterie pourrait affecter votre droit à la garantie. Si une batterie ne tient plus la charge, contactez le support.

Ne jetez pas les batteries ayant atteint leur durée de vie utile avec les ordures ménagères. Appliquez les lois et réglementations locales en matière de mise au rebut des batteries.

Conformité du laser

⚠ AVERTISSEMENT ! L'utilisation de méthodes de contrôle ou de réglage ou de procédures, autres que celles indiquées dans ce document ou dans le manuel d'installation d'appareils à rayon laser, peut exposer l'utilisateur à des radiations dangereuses. Pour réduire le risque d'exposition à un rayonnement dangereux :

- N'essayez pas d'ouvrir le boîtier du module. Il ne contient pas de composant réparable par l'utilisateur.
- N'effectuez pas de commandes, de réglages ou d'opérations sur l'appareil laser, en dehors de ce qui est indiqué dans le manuel d'installation du produit laser.
- Seuls les mainteneurs agréés HP sont autorisés à réparer l'unité.

Ce produit peut être fourni avec un périphérique de stockage optique (par exemple, un lecteur de CD ou DVD) et/ou un émetteur-récepteur fibre optique. Chacun de ces appareils qui contient un laser est classé comme produit laser de classe 1 conformément à la norme CEI/EN 60825-1 et répond aux critères de sécurité de cette norme.

Chaque produit laser est conforme aux paragraphes 21 CFR 1040.10 et 1040.11 des réglementations FDA des États-Unis ou est conforme à ces réglementations à l'exception des déviations relatives à l'avis sur le laser No. 50, en date du 24 juin 2007.



Homologations du périphérique de télécommunication

Le périphérique de télécommunication de cet ordinateur est homologué pour une connexion au réseau téléphonique des pays et régions dont les marques d'homologation apparaissent sur l'étiquette de produit située sur la partie inférieure de l'ordinateur ou sur le modem.

Reportez-vous au manuel de l'utilisateur livré avec le produit pour vous assurer que celui-ci est configuré pour le pays ou région dans lequel ou laquelle il se trouve. La sélection d'un pays ou d'une région autre que celui ou celle où se trouve le produit peut entraîner une configuration du modem en violation des lois sur les télécommunications de ce pays ou de cette région. De plus, il est possible que le modem ne fonctionne pas correctement si vous n'avez pas sélectionné correctement le pays/la région. Si, lorsque vous sélectionnez un pays ou une région, un message indique que votre pays ou région n'est pas pris en charge, cela signifie que le modem n'a pas été homologué dans ce pays ou cette région et qu'il ne doit donc pas être utilisé.

Avis sur les modems

Avis sur les modems pour les États-Unis

Ce matériel est conforme à l'article 68 des réglementations de la FCC et aux conditions adoptées par l'ACTA. Une étiquette est apposée sur la partie inférieure de l'ordinateur ou sur le modem. Elle inclut, entre autres informations, un identificateur de produit au format US:AAAEQ##TXXXX. Fournissez ces informations à la compagnie téléphonique si elle vous y invite.

Certification applicable de la prise USOC = RJ11C. La fiche et la prise utilisées pour connecter ce matériel au câblage des locaux et au réseau téléphonique doivent être conformes à l'article 68 des réglementations de la FCC et aux conditions adoptées par l'ACTA. Un cordon téléphonique et une fiche modulaire conformes sont fournis avec ce produit. Ils sont conçus pour être connectés à une prise modulable également conforme. Reportez-vous aux instructions d'installation pour plus d'informations.

Le REN est utilisé pour déterminer le nombre de périphériques qui peuvent être connectés à une ligne téléphonique. Si la ligne téléphonique regroupe un nombre trop important de REN, les périphériques peuvent ne pas sonner lors d'un appel entrant. Dans la plupart des emplacements, la somme des REN ne doit pas dépasser cinq (5). Pour connaître avec certitude le nombre de périphériques qui peuvent être connectés à une ligne, et donc le nombre total de REN, contactez votre compagnie téléphonique. Pour les produits homologués après le 23 juillet 2001, le REN fait partie de l'identificateur de produit dont le format est US:AAAEQ##TXXXX. Les chiffres représentés par le signe ## constituent le REN sans virgule (par exemple, 03 représente un REN de 0,3). Pour les produits antérieurs, le REN est indiqué séparément sur l'étiquette.

Si ce matériel HP dégrade le réseau téléphonique, la compagnie téléphonique vous avertira à l'avance qu'une interruption du service peut être requise. S'il n'est pas possible de vous informer de cette interruption à l'avance, la compagnie vous avertira au plus vite. En outre, vous serez informé de votre droit à déposer une réclamation auprès de la FCC si vous pensez que cela n'est nécessaire.

La compagnie téléphonique peut apporter des modifications à ses installations, équipements, opérations ou procédures pouvant affecter le bon fonctionnement du matériel. Dans ce cas, il vous en informera à l'avance afin que vous puissiez prendre les mesures nécessaires pour assurer un service téléphonique ininterrompu.

Si vous rencontrez des problèmes avec cet équipement, contactez le support technique. S'il détériore le réseau téléphonique, la compagnie téléphonique peut vous demander de le déconnecter jusqu'à ce que le problème soit résolu. Les seules réparations que vous pouvez effectuer sont celles qui sont présentées dans la section « Résolution des problèmes » du manuel de l'utilisateur, si ce dernier est fourni.

La connexion à des lignes partagées est soumise à des taxes dépendant de chaque État. Pour plus d'informations, contactez la commission des services publics ou la commission des entreprises.

Si votre domicile est équipé d'un dispositif d'alarme spécial connecté à la ligne téléphonique, vérifiez que l'installation de ce matériel HP ne le désactive pas. Pour toute question concernant les équipements susceptibles de désactiver votre alarme, consultez votre compagnie téléphonique ou un installateur qualifié.

Le Telephone Consumer Protection Act de 1991 rend illégal le fait d'utiliser un ordinateur ou tout autre dispositif électronique, y compris un télécopieur, pour envoyer des messages ne contenant pas clairement, dans une marge située dans la partie supérieure ou inférieure de chaque page transmise ou sur la première page de chaque transmission, la date et l'heure de l'envoi, ainsi que des éléments identifiant l'entreprise, l'entité ou la personne à l'origine du message, ainsi que le numéro de téléphone de la machine expéditrice, de l'entreprise, de l'entité ou de la personne. (Le numéro de téléphone fourni ne peut pas être un numéro en 900 ou tout autre numéro dont le coût dépasse celui d'un appel local ou longue distance.)

Pour programmer ces informations dans votre télécopieur, vous devez suivre la procédure décrite dans les instructions du logiciel de télécopie.

Déclarations sur les modems pour les États-Unis

Reportez-vous à la déclaration suivante du fournisseur du modem concernant le périphérique de modem installé dans votre ordinateur :

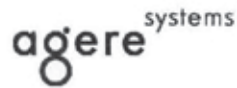

Brad Grande
Technical Manager

1110 American Parkway NE
Lehigh Valley Central Campus
Allentown, PA 18109
Phone: 610-712-7853
bgrande@agere.com

Supplier's Declaration of Conformity

Reference Number: Delphi D40 (revision AM5)
Place of Issue: Allentown, PA, USA
Date of Issue: 30th November 2006

Agere Systems Inc. at 1110 American Parkway NE, Lehigh Valley Central Campus, Allentown, PA 18109 in the United States of America, hereby certifies that the Modem, bearing labelling identification number US: AGSMD01BDELPHI complies with the Federal Communications Commission's ("FCC") Rules and Regulations 47 CFR Part 68, and the Administrative Council on Terminal Attachments ("ACTA")-adopted technical criteria TIA/EIA/IS-968, 968-A, 968-A-1, 968-A-2 and 968-A-3 Telecommunications – Telephone Terminal Equipment – Technical Requirements for Connection of Terminal Equipment To the Telephone Network.

A handwritten signature in black ink that reads "Brad Grande".

Brad Grande
Technical Manager

Avis sur les modems pour le Canada

Cet équipement est conforme aux spécifications techniques d'Industrie Canada applicables.

Le REN indique le nombre maximal d'appareils pouvant être connectés à une interface téléphonique. La terminaison d'une interface peut consister en une combinaison d'appareils quelconque à condition que la somme des REN de ces dispositifs ne dépasse pas 5. Le REN de ce terminal de communication est 1.

Avis sur les modems pour le Japon

Si l'ordinateur ne possède pas la marque de certification des périphériques japonais sur sa partie inférieure, reportez-vous à la marque de certification appropriée ci-dessous.

La marque de certification des périphériques japonais pour le modem télécopie/données V.92 56K est illustrée ci-dessous :



Si l'ordinateur ne possède pas la marque de certification des périphériques japonais sur sa partie inférieure, reportez-vous à la marque de certification appropriée ci-dessous.

La marque de certification des périphériques japonais pour le modem LSI Corporation PCI-SV92EX Soft est illustrée ci-dessous :



Déclarations sur les modems pour la Nouvelle-Zélande

L'octroi d'un Telepermit pour n'importe quel terminal de télécommunication indique uniquement que Telecom certifie que l'équipement est bien conforme aux exigences minimales de connexion à son réseau. Il ne constitue aucunement une prise de responsabilité quant au produit par Telecom, et n'apporte aucune sorte de garantie. Plus particulièrement, il n'apporte aucune garantie que l'équipement fonctionnera correctement et en tous points avec un autre équipement Telepermit d'une marque ou d'un modèle différent, et ne signifie pas non plus qu'un produit est compatible avec l'ensemble des services du réseau Telecom.

Quelles que soient les conditions d'utilisation, ce matériel ne peut fonctionner correctement aux vitesses supérieures à celles pour lesquelles il a été conçu. Telecom décline toute responsabilité si des difficultés devaient apparaître dans de telles circonstances.

Si cet équipement est doté de la composition à impulsions, Telecom ne garantit pas la prise en charge de celle-ci par la ligne.

L'utilisation de la composition à impulsions, sur une ligne partagée par plusieurs dispositifs, peut provoquer un déclenchement de la sonnerie ou des parasites et également une réponse erronée. Si ce type de problème se produit, l'utilisateur ne doit *pas* contacter les services techniques de Telecom Nouvelle-Zélande.

Certains paramètres nécessaires pour une conformité avec les exigences Telepermit de Telecom dépendent du matériel (PC) associé à cet appareil. Le matériel associé doit être configuré de manière à fonctionner dans les limites prescrites pour être conforme aux spécifications Telecom :

- a. Chaque appel manuel ne dépassera pas 10 tentatives d'appel au même numéro dans un intervalle de 30 minutes.
- b. Le matériel doit rester à l'état raccroché pendant une période d'au moins 30 secondes entre la fin d'une tentative d'appel et le début de la tentative suivante.
- c. Lorsque des appels automatiques sont passés à divers numéros, le matériel doit être configuré pour passer à l'état raccroché pendant une période d'au moins 5 secondes entre la fin d'une tentative d'appel et le début de la tentative suivante.
- d. Le matériel doit être configuré de telle manière que les appels soient traités dans un délai de 3 à 30 secondes à partir de la réception de la sonnerie (il doit donc être configuré entre 2 et 10 secondes).

Prise en charge vocale

Toutes les personnes qui utilisent cet appareil pour enregistrer des conversations téléphoniques doivent se soumettre à la législation de la Nouvelle-Zélande. Celle-ci exige qu'au moins une des deux parties participant à la conversation soit au courant de l'enregistrement. En outre, les principes relatifs à la nature des informations personnelles recueillies, aux objectifs de leur collecte, à leur utilisation et à la divulgation de ces informations à des tiers, principes répertoriés dans la loi sur la protection de la vie privée de 1993, doivent être respectés.

Ce matériel ne doit pas être configuré de manière à passer des appels automatiques au numéro d'urgence (111) mis en place par Telecom.

Avis de Macrovision Corporation

Ce produit inclut une technologie de protection de copyright protégée par des déclarations de méthode de certains brevets américains et d'autres droits de propriété intellectuelle appartenant à Macrovision Corporation et autres détenteurs de droits. L'utilisation de cette technologie de protection des droits d'auteur doit être autorisée par Macrovision Corporation et a pour but de permettre un visionnage domestique et d'autres utilisations limitées uniquement, sauf autorisation de Macrovision Corporation. L'ingénierie inverse et le désassemblage sont interdits.

2 Avis relatifs à la sécurité

Informations importantes relatives à la sécurité

⚠ AVERTISSEMENT ! Pour réduire les risques de blessures graves, lisez le manuel *Sécurité et ergonomie du poste de travail*. Il décrit l'installation du poste de travail, la posture ainsi que les conditions de sécurité et de travail appropriées pour les utilisateurs, et fournit des informations importantes sur la sécurité électrique et mécanique. Vous trouverez ce manuel sur le Web à l'adresse <http://www.hp.com/ergo>, ainsi que sur le CD de documentation qui accompagne le produit.

L'ordinateur peut être très lourd ; assurez-vous d'adopter une position ergonomique adéquate lors de sa manipulation.

Installez l'ordinateur à proximité d'une prise secteur. Le cordon d'alimentation secteur constitue le principal dispositif de déconnexion secteur de votre ordinateur et doit donc être facilement accessible. Si le cordon d'alimentation fourni avec votre ordinateur est équipé d'une fiche de mise à la terre, utilisez toujours le cordon d'alimentation avec une prise secteur correctement reliée à la terre, afin d'éviter tout risque de choc électrique.

Pour réduire les risques de choc électrique en provenance du réseau téléphonique, branchez votre ordinateur sur une prise secteur avant de le connecter à une ligne téléphonique. Par ailleurs, déconnectez votre ligne téléphonique avant de débrancher votre ordinateur de la prise secteur.

Débranchez le cordon du modem du réseau téléphonique avant d'installer ou d'enlever le capot de votre ordinateur.

N'utilisez pas l'ordinateur lorsque le capot est enlevé.

Pour plus de sécurité, débranchez toujours l'ordinateur de sa source d'alimentation, de tout système de télécommunications (comme les lignes téléphoniques), des réseaux et des modems avant d'exécuter toute opération de maintenance. Si vous ne respectez pas ces consignes, vous risquez de vous blesser ou de causer des dommages matériels. Le modem et l'alimentation de ce produit renferment des niveaux de tension dangereux.

Par mesure de sécurité, si la charge d'alimentation électrique du système dépasse les capacités de la configuration spécifique, le système peut désactiver temporairement certains ports USB.

⚠ AVERTISSEMENT ! Pour réduire le risque d'incendie, de choc électrique et de blessure lors de l'utilisation de ce périphérique, suivez systématiquement les consignes de sécurité de base, notamment :

- N'utilisez pas l'appareil à proximité de l'eau, par exemple près d'une baignoire, d'un lavabo, d'un évier ou d'une piscine, ou encore dans une cave humide.
- Évitez d'utiliser l'appareil pendant un orage. Il existe un risque d'électrocution dû à la foudre.
- N'utilisez jamais cet appareil pour signaler une fuite de gaz si vous vous trouvez à proximité de la fuite.
- Débranchez systématiquement le câble du modem avant d'ouvrir l'enceinte de l'appareil ou de toucher un câble modem non isolé, une prise jack ou un composant interne.
- Si le produit n'est pas fourni avec un câble téléphonique, utilisez exclusivement un câble de télécommunication 26 AWG ou supérieur.
- Ne branchez pas un câble de modem ou de téléphone sur la prise réseau (RJ-45).

CONSERVEZ CES INSTRUCTIONS.

 **IMPORTANT :** Si votre ordinateur est équipé d'un commutateur de tension pour une utilisation dans un système électrique 115 ou 230 V, le commutateur a été préréglé sur la tension correcte qui correspond à celle utilisée dans le pays ou la région où il a été vendu à l'origine. Mettre le commutateur sur la mauvaise position peut endommager l'ordinateur et annuler toute garantie implicite.

Ce produit n'a pas été évalué pour une connexion à un système d'alimentation informatique (un système de distribution de courant alternatif sans connexion directe à la terre, selon les normes de sécurité applicables).

Notice d'avertissement relative à la sécurité liée à la chaleur

 **AVERTISSEMENT !** Pour éviter tout risque de blessure associée à la chaleur ou de surchauffe de l'ordinateur portable, ne placez pas ce dernier sur vos genoux et n'obstruez pas ses ouvertures d'aération. Utilisez toujours l'ordinateur portable sur une surface plane et rigide. La ventilation ne doit pas être entravée par des éléments rigides, tels qu'une imprimante, ni par des éléments souples, tels que des coussins, du tissu ou un tapis épais. De même, l'adaptateur secteur ne doit rester en contact ni avec la peau ni avec un élément souple, tel que des coussins, un vêtement ou un tapis lorsque l'ordinateur est en cours de fonctionnement. L'ordinateur portable et l'adaptateur secteur sont conformes aux limites de température de surface accessibles à l'utilisateur, définies par les normes de sécurité applicables.

Avis sur les risques liés à la sécurité

Si vous observez l'une des situations suivantes (ou avez d'autres inquiétudes en matière de sécurité), n'utilisez pas l'ordinateur : bruit de crépitement, de sifflement ou de claquement ou forte odeur/fumée en provenance de l'ordinateur. La survenue de l'une de ces situations est normale en cas de défaillance d'un composant électronique interne de manière neutralisée et contrôlée. Cependant, ces situations peuvent également indiquer un risque de sécurité. Ne partez pas du principe qu'il s'agit d'une défaillance neutralisée. Mettez l'ordinateur hors tension, déconnectez-le de sa source d'alimentation, puis contactez l'assistance technique.

Conditions d'installation

Consultez les instructions d'installation avant de brancher cet équipement sur l'alimentation.

 **AVERTISSEMENT !** Cet ordinateur peut contenir des pièces sous tension et amovibles. Débranchez le cordon d'alimentation avant de retirer le boîtier. Remettez le boîtier bien en place avant de remettre l'ordinateur sous tension.

Avis sur l'acoustique





Le niveau de pression acoustique (LpA) est extrêmement en deçà de 70dB(A) (position de l'opérateur, fonctionnement normal, selon la norme ISO 7779). Pour afficher les données d'émission sonore du produit, rendez-vous sur « Déclarations IT ECO » à <http://www.hp.com/go/ted>, puis sélectionnez une catégorie de produit dans le menu déroulant.

Avis relatif aux batteries



- ⚠ AVERTISSEMENT !** Le produit peut contenir un module de batteries interne au dioxyde de manganèse/lithium, au pentoxyde de vanadium ou alcaline. Un risque d'explosion ou de brûlure existe en cas de manipulation incorrecte du module de batteries.
- ⚠ AVERTISSEMENT !** Ne pas essayer de recharger la pile.
- ⚠ AVERTISSEMENT !** Évitez de la soumettre à des températures supérieures à 60° C (140° F).
- ⚠ AVERTISSEMENT !** Pour limiter les risques liés à la sécurité, seule la batterie fournie avec l'ordinateur, une batterie de rechange fournie par HP ou une batterie compatible achetée comme accessoire auprès de HP doit être utilisée avec l'ordinateur. Le chargement rapide peut ne pas être disponible pour les batteries autres que HP ou non compatibles.
- ⚠ AVERTISSEMENT !** Pour réduire tout risque d'incendie ou de brûlure, vous ne devez pas le désassembler, l'écraser, le perforer, mettre à nu ses contacts ni le jeter dans le feu ou dans l'eau.
- ⚠ AVERTISSEMENT !** Il existe un risque d'explosion en cas de remplacement de la batterie par une batterie d'un type incorrect. Éliminez les batteries usagées en respectant les instructions.
- ⚠ AVERTISSEMENT !** Remplacez uniquement par une batterie HP prévue pour ce produit.
- ⚠ AVERTISSEMENT !** Ne pas ingérer la batterie, risque de brûlure chimique.
- ⚠ AVERTISSEMENT !** Ce produit contient une pile bouton. Si la pile bouton est ingérée, elle peut causer des brûlures internes graves en moins de 2 heures et peut entraîner la mort.
- ⚠ AVERTISSEMENT !** Conservez les batteries neuves et usagées hors de portée des enfants.
- ⚠ AVERTISSEMENT !** Si le compartiment de la batterie n'est pas fermé convenablement, arrêtez d'utiliser le produit et gardez hors de portée des enfants.
- ⚠ AVERTISSEMENT !** Si vous pensez que des batteries ont pu avoir été ingérées ou placées à l'intérieur de toute partie du corps, consulter immédiatement un médecin.
- ⚠ AVERTISSEMENT !** Si vous laissez une batterie dans un environnement comportant une température extrêmement élevée, cela peut entraîner une explosion ou la fuite du gaz ou liquide inflammable.
- ⚠ AVERTISSEMENT !** Une batterie soumise à une pression d'air très faible peut entraîner une explosion ou la fuite du gaz ou liquide inflammable.

Icône	Description
	Les piles, modules de batterie et accumulateurs ne doivent pas être jetés avec les ordures ménagères. Pour permettre leur recyclage ou leur mise au rebut, veuillez utiliser les systèmes de collecte publique ou renvoyez-les à HP, à un partenaire HP agréé ou à leurs agents.

Avis sur le ventilateur

-  **AVERTISSEMENT !**  Conservez les pièces fixes éloignées des parties mobiles.
 -  **AVERTISSEMENT !** Conservez les pièces fixes éloignées des hélices du ventilateur.
 -  **AVERTISSEMENT !** Conservez les pièces fixes hors de la trajectoire de mouvement.
-

Avis sur le niveau du volume du casque et des écouteurs

-  **AVERTISSEMENT !**  Pour éviter les dommages causés à votre système auditif, n'écoutez pas à des volumes élevés pendant des périodes prolongées.

Le réglage de la commande de volume, ainsi que du balancier compensateur d'autres paramètres hors de la position centrale peut augmenter la tension de sortie du casque/des écouteurs et par conséquent le niveau de pression acoustique. L'utilisation de facteurs influençant la sortie casque/écouteurs autres que ceux spécifiés par le fabricant (par exemple système d'exploitation, logiciel d'égalisation, microprogramme, pilote) peut augmenter la tension de sortie du casque/des écouteurs et par conséquent le niveau de pression acoustique.

Sécurité des lasers

Pour les produits équipés d'unités optiques ou d'émetteurs à fibre optique.

Ce produit peut être équipé d'un périphérique de stockage optique (c'est-à-dire un lecteur CD ou DVD) et/ou d'un émetteur-récepteur à fibre optique. Ces éléments comportent des lasers classés dans la catégorie des produits laser de classe 1, conformément à la norme IEC/EN 60825-1, et sont conformes à ses exigences.

Chacun de ces produits laser est conforme aux réglementations 21 CFR 1040.10 et 1040.11 de la US FDA ou est conforme à ces normes à l'exception des différences conformément à la notice des lasers No. 50, du 24 Juin 2007.

-  **AVERTISSEMENT !** L'utilisation de méthodes de contrôle ou de réglage ou de procédures, autres que celles indiquées dans ce document ou dans le manuel d'installation des appareils à rayon laser, peut exposer l'utilisateur à des radiations dangereuses. Pour réduire le risque d'exposition à un rayonnement dangereux :
 - N'essayez pas d'ouvrir le boîtier du module. Il ne contient pas de composant réparable par l'utilisateur.
 - N'effectuez pas de commandes, de réglages ou d'opérations sur l'appareil laser, en dehors de ce qui est indiqué dans le présent manuel.
 - Seuls les techniciens agréés HP sont autorisés à réparer l'unité.
-

Exigences relatives au bloc d'alimentation et au cordon d'alimentation

Exigences relatives à la mise à la terre des alimentations de classe 1

Pour une protection contre les défauts de courant, l'équipement doit être connecté à une borne de terre. Branchez le cordon d'alimentation du système sur une prise secteur fournissant une connexion de masse. Tout cordon alternatif risquerait de ne pas fournir une protection adéquate contre les défauts. Utilisez uniquement le cordon d'alimentation fourni avec ce produit ou un produit de remplacement agréé par HP Inc.

Avis pour le Brésil

Este equipamento deve ser conectado obrigatoriamente em tomada de rede de energia elétrica que possua aterramento (três pinos), conforme a norma nbr abnt 5410, visando a segurança dos usuários contra choques elétricos.

Danemark

Apparatets stikprop skal tilsluttes en stikkontakt med jord, som giver forbindelse til stikproppens jord.

Finlande

Laite on liitettävä suojakoskettimilla varustettuun pistorasiaan.

Norvège

Apparatet må tilkoples jordet stikkontakt.

Suède

Apparaten skall anslutas till jordat uttag.

Exigences relatives au bloc d'alimentation

Les alimentations sur certains produits sont équipées de commutateurs de tension externes. La fonction de sélection de tension sur le produit autorise son fonctionnement sous toute tension comprise entre 100-127 ou 200-240 volts secteur. Les alimentations sur les produits dépourvus de commutateurs de tension externes sont équipées de circuits internes qui détectent la tension d'entrée et basculent automatiquement sur la tension appropriée.

⚠ AVERTISSEMENT ! Pour limiter les problèmes de sécurité potentiels, utilisez avec cet ordinateur uniquement l'adaptateur secteur fourni avec l'ordinateur, un adaptateur secteur de remplacement fourni par HP ou un adaptateur secteur acheté comme accessoire auprès de HP.

Pour une utilisation en Norvège

Ce produit est également conçu pour un système électrique informatique avec tension phase-phase de 230 V.

Exigences relatives au cordon d'alimentation

⚠ AVERTISSEMENT ! Pour réduire les risques de choc électrique ou de détérioration du matériel :

- Branchez le cordon d'alimentation sur une prise secteur facilement accessible à tout moment.
 - Coupez l'alimentation de l'ordinateur en débranchant le cordon d'alimentation de la prise secteur.
 - Si l'ordinateur portable est fourni avec une fiche tripolaire, branchez le cordon sur une prise électrique tripolaire reliée à la terre. Ne désactivez pas la broche de mise à la terre du cordon d'alimentation en utilisant, par exemple, un adaptateur bipolaire. La broche de mise à la terre constitue un élément de sécurité essentiel.
-

Le jeu de cordon d'alimentation livré avec le produit est conforme aux exigences du pays dans lequel l'équipement a été acheté. Utilisez uniquement le cordon d'alimentation fourni avec l'appareil ou un cordon d'alimentation de remplacement fourni par HP Inc. ou par un revendeur agréé par HP Inc. Les références de pièces de rechange sont disponibles à l'adresse <http://www.hp.com/support>.

Les cordons d'alimentation destinés à être utilisés dans d'autres pays doivent respecter les normes du pays où vous utilisez le produit. Pour plus d'informations sur les exigences de cordon d'alimentation, contactez votre revendeur, votre mainteneur ou votre fournisseur de services agréé HP.

⚠ AVERTISSEMENT ! N'utilisez pas de cordons d'alimentation d'autres produits.

Un mauvais cordon d'alimentation peut entraîner un risque de décharge électrique ou d'incendie.

Les exigences présentées ci-après s'appliquent à tous les pays.

1. Le cordon d'alimentation doit être homologué par une agence accréditée, responsable de l'évaluation dans le pays où le cordon sera installé.
2. La longueur du cordon doit être comprise entre 1,8 m (6 pieds) et 3,6 m (12 pieds). Pour un cordon d'alimentation de 2 m (6,56 pieds) ou moins, le diamètre du cordon doit être d'au minimum 0,75 mm² ou 18 AWG. Si le cordon d'alimentation dépasse 2 m (6,56 pieds), le diamètre du cordon doit être d'au minimum 1 mm² ou 16 AWG.

Le cordon d'alimentation doit être branché à un endroit dégagé où il ne risque pas d'être piétiné ou coincé par des objets. Accordez une attention particulière à la fiche, à la prise murale et à l'endroit où le cordon sort du boîtier de l'appareil.

⚠ AVERTISSEMENT ! N'utilisez pas ce produit avec un cordon d'alimentation endommagé. Si le cordon d'alimentation est endommagé de quelque manière que ce soit, remplacez-le immédiatement. Un cordon endommagé peut entraîner des risques de blessure.

Informations sur le cordon d'alimentation

Si votre ordinateur ne vous a pas été livré avec un cordon d'alimentation ou un accessoire d'alimentation secteur compatible avec votre ordinateur, vous devrez acheter un cordon d'alimentation homologué pour votre pays ou votre région.

Les caractéristiques électriques du cordon d'alimentation doivent correspondre à la tension et au courant du produit tels qu'indiqués sur l'étiquette des caractéristiques électriques du produit. Les valeurs nominales de tension et d'intensité du cordon doivent être supérieures à celles indiquées sur l'ordinateur. En outre, le diamètre du cordon doit être au minimum de **0,75 mm²/18 AWG** et sa longueur doit être comprise entre **1 et 2 m**. Si vous avez des questions sur le type de cordon d'alimentation à utiliser, contactez votre fournisseur de service agréé.

Le cordon d'alimentation doit être placé de sorte que personne ne puisse marcher dessus ou qu'il ne puisse être pincé par des éléments placés contre ou sur le fil. Prêtez tout particulièrement attention à la fiche, à la prise murale et au point où le cordon d'alimentation sort du produit.

prise CC de la source d'alimentation externe HP



Avis sur les cordons d'alimentation pour le Japon

製品には、同梱された電源コードをお使い下さい。
同梱された電源コードは、他の製品では使用出来ません。

Spécifications du cordon d'alimentation pour le Japon

Pour une utilisation au Japon, utilisez uniquement le cordon d'alimentation fourni avec l'appareil.

⚠ ATTENTION : N'utilisez pas le cordon d'alimentation fourni avec ce produit pour alimenter d'autres appareils.

Risque de pincement

⚠ AVERTISSEMENT ! Observez les zones à risque de pincement. N'approchez pas vos doigts des pièces se refermant.

Protection des connecteurs de l'antenne TV

Mise à la terre d'une antenne de télévision externe

Si une antenne externe ou un système par câble est connecté(e) à ce produit, assurez-vous que l'antenne ou le système par câble est mis(e) à la terre électriquement de façon à vous protéger contre les surtensions et les accumulations d'électricité statique. L'article 810 du code électrique national (ANSI/NFPA 70) fournit des informations sur la mise à la terre de la monture et de la structure portante, la mise à la terre du fil d'entrée vers un dispositif de décharge de l'antenne, la taille des conducteurs de mise à la terre, l'emplacement du dispositif de décharge de l'antenne, la connexion aux électrodes de terre et les exigences relatives aux électrodes de terre.

Protection contre la foudre

Pour mieux protéger votre produit durant un orage ou lorsqu'il reste inutilisé et sans surveillance pendant une période prolongée, débranchez le câble de raccordement électrique, puis l'antenne ou le système par câble. Vous éviterez ainsi que la foudre ou des surtensions n'endommagent le produit.



Tableau 2-1 Mise à la terre de l'antenne

Référence	Composant de mise à la terre
1	Compteur électrique extérieur
2	Système d'électrode de mise à terre du compteur électrique (code électrique national, article 250, partie III)
3	Colliers de mise à la terre
4	Conducteurs de mise à la terre (code électrique national, section 810.21)
5	Dispositif de décharge de l'antenne (code électrique national, section 810.20)
6	Collier de mise à la terre
7	Fil d'entrée de l'antenne

Remarque destinée aux installateurs de systèmes de télévision par câble

Ce rappel a pour but d'attirer l'attention des installateurs de systèmes de télévision par câble sur la section 820.93 du code électrique national, qui fournit des directives pour la mise à la terre et spécifie notamment que le blindage du câble coaxial doit être connecté au système de mise à la terre du bâtiment, aussi près que possible du point d'entrée du câble.

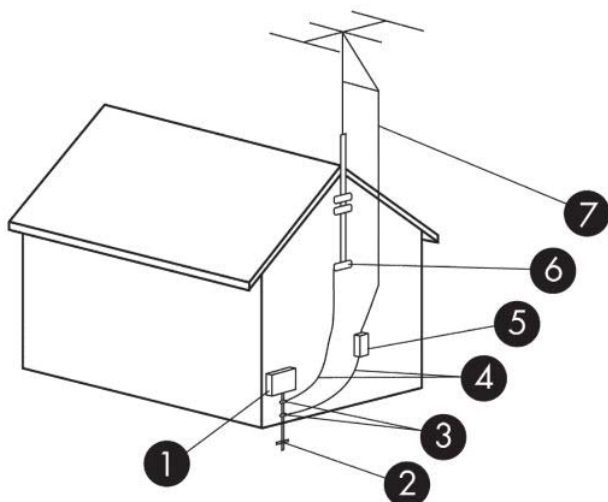
Avis sur les déplacements

⚠ AVERTISSEMENT ! Afin de réduire le risque de choc électrique, d'incendie ou de détérioration du matériel, n'essayez pas d'alimenter l'ordinateur au moyen d'un kit de conversion de tension destiné aux équipements ménagers.

Avis de sécurité pour la Chine

HP 工作站使用安全手册

使用须知

欢迎使用惠普工作站，为了您及仪器的安全，请您务必注意如下事项：

1. 仪器要和地线相接，要使用有正确接地插头的电源线，使用中国国家规定的 220V 电源。
2. 避免高温和尘土多的地方，否则易引起仪器内部部件的损坏。
3. 避免接近高温，避免接近直接热源，如直射太阳光、暖气等其它发热体。
4. 不要有异物或液体落入机内，以免部件短路。
5. 不要将磁体放置于仪器附近。

警告

为防止火灾或触电事故，请不要将该机放置于淋雨或潮湿处

如果您按照以上步骤操作时遇到了困难，或想了解其它产品性能，请在以下网页上寻找相关信息：<http://www.hp.com.cn>

或联系我们

中国惠普有限公司
地址：北京朝阳区建国路 112 号中国惠普大厦
电话：010-65643888

Chine : avis sur l'altitude

海拔警告仅适用于在海拔 2000m 以下地区使用的产品

Icône	Description
	海拔警告仅适用于在海拔 2000m 以下地区使用的产品。

Chine : avis sur une utilisation dans des conditions tropicales

热带警告仅适用于在非热带气候条件下使用的产品。

Icône	Description
	热带警告仅适用于在非热带气候条件下使用的产品。

Norvège et Suède : Avis de mise à la terre des câbles pour les produits équipés d'une carte TV

 **ATTENTION :** Pour réduire les problèmes de sécurité potentiels, utilisez un sectionneur galvanique pour le branchement à un réseau de distribution par câble.

使用過度恐傷害視力

注意事項:

- (1) 使用 30 分鐘請休息 10 分鐘。
- (2) 未滿 2 歲幼兒不看螢幕，2 歲以上每天看螢幕不要超過 1 小時。

3 Avis des agences environnementales

Ce chapitre présente des avis relatifs à l'environnement des différents pays ou régions et des informations de conformité. Certains de ces avis peuvent ne pas s'appliquer à votre produit.

Recyclage du matériel électronique, de l'emballage et de la batterie

HP encourage ses clients à recycler le matériel électronique usagé, l'emballage des cartouches d'impression d'origine HP et les piles rechargeables. Pour plus d'informations sur les programmes de recyclage, rendez-vous sur <http://www.hp.com/recycle>.

Pour obtenir des informations concernant le recyclage du produit au Japon, reportez-vous à <http://www.hp.com/jp/hardwarecycle/>.

Mise au rebut des équipements par les utilisateurs

Icône	Description
	Ce symbole indique que vous ne devez pas jeter votre produit avec les déchets ménagers. Il est de votre responsabilité de protéger la santé et l'environnement et d'éliminer votre équipement en le remettant à une déchetterie effectuant le recyclage des équipements électriques et électroniques. Pour plus d'informations, prenez contact avec votre service d'élimination des ordures ménagères ou ouvrez la page http://www.hp.com/recycle .

Mise au rebut des batteries alcalines au Brésil

Icône	Description
 Não descarte o produto eletrônico em lixo comum	Este produto eletroeletrônico e seus componentes não devem ser descartados no lixo comum, pois embora estejam em conformidade com padrões mundiais de restrição a substâncias nocivas, podem conter, ainda que em quantidades mínimas, substâncias impactantes ao meio ambiente. Ao final da vida útil deste produto, o usuário deverá entregá-lo à HP. A não observância dessa orientação sujeitará o infrator às sanções previstas em lei. Após o uso, as pilhas e/ou baterias dos produtos HP deverão ser entregues ao estabelecimento comercial ou rede de assistência técnica autorizada pela HP. Para maiores informações, inclusive sobre os pontos de recebimento, acesse: http://www.hp.com.br/reciclar

Informations sur le recyclage du matériel au Brésil

Icône	Description
	Este produto eletroeletrônico e seus componentes não devem ser descartados no lixo comum, pois embora estejam em conformidade com padrões mundiais de restrição a substâncias nocivas, podem conter, ainda que em quantidades mínimas, substâncias impactantes ao meio ambiente. Ao final da vida útil deste produto, o usuário deverá entregá-lo à HP. A não observância dessa orientação sujeitará o infrator às sanções previstas em lei. Após o uso, as pilhas e/ou baterias dos produtos HP deverão ser entregues ao estabelecimento comercial ou rede de assistência técnica autorizada pela HP.

Ícone	Description
Não descarte o produto eletrônico em lixo comum	Para maiores informações, inclusive sobre os pontos de recebimento, acesse: http://www.hp.com.br/reciclar

Informations de recyclage de la pile pour Taiwan

Ícone	Description
 廢電池請回收	Taiwan EPA demande aux fabricants ou aux importateurs de piles, conformément à l'Article 15 de la loi relative à la mise au rebut (Waste Disposal Act), d'indiquer les mentions de récupération des piles usagées dans des points de vente, brochures ou publicités. Contactez une entreprise de recyclage qualifiée pour la mise au rebut appropriée de la pile.

Certification ENERGY STAR® (certains produits uniquement)

ENERGY STAR est un programme de l'agence de protection environnementale des États-Unis qui aide les entreprises et les personnes à économiser de l'argent et à protéger le climat par le biais de l'utilisation de produits présentant une efficacité énergétique supérieure. Les produits certifiés ENERGY STAR limitent les émissions de gaz à effet de serre en répondant aux critères d'efficacité énergétique stricts édictés par l'Agence de protection environnementale des États-Unis. En tant que partenaire ENERGY STAR, HP Inc. a suivi le processus avancé de certification des produits de l'EPA pour s'assurer que les produits portant le logo ENERGY STAR respectaient les réglementations ENERGY STAR. Le logo suivant apparaît sur tous les ordinateurs respectant les spécifications ENERGY STAR :



Une exigence clé du programme ENERGY STAR pour les produits informatiques réside dans l'inclusion de fonctions de gestion de l'alimentation permettant de réduire sensiblement la consommation d'énergie lorsque le produit n'est pas utilisé. La gestion de l'alimentation permet à un ordinateur de passer automatiquement dans un mode basse consommation « veille » ou tout autre mode basse consommation, après une période définie d'inactivité. Les fonctions de gestion de l'alimentation ont été prédéfinies comme suit lorsque l'ordinateur fonctionne sur secteur :

Type d'ordinateur	Délai d'activation du mode veille de l'écran	Délai d'activation du mode veille de l'ordinateur (en minutes)	Sortie du mode veille
Notebooks, stations de travail mobiles	<= 15 minutes (selon le modèle)	<= 30 minutes (selon le modèle)	Le produit quitte le mode veille lorsque vous appuyez sur le bouton d'alimentation/veille. Si le Wake on Lan (WOL) est activé, le système peut sortir du mode veille en réponse à un signal réseau.
Tablettes	<= 1 minute	Non applicable	Non applicable
Ordinateurs de bureau, ordinateurs de bureau intégrés, stations de travail	<= 15 minutes (selon le modèle)	<= 30 minutes (selon le modèle)	Le produit quitte le mode veille lorsque l'utilisateur interagit avec un périphérique d'entrée, y compris la souris ou le clavier.

Type d'ordinateur	Délai d'activation du mode veille de l'écran	Délai d'activation du mode veille de l'ordinateur (en minutes)	Sortie du mode veille
			Si le Wake on Lan (WOL) est activé, le système peut sortir du mode veille en réponse à un signal réseau.
Clients légers	<= 15 minutes (selon le modèle)	<= 30 minutes lorsque le mode veille est pris en charge par le système d'exploitation (selon le modèle)	Si le mode veille est pris en charge par le système d'exploitation, le produit quitte le mode veille lorsque l'utilisateur interagit avec un périphérique d'entrée, y compris la souris ou le clavier. Si le Wake on Lan (WOL) est activé, le système peut sortir du mode veille en réponse à un signal réseau.

Pour les ordinateurs prenant en charge un profil d'utilisation « toujours sous tension, toujours connecté » où l'accès à Internet reste actif (par exemple sur les tablettes), des modes d'alimentation basse consommation alternatifs, comme les modes d'inactivité courte ou d'inactivité prolongée (tels que définis dans les exigences du programme ENERGY STAR pour les ordinateurs) sont fournis. Ils consomment très peu d'énergie (<= 10 Watts) et le cas échéant, optimisent l'autonomie du produit. Ces modes alternatifs sont dynamiques. Le mode veille de l'écran est activé après 1 minute d'inactivité de l'utilisateur.

L'ordinateur quitte le mode veille lorsque vous appuyez sur le bouton d'alimentation/veille. Lorsque la fonction Wake On LAN (WOL) est activée, l'ordinateur peut également quitter le mode veille en réponse à un signal réseau.

Plus d'informations sur les économies énergétiques et financières potentielles liées aux fonctions de gestion de l'alimentation sont présentées sur le site Web de gestion de l'alimentation ENERGY STAR de l'EPA à l'adresse <http://www.energystar.gov/powermanagement>.

Plus d'informations sur le programme ENERGY STAR et ses avantages pour l'environnement sont disponibles sur le site Web ENERGY STAR de l'EPA à l'adresse <http://www.energystar.gov>.

ENERGY STAR et le label ENERGY STAR sont des marques déposées détenues par l'Agence de protection environnementale des États-Unis.

Substances chimiques

HP s'engage à fournir à ses clients des informations sur les substances chimiques contenues dans ses produits, conformément aux normes juridiques en vigueur telles que le règlement concernant l'enregistrement, l'évaluation et l'autorisation des substances chimiques, ainsi que les restrictions applicables à ces substances (REACH, règlement CE N° 1907/2006 du Parlement européen et du Conseil). Des informations sur les substances chimiques contenues dans ce produit sont disponibles à l'adresse <http://www.hp.com/go/reach>.

Avis sur le mercure

Cette déclaration s'applique à tous les ordinateurs tout-en-un équipés d'écrans intégrés qui n'utilisent pas le rétroéclairage LED.

Ce produit HP peut contenir les matériaux suivants qui requièrent un traitement spécial à la fin de leur cycle de vie :

- Le mercure contenu dans la lampe fluorescente de l'écran à cristaux liquides (LCD)

Il se peut que l'élimination du mercure soit réglementée en raison de considérations environnementales. Pour obtenir des informations sur l'élimination et le traitement de cette substance, veuillez contacter les autorités locales concernées ou l'Electronic Industries Alliance (EIA) (<http://www.eiae.org>).

Matériau composé de perchlorate : une manipulation particulière peut être nécessaire

La batterie de l'horloge en temps réel est susceptible de contenir du perchlorate et peut nécessiter une manipulation particulière lors de son recyclage ou de sa mise au rebut en Californie. Reportez-vous au site <http://www.dtsc.ca.gov/hazardouswaste/perchlorate/>.

Avis sur l'environnement pour la Chine

回收信息说明

惠普公司对废弃的电子计算机（笔记本电脑）提供回收服务，更多信息请登陆

<http://www8.hp.com/us/en/hp-information/environment/product-recycling.html>

Étiquette de consommation énergétique des ordinateurs pour la Chine

Conformément à la réglementation sur la mise en place d'une étiquette de consommation énergétique des micro-ordinateurs pour la Chine, ce micro-ordinateur est équipé d'une étiquette d'efficacité énergétique. La classe d'efficacité énergétique (consommation énergétique typique) et la catégorie de produit, présentées sur l'étiquette, sont déterminées et calculées selon la norme GB28380-2012.

1. Classes d'efficacité énergétique

La classe est déterminée par la norme en calculant le niveau de consommation de base et en ajoutant la consommation des éléments supplémentaires, tels que la mémoire principale et les cartes graphiques. Quelle que soit la classe, la consommation énergétique typique ne doit pas dépasser la valeur indiquée dans le tableau suivant :

Type de produit		Consommation énergétique typique (kilowatt-heure)		
		Classe 1	Classe 2	Classe 3
Micro-ordinateur de bureau, tout-en-un	Catégorie A	98+ Σ Efa	148+ Σ Efa	198+ Σ Efa
	Catégorie B	125+ Σ Efa	175+ Σ Efa	225+ Σ Efa
	Catégorie C	159+ Σ Efa	209+ Σ Efa	259+ Σ Efa
	Catégorie D	184+ Σ Efa	234+ Σ Efa	284+ Σ Efa
Ordinateur portable	Catégorie A	20+ Σ Efa	35+ Σ Efa	45+ Σ Efa

Type de produit	Consommation énergétique typique (kilowatt-heure)		
	Catégorie B	26+ΣEfa	45+ΣEfa
Catégorie C	54,5+ΣEfa	75,0+ΣEfa	123,5+ΣEfa

REMARQUE : ΣEFA est la somme du facteur de puissance de fonctions supplémentaires du produit.

2. Consommation énergétique typique

Le chiffre de la consommation énergétique indiqué sur l'étiquette correspond aux données mesurées avec la configuration représentative qui couvre toutes les configurations de l'unité d'enregistrement sélectionnée conformément à la « Réglementation sur la mise en place d'une étiquette de consommation énergétique des micro-ordinateurs pour la Chine ». Par conséquent, la consommation énergétique réelle de ce micro-ordinateur spécifique peut ne pas être la même que celle des données de consommation énergétique typique présentées sur l'étiquette.

3. Catégorie de produit

La catégorie de produit est déterminée par la norme selon la configuration du micro-ordinateur. La classification des produits est conforme aux réglementations dans le tableau suivant :

Type de produit	Description de la configuration	
	Micro-ordinateur de bureau, tout-en-un	Ordinateur portable
Catégorie A	Micro-ordinateur de bureau et tout-en-un dont la configuration est en dehors du champ d'application de la catégorie B, C et D	Ordinateur portable dont la configuration est en dehors du champ d'application de la catégorie B et C
Catégorie B	2 cœurs physiques de processeurs et au moins 2 Go de mémoire système	Processeur graphique distinct
Catégorie C	Plus de 2 cœurs physiques de processeurs avec au moins l'une des fonctions suivantes : 1. Au moins 2 Go de mémoire système 2. Processeur graphique distinct	Le produit possède au moins 2 cœurs physiques de processeurs et 2 Go de mémoire système. Processeur graphique distinct avec une largeur de tampon de trame d'au moins 128 bits.
Catégorie D	Au moins 4 cœurs physiques de processeurs avec au moins l'une des fonctions suivantes : 1. Au moins 4 Go de mémoire système 2. Processeur graphique distinct avec une largeur de tampon de trame d'au moins 128 bits	

Pour plus de détails sur la spécification, veuillez vous reporter à la norme GB28380-2012.

本机根据《微型计算机能源效率标识实施规则》的要求加施中国能效标识。能效标识中显示的能效等级、典型能源消耗和产品类型均根据《微型计算机能效限定值及能效等级》(GB28380-2012)的要求确定。对上述标识内容的说明如下：

1. 能效等级

微型计算机的能效等级由基础能源消耗值和附加功能功耗因子之和决定。微型计算机能效各等级的典型能源消耗应不大于下表的规定

微型计算机类型		能源消耗(千瓦时)		
		1	2	3
台式微型计算机及一体机	A类	$98.0+\Sigma E_{fa}$	$148.0+\Sigma E_{fa}$	$198.0+\Sigma E_{fa}$
	B类	$125.0+\Sigma E_{fa}$	$175.0+\Sigma E_{fa}$	$225.0+\Sigma E_{fa}$
	C类	$159.0+\Sigma E_{fa}$	$209.0+\Sigma E_{fa}$	$259.0+\Sigma E_{fa}$
	D类	$184.0+\Sigma E_{fa}$	$234.0+\Sigma E_{fa}$	$284.0+\Sigma E_{fa}$
便携式计算机	A类	$20.0+\Sigma E_{fa}$	$35.0+\Sigma E_{fa}$	$45.0+\Sigma E_{fa}$
	B类	$26.0+\Sigma E_{fa}$	$45.0+\Sigma E_{fa}$	$65.0+\Sigma E_{fa}$
	C类	$54.5+\Sigma E_{fa}$	$75.0+\Sigma E_{fa}$	$123.5+\Sigma E_{fa}$

注： ΣE_{fa} 为微型计算机附加功能功耗因子之和

2. 典型能源消耗

典型能源消耗值代表一个备案单元中，符合《微型计算机能源效率标识实施规则》要求的代表性规格型号产品的数值。因此，本机的典型能源消耗值可能与其所加施的能效标识中所示的典型能源消耗值不一致。

3. 产品类型

产品类型根据微型计算机的配置确定。参见下表：

类型	配置说明	
	台式微型计算机及一体机	便携式计算机
A类	下列B类、C类、D类配置以外的台式微型计算机及一体机	下列B类、C类配置以外的便携式计算机
B类	中央处理器(CPU)物理核心数为2,系统内存大于等于2GB	具有独立图形显示单元(GPU)
C类	中央处理器(CPU)物理核心数大于2,且至少具有以下特征中的一条 a. 系统内存大于等于2GB; b. 独立图形显示单元(GPU)	中央处理器(CPU)物理核心数大于等于2,系统内存大于等于2GB,具有独立图形显示单元(GPU)且显存位宽大于等于128位。
D类	中央处理器(CPU)物理核心数大于等于4,且至少具有以下特征中的一条: a. 系统内存大于等于4GB; b. 具有独立图形显示单元(GPU)且显存位宽大于等于128位	

关于标识内容的更详细技术信息，请参考《微型计算机能效限定值及能效等级》(GB28380-2012)

Restrictions d'utilisation de substances dangereuses (RoHS) pour les ordinateurs portables et les tablettes en Chine

Tableau des substances/composants dangereux et leur contenu

Comme requis par les Méthodes pour la gestion des substances dangereuses à utilisation restreinte dans les produits électriques et électroniques de Chine



Nom de la pièce	Matières dangereuses					
	Plomb (Pb)	Mercure (Hg)	Cadmium (Cd)	Chrome hexavalent (Cr(VI))	Diphényles polybromés (PBB)	Éthers diphényles polybromés (PBDE)
Batterie	X	0	0	0	0	0
Câbles	X	0	0	0	0	0
Caméra	X	0	0	0	0	0
Châssis/Autre	X	0	0	0	0	0
Lecteur de carte mémoire flash	X	0	0	0	0	0
Lecteur de disquette	X	0	0	0	0	0
Disque dur	X	0	0	0	0	0
Casque	X	0	0	0	0	0
I/O PCAs	X	0	0	0	0	0
Clavier	X	0	0	0	0	0
Écran LCD	X	0	0	0	0	0
Support (CD/DVD/disquette)	0	0	0	0	0	0
Mémoire	X	0	0	0	0	0
Carte mère, processeur, dissipateurs thermiques	X	0	0	0	0	0
Souris	X	0	0	0	0	0
Unité de disque optique	X	0	0	0	0	0
Périphérique d'amarrage en option	X	0	0	0	0	0
Adaptateur d'alimentation	X	0	0	0	0	0
Bloc d'alimentation	X	0	0	0	0	0
Source d'alimentation	X	0	0	0	0	0
Télécommande	X	0	0	0	0	0
Lecteur de carte Smart Card/Java™	X	0	0	0	0	0

Nom de la pièce	Matières dangereuses					
	Plomb (Pb)	Mercure (Hg)	Cadmium (Cd)	Chrome hexavalent (Cr(VI))	Diphényles polybromés (PBB)	Éthers diphényles polybromés (PBDE)
Haut-parleurs externes	X	0	0	0	0	0
Tuner TV	X	0	0	0	0	0
Unité mémoire flash USB	X	0	0	0	0	0
Concentrateur USB	X	0	0	0	0	0
Webcam	X	0	0	0	0	0
Récepteur sans fil	X	0	0	0	0	0
Cartes sans fil	X	0	0	0	0	0

Ce formulaire a été préparé conformément aux dispositions de la norme SJ/T 11364.

0 : Indique que la quantité de la substance dangereuse mentionnée respecte les limites définies GB/T 26572 dans tous les matériaux homogènes du composant.

X : Indique que la quantité de la substance dangereuse mentionnée dépasse les limites requises par GB/T 26572 dans au moins un matériau homogène du composant.

Tous les éléments du tableau accompagnés d'un « X » sont conformes à la norme RoHS de l'Union européenne.

REMARQUE : La durée d'utilisation écologique en année, en référence, a été déterminée sur la base de conditions normales d'utilisation du produit, telles que la température et l'humidité.

笔记本电脑和平板电脑产品中有害物质或元素的名称及含量

根据中国《电器电子产品有害物质限制使用管理办法》



部件名称	有害物质					
	铅 (Pb)	汞 (Hg)	镉 (Cd)	六价铬 (Cr(VI))	多溴联苯 (PBB)	多溴二苯醚 (PBDE)
电池	X	0	0	0	0	0
线缆	X	0	0	0	0	0
摄像头	X	0	0	0	0	0
机箱/其他	X	0	0	0	0	0
闪存读卡器	X	0	0	0	0	0
软盘驱动器	X	0	0	0	0	0
硬盘驱动器	X	0	0	0	0	0
耳机	X	0	0	0	0	0
I/O PCA	X	0	0	0	0	0
键盘	X	0	0	0	0	0
液晶显示器 (LCD) 面板	X	0	0	0	0	0

部件名称	有害物质					
	铅 (Pb)	汞 (Hg)	镉 (Cd)	六价铬 (Cr(VI))	多溴联苯 (PBB)	多溴二苯醚 (PBDE)
介质 (CD/DVD/软盘)	0	0	0	0	0	0
内存	X	0	0	0	0	0
主板、处理器和散热器	X	0	0	0	0	0
鼠标	X	0	0	0	0	0
光盘驱动器	X	0	0	0	0	0
对接设备选件	X	0	0	0	0	0
电源适配器	X	0	0	0	0	0
电源	X	0	0	0	0	0
电源组	X	0	0	0	0	0
投影仪	X	0	0	0	0	0
遥控器	X	0	0	0	0	0
智能卡/Java™ 卡读卡器	X	0	0	0	0	0
扬声器(外置)	X	0	0	0	0	0
电视调谐器	X	0	0	0	0	0
USB 闪存驱动器	X	0	0	0	0	0
USB 集线器	X	0	0	0	0	0
网络摄像头	X	0	0	0	0	0
无线接收器	X	0	0	0	0	0
无线网卡	X	0	0	0	0	0

本表格依据 SJ/T 11364 的规定编制。

0：表示该有害物质在该部件所有均质材料中的含量均在 GB/T 26572 规定的限量要求以下。

X：表示该有害物质至少在该部件的某一均质材料中的含量超出 GB/T 26572 规定的限量要求。

注：环保使用期限的参考标识取决于产品正常工作的温度和湿度等条件

Restrictions d'utilisation de substances dangereuses pour la Chine (ROHS) pour les ordinateurs de bureau, clients légers, stations de travail personnelles, tout-en-un et les terminaux de point de vente

Tableau des substances/composants dangereux et leur contenu

Comme requis par les Méthodes pour la gestion des substances dangereuses à utilisation restreinte dans les produits électriques et électroniques de Chine



Nom de la pièce	Matières dangereuses					
	Plomb (Pb)	Mercure (Hg)	Cadmium (Cd)	Chrome hexavalent (Cr(VI))	Diphényles polybromés (PBB)	Éthers diphényles polybromés (PBDE)
Batterie	X	0	0	0	0	0
Câbles	X	0	0	0	0	0
Caméra	X	0	0	0	0	0
Châssis/Autre	X	0	0	0	0	0
Ventilateur	X	0	0	0	0	0
Lecteur de carte mémoire flash	X	0	0	0	0	0
Lecteur de disquette	X	0	0	0	0	0
Disque dur	X	0	0	0	0	0
Casque	X	0	0	0	0	0
Dissipateur thermique	X	0	0	0	0	0
I/O PCAs	X	0	0	0	0	0
Clavier	X	0	0	0	0	0
Écran LCD	X	0	0	0	0	0
Support (CD/DVD/ disquette)	0	0	0	0	0	0
Mémoire	X	0	0	0	0	0
Carte mère, processeur, dissipateurs thermiques	X	0	0	0	0	0
Souris	X	0	0	0	0	0
Unité de disque optique	X	0	0	0	0	0
Périphérique d'amarrage en option	X	0	0	0	0	0
Adaptateur d'alimentation	X	0	0	0	0	0
Source d'alimentation	X	0	0	0	0	0
Projecteur	X	0	0	0	0	0
Télécommande	X	0	0	0	0	0
Lecteur de carte Smart Card/Java™	X	0	0	0	0	0
Disques SSD	X	0	0	0	0	0
Haut-parleurs externes	X	0	0	0	0	0
Styler	X	0	0	0	0	0
Tapis tactile	X	0	0	0	0	0

Nom de la pièce	Matières dangereuses					
	Plomb (Pb)	Mercure (Hg)	Cadmium (Cd)	Chrome hexavalent (Cr(VI))	Diphényles polybromés (PBB)	Éthers diphényles polybromés (PBDE)
Tuner TV	X	0	0	0	0	0
Unité mémoire flash USB	X	0	0	0	0	0
Concentrateur USB	X	0	0	0	0	0
Webcam	X	0	0	0	0	0
Récepteur sans fil	X	0	0	0	0	0
Cartes sans fil	X	0	0	0	0	0
Plateau de capture 3D/ plaque tournante	X	0	0	0	0	0

Ce formulaire a été préparé conformément aux dispositions de SJ/T 11364.

0 : Indique que la quantité de la substance dangereuse mentionnée respecte les limites requises par GB/T 26572 dans tous les matériaux homogènes du composant.

X : Indique que la quantité de la substance dangereuse mentionnée dépasse les limites requises par GB/T 26572 dans au moins un matériau homogène du composant.

Tous les éléments du tableau accompagnés d'un « X » sont conformes à la norme RoHS de l'Union européenne.

REMARQUE : La durée d'utilisation écologique en année, en référence, a été déterminée sur la base de conditions normales d'utilisation du produit, telles que la température et l'humidité.

台式机、瘦客户端、个人工作站、一体机和销售点终端产品中有害物质或元素的名称及含量 (ROHS)

根据中国《电器电子产品有害物质限制使用管理办法》



部件名称	有害物质					
	铅 (Pb)	汞 (Hg)	镉 (Cd)	六价铬 (Cr(VI))	多溴联苯 (PBB)	多溴二苯醚 (PBDE)
电池	X	0	0	0	0	0
线缆	X	0	0	0	0	0
摄像头	X	0	0	0	0	0
机箱/其他	X	0	0	0	0	0
风扇	X	0	0	0	0	0
闪存读卡器	X	0	0	0	0	0
软盘驱动器	X	0	0	0	0	0
硬盘驱动器	X	0	0	0	0	0
耳机	X	0	0	0	0	0

部件名称	有害物质					
	铅 (Pb)	汞 (Hg)	镉 (Cd)	六价铬 (Cr(VI))	多溴联苯 (PBB)	多溴二苯醚 (PBDE)
散热器	X	0	0	0	0	0
I/O PCA	X	0	0	0	0	0
键盘	X	0	0	0	0	0
液晶显示器 (LCD) 面板	X	0	0	0	0	0
介质 (CD/DVD/软盘)	0	0	0	0	0	0
内存	X	0	0	0	0	0
主板、处理器和散热器	X	0	0	0	0	0
鼠标	X	0	0	0	0	0
光驱	X	0	0	0	0	0
对接设备选件	X	0	0	0	0	0
电源适配器	X	0	0	0	0	0
电源	X	0	0	0	0	0
投影仪	X	0	0	0	0	0
遥控器	X	0	0	0	0	0
智能卡/Java™ 卡读卡器	X	0	0	0	0	0
固态驱动器	X	0	0	0	0	0
扬声器(外置)	X	0	0	0	0	0
触控笔	X	0	0	0	0	0
触控板	X	0	0	0	0	0
电视调谐器	X	0	0	0	0	0
USB 闪存驱动器	X	0	0	0	0	0
USB 集线器	X	0	0	0	0	0
网络摄像头	X	0	0	0	0	0
无线接收器	X	0	0	0	0	0
无线网卡	X	0	0	0	0	0
3D 捕获台/转盘	X	0	0	0	0	0

本表格依据 SJ/T 11364 的规定编制。

0：表示该有害物质在该部件所有均质材料中的含量均在 GB/T 26572 规定的限量要求以下。

X：表示该有害物质至少在该部件的某一均质材料中的含量超出 GB/T 26572 规定的限量要求。

注：环保使用期限的参考标识取决于产品正常工作的温度和湿度等条件

台灣針對筆記型電腦和平板電腦的有害物質限制使用管理辦法 (RoHS)

限用物質含有情況標示聲明書

Declaration of the Presence Condition of the Restricted Substances Marking

限用物質及其化學符號						
Restricted substances and its chemical symbols						
單元 Unit	鉛 Lead (Pb)	汞 Mercury (Hg)	鎘 Cadmium (Cd)	六價鉻 Hexavalent chromium (Cr ⁺⁶)	多溴聯苯 Polybrominated biphenyls (PBB)	多溴二苯醚 Polybrominated diphenyl ethers (PBDE)
纜線 Cables	—	O	O	O	O	O
機殼/其他 Chassis/Other	—	O	O	O	O	O
輸入/輸出印刷 電路組件 I/O PCAs	—	O	O	O	O	O
液晶顯示器 (LCD) 面板 Liquid crystal display (LCD) panel	—	O	O	O	O	O
記憶體 Memory	O	O	O	O	O	O
主機板、處理 器、散熱器 Motherboard, processor, heat sinks	—	O	O	O	O	O
電源組 Power pack	—	O	O	O	O	O
電源供應器 Power supply	—	O	O	O	O	O
儲存裝置 Storage Devices	—	O	O	O	O	O
無線裝置 Wireless Devices	—	O	O	O	O	O

備考 1：「超出 0.1 %」及「超出 0.01 %」係指限用物質之百分比含量超出百分比含量基準值。
Note 1: "Exceeding 0.1 wt %" and "exceeding 0.01 wt %" indicate that the percentage content of the restricted substance exceeds the reference percentage value of presence condition.

備考 2：「O」係指該項限用物質之百分比含量未超出百分比含量基準值。
Note 2: "O" indicates that the percentage content of the restricted substance does not exceed the percentage of reference value of presence.

備考 3：「—」係指該項限用物質為排除項目。
Note 3: The "—" indicates that the restricted substance corresponds to the exemption.

若要取得最新版使用指南，請前往 <http://www.hp.com/support>，並依照指示尋找您的產品。然後選取「使用指南」。

To access the latest user guides, go to <http://www.hp.com/support>, and follow the instructions to find your product. Then select **User Guides**.

台灣針對桌上型電腦、精簡型電腦、個人工作站、一體成形電腦及銷售點終端機的有害物質限制使用管理辦法 (RoHS)

限用物質含有情況標示聲明書

Declaration of the Presence Condition of the Restricted Substances Marking

限用物質及其化學符號						
Restricted substances and its chemical symbols						
單元 Unit	鉛 Lead (Pb)	汞 Mercury (Hg)	鎘 Cadmium (Cd)	六價鉻 Hexavalent chromium (Cr ⁺⁶)	多溴聯苯 Polybrominated biphenyls (PBB)	多溴二苯醚 Polybrominated diphenyl ethers (PBDE)
纜線 Cables	—	○	○	○	○	○
機座/其他 Chassis/Other	—	○	○	○	○	○
輸入/輸出印刷電路組件 I/O PCAs	—	○	○	○	○	○
液晶顯示器 (LCD) 面板 (僅限於 AIO) Liquid crystal display (LCD) panel (for AIO only)	—	○	○	○	○	○
記憶體 Memory	○	○	○	○	○	○
主機板、處理器、散熱器 Motherboard, processor, heat sinks	—	○	○	○	○	○
電源供應器 Power supply	—	○	○	○	○	○
儲存裝置 Storage Devices	—	○	○	○	○	○

備考 1：「超出 0.1 %」及「超出 0.01 %」係指限用物質之百分比含量超出百分比含量基準值。
 Note 1: "Exceeding 0.1 wt %" and "exceeding 0.01 wt %" indicate that the percentage content of the restricted substance exceeds the reference percentage value of presence condition.

備考 2：「○」係指該項限用物質之百分比含量未超出百分比含量基準值。
 Note 2: "○" indicates that the percentage content of the restricted substance does not exceed the percentage of reference value of presence.

備考 3：「—」係指該項限用物質為排除項目。
 Note 3: The "—" indicates that the restricted substance corresponds to the exemption.

若要取得最新版使用指南，請前往 <http://www.hp.com/support>，並依照指示尋找您的產品。然後選取「使用指南」。

To access the latest user guides, go to <http://www.hp.com/support>, and follow the instructions to find your product. Then select **User Guides**.

Avis sur la restriction des substances dangereuses pour l'Inde (RoHS)

Ce produit, ainsi que ses consommables et pièces, est conforme aux dispositions de la loi « India E-waste Rule 2016 » relatives à la réduction des substances dangereuses. Il ne contient pas de concentrations de plomb, de mercure, de chrome hexavalent, de diphényles polybromés ou de polybromodiphényléthers dépassant 0,1 % du poids et 0,01 % du poids pour le cadmium, excepté dans les cas où les exemptions établies à l'annexe 2 de cette loi le permettent.

Informations sur le règlement 1275/2008 de la Commission européenne

Pour localiser les données sur la consommation électrique des produits, y compris lorsque le produit est en mode veille en réseau et que tous les ports réseau câblés et les appareils sans fil sont connectés, reportez-vous à la section P14 « Informations supplémentaires » des déclarations IT ECO à l'adresse <http://www.hp.com/hpinfo/globalcitizenship/environment/productdata/itecodesktop-pc.html>.

Le cas échéant, activez et désactivez le réseau sans fil en suivant les instructions incluses dans le manuel de l'utilisateur du produit ou du système d'exploitation. Des informations sont également disponibles à l'adresse <http://www.hp.com/support>.

Déclarations IT ECO

Ordinateur portable ou tablette

<http://www.hp.com/hpinfo/globalcitizenship/environment/productdata/iteconotebook-o.html>

Ordinateurs de bureau et clients légers

http://www.hp.com/hpinfo/globalcitizenship/environment/productdata/itecodesktop-pc.html?jumpid=reg_R1002_USEN

Stations de travail

<http://www.hp.com/hpinfo/globalcitizenship/environment/productdata/itecoworkstatio.html>

Avis sur la restriction des substances dangereuses pour le Japon (RoHS)

2008 年、日本における製品含有表示方法、JISC0950 が公示されました。製造事業者は、2006 年 7 月 1 日以降に販売される電気・電子機器の特定化学物質の含有に付きまして情報提供を義務付けられました。製品の部材表示に付きましては、

<http://www.hp.com/go/jisc0950>

を参照してください

A Japanese regulatory requirement, defined by specification JIS C 0950, 2008, mandates that manufacturers provide Material Content Declarations for certain categories of electronic products offered for sale after July 1, 2006.

To view the JIS C 0950 material declaration for this product, visit <http://www.hp.com/go/jisc0950>.

Ley para el Aprovechamiento Sustentable de la Energía de México

Ley para el Aprovechamiento Sustentable de la Energía de México

Se ha etiquetado este producto en conformidad con la Ley para el Aprovechamiento Sustentable de la Energía de México, que requiere la divulgación del consumo de energía del modo de uso normal (modo inactivo) y del modo de espera. Su producto es una de las muchas configuraciones de esta familia de modelos; el consumo de energía del modo inactivo de su configuración específica puede diferir de la información de la etiqueta. El consumo real de energía de su producto puede ser mayor o menor que el valor informado en la etiqueta de energía de producto para México a causa de factores como la configuración (componentes y módulos seleccionados) y el uso (tareas que se están efectuando, software instalado y en ejecución, etc.).



REMARQUE : Esta ley no es aplicable a las estaciones de trabajo.

Réglementation WEEE de la Turquie

Türkiye Cumhuriyeti: AEEE Yönetmeliğine Uygundur

Certifié TCO

Cette section s'applique uniquement aux produits portant le logo TCO Certified.

A third-party certification according to ISO 14024



Toward sustainable IT products

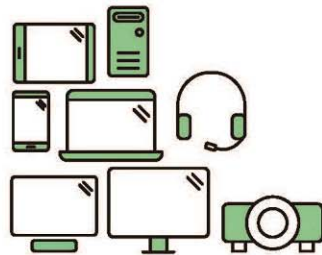

Say hello to a more sustainable product

IT products are associated with a wide range of sustainability risks throughout their life cycle. Human rights violations are common in the factories. Harmful substances are used both in products and their manufacture. Products can often have a short lifespan because of poor ergonomics, low quality and when they are not able to be repaired or upgraded.

This product is a better choice. It meets all the criteria in TCO Certified, the world's most comprehensive sustainability certification for IT products. Thank you for making a responsible product choice, that help drive progress towards a more sustainable future!

Criteria in TCO Certified have a life-cycle perspective and balance environmental and social responsibility. Conformity is verified by independent and approved verifiers that specialize in IT products, social responsibility or other sustainability issues. Verification is done both before and after the certificate is issued, covering the entire validity period. The process also includes ensuring that corrective actions are implemented in all cases of factory non-conformities. And last but not least, to make sure that the certification and independent verification is accurate, both TCO Certified and the verifiers are reviewed regularly.

Want to know more?

Read information about TCO Certified, full criteria documents, news and updates at [tcocertified.com](https://www.tcocertified.com). On the website you'll also find our Product Finder, which presents a complete, searchable listing of certified products.

TCO Certified Edge

Cette section s'applique uniquement aux produits portant le logo TCO Certified Edge.

A third-party certification according to ISO 14024



Toward sustainable IT products

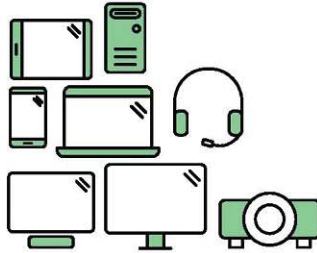

Say hello to a more sustainable product

IT products are associated with a wide range of sustainability risks throughout their life cycle. Human rights violations occur in the supply chain. Harmful substances are used both in products and their manufacture. Products can often have a short lifespan because of poor ergonomics, low quality and when they are not able to be repaired or upgraded.

This product is a better choice. It meets all the criteria in TCO Certified, the world's most comprehensive sustainability certification for IT products. Additionally, it fulfills the requirements of TCO Certified Edge, the supplemental certification that recognizes leading-edge products that exceed typical performance in a particular sustainability attribute. At our Product Finder (tcocertified.com/product-finder) you can find out which TCO Certified Edge criterion or criteria this product meets.

Criteria in TCO Certified have a life-cycle perspective and balance environmental and social responsibility. Compliance is verified by independent verification organizations that specialize in IT products, social responsibility or other sustainability issues. Verification is done both before and after the certificate is issued, covering the entire validity period. The process also includes ensuring that corrective actions are implemented in all cases of factory non-conformities.

Thank you for making a responsible product choice, that help drive progress towards a more sustainable future!

Want to know more?

Read information about TCO Certified, full criteria documents, news and updates at tcocertified.com. On the website you'll also find our Product Finder, which presents a complete, searchable listing of certified products.

Index

Symboles/Nombres

台灣對於危險物質的限制注意事項 38, 39
注意事項
台灣有害物質限制 38, 39

A

avis

Avis sur les périphériques sans fil pour la Thaïlande 8
batterie 9, 10, 18, 26
Brésil 3, 20
Canada 3
cordon d'alimentation pour le Japon 22
Cordons d'alimentation 22
Corée du Sud 8
déplacements 23
Environnement 26
ergonomie 5, 6
Japon 7
Macrovision Corporation 15
matériau composé de perchlorate 29
Mexique 7
mise au rebut des équipements 26
modem 11
niveau du volume du casque et des écouteurs 19
Réglementation pour la Biélorussie 3
restriction d'utilisation de substances dangereuses pour l'Inde 40
restriction d'utilisation de substances dangereuses pour la Chine 32, 34
restriction d'utilisation de substances dangereuses pour le Japon 40
sécurité des lasers 10, 19
Singapour 8
Taïwan 9

utilisation en vol 9
ventilateur 19
avis, ordinateurs portables
FCC (Federal Communications Commission) 2
avis, restriction d'utilisation de substances dangereuses pour la Chine 32, 34
avis, restriction d'utilisation de substances dangereuses pour le Japon 40
avis de certification GS 5, 6
avis de mise à la terre de câble 25
Avis de réglementation pour la Biélorussie 3
avis de restriction d'utilisation de substances dangereuses pour l'Inde 40
avis pour la Corée du Sud 8
avis pour le Brésil 3, 20
avis pour le Canada 3
avis pour le Japon 7
avis pour Macrovision Corporation 15
avis pour Taïwan 9
avis relatif aux appareils sans fil pour le Mexique 7
avis sur l'altitude 24
Avis sur l'environnement 26
Avis sur l'environnement pour la Chine 29
avis sur l'ergonomie 5, 6
avis sur la mise au rebut
batterie 26
batterie, remplacement par l'utilisateur 9
batterie scellée en usine 10
équipement 26
avis sur la mise au rebut des équipements 26
avis sur la sécurité des lasers 10, 19
avis sur le cordon d'alimentation 22
avis sur le niveau du volume, casque et écouteurs 19

avis sur le niveau du volume du casque et des écouteurs 19
avis sur les appareils sans fil pour Singapour 8
avis sur les cordons d'alimentation pour le Japon 22
Avis sur les cordons d'alimentation pour le Japon 22
avis sur les déplacements 23
avis sur les modems 11
Canada 14
Japon 14
Nouvelle-Zélande 15
Système américain 11, 13
avis sur les modems pour le Canada 14
avis sur les modems pour le Japon 14
avis sur les modems pour les États-Unis 11, 13
Avis sur les périphériques sans fil pour la Thaïlande 8
avis sur les utilisations en vol 9
avis sur le ventilateur 19
avis sur une utilisation dans des conditions tropicales 24

B

bandes de fréquences radio 5
batterie 18
batterie, avis 9, 10, 26

C

Carte TV, avis de mise à la terre de câble 25
Certification ENERGY STAR 27
certification TCO Certified 42
certification TCO Certified Edge 43

D

déclaration sur les modems pour la Nouvelle-Zélande 15

E

étiquette de consommation
énergétique des ordinateurs pour la
Chine 29
étiquettes, conformité 1

F

FCC (Federal Communications
Commission)
avis sur les ordinateurs
portables 2
câbles pour ordinateurs
portables 2
modifications apportées aux
ordinateurs portables 2

M

matériel électronique et de la
batterie, recyclage 26

N

niveaux de puissance maximale 5

O

ordinateurs portables, modifications
FCC (Federal Communications
Commission) 2

P

périphériques LAN sans fil 3
prise en charge vocale 15

R

recyclage de la batterie 26
recyclage du matériel électronique et
de la batterie 26
Règlement 1275/2008 de la
Commission européenne 40



Regulatory, Safety, and Environmental Notices

User Guide

© Copyright 2018, 2019 HP Development Company, L.P.

Bluetooth is a trademark owned by its proprietor and used by HP Inc. under license. ENERGY STAR and the ENERGY STAR mark are registered U.S. marks. Java is a registered trademark of Oracle and/or its affiliates.

The information contained herein is subject to change without notice. The only warranties for HP products and services are set forth in the express warranty statements accompanying such products and services. Nothing herein should be construed as constituting an additional warranty. HP shall not be liable for technical or editorial errors or omissions contained herein.

Fourth Edition: April 2019

First Edition: March 2018

Document Part Number: L25269-004

About This Guide

This guide provides regulatory, safety, and environmental information that is compliant with U.S., Canadian, and international regulations for notebook computers, tablets, desktops, thin clients, personal workstations, all-in-ones, and point-of-sale terminals.

To access the latest user guides, go to <http://www.hp.com/support>, and follow the instructions to find your product. Then select **User Guides**.





-
-  **WARNING!** Indicates a hazardous situation that, if not avoided, **could** result in serious injury or death.
 -  **CAUTION:** Indicates a hazardous situation that, if not avoided, **could** result in minor or moderate injury.
 -  **IMPORTANT:** Indicates information considered important but not hazard-related (for example, messages related to property damage). Warns the user that failure to follow a procedure exactly as described could result in loss of data or in damage to hardware or software. Also contains essential information to explain a concept or to complete a task.
 -  **NOTE:** Contains additional information to emphasize or supplement important points of the main text.
 -  **TIP:** Provides helpful hints for completing a task.
-

Table of contents

1 Regulatory notices	1
Accessing regulatory labels	1
Federal Communications Commission notice	1
Modifications	2
Cables	2
Products with wireless LAN devices or HP Mobile Broadband Modules	2
Belarus regulatory notice	3
Brazil notice	3
Canada notices	3
European Union regulatory notices	3
Declaration of Conformity	3
Products with radio functionality (EMF)	4
Restrictions for products with radio functionality (select products only)	4
Radio frequency bands and maximum power levels (select products and countries only)	4
Ergonomics notice	5
European telephone network declaration (Modem/Fax)	5
Australia and New Zealand notice	5
China WWAN notice	5
China radio equipment notice	5
Japan notice	6
Wireless LAN, Wireless WAN, and Bluetooth® certification markings	6
Mexico notice	6
Singapore wireless notice	7
South Korea notices	7
Thailand wireless notice	7
Taiwan NCC notices	8
Wireless LAN 802.11a devices	8
Wireless LAN 802.11 devices/Bluetooth devices/Short range devices	8
Airline travel notice	8
User-replaceable battery notices	8
Factory-sealed battery notices	9
Laser compliance	9
Telecommunications device approvals	9
Modem notices	10
U.S. modem statements	10

U.S. modem declarations	11
Canada modem statements	12
Japan modem statements	12
New Zealand modem statements	12
Voice support	13
Macrovision Corporation notice	13
2 Safety notices	14
Important safety information	14
Heat-related safety warning notice	15
Potential safety conditions notice	15
Installation conditions	15
Acoustics notice	15
Battery notices	15
Fan notices	16
Headset and earphone volume level notice	16
Laser safety	16
Power supply and power cord set requirements	17
Power supply class I grounding requirements	17
Brazil notice	17
Denmark	17
Finland	17
Norway	17
Sweden	17
Power supply requirements	17
For use in Norway	17
Power cord set requirements	18
Power cord notice	18
DC plug of external HP power supply	18
Japan power cord notice	19
Japan power cord requirements	19
Pinch hazard	19
TV antenna connectors protection	19
External television antenna grounding	19
Lightning protection	19
Note to CATV system installer	20
Travel notice	20
China safety notices	21
China: Altitude notice	21
China: Tropical warning notice	21
Norway and Sweden: Cable grounding notice for products with a TV tuner	22

使用過度恐傷害視力	22
3 Environmental notices	23
Electronic hardware, packaging and battery recycling	23
Disposal of waste equipment by users	23
Brazil alkaline battery disposal	23
Brazil hardware recycling information	23
Taiwan battery recycling information	24
ENERGY STAR® Certification (select products only)	24
Chemical substances	25
Mercury statement	25
Perchlorate material—special handling may apply	25
China environmental notices	26
China PC energy label	26
China restriction of hazardous substances (RoHS) for notebook and tablet computers	29
The Table of Hazardous Substances/Elements and their Content	29
笔记本电脑和平板电脑产品中有害物质或元素的名称及含量	30
China restriction of hazard substances (ROHS) for desktops, thin clients, personal workstations, all-in-ones, and point-of-sale terminals	31
The Table of Hazardous Substances/Elements and their Content	31
台式机、瘦客户端、个人工作站、一体机和销售点终端产品中有害物质或元素的名称及含量 (ROHS)	33
台灣針對筆記型電腦和平板電腦的有害物質限制使用管理辦法 (RoHS)	35
限用物質含有情況標示聲明書	35
台灣針對桌上型電腦、精簡型電腦、個人工作站、一體成形電腦及銷售點終端機的有害物質限制使用管理辦法 (RoHS)	36
限用物質含有情況標示聲明書	36
India restriction of hazardous substances (RoHS)	37
Information for European Union Commission Regulation 1275/2008	37
IT ECO declarations	37
Japan restriction of hazardous substances (RoHS)	37
Ley para el Aprovechamiento Sustentable de la Energía de México	38
Turkey WEEE regulation	38
TCO Certified	39
TCO Certified Edge	40
Index	41

1 Regulatory notices

This chapter provides country- and region-specific non-wireless and wireless regulatory notices and compliance information for the computer product. Some of these notices may not apply to your product.

One or more integrated wireless devices may be installed. In some environments, the use of wireless devices may be restricted. Such restrictions may apply aboard airplanes, in hospitals, near explosives, in hazardous locations, and so on. If you are uncertain of the policy that applies to the use of this product, ask for authorization to use it before you turn it on.

Accessing regulatory labels

Regulatory labels, which provide country or regional regulatory information (for example, FCC ID), may be physically located on the bottom of the computer, inside the battery bay (select products only), under the removable service door (select products only), on the back of the display, or on the wireless or modem module.

Some products may also provide electronic regulatory labels (e-labels) that can be accessed through the system BIOS.

 **NOTE:** Electronic labels are not available on all products.

 **NOTE:** Devices not for sale or use in the United States may not contain a FCC ID.

To view electronic regulatory labels:

1. Turn on or restart the computer.
2. Press **esc** or **f10** to enter Computer Setup.
3. Use a pointing device or the arrow keys to select **Advanced**, select **Electronic Labels**, and then press **enter**.
4. To view an electronic label, use a pointing device or the arrow keys to select one of the listed items, and then press **OK**.

 **NOTE:** The list of available electronic label items varies depending on the computer model and installed devices.

5. To exit Computer Setup menus without making any changes:

Select the **Exit** icon in the lower-right corner of the screen, and then follow the on-screen instructions.

– or –

Use the arrow keys to select **Main**, select **Ignore Changes and Exit**, and then press **enter**.

Federal Communications Commission notice

This equipment has been tested and found to comply with the limits for a Class B digital device, pursuant to Part 15 of the FCC Rules. These limits are designed to provide reasonable protection against harmful interference in a residential installation. This equipment generates, uses, and can radiate radio frequency energy and, if not installed and used in accordance with the instructions, may cause harmful interference to radio communications. However, there is no guarantee that interference will not occur in a particular installation.

If this equipment does cause harmful interference to radio or television reception, which can be determined by turning the equipment off and on, the user is encouraged to try to correct the interference by one or more of the following measures:

- Reorient or relocate the receiving antenna.
- Increase the separation between the equipment and receiver.
- Connect the equipment to an outlet on a circuit different from that to which the receiver is connected.
- Consult the dealer or an experienced radio or television technician for help.

This device complies with Part 15 of the FCC Rules. Operation is subject to the following two conditions:

1. This device may not cause harmful interference, and
2. This device must accept any interference received, including interference that may cause undesired operation.

For questions regarding this product:

- Write to:
HP Inc.
1501 Page Mill Road
Palo Alto, CA 94304
- Call HP at 650-857-1501
– or –
- Email techregshelp@hp.com

To identify this product, refer to the part, series, or model number found on the product.

Modifications

The FCC requires the user to be notified that any changes or modifications made to this device that are not expressly approved by HP may void the user's authority to operate the equipment.

Cables

To maintain compliance with FCC Rules and Regulations, connections to this device must be made with shielded cables having metallic RFI/EMI connector hoods.

Products with wireless LAN devices or HP Mobile Broadband Modules

This device must not be co-located or operating in conjunction with any other antenna or transmitter.

 **WARNING! Exposure to Radio Frequency Radiation** The radiated output power of this device is below the FCC radio frequency exposure limits. Nevertheless, the device should be used in a manner that is in conformance with the expected typical usage.

Belarus regulatory notice

The product complies with the Belarus National Radio/Telecom Technical Regulation TR 2018/024/BY.



Brazil notice

Este equipamento opera em caráter secundário, isto é, não tem direito a proteção contra interferência prejudicial, mesmo de estações do mesmo tipo, e não pode causar interferência a sistemas operando em caráter primário.

Este equipamento atende aos limites de Taxa de Absorção Específica referente à exposição a campos elétricos, magnéticos e eletromagnéticos de radiofrequências adotados pela ANATEL.

Ao operar o dispositivo a uma distância muito próxima do seu corpo, utilize um acessório de armazenamento não metálico para posicionar o dispositivo a uma distância mínima de 1,5 cm do corpo.

 **IMPORTANT:** A alimentação de energia é predefinida para 220/230Vv. Se você possuir tomada elétrica de 110/115Vv, por favor, altere a chave na parte traseira do seu computador para a tensão correta.

Canada notices

This Class B digital apparatus meets all requirements of the Canadian Interference-Causing Equipment Regulations, CAN ICES-3(B)/NMB-3(B). If this device has WLAN or Bluetooth capability, the device complies with Industry Canada licence-exempt RSS standard(s). Operation is subject to the following two conditions: (1) this device may not cause interference, and (2) this device must accept any interference, including interference that may cause undesired operation of the device.

 **WARNING! Exposure to Radio Frequency Radiation:** The radiated output power of this device is below the Industry Canada radio frequency exposure limits. Nevertheless, the device should be used in a manner that is in conformance with the expected typical usage.

 **IMPORTANT:** When using IEEE 802.11a, n, or ac wireless LAN, this product is restricted to indoor use, due to its operation in the 5.15- to 5.25-GHz frequency range. Industry Canada requires this product to be used indoors for the frequency range of 5.15 GHz to 5.25 GHz to reduce the potential for harmful interference to co-channel mobile satellite systems. High-power radar is allocated as the primary user of the 5.25- to 5.35-GHz and 5.65- to 5.85-GHz bands. These radar stations can cause interference with and/or damage to this device.

The antennas for this device are not replaceable. Any attempt at user access will damage your computer.

European Union regulatory notices

Declaration of Conformity

Products bearing the CE marking have been constructed so that they can operate in at least one EU Member State and comply with one or more of the following EU Directives as may be applicable:

RED 2014/53/EU; Low Voltage Directive 2014/35/EU; EMC Directive 2014/30/EU; Ecodesign Directive 2009/125/EC; RoHS Directive 2011/65/EU.

Compliance with these directives is assessed using applicable European Harmonised Standards.

The full Declaration of Conformity can be found at the following website: <http://www.hp.eu/certificates> (Search with the product model name or its Regulatory Model Number (RMN), which may be found on the regulatory label.)

The point of contact for regulatory matters is HP Deutschland GmbH, HQ-TRE, 71025, Boeblingen, Germany. Email techregshelp@hp.com

Products with radio functionality (EMF)

This product incorporates a radio transmitting and receiving device. For notebook computers in normal use, a separation distance of 20 cm ensures that radio frequency exposure levels comply with EU requirements. Products designed to be operated at closer proximities, such as tablet computers, comply with applicable EU requirements in typical operating positions. Products can be operated without maintaining a separation distance unless otherwise indicated in instructions specific to the product.

Restrictions for products with radio functionality (select products only)



IMPORTANT: IEEE 802.11x wireless LAN with 5.15–5.35 GHz frequency band is restricted for indoor use only in all countries reflected in the matrix. Using this WLAN application outdoors might lead to interference issues with existing radio services.

IMPORTANT: Fixed outdoor installations for WiGig application (57–66 GHz frequency band) are excluded in all countries reflected in the matrix.

Radio frequency bands and maximum power levels (select products and countries only)

Radio Technology	Maximum Transmit Power EIRP (mW)
Bluetooth; 2,4 GHz	100
NFC; 13,56 MHz	10
RFID; 125 kHz/13,56 MHz	Less than 1
WLAN Wi-Fi 802.11x; 2,4 GHz	100
WLAN Wi-Fi 802.11x; 5 GHz	200
WWAN 4G LTE; 700/800/900/1800/2100/2300/2600/3500 MHz	200
WWAN 3G UTMS; 900/2100 MHz	250
WWAN 2G GSM GPRS EDGE; 900 MHz	2000
WWAN 2G GSM GPRS EDGE; 1800 MHz	1000
WiGig 802.11ad; 60 GHz	316
NOTE: Use only HP-supported software drivers and correct country settings to ensure compliance.	

Ergonomics notice

When a mobile computer is used at the office workstation for display work tasks where the Visual Display Unit (VDU) Directive 90/270/EEC is applicable, an adequate external keyboard is required. Depending on the application and task, an adequate external monitor may also be necessary to attain working conditions comparable to a workstation setup.

Ref: EK1-ITB 2000 (voluntary GS certification)

Mobile computers bearing the "GS" approval mark meet the applicable ergonomic requirements. Without external keyboards, they are suitable only for short-time use for VDU tasks.

During mobile use with disadvantageous illumination conditions (e.g. direct sunlight) reflections may occur, which result in reduced readability.

A computer system comprising HP brand products meets the applicable ergonomic requirements if all affected constituent products bear the "GS" approval mark, for example Business Desktop PC, keyboard, PC-mouse and monitor.

European telephone network declaration (Modem/Fax)

The product herewith complies with the requirements of the applicable Directive and carries the CE marking accordingly. However, due to differences between the individual PSTNs provided in different countries/regions, the approval does not, of itself, give an unconditional assurance of successful operation on every PSTN network termination point. In the event of problems, you should contact your equipment supplier in the first instance.

Australia and New Zealand notice

This equipment incorporates a radio transmitting and receiving device. In normal use, a separation distance of 20 cm ensures that radio frequency exposure levels comply with the Australian and New Zealand Standards.

The computer must be connected to the Telecommunication Network through a line cord that meets the requirements of AS/CA S008.

⚠ WARNING! Modems without integral RJ11 connector that are shipped with this computer should not be installed in any other device.

China WWAN notice

重要信息：本公司建议用户通过官方渠道进行系统更新，非官方渠道的更新可能会带来安全风险。

China radio equipment notice

型号核准代码显示在产品本体的铭牌上

Japan notice

V-2 規定適合の場合

この装置は、クラスB情報技術装置です。この装置は、家庭環境で使用することを目的としていますが、この装置がラジオやテレビジョン受信機に近接して使用されると、受信障害を引き起こすことがあります。

取扱説明書に従って正しい取り扱いをして下さい。 VCCI-B

VCCI32-1 規定適合の場合

この装置は、クラスB機器です。この装置は、住宅環境で使用することを目的としていますが、この装置がラジオやテレビジョン受信機に近接して使用されると、受信障害を引き起こすことがあります。

取扱説明書に従って正しい取り扱いをして下さい。 VCCI - B

5GHz 帯を使用する特定無線設備は屋内使用に限られています。この機器を屋外で使用することは電波法で禁じられています。

Wireless LAN, Wireless WAN, and Bluetooth® certification markings

この機器は、技術基準適合証明または工事設計認証を受けた無線設備を搭載しています

This product contains certified radio equipment.



Some products may use electronic regulatory labels (e-labels). To view the certification mark and numbers on an e-label, please refer to the previous “Accessing regulatory labels” section.

一部の製品では、電子規定ラベル（eラベル）が使用されています。eラベルの技適マークと認証番号を確認するには、「規定ラベルの確認」の項目をご覧ください

Mexico notice

Declaración para México

La operación de este equipo está sujeta a las siguientes dos condiciones: (1) es posible que este equipo o dispositivo no cause interferencia perjudicial y (2) este equipo o dispositivo debe aceptar cualquier interferencia, incluyendo la que pueda causar su operación no deseada. The regulatory model number for this product is on the regulatory label.

If your product is provided with wireless accessories such as a keyboard or mouse and you need to identify the model of the accessory, refer to the label included on that accessory. The regulatory model number for this product is on the regulatory label.

Singapore wireless notice

Turn off any WWAN devices while you are aboard aircraft. The use of these devices aboard aircraft is illegal, may be dangerous to the operation of the aircraft, and may disrupt the cellular network. Failure to observe this instruction may lead to suspension or denial of cellular services to the offender, or legal action, or both.

Users are reminded to restrict the use of radio equipment in fuel depots, chemical plants, and where blasting operations are in progress.

As with other mobile radio transmitting equipment, users are advised that for satisfactory operation of the equipment and for the safety of personnel, no part of the human body should be allowed to come too close to the antennas during operation of the equipment.

This device has been designed to comply with applicable requirements for exposure to radio waves, based on scientific guidelines that include margins intended to assure the safety of all people, regardless of health and age. These radio wave exposure guidelines employ a unit of measurement known as the specific absorption rate (SAR). Tests for SAR are conducted using standardized methods, with the phone transmitting at its highest certified power level in all used frequency bands. The SAR data information is based on CENELEC's standards EN50360 and EN50361, which use the limit of 2 watts per kilogram, averaged over 10 grams of tissue.

South Korea notices

무선적용제품

해당 무선설비가 전파혼신 가능성이 있으므로 인명안전과 관련된 서비스는 할 수 없음 (무선모듈 제품이 설치되어 있는 경우).

몸 가까이에서 장치를 작동할 경우, 비금속 저장 액세스리틀을 사용하여 장치와 몸 사이에 2.5cm 이상의 거리를 유지하십시오.

Thailand wireless notice

เครื่องโทรคมนาคมและอุปกรณ์นี้ มีความสอดคล้องตามมาตรฐานหรือข้อกำหนดของ กสทช.

(This telecommunication equipment conforms to the requirements of NBTC.)

เครื่องวิทยุคมนาคมนี้มีระดับการแผ่คลื่นแม่เหล็กไฟฟ้าสอดคล้องตามมาตรฐานความปลอดภัยต่อสุขภาพของมนุษย์จากการใช้เครื่องวิทยุคมนาคมที่คณะกรรมการกิจการโทรคมนาคมแห่งชาติประกาศกำหนด

This radio communication equipment has the electromagnetic field strength in compliance with the Safety Standard for the Use of Radio communication Equipment on Human Health announced by the National Telecommunications Commission.

Taiwan NCC notices

Wireless LAN 802.11a devices

在 5.25G~5.35G 頻帶內操作之無線資訊傳輸設備僅適於室內使用

應避免影響附近雷達系統之操作。

Wireless LAN 802.11 devices/Bluetooth devices/Short range devices

低功率電波輻射性電機管理辦法

第十二條 經型式認證合格之低功率射頻電機，非經許可，公司、商號或使用者均不得擅自變更頻率、加大功率或變更原設計之特性及功能。

第十四條 低功率射頻電機之使用不得影響飛航安全及干擾合法通信；經發現有干擾現象時，應立即停用，並改善至無干擾時方得繼續使用。

前項合法通信，指依電信法規定作業之無線電通信。低功率射頻電機須忍受合法通信或工業、科學及醫療用電波輻射性電機設備之干擾。

Airline travel notice

Use of electronic equipment aboard commercial aircraft is at the discretion of the airline.

User-replaceable battery notices

When a battery has reached the end of its useful life, do not dispose of the battery in general household waste. Follow the local laws and regulations in your area for computer battery disposal.

HP encourages customers to recycle used electronic hardware, HP original print cartridges, and rechargeable batteries. For more information about recycling programs, refer to the HP website at <http://www.hp.com/recycle>.

For information about removing a user-replaceable battery, refer to the user guide included with the product.

Factory-sealed battery notices

The battery[ies] in this product cannot be easily replaced by users themselves. Removing or replacing the battery could affect your warranty coverage. If a battery is no longer holding a charge, contact support.

When a battery has reached the end of its useful life, do not dispose of the battery in general household waste. Follow the local laws and regulations in your area for battery disposal.

Laser compliance

⚠ WARNING! Use of controls or adjustments, or performance of procedures other than those specified in the laser product installation guide, may result in hazardous radiation exposure. To reduce the risk of exposure to hazardous radiation:

- Do not try to open the module enclosure. There are no user-serviceable components inside.
- Do not operate controls, make adjustments, or perform procedures to the laser device other than those specified in the laser product installation guide.
- Allow only authorized service providers to repair the unit.

This product may be provided with an optical storage device (for example, a CD or DVD drive) and/or a fiber optic transceiver. Each of these devices that contain a laser is classified as a Class 1 Laser Product in accordance with IEC/EN 60825-1 and meets the requirements for safety of that standard.

Each laser product complies with US FDA regulations of 21 CFR 1040.10 and 1040.11 or complies with those regulations except for deviations pursuant to Laser Notice No. 50 dated June 24, 2007.



Telecommunications device approvals

The telecommunications device in the computer is approved for connection to the telephone network in the countries and regions whose approval markings are indicated on the product label located on the bottom of the computer or on the modem.

Refer to the user guide included with the product to ensure that the product is configured for the country or region in which the product is located. Selecting a country or region other than the one in which it is located may cause the modem to be configured in a way that violates the telecommunication regulations/laws of that country or region. In addition, the modem may not function properly if the correct country or region selection is not made. If, when you select a country or region, a message appears that states that the country or region is not supported, this means that the modem has not been approved for use in this country or region and thus should not be used.

Modem notices

U.S. modem statements

This equipment complies with Part 68 of the FCC Rules and the requirements adopted by the ACTA. On the bottom of the computer or on the modem is a label that contains, among other information, a product identifier in the format US:AAAEQ##TXXXX. Provide this information to the telephone company if you are requested to do so.

Applicable certification jack USOC = RJ11C. A plug and jack used to connect this equipment to the premises wiring and telephone network must comply with the applicable FCC Part 68 rules and requirements adopted by the ACTA. A compliant telephone cord and modular plug is provided with this product. It is designed to be connected to a compatible modular jack that is also compliant. See installation instructions for details.

The REN is used to determine the number of devices that may be connected to a telephone line. Excessive RENs on a telephone line may result in the devices not ringing in response to an incoming call. In most but not all locations, the sum of RENs should not exceed five (5.0). To be certain of the number of devices that may be connected to a line, as determined by the total RENs, contact the local telephone company. For products approved after July 23, 2001, the REN for this product is part of the product identifier that has the format US:AAAEQ##TXXXX. The digits represented by ## are the REN without a decimal point (e.g., 03 is a REN of 0.3). For earlier products, the REN is separately shown on the label.

If this HP equipment causes harm to the telephone network, the telephone company will notify you in advance that temporary discontinuance of service may be required. But, if advance notice isn't practical, the telephone company will notify you as soon as possible. Also, you will be advised of your right to file a complaint with the FCC if you believe it is necessary.

The telephone company may make changes to its facilities, equipment, operations, or procedures that could affect the operation of the equipment. If this happens, the telephone company will provide advance notice in order for you to make necessary modifications to maintain uninterrupted telephone service.

If trouble is experienced with this equipment, call technical support. If the equipment is causing harm to the telephone network, the telephone company may request that you disconnect the equipment until the problem is resolved. You should perform repairs only to the equipment specifically discussed in the "Troubleshooting" section of the user guide, if one is provided.

Connection to party line service is subject to state tariffs. Contact the state public utility commission, public service commission, or corporation commission for information.

If your home has specially wired alarm equipment connected to the telephone line, ensure that the installation of this HP equipment does not disable your alarm equipment. If you have questions about what will disable alarm equipment, consult your telephone company or a qualified installer.

The Telephone Consumer Protection Act of 1991 makes it unlawful for any person to use a computer or other electronic device, including a fax machine, to send any message unless such message clearly contains in a margin at the top or bottom of each transmitted page, or on the first page of the transmission, the date and time it is sent and an identification of the business, other entity, or other individual sending the message, and the telephone number of the sending machine or such business, other entity, or individual. (The telephone number provided may not be a 900 number or any other number for which charges exceed local or long-distance transmission charges).

In order to program this information into your fax machine, you should complete the steps outlined in the faxing software instructions.

U.S. modem declarations

Refer to the following modem vendor declarations for the modem device installed in your computer:



Brad Grande
Technical Manager

1110 American Parkway NE
Lehigh Valley Central Campus
Allentown, PA 18109
Phone: 610-712-7853
bgrande@agere.com

Supplier's Declaration of Conformity

Reference Number: Delphi D40 (revision AM5)
Place of Issue: Allentown, PA, USA
Date of Issue: 30th November 2006

Agere Systems Inc. at 1110 American Parkway NE, Lehigh Valley Central Campus, Allentown, PA 18109 in the United States of America, hereby certifies that the Modem, bearing labelling identification number US: AGSMD01BDELPHI complies with the Federal Communications Commission's ("FCC") Rules and Regulations 47 CFR Part 68, and the Administrative Council on Terminal Attachments ("ACTA")-adopted technical criteria TIA/EIA/IS-968, 968-A, 968-A-1, 968-A-2 and 968-A-3 Telecommunications – Telephone Terminal Equipment – Technical Requirements for Connection of Terminal Equipment To the Telephone Network.

A handwritten signature in black ink that reads "Brad Grande".

Brad Grand
Technical Manager

Canada modem statements

This equipment meets the applicable Industry Canada technical specifications.

The Ringer Equivalence Number, REN, is an indication of the maximum number of devices allowed to be connected to a telephone interface. The termination on an interface may consist of any combination of devices, subject only to the requirement that the sum of the RENs of all devices does not exceed 5. The REN for this terminal equipment is 1.0.

Japan modem statements

If the computer does not have the Japanese certification mark on the bottom of the computer, refer to the appropriate certification marking below.

The Japanese certification mark for the V.92 56K Data/Fax Modem is below:



If the computer does not have the Japanese certification mark on the bottom of the computer, refer to the appropriate certification marking below.

The Japanese certification mark for the LSI Corporation PCI-SV92EX Soft modem is below:



New Zealand modem statements

The grant of a Telepermit for any item of terminal equipment indicates only that Telecom has accepted that the item complies with minimum conditions for connection to its network. It indicates no endorsement of the product by Telecom, nor does it provide any sort of warranty. Above all, it provides no assurance that any item will work correctly in all respects with another item of Telepermitted equipment of a different make or model, nor does it imply that any product is compatible with all of Telecom's network services.

This equipment is not capable, under all operating conditions, of correct operation at the higher speeds for which it is designed. Telecom will accept no responsibility should difficulties arise in such circumstances.

If this device is equipped with pulse dialing, note that there is no guarantee that Telecom lines will always continue to support pulse dialing.

Use of pulse dialing, when this equipment is connected to the same line as other equipment, may give rise to bell tinkle or noise and may also cause a false answer condition. Should such problems occur, the user should *not* contact the Telecom Faults Service.

Some parameters required for compliance with Telecom's Telepermit requirements are dependent on the equipment (PC) associated with this device. The associated equipment shall be set to operate within the following limits for compliance with Telecom's Specifications:

- a. There shall be no more than 10 call attempts to the same number within any 30-minute period for any single manual call initiation.
- b. The equipment shall go on-hook for a period of not less than 30 seconds between the end of one attempt and the beginning of the next attempt.
- c. Where automatic calls are made to different numbers, the equipment shall be set to go on-hook for a period of not less than 5 seconds between the end of one attempt and the beginning of the next attempt.
- d. The equipment shall be set to ensure that calls are answered between 3 and 30 seconds of receipt of ringing (So set between 2 and 10).

Voice support

All persons using this device for recording telephone conversations shall comply with New Zealand law. This requires that at least one party to the conversation is aware that it is being recorded. In addition, the Principles enumerated in the Privacy Act 1993 shall be complied with in respect to the nature of the personal information collected, the purpose for its collection, how it is to be used, and what is disclosed to any other party.

This equipment shall not be set to make automatic calls to the Telecom '111' Emergency Service.

Macrovision Corporation notice

This product incorporates copyright protection technology that is protected by method claims of certain U.S. patents and other intellectual property rights owned by Macrovision Corporation and other rights owners. Use of this copyright protection technology must be authorized by Macrovision Corporation and is intended for home and other limited viewing uses only, unless otherwise authorized by Macrovision Corporation. Reverse engineering or disassembly is prohibited.

2 Safety notices

Important safety information

 **WARNING!** To reduce the risk of serious injury, read the *Safety & Comfort Guide*. It describes proper workstation setup, posture, and health and work habits for computer users, and provides important electrical and mechanical safety information. This guide is located on the Web at <http://www.hp.com/ergo> and on the Documentation CD that is included with the product.

The computer may be heavy; be sure to use ergonomically correct lifting procedures when moving it.

Install the computer near an AC outlet. The AC power cord is your computer's main AC disconnecting device and must be easily accessible at all times. If the power cord provided with your computer has a grounded plug, always use the power cord with a properly grounded AC outlet to avoid the risk of electric shock.

To reduce the possibility of an electric shock from the telephone network, plug your computer into the AC outlet before connecting it to the telephone line. Also, disconnect the telephone line before unplugging your computer from the AC power outlet.

Always disconnect the modem cord from the telephone system before installing or removing your computer cover.

Do not operate the computer with the cover removed.

For your safety, always unplug the computer from its power source and from any telecommunications systems (such as telephone lines), networks, or modems before performing any service procedures. Failure to do so may result in personal injury or equipment damage. Hazardous voltage levels are inside the power supply and modem of this product.

As a safety precaution, if the system power load exceeds the specific configuration's capacities, the system may temporarily disable some USB ports.

 **WARNING!** To reduce the risk of fire, electric shock, and injury to persons when using this device, always follow basic safety precautions, including the following:

- Do not use this product near water—for example, near a bathtub, wash bowl, kitchen sink or laundry tub, in a wet basement, or near a swimming pool.
- Avoid using this product during an electrical storm. There is a remote risk of electric shock from lightning.
- Do not use this product to report a gas leak while in the vicinity of the leak.
- Always disconnect the modem cable before opening the equipment enclosure or touching an uninsulated modem cable, jack, or internal component.
- If this product was not provided with a telephone line cord, use only No. 26 AWG or larger telecommunication line cord.
- Do not plug a modem or telephone cable into the RJ-45 (network) jack.

SAVE THESE INSTRUCTIONS.

 **IMPORTANT:** If your computer is provided with a voltage select switch for use in a 115 or 230 V power system, the voltage select switch has been pre-set to the correct voltage setting for use in the particular country/region where it was initially sold. Changing the voltage select switch to the incorrect position can damage your computer and void any implied warranty.

This product has not been evaluated for connection to an “IT” power system (an AC distribution system with no direct connection to earth, according to applicable safety standards).

Heat-related safety warning notice

⚠ WARNING! To reduce the possibility of heat-related injuries or of overheating the mobile computer, do not place the mobile computer directly on your lap or obstruct the computer air vents. Use the mobile computer only on a hard, flat surface. Do not allow another hard surface, such as an adjoining optional printer, or a soft surface, such as pillows or rugs or clothing, to block airflow. Also, do not allow the AC adapter to contact the skin or a soft surface, such as pillows or rugs or clothing, during operation. The mobile computer and the AC adapter comply with the user-accessible surface temperature limits defined by applicable safety standards.

Potential safety conditions notice

If you notice any of the following conditions (or if you have other safety concerns), do not use the computer: crackling, hissing, or popping sound, or a strong odor or smoke coming from the computer. It is normal for these conditions to appear when an internal electronic component fails in a safe and controlled manner. However, these conditions may also indicate a potential safety issue. Do not assume it is a safe failure. Turn off the computer, disconnect it from its power source, and contact technical support for assistance.

Installation conditions

See installation instructions before connecting this equipment to the input supply.

⚠ WARNING! Energized and moving parts may be inside the computer. Disconnect power to the equipment before removing the enclosure. Replace and secure the enclosure before re-energizing the equipment.

Acoustics notice

Sound pressure level (LpA) is far below 70dB(A) (operator position, normal operation, according to ISO 7779). To display product noise emission data, go to “IT ECO Declarations” at <http://www.hp.com/go/ted>, and then select a product category from the drop-down menu.

Battery notices

⚠ WARNING! The product may contain an internal lithium manganese dioxide, vanadium pentoxide, or alkaline battery or battery pack. There is risk of fire and burns if the battery pack is not handled properly.

⚠ WARNING! Do not attempt to recharge the battery.

⚠ WARNING! Do not expose to temperatures higher than 60° C (140° F).

⚠ WARNING! To reduce potential safety issues, only the battery provided with the computer, a replacement battery provided by HP, or a compatible battery purchased as an accessory from HP should be used with the computer. Fast charging may not be available for non-compatible or non-HP batteries.

⚠ WARNING! To reduce the risk of fire or burns, do not disassemble, crush, puncture, short external contacts, or dispose of in fire or water.

⚠ WARNING! Risk of explosion if battery is replaced by an incorrect type. Dispose of used batteries according to the instructions.

⚠ WARNING! Replace only with the HP spare designated for this product.

- ⚠ **WARNING!** Do not ingest battery, a Chemical Burn Hazard.
- ⚠ **WARNING!** This product contains a coin/button cell battery. If the coin/button cell battery is swallowed, it can cause severe internal burns in just 2 hours and can lead to death.
- ⚠ **WARNING!** Keep new and used batteries away from children.
- ⚠ **WARNING!** If the battery compartment does not close securely, stop using the product and keep it away from children.
- ⚠ **WARNING!** If you think batteries might have been swallowed or placed inside any part of the body, seek immediate medical attention.
- ⚠ **WARNING!** Leaving a battery in an extremely high temperature surrounding environment can result in an explosion or the leakage of flammable liquid or gas.
- ⚠ **WARNING!** A battery subjected to extremely low air pressure may result in an explosion or the leakage of flammable liquid or gas.

Icon	Description
	Batteries, battery packs, and accumulators should not be disposed of together with the general household waste. In order to forward them to recycling or proper disposal, please use the public collection system or return them to HP, an authorized HP partner, or their agents.

Fan notices

- ⚠ **WARNING!**  Keep body parts away from moving parts.
- ⚠ **WARNING!** Keep body parts away from fan blades.
- ⚠ **WARNING!** Keep body parts out of the motion path.

Headset and earphone volume level notice

- ⚠ **WARNING!**  To prevent possible hearing damage, do not listen at high volume levels for long periods.

Adjustment of the volume control as well as the equalizer to other settings than the center position may increase the ear-/headphones output voltage and therefore the sound pressure level. The use of factors influencing the ear-/headphones output other than those specified by the manufacturer (e.g. operating system, equalizer software, firmware, driver) may increase the ear-/headphones output voltage and therefore the sound pressure level.

Laser safety

For products equipped with optical drives or fiber optic transceivers.

This product may be provided with an optical storage device (i.e., CD or DVD drive) and/or fiber optic transceiver. These contain lasers and are classified as Class 1 Laser Products in accordance with the standard IEC/EN 60825-1 and comply with its requirements.

Each laser product complies with US FDA Regulations of 21 CFR 1040.10 and 1040.11 or complies with those regulations except for deviations pursuant to Laser Notice No. 50, dated June 24, 2007.

⚠ WARNING! Use of controls or adjustments or performance of procedures other than those specified herein or in the laser product's installation guide may result in hazardous radiation exposure. To reduce the risk of exposure to hazardous radiation:

- Do not try to open the module enclosure. There are no user-serviceable components inside.
 - Do not operate controls, make adjustments, or perform procedures to the laser device other than those specified herein.
 - Allow only HP Authorized Service technicians to repair the unit.
-

Power supply and power cord set requirements

Power supply class I grounding requirements

For protection from fault currents, the equipment shall be connected to a grounding terminal. Plug the system power cord into an AC outlet that provides a ground connection. Substitute cords may not provide adequate fault protection. Only use the power cord supplied with this product or an HP Inc. authorized replacement.

Brazil notice

Este equipamento deve ser conectado obrigatoriamente em tomada de rede de energia elétrica que possua aterramento (três pinos), conforme a norma nbr abnt 5410, visando a segurança dos usuários contra choques elétricos.

Denmark

Apparatets stikprop skal tilsluttes en stikkontakt med jord, som giver forbindelse til stikproppens jord.

Finland

Laite on liitettävä suojakoskettimilla varustettuun pistorasiaan.

Norway

Apparatet må tilkoples jordet stikkontakt.

Sweden

Apparaten skall anslutas till jordat uttag.

Power supply requirements

The power supplies on some products have external power switches. The voltage select switch feature on the product permits it to operate from any line voltage between 100-127 or 200-240 volts AC. Power supplies on those products that do not have external power switches are equipped with internal circuits that sense the incoming voltage and automatically switch to the proper voltage.

⚠ WARNING! To reduce potential safety issues, only the AC adapter provided with the computer, a replacement AC adapter provided by HP, or an AC adapter purchased as an accessory from HP should be used with the computer.

For use in Norway

This product is also designed for an IT power system with phase-to-phase voltage 230V.

Power cord set requirements

⚠ WARNING! To reduce the risk of electric shock or damage to the equipment:

- Plug the power cord into an AC outlet that is easily accessible at all times.
- Disconnect power from the computer by unplugging the power cord from the AC outlet.
- If provided with a 3-pin attachment plug on the power cord, plug the cord into a grounded (earthed) 3-pin outlet. Do not disable the power cord grounding pin, for example, by attaching a 2-pin adapter. The grounding pin is an important safety feature.

The power cord set received with the product meets the requirements for use in the country where the equipment was originally purchased. Use only the power cord provided with the unit or an authorized replacement power cord from HP Inc. or an approved HP Inc. source. Replacement part numbers may be found at <http://www.hp.com/support>.

Power cord sets for use in other countries must meet the requirements of the country where you use the product. For more information on power cord set requirements, contact your authorized HP dealer, reseller, or service provider.

⚠ WARNING! Do not use power cords from other products.

Mismatched power cords may result in a shock and fire hazard.

The requirements listed below are applicable to all countries:

1. The power cord must be approved by an acceptable accredited agency responsible for evaluation in the country where the power cord set will be installed.
2. The length of the power cord must be between 1.8 m (6 feet) and 3.6 m (12 feet). For a power cord 2.0 m (6.56 feet) or less, the diameter of the wire must be a minimum of 0.75 mm² or 18AWG. If the power cord is longer than 2.0 m (6.56 feet), the diameter of the wire must be a minimum of 1.0 mm² or 16AWG.

The power cord should be routed so that it is not likely to be walked on or pinched by items placed upon it or against it. Particular attention should be paid to the plug, electrical outlet, and the point where the cord exits from the product.

⚠ WARNING! Do not operate this product with a damaged power cord set. If the power cord set is damaged in any manner, replace it immediately. Damaged cords may result in user exposure to hazards.

Power cord notice

If you were not provided with a power cord for the computer or for an external power accessory intended for use with the computer, you should purchase a power cord that is approved for use in your country or region.

The power cord must be rated for the product and for the voltage and current marked on the product's electrical ratings label. The voltage and current rating of the cord should be greater than the voltage and current rating marked on the product. In addition, the diameter of the wire must be a minimum of **0.75 mm²**/18AWG, and the length of the cord must be between **1.0 m** (3.2 ft) and **2 m** (6.56 ft). If you have questions about the type of power cord to use, contact your authorized service provider.

A power cord should be routed so that it is not likely to be walked on or pinched by items placed upon it or against it. Particular attention should be paid to the plug, electrical outlet, and the point where the cord exits from the product.

DC plug of external HP power supply



Japan power cord notice

製品には、同梱された電源コードをお使い下さい。
同梱された電源コードは、他の製品では使用出来ません。

Japan power cord requirements

For use in Japan, use only the power cord received with this product.

⚠ CAUTION: Do not use the power cord received with this product on any other products.

Pinch hazard

⚠ WARNING! Observe pinch hazard areas. Keep fingers away from closing parts.

TV antenna connectors protection

External television antenna grounding

If an outside antenna or cable system is connected to the product, be sure the antenna or cable system is electrically grounded so as to provide some protection against voltage surges and built-up static charges. Article 810 of the National Electrical Code, ANSI/NFPA 70, provides information with regard to proper electrical grounding of the mast and supporting structure, grounding of the lead-in wire to an antenna-discharge unit, size of grounding conductors, location of antenna-discharge unit, connection to grounding electrodes, and requirements for the grounding electrode.

Lightning protection

For added protection of any product during a lightning storm, or when it is left unattended and unused for long periods of time, unplug the product from the wall outlet and disconnect the antenna or cable system. This will prevent damage to the product from lightning and power line surges.

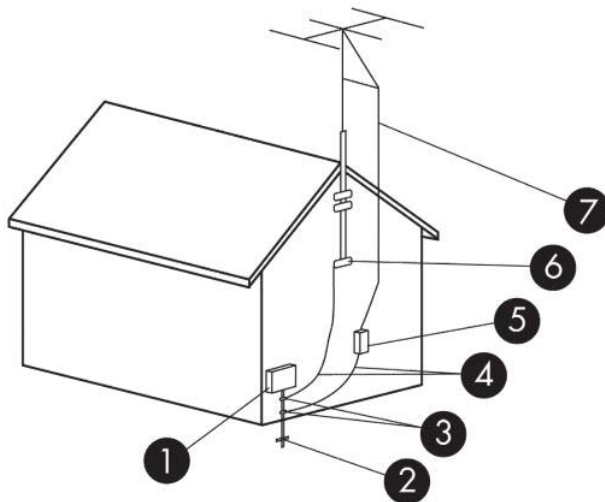

Table 2-1 Antenna Grounding

Reference	Grounding Component
1	Electric Service Equipment

Table 2-1 Antenna Grounding (continued)

Reference	Grounding Component
2	Power Service Grounding Electrode System (NEC Art 250, Part III)
3	Ground Clamps
4	Grounding Conductors (NEC Section 810.21)
5	Antenna Discharge Unit (NEC Section 810.20)
6	Ground Clamp
7	Antenna Lead-in Wire

Note to CATV system installer

This reminder is provided to call the CATV systems installer's attention to section 820.93 of the National Electric Code, which provides guidelines for proper grounding and in particular, specify that the Coaxial cable shield shall be connected to grounding system of the building, as close to the point of cable entry as practical.

Travel notice

 **WARNING!** To reduce the risk of electric shock, fire, or damage to the equipment, do not attempt to power the computer with a voltage converter kit sold for appliances.

China safety notices

HP 工作站使用安全手册

使用须知

欢迎使用惠普工作站，为了您及仪器的安全，请您务必注意如下事项：

1. 仪器要和地线相接，要使用有正确接地插头的电源线，使用中国国家规定的 220V 电源。
2. 避免高温和尘土多的地方，否则易引起仪器内部部件的损坏。
3. 避免接近高温，避免接近直接热源，如直射太阳光、暖气等其它发热体。
4. 不要有异物或液体落入机内，以免部件短路。
5. 不要将磁体放置于仪器附近。

警告

为防止火灾或触电事故，请不要将该机放置于淋雨或潮湿处

如果您按照以上步骤操作时遇到了困难，或想了解其它产品性能，请在以下网页上寻找相关信息：<http://www.hp.com.cn>

或联系我们

中国惠普有限公司
地址：北京朝阳区建国路 112 号中国惠普大厦
电话：010-65643888

China: Altitude notice

海拔警告仅适用于在海拔 2000m 以下地区使用的产品

Icon	Description
	海拔警告仅适用于在海拔 2000m 以下地区使用的产品。

China: Tropical warning notice

热带警告仅适用于在非热带气候条件下使用的产品。

Icon	Description
	热带警告仅适用于在非热带气候条件下使用的产品。

Norway and Sweden: Cable grounding notice for products with a TV tuner

 **CAUTION:** To reduce potential safety issues, use a galvanic isolator when connecting to a cable distribution system.

使用過度恐傷害視力

注意事項:

- (1) 使用 30 分鐘請休息 10 分鐘。
- (2) 未滿 2 歲幼兒不看螢幕，2 歲以上每天看螢幕不要超過 1 小時。

3 Environmental notices

This chapter provides country- and region-specific environmental notices and compliance information. Some of these notices may not apply to your product.

Electronic hardware, packaging and battery recycling

HP encourages customers to recycle used electronic hardware, HP original print cartridges packaging, and rechargeable batteries. For more information about recycling programs, go to <http://www.hp.com/recycle>.

For information about recycling the product in Japan, refer to <http://www.hp.com/jp/hardwarerecycle/>.

Disposal of waste equipment by users

Icon	Description
	This symbol means do not dispose of your product with your other household waste. Instead, you should protect human health and the environment by handing over your waste equipment to a designated collection point for the recycling of waste electrical and electronic equipment. For more information, please contact your household waste disposal service or go to http://www.hp.com/recycle .

Brazil alkaline battery disposal

Icon	Description
	Este produto eletroeletrônico e seus componentes não devem ser descartados no lixo comum, pois embora estejam em conformidade com padrões mundiais de restrição a substâncias nocivas, podem conter, ainda que em quantidades mínimas, substâncias impactantes ao meio ambiente. Ao final da vida útil deste produto, o usuário deverá entregá-lo à HP. A não observância dessa orientação sujeitará o infrator às sanções previstas em lei. Após o uso, as pilhas e/ou baterias dos produtos HP deverão ser entregues ao estabelecimento comercial ou rede de assistência técnica autorizada pela HP.
Não descarte o produto eletrônico em lixo comum	Para maiores informações, inclusive sobre os pontos de recebimento, acesse: http://www.hp.com.br/reciclar

Brazil hardware recycling information

Icon	Description
	Este produto eletroeletrônico e seus componentes não devem ser descartados no lixo comum, pois embora estejam em conformidade com padrões mundiais de restrição a substâncias nocivas, podem conter, ainda que em quantidades mínimas, substâncias impactantes ao meio ambiente. Ao final da vida útil deste produto, o usuário deverá entregá-lo à HP. A não observância dessa orientação sujeitará o infrator às sanções previstas em lei. Após o uso, as pilhas e/ou baterias dos produtos HP deverão ser entregues ao estabelecimento comercial ou rede de assistência técnica autorizada pela HP.
Não descarte o produto eletrônico em lixo comum	Para maiores informações, inclusive sobre os pontos de recebimento, acesse: http://www.hp.com.br/reciclar

Taiwan battery recycling information

Icon	Description
 廢電池請回收	<p>The Taiwan EPA requires dry battery manufacturing or importing firms, in accordance with Article 15 of the Waste Disposal Act, to indicate the recovery marks on the batteries used in sales, giveaways, or promotions. Contact a qualified Taiwanese recycler for proper battery disposal.</p>

ENERGY STAR® Certification (select products only)

ENERGY STAR is a U.S. Environmental Protection Agency voluntary program that helps businesses and individuals save money and protect our climate through superior energy efficiency. Products that earn the ENERGY STAR prevent greenhouse gas emissions by meeting strict energy efficiency criteria or requirements set by the U.S. Environmental Protection Agency. As an ENERGY STAR Partner, HP Inc. has followed the U.S. EPA’s enhanced product certification process to ensure that products marked with the ENERGY STAR logo are ENERGY STAR certified per the applicable ENERGY STAR guidelines. The following logo appears on all ENERGY STAR-certified computers:



A key ENERGY STAR requirement for computer products is power management features that significantly reduce energy consumption when the product is not in use. Power management allows a computer to automatically enter a low power “sleep” mode, or other low power mode, after a defined period of inactivity. The power management features have been preset as follows when the computer is operating on AC power:

Computer type	Time to activate display sleep mode	Time to activate computer sleep mode (minutes)	Resuming from sleep mode
Notebooks, Mobile Workstations	Less than or equal to 15 minutes (varies by model)	Less than or equal to 30 minutes (varies by model)	<p>Product will exit sleep mode when the power/sleep button is pressed.</p> <p>If Wake-on-Lan (WOL) is enabled, the system can resume from sleep in response to a network signal.</p>
Tablets/Slates	Less than or equal to 1 minute	Not applicable	Not applicable
Desktops, Integrated Desktops, Workstations	Less than or equal to 15 minutes (varies by model)	Less than or equal to 30 minutes (varies by model)	<p>Product will exit sleep mode when user interacts with any input device, including the mouse or keyboard.</p> <p>If Wake-on-Lan (WOL) is enabled, the system can resume from sleep in response to a network signal.</p>
Thin clients	Less than or equal to 15 minutes (varies by model)	Less than or equal to 30 minutes when sleep mode is supported by the operating system (varies by model)	When sleep mode is supported by operating system product will exit sleep mode when user interacts with any input device, including the mouse or keyboard.

Computer type	Time to activate display sleep mode	Time to activate computer sleep mode (minutes)	Resuming from sleep mode
			If Wake-on-Lan (WOL) is enabled, the system can resume from sleep in response to a network signal.

For computers that support an always-on, always-connected use profile where internet access is available (such as tablets and slates), alternative low power modes - such as Short or Long Idle modes (as defined in the ENERGY STAR Computer Program Requirements) are provided that consume very little power (<= 10 Watts) and when applicable, maximize product battery life. These alternative low power modes are dynamic, with the display sleep mode activated within 1 minute of user inactivity.

The computer exits Sleep when the power/Sleep button is pressed. When the Wake On LAN (WOL) feature is enabled, the computer can also exit Sleep in response to a network signal.

Additional information on the potential energy and financial savings of the power management feature can be found on the EPA ENERGY STAR Power Management website at <http://www.energystar.gov/powermanagement>.

Additional information on the ENERGY STAR program and its environmental benefits are available on the EPA ENERGY STAR website at <http://www.energystar.gov>.

ENERGY STAR and the ENERGY STAR mark are registered trademarks owned by the U.S. Environmental Protection Agency.

Chemical substances

HP is committed to providing our customers with information about the chemical substances in our products as needed to comply with legal requirements such as REACH (Regulation EC No. 1907/2006 of the European Parliament and the Council). A chemical information report for this product can be found at <http://www.hp.com/go/reach>.

Mercury statement

This statement applies to all-in-one computers with built-in display panels that do not use LED backlighting.

This HP product may contain the following material that might require special handling at end-of-life:

- Mercury in the fluorescent lamp in the display LCD

Disposal of mercury can be regulated because of environmental considerations. For disposal or recycling information, please contact your local authorities or the Electronic Industries Alliance (EIA) (<http://www.eiae.org>).

Perchlorate material—special handling may apply

The computer's real-time clock battery may contain perchlorate and may require special handling when recycled or disposed of in California. See <http://www.dtsc.ca.gov/hazardouswaste/perchlorate/>.

China environmental notices

回收信息说明

惠普公司对废弃的电子计算机（笔记本电脑）提供回收服务，更多信息请登陆

<http://www8.hp.com/us/en/hp-information/environment/product-recycling.html>

China PC energy label

In accordance with “The Regulation of the Implementation on China Energy Label for Microcomputers”, this microcomputer has an Energy Efficiency Label. The energy efficiency grade, TEC (Typical Energy Consumption), and product category presented on the label are determined and calculated according to the standard GB28380-2012.

1. Energy Efficiency Grades

The grade is determined by the standard with the calculation of base consumption level with the sum of all the allowances for additional components such as main memory and graphics card. For products of any grade, the TEC should not exceed the value specified in the following table:

Product Type		TEC (kilowatt hour)		
		Grade 1	Grade 2	Grade 3
Desktop microcomputer, AIO	Category A	98.0+ Σ Efa	148.0+ Σ Efa	198.0+ Σ Efa
	Category B	125.0+ Σ Efa	175.0+ Σ Efa	225.0+ Σ Efa
	Category C	159.0+ Σ Efa	209.0+ Σ Efa	259.0+ Σ Efa
	Category D	184.0+ Σ Efa	234.0+ Σ Efa	284.0+ Σ Efa
Portable Computer	Category A	20.0+ Σ Efa	35.0+ Σ Efa	45.0+ Σ Efa
	Category B	26.0+ Σ Efa	45.0+ Σ Efa	65.0+ Σ Efa
	Category C	54.5+ Σ Efa	75.0+ Σ Efa	123.5+ Σ Efa

NOTE: Σ Efa is the sum of power factor of product additional functions.

2. Typical Energy Consumption

The energy consumption figure presented on the label is the data measured with the representative configuration that covers all the configurations in the registration unit which is selected according to “The Regulation of the Implementation on China Energy Label for Microcomputers”. Thus, actual energy consumption of this specific microcomputer may not be the same as the TEC data presented in the label.

3. Product Category

The product category is determined by the standard according to the microcomputer’s configuration. The categorization of products complies with the regulations in the following table:

Product Type	Configuration Description
Desktop microcomputer, AIO	Portable Computer

Product Type	Configuration Description	
Category A	The desktop microcomputer and AIO whose configuration is out of the scope of Category B, C, and D	The portable computer whose configuration is out of the scope of Category B and C
Category B	CPU physical core number of 2, and system memory of not less than 2 GB	A Discrete GPU
Category C	CPU physical core number of over 2, with at least one of the following features: <ol style="list-style-type: none"> 1. System memory of not less than 2 GB 2. A Discrete GPU 	The product that has a CPU physical core number of not less than 2, system memory of not less than 2GB, A Discrete GPU with Frame Buffer Width not less than 128-bit.
Category D	CPU physical core number of not less than 4, with at least one of the following features: <ol style="list-style-type: none"> 1. System memory of not less than 4 GB 2. A Discrete GPU with Frame Buffer Width not less than 128-bit 	

For more details on the specification, please refer to the standard GB28380-2012.

本机根据《微型计算机能源效率标识实施规则》的要求加施中国能效标识。能效标识中显示的能效等级、典型能源消耗和产品类型均根据《微型计算机能效限定值及能效等级》（GB28380-2012）的要求确定。对上述标识内容的说明如下：

1. 能效等级

微型计算机的能效等级由基础能源消耗值和附加功能功耗因子之和决定。微型计算机能效各等级的典型能源消耗应不大于下表的规定

微型计算机类型		能源消耗(千瓦时)		
		1	2	3
台式微型计算机及一体机	A类	$98.0+\Sigma E_{fa}$	$148.0+\Sigma E_{fa}$	$198.0+\Sigma E_{fa}$
	B类	$125.0+\Sigma E_{fa}$	$175.0+\Sigma E_{fa}$	$225.0+\Sigma E_{fa}$
	C类	$159.0+\Sigma E_{fa}$	$209.0+\Sigma E_{fa}$	$259.0+\Sigma E_{fa}$
	D类	$184.0+\Sigma E_{fa}$	$234.0+\Sigma E_{fa}$	$284.0+\Sigma E_{fa}$
便携式计算机	A类	$20.0+\Sigma E_{fa}$	$35.0+\Sigma E_{fa}$	$45.0+\Sigma E_{fa}$
	B类	$26.0+\Sigma E_{fa}$	$45.0+\Sigma E_{fa}$	$65.0+\Sigma E_{fa}$
	C类	$54.5+\Sigma E_{fa}$	$75.0+\Sigma E_{fa}$	$123.5+\Sigma E_{fa}$

注： ΣE_{fa} 为微型计算机附加功能功耗因子之和

2. 典型能源消耗

典型能源消耗值代表一个备案单元中，符合《微型计算机能源效率标识实施规则》要求的代表性规格型号产品的数值。因此，本机的典型能源消耗值可能与其所加施的能效标识中所示的典型能源消耗值不一致。

3. 产品类型

产品类型根据微型计算机的配置确定。参见下表：

类型	配置说明	
	台式微型计算机及一体机	便携式计算机
A类	下列B类、C类、D类配置以外的台式微型计算机及一体机	下列B类、C类配置以外的便携式计算机
B类	中央处理器(CPU)物理核心数为2,系统内存大于等于2GB	具有独立图形显示单元(GPU)
C类	中央处理器(CPU)物理核心数大于2,且至少具有以下特征中的一条 a. a) 系统内存大于等于2GB; b. 独立图形显示单元(GPU)	中央处理器(CPU)物理核心数大于等于2,系统内存大于等于2GB,具有独立图形显示单元(GPU)且显存位宽大于等于128位。
D类	中央处理器(CPU)物理核心数大于等于4,且至少具有以下特征中的一条: a. 系统内存大于等于4GB; b. 具有独立图形显示单元(GPU)且显存位宽大于等于128位	

关于标识内容的更详细技术信息，请参考《微型计算机能效限定值及能效等级》(GB28380-2012)

China restriction of hazardous substances (RoHS) for notebook and tablet computers

The Table of Hazardous Substances/Elements and their Content

As required by China's Management Methods for Restricted Use of Hazardous Substances in Electrical and Electronic Products



Part Name	Hazardous Substances					
	Lead (Pb)	Mercury (Hg)	Cadmium (Cd)	Hexavalent Chromium (Cr(VI))	Polybrominated biphenyls (PBB)	Polybrominated diphenyl ethers (PBDE)
Battery	X	0	0	0	0	0
Cables	X	0	0	0	0	0
Camera	X	0	0	0	0	0
Chassis/Other	X	0	0	0	0	0
Flash memory card reader	X	0	0	0	0	0
Floppy disk drive	X	0	0	0	0	0
Hard disk drive	X	0	0	0	0	0
Headphones	X	0	0	0	0	0
I/O PCAs	X	0	0	0	0	0
Keyboard	X	0	0	0	0	0
Liquid crystal display (LCD) panel	X	0	0	0	0	0
Media (CD/DVD/floppy)	0	0	0	0	0	0
Memory	X	0	0	0	0	0
Motherboard, processor, heat sinks	X	0	0	0	0	0
Mouse	X	0	0	0	0	0
Optical disk drive	X	0	0	0	0	0
Optional docking device	X	0	0	0	0	0
Power adapter	X	0	0	0	0	0
Power pack	X	0	0	0	0	0
Power supply	X	0	0	0	0	0
Remote control	X	0	0	0	0	0
Smart card/Java™ card reader	X	0	0	0	0	0
Speakers, external	X	0	0	0	0	0

Part Name	Hazardous Substances					
	Lead (Pb)	Mercury (Hg)	Cadmium (Cd)	Hexavalent Chromium (Cr(VI))	Polybrominated biphenyls (PBB)	Polybrominated diphenyl ethers (PBDE)
TV tuner	X	0	0	0	0	0
USB flash memory drive	X	0	0	0	0	0
USB hub	X	0	0	0	0	0
Web camera	X	0	0	0	0	0
Wireless receiver	X	0	0	0	0	0
Wireless cards	X	0	0	0	0	0

This form has been prepared in compliance with the provisions of SJ/T 11364.

0: Indicates that the content of said hazardous substance in all of the homogenous materials in the component is within the limits required by GB/T 26572.

X: Indicates that the content of said hazardous substance exceeds the limits required by GB/T 26572 in at least one homogenous material in the component.

All parts named in this table with an "X" are in compliance with the European Union's RoHS Legislation.

NOTE: The referenced Environmental Protection Use Period Marking was determined according to normal operating use conditions of the product such as temperature and humidity.

笔记本电脑和平板电脑产品中有害物质或元素的名称及含量

根据中国《电器电子产品有害物质限制使用管理办法》



部件名称	有害物质					
	铅 (Pb)	汞 (Hg)	镉 (Cd)	六价铬 (Cr(VI))	多溴联苯 (PBB)	多溴二苯醚 (PBDE)
电池	X	0	0	0	0	0
线缆	X	0	0	0	0	0
摄像头	X	0	0	0	0	0
机箱/其他	X	0	0	0	0	0
闪存读卡器	X	0	0	0	0	0
软盘驱动器	X	0	0	0	0	0
硬盘驱动器	X	0	0	0	0	0
耳机	X	0	0	0	0	0
I/O PCA	X	0	0	0	0	0
键盘	X	0	0	0	0	0
液晶显示器 (LCD) 面板	X	0	0	0	0	0
介质 (CD/DVD/软盘)	0	0	0	0	0	0

部件名称	有害物质					
	铅 (Pb)	汞 (Hg)	镉 (Cd)	六价铬 (Cr(VI))	多溴联苯 (PBB)	多溴二苯醚 (PBDE)
内存	X	0	0	0	0	0
主板、处理器、散热器	X	0	0	0	0	0
鼠标	X	0	0	0	0	0
光盘驱动器	X	0	0	0	0	0
对接设备选件	X	0	0	0	0	0
电源适配器	X	0	0	0	0	0
电源	X	0	0	0	0	0
电源组	X	0	0	0	0	0
投影仪	X	0	0	0	0	0
遥控器	X	0	0	0	0	0
智能卡/Java™ 读卡器	X	0	0	0	0	0
扬声器 (外置)	X	0	0	0	0	0
电视调谐器	X	0	0	0	0	0
USB 闪存驱动器	X	0	0	0	0	0
USB 集线器	X	0	0	0	0	0
网络摄像头	X	0	0	0	0	0
无线接收器	X	0	0	0	0	0
无线网卡	X	0	0	0	0	0

本表格依据 SJ/T 11364 的规定编制。

0：表示该有害物质在该部件所有均质材料中的含量均在 GB/T 26572 规定的限量要求以下。

X：表示该有害物质至少在该部件的某一均质材料中的含量超出 GB/T 26572 规定的限量要求。

注：环保使用期限的参考标识取决于产品正常工作的温度和湿度等条件

China restriction of hazard substances (ROHS) for desktops, thin clients, personal workstations, all-in-ones, and point-of-sale terminals

The Table of Hazardous Substances/Elements and their Content

As required by China's Management Methods for Restricted Use of Hazardous Substances in Electrical and Electronic Products



Part Name	Hazardous Substances					
	Lead (Pb)	Mercury (Hg)	Cadmium (Cd)	Hexavalent Chromium (Cr(VI))	Polybrominated biphenyls (PBB)	Polybrominated diphenyl ethers (PBDE)
Battery	X	0	0	0	0	0
Cables	X	0	0	0	0	0
Camera	X	0	0	0	0	0
Chassis/Other	X	0	0	0	0	0
Fan	X	0	0	0	0	0
Flash memory card reader	X	0	0	0	0	0
Floppy disk drive	X	0	0	0	0	0
Hard disk drive	X	0	0	0	0	0
Headphones	X	0	0	0	0	0
Heat sink	X	0	0	0	0	0
I/O PCAs	X	0	0	0	0	0
Keyboard	X	0	0	0	0	0
Liquid crystal display (LCD) panel	X	0	0	0	0	0
Media (CD/DVD/floppy)	0	0	0	0	0	0
Memory	X	0	0	0	0	0
Motherboard, processor, heat sinks	X	0	0	0	0	0
Mouse	X	0	0	0	0	0
Optical disk drive	X	0	0	0	0	0
Optional docking device	X	0	0	0	0	0
Power adapter	X	0	0	0	0	0
Power supply	X	0	0	0	0	0
Projector	X	0	0	0	0	0
Remote control	X	0	0	0	0	0
Smart card/Java™ card reader	X	0	0	0	0	0
Solid-state drives	X	0	0	0	0	0
Speakers, external	X	0	0	0	0	0
Stylus	X	0	0	0	0	0
Touch mat	X	0	0	0	0	0
TV tuner	X	0	0	0	0	0
USB flash memory drive	X	0	0	0	0	0

Part Name	Hazardous Substances					
	Lead (Pb)	Mercury (Hg)	Cadmium (Cd)	Hexavalent Chromium (Cr(VI))	Polybrominated biphenyls (PBB)	Polybrominated diphenyl ethers (PBDE)
USB hub	X	0	0	0	0	0
Web camera	X	0	0	0	0	0
Wireless receiver	X	0	0	0	0	0
Wireless cards	X	0	0	0	0	0
3D Capture Stage/ Turntable	X	0	0	0	0	0

This form has been prepared in compliance with the provisions of SJ/T 11364.

0: Indicates that the content of said hazardous substance in all of the homogenous materials in the component is within the limits required by GB/T 26572.

X: Indicates that the content of said hazardous substance exceeds the limits required by GB/T 26572 in at least one homogenous material in the component.

All parts named in this table with an "X" are in compliance with the European Union's RoHS Legislation.

NOTE: The referenced Environmental Protection Use Period Marking was determined according to normal operating use conditions of the product such as temperature and humidity.

台式机、瘦客户端、个人工作站、一体机和销售点终端产品中有害物质或元素的名称及含量 (ROHS)

根据中国《电器电子产品有害物质限制使用管理办法》



部件名称	有害物质					
	铅 (Pb)	汞 (Hg)	镉 (Cd)	六价铬 (Cr(VI))	多溴联苯 (PBB)	多溴二苯醚 (PBDE)
电池	X	0	0	0	0	0
线缆	X	0	0	0	0	0
摄像头	X	0	0	0	0	0
机箱/其他	X	0	0	0	0	0
风扇	X	0	0	0	0	0
闪存读卡器	X	0	0	0	0	0
软盘驱动器	X	0	0	0	0	0
硬盘驱动器	X	0	0	0	0	0
耳机	X	0	0	0	0	0
散热器	X	0	0	0	0	0
I/O PCA	X	0	0	0	0	0

部件名称	有害物质					
	铅 (Pb)	汞 (Hg)	镉 (Cd)	六价铬 (Cr(VI))	多溴联苯 (PBB)	多溴二苯醚 (PBDE)
键盘	X	0	0	0	0	0
液晶显示器 (LCD) 面板	X	0	0	0	0	0
介质 (CD/DVD/软盘)	0	0	0	0	0	0
内存	X	0	0	0	0	0
主板、处理器、散热器	X	0	0	0	0	0
鼠标	X	0	0	0	0	0
光驱	X	0	0	0	0	0
对接设备选件	X	0	0	0	0	0
电源适配器	X	0	0	0	0	0
电源	X	0	0	0	0	0
投影仪	X	0	0	0	0	0
遥控器	X	0	0	0	0	0
智能卡/Java™ 读卡器	X	0	0	0	0	0
固态驱动器	X	0	0	0	0	0
扬声器 (外置)	X	0	0	0	0	0
触控笔	X	0	0	0	0	0
触控板	X	0	0	0	0	0
电视调谐器	X	0	0	0	0	0
USB 闪存驱动器	X	0	0	0	0	0
USB 集线器	X	0	0	0	0	0
网络摄像头	X	0	0	0	0	0
无线接收器	X	0	0	0	0	0
无线网卡	X	0	0	0	0	0
3D 捕获台/转盘	X	0	0	0	0	0

本表格依据 SJ/T 11364 的规定编制。

0：表示该有害物质在该部件所有均质材料中的含量均在 GB/T 26572 规定的限量要求以下。

X：表示该有害物质至少在该部件的某一均质材料中的含量超出 GB/T 26572 规定的限量要求。

注：环保使用期限的参考标识取决于产品正常工作的温度和湿度等条件

台灣針對筆記型電腦和平板電腦的有害物質限制使用管理辦法 (RoHS)

限用物質含有情況標示聲明書

Declaration of the Presence Condition of the Restricted Substances Marking

限用物質及其化學符號						
Restricted substances and its chemical symbols						
單元 Unit	鉛 Lead (Pb)	汞 Mercury (Hg)	鎘 Cadmium (Cd)	六價鉻 Hexavalent chromium (Cr ⁺⁶)	多溴聯苯 Polybrominated biphenyls (PBB)	多溴二苯醚 Polybrominated diphenyl ethers (PBDE)
纜線 Cables	—	0	0	0	0	0
機殼/其他 Chassis/Other	—	0	0	0	0	0
輸入/輸出印刷 電路組件 I/O PCAs	—	0	0	0	0	0
液晶顯示器 (LCD) 面板 Liquid crystal display (LCD) panel	—	0	0	0	0	0
記憶體 Memory	0	0	0	0	0	0
主機板、處理 器、散熱器 Motherboard, processor, heat sinks	—	0	0	0	0	0
電源組 Power pack	—	0	0	0	0	0
電源供應器 Power supply	—	0	0	0	0	0
儲存裝置 Storage Devices	—	0	0	0	0	0
無線裝置 Wireless Devices	—	0	0	0	0	0

備考 1：「超出 0.1 %」及「超出 0.01 %」係指限用物質之百分比含量超出百分比含量基準值。
 Note 1: "Exceeding 0.1 wt %" and "exceeding 0.01 wt %" indicate that the percentage content of the restricted substance exceeds the reference percentage value of presence condition.

備考 2：「0」係指該項限用物質之百分比含量未超出百分比含量基準值。
 Note 2: "0" indicates that the percentage content of the restricted substance does not exceed the percentage of reference value of presence.

備考 3：「—」係指該項限用物質為排除項目。
 Note 3: The "—" indicates that the restricted substance corresponds to the exemption.

若要取得最新版使用指南，請前往 <http://www.hp.com/support>，並依照指示尋找您的產品。然後選取「使用指南」。

To access the latest user guides, go to <http://www.hp.com/support>, and follow the instructions to find your product. Then select **User Guides**.

台灣針對桌上型電腦、精簡型電腦、個人工作站、一體成形電腦及銷售點終端機的有害物質限制使用管理辦法 (RoHS)

限用物質含有情況標示聲明書

Declaration of the Presence Condition of the Restricted Substances Marking

限用物質及其化學符號						
Restricted substances and its chemical symbols						
單元 Unit	鉛 Lead (Pb)	汞 Mercury (Hg)	鎘 Cadmium (Cd)	六價鉻 Hexavalent chromium (Cr *6)	多溴聯苯 Polybrominated biphenyls (PBB)	多溴二苯醚 Polybrominated diphenyl ethers (PBDE)
纜線 Cables	—	○	○	○	○	○
機座/其他 Chassis/Other	—	○	○	○	○	○
輸入/輸出印刷電路組件 I/O PCAs	—	○	○	○	○	○
液晶顯示器 (LCD) 面板 Liquid crystal display (LCD) panel (for AIO only)	—	○	○	○	○	○
記憶體 Memory	○	○	○	○	○	○
主機板、處理器、散熱器 Motherboard, processor, heat sinks	—	○	○	○	○	○
電源供應器 Power supply	—	○	○	○	○	○
儲存裝置 Storage Devices	—	○	○	○	○	○

備考 1：「超出 0.1 %」及「超出 0.01 %」係指限用物質之百分比含量超出百分比含量基準值。
 Note 1: "Exceeding 0.1 wt %" and "exceeding 0.01 wt %" indicate that the percentage content of the restricted substance exceeds the reference percentage value of presence condition.

備考 2：「○」係指該項限用物質之百分比含量未超出百分比含量基準值。
 Note 2: "O" indicates that the percentage content of the restricted substance does not exceed the percentage of reference value of presence.

備考 3：「—」係指該項限用物質為排除項目。
 Note 3: The "—" indicates that the restricted substance corresponds to the exemption.

若要取得最新版使用指南，請前往 <http://www.hp.com/support>，並依照指示尋找您的產品。然後選取「使用指南」。

To access the latest user guides, go to <http://www.hp.com/support>, and follow the instructions to find your product. Then select **User Guides**.

India restriction of hazardous substances (RoHS)

This product, as well as its related consumables and spares, complies with the reduction in hazardous substances provisions of the "India E-waste Rule 2016." It does not contain lead, mercury, hexavalent chromium, polybrominated biphenyls or polybrominated diphenyl ethers in concentrations exceeding 0.1 weight % and 0.01 weight % for cadmium, except where allowed pursuant to the exemptions set in Schedule 2 of the Rule.

Information for European Union Commission Regulation 1275/2008

To locate product power consumption data, including when the product is in networked standby with all wired network ports connected and wireless devices connected, refer to section P14 "Additional information" of the product IT ECO Declaration at <http://www.hp.com/hpinfo/globalcitizenship/environment/productdata/itecodesktop-pc.html>.

Where applicable, activate and deactivate a wireless network using the instructions included in the product user guide or the operating system. Information is also available at <http://www.hp.com/support>.

IT ECO declarations

Notebook or tablet PCs

<http://www.hp.com/hpinfo/globalcitizenship/environment/productdata/iteconotebook-o.html>

Desktop PCs and Thin Clients

http://www.hp.com/hpinfo/globalcitizenship/environment/productdata/itecodesktop-pc.html?jumpid=reg_R1002_USEN

Workstations

<http://www.hp.com/hpinfo/globalcitizenship/environment/productdata/itecoworkstatio.html>

Japan restriction of hazardous substances (RoHS)

2008年、日本における製品含有表示方法、JISC0950が公示されました。製造事業者は、2006年7月1日以降に販売される電気・電子機器の特定化学物質の含有に付きまして情報提供を義務付けられました。製品の部材表示に付きましては、

<http://www.hp.com/go/jisc0950>

を参照してください

A Japanese regulatory requirement, defined by specification JIS C 0950, 2008, mandates that manufacturers provide Material Content Declarations for certain categories of electronic products offered for sale after July 1, 2006.

To view the JIS C 0950 material declaration for this product, visit <http://www.hp.com/go/jisc0950>.

Ley para el Aprovechamiento Sustentable de la Energía de México

Ley para el Aprovechamiento Sustentable de la Energía de México

Se ha etiquetado este producto en conformidad con la Ley para el Aprovechamiento Sustentable de la Energía de México, que requiere la divulgación del consumo de energía del modo de uso normal (modo inactivo) y del modo de espera. Su producto es una de las muchas configuraciones de esta familia de modelos; el consumo de energía del modo inactivo de su configuración específica puede diferir de la información de la etiqueta. El consumo real de energía de su producto puede ser mayor o menor que el valor informado en la etiqueta de energía de producto para México a causa de factores como la configuración (componentes y módulos seleccionados) y el uso (tareas que se están efectuando, software instalado y en ejecución, etc.).



NOTE: Esta ley no es aplicable a las estaciones de trabajo.

Turkey WEEE regulation

Türkiye Cumhuriyeti: AEEE Yönetmeliğine Uygundur

TCO Certified

This section applies only to products bearing the TCO Certified logo.

A third-party certification according to ISO 14024



Toward sustainable IT products

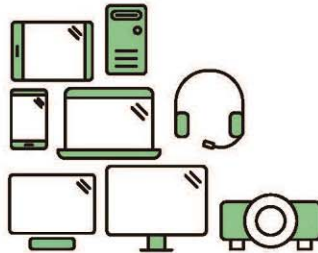

Say hello to a more sustainable product

IT products are associated with a wide range of sustainability risks throughout their life cycle. Human rights violations are common in the factories. Harmful substances are used both in products and their manufacture. Products can often have a short lifespan because of poor ergonomics, low quality and when they are not able to be repaired or upgraded.

This product is a better choice. It meets all the criteria in TCO Certified, the world's most comprehensive sustainability certification for IT products. Thank you for making a responsible product choice, that help drive progress towards a more sustainable future!

Criteria in TCO Certified have a life-cycle perspective and balance environmental and social responsibility. Conformity is verified by independent and approved verifiers that specialize in IT products, social responsibility or other sustainability issues. Verification is done both before and after the certificate is issued, covering the entire validity period. The process also includes ensuring that corrective actions are implemented in all cases of factory non-conformities. And last but not least, to make sure that the certification and independent verification is accurate, both TCO Certified and the verifiers are reviewed regularly.

Want to know more?

Read information about TCO Certified, full criteria documents, news and updates at tcocertified.com. On the website you'll also find our Product Finder, which presents a complete, searchable listing of certified products.

TCO Certified Edge

This section applies only to products bearing the TCO Certified Edge logo.

A third-party certification according to ISO 14024



Toward sustainable IT products

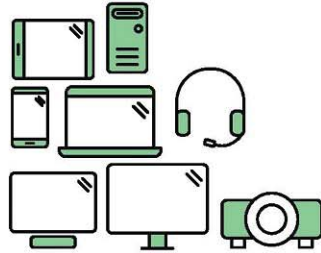

Say hello to a more sustainable product

IT products are associated with a wide range of sustainability risks throughout their life cycle. Human rights violations occur in the supply chain. Harmful substances are used both in products and their manufacture. Products can often have a short lifespan because of poor ergonomics, low quality and when they are not able to be repaired or upgraded.

This product is a better choice. It meets all the criteria in TCO Certified, the world's most comprehensive sustainability certification for IT products. Additionally, it fulfills the requirements of TCO Certified Edge, the supplemental certification that recognizes leading-edge products that exceed typical performance in a particular sustainability attribute. At our Product Finder (tcocertified.com/product-finder) you can find out which TCO Certified Edge criterion or criteria this product meets.

Criteria in TCO Certified have a life-cycle perspective and balance environmental and social responsibility. Compliance is verified by independent verification organizations that specialize in IT products, social responsibility or other sustainability issues. Verification is done both before and after the certificate is issued, covering the entire validity period. The process also includes ensuring that corrective actions are implemented in all cases of factory non-conformities.

Thank you for making a responsible product choice, that help drive progress towards a more sustainable future!

Want to know more?

Read information about TCO Certified, full criteria documents, news and updates at tcocertified.com. On the website you'll also find our Product Finder, which presents a complete, searchable listing of certified products.

Index

Symbols/Numerics

台灣對於危險物質的限制注意事項 35, 36
注意事項
台灣有害物質限制 35, 36

A

airline travel notice 8
altitude notice 21

B

battery 15
battery notice 8, 9, 23
battery recycling 23
Belarus regulatory notice 3
Brazil notice 3, 17

C

cable grounding notice 22
Canada modem statement 12
Canada notices 3
China environmental notices 26
China PC energy label 26
China restriction of hazardous substances notice 29, 31

D

disposal notices
battery 23
battery, user replacement 8
equipment 23
factory sealed battery 9

E

electronic hardware and battery recycling 23
ENERGY STAR certification 24
environmental notices 23
equipment disposal notice 23
ergonomics notice 5
European Union Commission Regulation 1275/2008 37

F

fan notice 16

Federal Communications Commission

notebook computers cables 2
notebook computers modifications 2
notebook computers notice 1

G

GS Notice 5

H

headset and earphone volume level notice 16

I

India restriction of hazardous substances notice 37

J

Japan modem statement 12
Japan notice 6
Japan power cord notice 19
Japan restriction of hazardous substances notice 37

L

labels, regulatory 1
laser safety notice 9, 16

M

Macrovision Corporation notice 13
maximum power levels 4
Mexico wireless notice 6
modem notices 10
modem statements
Canada 12
Japan 12
New Zealand 12
U.S. 10, 11
modifications, notebook computers
Federal Communications Commission 2

N

New Zealand modem statement 12

notices

airline travel 8
battery 8, 9, 15, 23
Belarus regulatory 3
Brazil 3, 17
Canada 3
China restriction of hazardous substances 29, 31
environmental 23
equipment disposal 23
ergonomics 5
fan 16
headset and earphone volume level 16
India restriction of hazardous substances 37
Japan 6
Japan power cord 19
Japan restriction of hazardous substances 37
laser safety 9, 16
Macrovision Corporation 13
Mexico 6
modem 10
perchlorate material 25
power cords 18
Singapore 7
South Korea 7
Taiwan 8
Thailand wireless notice 7
travel 20

notices, notebook computers
Federal Communications Commission 1

P

power cord notice 18

R

radio frequency bands 4
recycling, electronic hardware and battery 23

S

Singapore wireless notice 7

South Korea notice 7

T

Taiwan notice 8

TCO Certified Certification 39

TCO Certified Edge Certification 40

Thailand wireless notice 7

travel notice 20

tropical warning notice 21

TV tuner, cable grounding notice 22

U

U.S. modem statement 10, 11

V

voice support 13

volume level notice, headset and
earphone 16

W

wireless LAN devices 2



Regulatory, Safety, and Environmental Notices

User Guide

© Copyright 2018, 2019 HP Development Company, L.P.

Bluetooth is a trademark owned by its proprietor and used by HP Inc. under license. ENERGY STAR and the ENERGY STAR mark are registered U.S. marks. Java is a registered trademark of Oracle and/or its affiliates.

The information contained herein is subject to change without notice. The only warranties for HP products and services are set forth in the express warranty statements accompanying such products and services. Nothing herein should be construed as constituting an additional warranty. HP shall not be liable for technical or editorial errors or omissions contained herein.

Fourth Edition: April 2019

First Edition: March 2018

Document Part Number: L25269-004

About This Guide

This guide provides regulatory, safety, and environmental information that is compliant with U.S., Canadian, and international regulations for notebook computers, tablets, desktops, thin clients, personal workstations, all-in-ones, and point-of-sale terminals.

To access the latest user guides, go to <http://www.hp.com/support>, and follow the instructions to find your product. Then select **User Guides**.





-
-  **WARNING!** Indicates a hazardous situation that, if not avoided, **could** result in serious injury or death.
 -  **CAUTION:** Indicates a hazardous situation that, if not avoided, **could** result in minor or moderate injury.
 -  **IMPORTANT:** Indicates information considered important but not hazard-related (for example, messages related to property damage). Warns the user that failure to follow a procedure exactly as described could result in loss of data or in damage to hardware or software. Also contains essential information to explain a concept or to complete a task.
 -  **NOTE:** Contains additional information to emphasize or supplement important points of the main text.
 -  **TIP:** Provides helpful hints for completing a task.
-

Table of contents

1 Regulatory notices	1
Accessing regulatory labels	1
Federal Communications Commission notice	1
Modifications	2
Cables	2
Products with wireless LAN devices or HP Mobile Broadband Modules	2
Belarus regulatory notice	3
Brazil notice	3
Canada notices	3
European Union regulatory notices	3
Declaration of Conformity	3
Products with radio functionality (EMF)	4
Restrictions for products with radio functionality (select products only)	4
Radio frequency bands and maximum power levels (select products and countries only)	4
Ergonomics notice	5
European telephone network declaration (Modem/Fax)	5
Australia and New Zealand notice	5
China WWAN notice	5
China radio equipment notice	5
Japan notice	6
Wireless LAN, Wireless WAN, and Bluetooth® certification markings	6
Mexico notice	6
Singapore wireless notice	7
South Korea notices	7
Thailand wireless notice	7
Taiwan NCC notices	8
Wireless LAN 802.11a devices	8
Wireless LAN 802.11 devices/Bluetooth devices/Short range devices	8
Airline travel notice	8
User-replaceable battery notices	8
Factory-sealed battery notices	9
Laser compliance	9
Telecommunications device approvals	9
Modem notices	10
U.S. modem statements	10

U.S. modem declarations	11
Canada modem statements	12
Japan modem statements	12
New Zealand modem statements	12
Voice support	13
Macrovision Corporation notice	13
2 Safety notices	14
Important safety information	14
Heat-related safety warning notice	15
Potential safety conditions notice	15
Installation conditions	15
Acoustics notice	15
Battery notices	15
Fan notices	16
Headset and earphone volume level notice	16
Laser safety	16
Power supply and power cord set requirements	17
Power supply class I grounding requirements	17
Brazil notice	17
Denmark	17
Finland	17
Norway	17
Sweden	17
Power supply requirements	17
For use in Norway	17
Power cord set requirements	18
Power cord notice	18
DC plug of external HP power supply	18
Japan power cord notice	19
Japan power cord requirements	19
Pinch hazard	19
TV antenna connectors protection	19
External television antenna grounding	19
Lightning protection	19
Note to CATV system installer	20
Travel notice	20
China safety notices	21
China: Altitude notice	21
China: Tropical warning notice	21
Norway and Sweden: Cable grounding notice for products with a TV tuner	22

使用過度恐傷害視力	22
3 Environmental notices	23
Electronic hardware, packaging and battery recycling	23
Disposal of waste equipment by users	23
Brazil alkaline battery disposal	23
Brazil hardware recycling information	23
Taiwan battery recycling information	24
ENERGY STAR® Certification (select products only)	24
Chemical substances	25
Mercury statement	25
Perchlorate material—special handling may apply	25
China environmental notices	26
China PC energy label	26
China restriction of hazardous substances (RoHS) for notebook and tablet computers	29
The Table of Hazardous Substances/Elements and their Content	29
笔记本电脑和平板电脑产品中有害物质或元素的名称及含量	30
China restriction of hazard substances (ROHS) for desktops, thin clients, personal workstations, all-in-ones, and point-of-sale terminals	31
The Table of Hazardous Substances/Elements and their Content	31
台式机、瘦客户端、个人工作站、一体机和销售点终端产品中有害物质或元素的名称及含量 (ROHS)	33
台灣針對筆記型電腦和平板電腦的有害物質限制使用管理辦法 (RoHS)	35
限用物質含有情況標示聲明書	35
台灣針對桌上型電腦、精簡型電腦、個人工作站、一體成形電腦及銷售點終端機的有害物質限制使用管理辦法 (RoHS)	36
限用物質含有情況標示聲明書	36
India restriction of hazardous substances (RoHS)	37
Information for European Union Commission Regulation 1275/2008	37
IT ECO declarations	37
Japan restriction of hazardous substances (RoHS)	37
Ley para el Aprovechamiento Sustentable de la Energía de México	38
Turkey WEEE regulation	38
TCO Certified	39
TCO Certified Edge	40
Index	41

1 Regulatory notices

This chapter provides country- and region-specific non-wireless and wireless regulatory notices and compliance information for the computer product. Some of these notices may not apply to your product.

One or more integrated wireless devices may be installed. In some environments, the use of wireless devices may be restricted. Such restrictions may apply aboard airplanes, in hospitals, near explosives, in hazardous locations, and so on. If you are uncertain of the policy that applies to the use of this product, ask for authorization to use it before you turn it on.

Accessing regulatory labels

Regulatory labels, which provide country or regional regulatory information (for example, FCC ID), may be physically located on the bottom of the computer, inside the battery bay (select products only), under the removable service door (select products only), on the back of the display, or on the wireless or modem module.

Some products may also provide electronic regulatory labels (e-labels) that can be accessed through the system BIOS.

 **NOTE:** Electronic labels are not available on all products.

 **NOTE:** Devices not for sale or use in the United States may not contain a FCC ID.

To view electronic regulatory labels:

1. Turn on or restart the computer.
2. Press **esc** or **f10** to enter Computer Setup.
3. Use a pointing device or the arrow keys to select **Advanced**, select **Electronic Labels**, and then press **enter**.
4. To view an electronic label, use a pointing device or the arrow keys to select one of the listed items, and then press **OK**.

 **NOTE:** The list of available electronic label items varies depending on the computer model and installed devices.

5. To exit Computer Setup menus without making any changes:

Select the **Exit** icon in the lower-right corner of the screen, and then follow the on-screen instructions.

– or –

Use the arrow keys to select **Main**, select **Ignore Changes and Exit**, and then press **enter**.

Federal Communications Commission notice

This equipment has been tested and found to comply with the limits for a Class B digital device, pursuant to Part 15 of the FCC Rules. These limits are designed to provide reasonable protection against harmful interference in a residential installation. This equipment generates, uses, and can radiate radio frequency energy and, if not installed and used in accordance with the instructions, may cause harmful interference to radio communications. However, there is no guarantee that interference will not occur in a particular installation.

If this equipment does cause harmful interference to radio or television reception, which can be determined by turning the equipment off and on, the user is encouraged to try to correct the interference by one or more of the following measures:

- Reorient or relocate the receiving antenna.
- Increase the separation between the equipment and receiver.
- Connect the equipment to an outlet on a circuit different from that to which the receiver is connected.
- Consult the dealer or an experienced radio or television technician for help.

This device complies with Part 15 of the FCC Rules. Operation is subject to the following two conditions:

1. This device may not cause harmful interference, and
2. This device must accept any interference received, including interference that may cause undesired operation.

For questions regarding this product:

- Write to:
HP Inc.
1501 Page Mill Road
Palo Alto, CA 94304
- Call HP at 650-857-1501
– or –
- Email techregshelp@hp.com

To identify this product, refer to the part, series, or model number found on the product.

Modifications

The FCC requires the user to be notified that any changes or modifications made to this device that are not expressly approved by HP may void the user's authority to operate the equipment.

Cables

To maintain compliance with FCC Rules and Regulations, connections to this device must be made with shielded cables having metallic RFI/EMI connector hoods.

Products with wireless LAN devices or HP Mobile Broadband Modules

This device must not be co-located or operating in conjunction with any other antenna or transmitter.

 **WARNING! Exposure to Radio Frequency Radiation** The radiated output power of this device is below the FCC radio frequency exposure limits. Nevertheless, the device should be used in a manner that is in conformance with the expected typical usage.

Belarus regulatory notice

The product complies with the Belarus National Radio/Telecom Technical Regulation TR 2018/024/BY.



Brazil notice

Este equipamento opera em caráter secundário, isto é, não tem direito a proteção contra interferência prejudicial, mesmo de estações do mesmo tipo, e não pode causar interferência a sistemas operando em caráter primário.

Este equipamento atende aos limites de Taxa de Absorção Específica referente à exposição a campos elétricos, magnéticos e eletromagnéticos de radiofrequências adotados pela ANATEL.

Ao operar o dispositivo a uma distância muito próxima do seu corpo, utilize um acessório de armazenamento não metálico para posicionar o dispositivo a uma distância mínima de 1,5 cm do corpo.

 **IMPORTANT:** A alimentação de energia é predefinida para 220/230Vv. Se você possuir tomada elétrica de 110/115Vv, por favor, altere a chave na parte traseira do seu computador para a tensão correta.

Canada notices

This Class B digital apparatus meets all requirements of the Canadian Interference-Causing Equipment Regulations, CAN ICES-3(B)/NMB-3(B). If this device has WLAN or Bluetooth capability, the device complies with Industry Canada licence-exempt RSS standard(s). Operation is subject to the following two conditions: (1) this device may not cause interference, and (2) this device must accept any interference, including interference that may cause undesired operation of the device.

 **WARNING! Exposure to Radio Frequency Radiation:** The radiated output power of this device is below the Industry Canada radio frequency exposure limits. Nevertheless, the device should be used in a manner that is in conformance with the expected typical usage.

 **IMPORTANT:** When using IEEE 802.11a, n, or ac wireless LAN, this product is restricted to indoor use, due to its operation in the 5.15- to 5.25-GHz frequency range. Industry Canada requires this product to be used indoors for the frequency range of 5.15 GHz to 5.25 GHz to reduce the potential for harmful interference to co-channel mobile satellite systems. High-power radar is allocated as the primary user of the 5.25- to 5.35-GHz and 5.65- to 5.85-GHz bands. These radar stations can cause interference with and/or damage to this device.

The antennas for this device are not replaceable. Any attempt at user access will damage your computer.

European Union regulatory notices

Declaration of Conformity

Products bearing the CE marking have been constructed so that they can operate in at least one EU Member State and comply with one or more of the following EU Directives as may be applicable:

RED 2014/53/EU; Low Voltage Directive 2014/35/EU; EMC Directive 2014/30/EU; Ecodesign Directive 2009/125/EC; RoHS Directive 2011/65/EU.

Compliance with these directives is assessed using applicable European Harmonised Standards.

The full Declaration of Conformity can be found at the following website: <http://www.hp.eu/certificates> (Search with the product model name or its Regulatory Model Number (RMN), which may be found on the regulatory label.)

The point of contact for regulatory matters is HP Deutschland GmbH, HQ-TRE, 71025, Boeblingen, Germany. Email techregshelp@hp.com

Products with radio functionality (EMF)

This product incorporates a radio transmitting and receiving device. For notebook computers in normal use, a separation distance of 20 cm ensures that radio frequency exposure levels comply with EU requirements. Products designed to be operated at closer proximities, such as tablet computers, comply with applicable EU requirements in typical operating positions. Products can be operated without maintaining a separation distance unless otherwise indicated in instructions specific to the product.

Restrictions for products with radio functionality (select products only)



IMPORTANT: IEEE 802.11x wireless LAN with 5.15–5.35 GHz frequency band is restricted for indoor use only in all countries reflected in the matrix. Using this WLAN application outdoors might lead to interference issues with existing radio services.

IMPORTANT: Fixed outdoor installations for WiGig application (57–66 GHz frequency band) are excluded in all countries reflected in the matrix.

Radio frequency bands and maximum power levels (select products and countries only)

Radio Technology	Maximum Transmit Power EIRP (mW)
Bluetooth; 2,4 GHz	100
NFC; 13,56 MHz	10
RFID; 125 kHz/13,56 MHz	Less than 1
WLAN Wi-Fi 802.11x; 2,4 GHz	100
WLAN Wi-Fi 802.11x; 5 GHz	200
WWAN 4G LTE; 700/800/900/1800/2100/2300/2600/3500 MHz	200
WWAN 3G UTMS; 900/2100 MHz	250
WWAN 2G GSM GPRS EDGE; 900 MHz	2000
WWAN 2G GSM GPRS EDGE; 1800 MHz	1000
WiGig 802.11ad; 60 GHz	316
NOTE: Use only HP-supported software drivers and correct country settings to ensure compliance.	

Ergonomics notice

When a mobile computer is used at the office workstation for display work tasks where the Visual Display Unit (VDU) Directive 90/270/EEC is applicable, an adequate external keyboard is required. Depending on the application and task, an adequate external monitor may also be necessary to attain working conditions comparable to a workstation setup.

Ref: EK1-ITB 2000 (voluntary GS certification)

Mobile computers bearing the "GS" approval mark meet the applicable ergonomic requirements. Without external keyboards, they are suitable only for short-time use for VDU tasks.

During mobile use with disadvantageous illumination conditions (e.g. direct sunlight) reflections may occur, which result in reduced readability.

A computer system comprising HP brand products meets the applicable ergonomic requirements if all affected constituent products bear the "GS" approval mark, for example Business Desktop PC, keyboard, PC-mouse and monitor.

European telephone network declaration (Modem/Fax)

The product herewith complies with the requirements of the applicable Directive and carries the CE marking accordingly. However, due to differences between the individual PSTNs provided in different countries/regions, the approval does not, of itself, give an unconditional assurance of successful operation on every PSTN network termination point. In the event of problems, you should contact your equipment supplier in the first instance.

Australia and New Zealand notice

This equipment incorporates a radio transmitting and receiving device. In normal use, a separation distance of 20 cm ensures that radio frequency exposure levels comply with the Australian and New Zealand Standards.

The computer must be connected to the Telecommunication Network through a line cord that meets the requirements of AS/CA S008.

⚠ WARNING! Modems without integral RJ11 connector that are shipped with this computer should not be installed in any other device.

China WWAN notice

重要信息：本公司建议用户通过官方渠道进行系统更新，非官方渠道的更新可能会带来安全风险。

China radio equipment notice

型号核准代码显示在产品本体的铭牌上

Japan notice

V-2 規定適合の場合

この装置は、クラスB情報技術装置です。この装置は、家庭環境で使用することを目的としていますが、この装置がラジオやテレビジョン受信機に近接して使用されると、受信障害を引き起こすことがあります。

取扱説明書に従って正しい取り扱いをして下さい。 VCCI-B

VCCI32-1 規定適合の場合

この装置は、クラスB機器です。この装置は、住宅環境で使用することを目的としていますが、この装置がラジオやテレビジョン受信機に近接して使用されると、受信障害を引き起こすことがあります。

取扱説明書に従って正しい取り扱いをして下さい。 VCCI - B

5GHz 帯を使用する特定無線設備は屋内使用に限られています。この機器を屋外で使用することは電波法で禁じられています。

Wireless LAN, Wireless WAN, and Bluetooth® certification markings

この機器は、技術基準適合証明または工事設計認証を受けた無線設備を搭載しています

This product contains certified radio equipment.



Some products may use electronic regulatory labels (e-labels). To view the certification mark and numbers on an e-label, please refer to the previous “Accessing regulatory labels” section.

一部の製品では、電子規定ラベル（eラベル）が使用されています。eラベルの技適マークと認証番号を確認するには、「規定ラベルの確認」の項目をご覧ください

Mexico notice

Declaración para México

La operación de este equipo está sujeta a las siguientes dos condiciones: (1) es posible que este equipo o dispositivo no cause interferencia perjudicial y (2) este equipo o dispositivo debe aceptar cualquier interferencia, incluyendo la que pueda causar su operación no deseada. The regulatory model number for this product is on the regulatory label.

If your product is provided with wireless accessories such as a keyboard or mouse and you need to identify the model of the accessory, refer to the label included on that accessory. The regulatory model number for this product is on the regulatory label.

Singapore wireless notice

Turn off any WWAN devices while you are aboard aircraft. The use of these devices aboard aircraft is illegal, may be dangerous to the operation of the aircraft, and may disrupt the cellular network. Failure to observe this instruction may lead to suspension or denial of cellular services to the offender, or legal action, or both.

Users are reminded to restrict the use of radio equipment in fuel depots, chemical plants, and where blasting operations are in progress.

As with other mobile radio transmitting equipment, users are advised that for satisfactory operation of the equipment and for the safety of personnel, no part of the human body should be allowed to come too close to the antennas during operation of the equipment.

This device has been designed to comply with applicable requirements for exposure to radio waves, based on scientific guidelines that include margins intended to assure the safety of all people, regardless of health and age. These radio wave exposure guidelines employ a unit of measurement known as the specific absorption rate (SAR). Tests for SAR are conducted using standardized methods, with the phone transmitting at its highest certified power level in all used frequency bands. The SAR data information is based on CENELEC's standards EN50360 and EN50361, which use the limit of 2 watts per kilogram, averaged over 10 grams of tissue.

South Korea notices

무선적용제품

해당 무선설비가 전파혼신 가능성이 있으므로 인명안전과 관련된 서비스는 할 수 없음 (무선모듈 제품이 설치되어 있는 경우).

몸 가까이에서 장치를 작동할 경우, 비금속 저장 액세스리틀을 사용하여 장치와 몸 사이에 2.5cm 이상의 거리를 유지하십시오.

Thailand wireless notice

เครื่องโทรคมนาคมและอุปกรณ์นี้ มีความสอดคล้องตามมาตรฐานหรือข้อกำหนดของ กสทช.

(This telecommunication equipment conforms to the requirements of NBTC.)

เครื่องวิทยุคมนาคมนี้มีระดับการแผ่คลื่นแม่เหล็กไฟฟ้าสอดคล้องตามมาตรฐานความปลอดภัยต่อสุขภาพของมนุษย์จากการใช้เครื่องวิทยุคมนาคมที่คณะกรรมการกิจการโทรคมนาคมแห่งชาติประกาศกำหนด

This radio communication equipment has the electromagnetic field strength in compliance with the Safety Standard for the Use of Radio communication Equipment on Human Health announced by the National Telecommunications Commission.

Taiwan NCC notices

Wireless LAN 802.11a devices

在 5.25G~5.35G 頻帶內操作之無線資訊傳輸設備僅適於室內使用

應避免影響附近雷達系統之操作。

Wireless LAN 802.11 devices/Bluetooth devices/Short range devices

低功率電波輻射性電機管理辦法

第十二條 經型式認證合格之低功率射頻電機，非經許可，公司、商號或使用者均不得擅自變更頻率、加大功率或變更原設計之特性及功能。

第十四條 低功率射頻電機之使用不得影響飛航安全及干擾合法通信；經發現有干擾現象時，應立即停用，並改善至無干擾時方得繼續使用。

前項合法通信，指依電信法規定作業之無線電通信。低功率射頻電機須忍受合法通信或工業、科學及醫療用電波輻射性電機設備之干擾。

Airline travel notice

Use of electronic equipment aboard commercial aircraft is at the discretion of the airline.

User-replaceable battery notices

When a battery has reached the end of its useful life, do not dispose of the battery in general household waste. Follow the local laws and regulations in your area for computer battery disposal.

HP encourages customers to recycle used electronic hardware, HP original print cartridges, and rechargeable batteries. For more information about recycling programs, refer to the HP website at <http://www.hp.com/recycle>.

For information about removing a user-replaceable battery, refer to the user guide included with the product.

Factory-sealed battery notices

The battery[ies] in this product cannot be easily replaced by users themselves. Removing or replacing the battery could affect your warranty coverage. If a battery is no longer holding a charge, contact support.

When a battery has reached the end of its useful life, do not dispose of the battery in general household waste. Follow the local laws and regulations in your area for battery disposal.

Laser compliance

⚠ WARNING! Use of controls or adjustments, or performance of procedures other than those specified in the laser product installation guide, may result in hazardous radiation exposure. To reduce the risk of exposure to hazardous radiation:

- Do not try to open the module enclosure. There are no user-serviceable components inside.
- Do not operate controls, make adjustments, or perform procedures to the laser device other than those specified in the laser product installation guide.
- Allow only authorized service providers to repair the unit.

This product may be provided with an optical storage device (for example, a CD or DVD drive) and/or a fiber optic transceiver. Each of these devices that contain a laser is classified as a Class 1 Laser Product in accordance with IEC/EN 60825-1 and meets the requirements for safety of that standard.

Each laser product complies with US FDA regulations of 21 CFR 1040.10 and 1040.11 or complies with those regulations except for deviations pursuant to Laser Notice No. 50 dated June 24, 2007.



Telecommunications device approvals

The telecommunications device in the computer is approved for connection to the telephone network in the countries and regions whose approval markings are indicated on the product label located on the bottom of the computer or on the modem.

Refer to the user guide included with the product to ensure that the product is configured for the country or region in which the product is located. Selecting a country or region other than the one in which it is located may cause the modem to be configured in a way that violates the telecommunication regulations/laws of that country or region. In addition, the modem may not function properly if the correct country or region selection is not made. If, when you select a country or region, a message appears that states that the country or region is not supported, this means that the modem has not been approved for use in this country or region and thus should not be used.

Modem notices

U.S. modem statements

This equipment complies with Part 68 of the FCC Rules and the requirements adopted by the ACTA. On the bottom of the computer or on the modem is a label that contains, among other information, a product identifier in the format US:AAAEQ##TXXXX. Provide this information to the telephone company if you are requested to do so.

Applicable certification jack USOC = RJ11C. A plug and jack used to connect this equipment to the premises wiring and telephone network must comply with the applicable FCC Part 68 rules and requirements adopted by the ACTA. A compliant telephone cord and modular plug is provided with this product. It is designed to be connected to a compatible modular jack that is also compliant. See installation instructions for details.

The REN is used to determine the number of devices that may be connected to a telephone line. Excessive RENs on a telephone line may result in the devices not ringing in response to an incoming call. In most but not all locations, the sum of RENs should not exceed five (5.0). To be certain of the number of devices that may be connected to a line, as determined by the total RENs, contact the local telephone company. For products approved after July 23, 2001, the REN for this product is part of the product identifier that has the format US:AAAEQ##TXXXX. The digits represented by ## are the REN without a decimal point (e.g., 03 is a REN of 0.3). For earlier products, the REN is separately shown on the label.

If this HP equipment causes harm to the telephone network, the telephone company will notify you in advance that temporary discontinuance of service may be required. But, if advance notice isn't practical, the telephone company will notify you as soon as possible. Also, you will be advised of your right to file a complaint with the FCC if you believe it is necessary.

The telephone company may make changes to its facilities, equipment, operations, or procedures that could affect the operation of the equipment. If this happens, the telephone company will provide advance notice in order for you to make necessary modifications to maintain uninterrupted telephone service.

If trouble is experienced with this equipment, call technical support. If the equipment is causing harm to the telephone network, the telephone company may request that you disconnect the equipment until the problem is resolved. You should perform repairs only to the equipment specifically discussed in the "Troubleshooting" section of the user guide, if one is provided.

Connection to party line service is subject to state tariffs. Contact the state public utility commission, public service commission, or corporation commission for information.

If your home has specially wired alarm equipment connected to the telephone line, ensure that the installation of this HP equipment does not disable your alarm equipment. If you have questions about what will disable alarm equipment, consult your telephone company or a qualified installer.

The Telephone Consumer Protection Act of 1991 makes it unlawful for any person to use a computer or other electronic device, including a fax machine, to send any message unless such message clearly contains in a margin at the top or bottom of each transmitted page, or on the first page of the transmission, the date and time it is sent and an identification of the business, other entity, or other individual sending the message, and the telephone number of the sending machine or such business, other entity, or individual. (The telephone number provided may not be a 900 number or any other number for which charges exceed local or long-distance transmission charges).

In order to program this information into your fax machine, you should complete the steps outlined in the faxing software instructions.

U.S. modem declarations

Refer to the following modem vendor declarations for the modem device installed in your computer:



Brad Grande
Technical Manager

1110 American Parkway NE
Lehigh Valley Central Campus
Allentown, PA 18109
Phone: 610-712-7853
bgrande@agere.com

Supplier's Declaration of Conformity

Reference Number: Delphi D40 (revision AM5)
Place of Issue: Allentown, PA, USA
Date of Issue: 30th November 2006

Agere Systems Inc. at 1110 American Parkway NE, Lehigh Valley Central Campus, Allentown, PA 18109 in the United States of America, hereby certifies that the Modem, bearing labelling identification number US: AGSMD01BDELPHI complies with the Federal Communications Commission's ("FCC") Rules and Regulations 47 CFR Part 68, and the Administrative Council on Terminal Attachments ("ACTA")-adopted technical criteria TIA/EIA/IS-968, 968-A, 968-A-1, 968-A-2 and 968-A-3 Telecommunications – Telephone Terminal Equipment – Technical Requirements for Connection of Terminal Equipment To the Telephone Network.

A handwritten signature in black ink that reads "Brad Grande".

Brad Grand
Technical Manager

Canada modem statements

This equipment meets the applicable Industry Canada technical specifications.

The Ringer Equivalence Number, REN, is an indication of the maximum number of devices allowed to be connected to a telephone interface. The termination on an interface may consist of any combination of devices, subject only to the requirement that the sum of the RENs of all devices does not exceed 5. The REN for this terminal equipment is 1.0.

Japan modem statements

If the computer does not have the Japanese certification mark on the bottom of the computer, refer to the appropriate certification marking below.

The Japanese certification mark for the V.92 56K Data/Fax Modem is below:



If the computer does not have the Japanese certification mark on the bottom of the computer, refer to the appropriate certification marking below.

The Japanese certification mark for the LSI Corporation PCI-SV92EX Soft modem is below:



New Zealand modem statements

The grant of a Telepermit for any item of terminal equipment indicates only that Telecom has accepted that the item complies with minimum conditions for connection to its network. It indicates no endorsement of the product by Telecom, nor does it provide any sort of warranty. Above all, it provides no assurance that any item will work correctly in all respects with another item of Telepermitted equipment of a different make or model, nor does it imply that any product is compatible with all of Telecom's network services.

This equipment is not capable, under all operating conditions, of correct operation at the higher speeds for which it is designed. Telecom will accept no responsibility should difficulties arise in such circumstances.

If this device is equipped with pulse dialing, note that there is no guarantee that Telecom lines will always continue to support pulse dialing.

Use of pulse dialing, when this equipment is connected to the same line as other equipment, may give rise to bell tinkle or noise and may also cause a false answer condition. Should such problems occur, the user should *not* contact the Telecom Faults Service.

Some parameters required for compliance with Telecom's Telepermit requirements are dependent on the equipment (PC) associated with this device. The associated equipment shall be set to operate within the following limits for compliance with Telecom's Specifications:

- a. There shall be no more than 10 call attempts to the same number within any 30-minute period for any single manual call initiation.
- b. The equipment shall go on-hook for a period of not less than 30 seconds between the end of one attempt and the beginning of the next attempt.
- c. Where automatic calls are made to different numbers, the equipment shall be set to go on-hook for a period of not less than 5 seconds between the end of one attempt and the beginning of the next attempt.
- d. The equipment shall be set to ensure that calls are answered between 3 and 30 seconds of receipt of ringing (So set between 2 and 10).

Voice support

All persons using this device for recording telephone conversations shall comply with New Zealand law. This requires that at least one party to the conversation is aware that it is being recorded. In addition, the Principles enumerated in the Privacy Act 1993 shall be complied with in respect to the nature of the personal information collected, the purpose for its collection, how it is to be used, and what is disclosed to any other party.

This equipment shall not be set to make automatic calls to the Telecom '111' Emergency Service.

Macrovision Corporation notice

This product incorporates copyright protection technology that is protected by method claims of certain U.S. patents and other intellectual property rights owned by Macrovision Corporation and other rights owners. Use of this copyright protection technology must be authorized by Macrovision Corporation and is intended for home and other limited viewing uses only, unless otherwise authorized by Macrovision Corporation. Reverse engineering or disassembly is prohibited.

2 Safety notices

Important safety information

 **WARNING!** To reduce the risk of serious injury, read the *Safety & Comfort Guide*. It describes proper workstation setup, posture, and health and work habits for computer users, and provides important electrical and mechanical safety information. This guide is located on the Web at <http://www.hp.com/ergo> and on the Documentation CD that is included with the product.

The computer may be heavy; be sure to use ergonomically correct lifting procedures when moving it.

Install the computer near an AC outlet. The AC power cord is your computer's main AC disconnecting device and must be easily accessible at all times. If the power cord provided with your computer has a grounded plug, always use the power cord with a properly grounded AC outlet to avoid the risk of electric shock.

To reduce the possibility of an electric shock from the telephone network, plug your computer into the AC outlet before connecting it to the telephone line. Also, disconnect the telephone line before unplugging your computer from the AC power outlet.

Always disconnect the modem cord from the telephone system before installing or removing your computer cover.

Do not operate the computer with the cover removed.

For your safety, always unplug the computer from its power source and from any telecommunications systems (such as telephone lines), networks, or modems before performing any service procedures. Failure to do so may result in personal injury or equipment damage. Hazardous voltage levels are inside the power supply and modem of this product.

As a safety precaution, if the system power load exceeds the specific configuration's capacities, the system may temporarily disable some USB ports.

 **WARNING!** To reduce the risk of fire, electric shock, and injury to persons when using this device, always follow basic safety precautions, including the following:

- Do not use this product near water—for example, near a bathtub, wash bowl, kitchen sink or laundry tub, in a wet basement, or near a swimming pool.
- Avoid using this product during an electrical storm. There is a remote risk of electric shock from lightning.
- Do not use this product to report a gas leak while in the vicinity of the leak.
- Always disconnect the modem cable before opening the equipment enclosure or touching an uninsulated modem cable, jack, or internal component.
- If this product was not provided with a telephone line cord, use only No. 26 AWG or larger telecommunication line cord.
- Do not plug a modem or telephone cable into the RJ-45 (network) jack.

SAVE THESE INSTRUCTIONS.

 **IMPORTANT:** If your computer is provided with a voltage select switch for use in a 115 or 230 V power system, the voltage select switch has been pre-set to the correct voltage setting for use in the particular country/region where it was initially sold. Changing the voltage select switch to the incorrect position can damage your computer and void any implied warranty.

This product has not been evaluated for connection to an “IT” power system (an AC distribution system with no direct connection to earth, according to applicable safety standards).

Heat-related safety warning notice

⚠ WARNING! To reduce the possibility of heat-related injuries or of overheating the mobile computer, do not place the mobile computer directly on your lap or obstruct the computer air vents. Use the mobile computer only on a hard, flat surface. Do not allow another hard surface, such as an adjoining optional printer, or a soft surface, such as pillows or rugs or clothing, to block airflow. Also, do not allow the AC adapter to contact the skin or a soft surface, such as pillows or rugs or clothing, during operation. The mobile computer and the AC adapter comply with the user-accessible surface temperature limits defined by applicable safety standards.

Potential safety conditions notice

If you notice any of the following conditions (or if you have other safety concerns), do not use the computer: crackling, hissing, or popping sound, or a strong odor or smoke coming from the computer. It is normal for these conditions to appear when an internal electronic component fails in a safe and controlled manner. However, these conditions may also indicate a potential safety issue. Do not assume it is a safe failure. Turn off the computer, disconnect it from its power source, and contact technical support for assistance.

Installation conditions

See installation instructions before connecting this equipment to the input supply.

⚠ WARNING! Energized and moving parts may be inside the computer. Disconnect power to the equipment before removing the enclosure. Replace and secure the enclosure before re-energizing the equipment.

Acoustics notice

Sound pressure level (LpA) is far below 70dB(A) (operator position, normal operation, according to ISO 7779). To display product noise emission data, go to “IT ECO Declarations” at <http://www.hp.com/go/ted>, and then select a product category from the drop-down menu.

Battery notices

⚠ WARNING! The product may contain an internal lithium manganese dioxide, vanadium pentoxide, or alkaline battery or battery pack. There is risk of fire and burns if the battery pack is not handled properly.

⚠ WARNING! Do not attempt to recharge the battery.

⚠ WARNING! Do not expose to temperatures higher than 60° C (140° F).

⚠ WARNING! To reduce potential safety issues, only the battery provided with the computer, a replacement battery provided by HP, or a compatible battery purchased as an accessory from HP should be used with the computer. Fast charging may not be available for non-compatible or non-HP batteries.

⚠ WARNING! To reduce the risk of fire or burns, do not disassemble, crush, puncture, short external contacts, or dispose of in fire or water.

⚠ WARNING! Risk of explosion if battery is replaced by an incorrect type. Dispose of used batteries according to the instructions.

⚠ WARNING! Replace only with the HP spare designated for this product.

- ⚠ **WARNING!** Do not ingest battery, a Chemical Burn Hazard.
- ⚠ **WARNING!** This product contains a coin/button cell battery. If the coin/button cell battery is swallowed, it can cause severe internal burns in just 2 hours and can lead to death.
- ⚠ **WARNING!** Keep new and used batteries away from children.
- ⚠ **WARNING!** If the battery compartment does not close securely, stop using the product and keep it away from children.
- ⚠ **WARNING!** If you think batteries might have been swallowed or placed inside any part of the body, seek immediate medical attention.
- ⚠ **WARNING!** Leaving a battery in an extremely high temperature surrounding environment can result in an explosion or the leakage of flammable liquid or gas.
- ⚠ **WARNING!** A battery subjected to extremely low air pressure may result in an explosion or the leakage of flammable liquid or gas.

Icon	Description
	Batteries, battery packs, and accumulators should not be disposed of together with the general household waste. In order to forward them to recycling or proper disposal, please use the public collection system or return them to HP, an authorized HP partner, or their agents.

Fan notices

- ⚠ **WARNING!**  Keep body parts away from moving parts.
- ⚠ **WARNING!** Keep body parts away from fan blades.
- ⚠ **WARNING!** Keep body parts out of the motion path.

Headset and earphone volume level notice

- ⚠ **WARNING!**  To prevent possible hearing damage, do not listen at high volume levels for long periods.

Adjustment of the volume control as well as the equalizer to other settings than the center position may increase the ear-/headphones output voltage and therefore the sound pressure level. The use of factors influencing the ear-/headphones output other than those specified by the manufacturer (e.g. operating system, equalizer software, firmware, driver) may increase the ear-/headphones output voltage and therefore the sound pressure level.

Laser safety

For products equipped with optical drives or fiber optic transceivers.

This product may be provided with an optical storage device (i.e., CD or DVD drive) and/or fiber optic transceiver. These contain lasers and are classified as Class 1 Laser Products in accordance with the standard IEC/EN 60825-1 and comply with its requirements.

Each laser product complies with US FDA Regulations of 21 CFR 1040.10 and 1040.11 or complies with those regulations except for deviations pursuant to Laser Notice No. 50, dated June 24, 2007.

⚠ WARNING! Use of controls or adjustments or performance of procedures other than those specified herein or in the laser product's installation guide may result in hazardous radiation exposure. To reduce the risk of exposure to hazardous radiation:

- Do not try to open the module enclosure. There are no user-serviceable components inside.
 - Do not operate controls, make adjustments, or perform procedures to the laser device other than those specified herein.
 - Allow only HP Authorized Service technicians to repair the unit.
-

Power supply and power cord set requirements

Power supply class I grounding requirements

For protection from fault currents, the equipment shall be connected to a grounding terminal. Plug the system power cord into an AC outlet that provides a ground connection. Substitute cords may not provide adequate fault protection. Only use the power cord supplied with this product or an HP Inc. authorized replacement.

Brazil notice

Este equipamento deve ser conectado obrigatoriamente em tomada de rede de energia elétrica que possua aterramento (três pinos), conforme a norma nbr abnt 5410, visando a segurança dos usuários contra choques elétricos.

Denmark

Apparatets stikprop skal tilsluttes en stikkontakt med jord, som giver forbindelse til stikproppens jord.

Finland

Laite on liitettävä suojakoskettimilla varustettuun pistorasiaan.

Norway

Apparatet må tilkoples jordet stikkontakt.

Sweden

Apparaten skall anslutas till jordat uttag.

Power supply requirements

The power supplies on some products have external power switches. The voltage select switch feature on the product permits it to operate from any line voltage between 100-127 or 200-240 volts AC. Power supplies on those products that do not have external power switches are equipped with internal circuits that sense the incoming voltage and automatically switch to the proper voltage.

⚠ WARNING! To reduce potential safety issues, only the AC adapter provided with the computer, a replacement AC adapter provided by HP, or an AC adapter purchased as an accessory from HP should be used with the computer.

For use in Norway

This product is also designed for an IT power system with phase-to-phase voltage 230V.

Power cord set requirements

⚠ WARNING! To reduce the risk of electric shock or damage to the equipment:

- Plug the power cord into an AC outlet that is easily accessible at all times.
- Disconnect power from the computer by unplugging the power cord from the AC outlet.
- If provided with a 3-pin attachment plug on the power cord, plug the cord into a grounded (earthed) 3-pin outlet. Do not disable the power cord grounding pin, for example, by attaching a 2-pin adapter. The grounding pin is an important safety feature.

The power cord set received with the product meets the requirements for use in the country where the equipment was originally purchased. Use only the power cord provided with the unit or an authorized replacement power cord from HP Inc. or an approved HP Inc. source. Replacement part numbers may be found at <http://www.hp.com/support>.

Power cord sets for use in other countries must meet the requirements of the country where you use the product. For more information on power cord set requirements, contact your authorized HP dealer, reseller, or service provider.

⚠ WARNING! Do not use power cords from other products.

Mismatched power cords may result in a shock and fire hazard.

The requirements listed below are applicable to all countries:

1. The power cord must be approved by an acceptable accredited agency responsible for evaluation in the country where the power cord set will be installed.
2. The length of the power cord must be between 1.8 m (6 feet) and 3.6 m (12 feet). For a power cord 2.0 m (6.56 feet) or less, the diameter of the wire must be a minimum of 0.75 mm² or 18AWG. If the power cord is longer than 2.0 m (6.56 feet), the diameter of the wire must be a minimum of 1.0 mm² or 16AWG.

The power cord should be routed so that it is not likely to be walked on or pinched by items placed upon it or against it. Particular attention should be paid to the plug, electrical outlet, and the point where the cord exits from the product.

⚠ WARNING! Do not operate this product with a damaged power cord set. If the power cord set is damaged in any manner, replace it immediately. Damaged cords may result in user exposure to hazards.

Power cord notice

If you were not provided with a power cord for the computer or for an external power accessory intended for use with the computer, you should purchase a power cord that is approved for use in your country or region.

The power cord must be rated for the product and for the voltage and current marked on the product's electrical ratings label. The voltage and current rating of the cord should be greater than the voltage and current rating marked on the product. In addition, the diameter of the wire must be a minimum of **0.75 mm²**/18AWG, and the length of the cord must be between **1.0 m** (3.2 ft) and **2 m** (6.56 ft). If you have questions about the type of power cord to use, contact your authorized service provider.

A power cord should be routed so that it is not likely to be walked on or pinched by items placed upon it or against it. Particular attention should be paid to the plug, electrical outlet, and the point where the cord exits from the product.

DC plug of external HP power supply



Japan power cord notice

製品には、同梱された電源コードをお使い下さい。
同梱された電源コードは、他の製品では使用出来ません。

Japan power cord requirements

For use in Japan, use only the power cord received with this product.

⚠ CAUTION: Do not use the power cord received with this product on any other products.

Pinch hazard

⚠ WARNING! Observe pinch hazard areas. Keep fingers away from closing parts.

TV antenna connectors protection

External television antenna grounding

If an outside antenna or cable system is connected to the product, be sure the antenna or cable system is electrically grounded so as to provide some protection against voltage surges and built-up static charges. Article 810 of the National Electrical Code, ANSI/NFPA 70, provides information with regard to proper electrical grounding of the mast and supporting structure, grounding of the lead-in wire to an antenna-discharge unit, size of grounding conductors, location of antenna-discharge unit, connection to grounding electrodes, and requirements for the grounding electrode.

Lightning protection

For added protection of any product during a lightning storm, or when it is left unattended and unused for long periods of time, unplug the product from the wall outlet and disconnect the antenna or cable system. This will prevent damage to the product from lightning and power line surges.

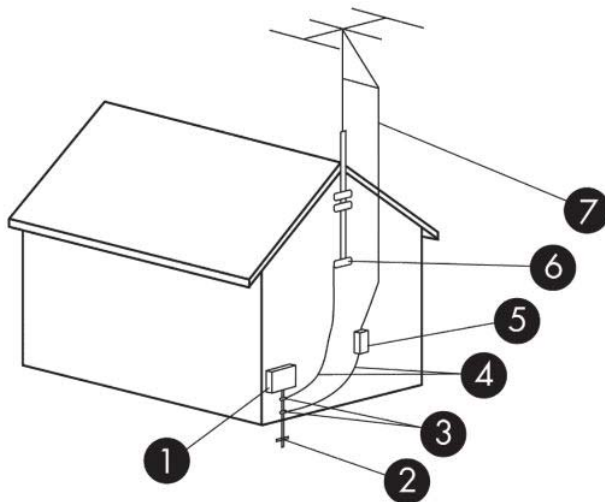

Table 2-1 Antenna Grounding

Reference	Grounding Component
1	Electric Service Equipment

Table 2-1 Antenna Grounding (continued)

Reference	Grounding Component
2	Power Service Grounding Electrode System (NEC Art 250, Part III)
3	Ground Clamps
4	Grounding Conductors (NEC Section 810.21)
5	Antenna Discharge Unit (NEC Section 810.20)
6	Ground Clamp
7	Antenna Lead-in Wire

Note to CATV system installer

This reminder is provided to call the CATV systems installer's attention to section 820.93 of the National Electric Code, which provides guidelines for proper grounding and in particular, specify that the Coaxial cable shield shall be connected to grounding system of the building, as close to the point of cable entry as practical.

Travel notice

 **WARNING!** To reduce the risk of electric shock, fire, or damage to the equipment, do not attempt to power the computer with a voltage converter kit sold for appliances.

China safety notices

HP 工作站使用安全手册

使用须知

欢迎使用惠普工作站，为了您及仪器的安全，请您务必注意如下事项：

1. 仪器要和地线相接，要使用有正确接地插头的电源线，使用中国国家规定的 220V 电源。
2. 避免高温和尘土多的地方，否则易引起仪器内部部件的损坏。
3. 避免接近高温，避免接近直接热源，如直射太阳光、暖气等其它发热体。
4. 不要有异物或液体落入机内，以免部件短路。
5. 不要将磁体放置于仪器附近。

警告

为防止火灾或触电事故，请不要将该机放置于淋雨或潮湿处

如果您按照以上步骤操作时遇到了困难，或想了解其它产品性能，请在以下网页上寻找相关信息：<http://www.hp.com.cn>

或联系我们

中国惠普有限公司
地址：北京朝阳区建国路 112 号中国惠普大厦
电话：010-65643888

China: Altitude notice

海拔警告仅适用于在海拔 2000m 以下地区使用的产品

Icon	Description
	海拔警告仅适用于在海拔 2000m 以下地区使用的产品。

China: Tropical warning notice

热带警告仅适用于在非热带气候条件下使用的产品。

Icon	Description
	热带警告仅适用于在非热带气候条件下使用的产品。

Norway and Sweden: Cable grounding notice for products with a TV tuner

 **CAUTION:** To reduce potential safety issues, use a galvanic isolator when connecting to a cable distribution system.

使用過度恐傷害視力

注意事項:

- (1) 使用 30 分鐘請休息 10 分鐘。
- (2) 未滿 2 歲幼兒不看螢幕，2 歲以上每天看螢幕不要超過 1 小時。

3 Environmental notices

This chapter provides country- and region-specific environmental notices and compliance information. Some of these notices may not apply to your product.

Electronic hardware, packaging and battery recycling

HP encourages customers to recycle used electronic hardware, HP original print cartridges packaging, and rechargeable batteries. For more information about recycling programs, go to <http://www.hp.com/recycle>.

For information about recycling the product in Japan, refer to <http://www.hp.com/jp/hardwarerecycle/>.

Disposal of waste equipment by users

Icon	Description
	This symbol means do not dispose of your product with your other household waste. Instead, you should protect human health and the environment by handing over your waste equipment to a designated collection point for the recycling of waste electrical and electronic equipment. For more information, please contact your household waste disposal service or go to http://www.hp.com/recycle .

Brazil alkaline battery disposal

Icon	Description
	Este produto eletroeletrônico e seus componentes não devem ser descartados no lixo comum, pois embora estejam em conformidade com padrões mundiais de restrição a substâncias nocivas, podem conter, ainda que em quantidades mínimas, substâncias impactantes ao meio ambiente. Ao final da vida útil deste produto, o usuário deverá entregá-lo à HP. A não observância dessa orientação sujeitará o infrator às sanções previstas em lei. Após o uso, as pilhas e/ou baterias dos produtos HP deverão ser entregues ao estabelecimento comercial ou rede de assistência técnica autorizada pela HP.
Não descarte o produto eletrônico em lixo comum	Para maiores informações, inclusive sobre os pontos de recebimento, acesse: http://www.hp.com.br/reciclar

Brazil hardware recycling information

Icon	Description
	Este produto eletroeletrônico e seus componentes não devem ser descartados no lixo comum, pois embora estejam em conformidade com padrões mundiais de restrição a substâncias nocivas, podem conter, ainda que em quantidades mínimas, substâncias impactantes ao meio ambiente. Ao final da vida útil deste produto, o usuário deverá entregá-lo à HP. A não observância dessa orientação sujeitará o infrator às sanções previstas em lei. Após o uso, as pilhas e/ou baterias dos produtos HP deverão ser entregues ao estabelecimento comercial ou rede de assistência técnica autorizada pela HP.
Não descarte o produto eletrônico em lixo comum	Para maiores informações, inclusive sobre os pontos de recebimento, acesse: http://www.hp.com.br/reciclar

Taiwan battery recycling information

Icon	Description
 廢電池請回收	<p>The Taiwan EPA requires dry battery manufacturing or importing firms, in accordance with Article 15 of the Waste Disposal Act, to indicate the recovery marks on the batteries used in sales, giveaways, or promotions. Contact a qualified Taiwanese recycler for proper battery disposal.</p>

ENERGY STAR® Certification (select products only)

ENERGY STAR is a U.S. Environmental Protection Agency voluntary program that helps businesses and individuals save money and protect our climate through superior energy efficiency. Products that earn the ENERGY STAR prevent greenhouse gas emissions by meeting strict energy efficiency criteria or requirements set by the U.S. Environmental Protection Agency. As an ENERGY STAR Partner, HP Inc. has followed the U.S. EPA’s enhanced product certification process to ensure that products marked with the ENERGY STAR logo are ENERGY STAR certified per the applicable ENERGY STAR guidelines. The following logo appears on all ENERGY STAR-certified computers:



A key ENERGY STAR requirement for computer products is power management features that significantly reduce energy consumption when the product is not in use. Power management allows a computer to automatically enter a low power “sleep” mode, or other low power mode, after a defined period of inactivity. The power management features have been preset as follows when the computer is operating on AC power:

Computer type	Time to activate display sleep mode	Time to activate computer sleep mode (minutes)	Resuming from sleep mode
Notebooks, Mobile Workstations	Less than or equal to 15 minutes (varies by model)	Less than or equal to 30 minutes (varies by model)	<p>Product will exit sleep mode when the power/sleep button is pressed.</p> <p>If Wake-on-Lan (WOL) is enabled, the system can resume from sleep in response to a network signal.</p>
Tablets/Slates	Less than or equal to 1 minute	Not applicable	Not applicable
Desktops, Integrated Desktops, Workstations	Less than or equal to 15 minutes (varies by model)	Less than or equal to 30 minutes (varies by model)	<p>Product will exit sleep mode when user interacts with any input device, including the mouse or keyboard.</p> <p>If Wake-on-Lan (WOL) is enabled, the system can resume from sleep in response to a network signal.</p>
Thin clients	Less than or equal to 15 minutes (varies by model)	Less than or equal to 30 minutes when sleep mode is supported by the operating system (varies by model)	When sleep mode is supported by operating system product will exit sleep mode when user interacts with any input device, including the mouse or keyboard.

Computer type	Time to activate display sleep mode	Time to activate computer sleep mode (minutes)	Resuming from sleep mode
			If Wake-on-Lan (WOL) is enabled, the system can resume from sleep in response to a network signal.

For computers that support an always-on, always-connected use profile where internet access is available (such as tablets and slates), alternative low power modes - such as Short or Long Idle modes (as defined in the ENERGY STAR Computer Program Requirements) are provided that consume very little power (<= 10 Watts) and when applicable, maximize product battery life. These alternative low power modes are dynamic, with the display sleep mode activated within 1 minute of user inactivity.

The computer exits Sleep when the power/Sleep button is pressed. When the Wake On LAN (WOL) feature is enabled, the computer can also exit Sleep in response to a network signal.

Additional information on the potential energy and financial savings of the power management feature can be found on the EPA ENERGY STAR Power Management website at <http://www.energystar.gov/powermanagement>.

Additional information on the ENERGY STAR program and its environmental benefits are available on the EPA ENERGY STAR website at <http://www.energystar.gov>.

ENERGY STAR and the ENERGY STAR mark are registered trademarks owned by the U.S. Environmental Protection Agency.

Chemical substances

HP is committed to providing our customers with information about the chemical substances in our products as needed to comply with legal requirements such as REACH (Regulation EC No. 1907/2006 of the European Parliament and the Council). A chemical information report for this product can be found at <http://www.hp.com/go/reach>.

Mercury statement

This statement applies to all-in-one computers with built-in display panels that do not use LED backlighting.

This HP product may contain the following material that might require special handling at end-of-life:

- Mercury in the fluorescent lamp in the display LCD

Disposal of mercury can be regulated because of environmental considerations. For disposal or recycling information, please contact your local authorities or the Electronic Industries Alliance (EIA) (<http://www.eiae.org>).

Perchlorate material—special handling may apply

The computer's real-time clock battery may contain perchlorate and may require special handling when recycled or disposed of in California. See <http://www.dtsc.ca.gov/hazardouswaste/perchlorate/>.

China environmental notices

回收信息说明

惠普公司对废弃的电子计算机（笔记本电脑）提供回收服务，更多信息请登陆

<http://www8.hp.com/us/en/hp-information/environment/product-recycling.html>

China PC energy label

In accordance with “The Regulation of the Implementation on China Energy Label for Microcomputers”, this microcomputer has an Energy Efficiency Label. The energy efficiency grade, TEC (Typical Energy Consumption), and product category presented on the label are determined and calculated according to the standard GB28380-2012.

1. Energy Efficiency Grades

The grade is determined by the standard with the calculation of base consumption level with the sum of all the allowances for additional components such as main memory and graphics card. For products of any grade, the TEC should not exceed the value specified in the following table:

Product Type		TEC (kilowatt hour)		
		Grade 1	Grade 2	Grade 3
Desktop microcomputer, AIO	Category A	98.0+ Σ Efa	148.0+ Σ Efa	198.0+ Σ Efa
	Category B	125.0+ Σ Efa	175.0+ Σ Efa	225.0+ Σ Efa
	Category C	159.0+ Σ Efa	209.0+ Σ Efa	259.0+ Σ Efa
	Category D	184.0+ Σ Efa	234.0+ Σ Efa	284.0+ Σ Efa
Portable Computer	Category A	20.0+ Σ Efa	35.0+ Σ Efa	45.0+ Σ Efa
	Category B	26.0+ Σ Efa	45.0+ Σ Efa	65.0+ Σ Efa
	Category C	54.5+ Σ Efa	75.0+ Σ Efa	123.5+ Σ Efa

NOTE: Σ Efa is the sum of power factor of product additional functions.

2. Typical Energy Consumption

The energy consumption figure presented on the label is the data measured with the representative configuration that covers all the configurations in the registration unit which is selected according to “The Regulation of the Implementation on China Energy Label for Microcomputers”. Thus, actual energy consumption of this specific microcomputer may not be the same as the TEC data presented in the label.

3. Product Category

The product category is determined by the standard according to the microcomputer’s configuration. The categorization of products complies with the regulations in the following table:

Product Type	Configuration Description
Desktop microcomputer, AIO	Portable Computer

Product Type	Configuration Description	
Category A	The desktop microcomputer and AIO whose configuration is out of the scope of Category B, C, and D	The portable computer whose configuration is out of the scope of Category B and C
Category B	CPU physical core number of 2, and system memory of not less than 2 GB	A Discrete GPU
Category C	CPU physical core number of over 2, with at least one of the following features: <ol style="list-style-type: none"> 1. System memory of not less than 2 GB 2. A Discrete GPU 	The product that has a CPU physical core number of not less than 2, system memory of not less than 2GB, A Discrete GPU with Frame Buffer Width not less than 128-bit.
Category D	CPU physical core number of not less than 4, with at least one of the following features: <ol style="list-style-type: none"> 1. System memory of not less than 4 GB 2. A Discrete GPU with Frame Buffer Width not less than 128-bit 	

For more details on the specification, please refer to the standard GB28380-2012.

本机根据《微型计算机能源效率标识实施规则》的要求加施中国能效标识。能效标识中显示的能效等级、典型能源消耗和产品类型均根据《微型计算机能效限定值及能效等级》（GB28380-2012）的要求确定。对上述标识内容的说明如下：

1. 能效等级

微型计算机的能效等级由基础能源消耗值和附加功能功耗因子之和决定。微型计算机能效各等级的典型能源消耗应不大于下表的规定

微型计算机类型		能源消耗(千瓦时)		
		1	2	3
台式微型计算机及一体机	A类	$98.0+\Sigma E_{fa}$	$148.0+\Sigma E_{fa}$	$198.0+\Sigma E_{fa}$
	B类	$125.0+\Sigma E_{fa}$	$175.0+\Sigma E_{fa}$	$225.0+\Sigma E_{fa}$
	C类	$159.0+\Sigma E_{fa}$	$209.0+\Sigma E_{fa}$	$259.0+\Sigma E_{fa}$
	D类	$184.0+\Sigma E_{fa}$	$234.0+\Sigma E_{fa}$	$284.0+\Sigma E_{fa}$
便携式计算机	A类	$20.0+\Sigma E_{fa}$	$35.0+\Sigma E_{fa}$	$45.0+\Sigma E_{fa}$
	B类	$26.0+\Sigma E_{fa}$	$45.0+\Sigma E_{fa}$	$65.0+\Sigma E_{fa}$
	C类	$54.5+\Sigma E_{fa}$	$75.0+\Sigma E_{fa}$	$123.5+\Sigma E_{fa}$

注： ΣE_{fa} 为微型计算机附加功能功耗因子之和

2. 典型能源消耗

典型能源消耗值代表一个备案单元中，符合《微型计算机能源效率标识实施规则》要求的代表性规格型号产品的数值。因此，本机的典型能源消耗值可能与其所加施的能效标识中所示的典型能源消耗值不一致。

3. 产品类型

产品类型根据微型计算机的配置确定。参见下表：

类型	配置说明	
	台式微型计算机及一体机	便携式计算机
A类	下列B类、C类、D类配置以外的台式微型计算机及一体机	下列B类、C类配置以外的便携式计算机
B类	中央处理器(CPU)物理核心数为2,系统内存大于等于2GB	具有独立图形显示单元(GPU)
C类	中央处理器(CPU)物理核心数大于2,且至少具有以下特征中的一条 a. a) 系统内存大于等于2GB; b. 独立图形显示单元(GPU)	中央处理器(CPU)物理核心数大于等于2,系统内存大于等于2GB,具有独立图形显示单元(GPU)且显存位宽大于等于128位。
D类	中央处理器(CPU)物理核心数大于等于4,且至少具有以下特征中的一条: a. 系统内存大于等于4GB; b. 具有独立图形显示单元(GPU)且显存位宽大于等于128位	

关于标识内容的更详细技术信息，请参考《微型计算机能效限定值及能效等级》(GB28380-2012)

China restriction of hazardous substances (RoHS) for notebook and tablet computers

The Table of Hazardous Substances/Elements and their Content

As required by China's Management Methods for Restricted Use of Hazardous Substances in Electrical and Electronic Products



Part Name	Hazardous Substances					
	Lead (Pb)	Mercury (Hg)	Cadmium (Cd)	Hexavalent Chromium (Cr(VI))	Polybrominated biphenyls (PBB)	Polybrominated diphenyl ethers (PBDE)
Battery	X	0	0	0	0	0
Cables	X	0	0	0	0	0
Camera	X	0	0	0	0	0
Chassis/Other	X	0	0	0	0	0
Flash memory card reader	X	0	0	0	0	0
Floppy disk drive	X	0	0	0	0	0
Hard disk drive	X	0	0	0	0	0
Headphones	X	0	0	0	0	0
I/O PCAs	X	0	0	0	0	0
Keyboard	X	0	0	0	0	0
Liquid crystal display (LCD) panel	X	0	0	0	0	0
Media (CD/DVD/floppy)	0	0	0	0	0	0
Memory	X	0	0	0	0	0
Motherboard, processor, heat sinks	X	0	0	0	0	0
Mouse	X	0	0	0	0	0
Optical disk drive	X	0	0	0	0	0
Optional docking device	X	0	0	0	0	0
Power adapter	X	0	0	0	0	0
Power pack	X	0	0	0	0	0
Power supply	X	0	0	0	0	0
Remote control	X	0	0	0	0	0
Smart card/Java™ card reader	X	0	0	0	0	0
Speakers, external	X	0	0	0	0	0

Part Name	Hazardous Substances					
	Lead (Pb)	Mercury (Hg)	Cadmium (Cd)	Hexavalent Chromium (Cr(VI))	Polybrominated biphenyls (PBB)	Polybrominated diphenyl ethers (PBDE)
TV tuner	X	0	0	0	0	0
USB flash memory drive	X	0	0	0	0	0
USB hub	X	0	0	0	0	0
Web camera	X	0	0	0	0	0
Wireless receiver	X	0	0	0	0	0
Wireless cards	X	0	0	0	0	0

This form has been prepared in compliance with the provisions of SJ/T 11364.

0: Indicates that the content of said hazardous substance in all of the homogenous materials in the component is within the limits required by GB/T 26572.

X: Indicates that the content of said hazardous substance exceeds the limits required by GB/T 26572 in at least one homogenous material in the component.

All parts named in this table with an "X" are in compliance with the European Union's RoHS Legislation.

NOTE: The referenced Environmental Protection Use Period Marking was determined according to normal operating use conditions of the product such as temperature and humidity.

笔记本电脑和平板电脑产品中有害物质或元素的名称及含量

根据中国《电器电子产品有害物质限制使用管理办法》



部件名称	有害物质					
	铅 (Pb)	汞 (Hg)	镉 (Cd)	六价铬 (Cr(VI))	多溴联苯 (PBB)	多溴二苯醚 (PBDE)
电池	X	0	0	0	0	0
线缆	X	0	0	0	0	0
摄像头	X	0	0	0	0	0
机箱/其他	X	0	0	0	0	0
闪存读卡器	X	0	0	0	0	0
软盘驱动器	X	0	0	0	0	0
硬盘驱动器	X	0	0	0	0	0
耳机	X	0	0	0	0	0
I/O PCA	X	0	0	0	0	0
键盘	X	0	0	0	0	0
液晶显示器 (LCD) 面板	X	0	0	0	0	0
介质 (CD/DVD/软盘)	0	0	0	0	0	0

部件名称	有害物质					
	铅 (Pb)	汞 (Hg)	镉 (Cd)	六价铬 (Cr(VI))	多溴联苯 (PBB)	多溴二苯醚 (PBDE)
内存	X	0	0	0	0	0
主板、处理器、散热器	X	0	0	0	0	0
鼠标	X	0	0	0	0	0
光盘驱动器	X	0	0	0	0	0
对接设备选件	X	0	0	0	0	0
电源适配器	X	0	0	0	0	0
电源	X	0	0	0	0	0
电源组	X	0	0	0	0	0
投影仪	X	0	0	0	0	0
遥控器	X	0	0	0	0	0
智能卡/Java™ 读卡器	X	0	0	0	0	0
扬声器 (外置)	X	0	0	0	0	0
电视调谐器	X	0	0	0	0	0
USB 闪存驱动器	X	0	0	0	0	0
USB 集线器	X	0	0	0	0	0
网络摄像头	X	0	0	0	0	0
无线接收器	X	0	0	0	0	0
无线网卡	X	0	0	0	0	0

本表格依据 SJ/T 11364 的规定编制。

0：表示该有害物质在该部件所有均质材料中的含量均在 GB/T 26572 规定的限量要求以下。

X：表示该有害物质至少在该部件的某一均质材料中的含量超出 GB/T 26572 规定的限量要求。

注：环保使用期限的参考标识取决于产品正常工作的温度和湿度等条件

China restriction of hazard substances (ROHS) for desktops, thin clients, personal workstations, all-in-ones, and point-of-sale terminals

The Table of Hazardous Substances/Elements and their Content

As required by China's Management Methods for Restricted Use of Hazardous Substances in Electrical and Electronic Products



Part Name	Hazardous Substances					
	Lead (Pb)	Mercury (Hg)	Cadmium (Cd)	Hexavalent Chromium (Cr(VI))	Polybrominated biphenyls (PBB)	Polybrominated diphenyl ethers (PBDE)
Battery	X	0	0	0	0	0
Cables	X	0	0	0	0	0
Camera	X	0	0	0	0	0
Chassis/Other	X	0	0	0	0	0
Fan	X	0	0	0	0	0
Flash memory card reader	X	0	0	0	0	0
Floppy disk drive	X	0	0	0	0	0
Hard disk drive	X	0	0	0	0	0
Headphones	X	0	0	0	0	0
Heat sink	X	0	0	0	0	0
I/O PCAs	X	0	0	0	0	0
Keyboard	X	0	0	0	0	0
Liquid crystal display (LCD) panel	X	0	0	0	0	0
Media (CD/DVD/floppy)	0	0	0	0	0	0
Memory	X	0	0	0	0	0
Motherboard, processor, heat sinks	X	0	0	0	0	0
Mouse	X	0	0	0	0	0
Optical disk drive	X	0	0	0	0	0
Optional docking device	X	0	0	0	0	0
Power adapter	X	0	0	0	0	0
Power supply	X	0	0	0	0	0
Projector	X	0	0	0	0	0
Remote control	X	0	0	0	0	0
Smart card/Java™ card reader	X	0	0	0	0	0
Solid-state drives	X	0	0	0	0	0
Speakers, external	X	0	0	0	0	0
Stylus	X	0	0	0	0	0
Touch mat	X	0	0	0	0	0
TV tuner	X	0	0	0	0	0
USB flash memory drive	X	0	0	0	0	0

Part Name	Hazardous Substances					
	Lead (Pb)	Mercury (Hg)	Cadmium (Cd)	Hexavalent Chromium (Cr(VI))	Polybrominated biphenyls (PBB)	Polybrominated diphenyl ethers (PBDE)
USB hub	X	0	0	0	0	0
Web camera	X	0	0	0	0	0
Wireless receiver	X	0	0	0	0	0
Wireless cards	X	0	0	0	0	0
3D Capture Stage/ Turntable	X	0	0	0	0	0

This form has been prepared in compliance with the provisions of SJ/T 11364.

0: Indicates that the content of said hazardous substance in all of the homogenous materials in the component is within the limits required by GB/T 26572.

X: Indicates that the content of said hazardous substance exceeds the limits required by GB/T 26572 in at least one homogenous material in the component.

All parts named in this table with an "X" are in compliance with the European Union's RoHS Legislation.

NOTE: The referenced Environmental Protection Use Period Marking was determined according to normal operating use conditions of the product such as temperature and humidity.

台式机、瘦客户端、个人工作站、一体机和销售点终端产品中有害物质或元素的名称及含量 (ROHS)

根据中国《电器电子产品有害物质限制使用管理办法》



部件名称	有害物质					
	铅 (Pb)	汞 (Hg)	镉 (Cd)	六价铬 (Cr(VI))	多溴联苯 (PBB)	多溴二苯醚 (PBDE)
电池	X	0	0	0	0	0
线缆	X	0	0	0	0	0
摄像头	X	0	0	0	0	0
机箱/其他	X	0	0	0	0	0
风扇	X	0	0	0	0	0
闪存读卡器	X	0	0	0	0	0
软盘驱动器	X	0	0	0	0	0
硬盘驱动器	X	0	0	0	0	0
耳机	X	0	0	0	0	0
散热器	X	0	0	0	0	0
I/O PCA	X	0	0	0	0	0

部件名称	有害物质					
	铅 (Pb)	汞 (Hg)	镉 (Cd)	六价铬 (Cr(VI))	多溴联苯 (PBB)	多溴二苯醚 (PBDE)
键盘	X	0	0	0	0	0
液晶显示器 (LCD) 面板	X	0	0	0	0	0
介质 (CD/DVD/软盘)	0	0	0	0	0	0
内存	X	0	0	0	0	0
主板、处理器、散热器	X	0	0	0	0	0
鼠标	X	0	0	0	0	0
光驱	X	0	0	0	0	0
对接设备选件	X	0	0	0	0	0
电源适配器	X	0	0	0	0	0
电源	X	0	0	0	0	0
投影仪	X	0	0	0	0	0
遥控器	X	0	0	0	0	0
智能卡/Java™ 读卡器	X	0	0	0	0	0
固态驱动器	X	0	0	0	0	0
扬声器 (外置)	X	0	0	0	0	0
触控笔	X	0	0	0	0	0
触控板	X	0	0	0	0	0
电视调谐器	X	0	0	0	0	0
USB 闪存驱动器	X	0	0	0	0	0
USB 集线器	X	0	0	0	0	0
网络摄像头	X	0	0	0	0	0
无线接收器	X	0	0	0	0	0
无线网卡	X	0	0	0	0	0
3D 捕获台/转盘	X	0	0	0	0	0

本表格依据 SJ/T 11364 的规定编制。

0：表示该有害物质在该部件所有均质材料中的含量均在 GB/T 26572 规定的限量要求以下。

X：表示该有害物质至少在该部件的某一均质材料中的含量超出 GB/T 26572 规定的限量要求。

注：环保使用期限的参考标识取决于产品正常工作的温度和湿度等条件

台灣針對筆記型電腦和平板電腦的有害物質限制使用管理辦法 (RoHS)

限用物質含有情況標示聲明書

Declaration of the Presence Condition of the Restricted Substances Marking

限用物質及其化學符號						
Restricted substances and its chemical symbols						
單元 Unit	鉛 Lead (Pb)	汞 Mercury (Hg)	鎘 Cadmium (Cd)	六價鉻 Hexavalent chromium (Cr ⁺⁶)	多溴聯苯 Polybrominated biphenyls (PBB)	多溴二苯醚 Polybrominated diphenyl ethers (PBDE)
纜線 Cables	—	0	0	0	0	0
機殼/其他 Chassis/Other	—	0	0	0	0	0
輸入/輸出印刷 電路組件 I/O PCAs	—	0	0	0	0	0
液晶顯示器 (LCD) 面板 Liquid crystal display (LCD) panel	—	0	0	0	0	0
記憶體 Memory	0	0	0	0	0	0
主機板、處理 器、散熱器 Motherboard, processor, heat sinks	—	0	0	0	0	0
電源組 Power pack	—	0	0	0	0	0
電源供應器 Power supply	—	0	0	0	0	0
儲存裝置 Storage Devices	—	0	0	0	0	0
無線裝置 Wireless Devices	—	0	0	0	0	0

備考 1：「超出 0.1 %」及「超出 0.01 %」係指限用物質之百分比含量超出百分比含量基準值。
Note 1: "Exceeding 0.1 wt %" and "exceeding 0.01 wt %" indicate that the percentage content of the restricted substance exceeds the reference percentage value of presence condition.

備考 2：「0」係指該項限用物質之百分比含量未超出百分比含量基準值。
Note 2: "0" indicates that the percentage content of the restricted substance does not exceed the percentage of reference value of presence.

備考 3：「—」係指該項限用物質為排除項目。
Note 3: The "—" indicates that the restricted substance corresponds to the exemption.

若要取得最新版使用指南，請前往 <http://www.hp.com/support>，並依照指示尋找您的產品。然後選取「使用指南」。

To access the latest user guides, go to <http://www.hp.com/support>, and follow the instructions to find your product. Then select **User Guides**.

台灣針對桌上型電腦、精簡型電腦、個人工作站、一體成形電腦及銷售點終端機的有害物質限制使用管理辦法 (RoHS)

限用物質含有情況標示聲明書

Declaration of the Presence Condition of the Restricted Substances Marking

限用物質及其化學符號						
Restricted substances and its chemical symbols						
單元 Unit	鉛 Lead (Pb)	汞 Mercury (Hg)	鎘 Cadmium (Cd)	六價鉻 Hexavalent chromium (Cr *6)	多溴聯苯 Polybrominated biphenyls (PBB)	多溴二苯醚 Polybrominated diphenyl ethers (PBDE)
纜線 Cables	—	○	○	○	○	○
機座/其他 Chassis/Other	—	○	○	○	○	○
輸入/輸出印刷電路組件 I/O PCAs	—	○	○	○	○	○
液晶顯示器 (LCD) 面板 Liquid crystal display (LCD) panel (for AIO only)	—	○	○	○	○	○
記憶體 Memory	○	○	○	○	○	○
主機板、處理器、散熱器 Motherboard, processor, heat sinks	—	○	○	○	○	○
電源供應器 Power supply	—	○	○	○	○	○
儲存裝置 Storage Devices	—	○	○	○	○	○

備考 1：「超出 0.1 %」及「超出 0.01 %」係指限用物質之百分比含量超出百分比含量基準值。
 Note 1: "Exceeding 0.1 wt %" and "exceeding 0.01 wt %" indicate that the percentage content of the restricted substance exceeds the reference percentage value of presence condition.

備考 2：「○」係指該項限用物質之百分比含量未超出百分比含量基準值。
 Note 2: "O" indicates that the percentage content of the restricted substance does not exceed the percentage of reference value of presence.

備考 3：「—」係指該項限用物質為排除項目。
 Note 3: The "—" indicates that the restricted substance corresponds to the exemption.

若要取得最新版使用指南，請前往 <http://www.hp.com/support>，並依照指示尋找您的產品。然後選取「使用指南」。

To access the latest user guides, go to <http://www.hp.com/support>, and follow the instructions to find your product. Then select **User Guides**.

India restriction of hazardous substances (RoHS)

This product, as well as its related consumables and spares, complies with the reduction in hazardous substances provisions of the "India E-waste Rule 2016." It does not contain lead, mercury, hexavalent chromium, polybrominated biphenyls or polybrominated diphenyl ethers in concentrations exceeding 0.1 weight % and 0.01 weight % for cadmium, except where allowed pursuant to the exemptions set in Schedule 2 of the Rule.

Information for European Union Commission Regulation 1275/2008

To locate product power consumption data, including when the product is in networked standby with all wired network ports connected and wireless devices connected, refer to section P14 "Additional information" of the product IT ECO Declaration at <http://www.hp.com/hpinfo/globalcitizenship/environment/productdata/itecodesktop-pc.html>.

Where applicable, activate and deactivate a wireless network using the instructions included in the product user guide or the operating system. Information is also available at <http://www.hp.com/support>.

IT ECO declarations

Notebook or tablet PCs

<http://www.hp.com/hpinfo/globalcitizenship/environment/productdata/iteconotebook-o.html>

Desktop PCs and Thin Clients

http://www.hp.com/hpinfo/globalcitizenship/environment/productdata/itecodesktop-pc.html?jumpid=reg_R1002_USEN

Workstations

<http://www.hp.com/hpinfo/globalcitizenship/environment/productdata/itecoworkstatio.html>

Japan restriction of hazardous substances (RoHS)

2008年、日本における製品含有表示方法、JISC0950が公示されました。製造事業者は、2006年7月1日以降に販売される電気・電子機器の特定化学物質の含有に付きまして情報提供を義務付けられました。製品の部材表示に付きましては、

<http://www.hp.com/go/jisc0950>

を参照してください

A Japanese regulatory requirement, defined by specification JIS C 0950, 2008, mandates that manufacturers provide Material Content Declarations for certain categories of electronic products offered for sale after July 1, 2006.

To view the JIS C 0950 material declaration for this product, visit <http://www.hp.com/go/jisc0950>.

Ley para el Aprovechamiento Sustentable de la Energía de México

Ley para el Aprovechamiento Sustentable de la Energía de México

Se ha etiquetado este producto en conformidad con la Ley para el Aprovechamiento Sustentable de la Energía de México, que requiere la divulgación del consumo de energía del modo de uso normal (modo inactivo) y del modo de espera. Su producto es una de las muchas configuraciones de esta familia de modelos; el consumo de energía del modo inactivo de su configuración específica puede diferir de la información de la etiqueta. El consumo real de energía de su producto puede ser mayor o menor que el valor informado en la etiqueta de energía de producto para México a causa de factores como la configuración (componentes y módulos seleccionados) y el uso (tareas que se están efectuando, software instalado y en ejecución, etc.).



NOTE: Esta ley no es aplicable a las estaciones de trabajo.

Turkey WEEE regulation

Türkiye Cumhuriyeti: AEEE Yönetmeliğine Uygundur

TCO Certified

This section applies only to products bearing the TCO Certified logo.

A third-party certification according to ISO 14024



Toward sustainable IT products

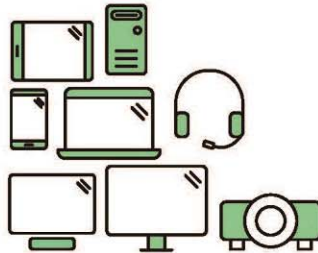

Say hello to a more sustainable product

IT products are associated with a wide range of sustainability risks throughout their life cycle. Human rights violations are common in the factories. Harmful substances are used both in products and their manufacture. Products can often have a short lifespan because of poor ergonomics, low quality and when they are not able to be repaired or upgraded.

This product is a better choice. It meets all the criteria in TCO Certified, the world's most comprehensive sustainability certification for IT products. Thank you for making a responsible product choice, that help drive progress towards a more sustainable future!

Criteria in TCO Certified have a life-cycle perspective and balance environmental and social responsibility. Conformity is verified by independent and approved verifiers that specialize in IT products, social responsibility or other sustainability issues. Verification is done both before and after the certificate is issued, covering the entire validity period. The process also includes ensuring that corrective actions are implemented in all cases of factory non-conformities. And last but not least, to make sure that the certification and independent verification is accurate, both TCO Certified and the verifiers are reviewed regularly.

Want to know more?

Read information about TCO Certified, full criteria documents, news and updates at tcocertified.com. On the website you'll also find our Product Finder, which presents a complete, searchable listing of certified products.

TCO Certified Edge

This section applies only to products bearing the TCO Certified Edge logo.

A third-party certification according to ISO 14024



Toward sustainable IT products

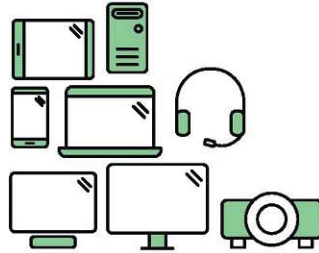

Say hello to a more sustainable product

IT products are associated with a wide range of sustainability risks throughout their life cycle. Human rights violations occur in the supply chain. Harmful substances are used both in products and their manufacture. Products can often have a short lifespan because of poor ergonomics, low quality and when they are not able to be repaired or upgraded.

This product is a better choice. It meets all the criteria in TCO Certified, the world's most comprehensive sustainability certification for IT products. Additionally, it fulfills the requirements of TCO Certified Edge, the supplemental certification that recognizes leading-edge products that exceed typical performance in a particular sustainability attribute. At our Product Finder (tcocertified.com/product-finder) you can find out which TCO Certified Edge criterion or criteria this product meets.

Criteria in TCO Certified have a life-cycle perspective and balance environmental and social responsibility. Compliance is verified by independent verification organizations that specialize in IT products, social responsibility or other sustainability issues. Verification is done both before and after the certificate is issued, covering the entire validity period. The process also includes ensuring that corrective actions are implemented in all cases of factory non-conformities.

Thank you for making a responsible product choice, that help drive progress towards a more sustainable future!

Want to know more?

Read information about TCO Certified, full criteria documents, news and updates at tcocertified.com. On the website you'll also find our Product Finder, which presents a complete, searchable listing of certified products.

Index

Symbols/Numerics

台灣對於危險物質的限制注意事項 35, 36
注意事項
台灣有害物質限制 35, 36

A

airline travel notice 8
altitude notice 21

B

battery 15
battery notice 8, 9, 23
battery recycling 23
Belarus regulatory notice 3
Brazil notice 3, 17

C

cable grounding notice 22
Canada modem statement 12
Canada notices 3
China environmental notices 26
China PC energy label 26
China restriction of hazardous substances notice 29, 31

D

disposal notices
battery 23
battery, user replacement 8
equipment 23
factory sealed battery 9

E

electronic hardware and battery recycling 23
ENERGY STAR certification 24
environmental notices 23
equipment disposal notice 23
ergonomics notice 5
European Union Commission Regulation 1275/2008 37

F

fan notice 16

Federal Communications Commission

notebook computers cables 2
notebook computers modifications 2
notebook computers notice 1

G

GS Notice 5

H

headset and earphone volume level notice 16

I

India restriction of hazardous substances notice 37

J

Japan modem statement 12
Japan notice 6
Japan power cord notice 19
Japan restriction of hazardous substances notice 37

L

labels, regulatory 1
laser safety notice 9, 16

M

Macrovision Corporation notice 13
maximum power levels 4
Mexico wireless notice 6
modem notices 10
modem statements
Canada 12
Japan 12
New Zealand 12
U.S. 10, 11
modifications, notebook computers
Federal Communications Commission 2

N

New Zealand modem statement 12

notices

airline travel 8
battery 8, 9, 15, 23
Belarus regulatory 3
Brazil 3, 17
Canada 3
China restriction of hazardous substances 29, 31
environmental 23
equipment disposal 23
ergonomics 5
fan 16
headset and earphone volume level 16
India restriction of hazardous substances 37
Japan 6
Japan power cord 19
Japan restriction of hazardous substances 37
laser safety 9, 16
Macrovision Corporation 13
Mexico 6
modem 10
perchlorate material 25
power cords 18
Singapore 7
South Korea 7
Taiwan 8
Thailand wireless notice 7
travel 20
notices, notebook computers
Federal Communications Commission 1

P

power cord notice 18

R

radio frequency bands 4
recycling, electronic hardware and battery 23

S

Singapore wireless notice 7

South Korea notice 7

T

Taiwan notice 8

TCO Certified Certification 39

TCO Certified Edge Certification 40

Thailand wireless notice 7

travel notice 20

tropical warning notice 21

TV tuner, cable grounding notice 22

U

U.S. modem statement 10, 11

V

voice support 13

volume level notice, headset and
earphone 16

W

wireless LAN devices 2



Informations sur les réglementations, la sécurité et les conditions d'utilisation

Manuel de l'utilisateur

© Copyright 2018, 2019 HP Development Company, L.P.

Bluetooth est une marque détenue par son propriétaire et utilisée sous licence par HP Inc. ENERGY STAR et la marque de ENERGY STAR sont des marques déposées aux États-Unis. Java est une marque déposée d'Oracle et/ou de ses filiales.

Les informations contenues dans ce document peuvent être modifiées sans préavis. Les garanties relatives aux produits et aux services HP sont décrites dans les déclarations de garantie limitée expresse qui les accompagnent. Aucun élément du présent document ne peut être interprété comme constituant une garantie supplémentaire. HP ne saurait être tenu pour responsable des erreurs ou omissions de nature technique ou rédactionnelle qui pourraient subsister dans le présent document.

Quatrième édition : avril 2019





Première édition : mars 2018

Référence du document : L25269-054

À propos de ce manuel

Ce manuel fournit des informations sur les réglementations, la sécurité et les conditions d'utilisation en conformité avec les réglementations américaines, canadiennes et internationales en matière d'ordinateurs portables, de tablettes, d'ordinateurs de bureau, de clients légers, de stations de travail personnelles, de tout-en-un et de terminaux de point de vente.

Pour accéder aux derniers manuels de l'utilisateur, ouvrez la page <http://www.hp.com/support>, et suivez les instructions pour retrouver votre produit. Puis, sélectionnez **Guides de l'utilisateur**.

-
-  **AVERTISSEMENT !** Signale une situation dangereuse qui, si elle n'est pas évitée, **peut** entraîner des blessures graves voire mortelles.
 -  **ATTENTION :** Signale une situation dangereuse qui, si elle n'est pas évitée, **peut** entraîner des blessures légères ou modérées.
 -  **IMPORTANT :** Signale des informations considérées comme importantes mais n'impliquant aucun danger (par exemple, des messages liés à des dommages matériels). Des avertissements signalent à l'utilisateur que tout non-respect scrupuleux d'une procédure peut entraîner une perte de données ou une détérioration du matériel ou des logiciels. Contient également des informations essentielles pour expliquer un concept ou pour accomplir une tâche.
 -  **REMARQUE :** Contient des informations supplémentaires qui soulignent ou complètent les points importants du texte principal.
 -  **CONSEIL :** Fournit des conseils utiles pour accomplir une tâche.
-

Sommaire

1 Avis de conformité	1
Accès aux étiquettes de conformité	1
Avis de la FCC	2
Modifications	2
Câbles	2
Produits avec appareils sans fil LAN ou modules mobiles à large bande HP	3
Avis de réglementation pour la Biélorussie	3
Avis pour le Brésil	3
Avis pour le Canada	3
Avis pour l'Union européenne	4
Déclaration de conformité	4
Produits équipés de fonctionnalité radio	5
Restrictions pour les produits équipés de fonctionnalité radio (certains produits uniquement)	5
Bandes de fréquences radio et niveaux de puissance maximale (certains produits et pays uniquement)	5
Avis sur l'ergonomie	5
Déclaration relative au réseau téléphonique européen (modem/fax)	6
Avis pour l'Australie et la Nouvelle-Zélande	6
Avis WWAN pour la Chine	6
Avis sur les équipements radio pour la Chine	6
Avis pour le Japon	7
Marques de certification des périphériques WLAN, WWAN et Bluetooth®	7
Avis pour le Mexique	7
Avis sur les appareils sans fil pour Singapour	8
Avis pour la Corée du Sud	8
Avis sur les périphériques sans fil pour la Thaïlande	8
Avis de la NCC pour Taïwan	9
Périphériques WLAN 802.11a	9
Périphériques sans fil LAN 802.11/Périphériques Bluetooth/Périphériques à courte portée	9
Avis sur les utilisations en vol	9
Avis sur les batteries remplaçables par l'utilisateur	9
Avis sur les batteries scellées en usine	10
Conformité du laser	10
Homologations du périphérique de télécommunication	11
Avis sur les modems	11
Avis sur les modems pour les États-Unis	11

Déclarations sur les modems pour les États-Unis	13
Avis sur les modems pour le Canada	14
Avis sur les modems pour le Japon	14
Déclarations sur les modems pour la Nouvelle-Zélande	15
Prise en charge vocale	15
Avis de Macrovision Corporation	15
2 Avis relatifs à la sécurité	16
Informations importantes relatives à la sécurité	16
Notice d'avertissement relative à la sécurité liée à la chaleur	17
Avis sur les risques liés à la sécurité	17
Conditions d'installation	17
Avis sur l'acoustique	18
Avis relatif aux batteries	18
Avis sur le ventilateur	19
Avis sur le niveau du volume du casque et des écouteurs	19
Sécurité des lasers	19
Exigences relatives au bloc d'alimentation et au cordon d'alimentation	19
Exigences relatives à la mise à la terre des alimentations de classe 1	19
Avis pour le Brésil	20
Danemark	20
Finlande	20
Norvège	20
Suède	20
Exigences relatives au bloc d'alimentation	20
Pour une utilisation en Norvège	20
Exigences relatives au cordon d'alimentation	20
Informations sur le cordon d'alimentation	22
prise CC de la source d'alimentation externe HP	22
Avis sur les cordons d'alimentation pour le Japon	22
Spécifications du cordon d'alimentation pour le Japon	22
Risque de pincement	22
Protection des connecteurs de l'antenne TV	22
Mise à la terre d'une antenne de télévision externe	22
Protection contre la foudre	23
Remarque destinée aux installateurs de systèmes de télévision par câble	23
Avis sur les déplacements	23
Avis de sécurité pour la Chine	24
Chine : avis sur l'altitude	24
Chine : avis sur une utilisation dans des conditions tropicales	24
Norvège et Suède : Avis de mise à la terre des câbles pour les produits équipés d'une carte TV	25

使用過度恐傷害視力	25
3 Avis des agences environnementales	26
Recyclage du matériel électronique, de l'emballage et de la batterie	26
Mise au rebut des équipements par les utilisateurs	26
Mise au rebut des batteries alcalines au Brésil	26
Informations sur le recyclage du matériel au Brésil	26
Informations de recyclage de la pile pour Taiwan	27
Certification ENERGY STAR® (certains produits uniquement)	27
Substances chimiques	28
Avis sur le mercure	28
Matériau composé de perchlorate : une manipulation particulière peut être nécessaire	29
Avis sur l'environnement pour la Chine	29
Étiquette de consommation énergétique des ordinateurs pour la Chine	29
Restrictions d'utilisation de substances dangereuses (RoHS) pour les ordinateurs portables et les tablettes en Chine	32
Tableau des substances/composants dangereux et leur contenu	32
笔记本电脑和平板电脑产品中有害物质或元素的名称及含量	33
Restrictions d'utilisation de substances dangereuses pour la Chine (ROHS) pour les ordinateurs de bureau, clients légers, stations de travail personnelles, tout-en-un et les terminaux de point de vente	34
Tableau des substances/composants dangereux et leur contenu	34
台式机、瘦客户端、个人工作站、一体机和销售点终端产品中有害物质或元素的名称及含量 (ROHS)	36
台灣針對筆記型電腦和平板電腦的有害物質限制使用管理辦法 (RoHS)	38
限用物質含有情況標示聲明書	38
台灣針對桌上型電腦、精簡型電腦、個人工作站、一體成形電腦及銷售點終端機的有害物質限制 使用管理辦法 (RoHS)	39
限用物質含有情況標示聲明書	39
Avis sur la restriction des substances dangereuses pour l'Inde (RoHS)	40
Informations sur le règlement 1275/2008 de la Commission européenne	40
Déclarations IT ECO	40
Avis sur la restriction des substances dangereuses pour le Japon (RoHS)	40
Ley para el Aprovechamiento Sustentable de la Energía de México	41
Réglementation WEEE de la Turquie	41
Certifié TCO	42
TCO Certified Edge	43
Index	44

1 Avis de conformité

Ce chapitre fournit des avis de réglementation spécifiques à des pays et à des régions concernant les produits filaires et sans fil, ainsi que des informations de conformité concernant l'ordinateur. Certains de ces avis peuvent ne pas s'appliquer à votre produit.

Un ou plusieurs appareils sans fil intégrés peuvent être installés. Dans certains environnements, l'utilisation d'appareils sans fil peut être limitée. Ces restrictions peuvent s'appliquer à bord des avions, dans les hôpitaux, dans les lieux à proximité d'explosifs, dans les environnements dangereux, etc. Si vous ne connaissez pas la politique relative à l'utilisation de ce produit, demandez l'autorisation de l'utiliser avant de le mettre sous tension.

Accès aux étiquettes de conformité

Les étiquettes de conformité, qui fournissent des informations sur les réglementations de votre pays ou région (par exemple, l'ID FCC), peuvent être situées physiquement sous l'ordinateur, à l'intérieur du compartiment de la batterie (certains produits uniquement), sous le cache de service amovible (certains produits uniquement), à l'arrière de l'écran ou sur le module du modem ou de l'appareil sans fil.

Certains produits peuvent également fournir des étiquettes de réglementation électroniques (e-étiquettes) accessibles via le système BIOS.

 **REMARQUE :** Les étiquettes électroniques ne sont pas disponibles sur tous les produits.

 **REMARQUE :** Les appareils qui ne sont pas destinés à la vente ou à une utilisation aux États-Unis ne possèdent peut-être pas d'ID FCC.

Pour afficher les étiquettes de conformité électroniques :

1. Mettez l'ordinateur sous tension ou redémarrez-le.
2. Appuyez sur **Échap** ou **F10** pour accéder à Computer Setup.
3. À l'aide d'un périphérique de pointage ou des touches de direction, sélectionnez **Advanced** (Avancé), **Electronic Labels** (Étiquettes de conformité), puis appuyez sur la touche **entrée**.
4. Pour afficher une étiquette électronique, utilisez un périphérique de pointage ou les touches de direction pour sélectionner un des éléments de la liste, puis appuyez sur **OK**.

 **REMARQUE :** La liste des éléments d'étiquette électronique disponibles varie en fonction du modèle d'ordinateur et des périphériques installés.

5. Pour quitter les menus de Computer Setup sans effectuer de modification :

Sélectionnez l'icône **Exit** (Quitter) dans le coin inférieur droit de l'écran, puis suivez les instructions à l'écran.

– ou –

Utilisez les touches de direction pour sélectionner **Main** (Principal), **Ignore Changes and Exit** (Ignorer les modifications et quitter), puis appuyez sur la touche **entrée**.

Avis de la FCC

Le présent équipement a été testé et déclaré conforme aux limites d'un appareil numérique de Classe B, telles que définies dans l'article 15 des réglementations FCC. Ces limites sont conçues pour fournir une protection raisonnable contre les interférences préjudiciables dans un environnement résidentiel. Le présent équipement génère, utilise et peut émettre une énergie de radiofréquence et, s'il n'est pas installé et utilisé conformément aux instructions, peut entraîner des interférences préjudiciables pour les radiocommunications. Cependant, tout risque d'interférences ne peut être totalement exclu dans certains environnements spécifiques.

Si cet équipement entraîne des interférences en matière de réception radio ou télévision, ce qui peut être vérifié en éteignant et en rallumant l'équipement, il est recommandé à l'utilisateur d'essayer de corriger les interférences en suivant une ou plusieurs des mesures suivantes :

- Réorienter ou déplacer l'antenne de réception.
- Augmenter la distance entre l'équipement et le récepteur.
- Brancher l'équipement sur un autre circuit que celui du récepteur.
- Demander conseil à votre revendeur ou à un technicien radio ou télévision expérimenté.

Cet appareil est conforme à l'article 15 des réglementations FCC. Son fonctionnement est soumis à deux conditions :

1. Cet appareil ne doit pas provoquer des interférences nuisibles, et
2. Cet appareil doit accepter toute interférence reçue, notamment des interférences pouvant provoquer un fonctionnement non voulu.

Pour toute question concernant ce produit :

- Écrivez à :
HP Inc.
1501 Page Mill Road
Palo Alto, CA 94304
- Appelez HP au 650-857-1501
–ou–
- Envoyez un courrier électronique à techregshelp@hp.com

Pour identifier ce produit, reportez-vous à la référence de pièce, de gamme ou de modèle indiquée sur le produit.

Modifications

La FCC stipule que l'utilisateur doit être informé que toute modification opérée sur l'appareil, n'ayant pas été expressément approuvée par HP, peut entraîner l'annulation des droits d'exploitation du produit dont bénéficie l'utilisateur.

Câbles

Pour être conformes à la réglementation de la FCC, les connexions d'entrée de l'appareil doivent être établies avec des câbles blindés munis d'embouts de connecteurs RFI/EMI métalliques.

Produits avec appareils sans fil LAN ou modules mobiles à large bande HP

Cet appareil ne doit pas être placé à côté ou fonctionner avec une autre antenne ou un autre émetteur.

⚠ AVERTISSEMENT ! Exposition aux radiations de fréquence radio La puissance de rayonnement de cet appareil est inférieure aux limites d'exposition aux radiations émises par les fréquences radio FCC. Toutefois, l'appareil doit être utilisé d'une manière conforme avec l'utilisation normale attendue.

Avis de réglementation pour la Biélorussie

Le produit est conforme à la réglementation technique nationale relative aux télécommunications/radio pour la Biélorussie TR 2018/024/BY.



Avis pour le Brésil

Este equipamento opera em caráter secundário, isto é, não tem direito a proteção contra interferência prejudicial, mesmo de estações do mesmo tipo, e não pode causar interferência a sistemas operando em caráter primário.

Este equipamento atende aos limites de Taxa de Absorção Específica referente à exposição a campos elétricos, magnéticos e eletromagnéticos de radiofrequências adotados pela ANATEL.

Ao operar o dispositivo a uma distância muito próxima do seu corpo, utilize um acessório de armazenamento não metálico para posicionar o dispositivo a uma distância mínima de 1,5 cm do corpo.

🔌 IMPORTANT : A alimentação de energia é predefinida para 220/230Vv. Se você possuir tomada elétrica de 110/115Vv, por favor, altere a chave na parte traseira do seu computador para a tensão correta.

Avis pour le Canada

Cet appareil numérique de Classe B respecte toutes les exigences des réglementations canadiennes sur les équipements pouvant causer des interférences, CAN ICES-3(B)/NMB-3(B). Si cet appareil est équipé de fonctions WLAN ou Bluetooth, il est conforme aux normes RSS exemptes de licence édictées par Industrie Canada. Son fonctionnement est soumis à deux conditions : (1) cet appareil ne doit pas générer d'interférence et (2) cet appareil doit supporter toutes les interférences reçues, y compris les interférences qui pourraient entraîner un dysfonctionnement de l'appareil.

⚠ AVERTISSEMENT ! Exposition aux radiations de fréquence radio : la puissance de rayonnement de cet appareil est inférieure aux limites d'exposition aux radiations émises par les fréquences radio édictées par Industrie Canada. Toutefois, l'appareil doit être utilisé d'une manière conforme avec l'utilisation normale attendue.

 **IMPORTANT :** Lorsque vous utilisez un réseau local sans fil IEEE 802.11 a, n ou ac, abstenez-vous d'utiliser ce matériel à l'extérieur. En effet, il fonctionne dans la plage de fréquences allant de 5,15 à 5,25 GHz. Industrie Canada exige que ce produit soit utilisé à l'intérieur d'un bâtiment pour la plage de fréquence allant de 5,15 à 5,25 GHz afin de réduire le risque d'interférences préjudiciables pour les systèmes de satellites mobiles utilisant le même canal. Les plages de 5,25 à 5,35 GHz et de 5,65 à 5,85 GHz sont allouées prioritairement aux radars haute puissance. Ces stations radar peuvent provoquer des interférences avec cet appareil ou l'endommager.

Les antennes de ce périphérique ne sont pas remplaçables. Toute tentative d'accès par l'utilisateur endommagera l'ordinateur.

Avis pour l'Union européenne

Déclaration de conformité

Les produits portant le marquage CE ont été conçus de façon à pouvoir fonctionner au moins dans un pays membre de l'UE et sont conformes à une ou plusieurs des directives de l'UE suivantes, le cas échéant :

RED 2014/53/EU ; Directive relative à la basse tension 2014/35/EU ; Directive EMC 2014/30/EU ; Directive Ecodesign 2009/125/CE ; Directive RoHS 2011/65/CE.

La conformité à ces directives est évaluée à l'aide des normes harmonisées européennes applicables.

L'intégralité de la déclaration de conformité est disponible sur le site Web suivant : <http://www.hp.eu/certificates> (recherchez le nom de modèle du produit ou son numéro de modèle réglementaire (RMN), qui est indiqué sur l'étiquette de conformité).

Pour toute question portant sur les réglementations, envoyez un courrier à : HP Deutschland GmbH, HQ-TRE, 71025, Boeblingen, Allemagne. Envoyez un courrier électronique à techregshelp@hp.com

Produits équipés de fonctionnalité radio

Ce produit intègre un appareil de transmission et réception radioélectrique. Lors d'une utilisation standard d'un ordinateur portable, l'observation d'une distance de séparation de 20 cm permet aux niveaux d'exposition des fréquences radio de respecter la conformité des normes de l'UE. Les produits conçus pour une utilisation en deçà de cette distance, tels que les tablettes, respectent la conformité aux normes de l'UE applicables dans les positions de fonctionnement standard. Les produits peuvent être utilisés sans garder une distance de séparation, sauf indication contraire dans les instructions spécifiques au produit.

Restrictions pour les produits équipés de fonctionnalité radio (certains produits uniquement)



AT	BE	BG	CH	CY
CZ	DE	DK	EE	EL
ES	FI	FR	HR	HU
IE	IS	IT	LI	LT
LU	LV	MT	NL	NO
PL	PT	RO	RS	SE
SI	SK	TR	UK	

IMPORTANT : Le LAN sans fil IEEE 802,11x avec une bande de fréquence de 5,15 à 5,35 GHz est limité à une utilisation intérieure uniquement dans l'ensemble des pays listés dans la matrice. L'utilisation de cette application WLAN en extérieur peut engendrer des problèmes d'interférences avec les services radio existants.

IMPORTANT : Les installations extérieures fixes pour l'application WiGig (bande de fréquence 57–66 GHz) sont exclues pour l'ensemble des pays listés dans la matrice.

Bandes de fréquences radio et niveaux de puissance maximale (certains produits et pays uniquement)

Technologie Radio	Puissance maximale de transmission PIRE (mW)
Bluetooth ; 2,4 GHz	100
NFC ; 13,56 MHz	10
RFID ; 125 kHz/13,56 MHz	Moins de 1
WLAN Wi-Fi 802.11 x ; 2,4 GHz	100
WLAN Wi-Fi 802.11 x ; 5 GHz	200
WWAN 4G LTE ; 700/800/900/1800/2100/2300/2600/3500 MHz	200
WWAN 3G UTMS ; 900/2100 MHz	250
WWAN 2G GSM GPRS EDGE ; 900 MHz	2000
WWAN 2G GSM GPRS EDGE ; 1800 MHz	1000
WiGig 802.11ad ; 60 GHz	316
REMARQUE : Utiliser uniquement les pilotes logiciels compatibles HP et corriger les paramètres régionaux pour assurer la conformité.	

Avis sur l'ergonomie

Lorsqu'un ordinateur portable est utilisé sur une station de travail professionnelle dans le cadre d'un travail sur écran de visualisation où la directive 90/270/CEE relative aux écrans de visualisation est applicable, un clavier externe adapté est recommandé. Selon l'application et le travail réalisé, un moniteur externe adapté peut également être nécessaire pour obtenir des conditions de travail comparables à celles d'une station de travail.

Réf : EK1-ITB 2000 (certification GS volontaire)

Les ordinateurs portables portant la marque d'homologation « GS » sont conformes aux exigences en matière d'ergonomie. Sans clavier externe, ils sont uniquement adaptés aux tâches ponctuelles sur écran de visualisation.

Une utilisation mobile dans de mauvaises conditions de luminosité (par exemple, lumière directe du soleil) peut occasionner des reflets et donc réduire la lisibilité.

Un système informatique composé de produits de la marque HP respecte les exigences applicables relatives à l'ergonomie si tous les produits inclus concernés portent la marque de conformité « GS », par exemple un ordinateur de bureau professionnel, un clavier, une souris et un moniteur.

Déclaration relative au réseau téléphonique européen (modem/fax)

Le produit ci-joint est conforme aux spécifications de la directive applicable et porte en conséquence la marque CE. Cependant, des différences existant entre les réseaux téléphoniques publics commutés (RTPC) nationaux présents dans les différents pays/régions, cette homologation en elle-même ne garantit pas la réussite de toutes les opérations sur tous les points de terminaison du RTPC. En cas de problème, prenez contact avec le fournisseur auprès duquel vous vous êtes procuré votre équipement.

Avis pour l'Australie et la Nouvelle-Zélande

Cet équipement intègre un appareil de transmission et réception radioélectrique. Lors d'une utilisation standard, l'observation d'une distance de séparation de 20 cm permet aux niveaux d'exposition des fréquences radio de respecter la conformité des normes australiennes et néo-zélandaises.

L'ordinateur doit être connecté au réseau de télécommunications par un câble répondant aux critères de la norme AS/CA S008.

⚠ AVERTISSEMENT ! Les modems sans connecteur RJ11 intégral qui sont livrés avec cet ordinateur ne doivent pas être installés dans un autre périphérique.

Avis WWAN pour la Chine

重要信息：本公司建议用户通过官方渠道进行系统更新，非官方渠道的更新可能会带来安全风险。

Avis sur les équipements radio pour la Chine

型号核准代码显示在产品本体的铭牌上

Avis pour le Japon

V2 規定適合の場合

この装置は、クラスB情報技術装置です。この装置は、家庭環境で使用することを目的としていますが、この装置がラジオやテレビジョン受信機に近接して使用されると、受信障害を引き起こすことがあります。

取扱説明書に従って正しい取り扱いをして下さい。 VCCI-B

VCCI321 規定適合の場合

この装置は、クラスB機器です。この装置は、住宅環境で使用することを目的としていますが、この装置がラジオやテレビジョン受信機に近接して使用されると、受信障害を引き起こすことがあります。

取扱説明書に従って正しい取り扱いをして下さい。 VCCI-B

5GHz帯を使用する特定無線設備は屋内使用に限られています。この機器を屋外で使用することは電波法で禁じられています。

Marques de certification des périphériques WLAN, WWAN et Bluetooth®

この機器は、技術基準適合証明または工事設計認証を受けた無線設備を搭載しています
This product contains certified radio equipment.



Some products may use electronic regulatory labels (e-labels). To view the certification mark and numbers on an e-label, please refer to the previous “Accessing regulatory labels” section.

一部の製品では、電子規定ラベル(eラベル)が使用されています。eラベルの技適マークと認証番号を確認するには、「規定ラベルの確認」の項目をご覧ください

Avis pour le Mexique

Declaración para México

La operación de este equipo está sujeta a las siguientes dos condiciones: (1) es posible que este equipo o dispositivo no cause interferencia perjudicial y (2) este equipo o dispositivo debe aceptar cualquier interferencia, incluyendo la que pueda causar su operación no deseada. El número de modelo reglamentario de este producto está en la etiqueta normativa.

Si votre produit est fourni avec des accessoires sans fil, tels qu'un clavier ou une souris, et si vous devez identifier le modèle de l'accessoire, reportez-vous à l'étiquette apposée sur cet accessoire. Le numéro de modèle réglementaire de ce produit se trouve sur l'étiquette réglementaire.

Avis sur les appareils sans fil pour Singapour

Mettez hors tension tout appareil réseau large bande sans fil (WWAN) lorsque vous êtes à bord d'un avion. L'utilisation de tels appareils à bord d'un avion est illégale, peut être dangereuse pour le fonctionnement de l'avion et peut perturber le réseau cellulaire. Le non-respect de cette instruction peut entraîner la suspension ou le refus de services cellulaires au contrevenant, ou des actions juridiques, ou les deux.

Les utilisateurs doivent limiter l'emploi d'équipement radio dans des dépôts de carburant, usines chimiques et là où des explosions sont en cours.

Comme pour les autres équipements mobiles de transmission par fréquences radioélectriques, il est recommandé aux utilisateurs, pour le bon fonctionnement de leur équipement et pour la sécurité du personnel, de ne pas trop approcher les antennes du corps humain au cours du fonctionnement de l'équipement.

Ce périphérique a été conçu pour être conforme aux exigences applicables pour l'exposition aux ondes radio, en fonction de normes scientifiques qui comprennent des plages destinées à assurer la sécurité de tout le monde, quel que soit l'âge et l'état de santé. Ces règles d'exposition aux ondes radio utilisent une unité de mesure appelée taux d'absorption spécifique (SAR - Specific Absorption Rate). Les tests relatifs aux taux d'absorption sont menés à l'aide de méthodes standardisées, le téléphone transmettant à son niveau certifié le plus élevé dans toutes les bandes de fréquences utilisées. Les informations de données SAR se basent sur les normes EN50360 et EN50361 de CENELEC, qui utilisent la limite de 2 watts par kilogramme, sur une moyenne de 10 grammes de tissu.

Avis pour la Corée du Sud

무선적용제품

해당 무선설비가 전파혼신 가능성이 있으므로 인명안전과 관련된 서비스는 할 수 없음 (무선모듈 제품이 설치되어 있는 경우).

몸 가까이에서 장치를 작동할 경우, 비금속 저장 액세스리를 사용하여 장치와 몸 사이에 2.5cm 이상의 거리를 유지하십시오.

Avis sur les périphériques sans fil pour la Thaïlande

เครื่องโทรคมนาคมและอุปกรณ์นี้ มีความสอดคล้องตามมาตรฐานหรือข้อกำหนดของ กสทช.

(Cet équipement de télécommunication se conforme aux exigences NBTC.)

เครื่องวิทยุคมนาคมนี้มีระดับการแผ่คลื่นแม่เหล็กไฟฟ้าสอดคล้องตามมาตรฐานความปลอดภัยต่อสุขภาพของมนุษย์จากการใช้เครื่องวิทยุคมนาคมที่คณะกรรมการกิจการโทรคมนาคมแห่งชาติประกาศกำหนด

Cet équipement de communication radio possède une force de champ électromagnétique conforme à la norme de sécurité pour l'utilisation d'équipement de communication radio vis-à-vis de la santé des personnes annoncée par la Commission nationale des télécommunications.

Avis de la NCC pour Taïwan

Périphériques WLAN 802.11a

在 5.25G~5.35G 頻帶內操作之無線
資訊傳輸設備僅適於室內使用

應避免影響附近雷達系統之操作。

Périphériques sans fil LAN 802.11/Périphériques Bluetooth/Périphériques à courte portée

低功率電波輻射性電機管理辦法

第十二條 經型式認證合格之低功率射頻電機，非經許可，公司、商號或使用者均不得擅自變更頻率、加大功率或變更原設計之特性及功能。

第十四條 低功率射頻電機之使用不得影響飛航安全及干擾合法通信；經發現有干擾現象時，應立即停用，並改善至無干擾時方得繼續使用。

前項合法通信，指依電信法規定作業之無線電通信。低功率射頻電機須忍受合法通信或工業、科學及醫療用電波輻射性電機設備之干擾。

Avis sur les utilisations en vol

L'utilisation d'appareils électroniques à bord des avions de ligne est laissée à l'appréciation de la compagnie aérienne.

Avis sur les batteries remplaçables par l'utilisateur

Ne jetez pas les batteries ayant atteint leur durée de vie utile avec les ordures ménagères. Appliquez les lois et réglementations locales en matière de mise au rebut des batteries d'ordinateur.

HP encourage ses clients à recycler le matériel électronique usagé, les cartouches d'impression d'origine HP et les piles rechargeables. Pour plus d'informations sur les programmes de recyclage, consultez le site Web HP à l'adresse <http://www.hp.com/recycle>.

Pour des informations sur le retrait d'une batterie remplaçable par l'utilisateur, reportez-vous au manuel de l'utilisateur livré avec le produit.

Avis sur les batteries scellées en usine

La ou les batteries de ce produit ne peuvent pas être facilement remplacées par les utilisateurs. Le retrait ou le remplacement de la batterie pourrait affecter votre droit à la garantie. Si une batterie ne tient plus la charge, contactez le support.

Ne jetez pas les batteries ayant atteint leur durée de vie utile avec les ordures ménagères. Appliquez les lois et réglementations locales en matière de mise au rebut des batteries.

Conformité du laser

⚠ AVERTISSEMENT ! L'utilisation de méthodes de contrôle ou de réglage ou de procédures, autres que celles indiquées dans ce document ou dans le manuel d'installation d'appareils à rayon laser, peut exposer l'utilisateur à des radiations dangereuses. Pour réduire le risque d'exposition à un rayonnement dangereux :

- N'essayez pas d'ouvrir le boîtier du module. Il ne contient pas de composant réparable par l'utilisateur.
- N'effectuez pas de commandes, de réglages ou d'opérations sur l'appareil laser, en dehors de ce qui est indiqué dans le manuel d'installation du produit laser.
- Seuls les mainteneurs agréés HP sont autorisés à réparer l'unité.

Ce produit peut être fourni avec un périphérique de stockage optique (par exemple, un lecteur de CD ou DVD) et/ou un émetteur-récepteur fibre optique. Chacun de ces appareils qui contient un laser est classé comme produit laser de classe 1 conformément à la norme CEI/EN 60825-1 et répond aux critères de sécurité de cette norme.

Chaque produit laser est conforme aux paragraphes 21 CFR 1040.10 et 1040.11 des réglementations FDA des États-Unis ou est conforme à ces réglementations à l'exception des déviations relatives à l'avis sur le laser No. 50, en date du 24 juin 2007.



Homologations du périphérique de télécommunication

Le périphérique de télécommunication de cet ordinateur est homologué pour une connexion au réseau téléphonique des pays et régions dont les marques d'homologation apparaissent sur l'étiquette de produit située sur la partie inférieure de l'ordinateur ou sur le modem.

Reportez-vous au manuel de l'utilisateur livré avec le produit pour vous assurer que celui-ci est configuré pour le pays ou région dans lequel ou laquelle il se trouve. La sélection d'un pays ou d'une région autre que celui ou celle où se trouve le produit peut entraîner une configuration du modem en violation des lois sur les télécommunications de ce pays ou de cette région. De plus, il est possible que le modem ne fonctionne pas correctement si vous n'avez pas sélectionné correctement le pays/la région. Si, lorsque vous sélectionnez un pays ou une région, un message indique que votre pays ou région n'est pas pris en charge, cela signifie que le modem n'a pas été homologué dans ce pays ou cette région et qu'il ne doit donc pas être utilisé.

Avis sur les modems

Avis sur les modems pour les États-Unis

Ce matériel est conforme à l'article 68 des réglementations de la FCC et aux conditions adoptées par l'ACTA. Une étiquette est apposée sur la partie inférieure de l'ordinateur ou sur le modem. Elle inclut, entre autres informations, un identificateur de produit au format US:AAAEQ##TXXXX. Fournissez ces informations à la compagnie téléphonique si elle vous y invite.

Certification applicable de la prise USOC = RJ11C. La fiche et la prise utilisées pour connecter ce matériel au câblage des locaux et au réseau téléphonique doivent être conformes à l'article 68 des réglementations de la FCC et aux conditions adoptées par l'ACTA. Un cordon téléphonique et une fiche modulaire conformes sont fournis avec ce produit. Ils sont conçus pour être connectés à une prise modulable également conforme. Reportez-vous aux instructions d'installation pour plus d'informations.

Le REN est utilisé pour déterminer le nombre de périphériques qui peuvent être connectés à une ligne téléphonique. Si la ligne téléphonique regroupe un nombre trop important de REN, les périphériques peuvent ne pas sonner lors d'un appel entrant. Dans la plupart des emplacements, la somme des REN ne doit pas dépasser cinq (5). Pour connaître avec certitude le nombre de périphériques qui peuvent être connectés à une ligne, et donc le nombre total de REN, contactez votre compagnie téléphonique. Pour les produits homologués après le 23 juillet 2001, le REN fait partie de l'identificateur de produit dont le format est US:AAAEQ##TXXXX. Les chiffres représentés par le signe ## constituent le REN sans virgule (par exemple, 03 représente un REN de 0,3). Pour les produits antérieurs, le REN est indiqué séparément sur l'étiquette.

Si ce matériel HP dégrade le réseau téléphonique, la compagnie téléphonique vous avertira à l'avance qu'une interruption du service peut être requise. S'il n'est pas possible de vous informer de cette interruption à l'avance, la compagnie vous avertira au plus vite. En outre, vous serez informé de votre droit à déposer une réclamation auprès de la FCC si vous pensez que cela n'est nécessaire.

La compagnie téléphonique peut apporter des modifications à ses installations, équipements, opérations ou procédures pouvant affecter le bon fonctionnement du matériel. Dans ce cas, il vous en informera à l'avance afin que vous puissiez prendre les mesures nécessaires pour assurer un service téléphonique ininterrompu.

Si vous rencontrez des problèmes avec cet équipement, contactez le support technique. S'il détériore le réseau téléphonique, la compagnie téléphonique peut vous demander de le déconnecter jusqu'à ce que le problème soit résolu. Les seules réparations que vous pouvez effectuer sont celles qui sont présentées dans la section « Résolution des problèmes » du manuel de l'utilisateur, si ce dernier est fourni.

La connexion à des lignes partagées est soumise à des taxes dépendant de chaque État. Pour plus d'informations, contactez la commission des services publics ou la commission des entreprises.

Si votre domicile est équipé d'un dispositif d'alarme spécial connecté à la ligne téléphonique, vérifiez que l'installation de ce matériel HP ne le désactive pas. Pour toute question concernant les équipements susceptibles de désactiver votre alarme, consultez votre compagnie téléphonique ou un installateur qualifié.

Le Telephone Consumer Protection Act de 1991 rend illégal le fait d'utiliser un ordinateur ou tout autre dispositif électronique, y compris un télécopieur, pour envoyer des messages ne contenant pas clairement, dans une marge située dans la partie supérieure ou inférieure de chaque page transmise ou sur la première page de chaque transmission, la date et l'heure de l'envoi, ainsi que des éléments identifiant l'entreprise, l'entité ou la personne à l'origine du message, ainsi que le numéro de téléphone de la machine expéditrice, de l'entreprise, de l'entité ou de la personne. (Le numéro de téléphone fourni ne peut pas être un numéro en 900 ou tout autre numéro dont le coût dépasse celui d'un appel local ou longue distance.)

Pour programmer ces informations dans votre télécopieur, vous devez suivre la procédure décrite dans les instructions du logiciel de télécopie.

Déclarations sur les modems pour les États-Unis

Reportez-vous à la déclaration suivante du fournisseur du modem concernant le périphérique de modem installé dans votre ordinateur :



Brad Grande
Technical Manager

1110 American Parkway NE
Lehigh Valley Central Campus
Allentown, PA 18109
Phone: 610-712-7853
bgrande@agere.com

Supplier's Declaration of Conformity

Reference Number: Delphi D40 (revision AM5)
Place of Issue: Allentown, PA, USA
Date of Issue: 30th November 2006

Agere Systems Inc. at 1110 American Parkway NE, Lehigh Valley Central Campus, Allentown, PA 18109 in the United States of America, hereby certifies that the Modem, bearing labelling identification number US: AGSMD01BDELPHI complies with the Federal Communications Commission's ("FCC") Rules and Regulations 47 CFR Part 68, and the Administrative Council on Terminal Attachments ("ACTA")-adopted technical criteria TIA/EIA/IS-968, 968-A, 968-A-1, 968-A-2 and 968-A-3 Telecommunications – Telephone Terminal Equipment – Technical Requirements for Connection of Terminal Equipment To the Telephone Network.

A handwritten signature in black ink that reads "Brad Grande".

Brad Grande
Technical Manager

Avis sur les modems pour le Canada

Cet équipement est conforme aux spécifications techniques d'Industrie Canada applicables.

Le REN indique le nombre maximal d'appareils pouvant être connectés à une interface téléphonique. La terminaison d'une interface peut consister en une combinaison d'appareils quelconque à condition que la somme des REN de ces dispositifs ne dépasse pas 5. Le REN de ce terminal de communication est 1.

Avis sur les modems pour le Japon

Si l'ordinateur ne possède pas la marque de certification des périphériques japonais sur sa partie inférieure, reportez-vous à la marque de certification appropriée ci-dessous.

La marque de certification des périphériques japonais pour le modem télécopie/données V.92 56K est illustrée ci-dessous :



Si l'ordinateur ne possède pas la marque de certification des périphériques japonais sur sa partie inférieure, reportez-vous à la marque de certification appropriée ci-dessous.

La marque de certification des périphériques japonais pour le modem LSI Corporation PCI-SV92EX Soft est illustrée ci-dessous :



Déclarations sur les modems pour la Nouvelle-Zélande

L'octroi d'un Telepermit pour n'importe quel terminal de télécommunication indique uniquement que Telecom certifie que l'équipement est bien conforme aux exigences minimales de connexion à son réseau. Il ne constitue aucunement une prise de responsabilité quant au produit par Telecom, et n'apporte aucune sorte de garantie. Plus particulièrement, il n'apporte aucune garantie que l'équipement fonctionnera correctement et en tous points avec un autre équipement Telepermit d'une marque ou d'un modèle différent, et ne signifie pas non plus qu'un produit est compatible avec l'ensemble des services du réseau Telecom.

Quelles que soient les conditions d'utilisation, ce matériel ne peut fonctionner correctement aux vitesses supérieures à celles pour lesquelles il a été conçu. Telecom décline toute responsabilité si des difficultés devaient apparaître dans de telles circonstances.

Si cet équipement est doté de la composition à impulsions, Telecom ne garantit pas la prise en charge de celle-ci par la ligne.

L'utilisation de la composition à impulsions, sur une ligne partagée par plusieurs dispositifs, peut provoquer un déclenchement de la sonnerie ou des parasites et également une réponse erronée. Si ce type de problème se produit, l'utilisateur ne doit *pas* contacter les services techniques de Telecom Nouvelle-Zélande.

Certains paramètres nécessaires pour une conformité avec les exigences Telepermit de Telecom dépendent du matériel (PC) associé à cet appareil. Le matériel associé doit être configuré de manière à fonctionner dans les limites prescrites pour être conforme aux spécifications Telecom :

- a. Chaque appel manuel ne dépassera pas 10 tentatives d'appel au même numéro dans un intervalle de 30 minutes.
- b. Le matériel doit rester à l'état raccroché pendant une période d'au moins 30 secondes entre la fin d'une tentative d'appel et le début de la tentative suivante.
- c. Lorsque des appels automatiques sont passés à divers numéros, le matériel doit être configuré pour passer à l'état raccroché pendant une période d'au moins 5 secondes entre la fin d'une tentative d'appel et le début de la tentative suivante.
- d. Le matériel doit être configuré de telle manière que les appels soient traités dans un délai de 3 à 30 secondes à partir de la réception de la sonnerie (il doit donc être configuré entre 2 et 10 secondes).

Prise en charge vocale

Toutes les personnes qui utilisent cet appareil pour enregistrer des conversations téléphoniques doivent se soumettre à la législation de la Nouvelle-Zélande. Celle-ci exige qu'au moins une des deux parties participant à la conversation soit au courant de l'enregistrement. En outre, les principes relatifs à la nature des informations personnelles recueillies, aux objectifs de leur collecte, à leur utilisation et à la divulgation de ces informations à des tiers, principes répertoriés dans la loi sur la protection de la vie privée de 1993, doivent être respectés.

Ce matériel ne doit pas être configuré de manière à passer des appels automatiques au numéro d'urgence (111) mis en place par Telecom.

Avis de Macrovision Corporation

Ce produit inclut une technologie de protection de copyright protégée par des déclarations de méthode de certains brevets américains et d'autres droits de propriété intellectuelle appartenant à Macrovision Corporation et autres détenteurs de droits. L'utilisation de cette technologie de protection des droits d'auteur doit être autorisée par Macrovision Corporation et a pour but de permettre un visionnage domestique et d'autres utilisations limitées uniquement, sauf autorisation de Macrovision Corporation. L'ingénierie inverse et le désassemblage sont interdits.

2 Avis relatifs à la sécurité

Informations importantes relatives à la sécurité

⚠ AVERTISSEMENT ! Pour réduire les risques de blessures graves, lisez le manuel *Sécurité et ergonomie du poste de travail*. Il décrit l'installation du poste de travail, la posture ainsi que les conditions de sécurité et de travail appropriées pour les utilisateurs, et fournit des informations importantes sur la sécurité électrique et mécanique. Vous trouverez ce manuel sur le Web à l'adresse <http://www.hp.com/ergo>, ainsi que sur le CD de documentation qui accompagne le produit.

L'ordinateur peut être très lourd ; assurez-vous d'adopter une position ergonomique adéquate lors de sa manipulation.

Installez l'ordinateur à proximité d'une prise secteur. Le cordon d'alimentation secteur constitue le principal dispositif de déconnexion secteur de votre ordinateur et doit donc être facilement accessible. Si le cordon d'alimentation fourni avec votre ordinateur est équipé d'une fiche de mise à la terre, utilisez toujours le cordon d'alimentation avec une prise secteur correctement reliée à la terre, afin d'éviter tout risque de choc électrique.

Pour réduire les risques de choc électrique en provenance du réseau téléphonique, branchez votre ordinateur sur une prise secteur avant de le connecter à une ligne téléphonique. Par ailleurs, déconnectez votre ligne téléphonique avant de débrancher votre ordinateur de la prise secteur.

Débranchez le cordon du modem du réseau téléphonique avant d'installer ou d'enlever le capot de votre ordinateur.

N'utilisez pas l'ordinateur lorsque le capot est enlevé.

Pour plus de sécurité, débranchez toujours l'ordinateur de sa source d'alimentation, de tout système de télécommunications (comme les lignes téléphoniques), des réseaux et des modems avant d'exécuter toute opération de maintenance. Si vous ne respectez pas ces consignes, vous risquez de vous blesser ou de causer des dommages matériels. Le modem et l'alimentation de ce produit renferment des niveaux de tension dangereux.

Par mesure de sécurité, si la charge d'alimentation électrique du système dépasse les capacités de la configuration spécifique, le système peut désactiver temporairement certains ports USB.

⚠ AVERTISSEMENT ! Pour réduire le risque d'incendie, de choc électrique et de blessure lors de l'utilisation de ce périphérique, suivez systématiquement les consignes de sécurité de base, notamment :

- N'utilisez pas l'appareil à proximité de l'eau, par exemple près d'une baignoire, d'un lavabo, d'un évier ou d'une piscine, ou encore dans une cave humide.
- Évitez d'utiliser l'appareil pendant un orage. Il existe un risque d'électrocution dû à la foudre.
- N'utilisez jamais cet appareil pour signaler une fuite de gaz si vous vous trouvez à proximité de la fuite.
- Débranchez systématiquement le câble du modem avant d'ouvrir l'enceinte de l'appareil ou de toucher un câble modem non isolé, une prise jack ou un composant interne.
- Si le produit n'est pas fourni avec un câble téléphonique, utilisez exclusivement un câble de télécommunication 26 AWG ou supérieur.
- Ne branchez pas un câble de modem ou de téléphone sur la prise réseau (RJ-45).

CONSERVEZ CES INSTRUCTIONS.

 **IMPORTANT :** Si votre ordinateur est équipé d'un commutateur de tension pour une utilisation dans un système électrique 115 ou 230 V, le commutateur a été préréglé sur la tension correcte qui correspond à celle utilisée dans le pays ou la région où il a été vendu à l'origine. Mettre le commutateur sur la mauvaise position peut endommager l'ordinateur et annuler toute garantie implicite.

Ce produit n'a pas été évalué pour une connexion à un système d'alimentation informatique (un système de distribution de courant alternatif sans connexion directe à la terre, selon les normes de sécurité applicables).

Notice d'avertissement relative à la sécurité liée à la chaleur

 **AVERTISSEMENT !** Pour éviter tout risque de blessure associée à la chaleur ou de surchauffe de l'ordinateur portable, ne placez pas ce dernier sur vos genoux et n'obstruez pas ses ouvertures d'aération. Utilisez toujours l'ordinateur portable sur une surface plane et rigide. La ventilation ne doit pas être entravée par des éléments rigides, tels qu'une imprimante, ni par des éléments souples, tels que des coussins, du tissu ou un tapis épais. De même, l'adaptateur secteur ne doit rester en contact ni avec la peau ni avec un élément souple, tel que des coussins, un vêtement ou un tapis lorsque l'ordinateur est en cours de fonctionnement. L'ordinateur portable et l'adaptateur secteur sont conformes aux limites de température de surface accessibles à l'utilisateur, définies par les normes de sécurité applicables.

Avis sur les risques liés à la sécurité

Si vous observez l'une des situations suivantes (ou avez d'autres inquiétudes en matière de sécurité), n'utilisez pas l'ordinateur : bruit de crépitement, de sifflement ou de claquement ou forte odeur/fumée en provenance de l'ordinateur. La survenue de l'une de ces situations est normale en cas de défaillance d'un composant électronique interne de manière neutralisée et contrôlée. Cependant, ces situations peuvent également indiquer un risque de sécurité. Ne partez pas du principe qu'il s'agit d'une défaillance neutralisée. Mettez l'ordinateur hors tension, déconnectez-le de sa source d'alimentation, puis contactez l'assistance technique.

Conditions d'installation

Consultez les instructions d'installation avant de brancher cet équipement sur l'alimentation.

 **AVERTISSEMENT !** Cet ordinateur peut contenir des pièces sous tension et amovibles. Débranchez le cordon d'alimentation avant de retirer le boîtier. Remettez le boîtier bien en place avant de remettre l'ordinateur sous tension.

Avis sur l'acoustique





Le niveau de pression acoustique (LpA) est extrêmement en deçà de 70dB(A) (position de l'opérateur, fonctionnement normal, selon la norme ISO 7779). Pour afficher les données d'émission sonore du produit, rendez-vous sur « Déclarations IT ECO » à <http://www.hp.com/go/ited>, puis sélectionnez une catégorie de produit dans le menu déroulant.

Avis relatif aux batteries



- ⚠ AVERTISSEMENT !** Le produit peut contenir un module de batteries interne au dioxyde de manganèse/lithium, au pentoxyde de vanadium ou alcaline. Un risque d'explosion ou de brûlure existe en cas de manipulation incorrecte du module de batteries.
- ⚠ AVERTISSEMENT !** Ne pas essayer de recharger la pile.
- ⚠ AVERTISSEMENT !** Évitez de la soumettre à des températures supérieures à 60° C (140° F).
- ⚠ AVERTISSEMENT !** Pour limiter les risques liés à la sécurité, seule la batterie fournie avec l'ordinateur, une batterie de rechange fournie par HP ou une batterie compatible achetée comme accessoire auprès de HP doit être utilisée avec l'ordinateur. Le chargement rapide peut ne pas être disponible pour les batteries autres que HP ou non compatibles.
- ⚠ AVERTISSEMENT !** Pour réduire tout risque d'incendie ou de brûlure, vous ne devez pas le désassembler, l'écraser, le perforer, mettre à nu ses contacts ni le jeter dans le feu ou dans l'eau.
- ⚠ AVERTISSEMENT !** Il existe un risque d'explosion en cas de remplacement de la batterie par une batterie d'un type incorrect. Éliminez les batteries usagées en respectant les instructions.
- ⚠ AVERTISSEMENT !** Remplacez uniquement par une batterie HP prévue pour ce produit.
- ⚠ AVERTISSEMENT !** Ne pas ingérer la batterie, risque de brûlure chimique.
- ⚠ AVERTISSEMENT !** Ce produit contient une pile bouton. Si la pile bouton est ingérée, elle peut causer des brûlures internes graves en moins de 2 heures et peut entraîner la mort.
- ⚠ AVERTISSEMENT !** Conservez les batteries neuves et usagées hors de portée des enfants.
- ⚠ AVERTISSEMENT !** Si le compartiment de la batterie n'est pas fermé convenablement, arrêtez d'utiliser le produit et gardez hors de portée des enfants.
- ⚠ AVERTISSEMENT !** Si vous pensez que des batteries ont pu avoir été ingérées ou placées à l'intérieur de toute partie du corps, consulter immédiatement un médecin.
- ⚠ AVERTISSEMENT !** Si vous laissez une batterie dans un environnement comportant une température extrêmement élevée, cela peut entraîner une explosion ou la fuite du gaz ou liquide inflammable.
- ⚠ AVERTISSEMENT !** Une batterie soumise à une pression d'air très faible peut entraîner une explosion ou la fuite du gaz ou liquide inflammable.

Icône	Description
	Les piles, modules de batterie et accumulateurs ne doivent pas être jetés avec les ordures ménagères. Pour permettre leur recyclage ou leur mise au rebut, veuillez utiliser les systèmes de collecte publique ou renvoyez-les à HP, à un partenaire HP agréé ou à leurs agents.

Avis sur le ventilateur

-  **AVERTISSEMENT !**  Conservez les pièces fixes éloignées des parties mobiles.
-  **AVERTISSEMENT !** Conservez les pièces fixes éloignées des hélices du ventilateur.
-  **AVERTISSEMENT !** Conservez les pièces fixes hors de la trajectoire de mouvement.
-

Avis sur le niveau du volume du casque et des écouteurs

-  **AVERTISSEMENT !**  Pour éviter les dommages causés à votre système auditif, n'écoutez pas à des volumes élevés pendant des périodes prolongées.

Le réglage de la commande de volume, ainsi que du balancier compensateur d'autres paramètres hors de la position centrale peut augmenter la tension de sortie du casque/des écouteurs et par conséquent le niveau de pression acoustique. L'utilisation de facteurs influençant la sortie casque/écouteurs autres que ceux spécifiés par le fabricant (par exemple système d'exploitation, logiciel d'égalisation, microprogramme, pilote) peut augmenter la tension de sortie du casque/des écouteurs et par conséquent le niveau de pression acoustique.

Sécurité des lasers

Pour les produits équipés d'unités optiques ou d'émetteurs à fibre optique.

Ce produit peut être équipé d'un périphérique de stockage optique (c'est-à-dire un lecteur CD ou DVD) et/ou d'un émetteur-récepteur à fibre optique. Ces éléments comportent des lasers classés dans la catégorie des produits laser de classe 1, conformément à la norme IEC/EN 60825-1, et sont conformes à ses exigences.

Chacun de ces produits laser est conforme aux réglementations 21 CFR 1040.10 et 1040.11 de la US FDA ou est conforme à ces normes à l'exception des différences conformément à la notice des lasers No. 50, du 24 Juin 2007.

-  **AVERTISSEMENT !** L'utilisation de méthodes de contrôle ou de réglage ou de procédures, autres que celles indiquées dans ce document ou dans le manuel d'installation des appareils à rayon laser, peut exposer l'utilisateur à des radiations dangereuses. Pour réduire le risque d'exposition à un rayonnement dangereux :
- N'essayez pas d'ouvrir le boîtier du module. Il ne contient pas de composant réparable par l'utilisateur.
 - N'effectuez pas de commandes, de réglages ou d'opérations sur l'appareil laser, en dehors de ce qui est indiqué dans le présent manuel.
 - Seuls les techniciens agréés HP sont autorisés à réparer l'unité.
-

Exigences relatives au bloc d'alimentation et au cordon d'alimentation

Exigences relatives à la mise à la terre des alimentations de classe 1

Pour une protection contre les défauts de courant, l'équipement doit être connecté à une borne de terre. Branchez le cordon d'alimentation du système sur une prise secteur fournissant une connexion de masse. Tout cordon alternatif risquerait de ne pas fournir une protection adéquate contre les défauts. Utilisez uniquement le cordon d'alimentation fourni avec ce produit ou un produit de remplacement agréé par HP Inc.

Avis pour le Brésil

Este equipamento deve ser conectado obrigatoriamente em tomada de rede de energia elétrica que possua aterramento (três pinos), conforme a norma nbr abnt 5410, visando a segurança dos usuários contra choques elétricos.

Danemark

Apparatets stikprop skal tilsluttes en stikkontakt med jord, som giver forbindelse til stikproppens jord.

Finlande

Laite on liitettävä suojakoskettimilla varustettuun pistorasiaan.

Norvège

Apparatet må tilkoples jordet stikkontakt.

Suède

Apparaten skall anslutas till jordat uttag.

Exigences relatives au bloc d'alimentation

Les alimentations sur certains produits sont équipées de commutateurs de tension externes. La fonction de sélection de tension sur le produit autorise son fonctionnement sous toute tension comprise entre 100-127 ou 200-240 volts secteur. Les alimentations sur les produits dépourvus de commutateurs de tension externes sont équipées de circuits internes qui détectent la tension d'entrée et basculent automatiquement sur la tension appropriée.

⚠ AVERTISSEMENT ! Pour limiter les problèmes de sécurité potentiels, utilisez avec cet ordinateur uniquement l'adaptateur secteur fourni avec l'ordinateur, un adaptateur secteur de remplacement fourni par HP ou un adaptateur secteur acheté comme accessoire auprès de HP.

Pour une utilisation en Norvège

Ce produit est également conçu pour un système électrique informatique avec tension phase-phase de 230 V.

Exigences relatives au cordon d'alimentation

⚠ AVERTISSEMENT ! Pour réduire les risques de choc électrique ou de détérioration du matériel :

- Branchez le cordon d'alimentation sur une prise secteur facilement accessible à tout moment.
 - Coupez l'alimentation de l'ordinateur en débranchant le cordon d'alimentation de la prise secteur.
 - Si l'ordinateur portable est fourni avec une fiche tripolaire, branchez le cordon sur une prise électrique tripolaire reliée à la terre. Ne désactivez pas la broche de mise à la terre du cordon d'alimentation en utilisant, par exemple, un adaptateur bipolaire. La broche de mise à la terre constitue un élément de sécurité essentiel.
-

Le jeu de cordon d'alimentation livré avec le produit est conforme aux exigences du pays dans lequel l'équipement a été acheté. Utilisez uniquement le cordon d'alimentation fourni avec l'appareil ou un cordon d'alimentation de remplacement fourni par HP Inc. ou par un revendeur agréé par HP Inc. Les références de pièces de rechange sont disponibles à l'adresse <http://www.hp.com/support>.

Les cordons d'alimentation destinés à être utilisés dans d'autres pays doivent respecter les normes du pays où vous utilisez le produit. Pour plus d'informations sur les exigences de cordon d'alimentation, contactez votre revendeur, votre mainteneur ou votre fournisseur de services agréé HP.

⚠ AVERTISSEMENT ! N'utilisez pas de cordons d'alimentation d'autres produits.

Un mauvais cordon d'alimentation peut entraîner un risque de décharge électrique ou d'incendie.

Les exigences présentées ci-après s'appliquent à tous les pays.

1. Le cordon d'alimentation doit être homologué par une agence accréditée, responsable de l'évaluation dans le pays où le cordon sera installé.
2. La longueur du cordon doit être comprise entre 1,8 m (6 pieds) et 3,6 m (12 pieds). Pour un cordon d'alimentation de 2 m (6,56 pieds) ou moins, le diamètre du cordon doit être d'au minimum 0,75 mm² ou 18 AWG. Si le cordon d'alimentation dépasse 2 m (6,56 pieds), le diamètre du cordon doit être d'au minimum 1 mm² ou 16 AWG.

Le cordon d'alimentation doit être branché à un endroit dégagé où il ne risque pas d'être piétiné ou coincé par des objets. Accordez une attention particulière à la fiche, à la prise murale et à l'endroit où le cordon sort du boîtier de l'appareil.

⚠ AVERTISSEMENT ! N'utilisez pas ce produit avec un cordon d'alimentation endommagé. Si le cordon d'alimentation est endommagé de quelque manière que ce soit, remplacez-le immédiatement. Un cordon endommagé peut entraîner des risques de blessure.

Informations sur le cordon d'alimentation

Si votre ordinateur ne vous a pas été livré avec un cordon d'alimentation ou un accessoire d'alimentation secteur compatible avec votre ordinateur, vous devrez acheter un cordon d'alimentation homologué pour votre pays ou votre région.

Les caractéristiques électriques du cordon d'alimentation doivent correspondre à la tension et au courant du produit tels qu'indiqués sur l'étiquette des caractéristiques électriques du produit. Les valeurs nominales de tension et d'intensité du cordon doivent être supérieures à celles indiquées sur l'ordinateur. En outre, le diamètre du cordon doit être au minimum de **0,75 mm²/18 AWG** et sa longueur doit être comprise entre **1 et 2 m**. Si vous avez des questions sur le type de cordon d'alimentation à utiliser, contactez votre fournisseur de service agréé.

Le cordon d'alimentation doit être placé de sorte que personne ne puisse marcher dessus ou qu'il ne puisse être pincé par des éléments placés contre ou sur le fil. Prêtez tout particulièrement attention à la fiche, à la prise murale et au point où le cordon d'alimentation sort du produit.

prise CC de la source d'alimentation externe HP



Avis sur les cordons d'alimentation pour le Japon

製品には、同梱された電源コードをお使い下さい。
同梱された電源コードは、他の製品では使用出来ません。

Spécifications du cordon d'alimentation pour le Japon

Pour une utilisation au Japon, utilisez uniquement le cordon d'alimentation fourni avec l'appareil.

⚠ ATTENTION : N'utilisez pas le cordon d'alimentation fourni avec ce produit pour alimenter d'autres appareils.

Risque de pincement

⚠ AVERTISSEMENT ! Observez les zones à risque de pincement. N'approchez pas vos doigts des pièces se refermant.

Protection des connecteurs de l'antenne TV

Mise à la terre d'une antenne de télévision externe

Si une antenne externe ou un système par câble est connecté(e) à ce produit, assurez-vous que l'antenne ou le système par câble est mis(e) à la terre électriquement de façon à vous protéger contre les surtensions et les accumulations d'électricité statique. L'article 810 du code électrique national (ANSI/NFPA 70) fournit des informations sur la mise à la terre de la monture et de la structure portante, la mise à la terre du fil d'entrée vers un dispositif de décharge de l'antenne, la taille des conducteurs de mise à la terre, l'emplacement du dispositif de décharge de l'antenne, la connexion aux électrodes de terre et les exigences relatives aux électrodes de terre.

Protection contre la foudre

Pour mieux protéger votre produit durant un orage ou lorsqu'il reste inutilisé et sans surveillance pendant une période prolongée, débranchez le câble de raccordement électrique, puis l'antenne ou le système par câble. Vous éviterez ainsi que la foudre ou des surtensions n'endommagent le produit.



Tableau 2-1 Mise à la terre de l'antenne

Référence	Composant de mise à la terre
1	Compteur électrique extérieur
2	Système d'électrode de mise à terre du compteur électrique (code électrique national, article 250, partie III)
3	Colliers de mise à la terre
4	Conducteurs de mise à la terre (code électrique national, section 810.21)
5	Dispositif de décharge de l'antenne (code électrique national, section 810.20)
6	Collier de mise à la terre
7	Fil d'entrée de l'antenne

Remarque destinée aux installateurs de systèmes de télévision par câble

Ce rappel a pour but d'attirer l'attention des installateurs de systèmes de télévision par câble sur la section 820.93 du code électrique national, qui fournit des directives pour la mise à la terre et spécifie notamment que le blindage du câble coaxial doit être connecté au système de mise à la terre du bâtiment, aussi près que possible du point d'entrée du câble.

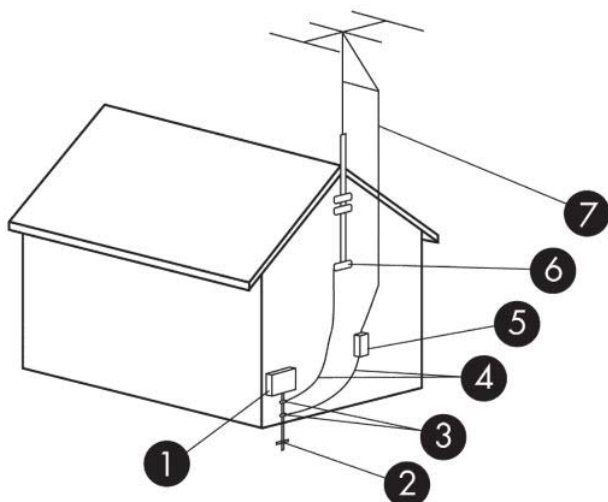
Avis sur les déplacements

⚠ AVERTISSEMENT ! Afin de réduire le risque de choc électrique, d'incendie ou de détérioration du matériel, n'essayez pas d'alimenter l'ordinateur au moyen d'un kit de conversion de tension destiné aux équipements ménagers.

Avis de sécurité pour la Chine

HP 工作站使用安全手册

使用须知

欢迎使用惠普工作站，为了您及仪器的安全，请您务必注意如下事项：

1. 仪器要和地线相接，要使用有正确接地插头的电源线，使用中国国家规定的 220V 电源。
2. 避免高温和尘土多的地方，否则易引起仪器内部部件的损坏。
3. 避免接近高温，避免接近直接热源，如直射太阳光、暖气等其它发热体。
4. 不要有异物或液体落入机内，以免部件短路。
5. 不要将磁体放置于仪器附近。

警告

为防止火灾或触电事故，请不要将该机放置于淋雨或潮湿处

如果您按照以上步骤操作时遇到了困难，或想了解其它产品性能，请在以下网页上寻找相关信息：<http://www.hp.com.cn>

或联系我们

中国惠普有限公司
地址：北京朝阳区建国路 112 号中国惠普大厦
电话：010-65643888

Chine : avis sur l'altitude

海拔警告仅适用于在海拔 2000m 以下地区使用的产品

Icône	Description
	海拔警告仅适用于在海拔 2000m 以下地区使用的产品。

Chine : avis sur une utilisation dans des conditions tropicales

热带警告仅适用于在非热带气候条件下使用的产品。

Icône	Description
	热带警告仅适用于在非热带气候条件下使用的产品。

Norvège et Suède : Avis de mise à la terre des câbles pour les produits équipés d'une carte TV

 **ATTENTION :** Pour réduire les problèmes de sécurité potentiels, utilisez un sectionneur galvanique pour le branchement à un réseau de distribution par câble.

使用過度恐傷害視力

注意事項:

- (1) 使用 30 分鐘請休息 10 分鐘。
- (2) 未滿 2 歲幼兒不看螢幕， 2 歲以上每天看螢幕不要超過 1 小時。

3 Avis des agences environnementales

Ce chapitre présente des avis relatifs à l'environnement des différents pays ou régions et des informations de conformité. Certains de ces avis peuvent ne pas s'appliquer à votre produit.

Recyclage du matériel électronique, de l'emballage et de la batterie

HP encourage ses clients à recycler le matériel électronique usagé, l'emballage des cartouches d'impression d'origine HP et les piles rechargeables. Pour plus d'informations sur les programmes de recyclage, rendez-vous sur <http://www.hp.com/recycle>.

Pour obtenir des informations concernant le recyclage du produit au Japon, reportez-vous à <http://www.hp.com/jp/hardwarecycle/>.

Mise au rebut des équipements par les utilisateurs

Icône	Description
	Ce symbole indique que vous ne devez pas jeter votre produit avec les déchets ménagers. Il est de votre responsabilité de protéger la santé et l'environnement et d'éliminer votre équipement en le remettant à une déchetterie effectuant le recyclage des équipements électriques et électroniques. Pour plus d'informations, prenez contact avec votre service d'élimination des ordures ménagères ou ouvrez la page http://www.hp.com/recycle .

Mise au rebut des batteries alcalines au Brésil

Icône	Description
 Não descarte o produto eletrônico em lixo comum	Este produto eletroeletrônico e seus componentes não devem ser descartados no lixo comum, pois embora estejam em conformidade com padrões mundiais de restrição a substâncias nocivas, podem conter, ainda que em quantidades mínimas, substâncias impactantes ao meio ambiente. Ao final da vida útil deste produto, o usuário deverá entregá-lo à HP. A não observância dessa orientação sujeitará o infrator às sanções previstas em lei. Após o uso, as pilhas e/ou baterias dos produtos HP deverão ser entregues ao estabelecimento comercial ou rede de assistência técnica autorizada pela HP. Para maiores informações, inclusive sobre os pontos de recebimento, acesse: http://www.hp.com.br/reciclar

Informations sur le recyclage du matériel au Brésil

Icône	Description
	Este produto eletroeletrônico e seus componentes não devem ser descartados no lixo comum, pois embora estejam em conformidade com padrões mundiais de restrição a substâncias nocivas, podem conter, ainda que em quantidades mínimas, substâncias impactantes ao meio ambiente. Ao final da vida útil deste produto, o usuário deverá entregá-lo à HP. A não observância dessa orientação sujeitará o infrator às sanções previstas em lei. Após o uso, as pilhas e/ou baterias dos produtos HP deverão ser entregues ao estabelecimento comercial ou rede de assistência técnica autorizada pela HP.

Ícone	Description
Não descarte o produto eletrônico em lixo comum	Para maiores informações, inclusive sobre os pontos de recebimento, acesse: http://www.hp.com.br/reciclar

Informations de recyclage de la pile pour Taiwan

Ícone	Description
 廢電池請回收	Taiwan EPA demande aux fabricants ou aux importateurs de piles, conformément à l'Article 15 de la loi relative à la mise au rebut (Waste Disposal Act), d'indiquer les mentions de récupération des piles usagées dans des points de vente, brochures ou publicités. Contactez une entreprise de recyclage qualifiée pour la mise au rebut appropriée de la pile.

Certification ENERGY STAR® (certains produits uniquement)

ENERGY STAR est un programme de l'agence de protection environnementale des États-Unis qui aide les entreprises et les personnes à économiser de l'argent et à protéger le climat par le biais de l'utilisation de produits présentant une efficacité énergétique supérieure. Les produits certifiés ENERGY STAR limitent les émissions de gaz à effet de serre en répondant aux critères d'efficacité énergétique stricts édictés par l'Agence de protection environnementale des États-Unis. En tant que partenaire ENERGY STAR, HP Inc. a suivi le processus avancé de certification des produits de l'EPA pour s'assurer que les produits portant le logo ENERGY STAR respectaient les réglementations ENERGY STAR. Le logo suivant apparaît sur tous les ordinateurs respectant les spécifications ENERGY STAR :



Une exigence clé du programme ENERGY STAR pour les produits informatiques réside dans l'inclusion de fonctions de gestion de l'alimentation permettant de réduire sensiblement la consommation d'énergie lorsque le produit n'est pas utilisé. La gestion de l'alimentation permet à un ordinateur de passer automatiquement dans un mode basse consommation « veille » ou tout autre mode basse consommation, après une période définie d'inactivité. Les fonctions de gestion de l'alimentation ont été prédéfinies comme suit lorsque l'ordinateur fonctionne sur secteur :

Type d'ordinateur	Délai d'activation du mode veille de l'écran	Délai d'activation du mode veille de l'ordinateur (en minutes)	Sortie du mode veille
Notebooks, stations de travail mobiles	<= 15 minutes (selon le modèle)	<= 30 minutes (selon le modèle)	Le produit quitte le mode veille lorsque vous appuyez sur le bouton d'alimentation/veille. Si le Wake on Lan (WOL) est activé, le système peut sortir du mode veille en réponse à un signal réseau.
Tablettes	<= 1 minute	Non applicable	Non applicable
Ordinateurs de bureau, ordinateurs de bureau intégrés, stations de travail	<= 15 minutes (selon le modèle)	<= 30 minutes (selon le modèle)	Le produit quitte le mode veille lorsque l'utilisateur interagit avec un périphérique d'entrée, y compris la souris ou le clavier.

Type d'ordinateur	Délai d'activation du mode veille de l'écran	Délai d'activation du mode veille de l'ordinateur (en minutes)	Sortie du mode veille
			Si le Wake on Lan (WOL) est activé, le système peut sortir du mode veille en réponse à un signal réseau.
Clients légers	<= 15 minutes (selon le modèle)	<= 30 minutes lorsque le mode veille est pris en charge par le système d'exploitation (selon le modèle)	Si le mode veille est pris en charge par le système d'exploitation, le produit quitte le mode veille lorsque l'utilisateur interagit avec un périphérique d'entrée, y compris la souris ou le clavier. Si le Wake on Lan (WOL) est activé, le système peut sortir du mode veille en réponse à un signal réseau.

Pour les ordinateurs prenant en charge un profil d'utilisation « toujours sous tension, toujours connecté » où l'accès à Internet reste actif (par exemple sur les tablettes), des modes d'alimentation basse consommation alternatifs, comme les modes d'inactivité courte ou d'inactivité prolongée (tels que définis dans les exigences du programme ENERGY STAR pour les ordinateurs) sont fournis. Ils consomment très peu d'énergie (<= 10 Watts) et le cas échéant, optimisent l'autonomie du produit. Ces modes alternatifs sont dynamiques. Le mode veille de l'écran est activé après 1 minute d'inactivité de l'utilisateur.

L'ordinateur quitte le mode veille lorsque vous appuyez sur le bouton d'alimentation/veille. Lorsque la fonction Wake On LAN (WOL) est activée, l'ordinateur peut également quitter le mode veille en réponse à un signal réseau.

Plus d'informations sur les économies énergétiques et financières potentielles liées aux fonctions de gestion de l'alimentation sont présentées sur le site Web de gestion de l'alimentation ENERGY STAR de l'EPA à l'adresse <http://www.energystar.gov/powermanagement>.

Plus d'informations sur le programme ENERGY STAR et ses avantages pour l'environnement sont disponibles sur le site Web ENERGY STAR de l'EPA à l'adresse <http://www.energystar.gov>.

ENERGY STAR et le label ENERGY STAR sont des marques déposées détenues par l'Agence de protection environnementale des États-Unis.

Substances chimiques

HP s'engage à fournir à ses clients des informations sur les substances chimiques contenues dans ses produits, conformément aux normes juridiques en vigueur telles que le règlement concernant l'enregistrement, l'évaluation et l'autorisation des substances chimiques, ainsi que les restrictions applicables à ces substances (REACH, règlement CE N° 1907/2006 du Parlement européen et du Conseil). Des informations sur les substances chimiques contenues dans ce produit sont disponibles à l'adresse <http://www.hp.com/go/reach>.

Avis sur le mercure

Cette déclaration s'applique à tous les ordinateurs tout-en-un équipés d'écrans intégrés qui n'utilisent pas le rétroéclairage LED.

Ce produit HP peut contenir les matériaux suivants qui requièrent un traitement spécial à la fin de leur cycle de vie :

- Le mercure contenu dans la lampe fluorescente de l'écran à cristaux liquides (LCD)

Il se peut que l'élimination du mercure soit réglementée en raison de considérations environnementales. Pour obtenir des informations sur l'élimination et le traitement de cette substance, veuillez contacter les autorités locales concernées ou l'Electronic Industries Alliance (EIA) (<http://www.eiae.org>).

Matériau composé de perchlorate : une manipulation particulière peut être nécessaire

La batterie de l'horloge en temps réel est susceptible de contenir du perchlorate et peut nécessiter une manipulation particulière lors de son recyclage ou de sa mise au rebut en Californie. Reportez-vous au site <http://www.dtsc.ca.gov/hazardouswaste/perchlorate/>.

Avis sur l'environnement pour la Chine

回收信息说明

惠普公司对废弃的电子计算机（笔记本电脑）提供回收服务，更多信息请登陆

<http://www8.hp.com/us/en/hp-information/environment/product-recycling.html>

Étiquette de consommation énergétique des ordinateurs pour la Chine

Conformément à la réglementation sur la mise en place d'une étiquette de consommation énergétique des micro-ordinateurs pour la Chine, ce micro-ordinateur est équipé d'une étiquette d'efficacité énergétique. La classe d'efficacité énergétique (consommation énergétique typique) et la catégorie de produit, présentées sur l'étiquette, sont déterminées et calculées selon la norme GB28380-2012.

1. Classes d'efficacité énergétique

La classe est déterminée par la norme en calculant le niveau de consommation de base et en ajoutant la consommation des éléments supplémentaires, tels que la mémoire principale et les cartes graphiques. Quelle que soit la classe, la consommation énergétique typique ne doit pas dépasser la valeur indiquée dans le tableau suivant :

Type de produit		Consommation énergétique typique (kilowatt-heure)		
		Classe 1	Classe 2	Classe 3
Micro-ordinateur de bureau, tout-en-un	Catégorie A	98+ Σ Efa	148+ Σ Efa	198+ Σ Efa
	Catégorie B	125+ Σ Efa	175+ Σ Efa	225+ Σ Efa
	Catégorie C	159+ Σ Efa	209+ Σ Efa	259+ Σ Efa
	Catégorie D	184+ Σ Efa	234+ Σ Efa	284+ Σ Efa
Ordinateur portable	Catégorie A	20+ Σ Efa	35+ Σ Efa	45+ Σ Efa

Type de produit	Consommation énergétique typique (kilowatt-heure)		
	Catégorie B	26+ΣEfa	45+ΣEfa
Catégorie C	54,5+ΣEfa	75,0+ΣEfa	123,5+ΣEfa

REMARQUE : ΣEFA est la somme du facteur de puissance de fonctions supplémentaires du produit.

2. Consommation énergétique typique

Le chiffre de la consommation énergétique indiqué sur l'étiquette correspond aux données mesurées avec la configuration représentative qui couvre toutes les configurations de l'unité d'enregistrement sélectionnée conformément à la « Réglementation sur la mise en place d'une étiquette de consommation énergétique des micro-ordinateurs pour la Chine ». Par conséquent, la consommation énergétique réelle de ce micro-ordinateur spécifique peut ne pas être la même que celle des données de consommation énergétique typique présentées sur l'étiquette.

3. Catégorie de produit

La catégorie de produit est déterminée par la norme selon la configuration du micro-ordinateur. La classification des produits est conforme aux réglementations dans le tableau suivant :

Type de produit	Description de la configuration	
	Micro-ordinateur de bureau, tout-en-un	Ordinateur portable
Catégorie A	Micro-ordinateur de bureau et tout-en-un dont la configuration est en dehors du champ d'application de la catégorie B, C et D	Ordinateur portable dont la configuration est en dehors du champ d'application de la catégorie B et C
Catégorie B	2 cœurs physiques de processeurs et au moins 2 Go de mémoire système	Processeur graphique distinct
Catégorie C	Plus de 2 cœurs physiques de processeurs avec au moins l'une des fonctions suivantes : 1. Au moins 2 Go de mémoire système 2. Processeur graphique distinct	Le produit possède au moins 2 cœurs physiques de processeurs et 2 Go de mémoire système. Processeur graphique distinct avec une largeur de tampon de trame d'au moins 128 bits.
Catégorie D	Au moins 4 cœurs physiques de processeurs avec au moins l'une des fonctions suivantes : 1. Au moins 4 Go de mémoire système 2. Processeur graphique distinct avec une largeur de tampon de trame d'au moins 128 bits	

Pour plus de détails sur la spécification, veuillez vous reporter à la norme GB28380-2012.

本机根据《微型计算机能源效率标识实施规则》的要求加施中国能效标识。能效标识中显示的能效等级、典型能源消耗和产品类型均根据《微型计算机能效限定值及能效等级》(GB28380-2012)的要求确定。对上述标识内容的说明如下：

1. 能效等级

微型计算机的能效等级由基础能源消耗值和附加功能功耗因子之和决定。微型计算机能效各等级的典型能源消耗应不大于下表的规定

微型计算机类型		能源消耗(千瓦时)		
		1	2	3
台式微型计算机及一体机	A类	$98.0+\Sigma E_{fa}$	$148.0+\Sigma E_{fa}$	$198.0+\Sigma E_{fa}$
	B类	$125.0+\Sigma E_{fa}$	$175.0+\Sigma E_{fa}$	$225.0+\Sigma E_{fa}$
	C类	$159.0+\Sigma E_{fa}$	$209.0+\Sigma E_{fa}$	$259.0+\Sigma E_{fa}$
	D类	$184.0+\Sigma E_{fa}$	$234.0+\Sigma E_{fa}$	$284.0+\Sigma E_{fa}$
便携式计算机	A类	$20.0+\Sigma E_{fa}$	$35.0+\Sigma E_{fa}$	$45.0+\Sigma E_{fa}$
	B类	$26.0+\Sigma E_{fa}$	$45.0+\Sigma E_{fa}$	$65.0+\Sigma E_{fa}$
	C类	$54.5+\Sigma E_{fa}$	$75.0+\Sigma E_{fa}$	$123.5+\Sigma E_{fa}$

注： ΣE_{fa} 为微型计算机附加功能功耗因子之和

2. 典型能源消耗

典型能源消耗值代表一个备案单元中，符合《微型计算机能源效率标识实施规则》要求的代表性规格型号产品的数值。因此，本机的典型能源消耗值可能与其所加施的能效标识中所示的典型能源消耗值不一致。

3. 产品类型

产品类型根据微型计算机的配置确定。参见下表：

类型	配置说明	
	台式微型计算机及一体机	便携式计算机
A类	下列B类、C类、D类配置以外的台式微型计算机及一体机	下列B类、C类配置以外的便携式计算机
B类	中央处理器(CPU)物理核心数为2,系统内存大于等于2GB	具有独立图形显示单元(GPU)
C类	中央处理器(CPU)物理核心数大于2,且至少具有以下特征中的一条 a. 系统内存大于等于2GB; b. 独立图形显示单元(GPU)	中央处理器(CPU)物理核心数大于等于2,系统内存大于等于2GB,具有独立图形显示单元(GPU)且显存位宽大于等于128位。
D类	中央处理器(CPU)物理核心数大于等于4,且至少具有以下特征中的一条: a. 系统内存大于等于4GB; b. 具有独立图形显示单元(GPU)且显存位宽大于等于128位	

关于标识内容的更详细技术信息，请参考《微型计算机能效限定值及能效等级》(GB28380-2012)

Restrictions d'utilisation de substances dangereuses (RoHS) pour les ordinateurs portables et les tablettes en Chine

Tableau des substances/composants dangereux et leur contenu

Comme requis par les Méthodes pour la gestion des substances dangereuses à utilisation restreinte dans les produits électriques et électroniques de Chine



Nom de la pièce	Matières dangereuses					
	Plomb (Pb)	Mercure (Hg)	Cadmium (Cd)	Chrome hexavalent (Cr(VI))	Diphényles polybromés (PBB)	Éthers diphényles polybromés (PBDE)
Batterie	X	0	0	0	0	0
Câbles	X	0	0	0	0	0
Caméra	X	0	0	0	0	0
Châssis/Autre	X	0	0	0	0	0
Lecteur de carte mémoire flash	X	0	0	0	0	0
Lecteur de disquette	X	0	0	0	0	0
Disque dur	X	0	0	0	0	0
Casque	X	0	0	0	0	0
I/O PCAs	X	0	0	0	0	0
Clavier	X	0	0	0	0	0
Écran LCD	X	0	0	0	0	0
Support (CD/DVD/disquette)	0	0	0	0	0	0
Mémoire	X	0	0	0	0	0
Carte mère, processeur, dissipateurs thermiques	X	0	0	0	0	0
Souris	X	0	0	0	0	0
Unité de disque optique	X	0	0	0	0	0
Périphérique d'amarrage en option	X	0	0	0	0	0
Adaptateur d'alimentation	X	0	0	0	0	0
Bloc d'alimentation	X	0	0	0	0	0
Source d'alimentation	X	0	0	0	0	0
Télécommande	X	0	0	0	0	0
Lecteur de carte Smart Card/Java™	X	0	0	0	0	0

Nom de la pièce	Matières dangereuses					
	Plomb (Pb)	Mercure (Hg)	Cadmium (Cd)	Chrome hexavalent (Cr(VI))	Diphényles polybromés (PBB)	Éthers diphényles polybromés (PBDE)
Haut-parleurs externes	X	0	0	0	0	0
Tuner TV	X	0	0	0	0	0
Unité mémoire flash USB	X	0	0	0	0	0
Concentrateur USB	X	0	0	0	0	0
Webcam	X	0	0	0	0	0
Récepteur sans fil	X	0	0	0	0	0
Cartes sans fil	X	0	0	0	0	0

Ce formulaire a été préparé conformément aux dispositions de la norme SJ/T 11364.

0 : Indique que la quantité de la substance dangereuse mentionnée respecte les limites définies GB/T 26572 dans tous les matériaux homogènes du composant.

X : Indique que la quantité de la substance dangereuse mentionnée dépasse les limites requises par GB/T 26572 dans au moins un matériau homogène du composant.

Tous les éléments du tableau accompagnés d'un « X » sont conformes à la norme RoHS de l'Union européenne.

REMARQUE : La durée d'utilisation écologique en année, en référence, a été déterminée sur la base de conditions normales d'utilisation du produit, telles que la température et l'humidité.

笔记本电脑和平板电脑产品中有害物质或元素的名称及含量

根据中国《电器电子产品有害物质限制使用管理办法》



部件名称	有害物质					
	铅 (Pb)	汞 (Hg)	镉 (Cd)	六价铬 (Cr(VI))	多溴联苯 (PBB)	多溴二苯醚 (PBDE)
电池	X	0	0	0	0	0
线缆	X	0	0	0	0	0
摄像头	X	0	0	0	0	0
机箱/其他	X	0	0	0	0	0
闪存读卡器	X	0	0	0	0	0
软盘驱动器	X	0	0	0	0	0
硬盘驱动器	X	0	0	0	0	0
耳机	X	0	0	0	0	0
I/O PCA	X	0	0	0	0	0
键盘	X	0	0	0	0	0
液晶显示器 (LCD) 面板	X	0	0	0	0	0

部件名称	有害物质					
	铅 (Pb)	汞 (Hg)	镉 (Cd)	六价铬 (Cr(VI))	多溴联苯 (PBB)	多溴二苯醚 (PBDE)
介质 (CD/DVD/软盘)	0	0	0	0	0	0
内存	X	0	0	0	0	0
主板、处理器和散热器	X	0	0	0	0	0
鼠标	X	0	0	0	0	0
光盘驱动器	X	0	0	0	0	0
对接设备选件	X	0	0	0	0	0
电源适配器	X	0	0	0	0	0
电源	X	0	0	0	0	0
电源组	X	0	0	0	0	0
投影仪	X	0	0	0	0	0
遥控器	X	0	0	0	0	0
智能卡/Java™ 卡读卡器	X	0	0	0	0	0
扬声器(外置)	X	0	0	0	0	0
电视调谐器	X	0	0	0	0	0
USB 闪存驱动器	X	0	0	0	0	0
USB 集线器	X	0	0	0	0	0
网络摄像头	X	0	0	0	0	0
无线接收器	X	0	0	0	0	0
无线网卡	X	0	0	0	0	0

本表格依据 SJ/T 11364 的规定编制。

0：表示该有害物质在该部件所有均质材料中的含量均在 GB/T 26572 规定的限量要求以下。

X：表示该有害物质至少在该部件的某一均质材料中的含量超出 GB/T 26572 规定的限量要求。

注：环保使用期限的参考标识取决于产品正常工作的温度和湿度等条件

Restrictions d'utilisation de substances dangereuses pour la Chine (ROHS) pour les ordinateurs de bureau, clients légers, stations de travail personnelles, tout-en-un et les terminaux de point de vente

Tableau des substances/composants dangereux et leur contenu

Comme requis par les Méthodes pour la gestion des substances dangereuses à utilisation restreinte dans les produits électriques et électroniques de Chine



Nom de la pièce	Matières dangereuses					
	Plomb (Pb)	Mercure (Hg)	Cadmium (Cd)	Chrome hexavalent (Cr(VI))	Diphényles polybromés (PBB)	Éthers diphényles polybromés (PBDE)
Batterie	X	0	0	0	0	0
Câbles	X	0	0	0	0	0
Caméra	X	0	0	0	0	0
Châssis/Autre	X	0	0	0	0	0
Ventilateur	X	0	0	0	0	0
Lecteur de carte mémoire flash	X	0	0	0	0	0
Lecteur de disquette	X	0	0	0	0	0
Disque dur	X	0	0	0	0	0
Casque	X	0	0	0	0	0
Dissipateur thermique	X	0	0	0	0	0
I/O PCAs	X	0	0	0	0	0
Clavier	X	0	0	0	0	0
Écran LCD	X	0	0	0	0	0
Support (CD/DVD/ disquette)	0	0	0	0	0	0
Mémoire	X	0	0	0	0	0
Carte mère, processeur, dissipateurs thermiques	X	0	0	0	0	0
Souris	X	0	0	0	0	0
Unité de disque optique	X	0	0	0	0	0
Périphérique d'amarrage en option	X	0	0	0	0	0
Adaptateur d'alimentation	X	0	0	0	0	0
Source d'alimentation	X	0	0	0	0	0
Projecteur	X	0	0	0	0	0
Télécommande	X	0	0	0	0	0
Lecteur de carte Smart Card/Java™	X	0	0	0	0	0
Disques SSD	X	0	0	0	0	0
Haut-parleurs externes	X	0	0	0	0	0
Styler	X	0	0	0	0	0
Tapis tactile	X	0	0	0	0	0

Nom de la pièce	Matières dangereuses					
	Plomb (Pb)	Mercure (Hg)	Cadmium (Cd)	Chrome hexavalent (Cr(VI))	Diphényles polybromés (PBB)	Éthers diphényles polybromés (PBDE)
Tuner TV	X	0	0	0	0	0
Unité mémoire flash USB	X	0	0	0	0	0
Concentrateur USB	X	0	0	0	0	0
Webcam	X	0	0	0	0	0
Récepteur sans fil	X	0	0	0	0	0
Cartes sans fil	X	0	0	0	0	0
Plateau de capture 3D/ plaque tournante	X	0	0	0	0	0

Ce formulaire a été préparé conformément aux dispositions de SJ/T 11364.

0 : Indique que la quantité de la substance dangereuse mentionnée respecte les limites requises par GB/T 26572 dans tous les matériaux homogènes du composant.

X : Indique que la quantité de la substance dangereuse mentionnée dépasse les limites requises par GB/T 26572 dans au moins un matériau homogène du composant.

Tous les éléments du tableau accompagnés d'un « X » sont conformes à la norme RoHS de l'Union européenne.

REMARQUE : La durée d'utilisation écologique en année, en référence, a été déterminée sur la base de conditions normales d'utilisation du produit, telles que la température et l'humidité.

台式机、瘦客户端、个人工作站、一体机和销售点终端产品中有害物质或元素的名称及含量 (ROHS)

根据中国《电器电子产品有害物质限制使用管理办法》



部件名称	有害物质					
	铅 (Pb)	汞 (Hg)	镉 (Cd)	六价铬 (Cr(VI))	多溴联苯 (PBB)	多溴二苯醚 (PBDE)
电池	X	0	0	0	0	0
线缆	X	0	0	0	0	0
摄像头	X	0	0	0	0	0
机箱/其他	X	0	0	0	0	0
风扇	X	0	0	0	0	0
闪存读卡器	X	0	0	0	0	0
软盘驱动器	X	0	0	0	0	0
硬盘驱动器	X	0	0	0	0	0
耳机	X	0	0	0	0	0

部件名称	有害物质					
	铅 (Pb)	汞 (Hg)	镉 (Cd)	六价铬 (Cr(VI))	多溴联苯 (PBB)	多溴二苯醚 (PBDE)
散热器	X	0	0	0	0	0
I/O PCA	X	0	0	0	0	0
键盘	X	0	0	0	0	0
液晶显示器 (LCD) 面板	X	0	0	0	0	0
介质 (CD/DVD/软盘)	0	0	0	0	0	0
内存	X	0	0	0	0	0
主板、处理器和散热器	X	0	0	0	0	0
鼠标	X	0	0	0	0	0
光驱	X	0	0	0	0	0
对接设备选件	X	0	0	0	0	0
电源适配器	X	0	0	0	0	0
电源	X	0	0	0	0	0
投影仪	X	0	0	0	0	0
遥控器	X	0	0	0	0	0
智能卡/Java™ 卡读卡器	X	0	0	0	0	0
固态驱动器	X	0	0	0	0	0
扬声器(外置)	X	0	0	0	0	0
触控笔	X	0	0	0	0	0
触控板	X	0	0	0	0	0
电视调谐器	X	0	0	0	0	0
USB 闪存驱动器	X	0	0	0	0	0
USB 集线器	X	0	0	0	0	0
网络摄像头	X	0	0	0	0	0
无线接收器	X	0	0	0	0	0
无线网卡	X	0	0	0	0	0
3D 捕获台/转盘	X	0	0	0	0	0

本表格依据 SJ/T 11364 的规定编制。

0：表示该有害物质在该部件所有均质材料中的含量均在 GB/T 26572 规定的限量要求以下。

X：表示该有害物质至少在该部件的某一均质材料中的含量超出 GB/T 26572 规定的限量要求。

注：环保使用期限的参考标识取决于产品正常工作的温度和湿度等条件

台灣針對筆記型電腦和平板電腦的有害物質限制使用管理辦法 (RoHS)

限用物質含有情況標示聲明書

Declaration of the Presence Condition of the Restricted Substances Marking

限用物質及其化學符號						
Restricted substances and its chemical symbols						
單元 Unit	鉛 Lead (Pb)	汞 Mercury (Hg)	鎘 Cadmium (Cd)	六價鉻 Hexavalent chromium (Cr ⁺⁶)	多溴聯苯 Polybrominated biphenyls (PBB)	多溴二苯醚 Polybrominated diphenyl ethers (PBDE)
纜線 Cables	—	O	O	O	O	O
機殼/其他 Chassis/Other	—	O	O	O	O	O
輸入/輸出印刷 電路組件 I/O PCAs	—	O	O	O	O	O
液晶顯示器 (LCD) 面板 Liquid crystal display (LCD) panel	—	O	O	O	O	O
記憶體 Memory	O	O	O	O	O	O
主機板、處理 器、散熱器 Motherboard, processor, heat sinks	—	O	O	O	O	O
電源組 Power pack	—	O	O	O	O	O
電源供應器 Power supply	—	O	O	O	O	O
儲存裝置 Storage Devices	—	O	O	O	O	O
無線裝置 Wireless Devices	—	O	O	O	O	O

備考 1：「超出 0.1 %」及「超出 0.01 %」係指限用物質之百分比含量超出百分比含量基準值。
Note 1: "Exceeding 0.1 wt %" and "exceeding 0.01 wt %" indicate that the percentage content of the restricted substance exceeds the reference percentage value of presence condition.

備考 2：「O」係指該項限用物質之百分比含量未超出百分比含量基準值。
Note 2: "O" indicates that the percentage content of the restricted substance does not exceed the percentage of reference value of presence.

備考 3：「—」係指該項限用物質為排除項目。
Note 3: The "—" indicates that the restricted substance corresponds to the exemption.

若要取得最新版使用指南，請前往 <http://www.hp.com/support>，並依照指示尋找您的產品。然後選取「使用指南」。

To access the latest user guides, go to <http://www.hp.com/support>, and follow the instructions to find your product. Then select **User Guides**.

台灣針對桌上型電腦、精簡型電腦、個人工作站、一體成形電腦及銷售點終端機的有害物質限制使用管理辦法 (RoHS)

限用物質含有情況標示聲明書

Declaration of the Presence Condition of the Restricted Substances Marking

限用物質及其化學符號						
Restricted substances and its chemical symbols						
單元 Unit	鉛 Lead (Pb)	汞 Mercury (Hg)	鎘 Cadmium (Cd)	六價鉻 Hexavalent chromium (Cr ⁺⁶)	多溴聯苯 Polybrominated biphenyls (PBB)	多溴二苯醚 Polybrominated diphenyl ethers (PBDE)
纜線 Cables	—	○	○	○	○	○
機座/其他 Chassis/Other	—	○	○	○	○	○
輸入/輸出印刷電路組件 I/O PCAs	—	○	○	○	○	○
液晶顯示器 (LCD) 面板 (僅限於 AIO) Liquid crystal display (LCD) panel (for AIO only)	—	○	○	○	○	○
記憶體 Memory	○	○	○	○	○	○
主機板、處理器、散熱器 Motherboard, processor, heat sinks	—	○	○	○	○	○
電源供應器 Power supply	—	○	○	○	○	○
儲存裝置 Storage Devices	—	○	○	○	○	○

備考 1：「超出 0.1 %」及「超出 0.01 %」係指限用物質之百分比含量超出百分比含量基準值。
 Note 1: "Exceeding 0.1 wt %" and "exceeding 0.01 wt %" indicate that the percentage content of the restricted substance exceeds the reference percentage value of presence condition.

備考 2：「○」係指該項限用物質之百分比含量未超出百分比含量基準值。
 Note 2: "○" indicates that the percentage content of the restricted substance does not exceed the percentage of reference value of presence.

備考 3：「—」係指該項限用物質為排除項目。
 Note 3: The "—" indicates that the restricted substance corresponds to the exemption.

若要取得最新版使用指南，請前往 <http://www.hp.com/support>，並依照指示尋找您的產品。然後選取「使用指南」。

To access the latest user guides, go to <http://www.hp.com/support>, and follow the instructions to find your product. Then select **User Guides**.

Avis sur la restriction des substances dangereuses pour l'Inde (RoHS)

Ce produit, ainsi que ses consommables et pièces, est conforme aux dispositions de la loi « India E-waste Rule 2016 » relatives à la réduction des substances dangereuses. Il ne contient pas de concentrations de plomb, de mercure, de chrome hexavalent, de diphényles polybromés ou de polybromodiphényléthers dépassant 0,1 % du poids et 0,01 % du poids pour le cadmium, excepté dans les cas où les exemptions établies à l'annexe 2 de cette loi le permettent.

Informations sur le règlement 1275/2008 de la Commission européenne

Pour localiser les données sur la consommation électrique des produits, y compris lorsque le produit est en mode veille en réseau et que tous les ports réseau câblés et les appareils sans fil sont connectés, reportez-vous à la section P14 « Informations supplémentaires » des déclarations IT ECO à l'adresse <http://www.hp.com/hpinfo/globalcitizenship/environment/productdata/itecodesktop-pc.html>.

Le cas échéant, activez et désactivez le réseau sans fil en suivant les instructions incluses dans le manuel de l'utilisateur du produit ou du système d'exploitation. Des informations sont également disponibles à l'adresse <http://www.hp.com/support>.

Déclarations IT ECO

Ordinateur portable ou tablette

<http://www.hp.com/hpinfo/globalcitizenship/environment/productdata/iteconotebook-o.html>

Ordinateurs de bureau et clients légers

http://www.hp.com/hpinfo/globalcitizenship/environment/productdata/itecodesktop-pc.html?jumpid=reg_R1002_USEN

Stations de travail

<http://www.hp.com/hpinfo/globalcitizenship/environment/productdata/itecoworkstatio.html>

Avis sur la restriction des substances dangereuses pour le Japon (RoHS)

2008 年、日本における製品含有表示方法、JISC0950 が公示されました。製造事業者は、2006 年 7 月 1 日以降に販売される電気・電子機器の特定化学物質の含有に付きまして情報提供を義務付けられました。製品の部材表示に付きましては、

<http://www.hp.com/go/jisc0950>

を参照してください

A Japanese regulatory requirement, defined by specification JIS C 0950, 2008, mandates that manufacturers provide Material Content Declarations for certain categories of electronic products offered for sale after July 1, 2006.

To view the JIS C 0950 material declaration for this product, visit <http://www.hp.com/go/jisc0950>.

Ley para el Aprovechamiento Sustentable de la Energía de México

Ley para el Aprovechamiento Sustentable de la Energía de México

Se ha etiquetado este producto en conformidad con la Ley para el Aprovechamiento Sustentable de la Energía de México, que requiere la divulgación del consumo de energía del modo de uso normal (modo inactivo) y del modo de espera. Su producto es una de las muchas configuraciones de esta familia de modelos; el consumo de energía del modo inactivo de su configuración específica puede diferir de la información de la etiqueta. El consumo real de energía de su producto puede ser mayor o menor que el valor informado en la etiqueta de energía de producto para México a causa de factores como la configuración (componentes y módulos seleccionados) y el uso (tareas que se están efectuando, software instalado y en ejecución, etc.).



REMARQUE : Esta ley no es aplicable a las estaciones de trabajo.

Réglementation WEEE de la Turquie

Türkiye Cumhuriyeti: AEEE Yönetmeliğine Uygundur

Certifié TCO

Cette section s'applique uniquement aux produits portant le logo TCO Certified.

A third-party certification according to ISO 14024



Toward sustainable IT products

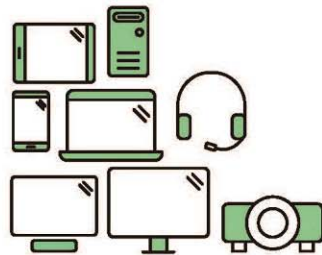

Say hello to a more sustainable product

IT products are associated with a wide range of sustainability risks throughout their life cycle. Human rights violations are common in the factories. Harmful substances are used both in products and their manufacture. Products can often have a short lifespan because of poor ergonomics, low quality and when they are not able to be repaired or upgraded.

This product is a better choice. It meets all the criteria in TCO Certified, the world's most comprehensive sustainability certification for IT products. Thank you for making a responsible product choice, that help drive progress towards a more sustainable future!

Criteria in TCO Certified have a life-cycle perspective and balance environmental and social responsibility. Conformity is verified by independent and approved verifiers that specialize in IT products, social responsibility or other sustainability issues. Verification is done both before and after the certificate is issued, covering the entire validity period. The process also includes ensuring that corrective actions are implemented in all cases of factory non-conformities. And last but not least, to make sure that the certification and independent verification is accurate, both TCO Certified and the verifiers are reviewed regularly.

Want to know more?

Read information about TCO Certified, full criteria documents, news and updates at tcocertified.com. On the website you'll also find our Product Finder, which presents a complete, searchable listing of certified products.

TCO Certified Edge

Cette section s'applique uniquement aux produits portant le logo TCO Certified Edge.

A third-party certification according to ISO 14024



Toward sustainable IT products

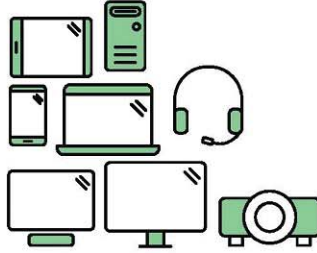

Say hello to a more sustainable product

IT products are associated with a wide range of sustainability risks throughout their life cycle. Human rights violations occur in the supply chain. Harmful substances are used both in products and their manufacture. Products can often have a short lifespan because of poor ergonomics, low quality and when they are not able to be repaired or upgraded.

This product is a better choice. It meets all the criteria in TCO Certified, the world's most comprehensive sustainability certification for IT products. Additionally, it fulfills the requirements of TCO Certified Edge, the supplemental certification that recognizes leading-edge products that exceed typical performance in a particular sustainability attribute. At our Product Finder (tcocertified.com/product-finder) you can find out which TCO Certified Edge criterion or criteria this product meets.

Criteria in TCO Certified have a life-cycle perspective and balance environmental and social responsibility. Compliance is verified by independent verification organizations that specialize in IT products, social responsibility or other sustainability issues. Verification is done both before and after the certificate is issued, covering the entire validity period. The process also includes ensuring that corrective actions are implemented in all cases of factory non-conformities.

Thank you for making a responsible product choice, that help drive progress towards a more sustainable future!

Want to know more?

Read information about TCO Certified, full criteria documents, news and updates at tcocertified.com. On the website you'll also find our Product Finder, which presents a complete, searchable listing of certified products.

Index

Symboles/Nombres

台灣對於危險物質的限制注意事項 38, 39
注意事項
台灣有害物質限制 38, 39

A

avis

Avis sur les périphériques sans fil pour la Thaïlande 8
batterie 9, 10, 18, 26
Brésil 3, 20
Canada 3
cordon d'alimentation pour le Japon 22
Cordons d'alimentation 22
Corée du Sud 8
déplacements 23
Environnement 26
ergonomie 5, 6
Japon 7
Macrovision Corporation 15
matériau composé de perchlorate 29
Mexique 7
mise au rebut des équipements 26
modem 11
niveau du volume du casque et des écouteurs 19
Réglementation pour la Biélorussie 3
restriction d'utilisation de substances dangereuses pour l'Inde 40
restriction d'utilisation de substances dangereuses pour la Chine 32, 34
restriction d'utilisation de substances dangereuses pour le Japon 40
sécurité des lasers 10, 19
Singapour 8
Taïwan 9

utilisation en vol 9
ventilateur 19
avis, ordinateurs portables
FCC (Federal Communications Commission) 2
avis, restriction d'utilisation de substances dangereuses pour la Chine 32, 34
avis, restriction d'utilisation de substances dangereuses pour le Japon 40
avis de certification GS 5, 6
avis de mise à la terre de câble 25
Avis de réglementation pour la Biélorussie 3
avis de restriction d'utilisation de substances dangereuses pour l'Inde 40
avis pour la Corée du Sud 8
avis pour le Brésil 3, 20
avis pour le Canada 3
avis pour le Japon 7
avis pour Macrovision Corporation 15
avis pour Taïwan 9
avis relatif aux appareils sans fil pour le Mexique 7
avis sur l'altitude 24
Avis sur l'environnement 26
Avis sur l'environnement pour la Chine 29
avis sur l'ergonomie 5, 6
avis sur la mise au rebut
batterie 26
batterie, remplacement par l'utilisateur 9
batterie scellée en usine 10
équipement 26
avis sur la mise au rebut des équipements 26
avis sur la sécurité des lasers 10, 19
avis sur le cordon d'alimentation 22
avis sur le niveau du volume, casque et écouteurs 19

avis sur le niveau du volume du casque et des écouteurs 19
avis sur les appareils sans fil pour Singapour 8
avis sur les cordons d'alimentation pour le Japon 22
Avis sur les cordons d'alimentation pour le Japon 22
avis sur les déplacements 23
avis sur les modems 11
Canada 14
Japon 14
Nouvelle-Zélande 15
Système américain 11, 13
avis sur les modems pour le Canada 14
avis sur les modems pour le Japon 14
avis sur les modems pour les États-Unis 11, 13
Avis sur les périphériques sans fil pour la Thaïlande 8
avis sur les utilisations en vol 9
avis sur le ventilateur 19
avis sur une utilisation dans des conditions tropicales 24

B

bandes de fréquences radio 5
batterie 18
batterie, avis 9, 10, 26

C

Carte TV, avis de mise à la terre de câble 25
Certification ENERGY STAR 27
certification TCO Certified 42
certification TCO Certified Edge 43

D

déclaration sur les modems pour la Nouvelle-Zélande 15

E

étiquette de consommation
énergétique des ordinateurs pour la
Chine 29
étiquettes, conformité 1

F

FCC (Federal Communications
Commission)
avis sur les ordinateurs
portables 2
câbles pour ordinateurs
portables 2
modifications apportées aux
ordinateurs portables 2

M

matériel électronique et de la
batterie, recyclage 26

N

niveaux de puissance maximale 5

O

ordinateurs portables, modifications
FCC (Federal Communications
Commission) 2

P

périphériques LAN sans fil 3
prise en charge vocale 15

R

recyclage de la batterie 26
recyclage du matériel électronique et
de la batterie 26
Règlement 1275/2008 de la
Commission européenne 40