

## FCC Test Report

### (PART 90)

**Report No.:** RF190516C01-11

**FCC ID:** B94HNQ20PK

**Test Model:** HSN-Q20C

**Received Date:** May 16, 2019

**Test Date:** May 28 ~ Jun. 06, 2019

**Issued Date:** Jun. 26, 2019

**Applicant:** HP Inc.

**Address:** 3390 East Harmony Road, Fort Collins, Colorado 80528, United States

**Issued By:** Bureau Veritas Consumer Products Services (H.K.) Ltd., Taoyuan Branch

**Lab Address:** No. 47-2, 14th Ling, Chia Pau Vil., Lin Kou Dist., New Taipei City, Taiwan ( R.O.C )

**Test Location:** No. 19, Hwa Ya 2nd Rd, Wen Hwa Vil, Kwei Shan Dist., Taoyuan City 33383, Taiwan (R.O.C)

**FCC Registration /  
Designation Number:** 788550 / TW0003



This report is for your exclusive use. Any copying or replication of this report to or for any other person or entity, or use of our name or trademark, is permitted only with our prior written permission. This report sets forth our findings solely with respect to the test samples identified herein. The results set forth in this report are not indicative or representative of the quality or characteristics of the lot from which a test sample was taken or any similar or identical product unless specifically and expressly noted. Our report includes all of the tests requested by you and the results thereof based upon the information that you provided to us. You have 60 days from date of issuance of this report to notify us of any material error or omission caused by our negligence, provided, however, that such notice shall be in writing and shall specifically address the issue you wish to raise. A failure to raise such issue within the prescribed time shall constitute your unqualified acceptance of the completeness of this report, the tests conducted and the correctness of the report contents. Unless specific mention, the uncertainty of measurement has been explicitly taken into account to declare the compliance or non-compliance to the specification. The report must not be used by the client to claim product certification, approval, or endorsement by TAF or any government agencies.

## Table of Contents

<b>Release Control Record</b> .....	<b>4</b>
<b>1 Certificate of Conformity</b> .....	<b>5</b>
<b>2 Summary of Test Results</b> .....	<b>6</b>
2.1 Measurement Uncertainty .....	7
2.2 Test Site and Instruments .....	8
<b>3 General Information</b> .....	<b>9</b>
3.1 General Description of EUT .....	9
3.2 Configuration of System under Test .....	10
3.2.1 Description of Support Units .....	10
3.3 Test Mode Applicability and Tested Channel Detail .....	11
3.4 EUT Operating Conditions .....	13
3.5 General Description of Applied Standards .....	13
<b>4 Test Types and Results</b> .....	<b>14</b>
4.1 Output Power Measurement .....	14
4.1.1 Limits of Output Power Measurement .....	14
4.1.2 Test Procedures .....	14
4.1.3 Test Setup .....	15
4.1.4 Test Results .....	16
4.2 Modulation Characteristics Measurement .....	23
4.2.1 Limits of Modulation Characteristics .....	23
4.2.2 Test Setup .....	23
4.2.3 Test Procedure .....	23
4.2.4 Test Results .....	24
4.3 Frequency Stability Measurement .....	26
4.3.1 Limits of Frequency Stability Measurement .....	26
4.3.2 Test Procedure .....	26
4.3.3 Test Setup .....	26
4.3.4 Test Results .....	27
4.4 Occupied Bandwidth Measurement .....	33
4.4.1 Limits of Occupied Bandwidth Measurement .....	33
4.4.2 Test Procedure .....	33
4.4.3 Test Setup .....	33
4.4.4 Test Results .....	34
4.5 Emission Mask Measurement .....	37
4.5.1 Limits of Emission Mask Measurement .....	37
4.5.2 Test Setup .....	37
4.5.3 Test Procedures .....	37
4.5.4 Test Results .....	38
4.6 Band Edge Measurement .....	52
4.6.1 Limits of Band Edge Measurement .....	52
4.6.2 Test Setup .....	52
4.6.3 Test Procedures .....	52
4.6.4 Test Results .....	53
4.7 Conducted Spurious Emissions .....	57
4.7.1 Limits of Conducted Spurious Emissions Measurement .....	57
4.7.2 Test Setup .....	57
4.7.3 Test Procedure .....	57
4.7.4 Test Results .....	58
4.8 Radiated Emission Measurement .....	64
4.8.1 Limits of Radiated Emission Measurement .....	64
4.8.2 Test Procedure .....	64
4.8.3 Deviation from Test Standard .....	64
4.8.4 Test Setup .....	65

4.8.5 Test Results .....	66
<b>5 Pictures of Test Arrangements.....</b>	<b>90</b>
<b>Appendix – Information of the Testing Laboratories .....</b>	<b>91</b>

### Release Control Record

Issue No.	Description	Date Issued
RF190516C01-11	Original Release	Jun. 26, 2019

## 1 Certificate of Conformity

**Product:** Notebook Computer

**Brand:** HP

**Test Model:** HSN-Q20C

**Sample Status:** Engineering Sample

**Applicant:** HP Inc.

**Test Date:** May 28 ~ Jun. 06, 2019

**Standards:** FCC Part 90, Subpart I, S, R  
FCC Part 2

The above equipment has been tested by **Bureau Veritas Consumer Products Services (H.K.) Ltd., Taoyuan Branch**, and found compliance with the requirement of the above standards. The test record, data evaluation & Equipment Under Test (EUT) configurations represented herein are true and accurate accounts of the measurements of the sample's RF characteristics under the conditions specified in this report.

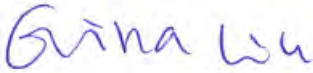
**Prepared by :** , **Date:** Jun. 26, 2019  
Gina Liu / Specialist

**Approved by :** , **Date:** Jun. 26, 2019  
Dylan Chiou / Project Engineer

## 2 Summary of Test Results

Applied Standard: FCC Part 90 & Part 2 (LTE 14)			
FCC Clause	Test Item	Result	Remarks
2.1046 90.542 (a)(7)	Effective Radiated Power	Pass	Meet the requirement of limit.
2.1047	Modulation Characteristics	Pass	Meet the requirement.
2.1055 90.539 (e)	Frequency Stability	Pass	Meet the requirement of limit.
2.1049	Occupied Bandwidth	Pass	Meet the requirement of limit.
90.210 (n)	Emission Masks	Pass	Meet the requirement of limit.
2.1051 90.543 (e)(2)(3)	Band Edge Measurements	Pass	Meet the requirement of limit.
2.1051 90.543 (e)(3)	Conducted Spurious Emissions	Pass	Meet the requirement of limit.
2.1053 90.543 (e)(f)	Radiated Spurious Emissions	Pass	Meet the requirement of limit. Minimum passing margin is -10.43 dB at 1586 MHz.

Applied Standard: FCC Part 90 & Part 2 (LTE 26)			
FCC Clause	Test Item	Result	Remarks
2.1046 90.635 (b)	Effective Radiated Power	Pass	Meet the requirement of limit.
2.1047	Modulation Characteristics	Pass	Meet the requirement.
2.1055 90.213	Frequency Stability	Pass	Meet the requirement of limit.
2.1049 90.209	Occupied Bandwidth	Pass	Meet the requirement of limit.
.1051 90.210	Emission Masks	Pass	Meet the requirement of limit.
2.1051 90.691	Conducted Spurious Emissions	Pass	Meet the requirement of limit.
2.1053 90.691	Radiated Spurious Emissions	Pass	Meet the requirement of limit. Minimum passing margin is -35.28 dB at 195.87 MHz.

Note: Determining compliance based on the results of the compliance measurement, not taking into account measurement instrumentation uncertainty.

## 2.1 Measurement Uncertainty

Where relevant, the following measurement uncertainty levels have been estimated for tests performed on the EUT as specified in CISPR 16-4-2:

Measurement	Frequency	Expanded Uncertainty (k=2) (±)
Radiated Emissions up to 1 GHz	9 kHz ~ 30 MHz	3.04 dB
	30 MHz ~ 200 MHz	2.93 dB
	200 MHz ~ 1000 MHz	2.95 dB
Radiated Emissions above 1 GHz	1 GHz ~ 18 GHz	2.26 dB
	18 GHz ~ 40 GHz	1.94 dB

## 2.2 Test Site and Instruments

Description & Manufacturer	Model No.	Serial No.	Date of Calibration	Due Date of Calibration
Test Receiver Agilent	N9038A	MY51210203	Mar. 18, 2019	Mar. 17, 2020
Spectrum Analyzer Agilent	N9010A	MY52220314	Dec. 13, 2018	Dec. 12, 2019
Spectrum Analyzer ROHDE & SCHWARZ	FSU43	101261	Apr. 15, 2019	Apr. 14, 2020
HORN Antenna SCHWARZBECK	BBHA 9120 D	9120D-969	Nov. 25, 2018	Nov. 24, 2019
BILOG Antenna SCHWARZBECK	VULB9168	9168-472	Nov. 23, 2018	Nov. 22, 2019
Double Ridge Guide Horn Antenna EMCO	3115	5619	Nov. 25, 2018	Nov. 24, 2019
BILOG Antenna SCHWARZBECK	VULB 9168	9168-153	Nov. 23, 2018	Nov. 22, 2019
Fixed Attenuator WORKEN	MDCS18N-10	MDCS18N-10-01	Apr. 15, 2019	Apr. 14, 2020
MXG Vector signal generator Agilent	N5182B	MY53050430	Nov. 19, 2018	Nov. 18, 2019
Preamplifier EMCI	EMC 012645	980115	Oct. 12, 2018	Oct. 11, 2019
Preamplifier EMCI	EMC 330H	980112	Oct. 12, 2018	Oct. 11, 2019
RF Coaxial Cable HUBER+SUHNNER	EMC104-SM-SM-800 0&3000	140811+170717	Oct. 12, 2018	Oct. 11, 2019
RF Coaxial Cable HUBER+SUHNNER	SUCOFLEX 104	EMC104-SM-SM-1 000(140807)	Oct. 12, 2018	Oct. 11, 2019
RF Coaxial Cable WOKEN	8D-FB	Cable-Ch10-01	Oct. 12, 2018	Oct. 11, 2019
Boresight Antenna Fixture	FBA-01	FBA-SIP01	NA	NA
Software BV ADT	E3 6.120103	NA	NA	NA
Antenna Tower MF	MFA-440H	NA	NA	NA
Turn Table MF	MFT-201SS	NA	NA	NA
Antenna Tower & Turn Table Controller MF	MF-7802	NA	NA	NA
Radio Communication Analyzer Anritsu	MT8821C	6261806803	Jan. 22, 2019	Jan. 21, 2020
Radio Communication Analyzer Anritsu	MT8820C	6201300640	Aug. 16, 2017	Aug. 15, 2019
Temperature & Humidity Chamber	GTH-120-40-CP-AR	MAA1306-019	Sep. 05, 2018	Sep. 04, 2019
DC Power Supply Topward	33010D	807748	NA	NA

Note: 1. The calibration interval of the above test instruments is 12 / 24 months and the calibrations are traceable to NML/ROC and NIST/USA.

2. The test was performed in HwaYa Chamber 10.



### 3 General Information

#### 3.1 General Description of EUT

<b>Product</b>	Notebook Computer	
<b>Brand</b>	HP	
<b>Test Model</b>	HSN-Q20C	
<b>Status of EUT</b>	Engineering Sample	
<b>Power Supply Rating</b>	5 or 9 or 12 or 15 or 20 Vdc (Adapter)	
<b>Modulation Type</b>	LTE	QPSK, 16QAM, 64QAM
<b>Frequency Range</b>	LTE Band 14 (Channel Bandwidth: 5 MHz)	790.5 ~ 795.5 MHz
	LTE Band 14 (Channel Bandwidth: 10 MHz)	793 MHz
	LTE Band 26 (Channel Bandwidth: 1.4 MHz)	814.7 ~ 823.3 MHz
	LTE Band 26 (Channel Bandwidth: 3 MHz)	815.5 ~ 822.5 MHz
	LTE Band 26 (Channel Bandwidth: 5 MHz)	816.5 ~ 821.5 MHz
	LTE Band 26 (Channel Bandwidth: 10 MHz)	819 MHz
<b>Emission Designator</b>	LTE Band 14 (Channel Bandwidth: 5 MHz)	4M50D7W
	LTE Band 14 (Channel Bandwidth: 10 MHz)	8M96D7W
	LTE Band 26 (Channel Bandwidth: 1.4 MHz)	1M09D7W
	LTE Band 26 (Channel Bandwidth: 3 MHz)	2M71G7D
	LTE Band 26 (Channel Bandwidth: 5 MHz)	4M50D7W
	LTE Band 26 (Channel Bandwidth: 10 MHz)	8M98G7D
<b>Max. ERP Power</b>	LTE Band 14 (Channel Bandwidth: 5 MHz)	34.28 mW
	LTE Band 14 (Channel Bandwidth: 10 MHz)	36.56 mW
	LTE Band 26 (Channel Bandwidth: 1.4 MHz)	23.99 mW
	LTE Band 26 (Channel Bandwidth: 3 MHz)	25.29 mW
	LTE Band 26 (Channel Bandwidth: 5 MHz)	27.29 mW
	LTE Band 26 (Channel Bandwidth: 10 MHz)	29.38 mW
<b>Antenna Type</b>	Couple Antenna	
<b>Antenna Gain</b>	LTE Band 14	-4.41 dBi
	LTE Band 26	-5.86 dBi
<b>Accessory Device</b>	Refer to Note as below	
<b>Data Cable Supplied</b>	Refer to Note as below	

Note:

1. The WWAN module (Brand: Fibocom, Model: L860-GL) was installed in the EUT.
2. The EUT contains following accessory devices.

Product	Brand	Model	Description
Adapter	hp	TPN-TA02	I/P: 100-240 Vac, 50-60 Hz, 1.6 A O/P: 5 Vdc, 3 A or 9 Vdc, 3 A or 12 Vdc, 5 A or 15 Vdc, 4.33 A or 20 Vdc, 3.25 A

3. The above EUT information is declared by manufacturer and for more detailed features description, please refers to the manufacturer's specifications or user's manual.

### 3.2 Configuration of System under Test

#### <Radiated Emission Test>

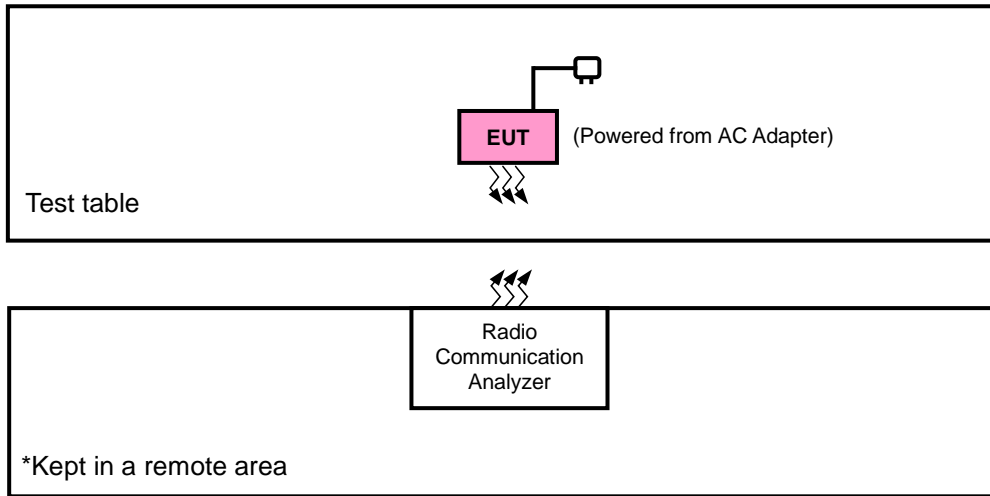

#### <E.R.P. Test>

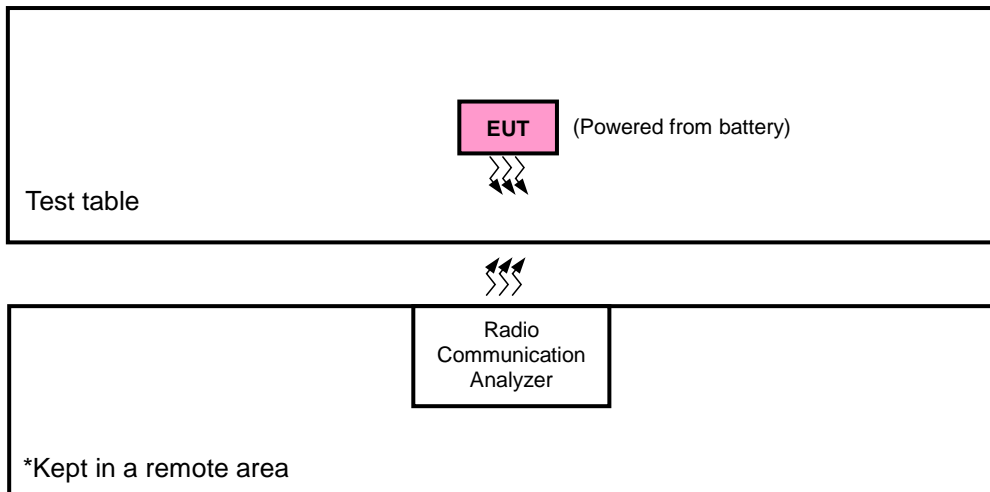

#### 3.2.1 Description of Support Units

The EUT has been tested as an independent unit together with other necessary accessories or support units.

### 3.3 Test Mode Applicability and Tested Channel Detail

Pre-Scan has been conducted to determine the worst-case mode from all possible combinations between available modulations, data rates, XYZ axis and NB mode, and antenna ports

The worst case was found when positioned as the table below. Following channel(s) was (were) selected for the final test as listed below:

Band	ERP	Radiated Emission
LTE Band 14	NB mode	Y-axis
LTE Band 26	NB mode	Z-axis

#### LTE Band 14

EUT Configure Mode	Test Item	Available Channel	Tested Channel	Channel Bandwidth	Modulation	Mode
-	ERP	23305 to 23355	23305, 23330, 23355	5 MHz	QPSK, 16QAM, 64QAM	1 RB / 0 RB Offset
		23330	23330	10 MHz	QPSK, 16QAM, 64QAM	1 RB / 0 RB Offset
-	Modulation Characteristics	23330	23330	5 MHz	QPSK, 16QAM, 64QAM	25 RB / 0 RB Offset
-	Frequency Stability	23305 to 23355	23305, 23355	5 MHz	QPSK	1 RB / 0 RB Offset
		23330	23330	10 MHz	QPSK	1 RB / 0 RB Offset
-	Occupied Bandwidth	23305 to 23355	23305, 23330, 23355	5 MHz	QPSK, 16QAM, 64QAM	25 RB / 0 RB Offset
		23330	23330	10 MHz	QPSK, 16QAM, 64QAM	50 RB / 0 RB Offset
-	Emission Mask	23305 to 23355	23305, 23330, 23355	5 MHz	QPSK, 16QAM, 64QAM	25 RB / 0 RB Offset
		23330	23330	10 MHz	QPSK, 16QAM, 64QAM	50 RB / 0 RB Offset
-	Band Edge	23305 to 23355	23305, 23355	5 MHz	QPSK, 16QAM, 64QAM	1 RB / 0 RB Offset 25 RB / 0 RB Offset
		23330	23330	10 MHz	QPSK, 16QAM, 64QAM	1 RB / 0 RB Offset 50 RB / 0 RB Offset
-	Conducted Emission	23305 to 23355	23305, 23330, 23355	5 MHz	QPSK	1 RB / 0 RB Offset
		23330	23330	10 MHz	QPSK	1 RB / 0 RB Offset
-	Radiated Emission	23305 to 23355	23305, 23330, 23355	5 MHz	QPSK	1 RB / 0 RB Offset
		23330	23330	10 MHz	QPSK	1 RB / 0 RB Offset

#### Note:

1. This device was tested under all bandwidths, RB configurations and modulations. The worst case was found in QPSK modulation.
2. For radiated emission above 1 GHz, according to 3GPP 36.521 Section 6.6.3.1.4, choose the lowest, 5 MHz & highest channel bandwidth for final test.

## LTE Band 26

EUT Configure Mode	Test Item	Available Channel	Tested Channel	Channel Bandwidth	Modulation	Mode
-	ERP	26697 to 26783	26697, 26740, 26783	1.4 MHz	QPSK, 16QAM, 64QAM	1 RB / 5 RB Offset
		26705 to 26775	26705, 26740, 26775	3 MHz	QPSK, 16QAM, 64QAM	1 RB / 14 RB Offset
		26715 to 26765	26715, 26740, 26765	5 MHz	QPSK, 16QAM, 64QAM	1 RB / 24 RB Offset
		26740	26740	10 MHz	QPSK, 16QAM, 64QAM	1 RB / 49 RB Offset
-	Modulation Characteristics	26740	26740	10 MHz	QPSK, 16QAM, 64QAM	50 RB / 0 RB Offset
-	Frequency Stability	26697 to 26783	26697, 26783	1.4 MHz	QPSK	1 RB / 0 RB Offset
		26705 to 26775	26705, 26775	3 MHz	QPSK	1 RB / 0 RB Offset
		26715 to 26765	26715, 26765	5 MHz	QPSK	1 RB / 0 RB Offset
		26740	26740	10 MHz	QPSK	1 RB / 0 RB Offset
-	Occupied Bandwidth	26697 to 26783	26697, 26740, 26783	1.4 MHz	QPSK, 16QAM, 64QAM	6 RB / 0 RB Offset
		26705 to 26775	26705, 26740, 26775	3 MHz	QPSK, 16QAM, 64QAM	15 RB / 0 RB Offset
		26715 to 26765	26715, 26740, 26765	5 MHz	QPSK, 16QAM, 64QAM	25 RB / 0 RB Offset
		26740	26740	10 MHz	QPSK, 16QAM, 64QAM	50 RB / 0 RB Offset
-	Emission Mask	26697 to 26783	26697, 26740, 26783	1.4 MHz	QPSK, 16QAM, 64QAM	6 RB / 0 RB Offset
		26705 to 26775	26705, 26740, 26775	3 MHz	QPSK, 16QAM, 64QAM	15 RB / 0 RB Offset
		26715 to 26765	26715, 26740, 26765	5 MHz	QPSK, 16QAM, 64QAM	25 RB / 0 RB Offset
		26740	26740	10 MHz	QPSK, 16QAM, 64QAM	50 RB / 0 RB Offset
-	Conducted Emission	26697 to 26783	26697, 26740, 26783	1.4 MHz	QPSK	1 RB / 5 RB Offset
		26705 to 26775	26705, 26740, 26775	3 MHz	QPSK	1 RB / 14 RB Offset
		26715 to 26765	26715, 26740, 26765	5 MHz	QPSK	1 RB / 24 RB Offset
		26740	26740	10 MHz	QPSK	1 RB / 49 RB Offset
-	Radiated Emission	26697 to 26783	26697, 26740, 26783	1.4 MHz	QPSK	1 RB / 5 RB Offset
		26715 to 26765	26715, 26740, 26765	5 MHz	QPSK	1 RB / 24 RB Offset
		26740	26740	10 MHz	QPSK	1 RB / 49 RB Offset

### Note:

1. This device was tested under all bandwidths, RB configurations and modulations. The worst case was found in QPSK modulation.
2. For radiated emission above 1 GHz, according to 3GPP 36.521 Section 6.6.3.1.4, choose the lowest, 5 MHz & highest channel bandwidth for final test.

**Test Condition:**

Test Item	Environmental Conditions	Input Power	Tested By
ERP	25 deg. C, 65 % RH	120 Vac, 60 Hz	Thomas Wei
Modulation Characteristics	25 deg. C, 65 % RH	120 Vac, 60 Hz	Wayne Lin
Frequency Stability	25 deg. C, 65 % RH	120 Vac, 60 Hz	Wayne Lin
Occupied Bandwidth	25 deg. C, 65 % RH	120 Vac, 60 Hz	Wayne Lin
Peak to Average Ratio	25 deg. C, 65 % RH	120 Vac, 60 Hz	Wayne Lin
Emission Mask	25 deg. C, 65 % RH	120 Vac, 60 Hz	Wayne Lin
Band Edge	25 deg. C, 65 % RH	120 Vac, 60 Hz	Wayne Lin
Conducted Emission	25 deg. C, 65 % RH	120 Vac, 60 Hz	Wayne Lin
Radiated Emission	25 deg. C, 65 % RH	120 Vac, 60 Hz	Getaz Yang, Thomas Wei

**3.4 EUT Operating Conditions**

The EUT makes a call to the communication simulator. The communication simulator station system controlled a EUT to export maximum output power under transmission mode and specific channel frequency

**3.5 General Description of Applied Standards**

The EUT is a RF Product. According to the specifications of the manufacturer, it must comply with the requirements of the following standards:

**FCC 47 CFR Part 2**

**FCC 47 CFR Part 90**

**KDB 971168 D01 Power Meas License Digital Systems v03r01**

**KDB 971168 D02 Misc Rev Approv License Devices v02r01**

**ANSI/TIA/EIA-603-E 2016**

**ANSI 63.26-2015**

**Note:** All test items have been performed and recorded as per the above standards.

## 4 Test Types and Results

### 4.1 Output Power Measurement

#### 4.1.1 Limits of Output Power Measurement

##### LTE Band 14

Portable stations (hand-held devices) transmitting in the 758-768 MHz band and the 788-798 MHz band are limited to 3 watts ERP.

##### LTE Band 26

The maximum output power of the transmitter for mobile stations is 100 watts (20 dBw) ERP.

#### 4.1.2 Test Procedures

##### **EIRP / ERP Measurement:**

- a. All measurements were done at low, middle and high operational frequency range. RBW and VBW is 10 MHz for LTE mode.
- b. Substitution method is used for E.I.R.P measurement. In the semi-anechoic chamber, EUT placed on the 0.8 m (below or equal 1 GHz) and/or 1.5 m (above 1 GHz) height of Turn Table, rotated the table around 360 degrees to search the maximum radiation power and receiver antenna shall be rotated vertical and horizontal polarization and moved height from 1 m to 4 m to find the maximum polar radiated power. The "Read Value" is the spectrum reading the maximum power value.
- c. The substitution horn antenna is substituted for EUT at the same position and signals generator export the CW signal to the substitution antenna via a tx cable. Rotated the Turn Table and moved receiving antenna to find the maximum radiation power. Adjust output power level of S.G to get a Value of spectrum reading equal to "Read Value" of step b. Record the power level of S.G.
- d.  $EIRP = \text{Output power level of S.G} - \text{TX cable loss} + \text{Antenna gain of substitution horn}$ . E.R.P power can be calculated form E.I.R.P power by subtracting the gain of dipole,  $E.R.P \text{ power} = E.I.P.R \text{ power} - 2.15 \text{ dB}$ .

##### **Conducted Power Measurement:**

- a. The EUT was set up for the maximum power with LTE link data modulation and link up with simulator.
- b. Set the EUT to transmit under low, middle and high channel and record the power level shown on simulator.

### 4.1.3 Test Setup

#### EIRP / ERP Measurement:

<Radiated Emission below or equal 1 GHz>

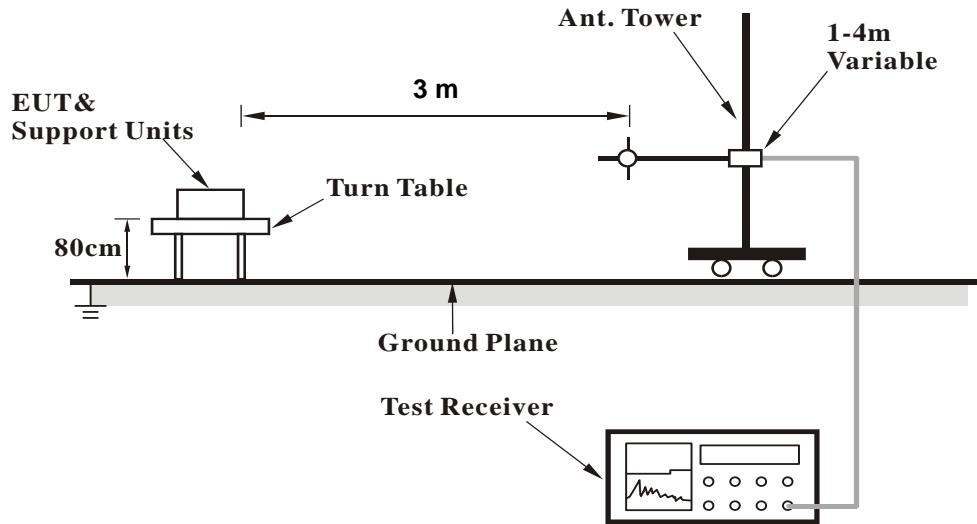

<Radiated Emission above 1 GHz>

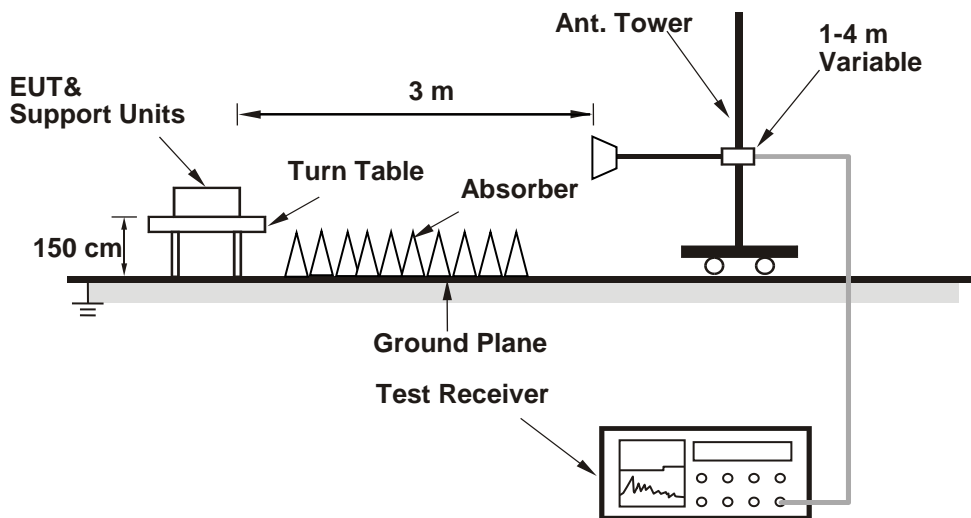

For the actual test configuration, please refer to the attached file (Test Setup Photo).

#### Conducted Power Measurement:

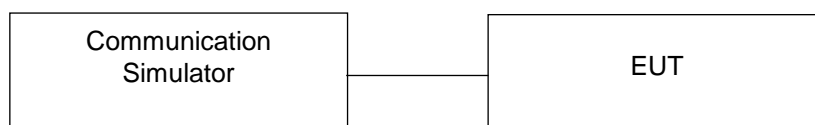

#### 4.1.4 Test Results

#### Conducted Output Power (dBm)

LTE Band 14																				
BW	MCS Index	RB Size	RB Offset	Low	Mid	High	3GPP MPR (dB)	BW	MCS Index	RB Size	RB Offset	Low	Mid	High	3GPP MPR (dB)					
																Channel	23330	23305	23330	23355
																Frequency (MHz)	793.0	790.5	793.0	795.5
10M	QPSK	1	0		22.94		0	5M	QPSK	1	0	22.81	22.84	22.82	0					
		1	24		22.88		0			1	12	22.80	22.83	22.78	0					
		1	49		22.86		0			1	24	22.79	22.80	22.76	0					
		25	0		21.95		1			12	0	21.83	21.94	21.85	1					
		25	12		21.93		1			12	6	21.89	21.83	21.86	1					
		25	25		21.88		1			12	13	21.83	21.85	21.80	1					
	50	0		22.00		1	25		0	21.91	21.92	21.98	1							
	16QAM	1	0		22.24		1		16QAM	1	0	22.19	22.18	22.17	1					
		1	24		22.23		1			1	12	22.18	22.13	22.19	1					
		1	49		22.21		1			1	24	22.13	22.13	22.12	1					
		25	0		21.09		2			12	0	20.97	21.09	21.00	2					
		25	12		21.06		2			12	6	21.01	20.97	21.02	2					
		25	25		20.99		2			12	13	20.95	20.97	20.89	2					
	50	0		21.10		2	25		0	21.01	21.01	20.99	2							
	64QAM	1	0		21.23		2		64QAM	1	0	21.15	21.16	21.11	2					
		1	24		21.19		2			1	12	21.08	21.11	21.07	2					
		1	49		21.15		2			1	24	21.05	21.07	21.04	2					
		25	0		20.08		3			12	0	19.99	20.02	19.96	3					
25		12		20.07		3	12	6		20.04	20.03	19.95	3							
25		25		20.02		3	12	13		19.99	19.93	19.95	3							
50	0		20.07		3	25	0	19.95	19.98	20.05	3									



LTE Band 26															
BW	MCS Index	RB Size	RB Offset	Mid			3GPP MPR (dB)	BW	MCS Index	RB Size	RB Offset	Low	Mid	High	3GPP MPR (dB)
				Channel								26715	26740	26765	
				Frequency (MHz)								816.5	819.0	821.5	
10M	QPSK	1	0	23.12			0	5M	QPSK	1	0	23.01	23.12	23.13	0
		1	24	23.06			0			1	12	23.06	23.06	23.08	0
		1	49	23.20			0			1	24	23.11	23.20	23.20	0
		25	0	22.05			1			12	0	22.06	22.05	22.01	1
		25	12	22.05			1			12	6	22.03	22.05	22.05	1
		25	25	22.07			1			12	13	22.02	22.07	22.07	1
		50	0	22.06			1			25	0	22.02	22.06	22.06	1
	16QAM	1	0	22.03			1	5M	16QAM	1	0	22.03	22.03	22.13	1
		1	24	22.06			1			1	12	22.07	22.06	22.05	1
		1	49	22.13			1			1	24	22.04	22.13	22.15	1
		25	0	21.03			2			12	0	21.03	21.03	21.07	2
		25	12	21.02			2			12	6	21.03	21.02	21.03	2
		25	25	21.03			2			12	13	21.04	21.03	21.07	2
		50	0	21.05			2			25	0	21.03	21.05	21.04	2
	64QAM	1	0	21.13			2	5M	64QAM	1	0	21.07	21.13	21.06	2
		1	24	21.02			2			1	12	21.04	21.02	21.03	2
		1	49	21.11			2			1	24	21.08	21.11	21.16	2
		25	0	21.05			3			12	0	20.03	21.05	21.02	3
		25	12	21.03			3			12	6	20.05	21.03	20.04	3
		25	25	21.06			3			12	13	20.06	21.06	20.02	3
		50	0	21.05			3			25	0	20.03	21.05	20.05	3
BW	MCS Index	RB Size	RB Offset	Low	Mid	High	3GPP MPR (dB)	BW	MCS Index	RB Size	RB Offset	Low	Mid	High	3GPP MPR (dB)
				Channel								26697	26740	26783	
				Frequency (MHz)								814.7	819.0	823.3	
3M	QPSK	1	0	23.03	23.01	23.11	0	1.4M	QPSK	1	0	23.09	23.00	23.04	0
		1	7	23.02	23.01	22.96	0			1	2	23.06	22.96	23.04	0
		1	14	23.05	23.11	23.10	0			1	5	23.07	23.07	23.11	0
		8	0	22.03	21.99	21.99	1			3	0	23.04	23.04	23.00	0
		8	3	22.06	22.05	21.98	1			3	1	23.06	22.96	22.98	0
		8	7	22.03	21.99	21.94	1			3	3	23.01	23.02	23.04	0
		15	0	22.05	21.97	21.92	1			6	0	22.06	22.06	22.00	1
	16QAM	1	0	22.03	22.00	22.05	1	1.4M	16QAM	1	0	22.03	22.00	22.04	1
		1	7	22.06	22.00	21.92	1			1	2	22.06	21.98	22.03	1
		1	14	22.03	22.12	22.03	1			1	5	22.05	21.98	22.05	1
		8	0	21.03	21.00	21.00	2			3	0	22.07	21.88	22.07	1
		8	3	21.06	20.94	21.01	2			3	1	22.06	22.02	22.00	1
		8	7	21.07	20.88	21.06	2			3	3	22.06	21.94	22.05	1
		15	0	21.03	20.96	21.02	2			6	0	21.06	21.02	21.04	2
	64QAM	1	0	21.06	21.12	20.97	2	1.4M	64QAM	1	0	21.04	21.02	20.92	2
		1	7	21.05	20.95	21.01	2			1	2	21.05	20.87	20.96	2
		1	14	21.07	21.11	21.01	2			1	5	21.01	21.09	21.05	2
		8	0	20.01	20.92	20.98	3			3	0	21.06	21.97	21.96	2
		8	3	21.07	20.93	19.91	3			3	1	21.06	21.90	20.97	2
		8	7	21.03	20.94	19.89	3			3	3	21.04	22.05	21.00	2
		15	0	21.06	20.99	20.05	3			6	0	21.06	20.92	20.00	3

**ERP Power (dBm)**

LTE Band 14							
Channel Bandwidth: 5 MHz / QPSK							
Plane	Channel	Frequency (MHz)	Reading (dBm)	Correction Factor (dB)	ERP (dBm)	ERP (mW)	Polarization (H/V)
NB	23305	790.5	-18.67	32.24	11.42	13.87	H
	23330	793.0	-18.50	32.17	11.52	14.19	
	23355	795.5	-18.48	32.11	11.48	14.06	
	23305	790.5	-15.03	32.43	15.25	33.50	V
	23330	793.0	-14.92	32.42	15.35	34.28	
	23355	795.5	-15.02	32.46	15.29	33.81	
Channel Bandwidth: 5 MHz / 16QAM							
NB	23305	790.5	-19.72	32.24	10.37	10.89	H
	23330	793.0	-19.55	32.17	10.47	11.14	
	23355	795.5	-19.55	32.11	10.41	10.99	
	23305	790.5	-16.25	32.43	14.03	25.29	V
	23330	793.0	-16.12	32.42	14.15	26.00	
	23355	795.5	-16.22	32.46	14.09	25.64	
Channel Bandwidth: 5 MHz / 64QAM							
NB	23305	790.5	-20.83	32.24	9.26	8.43	H
	23330	793.0	-20.64	32.17	9.38	8.67	
	23355	795.5	-20.64	32.11	9.32	8.55	
	23305	790.5	-17.34	32.43	12.94	19.68	V
	23330	793.0	-17.20	32.42	13.07	20.28	
	23355	795.5	-17.31	32.46	13.00	19.95	

Note: ERP (dBm) = Reading (dBm) + Correction Factor (dB) – 2.15

LTE Band 14							
Channel Bandwidth: 10 MHz / QPSK							
Plane	Channel	Frequency (MHz)	Reading (dBm)	Correction Factor (dB)	ERP (dBm)	ERP (mW)	Polarization (H/V)
NB	23330	793.0	-18.21	32.17	11.81	15.17	H
	23330	793.0	-14.64	32.42	15.63	36.56	V
Channel Bandwidth: 10 MHz / 16QAM							
NB	23330	793.0	-19.29	32.17	10.73	11.83	H
	23330	793.0	-15.84	32.42	14.43	27.73	V
Channel Bandwidth: 10 MHz / 64QAM							
NB	23330	793.0	-20.44	32.17	9.58	9.08	H
	23330	793.0	-16.98	32.42	13.29	21.33	V

Note: ERP (dBm) = Reading (dBm) + Correction Factor (dB) – 2.15

LTE Band 26							
Channel Bandwidth: 1.4 MHz / QPSK							
Plane	Channel	Frequency (MHz)	Reading (dBm)	Correction Factor (dB)	ERP (dBm)	ERP (mW)	Polarization (H/V)
NB	26697	814.7	-16.19	32.01	13.67	23.28	H
	26740	819.0	-16.16	32.11	13.80	23.99	
	26783	823.3	-16.42	32.32	13.75	23.71	
	V	26697	814.7	-21.78	32.54	8.61	7.26
		26740	819.0	-21.64	32.51	8.72	7.45
		26783	823.3	-21.67	32.51	8.69	7.40
Channel Bandwidth: 1.4 MHz / 16QAM							
NB	26697	814.7	-16.95	32.01	12.91	19.54	H
	26740	819.0	-16.92	32.11	13.04	20.14	
	26783	823.3	-17.18	32.32	12.99	19.91	
	V	26697	814.7	-22.64	32.54	7.75	5.96
		26740	819.0	-22.52	32.51	7.84	6.08
		26783	823.3	-22.57	32.51	7.79	6.01
Channel Bandwidth: 1.4 MHz / 64QAM							
NB	26697	814.7	-18.06	32.01	11.80	15.14	H
	26740	819.0	-18.04	32.11	11.92	15.56	
	26783	823.3	-18.30	32.32	11.87	15.38	
	V	26697	814.7	-23.89	32.54	6.50	4.47
		26740	819.0	-23.72	32.51	6.64	4.61
		26783	823.3	-23.77	32.51	6.59	4.56

Note: ERP (dBm) = Reading (dBm) + Correction Factor (dB) – 2.15

LTE Band 26							
Channel Bandwidth: 3 MHz / QPSK							
Plane	Channel	Frequency (MHz)	Reading (dBm)	Correction Factor (dB)	ERP (dBm)	ERP (mW)	Polarization (H/V)
NB	26705	815.5	-16.06	32.02	13.81	24.04	H
	26740	819.0	-15.93	32.11	14.03	25.29	
	26775	822.5	-16.09	32.18	13.94	24.77	
	26705	815.5	-21.38	32.5	8.97	7.89	V
	26740	819.0	-21.30	32.51	9.06	8.05	
	26775	822.5	-21.32	32.47	9.00	7.94	
Channel Bandwidth: 3 MHz / 16QAM							
NB	26705	815.5	-16.69	32.02	13.18	20.80	H
	26740	819.0	-16.69	32.11	13.27	21.23	
	26775	822.5	-16.80	32.18	13.23	21.04	
	26705	815.5	-22.41	32.5	7.94	6.22	V
	26740	819.0	-22.31	32.51	8.05	6.38	
	26775	822.5	-22.32	32.47	8.00	6.31	
Channel Bandwidth: 3 MHz / 64QAM							
NB	26705	815.5	-17.71	32.02	12.16	16.44	H
	26740	819.0	-17.73	32.11	12.23	16.71	
	26775	822.5	-17.85	32.18	12.18	16.52	
	26705	815.5	-23.58	32.5	6.77	4.75	V
	26740	819.0	-23.44	32.51	6.92	4.92	
	26775	822.5	-23.44	32.47	6.88	4.88	

Note: ERP (dBm) = Reading (dBm) + Correction Factor (dB) – 2.15

LTE Band 26							
Channel Bandwidth: 5 MHz / QPSK							
Plane	Channel	Frequency (MHz)	Reading (dBm)	Correction Factor (dB)	ERP (dBm)	ERP (mW)	Polarization (H/V)
NB	26715	816.5	-15.71	32.04	14.18	26.18	H
	26740	819.0	-15.60	32.11	14.36	27.29	
	26765	821.5	-15.35	31.79	14.29	26.85	
	26715	816.5	-21.24	32.52	9.13	8.18	V
	26740	819.0	-21.07	32.51	9.29	8.49	
	26765	821.5	-20.82	32.17	9.20	8.32	
Channel Bandwidth: 5 MHz / 16QAM							
NB	26715	816.5	-16.41	32.04	13.48	22.28	H
	26740	819.0	-16.44	32.11	13.52	22.49	
	26765	821.5	-16.14	31.79	13.50	22.39	
	26715	816.5	-22.18	32.52	8.19	6.59	V
	26740	819.0	-22.08	32.51	8.28	6.73	
	26765	821.5	-21.79	32.17	8.23	6.65	
Channel Bandwidth: 5 MHz / 64QAM							
NB	26715	816.5	-17.51	32.04	12.38	17.30	H
	26740	819.0	-17.50	32.11	12.46	17.62	
	26765	821.5	-17.22	31.79	12.42	17.46	
	26715	816.5	-23.20	32.52	7.17	5.21	V
	26740	819.0	-23.13	32.51	7.23	5.28	
	26765	821.5	-22.83	32.17	7.19	5.24	

Note: ERP (dBm) = Reading (dBm) + Correction Factor (dB) – 2.15

LTE Band 26							
Channel Bandwidth: 10 MHz / QPSK							
Plane	Channel	Frequency (MHz)	Reading (dBm)	Correction Factor (dB)	ERP (dBm)	ERP (mW)	Polarization (H/V)
NB	26740	819.0	-15.28	32.11	14.68	29.38	H
	26740	819.0	-20.87	32.51	9.49	8.89	V
Channel Bandwidth: 10 MHz / 16QAM							
NB	26740	819.0	-16.20	32.11	13.76	23.77	H
	26740	819.0	-21.80	32.51	8.56	7.18	V
Channel Bandwidth: 10 MHz / 64QAM							
NB	26740	819.0	-17.24	32.11	12.72	18.71	H
	26740	819.0	-22.81	32.51	7.55	5.69	V

Note: ERP (dBm) = Reading (dBm) + Correction Factor (dB) – 2.15

## 4.2 Modulation Characteristics Measurement

### 4.2.1 Limits of Modulation Characteristics

N/A

### 4.2.2 Test Setup



### 4.2.3 Test Procedure

Connect the EUT to Communication Simulator via the antenna connector. The frequency band is set as EUT supported Modulation and Channels, the EUT output is matched with 50 ohm load, the waveform quality and constellation of the EUT was tested.

### 4.2.4 Test Results

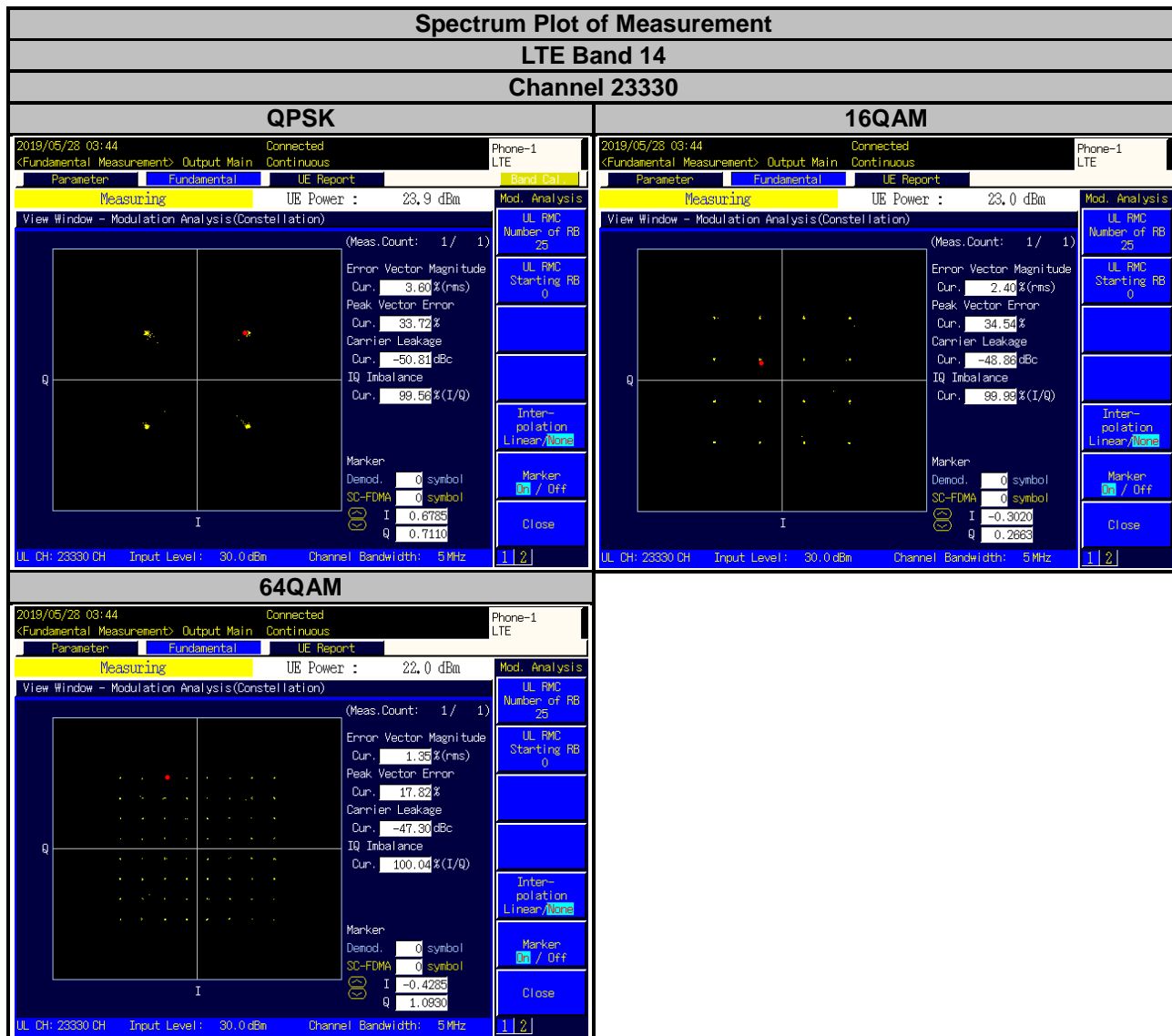



**Spectrum Plot of Measurement**  
**LTE Band 26**  
**Channel 26740**

**QPSK**

**16QAM**

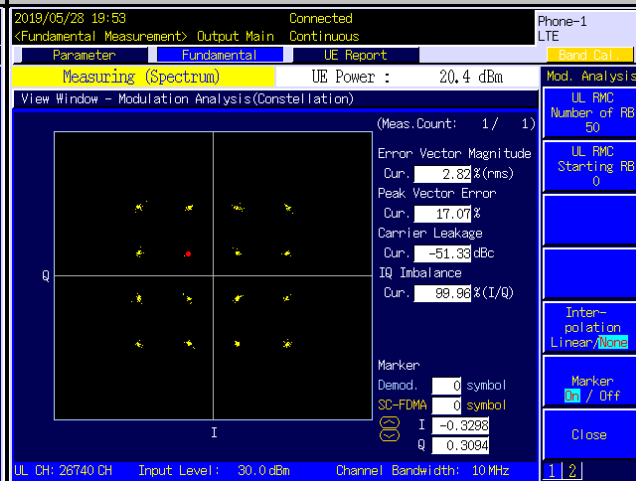
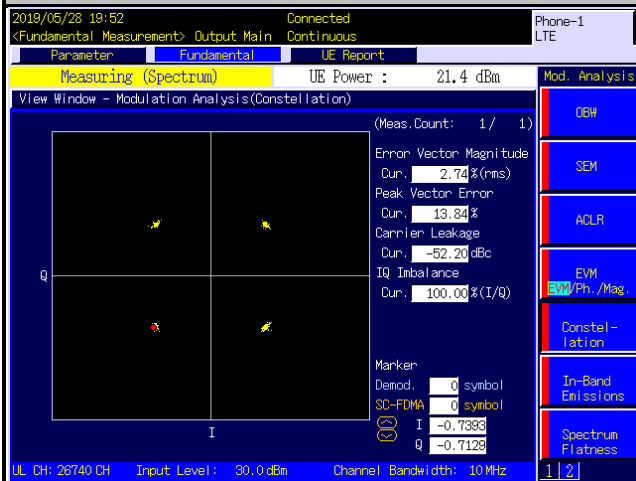

**64QAM**

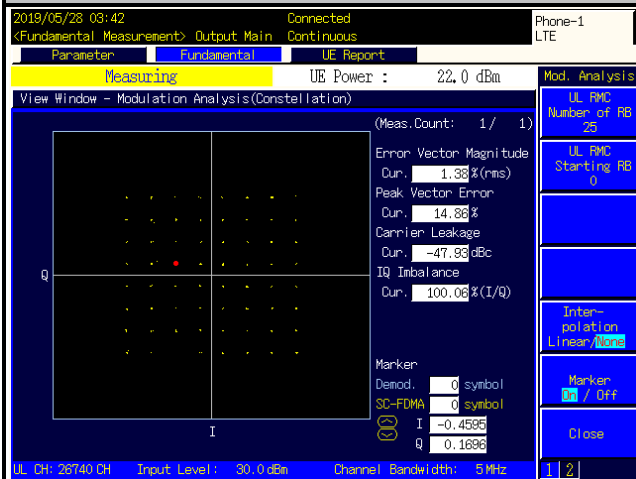

### 4.3 Frequency Stability Measurement

#### 4.3.1 Limits of Frequency Stability Measurement

##### LTE Band 14

The frequency stability of mobile, portable and control transmitters operating in the wideband segment must be 1.25 parts per million or better when AFC is locked to a base station, and 5 parts per million or better when AFC is not locked.

##### LTE Band 26

1.5 ppm is for base and fixed station. 2.5 ppm is for mobile station.

#### 4.3.2 Test Procedure

- Device is placed at the oven room. The oven room could control the temperatures and humidity. Power warm up is at least 15 min and power applied should perform before recording frequency error.
- EUT is connected the external power supply to control the DC input power. The test voltage range is from minimum to maximum working voltage. Each step shall be record the frequency error rate.
- The temperature range step is 10 degrees in this test items. All temperature levels shall be hold the  $\pm 0.5^\circ\text{C}$  during the measurement testing. The each temperature step shall be at least 0.5 hours, consider the EUT could be test under the stability condition.

**NOTE:** The frequency error was recorded frequency error from the communication simulator.

#### 4.3.3 Test Setup

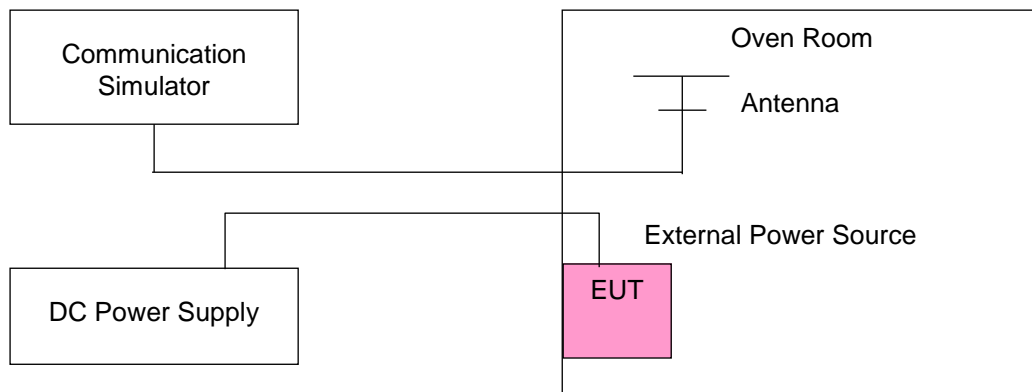

#### 4.3.4 Test Results

##### Frequency Error vs. Voltage

Voltage (Volts)	LTE Band 14				Limit (ppm)
	Channel Bandwidth: 5 MHz				
	Low Channel		High Channel		
	Frequency (MHz)	Frequency Error (ppm)	Frequency (MHz)	Frequency Error (ppm)	
120	790.500001	0.001	795.500000	0.002	1.25
102	790.500001	0.002	795.500000	0.002	1.25
138	790.500001	0.002	795.500000	0.005	1.25

**Note:** The applicant defined the normal working voltage of the battery is from 102 Vac to 138 Vac.

##### Frequency Error vs. Temperature

Temp. (°C)	LTE Band 14				Limit (ppm)
	Channel Bandwidth: 5 MHz				
	Low Channel		High Channel		
	Frequency (MHz)	Frequency Error (ppm)	Frequency (MHz)	Frequency Error (ppm)	
-30	790.500004	0.005	795.500000	0.004	1.25
-20	790.500002	0.002	795.500000	0.003	1.25
-10	790.500003	0.003	795.500000	0.001	1.25
0	790.500004	0.005	795.500000	0.002	1.25
10	790.500002	0.003	795.500000	0.002	1.25
20	790.499997	-0.004	795.500000	-0.003	1.25
30	790.499997	-0.004	795.500000	-0.003	1.25
40	790.499999	-0.002	795.500000	-0.005	1.25
50	790.499997	-0.004	795.500000	-0.001	1.25

Frequency Error vs. Voltage

Voltage (Volts)	LTE Band 14		Limit (ppm)
	Channel Bandwidth: 10 MHz		
	Frequency (MHz)	Frequency Error (ppm)	
120	793.000003	0.004	1.25
102	793.000004	0.005	1.25
138	793.000004	0.005	1.25

**Note:** The applicant defined the normal working voltage of the battery is from 102 Vac to 138 Vac.

Frequency Error vs. Temperature

Temp. (°C)	LTE Band 14		Limit (ppm)
	Channel Bandwidth: 10 MHz		
	Frequency (MHz)	Frequency Error (ppm)	
-30	793.000004	0.004	1.25
-20	793.000002	0.002	1.25
-10	793.000003	0.003	1.25
0	793.000003	0.004	1.25
10	793.000004	0.005	1.25
20	792.999998	-0.002	1.25
30	792.999997	-0.004	1.25
40	792.999997	-0.003	1.25
50	792.999998	-0.003	1.25

Frequency Error vs. Voltage

Voltage (Volts)	LTE Band 26				Limit (ppm)
	Channel Bandwidth: 1.4 MHz				
	Low Channel		High Channel		
	Frequency (MHz)	Frequency Error (ppm)	Frequency (MHz)	Frequency Error (ppm)	
120	814.700002	0.003	823.300000	0.003	2.5
102	814.700003	0.003	823.300000	0.003	2.5
138	814.700004	0.005	823.300000	0.005	2.5

**Note:** The applicant defined the normal working voltage of the battery is from 102 Vac to 138 Vac.

Frequency Error vs. Temperature

Temp. (°C)	LTE Band 26				Limit (ppm)
	Channel Bandwidth: 1.4 MHz				
	Low Channel		High Channel		
	Frequency (MHz)	Frequency Error (ppm)	Frequency (MHz)	Frequency Error (ppm)	
-30	814.700002	0.002	823.300000	0.003	2.5
-20	814.700004	0.005	823.300000	0.002	2.5
-10	814.700003	0.003	823.300000	0.003	2.5
0	814.700002	0.003	823.300000	0.003	2.5
10	814.700002	0.003	823.300000	0.003	2.5
20	814.699999	-0.001	823.300000	-0.004	2.5
30	814.699996	-0.005	823.300000	-0.002	2.5
40	814.699997	-0.004	823.300000	-0.003	2.5
50	814.699999	-0.002	823.300000	-0.002	2.5

Frequency Error vs. Voltage

Voltage (Volts)	LTE Band 26				Limit (ppm)
	Channel Bandwidth: 3 MHz				
	Low Channel		High Channel		
	Frequency (MHz)	Frequency Error (ppm)	Frequency (MHz)	Frequency Error (ppm)	
120	815.500002	0.003	822.500000	0.004	2.5
102	815.500003	0.004	822.500000	0.003	2.5
138	815.500002	0.003	822.500000	0.002	2.5

**Note:** The applicant defined the normal working voltage of the battery is from 102 Vac to 138 Vac.

Frequency Error vs. Temperature

Temp. (°C)	LTE Band 26				Limit (ppm)
	Channel Bandwidth: 3 MHz				
	Low Channel		High Channel		
	Frequency (MHz)	Frequency Error (ppm)	Frequency (MHz)	Frequency Error (ppm)	
-30	815.500003	0.003	822.500000	0.005	2.5
-20	815.500002	0.003	822.500000	0.003	2.5
-10	815.500002	0.002	822.500000	0.004	2.5
0	815.500003	0.004	822.500000	0.002	2.5
10	815.500003	0.004	822.500000	0.002	2.5
20	815.499999	-0.002	822.500000	-0.003	2.5
30	815.499998	-0.003	822.500000	-0.003	2.5
40	815.499998	-0.002	822.500000	-0.003	2.5
50	815.499999	-0.002	822.500000	-0.004	2.5

## Frequency Error vs. Voltage

Voltage (Volts)	LTE Band 26				Limit (ppm)
	Channel Bandwidth: 5 MHz				
	Low Channel		High Channel		
	Frequency (MHz)	Frequency Error (ppm)	Frequency (MHz)	Frequency Error (ppm)	
120	816.500003	0.004	821.500000	0.004	2.5
102	816.500002	0.002	821.500000	0.005	2.5
138	816.500002	0.003	821.500000	0.003	2.5

**Note:** The applicant defined the normal working voltage of the battery is from 102 Vac to 138 Vac.

## Frequency Error vs. Temperature

Temp. (°C)	LTE Band 26				Limit (ppm)
	Channel Bandwidth: 5 MHz				
	Low Channel		High Channel		
	Frequency (MHz)	Frequency Error (ppm)	Frequency (MHz)	Frequency Error (ppm)	
-30	816.500003	0.004	821.500000	0.002	2.5
-20	816.500003	0.004	821.500000	0.003	2.5
-10	816.500004	0.005	821.500000	0.004	2.5
0	816.500001	0.001	821.500000	0.003	2.5
10	816.500002	0.003	821.500000	0.004	2.5
20	816.499997	-0.004	821.500000	-0.001	2.5
30	816.499998	-0.002	821.500000	-0.004	2.5
40	816.499997	-0.004	821.500000	-0.001	2.5
50	816.499997	-0.003	821.500000	-0.001	2.5

Frequency Error vs. Voltage

Voltage (Volts)	LTE Band 26		Limit (ppm)
	Channel Bandwidth: 10 MHz		
	Frequency (MHz)	Frequency Error (ppm)	
120	819.000003	0.003	2.5
102	819.000003	0.004	2.5
138	819.000002	0.002	2.5

**Note:** The applicant defined the normal working voltage of the battery is from 102 Vac to 138 Vac.

Frequency Error vs. Temperature

Temp. (°C)	LTE Band 26		Limit (ppm)
	Channel Bandwidth: 10 MHz		
	Frequency (MHz)	Frequency Error (ppm)	
-30	819.000002	0.003	2.5
-20	819.000003	0.004	2.5
-10	819.000001	0.002	2.5
0	819.000002	0.002	2.5
10	819.000001	0.001	2.5
20	818.999999	-0.002	2.5
30	818.999997	-0.004	2.5
40	818.999996	-0.005	2.5
50	818.999996	-0.005	2.5



## 4.4 Occupied Bandwidth Measurement

### 4.4.1 Limits of Occupied Bandwidth Measurement

The width of a frequency band such that, below the lower and above the upper frequency limits, the mean powers emitted are each equal to a specified percentage 0.5 % of the total mean power of a given emission.

### 4.4.2 Test Procedure

The EUT makes a call to the communication simulator. All measurements were done at low, middle and high operational frequency range. The communication simulator station system controlled a EUT to export maximum output power under transmission mode and specific channel frequency. Use OBW measurement function of Spectrum analyzer to measure 99 % occupied bandwidth.

### 4.4.3 Test Setup

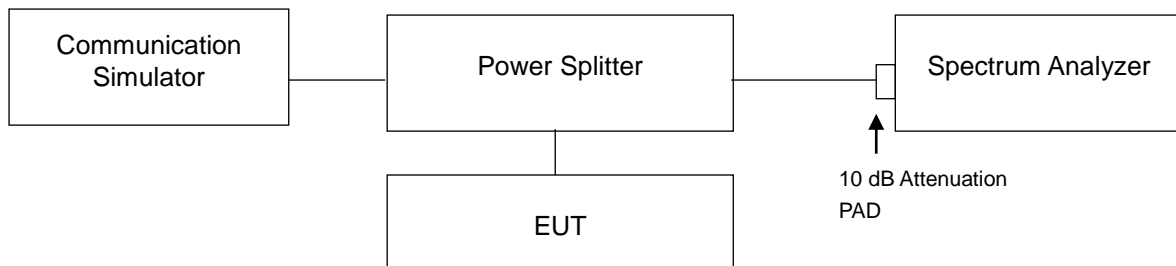

#### 4.4.4 Test Results

LTE Band 14							
Channel Bandwidth: 5 MHz							
Channel	Frequency (MHz)	99 % Occupied Bandwidth (MHz)			26 dB Bandwidth (MHz)		
		QPSK	16QAM	64QAM	QPSK	16QAM	64QAM
23305	790.5	4.492	4.493	4.490	4.828	4.821	4.819
23330	793.0	4.489	4.493	4.494	4.802	4.828	4.827
23355	795.5	4.497	4.497	4.496	4.807	4.822	4.821

  

Channel Bandwidth: 10 MHz							
Channel	Frequency (MHz)	99 % Occupied Bandwidth (MHz)			26 dB Bandwidth (MHz)		
		QPSK	16QAM	64QAM	QPSK	16QAM	64QAM
23330	793.0	8.956	8.957	8.949	9.651	9.692	9.670

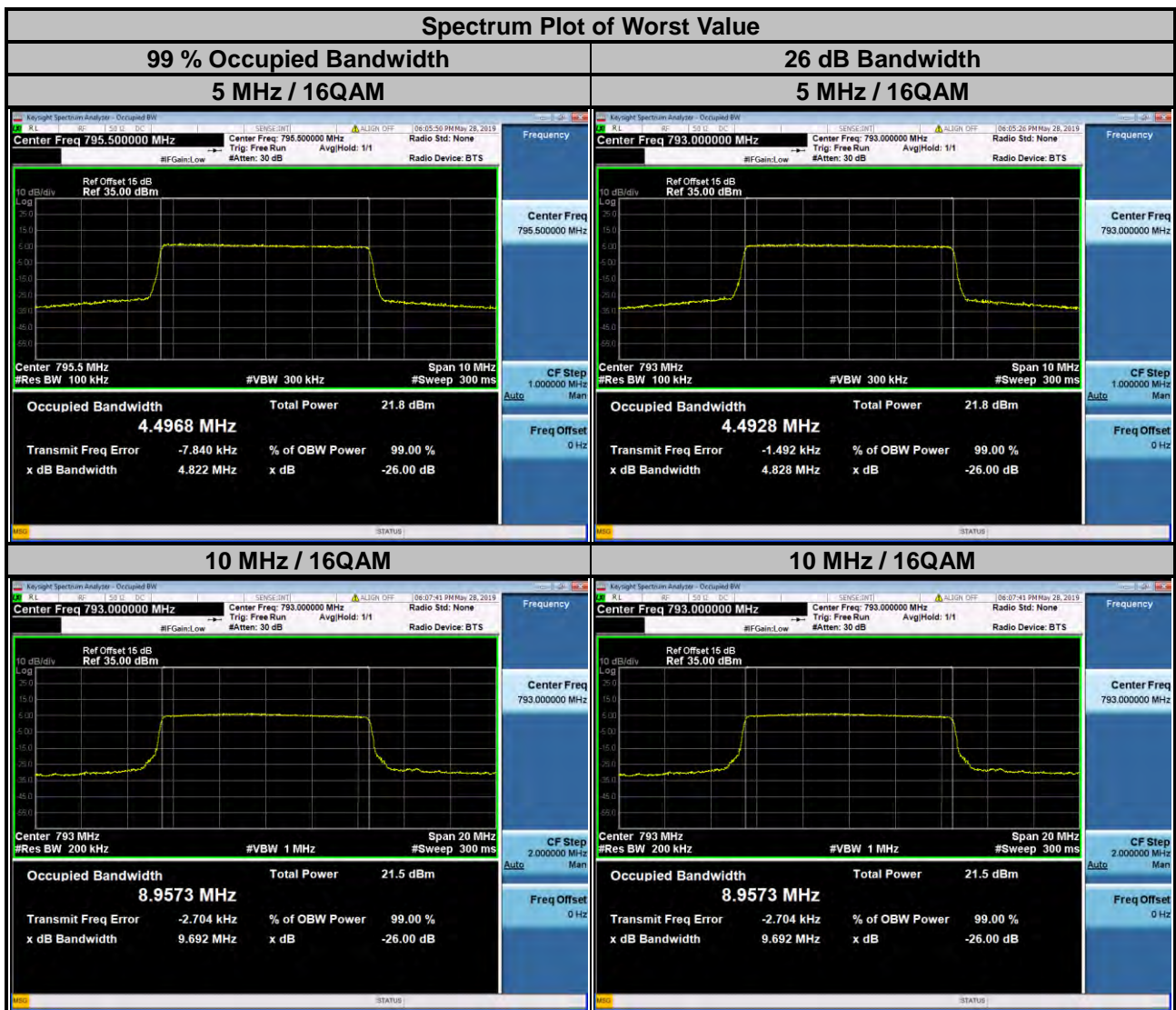

LTE Band 26							
Channel Bandwidth: 1.4 MHz							
Channel	Frequency (MHz)	99 % Occupied Bandwidth (MHz)			26 dB Bandwidth (MHz)		
		QPSK	16QAM	64QAM	QPSK	16QAM	64QAM
26697	814.7	1.092	1.094	1.093	1.244	1.241	1.240
26740	819.0	1.092	1.092	1.092	1.245	1.241	1.248
26783	823.3	1.094	1.091	1.094	1.243	1.246	1.243

Channel Bandwidth: 3 MHz							
Channel	Frequency (MHz)	99 % Occupied Bandwidth (MHz)			26 dB Bandwidth (MHz)		
		QPSK	16QAM	64QAM	QPSK	16QAM	64QAM
26705	815.5	2.705	2.704	2.701	2.974	2.972	2.986
26740	819.0	2.702	2.700	2.702	2.968	2.961	2.974
26775	822.5	2.701	2.700	2.696	2.974	2.963	2.959

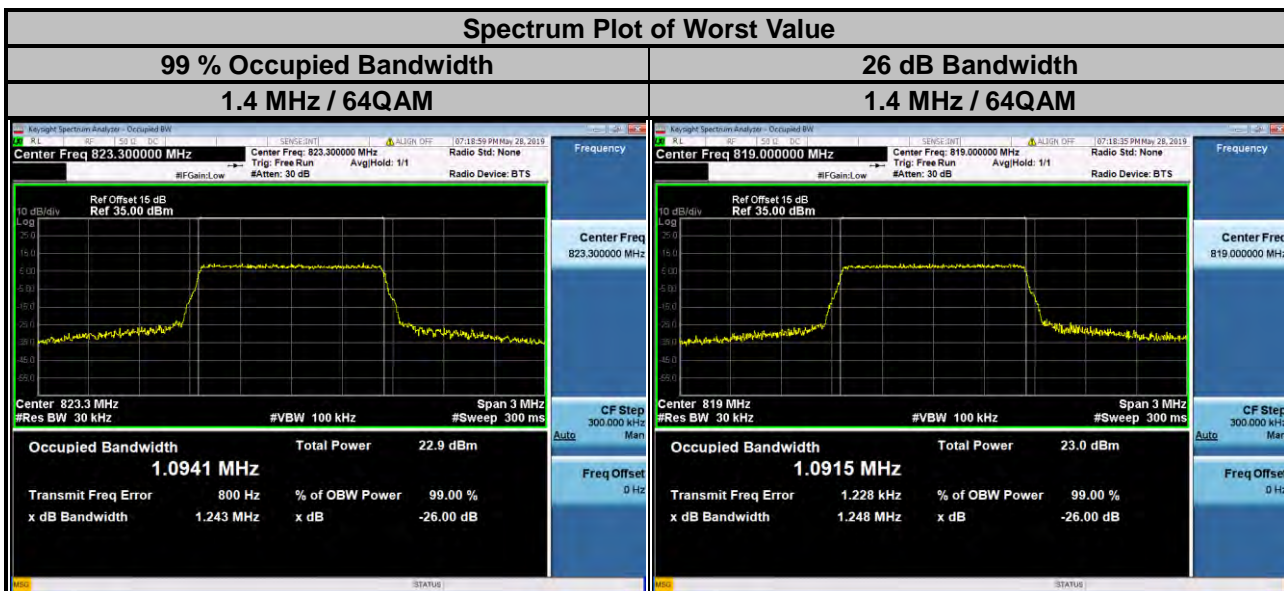

LTE Band 26							
Channel Bandwidth: 5 MHz							
Channel	Frequency (MHz)	99 % Occupied Bandwidth (MHz)			26 dB Bandwidth (MHz)		
		QPSK	16QAM	64QAM	QPSK	16QAM	64QAM
26715	816.5	4.500	4.501	4.503	4.824	4.831	4.869
26740	819.0	4.494	4.491	4.493	4.829	4.848	4.827
26765	821.5	4.491	4.491	4.493	4.837	4.828	4.814

Channel Bandwidth: 10 MHz							
Channel	Frequency (MHz)	99 % Occupied Bandwidth (MHz)			26 dB Bandwidth (MHz)		
		QPSK	16QAM	64QAM	QPSK	16QAM	64QAM
26740	819.0	8.977	8.972	8.969	9.644	9.773	9.707



## 4.5 Emission Mask Measurement

### 4.5.1 Limits of Emission Mask Measurement

#### LTE Band 14

1. On any frequency removed from the assigned frequency by more than 50 percent, but not more than 100 percent of the authorized bandwidth: At least 25 dB.
2. On any frequency removed from the assigned frequency by more than 100 percent, but not more than 250 percent of the authorized bandwidth: At least 35 dB.
3. On any frequency removed from the assigned frequency by more than 250 percent of the authorized bandwidth: At least  $43 + 10 \log (P)$  dB.

#### LTE Band 26

According to FCC part 90.691 shall be tested the emission mask. For any frequency removed from the EA licensee's frequency block by up to and including 37.5 kHz, the power of any emission shall be attenuated below the transmitter power (P) in watts by at least  $116 \log_{10}(f/6.1)$  decibels or  $50 + 10 \log_{10}(P)$  decibels or 80 decibels, whichever is the lesser attenuation, where f is the frequency removed from the center of the outer channel in the block in kilohertz and where f is greater than 12.5 kHz.

For any frequency removed from the EA licensee's frequency block greater than 37.5 kHz, the power of any emission shall be attenuated below the transmitter power (P) in watts by at least  $43 + 10 \log_{10}(P)$  decibels or 80 decibels, whichever is the lesser attenuation, where f is the frequency removed from the center of the outer channel in the block in kilohertz and where f is greater than 37.5 kHz.

For §90.691(a), RBW=300 Hz for offset less than 37.5 kHz from channel edge and RBW=100 kHz for offsets greater than 37.5 kHz is allowed.

### 4.5.2 Test Setup

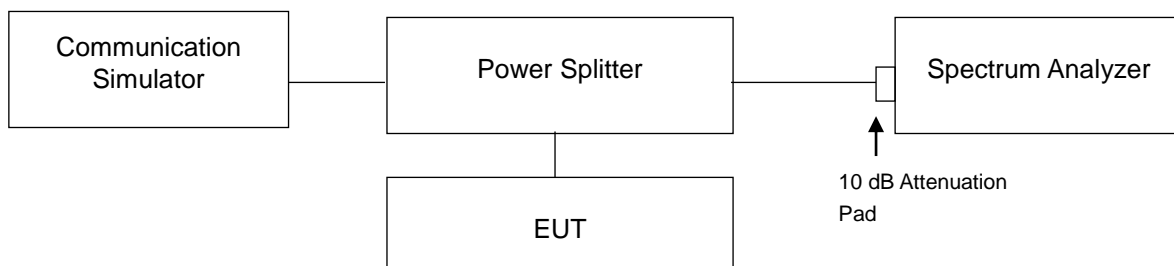

### 4.5.3 Test Procedures

- a. The measurement used the power splitter via EUT RF power connector between simulation base station and spectrum analyzer.
- b. Record the test plot.

### 4.5.4 Test Results

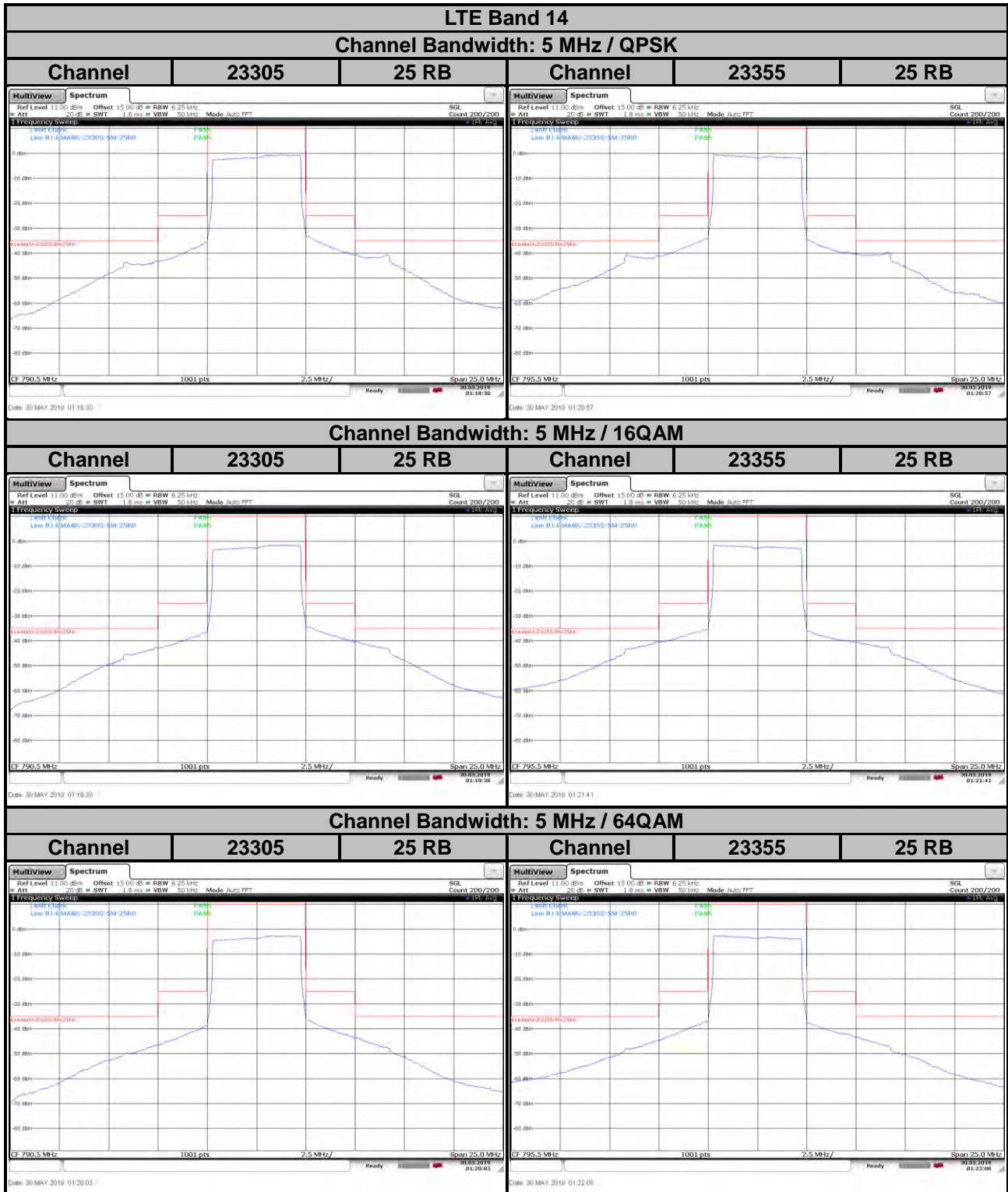

**LTE Band 14**

<b>Channel Bandwidth: 10 MHz / QPSK</b>	<b>Channel Bandwidth: 10 MHz / 16QAM</b>
---	--

<b>Channel</b>	<b>23330</b>	<b>50 RB</b>	<b>Channel</b>	<b>23330</b>	<b>50 RB</b>
----------------	--------------	--------------	----------------	--------------	--------------



**Channel Bandwidth: 10 MHz / 64QAM**

<b>Channel</b>	<b>23330</b>	<b>50 RB</b>
----------------	--------------	--------------



### LTE Band 26

Channel Bandwidth: 1.4 MHz / QPSK

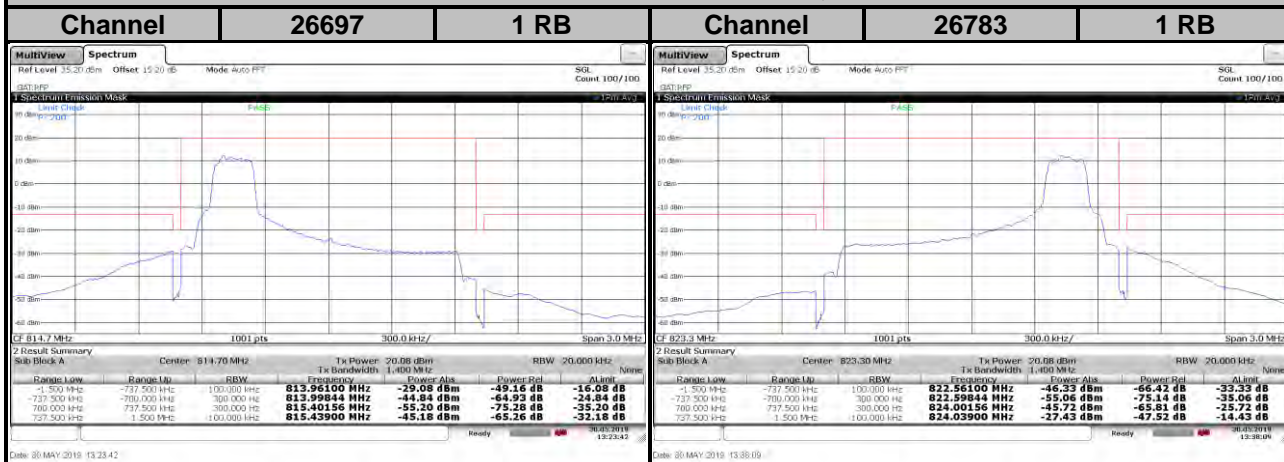



### LTE Band 26

#### Channel Bandwidth: 1.4 MHz / 16QAM

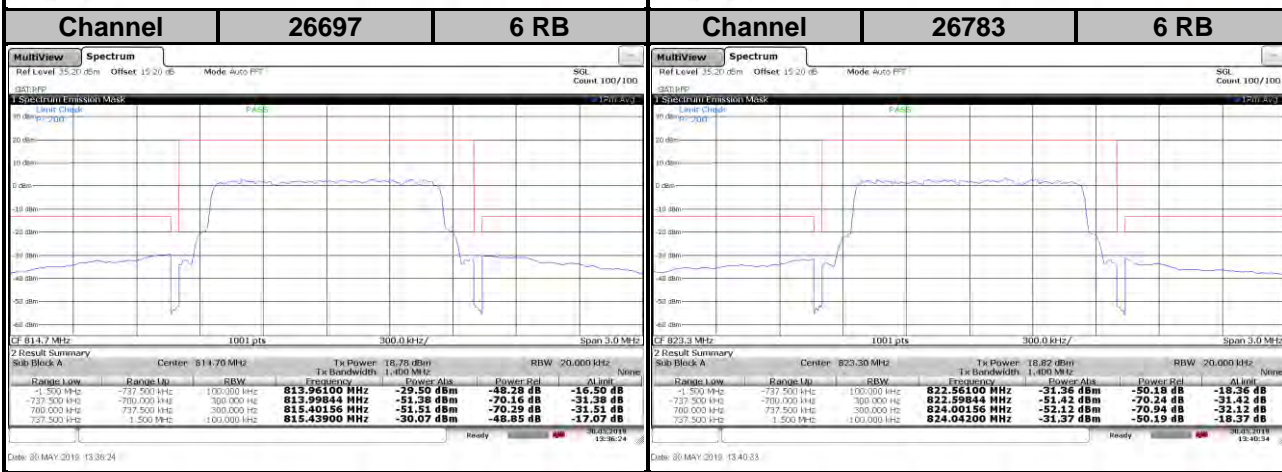
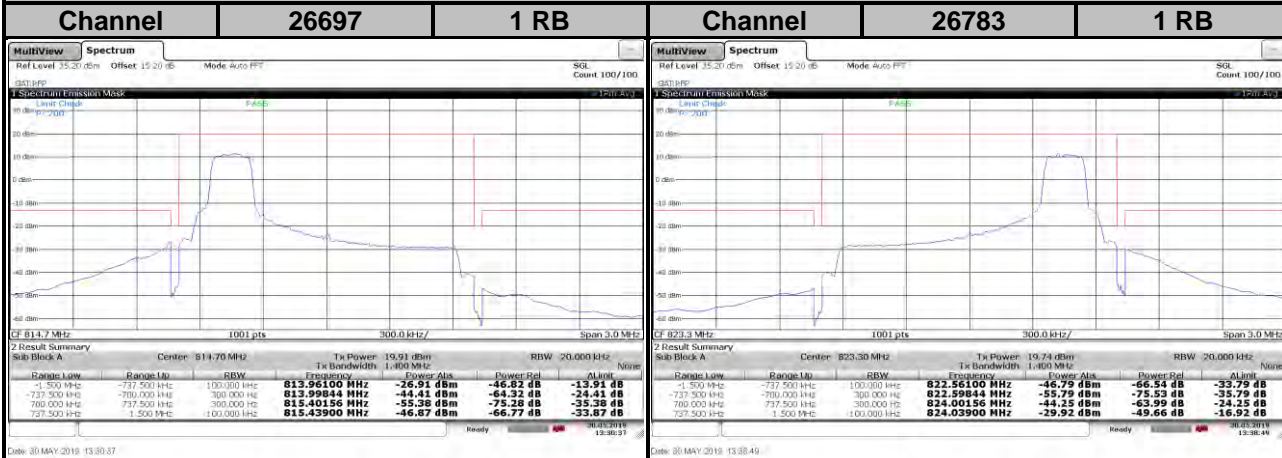

### LTE Band 26

### Channel Bandwidth: 1.4 MHz / 64QAM

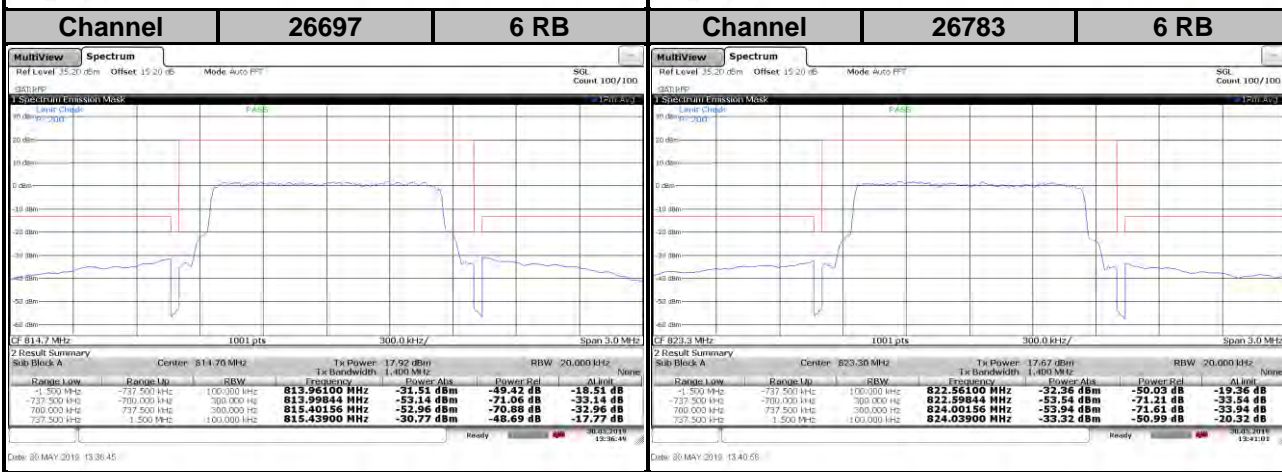
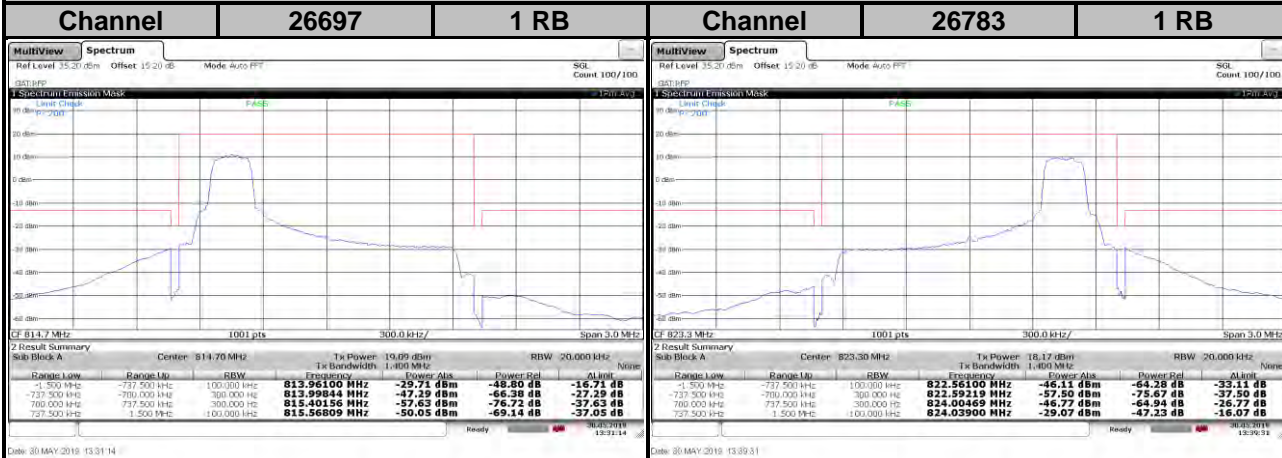

### LTE Band 26

### Channel Bandwidth: 3 MHz / QPSK

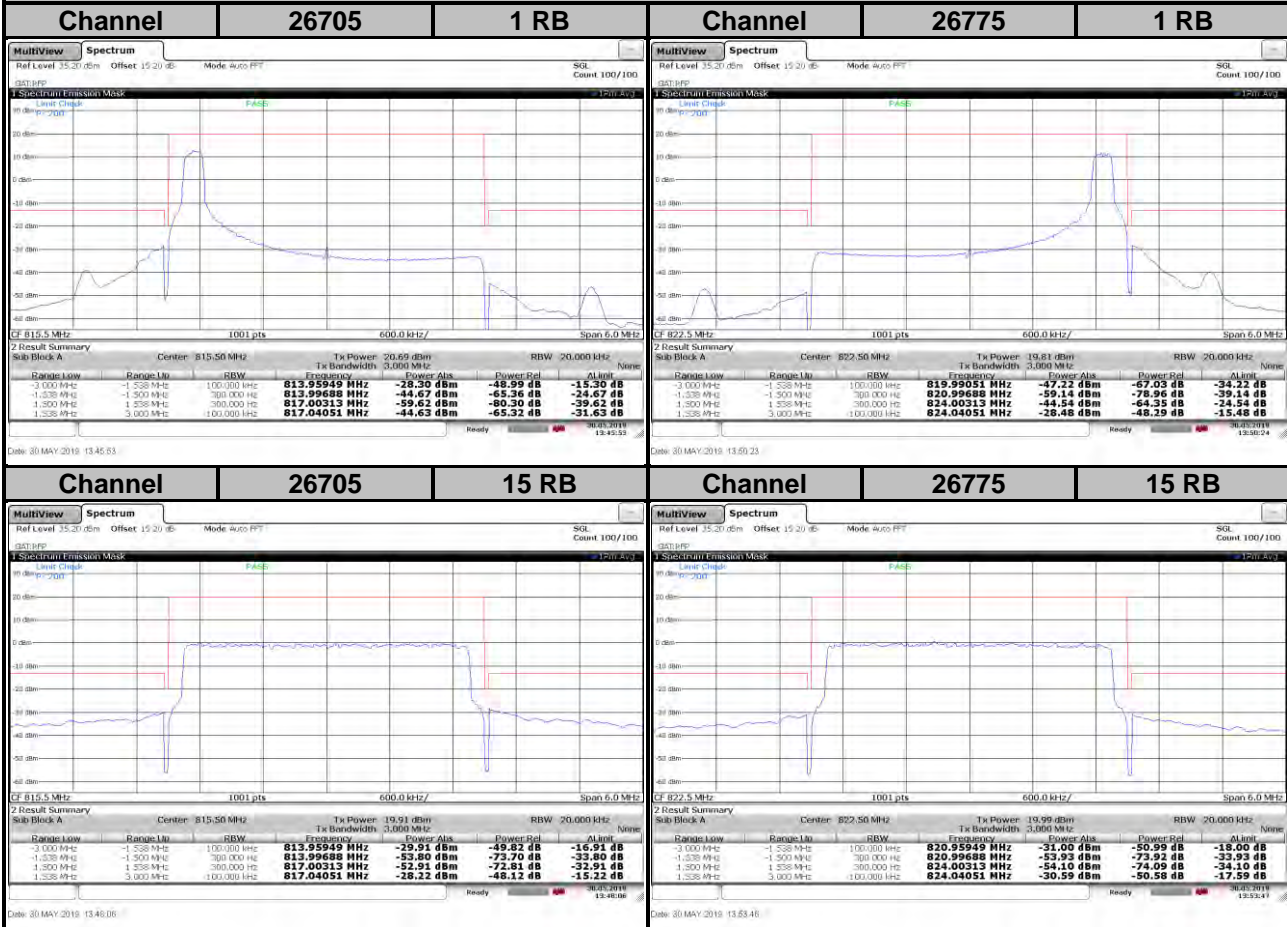

**LTE Band 26**

**Channel Bandwidth: 3 MHz / 16QAM**

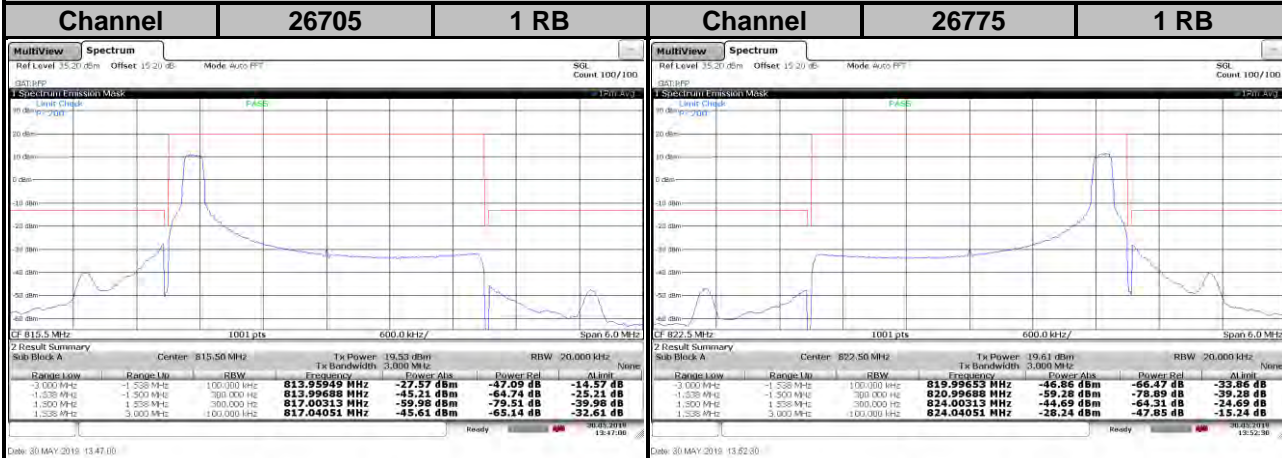

### LTE Band 26

Channel Bandwidth: 3 MHz / 64QAM

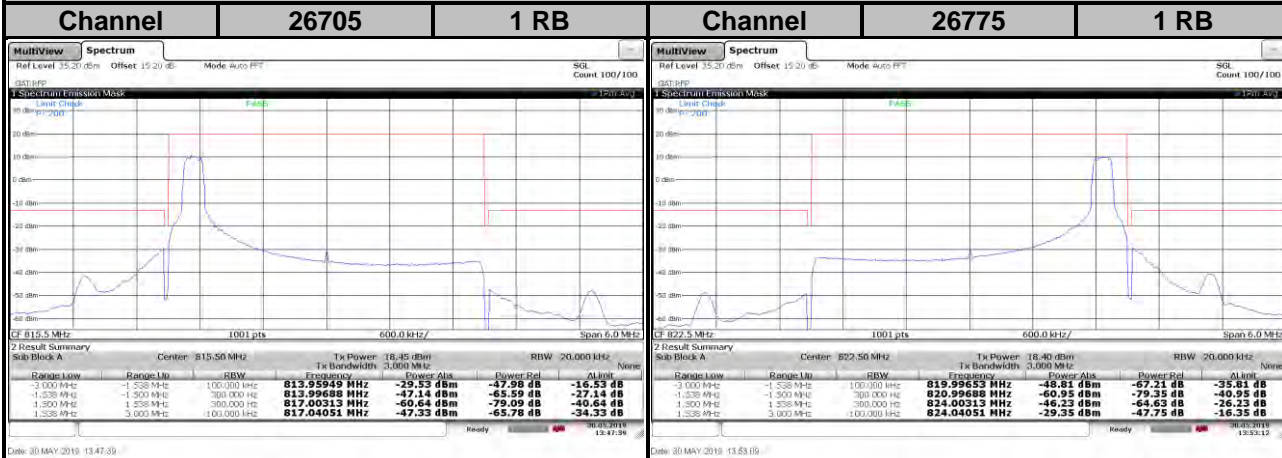

### LTE Band 26

#### Channel Bandwidth: 5 MHz / QPSK

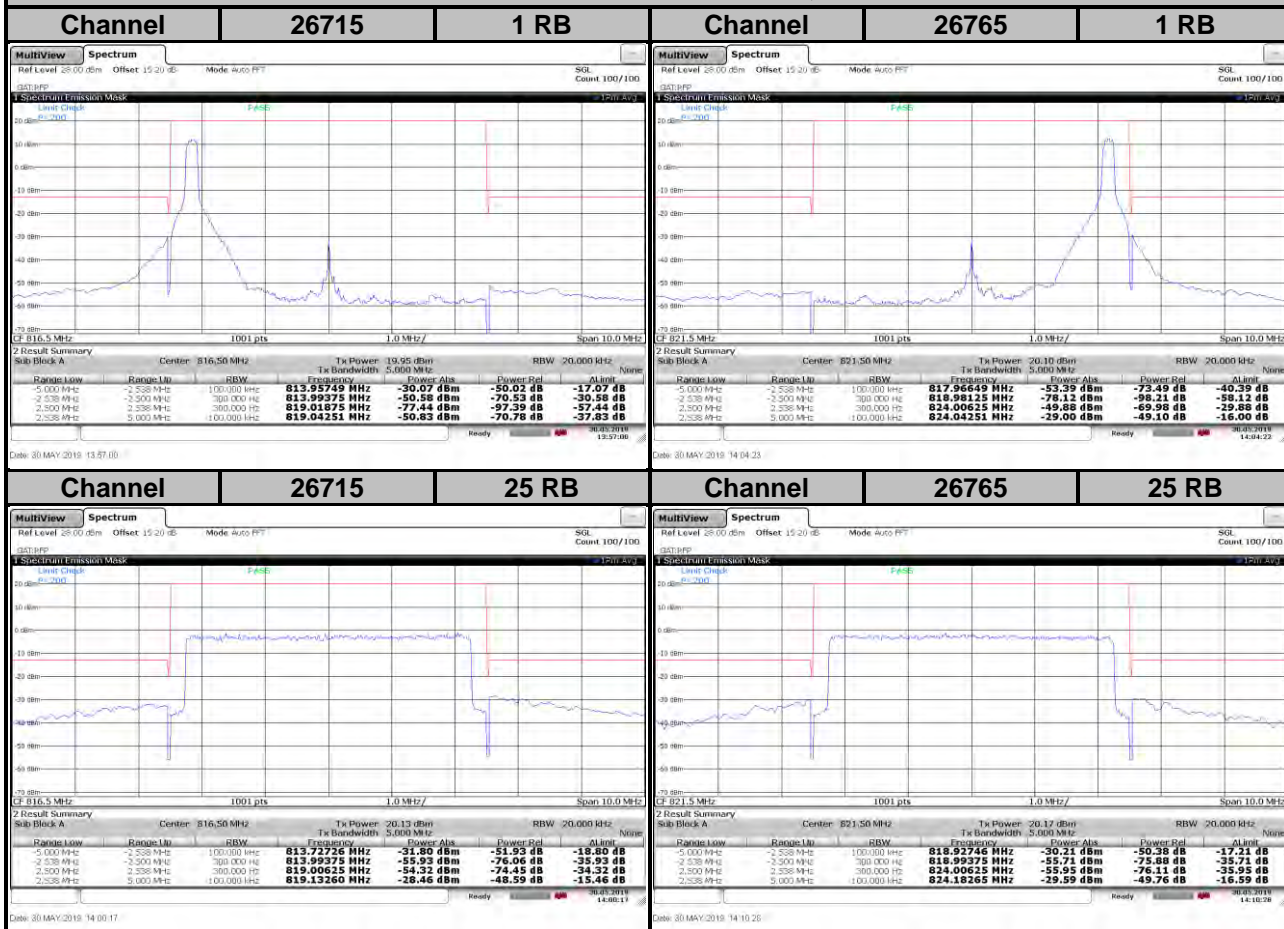

### LTE Band 26

Channel Bandwidth: 5 MHz / 16QAM

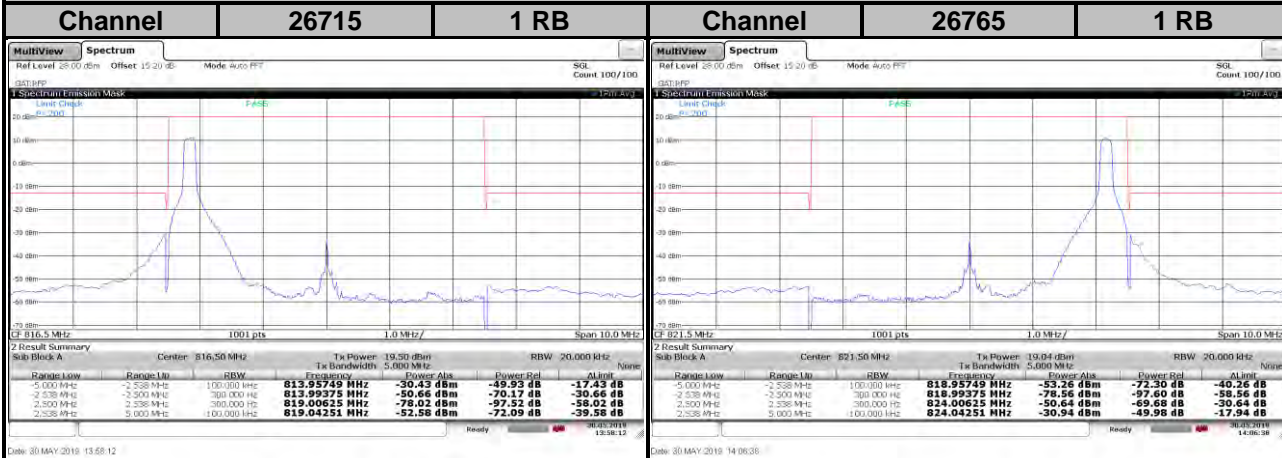

**LTE Band 26**

**Channel Bandwidth: 5 MHz / 64QAM**

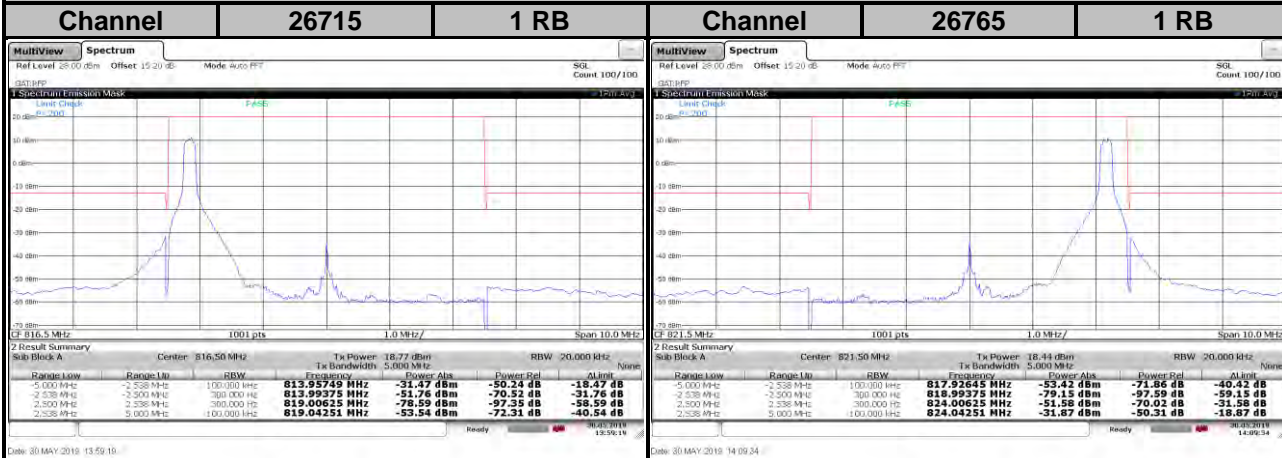



**LTE Band 26**  
**Channel Bandwidth: 10 MHz / QPSK**

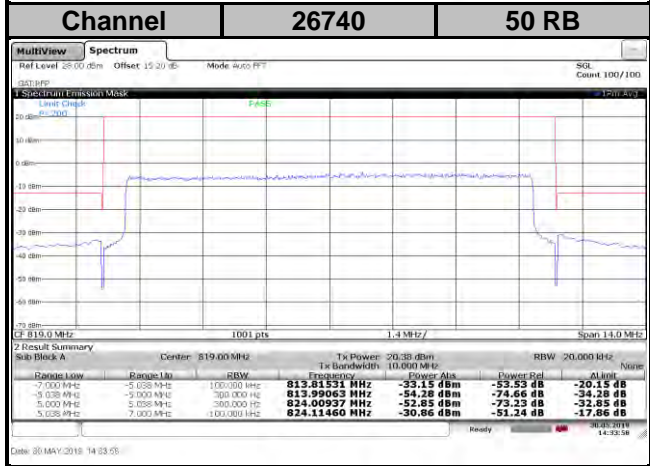

**LTE Band 26**  
**Channel Bandwidth: 10 MHz / 16QAM**

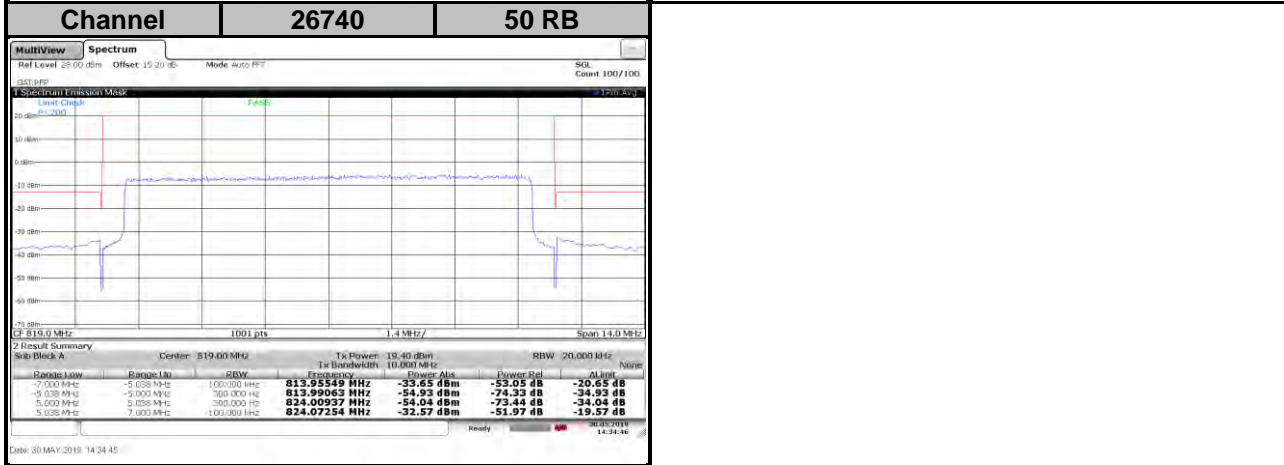
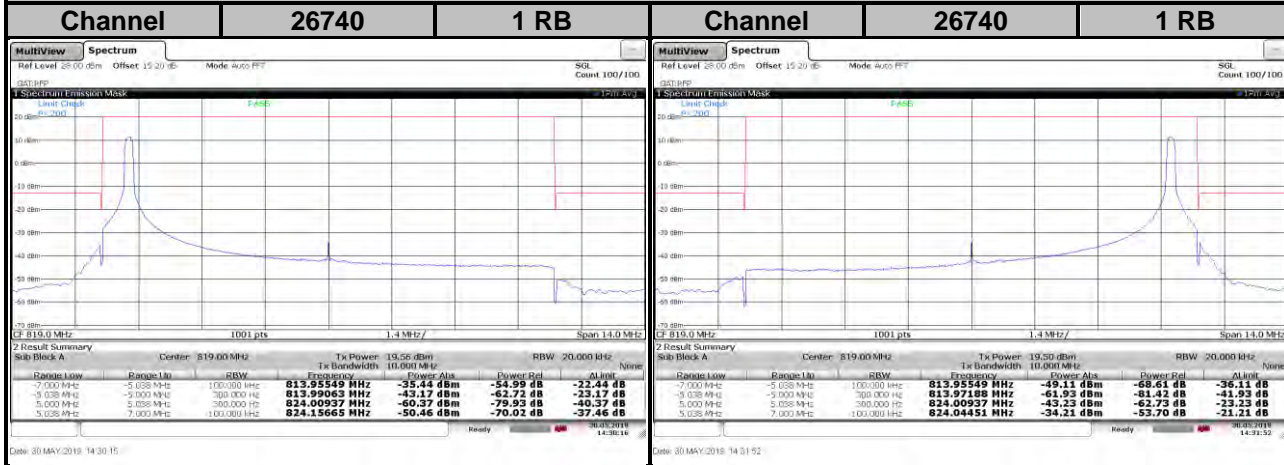

### LTE Band 26

Channel Bandwidth: 10 MHz / 64QAM

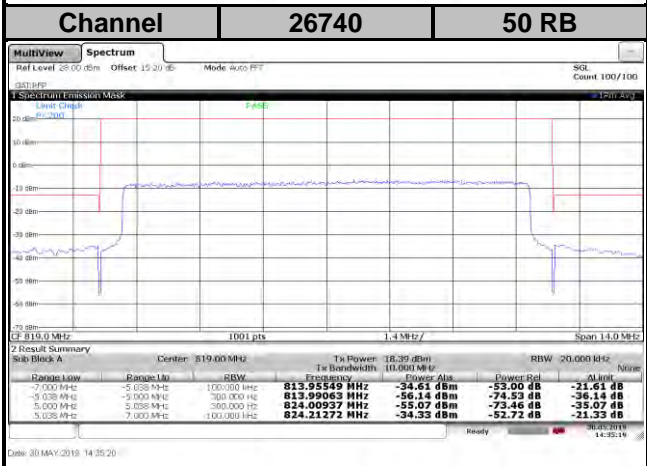
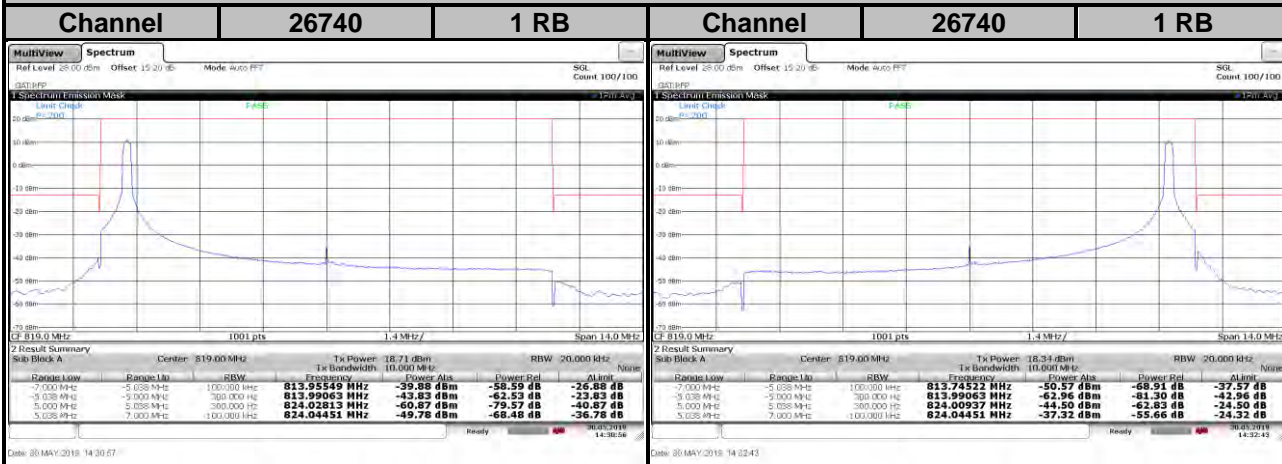

## 4.6 Band Edge Measurement

### 4.6.1 Limits of Band Edge Measurement

- (1) On all frequencies between 769 - 775 MHz and 799 - 805 MHz, by a factor not less than  $76 + 10 \log (P)$  dB in a 6.25 kHz band segment, for base and fixed stations.
- (2) On all frequencies between 769 - 775 MHz and 799 - 805 MHz, by a factor not less than  $65 + 10 \log (P)$  dB in a 6.25 kHz band segment, for mobile and portable stations.
- (3) On any frequency between 775 - 788 MHz, above 805 MHz, and below 758 MHz, by at least  $43 + 10 \log (P)$ .

### 4.6.2 Test Setup

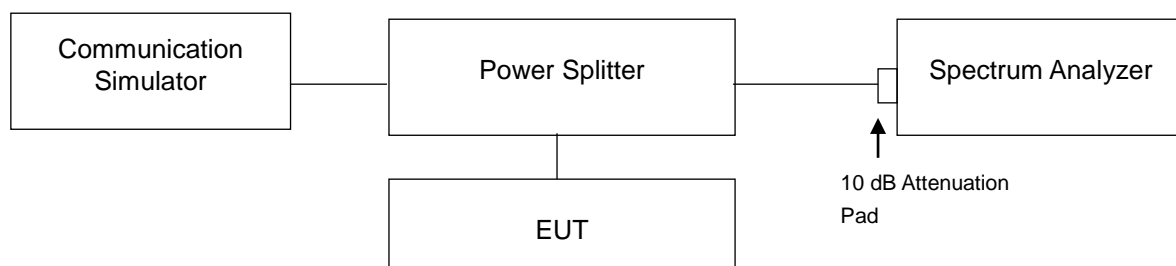

### 4.6.3 Test Procedures

- a. All measurements were done at low and high operational frequency range.
- b. The band edge measurement used the power splitter via EUT RF power connector between signal generator and spectrum analyzer. This splitter loss, attenuator loss and cable loss are the worst loss 15 dB in the transmitted path track.
- c. Record the max. trace plot into the test report.

### 4.6.4 Test Results

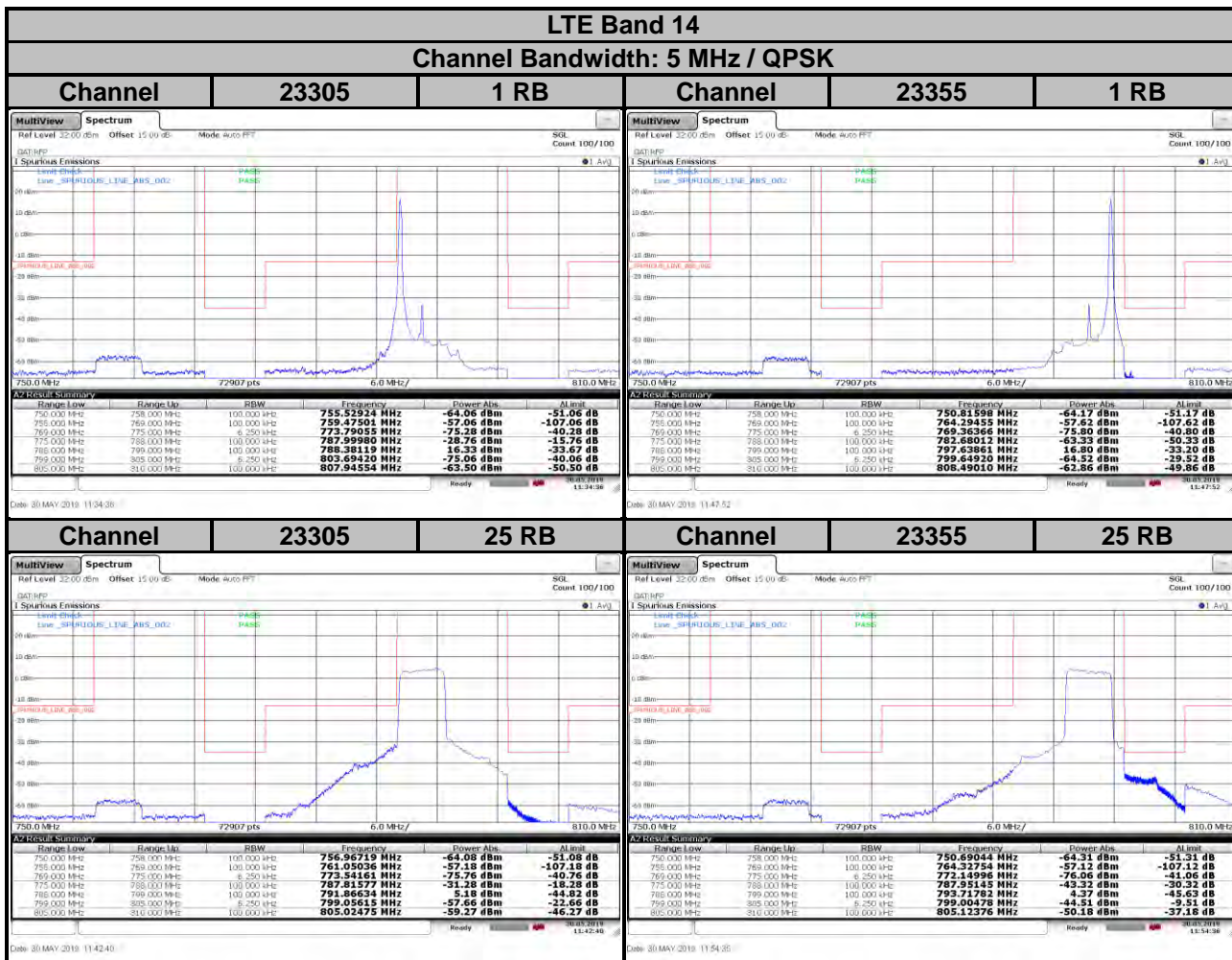

### LTE Band 14

Channel Bandwidth: 5 MHz / 16QAM

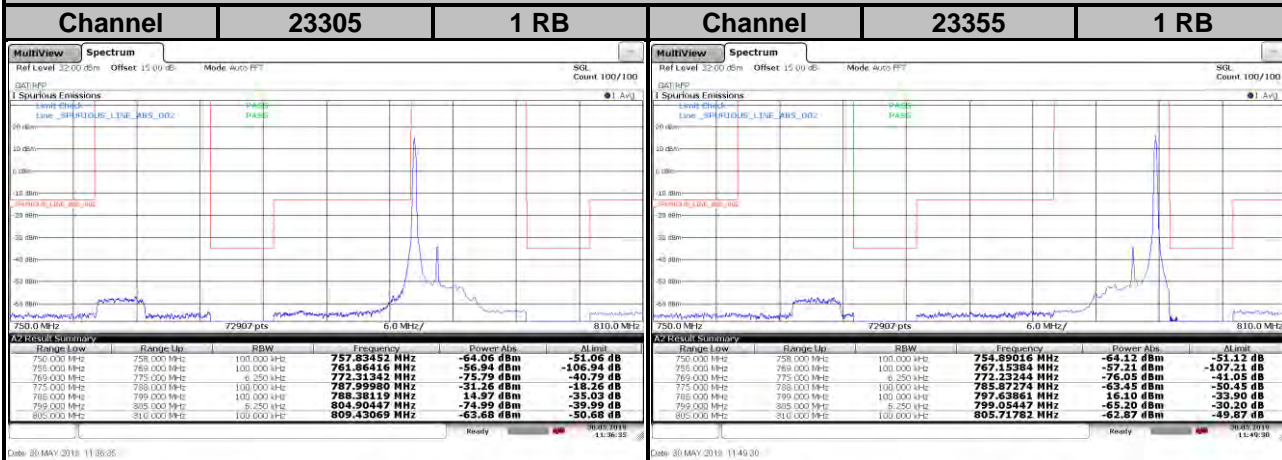

Date: 20 MAY 2018 11:38:35

Date: 20 MAY 2018 11:40:30

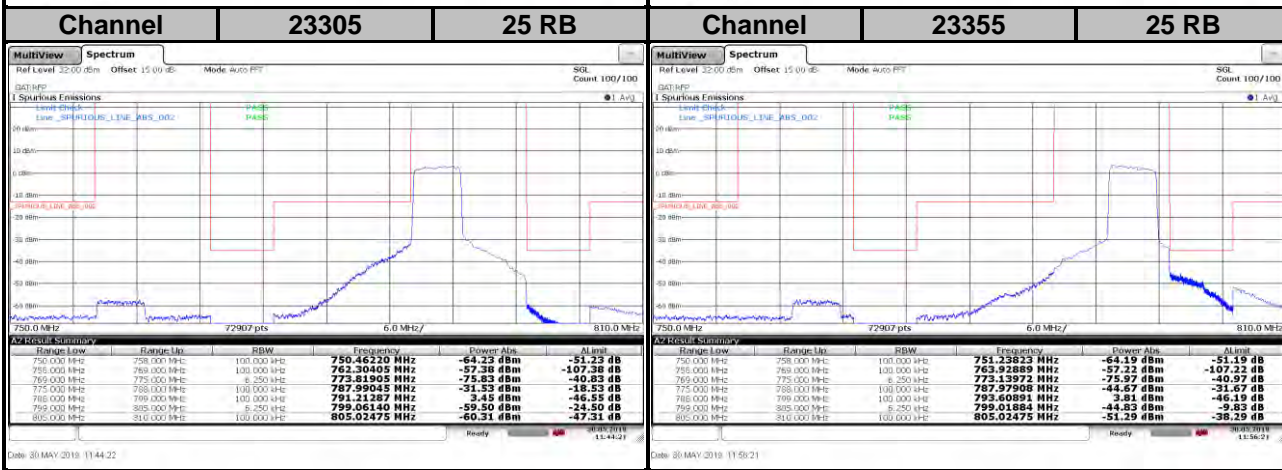

Date: 20 MAY 2018 11:44:22

Date: 20 MAY 2018 11:50:21

### LTE Band 14

Channel Bandwidth: 5 MHz / 64QAM

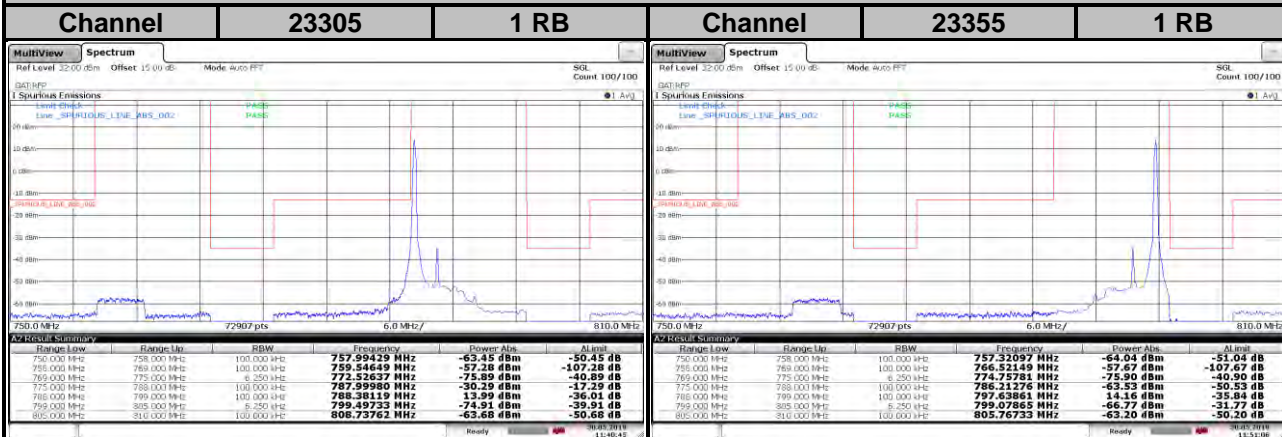

Date: 30 MAY 2018 11:40:45

Date: 30 MAY 2018 11:51:06

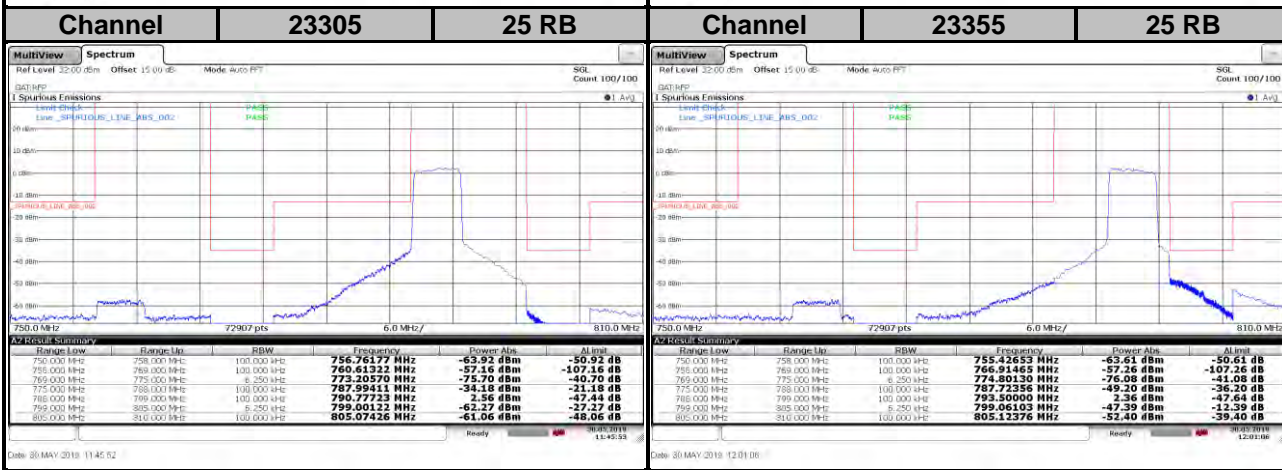

Date: 30 MAY 2018 11:45:52

Date: 30 MAY 2018 12:01:06

### LTE Band 14

Channel Bandwidth: 10 MHz / QPSK

Channel Bandwidth: 10 MHz / 16QAM

Channel 23330

50 RB

Channel 23330

50 RB

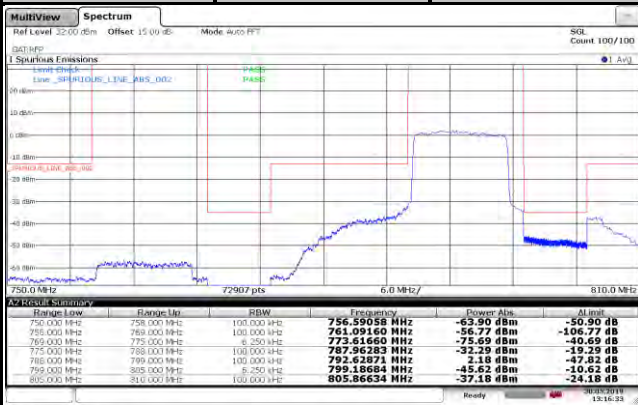

Date: 20 MAY 2018 13:18:22

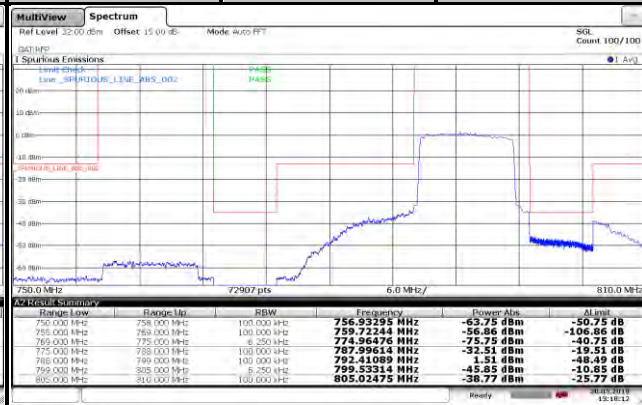

Date: 20 MAY 2018 13:18:12

Channel Bandwidth: 10 MHz / 64QAM

Channel 23330

50 RB

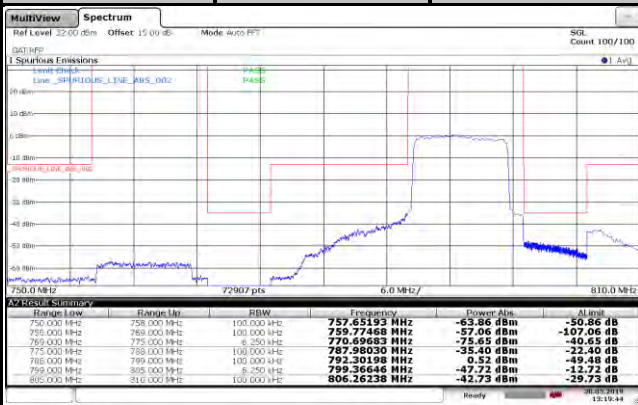

Date: 20 MAY 2018 13:18:45



## 4.7 Conducted Spurious Emissions

### 4.7.1 Limits of Conducted Spurious Emissions Measurement

The power of any emission outside a licensee's frequency block shall be attenuated below the transmitter power (P) by at least  $43 + 10 \log_{10}(P)$  dB. The limit of emission is equal to -13 dBm.

On all frequencies between 769–775 MHz and 799–805 MHz, by a factor not less than  $65 + 10 \log (P)$  dB in a 6.25 kHz band segment, for mobile and portable stations.

### 4.7.2 Test Setup

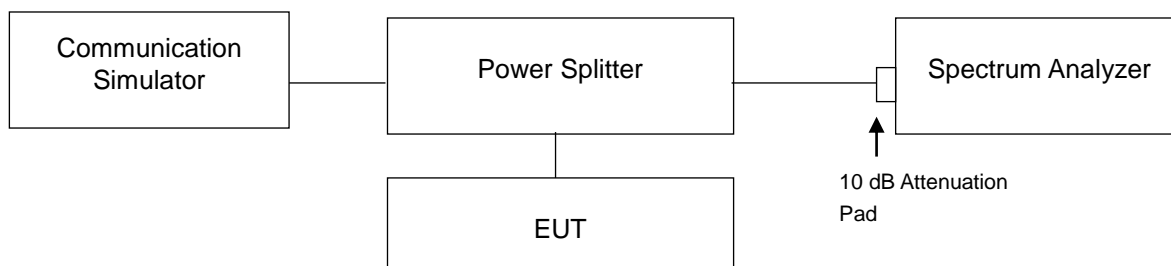

### 4.7.3 Test Procedure

- The EUT makes a phone call to the communication simulator. All measurements were done at low, middle and high operational frequency range.
- Measuring frequency range is from 9 kHz to 1 GHz. 10 dB attenuation pad is connected with spectrum. RBW = 100 or 300 kHz and VBW = 300 k or 1 MHz are used for conducted emission measurement.
- Measuring frequency range is from 1 GHz to 8 / 9 GHz. 10 dB attenuation pad is connected with spectrum. RBW = 1 MHz and VBW = 3 MHz are used for conducted emission measurement.

### 4.7.4 Test Results

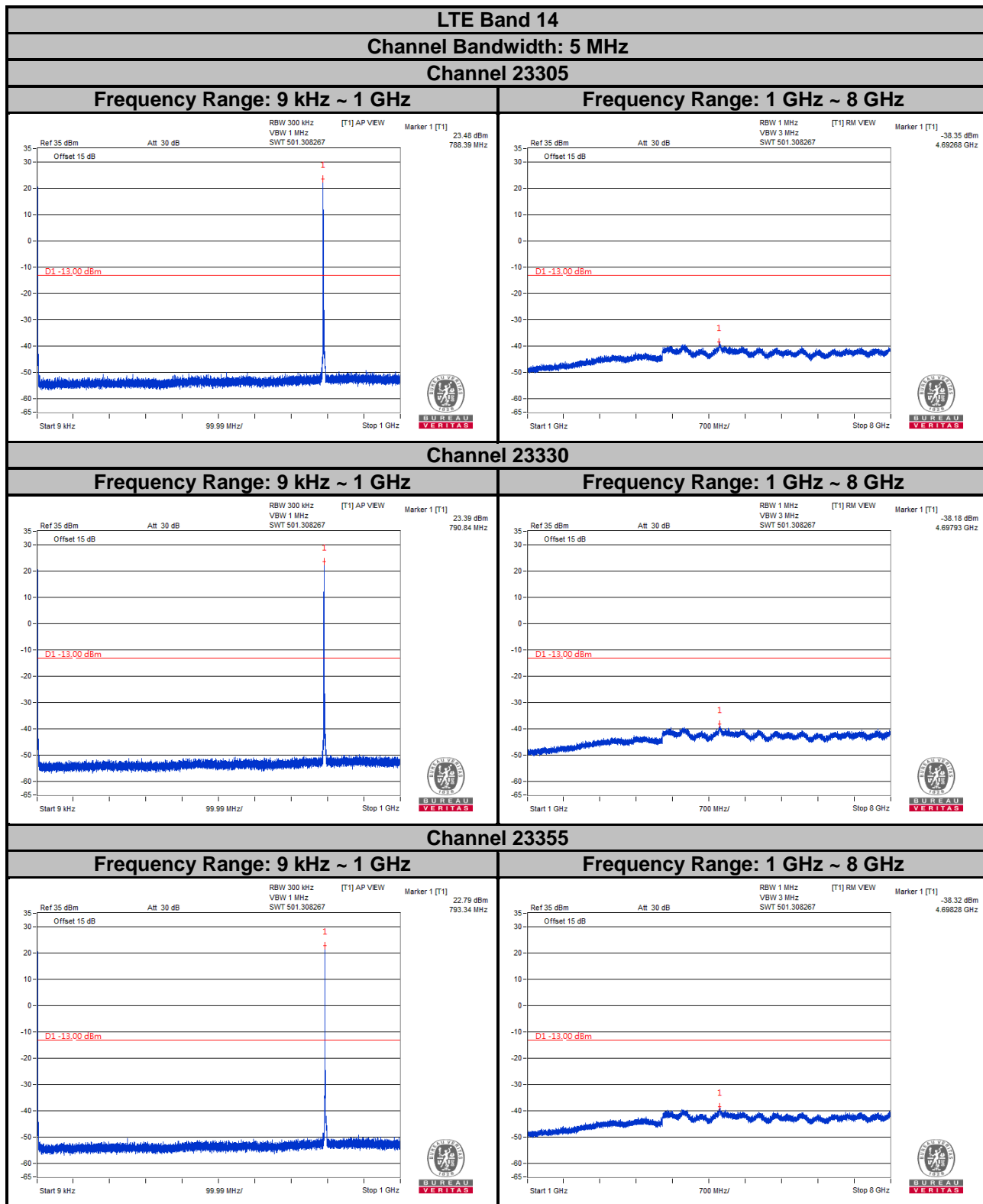

Note: The signal over the limit in 9 kHz is from spectrum analyzer.

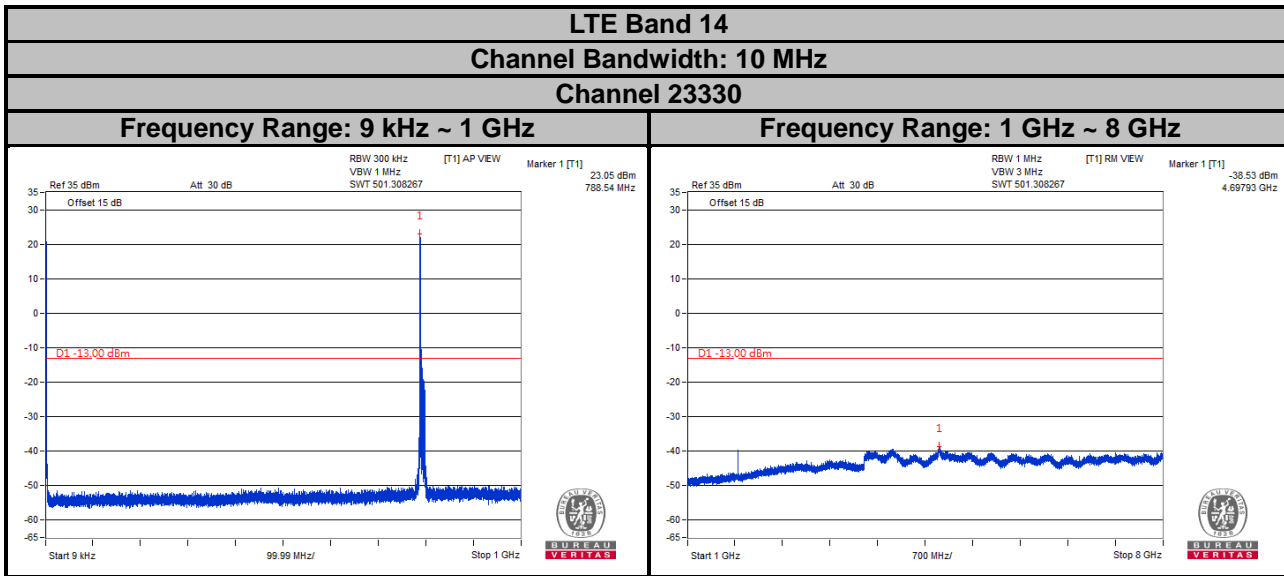

Note: The signal over the limit in 9 kHz is from spectrum analyzer.

**LTE Band 26**  
**Channel Bandwidth: 1.4 MHz**  
**Channel 26697**

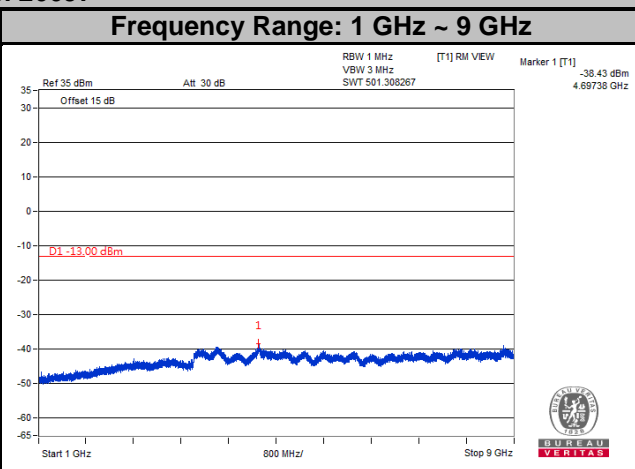
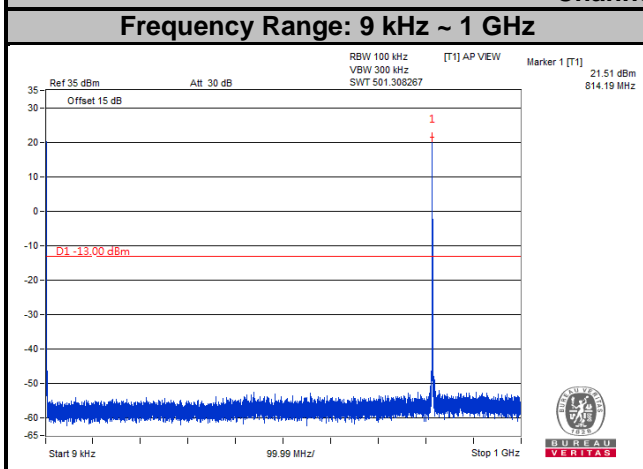

**Channel 26740**

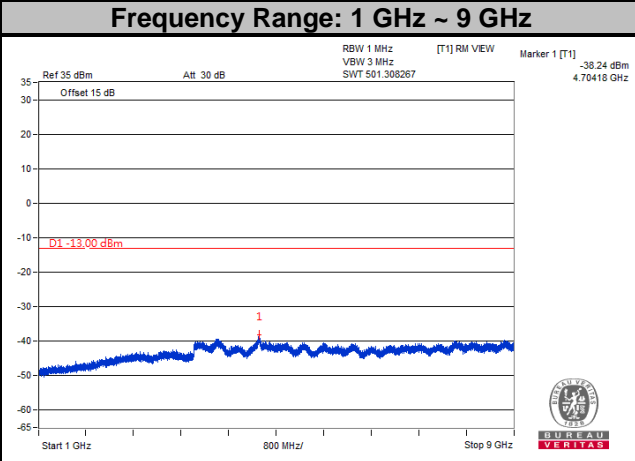
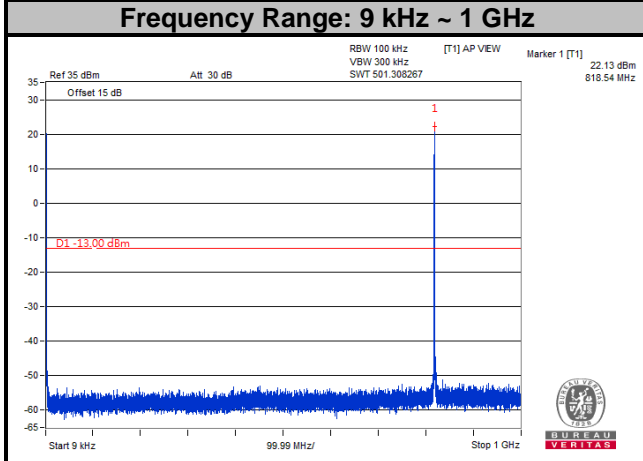

**Channel 26783**

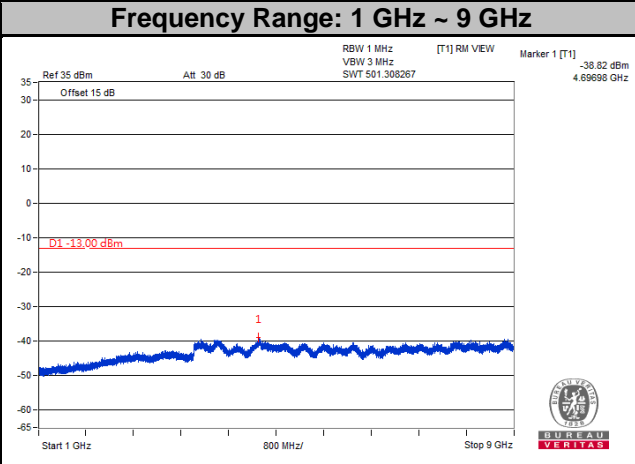
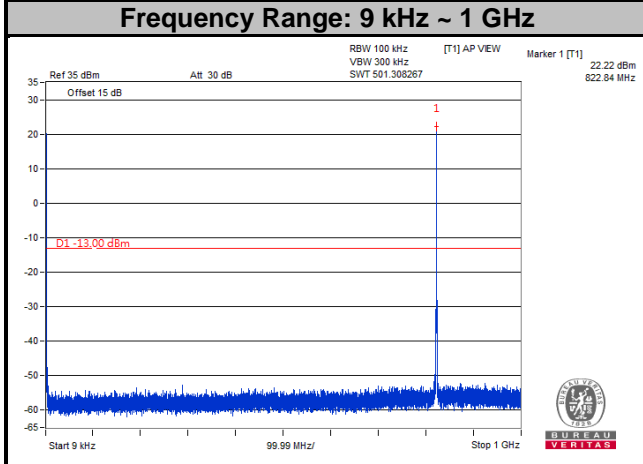

Note: The signal over the limit in 9 kHz is from spectrum analyzer.

**LTE Band 26**  
**Channel Bandwidth: 3 MHz**  
**Channel 26705**

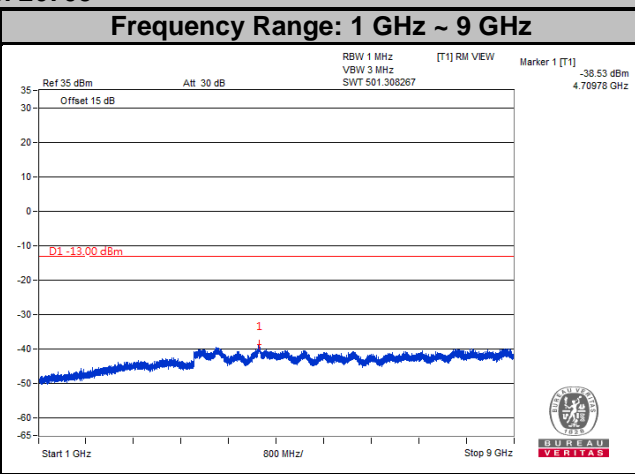
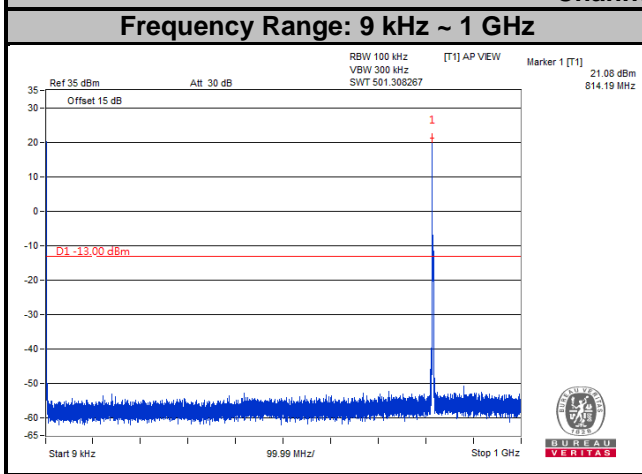

**Channel 26740**

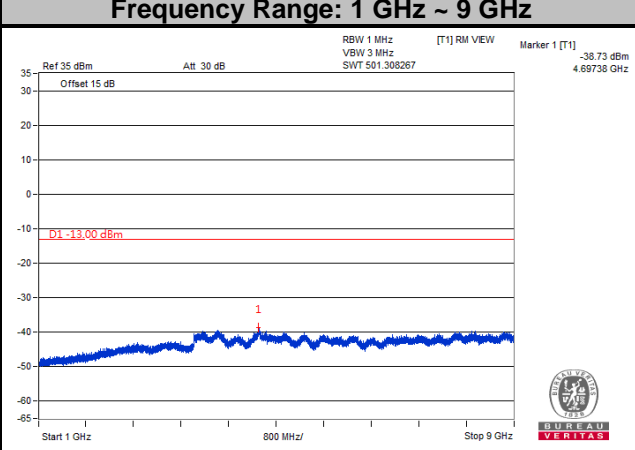
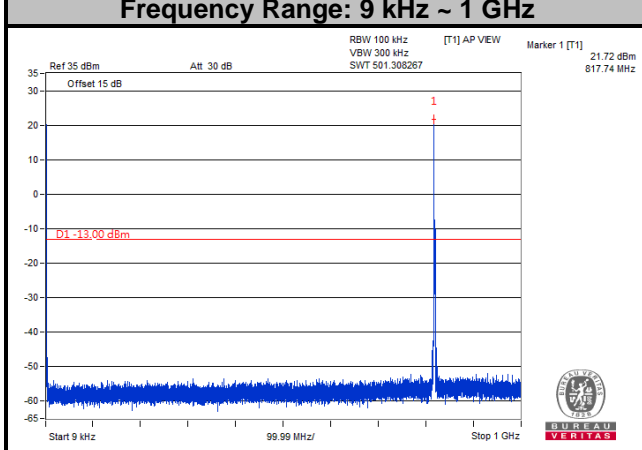

**Channel 26775**

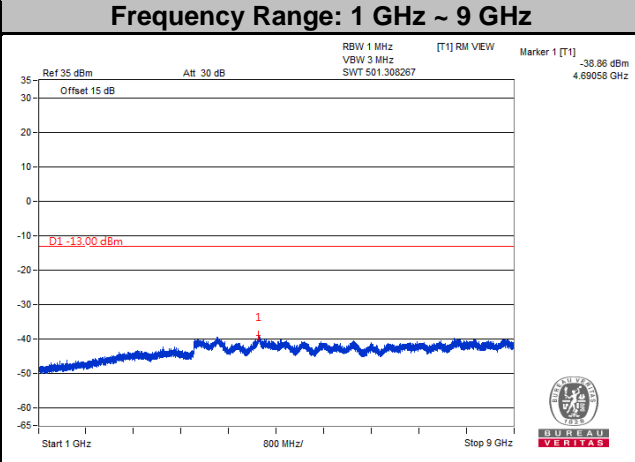
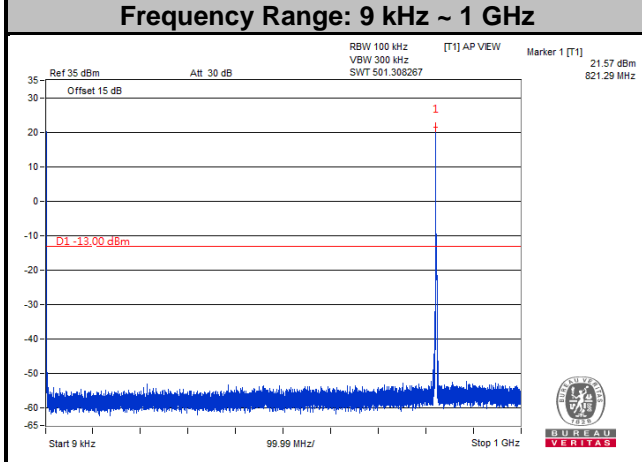

Note: The signal over the limit in 9 kHz is from spectrum analyzer.

**LTE Band 26**  
**Channel Bandwidth: 5 MHz**  
**Channel 26715**

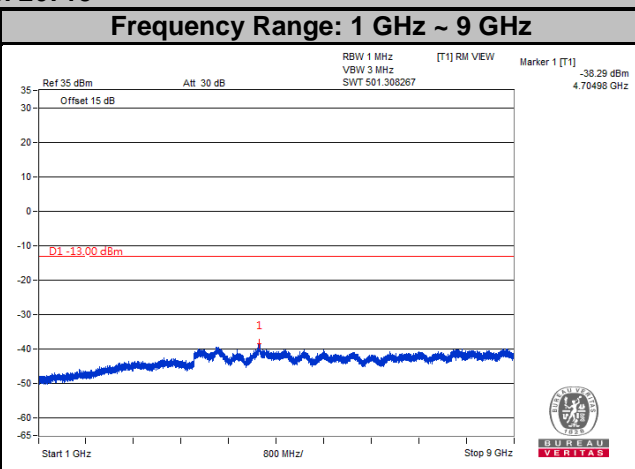
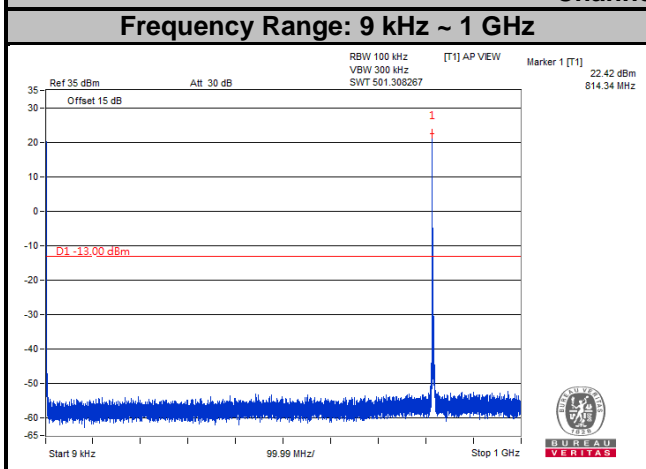

**Channel 26740**

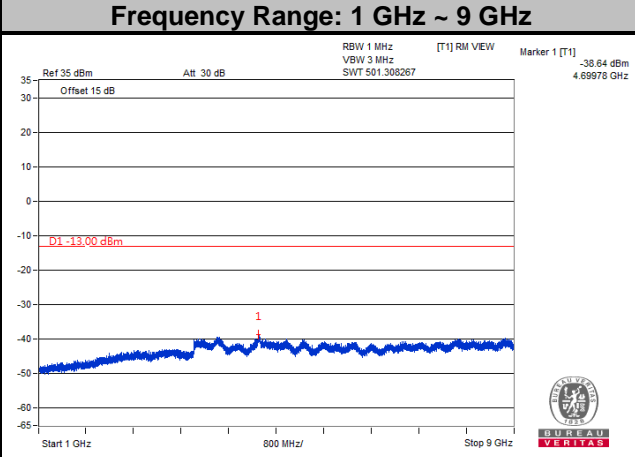
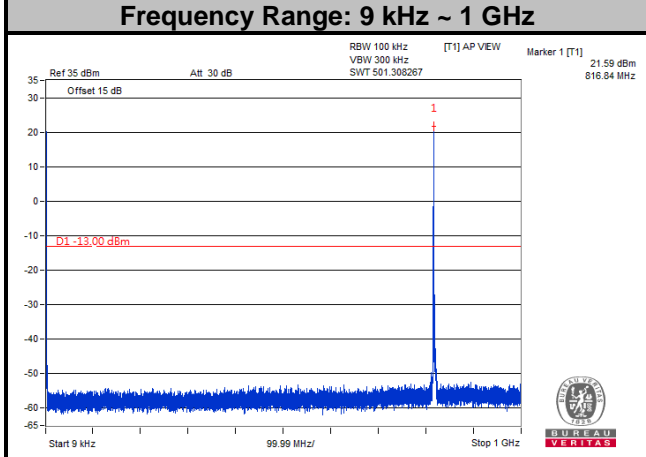

**Channel 26765**

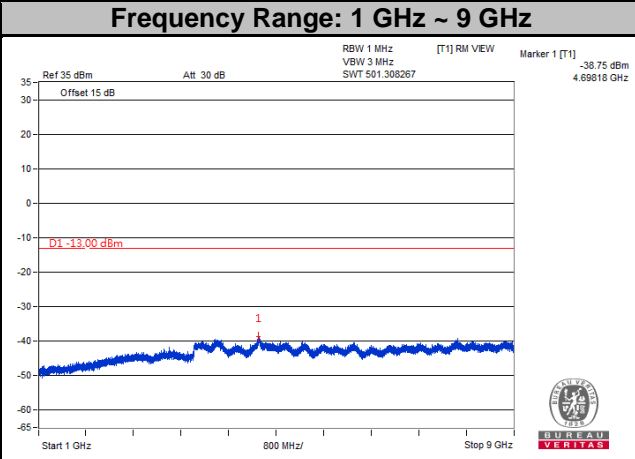
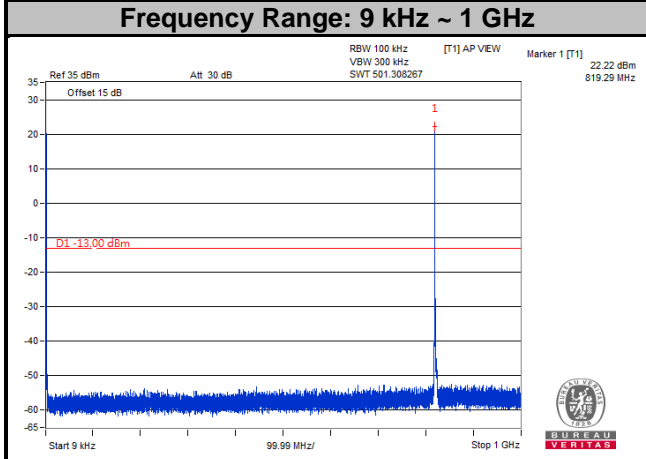

Note: The signal over the limit in 9 kHz is from spectrum analyzer.

LTE Band 26

Channel Bandwidth: 10 MHz

Channel 26740

Frequency Range: 9 kHz ~ 1 GHz

Frequency Range: 1 GHz ~ 9 GHz

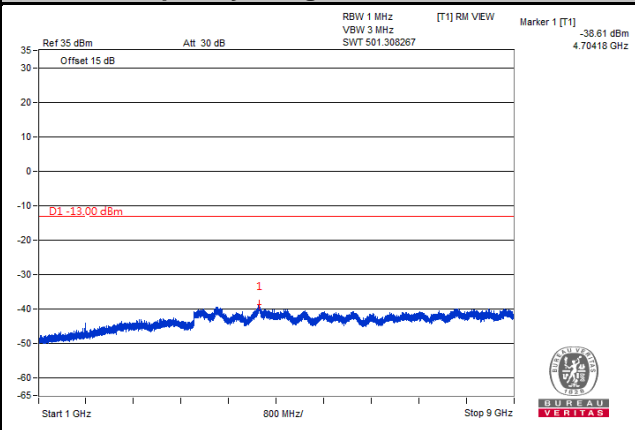
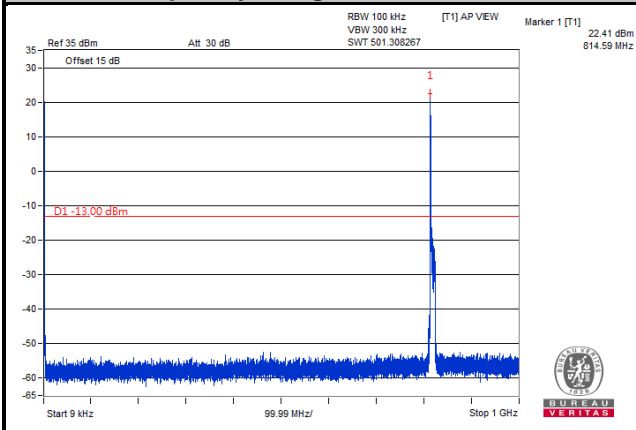

Note: The signal over the limit in 9 kHz is from spectrum analyzer.

## 4.8 Radiated Emission Measurement

### 4.8.1 Limits of Radiated Emission Measurement

- (1) The power of any emission outside a licensee's frequency block shall be attenuated below the transmitter power (P) by at least  $43 + 10 \log (P)$  dB. The limit of emission is equal to -13 dBm.
- (2) For operations in the 758-775 MHz and 788-805 MHz bands, all emissions including harmonics in the band 1559-1610 MHz shall be limited to -70 dBW/MHz equivalent isotropically radiated power (EIRP) for wideband signals, and -80 dBW EIRP for discrete emissions of less than 700 Hz bandwidth.

### 4.8.2 Test Procedure

- a. Substitution method is used for E.I.R.P measurement. In the semi-anechoic chamber, EUT placed on the 0.8 m (below or equal 1 GHz) and/or 1.5 m (above 1 GHz) height of Turn Table, rotated the table around 360 degrees to search the maximum radiation power and receiver antenna shall be rotated vertical and horizontal polarization and moved height from 1 m to 4 m to find the maximum polar radiated power. The "Read Value" is the spectrum reading the maximum power value.
- b. The substitution horn antenna is substituted for EUT at the same position and signals generator export the CW signal to the substitution antenna via a TX cable. Rotated the Turn Table and moved receiving antenna to find the maximum radiation power. Adjust output power level of S.G to get a Value of spectrum reading equal to "Read Value" of step a. Record the power level of S.G.
- c.  $EIRP = \text{Output power level of S.G} - \text{TX cable loss} + \text{Antenna gain of substitution horn}$ .
- d. E.R.P power can be calculated form E.I.R.P power by subtracting the gain of dipole,  $E.R.P \text{ power} = E.I.P.R \text{ power} - 2.15 \text{ dB}$ .

**Note:** The resolution bandwidth of spectrum analyzer is 1 MHz and the video bandwidth is 3 MHz.

### 4.8.3 Deviation from Test Standard

No deviation.



4.8.4 Test Setup

<Radiated Emission below or equal 1 GHz>

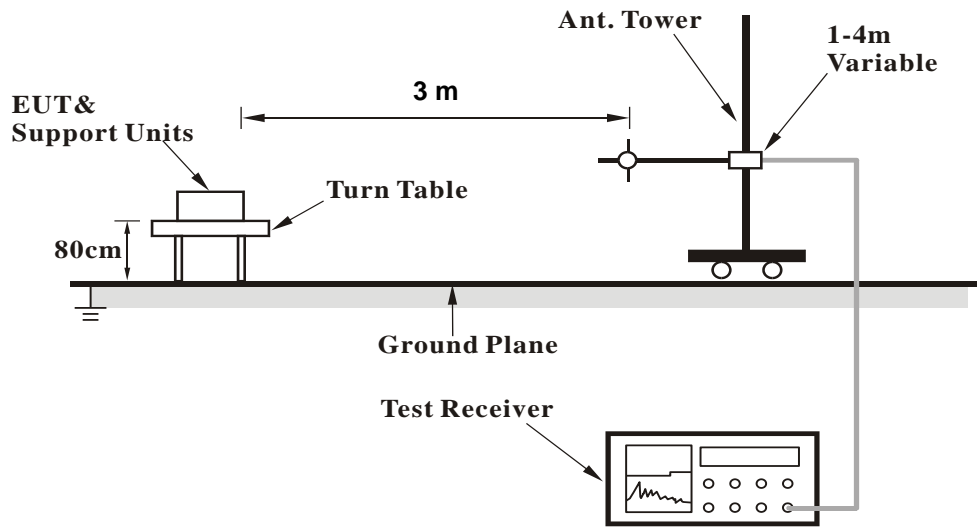

<Radiated Emission above 1 GHz>

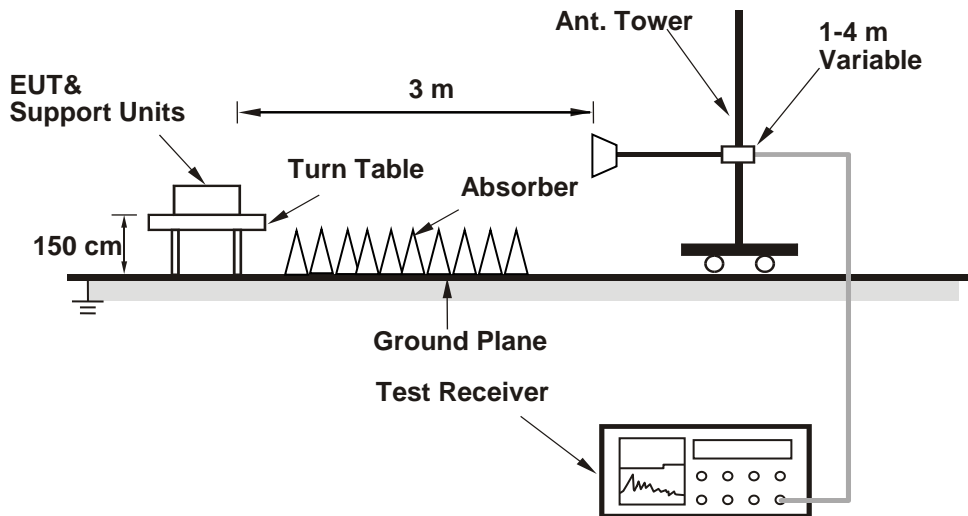

For the actual test configuration, please refer to the attached file (Test Setup Photo).

4.8.5 Test Results

LTE Band 14

Channel Bandwidth: 5 MHz / QPSK

Low Channel



Bureau Veritas Consumer Products Services Ltd., Taoyuan Branch

A D T

Data: 3

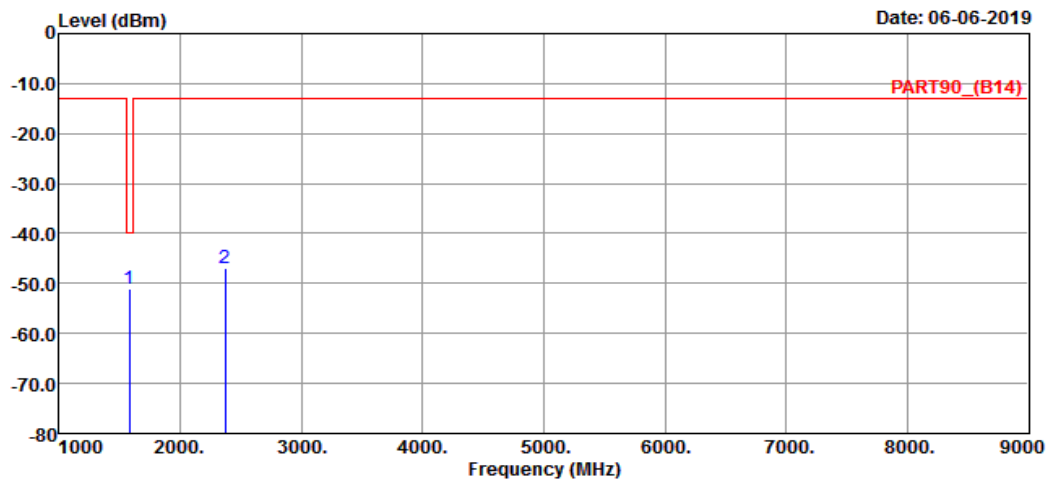

Site : 966 Chamber 5  
 Condition: PART90\_(B14) HORIZONTAL  
 Remak : LTE Band 14 QPSK\_5M Link\_L-CH  
 Tested by: Thomas Wei

	Freq	Level	Read Level	Limit	Line Factor	Over Limit	Remark
	MHz	dBm	dBm	dBm	dB	dB	
1 pp	1581.00	-50.97	-37.59	-40.00	-13.38	-10.97	Peak
2	2371.50	-46.96	-37.33	-13.00	-9.63	-33.96	Peak



Bureau Veritas Consumer Products Services Ltd., Taoyuan Branch

A D T

Data: 4

Date: 06-06-2019

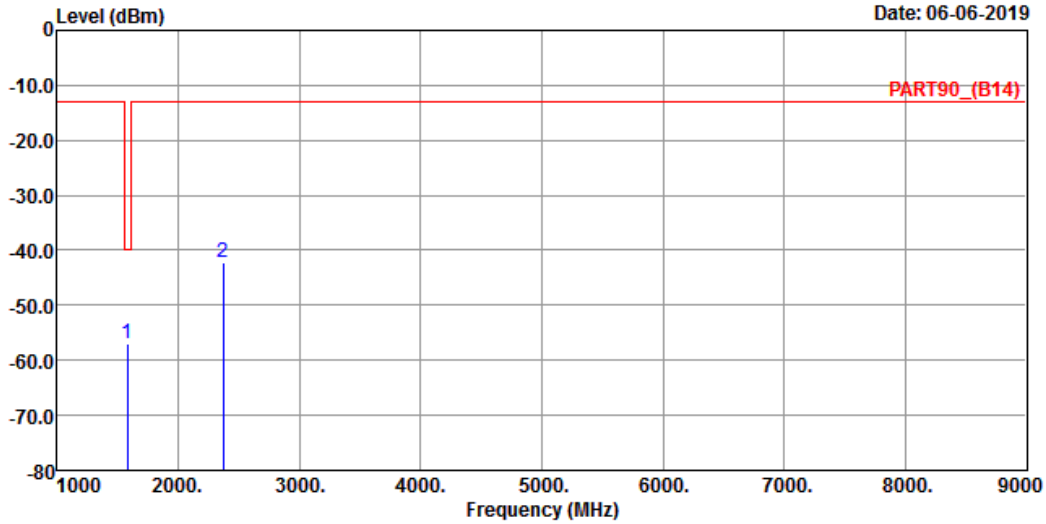

Site : 966 Chamber 5  
 Condition: PART90\_(B14) VERTICAL  
 Remak : LTE Band 14 QPSK\_5M Link\_L-CH  
 Tested by: Thomas Wei

	Freq	Level	Read Level	Limit	Line Factor	Over Limit	Remark
	MHz	dBm	dBm	dBm	dB	dB	
1 pp	1581.00	-56.99	-43.61	-40.00	-13.38	-16.99	Peak
2	2371.50	-42.18	-32.55	-13.00	-9.63	-29.18	Peak



Bureau Veritas Consumer Products Services Ltd., Taoyuan Branch

A D T

Data: 3

Date: 06-06-2019

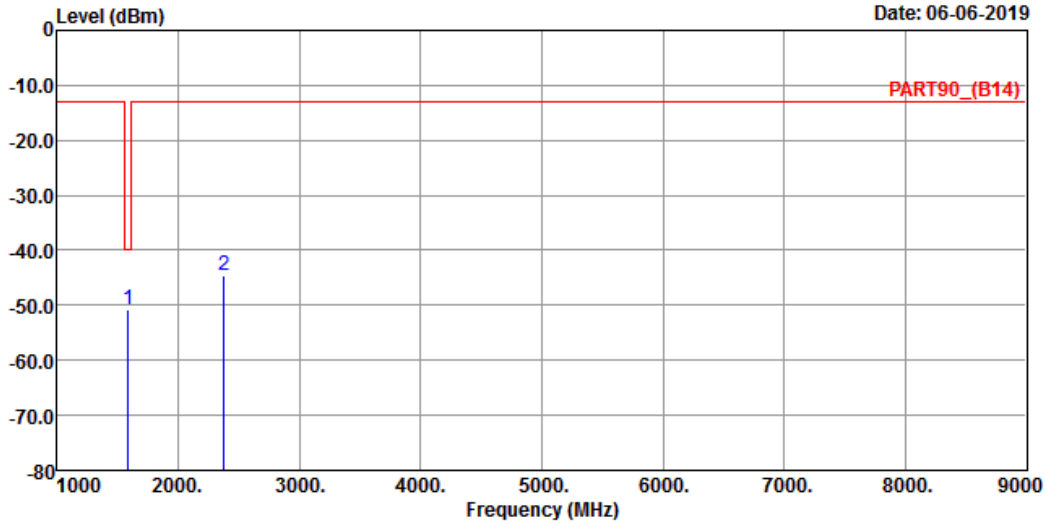

Site : 966 Chamber 5  
 Condition: PART90\_(B14) HORIZONTAL  
 Remak : LTE Band 14 QPSK\_5M Link\_M-CH  
 Tested by: Thomas Wei

	Freq	Level	Read Level	Limit	Line Factor	Over Limit	Remark
	MHz	dBm	dBm	dBm	dB	dB	
1 pp	1586.00	-50.83	-37.44	-40.00	-13.39	-10.83	Peak
2	2379.00	-44.69	-35.00	-13.00	-9.69	-31.69	Peak

Middle Channel



Bureau Veritas Consumer Products Services Ltd., Taoyuan Branch

A D T

Data: 3

Date: 06-06-2019

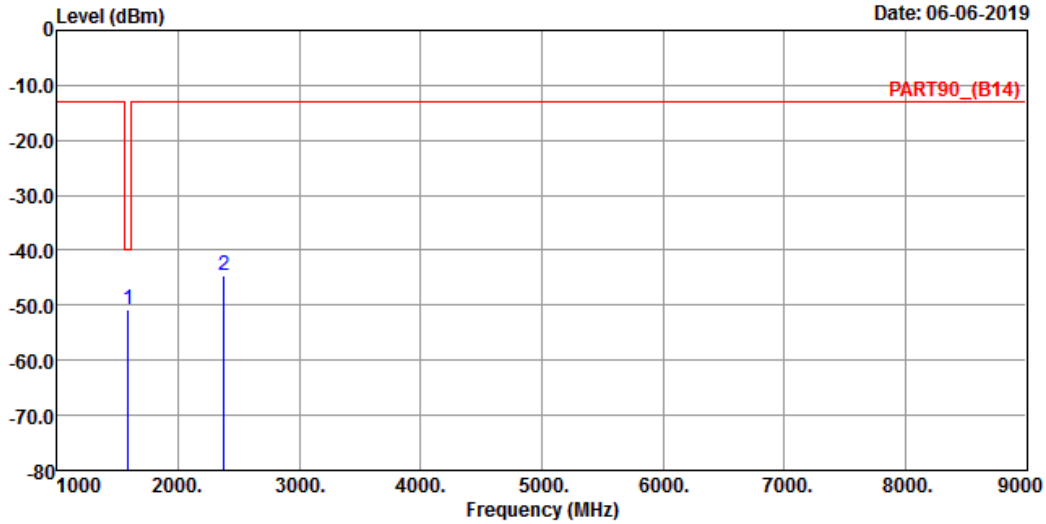

Site : 966 Chamber 5  
 Condition: PART90\_(B14) HORIZONTAL  
 Remak : LTE Band 14 QPSK\_5M Link\_M-CH  
 Tested by: Thomas Wei

	Freq	Level	Read Level	Limit	Line Factor	Over Limit	Remark
	MHz	dBm	dBm	dBm	dB	dB	
1	pp 1586.00	-50.83	-37.44	-40.00	-13.39	-10.83	Peak
2	2379.00	-44.69	-35.00	-13.00	-9.69	-31.69	Peak



Bureau Veritas Consumer Products Services Ltd., Taoyuan Branch

A D T

Data: 4

Date: 06-06-2019

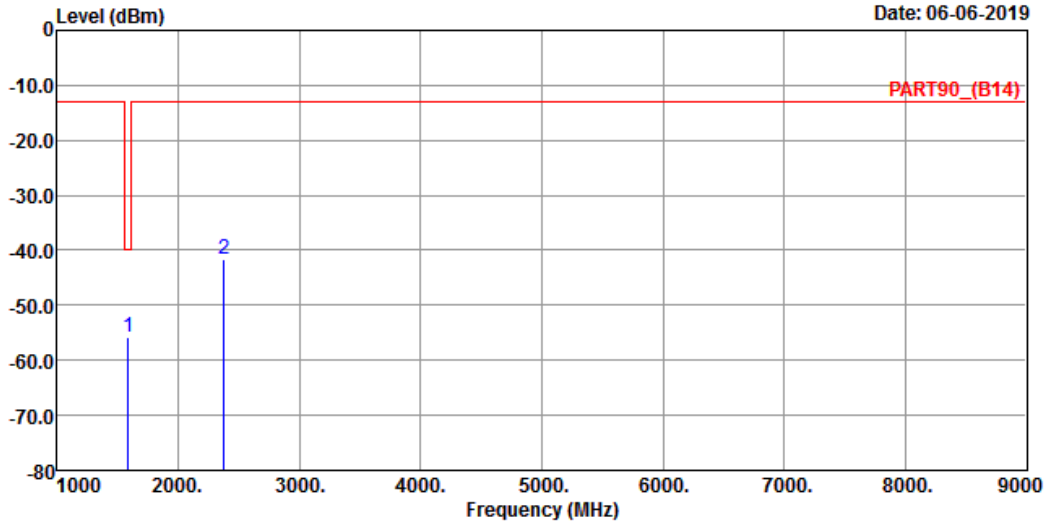

Site : 966 Chamber 5  
 Condition: PART90\_(B14) VERTICAL  
 Remak : LTE Band 14 QPSK\_5M Link\_M-CH  
 Tested by: Thomas Wei

	Freq	Level	Read Level	Limit	Line Factor	Over Limit	Remark
	MHz	dBm	dBm	dBm	dB	dB	
1 pp	1586.00	-55.93	-42.54	-40.00	-13.39	-15.93	Peak
2	2379.00	-41.57	-31.88	-13.00	-9.69	-28.57	Peak

High Channel



Bureau Veritas Consumer Products Services Ltd., Taoyuan Branch

A D T

Data: 3

Date: 06-06-2019

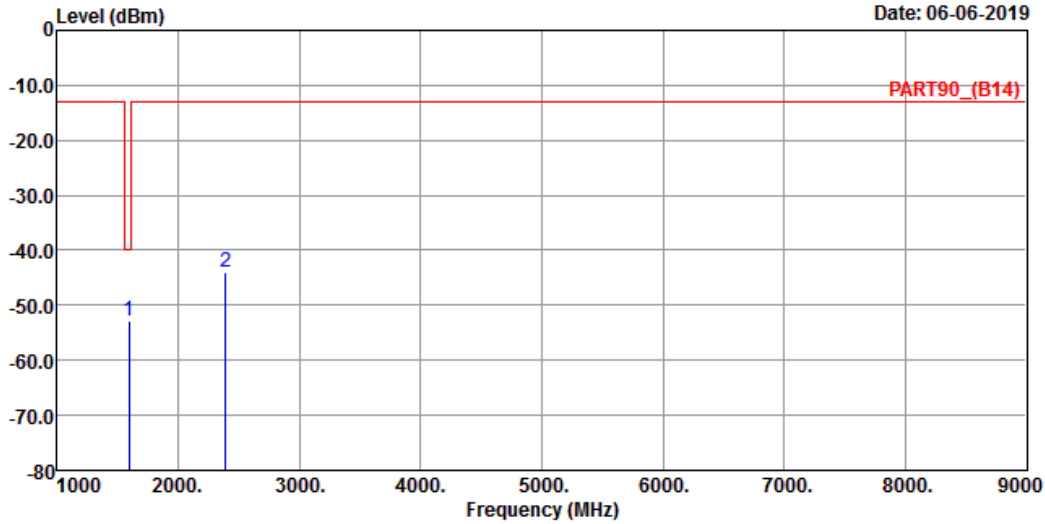

Site : 966 Chamber 5  
 Condition: PART90\_(B14) HORIZONTAL  
 Remak : LTE Band 14 QPSK\_5M Link\_H-CH  
 Tested by: Thomas Wei

	Freq	Level	Read Level	Limit	Line Factor	Over Limit	Remark
	MHz	dBm	dBm	dBm	dB	dB	
1 pp	1591.00	-52.94	-39.53	-40.00	-13.41	-12.94	Peak
2	2386.50	-43.92	-34.17	-13.00	-9.75	-30.92	Peak



Bureau Veritas Consumer Products Services Ltd., Taoyuan Branch

A D T

Data: 4

Date: 06-06-2019

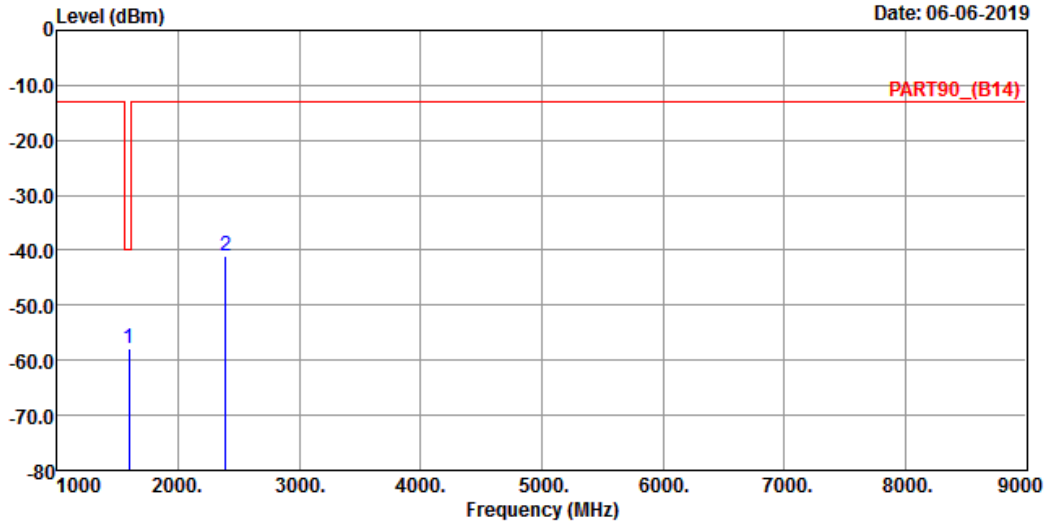

Site : 966 Chamber 5  
 Condition: PART90\_(B14) VERTICAL  
 Remark : LTE Band 14 QPSK\_5M Link\_H-CH  
 Tested by: Thomas Wei

	Freq	Level	Read Level	Limit	Line Factor	Over Limit	Remark
	MHz	dBm	dBm	dBm	dB	dB	
1 pp	1591.00	-57.92	-44.51	-40.00	-13.41	-17.92	Peak
2	2386.50	-41.12	-31.37	-13.00	-9.75	-28.12	Peak



Channel Bandwidth: 10 MHz / QPSK  
Middle Channel



Bureau Veritas Consumer Products Services Ltd., Taoyuan Branch

A D T

Data: 5

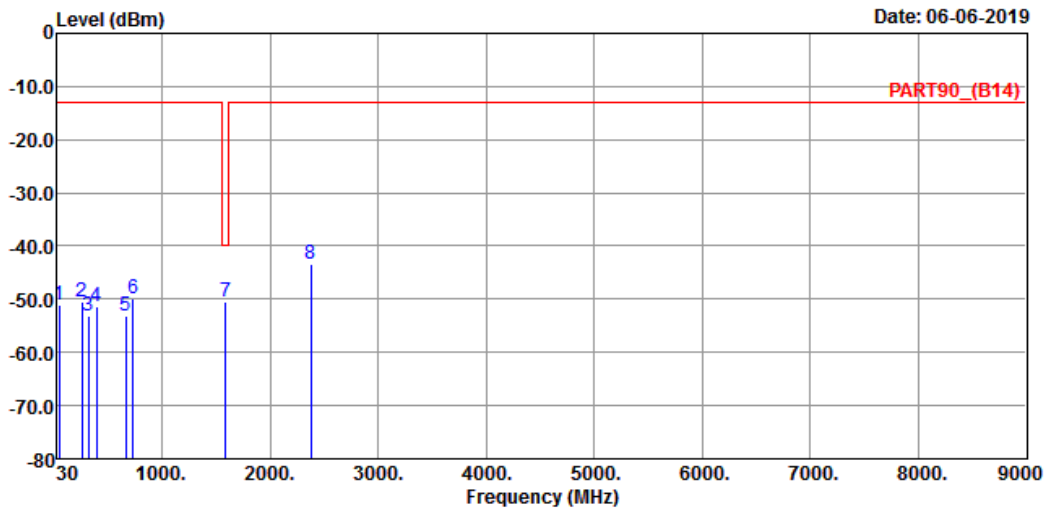

Site : 966 Chamber 5  
Condition: PART90\_(B14) HORIZONTAL  
Remak : LTE Band 14 QPSK\_10M Link\_M-CH  
Tested by: Thomas Wei

	Freq	Level	Read Level	Limit	Line Factor	Over Limit	Remark
	MHz	dBm	dBm	dBm	dB	dB	
1	43.58	-51.13	-49.66	-13.00	-1.47	-38.13	Peak
2	257.95	-50.36	-44.21	-13.00	-6.15	-37.36	Peak
3	314.21	-53.01	-46.22	-13.00	-6.79	-40.01	Peak
4	393.75	-51.47	-45.49	-13.00	-5.98	-38.47	Peak
5	666.32	-53.25	-52.62	-13.00	-0.63	-40.25	Peak
6	732.28	-49.75	-50.28	-13.00	0.53	-36.75	Peak
7 pp	1586.00	-50.43	-37.04	-40.00	-13.39	-10.43	Peak
8	2379.00	-43.30	-33.61	-13.00	-9.69	-30.30	Peak



Bureau Veritas Consumer Products Services Ltd., Taoyuan Branch

A D T

Data: 6

Date: 06-06-2019

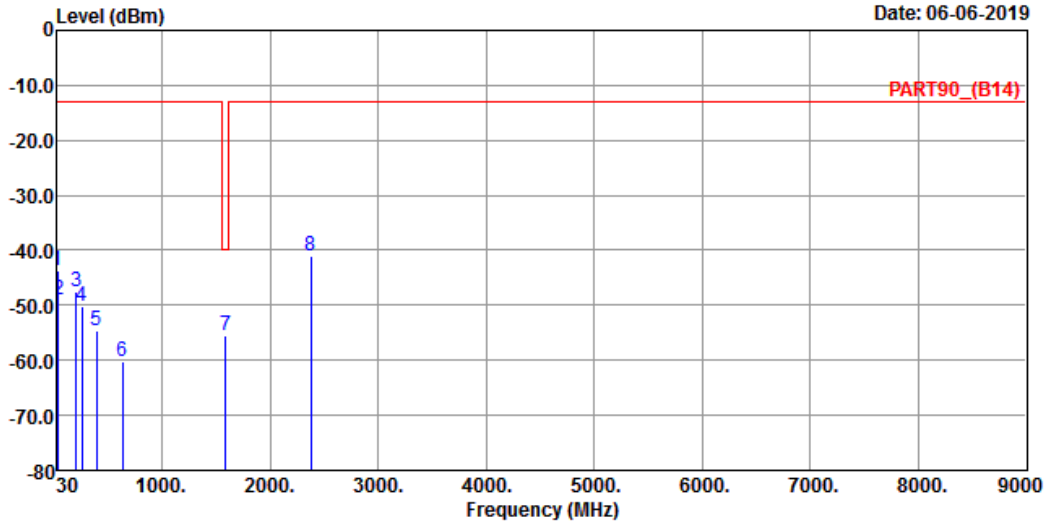

Site : 966 Chamber 5  
 Condition: PART90\_(B14) VERTICAL  
 Remak : LTE Band 14 QPSK\_10M Link\_M-CH  
 Tested by: Thomas Wei

	Freq	Level	Read Level	Limit	Line Factor	Over Limit	Remark
	MHz	dBm	dBm	dBm	dB	dB	
1	31.94	-43.65	-43.05	-13.00	-0.60	-30.65	Peak
2	42.61	-49.04	-48.10	-13.00	-0.94	-36.04	Peak
3	203.63	-47.39	-39.53	-13.00	-7.86	-34.39	Peak
4	260.86	-50.16	-43.95	-13.00	-6.21	-37.16	Peak
5	395.69	-54.47	-48.50	-13.00	-5.97	-41.47	Peak
6	633.34	-60.28	-59.44	-13.00	-0.84	-47.28	Peak
7 pp	1586.00	-55.49	-42.10	-40.00	-13.39	-15.49	Peak
8	2379.00	-41.01	-31.32	-13.00	-9.69	-28.01	Peak



Bureau Veritas Consumer Products Services Ltd., Taoyuan Branch

A D T

Data: 3

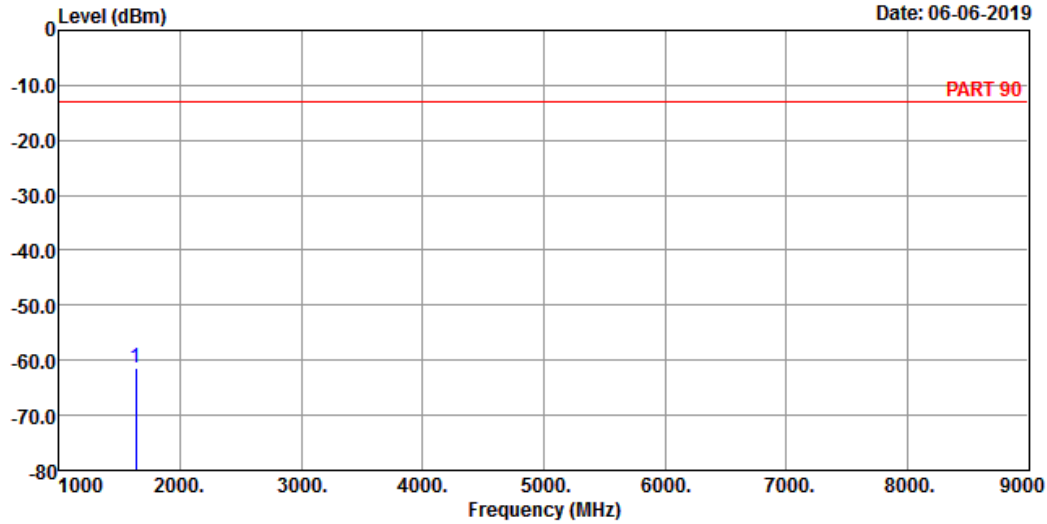

Site : 966 Chamber 5  
 Condition: PART 90 HORIZONTAL  
 Remark : LTE Band 26 QPSK\_1.4M Link\_L-CH  
 Tested by: Getaz Yang

Freq	Level	Read Level	Limit	Line Factor	Over Limit	Remark
MHz	dBm	dBm	dBm	dB	dB	
1 pp 1629.40	-61.34	-46.55	-13.00	-14.79	-48.34	Peak

LTE Band 26  
 Channel Bandwidth: 1.4 MHz / QPSK  
 Low Channel



Bureau Veritas Consumer Products Services Ltd., Taoyuan Branch

A D T

Data: 3

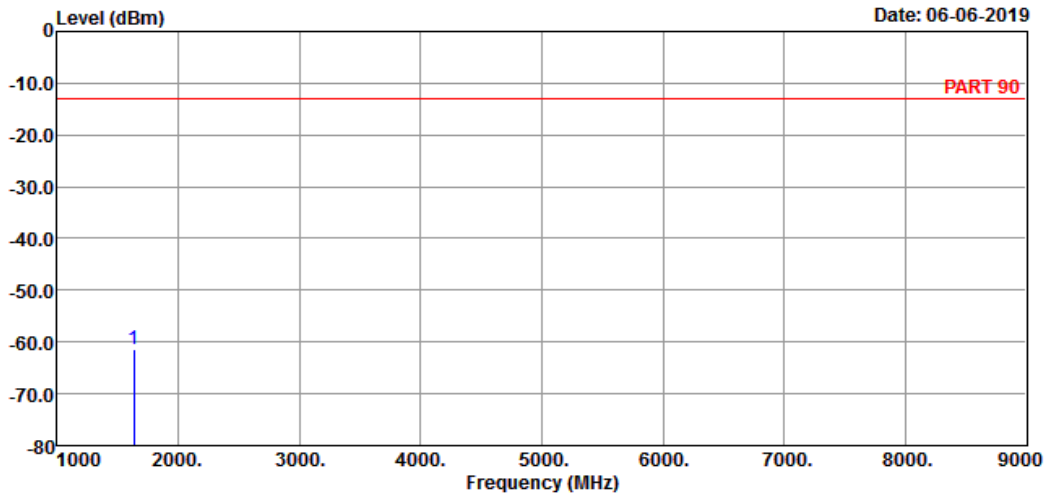

Site : 966 Chamber 5  
 Condition: PART 90 HORIZONTAL  
 Remak : LTE Band 26 QPSK\_1.4M Link\_L-CH  
 Tested by: Getaz Yang

Freq	Level	Read Level	Limit	Over	Remark
MHz	dBm	dBm	dBm	dB	dB
1629.40	-61.34	-46.55	-13.00	-14.79	-48.34 Peak



Bureau Veritas Consumer Products Services Ltd., Taoyuan Branch

A D T

Data: 4

Date: 06-06-2019

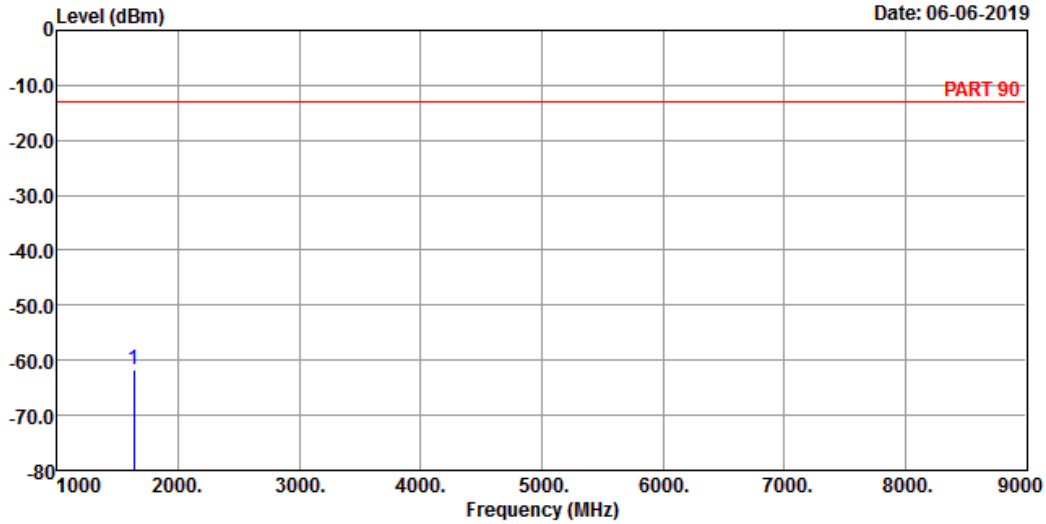

Site : 966 Chamber 5  
 Condition: PART 90 VERTICAL  
 Remark : LTE Band 26 QPSK\_1.4M Link\_L-CH  
 Tested by: Getaz Yang

Freq	Level	Read Level	Limit	Line Factor	Over Limit	Remark
MHz	dBm	dBm	dBm	dB	dB	
1 pp 1629.40	-61.84	-47.05	-13.00	-14.79	-48.84	Peak

Middle Channel



Bureau Veritas Consumer Products Services Ltd., Taoyuan Branch

A D T

Data: 3

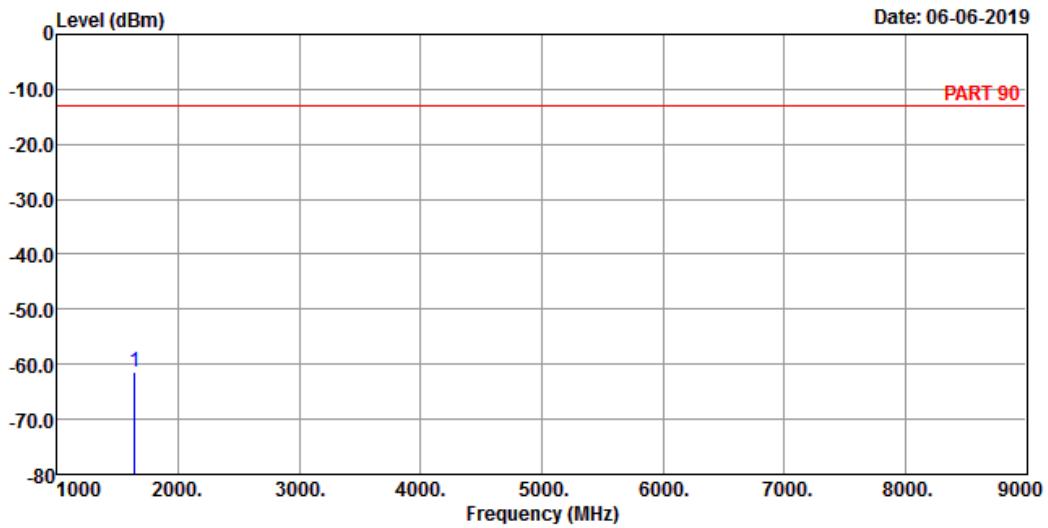

Site : 966 Chamber 5  
 Condition: PART 90 HORIZONTAL  
 Remak : LTE Band 26 QPSK\_1.4M Link\_M-CH  
 Tested by: Getaz Yang

Freq	Level	Read Level	Limit	Over	Remark
MHz	dBm	dBm	dBm	dB	dB

1 pp 1638.00 -61.51 -46.72 -13.00 -14.79 -48.51 Peak



Bureau Veritas Consumer Products Services Ltd., Taoyuan Branch

A D T

Data: 4

Date: 06-06-2019

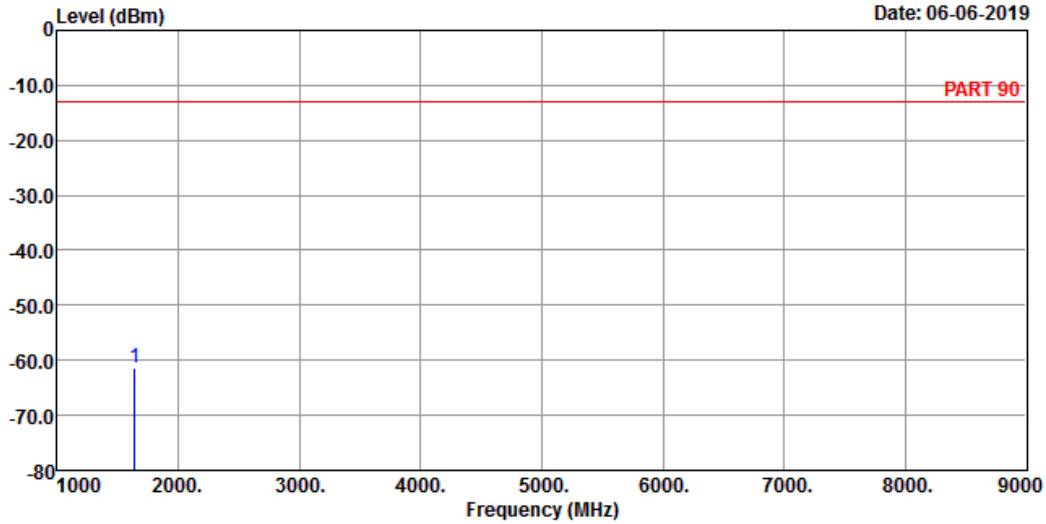

Site : 966 Chamber 5  
 Condition: PART 90 VERTICAL  
 Remak : LTE Band 26 QPSK\_1.4M Link\_M-CH  
 Tested by: Getaz Yang

Freq	Level	Read Level	Limit	Line Factor	Over Limit	Remark
MHz	dBm	dBm	dBm	dB	dB	
1 pp 1638.00	-61.35	-46.56	-13.00	-14.79	-48.35	Peak

High Channel



Bureau Veritas Consumer Products Services Ltd., Taoyuan Branch

A D T

Data: 3

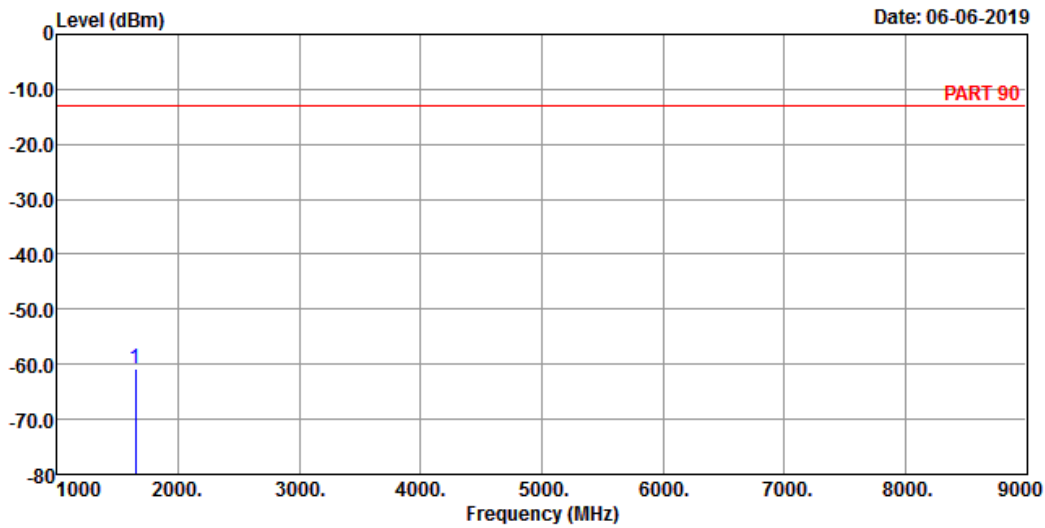

Site : 966 Chamber 5  
 Condition: PART 90 HORIZONTAL  
 Remak : LTE Band 26 QPSK\_1.4M Link\_H-CH  
 Tested by: Getaz Yang

Freq	Level	Read Level	Limit	Over	Remark
MHz	dBm	dBm	dBm	dB	

1 pp 1646.60 -60.71 -45.98 -13.00 -14.73 -47.71 Peak





Bureau Veritas Consumer Products Services Ltd., Taoyuan Branch

A D T

Data: 4

Date: 06-06-2019

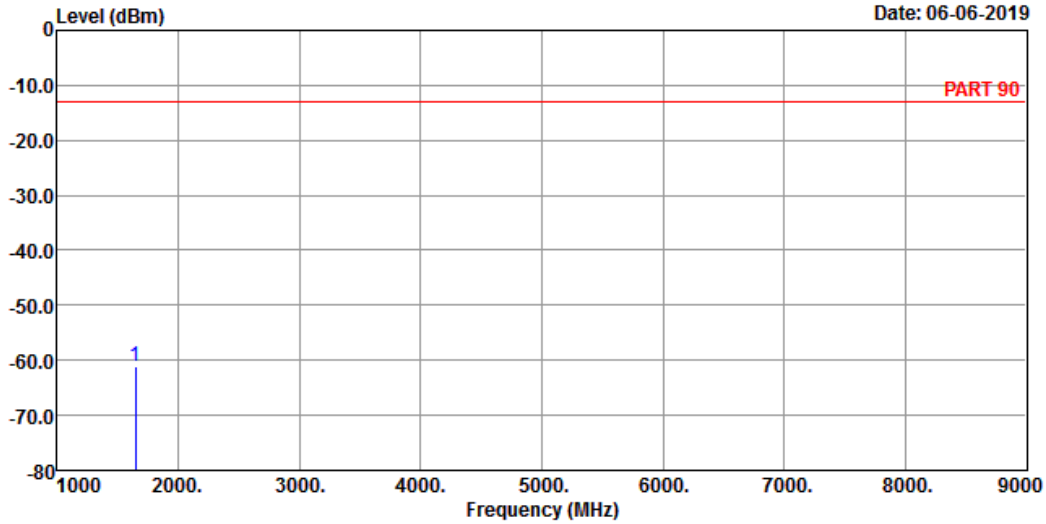

Site : 966 Chamber 5  
 Condition: PART 90 VERTICAL  
 Remark : LTE Band 26 QPSK\_1.4M Link\_H-CH  
 Tested by: Getaz Yang

Freq	Level	Read Level	Limit	Line Factor	Over Limit	Remark
MHz	dBm	dBm	dBm	dB	dB	
1 pp 1646.60	-61.10	-46.37	-13.00	-14.73	-48.10	Peak

Channel Bandwidth: 5 MHz / QPSK  
Low Channel



Bureau Veritas Consumer Products Services Ltd., Taoyuan Branch

A D T

Data: 3

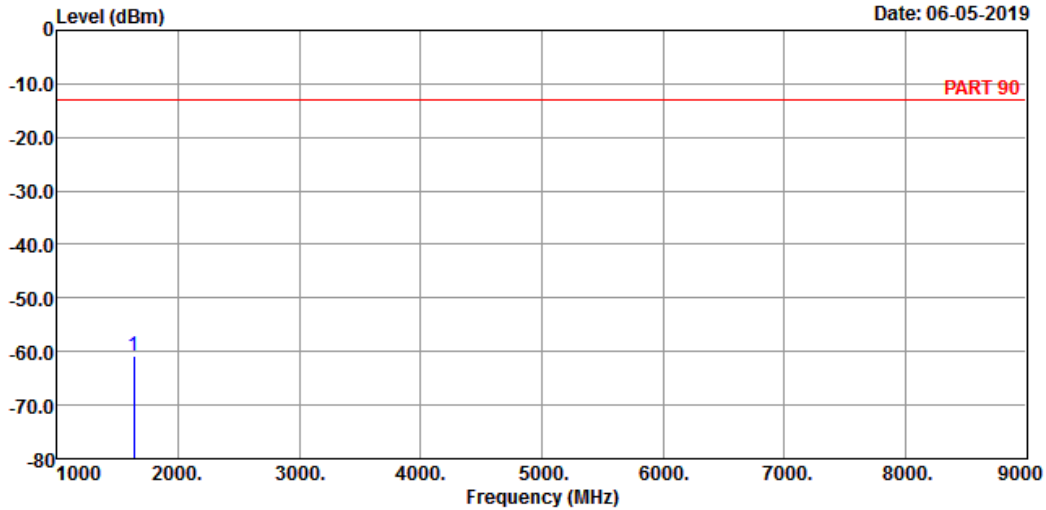

Site : 966 Chamber 5  
Condition: PART 90 HORIZONTAL  
Remak : LTE Band 26 QPSK\_5M Link\_L-CH  
Tested by: Getaz Yang

Freq	Level	Read Level	Limit	Line Factor	Over Limit	Remark
MHz	dBm	dBm	dBm	dB	dB	

1 pp 1633.00 -60.76 -45.97 -13.00 -14.79 -47.76 Peak



Bureau Veritas Consumer Products Services Ltd., Taoyuan Branch

A D T

Data: 4

Date: 06-05-2019

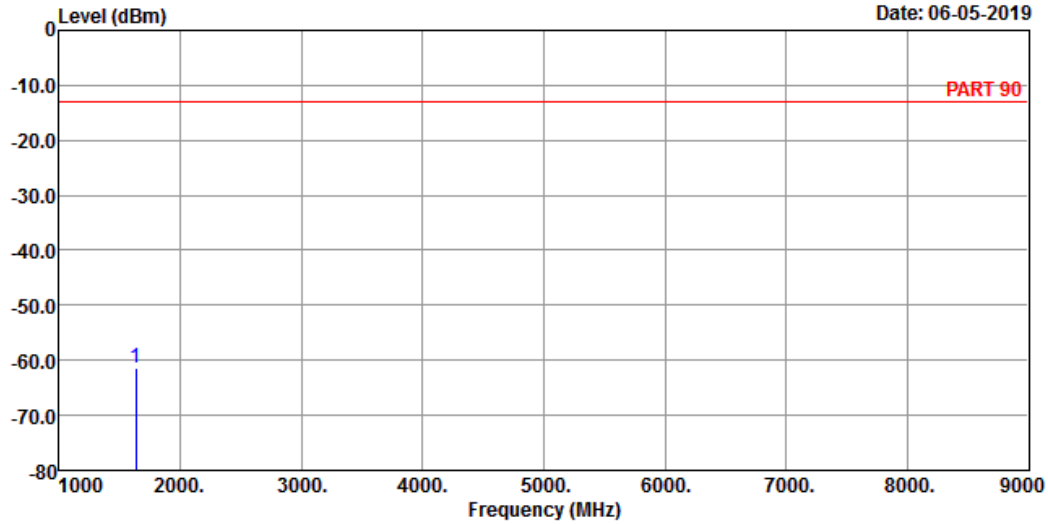

Site : 966 Chamber 5  
 Condition: PART 90 VERTICAL  
 Remak : LTE Band 26 QPSK\_5M Link\_L-CH  
 Tested by: Getaz Yang

Freq	Level	Read Level	Limit	Line Factor	Over Limit	Remark
MHz	dBm	dBm	dBm	dB	dB	
1 pp 1633.00	-61.49	-46.70	-13.00	-14.79	-48.49	Peak

Middle Channel



Bureau Veritas Consumer Products Services Ltd., Taoyuan Branch

A D T

Data: 3

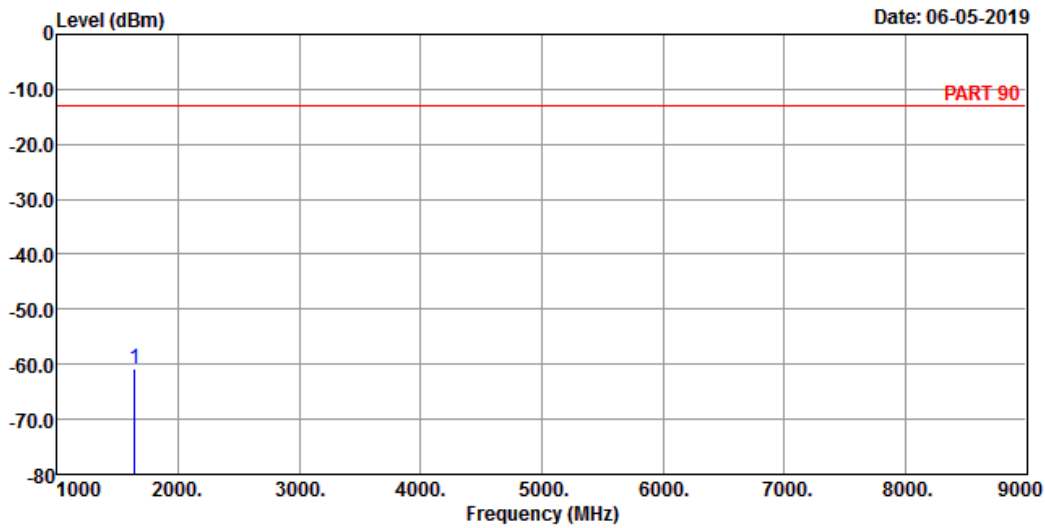

Site : 966 Chamber 5  
 Condition: PART 90 HORIZONTAL  
 Remak : LTE Band 26 QPSK\_5M Link\_M-CH  
 Tested by: Getaz Yang

Freq	Level	Read Level	Limit	Line Factor	Over Limit	Remark
MHz	dBm	dBm	dBm	dB	dB	

1 pp 1638.00 -60.73 -45.94 -13.00 -14.79 -47.73 Peak



Bureau Veritas Consumer Products Services Ltd., Taoyuan Branch

A D T

Data: 4

Date: 06-05-2019

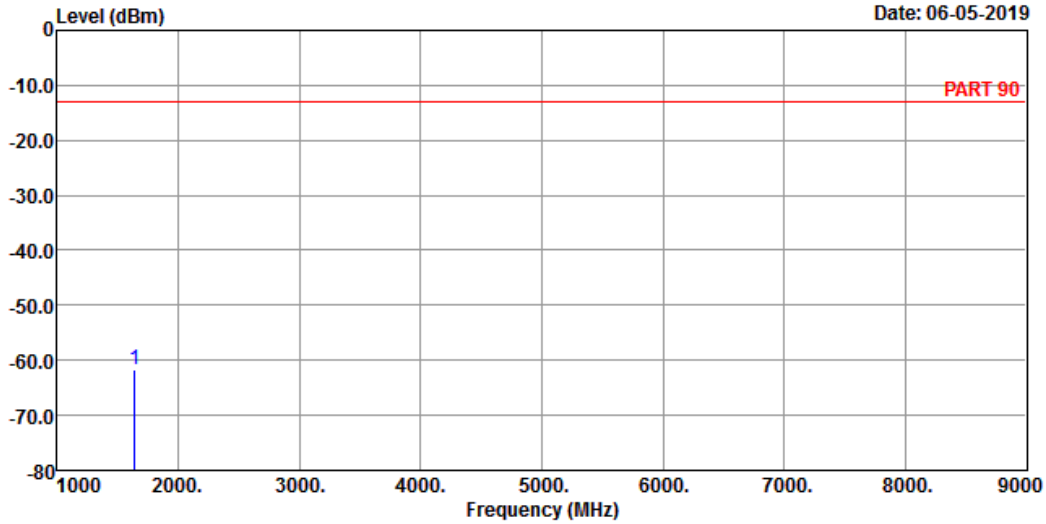

Site : 966 Chamber 5  
 Condition: PART 90 VERTICAL  
 Remak : LTE Band 26 QPSK\_5M Link\_M-CH  
 Tested by: Getaz Yang

Freq	Level	Read Level	Limit	Line Factor	Over Limit	Remark
MHz	dBm	dBm	dBm	dB	dB	
1 pp 1638.00	-61.56	-46.77	-13.00	-14.79	-48.56	Peak

# High Channel



Bureau Veritas Consumer Products Services Ltd., Taoyuan Branch

A D T

Data: 3

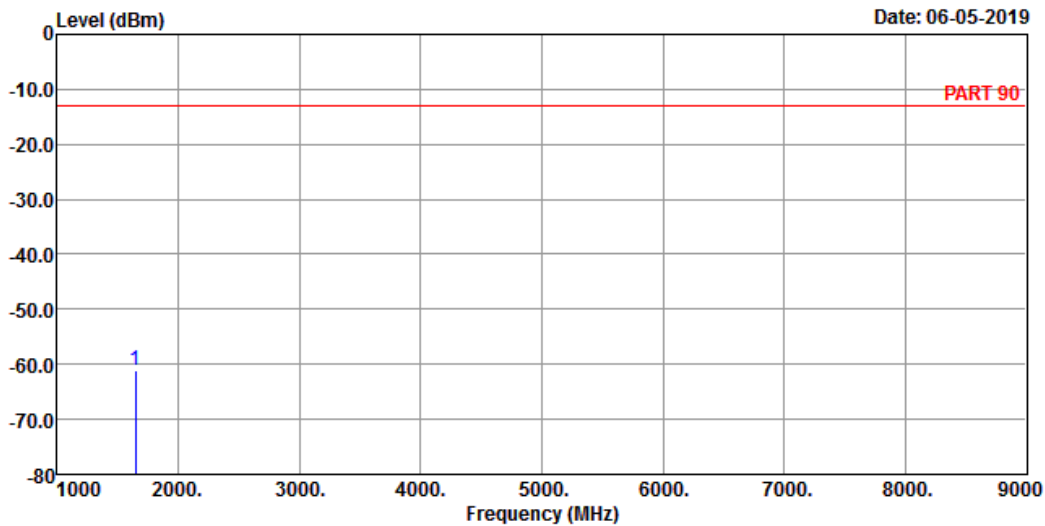

Site : 966 Chamber 5  
 Condition: PART 90 HORIZONTAL  
 Remak : LTE Band 26 QPSK\_5M Link\_H-CH  
 Tested by: Getaz Yang

Freq	Level	Read Level	Limit	Line Factor	Over Limit	Remark
MHz	dBm	dBm	dBm	dB	dB	

1 pp 1643.00 -61.13 -46.40 -13.00 -14.73 -48.13 Peak



Bureau Veritas Consumer Products Services Ltd., Taoyuan Branch

A D T

Data: 4

Date: 06-05-2019

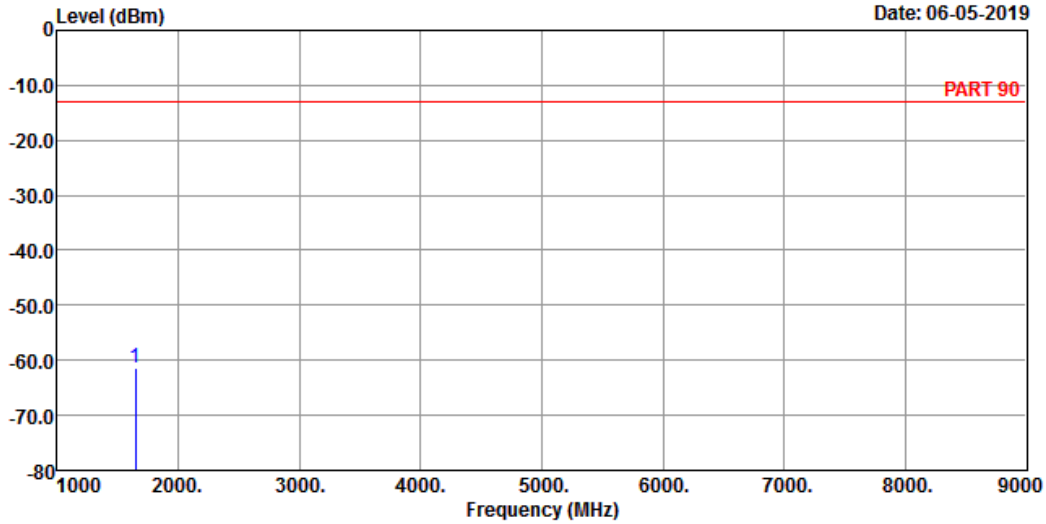

Site : 966 Chamber 5  
 Condition: PART 90 VERTICAL  
 Remak : LTE Band 26 QPSK\_5M Link\_H-CH  
 Tested by: Getaz Yang

Freq	Level	Read Level	Limit	Line Factor	Over Limit	Remark
MHz	dBm	dBm	dBm	dB	dB	
1 pp 1643.00	-61.36	-46.63	-13.00	-14.73	-48.36	Peak

Channel Bandwidth: 10 MHz / QPSK  
Middle Channel



Bureau Veritas Consumer Products Services Ltd., Taoyuan Branch

A D T

Data: 5

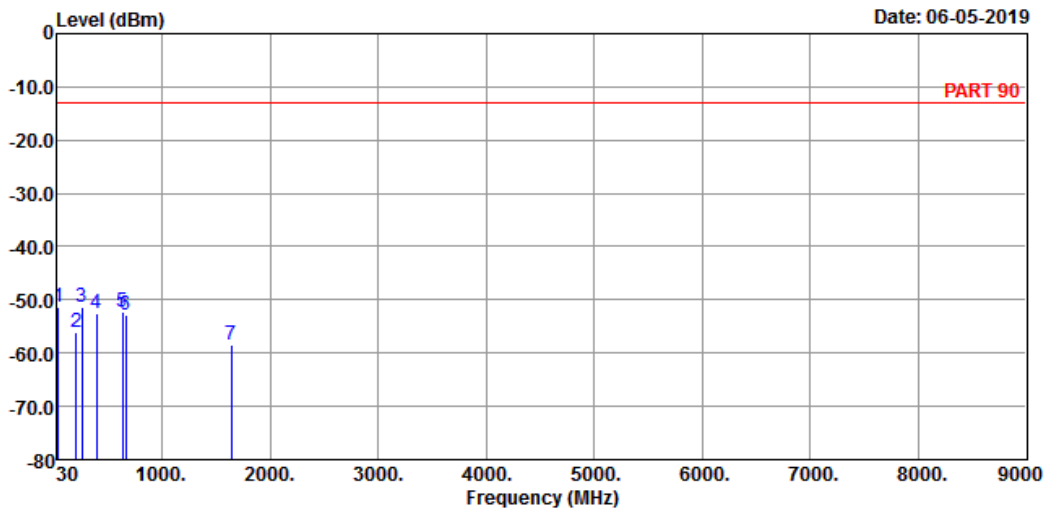

Site : 966 Chamber 5  
Condition: PART 90 HORIZONTAL  
Remak : LTE Band 26 QPSK\_10M Link\_M-CH  
Tested by: Getaz Yang

	Freq	Level	Read Level	Limit	Line Factor	Over Limit	Remark
	MHz	dBm	dBm	dBm	dB	dB	
1	42.61	-51.34	-50.40	-13.00	-0.94	-38.34	Peak
2	203.63	-56.14	-48.28	-13.00	-7.86	-43.14	Peak
3 pp	258.92	-51.27	-45.10	-13.00	-6.17	-38.27	Peak
4	390.84	-52.60	-46.60	-13.00	-6.00	-39.60	Peak
5	630.43	-52.31	-51.48	-13.00	-0.83	-39.31	Peak
6	666.32	-52.75	-52.12	-13.00	-0.63	-39.75	Peak
7	1638.00	-58.36	-43.57	-13.00	-14.79	-45.36	Peak





Bureau Veritas Consumer Products Services Ltd., Taoyuan Branch

A D T

Data: 6

Date: 06-05-2019

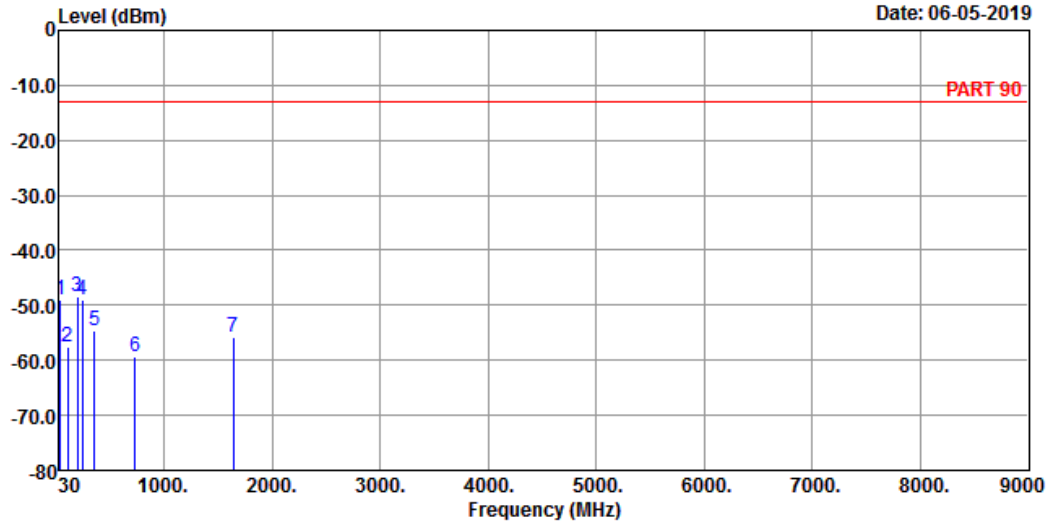

Site : 966 Chamber 5  
 Condition: PART 90 VERTICAL  
 Remak : LTE Band 26 QPSK\_10M Link\_M-CH  
 Tested by: Getaz Yang

	Freq	Level	Read Level	Limit	Line Factor	Over Limit	Remark
	MHz	dBm	dBm	dBm	dB	dB	
1	42.61	-48.86	-47.92	-13.00	-0.94	-35.86	Peak
2	103.72	-57.43	-46.96	-13.00	-10.47	-44.43	Peak
3 pp	195.87	-48.28	-40.63	-13.00	-7.65	-35.28	Peak
4	246.31	-49.03	-42.88	-13.00	-6.15	-36.03	Peak
5	355.92	-54.72	-48.52	-13.00	-6.20	-41.72	Peak
6	733.25	-59.30	-59.85	-13.00	0.55	-46.30	Peak
7	1638.00	-55.68	-40.89	-13.00	-14.79	-42.68	Peak

## 5 Pictures of Test Arrangements

Please refer to the attached file (Test Setup Photo).

## Appendix – Information of the Testing Laboratories

We, Bureau Veritas Consumer Products Services (H.K.) Ltd., Taoyuan Branch, were founded in 1988 to provide our best service in EMC, Radio, Telecom and Safety consultation. Our laboratories are FCC recognized accredited test firms and accredited according to ISO/IEC 17025.

If you have any comments, please feel free to contact us at the following:

**Lin Kou EMC/RF Lab**

Tel: 886-2-26052180

Fax: 886-2-26051924

**Hsin Chu EMC/RF/Telecom Lab**

Tel: 886-3-6668565

Fax: 886-3-6668323

**Hwa Ya EMC/RF/Safety Lab**

Tel: 886-3-3183232

Fax: 886-3-3270892

**Email:** [service.adt@tw.bureauveritas.com](mailto:service.adt@tw.bureauveritas.com)

**Web Site:** [www.bureauveritas-adt.com](http://www.bureauveritas-adt.com)

The address and road map of all our labs can be found in our web site also.

--- END ---