

FCC Test Report

(PART 27)

Report No.: RF190516C01-8

FCC ID: B94HNQ20PK

Test Model: HSN-Q20C

Received Date: May 16, 2019

Test Date: May 25 ~ Jun. 07, 2019

Issued Date: Jun. 26, 2019

Applicant: HP Inc.

Address: 3390 East Harmony Road, Fort Collins, Colorado 80528, United States

Issued By: Bureau Veritas Consumer Products Services (H.K.) Ltd., Taoyuan Branch

Lab Address: No. 47-2, 14th Ling, Chia Pau Vil., Lin Kou Dist., New Taipei City, Taiwan
(R.O.C)

Test Location: No. 19, Hwa Ya 2nd Rd, Wen Hwa Vil, Kwei Shan Dist., Taoyuan City
33383, Taiwan (R.O.C)

**FCC Registration /
Designation Number:** 788550 / TW0003



This report is for your exclusive use. Any copying or replication of this report to or for any other person or entity, or use of our name or trademark, is permitted only with our prior written permission. This report sets forth our findings solely with respect to the test samples identified herein. The results set forth in this report are not indicative or representative of the quality or characteristics of the lot from which a test sample was taken or any similar or identical product unless specifically and expressly noted. Our report includes all of the tests requested by you and the results thereof based upon the information that you provided to us. You have 60 days from date of issuance of this report to notify us of any material error or omission caused by our negligence, provided, however, that such notice shall be in writing and shall specifically address the issue you wish to raise. A failure to raise such issue within the prescribed time shall constitute your unqualified acceptance of the completeness of this report, the tests conducted and the correctness of the report contents. Unless specific mention, the uncertainty of measurement has been explicitly taken into account to declare the compliance or non-compliance to the specification. The report must not be used by the client to claim product certification, approval, or endorsement by TAF or any government agencies

Table of Contents

Release Control Record	4
1 Certificate of Conformity	5
2 Summary of Test Results	6
2.1 Measurement Uncertainty	9
2.2 Test Site and Instruments	10
3 General Information	11
3.1 General Description of EUT	11
3.2 Configuration of System under Test	13
3.2.1 Description of Support Units	13
3.3 Test Mode Applicability and Tested Channel Detail	14
3.4 EUT Operating Conditions	22
3.5 General Description of Applied Standards	22
4 Test Types and Results	23
4.1 Output Power Measurement	23
4.1.1 Limits of Output Power Measurement	23
4.1.2 Test Procedures	23
4.1.3 Test Setup	24
4.1.4 Test Results	25
4.2 Modulation Characteristics Measurement	49
4.2.1 Limits of Modulation Characteristics	49
4.2.2 Test Setup	49
4.2.3 Test Procedure	49
4.2.4 Test Results	50
4.3 Frequency Stability Measurement	55
4.3.1 Limits of Frequency Stability Measurement	55
4.3.2 Test Procedure	55
4.3.3 Test Setup	55
4.3.4 Test Results	56
4.4 Occupied Bandwidth Measurement	77
4.4.1 Limits of Occupied Bandwidth Measurement	77
4.4.2 Test Procedure	77
4.4.3 Test Setup	77
4.4.4 Test Result	78
4.5 Band Edge Measurement	89
4.5.1 Limits of Band Edge Measurement	89
4.5.2 Test Setup	89
4.5.3 Test Procedures	89
4.5.4 Test Results	90
4.6 Peak to Average Ratio	112
4.6.1 Limits of Peak to Average Ratio Measurement	112
4.6.2 Test Setup	112
4.6.3 Test Procedures	112
4.6.4 Test Results	112
4.7 Conducted Spurious Emissions	123
4.7.1 Limits of Conducted Spurious Emissions Measurement	123
4.7.2 Test Setup	123
4.7.3 Test Procedure	123
4.7.4 Test Results	124
4.8 Radiated Emission Measurement	147
4.8.1 Limits of Radiated Emission Measurement	147
4.8.2 Test Procedure	147
4.8.3 Deviation from Test Standard	147
4.8.4 Test Setup	148

4.8.5 Test Results	149
5 Pictures of Test Arrangements.....	229
Appendix – Information of the Testing Laboratories	230

Release Control Record

Issue No.	Description	Date Issued
RF190516C01-8	Original Release	Jun. 26, 2019

1 Certificate of Conformity

Product: Notebook Computer

Brand: HP

Test Model: HSN-Q20C

Sample Status: Engineering Sample

Applicant: HP Inc.

Test Date: May 25 ~ Jun. 07, 2019

Standards: FCC Part 27, Subpart C, H, F, L

The above equipment has been tested by **Bureau Veritas Consumer Products Services (H.K.) Ltd., Taoyuan Branch**, and found compliance with the requirement of the above standards. The test record, data evaluation & Equipment Under Test (EUT) configurations represented herein are true and accurate accounts of the measurements of the sample's RF characteristics under the conditions specified in this report.

Prepared by : Gina Liu, **Date:** Jun. 26, 2019
Gina Liu / Specialist

Approved by : Dylan Chiou, **Date:** Jun. 26, 2019
Dylan Chiou / Project Engineer

2 Summary of Test Results

Applied Standard: FCC Part 27 & Part 2 (WCDMA)			
FCC Clause	Test Item	Result	Remarks
2.1046 27.50(d)(4)	Equivalent Isotropic Radiated Power	Pass	Meet the requirement of limit.
2.1047	Modulation Characteristics	Pass	Meet the requirement.
2.1055 27.54	Frequency Stability	Pass	Meet the requirement of limit.
2.1049	Occupied Bandwidth	Pass	Meet the requirement of limit.
27.50(d)(5)	Peak to Average Ratio	Pass	Meet the requirement of limit.
27.53(h)	Band Edge Measurements	Pass	Meet the requirement of limit.
2.1051 27.53(h)	Conducted Spurious Emissions	Pass	Meet the requirement of limit.
2.1053 27.53(h)	Radiated Spurious Emissions	Pass	Meet the requirement of limit. Minimum passing margin is -30.69 dB at 30.00 MHz.

Applied Standard: FCC Part 27 & Part 2 (LTE 4)			
FCC Clause	Test Item	Result	Remarks
2.1046 27.50(d)(4)	Maximum Peak Output Power	Pass	Meet the requirement of limit.
2.1047	Modulation Characteristics	Pass	Meet the requirement.
2.1055 27.54	Frequency Stability	Pass	Meet the requirement of limit.
2.1049	Occupied Bandwidth	Pass	Meet the requirement of limit.
27.50(d)(5)	Peak to Average Ratio	Pass	Meet the requirement of limit.
27.53(h)	Band Edge Measurements	Pass	Meet the requirement of limit.
2.1051 27.53(h)	Conducted Spurious Emissions	Pass	Meet the requirement of limit.
2.1053 27.53(h)	Radiated Spurious Emissions	Pass	Meet the requirement of limit. Minimum passing margin is -31.13 dB at 30.00 MHz.

Applied Standard: FCC Part 27 & Part 2 (LTE 12)			
FCC Clause	Test Item	Result	Remarks
2.1046 27.50(c)(10)	Maximum Peak Output Power	Pass	Meet the requirement of limit.
2.1047	Modulation Characteristics	Pass	Meet the requirement.
2.1055 27.54	Frequency Stability	Pass	Meet the requirement of limit.
2.1049	Occupied Bandwidth	Pass	Meet the requirement of limit.
---	Peak to Average Ratio	Pass	Meet the requirement of limit.
27.53(g)	Band Edge Measurements	Pass	Meet the requirement of limit.
2.1051 27.53(g)	Conducted Spurious Emissions	Pass	Meet the requirement of limit.
2.1053 27.53(g)	Radiated Spurious Emissions	Pass	Meet the requirement of limit. Minimum passing margin is -19.84 dB at 2122.50 MHz.

Applied Standard: FCC Part 27 & Part 2 (LTE 13)			
FCC Clause	Test Item	Result	Remarks
2.1046 27.50(b)(10)	Maximum Peak Output Power	Pass	Meet the requirement of limit.
2.1047	Modulation Characteristics	Pass	Meet the requirement.
2.1055 27.54	Frequency Stability	Pass	Meet the requirement of limit.
2.1049	Occupied Bandwidth	Pass	Meet the requirement of limit.
---	Peak to Average Ratio	Pass	Meet the requirement of limit.
27.53(c)(2)(4)	Band Edge Measurements	Pass	Meet the requirement of limit.
2.1051 27.53(c)(2)&(f)	Conducted Spurious Emissions	Pass	Meet the requirement of limit.
2.1053 27.53(c)(2)&(f)	Radiated Spurious Emissions	Pass	Meet the requirement of limit. Minimum passing margin is -18.35 dB at 1564 MHz.

Applied Standard: FCC Part 27 & Part 2 (LTE 17)			
FCC Clause	Test Item	Result	Remarks
2.1046 27.50(c)(10)	Maximum Peak Output Power	Pass	Meet the requirement of limit.
2.1047	Modulation Characteristics	Pass	Meet the requirement.
2.1055 27.54	Frequency Stability	Pass	Meet the requirement of limit.
2.1049	Occupied Bandwidth	Pass	Meet the requirement of limit.
---	Peak to Average Ratio	Pass	Meet the requirement of limit.
27.53(g)	Band Edge Measurements	Pass	Meet the requirement of limit.
2.1051 27.53(g)	Conducted Spurious Emissions	Pass	Meet the requirement of limit.
2.1053 27.53(g)	Radiated Spurious Emissions	Pass	Meet the requirement of limit. Minimum passing margin is -29.03 dB at 2133 MHz.

Applied Standard: FCC Part 27 & Part 2 (LTE 66)			
FCC Clause	Test Item	Result	Remarks
2.1046 27.50(d)(4)	Maximum Peak Output Power	Pass	Meet the requirement of limit.
2.1047	Modulation Characteristics	Pass	Meet the requirement.
2.1055 27.54	Frequency Stability	Pass	Meet the requirement of limit.
2.1049	Occupied Bandwidth	Pass	Meet the requirement of limit.
27.50(d)(5)	Peak to Average Ratio	Pass	Meet the requirement of limit.
27.53(h)	Band Edge Measurements	Pass	Meet the requirement of limit.
2.1051 27.53(h)	Conducted Spurious Emissions	Pass	Meet the requirement of limit.
2.1053 27.53(h)	Radiated Spurious Emissions	Pass	Meet the requirement of limit. Minimum passing margin is -34.08 dB at 43.58 MHz.

Note: Determining compliance based on the results of the compliance measurement, not taking into account measurement instrumentation uncertainty.

2.1 Measurement Uncertainty

Where relevant, the following measurement uncertainty levels have been estimated for tests performed on the EUT as specified in CISPR 16-4-2:

Measurement	Frequency	Expanded Uncertainty (k=2) (±)
Radiated Emissions up to 1 GHz	9 kHz ~ 30 MHz	3.04 dB
	30 MHz ~ 200 MHz	2.93 dB
	200 MHz ~ 1000 MHz	2.95 dB
Radiated Emissions above 1 GHz	1 GHz ~ 18 GHz	2.26 dB
	18 GHz ~ 40 GHz	1.94 dB

2.2 Test Site and Instruments

Description & Manufacturer	Model No.	Serial No.	Date of Calibration	Due Date of Calibration
Test Receiver Agilent	N9038A	MY51210203	Mar. 18, 2019	Mar. 17, 2020
Spectrum Analyzer Agilent	N9010A	MY52220314	Dec. 13, 2018	Dec. 12, 2019
Spectrum Analyzer ROHDE & SCHWARZ	FSU43	101261	Apr. 15, 2019	Apr. 14, 2020
HORN Antenna SCHWARZBECK	BBHA 9120 D	9120D-969	Nov. 25, 2018	Nov. 24, 2019
BILOG Antenna SCHWARZBECK	VULB9168	9168-472	Nov. 23, 2018	Nov. 22, 2019
Double Ridge Guide Horn Antenna EMCO	3115	5619	Nov. 25, 2018	Nov. 24, 2019
BILOG Antenna SCHWARZBECK	VULB 9168	9168-153	Nov. 23, 2018	Nov. 22, 2019
Fixed Attenuator WORKEN	MDCS18N-10	MDCS18N-10-01	Apr. 15, 2019	Apr. 14, 2020
MXG Vector signal generator Agilent	N5182B	MY53050430	Nov. 19, 2018	Nov. 18, 2019
Preamplifier EMCI	EMC 012645	980115	Oct. 12, 2018	Oct. 11, 2019
Preamplifier EMCI	EMC 330H	980112	Oct. 12, 2018	Oct. 11, 2019
RF Coaxial Cable HUBER+SUHNNER	EMC104-SM-SM-800 0&3000	140811+170717	Oct. 12, 2018	Oct. 11, 2019
RF Coaxial Cable HUBER+SUHNNER	SUCOFLEX 104	EMC104-SM-SM-1 000(140807)	Oct. 12, 2018	Oct. 11, 2019
RF Coaxial Cable WOKEN	8D-FB	Cable-Ch10-01	Oct. 12, 2018	Oct. 11, 2019
Boresight Antenna Fixture	FBA-01	FBA-SIP01	NA	NA
Software BV ADT	E3 6.120103	NA	NA	NA
Antenna Tower MF	MFA-440H	NA	NA	NA
Turn Table MF	MFT-201SS	NA	NA	NA
Antenna Tower & Turn Table Controller MF	MF-7802	NA	NA	NA
Radio Communication Analyzer Anritsu	MT8821C	6261806803	Jan. 22, 2019	Jan. 21, 2020
Radio Communication Analyzer Anritsu	MT8820C	6201300640	Aug. 16, 2017	Aug. 15, 2019
Temperature & Humidity Chamber	GTH-120-40-CP-AR	MAA1306-019	Sep. 05, 2018	Sep. 04, 2019
DC Power Supply Topward	33010D	807748	NA	NA

- Note: 1. The calibration interval of the above test instruments is 12 / 24 months and the calibrations are traceable to NML/ROC and NIST/USA.
2. The test was performed in HwaYa Chamber 10.

3 General Information

3.1 General Description of EUT

Product	Notebook Computer	
Brand	HP	
Test Model	HSN-Q20C	
Status of EUT	Engineering Sample	
Power Supply Rating	5 or 9 or 12 or 15 or 20 Vdc (Adapter)	
Modulation Type	WCDMA	QPSK
	LTE	QPSK, 16QAM, 64QAM
Frequency Range	WCDMA	1712.4 ~ 1752.6 MHz
	LTE Band 4 (Channel Bandwidth: 1.4 MHz)	1710.7 ~ 1754.3 MHz
	LTE Band 4 (Channel Bandwidth: 3 MHz)	1711.5 ~ 1753.5 MHz
	LTE Band 4 (Channel Bandwidth: 5 MHz)	1712.5 ~ 1752.5 MHz
	LTE Band 4 (Channel Bandwidth: 10 MHz)	1715.0 ~ 1750.0 MHz
	LTE Band 4 (Channel Bandwidth: 15 MHz)	1717.5 ~ 1747.5 MHz
	LTE Band 4 (Channel Bandwidth: 20 MHz)	1720.0 ~ 1745.0 MHz
	LTE Band 12 (Channel Bandwidth: 1.4 MHz)	699.7 ~ 715.3 MHz
	LTE Band 12 (Channel Bandwidth: 3 MHz)	700.5 ~ 714.5 MHz
	LTE Band 12 (Channel Bandwidth: 5 MHz)	701.5 ~ 713.5 MHz
	LTE Band 12 (Channel Bandwidth: 10 MHz)	704.0 ~ 711.0 MHz
	LTE Band 13 (Channel Bandwidth: 5 MHz)	779.5 ~ 784.5 MHz
	LTE Band 13 (Channel Bandwidth: 10 MHz)	782.0 MHz
	LTE Band 17 (Channel Bandwidth: 5 MHz)	706.5 ~ 713.5 MHz
	LTE Band 17 (Channel Bandwidth: 10 MHz)	709.0 ~ 711.0 MHz
	LTE Band 66 (Channel Bandwidth: 1.4 MHz)	1710.7 ~ 1779.3 MHz
	LTE Band 66 (Channel Bandwidth: 3 MHz)	1711.5 ~ 1778.5 MHz
	LTE Band 66 (Channel Bandwidth: 5 MHz)	1712.5 ~ 1777.5 MHz
	LTE Band 66 (Channel Bandwidth: 10 MHz)	1715.0 ~ 1775.0 MHz
	LTE Band 66 (Channel Bandwidth: 15 MHz)	1717.5 ~ 1772.5 MHz
LTE Band 66 (Channel Bandwidth: 20 MHz)	1720.0 ~ 1770.0 MHz	
Emission Designator	WCDMA	4M08F9W
	LTE Band 4 (Channel Bandwidth: 1.4 MHz)	1M09G7D
	LTE Band 4 (Channel Bandwidth: 3 MHz)	2M71G7D
	LTE Band 4 (Channel Bandwidth: 5 MHz)	4M50G7D
	LTE Band 4 (Channel Bandwidth: 10 MHz)	8M99D7W
	LTE Band 4 (Channel Bandwidth: 15 MHz)	13M5G7D
	LTE Band 4 (Channel Bandwidth: 20 MHz)	18M0G7D
	LTE Band 12 (Channel Bandwidth: 1.4 MHz)	1M09D7W
	LTE Band 12 (Channel Bandwidth: 3 MHz)	2M70G7D
	LTE Band 12 (Channel Bandwidth: 5 MHz)	4M50G7D
	LTE Band 12 (Channel Bandwidth: 10 MHz)	9M01G7D
	LTE Band 13 (Channel Bandwidth: 5 MHz)	4M51D7W
	LTE Band 13 (Channel Bandwidth: 10 MHz)	8M95D7W
	LTE Band 17 (Channel Bandwidth: 5 MHz)	4M51G7D

	LTE Band 17 (Channel Bandwidth: 10 MHz)	9M00D7W
	LTE Band 66 (Channel Bandwidth: 1.4 MHz)	1M10D7W
	LTE Band 66 (Channel Bandwidth: 3 MHz)	2M71G7D
	LTE Band 66 (Channel Bandwidth: 5 MHz)	4M50D7W
	LTE Band 66 (Channel Bandwidth: 10 MHz)	9M00D7W
	LTE Band 66 (Channel Bandwidth: 15 MHz)	13M5D7W
	LTE Band 66 (Channel Bandwidth: 20 MHz)	18M0G7D
Max. ERP Power	LTE Band 12 (Channel Bandwidth: 1.4 MHz)	27.99 mW
	LTE Band 12 (Channel Bandwidth: 3 MHz)	29.44 mW
	LTE Band 12 (Channel Bandwidth: 5 MHz)	31.77 mW
	LTE Band 12 (Channel Bandwidth: 10 MHz)	33.27 mW
	LTE Band 13 (Channel Bandwidth: 5 MHz)	37.50 mW
	LTE Band 13 (Channel Bandwidth: 10 MHz)	39.54 mW
	LTE Band 17 (Channel Bandwidth: 5 MHz)	32.43 mW
LTE Band 17 (Channel Bandwidth: 10 MHz)	34.04 mW	
Max. EIRP Power	WCDMA	56.49 mW
	LTE Band 4 (Channel Bandwidth: 1.4 MHz)	40.36 mW
	LTE Band 4 (Channel Bandwidth: 3 MHz)	42.46 mW
	LTE Band 4 (Channel Bandwidth: 5 MHz)	46.03 mW
	LTE Band 4 (Channel Bandwidth: 10 MHz)	49.09 mW
	LTE Band 4 (Channel Bandwidth: 15 MHz)	51.52 mW
	LTE Band 4 (Channel Bandwidth: 20 MHz)	54.58 mW
	LTE Band 66 (Channel Bandwidth: 1.4 MHz)	48.19 mW
	LTE Band 66 (Channel Bandwidth: 3 MHz)	51.17 mW
	LTE Band 66 (Channel Bandwidth: 5 MHz)	54.08 mW
	LTE Band 66 (Channel Bandwidth: 10 MHz)	57.28 mW
	LTE Band 66 (Channel Bandwidth: 15 MHz)	60.53 mW
LTE Band 66 (Channel Bandwidth: 20 MHz)	63.83 mW	
Antenna Type	Couple Antenna	
Antenna Gain	WCDMA	-5.43 dBi
	LTE Band 4	-5.43 dBi
	LTE Band 12	-5.21 dBi
	LTE Band 13	-4.32 dBi
	LTE Band 17	-5.21 dBi
	LTE Band 66	-5.43 dBi
Accessory Device	Refer to Note as below	
Data Cable Supplied	N/A	

Note:

1. The WWAN module (Brand: Fibocom, Model: L860-GL) was installed in the EUT.
2. The EUT contains following accessory devices.

Product	Brand	Model	Description
Adapter	hp	TPN-TA02	I/P: 100-240 Vac, 50-60 Hz, 1.6 A O/P: 5 Vdc, 3 A or 9 Vdc, 3 A or 12 Vdc, 5 A or 15 Vdc, 4.33 A or 20 Vdc, 3.25 A

3. The above EUT information is declared by manufacturer and for more detailed features description, please refers to the manufacturer's specifications or user's manual.

3.2 Configuration of System under Test

<Radiated Emission Test>

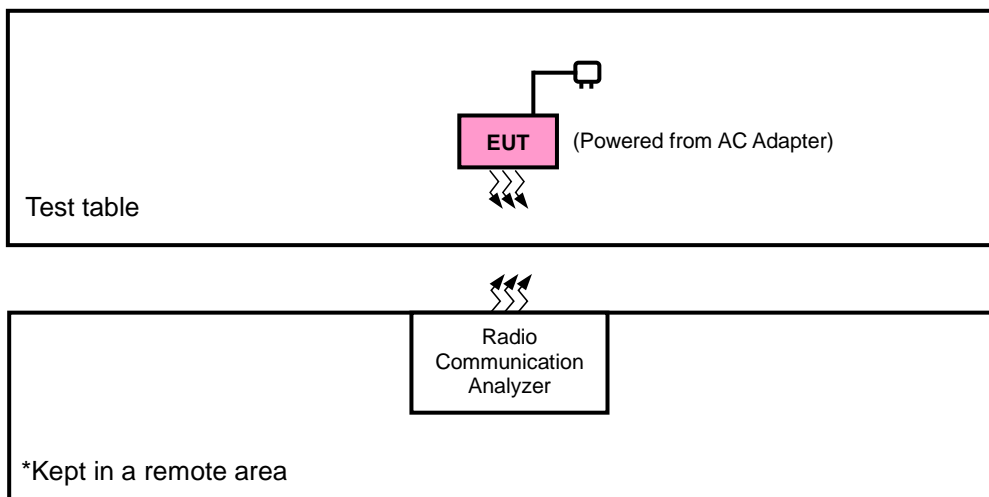

<E.R.P. / E.I.R.P. Test>

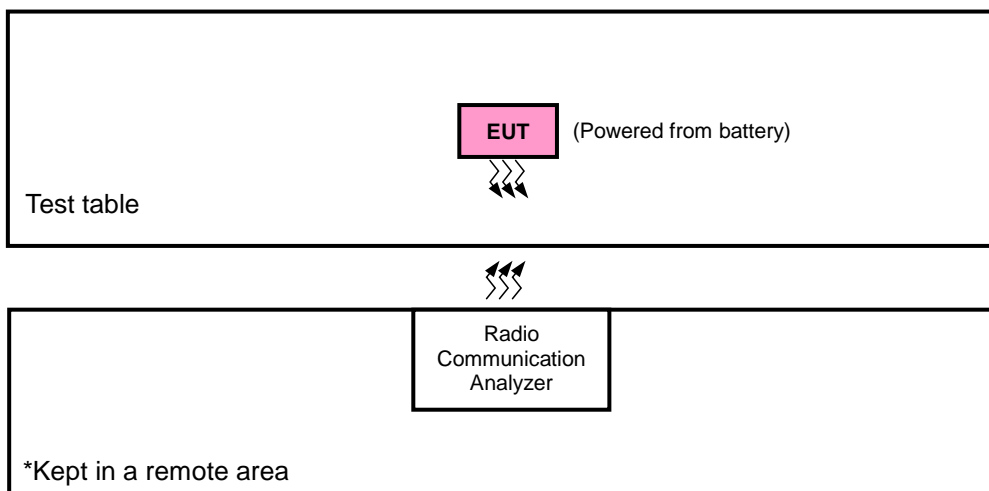

3.2.1 Description of Support Units

The EUT has been tested as an independent unit together with other necessary accessories or support units.

3.3 Test Mode Applicability and Tested Channel Detail

Pre-Scan has been conducted to determine the worst-case mode from all possible combinations between available modulations, data rates, XYZ axis and NB mode, and antenna ports

The worst case was found when positioned as the table below. Following channel(s) was (were) selected for the final test as listed below:

Band	ERP / EIRP	Radiated Emission
WCDMA	NB mode	Z-axis
LTE Band 4	NB mode	Z-axis
LTE Band 12	NB mode	NB mode
LTE Band 13	NB mode	X-axis
LTE Band 17	NB mode	NB mode
LTE Band 66	NB mode	Z-axis

WCDMA

EUT Configure Mode	Test Item	Available Channel	Tested Channel	Mode
-	EIRP	1312 to 1513	1312, 1413, 1513	WCDMA
-	Modulation Characteristics	1312 to 1513	1413	WCDMA
-	Frequency Stability	1312 to 1513	1312, 1513	WCDMA
-	Occupied Bandwidth	1312 to 1513	1312, 1413, 1513	WCDMA
-	Band Edge	1312 to 1513	1312, 1513	WCDMA
-	Peak to Average Ratio	1312 to 1513	1312, 1413, 1513	WCDMA
-	Conducted Emission	1312 to 1513	1312, 1413, 1513	WCDMA
-	Radiated Emission	1312 to 1513	1312, 1413, 1513	WCDMA

LTE Band 4

EUT Configure Mode	Test Item	Available Channel	Tested Channel	Channel Bandwidth	Modulation	Mode
-	EIRP	19957 to 20393	19957, 20175, 20393	1.4 MHz	QPSK, 16QAM, 64QAM	1 RB / 2 RB Offset
		19965 to 20385	19965, 20175, 20385	3 MHz	QPSK, 16QAM, 64QAM	1 RB / 7 RB Offset
		19975 to 20375	19975, 20175, 20375	5 MHz	QPSK, 16QAM, 64QAM	1 RB / 24 RB Offset
		20000 to 20350	20000, 20175, 20350	10 MHz	QPSK, 16QAM, 64QAM	1 RB / 49 RB Offset
		20025 to 20325	20025, 20175, 20325	15 MHz	QPSK, 16QAM, 64QAM	1 RB / 37 RB Offset
		20050 to 20300	20050, 20175, 20300	20 MHz	QPSK, 16QAM, 64QAM	1 RB / 50 RB Offset
-	Modulation Characteristics	20050 to 20300	20175	20 MHz	QPSK, 16QAM, 64QAM	100 RB / 0 RB Offset
-	Frequency Stability	19957 to 20393	19957, 20393	1.4 MHz	QPSK	1 RB / 0 RB Offset
		19965 to 20385	19965, 20385	3 MHz	QPSK	1 RB / 0 RB Offset
		19975 to 20375	19975, 20375	5 MHz	QPSK	1 RB / 0 RB Offset
		20000 to 20350	20000, 20350	10 MHz	QPSK	1 RB / 0 RB Offset
		20025 to 20325	20025, 20325	15 MHz	QPSK	1 RB / 0 RB Offset
		20050 to 20300	20050, 20300	20 MHz	QPSK	1 RB / 0 RB Offset
-	Occupied Bandwidth	19957 to 20393	19957, 20175, 20393	1.4 MHz	QPSK, 16QAM, 64QAM	6 RB / 0 RB Offset
		19965 to 20385	19965, 20175, 20385	3 MHz	QPSK, 16QAM, 64QAM	15 RB / 0 RB Offset
		19975 to 20375	19975, 20175, 20375	5 MHz	QPSK, 16QAM, 64QAM	25 RB / 0 RB Offset
		20000 to 20350	20000, 20175, 20350	10 MHz	QPSK, 16QAM, 64QAM	50 RB / 0 RB Offset
		20025 to 20325	20025, 20175, 20325	15 MHz	QPSK, 16QAM, 64QAM	75 RB / 0 RB Offset
		20050 to 20300	20050, 20175, 20300	20 MHz	QPSK, 16QAM, 64QAM	100 RB / 0 RB Offset
-	Peak to Average Ratio	19957 to 20393	19957, 20175, 20393	1.4 MHz	QPSK, 16QAM, 64QAM	1 RB / 2 RB Offset
		19965 to 20385	19965, 20175, 20385	3 MHz	QPSK, 16QAM, 64QAM	1 RB / 7 RB Offset
		19975 to 20375	19975, 20175, 20375	5 MHz	QPSK, 16QAM, 64QAM	1 RB / 24 RB Offset
		20000 to 20350	20000, 20175, 20350	10 MHz	QPSK, 16QAM, 64QAM	1 RB / 49 RB Offset
		20025 to 20325	20025, 20175, 20325	15 MHz	QPSK, 16QAM, 64QAM	1 RB / 37 RB Offset
		20050 to 20300	20050, 20175, 20300	20 MHz	QPSK, 16QAM, 64QAM	1 RB / 50 RB Offset

EUT Configure Mode	Test Item	Available Channel	Tested Channel	Channel Bandwidth	Modulation	Mode		
-	Band Edge	19957 to 20393	19957	1.4 MHz	QPSK	1 RB / 0 RB Offset		
			20393	1.4 MHz		6 RB / 0 RB Offset		
		19965 to 20385	19965	3 MHz	QPSK	1 RB / 5 RB Offset		
			20385	3 MHz		6 RB / 0 RB Offset		
		19975 to 20375	19975	5 MHz	QPSK	1 RB / 0 RB Offset		
			20375	5 MHz		15 RB / 0 RB Offset		
		20000 to 20350	20000	10 MHz	QPSK	1 RB / 14 RB Offset		
			20350	10 MHz		15 RB / 0 RB Offset		
		20025 to 20325	20025	15 MHz	QPSK	1 RB / 0 RB Offset		
			20325	15 MHz		25 RB / 0 RB Offset		
		20050 to 20300	20050	20 MHz	QPSK	1 RB / 24 RB Offset		
			20300	20 MHz		25 RB / 0 RB Offset		
		-	Conducted Emission	19957 to 20393	19957, 20175, 20393	1.4 MHz	QPSK	1 RB / 0 RB Offset
				19965 to 20385	19965, 20175, 20385	3 MHz		50 RB / 0 RB Offset
				19975 to 20375	19975, 20175, 20375	5 MHz		1 RB / 49 RB Offset
				20000 to 20350	20000, 20175, 20350	10 MHz		50 RB / 0 RB Offset
				20025 to 20325	20025, 20175, 20325	15 MHz		1 RB / 74 RB Offset
				20050 to 20300	20050, 20175, 20300	20 MHz		75 RB / 0 RB Offset
-	Radiated Emission	19957 to 20393	19957, 20175, 20393	1.4 MHz	QPSK	1 RB / 0 RB Offset		
		19975 to 20375	19975, 20175, 20375	5 MHz		100 RB / 0 RB Offset		
		20050 to 20300	20050, 20175, 20300	20 MHz		1 RB / 99 RB Offset		
						100 RB / 0 RB Offset		

Note:

1. This device was tested under all bandwidths, RB configurations and modulations. The worst case was found in QPSK modulation.
2. For radiated emission above 1 GHz, according to 3GPP 36.521 Section 6.6.3.1.4, choose the lowest, 5 MHz & highest channel bandwidth for final test.

LTE Band 12

EUT Configure Mode	Test Item	Available Channel	Tested Channel	Channel Bandwidth	Modulation	Mode		
-	ERP	23017 to 23173	23017, 23095, 23173	1.4 MHz	QPSK, 16QAM, 64QAM	1 RB / 0 RB Offset		
		23025 to 23165	23025, 23095, 23165	3 MHz	QPSK, 16QAM, 64QAM	1 RB / 0 RB Offset		
		23035 to 23155	23035, 23095, 23155	5 MHz	QPSK, 16QAM, 64QAM	1 RB / 0 RB Offset		
		23060 to 23130	23060, 23095, 23130	10 MHz	QPSK, 16QAM, 64QAM	1 RB / 0 RB Offset		
-	Modulation Characteristics	23060 to 23130	23095	10 MHz	QPSK, 16QAM, 64QAM	50 RB / 0 RB Offset		
-	Frequency Stability	23017 to 23173	23017, 23173	1.4 MHz	QPSK	1 RB / 0 RB Offset		
		23025 to 23165	23025, 23165	3 MHz	QPSK	1 RB / 0 RB Offset		
		23035 to 23155	23035, 23155	5 MHz	QPSK	1 RB / 0 RB Offset		
		23060 to 23130	23060, 23130	10 MHz	QPSK	1 RB / 0 RB Offset		
-	Occupied Bandwidth	23017 to 23173	23017, 23095, 23173	1.4 MHz	QPSK, 16QAM, 64QAM	6 RB / 0 RB Offset		
		23025 to 23165	23025, 23095, 23165	3 MHz	QPSK, 16QAM, 64QAM	15 RB / 0 RB Offset		
		23035 to 23155	23035, 23095, 23155	5 MHz	QPSK, 16QAM, 64QAM	25 RB / 0 RB Offset		
		23060 to 23130	23060, 23095, 23130	10 MHz	QPSK, 16QAM, 64QAM	50 RB / 0 RB Offset		
-	Peak to Average Ratio	23017 to 23173	23017, 23095, 23173	1.4 MHz	QPSK, 16QAM, 64QAM	1 RB / 0 RB Offset		
		23025 to 23165	23025, 23095, 23165	3 MHz	QPSK, 16QAM, 64QAM	1 RB / 0 RB Offset		
		23035 to 23155	23035, 23095, 23155	5 MHz	QPSK, 16QAM, 64QAM	1 RB / 0 RB Offset		
		23060 to 23130	23060, 23095, 23130	10 MHz	QPSK, 16QAM, 64QAM	1 RB / 0 RB Offset		
-	Band Edge	23017 to 23173	23017	1.4 MHz	QPSK	1 RB / 0 RB Offset 6 RB / 0 RB Offset		
			23173	1.4 MHz	QPSK	1 RB / 5 RB Offset 6 RB / 0 RB Offset		
		23025 to 23165	23025	3 MHz	QPSK	1 RB / 0 RB Offset 15 RB / 0 RB Offset		
			23165	3 MHz	QPSK	1 RB / 14 RB Offset 15 RB / 0 RB Offset		
		23035 to 23155	23035	5 MHz	QPSK	1 RB / 0 RB Offset 25 RB / 0 RB Offset		
			23155	5 MHz	QPSK	1 RB / 24 RB Offset 25 RB / 0 RB Offset		
		23060 to 23130	23060	10 MHz	QPSK	1 RB / 0 RB Offset 50 RB / 0 RB Offset		
			23130	10 MHz	QPSK	1 RB / 49 RB Offset 50 RB / 0 RB Offset		
		-	Conducted Emission	23017 to 23173	23017, 23095, 23173	1.4 MHz	QPSK	1 RB / 0 RB Offset
				23025 to 23165	23025, 23095, 23165	3 MHz	QPSK	1 RB / 0 RB Offset
				23035 to 23155	23035, 23095, 23155	5 MHz	QPSK	1 RB / 0 RB Offset
				23060 to 23130	23060, 23095, 23130	10 MHz	QPSK	1 RB / 0 RB Offset
-	Radiated Emission	23017 to 23173	23017, 23095, 23173	1.4 MHz	QPSK	1 RB / 0 RB Offset		
		23035 to 23155	23035, 23095, 23155	5 MHz	QPSK	1 RB / 0 RB Offset		
		23060 to 23130	23060, 23095, 23130	10 MHz	QPSK	1 RB / 0 RB Offset		

Note:

1. This device was tested under all bandwidths, RB configurations and modulations. The worst case was found in QPSK modulation.
2. For radiated emission above 1 GHz, according to 3GPP 36.521 Section 6.6.3.1.4, choose the lowest, 5 MHz & highest channel bandwidth for final test.

LTE Band 13

EUT Configure Mode	Test Item	Available Channel	Tested Channel	Channel Bandwidth	Modulation	Mode
-	ERP	23205 to 23255	23205, 23230, 23255	5 MHz	QPSK, 16QAM, 64QAM	1 RB / 0 RB Offset
		23230	23230	10 MHz	QPSK, 16QAM, 64QAM	1 RB / 0 RB Offset
-	Modulation Characteristics	23230	23230	10 MHz	QPSK, 16QAM, 64QAM	50 RB / 0 RB Offset
-	Frequency Stability	23205 to 23255	23205, 23255	5 MHz	QPSK	1 RB / 0 RB Offset
		23230	23230	10 MHz	QPSK	1 RB / 0 RB Offset
-	Occupied Bandwidth	23205 to 23255	23205, 23230, 23255	5 MHz	QPSK, 16QAM, 64QAM	25 RB / 0 RB Offset
		23230	23230	10 MHz	QPSK, 16QAM, 64QAM	50 RB / 0 RB Offset
-	Peak to Average Ratio	23205 to 23255	23205, 23230, 23255	5 MHz	QPSK, 16QAM, 64QAM	1 RB / 0 RB Offset
		23230	23230	10 MHz	QPSK, 16QAM, 64QAM	1 RB / 0 RB Offset
-	Band Edge	23205 to 23255	23205	5 MHz	QPSK	1 RB / 0 RB Offset
			23255	5 MHz	QPSK	25 RB / 0 RB Offset
		23230	23230	10 MHz	QPSK	1 RB / 24 RB Offset
			23230	10 MHz	QPSK	25 RB / 0 RB Offset
			23230	10 MHz	QPSK	1 RB / 0 RB Offset
			23230	10 MHz	QPSK	50 RB / 0 RB Offset
-	Conducted Emission	23205 to 23255	23205, 23230, 23255	5 MHz	QPSK	1 RB / 0 RB Offset
		23230	23230	10 MHz	QPSK	1 RB / 0 RB Offset
-	Radiated Emission	23205 to 23255	23205, 23230, 23255	5 MHz	QPSK	1 RB / 0 RB Offset
		23230	23230	10 MHz	QPSK	1 RB / 0 RB Offset

Note:

1. This device was tested under all bandwidths, RB configurations and modulations. The worst case was found in QPSK modulation.
2. For radiated emission above 1 GHz, according to 3GPP 36.521 Section 6.6.3.1.4, choose the lowest, 5 MHz & highest channel bandwidth for final test.

LTE Band 17

EUT Configure Mode	Test Item	Available Channel	Tested Channel	Channel Bandwidth	Modulation	Mode
-	ERP	23755 to 23825	23755, 23790, 23825	5 MHz	QPSK, 16QAM, 64QAM	1 RB / 0 RB Offset
		23780 to 23800	23780, 23790, 23800	10 MHz	QPSK, 16QAM, 64QAM	1 RB / 0 RB Offset
-	Modulation Characteristics	23780 to 23800	23790	10 MHz	QPSK, 16QAM, 64QAM	50 RB / 0 RB Offset
-	Frequency Stability	23755 to 23825	23755, 23825	5 MHz	QPSK	1 RB / 0 RB Offset
		23780 to 23800	23780, 23800	10 MHz	QPSK	1 RB / 0 RB Offset
-	Occupied Bandwidth	23755 to 23825	23755, 23790, 23825	5 MHz	QPSK, 16QAM, 64QAM	25 RB / 0 RB Offset
		23780 to 23800	23780, 23790, 23800	10 MHz	QPSK, 16QAM, 64QAM	50 RB / 0 RB Offset
-	Peak to Average Ratio	23755 to 23825	23755, 23790, 23825	5 MHz	QPSK, 16QAM, 64QAM	1 RB / 12 RB Offset
		23780 to 23800	23780, 23790, 23800	10 MHz	QPSK, 16QAM, 64QAM	1 RB / 24 RB Offset
-	Band Edge	23755 to 23825	23755	5 MHz	QPSK	1 RB / 0 RB Offset 25 RB / 0 RB Offset
			23825	5 MHz	QPSK	1 RB / 24 RB Offset 25 RB / 0 RB Offset
		23780 to 23800	23780	10 MHz	QPSK	1 RB / 0 RB Offset 50 RB / 0 RB Offset
			23800	10 MHz	QPSK	1 RB / 49 RB Offset 50 RB / 0 RB Offset

Note:

1. This device was tested under all bandwidths, RB configurations and modulations. The worst case was found in QPSK modulation.
2. For radiated emission above 1 GHz, according to 3GPP 36.521 Section 6.6.3.1.4, choose the lowest, 5 MHz & highest channel bandwidth for final test.

LTE Band 66

EUT Configure Mode	Test Item	Available Channel	Tested Channel	Channel Bandwidth	Modulation	Mode
-	EIRP	131979 to 132665	131979, 132322, 132665	1.4 MHz	QPSK, 16QAM, 64QAM	1 RB / 0 RB Offset
		131987 to 132657	131987, 132322, 132657	3 MHz	QPSK, 16QAM, 64QAM	1 RB / 0 RB Offset
		131997 to 132647	131997, 132322, 132647	5 MHz	QPSK, 16QAM, 64QAM	1 RB / 0 RB Offset
		132022 to 132622	132022, 132322, 132622	10 MHz	QPSK, 16QAM, 64QAM	1 RB / 0 RB Offset
		132047 to 132597	132047, 132322, 132597	15 MHz	QPSK, 16QAM, 64QAM	1 RB / 0 RB Offset
		132072 to 132572	132072, 132322, 132572	20 MHz	QPSK, 16QAM, 64QAM	1 RB / 0 RB Offset
-	Modulation Characteristics	132072 to 132572	132322	20 MHz	QPSK, 16QAM, 64QAM	100 RB / 0 RB Offset
-	Frequency Stability	131979 to 132665	131979, 132665	1.4 MHz	QPSK	1 RB / 0 RB Offset
		131987 to 132657	131987, 132657	3 MHz	QPSK	1 RB / 0 RB Offset
		131997 to 132647	131997, 132647	5 MHz	QPSK	1 RB / 0 RB Offset
		132022 to 132622	132022, 132622	10 MHz	QPSK	1 RB / 0 RB Offset
		132047 to 132597	132047, 132597	15 MHz	QPSK	1 RB / 0 RB Offset
		132072 to 132572	132072, 132572	20 MHz	QPSK	1 RB / 0 RB Offset
-	Occupied Bandwidth	131979 to 132665	131979, 132322, 132665	1.4 MHz	QPSK, 16QAM, 64QAM	6 RB / 0 RB Offset
		131987 to 132657	131987, 132322, 132657	3 MHz	QPSK, 16QAM, 64QAM	15 RB / 0 RB Offset
		131997 to 132647	131997, 132322, 132647	5 MHz	QPSK, 16QAM, 64QAM	25 RB / 0 RB Offset
		132022 to 132622	132022, 132322, 132622	10 MHz	QPSK, 16QAM, 64QAM	50 RB / 0 RB Offset
		132047 to 132597	132047, 132322, 132597	15 MHz	QPSK, 16QAM, 64QAM	75 RB / 0 RB Offset
		132072 to 132572	132072, 132322, 132572	20 MHz	QPSK, 16QAM, 64QAM	100 RB / 0 RB Offset
-	Peak to Average Ratio	131979 to 132665	131979, 132322, 132665	1.4 MHz	QPSK, 16QAM, 64QAM	1 RB / 0 RB Offset
		131987 to 132657	131987, 132322, 132657	3 MHz	QPSK, 16QAM, 64QAM	1 RB / 0 RB Offset
		131997 to 132647	131997, 132322, 132647	5 MHz	QPSK, 16QAM, 64QAM	1 RB / 0 RB Offset
		132022 to 132622	132022, 132322, 132622	10 MHz	QPSK, 16QAM, 64QAM	1 RB / 0 RB Offset
		132047 to 132597	132047, 132322, 132597	15 MHz	QPSK, 16QAM, 64QAM	1 RB / 0 RB Offset
		132072 to 132572	132072, 132322, 132572	20 MHz	QPSK, 16QAM, 64QAM	1 RB / 0 RB Offset

EUT Configure Mode	Test Item	Available Channel	Tested Channel	Channel Bandwidth	Modulation	Mode		
-	Band Edge	131979 to 132665	131979	1.4 MHz	QPSK	1 RB / 0 RB Offset 6 RB / 0 RB Offset		
			132665	1.4 MHz	QPSK	1 RB / 5 RB Offset 6 RB / 0 RB Offset		
		131987 to 132657	131987	3 MHz	QPSK	1 RB / 0 RB Offset 15 RB / 0 RB Offset		
			132657	3 MHz	QPSK	1 RB / 14 RB Offset 15 RB / 0 RB Offset		
		131997 to 132647	131997	5 MHz	QPSK	1 RB / 0 RB Offset 25 RB / 0 RB Offset		
			132647	5 MHz	QPSK	1 RB / 24 RB Offset 25 RB / 0 RB Offset		
		132022 to 132622	132022	10 MHz	QPSK	1 RB / 0 RB Offset 50 RB / 0 RB Offset		
			132622	10 MHz	QPSK	1 RB / 49 RB Offset 50 RB / 0 RB Offset		
		132047 to 132597	132047	15 MHz	QPSK	1 RB / 0 RB Offset 75 RB / 0 RB Offset		
			132597	15 MHz	QPSK	1 RB / 74 RB Offset 75 RB / 0 RB Offset		
		132072 to 132572	132072	20 MHz	QPSK	1 RB / 0 RB Offset 100 RB / 0 RB Offset		
			132572	20 MHz	QPSK	1 RB / 99 RB Offset 100 RB / 0 RB Offset		
		-	Conducted Emission	131979 to 132665	131979, 132322, 132665	1.4 MHz	QPSK	1 RB / 0 RB Offset
				131987 to 132657	131987, 132322, 132657	3 MHz	QPSK	1 RB / 0 RB Offset
				131997 to 132647	131997, 132322, 132647	5 MHz	QPSK	1 RB / 0 RB Offset
				132022 to 132622	132022, 132322, 132622	10 MHz	QPSK	1 RB / 0 RB Offset
				132047 to 132597	132047, 132322, 132597	15 MHz	QPSK	1 RB / 0 RB Offset
				132072 to 132572	132072, 132322, 132572	20 MHz	QPSK	1 RB / 0 RB Offset
-	Radiated Emission	131979 to 132665	131979, 132322, 132665	1.4 MHz	QPSK	1 RB / 0 RB Offset		
		131997 to 132647	131997, 132322, 132647	5 MHz	QPSK	1 RB / 0 RB Offset		
		132072 to 132572	132072, 132322, 132572	20 MHz	QPSK	1 RB / 0 RB Offset		

Note:

1. This device was tested under all bandwidths, RB configurations and modulations. The worst case was found in QPSK modulation.
2. For radiated emission above 1 GHz, according to 3GPP 36.521 Section 6.6.3.1.4, choose the lowest, 5 MHz & highest channel bandwidth for final test.

Test Condition:

Test Item	Environmental Conditions	Input Power	Tested By
ERP / EIRP	25 deg. C, 65 % RH	120 Vac, 60 Hz	Getaz Yang
Modulation Characteristics	25 deg. C, 65 % RH	120 Vac, 60 Hz	Wayne Lin
Frequency Stability	25 deg. C, 65 % RH	120 Vac, 60 Hz	Wayne Lin
Occupied Bandwidth	25 deg. C, 65 % RH	120 Vac, 60 Hz	Wayne Lin
Band Edge	25 deg. C, 65 % RH	120 Vac, 60 Hz	Wayne Lin
Peak to Average Ratio	25 deg. C, 65 % RH	120 Vac, 60 Hz	Wayne Lin
Conducted Emission	25 deg. C, 65 % RH	120 Vac, 60 Hz	Wayne Lin
Radiated Emission	25 deg. C, 65 % RH	120 Vac, 60 Hz	Getaz Yang, Thomas Wei

3.4 EUT Operating Conditions

The EUT makes a call to the communication simulator. The communication simulator station system controlled a EUT to export maximum output power under transmission mode and specific channel frequency

3.5 General Description of Applied Standards

The EUT is a RF Product. According to the specifications of the manufacturer, it must comply with the requirements of the following standards:

FCC 47 CFR Part 2

FCC 47 CFR Part 27

KDB 971168 D01 Power Meas License Digital Systems v03r01

ANSI/TIA/EIA-603-E 2016

ANSI 63.26-2015

Note: All test items have been performed and recorded as per the above standards.

4 Test Types and Results

4.1 Output Power Measurement

4.1.1 Limits of Output Power Measurement

Fixed, mobile, and portable (hand-held) stations operating in the 1710–1755 MHz band and mobile and portable stations operating in the 1695-1710 MHz and 1755-1780 MHz bands are limited to 1 watt EIRP.

Portable stations (hand-held devices) operating in the 746-757 MHz, 776-788 MHz and 805-806 MHz band are limited to 3 watts ERP

Portable stations (hand-held device) operating in the 600 MHz uplink band and the 698-746 MHz band, and fixed and mobile stations in the 600 MHz uplink band are limited to 3 watts ERP.

4.1.2 Test Procedures

EIRP / ERP Measurement:

- a. All measurements were done at low, middle and high operational frequency range. RBW and VBW is 5 MHz for WCDMA and 10 MHz for LTE mode.
- b. Substitution method is used for E.I.R.P measurement. In the semi-anechoic chamber, EUT placed on the 0.8 m (below or equal 1 GHz) and/or 1.5 m (above 1 GHz) height of Turn Table, rotated the table around 360 degrees to search the maximum radiation power and receiver antenna shall be rotated vertical and horizontal polarization and moved height from 1 m to 4 m to find the maximum polar radiated power. The “Read Value” is the spectrum reading the maximum power value.
- c. The substitution horn antenna is substituted for EUT at the same position and signals generator export the CW signal to the substitution antenna via a tx cable. Rotated the Turn Table and moved receiving antenna to find the maximum radiation power. Adjust output power level of S.G to get a Value of spectrum reading equal to “Read Value” of step b. Record the power level of S.G.
- d. $EIRP = \text{Output power level of S.G} - \text{TX cable loss} + \text{Antenna gain of substitution horn}$. E.R.P power can be calculated form E.I.R.P power by subtracting the gain of dipole, $E.R.P \text{ power} = E.I.R.P \text{ power} - 2.15 \text{ dB}$.

Conducted Power Measurement:

- a. The EUT was set up for the maximum power with WCDMA and LTE link data modulation and link up with simulator.
- b. Set the EUT to transmit under low, middle and high channel and record the power level shown on simulator.

4.1.3 Test Setup

EIRP / ERP Measurement:

<Radiated Emission below or equal 1 GHz>

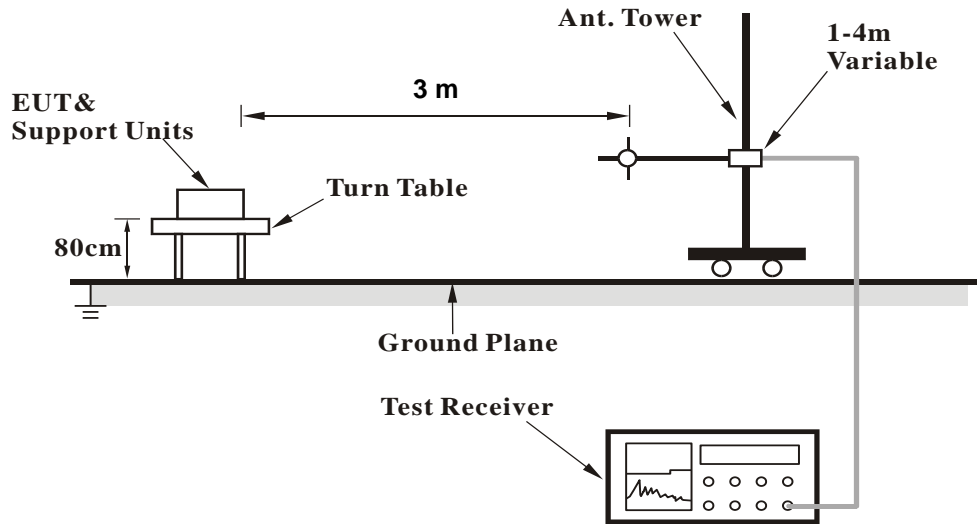

<Radiated Emission above 1 GHz>

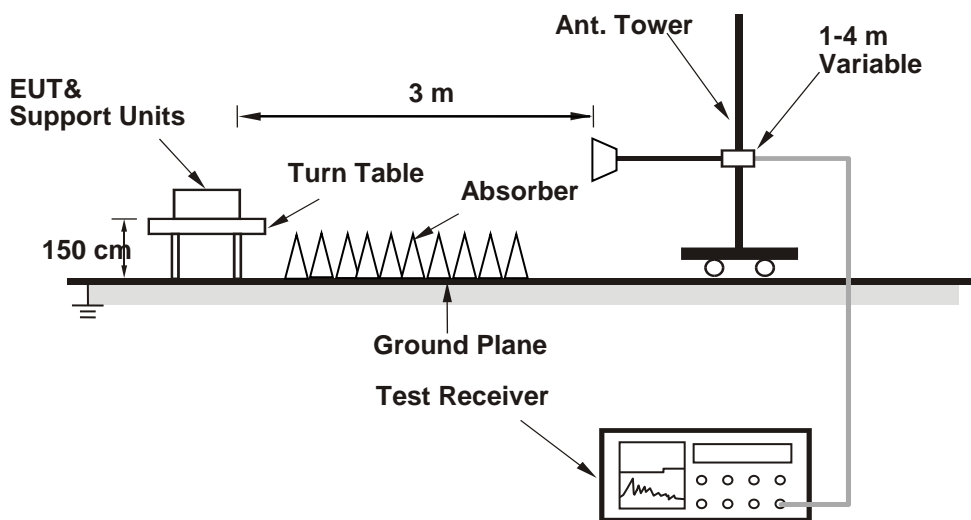

For the actual test configuration, please refer to the attached file (Test Setup Photo).

Conducted Power Measurement:

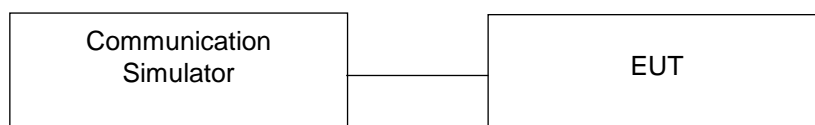

4.1.4 Test Results

Conducted Output Power (dBm)

Band Channel	WCDMA Band IV			3GPP MPR (dB)
	1312	1413	1513	
Frequency (MHz)	1712.4	1732.6	1752.6	
RMC 12.2K	23.67	23.73	23.91	-
HSDPA Subtest-1	23.65	23.71	23.89	0
HSDPA Subtest-2	23.37	23.43	23.61	0
HSDPA Subtest-3	23.11	23.17	23.35	0.5
HSDPA Subtest-4	22.84	22.90	23.08	0.5
DC-HSDPA Subtest-1	23.58	23.64	23.82	0
DC-HSDPA Subtest-2	23.30	23.36	23.54	0
DC-HSDPA Subtest-3	23.04	23.10	23.28	0.5
DC-HSDPA Subtest-4	22.77	22.83	23.01	0.5
HSUPA Subtest-1	23.20	23.26	23.44	0
HSUPA Subtest-2	21.35	21.41	21.59	2
HSUPA Subtest-3	22.35	22.41	22.59	1
HSUPA Subtest-4	21.64	21.70	21.88	2
HSUPA Subtest-5	23.36	23.42	23.60	0

LTE Band 4

BW	MCS Index	RB Size	RB Offset	Low	Mid	High	3GPP MPR (dB)	BW	MCS Index	RB Size	RB Offset	Low	Mid	High	3GPP MPR (dB)		
		Channel		20050	20175	20300				Channel		20025	20175	20325			
		Frequency (MHz)		1720.0	1732.5	1745.0				Frequency (MHz)		1717.5	1732.5	1747.5			
20M	QPSK	1	0	23.35	23.32	23.42	0	15M	QPSK	1	0	23.28	23.24	23.42	0		
		1	50	23.40	23.38	23.51	0			1	37	23.36	23.36	23.46	0		
		1	99	23.45	23.41	23.48	0			1	74	23.35	23.38	23.38	0		
		50	0	22.32	22.27	22.39	1			36	0	22.31	22.26	22.38	1		
		50	25	22.36	22.33	22.41	1			36	19	22.32	22.21	22.32	1		
		50	50	22.31	22.28	22.36	1			36	39	22.27	22.23	22.31	1		
	100	0	22.33	22.29	22.39	1	75		0	22.33	22.25	22.35	1				
	16QAM	1	0	21.66	22.31	21.70	1		16QAM	1	0	21.65	22.23	21.68	1		
		1	50	22.30	22.34	22.51	1			1	37	22.34	22.28	22.45	1		
		1	99	22.37	22.39	22.47	1			1	74	22.30	22.41	22.40	1		
		50	0	21.29	21.29	21.33	2			36	0	21.18	21.17	21.30	2		
		50	25	21.23	21.22	21.32	2			36	19	21.16	21.09	21.29	2		
		50	50	21.25	21.22	21.29	2			36	39	21.25	21.16	21.21	2		
	100	0	21.23	21.19	21.32	2	75		0	21.30	21.20	21.28	2				
	64QAM	1	0	21.32	21.24	21.40	2		64QAM	1	0	21.20	21.19	21.37	2		
		1	50	21.35	21.38	21.49	2			1	37	21.37	21.31	21.41	2		
		1	99	21.40	21.32	21.40	2			1	74	21.36	21.24	21.40	2		
		50	0	20.26	20.29	20.37	3			36	0	20.23	20.29	20.28	3		
		50	25	20.31	20.20	20.32	3			36	19	20.23	20.11	20.34	3		
		50	50	20.25	20.26	20.34	3			36	39	20.24	20.08	20.22	3		
	100	0	20.24	20.26	20.34	3	75		0	20.28	20.20	20.22	3				
	10M	QPSK	1	0	23.34	23.21	23.26		0	5M	QPSK	1	0	23.34	23.23	23.20	0
			1	24	23.34	23.19	23.44		0			1	12	23.25	23.13	23.29	0
			1	49	23.34	23.30	23.46		0			1	24	23.34	23.22	23.29	0
25			0	22.31	22.32	22.28	1	12	0			22.23	22.20	22.31	1		
25			12	22.12	22.14	22.31	1	12	6			22.22	22.16	22.25	1		
25			25	22.16	22.13	22.25	1	12	13			22.22	22.25	22.27	1		
50		0	22.11	22.20	22.24	1	25	0	22.24		22.15	22.25	1				
16QAM		1	0	21.47	22.18	21.68	1	16QAM	1		0	21.49	22.08	21.56	1		
		1	24	22.26	22.27	22.30	1		1		12	22.24	22.19	22.26	1		
		1	49	22.32	22.17	22.43	1		1		24	22.32	22.30	22.40	1		
		25	0	21.12	21.30	21.36	2		12		0	21.24	21.06	21.23	2		
		25	12	21.15	21.06	21.11	2		12		6	21.10	21.04	21.30	2		
		25	25	21.15	21.07	21.11	2		12		13	21.12	21.00	21.23	2		
50		0	21.16	21.13	21.14	2	25	0	21.14		21.11	21.28	2				
64QAM		1	0	21.17	21.13	21.13	2	64QAM	1		0	21.23	21.17	21.34	2		
		1	24	21.32	21.23	21.37	2		1		12	21.27	21.21	21.19	2		
		1	49	21.28	21.37	21.28	2		1		24	21.31	21.20	21.32	2		
		25	0	20.20	20.23	20.24	3		12		0	20.21	20.29	20.32	3		
		25	12	20.14	20.02	20.24	3		12		6	20.11	20.16	20.10	3		
		25	25	20.07	20.03	20.25	3		12		13	20.18	20.18	20.14	3		
50		0	20.21	20.06	20.19	3	25	0	20.17		20.15	20.09	3				
3M		QPSK	1	0	23.12	23.13	23.19	0	1.4M		QPSK	1	0	23.23	23.19	23.28	0
			1	7	23.32	23.20	23.49	0				1	2	23.23	23.20	23.47	0
			1	14	23.29	23.23	23.45	0				1	5	23.40	23.18	23.35	0
	8		0	22.24	22.17	22.20	1	3		0		23.23	23.14	23.28	0		
	8		3	22.22	22.25	22.32	1	3		1		23.18	23.25	23.30	0		
	8		7	22.23	22.12	22.31	1	3		3		23.21	23.09	23.17	0		
	15	0	22.23	22.15	22.24	1	6	0		22.17	22.04	22.19	1				
	16QAM	1	0	21.49	22.12	21.68	1	16QAM		1	0	21.50	22.06	21.53	1		
		1	7	22.27	22.30	22.36	1			1	2	22.22	22.08	22.39	1		
		1	14	22.19	22.19	22.30	1			1	5	22.27	22.23	22.31	1		
		8	0	21.26	21.01	21.20	2			3	0	22.30	22.19	22.22	1		
		8	3	21.20	21.19	21.09	2			3	1	22.10	22.24	22.32	1		
		8	7	21.13	21.10	21.22	2			3	3	22.20	22.02	22.19	1		
	15	0	21.08	21.27	21.18	2	6	0		21.12	21.18	21.15	2				
	64QAM	1	0	21.14	21.09	21.28	2	64QAM		1	0	21.12	21.14	21.19	2		
		1	7	21.08	21.12	21.37	2			1	2	21.26	21.24	21.36	2		
		1	14	21.29	21.32	21.28	2			1	5	21.32	21.11	21.27	2		
		8	0	20.24	20.13	20.32	3			3	0	21.15	21.23	21.21	2		
		8	3	20.10	20.12	20.25	3			3	1	21.08	21.11	21.13	2		
		8	7	20.13	19.99	20.20	3			3	3	20.97	21.13	21.15	2		
	15	0	20.10	20.08	20.22	3	6	0		20.19	20.23	20.27	3				

LTE Band 12

BW	MCS Index	RB Size	RB Offset	Low	Mid	High	3GPP MPR (dB)	BW	MCS Index	RB Size	RB Offset	Low	Mid	High	3GPP MPR (dB)		
		Channel		23060	23095	23130				Channel		23035	23095	23155			
		Frequency (MHz)		704.0	707.5	711.0				Frequency (MHz)		701.5	707.5	713.5			
10M	QPSK	1	0	23.04	23.09	23.14	0	5M	QPSK	1	0	22.93	23.06	22.96	0		
		1	24	23.03	23.08	23.13	0			1	12	22.93	23.02	22.97	0		
		1	49	22.91	22.94	23.05	0			1	24	22.71	22.75	22.81	0		
		25	0	22.04	22.09	22.14	1			12	0	21.91	21.98	21.85	1		
		25	12	22.06	22.06	22.12	1			12	6	21.96	21.91	21.96	1		
		25	25	21.97	22.02	22.07	1			12	13	21.85	21.79	21.88	1		
	16QAM	50	0	22.03	22.06	22.13	1		25	0	21.88	21.99	21.88	1			
		1	0	21.98	22.00	22.07	1		16QAM	1	0	21.91	21.87	22.01	1		
		1	24	21.96	22.03	22.12	1			1	12	21.87	21.89	21.89	1		
		1	49	21.89	21.92	22.03	1			1	24	21.72	21.77	21.78	1		
		25	0	20.99	21.05	21.05	2			12	0	20.95	20.97	21.06	2		
		25	12	20.96	21.03	21.02	2			12	6	20.93	20.85	20.96	2		
	25	25	20.91	21.00	21.01	2	12			13	20.71	20.88	20.77	2			
	64QAM	50	0	20.93	21.05	21.05	2		25	0	20.86	20.94	21.04	2			
		1	0	20.96	21.04	21.12	2		64QAM	1	0	20.91	20.93	20.96	2		
		1	24	20.99	20.99	21.04	2			1	12	20.86	20.97	20.89	2		
		1	49	20.90	20.86	21.05	2			1	24	20.76	20.71	20.72	2		
		25	0	20.02	20.07	20.08	3			12	0	19.87	19.94	19.95	3		
		25	12	19.98	19.98	20.03	3			12	6	19.87	19.88	19.95	3		
	25	25	19.90	20.01	20.06	3	12			13	19.77	19.89	20.00	3			
	3M	QPSK	1	0	22.95	23.02	23.04		0	1.4M	QPSK	1	0	22.87	22.94	23.00	0
			1	7	23.02	22.97	22.99		0			1	2	22.97	22.93	22.99	0
			1	14	22.74	22.75	22.89		0			1	5	22.78	22.86	22.85	0
			8	0	21.83	22.00	22.04		1			3	0	22.95	22.93	23.04	0
8			3	21.91	21.90	22.10	1	3	1			22.89	22.92	22.94	0		
8			7	21.77	21.91	21.85	1	3	3			22.88	22.83	22.93	0		
16QAM		15	0	21.85	21.88	21.88	1	6	0		21.81	21.96	21.89	1			
		1	0	21.83	21.89	21.96	1	16QAM	1		0	21.88	22.02	21.98	1		
		1	7	21.80	21.83	21.96	1		1		2	21.84	21.88	21.83	1		
		1	14	21.78	21.77	21.90	1		1		5	21.74	21.79	21.94	1		
		8	0	20.86	20.97	20.86	2		3		0	21.83	21.91	22.01	1		
		8	3	20.80	20.77	20.97	2		3		1	21.88	21.87	21.98	1		
8		7	20.74	20.76	20.90	2	3		3		21.79	21.92	21.95	1			
64QAM		15	0	20.79	20.83	20.95	2	6	0		20.77	20.90	20.96	2			
		1	0	20.93	20.91	21.00	2	64QAM	1		0	20.85	20.92	20.96	2		
		1	7	20.90	20.95	20.91	2		1		2	20.79	20.98	21.07	2		
		1	14	20.79	20.73	20.92	2		1		5	20.65	20.85	20.78	2		
		8	0	19.87	19.88	19.94	3		3		0	20.87	21.01	20.92	2		
		8	3	19.89	19.92	19.90	3		3		1	20.86	20.94	20.92	2		
8		7	19.67	19.86	19.86	3	3		3		20.90	20.78	21.01	2			
10M		QPSK	15	0	19.87	19.93	19.91	3	6		0	19.86	19.80	20.08	3		

LTE Band 13

BW	MCS Index	RB Size	RB Offset	Low	Mid	High	3GPP MPR (dB)	BW	MCS Index	RB Size	RB Offset	Low	Mid	High	3GPP MPR (dB)
		Channel		23230	23230	23225				Channel		23205	23230	23225	
		Frequency (MHz)		782.0	779.5	784.5				Frequency (MHz)		779.5	782.0	784.5	
10M	QPSK	1	0		22.98		0	5M	QPSK	1	0	22.78	22.86	22.97	0
		1	24		22.93		0			1	12	22.87	22.95	22.96	0
		1	49		22.86		0			1	24	22.74	22.81	22.85	0
		25	0		21.99		1			12	0	21.74	21.82	21.94	1
		25	12		21.92		1			12	6	21.75	21.80	22.02	1
		25	25		21.91		1			12	13	21.83	21.91	21.93	1
	16QAM	50	0		21.96		1		25	0	21.80	21.88	21.99	1	
		1	0		21.91		1		16QAM	1	0	21.77	21.85	21.87	1
		1	24		21.93		1			1	12	21.78	21.95	21.88	1
		1	49		21.79		1			1	24	21.66	21.78	21.84	1
		25	0		20.95		2			12	0	20.64	20.74	20.90	2
		25	12		20.85		2			12	6	20.70	20.70	21.00	2
	25	25		20.87		2	12			13	20.82	20.82	20.84	2	
	64QAM	50	0		20.90		2		25	0	20.78	20.79	20.91	2	
		1	0		20.88		2		64QAM	1	0	20.74	20.83	20.87	2
		1	24		20.87		2			1	12	20.86	20.88	20.86	2
		1	49		20.77		2			1	24	20.69	20.81	20.79	2
		25	0		19.95		3			12	0	19.67	19.77	19.88	3
		25	12		19.91		3			12	6	19.71	19.77	20.01	3
	25	25		19.83		3	12			13	19.75	19.86	19.89	3	
	10M	QPSK	50	0		19.86			3	25	0	19.73	19.78	19.96	3

LTE Band 17

BW	MCS Index	RB Size	RB Offset	Low	Mid	High	3GPP MPR (dB)	BW	MCS Index	RB Size	RB Offset	Low	Mid	High	3GPP MPR (dB)
		Channel		23780	23790	23800				Channel		23755	23790	23825	
		Frequency (MHz)		709.0	710.0	711.0				Frequency (MHz)		706.5	710.0	713.5	
10M	QPSK	1	0	23.14	23.16	23.07	0	5M	QPSK	1	0	23.06	23.12	23.05	0
		1	24	23.03	23.05	22.96	0			1	12	23.02	23.03	22.87	0
		1	49	22.94	22.96	22.87	0			1	24	22.91	22.86	22.86	0
		25	0	22.05	22.07	21.98	1			12	0	22.00	22.02	21.97	1
		25	12	22.00	22.02	21.93	1			12	6	21.90	21.96	21.83	1
		25	25	21.99	22.01	21.92	1			12	13	21.92	21.98	21.83	1
	50	0	22.04	22.06	21.97	1	25		0	22.02	22.01	21.90	1		
	16QAM	1	0	22.40	22.42	22.33	1		1	0	22.31	22.33	22.31	1	
		1	24	22.39	22.41	22.32	1		1	12	22.33	22.31	22.29	1	
		1	49	22.29	22.31	22.22	1		1	24	22.26	22.28	22.14	1	
		25	0	21.18	21.20	21.11	2		12	0	21.15	21.15	21.06	2	
		25	12	21.14	21.16	21.07	2		12	6	21.07	21.16	21.05	2	
		25	25	21.16	21.18	21.09	2		12	13	21.08	21.15	21.06	2	
	50	0	21.05	21.07	20.98	2	25		0	21.05	21.07	20.89	2		
	64QAM	1	0	21.40	21.42	21.33	2		64QAM	1	0	21.37	21.42	21.31	2
		1	24	21.38	21.40	21.31	2			1	12	21.37	21.33	21.31	2
		1	49	21.29	21.31	21.22	2			1	24	21.24	21.27	21.14	2
		25	0	20.16	20.18	20.09	3			12	0	20.11	20.08	20.00	3
		25	12	20.13	20.15	20.06	3			12	6	20.13	20.13	19.99	3
		25	25	20.15	20.17	20.08	3			12	13	20.12	20.14	20.06	3
	50	0	20.05	20.07	19.98	3	25		0	19.96	20.05	19.93	3		

LTE Band 66

BW	MCS Index	RB Size	RB Offset	Low	Mid	High	3GPP MPR (dB)	BW	MCS Index	RB Size	RB Offset	Low	Mid	High	3GPP MPR (dB)
		Channel		132072	132322	132572				Channel		132047	132322	132597	
		Frequency (MHz)		1720.0	1745.0	1770.0				Frequency (MHz)		1717.5	1745.0	1772.5	
20M	QPSK	1	0	23.37	23.58	23.50	0	15M	QPSK	1	0	23.34	23.49	23.49	0
		1	50	23.20	23.40	23.32	0			1	37	23.15	23.36	23.29	0
		1	99	23.23	23.43	23.36	0			1	74	23.17	23.40	23.36	0
		50	0	22.20	22.41	22.33	1			36	0	22.10	22.40	22.34	1
		50	25	22.13	22.34	22.35	1			36	19	22.12	22.26	22.30	1
		50	50	22.12	22.33	22.30	1			36	39	22.12	22.31	22.26	1
	100	0	22.19	22.40	22.32	1	75		0	22.16	22.39	22.23	1		
	16QAM	1	0	22.35	22.50	22.45	1		16QAM	1	0	22.28	22.42	22.44	1
		1	50	22.10	22.30	22.24	1			1	37	22.07	22.38	22.27	1
		1	99	22.22	22.33	22.31	1			1	74	22.17	22.34	22.22	1
		50	0	21.10	21.38	21.29	2			36	0	21.08	21.28	21.24	2
		50	25	21.12	21.29	21.25	2			36	19	21.00	21.28	21.18	2
		50	50	21.02	21.29	21.25	2			36	39	21.09	21.16	21.14	2
	100	0	21.17	21.37	21.27	2	75		0	21.07	21.30	21.12	2		
	64QAM	1	0	21.37	21.55	21.45	2		64QAM	1	0	21.32	21.41	21.34	2
		1	50	21.18	21.39	21.30	2			1	37	21.12	21.28	21.17	2
		1	99	21.15	21.39	21.30	2			1	74	21.14	21.35	21.29	2
		50	0	20.18	20.36	20.23	3			36	0	20.12	20.29	20.20	3
50		25	20.13	20.24	20.27	3	36	19		19.96	20.20	20.27	3		
50		50	20.12	20.23	20.23	3	36	39		20.09	20.25	20.20	3		
100	0	20.09	20.35	20.30	3	75	0	20.11	20.31	20.19	3				
10M	QPSK	1	0	23.34	23.57	23.34	0	5M	QPSK	1	0	23.25	23.50	23.30	0
		1	24	22.97	23.36	23.14	0			1	12	23.04	23.35	23.08	0
		1	49	23.04	23.27	23.24	0			1	24	23.08	23.26	23.20	0
		25	0	22.01	22.40	22.25	1			12	0	21.99	22.25	22.09	1
		25	12	22.01	22.30	22.11	1			12	6	22.01	22.13	22.07	1
		25	25	21.94	22.23	22.25	1			12	13	22.00	22.17	22.14	1
	50	0	22.05	22.34	22.19	1	25		0	21.99	22.25	22.12	1		
	16QAM	1	0	22.17	22.35	22.27	1		16QAM	1	0	22.20	22.34	22.34	1
		1	24	21.99	22.25	22.25	1			1	12	22.11	22.26	22.09	1
		1	49	21.99	22.17	22.10	1			1	24	22.11	22.22	22.19	1
		25	0	21.02	21.17	21.18	2			12	0	21.01	21.17	21.18	2
		25	12	21.04	21.25	21.24	2			12	6	20.95	21.13	21.18	2
		25	25	21.05	21.23	21.10	2			12	13	20.98	21.19	21.11	2
	50	0	21.09	21.20	21.16	2	25		0	20.97	21.25	21.08	2		
	64QAM	1	0	21.27	21.29	21.32	2		64QAM	1	0	21.17	21.35	21.34	2
		1	24	21.09	21.20	21.11	2			1	12	21.00	21.18	21.13	2
		1	49	21.00	21.24	21.16	2			1	24	21.09	21.26	21.28	2
		25	0	20.00	20.20	20.21	3			12	0	20.05	20.11	20.11	3
25		12	20.07	20.07	20.26	3	12	6		19.99	20.21	20.13	3		
25		25	19.91	20.11	20.13	3	12	13		19.89	20.00	20.05	3		
50	0	20.01	20.21	20.16	3	25	0	20.12	20.30	20.13	3				
3M	QPSK	1	0	23.25	23.46	23.42	0	1.4M	QPSK	1	0	23.25	23.34	23.41	0
		1	7	23.12	23.21	23.20	0			1	2	22.98	23.31	23.16	0
		1	14	23.08	23.30	23.15	0			1	5	23.07	23.21	23.31	0
		8	0	22.08	22.29	22.19	1			3	0	23.07	23.33	23.23	0
		8	3	21.93	22.18	22.33	1			3	1	22.99	23.19	23.22	0
		8	7	22.04	22.27	22.17	1			3	3	22.94	23.31	23.21	0
	15	0	22.09	22.33	22.16	1	6		0	22.15	22.33	22.23	1		
	16QAM	1	0	22.16	22.54	22.40	1		16QAM	1	0	22.24	22.35	22.27	1
		1	7	22.12	22.23	22.32	1			1	2	22.03	22.13	22.08	1
		1	14	21.98	22.17	22.20	1			1	5	22.14	22.26	22.20	1
		8	0	20.99	21.14	21.08	2			3	0	21.99	22.33	22.11	1
		8	3	21.00	21.09	21.12	2			3	1	21.93	22.25	22.19	1
		8	7	20.93	21.07	21.06	2			3	3	21.92	22.19	22.28	1
	15	0	20.99	21.26	21.10	2	6		0	20.98	21.20	21.13	2		
	64QAM	1	0	21.11	21.44	21.26	2		64QAM	1	0	21.16	21.35	21.36	2
		1	7	20.93	21.35	21.17	2			1	2	21.04	21.30	21.01	2
		1	14	21.14	21.29	21.19	2			1	5	21.11	21.33	21.16	2
		8	0	20.09	20.25	20.11	3			3	0	20.93	21.34	21.17	2
8		3	20.00	20.10	20.25	3	3	1		20.90	21.17	21.11	2		
8		7	19.95	20.17	20.06	3	3	3		20.98	21.18	21.08	2		
15	0	20.04	20.12	20.26	3	6	0	19.99	20.23	20.10	3				

ERP Power (dBm)

LTE Band 12							
Channel Bandwidth: 1.4 MHz / QPSK							
Plane	Channel	Frequency (MHz)	Reading (dBm)	Correction Factor (dB)	ERP (dBm)	ERP (mW)	Polarization (H/V)
NB	23017	699.7	-14.11	30.36	14.10	25.70	H
	23095	707.5	-13.55	30.17	14.47	27.99	
	23173	715.3	-13.79	30.17	14.23	26.49	
	23017	699.7	-19.55	32.03	10.33	10.79	V
	23095	707.5	-19.43	31.98	10.40	10.96	
	23173	715.3	-19.54	32.06	10.37	10.89	
Channel Bandwidth: 1.4 MHz / 16QAM							
NB	23017	699.7	-15.14	30.36	13.07	20.28	H
	23095	707.5	-14.59	30.17	13.43	22.03	
	23173	715.3	-14.84	30.17	13.18	20.80	
	23017	699.7	-20.70	32.03	9.18	8.28	V
	23095	707.5	-20.23	31.98	9.60	9.12	
	23173	715.3	-20.66	32.06	9.25	8.41	
Channel Bandwidth: 1.4 MHz / 64QAM							
NB	23017	699.7	-16.29	30.36	11.92	15.56	H
	23095	707.5	-15.82	30.17	12.20	16.60	
	23173	715.3	-16.01	30.17	12.01	15.89	
	23017	699.7	-21.79	32.03	8.09	6.44	V
	23095	707.5	-21.36	31.98	8.47	7.03	
	23173	715.3	-21.71	32.06	8.20	6.61	

Note: ERP (dBm) = Reading (dBm) + Correction Factor (dB) – 2.15

LTE Band 12							
Channel Bandwidth: 3 MHz / QPSK							
Plane	Channel	Frequency (MHz)	Reading (dBm)	Correction Factor (dB)	ERP (dBm)	ERP (mW)	Polarization (H/V)
NB	23025	700.5	-13.58	30.17	14.44	27.80	H
	23095	707.5	-13.33	30.17	14.69	29.44	
	23165	714.5	-13.52	30.18	14.51	28.25	
	23025	700.5	-19.24	31.96	10.57	11.40	V
	23095	707.5	-19.12	31.98	10.71	11.78	
	23165	714.5	-19.22	32.03	10.66	11.64	
Channel Bandwidth: 3 MHz / 16QAM							
NB	23025	700.5	-14.72	30.17	13.30	21.38	H
	23095	707.5	-14.38	30.17	13.64	23.12	
	23165	714.5	-14.60	30.18	13.43	22.03	
	23025	700.5	-20.43	31.96	9.38	8.67	V
	23095	707.5	-19.96	31.98	9.87	9.71	
	23165	714.5	-20.36	32.03	9.52	8.95	
Channel Bandwidth: 3 MHz / 64QAM							
NB	23025	700.5	-15.78	30.17	12.24	16.75	H
	23095	707.5	-15.55	30.17	12.47	17.66	
	23165	714.5	-15.76	30.18	12.27	16.87	
	23025	700.5	-21.50	31.96	8.31	6.78	V
	23095	707.5	-21.09	31.98	8.74	7.48	
	23165	714.5	-21.47	32.03	8.41	6.93	

Note: ERP (dBm) = Reading (dBm) + Correction Factor (dB) – 2.15

LTE Band 12							
Channel Bandwidth: 5 MHz / QPSK							
Plane	Channel	Frequency (MHz)	Reading (dBm)	Correction Factor (dB)	ERP (dBm)	ERP (mW)	Polarization (H/V)
NB	23035	701.5	-13.30	30.17	14.72	29.65	H
	23095	707.5	-13.00	30.17	15.02	31.77	
	23155	713.5	-13.23	30.18	14.80	30.20	
	23035	701.5	-18.96	31.96	10.85	12.16	V
	23095	707.5	-18.82	31.98	11.01	12.62	
	23155	713.5	-18.91	32.03	10.97	12.50	
Channel Bandwidth: 5 MHz / 16QAM							
NB	23035	701.5	-14.41	30.17	13.61	22.96	H
	23095	707.5	-14.15	30.17	13.87	24.38	
	23155	713.5	-14.34	30.18	13.69	23.39	
	23035	701.5	-20.12	31.96	9.69	9.31	V
	23095	707.5	-19.73	31.98	10.10	10.23	
	23155	713.5	-20.12	32.03	9.76	9.46	
Channel Bandwidth: 5 MHz / 64QAM							
NB	23035	701.5	-15.50	30.17	12.52	17.86	H
	23095	707.5	-15.34	30.17	12.68	18.54	
	23155	713.5	-15.48	30.18	12.55	17.99	
	23035	701.5	-21.27	31.96	8.54	7.14	V
	23095	707.5	-20.89	31.98	8.94	7.83	
	23155	713.5	-21.18	32.03	8.70	7.41	

Note: ERP (dBm) = Reading (dBm) + Correction Factor (dB) – 2.15

LTE Band 12							
Channel Bandwidth: 10 MHz / QPSK							
Plane	Channel	Frequency (MHz)	Reading (dBm)	Correction Factor (dB)	ERP (dBm)	ERP (mW)	Polarization (H/V)
NB	23060	704.0	-12.95	30.17	15.07	32.14	H
	23095	707.5	-12.80	30.17	15.22	33.27	
	23130	711.0	-12.89	30.18	15.14	32.66	
	23060	704.0	-18.71	31.96	11.10	12.88	V
	23095	707.5	-18.56	31.98	11.27	13.40	
	23130	711.0	-18.69	32.03	11.19	13.15	
Channel Bandwidth: 10 MHz / 16QAM							
NB	23060	704.0	-14.13	30.17	13.89	24.49	H
	23095	707.5	-13.94	30.17	14.08	25.59	
	23130	711.0	-14.11	30.18	13.92	24.66	
	23060	704.0	-19.87	31.96	9.94	9.86	V
	23095	707.5	-19.53	31.98	10.30	10.72	
	23130	711.0	-19.83	32.03	10.05	10.12	
Channel Bandwidth: 10 MHz / 64QAM							
NB	23060	704.0	-15.22	30.17	12.80	19.05	H
	23095	707.5	-15.10	30.17	12.92	19.59	
	23130	711.0	-15.21	30.18	12.82	19.14	
	23060	704.0	-20.91	31.96	8.90	7.76	V
	23095	707.5	-20.65	31.98	9.18	8.28	
	23130	711.0	-20.97	32.03	8.91	7.78	

Note: ERP (dBm) = Reading (dBm) + Correction Factor (dB) – 2.15

LTE Band 13							
Channel Bandwidth: 5 MHz / QPSK							
Plane	Channel	Frequency (MHz)	Reading (dBm)	Correction Factor (dB)	ERP (dBm)	ERP (mW)	Polarization (H/V)
NB	23205	779.5	-18.13	32.24	11.96	15.70	H
	23230	782.0	-17.83	32.17	12.19	16.56	
	23255	784.5	-17.88	32.11	12.08	16.14	
	23205	779.5	-14.69	32.43	15.59	36.22	V
	23230	782.0	-14.53	32.42	15.74	37.50	
	23255	784.5	-14.64	32.46	15.67	36.90	
Channel Bandwidth: 5 MHz / 16QAM							
NB	23205	779.5	-18.84	32.24	11.25	13.34	H
	23230	782.0	-18.65	32.17	11.37	13.71	
	23255	784.5	-18.66	32.11	11.30	13.49	
	23205	779.5	-15.73	32.43	14.55	28.51	V
	23230	782.0	-15.59	32.42	14.68	29.38	
	23255	784.5	-15.70	32.46	14.61	28.91	
Channel Bandwidth: 5 MHz / 64QAM							
NB	23205	779.5	-19.96	32.24	10.13	10.30	H
	23230	782.0	-19.72	32.17	10.30	10.72	
	23255	784.5	-19.75	32.11	10.21	10.50	
	23205	779.5	-16.79	32.43	13.49	22.34	V
	23230	782.0	-16.58	32.42	13.69	23.39	
	23255	784.5	-16.71	32.46	13.60	22.91	

Note: ERP (dBm) = Reading (dBm) + Correction Factor (dB) – 2.15

LTE Band 13							
Channel Bandwidth: 10 MHz / QPSK							
Plane	Channel	Frequency (MHz)	Reading (dBm)	Correction Factor (dB)	ERP (dBm)	ERP (mW)	Polarization (H/V)
NB	23230	782.0	-17.48	32.17	12.54	17.95	H
	23230	782.0	-14.30	32.42	15.97	39.54	V
Channel Bandwidth: 10 MHz / 16QAM							
NB	23230	782.0	-18.45	32.17	11.57	14.35	H
	23230	782.0	-15.28	32.42	14.99	31.55	V
Channel Bandwidth: 10 MHz / 64QAM							
NB	23230	782.0	-19.47	32.17	10.55	11.35	H
	23230	782.0	-16.32	32.42	13.95	24.83	V

Note: ERP (dBm) = Reading (dBm) + Correction Factor (dB) – 2.15

LTE Band 17							
Channel Bandwidth: 5 MHz / QPSK							
Plane	Channel	Frequency (MHz)	Reading (dBm)	Correction Factor (dB)	ERP (dBm)	ERP (mW)	Polarization (H/V)
NB	23755	706.5	-16.83	30.36	11.38	13.74	H
	23790	710.0	-16.60	30.17	11.42	13.87	
	23825	713.5	-16.74	30.17	11.28	13.43	
	23755	706.5	-14.91	32.03	14.97	31.41	V
	23790	710.0	-14.72	31.98	15.11	32.43	
	23825	713.5	-15.02	32.06	14.89	30.83	
Channel Bandwidth: 5 MHz / 16QAM							
NB	23755	706.5	-17.86	30.36	10.35	10.84	H
	23790	710.0	-17.56	30.17	10.46	11.12	
	23825	713.5	-17.90	30.17	10.12	10.28	
	23755	706.5	-15.99	32.03	13.89	24.49	V
	23790	710.0	-15.89	31.98	13.94	24.77	
	23825	713.5	-16.05	32.06	13.86	24.32	
Channel Bandwidth: 5 MHz / 64QAM							
NB	23755	706.5	-18.95	30.36	9.26	8.43	H
	23790	710.0	-18.64	30.17	9.38	8.67	
	23825	713.5	-18.85	30.17	9.17	8.26	
	23755	706.5	-17.01	32.03	12.87	19.36	V
	23790	710.0	-16.87	31.98	12.96	19.77	
	23825	713.5	-17.09	32.06	12.82	19.14	

Note: ERP (dBm) = Reading (dBm) + Correction Factor (dB) – 2.15

LTE Band 17							
Channel Bandwidth: 10 MHz / QPSK							
Plane	Channel	Frequency (MHz)	Reading (dBm)	Correction Factor (dB)	ERP (dBm)	ERP (mW)	Polarization (H/V)
NB	23780	709.0	-16.40	30.17	11.62	14.52	H
	23790	710.0	-16.31	30.17	11.71	14.83	
	23800	711.0	-16.50	30.18	11.53	14.22	
	23780	709.0	-14.56	31.96	15.25	33.50	V
	23790	710.0	-14.51	31.98	15.32	34.04	
	23800	711.0	-14.69	32.03	15.19	33.04	
Channel Bandwidth: 10 MHz / 16QAM							
NB	23780	709.0	-17.41	30.17	10.61	11.51	H
	23790	710.0	-17.33	30.17	10.69	11.72	
	23800	711.0	-17.58	30.18	10.45	11.09	
	23780	709.0	-15.69	31.96	14.12	25.82	V
	23790	710.0	-15.59	31.98	14.24	26.55	
	23800	711.0	-15.84	32.03	14.04	25.35	
Channel Bandwidth: 10 MHz / 64QAM							
NB	23780	709.0	-18.50	30.17	9.52	8.95	H
	23790	710.0	-18.44	30.17	9.58	9.08	
	23800	711.0	-18.61	30.18	9.42	8.75	
	23780	709.0	-16.71	31.96	13.10	20.42	V
	23790	710.0	-16.63	31.98	13.20	20.89	
	23800	711.0	-16.83	32.03	13.05	20.18	

Note: ERP (dBm) = Reading (dBm) + Correction Factor (dB) – 2.15

EIRP Power (dBm)

WCDMA							
Plane	Channel	Frequency (MHz)	Reading (dBm)	Correction Factor (dB)	EIRP (dBm)	EIRP (mW)	Polarization (H/V)
NB	1312	1712.4	-24.88	36.29	11.41	13.84	H
	1413	1732.6	-25.11	36.69	11.58	14.39	
	1513	1752.6	-25.31	36.98	11.67	14.69	
	1312	1712.4	-19.80	37.11	17.31	53.83	V
	1413	1732.6	-20.17	37.60	17.43	55.34	
	1513	1752.6	-20.13	37.65	17.52	56.49	

Note: EIRP (dBm) = Reading (dBm) + Correction Factor (dB)

LTE Band 4							
Channel Bandwidth: 1.4 MHz / QPSK							
Plane	Channel	Frequency (MHz)	Reading (dBm)	Correction Factor (dB)	EIRP (dBm)	EIRP (mW)	Polarization (H/V)
NB	19957	1710.7	-26.37	36.45	10.08	10.19	H
	20175	1732.5	-26.77	36.80	10.03	10.07	
	20393	1754.3	-26.79	36.94	10.15	10.35	
	19957	1710.7	-21.34	37.28	15.94	39.26	V
	20175	1732.5	-21.79	37.63	15.84	38.37	
	20393	1754.3	-21.58	37.64	16.06	40.36	
Channel Bandwidth: 1.4 MHz / 16QAM							
NB	19957	1710.7	-27.28	36.45	9.17	8.26	H
	20175	1732.5	-27.84	36.80	8.96	7.87	
	20393	1754.3	-27.64	36.94	9.30	8.51	
	19957	1710.7	-22.42	37.28	14.86	30.62	V
	20175	1732.5	-23.09	37.63	14.54	28.44	
	20393	1754.3	-22.73	37.64	14.91	30.97	
Channel Bandwidth: 1.4 MHz / 64QAM							
NB	19957	1710.7	-28.51	36.45	7.94	6.22	H
	20175	1732.5	-28.93	36.80	7.87	6.12	
	20393	1754.3	-28.84	36.94	8.10	6.46	
	19957	1710.7	-23.39	37.28	13.89	24.49	V
	20175	1732.5	-24.01	37.63	13.62	23.01	
	20393	1754.3	-23.64	37.64	14.00	25.12	

Note: EIRP (dBm) = Reading (dBm) + Correction Factor (dB)

LTE Band 4							
Channel Bandwidth: 3 MHz / QPSK							
Plane	Channel	Frequency (MHz)	Reading (dBm)	Correction Factor (dB)	EIRP (dBm)	EIRP (mW)	Polarization (H/V)
NB	19965	1711.5	-26.07	36.45	10.38	10.91	H
	20175	1732.5	-26.48	36.80	10.32	10.76	
	20385	1753.5	-26.54	36.94	10.40	10.96	
	19965	1711.5	-21.07	37.28	16.21	41.78	V
	20175	1732.5	-21.59	37.63	16.04	40.18	
	20385	1753.5	-21.36	37.64	16.28	42.46	
Channel Bandwidth: 3 MHz / 16QAM							
NB	19965	1711.5	-27.05	36.45	9.40	8.71	H
	20175	1732.5	-27.55	36.80	9.25	8.41	
	20385	1753.5	-27.40	36.94	9.54	8.99	
	19965	1711.5	-22.14	37.28	15.14	32.66	V
	20175	1732.5	-22.79	37.63	14.84	30.48	
	20385	1753.5	-22.45	37.64	15.19	33.04	
Channel Bandwidth: 3 MHz / 64QAM							
NB	19965	1711.5	-28.25	36.45	8.20	6.61	H
	20175	1732.5	-28.61	36.80	8.19	6.59	
	20385	1753.5	-28.58	36.94	8.36	6.85	
	19965	1711.5	-23.10	37.28	14.18	26.18	V
	20175	1732.5	-23.69	37.63	13.94	24.77	
	20385	1753.5	-23.36	37.64	14.28	26.79	

Note: EIRP (dBm) = Reading (dBm) + Correction Factor (dB)

LTE Band 4							
Channel Bandwidth: 5 MHz / QPSK							
Plane	Channel	Frequency (MHz)	Reading (dBm)	Correction Factor (dB)	EIRP (dBm)	EIRP (mW)	Polarization (H/V)
NB	19975	1712.5	-25.79	36.45	10.66	11.64	H
	20175	1732.5	-26.27	36.80	10.53	11.30	
	20375	1752.5	-26.19	36.94	10.75	11.89	
	19975	1712.5	-20.79	37.28	16.49	44.57	V
	20175	1732.5	-21.32	37.63	16.31	42.76	
	20375	1752.5	-21.01	37.64	16.63	46.03	
Channel Bandwidth: 5 MHz / 16QAM							
NB	19975	1712.5	-26.85	36.45	9.60	9.12	H
	20175	1732.5	-27.26	36.80	9.54	8.99	
	20375	1752.5	-27.15	36.94	9.79	9.53	
	19975	1712.5	-21.82	37.28	15.46	35.16	V
	20175	1732.5	-22.48	37.63	15.15	32.73	
	20375	1752.5	-22.15	37.64	15.49	35.40	
Channel Bandwidth: 5 MHz / 64QAM							
NB	19975	1712.5	-27.99	36.45	8.46	7.01	H
	20175	1732.5	-28.39	36.80	8.41	6.93	
	20375	1752.5	-28.32	36.94	8.62	7.28	
	19975	1712.5	-22.90	37.28	14.38	27.42	V
	20175	1732.5	-23.43	37.63	14.20	26.30	
	20375	1752.5	-23.10	37.64	14.54	28.44	

Note: EIRP (dBm) = Reading (dBm) + Correction Factor (dB)

LTE Band 4							
Channel Bandwidth: 10 MHz / QPSK							
Plane	Channel	Frequency (MHz)	Reading (dBm)	Correction Factor (dB)	EIRP (dBm)	EIRP (mW)	Polarization (H/V)
NB	20000	1715.0	-25.68	36.64	10.96	12.47	H
	20175	1732.5	-26.02	36.80	10.78	11.97	
	20350	1750.0	-25.73	36.80	11.07	12.79	
	20000	1715.0	-20.64	37.44	16.80	47.86	V
	20175	1732.5	-20.97	37.63	16.66	46.34	
	20350	1750.0	-20.73	37.64	16.91	49.09	
Channel Bandwidth: 10 MHz / 16QAM							
NB	20000	1715.0	-26.78	36.64	9.86	9.68	H
	20175	1732.5	-26.96	36.80	9.84	9.64	
	20350	1750.0	-26.78	36.80	10.02	10.05	
	20000	1715.0	-21.76	37.44	15.68	36.98	V
	20175	1732.5	-22.19	37.63	15.44	34.99	
	20350	1750.0	-21.88	37.64	15.76	37.67	
Channel Bandwidth: 10 MHz / 64QAM							
NB	20000	1715.0	-27.89	36.64	8.75	7.50	H
	20175	1732.5	-28.11	36.80	8.69	7.40	
	20350	1750.0	-27.97	36.80	8.83	7.64	
	20000	1715.0	-22.86	37.44	14.58	28.71	V
	20175	1732.5	-23.11	37.63	14.52	28.31	
	20350	1750.0	-22.89	37.64	14.75	29.85	

Note: EIRP (dBm) = Reading (dBm) + Correction Factor (dB)

LTE Band 4							
Channel Bandwidth: 15 MHz / QPSK							
Plane	Channel	Frequency (MHz)	Reading (dBm)	Correction Factor (dB)	EIRP (dBm)	EIRP (mW)	Polarization (H/V)
NB	20025	1717.5	-25.20	36.45	11.25	13.34	H
	20175	1732.5	-25.74	36.80	11.06	12.76	
	20325	1747.5	-25.65	36.94	11.29	13.46	
	20025	1717.5	-20.26	37.28	17.02	50.35	V
	20175	1732.5	-20.70	37.63	16.93	49.32	
	20325	1747.5	-20.52	37.64	17.12	51.52	
Channel Bandwidth: 15 MHz / 16QAM							
NB	20025	1717.5	-26.31	36.45	10.14	10.33	H
	20175	1732.5	-26.74	36.80	10.06	10.14	
	20325	1747.5	-26.72	36.94	10.22	10.52	
	20025	1717.5	-21.25	37.28	16.03	40.09	V
	20175	1732.5	-21.89	37.63	15.74	37.50	
	20325	1747.5	-21.58	37.64	16.06	40.36	
Channel Bandwidth: 15 MHz / 64QAM							
NB	20025	1717.5	-27.45	36.45	9.00	7.94	H
	20175	1732.5	-27.86	36.80	8.94	7.83	
	20325	1747.5	-27.80	36.94	9.14	8.20	
	20025	1717.5	-22.40	37.28	14.88	30.76	V
	20175	1732.5	-22.91	37.63	14.72	29.65	
	20325	1747.5	-22.61	37.64	15.03	31.84	

Note: EIRP (dBm) = Reading (dBm) + Correction Factor (dB)

LTE Band 4							
Channel Bandwidth: 20 MHz / QPSK							
Plane	Channel	Frequency (MHz)	Reading (dBm)	Correction Factor (dB)	EIRP (dBm)	EIRP (mW)	Polarization (H/V)
NB	20050	1720.0	-24.97	36.45	11.48	14.06	H
	20175	1732.5	-25.39	36.80	11.41	13.84	
	20300	1745.0	-25.39	36.94	11.55	14.29	
	20050	1720.0	-19.96	37.28	17.32	53.95	V
	20175	1732.5	-20.35	37.63	17.28	53.46	
	20300	1745.0	-20.27	37.64	17.37	54.58	
Channel Bandwidth: 20 MHz / 16QAM							
NB	20050	1720.0	-26.00	36.45	10.45	11.09	H
	20175	1732.5	-26.50	36.80	10.30	10.72	
	20300	1745.0	-26.39	36.94	10.55	11.35	
	20050	1720.0	-20.97	37.28	16.31	42.76	V
	20175	1732.5	-21.57	37.63	16.06	40.36	
	20300	1745.0	-21.29	37.64	16.35	43.15	
Channel Bandwidth: 20 MHz / 64QAM							
NB	20050	1720.0	-27.13	36.45	9.32	8.55	H
	20175	1732.5	-27.64	36.80	9.16	8.24	
	20300	1745.0	-27.54	36.94	9.40	8.71	
	20050	1720.0	-22.08	37.28	15.20	33.11	V
	20175	1732.5	-22.59	37.63	15.04	31.92	
	20300	1745.0	-22.40	37.64	15.24	33.42	

Note: EIRP (dBm) = Reading (dBm) + Correction Factor (dB)

LTE Band 66							
Channel Bandwidth: 1.4 MHz / QPSK							
Plane	Channel	Frequency (MHz)	Reading (dBm)	Correction Factor (dB)	EIRP (dBm)	EIRP (mW)	Polarization (H/V)
NB	131979	1710.7	-27.65	36.45	8.80	7.59	H
	132322	1745.0	-27.50	36.80	9.30	8.51	
	132665	1779.3	-27.81	36.94	9.13	8.18	
	131979	1710.7	-20.59	37.28	16.69	46.67	V
	132322	1745.0	-20.80	37.63	16.83	48.19	
	132665	1779.3	-20.85	37.64	16.79	47.75	
Channel Bandwidth: 1.4 MHz / 16QAM							
NB	131979	1710.7	-28.64	36.45	7.81	6.04	H
	132322	1745.0	-28.49	36.80	8.31	6.78	
	132665	1779.3	-28.80	36.94	8.14	6.52	
	131979	1710.7	-21.58	37.28	15.70	37.15	V
	132322	1745.0	-21.79	37.63	15.84	38.37	
	132665	1779.3	-21.84	37.64	15.80	38.02	
Channel Bandwidth: 1.4 MHz / 64QAM							
NB	131979	1710.7	-29.69	36.45	6.76	4.74	H
	132322	1745.0	-29.54	36.80	7.26	5.32	
	132665	1779.3	-29.85	36.94	7.09	5.12	
	131979	1710.7	-22.63	37.28	14.65	29.17	V
	132322	1745.0	-22.84	37.63	14.79	30.13	
	132665	1779.3	-22.89	37.64	14.75	29.85	

Note: EIRP (dBm) = Reading (dBm) + Correction Factor (dB)

LTE Band 66							
Channel Bandwidth: 3 MHz / QPSK							
Plane	Channel	Frequency (MHz)	Reading (dBm)	Correction Factor (dB)	EIRP (dBm)	EIRP (mW)	Polarization (H/V)
NB	131987	1711.5	-27.39	36.45	9.06	8.05	H
	132322	1745.0	-27.24	36.80	9.56	9.04	
	132657	1778.5	-27.55	36.94	9.39	8.69	
	131987	1711.5	-20.33	37.28	16.95	49.55	V
	132322	1745.0	-20.54	37.63	17.09	51.17	
	132657	1778.5	-20.59	37.64	17.05	50.70	
Channel Bandwidth: 3 MHz / 16QAM							
NB	131987	1711.5	-28.38	36.45	8.07	6.41	H
	132322	1745.0	-28.23	36.80	8.57	7.19	
	132657	1778.5	-28.54	36.94	8.40	6.92	
	131987	1711.5	-21.32	37.28	15.96	39.45	V
	132322	1745.0	-21.53	37.63	16.10	40.74	
	132657	1778.5	-21.58	37.64	16.06	40.36	
Channel Bandwidth: 3 MHz / 64QAM							
NB	131987	1711.5	-29.43	36.45	7.02	5.04	H
	132322	1745.0	-29.28	36.80	7.52	5.65	
	132657	1778.5	-29.59	36.94	7.35	5.43	
	131987	1711.5	-22.37	37.28	14.91	30.97	V
	132322	1745.0	-22.58	37.63	15.05	31.99	
	132657	1778.5	-22.63	37.64	15.01	31.70	

Note: EIRP (dBm) = Reading (dBm) + Correction Factor (dB)

LTE Band 66							
Channel Bandwidth: 5 MHz / QPSK							
Plane	Channel	Frequency (MHz)	Reading (dBm)	Correction Factor (dB)	EIRP (dBm)	EIRP (mW)	Polarization (H/V)
NB	131997	1712.5	-27.15	36.45	9.30	8.51	H
	132322	1745.0	-27.00	36.80	9.80	9.55	
	132647	1777.5	-27.31	36.94	9.63	9.18	
	131997	1712.5	-20.09	37.28	17.19	52.36	V
	132322	1745.0	-20.30	37.63	17.33	54.08	
	132647	1777.5	-20.35	37.64	17.29	53.58	
Channel Bandwidth: 5 MHz / 16QAM							
NB	131997	1712.5	-28.13	36.45	8.32	6.79	H
	132322	1745.0	-27.98	36.80	8.82	7.62	
	132647	1777.5	-28.29	36.94	8.65	7.33	
	131997	1712.5	-21.07	37.28	16.21	41.78	V
	132322	1745.0	-21.28	37.63	16.35	43.15	
	132647	1777.5	-21.33	37.64	16.31	42.76	
Channel Bandwidth: 5 MHz / 64QAM							
NB	131997	1712.5	-29.19	36.45	7.26	5.32	H
	132322	1745.0	-29.04	36.80	7.76	5.97	
	132647	1777.5	-29.35	36.94	7.59	5.74	
	131997	1712.5	-22.13	37.28	15.15	32.73	V
	132322	1745.0	-22.34	37.63	15.29	33.81	
	132647	1777.5	-22.39	37.64	15.25	33.50	

Note: EIRP (dBm) = Reading (dBm) + Correction Factor (dB)

LTE Band 66							
Channel Bandwidth: 10 MHz / QPSK							
Plane	Channel	Frequency (MHz)	Reading (dBm)	Correction Factor (dB)	EIRP (dBm)	EIRP (mW)	Polarization (H/V)
NB	132022	1715.0	-27.09	36.64	9.55	9.02	H
	132322	1745.0	-26.75	36.80	10.05	10.12	
	132622	1775.0	-26.92	36.80	9.88	9.73	
	132022	1715.0	-20.00	37.44	17.44	55.46	V
	132322	1745.0	-20.05	37.63	17.58	57.28	
	132622	1775.0	-20.10	37.64	17.54	56.75	
Channel Bandwidth: 10 MHz / 16QAM							
NB	132022	1715.0	-28.08	36.64	8.56	7.18	H
	132322	1745.0	-27.74	36.80	9.06	8.05	
	132622	1775.0	-27.91	36.80	8.89	7.74	
	132022	1715.0	-20.99	37.44	16.45	44.16	V
	132322	1745.0	-21.04	37.63	16.59	45.60	
	132622	1775.0	-21.09	37.64	16.55	45.19	
Channel Bandwidth: 10 MHz / 64QAM							
NB	132022	1715.0	-29.15	36.64	7.49	5.61	H
	132322	1745.0	-28.81	36.80	7.99	6.30	
	132622	1775.0	-28.98	36.80	7.82	6.05	
	132022	1715.0	-22.06	37.44	15.38	34.51	V
	132322	1745.0	-22.11	37.63	15.52	35.65	
	132622	1775.0	-22.16	37.64	15.48	35.32	

Note: EIRP (dBm) = Reading (dBm) + Correction Factor (dB)

LTE Band 66							
Channel Bandwidth: 15 MHz / QPSK							
Plane	Channel	Frequency (MHz)	Reading (dBm)	Correction Factor (dB)	EIRP (dBm)	EIRP (mW)	Polarization (H/V)
NB	132047	1717.5	-26.66	36.45	9.79	9.53	H
	132322	1745.0	-26.51	36.80	10.29	10.69	
	132597	1772.5	-26.82	36.94	10.12	10.28	
	132047	1717.5	-19.60	37.28	17.68	58.61	V
	132322	1745.0	-19.81	37.63	17.82	60.53	
	132597	1772.5	-19.86	37.64	17.78	59.98	
Channel Bandwidth: 15 MHz / 16QAM							
NB	132047	1717.5	-27.68	36.45	8.77	7.53	H
	132322	1745.0	-27.53	36.80	9.27	8.45	
	132597	1772.5	-27.84	36.94	9.10	8.13	
	132047	1717.5	-20.62	37.28	16.66	46.34	V
	132322	1745.0	-20.83	37.63	16.80	47.86	
	132597	1772.5	-20.88	37.64	16.76	47.42	
Channel Bandwidth: 15 MHz / 64QAM							
NB	132047	1717.5	-28.72	36.45	7.73	5.93	H
	132322	1745.0	-28.57	36.80	8.23	6.65	
	132597	1772.5	-28.88	36.94	8.06	6.40	
	132047	1717.5	-21.66	37.28	15.62	36.48	V
	132322	1745.0	-21.87	37.63	15.76	37.67	
	132597	1772.5	-21.92	37.64	15.72	37.33	

Note: EIRP (dBm) = Reading (dBm) + Correction Factor (dB)

LTE Band 66							
Channel Bandwidth: 20 MHz / QPSK							
Plane	Channel	Frequency (MHz)	Reading (dBm)	Correction Factor (dB)	EIRP (dBm)	EIRP (mW)	Polarization (H/V)
NB	132072	1720.0	-26.43	36.45	10.02	10.05	H
	132322	1745.0	-26.28	36.80	10.52	11.27	
	132572	1770.0	-26.59	36.94	10.35	10.84	
	132072	1720.0	-19.37	37.28	17.91	61.80	V
	132322	1745.0	-19.58	37.63	18.05	63.83	
	132572	1770.0	-19.63	37.64	18.01	63.24	
Channel Bandwidth: 20 MHz / 16QAM							
NB	132072	1720.0	-27.45	36.45	9.00	7.94	H
	132322	1745.0	-27.30	36.80	9.50	8.91	
	132572	1770.0	-27.61	36.94	9.33	8.57	
	132072	1720.0	-20.39	37.28	16.89	48.87	V
	132322	1745.0	-20.60	37.63	17.03	50.47	
	132572	1770.0	-20.65	37.64	16.99	50.00	
Channel Bandwidth: 20 MHz / 64QAM							
NB	132072	1720.0	-28.47	36.45	7.98	6.28	H
	132322	1745.0	-28.32	36.80	8.48	7.05	
	132572	1770.0	-28.63	36.94	8.31	6.78	
	132072	1720.0	-21.41	37.28	15.87	38.64	V
	132322	1745.0	-21.62	37.63	16.01	39.90	
	132572	1770.0	-21.67	37.64	15.97	39.54	

Note: EIRP (dBm) = Reading (dBm) + Correction Factor (dB)

4.2 Modulation Characteristics Measurement

4.2.1 Limits of Modulation Characteristics

N/A

4.2.2 Test Setup



4.2.3 Test Procedure

Connect the EUT to Communication Simulator via the antenna connector. The frequency band is set as EUT supported Modulation and Channels, the EUT output is matched with 50 ohm load, the waveform quality and constellation of the EUT was tested.

4.2.4 Test Results

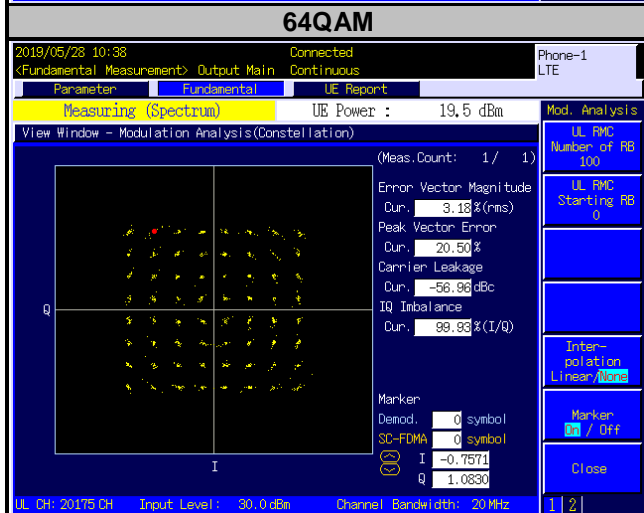
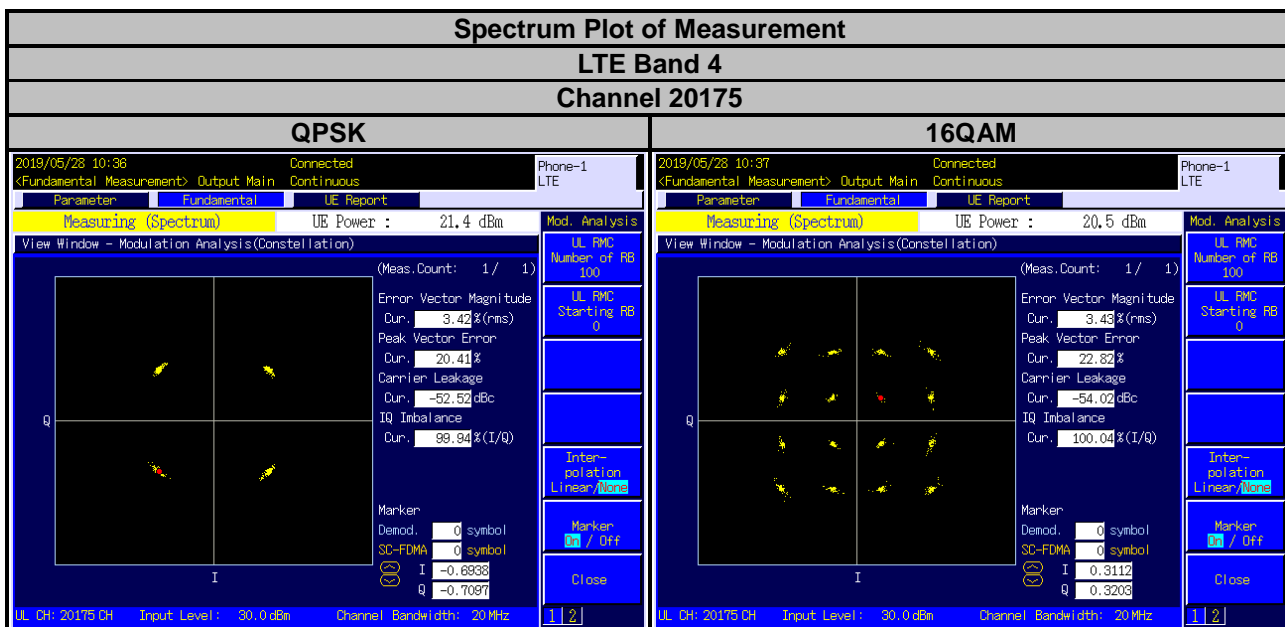
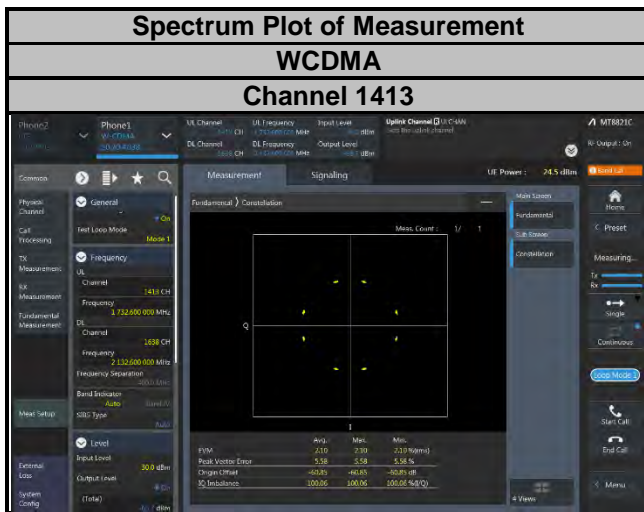

LTE Band 12
Channel 23095

QPSK

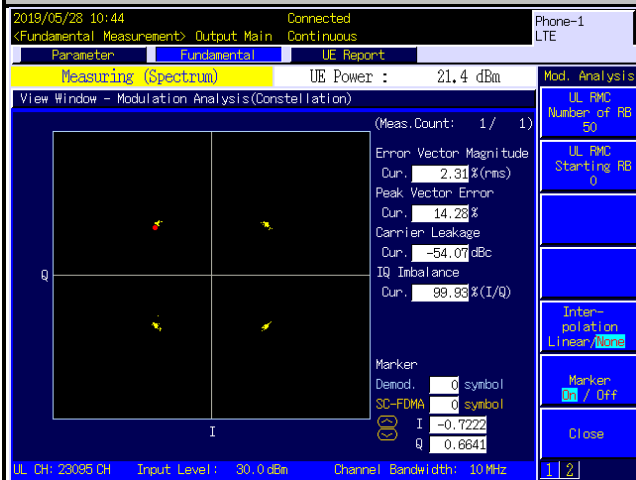

16QAM

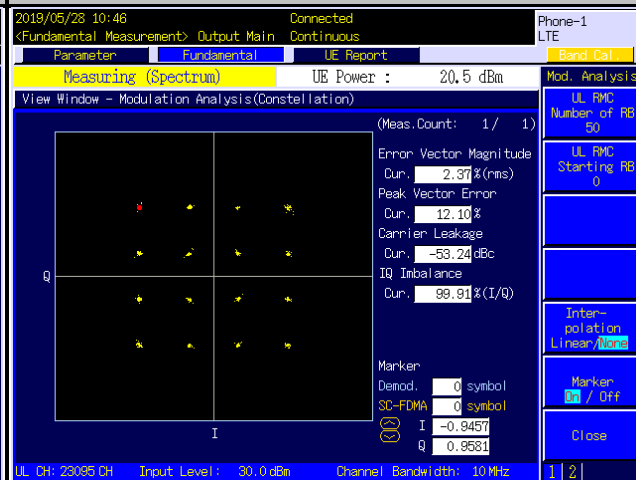

64QAM

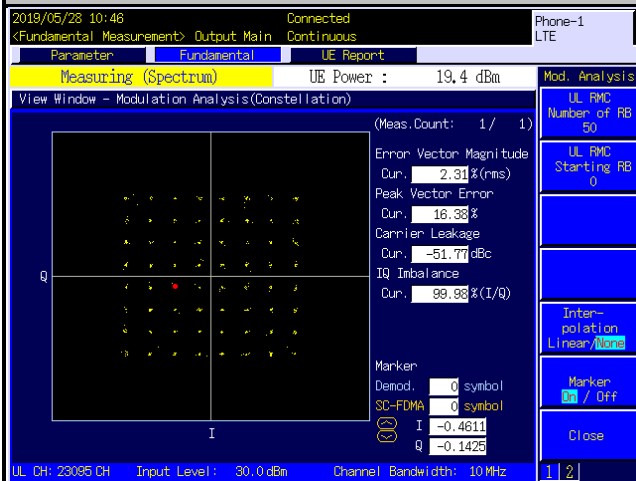

Spectrum Plot of Measurement

LTE Band 13

Channel 23230

QPSK

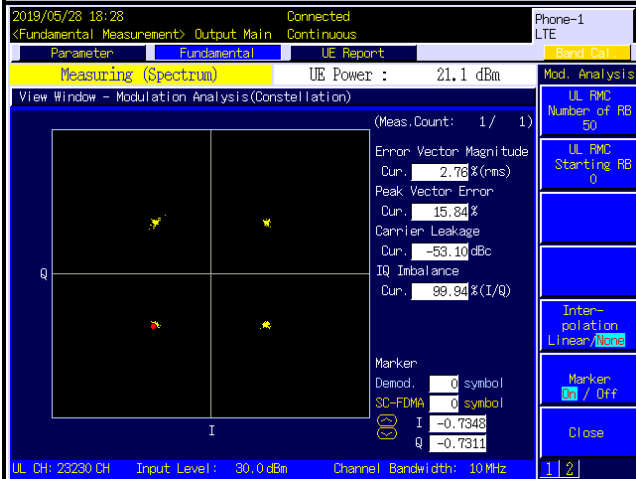

16QAM

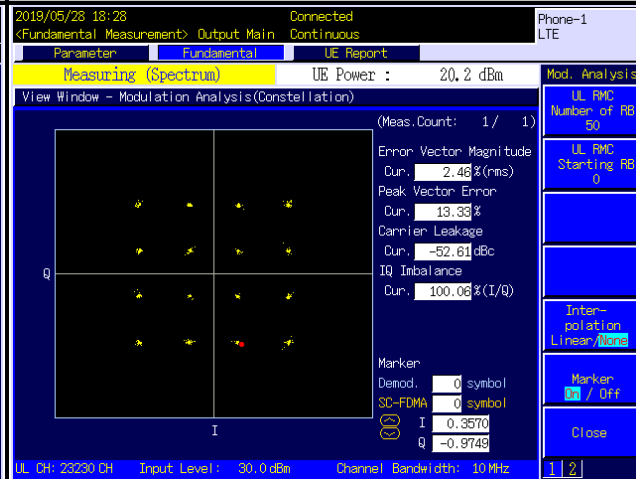

64QAM

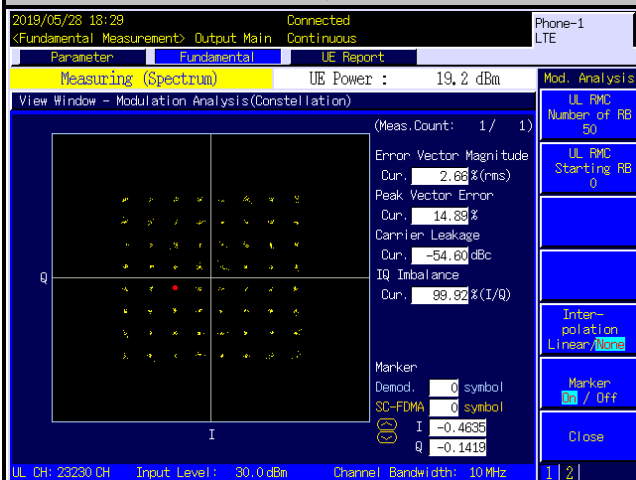

**LTE Band 17
Channel 23790**

QPSK

16QAM

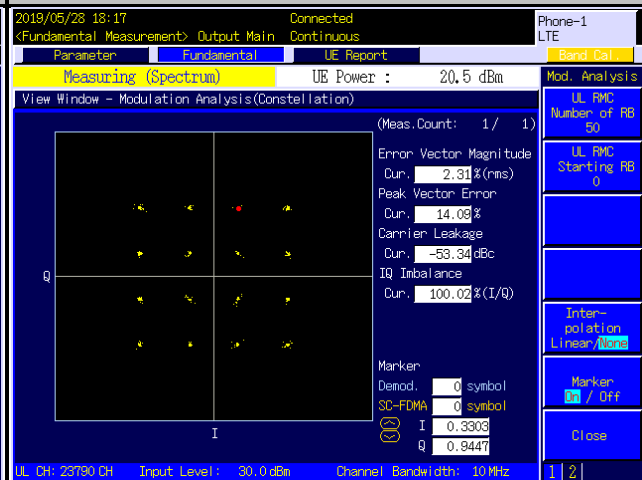
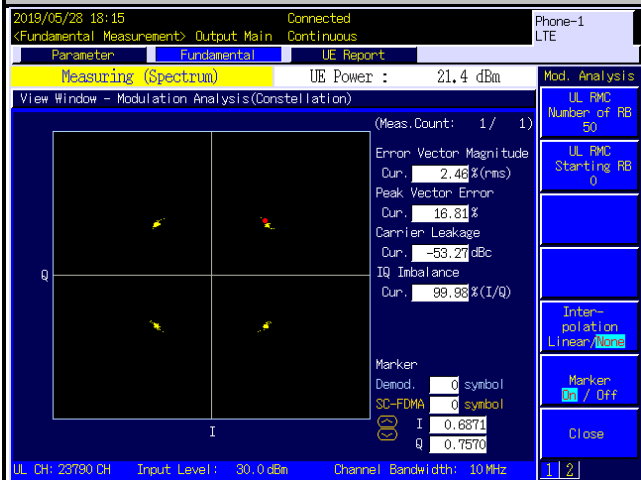

64QAM

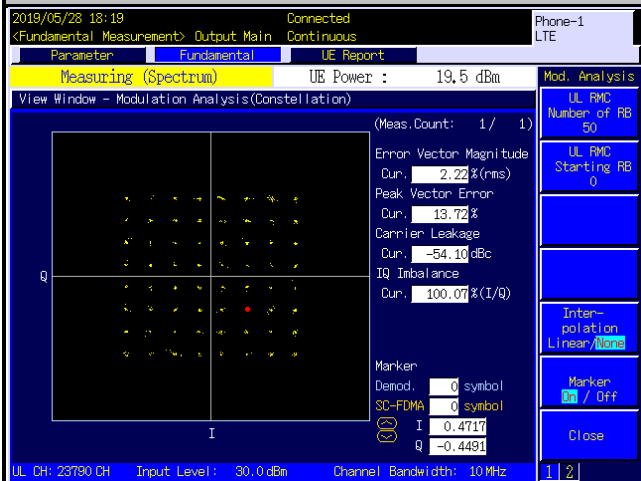



4.3 Frequency Stability Measurement

4.3.1 Limits of Frequency Stability Measurement

The frequency stability shall be sufficient to ensure that the fundamental emissions stay within the authorized bands of operation.

4.3.2 Test Procedure

- Device is placed at the oven room. The oven room could control the temperatures and humidity. Power warm up is at least 15 min and power applied should perform before recording frequency error.
- EUT is connected the external power supply to control the DC input power. The test voltage range is from minimum to maximum working voltage. Each step shall be record the frequency error rate.
- The temperature range step is 10 degrees in this test items. All temperature levels shall be hold the $\pm 0.5^{\circ}\text{C}$ during the measurement testing. The each temperature step shall be at least 0.5 hours, consider the EUT could be test under the stability condition.

Note: The frequency error was recorded frequency error from the communication simulator.

4.3.3 Test Setup

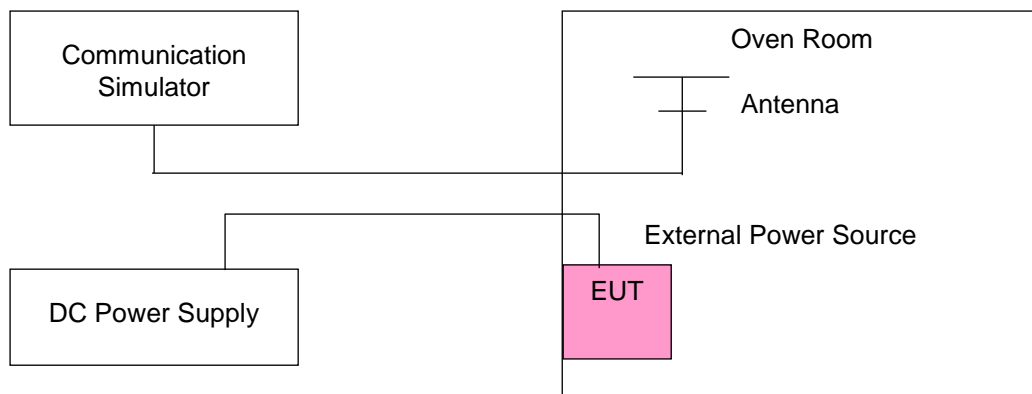

4.3.4 Test Results

Frequency Error vs. Voltage

Voltage (Volts)	WCDMA			
	Low Channel		High Channel	
	Frequency (MHz)	Frequency Error (ppm)	Frequency (MHz)	Frequency Error (ppm)
120	1712.400002	0.001	1752.600003	0.002
102	1712.400003	0.002	1752.600002	0.001
138	1712.400004	0.002	1752.600001	0.001

Note: The applicant defined the normal working voltage of the battery is from 102 Vac to 138 Vac.

Frequency Error vs. Temperature

Temp. (°C)	WCDMA			
	Low Channel		High Channel	
	Frequency (MHz)	Frequency Error (ppm)	Frequency (MHz)	Frequency Error (ppm)
-30	1712.400004	0.002	1752.600001	0.001
-20	1712.400002	0.001	1752.600003	0.001
-10	1712.400003	0.002	1752.600001	0.001
0	1712.400003	0.002	1752.600001	0.001
10	1712.400003	0.002	1752.600002	0.001
20	1712.399999	-0.001	1752.599998	-0.001
30	1712.399999	-0.001	1752.599997	-0.002
40	1712.399997	-0.002	1752.599999	-0.001
50	1712.399998	-0.001	1752.599999	-0.001

Frequency Error vs. Voltage

Voltage (Volts)	LTE Band 4			
	Channel Bandwidth: 1.4 MHz			
	Low Channel		High Channel	
	Frequency (MHz)	Frequency Error (ppm)	Frequency (MHz)	Frequency Error (ppm)
120	1710.700003	0.002	1754.300001	0.001
102	1710.700002	0.001	1754.300002	0.001
138	1710.700003	0.002	1754.300002	0.001

Note: The applicant defined the normal working voltage of the battery is from 102 Vac to 138 Vac.

Frequency Error vs. Temperature

Temp. (°C)	LTE Band 4			
	Channel Bandwidth: 1.4 MHz			
	Low Channel		High Channel	
	Frequency (MHz)	Frequency Error (ppm)	Frequency (MHz)	Frequency Error (ppm)
-30	1710.700003	0.002	1754.300003	0.002
-20	1710.700002	0.001	1754.300001	0.001
-10	1710.700002	0.001	1754.300002	0.001
0	1710.700002	0.001	1754.300004	0.002
10	1710.700002	0.001	1754.300002	0.001
20	1710.699998	-0.001	1754.299998	-0.001
30	1710.699999	-0.001	1754.299997	-0.002
40	1710.699999	-0.001	1754.299999	-0.001
50	1710.699998	-0.001	1754.299996	-0.002

Frequency Error vs. Voltage

Voltage (Volts)	LTE Band 4			
	Channel Bandwidth: 3 MHz			
	Low Channel		High Channel	
	Frequency (MHz)	Frequency Error (ppm)	Frequency (MHz)	Frequency Error (ppm)
120	1710.700004	0.002	1754.300003	0.002
102	1710.700003	0.001	1754.300003	0.002
138	1710.700003	0.002	1754.300002	0.001

Note: The applicant defined the normal working voltage of the battery is from 102 Vac to 138 Vac.

Frequency Error vs. Temperature

Temp. (°C)	LTE Band 4			
	Channel Bandwidth: 3 MHz			
	Low Channel		High Channel	
	Frequency (MHz)	Frequency Error (ppm)	Frequency (MHz)	Frequency Error (ppm)
-30	1710.700003	0.002	1754.300002	0.001
-20	1710.700003	0.002	1754.300002	0.001
-10	1710.700003	0.002	1754.300001	0.001
0	1710.700001	0.001	1754.300003	0.002
10	1710.700001	0.001	1754.300002	0.001
20	1710.699997	-0.002	1754.299999	-0.001
30	1710.699999	-0.001	1754.299997	-0.001
40	1710.699999	-0.001	1754.299997	-0.002
50	1710.699998	-0.001	1754.299999	-0.001

Frequency Error vs. Voltage

Voltage (Volts)	LTE Band 4			
	Channel Bandwidth: 5 MHz			
	Low Channel		High Channel	
	Frequency (MHz)	Frequency Error (ppm)	Frequency (MHz)	Frequency Error (ppm)
120	1710.700002	0.001	1754.300004	0.002
102	1710.700001	0.001	1754.300003	0.002
138	1710.700001	0.001	1754.300003	0.002

Note: The applicant defined the normal working voltage of the battery is from 102 Vac to 138 Vac.

Frequency Error vs. Temperature

Temp. (°C)	LTE Band 4			
	Channel Bandwidth: 5 MHz			
	Low Channel		High Channel	
	Frequency (MHz)	Frequency Error (ppm)	Frequency (MHz)	Frequency Error (ppm)
-30	1710.700003	0.002	1754.300003	0.002
-20	1710.700004	0.002	1754.300002	0.001
-10	1710.700002	0.001	1754.300004	0.002
0	1710.700002	0.001	1754.300004	0.002
10	1710.700003	0.002	1754.300004	0.002
20	1710.699996	-0.002	1754.299996	-0.002
30	1710.699998	-0.001	1754.299997	-0.002
40	1710.699996	-0.002	1754.299996	-0.002
50	1710.699997	-0.002	1754.299996	-0.002

Frequency Error vs. Voltage

Voltage (Volts)	LTE Band 4			
	Channel Bandwidth: 10 MHz			
	Low Channel		High Channel	
	Frequency (MHz)	Frequency Error (ppm)	Frequency (MHz)	Frequency Error (ppm)
120	1710.700002	0.001	1754.300003	0.002
102	1710.700002	0.001	1754.300003	0.001
138	1710.700001	0.001	1754.300003	0.002

Note: The applicant defined the normal working voltage of the battery is from 102 Vac to 138 Vac.

Frequency Error vs. Temperature

Temp. (°C)	LTE Band 4			
	Channel Bandwidth: 10 MHz			
	Low Channel		High Channel	
	Frequency (MHz)	Frequency Error (ppm)	Frequency (MHz)	Frequency Error (ppm)
-30	1710.700002	0.001	1754.300002	0.001
-20	1710.700002	0.001	1754.300001	0.001
-10	1710.700002	0.001	1754.300003	0.001
0	1710.700002	0.001	1754.300004	0.002
10	1710.700002	0.001	1754.300002	0.001
20	1710.699997	-0.002	1754.299998	-0.001
30	1710.699997	-0.002	1754.299999	-0.001
40	1710.699999	-0.001	1754.299996	-0.002
50	1710.699997	-0.002	1754.299999	-0.001

Frequency Error vs. Voltage

Voltage (Volts)	LTE Band 4			
	Channel Bandwidth: 15 MHz			
	Low Channel		High Channel	
	Frequency (MHz)	Frequency Error (ppm)	Frequency (MHz)	Frequency Error (ppm)
120	1710.700004	0.002	1754.300003	0.002
102	1710.700002	0.001	1754.300003	0.002
138	1710.700004	0.002	1754.300002	0.001

Note: The applicant defined the normal working voltage of the battery is from 102 Vac to 138 Vac.

Frequency Error vs. Temperature

Temp. (°C)	LTE Band 4			
	Channel Bandwidth: 15 MHz			
	Low Channel		High Channel	
	Frequency (MHz)	Frequency Error (ppm)	Frequency (MHz)	Frequency Error (ppm)
-30	1710.700003	0.002	1754.300002	0.001
-20	1710.700003	0.002	1754.300002	0.001
-10	1710.700002	0.001	1754.300004	0.002
0	1710.700002	0.001	1754.300004	0.002
10	1710.700001	0.001	1754.300002	0.001
20	1710.699997	-0.002	1754.299997	-0.002
30	1710.699997	-0.002	1754.299997	-0.002
40	1710.699996	-0.002	1754.299998	-0.001
50	1710.699999	-0.001	1754.299996	-0.002

Frequency Error vs. Voltage

Voltage (Volts)	LTE Band 4			
	Channel Bandwidth: 20 MHz			
	Low Channel		High Channel	
	Frequency (MHz)	Frequency Error (ppm)	Frequency (MHz)	Frequency Error (ppm)
120	1710.700004	0.002	1754.300002	0.001
102	1710.700002	0.001	1754.300003	0.002
138	1710.700002	0.001	1754.300003	0.002

Note: The applicant defined the normal working voltage of the battery is from 102 Vac to 138 Vac.

Frequency Error vs. Temperature

Temp. (°C)	LTE Band 4			
	Channel Bandwidth: 20 MHz			
	Low Channel		High Channel	
	Frequency (MHz)	Frequency Error (ppm)	Frequency (MHz)	Frequency Error (ppm)
-30	1710.700001	0.001	1754.300001	0.001
-20	1710.700003	0.002	1754.300002	0.001
-10	1710.700002	0.001	1754.300003	0.002
0	1710.700003	0.002	1754.300003	0.002
10	1710.700004	0.002	1754.300004	0.002
20	1710.699999	-0.001	1754.299998	-0.001
30	1710.699998	-0.001	1754.299997	-0.002
40	1710.699997	-0.002	1754.299997	-0.001
50	1710.699999	-0.001	1754.299996	-0.002

Frequency Error vs. Voltage

Voltage (Volts)	LTE Band 12			
	Channel Bandwidth: 1.4 MHz			
	Low Channel		High Channel	
	Frequency (MHz)	Frequency Error (ppm)	Frequency (MHz)	Frequency Error (ppm)
120	699.700004	0.005	715.300004	0.006
102	699.700002	0.002	715.300003	0.004
138	699.700002	0.003	715.300003	0.004

Note: The applicant defined the normal working voltage of the battery is from 102 Vac to 138 Vac.

Frequency Error vs. Temperature

Temp. (°C)	LTE Band 12			
	Channel Bandwidth: 1.4 MHz			
	Low Channel		High Channel	
	Frequency (MHz)	Frequency Error (ppm)	Frequency (MHz)	Frequency Error (ppm)
-30	699.700003	0.004	715.300004	0.005
-20	699.700002	0.003	715.300001	0.002
-10	699.700003	0.004	715.300002	0.003
0	699.700003	0.004	715.300002	0.003
10	699.700004	0.005	715.300003	0.004
20	699.699996	-0.005	715.299999	-0.002
30	699.699998	-0.003	715.299996	-0.005
40	699.699999	-0.002	715.299998	-0.003
50	699.699997	-0.005	715.299997	-0.004

Frequency Error vs. Voltage

Voltage (Volts)	LTE Band 12			
	Channel Bandwidth: 3 MHz			
	Low Channel		High Channel	
	Frequency (MHz)	Frequency Error (ppm)	Frequency (MHz)	Frequency Error (ppm)
120	699.700002	0.003	715.300002	0.003
102	699.700004	0.006	715.300003	0.004
138	699.700002	0.003	715.300002	0.003

Note: The applicant defined the normal working voltage of the battery is from 102 Vac to 138 Vac.

Frequency Error vs. Temperature

Temp. (°C)	LTE Band 12			
	Channel Bandwidth: 3 MHz			
	Low Channel		High Channel	
	Frequency (MHz)	Frequency Error (ppm)	Frequency (MHz)	Frequency Error (ppm)
-30	699.700003	0.004	715.300002	0.002
-20	699.700003	0.004	715.300003	0.004
-10	699.700002	0.003	715.300004	0.005
0	699.700001	0.002	715.300002	0.003
10	699.700001	0.001	715.300004	0.006
20	699.699997	-0.004	715.299997	-0.004
30	699.699998	-0.003	715.299997	-0.004
40	699.699996	-0.005	715.299997	-0.005
50	699.699997	-0.004	715.299997	-0.005

Frequency Error vs. Voltage

Voltage (Volts)	LTE Band 12			
	Channel Bandwidth: 5 MHz			
	Low Channel		High Channel	
	Frequency (MHz)	Frequency Error (ppm)	Frequency (MHz)	Frequency Error (ppm)
120	699.700004	0.005	715.300004	0.006
102	699.700004	0.006	715.300003	0.005
138	699.700002	0.003	715.300003	0.004

Note: The applicant defined the normal working voltage of the battery is from 102 Vac to 138 Vac.

Frequency Error vs. Temperature

Temp. (°C)	LTE Band 12			
	Channel Bandwidth: 5 MHz			
	Low Channel		High Channel	
	Frequency (MHz)	Frequency Error (ppm)	Frequency (MHz)	Frequency Error (ppm)
-30	699.700002	0.003	715.300003	0.004
-20	699.700002	0.003	715.300002	0.003
-10	699.700002	0.002	715.300002	0.003
0	699.700001	0.002	715.300002	0.003
10	699.700003	0.004	715.300003	0.004
20	699.699996	-0.006	715.299997	-0.005
30	699.699998	-0.002	715.299999	-0.002
40	699.699997	-0.005	715.299996	-0.005
50	699.699998	-0.003	715.299997	-0.005

Frequency Error vs. Voltage

Voltage (Volts)	LTE Band 12			
	Channel Bandwidth: 10 MHz			
	Low Channel		High Channel	
	Frequency (MHz)	Frequency Error (ppm)	Frequency (MHz)	Frequency Error (ppm)
120	699.700001	0.002	715.300002	0.003
102	699.700004	0.006	715.300002	0.003
138	699.700002	0.003	715.300003	0.004

Note: The applicant defined the normal working voltage of the battery is from 102 Vac to 138 Vac.

Frequency Error vs. Temperature

Temp. (°C)	LTE Band 12			
	Channel Bandwidth: 10 MHz			
	Low Channel		High Channel	
	Frequency (MHz)	Frequency Error (ppm)	Frequency (MHz)	Frequency Error (ppm)
-30	699.700004	0.005	715.300004	0.005
-20	699.700002	0.003	715.300003	0.004
-10	699.700002	0.003	715.300002	0.003
0	699.700002	0.003	715.300003	0.005
10	699.700001	0.002	715.300002	0.002
20	699.699999	-0.002	715.299998	-0.003
30	699.699998	-0.002	715.299997	-0.004
40	699.699999	-0.002	715.299997	-0.004
50	699.699997	-0.004	715.299998	-0.002

Frequency Error vs. Voltage

Voltage (Volts)	LTE Band 13			
	Channel Bandwidth: 5 MHz			
	Low Channel		High Channel	
	Frequency (MHz)	Frequency Error (ppm)	Frequency (MHz)	Frequency Error (ppm)
120	779.500004	0.004	784.500004	0.005
102	779.500002	0.002	784.500002	0.003
138	779.500002	0.003	784.500002	0.002

Note: The applicant defined the normal working voltage of the battery is from 102 Vac to 138 Vac.

Frequency Error vs. Temperature

Temp. (°C)	LTE Band 13			
	Channel Bandwidth: 5 MHz			
	Low Channel		High Channel	
	Frequency (MHz)	Frequency Error (ppm)	Frequency (MHz)	Frequency Error (ppm)
-30	779.500004	0.005	784.500003	0.004
-20	779.500002	0.002	784.500003	0.004
-10	779.500004	0.005	784.500003	0.004
0	779.500002	0.002	784.500002	0.002
10	779.500002	0.002	784.500002	0.002
20	779.499998	-0.003	784.499997	-0.003
30	779.499999	-0.001	784.499998	-0.002
40	779.499997	-0.004	784.499996	-0.005
50	779.499997	-0.004	784.499997	-0.004

Frequency Error vs. Voltage

Voltage (Volts)	LTE Band 13	
	Channel Bandwidth: 10 MHz	
	Frequency (MHz)	Frequency Error (ppm)
120	779.500004	0.005
102	779.500003	0.004
138	779.500001	0.001

Note: The applicant defined the normal working voltage of the battery is from 102 Vac to 138 Vac.

Frequency Error vs. Temperature

Temp. (°C)	LTE Band 13	
	Channel Bandwidth: 10 MHz	
	Frequency (MHz)	Frequency Error (ppm)
-30	779.500004	0.005
-20	779.500001	0.002
-10	779.500002	0.003
0	779.500002	0.002
10	779.500003	0.003
20	779.499999	-0.001
30	779.499999	-0.002
40	779.499997	-0.004
50	779.499999	-0.002

Frequency Error vs. Voltage

Voltage (Volts)	LTE Band 17			
	Channel Bandwidth: 5 MHz			
	Low Channel		High Channel	
	Frequency (MHz)	Frequency Error (ppm)	Frequency (MHz)	Frequency Error (ppm)
120	706.500003	0.004	713.500003	0.005
102	706.500003	0.004	713.500004	0.005
138	706.500004	0.006	713.500002	0.003

Note: The applicant defined the normal working voltage of the battery is from 102 Vac to 138 Vac.

Frequency Error vs. Temperature

Temp. (°C)	LTE Band 17			
	Channel Bandwidth: 5 MHz			
	Low Channel		High Channel	
	Frequency (MHz)	Frequency Error (ppm)	Frequency (MHz)	Frequency Error (ppm)
-30	706.500002	0.003	713.500003	0.004
-20	706.500002	0.003	713.500001	0.001
-10	706.500002	0.003	713.500002	0.003
0	706.500003	0.004	713.500004	0.005
10	706.500003	0.004	713.500002	0.002
20	706.499997	-0.005	713.499998	-0.003
30	706.499998	-0.003	713.499996	-0.005
40	706.499996	-0.006	713.499999	-0.002
50	706.499998	-0.002	713.499997	-0.004

Frequency Error vs. Voltage

Voltage (Volts)	LTE Band 17			
	Channel Bandwidth: 10 MHz			
	Low Channel		High Channel	
	Frequency (MHz)	Frequency Error (ppm)	Frequency (MHz)	Frequency Error (ppm)
120	706.500003	0.005	713.500003	0.005
102	706.500002	0.003	713.500003	0.005
138	706.500003	0.005	713.500003	0.005

Note: The applicant defined the normal working voltage of the battery is from 102 Vac to 138 Vac.

Frequency Error vs. Temperature

Temp. (°C)	LTE Band 17			
	Channel Bandwidth: 10 MHz			
	Low Channel		High Channel	
	Frequency (MHz)	Frequency Error (ppm)	Frequency (MHz)	Frequency Error (ppm)
-30	706.500002	0.003	713.500002	0.003
-20	706.500001	0.002	713.500001	0.002
-10	706.500004	0.005	713.500001	0.001
0	706.500002	0.003	713.500002	0.003
10	706.500004	0.005	713.500003	0.005
20	706.499997	-0.005	713.499998	-0.002
30	706.499997	-0.005	713.499998	-0.002
40	706.499999	-0.002	713.499998	-0.003
50	706.499997	-0.004	713.499996	-0.005

Frequency Error vs. Voltage

Voltage (Volts)	LTE Band 66			
	Channel Bandwidth: 1.4 MHz			
	Low Channel		High Channel	
	Frequency (MHz)	Frequency Error (ppm)	Frequency (MHz)	Frequency Error (ppm)
120	1710.700004	0.002	1779.300003	0.001
102	1710.700002	0.001	1779.300003	0.002
138	1710.700004	0.002	1779.300003	0.002

Note: The applicant defined the normal working voltage of the battery is from 102 Vac to 138 Vac.

Frequency Error vs. Temperature

Temp. (°C)	LTE Band 66			
	Channel Bandwidth: 1.4 MHz			
	Low Channel		High Channel	
	Frequency (MHz)	Frequency Error (ppm)	Frequency (MHz)	Frequency Error (ppm)
-30	1710.700002	0.001	1779.300002	0.001
-20	1710.700003	0.002	1779.300004	0.002
-10	1710.700003	0.002	1779.300004	0.002
0	1710.700003	0.002	1779.300002	0.001
10	1710.700004	0.002	1779.300001	0.001
20	1710.699997	-0.002	1779.299997	-0.002
30	1710.699996	-0.002	1779.299998	-0.001
40	1710.699997	-0.002	1779.299996	-0.002
50	1710.699999	-0.001	1779.299998	-0.001

Frequency Error vs. Voltage

Voltage (Volts)	LTE Band 66			
	Channel Bandwidth: 3 MHz			
	Low Channel		High Channel	
	Frequency (MHz)	Frequency Error (ppm)	Frequency (MHz)	Frequency Error (ppm)
120	1710.700003	0.002	1779.300004	0.002
102	1710.700002	0.001	1779.300001	0.001
138	1710.700004	0.002	1779.300002	0.001

Note: The applicant defined the normal working voltage of the battery is from 102 Vac to 138 Vac.

Frequency Error vs. Temperature

Temp. (°C)	LTE Band 66			
	Channel Bandwidth: 3 MHz			
	Low Channel		High Channel	
	Frequency (MHz)	Frequency Error (ppm)	Frequency (MHz)	Frequency Error (ppm)
-30	1710.700002	0.001	1779.300001	0.001
-20	1710.700002	0.001	1779.300003	0.002
-10	1710.700002	0.001	1779.300003	0.002
0	1710.700003	0.002	1779.300002	0.001
10	1710.700001	0.001	1779.300003	0.002
20	1710.699997	-0.002	1779.299999	-0.001
30	1710.699997	-0.002	1779.299998	-0.001
40	1710.699996	-0.002	1779.299996	-0.002
50	1710.699998	-0.001	1779.299996	-0.002

Frequency Error vs. Voltage

Voltage (Volts)	LTE Band 66			
	Channel Bandwidth: 5 MHz			
	Low Channel		High Channel	
	Frequency (MHz)	Frequency Error (ppm)	Frequency (MHz)	Frequency Error (ppm)
120	1710.700002	0.001	1779.300003	0.002
102	1710.700002	0.001	1779.300003	0.002
138	1710.700002	0.001	1779.300003	0.001

Note: The applicant defined the normal working voltage of the battery is from 102 Vac to 138 Vac.

Frequency Error vs. Temperature

Temp. (°C)	LTE Band 66			
	Channel Bandwidth: 5 MHz			
	Low Channel		High Channel	
	Frequency (MHz)	Frequency Error (ppm)	Frequency (MHz)	Frequency Error (ppm)
-30	1710.700001	0.001	1779.300003	0.002
-20	1710.700001	0.001	1779.300003	0.002
-10	1710.700003	0.002	1779.300002	0.001
0	1710.700002	0.001	1779.300001	0.001
10	1710.700003	0.002	1779.300002	0.001
20	1710.699997	-0.002	1779.299998	-0.001
30	1710.699999	-0.001	1779.299998	-0.001
40	1710.699997	-0.002	1779.299996	-0.002
50	1710.699996	-0.002	1779.299999	-0.001

Frequency Error vs. Voltage

Voltage (Volts)	LTE Band 66			
	Channel Bandwidth: 10 MHz			
	Low Channel		High Channel	
	Frequency (MHz)	Frequency Error (ppm)	Frequency (MHz)	Frequency Error (ppm)
120	1710.700003	0.002	1779.300004	0.002
102	1710.700003	0.002	1779.300004	0.002
138	1710.700001	0.001	1779.300002	0.001

Note: The applicant defined the normal working voltage of the battery is from 102 Vac to 138 Vac.

Frequency Error vs. Temperature

Temp. (°C)	LTE Band 66			
	Channel Bandwidth: 10 MHz			
	Low Channel		High Channel	
	Frequency (MHz)	Frequency Error (ppm)	Frequency (MHz)	Frequency Error (ppm)
-30	1710.700003	0.001	1779.300002	0.001
-20	1710.700003	0.002	1779.300003	0.001
-10	1710.700002	0.001	1779.300001	0.001
0	1710.700002	0.001	1779.300003	0.002
10	1710.700003	0.002	1779.300003	0.002
20	1710.699998	-0.001	1779.299996	-0.002
30	1710.699998	-0.001	1779.299997	-0.001
40	1710.699999	-0.001	1779.299998	-0.001
50	1710.699998	-0.001	1779.299996	-0.002

Frequency Error vs. Voltage

Voltage (Volts)	LTE Band 66			
	Channel Bandwidth: 15 MHz			
	Low Channel		High Channel	
	Frequency (MHz)	Frequency Error (ppm)	Frequency (MHz)	Frequency Error (ppm)
120	1710.700004	0.002	1779.300004	0.002
102	1710.700002	0.001	1779.300002	0.001
138	1710.700004	0.002	1779.300002	0.001

Note: The applicant defined the normal working voltage of the battery is from 102 Vac to 138 Vac.

Frequency Error vs. Temperature

Temp. (°C)	LTE Band 66			
	Channel Bandwidth: 15 MHz			
	Low Channel		High Channel	
	Frequency (MHz)	Frequency Error (ppm)	Frequency (MHz)	Frequency Error (ppm)
-30	1710.700003	0.002	1779.300004	0.002
-20	1710.700002	0.001	1779.300001	0.001
-10	1710.700002	0.001	1779.300003	0.001
0	1710.700003	0.002	1779.300003	0.001
10	1710.700002	0.001	1779.300003	0.002
20	1710.699998	-0.001	1779.299998	-0.001
30	1710.699999	-0.001	1779.299997	-0.002
40	1710.699998	-0.001	1779.299996	-0.002
50	1710.699998	-0.001	1779.299999	-0.001

Frequency Error vs. Voltage

Voltage (Volts)	LTE Band 66			
	Channel Bandwidth: 20 MHz			
	Low Channel		High Channel	
	Frequency (MHz)	Frequency Error (ppm)	Frequency (MHz)	Frequency Error (ppm)
120	1710.700003	0.002	1779.300003	0.002
102	1710.700001	0.001	1779.300003	0.002
138	1710.700004	0.002	1779.300004	0.002

Note: The applicant defined the normal working voltage of the battery is from 102 Vac to 138 Vac.

Frequency Error vs. Temperature

Temp. (°C)	LTE Band 66			
	Channel Bandwidth: 20 MHz			
	Low Channel		High Channel	
	Frequency (MHz)	Frequency Error (ppm)	Frequency (MHz)	Frequency Error (ppm)
-30	1710.700002	0.001	1779.300001	0.001
-20	1710.700003	0.002	1779.300004	0.002
-10	1710.700003	0.002	1779.300003	0.002
0	1710.700002	0.001	1779.300004	0.002
10	1710.700004	0.002	1779.300003	0.001
20	1710.699998	-0.001	1779.299998	-0.001
30	1710.699999	-0.001	1779.299997	-0.002
40	1710.699999	-0.001	1779.299998	-0.001
50	1710.699999	-0.001	1779.299998	-0.001

4.4 Occupied Bandwidth Measurement

4.4.1 Limits of Occupied Bandwidth Measurement

The width of a frequency band such that, below the lower and above the upper frequency limits, the mean powers emitted are each equal to a specified percentage 0.5 % of the total mean power of a given emission.

4.4.2 Test Procedure

- The conducted occupied bandwidth used the power splitter via EUT RF power connector between simulation base station and spectrum analyzer.
- Use OBW measurement function of Spectrum analyzer to measure 99 % occupied bandwidth.

4.4.3 Test Setup

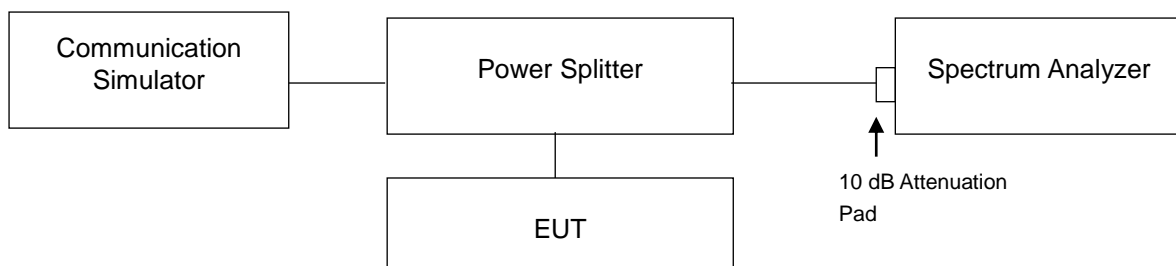

4.4.4 Test Result

WCDMA			
Channel	Frequency (MHz)	99 % Occupied Bandwidth (MHz)	26 dB Bandwidth (MHz)
1312	1712.4	4.082	4.655
1413	1732.6	4.083	4.670
1513	1752.6	4.077	4.657

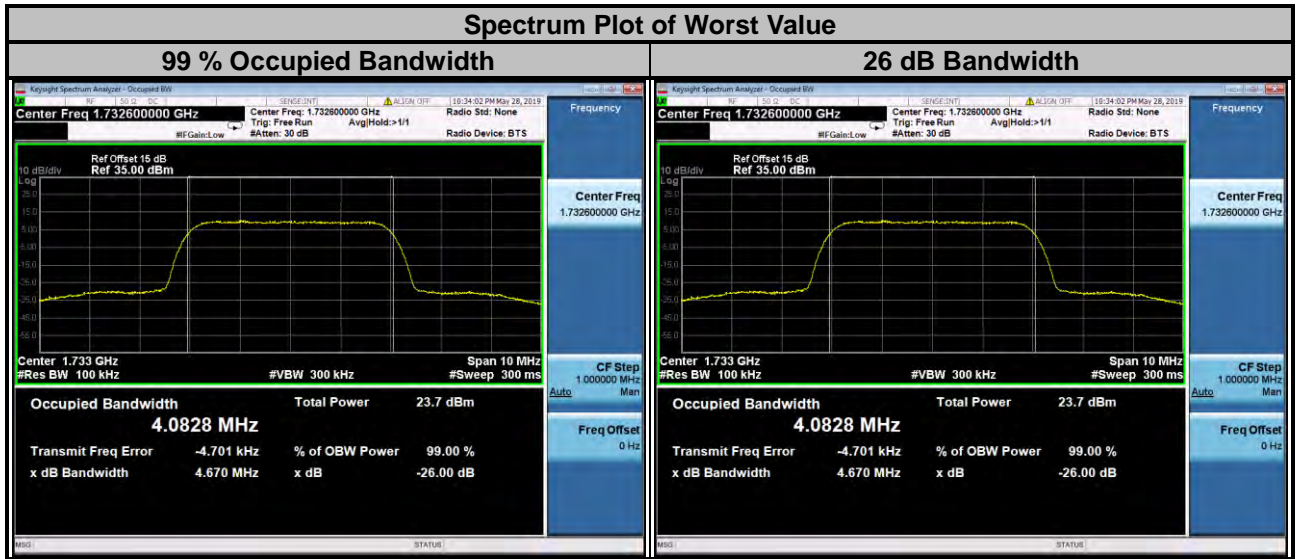

LTE Band 4							
Channel Bandwidth: 1.4 MHz							
Channel	Frequency (MHz)	99 % Occupied Bandwidth (MHz)			26 dB Bandwidth (MHz)		
		QPSK	16QAM	64QAM	QPSK	16QAM	64QAM
19957	1710.7	1.091	1.091	1.092	1.250	1.247	1.248
20175	1732.5	1.092	1.092	1.090	1.244	1.246	1.245
20393	1754.3	1.091	1.092	1.092	1.247	1.249	1.249

Channel Bandwidth: 3 MHz							
Channel	Frequency (MHz)	99 % Occupied Bandwidth (MHz)			26 dB Bandwidth (MHz)		
		QPSK	16QAM	64QAM	QPSK	16QAM	64QAM
19965	1711.5	2.703	2.701	2.702	2.966	2.959	2.969
20175	1732.5	2.705	2.703	2.701	2.975	2.967	2.970
20385	1753.5	2.705	2.700	2.701	2.960	2.978	2.965

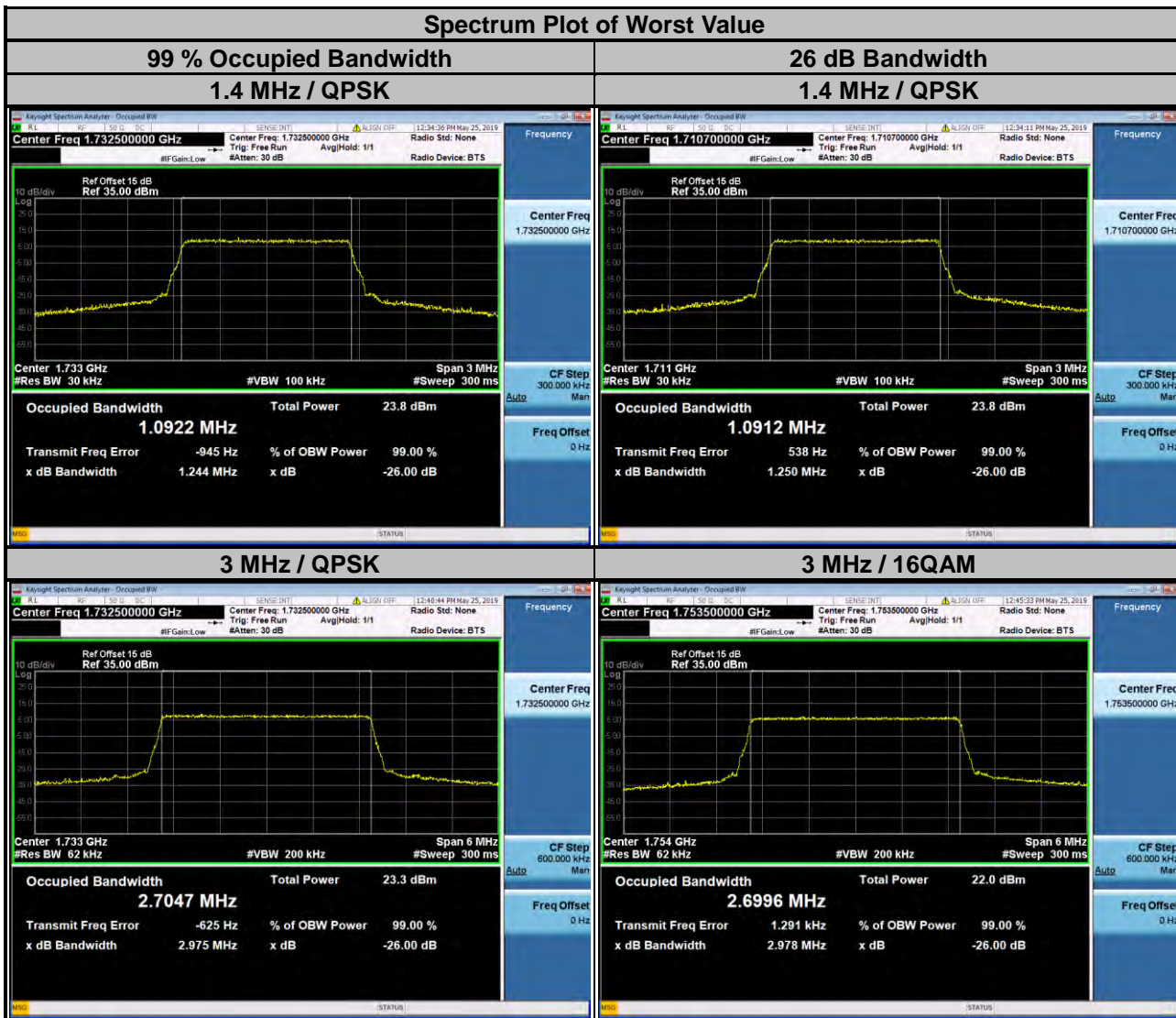

LTE Band 4							
Channel Bandwidth: 5 MHz							
Channel	Frequency (MHz)	99 % Occupied Bandwidth (MHz)			26 dB Bandwidth (MHz)		
		QPSK	16QAM	64QAM	QPSK	16QAM	64QAM
19975	1712.5	4.492	4.497	4.496	4.852	4.846	4.841
20175	1732.5	4.498	4.497	4.494	4.833	4.848	4.844
20375	1752.5	4.494	4.498	4.497	4.832	4.847	4.845
Channel Bandwidth: 10 MHz							
Channel	Frequency (MHz)	99 % Occupied Bandwidth (MHz)			26 dB Bandwidth (MHz)		
		QPSK	16QAM	64QAM	QPSK	16QAM	64QAM
20000	1715.0	8.985	8.983	8.988	9.817	9.809	9.788
20175	1732.5	8.982	8.984	8.992	9.906	9.814	9.880
20350	1750.0	8.991	8.983	8.992	9.843	9.884	9.902

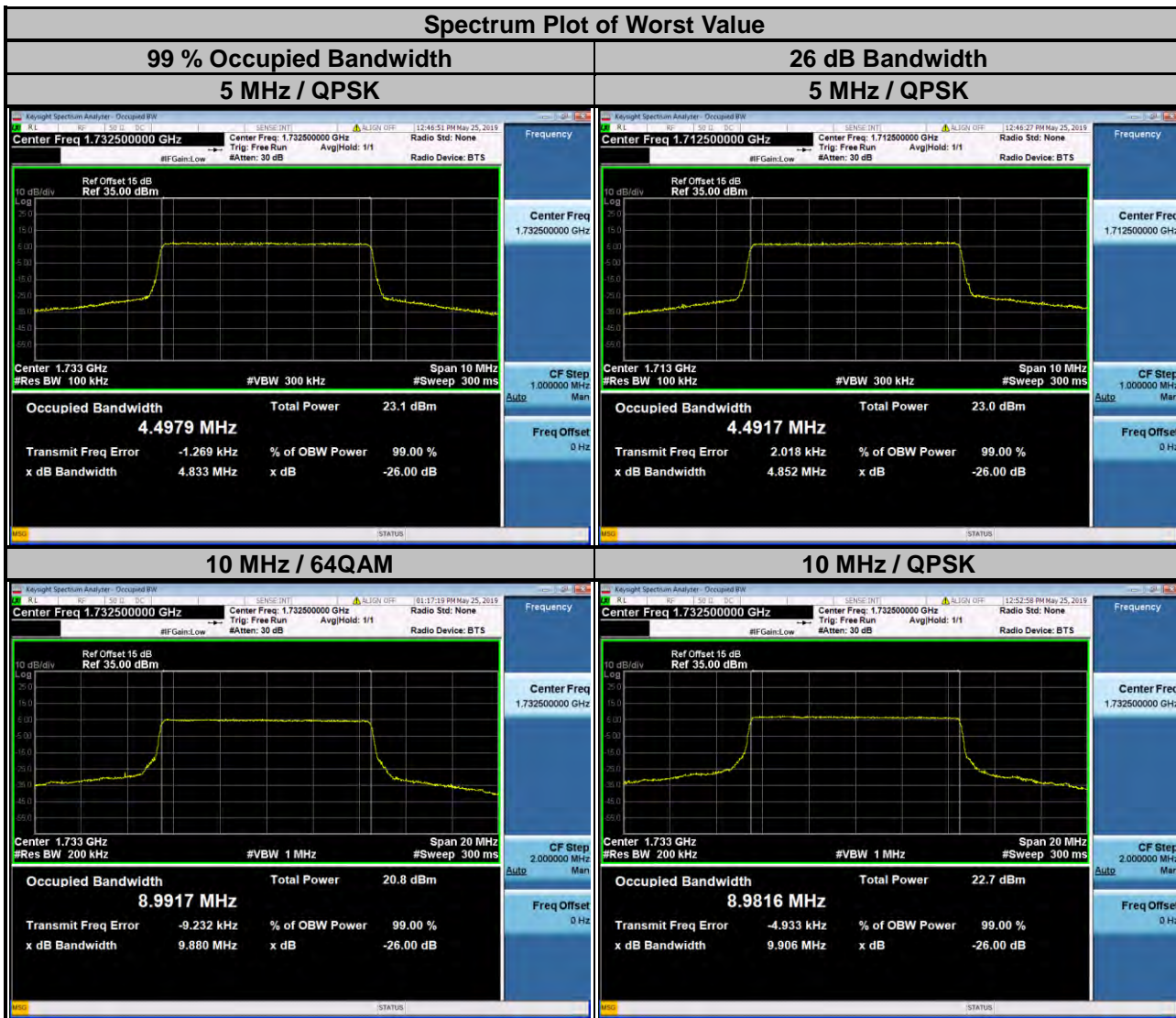

LTE Band 4							
Channel Bandwidth: 15 MHz							
Channel	Frequency (MHz)	99 % Occupied Bandwidth (MHz)			26 dB Bandwidth (MHz)		
		QPSK	16QAM	64QAM	QPSK	16QAM	64QAM
20025	1717.5	13.453	13.457	13.460	14.330	14.270	14.360
20175	1732.5	13.472	13.474	13.461	14.360	14.290	14.290
20325	1747.5	13.483	13.473	13.482	14.380	14.370	14.340

Channel Bandwidth: 20 MHz							
Channel	Frequency (MHz)	99 % Occupied Bandwidth (MHz)			26 dB Bandwidth (MHz)		
		QPSK	16QAM	64QAM	QPSK	16QAM	64QAM
20050	1720.0	17.922	17.914	17.917	19.040	19.040	19.020
20175	1732.5	17.963	17.962	17.960	19.060	19.050	19.060
20300	1745.0	18.002	17.998	17.991	19.090	19.110	19.080



LTE Band 12							
Channel Bandwidth: 1.4 MHz							
Channel	Frequency (MHz)	99 % Occupied Bandwidth (MHz)			26 dB Bandwidth (MHz)		
		QPSK	16QAM	64QAM	QPSK	16QAM	64QAM
23017	699.7	1.091	1.091	1.092	1.242	1.246	1.245
23095	707.5	1.091	1.091	1.091	1.246	1.245	1.246
23173	715.3	1.092	1.093	1.093	1.241	1.243	1.250

Channel Bandwidth: 3 MHz							
Channel	Frequency (MHz)	99 % Occupied Bandwidth (MHz)			26 dB Bandwidth (MHz)		
		QPSK	16QAM	64QAM	QPSK	16QAM	64QAM
23025	700.5	2.701	2.699	2.698	2.963	2.962	2.963
23095	707.5	2.702	2.702	2.701	2.965	2.965	2.960
23165	714.5	2.701	2.701	2.702	2.964	2.965	2.974

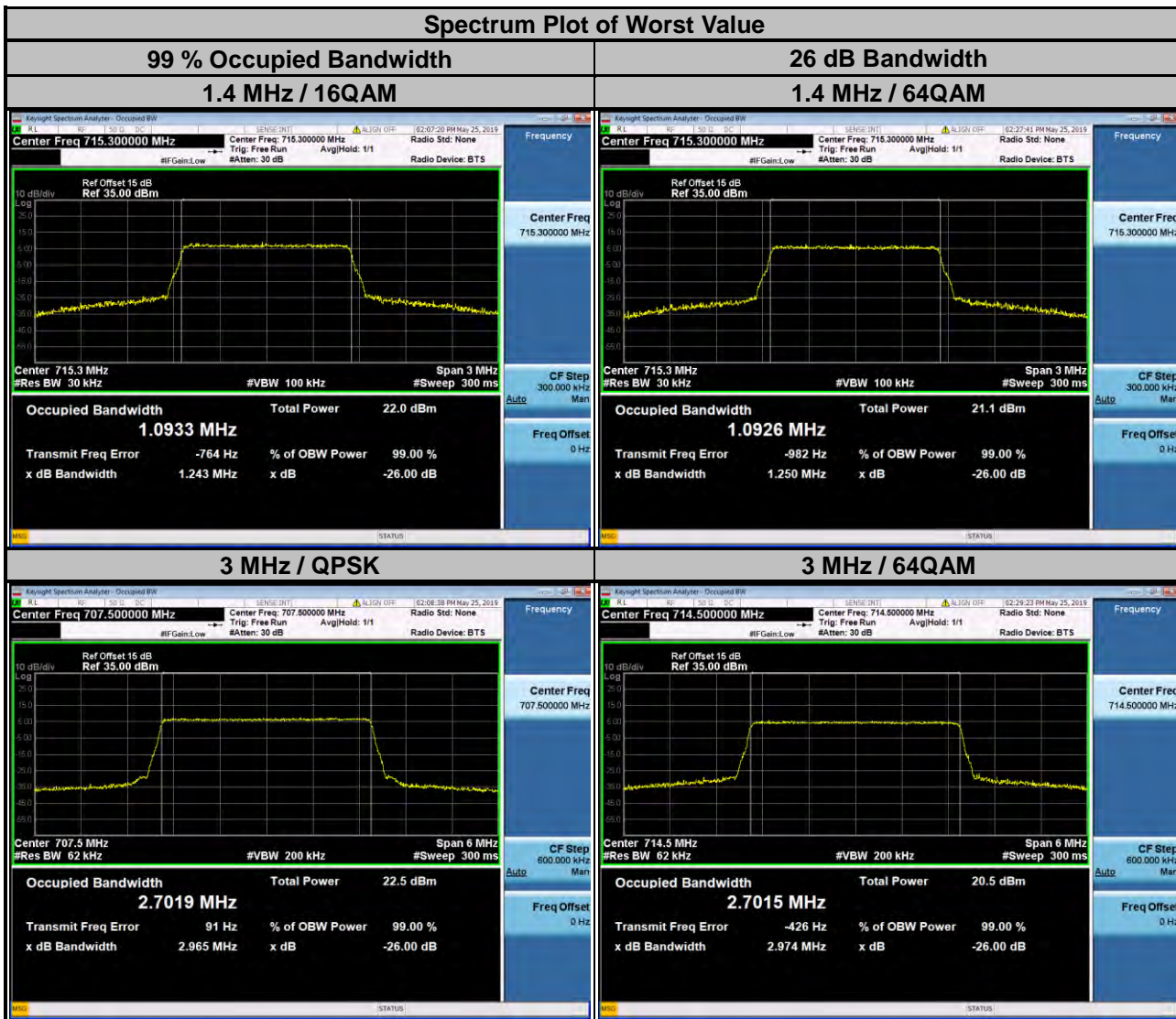

LTE Band 12							
Channel Bandwidth: 5 MHz							
Channel	Frequency (MHz)	99 % Occupied Bandwidth (MHz)			26 dB Bandwidth (MHz)		
		QPSK	16QAM	64QAM	QPSK	16QAM	64QAM
23035	701.5	4.492	4.493	4.490	4.840	4.823	4.845
23095	707.5	4.503	4.498	4.500	4.843	4.825	4.849
23155	713.5	4.494	4.492	4.492	4.821	4.823	4.856

Channel Bandwidth: 10 MHz							
Channel	Frequency (MHz)	99 % Occupied Bandwidth (MHz)			26 dB Bandwidth (MHz)		
		QPSK	16QAM	64QAM	QPSK	16QAM	64QAM
23060	704.0	8.988	8.991	8.990	9.784	9.838	9.771
23095	707.5	9.010	9.007	9.008	9.963	9.867	9.957
23130	711.0	8.980	8.976	8.979	9.785	9.779	9.909

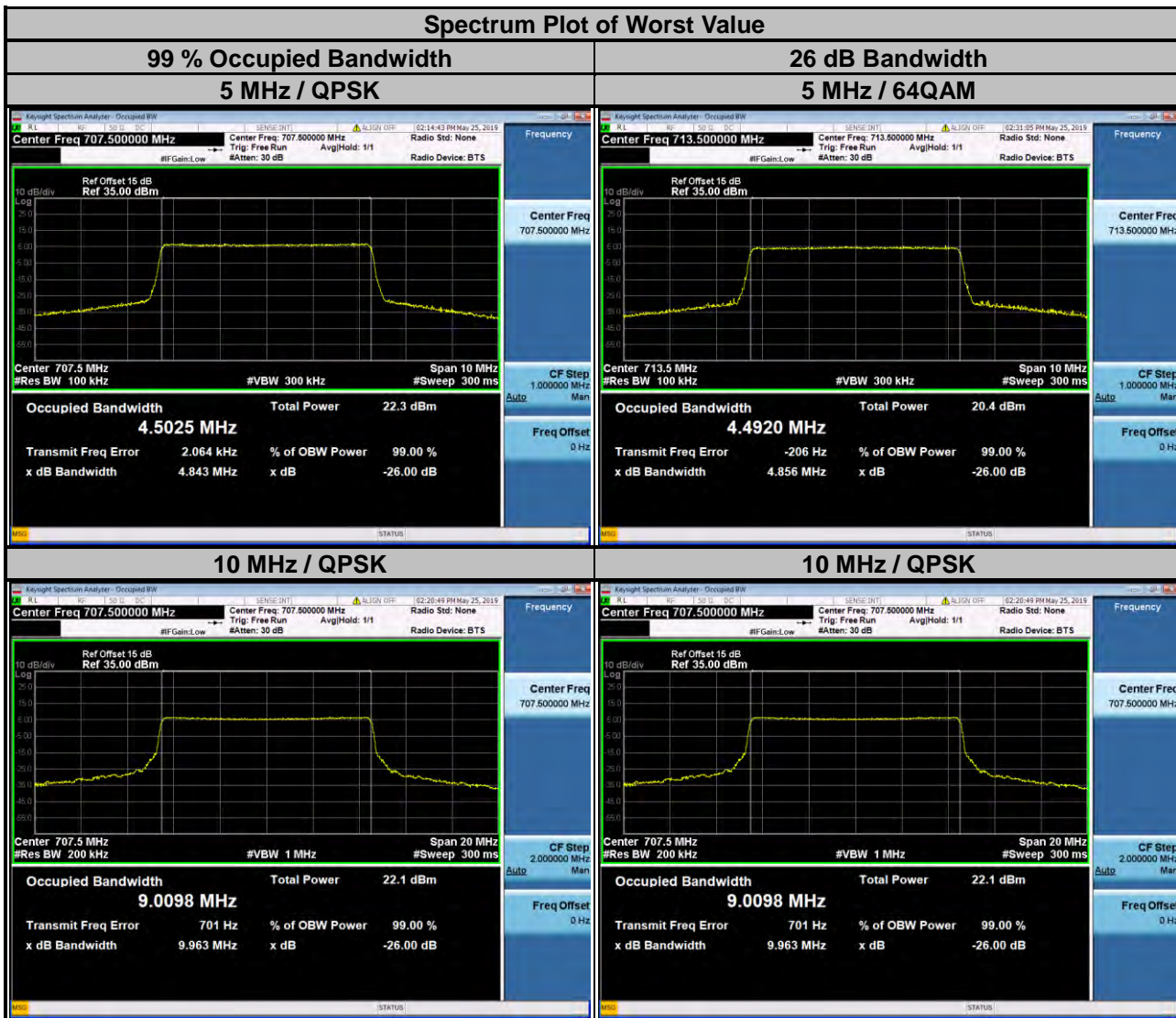

LTE Band 13							
Channel Bandwidth: 5 MHz							
Channel	Frequency (MHz)	99 % Occupied Bandwidth (MHz)			26 dB Bandwidth (MHz)		
		QPSK	16QAM	64QAM	QPSK	16QAM	64QAM
23205	779.5	4.504	4.503	4.508	4.825	4.806	4.839
23230	782.0	4.481	4.480	4.480	4.795	4.792	4.801
23255	784.5	4.486	4.488	4.489	4.781	4.795	4.827

Channel Bandwidth: 10 MHz							
Channel	Frequency (MHz)	99 % Occupied Bandwidth (MHz)			26 dB Bandwidth (MHz)		
		QPSK	16QAM	64QAM	QPSK	16QAM	64QAM
23230	782.0	8.941	8.949	8.945	9.526	9.573	9.584

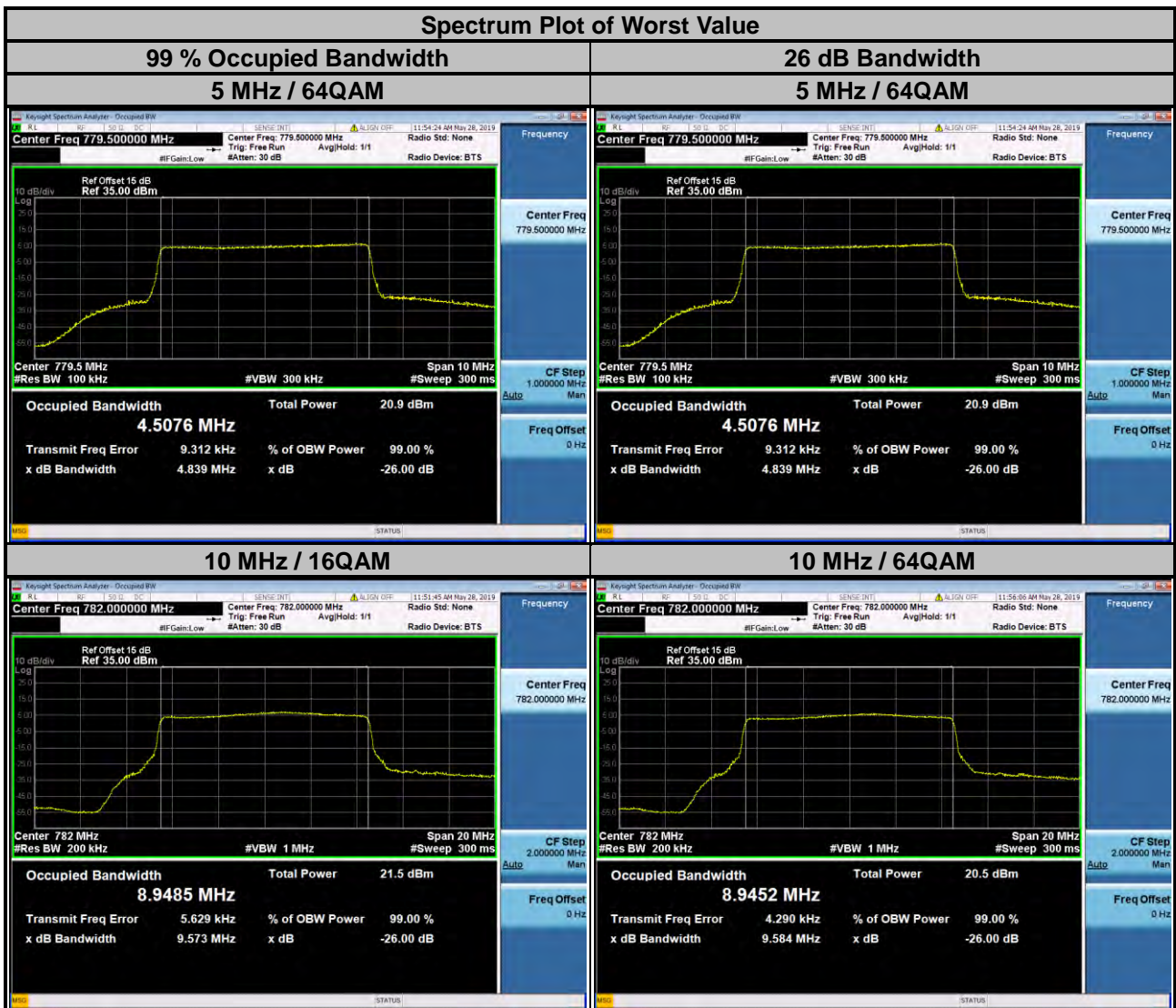

LTE Band 17							
Channel Bandwidth: 5 MHz							
Channel	Frequency (MHz)	99 % Occupied Bandwidth (MHz)			26 dB Bandwidth (MHz)		
		QPSK	16QAM	64QAM	QPSK	16QAM	64QAM
23755	706.5	4.506	4.494	4.500	4.865	4.846	4.844
23790	710.0	4.492	4.495	4.495	4.847	4.817	4.837
23825	713.5	4.492	4.495	4.492	4.830	4.845	4.843

Channel Bandwidth: 10 MHz							
Channel	Frequency (MHz)	99 % Occupied Bandwidth (MHz)			26 dB Bandwidth (MHz)		
		QPSK	16QAM	64QAM	QPSK	16QAM	64QAM
23780	709.0	8.994	9.002	8.997	9.888	9.867	9.831
23790	710.0	8.992	8.987	8.991	9.808	9.791	9.817
23800	711.0	8.980	8.984	8.975	9.794	9.895	9.888



LTE Band 66							
Channel Bandwidth: 1.4 MHz							
Channel	Frequency (MHz)	99 % Occupied Bandwidth (MHz)			26 dB Bandwidth (MHz)		
		QPSK	16QAM	64QAM	QPSK	16QAM	64QAM
131979	1710.7	1.094	1.091	1.093	1.245	1.245	1.249
132322	1745.0	1.092	1.091	1.093	1.245	1.243	1.242
132665	1779.3	1.091	1.095	1.092	1.240	1.246	1.248

Channel Bandwidth: 3 MHz							
Channel	Frequency (MHz)	99 % Occupied Bandwidth (MHz)			26 dB Bandwidth (MHz)		
		QPSK	16QAM	64QAM	QPSK	16QAM	64QAM
131987	1711.5	2.703	2.701	2.700	2.972	2.963	2.958
132322	1745.0	2.703	2.701	2.703	2.977	2.972	2.961
132657	1778.5	2.706	2.701	2.705	2.973	2.971	2.974

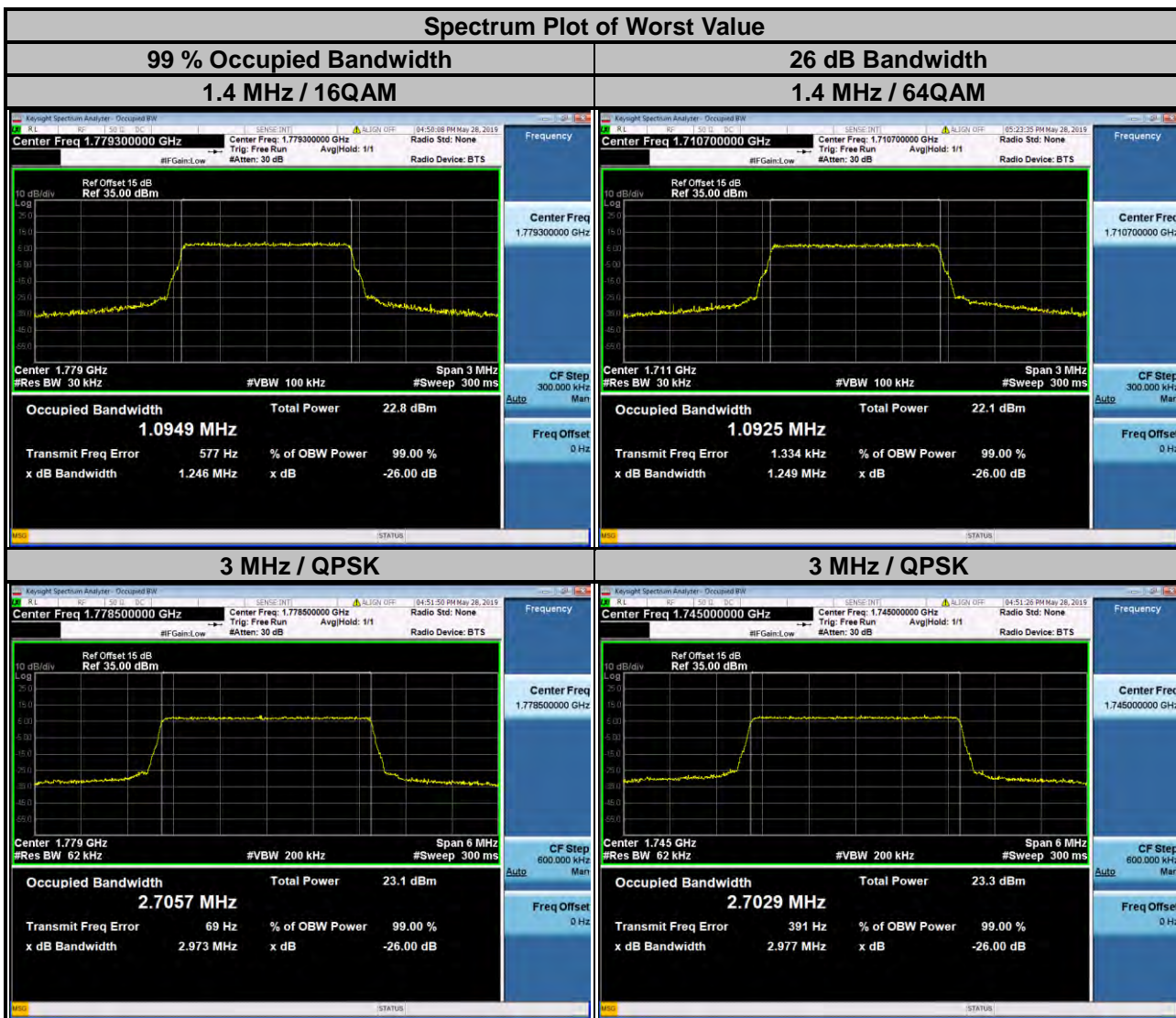

LTE Band 66							
Channel Bandwidth: 5 MHz							
Channel	Frequency (MHz)	99 % Occupied Bandwidth (MHz)			26 dB Bandwidth (MHz)		
		QPSK	16QAM	64QAM	QPSK	16QAM	64QAM
131997	1712.5	4.494	4.497	4.497	4.833	4.848	4.842
132322	1745.0	4.496	4.500	4.495	4.850	4.860	4.839
132647	1777.5	4.495	4.500	4.501	4.848	4.840	4.857

Channel Bandwidth: 10 MHz							
Channel	Frequency (MHz)	99 % Occupied Bandwidth (MHz)			26 dB Bandwidth (MHz)		
		QPSK	16QAM	64QAM	QPSK	16QAM	64QAM
132022	1715.0	8.980	8.981	8.982	9.818	9.839	9.754
132322	1745.0	8.995	8.995	8.997	9.899	9.938	9.857
132622	1775.0	8.995	8.994	8.993	9.916	9.882	9.815



LTE Band 66							
Channel Bandwidth: 15 MHz							
Channel	Frequency (MHz)	99 % Occupied Bandwidth (MHz)			26 dB Bandwidth (MHz)		
		QPSK	16QAM	64QAM	QPSK	16QAM	64QAM
132047	1717.5	13.461	13.460	13.459	14.310	14.310	14.320
132322	1745.0	13.482	13.474	13.485	14.370	14.340	14.420
132597	1772.5	13.470	13.460	13.459	14.320	14.290	14.310

Channel Bandwidth: 20 MHz							
Channel	Frequency (MHz)	99 % Occupied Bandwidth (MHz)			26 dB Bandwidth (MHz)		
		QPSK	16QAM	64QAM	QPSK	16QAM	64QAM
132072	1720.0	17.921	17.912	17.921	19.050	19.040	19.060
132322	1745.0	18.002	18.001	18.001	19.140	19.110	19.100
132572	1770.0	17.934	17.934	17.931	19.060	19.060	19.040



4.5 Band Edge Measurement

4.5.1 Limits of Band Edge Measurement

For operations in the 698-787 MHz band, the power of any emission outside a licensee's frequency band(s) of operation shall be attenuated below the transmitter power (P) within the licensed band(s) of operation, measured in watts, by at least $43 + 10 \log (P)$ dB. Compliance with this provision is based on the use of measurement instrumentation employing a resolution bandwidth of 100 kilohertz or greater.

However, in the 100 kilohertz bands immediately outside and adjacent to a licensee's frequency block, a resolution bandwidth of at least 30 kHz may be employed.

For operations in the 746-758 MHz band and the 776-788 MHz band, the power of any emission outside a licensee's frequency band(s) of operation shall be attenuated below the transmitter power (P) within the licensed band(s) of operation, measured in watts, by at least $43 + 10 \log (P)$ dB.

On all frequencies between 763-775 MHz and 793-805 MHz, by a factor no less than $65 + 10 \log (P)$ dB in a 6.25 kHz band segment, for mobile and portable stations.

For operations in the 1710–1755 MHz bands, the power of any emission outside a licensee's frequency block shall be attenuated below the transmitter power (P) by at least $43 + 10 \log (P)$ dB.

4.5.2 Test Setup

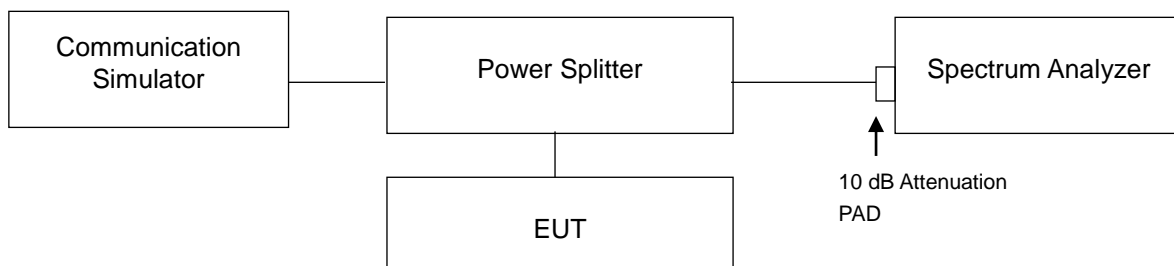

4.5.3 Test Procedures

- All measurements were done at low and high operational frequency range.
- The center frequency of spectrum is the band edge frequency and span is 5 MHz. RB of the spectrum is 47 kHz and VB of the spectrum is 150 kHz (WCDMA).
- The center frequency of spectrum is the band edge frequency and span is 1 MHz. RB of the spectrum is 15 or 30 kHz and VB of the spectrum is 51 or 100 kHz (LTE Bandwidth 1.4 MHz).
- The center frequency of spectrum is the band edge frequency and span is 1 MHz. RB of the spectrum is 30 kHz and VB of the spectrum is 100 kHz (LTE Bandwidth 3 MHz).
- The center frequency of spectrum is the band edge frequency and span is 1 MHz. RB of the spectrum is 62 kHz and VB of the spectrum is 200 kHz (LTE Bandwidth 5 MHz).
- The center frequency of spectrum is the band edge frequency and span is 1 MHz. RB of the spectrum is 100 kHz and VB of the spectrum is 300 kHz (LTE Bandwidth 10 MHz).
- The center frequency of spectrum is the band edge frequency and span is 1 MHz. RB of the spectrum is 150 kHz and VB of the spectrum is 470 kHz (LTE Bandwidth 15 MHz).
- The center frequency of spectrum is the band edge frequency and span is 1 MHz. RB of the spectrum is 200 kHz and VB of the spectrum is 1 MHz (LTE Bandwidth 20 MHz).
- Record the max. trace plot into the test report.

4.5.4 Test Results

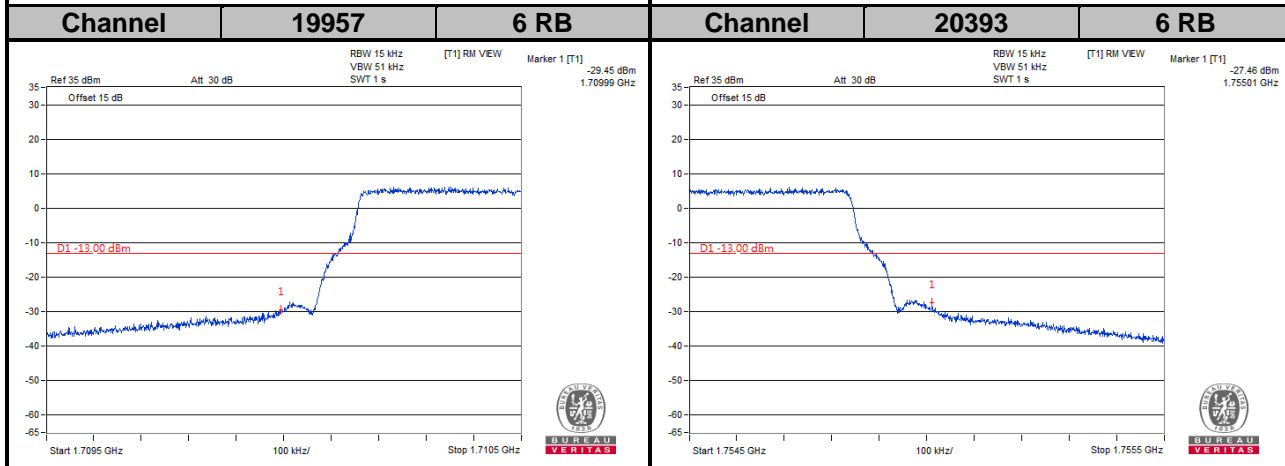
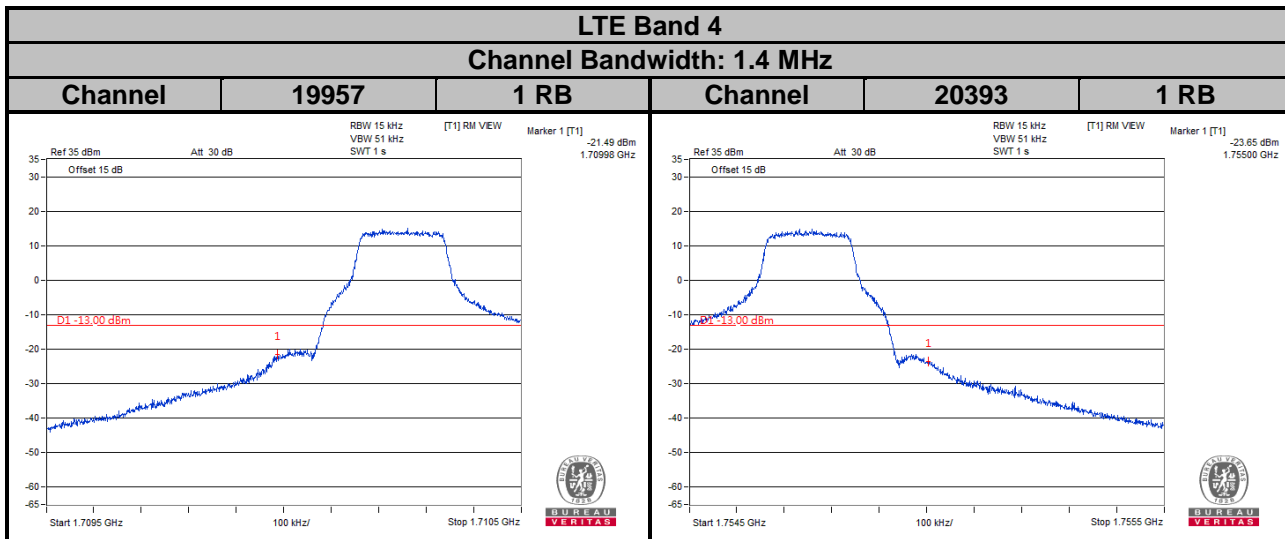
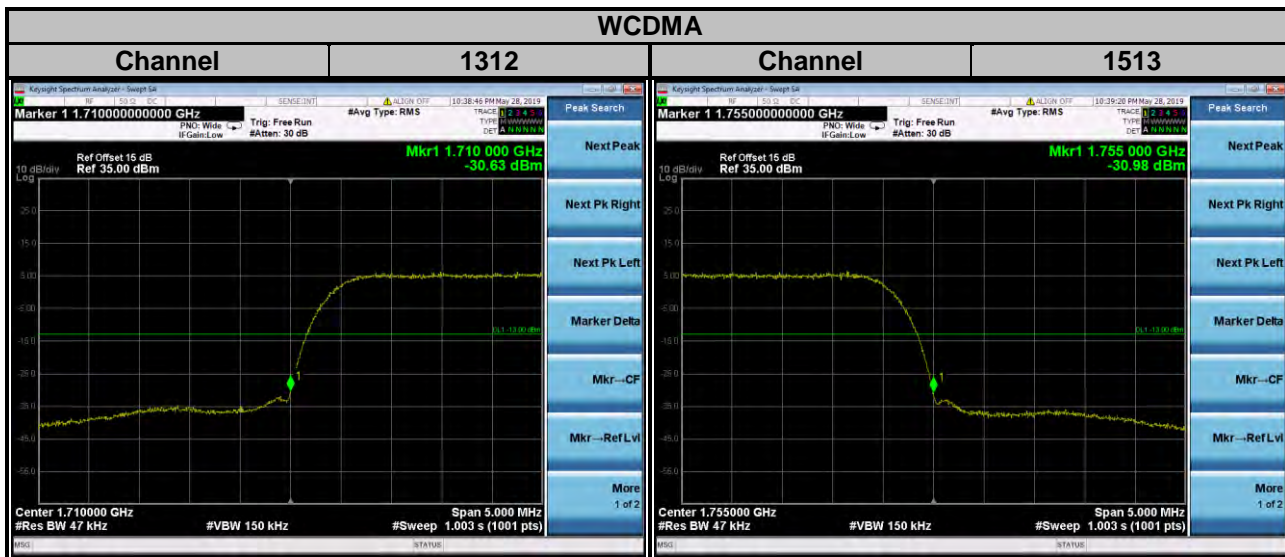

LTE Band 4

Channel Bandwidth: 3 MHz

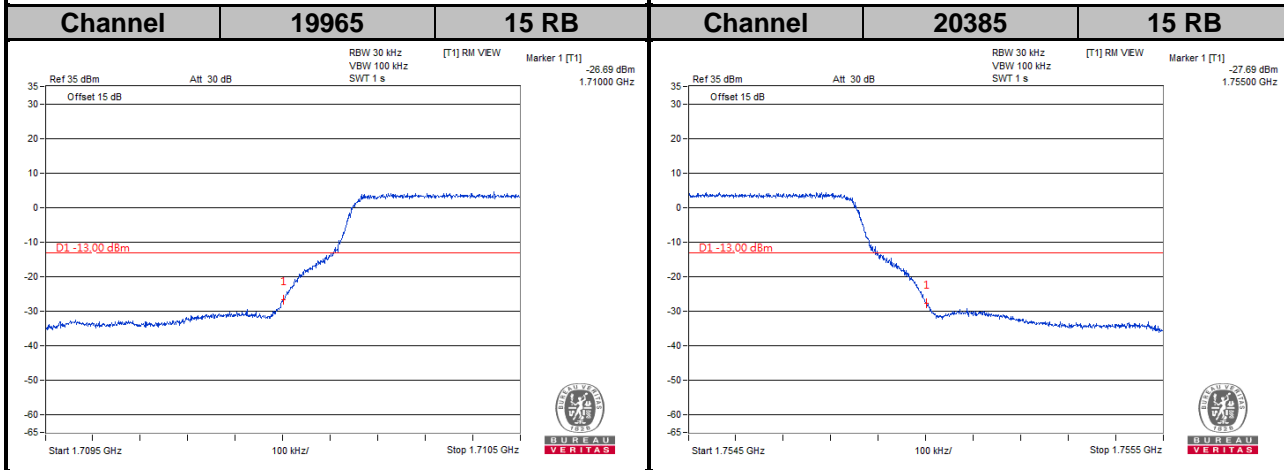
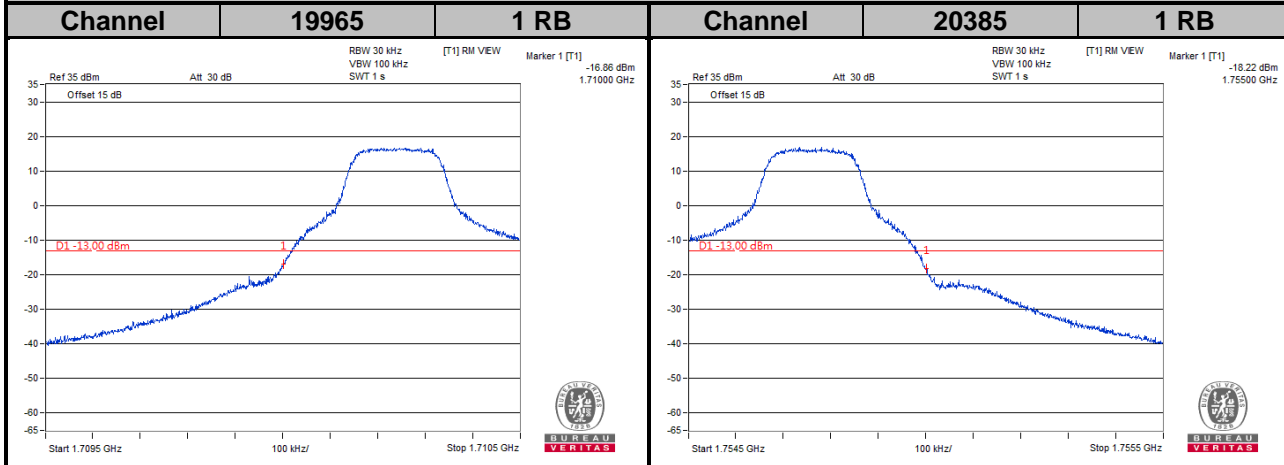

LTE Band 4
Channel Bandwidth: 5 MHz

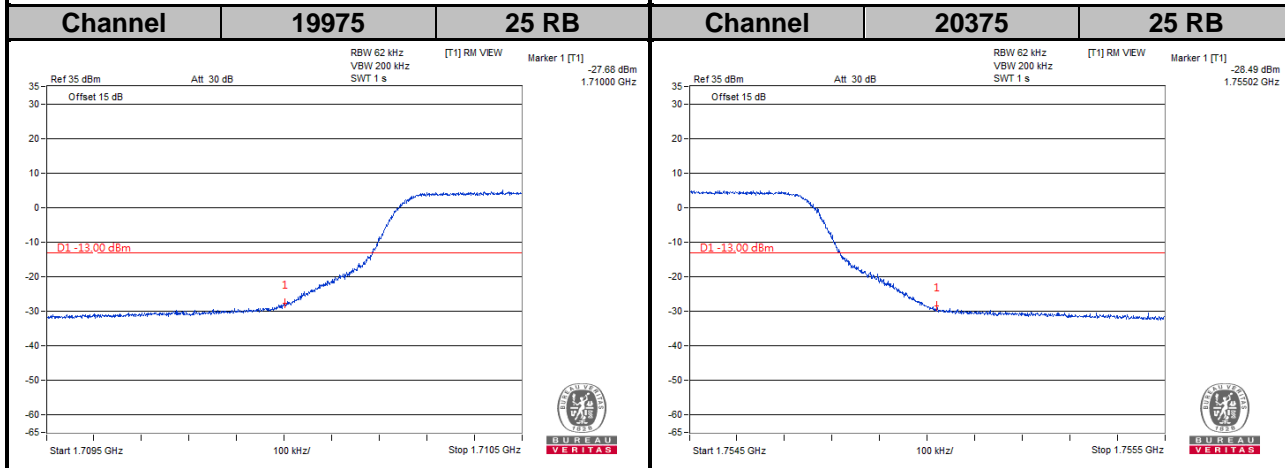
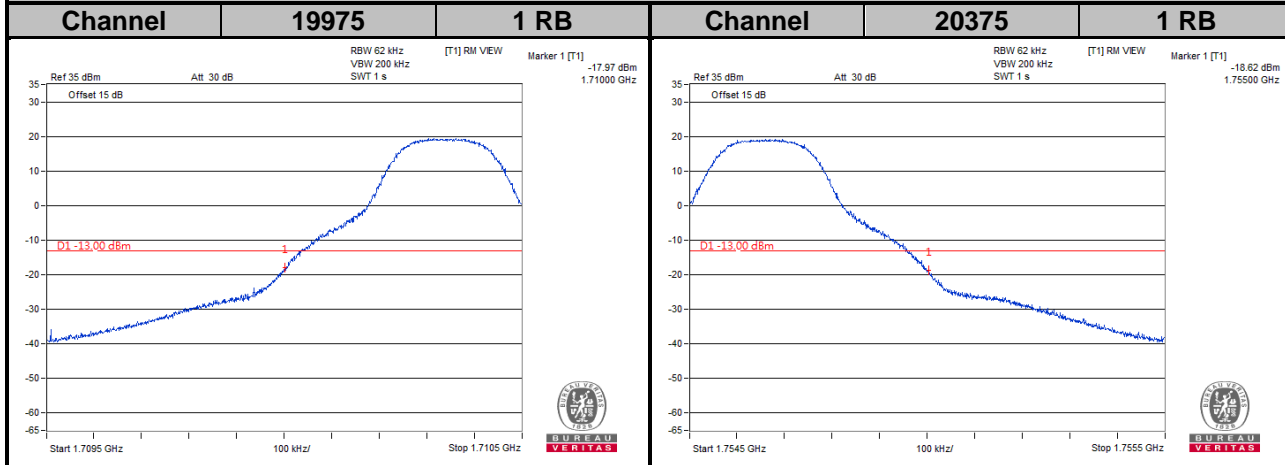

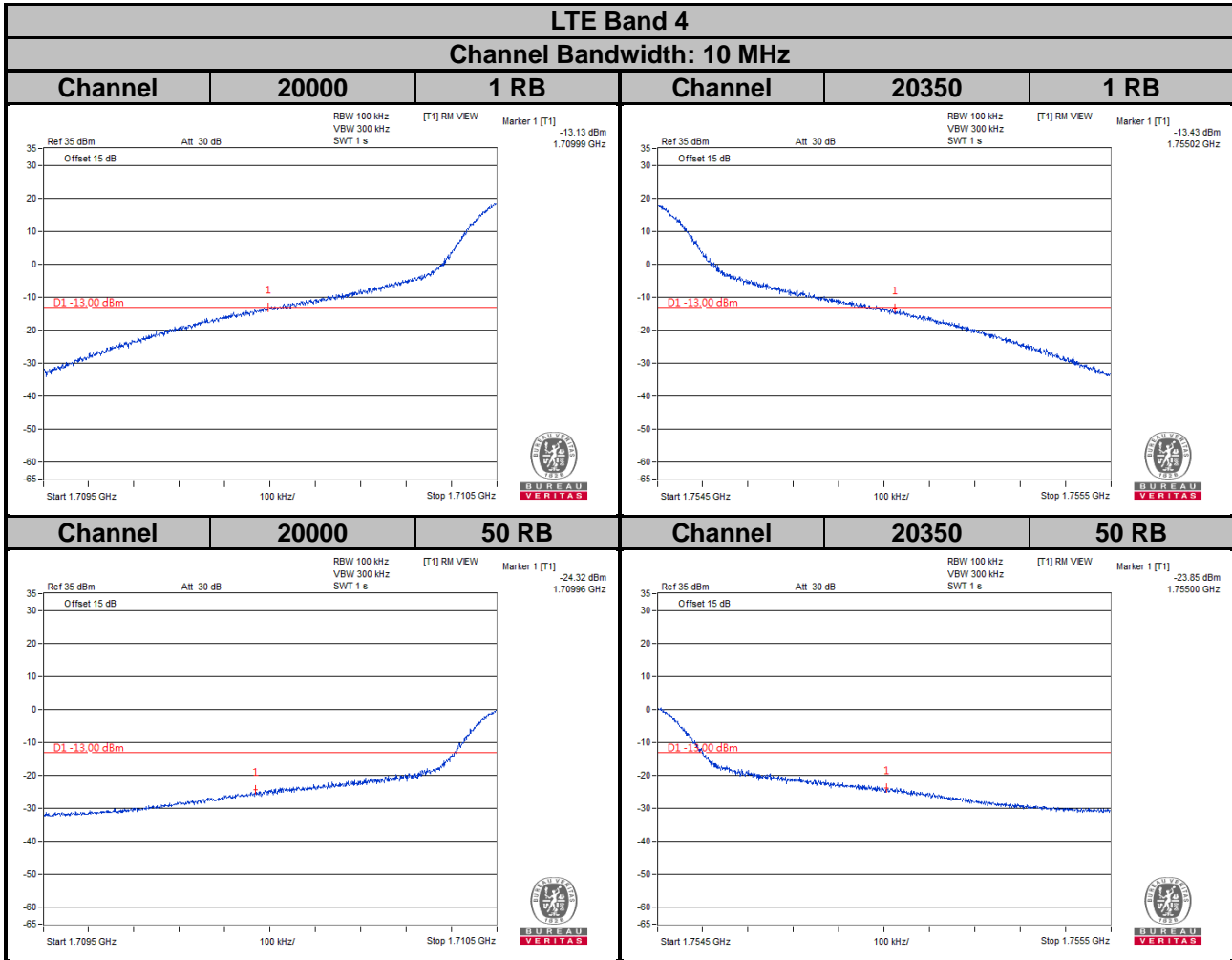

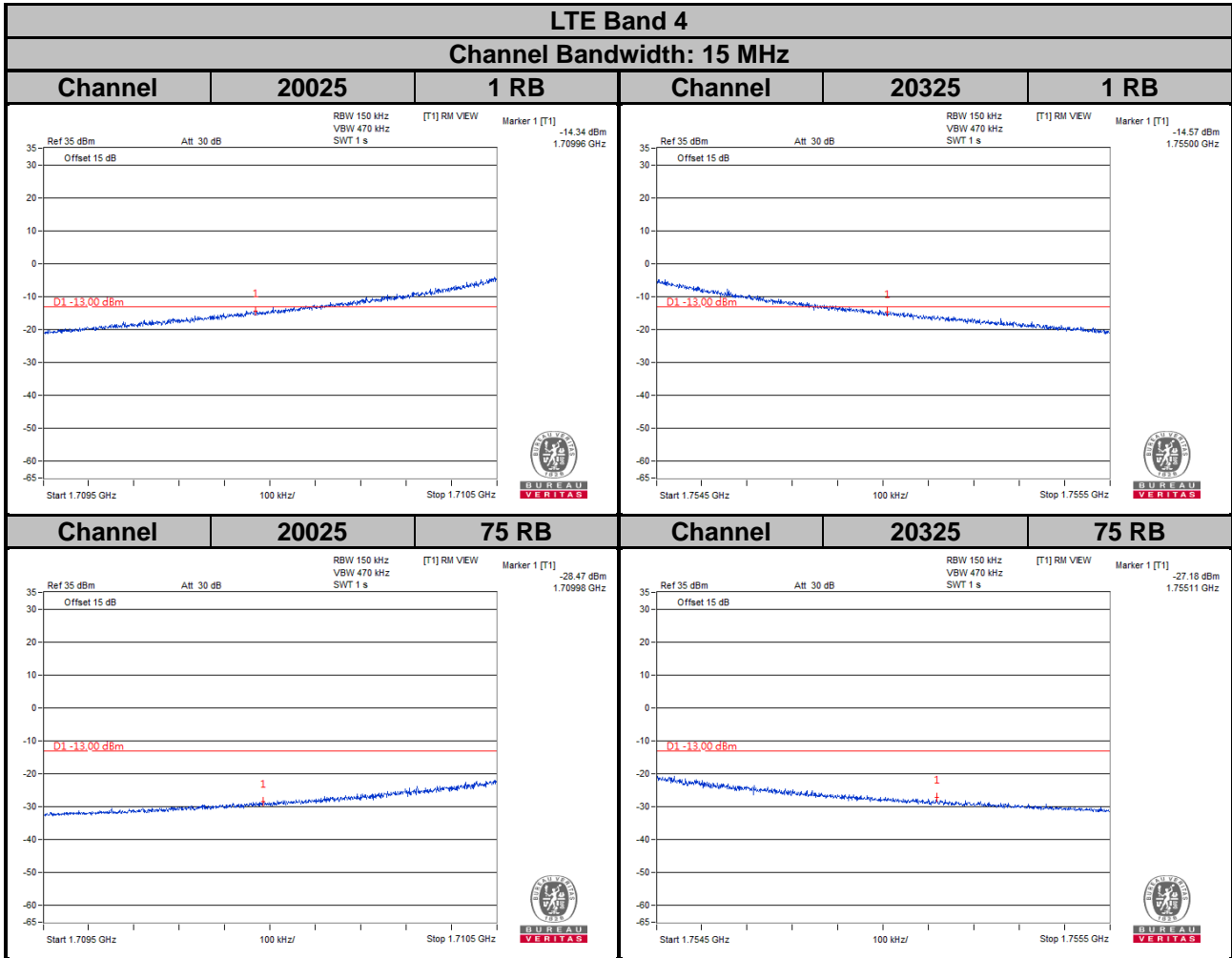

LTE Band 4

Channel Bandwidth: 20 MHz

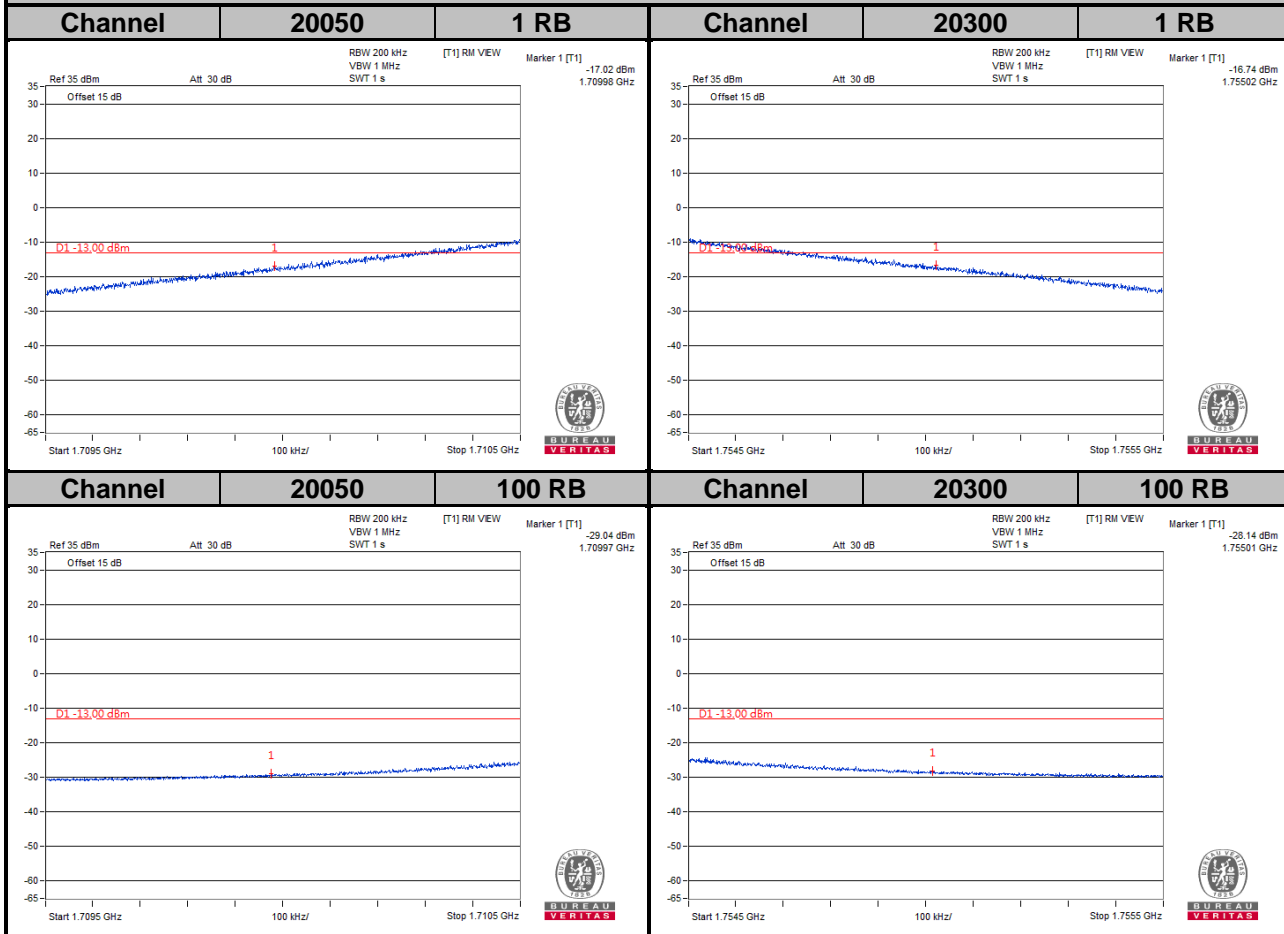

LTE Band 12
Channel Bandwidth: 1.4 MHz

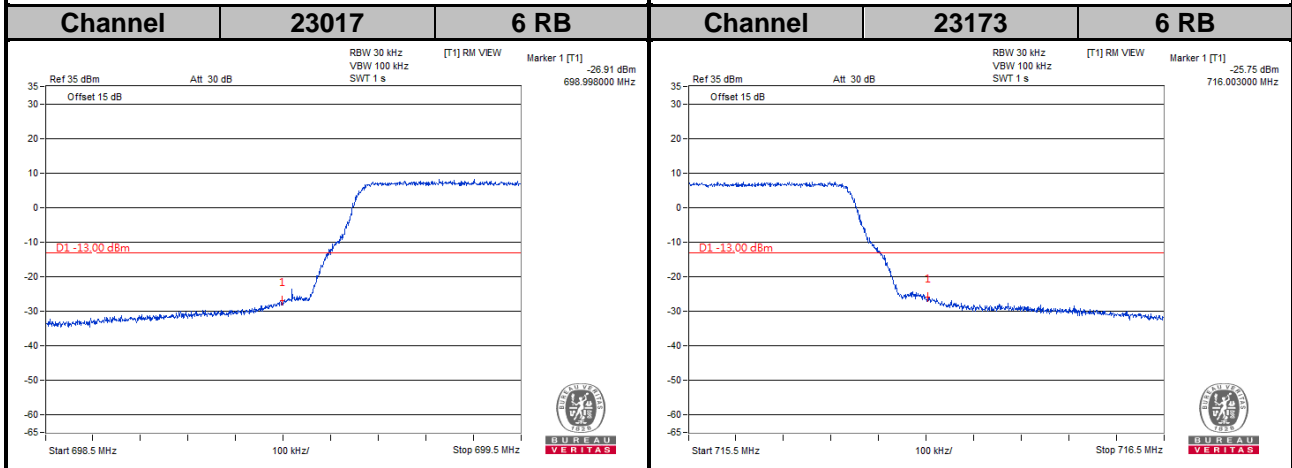
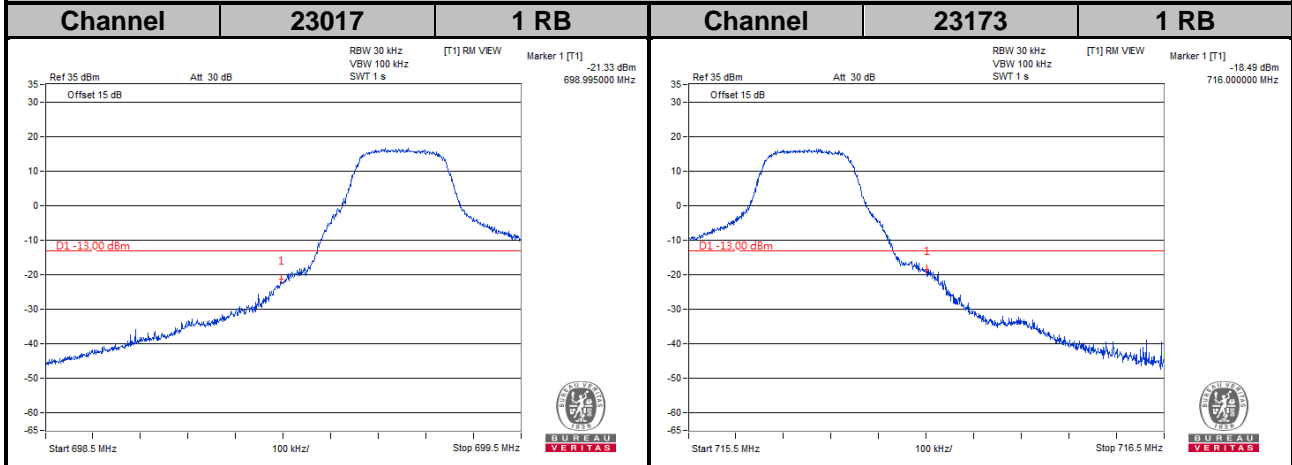

LTE Band 12
Channel Bandwidth: 3 MHz

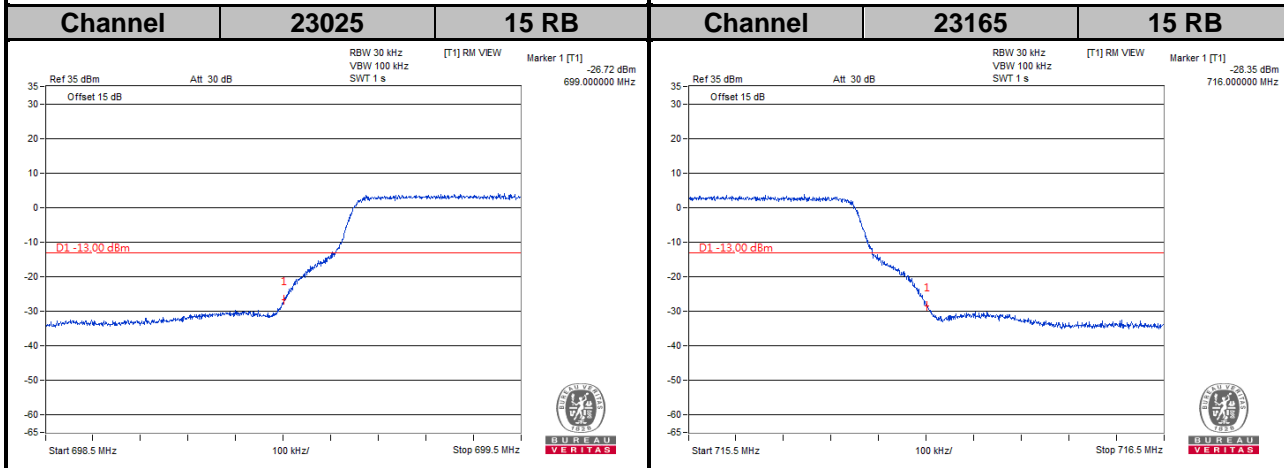
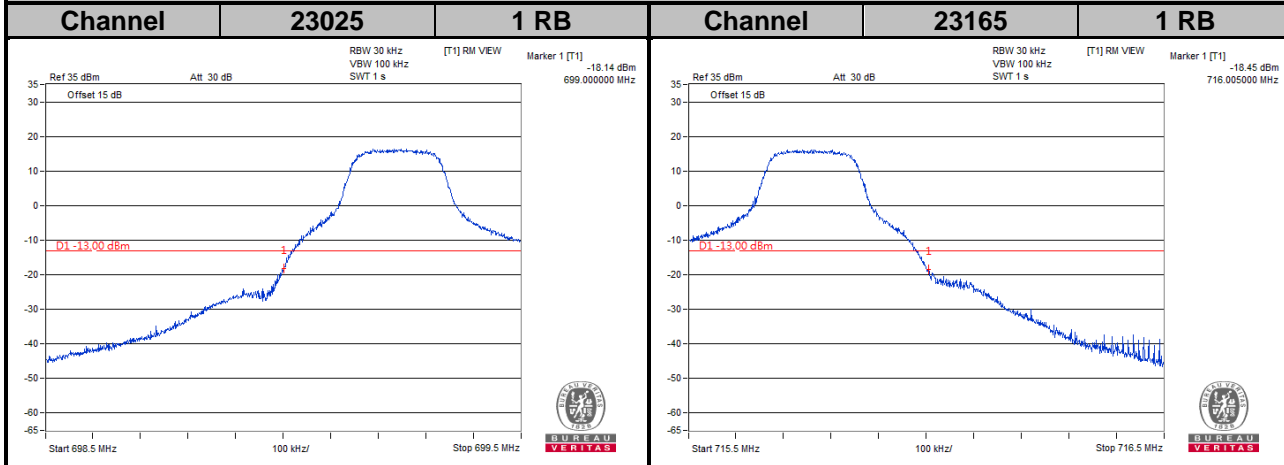

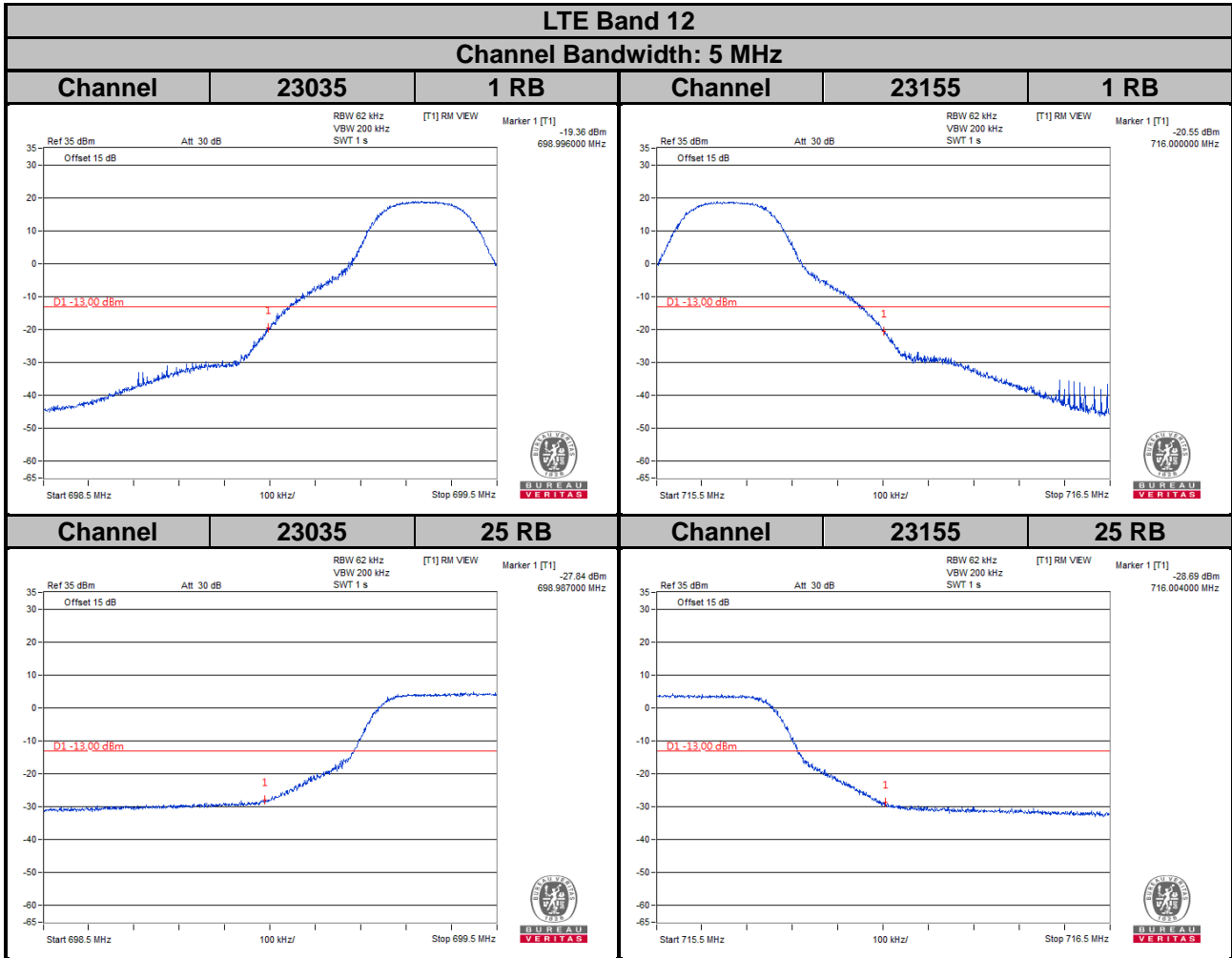

LTE Band 12
Channel Bandwidth: 10 MHz

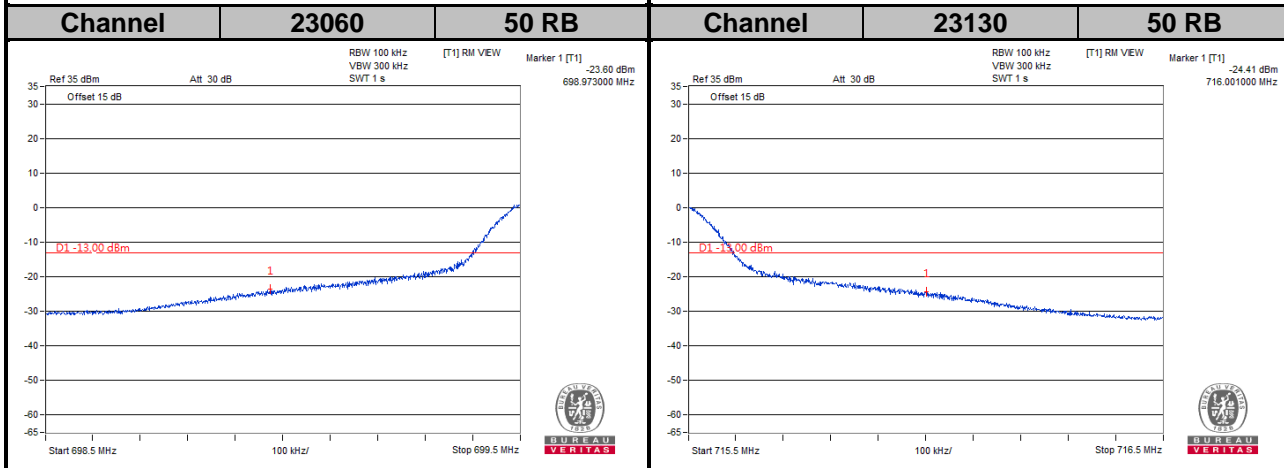
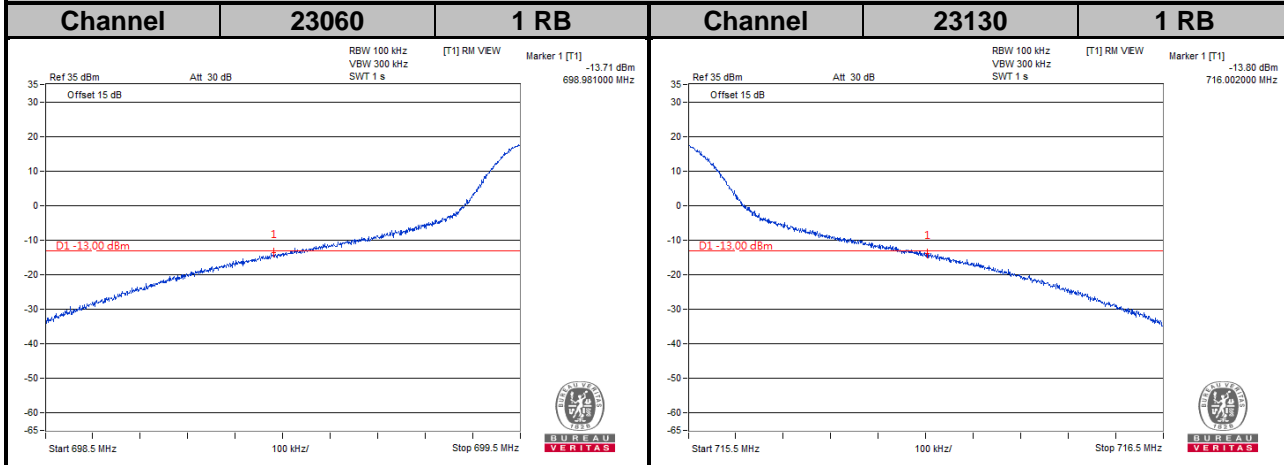

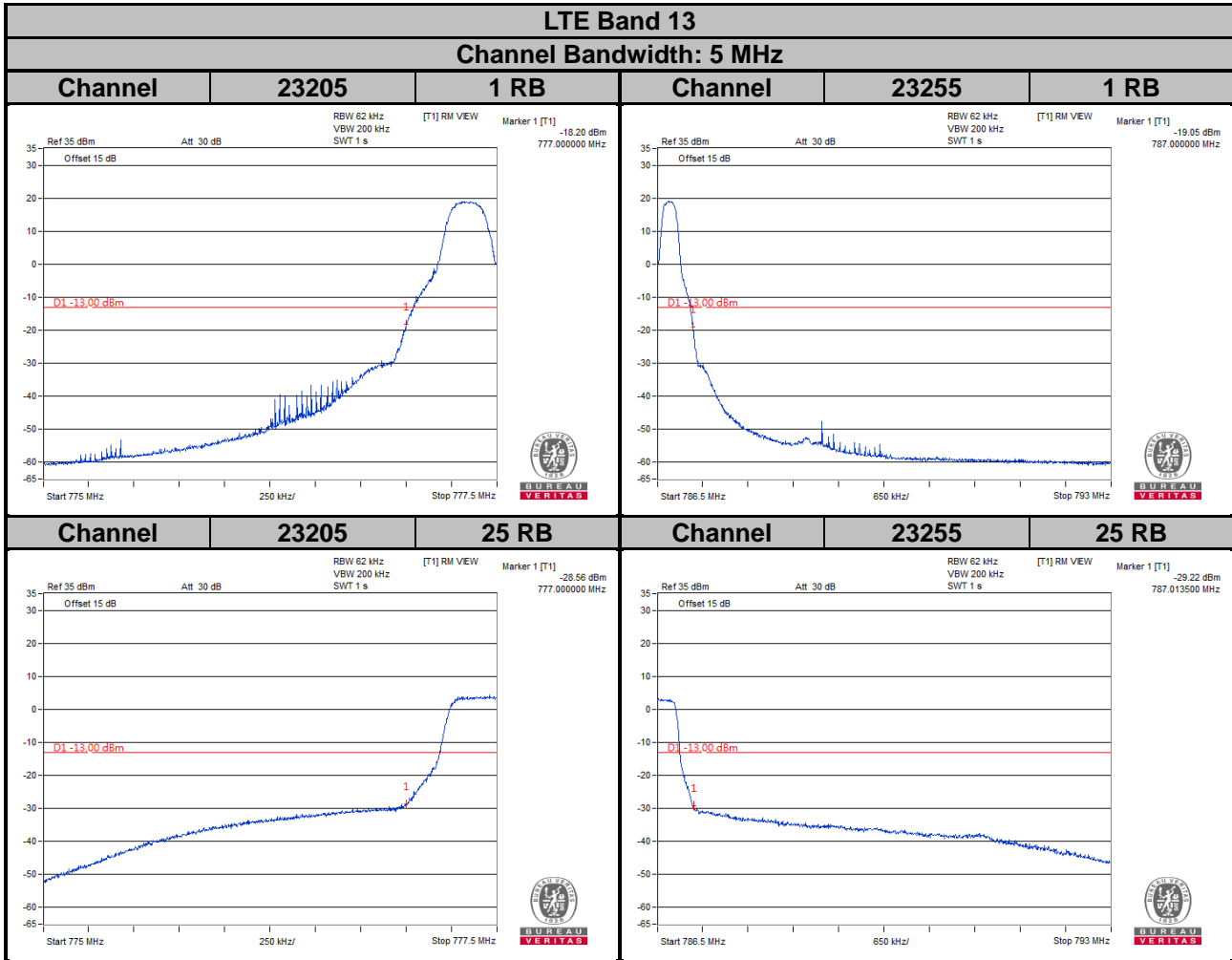

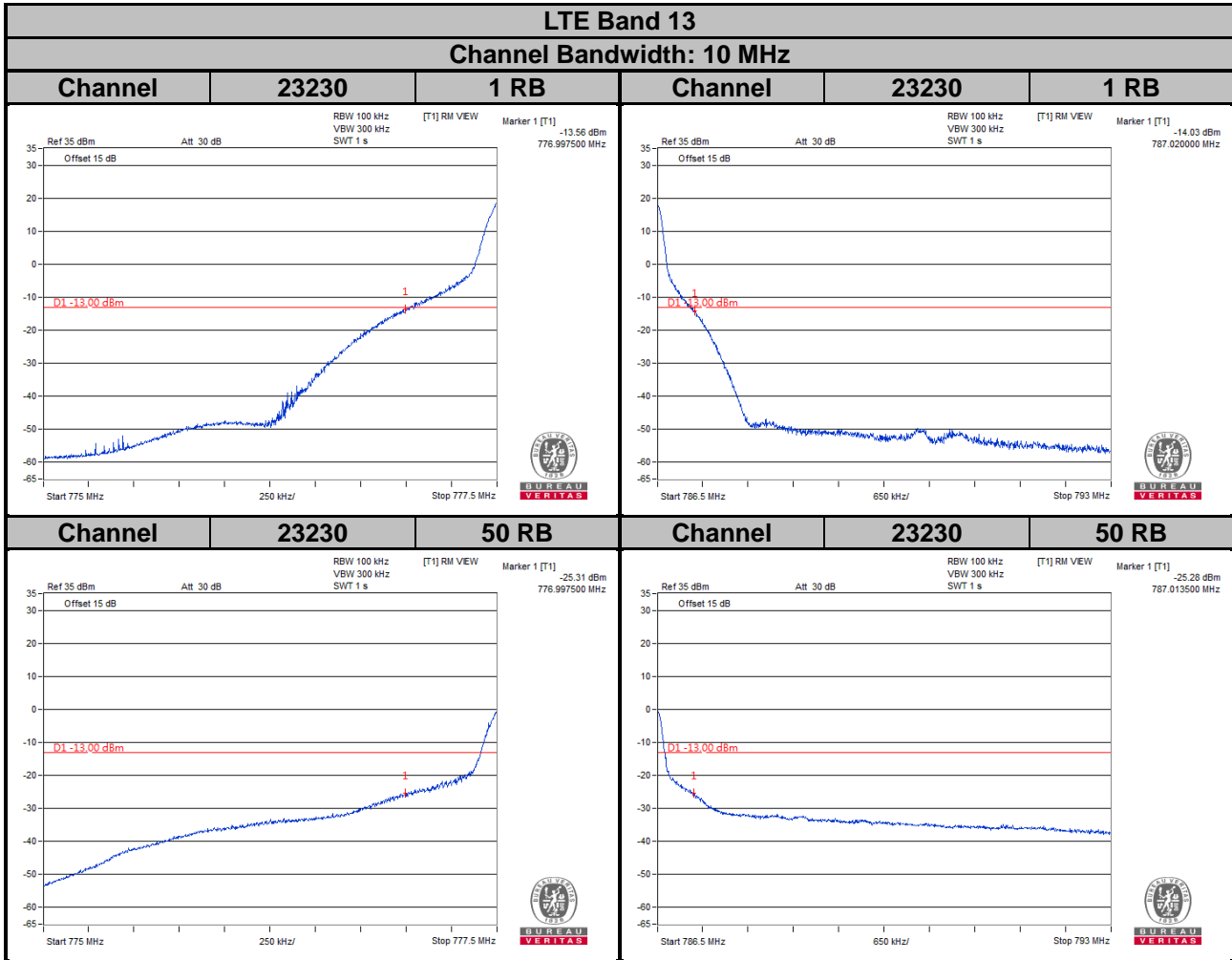

LTE Band 17
Channel Bandwidth: 5 MHz

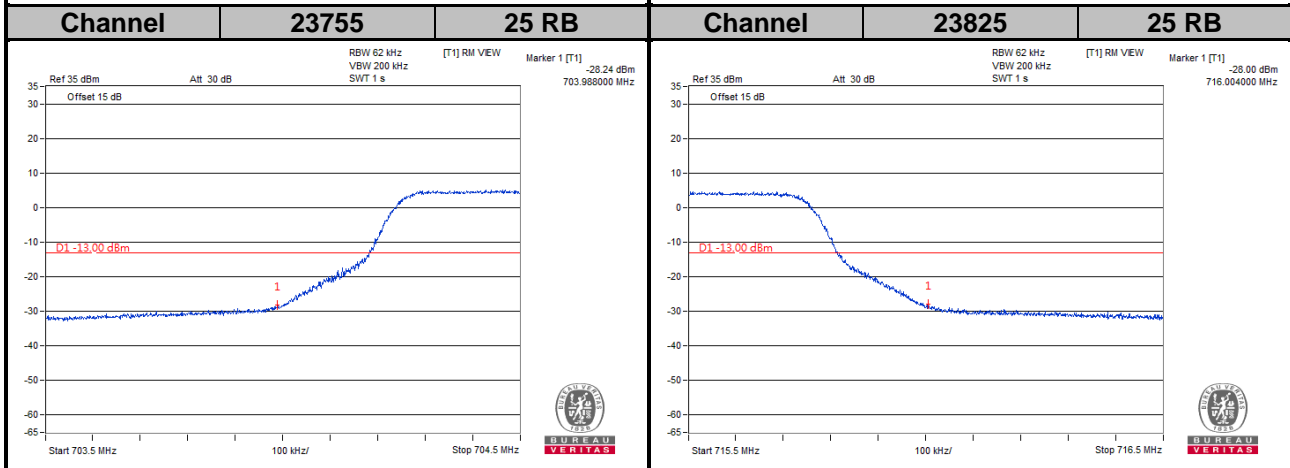
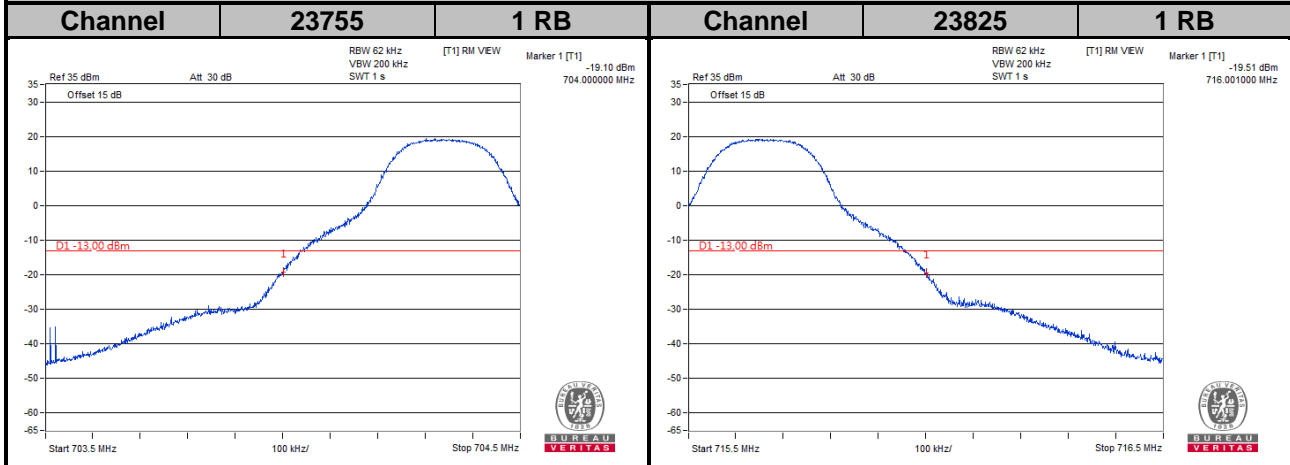

LTE Band 17
Channel Bandwidth: 10 MHz

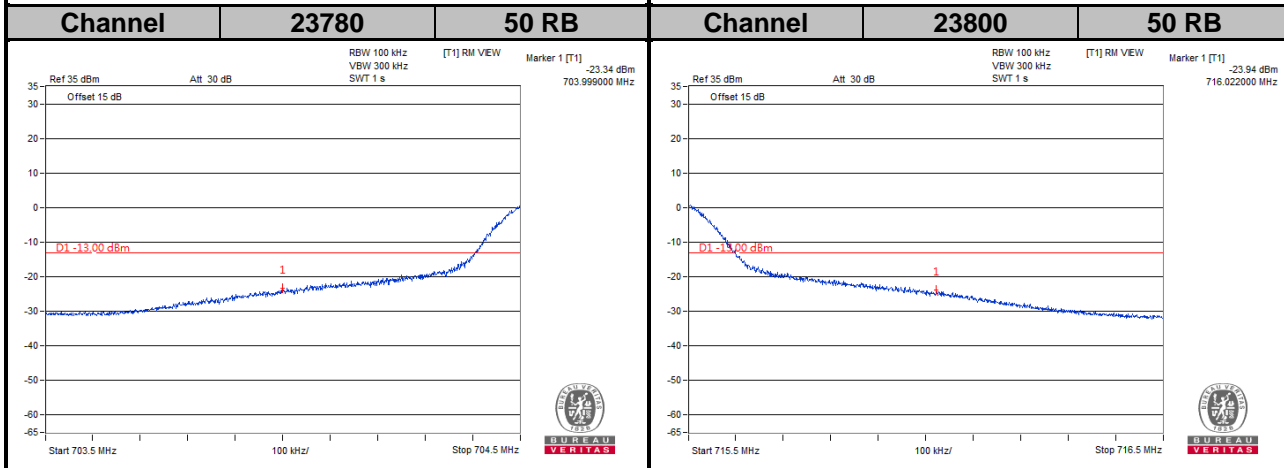
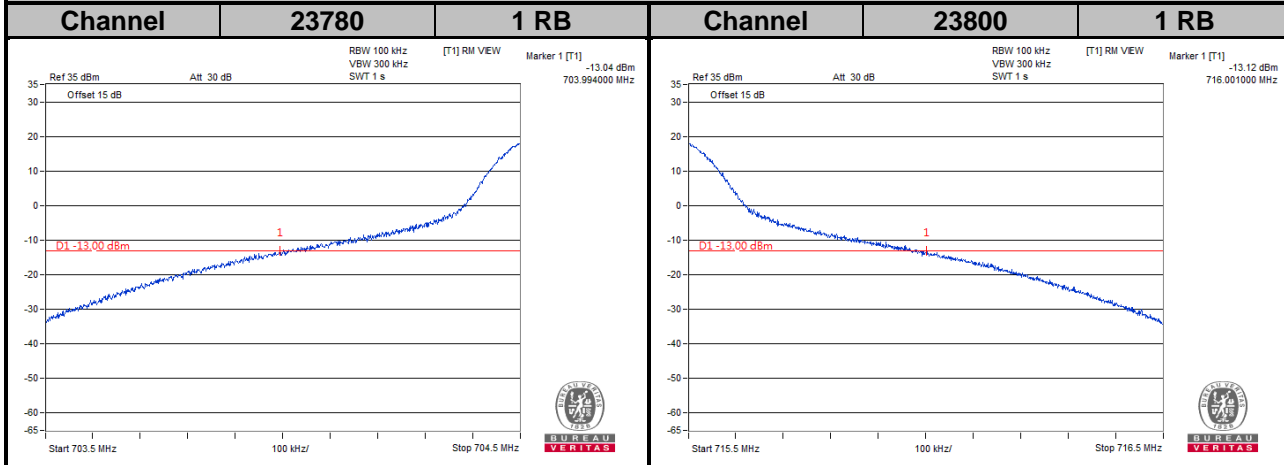

LTE Band 66

Channel Bandwidth: 1.4 MHz

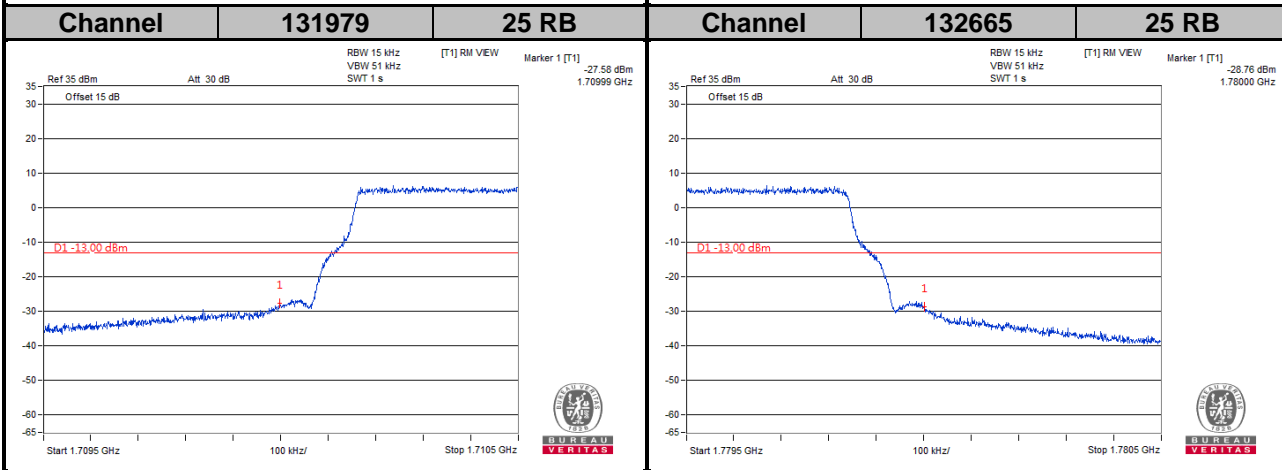
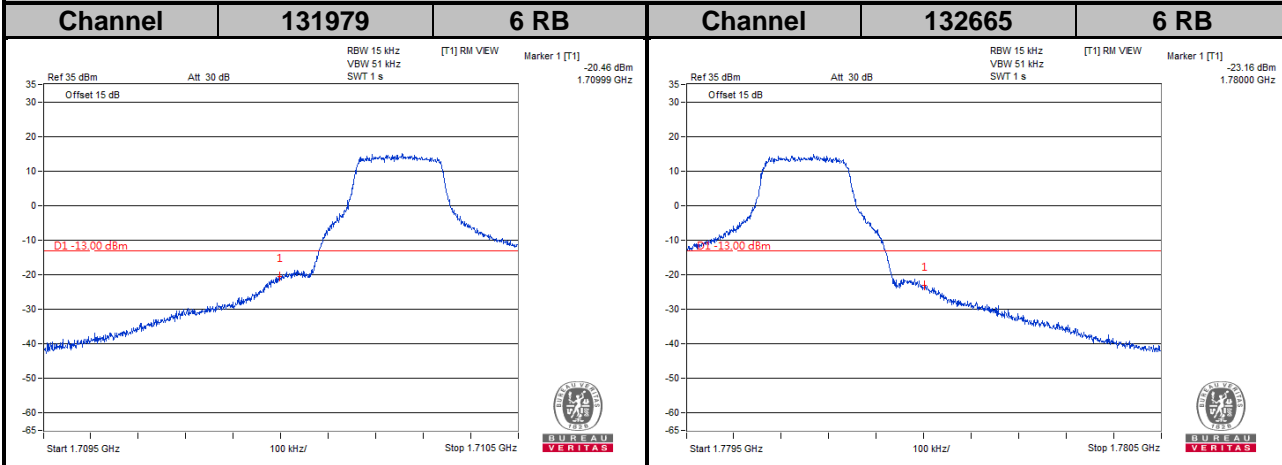

LTE Band 66

Channel Bandwidth: 3 MHz

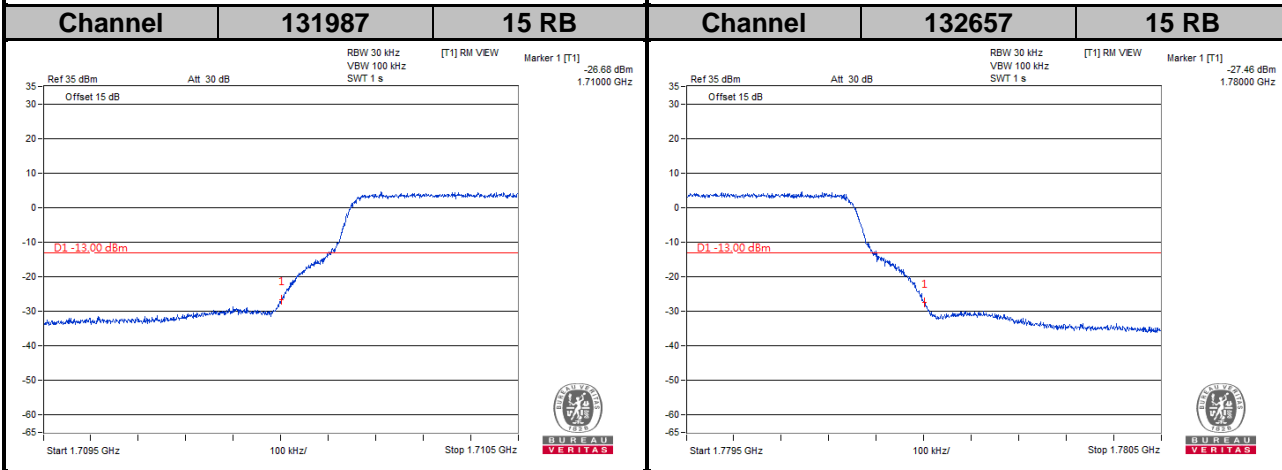
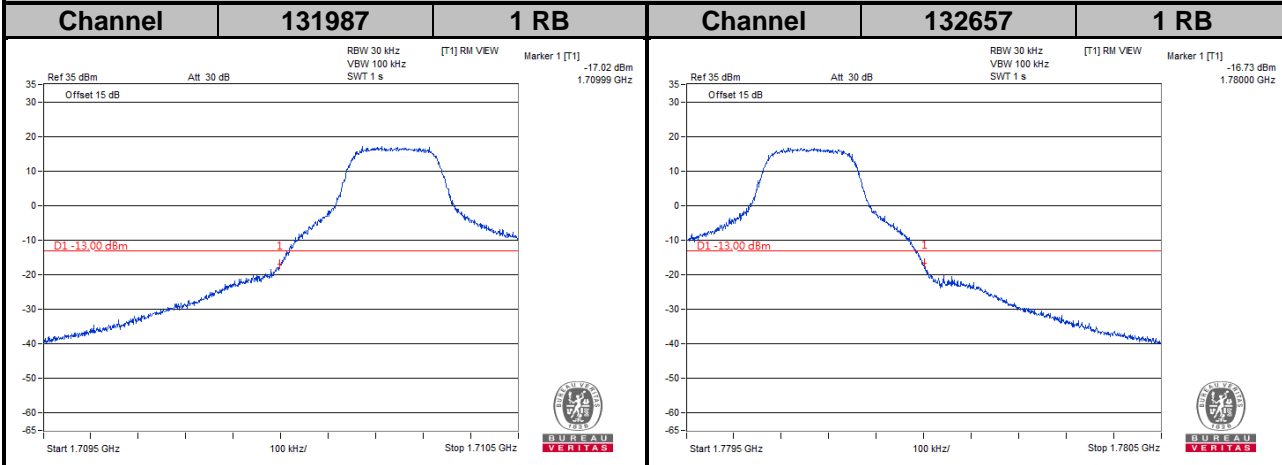

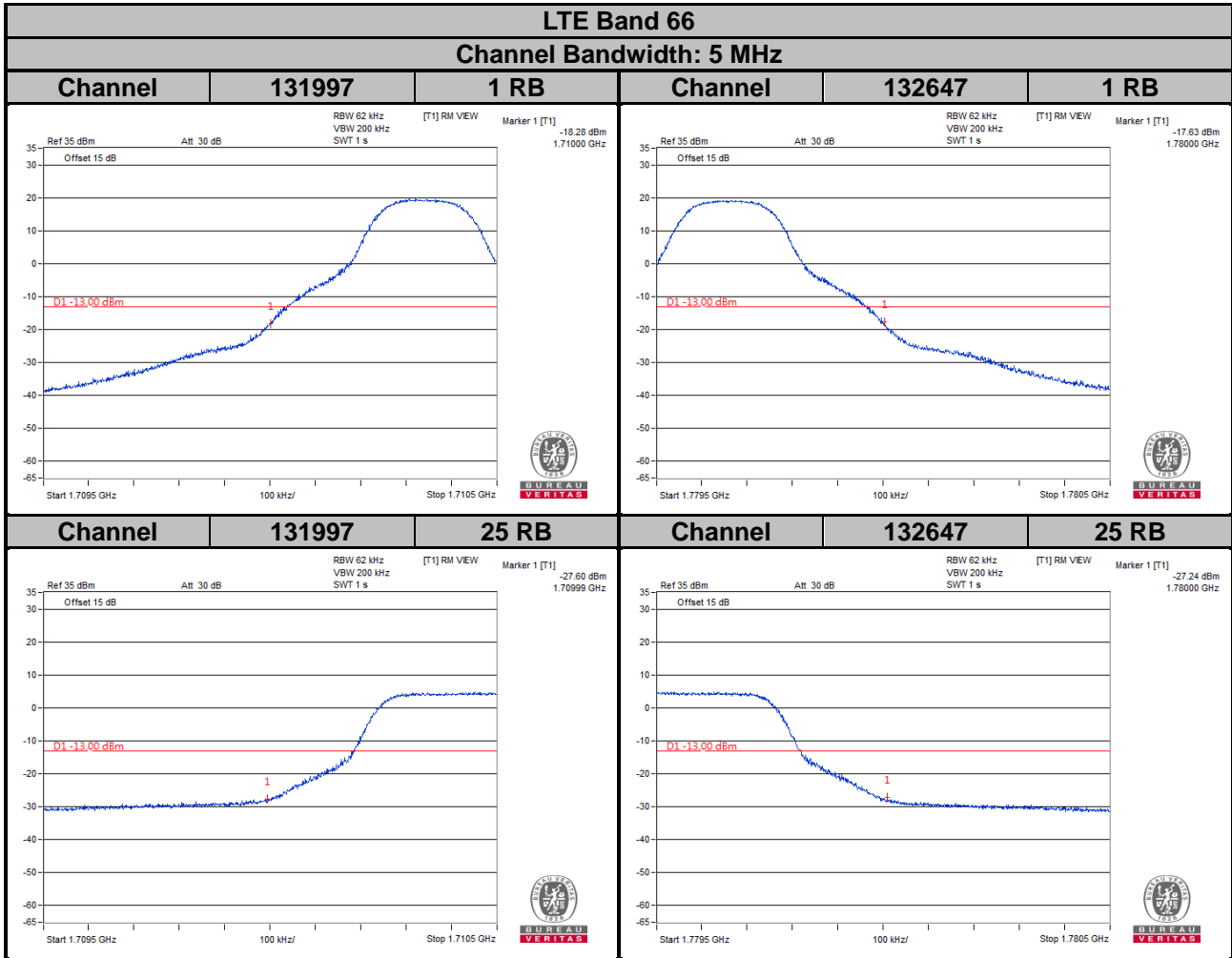

LTE Band 66

Channel Bandwidth: 10 MHz

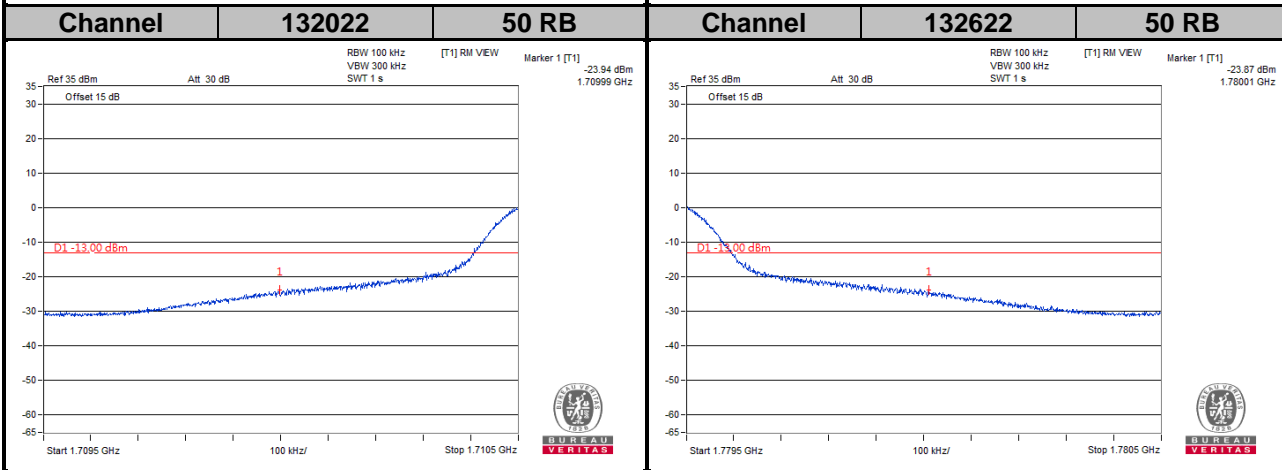
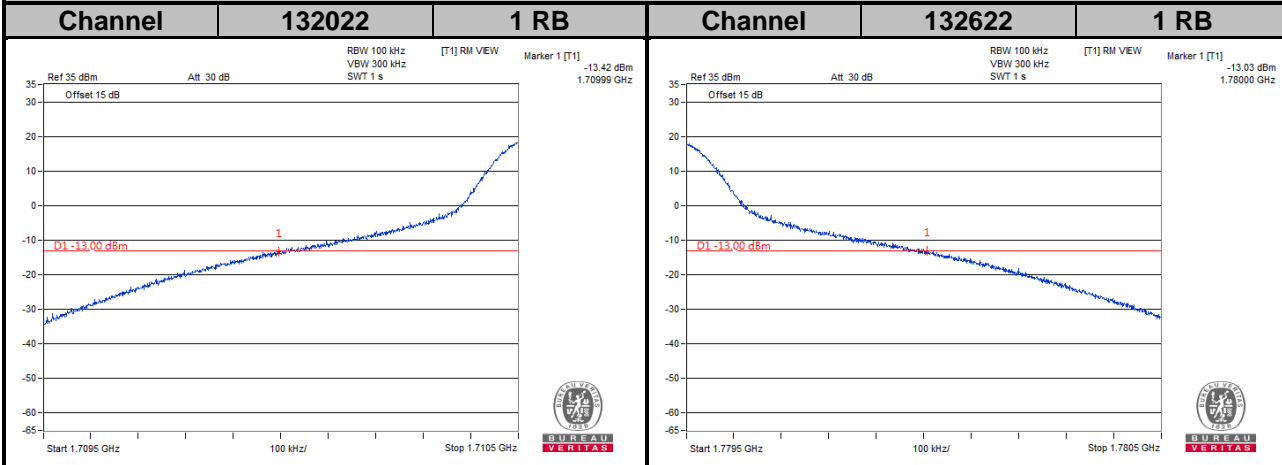

LTE Band 66
Channel Bandwidth: 15 MHz

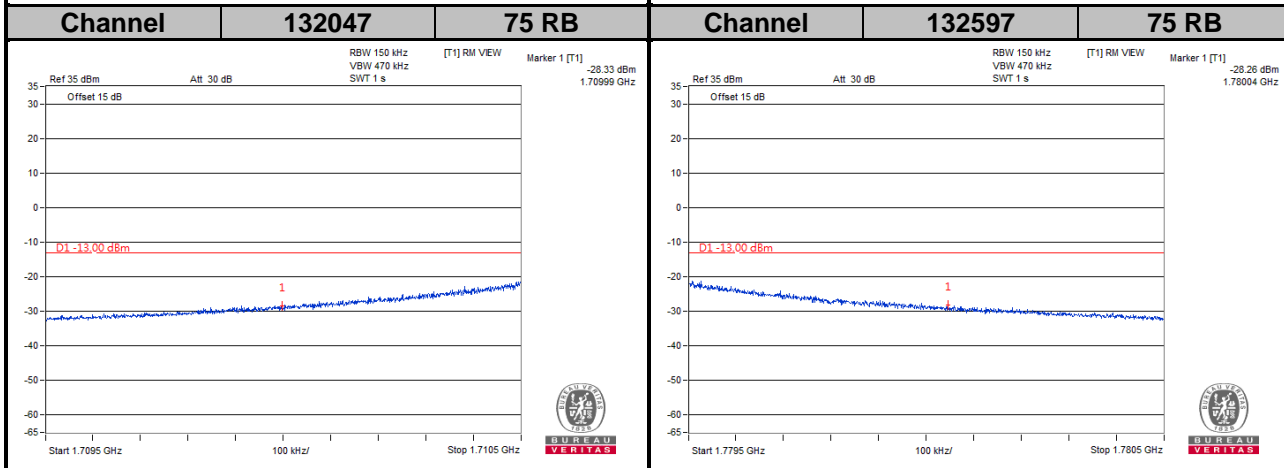
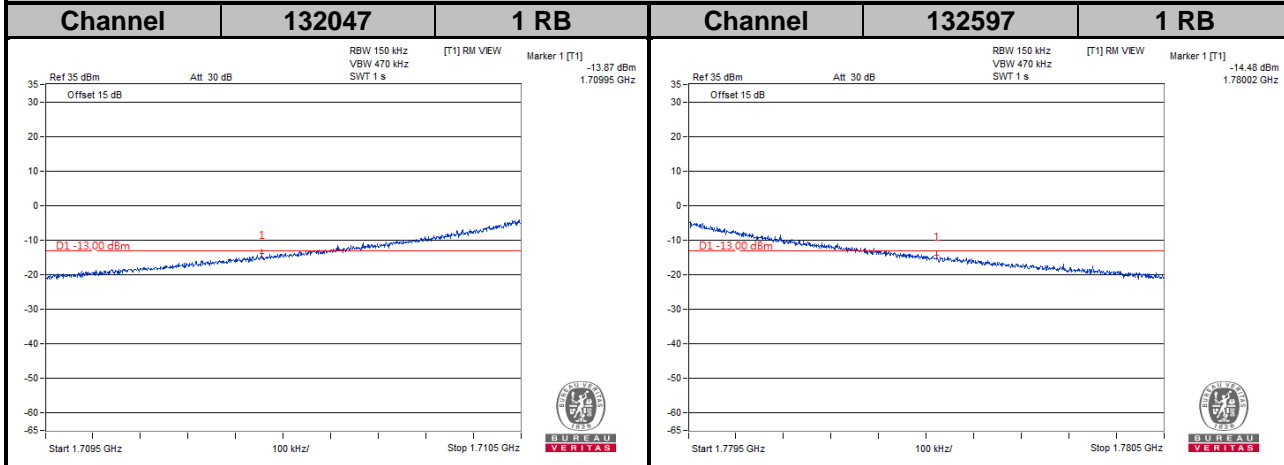

LTE Band 66

Channel Bandwidth: 20 MHz

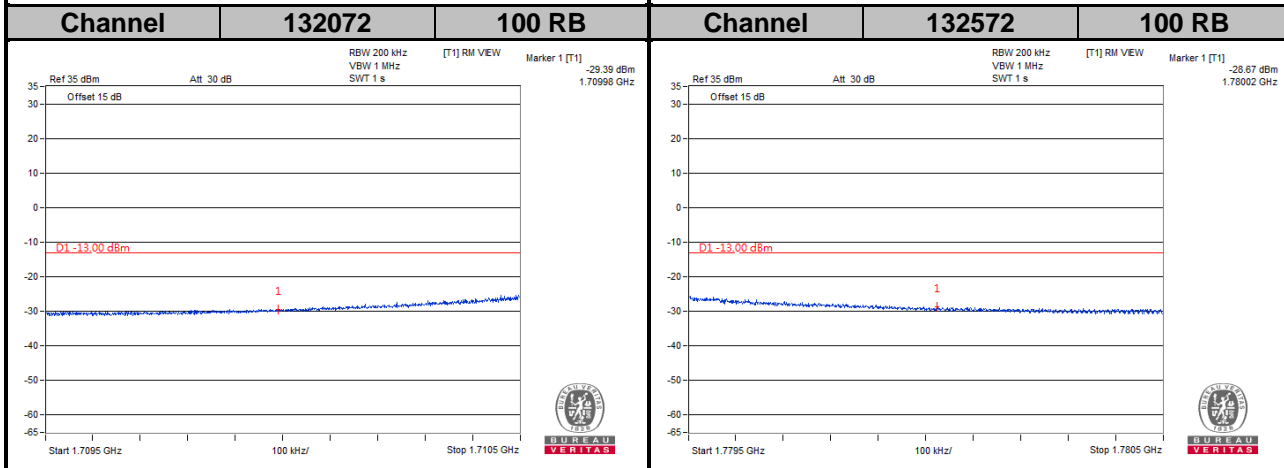
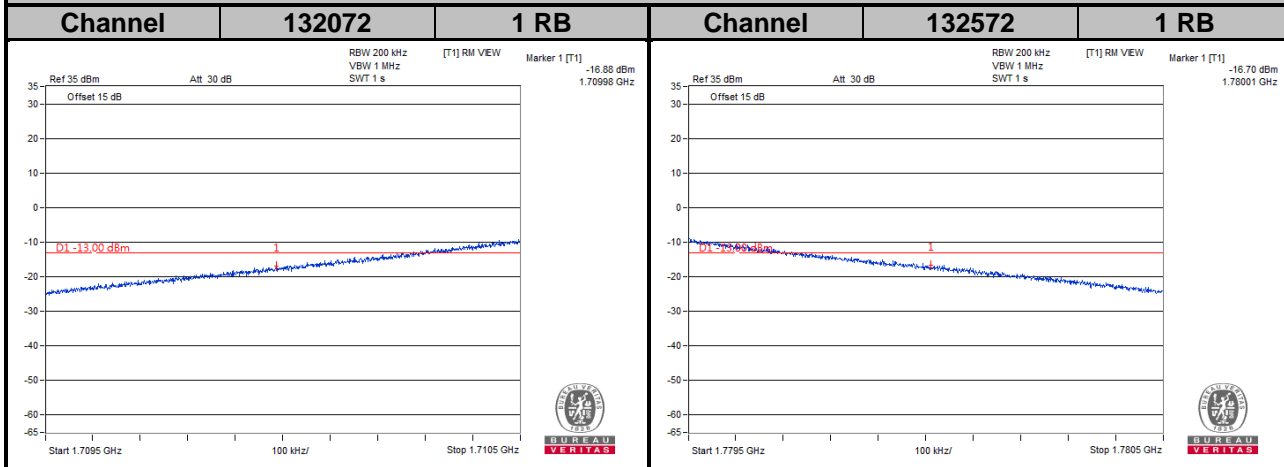

Emission Mask

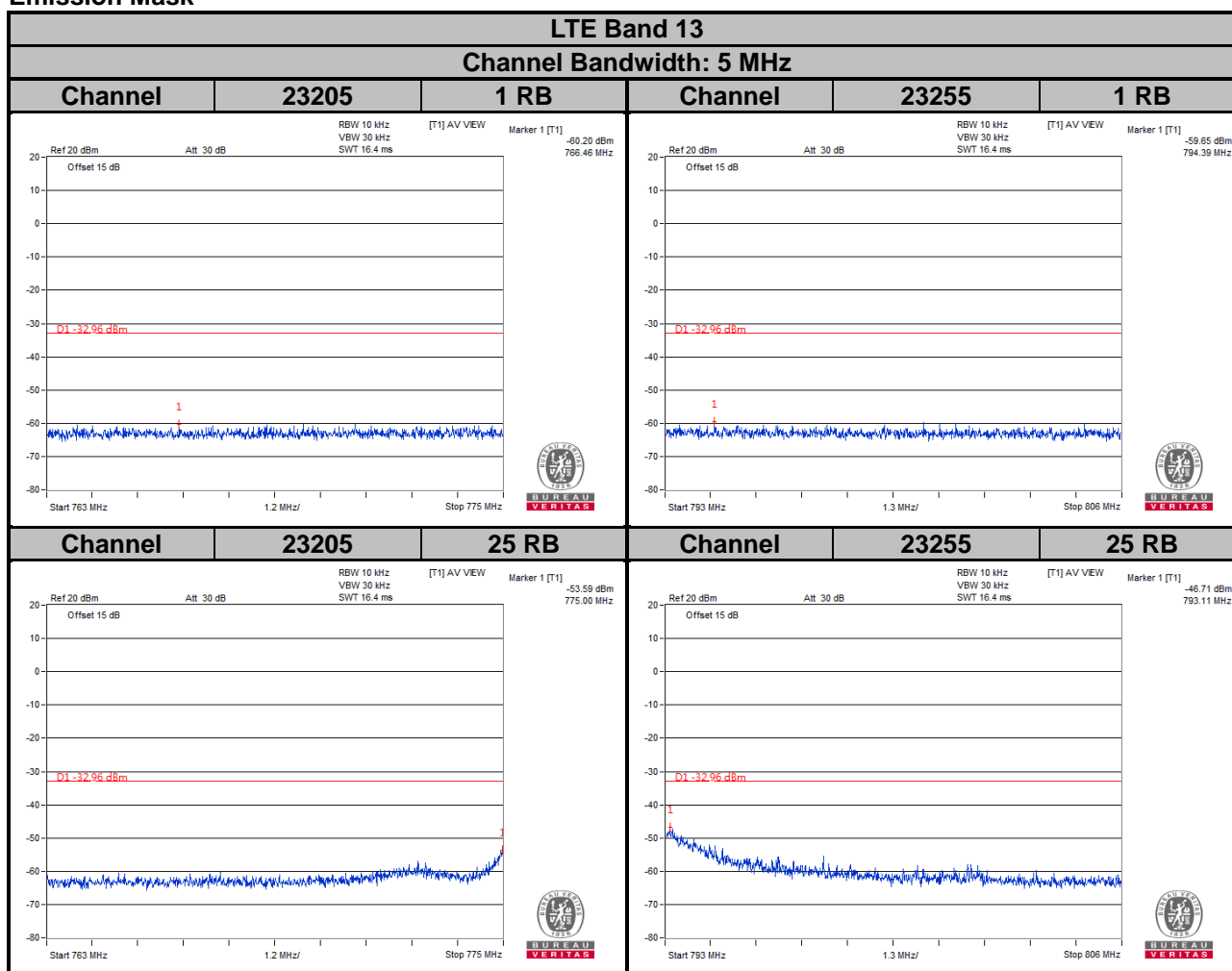

For the 763 - 775 MHz and 793 - 805 MHz band, the FCC limit is $65 + 10\log(P[\text{watt}])$ in a 6.25 kHz bandwidth. Since it was not possible to set the resolution bandwidth to 6.25 kHz with the available equipment, a bandwidth of 10 kHz was used instead to show compliance. By using a 10 kHz bandwidth on the spectrum analyzer.

$$10\log(10\text{kHz}/6.25\text{kHz}) = 2.04 \text{ dB}$$

$$\text{Limit line} = -35 \text{ dBm} + 2.04 \text{ dB} = -32.96 \text{ dBm}$$

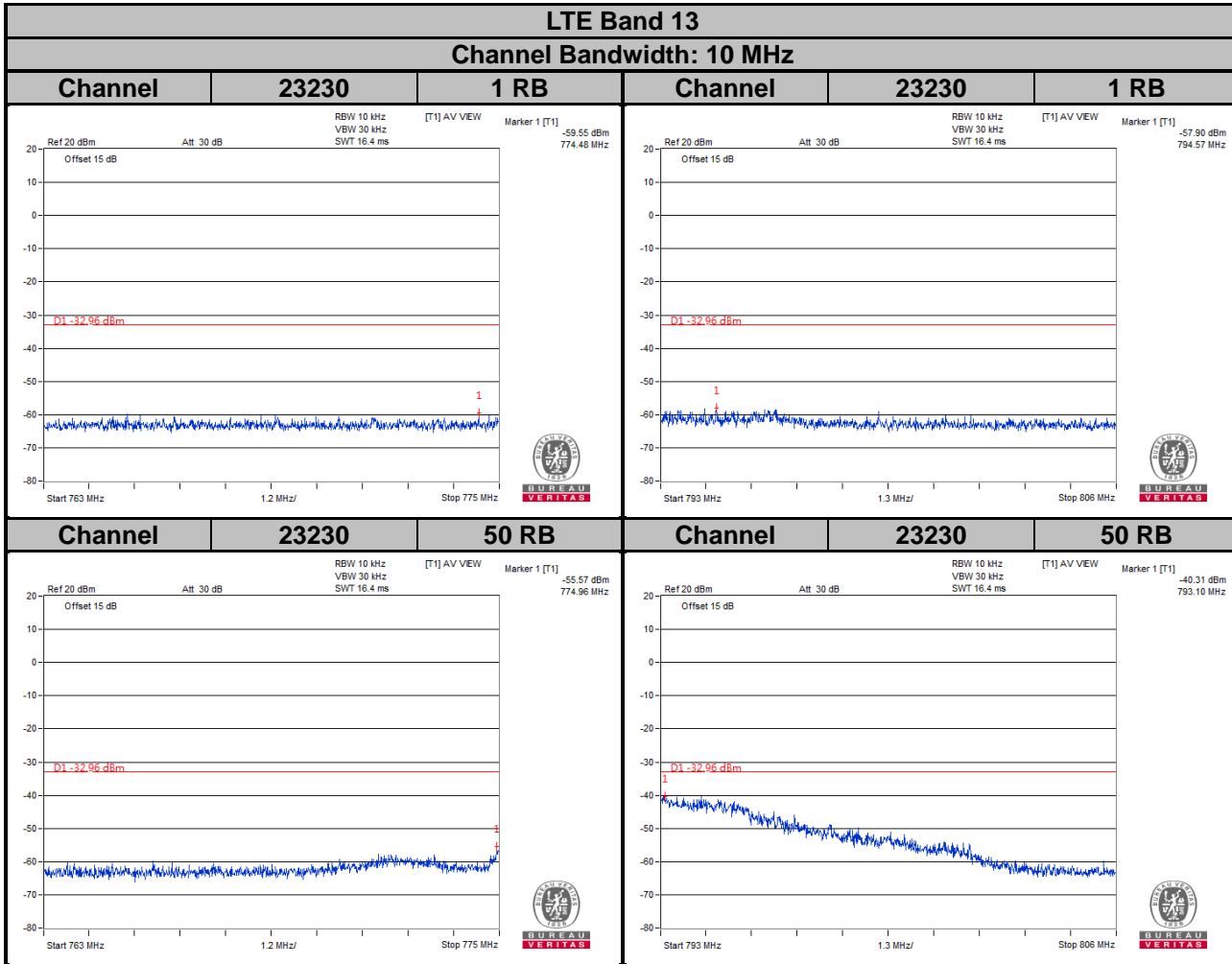

For the 763 - 775 MHz and 793 - 805 MHz band, the FCC limit is $65+10\log(P[\text{watt}])$ in a 6.25 kHz bandwidth. Since it was not possible to set the resolution bandwidth to 6.25 kHz with the available equipment, a bandwidth of 10 kHz was used instead to show compliance. By using a 10 kHz bandwidth on the spectrum analyzer.

$$10\log(10\text{kHz}/6.25\text{kHz}) = 2.04 \text{ dB}$$

$$\text{Limit line} = -35 \text{ dBm} + 2.04 \text{ dB} = -32.96 \text{ dBm}$$