

FCC Test Report

(PART 27)

Report No.: RF190516C01-9

FCC ID: B94HNQ20PK

Test Model: HSN-Q20C

Received Date: May 16, 2019

Test Date: May 25 ~ Jun. 06, 2019

Issued Date: Jun. 26, 2019

Applicant: HP Inc.

Address: 3390 East Harmony Road, Fort Collins, Colorado 80528, United States

Issued By: Bureau Veritas Consumer Products Services (H.K.) Ltd., Taoyuan Branch

Lab Address: No. 47-2, 14th Ling, Chia Pau Vil., Lin Kou Dist., New Taipei City, Taiwan
(R.O.C)

Test Location: No. 19, Hwa Ya 2nd Rd, Wen Hwa Vil, Kwei Shan Dist., Taoyuan City
33383, Taiwan (R.O.C)

**FCC Registration /
Designation Number:** 788550 / TW0003



This report is for your exclusive use. Any copying or replication of this report to or for any other person or entity, or use of our name or trademark, is permitted only with our prior written permission. This report sets forth our findings solely with respect to the test samples identified herein. The results set forth in this report are not indicative or representative of the quality or characteristics of the lot from which a test sample was taken or any similar or identical product unless specifically and expressly noted. Our report includes all of the tests requested by you and the results thereof based upon the information that you provided to us. You have 60 days from date of issuance of this report to notify us of any material error or omission caused by our negligence, provided, however, that such notice shall be in writing and shall specifically address the issue you wish to raise. A failure to raise such issue within the prescribed time shall constitute your unqualified acceptance of the completeness of this report, the tests conducted and the correctness of the report contents. Unless specific mention, the uncertainty of measurement has been explicitly taken into account to declare the compliance or non-compliance to the specification. The report must not be used by the client to claim product certification, approval, or endorsement by TAF or any government agencies

Table of Contents

Release Control Record	4
1 Certificate of Conformity	5
2 Summary of Test Results	6
2.1 Measurement Uncertainty	6
2.2 Test Site and Instruments	7
3 General Information	8
3.1 General Description of EUT	8
3.2 Configuration of System under Test	10
3.2.1 Description of Support Units	10
3.3 Test Mode Applicability and Tested Channel Detail	11
3.4 EUT Operating Conditions	14
3.5 General Description of Applied Standards	14
4 Test Types and Results	15
4.1 Output Power Measurement	15
4.1.1 Limits of Output Power Measurement	15
4.1.2 Test Procedures	15
4.1.3 Test Setup	16
4.1.4 Test Results	17
4.2 Modulation Characteristics Measurement	32
4.2.1 Limits of Modulation Characteristics	32
4.2.2 Test Setup	32
4.2.3 Test Procedure	32
4.2.4 Test Results	33
4.3 Frequency Stability Measurement	35
4.3.1 Limits of Frequency Stability Measurement	36
4.3.2 Test Procedure	36
4.3.3 Test Setup	36
4.3.4 Test Results	37
4.4 Occupied Bandwidth Measurement	49
4.4.1 Limits of Occupied Bandwidth Measurement	49
4.4.2 Test Procedure	49
4.4.3 Test Setup	49
4.4.4 Test Results	50
4.5 Out-of-Band Emissions Measurement	56
4.5.1 Limits of Out-of-Band Emissions Measurement	56
4.5.2 Test Setup	56
4.5.3 Test Procedures	56
4.5.4 Test Results	57
4.6 Peak to Average Ratio	93
4.6.1 Limits of Peak to Average Ratio Measurement	93
4.6.2 Test Setup	93
4.6.3 Test Procedures	93
4.6.4 Test Results	94
4.7 Conducted Spurious Emissions	100
4.7.1 Limits of Conducted Spurious Emissions Measurement	100
4.7.2 Test Setup	100
4.7.3 Test Procedure	100
4.7.4 Test Results	101
4.8 Radiated Emission Measurement	137
4.8.1 Limits of Radiated Emission Measurement	137
4.8.2 Test Procedure	137
4.8.3 Deviation from Test Standard	137
4.8.4 Test Setup	138

4.8.5 Test Results	139
5 Pictures of Test Arrangements.....	175
Appendix – Information of the Testing Laboratories	176

Release Control Record

Issue No.	Description	Date Issued
RF190516C01-9	Original Release	Jun. 26, 2019

1 Certificate of Conformity

Product: Notebook Computer

Brand: HP

Test Model: HSN-Q20C

Sample Status: Engineering Sample

Applicant: HP Inc.

Test Date: May 25 ~ Jun. 06, 2019

Standards: FCC Part 27, Subpart C, M

The above equipment has been tested by **Bureau Veritas Consumer Products Services (H.K.) Ltd., Taoyuan Branch**, and found compliance with the requirement of the above standards. The test record, data evaluation & Equipment Under Test (EUT) configurations represented herein are true and accurate accounts of the measurements of the sample's RF characteristics under the conditions specified in this report.

Prepared by : Gina Liu , **Date:** Jun. 26, 2019
Gina Liu / Specialist

Approved by : Dylan Chiou , **Date:** Jun. 26, 2019
Dylan Chiou / Project Engineer

2 Summary of Test Results

Applied Standard: FCC Part 27 & Part 2			
FCC Clause	Test Item	Result	Remarks
2.1046 27.50(h)(2)	Equivalent Isotropic Radiated Power	Pass	Meet the requirement of limit.
2.1047	Modulation Characteristics	Pass	Meet the requirement.
2.1055 27.54	Frequency Stability	Pass	Meet the requirement of limit.
2.1049 27.53(m)(6)	Occupied Bandwidth	Pass	Meet the requirement of limit.
--	Peak to Average Ratio	Pass	Meet the requirement of limit.
2.1051 27.53(m)(4)(6)	Out-of-Band Emissions Measurements	Pass	Meet the requirement of limit.
2.1051 27.53(m)(4)(6)	Conducted Spurious Emissions	Pass	Meet the requirement of limit.
2.1053 27.53(m)(4)(6)	Radiated Spurious Emissions	Pass	Meet the requirement of limit. Minimum passing margin is -17.21 dB at 31.94 MHz.

Note: Determining compliance based on the results of the compliance measurement, not taking into account measurement instrumentation uncertainty.

2.1 Measurement Uncertainty

Where relevant, the following measurement uncertainty levels have been estimated for tests performed on the EUT as specified in CISPR 16-4-2:

Measurement	Frequency	Expanded Uncertainty (k=2) (±)
Radiated Emissions up to 1 GHz	9 kHz ~ 30 MHz	3.04 dB
	30 MHz ~ 200 MHz	2.93 dB
	200 MHz ~ 1000 MHz	2.95 dB
Radiated Emissions above 1 GHz	1 GHz ~ 18 GHz	2.26 dB
	18 GHz ~ 40 GHz	1.94 dB

2.2 Test Site and Instruments

Description & Manufacturer	Model No.	Serial No.	Date of Calibration	Due Date of Calibration
Test Receiver Agilent	N9038A	MY51210203	Mar. 18, 2019	Mar. 17, 2020
Spectrum Analyzer Agilent	N9010A	MY52220314	Dec. 13, 2018	Dec. 12, 2019
Spectrum Analyzer ROHDE & SCHWARZ	FSU43	101261	Apr. 15, 2019	Apr. 14, 2020
HORN Antenna SCHWARZBECK	BBHA 9170	148	Nov. 25, 2018	Nov. 24, 2019
HORN Antenna SCHWARZBECK	BBHA 9120 D	9120D-969	Nov. 25, 2018	Nov. 24, 2019
BILOG Antenna SCHWARZBECK	VULB9168	9168-472	Nov. 23, 2018	Nov. 22, 2019
Double Ridge Guide Horn Antenna EMCO	3115	5619	Nov. 25, 2018	Nov. 24, 2019
BILOG Antenna SCHWARZBECK	VULB 9168	9168-153	Nov. 23, 2018	Nov. 22, 2019
Fixed Attenuator WORKEN	MDCS18N-10	MDCS18N-10-01	Apr. 15, 2019	Apr. 14, 2020
MXG Vector signal generator Agilent	N5182B	MY53050430	Nov. 19, 2018	Nov. 18, 2019
Preamplifier EMCI	EMC 184045	980116	Oct. 12, 2018	Oct. 11, 2019
Preamplifier EMCI	EMC 012645	980115	Oct. 12, 2018	Oct. 11, 2019
Preamplifier EMCI	EMC 330H	980112	Oct. 12, 2018	Oct. 11, 2019
RF Coaxial Cable HUBER+SUHNNER	EMC104-SM-SM-800 0&3000	140811+170717	Oct. 12, 2018	Oct. 11, 2019
RF Coaxial Cable HUBER+SUHNNER	SUCOFLEX 104	EMC104-SM-SM-1 000(140807)	Oct. 12, 2018	Oct. 11, 2019
RF Coaxial Cable WOKEN	8D-FB	Cable-Ch10-01	Oct. 12, 2018	Oct. 11, 2019
Boresight Antenna Fixture	FBA-01	FBA-SIP01	NA	NA
Software BV ADT	E3 6.120103	NA	NA	NA
Antenna Tower MF	MFA-440H	NA	NA	NA
Turn Table MF	MFT-201SS	NA	NA	NA
Antenna Tower & Turn Table Controller MF	MF-7802	NA	NA	NA
Radio Communication Analyzer Anritsu	MT8820C	6201300640	Aug. 16, 2017	Aug. 15, 2019
Temperature & Humidity Chamber	GTH-120-40-CP-AR	MAA1306-019	Sep. 05, 2018	Sep. 04, 2019
DC Power Supply Topward	33010D	807748	NA	NA

Note: 1. The calibration interval of the above test instruments is 12 / 24 months and the calibrations are traceable to NML/ROC and NIST/USA.

2. The test was performed in HwaYa Chamber 10.

3 General Information

3.1 General Description of EUT

Product	Notebook Computer	
Brand	HP	
Test Model	HSN-Q20C	
Status of EUT	Engineering Sample	
Power Supply Rating	5 or 9 or 12 or 15 or 20 Vdc (Adapter)	
Modulation Type	QPSK, 16QAM, 64QAM	
Frequency Range	LTE Band 7 (Channel Bandwidth: 5 MHz)	2502.5 ~ 2567.5 MHz
	LTE Band 7 (Channel Bandwidth: 10 MHz)	2505 ~ 2565 MHz
	LTE Band 7 (Channel Bandwidth: 15 MHz)	2507.5 ~ 2562.5 MHz
	LTE Band 7 (Channel Bandwidth: 20 MHz)	2510 ~ 2560 MHz
	LTE Band 38 (Channel Bandwidth: 5 MHz)	2572.5 ~ 2617.5 MHz
	LTE Band 38 (Channel Bandwidth: 10 MHz)	2575.0 ~ 2615.0 MHz
	LTE Band 38 (Channel Bandwidth: 15 MHz)	2577.5 ~ 2612.5 MHz
	LTE Band 38 (Channel Bandwidth: 20 MHz)	2580.0 ~ 2610.0 MHz
	LTE Band 41 (Channel Bandwidth: 5 MHz)	2498.5 ~ 2687.5 MHz
	LTE Band 41 (Channel Bandwidth: 10 MHz)	2501.0 ~ 2685.0 MHz
	LTE Band 41 (Channel Bandwidth: 15 MHz)	2503.5 ~ 2682.5 MHz
	LTE Band 41 (Channel Bandwidth: 20 MHz)	2506.0 ~ 2680.0 MHz
Max. EIRP Power	LTE Band 7 (Channel Bandwidth: 5 MHz)	49.20 mW
	LTE Band 7 (Channel Bandwidth: 10 MHz)	52.12 mW
	LTE Band 7 (Channel Bandwidth: 15 MHz)	55.85 mW
	LTE Band 7 (Channel Bandwidth: 20 MHz)	59.84 mW
	LTE Band 38 (Channel Bandwidth: 5 MHz)	33.65 mW
	LTE Band 38 (Channel Bandwidth: 10 MHz)	35.48 mW
	LTE Band 38 (Channel Bandwidth: 15 MHz)	37.50 mW
	LTE Band 38 (Channel Bandwidth: 20 MHz)	39.54 mW
	LTE Band 41 (Channel Bandwidth: 5 MHz)	35.56 mW
	LTE Band 41 (Channel Bandwidth: 10 MHz)	37.67 mW
	LTE Band 41 (Channel Bandwidth: 15 MHz)	39.81 mW
	LTE Band 41 (Channel Bandwidth: 20 MHz)	42.07 mW
Emission Designator	LTE Band 7 (Channel Bandwidth: 5 MHz)	4M50D7W
	LTE Band 7 (Channel Bandwidth: 10 MHz)	8M99D7W
	LTE Band 7 (Channel Bandwidth: 15 MHz)	13M5D7W
	LTE Band 7 (Channel Bandwidth: 20 MHz)	18M0G7D
	LTE Band 38 (Channel Bandwidth: 5 MHz)	4M51D7W
	LTE Band 38 (Channel Bandwidth: 10 MHz)	9M00G7D
	LTE Band 38 (Channel Bandwidth: 15 MHz)	13M5D7W
	LTE Band 38 (Channel Bandwidth: 20 MHz)	18M0D7W
	LTE Band 41 (Channel Bandwidth: 5 MHz)	4M51D7W
	LTE Band 41 (Channel Bandwidth: 10 MHz)	9M00G7D
	LTE Band 41 (Channel Bandwidth: 15 MHz)	13M5G7D
	LTE Band 41 (Channel Bandwidth: 20 MHz)	18M0G7D

Antenna Type	Couple Antenna	
Antenna Gain	LTE Band 7	-4.90 dBi
	LTE Band 38	-5.68 dBi
	LTE Band 41	-4.90 dBi
Accessory Device	Refer to Note as below	
Data Cable Supplied	Refer to Note as below	

Note:

1. The WWAN module (Brand: Fibocom, Model: L860-GL) was installed in the EUT.
2. The EUT contains following accessory devices.

Product	Brand	Model	Description
Adapter	hp	TPN-TA02	I/P: 100-240 Vac, 50-60 Hz, 1.6 A O/P: 5 Vdc, 3 A or 9 Vdc, 3 A or 12 Vdc, 5 A or 15 Vdc, 4.33 A or 20 Vdc, 3.25 A

3. The above EUT information is declared by manufacturer and for more detailed features description, please refers to the manufacturer's specifications or user's manual.

3.2 Configuration of System under Test

<Radiated Emission Test>

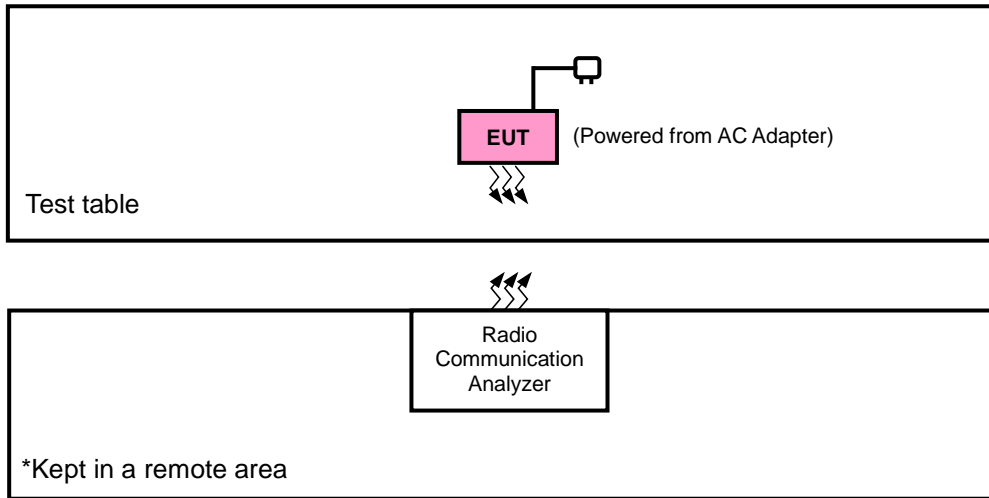

<E.I.R.P. Test>

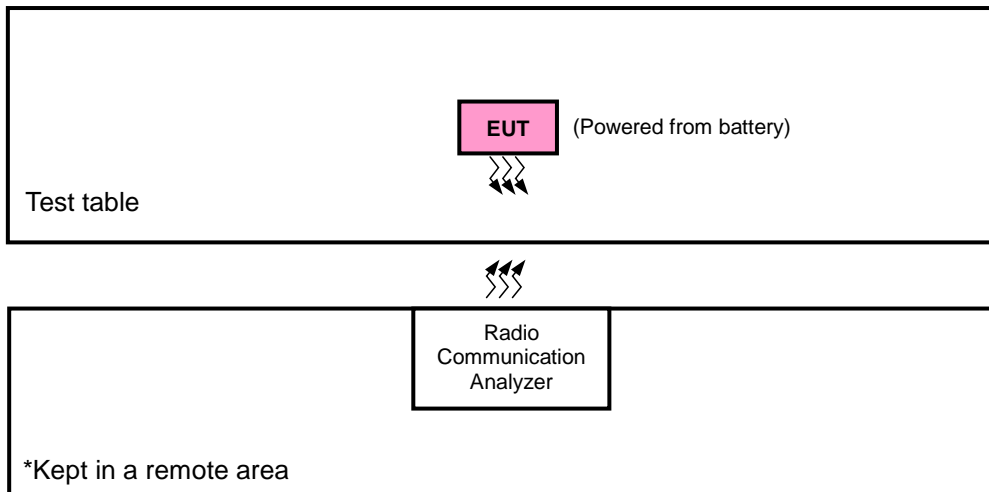

3.2.1 Description of Support Units

The EUT has been tested as an independent unit together with other necessary accessories or support units.

3.3 Test Mode Applicability and Tested Channel Detail

Pre-Scan has been conducted to determine the worst-case mode from all possible combinations between available modulations, data rates, XYZ axis and NB mode, and antenna ports.

The worst case was found when positioned as the table below. Following channel(s) was (were) selected for the final test as listed below:

Band	EIRP	Radiated Emission
LTE Band 7	NB mode	Z-axis
LTE Band 38	NB mode	Z-axis
LTE Band 41	NB mode	Z-axis

LTE Band 7

EUT Configure Mode	Test Item	Available Channel	Tested Channel	Channel Bandwidth	Modulation	Mode
-	EIRP	20775 to 21425	20775, 21100, 21425	5 MHz	QPSK, 16QAM, 64QAM	1 RB / 0 RB Offset
		20800 to 21400	20800, 21100, 21400	10 MHz	QPSK, 16QAM, 64QAM	1 RB / 0 RB Offset
		20825 to 21375	20825, 21100, 21375	15 MHz	QPSK, 16QAM, 64QAM	1 RB / 0 RB Offset
		20850 to 21350	20850, 21100 21350	20 MHz	QPSK, 16QAM, 64QAM	1 RB / 0 RB Offset
-	Modulation Characteristics	20850 to 21350	21110	20 MHz	QPSK, 16QAM, 64QAM	100 RB / 0 RB Offset
-	Frequency Stability	20775 to 21425	20775, 21425	5 MHz	QPSK	1 RB / 0 RB Offset
		20800 to 21400	20800, 21400	10 MHz	QPSK	1 RB / 0 RB Offset
		20825 to 21375	20825, 21375	15 MHz	QPSK	1 RB / 0 RB Offset
		20850 to 21350	20850, 21350	20 MHz	QPSK	1 RB / 0 RB Offset
-	Occupied Bandwidth	20775 to 21425	20775, 21100, 21425	5 MHz	QPSK, 16QAM, 64QAM	25 RB / 0 RB Offset
		20800 to 21400	20800, 21100, 21400	10 MHz	QPSK, 16QAM, 64QAM	50 RB / 0 RB Offset
		20825 to 21375	20825, 21100, 21375	15 MHz	QPSK, 16QAM, 64QAM	75 RB / 0 RB Offset
		20850 to 21350	20850, 21100 21350	20 MHz	QPSK, 16QAM, 64QAM	100 RB / 0 RB Offset
-	Peak to Average Ratio	20775 to 21425	20775, 21100, 21425	5 MHz	QPSK, 16QAM, 64QAM	1 RB / 0 RB Offset
		20800 to 21400	20800, 21100, 21400	10 MHz	QPSK, 16QAM, 64QAM	1 RB / 0 RB Offset
		20825 to 21375	20825, 21100, 21375	15 MHz	QPSK, 16QAM, 64QAM	1 RB / 0 RB Offset
		20850 to 21350	20850, 21100 21350	20 MHz	QPSK, 16QAM, 64QAM	1 RB / 0 RB Offset
-	Out-of-Band Emissions	20775 to 21425	20775, 21425	5 MHz	QPSK, 16QAM, 64QAM	25 RB / 0 RB Offset
		20800 to 21400	20800, 21400	10 MHz	QPSK, 16QAM, 64QAM	50 RB / 0 RB Offset
		20825 to 21375	20825, 21375	15 MHz	QPSK, 16QAM, 64QAM	75 RB / 0 RB Offset
		20850 to 21350	20850, 21350	20 MHz	QPSK, 16QAM, 64QAM	100 RB / 0 RB Offset
-	Conducted Emission	20775 to 21425	20775, 21100, 21425	5 MHz	QPSK	1 RB / 0 RB Offset
		20800 to 21400	20800, 21100, 21400	10 MHz	QPSK	1 RB / 0 RB Offset
		20825 to 21375	20825, 21100, 21375	15 MHz	QPSK	1 RB / 0 RB Offset
		20850 to 21350	20850, 21100 21350	20 MHz	QPSK	1 RB / 0 RB Offset
-	Radiated Emission	20775 to 21425	20775, 21100, 21425	5 MHz	QPSK	1 RB / 0 RB Offset
		20850 to 21350	20850, 21100 21350	20 MHz	QPSK	1 RB / 0 RB Offset

Note:

1. This device was tested under all bandwidths, RB configurations and modulations. The worst case was found in QPSK modulation.
2. For radiated emission above 1 GHz, according to 3GPP 36.521 Section 6.6.3.1.4, choose the lowest, 5 MHz & highest channel bandwidth for final test.

LTE Band 38

EUT Configure Mode	Test Item	Available Channel	Tested Channel	Channel Bandwidth	Modulation	Mode
-	EIRP	37775 to 38225	37775, 38000, 38225	5 MHz	QPSK, 16QAM, 64QAM	1 RB / 12 RB Offset
		37800 to 38200	37800, 38000, 38200	10 MHz	QPSK, 16QAM, 64QAM	1 RB / 0 RB Offset
		37825 to 38175	37825, 38000, 38175	15 MHz	QPSK, 16QAM, 64QAM	1 RB / 37 RB Offset
		37850 to 38150	37850, 38000, 38150	20 MHz	QPSK, 16QAM, 64QAM	1 RB / 0 RB Offset
-	Modulation Characteristics	37850 to 38150	38000	20 MHz	QPSK, 16QAM, 64QAM	100 RB / 0 RB Offset
-	Frequency Stability	37775 to 38225	37775, 38225	5 MHz	QPSK	1 RB / 0 RB Offset
		37800 to 38200	37800, 38200	10 MHz	QPSK	1 RB / 0 RB Offset
		37825 to 38175	37825, 38175	15 MHz	QPSK	1 RB / 0 RB Offset
		37850 to 38150	37850, 38150	20 MHz	QPSK	1 RB / 0 RB Offset
-	Occupied Bandwidth	37775 to 38225	37775, 38000, 38225	5 MHz	QPSK, 16QAM, 64QAM	25 RB / 0 RB Offset
		37800 to 38200	37800, 38000, 38200	10 MHz	QPSK, 16QAM, 64QAM	50 RB / 0 RB Offset
		37825 to 38175	37825, 38000, 38175	15 MHz	QPSK, 16QAM, 64QAM	75 RB / 0 RB Offset
		37850 to 38150	37850, 38000, 38150	20 MHz	QPSK, 16QAM, 64QAM	100 RB / 0 RB Offset
-	Peak to Average Ratio	37775 to 38225	37775, 38000, 38225	5 MHz	QPSK, 16QAM, 64QAM	1 RB / 12 RB Offset
		37800 to 38200	37800, 38000, 38200	10 MHz	QPSK, 16QAM, 64QAM	1 RB / 0 RB Offset
		37825 to 38175	37825, 38000, 38175	15 MHz	QPSK, 16QAM, 64QAM	1 RB / 37 RB Offset
		37850 to 38150	37850, 38000, 38150	20 MHz	QPSK, 16QAM, 64QAM	1 RB / 0 RB Offset
-	Out-of-Band Emissions	37775 to 38225	37775, 38225	5 MHz	QPSK, 16QAM, 64QAM	25 RB / 0 RB Offset
		37800 to 38200	37800, 38200	10 MHz	QPSK, 16QAM, 64QAM	50 RB / 0 RB Offset
		37825 to 38175	37825, 38175	15 MHz	QPSK, 16QAM, 64QAM	75 RB / 0 RB Offset
		37850 to 38150	37850, 38150	20 MHz	QPSK, 16QAM, 64QAM	100 RB / 0 RB Offset
-	Conducted Emission	37775 to 38225	37775, 38000, 38225	5 MHz	QPSK	1 RB / 12 RB Offset
		37800 to 38200	37800, 38000, 38200	10 MHz	QPSK	1 RB / 0 RB Offset
		37825 to 38175	37825, 38000, 38175	15 MHz	QPSK	1 RB / 37 RB Offset
		37850 to 38150	37850, 38000, 38150	20 MHz	QPSK	1 RB / 0 RB Offset
-	Radiated Emission	37775 to 38225	37775, 38000, 38225	5 MHz	QPSK	1 RB / 12 RB Offset
		37850 to 38150	37850, 38000, 38150	20 MHz	QPSK	1 RB / 0 RB Offset

Note:

1. This device was tested under all bandwidths, RB configurations and modulations. The worst case was found in QPSK modulation.
2. For radiated emission above 1 GHz, according to 3GPP 36.521 Section 6.6.3.1.4, choose the lowest, 5 MHz & highest channel bandwidth for final test.

LTE Band 41

EUT Configure Mode	Test Item	Available Channel	Tested Channel	Channel Bandwidth	Modulation	Mode
-	EIRP	39675 to 41565	39675, 40620, 41565	5 MHz	QPSK, 16QAM, 64QAM	1 RB / 0 RB Offset
		39700 to 41540	39700, 40620, 41540	10 MHz	QPSK, 16QAM, 64QAM	1 RB / 0 RB Offset
		39725 to 41515	39725, 40620, 41515	15 MHz	QPSK, 16QAM, 64QAM	1 RB / 0 RB Offset
		39750 to 41490	39750, 40620, 41490	20 MHz	QPSK, 16QAM, 64QAM	1 RB / 0 RB Offset
-	Modulation Characteristics	39750 to 41490	40620	20 MHz	QPSK, 16QAM, 64QAM	100 RB / 0 RB Offset
-	Frequency Stability	39675 to 41565	39675, 41565	5 MHz	QPSK	1 RB / 0 RB Offset
		39700 to 41540	39700, 41540	10 MHz	QPSK	1 RB / 0 RB Offset
		39725 to 41515	39725, 41515	15 MHz	QPSK	1 RB / 0 RB Offset
		39750 to 41490	39750, 41490	20 MHz	QPSK	1 RB / 0 RB Offset
-	Occupied Bandwidth	39675 to 41565	39675, 40620, 41565	5 MHz	QPSK, 16QAM, 64QAM	25 RB / 0 RB Offset
		39700 to 41540	39700, 40620, 41540	10 MHz	QPSK, 16QAM, 64QAM	50 RB / 0 RB Offset
		39725 to 41515	39725, 40620, 41515	15 MHz	QPSK, 16QAM, 64QAM	75 RB / 0 RB Offset
		39750 to 41490	39750, 40620, 41490	20 MHz	QPSK, 16QAM, 64QAM	100 RB / 0 RB Offset
-	Peak to Average Ratio	39675 to 41565	39675, 40620, 41565	5 MHz	QPSK, 16QAM, 64QAM	1 RB / 0 RB Offset
		39700 to 41540	39700, 40620, 41540	10 MHz	QPSK, 16QAM, 64QAM	1 RB / 0 RB Offset
		39725 to 41515	39725, 40620, 41515	15 MHz	QPSK, 16QAM, 64QAM	1 RB / 0 RB Offset
		39750 to 41490	39750, 40620, 41490	20 MHz	QPSK, 16QAM, 64QAM	1 RB / 0 RB Offset
-	Out-of-Band Emissions	39675 to 41565	39675, 41565	5 MHz	QPSK, 16QAM, 64QAM	25 RB / 0 RB Offset
		39700 to 41540	39700, 41540	10 MHz	QPSK, 16QAM, 64QAM	50 RB / 0 RB Offset
		39725 to 41515	39725, 41515	15 MHz	QPSK, 16QAM, 64QAM	75 RB / 0 RB Offset
		39750 to 41490	39750, 41490	20 MHz	QPSK, 16QAM, 64QAM	100 RB / 0 RB Offset
-	Conducted Emission	39675 to 41565	39675, 40620, 41565	5 MHz	QPSK	1 RB / 0 RB Offset
		39700 to 41540	39700, 40620, 41540	10 MHz	QPSK	1 RB / 0 RB Offset
		39725 to 41515	39725, 40620, 41515	15 MHz	QPSK	1 RB / 0 RB Offset
		39750 to 41490	39750, 40620, 41490	20 MHz	QPSK	1 RB / 0 RB Offset
-	Radiated Emission	39675 to 41565	39675, 40620, 41565	5 MHz	QPSK	1 RB / 0 RB Offset
		39750 to 41490	39750, 40620, 41490	20 MHz	QPSK	1 RB / 0 RB Offset

Note:

1. This device was tested under all bandwidths, RB configurations and modulations. The worst case was found in QPSK modulation.
2. For radiated emission above 1 GHz, according to 3GPP 36.521 Section 6.6.3.1.4, choose the lowest, 5 MHz & highest channel bandwidth for final test.

Test Condition:

Test Item	Environmental Conditions	Input Power	Tested By
EIRP	25 deg. C, 65 % RH	120 Vac, 60 Hz	Thomas Wei
Modulation Characteristics	25 deg. C, 65 % RH	120 Vac, 60 Hz	Wayne Lin
Frequency Stability	25 deg. C, 65 % RH	120 Vac, 60 Hz	Wayne Lin
Occupied Bandwidth	25 deg. C, 65 % RH	120 Vac, 60 Hz	Wayne Lin
Out-of-Band Emissions	25 deg. C, 65 % RH	120 Vac, 60 Hz	Wayne Lin
Peak to Average Ratio	25 deg. C, 65 % RH	120 Vac, 60 Hz	Wayne Lin
Conducted Emission	25 deg. C, 65 % RH	120 Vac, 60 Hz	Wayne Lin
Radiated Emission	25 deg. C, 65 % RH	120 Vac, 60 Hz	Thomas Wei

3.4 EUT Operating Conditions

The EUT makes a call to the communication simulator. The communication simulator station system controlled a EUT to export maximum output power under transmission mode and specific channel frequency

3.5 General Description of Applied Standards

The EUT is a RF Product. According to the specifications of the manufacturer, it must comply with the requirements of the following standards:

FCC 47 CFR Part 2

FCC 47 CFR Part 27

KDB 971168 D01 Power Meas License Digital Systems v03r01

ANSI/TIA/EIA-603-E 2016

ANSI 63.26-2015

Note: All test items have been performed and recorded as per the above standards.

4 Test Types and Results

4.1 Output Power Measurement

4.1.1 Limits of Output Power Measurement

The radiated peak output power shall be according to the specific rule Part 27.50(h)(2) that “Mobile stations are limited to 2.0 watts EIRP. All user stations are limited to 2 watts transmitter output power” and 27.50(i) specific that “Peak transmit power must be measure over any interval of continuous transmission using instrumentation calibration in terms of rms-equivalent voltage.”

4.1.2 Test Procedures

EIRP Measurement:

- a. All measurements were done at low, middle and high operational frequency range. RBW and VBW is 10 MHz for LTE mode.
- b. Substitution method is used for E.I.R.P measurement. In the semi-anechoic chamber, EUT placed on the 0.8 m (below or equal 1 GHz) and/or 1.5 m (above 1 GHz) height of Turn Table, rotated the table around 360 degrees to search the maximum radiation power and receiver antenna shall be rotated vertical and horizontal polarization and moved height from 1 m to 4 m to find the maximum polar radiated power. The “Read Value” is the spectrum reading the maximum power value.
- c. The substitution horn antenna is substituted for EUT at the same position and signals generator export the CW signal to the substitution antenna via a tx cable. Rotated the Turn Table and moved receiving antenna to find the maximum radiation power. Adjust output power level of S.G to get a Value of spectrum reading equal to “Read Value“ of step b. Record the power level of S.G.
- d. $EIRP = \text{Output power level of S.G} - \text{TX cable loss} + \text{Antenna gain of substitution horn}.$

Conducted Power Measurement:

- a. The EUT was set up for the maximum power with LTE link data modulation and link up with simulator.
- b. Set the EUT to transmit under low, middle and high channel and record the power level shown on simulator.

4.1.3 Test Setup

**EIRP / ERP Measurement:
<Radiated Emission below or equal 1 GHz>**

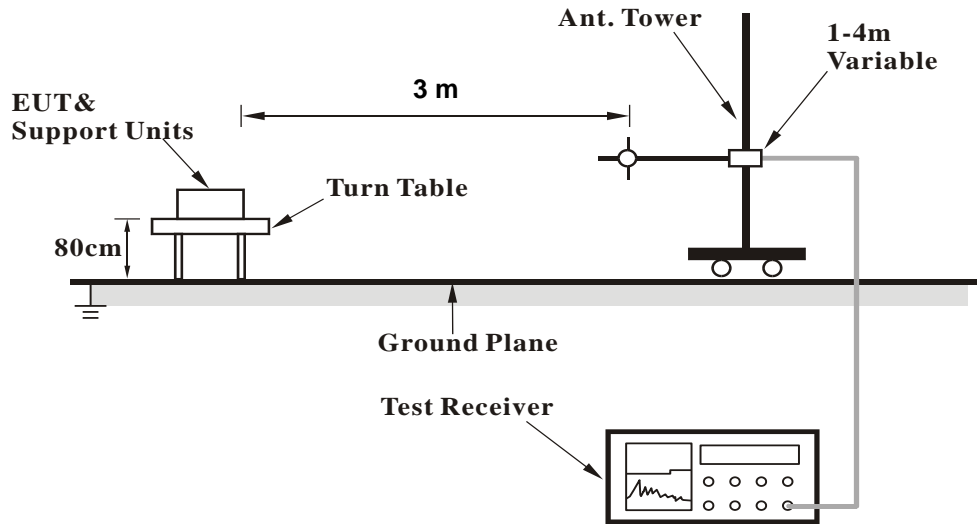

<Radiated Emission above 1 GHz>

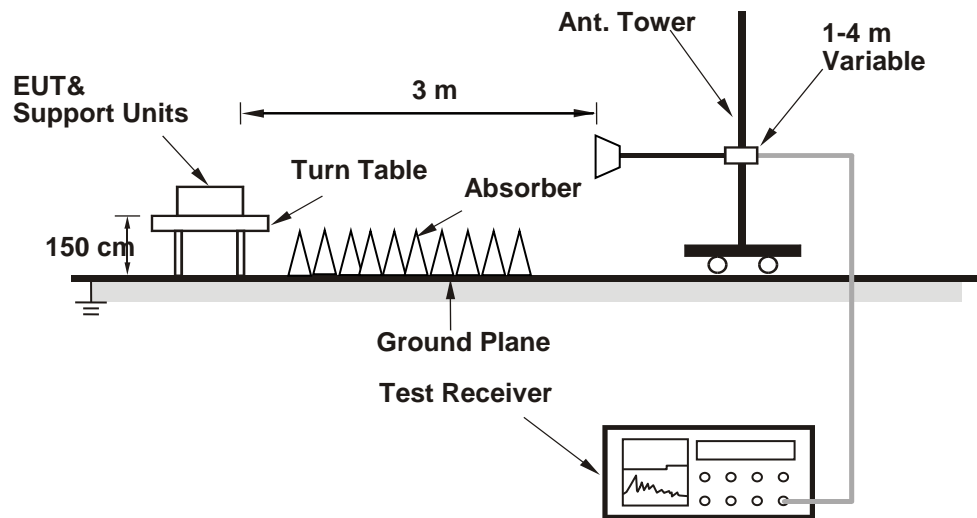

For the actual test configuration, please refer to the attached file (Test Setup Photo).

Conducted Power Measurement:

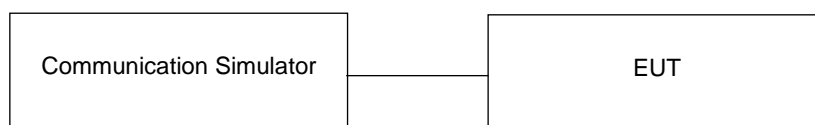

4.1.4 Test Results

Conducted Output Power (dBm)

LTE Band 7															
BW	MCS Index	RB Size	RB Offset	Low	Mid	High	3GPP MPR (dB)	BW	MCS Index	RB Size	RB Offset	Low	Mid	High	3GPP MPR (dB)
				20850	21100	21350						20825	21100	21375	
		Channel Frequency (MHz)	2510.0	2535.0	2560.0	Channel Frequency (MHz)	2507.5			2535.0	2562.5				
20M	QPSK	1	0	23.11	23.27	23.40	0	15M	QPSK	1	0	23.11	23.24	23.37	0
		1	50	23.08	23.15	23.28	0			1	37	23.06	23.05	23.25	0
		1	99	23.02	23.13	23.30	0			1	74	23.02	23.04	23.25	0
		50	0	22.19	22.35	22.48	1			36	0	22.14	22.34	22.47	1
		50	25	22.15	22.29	22.45	1			36	19	22.14	22.27	22.40	1
		50	50	22.06	22.14	22.30	1			36	39	21.98	22.08	22.20	1
	16QAM	100	0	22.18	22.33	22.46	1		75	0	22.18	22.26	22.38	1	
		1	0	22.09	22.24	22.39	1		1	0	22.03	22.20	22.29	1	
		1	50	22.01	22.08	22.24	1		1	37	21.94	22.08	22.22	1	
		1	99	22.02	22.03	22.20	1		1	74	21.89	22.05	22.21	1	
		50	0	21.12	21.35	21.43	2		36	0	21.05	21.24	21.31	2	
		50	25	21.10	21.23	21.42	2		36	19	21.02	21.23	21.41	2	
	64QAM	50	50	21.02	21.08	21.22	2		36	39	21.00	21.07	21.17	2	
		100	0	21.16	21.26	21.44	2		75	0	21.06	21.13	21.34	2	
		1	0	21.11	21.21	21.37	2		1	0	20.93	21.19	21.23	2	
		1	50	21.06	21.13	21.21	2		1	37	21.01	21.03	21.14	2	
		1	99	20.98	21.05	21.23	2		1	74	20.95	21.00	21.14	2	
		50	0	20.15	20.28	20.40	3		36	0	20.05	20.30	20.39	3	
10M	QPSK	50	25	20.10	20.21	20.36	3	5M	QPSK	36	19	20.09	20.17	20.30	3
		50	50	19.98	20.07	20.30	3			36	39	19.99	20.07	20.26	3
		100	0	20.17	20.23	20.42	3			75	0	20.11	20.27	20.26	3
		1	0	23.08	23.09	23.34	0			1	0	22.98	23.21	23.22	0
		1	24	22.87	23.06	23.22	0			1	12	22.99	23.00	23.08	0
		1	49	22.92	23.05	23.22	0			1	24	22.79	23.12	23.16	0
	16QAM	25	0	22.07	22.12	22.45	1		12	0	22.12	22.27	22.14	1	
		25	12	21.97	22.22	22.33	1		12	6	22.02	22.18	22.38	1	
		25	25	21.99	21.91	22.27	1		12	13	22.00	21.95	22.07	1	
		50	0	22.05	22.21	22.33	1		25	0	22.04	22.18	22.19	1	
		1	0	22.04	22.18	22.20	1		1	0	21.87	22.02	22.27	1	
		1	24	21.87	22.07	22.08	1		1	12	21.90	21.96	22.18	1	
	64QAM	1	49	21.85	22.00	22.07	1		1	24	21.85	22.04	22.19	1	
		25	0	21.03	21.23	21.27	2		12	0	21.06	21.13	21.28	2	
		25	12	20.83	21.13	21.20	2		12	6	20.93	21.11	21.25	2	
		25	25	20.82	21.04	21.15	2		12	13	20.88	21.03	21.11	2	
		50	0	20.88	21.23	21.25	2		25	0	20.89	21.22	21.19	2	
		1	0	20.96	21.09	21.22	2		1	0	20.97	20.94	21.25	2	
16QAM	1	24	20.77	20.91	21.06	2	1	12	20.93	20.94	21.09	2			
	1	49	20.97	21.02	21.05	2	1	24	20.94	21.01	21.18	2			
	25	0	19.95	20.16	20.14	3	12	0	19.98	20.23	20.34	3			
	25	12	19.99	20.23	20.37	3	12	6	19.96	20.13	20.42	3			
	25	25	19.91	19.96	20.09	3	12	13	19.94	20.02	20.14	3			
	50	0	20.11	20.15	20.29	3	25	0	20.03	20.21	20.22	3			

LTE Band 38

BW	MCS Index	RB Size	RB Offset	Low	Mid	High	3GPP MPR (dB)	BW	MCS Index	RB Size	RB Offset	Low	Mid	High	3GPP MPR (dB)		
				Channel	37850	38000						38150	Channel	37825		38000	38175
				Frequency (MHz)	2580	2595						2610	Frequency (MHz)	2577.5		2595	2612.5
20M	QPSK	1	0	22.87	22.82	22.88	0	15M	QPSK	1	0	22.81	22.76	22.78	0		
		1	50	22.86	22.81	22.87	0			1	37	22.81	22.81	22.77	0		
		1	99	22.84	22.79	22.85	0			1	74	22.77	22.72	22.75	0		
		50	0	21.83	21.78	21.84	1			36	0	21.78	21.71	21.81	1		
		50	25	21.73	21.68	21.74	1			36	19	21.71	21.65	21.68	1		
		50	50	21.72	21.67	21.73	1			36	39	21.67	21.57	21.67	1		
		100	0	21.76	21.71	21.77	1			75	0	21.70	21.71	21.71	1		
		1	0	21.81	21.76	21.82	1			16QAM	1	0	21.78	21.70	21.75	1	
	1	50	21.70	21.65	21.71	1	1		37		21.62	21.62	21.71	1			
	1	99	21.68	21.63	21.69	1	1		74		21.60	21.60	21.62	1			
	50	0	20.87	20.82	20.88	2	36		0		20.83	20.82	20.85	2			
	50	25	20.79	20.74	20.80	2	36		19		20.75	20.73	20.75	2			
	50	50	20.80	20.75	20.81	2	36		39		20.79	20.73	20.81	2			
	100	0	20.79	20.74	20.80	2	75		0		20.76	20.69	20.74	2			
	1	0	20.88	20.83	20.89	2	64QAM		1		0	20.78	20.75	20.85	2		
	1	50	20.72	20.67	20.73	2			1	37	20.72	20.59	20.73	2			
	1	99	20.67	20.62	20.68	2			1	74	20.60	20.53	20.67	2			
	50	0	19.93	19.88	19.94	3			36	0	19.85	19.78	19.93	3			
	50	25	19.83	19.78	19.84	3			36	19	19.78	19.78	19.84	3			
	50	50	19.81	19.76	19.82	3			36	39	19.73	19.69	19.72	3			
	100	0	19.81	19.76	19.82	3			75	0	19.72	19.69	19.74	3			
	10M	QPSK	1	0	22.87	22.75			22.77	0	5M	QPSK	1	0	22.76	22.72	22.53
			1	24	22.76	22.70	22.76		0	1			12	22.83	22.67	22.72	0
			1	49	22.66	22.61	22.79		0	1			24	22.68	22.67	22.65	0
25			0	21.63	21.65	21.68	1	12	0	21.63			21.67	21.57	1		
25			12	21.66	21.52	21.65	1	12	6	21.65			21.54	21.42	1		
25			25	21.65	21.50	21.67	1	12	13	21.68			21.57	21.48	1		
50			0	21.64	21.55	21.73	1	25	0	21.73			21.55	21.53	1		
1			0	21.70	21.66	21.70	1	16QAM	1	0			21.72	21.67	21.64	1	
1		24	21.52	21.44	21.47	1	1		12	21.59		21.61	21.55	1			
1		49	21.61	21.52	21.55	1	1		24	21.54		21.47	21.52	1			
25		0	20.70	20.71	20.70	2	12		0	20.84		20.62	20.75	2			
25		12	20.58	20.55	20.69	2	12		6	20.74		20.55	20.71	2			
25		25	20.64	20.64	20.72	2	12		13	20.56		20.64	20.67	2			
50		0	20.70	20.54	20.73	2	25		0	20.70		20.60	20.67	2			
1		0	20.81	20.69	20.78	2	64QAM		1	0		20.65	20.61	20.70	2		
1		24	20.67	20.64	20.58	2		1	12	20.55		20.51	20.59	2			
1		49	20.51	20.52	20.58	2		1	24	20.44		20.47	20.60	2			
25		0	19.85	19.79	19.91	3		12	0	19.75		19.70	19.79	3			
25		12	19.69	19.75	19.70	3		12	6	19.70		19.66	19.78	3			
25		25	19.63	19.73	19.74	3		12	13	19.62		19.60	19.76	3			
50		0	19.68	19.61	19.71	3		25	0	19.75		19.75	19.61	3			

LTE Band 41

BW	MCS Index	RB Size	RB Offset	Low	Mid	Mid	Mid	High	3GPP MPR (dB)	BW	MCS Index	RB Size	RB Offset	Low	Mid	Mid	Mid	High	3GPP MPR (dB)
		Channel	Channel	39790	40185	40620	41055	41490				39765	40173	40620	41068	41515			
		Frequency (MHz)	Frequency (MHz)	2510.0	2549.5	2593.0	2636.5	2680.0				2507.5	2548.3	2593.0	2637.8	2682.5			
20M	QPSK	1	0	23.12	22.91	22.83	22.76	23.13	0	15M	QPSK	1	0	23.06	22.84	22.77	22.73	23.05	0
		1	50	23.04	22.83	22.75	22.68	23.05	0			1	37	23.05	22.74	22.75	22.58	22.96	0
		1	99	23.11	22.90	22.82	22.75	23.12	0			1	74	23.04	22.85	22.79	22.72	23.09	0
		50	0	22.05	21.84	21.76	21.69	22.06	1			36	0	22.04	21.84	21.67	21.61	22.03	1
		50	25	22.02	21.81	21.73	21.66	22.03	1			36	19	21.97	21.79	21.69	21.57	21.92	1
		50	50	22.01	21.80	21.72	21.65	22.02	1			36	39	21.92	21.76	21.66	21.55	22.01	1
		100	0	22.06	21.85	21.77	21.70	22.07	1			75	0	22.07	21.81	21.71	21.70	21.96	1
	16QAM	1	0	21.98	21.76	21.68	21.61	21.97	1		16QAM	1	0	22.04	21.87	21.77	21.74	22.04	1
		1	50	21.96	21.74	21.66	21.59	21.95	1			1	37	22.05	21.82	21.70	21.66	22.02	1
		1	99	21.92	21.70	21.62	21.55	21.91	1			1	74	22.02	21.87	21.77	21.73	22.05	1
		50	0	21.06	20.84	20.76	20.69	21.05	2			36	0	21.06	20.83	20.76	20.69	21.03	2
		50	25	21.04	20.82	20.74	20.67	21.03	2			36	19	20.97	20.76	20.64	20.61	21.00	2
		50	50	21.03	20.81	20.73	20.66	21.02	2			36	39	21.00	20.78	20.64	20.57	20.92	2
		100	0	21.02	20.80	20.72	20.65	21.01	2			75	0	20.97	20.81	20.75	20.70	21.05	2
	64QAM	1	0	21.05	20.83	20.75	20.68	21.04	2		64QAM	1	0	21.10	20.84	20.80	20.73	21.05	2
		1	50	20.93	20.71	20.63	20.56	20.92	2			1	37	21.02	20.78	20.66	20.59	20.96	2
		1	99	21.01	20.79	20.71	20.64	21.00	2			1	74	21.09	20.88	20.82	20.68	21.05	2
		50	0	20.09	19.87	19.79	19.72	20.08	3			36	0	20.02	19.84	19.71	19.66	20.00	3
		50	25	20.07	19.85	19.77	19.70	20.06	3			36	19	20.01	19.79	19.65	19.59	19.93	3
		50	50	20.04	19.82	19.74	19.67	20.03	3			36	39	19.92	19.76	19.66	19.58	20.00	3
		100	0	20.02	19.80	19.72	19.65	20.01	3			75	0	20.01	19.81	19.75	19.70	20.02	3
RB Size	RB Offset	Low	Mid	Mid	Mid	High	3GPP MPR (dB)	BW	MCS Index	RB Size	RB Offset	Low	Mid	Mid	Mid	High	3GPP MPR (dB)		
Channel	Channel	39740	40160	40620	41080	41540				39715	40148	40620	41093	41565					
Frequency (MHz)	Frequency (MHz)	2505.0	2547.0	2593.0	2639.0	2685.0				2502.5	2545.8	2593.0	2640.3	2687.5					
10M	QPSK	1	0	23.03	22.80	22.71	22.63	23.04	0	5M	QPSK	1	0	23.03	22.80	22.73	22.65	23.05	0
		1	24	22.92	22.71	22.69	22.67	22.88	0			1	12	22.86	22.76	22.73	22.57	22.94	0
		1	49	22.97	22.89	22.69	22.73	22.99	0			1	24	23.00	22.81	22.72	22.69	23.02	0
		25	0	21.95	21.72	21.65	21.68	21.96	1			12	0	22.00	21.72	21.64	21.57	21.92	1
		25	12	21.94	21.68	21.63	21.52	21.88	1			12	6	21.96	21.68	21.65	21.54	21.94	1
		25	25	22.02	21.63	21.63	21.54	21.91	1			12	13	21.90	21.76	21.54	21.53	21.82	1
		50	0	21.96	21.85	21.63	21.63	21.91	1			25	0	21.98	21.69	21.75	21.62	21.97	1
	16QAM	1	0	21.96	21.86	21.72	21.61	22.03	1		16QAM	1	0	22.06	21.82	21.73	21.62	21.99	1
		1	24	21.99	21.68	21.69	21.65	21.93	1			1	12	21.91	21.72	21.74	21.52	21.92	1
		1	49	21.99	21.84	21.73	21.65	22.04	1			1	24	22.09	21.84	21.70	21.72	21.97	1
		25	0	20.93	20.75	20.63	20.65	20.94	2			12	0	21.00	20.77	20.74	20.56	20.94	2
		25	12	20.97	20.65	20.68	20.51	20.96	2			12	6	21.00	20.71	20.60	20.55	20.96	2
		25	25	21.02	20.65	20.60	20.58	20.90	2			12	13	20.99	20.78	20.58	20.56	20.86	2
		50	0	20.94	20.80	20.66	20.64	20.89	2			25	0	20.94	20.71	20.72	20.64	20.97	2
	64QAM	1	0	20.94	20.87	20.69	20.64	20.98	2		64QAM	1	0	21.09	20.79	20.74	20.67	20.99	2
		1	24	21.02	20.77	20.63	20.65	20.93	2			1	12	20.89	20.77	20.68	20.54	20.87	2
		1	49	20.95	20.83	20.69	20.70	21.02	2			1	24	21.07	20.78	20.69	20.73	20.99	2
		25	0	19.91	19.70	19.66	19.66	20.02	3			12	0	19.97	19.79	19.66	19.49	19.92	3
		25	12	19.97	19.63	19.68	19.48	19.89	3			12	6	19.97	19.65	19.61	19.57	19.88	3
		25	25	19.94	19.69	19.56	19.58	19.85	3			12	13	19.93	19.72	19.55	19.58	19.92	3
		50	0	20.01	19.78	19.64	19.58	19.89	3			25	0	19.97	19.69	19.75	19.59	19.90	3

EIRP Power (dBm)

LTE Band 7							
Channel Bandwidth: 5 MHz / QPSK							
Plane	Channel	Frequency (MHz)	Reading (dBm)	Correction Factor (dB)	EIRP (dBm)	EIRP (mW)	Polarization (H/V)
NB	20775	2502.5	-29.57	38.52	8.95	7.85	H
	21100	2535.0	-29.34	38.36	9.02	7.98	
	21425	2567.5	-29.48	38.58	9.10	8.13	
	20775	2502.5	-22.24	38.92	16.68	46.56	V
	21100	2535.0	-22.48	39.26	16.78	47.64	
	21425	2567.5	-22.30	39.22	16.92	49.20	
Channel Bandwidth: 5 MHz / 16QAM							
NB	20775	2502.5	-30.50	38.52	8.02	6.34	H
	21100	2535.0	-30.23	38.36	8.13	6.50	
	21425	2567.5	-30.38	38.58	8.20	6.61	
	20775	2502.5	-23.26	38.92	15.66	36.81	V
	21100	2535.0	-23.48	39.26	15.78	37.84	
	21425	2567.5	-23.33	39.22	15.89	38.82	
Channel Bandwidth: 5 MHz / 64QAM							
NB	20775	2502.5	-31.67	38.52	6.85	4.84	H
	21100	2535.0	-31.45	38.36	6.91	4.91	
	21425	2567.5	-31.49	38.58	7.09	5.12	
	20775	2502.5	-24.28	38.92	14.64	29.11	V
	21100	2535.0	-24.50	39.26	14.76	29.92	
	21425	2567.5	-24.41	39.22	14.81	30.27	

Note: EIRP (dBm) = Reading (dBm) + Correction Factor (dB)

LTE Band 7							
Channel Bandwidth: 10 MHz / QPSK							
Plane	Channel	Frequency (MHz)	Reading (dBm)	Correction Factor (dB)	EIRP (dBm)	EIRP (mW)	Polarization (H/V)
NB	20800	2505.0	-29.46	38.65	9.19	8.30	H
	21100	2535.0	-29.01	38.36	9.35	8.61	
	21400	2565.0	-29.09	38.49	9.40	8.71	
	20800	2505.0	-21.85	38.84	16.99	50.00	V
	21100	2535.0	-22.13	39.26	17.13	51.64	
	21400	2565.0	-21.93	39.10	17.17	52.12	
Channel Bandwidth: 10 MHz / 16QAM							
NB	20800	2505.0	-30.40	38.65	8.25	6.68	H
	21100	2535.0	-29.99	38.36	8.37	6.87	
	21400	2565.0	-30.02	38.49	8.47	7.03	
	20800	2505.0	-22.95	38.84	15.89	38.82	V
	21100	2535.0	-23.20	39.26	16.06	40.36	
	21400	2565.0	-22.99	39.10	16.11	40.83	
Channel Bandwidth: 10 MHz / 64QAM							
NB	20800	2505.0	-31.50	38.65	7.15	5.19	H
	21100	2535.0	-31.19	38.36	7.17	5.21	
	21400	2565.0	-31.14	38.49	7.35	5.43	
	20800	2505.0	-23.90	38.84	14.94	31.19	V
	21100	2535.0	-24.25	39.26	15.01	31.70	
	21400	2565.0	-24.07	39.10	15.03	31.84	

Note: EIRP (dBm) = Reading (dBm) + Correction Factor (dB)

LTE Band 7							
Channel Bandwidth: 15 MHz / QPSK							
Plane	Channel	Frequency (MHz)	Reading (dBm)	Correction Factor (dB)	EIRP (dBm)	EIRP (mW)	Polarization (H/V)
NB	20825	2507.5	-28.99	38.52	9.53	8.97	H
	21100	2535.0	-28.68	38.36	9.68	9.29	
	21375	2562.5	-28.84	38.58	9.74	9.42	
	20825	2507.5	-21.61	38.92	17.31	53.83	V
	21100	2535.0	-21.84	39.26	17.42	55.21	
	21375	2562.5	-21.75	39.22	17.47	55.85	
Channel Bandwidth: 15 MHz / 16QAM							
NB	20825	2507.5	-29.99	38.52	8.53	7.13	H
	21100	2535.0	-29.76	38.36	8.60	7.24	
	21375	2562.5	-29.89	38.58	8.69	7.40	
	20825	2507.5	-22.76	38.92	16.16	41.30	V
	21100	2535.0	-22.92	39.26	16.34	43.05	
	21375	2562.5	-22.84	39.22	16.38	43.45	
Channel Bandwidth: 15 MHz / 64QAM							
NB	20825	2507.5	-31.13	38.52	7.39	5.48	H
	21100	2535.0	-30.94	38.36	7.42	5.52	
	21375	2562.5	-31.01	38.58	7.57	5.71	
	20825	2507.5	-23.74	38.92	15.18	32.96	V
	21100	2535.0	-24.02	39.26	15.24	33.42	
	21375	2562.5	-23.90	39.22	15.32	34.04	

Note: EIRP (dBm) = Reading (dBm) + Correction Factor (dB)

LTE Band 7							
Channel Bandwidth: 20 MHz / QPSK							
Plane	Channel	Frequency (MHz)	Reading (dBm)	Correction Factor (dB)	EIRP (dBm)	EIRP (mW)	Polarization (H/V)
NB	20850	2510.0	-28.65	38.52	9.87	9.71	H
	21100	2535.0	-28.44	38.36	9.92	9.82	
	21350	2560.0	-28.50	38.58	10.08	10.19	
	20850	2510.0	-21.32	38.92	17.60	57.54	V
	21100	2535.0	-21.61	39.26	17.65	58.21	
	21350	2560.0	-21.45	39.22	17.77	59.84	
Channel Bandwidth: 20 MHz / 16QAM							
NB	20850	2510.0	-29.72	38.52	8.80	7.59	H
	21100	2535.0	-29.53	38.36	8.83	7.64	
	21350	2560.0	-29.60	38.58	8.98	7.91	
	20850	2510.0	-22.43	38.92	16.49	44.57	V
	21100	2535.0	-22.69	39.26	16.57	45.39	
	21350	2560.0	-22.61	39.22	16.61	45.81	
Channel Bandwidth: 20 MHz / 64QAM							
NB	20850	2510.0	-30.87	38.52	7.65	5.82	H
	21100	2535.0	-30.67	38.36	7.69	5.87	
	21350	2560.0	-30.69	38.58	7.89	6.15	
	20850	2510.0	-23.51	38.92	15.41	34.75	V
	21100	2535.0	-23.71	39.26	15.55	35.89	
	21350	2560.0	-23.66	39.22	15.56	35.97	

Note: EIRP (dBm) = Reading (dBm) + Correction Factor (dB)

LTE Band 38							
Channel Bandwidth: 5 MHz / QPSK							
Plane	Channel	Frequency (MHz)	Reading (dBm)	Correction Factor (dB)	EIRP (dBm)	EIRP (mW)	Polarization (H/V)
NB	37775	2572.5	-28.91	38.99	10.08	10.19	H
	38000	2595.0	-28.22	38.17	9.95	9.89	
	38225	2617.5	-28.40	38.55	10.15	10.35	
	37775	2572.5	-24.04	39.27	15.23	33.34	V
	38000	2595.0	-23.48	38.68	15.20	33.11	
	38225	2617.5	-23.28	38.55	15.27	33.65	
Channel Bandwidth: 5 MHz / 16QAM							
NB	37775	2572.5	-29.94	38.99	9.05	8.04	H
	38000	2595.0	-29.25	38.17	8.92	7.80	
	38225	2617.5	-29.43	38.55	9.12	8.17	
	37775	2572.5	-25.07	39.27	14.20	26.30	V
	38000	2595.0	-24.51	38.68	14.17	26.12	
	38225	2617.5	-24.31	38.55	14.24	26.55	
Channel Bandwidth: 5 MHz / 64QAM							
NB	37775	2572.5	-30.93	38.99	8.06	6.40	H
	38000	2595.0	-30.24	38.17	7.93	6.21	
	38225	2617.5	-30.42	38.55	8.13	6.50	
	37775	2572.5	-26.06	39.27	13.21	20.94	V
	38000	2595.0	-25.50	38.68	13.18	20.80	
	38225	2617.5	-25.30	38.55	13.25	21.13	

Note: EIRP (dBm) = Reading (dBm) + Correction Factor (dB)

LTE Band 38							
Channel Bandwidth: 10 MHz / QPSK							
Plane	Channel	Frequency (MHz)	Reading (dBm)	Correction Factor (dB)	EIRP (dBm)	EIRP (mW)	Polarization (H/V)
NB	37800	2575.0	-28.67	38.98	10.31	10.74	H
	38000	2595.0	-27.99	38.17	10.18	10.42	
	38200	2615.0	-28.07	38.45	10.38	10.91	
	37800	2575.0	-23.58	39.04	15.46	35.16	V
	38000	2595.0	-23.25	38.68	15.43	34.91	
	38200	2615.0	-23.10	38.60	15.50	35.48	
Channel Bandwidth: 10 MHz / 16QAM							
NB	37800	2575.0	-29.69	38.98	9.29	8.49	H
	38000	2595.0	-29.01	38.17	9.16	8.24	
	38200	2615.0	-29.09	38.45	9.36	8.63	
	37800	2575.0	-24.60	39.04	14.44	27.80	V
	38000	2595.0	-24.27	38.68	14.41	27.61	
	38200	2615.0	-24.12	38.60	14.48	28.05	
Channel Bandwidth: 10 MHz / 64QAM							
NB	37800	2575.0	-30.70	38.98	8.28	6.73	H
	38000	2595.0	-30.02	38.17	8.15	6.53	
	38200	2615.0	-30.10	38.45	8.35	6.84	
	37800	2575.0	-25.61	39.04	13.43	22.03	V
	38000	2595.0	-25.28	38.68	13.40	21.88	
	38200	2615.0	-25.13	38.60	13.47	22.23	

Note: EIRP (dBm) = Reading (dBm) + Correction Factor (dB)

LTE Band 38							
Channel Bandwidth: 15 MHz / QPSK							
Plane	Channel	Frequency (MHz)	Reading (dBm)	Correction Factor (dB)	EIRP (dBm)	EIRP (mW)	Polarization (H/V)
NB	37825	2577.5	-28.54	39.09	10.55	11.35	H
	38000	2595.0	-27.75	38.17	10.42	11.02	
	38175	2612.5	-27.90	38.52	10.62	11.53	
	37825	2577.5	-23.34	39.04	15.70	37.15	V
	38000	2595.0	-23.01	38.68	15.67	36.90	
	38175	2612.5	-22.92	38.66	15.74	37.50	
Channel Bandwidth: 15 MHz / 16QAM							
NB	37825	2577.5	-29.57	39.09	9.52	8.95	H
	38000	2595.0	-28.78	38.17	9.39	8.69	
	38175	2612.5	-28.93	38.52	9.59	9.10	
	37825	2577.5	-24.37	39.04	14.67	29.31	V
	38000	2595.0	-24.04	38.68	14.64	29.11	
	38175	2612.5	-23.95	38.66	14.71	29.58	
Channel Bandwidth: 15 MHz / 64QAM							
NB	37825	2577.5	-30.58	39.09	8.51	7.10	H
	38000	2595.0	-29.79	38.17	8.38	6.89	
	38175	2612.5	-29.94	38.52	8.58	7.21	
	37825	2577.5	-25.38	39.04	13.66	23.23	V
	38000	2595.0	-25.05	38.68	13.63	23.07	
	38175	2612.5	-24.96	38.66	13.70	23.44	

Note: EIRP (dBm) = Reading (dBm) + Correction Factor (dB)

LTE Band 38							
Channel Bandwidth: 20 MHz / QPSK							
Plane	Channel	Frequency (MHz)	Reading (dBm)	Correction Factor (dB)	EIRP (dBm)	EIRP (mW)	Polarization (H/V)
NB	37850	2580.0	-28.48	39.26	10.78	11.97	H
	38000	2595.0	-27.52	38.17	10.65	11.61	
	38150	2610.0	-27.86	38.71	10.85	12.16	
	37850	2580.0	-23.40	39.33	15.93	39.17	V
	38000	2595.0	-22.78	38.68	15.90	38.90	
	38150	2610.0	-22.79	38.76	15.97	39.54	
Channel Bandwidth: 20 MHz / 16QAM							
NB	37850	2580.0	-29.50	39.26	9.76	9.46	H
	38000	2595.0	-28.54	38.17	9.63	9.18	
	38150	2610.0	-28.88	38.71	9.83	9.62	
	37850	2580.0	-24.42	39.33	14.91	30.97	V
	38000	2595.0	-23.80	38.68	14.88	30.76	
	38150	2610.0	-23.81	38.76	14.95	31.26	
Channel Bandwidth: 20 MHz / 64QAM							
NB	37850	2580.0	-30.51	39.26	8.75	7.50	H
	38000	2595.0	-29.55	38.17	8.62	7.28	
	38150	2610.0	-29.89	38.71	8.82	7.62	
	37850	2580.0	-25.43	39.33	13.90	24.55	V
	38000	2595.0	-24.81	38.68	13.87	24.38	
	38150	2610.0	-24.82	38.76	13.94	24.77	

Note: EIRP (dBm) = Reading (dBm) + Correction Factor (dB)

LTE Band 41							
Channel Bandwidth: 5 MHz / QPSK							
Plane	Channel	Frequency (MHz)	Reading (dBm)	Correction Factor (dB)	EIRP (dBm)	EIRP (mW)	Polarization (H/V)
NB	39675	2498.5	-29.51	38.99	9.48	8.87	H
	40620	2593.0	-28.91	38.17	9.26	8.43	
	41565	2687.5	-29.02	38.55	9.53	8.97	
	39675	2498.5	-23.79	39.27	15.48	35.32	V
	40620	2593.0	-23.48	38.68	15.20	33.11	
	41565	2687.5	-23.04	38.55	15.51	35.56	
Channel Bandwidth: 5 MHz / 16QAM							
NB	39675	2498.5	-30.52	38.99	8.47	7.03	H
	40620	2593.0	-29.92	38.17	8.25	6.68	
	41565	2687.5	-30.03	38.55	8.52	7.11	
	39675	2498.5	-24.80	39.27	14.47	27.99	V
	40620	2593.0	-24.49	38.68	14.19	26.24	
	41565	2687.5	-24.05	38.55	14.50	28.18	
Channel Bandwidth: 5 MHz / 64QAM							
NB	39675	2498.5	-31.55	38.99	7.44	5.55	H
	40620	2593.0	-30.95	38.17	7.22	5.27	
	41565	2687.5	-31.06	38.55	7.49	5.61	
	39675	2498.5	-25.83	39.27	13.44	22.08	V
	40620	2593.0	-25.52	38.68	13.16	20.70	
	41565	2687.5	-25.08	38.55	13.47	22.23	

Note: EIRP (dBm) = Reading (dBm) + Correction Factor (dB)

LTE Band 41							
Channel Bandwidth: 10 MHz / QPSK							
Plane	Channel	Frequency (MHz)	Reading (dBm)	Correction Factor (dB)	EIRP (dBm)	EIRP (mW)	Polarization (H/V)
NB	39700	2501.0	-29.25	38.98	9.73	9.40	H
	40620	2593.0	-28.66	38.17	9.51	8.93	
	41540	2685.0	-28.67	38.45	9.78	9.51	
	39700	2501.0	-23.31	39.04	15.73	37.41	V
	40620	2593.0	-23.23	38.68	15.45	35.08	
	41540	2685.0	-22.84	38.60	15.76	37.67	
Channel Bandwidth: 10 MHz / 16QAM							
NB	39700	2501.0	-30.26	38.98	8.72	7.45	H
	40620	2593.0	-29.67	38.17	8.50	7.08	
	41540	2685.0	-29.68	38.45	8.77	7.53	
	39700	2501.0	-24.32	39.04	14.72	29.65	V
	40620	2593.0	-24.24	38.68	14.44	27.80	
	41540	2685.0	-23.85	38.60	14.75	29.85	
Channel Bandwidth: 10 MHz / 64QAM							
NB	39700	2501.0	-31.28	38.98	7.70	5.89	H
	40620	2593.0	-30.69	38.17	7.48	5.60	
	41540	2685.0	-30.70	38.45	7.75	5.96	
	39700	2501.0	-25.34	39.04	13.70	23.44	V
	40620	2593.0	-25.26	38.68	13.42	21.98	
	41540	2685.0	-24.87	38.60	13.73	23.60	

Note: EIRP (dBm) = Reading (dBm) + Correction Factor (dB)

LTE Band 41							
Channel Bandwidth: 15 MHz / QPSK							
Plane	Channel	Frequency (MHz)	Reading (dBm)	Correction Factor (dB)	EIRP (dBm)	EIRP (mW)	Polarization (H/V)
NB	39725	2503.5	-29.12	39.09	9.97	9.93	H
	40620	2593.0	-28.42	38.17	9.75	9.44	
	41515	2682.5	-28.50	38.52	10.02	10.05	
	39725	2503.5	-23.07	39.04	15.97	39.54	V
	40620	2593.0	-22.99	38.68	15.69	37.07	
	41515	2682.5	-22.66	38.66	16.00	39.81	
Channel Bandwidth: 15 MHz / 16QAM							
NB	39725	2503.5	-30.14	39.09	8.95	7.85	H
	40620	2593.0	-29.44	38.17	8.73	7.46	
	41515	2682.5	-29.52	38.52	9.00	7.94	
	39725	2503.5	-24.09	39.04	14.95	31.26	V
	40620	2593.0	-24.01	38.68	14.67	29.31	
	41515	2682.5	-23.68	38.66	14.98	31.48	
Channel Bandwidth: 15 MHz / 64QAM							
NB	39725	2503.5	-31.16	39.09	7.93	6.21	H
	40620	2593.0	-30.46	38.17	7.71	5.90	
	41515	2682.5	-30.54	38.52	7.98	6.28	
	39725	2503.5	-25.11	39.04	13.93	24.72	V
	40620	2593.0	-25.03	38.68	13.65	23.17	
	41515	2682.5	-24.70	38.66	13.96	24.89	

Note: EIRP (dBm) = Reading (dBm) + Correction Factor (dB)

LTE Band 41							
Channel Bandwidth: 20 MHz / QPSK							
Plane	Channel	Frequency (MHz)	Reading (dBm)	Correction Factor (dB)	EIRP (dBm)	EIRP (mW)	Polarization (H/V)
NB	39750	2506.0	-29.05	39.26	10.21	10.50	H
	40620	2593.0	-28.18	38.17	9.99	9.98	
	41490	2680.0	-28.45	38.71	10.26	10.62	
	39750	2506.0	-23.12	39.33	16.21	41.78	V
	40620	2593.0	-22.75	38.68	15.93	39.17	
	41490	2680.0	-22.52	38.76	16.24	42.07	
Channel Bandwidth: 20 MHz / 16QAM							
NB	39750	2506.0	-30.07	39.26	9.19	8.30	H
	40620	2593.0	-29.20	38.17	8.97	7.89	
	41490	2680.0	-29.47	38.71	9.24	8.39	
	39750	2506.0	-24.14	39.33	15.19	33.04	V
	40620	2593.0	-23.77	38.68	14.91	30.97	
	41490	2680.0	-23.54	38.76	15.22	33.27	
Channel Bandwidth: 20 MHz / 64QAM							
NB	39750	2506.0	-31.09	39.26	8.17	6.56	H
	40620	2593.0	-30.22	38.17	7.95	6.24	
	41490	2680.0	-30.49	38.71	8.22	6.64	
	39750	2506.0	-25.16	39.33	14.17	26.12	V
	40620	2593.0	-24.79	38.68	13.89	24.49	
	41490	2680.0	-24.56	38.76	14.20	26.30	

Note: EIRP (dBm) = Reading (dBm) + Correction Factor (dB)

4.2 Modulation Characteristics Measurement

4.2.1 Limits of Modulation Characteristics

N/A

4.2.2 Test Setup



4.2.3 Test Procedure

Connect the EUT to Communication Simulator via the antenna connector. The frequency band is set as EUT supported Modulation and Channels, the EUT output is matched with 50 ohm load, the waveform quality and constellation of the EUT was tested.

4.2.4 Test Results

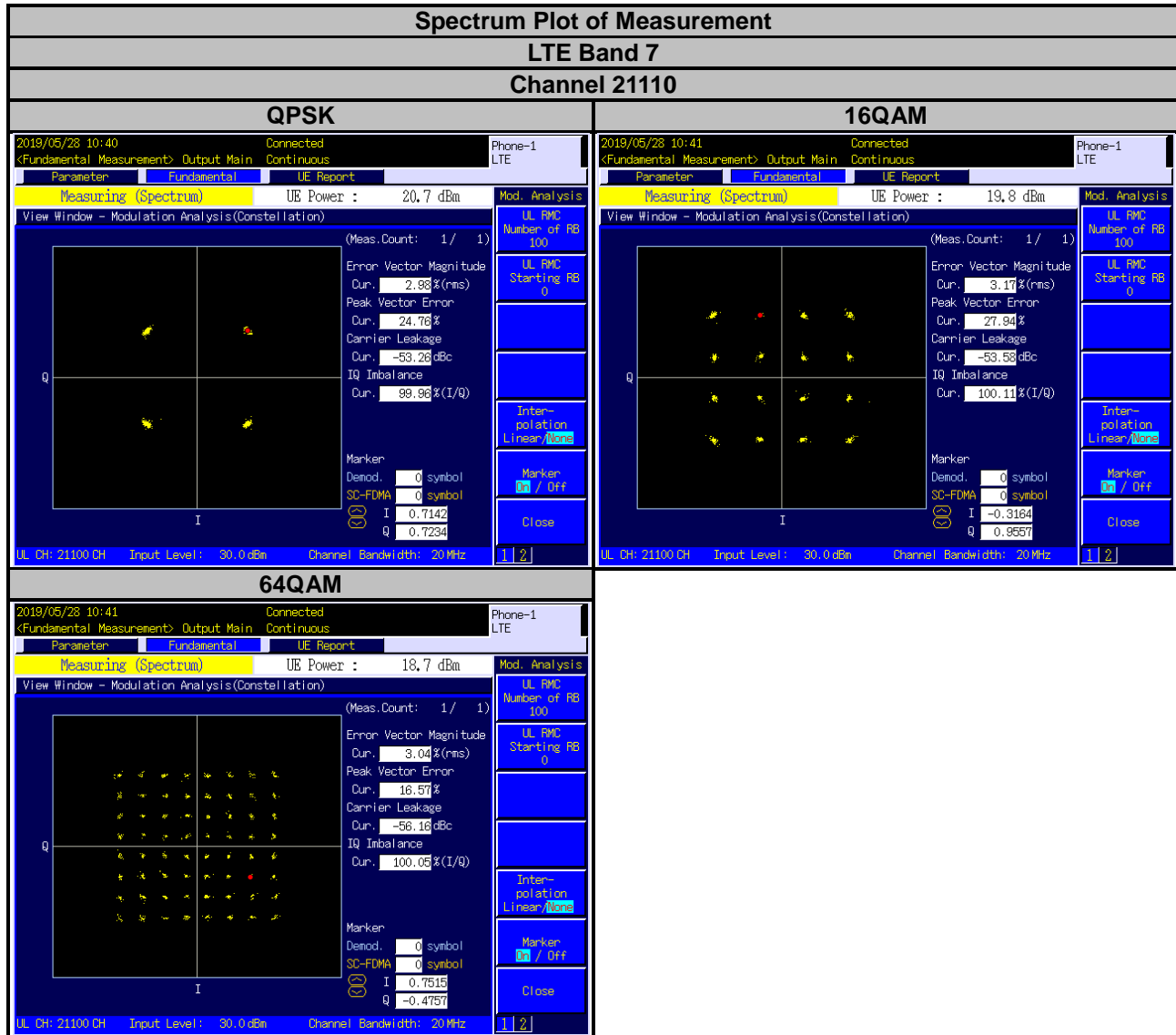

LTE Band 38
Channel 38000

QPSK

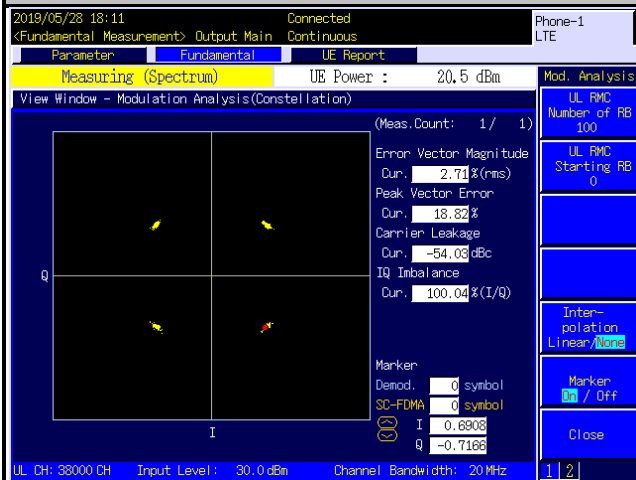

16QAM

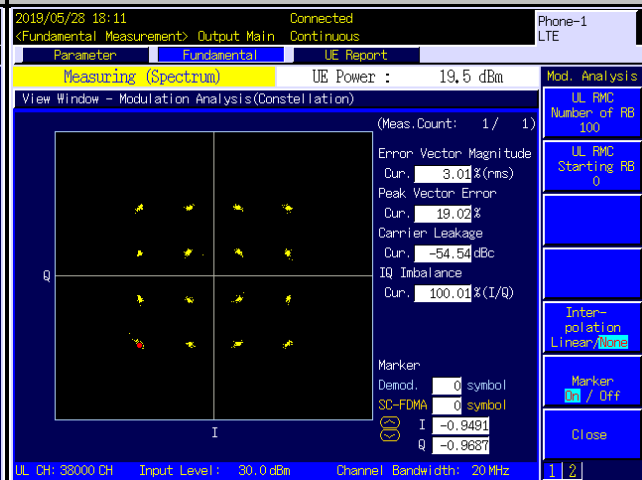

64QAM

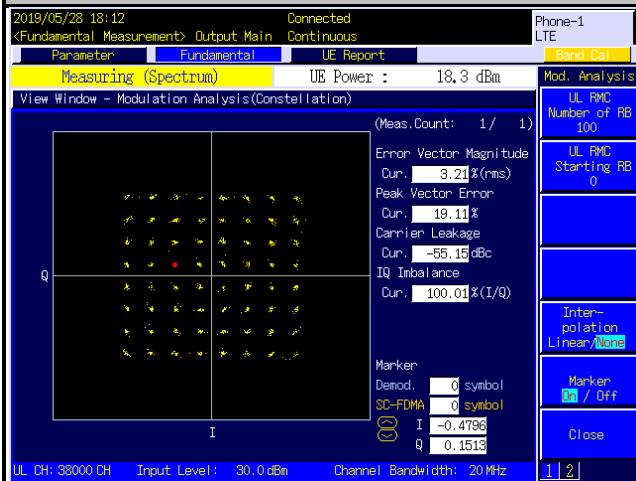

LTE Band 41
Channel 40620

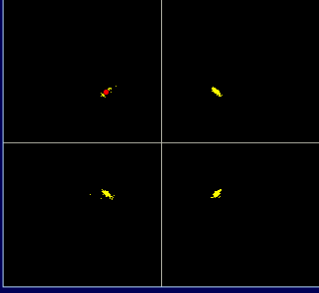
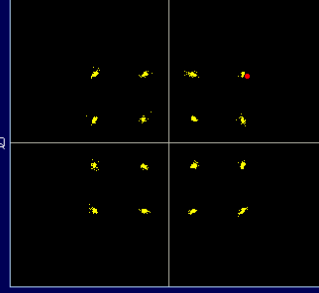
QPSK	16QAM
<p>2019/05/28 18:10 Connected <Fundamental Measurement> Output Main Continuous Phone-1 LTE</p> <p>Parameter Fundamental UE Report</p> <p>Measuring (Spectrum) UE Power : 20,6 dBm Mod. Analysis</p> <p>View Window - Modulation Analysis (Constellation)</p> <div style="display: flex; justify-content: space-between;"> <div style="width: 45%;">  <p>(Meas. Count: 1 / 1)</p> <p>Error Vector Magnitude Dur. 2.73% (rms)</p> <p>Peak Vector Error Dur. 19.95%</p> <p>Carrier Leakage Dur. -55.47 dBc</p> <p>IQ Inbalance Dur. 100.04% (I/Q)</p> <p>Marker Demod. 0 symbol SC-FDMA 0 symbol I -0.7170 Q 0.6972</p> </div> <div style="width: 45%;"> <p>UL FMC Number of RB 100 UL FMC Starting RB 0</p> <p>Interpolation Linear / None</p> <p>Marker On / Off</p> <p>Close</p> </div> </div> <p>UL CH: 40620 CH Input Level: 30.0 dBm Channel Bandwidth: 20 MHz</p>	<p>2019/05/28 18:09 Connected <Fundamental Measurement> Output Main Continuous Phone-1 LTE</p> <p>Parameter Fundamental UE Report Band Cal</p> <p>Measuring (Spectrum) UE Power : 19,6 dBm Mod. Analysis</p> <p>View Window - Modulation Analysis (Constellation)</p> <div style="display: flex; justify-content: space-between;"> <div style="width: 45%;">  <p>(Meas. Count: 1 / 1)</p> <p>Error Vector Magnitude Dur. 3.02% (rms)</p> <p>Peak Vector Error Dur. 20.11%</p> <p>Carrier Leakage Dur. -54.32 dBc</p> <p>IQ Inbalance Dur. 100.08% (I/Q)</p> <p>Marker Demod. 0 symbol SC-FDMA 0 symbol I 0.9987 Q 0.9187</p> </div> <div style="width: 45%;"> <p>UL FMC Number of RB 100 UL FMC Starting RB 0</p> <p>Interpolation Linear / None</p> <p>Marker On / Off</p> <p>Close</p> </div> </div> <p>UL CH: 40620 CH Input Level: 30.0 dBm Channel Bandwidth: 20 MHz</p>

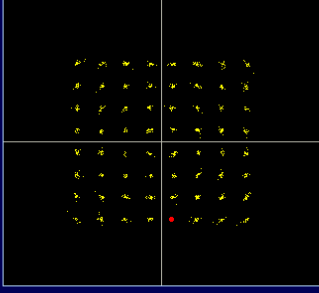
64QAM
<p>2019/05/28 18:09 Connected <Fundamental Measurement> Output Main Continuous Phone-1 LTE</p> <p>Parameter Fundamental UE Report</p> <p>Measuring (Spectrum) UE Power : 18,6 dBm Mod. Analysis</p> <p>View Window - Modulation Analysis (Constellation)</p> <div style="display: flex; justify-content: space-between;"> <div style="width: 45%;">  <p>(Meas. Count: 1 / 1)</p> <p>Error Vector Magnitude Dur. 3.04% (rms)</p> <p>Peak Vector Error Dur. 17.00%</p> <p>Carrier Leakage Dur. -53.98 dBc</p> <p>IQ Inbalance Dur. 99.95% (I/Q)</p> <p>Marker Demod. 0 symbol SC-FDMA 0 symbol I 0.1362 Q -1.0821</p> </div> <div style="width: 45%;"> <p>UL FMC Number of RB 100 UL FMC Starting RB 0</p> <p>Interpolation Linear / None</p> <p>Marker On / Off</p> <p>Close</p> </div> </div> <p>UL CH: 40620 CH Input Level: 30.0 dBm Channel Bandwidth: 20 MHz</p>

4.3 Frequency Stability Measurement

4.3.1 Limits of Frequency Stability Measurement

According to the FCC part 2.1055 shall be tested the frequency stability. The rule is defined that "The frequency stability shall be sufficient to ensure that the fundamental emission stays within the authorized frequency block." The test extreme voltage is according to the 2.1055(d)(1) Vary primary supply voltage from 85 to 115 percent of the nominal value for other than hand carried battery equipment and the extreme temperature rule is comply with specification of EUT $-30^{\circ}\text{C} \sim 50^{\circ}\text{C}$.

4.3.2 Test Procedure

- Device is placed at the oven room. The oven room could control the temperatures and humidity. Power warm up is at least 15 min and power applied should perform before recording frequency error.
- EUT is connected the external power supply to control the DC input power. The test voltage range is from minimum to maximum working voltage. Each step shall be record the frequency error rate.
- The temperature range step is 10 degrees in this test items. All temperature levels shall be hold the $\pm 0.5^{\circ}\text{C}$ during the measurement testing. The each temperature step shall be at least 0.5 hours, consider the EUT could be test under the stability condition.

NOTE: The frequency error was recorded frequency error from the communication simulator.

4.3.3 Test Setup

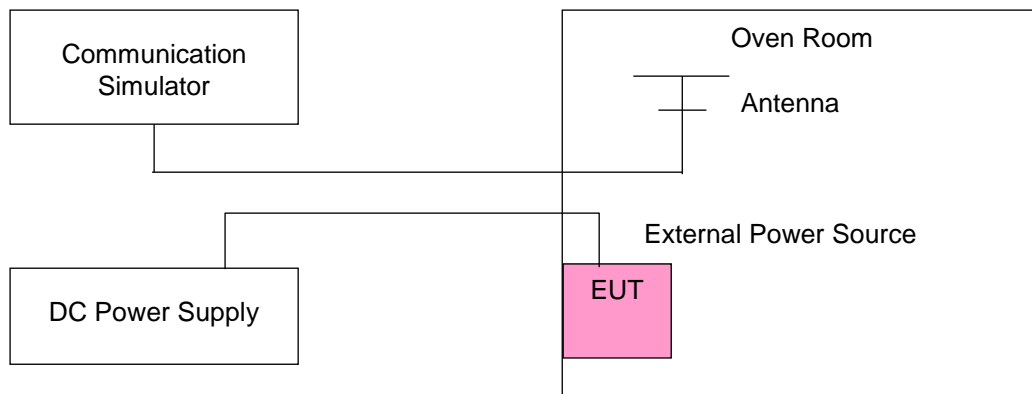

4.3.4 Test Results

Frequency Error vs. Voltage

Voltage (Volts)	LTE Band 7			
	Channel Bandwidth: 5 MHz			
	Low Channel		High Channel	
	Frequency (MHz)	Frequency Error (ppm)	Frequency (MHz)	Frequency Error (ppm)
120	2502.500001	0.001	2567.500002	0.001
102	2502.500002	0.001	2567.500002	0.001
138	2502.500004	0.001	2567.500004	0.001

Note: The applicant defined the normal working voltage of the battery is from 102 Vac to 138 Vac.

Frequency Error vs. Temperature

Temp. (°C)	LTE Band 7			
	Channel Bandwidth: 5 MHz			
	Low Channel		High Channel	
	Frequency (MHz)	Frequency Error (ppm)	Frequency (MHz)	Frequency Error (ppm)
-30	2502.500001	0.000	2567.500001	0.000
-20	2502.500003	0.001	2567.500003	0.001
-10	2502.500002	0.001	2567.500003	0.001
0	2502.500004	0.001	2567.500002	0.001
10	2502.500003	0.001	2567.500003	0.001
20	2502.499999	-0.001	2567.499996	-0.001
30	2502.499998	-0.001	2567.499997	-0.001
40	2502.499998	-0.001	2567.499998	-0.001
50	2502.499997	-0.001	2567.499997	-0.001

Frequency Error vs. Voltage

Voltage (Volts)	LTE Band 7			
	Channel Bandwidth: 10 MHz			
	Low Channel		High Channel	
	Frequency (MHz)	Frequency Error (ppm)	Frequency (MHz)	Frequency Error (ppm)
120	2502.500003	0.001	2567.500004	0.001
102	2502.500003	0.001	2567.500004	0.001
138	2502.500003	0.001	2567.500003	0.001

Note: The applicant defined the normal working voltage of the battery is from 102 Vac to 138 Vac.

Frequency Error vs. Temperature

Temp. (°C)	LTE Band 7			
	Channel Bandwidth: 10 MHz			
	Low Channel		High Channel	
	Frequency (MHz)	Frequency Error (ppm)	Frequency (MHz)	Frequency Error (ppm)
-30	2502.500003	0.001	2567.500002	0.001
-20	2502.500003	0.001	2567.500003	0.001
-10	2502.500001	0.000	2567.500001	0.000
0	2502.500004	0.002	2567.500003	0.001
10	2502.500002	0.001	2567.500002	0.001
20	2502.499996	-0.001	2567.499998	-0.001
30	2502.499999	-0.001	2567.499999	-0.001
40	2502.499999	-0.001	2567.499998	-0.001
50	2502.499997	-0.001	2567.499997	-0.001

Frequency Error vs. Voltage

Voltage (Volts)	LTE Band 7			
	Channel Bandwidth: 15 MHz			
	Low Channel		High Channel	
	Frequency (MHz)	Frequency Error (ppm)	Frequency (MHz)	Frequency Error (ppm)
120	2502.500003	0.001	2567.500002	0.001
102	2502.500002	0.001	2567.500003	0.001
138	2502.500001	0.001	2567.500004	0.001

Note: The applicant defined the normal working voltage of the battery is from 102 Vac to 138 Vac.

Frequency Error vs. Temperature

Temp. (°C)	LTE Band 7			
	Channel Bandwidth: 15 MHz			
	Low Channel		High Channel	
	Frequency (MHz)	Frequency Error (ppm)	Frequency (MHz)	Frequency Error (ppm)
-30	2502.500003	0.001	2567.500003	0.001
-20	2502.500001	0.000	2567.500001	0.000
-10	2502.500004	0.002	2567.500002	0.001
0	2502.500002	0.001	2567.500003	0.001
10	2502.500001	0.001	2567.500002	0.001
20	2502.499996	-0.001	2567.499998	-0.001
30	2502.499996	-0.002	2567.499997	-0.001
40	2502.499998	-0.001	2567.499997	-0.001
50	2502.499997	-0.001	2567.499999	-0.001

Frequency Error vs. Voltage

Voltage (Volts)	LTE Band 7			
	Channel Bandwidth: 20 MHz			
	Low Channel		High Channel	
	Frequency (MHz)	Frequency Error (ppm)	Frequency (MHz)	Frequency Error (ppm)
120	2502.500003	0.001	2567.500004	0.001
102	2502.500001	0.001	2567.500004	0.002
138	2502.500002	0.001	2567.500004	0.001

Note: The applicant defined the normal working voltage of the battery is from 102 Vac to 138 Vac.

Frequency Error vs. Temperature

Temp. (°C)	LTE Band 7			
	Channel Bandwidth: 20 MHz			
	Low Channel		High Channel	
	Frequency (MHz)	Frequency Error (ppm)	Frequency (MHz)	Frequency Error (ppm)
-30	2502.500002	0.001	2567.500002	0.001
-20	2502.500004	0.001	2567.500002	0.001
-10	2502.500004	0.002	2567.500003	0.001
0	2502.500003	0.001	2567.500002	0.001
10	2502.500001	0.000	2567.500003	0.001
20	2502.499996	-0.001	2567.499998	-0.001
30	2502.499998	-0.001	2567.499999	-0.001
40	2502.499997	-0.001	2567.499998	-0.001
50	2502.499999	-0.001	2567.499999	0.000

Frequency Error vs. Voltage

Voltage (Volts)	LTE Band 38			
	Channel Bandwidth: 5 MHz			
	Low Channel		High Channel	
	Frequency (MHz)	Frequency Error (ppm)	Frequency (MHz)	Frequency Error (ppm)
120	2572.500002	0.001	2617.500004	0.001
102	2572.500003	0.001	2617.500003	0.001
138	2572.500004	0.001	2617.500002	0.001

Note: The applicant defined the normal working voltage of the battery is from 102 Vac to 138 Vac.

Frequency Error vs. Temperature

Temp. (°C)	LTE Band 38			
	Channel Bandwidth: 5 MHz			
	Low Channel		High Channel	
	Frequency (MHz)	Frequency Error (ppm)	Frequency (MHz)	Frequency Error (ppm)
-30	2572.500002	0.001	2617.500002	0.001
-20	2572.500001	0.000	2617.500001	0.000
-10	2572.500003	0.001	2617.500002	0.001
0	2572.500002	0.001	2617.500002	0.001
10	2572.500003	0.001	2617.500003	0.001
20	2572.499997	-0.001	2617.499997	-0.001
30	2572.499997	-0.001	2617.499998	-0.001
40	2572.499999	0.000	2617.499996	-0.001
50	2572.499998	-0.001	2617.499998	-0.001

Frequency Error vs. Voltage

Voltage (Volts)	LTE Band 38			
	Channel Bandwidth: 10 MHz			
	Low Channel		High Channel	
	Frequency (MHz)	Frequency Error (ppm)	Frequency (MHz)	Frequency Error (ppm)
120	2572.500002	0.001	2617.500003	0.001
102	2572.500002	0.001	2617.500001	0.001
138	2572.500001	0.000	2617.500003	0.001

Note: The applicant defined the normal working voltage of the battery is from 102 Vac to 138 Vac.

Frequency Error vs. Temperature

Temp. (°C)	LTE Band 38			
	Channel Bandwidth: 10 MHz			
	Low Channel		High Channel	
	Frequency (MHz)	Frequency Error (ppm)	Frequency (MHz)	Frequency Error (ppm)
-30	2572.500004	0.001	2617.500002	0.001
-20	2572.500002	0.001	2617.500003	0.001
-10	2572.500002	0.001	2617.500004	0.002
0	2572.500004	0.001	2617.500003	0.001
10	2572.500004	0.001	2617.500002	0.001
20	2572.499998	-0.001	2617.499998	-0.001
30	2572.499996	-0.002	2617.499998	-0.001
40	2572.499999	-0.001	2617.499999	0.000
50	2572.499997	-0.001	2617.499999	0.000

Frequency Error vs. Voltage

Voltage (Volts)	LTE Band 38			
	Channel Bandwidth: 15 MHz			
	Low Channel		High Channel	
	Frequency (MHz)	Frequency Error (ppm)	Frequency (MHz)	Frequency Error (ppm)
120	2572.500002	0.001	2617.500004	0.001
102	2572.500001	0.001	2617.500004	0.001
138	2572.500003	0.001	2617.500003	0.001

Note: The applicant defined the normal working voltage of the battery is from 102 Vac to 138 Vac.

Frequency Error vs. Temperature

Temp. (°C)	LTE Band 38			
	Channel Bandwidth: 15 MHz			
	Low Channel		High Channel	
	Frequency (MHz)	Frequency Error (ppm)	Frequency (MHz)	Frequency Error (ppm)
-30	2572.500004	0.001	2617.500003	0.001
-20	2572.500002	0.001	2617.500004	0.001
-10	2572.500003	0.001	2617.500002	0.001
0	2572.500002	0.001	2617.500004	0.002
10	2572.500004	0.001	2617.500002	0.001
20	2572.499997	-0.001	2617.499997	-0.001
30	2572.499999	-0.001	2617.499996	-0.001
40	2572.499997	-0.001	2617.499998	-0.001
50	2572.499996	-0.001	2617.499999	0.000

Frequency Error vs. Voltage

Voltage (Volts)	LTE Band 38			
	Channel Bandwidth: 20 MHz			
	Low Channel		High Channel	
	Frequency (MHz)	Frequency Error (ppm)	Frequency (MHz)	Frequency Error (ppm)
120	2572.500002	0.001	2617.500003	0.001
102	2572.500004	0.001	2617.500003	0.001
138	2572.500001	0.001	2617.500002	0.001

Note: The applicant defined the normal working voltage of the battery is from 102 Vac to 138 Vac.

Frequency Error vs. Temperature

Temp. (°C)	LTE Band 38			
	Channel Bandwidth: 20 MHz			
	Low Channel		High Channel	
	Frequency (MHz)	Frequency Error (ppm)	Frequency (MHz)	Frequency Error (ppm)
-30	2572.500001	0.001	2617.500003	0.001
-20	2572.500001	0.000	2617.500004	0.001
-10	2572.500001	0.001	2617.500002	0.001
0	2572.500002	0.001	2617.500001	0.001
10	2572.500001	0.000	2617.500002	0.001
20	2572.499999	-0.001	2617.499998	-0.001
30	2572.499997	-0.001	2617.499999	-0.001
40	2572.499998	-0.001	2617.499999	-0.001
50	2572.499999	0.000	2617.499998	-0.001

Frequency Error vs. Voltage

Voltage (Volts)	LTE Band 41			
	Channel Bandwidth: 5 MHz			
	Low Channel		High Channel	
	Frequency (MHz)	Frequency Error (ppm)	Frequency (MHz)	Frequency Error (ppm)
120	2498.500002	0.001	2687.500003	0.001
102	2498.500002	0.001	2687.500002	0.001
138	2498.500003	0.001	2687.500001	0.000

Note: The applicant defined the normal working voltage of the battery is from 102 Vac to 138 Vac.

Frequency Error vs. Temperature

Temp. (°C)	LTE Band 41			
	Channel Bandwidth: 5 MHz			
	Low Channel		High Channel	
	Frequency (MHz)	Frequency Error (ppm)	Frequency (MHz)	Frequency Error (ppm)
-30	2498.500003	0.001	2687.500002	0.001
-20	2498.500004	0.001	2687.500004	0.001
-10	2498.500002	0.001	2687.500003	0.001
0	2498.500002	0.001	2687.500001	0.000
10	2498.500003	0.001	2687.500003	0.001
20	2498.499998	-0.001	2687.499998	-0.001
30	2498.499999	0.000	2687.499999	-0.001
40	2498.499997	-0.001	2687.499998	-0.001
50	2498.499999	-0.001	2687.499999	0.000

Frequency Error vs. Voltage

Voltage (Volts)	LTE Band 41			
	Channel Bandwidth: 10 MHz			
	Low Channel		High Channel	
	Frequency (MHz)	Frequency Error (ppm)	Frequency (MHz)	Frequency Error (ppm)
120	2498.500003	0.001	2687.500003	0.001
102	2498.500004	0.002	2687.500003	0.001
138	2498.500003	0.001	2687.500003	0.001

Note: The applicant defined the normal working voltage of the battery is from 102 Vac to 138 Vac.

Frequency Error vs. Temperature

Temp. (°C)	LTE Band 41			
	Channel Bandwidth: 10 MHz			
	Low Channel		High Channel	
	Frequency (MHz)	Frequency Error (ppm)	Frequency (MHz)	Frequency Error (ppm)
-30	2498.500001	0.000	2687.500002	0.001
-20	2498.500004	0.002	2687.500001	0.000
-10	2498.500003	0.001	2687.500003	0.001
0	2498.500003	0.001	2687.500003	0.001
10	2498.500001	0.000	2687.500002	0.001
20	2498.499998	-0.001	2687.499999	-0.001
30	2498.499997	-0.001	2687.499999	-0.001
40	2498.499997	-0.001	2687.499996	-0.001
50	2498.499998	-0.001	2687.499998	-0.001

Frequency Error vs. Voltage

Voltage (Volts)	LTE Band 41			
	Channel Bandwidth: 15 MHz			
	Low Channel		High Channel	
	Frequency (MHz)	Frequency Error (ppm)	Frequency (MHz)	Frequency Error (ppm)
120	2498.500002	0.001	2687.500001	0.000
102	2498.500003	0.001	2687.500003	0.001
138	2498.500002	0.001	2687.500003	0.001

Note: The applicant defined the normal working voltage of the battery is from 102 Vac to 138 Vac.

Frequency Error vs. Temperature

Temp. (°C)	LTE Band 41			
	Channel Bandwidth: 15 MHz			
	Low Channel		High Channel	
	Frequency (MHz)	Frequency Error (ppm)	Frequency (MHz)	Frequency Error (ppm)
-30	2498.500001	0.000	2687.500004	0.001
-20	2498.500004	0.001	2687.500002	0.001
-10	2498.500004	0.002	2687.500003	0.001
0	2498.500003	0.001	2687.500001	0.000
10	2498.500003	0.001	2687.500004	0.001
20	2498.499997	-0.001	2687.499997	-0.001
30	2498.499998	-0.001	2687.499996	-0.001
40	2498.499997	-0.001	2687.499998	-0.001
50	2498.499996	-0.001	2687.499997	-0.001

Frequency Error vs. Voltage

Voltage (Volts)	LTE Band 41			
	Channel Bandwidth: 20 MHz			
	Low Channel		High Channel	
	Frequency (MHz)	Frequency Error (ppm)	Frequency (MHz)	Frequency Error (ppm)
120	2498.500003	0.001	2687.500002	0.001
102	2498.500004	0.002	2687.500003	0.001
138	2498.500003	0.001	2687.500002	0.001

Note: The applicant defined the normal working voltage of the battery is from 102 Vac to 138 Vac.

Frequency Error vs. Temperature

Temp. (°C)	LTE Band 41			
	Channel Bandwidth: 20 MHz			
	Low Channel		High Channel	
	Frequency (MHz)	Frequency Error (ppm)	Frequency (MHz)	Frequency Error (ppm)
-30	2498.500004	0.002	2687.500003	0.001
-20	2498.500003	0.001	2687.500003	0.001
-10	2498.500004	0.001	2687.500002	0.001
0	2498.500002	0.001	2687.500004	0.001
10	2498.500003	0.001	2687.500001	0.000
20	2498.499998	-0.001	2687.499997	-0.001
30	2498.499996	-0.002	2687.499997	-0.001
40	2498.499999	-0.001	2687.499998	-0.001
50	2498.499997	-0.001	2687.499997	-0.001

4.4 Occupied Bandwidth Measurement

4.4.1 Limits of Occupied Bandwidth Measurement

The width of a frequency band such that, below the lower and above the upper frequency limits, the mean powers emitted are each equal to a specified percentage 0.5 % of the total mean power of a given emission.

4.4.2 Test Procedure

- a. The conducted occupied bandwidth used the power splitter via EUT RF power connector between simulation base station and spectrum analyzer.
- b. Use OBW measurement function of Spectrum analyzer to measure 99 % occupied bandwidth.

4.4.3 Test Setup

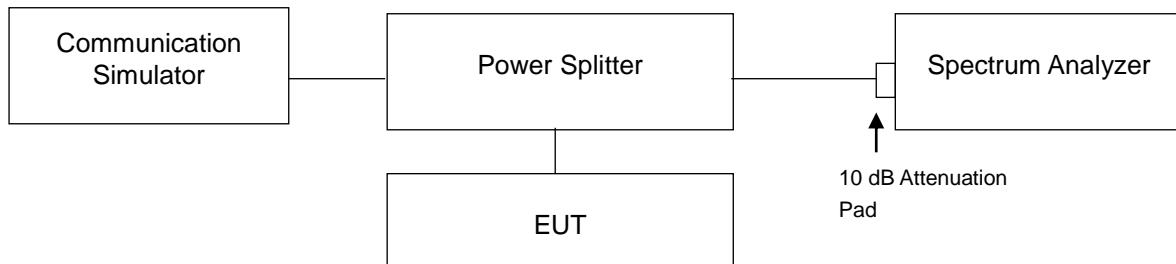

4.4.4 Test Results

LTE Band 7							
Channel Bandwidth: 5 MHz							
Channel	Frequency (MHz)	99 % Occupied Bandwidth (MHz)			26 dB Bandwidth (MHz)		
		QPSK	16QAM	64QAM	QPSK	16QAM	64QAM
20775	2502.5	4.496	4.489	4.496	4.839	4.843	4.837
21100	2535.0	4.500	4.498	4.498	4.834	4.860	4.828
21425	2567.5	4.493	4.497	4.501	4.856	4.860	4.863

Channel Bandwidth: 10 MHz							
Channel	Frequency (MHz)	99 % Occupied Bandwidth (MHz)			26 dB Bandwidth (MHz)		
		QPSK	16QAM	64QAM	QPSK	16QAM	64QAM
20800	2505.0	8.985	8.985	8.979	9.967	9.888	9.922
21100	2535.0	8.985	8.982	8.981	9.787	9.882	9.900
21400	2565.0	8.984	8.994	8.995	9.848	9.949	9.969

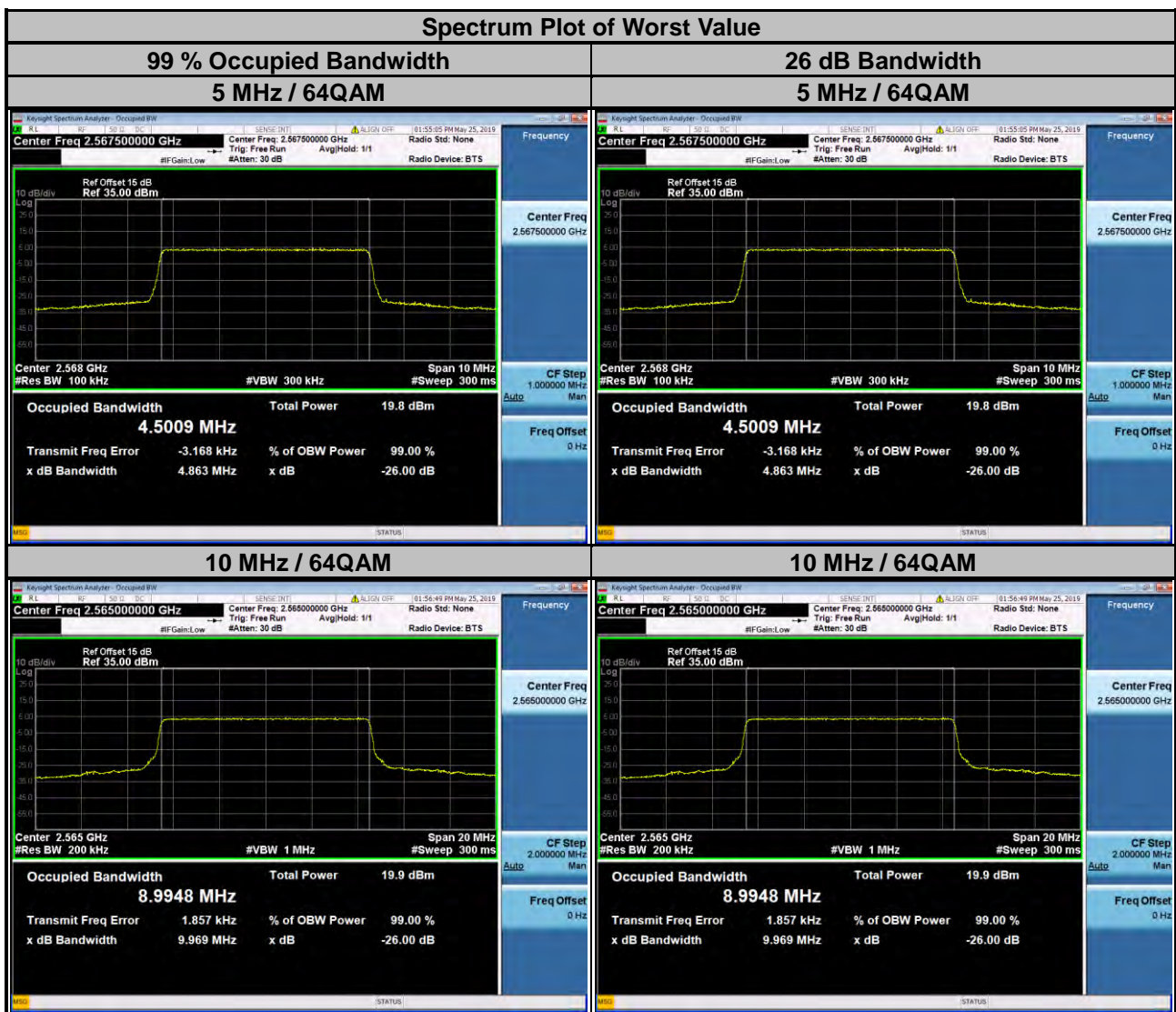

LTE Band 7							
Channel Bandwidth: 15 MHz							
Channel	Frequency (MHz)	99 % Occupied Bandwidth (MHz)			26 dB Bandwidth (MHz)		
		QPSK	16QAM	64QAM	QPSK	16QAM	64QAM
20825	2507.5	13.490	13.473	13.464	14.340	14.350	14.360
21100	2535.0	13.470	13.472	13.468	14.340	14.420	14.340
21375	2562.5	13.478	13.485	13.495	14.340	14.470	14.420
Channel Bandwidth: 20 MHz							
Channel	Frequency (MHz)	99 % Occupied Bandwidth (MHz)			26 dB Bandwidth (MHz)		
		QPSK	16QAM	64QAM	QPSK	16QAM	64QAM
20850	2510.0	18.006	18.004	17.983	19.060	19.070	19.070
21100	2535.0	17.971	17.969	17.965	19.070	19.060	19.070
21350	2560.0	17.995	17.996	17.997	19.130	19.140	19.110



LTE Band 38							
Channel Bandwidth: 5 MHz							
Channel	Frequency (MHz)	99 % Occupied Bandwidth (MHz)			26 dB Bandwidth (MHz)		
		QPSK	16QAM	64QAM	QPSK	16QAM	64QAM
37775	2572.5	4.493	4.507	4.495	4.803	4.872	4.846
38000	2595.0	4.500	4.500	4.496	4.842	4.874	4.843
38225	2617.5	4.500	4.496	4.501	4.844	4.834	4.860

Channel Bandwidth: 10 MHz							
Channel	Frequency (MHz)	99 % Occupied Bandwidth (MHz)			26 dB Bandwidth (MHz)		
		QPSK	16QAM	64QAM	QPSK	16QAM	64QAM
37800	2575.0	8.989	8.989	8.982	9.929	9.799	9.836
38000	2595.0	8.997	8.986	8.991	9.953	9.785	9.871
38200	2615.0	8.982	8.989	8.987	9.918	9.882	9.965



LTE Band 38							
Channel Bandwidth: 15 MHz							
Channel	Frequency (MHz)	99 % Occupied Bandwidth (MHz)			26 dB Bandwidth (MHz)		
		QPSK	16QAM	64QAM	QPSK	16QAM	64QAM
37825	2577.5	13.480	13.469	13.483	14.430	14.320	14.430
38000	2595.0	13.471	13.463	13.461	14.380	14.450	14.340
38175	2612.5	13.475	13.467	13.470	14.350	14.430	14.390

Channel Bandwidth: 20 MHz							
Channel	Frequency (MHz)	99 % Occupied Bandwidth (MHz)			26 dB Bandwidth (MHz)		
		QPSK	16QAM	64QAM	QPSK	16QAM	64QAM
37850	2580.0	17.986	17.969	17.989	19.080	19.080	19.080
38000	2595.0	17.977	17.971	17.969	19.070	19.120	19.060
38150	2610.0	17.974	17.965	17.965	19.080	19.110	19.090



LTE Band 41							
Channel Bandwidth: 5 MHz							
Channel	Frequency (MHz)	99 % Occupied Bandwidth (MHz)			26 dB Bandwidth (MHz)		
		QPSK	16QAM	64QAM	QPSK	16QAM	64QAM
39675	2498.5	4.502	4.495	4.500	4.854	4.827	4.852
40620	2593.0	4.499	4.493	4.495	4.868	4.828	4.849
41565	2687.5	4.500	4.493	4.506	4.830	4.832	4.887

Channel Bandwidth: 10 MHz							
Channel	Frequency (MHz)	99 % Occupied Bandwidth (MHz)			26 dB Bandwidth (MHz)		
		QPSK	16QAM	64QAM	QPSK	16QAM	64QAM
39700	2501.0	8.981	8.984	8.986	9.747	9.872	9.855
40620	2593.0	8.997	8.994	8.991	9.928	9.920	9.914
41540	2685.0	8.987	8.978	8.976	9.851	9.766	9.866



LTE Band 41							
Channel Bandwidth: 15 MHz							
Channel	Frequency (MHz)	99 % Occupied Bandwidth (MHz)			26 dB Bandwidth (MHz)		
		QPSK	16QAM	64QAM	QPSK	16QAM	64QAM
39725	2503.5	13.462	13.462	13.469	14.290	14.340	14.310
40620	2593.0	13.470	13.470	13.473	14.370	14.420	14.350
41515	2682.5	13.473	13.455	13.472	14.330	14.310	14.380

Channel Bandwidth: 20 MHz							
Channel	Frequency (MHz)	99 % Occupied Bandwidth (MHz)			26 dB Bandwidth (MHz)		
		QPSK	16QAM	64QAM	QPSK	16QAM	64QAM
39750	2506.0	17.954	17.946	17.964	19.050	19.070	19.050
40620	2593.0	17.961	17.961	17.975	19.080	19.070	19.100
41490	2680.0	17.987	17.965	17.970	19.070	19.060	19.100



4.5 Out-of-Band Emissions Measurement

4.5.1 Limits of Out-of-Band Emissions Measurement

According to FCC 27.53(m)(4)&(6) specified that power of any emission outside of the channel edge must be attenuated below the transmitting power (P) by a factor shall be not less than $40 + 10 \log (P)$ dB on all frequencies between the channel edge and 5 megahertz from the channel edge, $43 + 10 \log (P)$ dB on all frequencies between 5 megahertz and X megahertz from the channel edge, and $55 + 10 \log (P)$ dB on all frequencies more than X megahertz from the channel edge, where X is the greater of 6 megahertz or the actual emission bandwidth. In addition, the attenuation factor shall not be less that $43 + 10 \log (P)$ dB on all frequencies between 2490.5 MHz and 2496 MHz and $55 + 10 \log (P)$ dB at or below 2490.5 MHz. In the 1 MHz bands immediately outside and adjacent to the frequency block a resolution bandwidth of at least two percent may be employed, except when the 1 megahertz band is 2495-2496 MHz, in which case a resolution bandwidth of at least one percent may be employed.

4.5.2 Test Setup

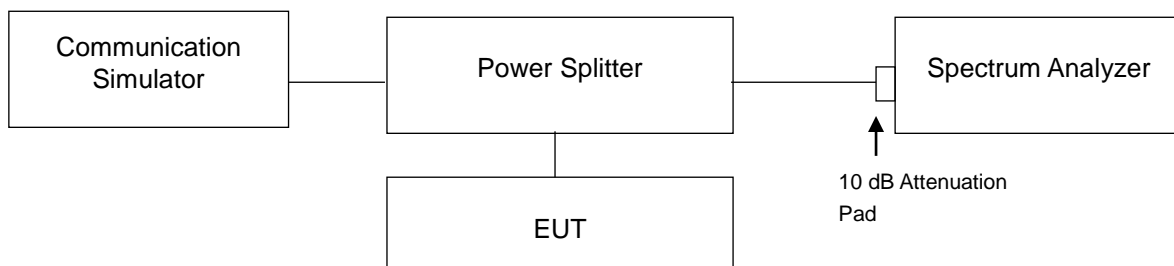

4.5.3 Test Procedures

- The EUT was set up for the maximum peak power with LTE link data modulation. The power was measured with R&S Spectrum Analyzer. All measurements were done at 2 channels (low and high operational frequency range).
- The out-of-band emissions measurement used the power splitter via EUT RF power connector between simulation base station and spectrum analyzer.
- Record the max. trace plot into the test report.

4.5.4 Test Results

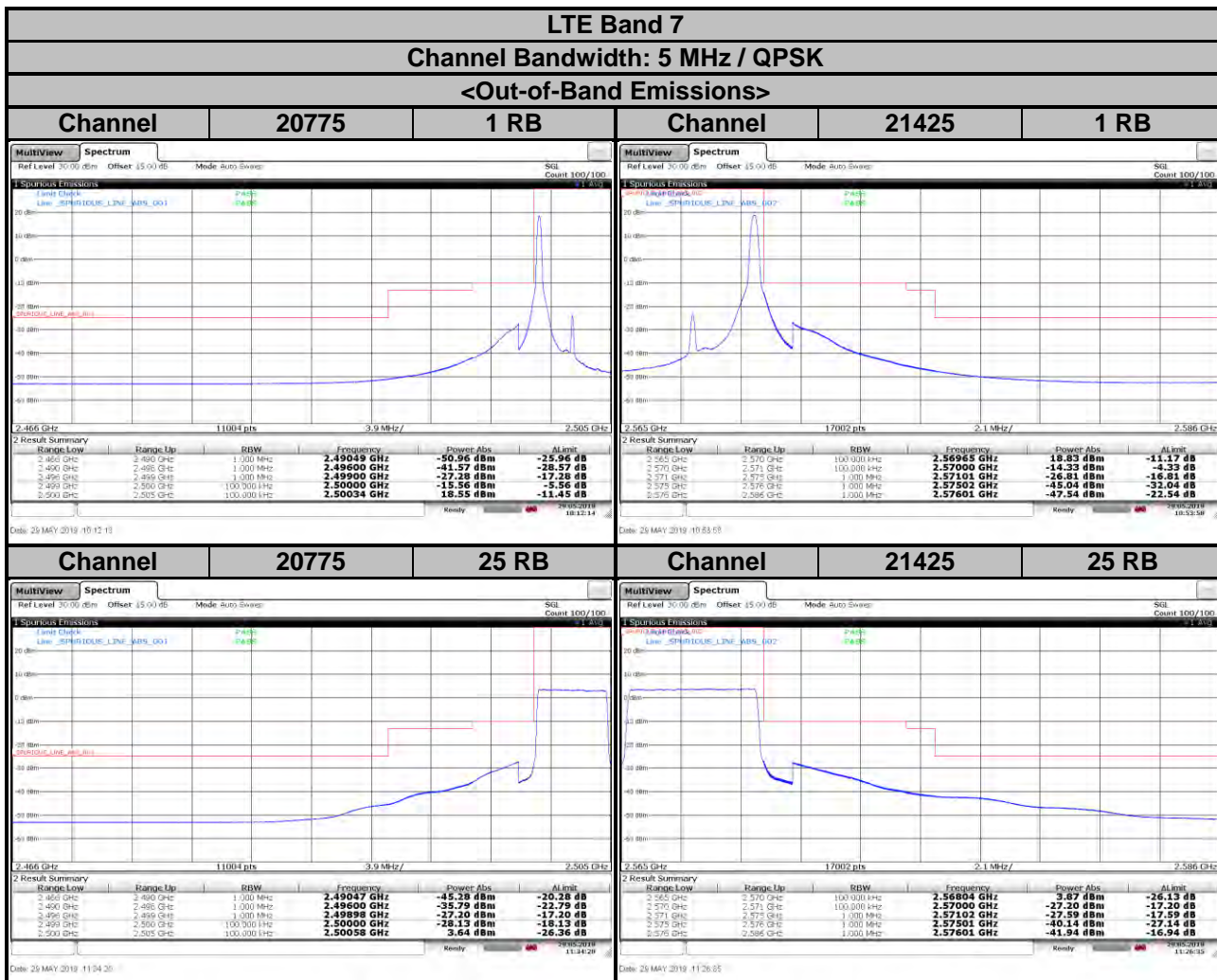

LTE Band 7
Channel Bandwidth: 5 MHz / 16QAM

<Out-of-Band Emissions>

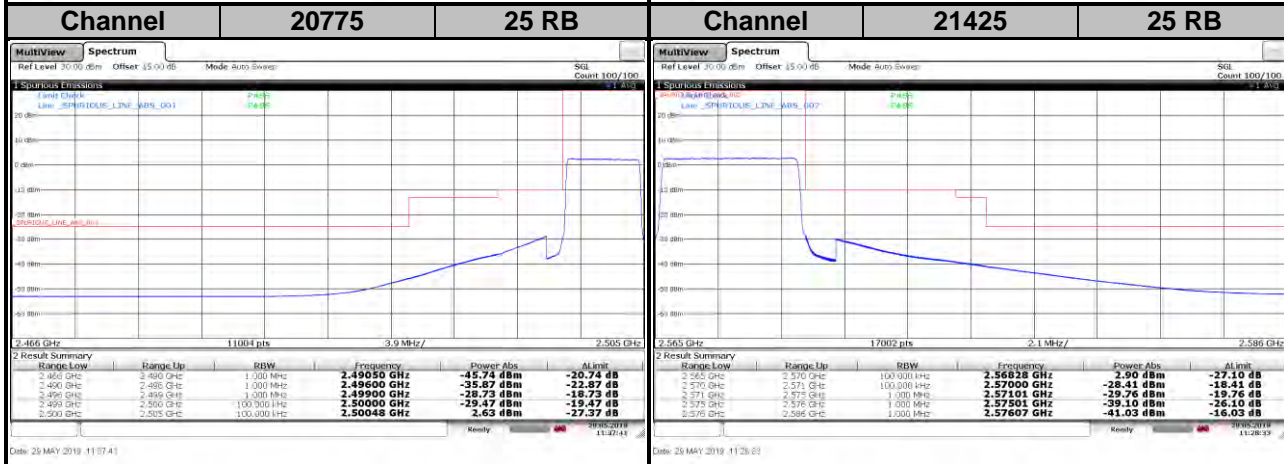
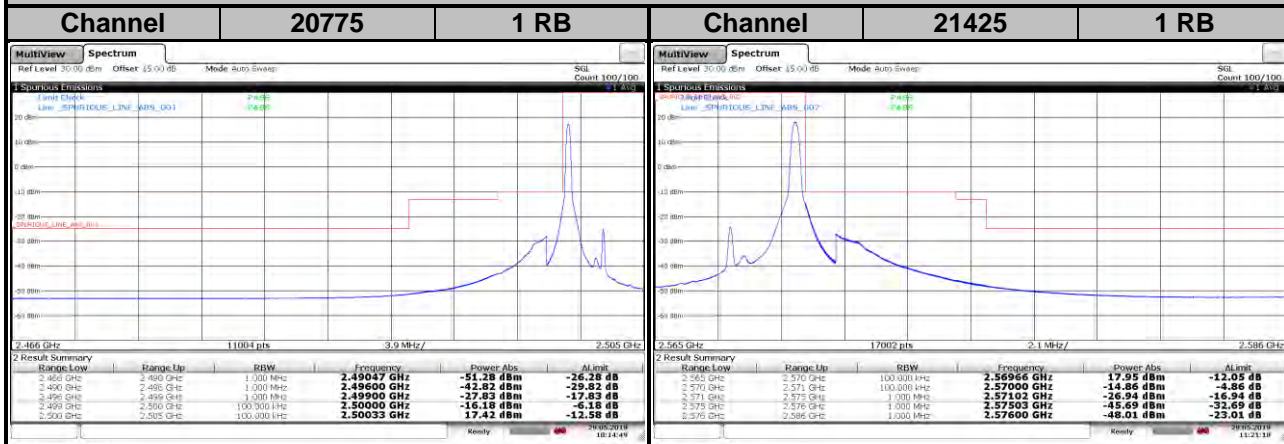

LTE Band 7
Channel Bandwidth: 5 MHz / 64QAM

<Out-of-Band Emissions>

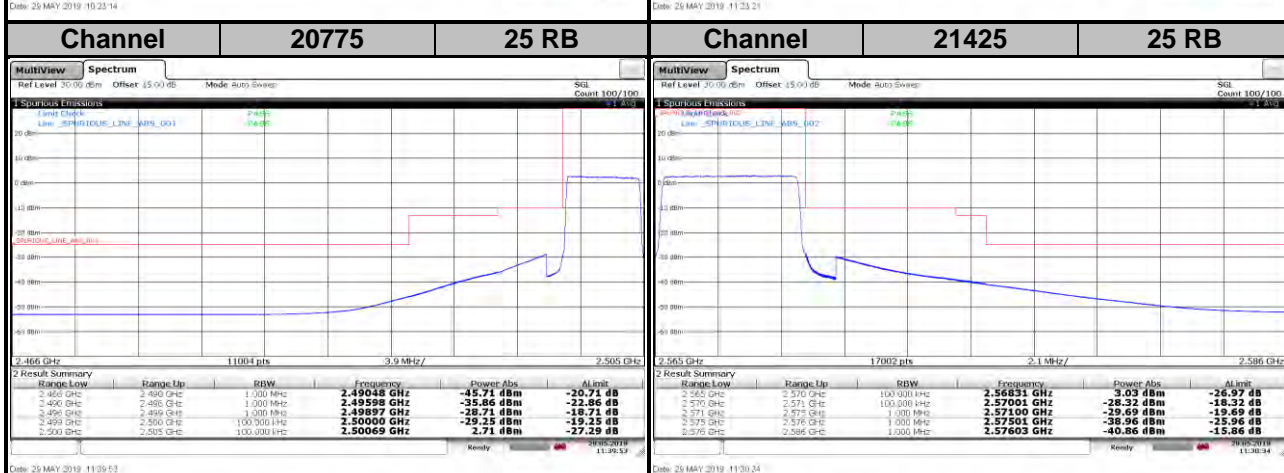
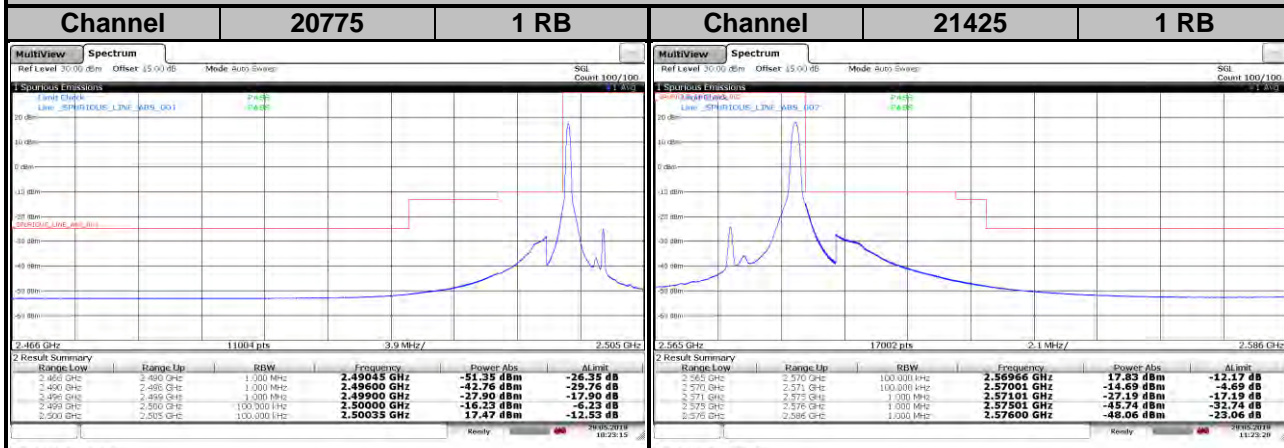

LTE Band 7

Channel Bandwidth: 10 MHz / QPSK

<Out-of-Band Emissions>

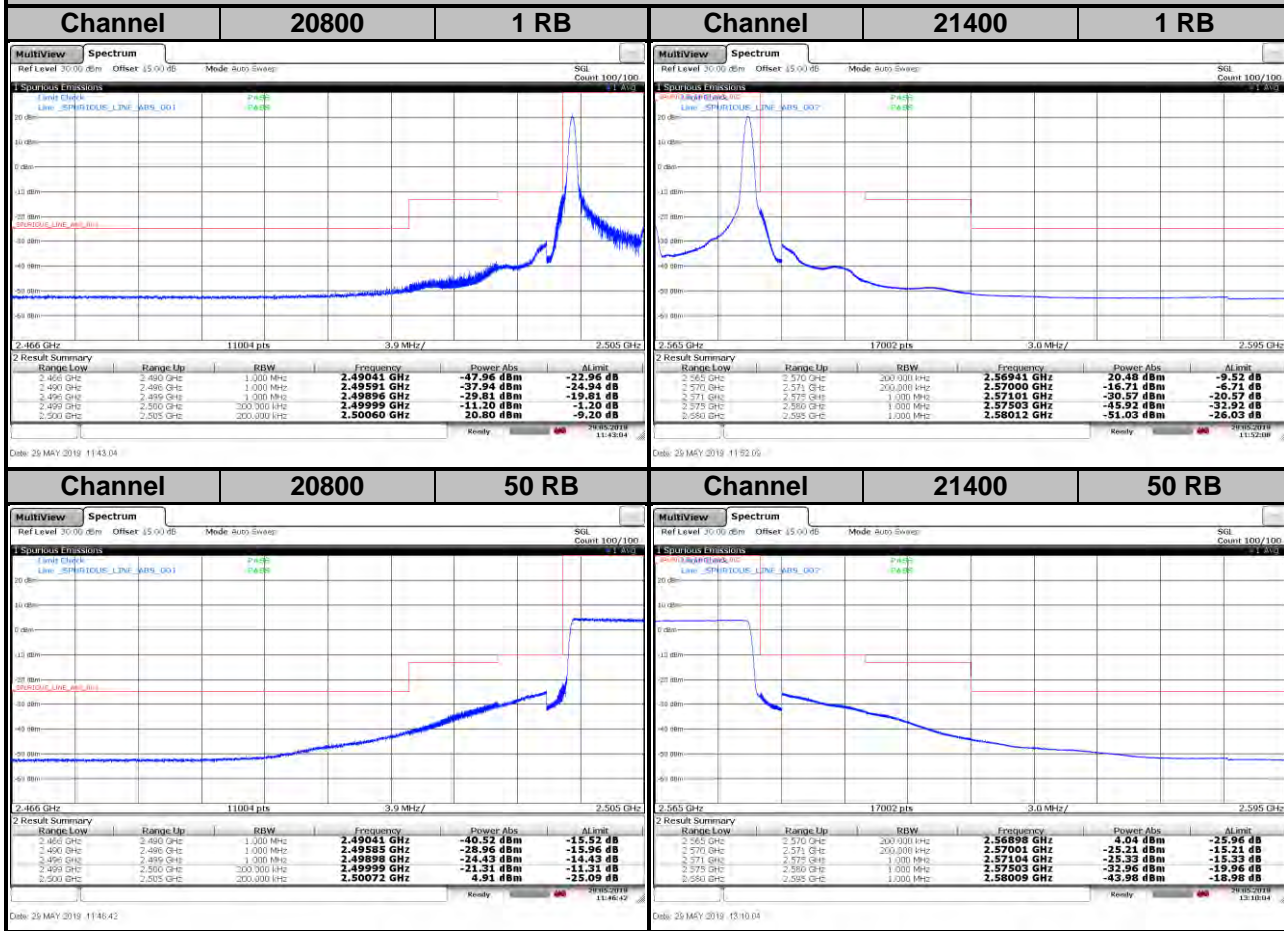

LTE Band 7

Channel Bandwidth: 10 MHz / 16QAM

<Out-of-Band Emissions>

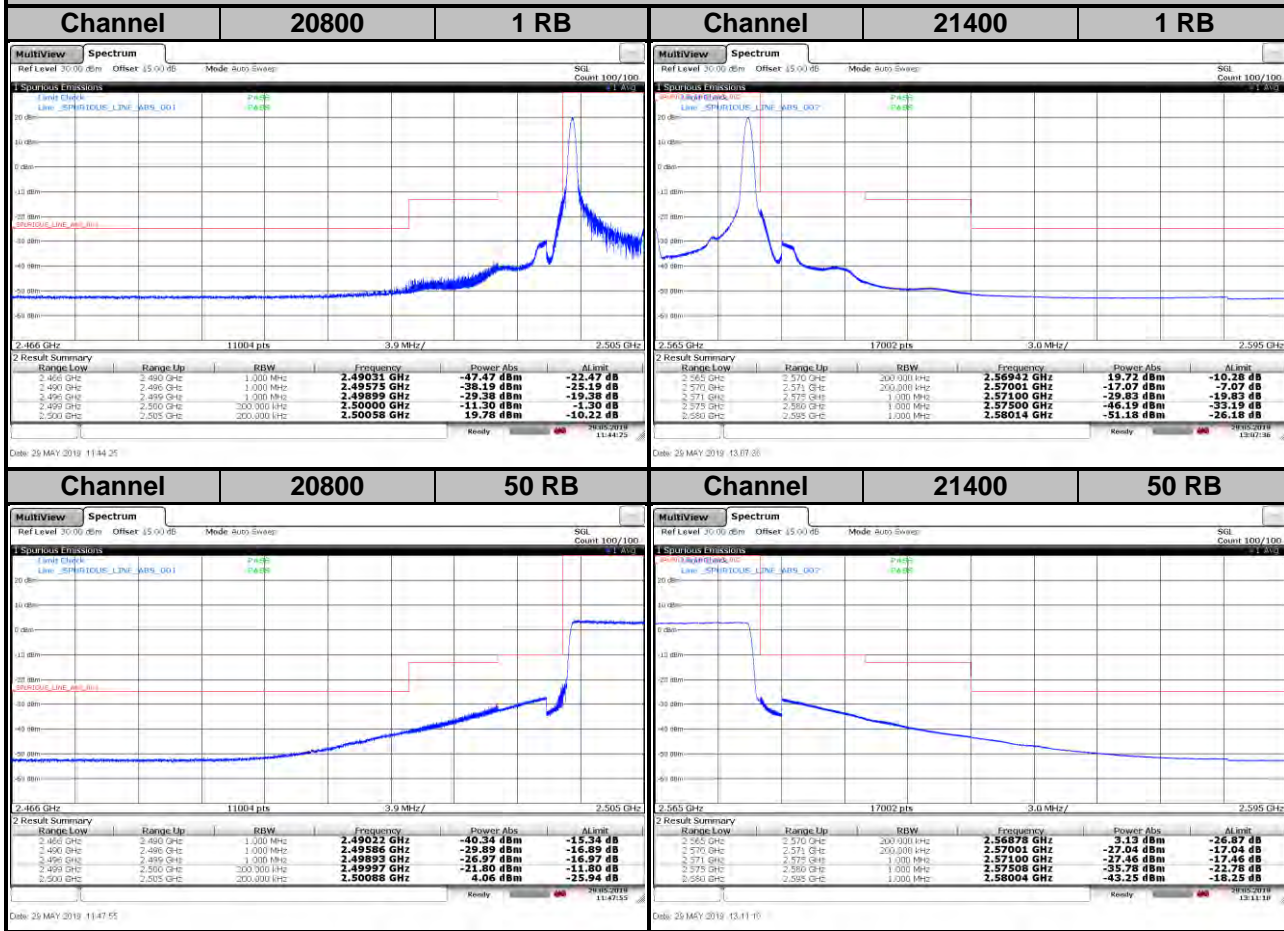

LTE Band 7

Channel Bandwidth: 10 MHz / 64QAM

<Out-of-Band Emissions>

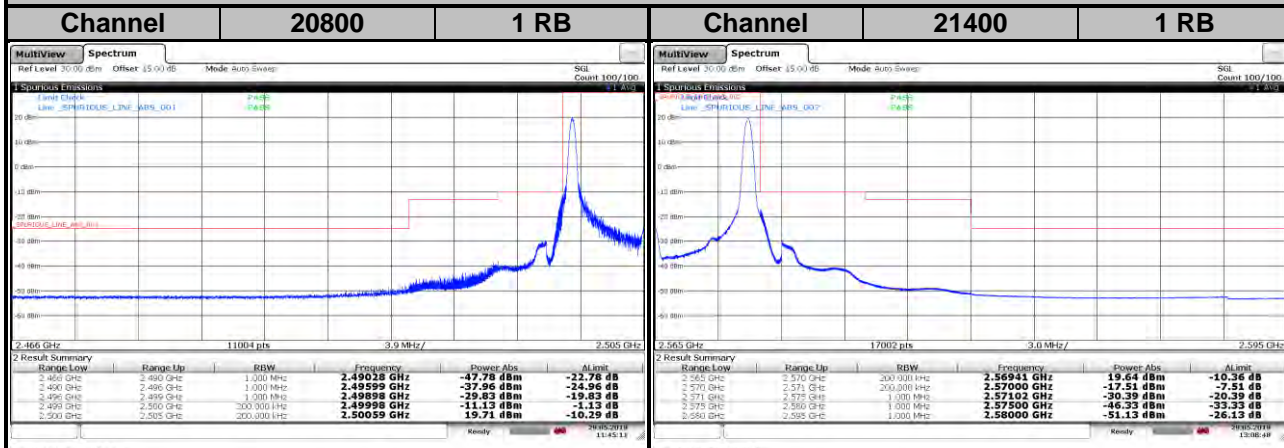

Date: 29 MAY 2019 11:45:10 Date: 29 MAY 2019 13:08:45

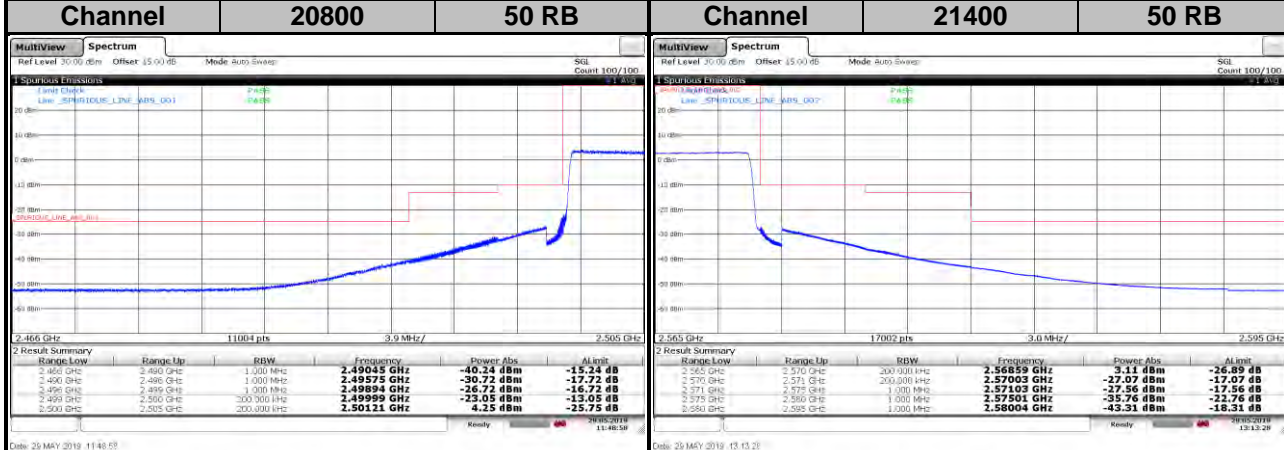

Date: 29 MAY 2019 11:48:53 Date: 29 MAY 2019 13:13:29

LTE Band 7

Channel Bandwidth: 15 MHz / QPSK

<Out-of-Band Emissions>

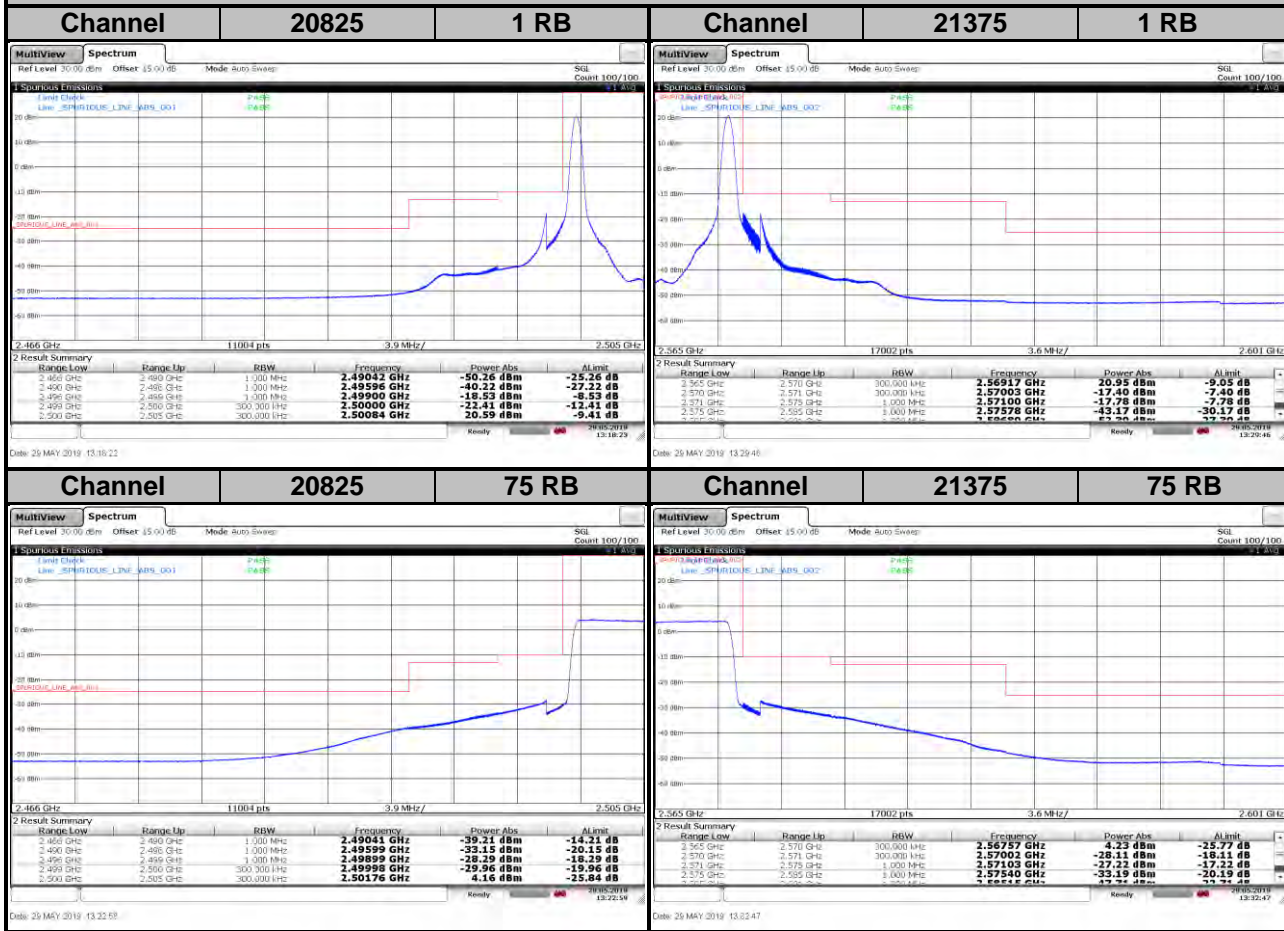

LTE Band 7

Channel Bandwidth: 15 MHz / 16QAM

<Out-of-Band Emissions>

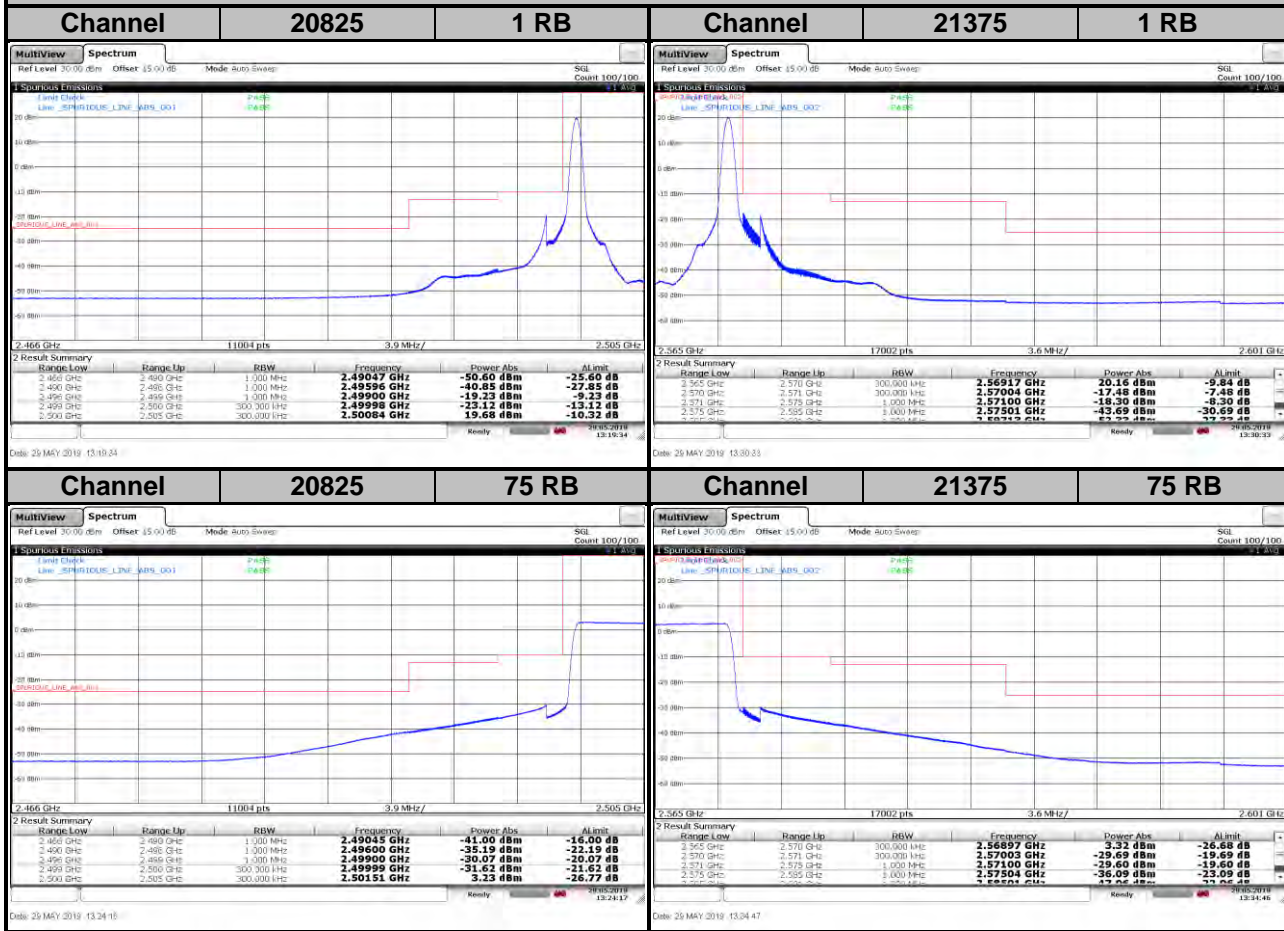

LTE Band 7

Channel Bandwidth: 15 MHz / 64QAM

<Out-of-Band Emissions>

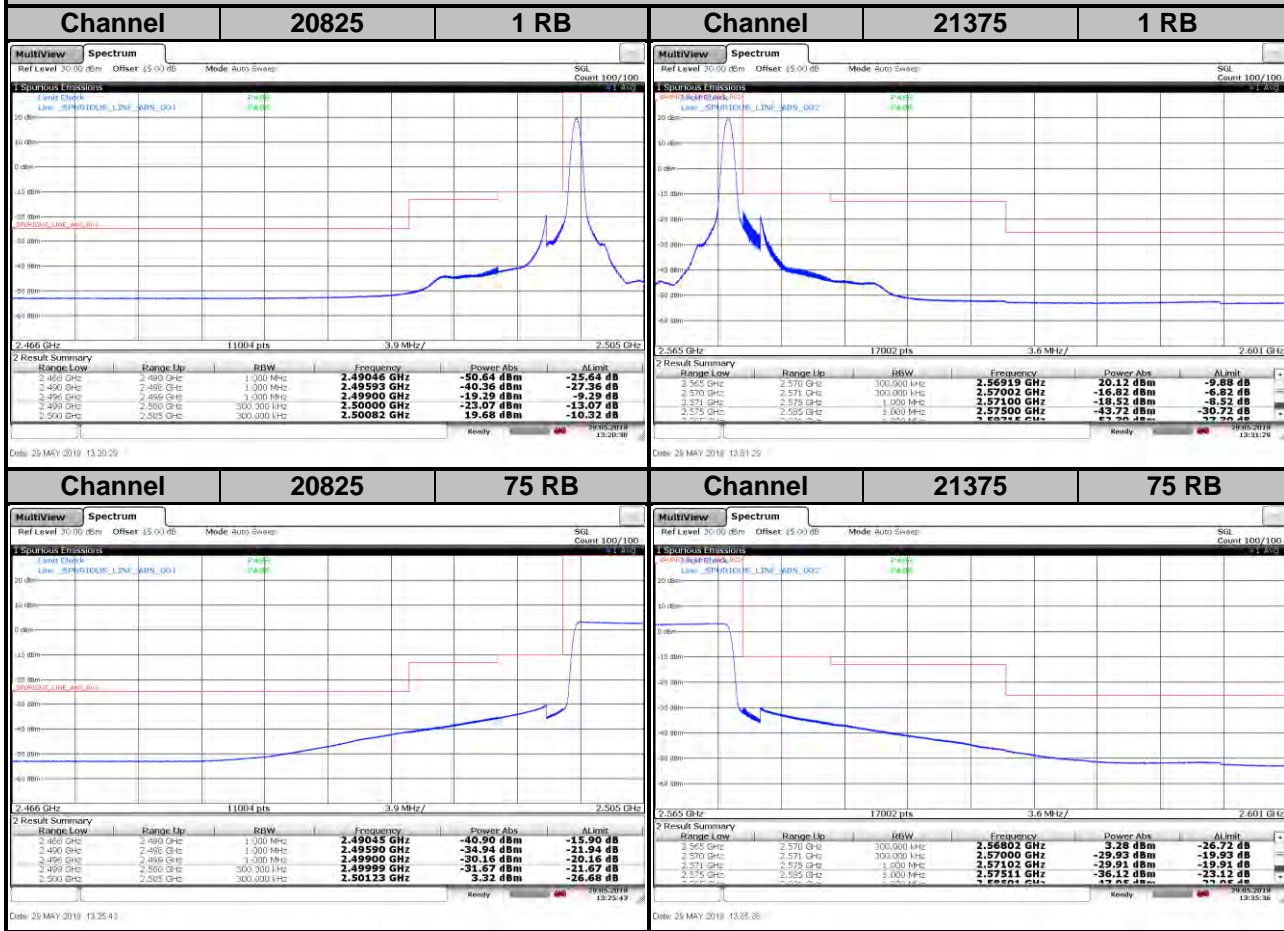

LTE Band 7

Channel Bandwidth: 20 MHz / QPSK

<Out-of-Band Emissions>

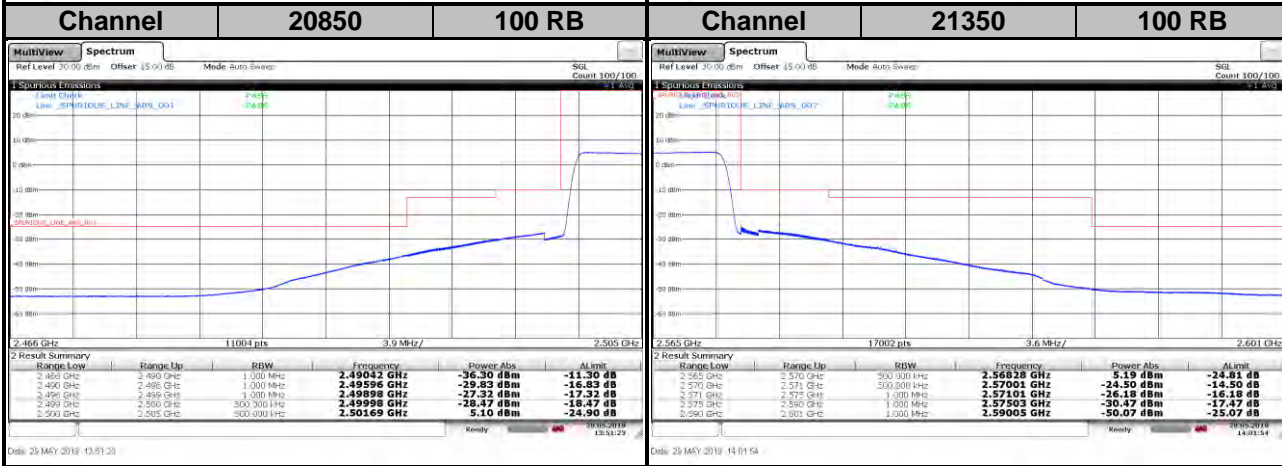
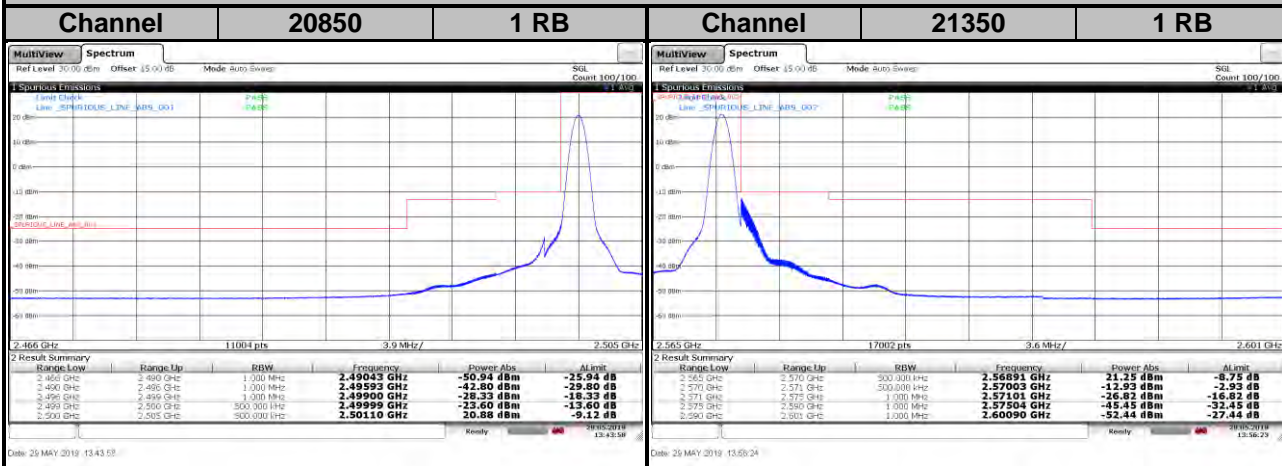

LTE Band 7

Channel Bandwidth: 20 MHz / 16QAM

<Out-of-Band Emissions>

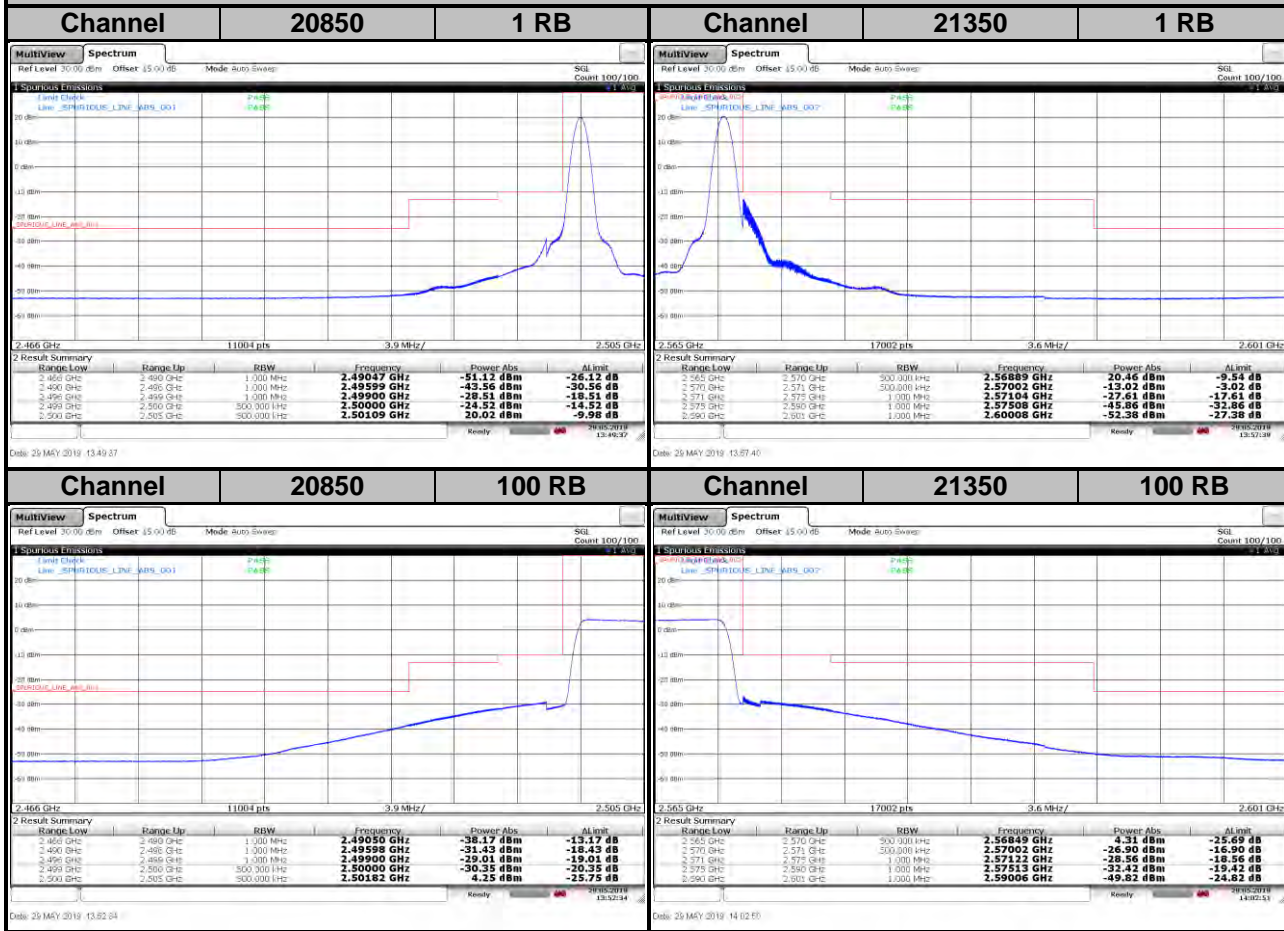

LTE Band 7

Channel Bandwidth: 20 MHz / 64QAM

<Out-of-Band Emissions>

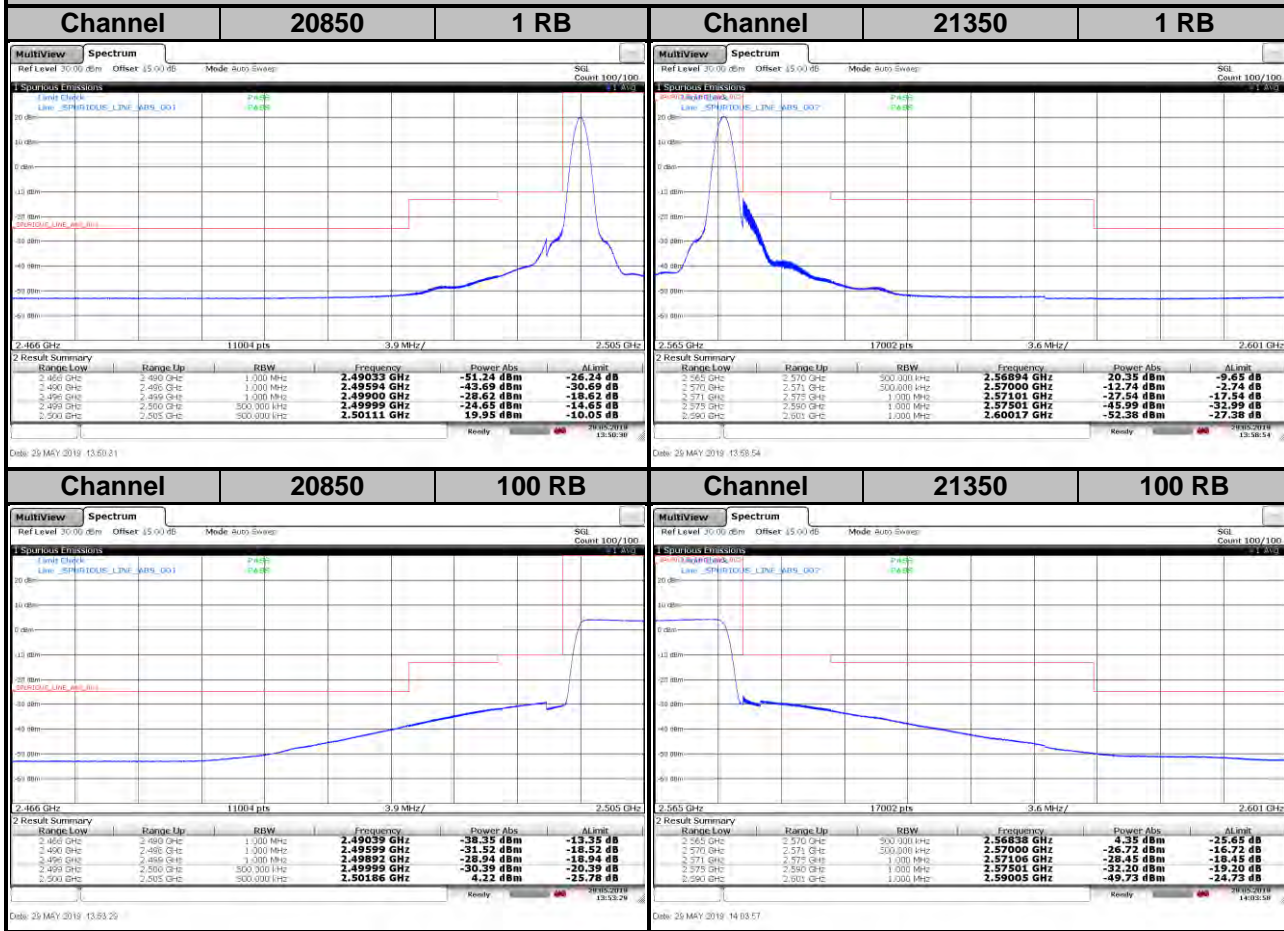

LTE Band 38
Channel Bandwidth: 5 MHz / QPSK

<Out-of-Band Emissions>

