

FCC Test Report

(PART 90S)

Report No.: RF180704C01-5

FCC ID: ZMOL850GLD

Test Model: L850-GL

Received Date: Jul. 04, 2018

Test Date: Jul. 10, 2018 ~ Jul. 16, 2018

Issued Date: Jul. 19, 2018

Applicant: Fibocom Wireless Inc.

Address: 5/F, Tower A, Technology Building II, 1057 Nanhai Blvd, Nanshan, Shenzhen, China

Issued By: Bureau Veritas Consumer Products Services (H.K.) Ltd., Taoyuan Branch

Lab Address: No. 47-2, 14th Ling, Chia Pau Vil., Lin Kou Dist., New Taipei City, Taiwan (R.O.C)

Test Location: No. 19, Hwa Ya 2nd Rd, Wen Hwa Vil, Kwei Shan Dist., Taoyuan City 33383, Taiwan (R.O.C)

**FCC Registration /
Designation Number:** 788550 / TW0003



This report is for your exclusive use. Any copying or replication of this report to or for any other person or entity, or use of our name or trademark, is permitted only with our prior written permission. This report sets forth our findings solely with respect to the test samples identified herein. The results set forth in this report are not indicative or representative of the quality or characteristics of the lot from which a test sample was taken or any similar or identical product unless specifically and expressly noted. Our report includes all of the tests requested by you and the results thereof based upon the information that you provided to us. You have 60 days from date of issuance of this report to notify us of any material error or omission caused by our negligence, provided, however, that such notice shall be in writing and shall specifically address the issue you wish to raise. A failure to raise such issue within the prescribed time shall constitute your unqualified acceptance of the completeness of this report, the tests conducted and the correctness of the report contents. Unless specific mention, the uncertainty of measurement has been explicitly taken into account to declare the compliance or non-compliance to the specification. The report must not be used by the client to claim product certification, approval, or endorsement by TAF or any government agencies

Table of Contents

Release Control Record	3
1 Certificate of Conformity	4
2 Summary of Test Results	5
2.1 Measurement Uncertainty	5
2.2 Test Site and Instruments	6
3 General Information	7
3.1 General Description of EUT	7
3.2 Configuration of System under Test	8
3.2.1 Description of Support Units	8
3.3 Test Mode Applicability and Tested Channel Detail	8
3.4 EUT Operating Conditions	10
3.5 General Description of Applied Standards	10
4 Test Types and Results	11
4.1 Output Power Measurement	11
4.1.1 Limits of Output Power Measurement	11
4.1.2 Test Procedures	11
4.1.3 Test Setup	11
4.1.4 Test Results	12
4.2 Modulation Characteristics Measurement	14
4.2.1 Limits of Modulation Characteristics	14
4.2.2 Test Setup	14
4.2.3 Test Procedure	14
4.2.4 Test Results	15
4.3 Frequency Stability Measurement	16
4.3.1 Limits of Frequency Stability Measurement	16
4.3.2 Test Procedure	16
4.3.3 Test Setup	16
4.3.4 Test Results	17
4.4 Occupied Bandwidth Measurement	21
4.4.1 Limits of Occupied Bandwidth Measurement	21
4.4.2 Test Procedure	21
4.4.3 Test Setup	21
4.4.4 Test Results	22
4.5 Emission Mask Measurement	24
4.5.1 Limits of Band Edge Measurement	24
4.5.2 Test Setup	24
4.5.3 Test Procedures	24
4.5.4 Test Results	25
4.6 Conducted Spurious Emissions	29
4.6.1 Limits of Conducted Spurious Emissions Measurement	29
4.6.2 Test Setup	29
4.6.3 Test Procedure	29
4.6.4 Test Results	30
4.7 Radiated Emission Measurement	34
4.7.1 Limits of Radiated Emission Measurement	34
4.7.2 Test Procedure	34
4.7.3 Deviation from Test Standard	34
4.7.4 Test Setup	35
4.7.5 Test Results	36
5 Pictures of Test Arrangements	44
Appendix – Information on the Testing Laboratories	45

Release Control Record

Issue No.	Description	Date Issued
RF180704C01-5	Original Release	Jul. 19, 2018

1 Certificate of Conformity

Product: LTE module

Brand: Fibocom

Test Model: L850-GL

Sample Status: Identical Prototype

Applicant: Fibocom Wireless Inc.

Test Date: Jul. 10, 2018 ~ Jul. 16, 2018

Standards: FCC Part 90, Subpart S
FCC Part 2

The above equipment has been tested by **Bureau Veritas Consumer Products Services (H.K.) Ltd., Taoyuan Branch**, and found compliance with the requirement of the above standards. The test record, data evaluation & Equipment Under Test (EUT) configurations represented herein are true and accurate accounts of the measurements of the sample's RF characteristics under the conditions specified in this report.

Prepared by :

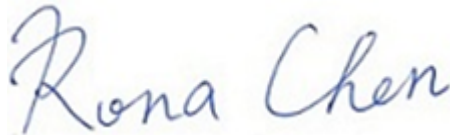

Date:

Jul. 19, 2018

Rona Chen / Specialist

Approved by :



Date:

Jul. 19, 2018

Dylan Chiou / Project Engineer

2 Summary of Test Results

Applied Standard: FCC Part 90 & Part 2 (LTE 26)			
FCC Clause	Test Item	Result	Remarks
2.1046 90.635 (b)	Effective Radiated Power	Pass	Meet the requirement of limit.
2.1047	Modulation Characteristics	Pass	Meet the requirement.
2.1055 90.213	Frequency Stability	Pass	Meet the requirement of limit.
2.1049 90.209	Occupied Bandwidth (*)	Pass	Meet the requirement of limit.
2.1051 90.209	Emission Masks	Pass	Meet the requirement of limit.
2.1051 90.691	Conducted Spurious Emissions	Pass	Meet the requirement of limit.
2.1053 90.691	Radiated Spurious Emissions	Pass	Meet the requirement of limit. Minimum passing margin is -31.93 dB at 42.61 MHz.

2.1 Measurement Uncertainty

Where relevant, the following measurement uncertainty levels have been estimated for tests performed on the EUT as specified in CISPR 16-4-2:

Measurement	Frequency	Expanded Uncertainty (k=2) (±)
Radiated Emissions up to 1 GHz	30 MHz ~ 200 MHz	2.93 dB
	200 MHz ~ 1000 MHz	2.95 dB
Radiated Emissions above 1 GHz	1 GHz ~ 18 GHz	2.26 dB
	18 GHz ~ 40 GHz	1.94 dB

2.2 Test Site and Instruments

Description & Manufacturer	Model No.	Serial No.	Date of Calibration	Due Date of Calibration
Test Receiver Agilent	N9038A	MY51210203	Mar. 16, 2018	Mar. 15, 2019
Spectrum Analyzer Agilent	N9010A	MY52220314	Nov. 24, 2017	Nov. 23, 2018
Spectrum Analyzer ROHDE & SCHWARZ	FSU43	101261	Jan. 11, 2018	Jan. 10, 2019
Double Ridge Guide Horn Antenna EMCO	3115	5619	Nov. 30, 2017	Nov. 29, 2018
BILOG Antenna SCHWARZBECK	VULB 9168	9168-153	Dec. 06, 2017	Dec. 05, 2018
Fixed Attenuator Mini-Circuits	MDCS18N-10	MDCS18N-10-01	Apr. 16, 2018	Apr. 15, 2019
Preamplifier EMCI	EMC 012645	980115	Oct. 20, 2017	Oct. 19, 2018
Preamplifier EMCI	EMC 184045	980116	Oct. 20, 2017	Oct. 19, 2018
Preamplifier EMCI	EMC 330H	980112	Oct. 13, 2017	Oct. 12, 2018
Power Meter Anritsu	ML2495A	1012010	Aug. 15, 2017	Aug. 14, 2018
Power Sensor Anritsu	MA2411B	1315050	Aug. 15, 2017	Aug. 14, 2018
RF Coaxial Cable HUBER+SUHNNER	EMC104-SM-SM-800 0&3000	140811+170717	Oct. 20, 2017	Oct. 19, 2018
RF Coaxial Cable HUBER+SUHNNER	SUCOFLEX 104	EMC104-SM-SM- 1000(140807)	Oct. 20, 2017	Oct. 19, 2018
RF Coaxial Cable Worken	8D-FB	Cable-Ch10-01	Oct. 20, 2017	Oct. 19, 2018
Software BV ADT	E3 6.120103	NA	NA	NA
Antenna Tower MF	MFA-440H	NA	NA	NA
Turn Table MF	MFT-201SS	NA	NA	NA
Antenna Tower & Turn Table Controller MF	MF-7802	NA	NA	NA
Radio Communication Analyzer	MT8820C	6201300640	Aug. 16, 2017	Aug. 15, 2019
Temperature & Humidity Chamber	GTH-120-40-CP-AR	MAA1306-019	Sep. 08, 2017	Sep. 07, 2018
DC Power Supply Topward	33010D	807748	Oct. 25, 2016	Oct. 24, 2018
Digital Multimeter Fluke	87-III	70360742	Jun. 29, 2018	Jun. 28, 2019

- Note: 1. The calibration interval of the above test instruments is 12 / 24 months and the calibrations are traceable to NML/ROC and NIST/USA.
2. The test was performed in HwaYa Chamber 10.
3. The horn antenna and preamplifier (model: EMC 184045) are used only for the measurement of emission frequency above 1 GHz if tested.
4. The IC Site Registration No. is IC7450F-10.

3 General Information

3.1 General Description of EUT

Product	LTE module	
Brand	Fibocom	
Test Model	L850-GL	
Status of EUT	Identical Prototype	
Power Supply Rating	3.3 Vdc (Host equipment)	
Modulation Type	LTE	QPSK, 16QAM
Frequency Range	LTE Band 26 (Channel Bandwidth: 1.4 MHz)	814.7 ~ 823.3 MHz
	LTE Band 26 (Channel Bandwidth: 3 MHz)	815.5 ~ 822.5 MHz
	LTE Band 26 (Channel Bandwidth: 5 MHz)	816.5 ~ 821.5 MHz
	LTE Band 26 (Channel Bandwidth: 10 MHz)	819 MHz
Emission Designator	LTE Band 26 (Channel Bandwidth: 1.4 MHz)	1M09G7D
	LTE Band 26 (Channel Bandwidth: 3 MHz)	2M70G7D
	LTE Band 26 (Channel Bandwidth: 5 MHz)	4M50W7D
	LTE Band 26 (Channel Bandwidth: 10 MHz)	9M02G7D
Max. ERP Power	LTE Band 26 (Channel Bandwidth: 1.4 MHz)	217.77 mW
	LTE Band 26 (Channel Bandwidth: 3 MHz)	221.82 mW
	LTE Band 26 (Channel Bandwidth: 5 MHz)	226.99 mW
	LTE Band 26 (Channel Bandwidth: 10 MHz)	229.61 mW
Antenna Type	External Antenna with 3.0 dBi gain	
Accessory Device	N/A	
Data Cable Supplied	N/A	

Note:

1. The above EUT information is declared by manufacturer and for more detailed features description, please refers to the manufacturer's specifications or user's manual.

3.2 Configuration of System under Test

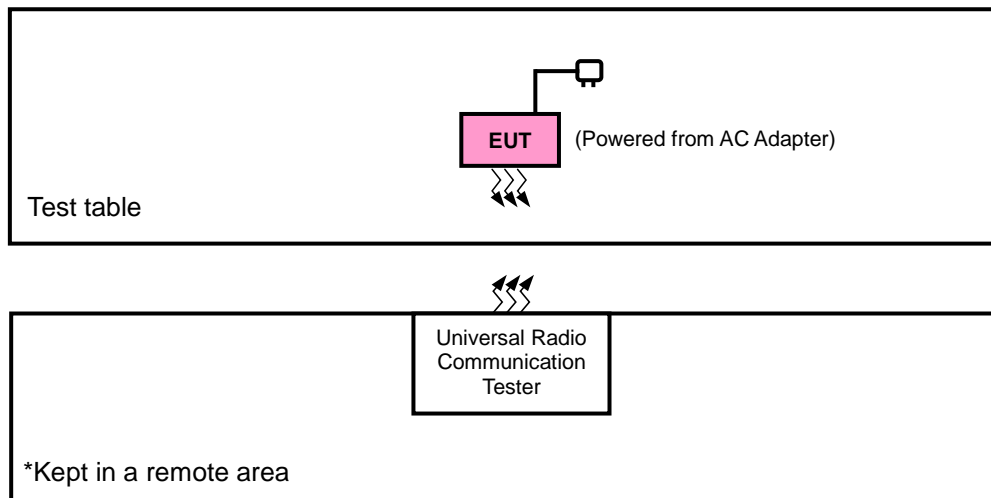

3.2.1 Description of Support Units

The EUT has been tested as an independent unit together with other necessary accessories or support units.

3.3 Test Mode Applicability and Tested Channel Detail

Pre-Scan has been conducted to determine the worst-case mode from all possible combinations between available modulations, data rates, XYZ axis, and antenna ports

The worst case was found when positioned as the table below. Following channel(s) was (were) selected for the final test as listed below:

Band	Radiated Emission
LTE Band 26	Z-axis

LTE Band 26

EUT Config ure Mode	Test Item	Available Channel	Tested Channel	Channel Bandwidth	Modulation	Mode
-	ERP	26697 to 26783	26697, 26740, 26783	1.4 MHz	QPSK, 16QAM	1 RB / 0 RB Offset
		26705 to 26775	26705, 26740, 26775	3 MHz	QPSK, 16QAM	1 RB / 0 RB Offset
		26715 to 26765	26715, 26740, 26765	5 MHz	QPSK, 16QAM	1 RB / 0 RB Offset
		26740	26740	10 MHz	QPSK, 16QAM	1 RB / 0 RB Offset
-	Modulation Characteristics	26715 to 26765	26740	5 MHz	QPSK, 16QAM	25 RB / 0 RB Offset
-	Frequency Stability	26697 to 26783	26697, 26783	1.4 MHz	QPSK	1 RB / 2 RB Offset
		26705 to 26775	26705, 26775	3 MHz	QPSK	1 RB / 7 RB Offset
		26715 to 26765	26715, 26765	5 MHz	QPSK	1 RB / 12 RB Offset
		26740	26740	10 MHz	QPSK	1 RB / 49 RB Offset
-	Occupied Bandwidth	26697 to 26783	26697, 26740, 26783	1.4 MHz	QPSK, 16QAM	6 RB / 0 RB Offset
		26705 to 26775	26705, 26740, 26775	3 MHz	QPSK, 16QAM	15 RB / 0 RB Offset
		26715 to 26765	26715, 26740, 26765	5 MHz	QPSK, 16QAM	25 RB / 0 RB Offset
		26740	26740	10 MHz	QPSK, 16QAM	50 RB / 0 RB Offset
-	Emission Mask	26697 to 26783	26697, 26740, 26783	1.4 MHz	QPSK, 16QAM	6 RB / 0 RB Offset
		26705 to 26775	26705, 26740, 26775	3 MHz	QPSK, 16QAM	15 RB / 0 RB Offset
		26715 to 26765	26715, 26740, 26765	5 MHz	QPSK, 16QAM	25 RB / 0 RB Offset
		26740	26740	10 MHz	QPSK, 16QAM	50 RB / 0 RB Offset
-	Conducted Emission	26697 to 26783	26697, 26740, 26783	1.4 MHz	QPSK	1 RB / 0 RB Offset
		26705 to 26775	26705, 26740, 26775	3 MHz	QPSK	1 RB / 0 RB Offset
		26715 to 26765	26715, 26740, 26765	5 MHz	QPSK	1 RB / 0 RB Offset
		26740	26740	10 MHz	QPSK	1 RB / 0 RB Offset
-	Radiated Emission	26697 to 26783	26697, 26740, 26783	1.4 MHz	QPSK	1 RB / 0 RB Offset
		26715 to 26765	26715, 26740, 26765	5 MHz	QPSK	1 RB / 0 RB Offset
		26740	26740	10 MHz	QPSK	1 RB / 0 RB Offset

Note: This device was tested under all bandwidths, RB configurations and modulations. The worst case was found in QPSK modulation.

Test Condition:

Test Item	Environmental Conditions	Input Power	Tested By
ERP	25 deg. C, 65 % RH	3.3 Vdc	Getaz Yang
Modulation Characteristics	25 deg. C, 65 % RH	3.3 Vdc	Getaz Yang
Frequency Stability	25 deg. C, 65 % RH	3.3 Vdc	Getaz Yang
Occupied Bandwidth	25 deg. C, 65 % RH	3.3 Vdc	Getaz Yang
Peak to Average Ratio	25 deg. C, 65 % RH	3.3 Vdc	Getaz Yang
Emission Mask	25 deg. C, 65 % RH	3.3 Vdc	Getaz Yang
Conducted Emission	25 deg. C, 65 % RH	3.3 Vdc	Getaz Yang
Radiated Emission	25 deg. C, 65 % RH	120 Vac, 60 Hz	Thomas Wei Jisyong Wang

3.4 EUT Operating Conditions

The EUT makes a call to the communication simulator. The communication simulator station system controlled a EUT to export maximum output power under transmission mode and specific channel frequency

3.5 General Description of Applied Standards

The EUT is a RF Product. According to the specifications of the manufacturer, it must comply with the requirements of the following standards:

FCC 47 CFR Part 2

FCC 47 CFR Part 90

KDB 971168 D01 Power Meas License Digital Systems v03r01

ANSI/TIA/EIA-603-E 2016

ANSI 63.26-2015

Note: All test items have been performed and recorded as per the above standards.

4 Test Types and Results

4.1 Output Power Measurement

4.1.1 Limits of Output Power Measurement

Mobile / Portable station are limited to 100 watts e.r.p.

4.1.2 Test Procedures

Conducted Power Measurement:

- a. The EUT was set up for the maximum power with LTE link data modulation and link up with simulator.
- b. Set the EUT to transmit under low, middle and high channel and record the power level shown on simulator.

EIRP / ERP Measurement:

- a. $EIRP = \text{Conducted Output power level} + \text{Antenna gain}$.
- b. ERP power can be calculated from EIRP power by subtracting the gain of dipole, $ERP \text{ power} = EIRP \text{ power} - 2.15dBi$.
- c. $ERP = \text{Conducted Output power level} + \text{Antenna gain (dBi)} - \text{Isotropically Factor (2.15dB)}$

4.1.3 Test Setup



4.1.4 Test Results

Conducted Output Power (dBm)

Band / BW	RB Size	RB Offset	QPSK			3GPP MPR (dB)	16QAM			3GPP MPR (dB)
			Low Ch 26697	Mid Ch 26740	High Ch 26783		Low Ch 26697	Mid Ch 26740	High Ch 26783	
			814.7 MHz	819.0 MHz	823.3 MHz		814.7 MHz	819.0 MHz	823.3 MHz	
26 / 1.4M	1	0	22.53	22.21	22.01	0	21.48	21.14	20.99	1
	1	2	22.46	22.10	21.88	0	21.44	21.04	20.85	1
	1	5	22.23	21.92	21.66	0	21.20	20.88	20.55	1
	3	0	21.48	22.17	21.98	0	20.36	21.14	20.94	1
	3	1	21.28	21.97	21.87	0	20.19	20.99	20.70	1
	3	3	21.29	21.94	21.62	0	20.05	20.80	20.53	1
	6	0	21.47	21.17	20.93	1	20.30	19.93	19.75	2

Band / BW	RB Size	RB Offset	QPSK			3GPP MPR (dB)	16QAM			3GPP MPR (dB)
			Low Ch 26705	Mid Ch 26740	High Ch 26775		Low Ch 26705	Mid Ch 26740	High Ch 26775	
			815.5 MHz	819.0 MHz	822.5 MHz		815.5 MHz	819.0 MHz	822.5 MHz	
26 / 3M	1	0	22.61	22.30	22.13	0	21.36	21.28	21.04	1
	1	7	22.52	22.18	21.98	0	21.44	21.06	20.99	1
	1	14	22.35	22.02	21.82	0	21.22	21.00	20.79	1
	8	0	21.59	21.24	21.04	1	20.31	20.15	19.96	2
	8	3	21.41	21.04	20.84	1	20.25	20.00	19.79	2
	8	7	21.27	21.01	20.79	1	20.11	19.91	19.66	2
	15	0	21.43	21.14	20.91	1	20.29	20.09	19.98	2

Band / BW	RB Size	RB Offset	QPSK			3GPP MPR (dB)	16QAM			3GPP MPR (dB)
			Low Ch 26715	Mid Ch 26740	High Ch 26765		Low Ch 26715	Mid Ch 26740	High Ch 26765	
			816.5 MHz	819.0 MHz	821.5 MHz		816.5 MHz	819.0 MHz	821.5 MHz	
26 / 5M	1	0	22.71	22.43	22.25	0	21.43	21.34	21.21	1
	1	12	22.53	22.29	22.15	0	21.51	21.30	21.06	1
	1	24	22.41	22.16	21.97	0	21.36	21.07	20.88	1
	12	0	21.56	21.42	21.22	1	20.48	20.31	20.05	2
	12	6	21.42	21.30	21.13	1	20.32	20.27	20.03	2
	12	13	21.31	21.08	20.85	1	20.22	20.09	19.92	2
	25	0	21.50	21.34	21.21	1	20.38	20.34	20.15	2

Band / BW	RB Size	RB Offset	QPSK	3GPP MPR (dB)	16QAM	3GPP MPR (dB)
			Mid Ch 26740		Mid Ch 26740	
			819.0 MHz		819.0 MHz	
26 / 10M	1	0	22.76	0	21.51	1
	1	24	22.62	0	21.59	1
	1	49	22.42	0	21.42	1
	25	0	21.65	1	20.33	2
	25	12	21.40	1	20.29	2
	25	25	21.37	1	20.26	2
	50	0	21.51	1	20.49	2

ERP Power (dBm)

Note: ERP (dBm) = Max. Conducted Power (dBm) + Gain (dBi) – 2.15

Band 26 / 1.4M, 1RB#0						
Test Mode	QPSK			16QAM		
	Low Ch 26697	Mid Ch 26740	High Ch 26783	Low Ch 26697	Mid Ch 26740	High Ch 26783
	814.7 MHz	819.0 MHz	823.3 MHz	814.7 MHz	819.0 MHz	823.3 MHz
Max. Cond. Power (dBm)	22.53	22.21	22.01	21.48	21.14	20.99
Max. ERP Power (dBm)	23.38	23.06	22.86	22.33	21.99	21.84
Max. ERP Power (mW)	217.77	202.30	193.20	171.00	158.12	152.76

Band 26 / 3M, 1RB#0						
Test Mode	QPSK			16QAM		
	Low Ch 26705	Mid CH 26740	High CH 26775	Low Ch 26705	Mid CH 26740	High CH 26775
	815.5 MHz	819.0 MHz	822.5 MHz	815.5 MHz	819.0 MHz	822.5 MHz
Max. Cond. Power (dBm)	22.61	22.30	22.13	21.36	21.28	21.04
Max. ERP Power (dBm)	23.46	23.15	22.98	22.21	22.13	21.89
Max. ERP Power (mW)	221.82	206.54	198.61	166.34	163.31	154.53

Band 26 / 5M, 1RB#0						
Test Mode	QPSK			16QAM		
	Low Ch 26715	Mid Ch 26740	High Ch 26765	Low Ch 26715	Mid Ch 26740	High Ch 26765
	816.5 MHz	819.0 MHz	821.5 MHz	816.5 MHz	819.0 MHz	821.5 MHz
Max. Cond. Power (dBm)	22.71	22.43	22.25	21.43	21.34	21.21
Max. ERP Power (dBm)	23.56	23.28	23.10	22.28	22.19	22.06
Max. ERP Power (mW)	226.99	212.81	204.17	169.04	165.58	160.69

Band 26 / 10M, 1RB#0						
Test Mode	QPSK			16QAM		
		Mid Ch 26740			Mid Ch 26740	
		819.0 MHz			819.0 MHz	
Max. Cond. Power (dBm)		22.76			21.51	
Max. ERP Power (dBm)		23.61			22.36	
Max. ERP Power (mW)		229.61			172.19	

4.2 Modulation Characteristics Measurement

4.2.1 Limits of Modulation Characteristics

N/A

4.2.2 Test Setup

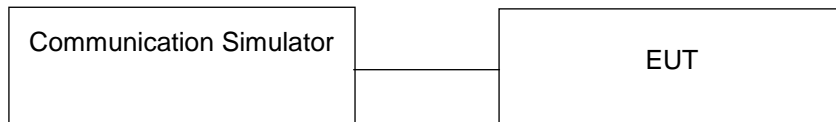

4.2.3 Test Procedure

Connect the EUT to Communication Simulator via the antenna connector. The frequency band is set as EUT supported Modulation and Channels, the EUT output is matched with 50 ohm load, the waveform quality and constellation of the EUT was tested.

4.2.4 Test Results

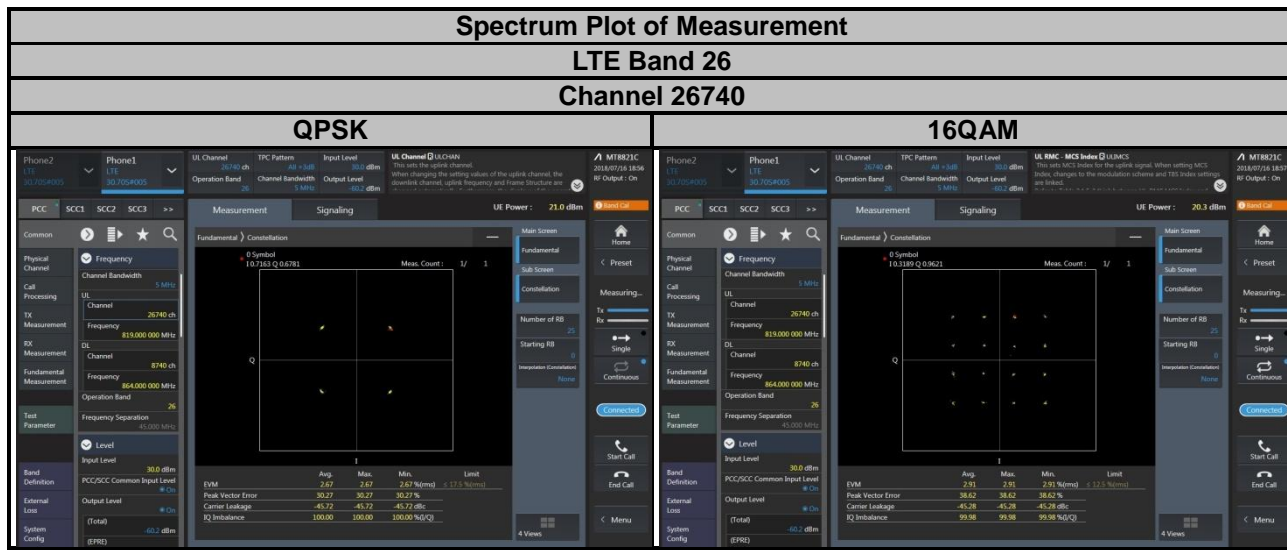

4.3 Frequency Stability Measurement

4.3.1 Limits of Frequency Stability Measurement

1.5 ppm is for base and fixed station. 2.5 ppm is for mobile station.

4.3.2 Test Procedure

- a. Device is placed at the oven room. The oven room could control the temperatures and humidity. Power warm up is at least 15 min and power applied should perform before recording frequency error.
- b. EUT is connected the external power supply to control the DC input power. The test voltage range is from minimum to maximum working voltage. Each step shall be record the frequency error rate.
- c. The temperature range step is 10 degrees in this test items. All temperature levels shall be hold the ± 0.5 °C during the measurement testing. The each temperature step shall be at least 0.5 hours, consider the EUT could be test under the stability condition.

NOTE: The frequency error was recorded frequency error from the communication simulator.

4.3.3 Test Setup

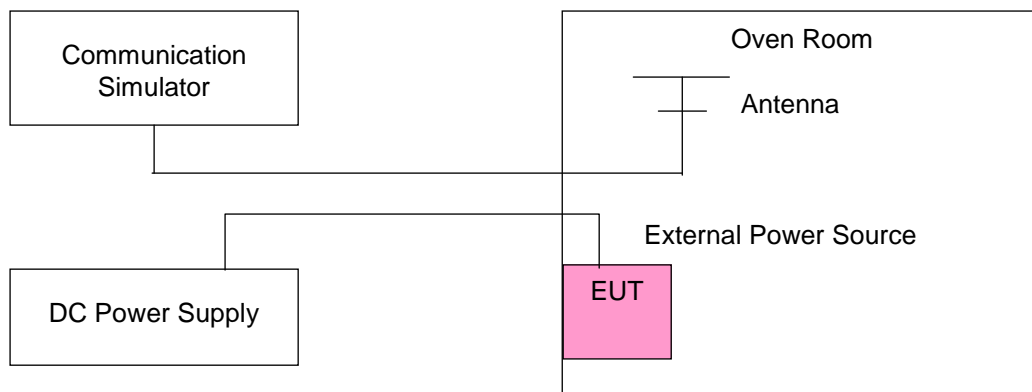

4.3.4 Test Results

Frequency Error vs. Voltage

Voltage (Volts)	LTE Band 26				Limit (ppm)
	Channel Bandwidth: 1.4 MHz				
	Low Channel		High Channel		
	Frequency (MHz)	Frequency Error (ppm)	Frequency (MHz)	Frequency Error (ppm)	
3.3	814.700001	0.001	823.300001	0.001	2.5
3.135	814.700003	0.004	823.300004	0.004	2.5
4.4	814.700003	0.004	823.300002	0.002	2.5

Note: The applicant defined the normal working voltage of the battery is from 3.135 Vdc to 4.4 Vdc.

Frequency Error vs. Temperature

Temp. (°C)	LTE Band 26				Limit (ppm)
	Channel Bandwidth: 1.4 MHz				
	Low Channel		High Channel		
	Frequency (MHz)	Frequency Error (ppm)	Frequency (MHz)	Frequency Error (ppm)	
-30	814.700003	0.004	823.300003	0.004	2.5
-20	814.700003	0.004	823.300004	0.005	2.5
-10	814.700003	0.003	823.300004	0.004	2.5
0	814.700002	0.002	823.300003	0.004	2.5
10	814.700003	0.003	823.300004	0.005	2.5
20	814.699997	-0.004	823.299999	-0.002	2.5
30	814.699997	-0.003	823.299998	-0.002	2.5
40	814.699999	-0.001	823.299999	-0.001	2.5
50	814.699999	-0.002	823.299997	-0.004	2.5
55	814.699999	-0.001	823.299999	-0.002	2.5

Frequency Error vs. Voltage

Voltage (Volts)	LTE Band 26				Limit (ppm)
	Channel Bandwidth: 3 MHz				
	Low Channel		High Channel		
	Frequency (MHz)	Frequency Error (ppm)	Frequency (MHz)	Frequency Error (ppm)	
3.3	815.500001	0.001	822.500002	0.002	2.5
3.135	815.500002	0.002	822.500002	0.002	2.5
4.4	815.500004	0.004	822.500003	0.004	2.5

Note: The applicant defined the normal working voltage of the battery is from 3.135 Vdc to 4.4 Vdc.

Frequency Error vs. Temperature

Temp. (°C)	LTE Band 26				Limit (ppm)
	Channel Bandwidth: 3 MHz				
	Low Channel		High Channel		
	Frequency (MHz)	Frequency Error (ppm)	Frequency (MHz)	Frequency Error (ppm)	
-30	815.500002	0.002	822.500002	0.003	2.5
-20	815.500002	0.002	822.500003	0.003	2.5
-10	815.500002	0.003	822.500002	0.002	2.5
0	815.500003	0.003	822.500001	0.002	2.5
10	815.500002	0.002	822.500001	0.001	2.5
20	815.499997	-0.003	822.499998	-0.003	2.5
30	815.499997	-0.003	822.499998	-0.002	2.5
40	815.499998	-0.003	822.499996	-0.005	2.5
50	815.499999	-0.002	822.499997	-0.004	2.5
55	815.499997	-0.004	822.499997	-0.003	2.5

Frequency Error vs. Voltage

Voltage (Volts)	LTE Band 26				Limit (ppm)
	Channel Bandwidth: 5 MHz				
	Low Channel		High Channel		
	Frequency (MHz)	Frequency Error (ppm)	Frequency (MHz)	Frequency Error (ppm)	
3.3	816.500004	0.005	821.500001	0.001	2.5
3.135	816.500002	0.003	821.500002	0.002	2.5
4.4	816.500003	0.004	821.500002	0.002	2.5

Note: The applicant defined the normal working voltage of the battery is from 3.135 Vdc to 4.4 Vdc.

Frequency Error vs. Temperature

Temp. (°C)	LTE Band 26				Limit (ppm)
	Channel Bandwidth: 5 MHz				
	Low Channel		High Channel		
	Frequency (MHz)	Frequency Error (ppm)	Frequency (MHz)	Frequency Error (ppm)	
-30	816.500002	0.003	821.500003	0.004	2.5
-20	816.500001	0.001	821.500004	0.004	2.5
-10	816.500001	0.001	821.500003	0.003	2.5
0	816.500003	0.004	821.500001	0.002	2.5
10	816.500004	0.005	821.500003	0.004	2.5
20	816.499996	-0.005	821.499996	-0.005	2.5
30	816.499999	-0.001	821.499999	-0.002	2.5
40	816.499998	-0.002	821.499997	-0.003	2.5
50	816.499999	-0.001	821.499998	-0.002	2.5
55	816.499998	-0.002	821.499996	-0.005	2.5

Frequency Error vs. Voltage

Voltage (Volts)	LTE Band 26		Limit (ppm)
	Channel Bandwidth: 10 MHz		
	Frequency (MHz)	Frequency Error (ppm)	
3.3	819.000003	0.004	2.5
3.135	819.000002	0.002	2.5
4.4	819.000002	0.002	2.5

Note: The applicant defined the normal working voltage of the battery is from 3.135 Vdc to 4.4 Vdc.

Frequency Error vs. Temperature

Temp. (°C)	LTE Band 26		Limit (ppm)
	Channel Bandwidth: 10 MHz		
	Frequency (MHz)	Frequency Error (ppm)	
-30	819.000004	0.005	2.5
-20	819.000004	0.005	2.5
-10	819.000003	0.003	2.5
0	819.000002	0.003	2.5
10	819.000002	0.002	2.5
20	818.999997	-0.004	2.5
30	818.999999	-0.002	2.5
40	818.999997	-0.004	2.5
50	818.999997	-0.003	2.5
55	818.999998	-0.002	2.5

4.4 Occupied Bandwidth Measurement

4.4.1 Limits of Occupied Bandwidth Measurement

The width of a frequency band such that, below the lower and above the upper frequency limits, the mean powers emitted are each equal to a specified percentage 0.5 %of the total mean power of a given emission.

4.4.2 Test Procedure

The EUT makes a call to the communication simulator. All measurements were done at low, middle and high operational frequency range. The communication simulator station system controlled a EUT to export maximum output power under transmission mode and specific channel frequency. Use OBW measurement function of Spectrum analyzer to measure 99 % occupied bandwidth.

4.4.3 Test Setup

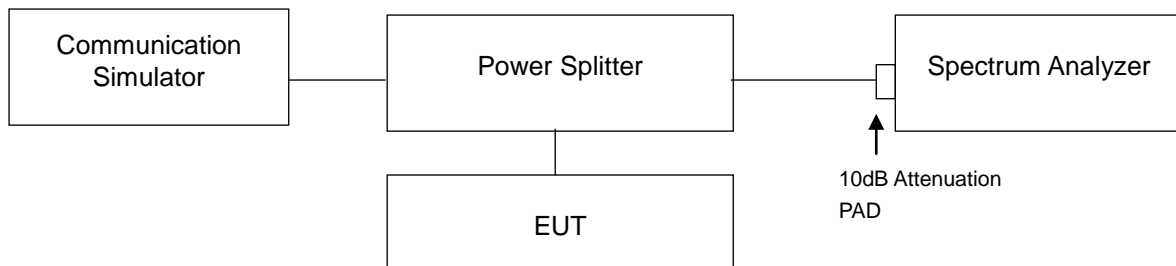

4.4.4 Test Results

LTE Band 26							
Channel Bandwidth: 1.4 MHz				Channel Bandwidth: 3 MHz			
Channel	Frequency (MHz)	99 % Occupied Bandwidth (MHz)		Channel	Frequency (MHz)	99 % Occupied Bandwidth (MHz)	
		QPSK	16QAM			QPSK	16QAM
26697	814.7	1.09	1.09	26705	815.5	2.70	2.70
26740	819.0	1.09	1.09	26740	819.0	2.70	2.70
26783	823.3	1.09	1.09	26775	822.5	2.70	2.70

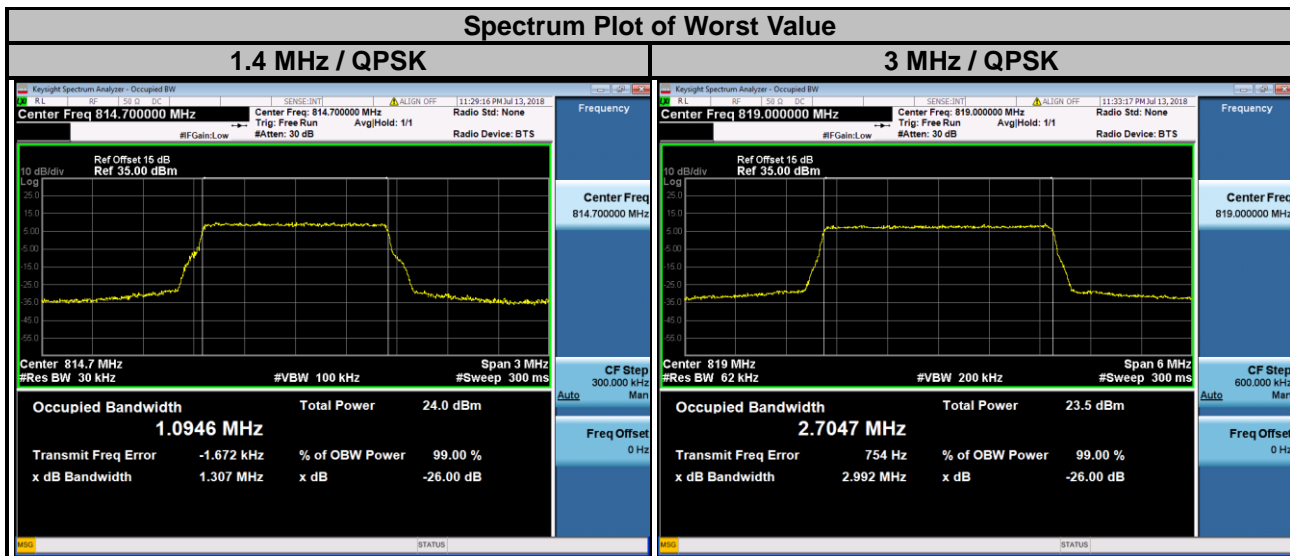

LTE Band 26							
Channel Bandwidth: 5 MHz				Channel Bandwidth: 10 MHz			
Channel	Frequency (MHz)	99 % Occupied Bandwidth (MHz)		Channel	Frequency (MHz)	99 % Occupied Bandwidth (MHz)	
		QPSK	16QAM			QPSK	16QAM
26715	816.5	4.49	4.50	26740	819.0	9.02	9.01
26740	819.0	4.50	4.50				
26765	821.5	4.50	4.50				

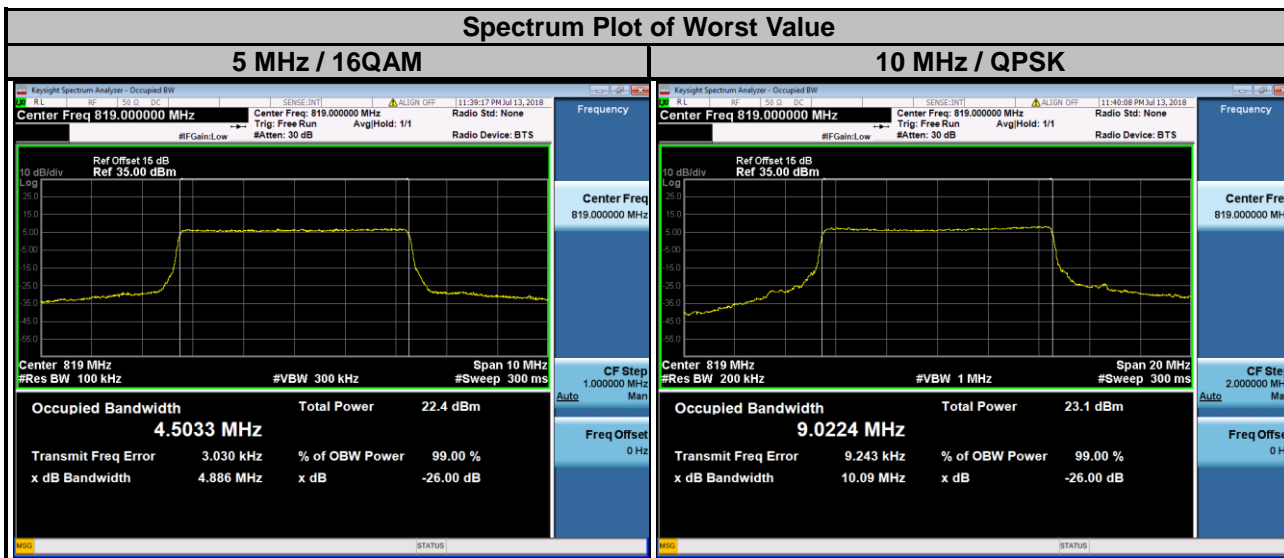

4.5 Emission Mask Measurement

4.5.1 Limits of Band Edge Measurement

According to FCC part 90.691 shall be tested the emission mask. For any frequency removed from the EA licensee's frequency block by up to and including 37.5 kHz, the power of any emission shall be attenuated below the transmitter power (P) in watts by at least $116 \text{ Log}_{10}(f/6.1)$ decibels or $50+10\text{Log}_{10}(P)$ decibels or 80 decibels, whichever is the lesser attenuation, where f is the frequency removed from the center of the outer channel in the block in kilohertz and where f is greater than 12.5 kHz.

4.5.2 Test Setup

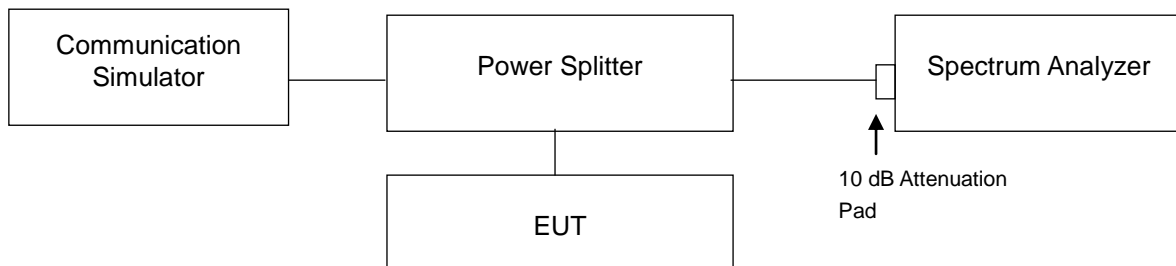

4.5.3 Test Procedures

- The measurement used the power splitter via EUT RF power connector between simulation base station and spectrum analyzer.
- Record the test plot.

4.5.4 Test Results

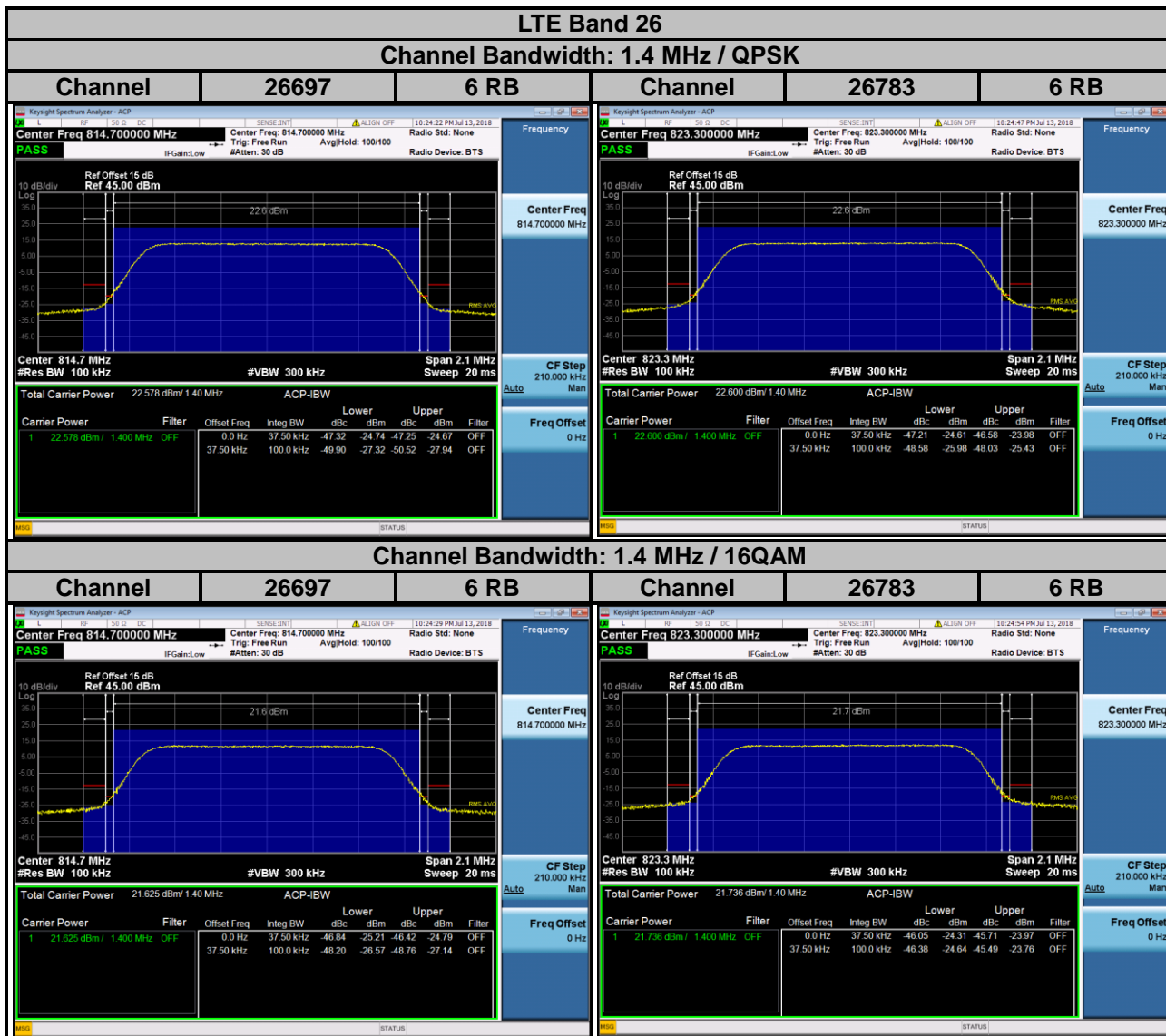

LTE Band 26
Channel Bandwidth: 3 MHz / QPSK



Channel Bandwidth: 3 MHz / 16QAM

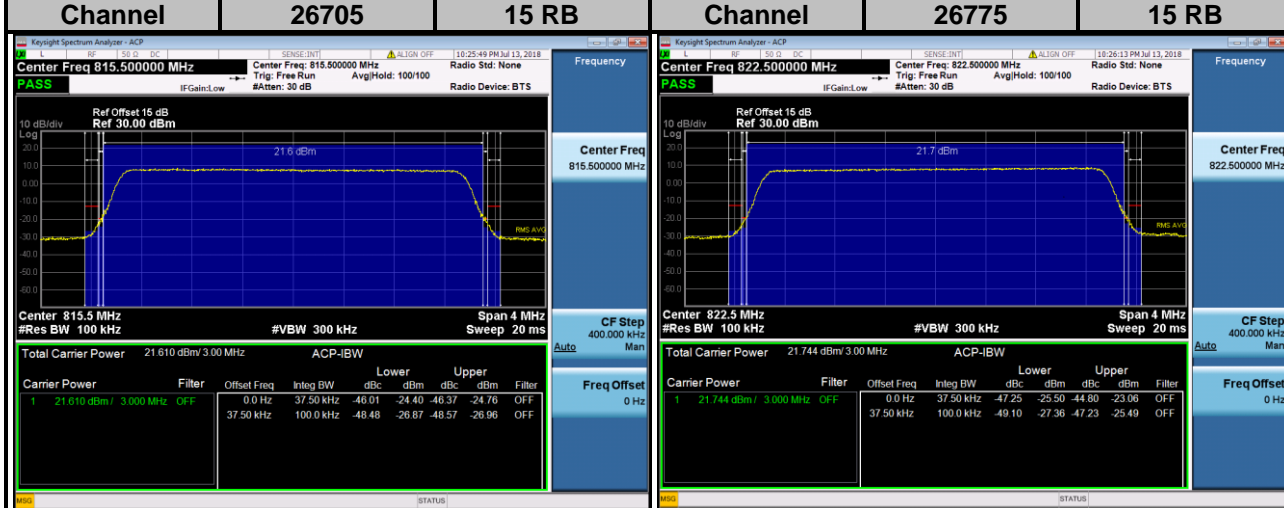

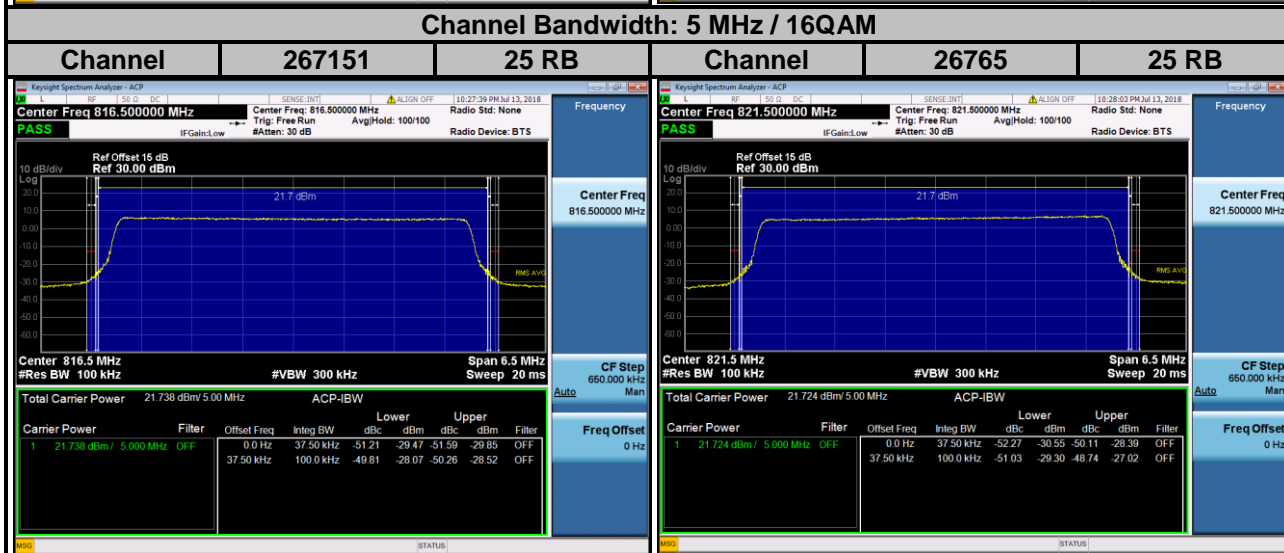
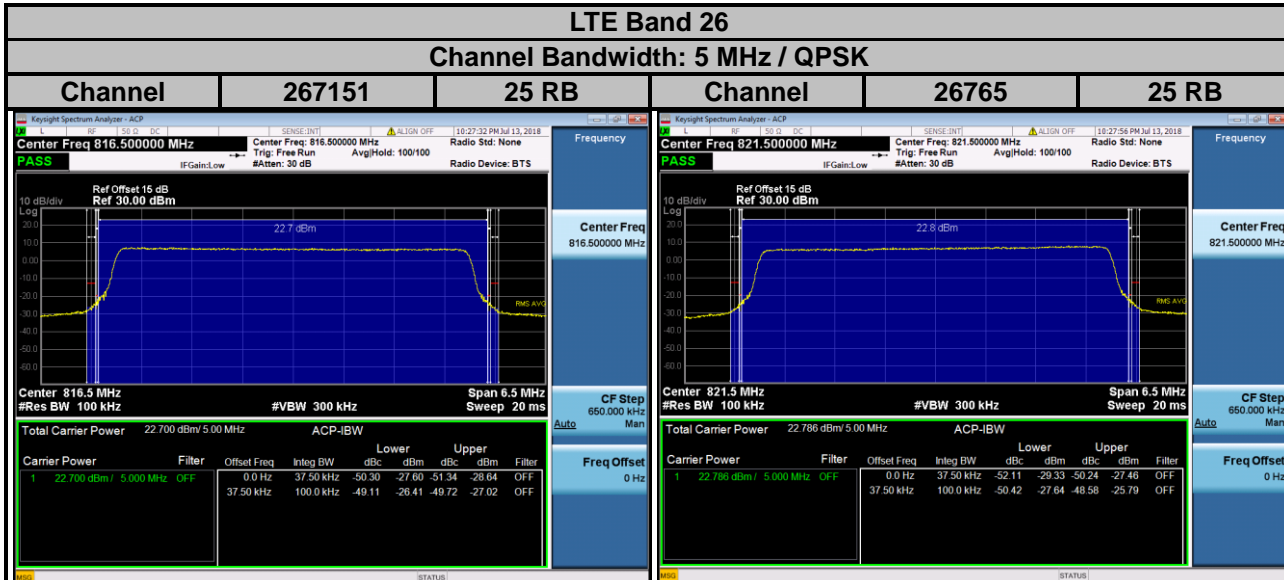

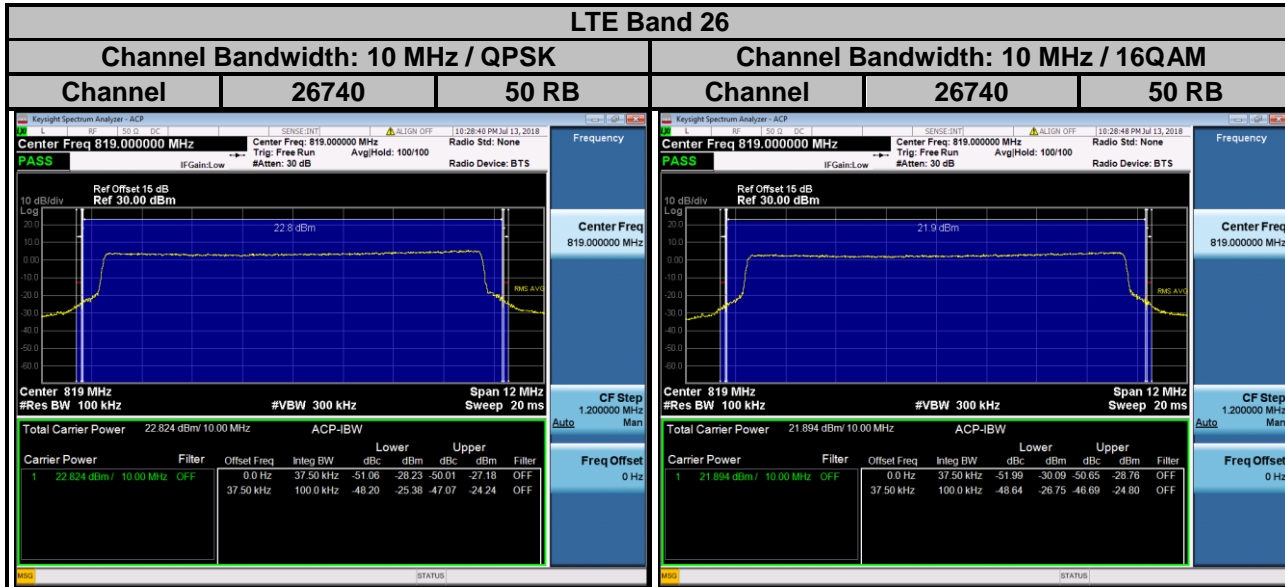

4.6 Conducted Spurious Emissions

4.6.1 Limits of Conducted Spurious Emissions Measurement

The power of any emission outside a licensee's frequency block shall be attenuated below the transmitter power (P) by at least $43 + 10 \log_{10}(P)$ dB. The limit of emission is equal to -13 dBm.

On all frequencies between 769 – 775 MHz and 799 – 805 MHz, by a factor not less than $65 + 10 \log(P)$ dB in a 6.25 kHz band segment, for mobile and portable stations.

4.6.2 Test Setup

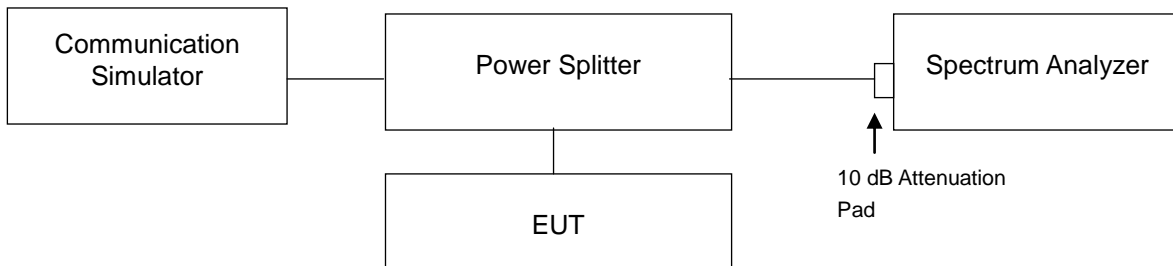

4.6.3 Test Procedure

- The EUT makes a phone call to the communication simulator. All measurements were done at low, middle and high operational frequency range.
- Measuring frequency range is from 9 kHz to 10 GHz. 10 dB attenuation pad is connected with spectrum. RBW = 100 kHz and VBW = 300 kHz for 9 kHz to 1 GHz and RBW = 1 MHz and VBW = 3 MHz for 1 GHz to 10 GHz is used for conducted emission measurement.

4.6.4 Test Results

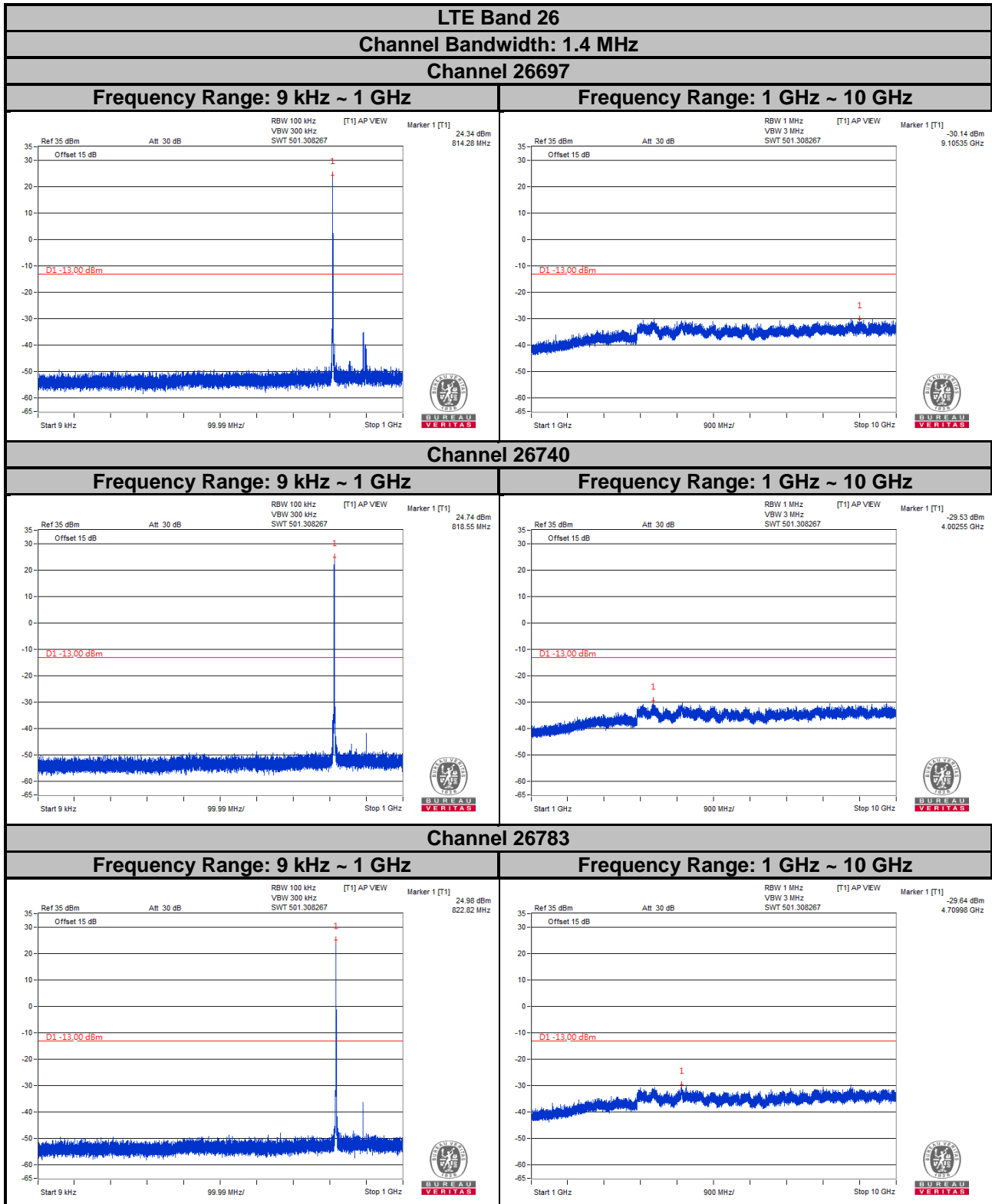

LTE Band 26
Channel Bandwidth: 3 MHz
Channel 26705

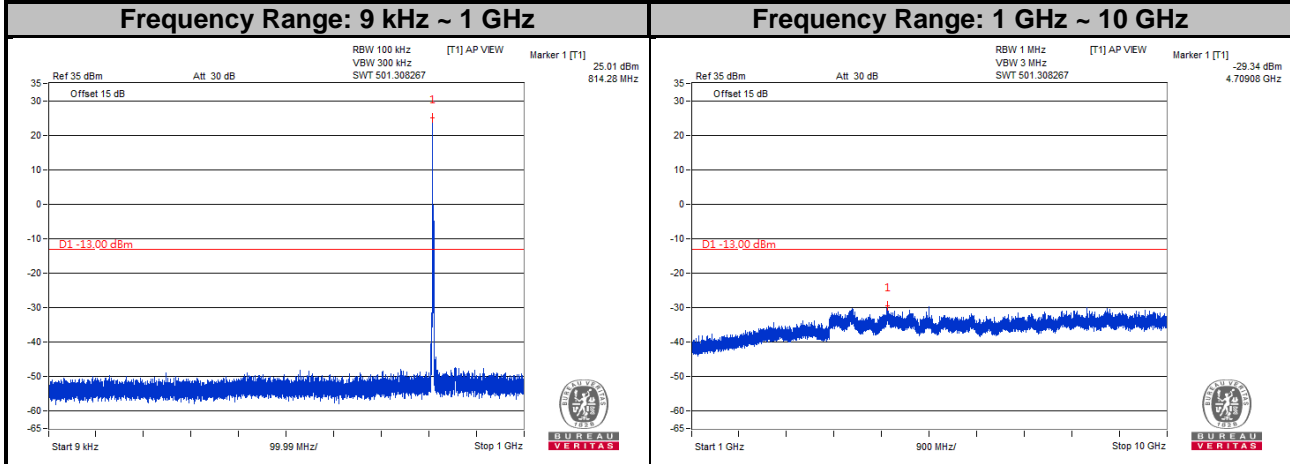

Channel 26740

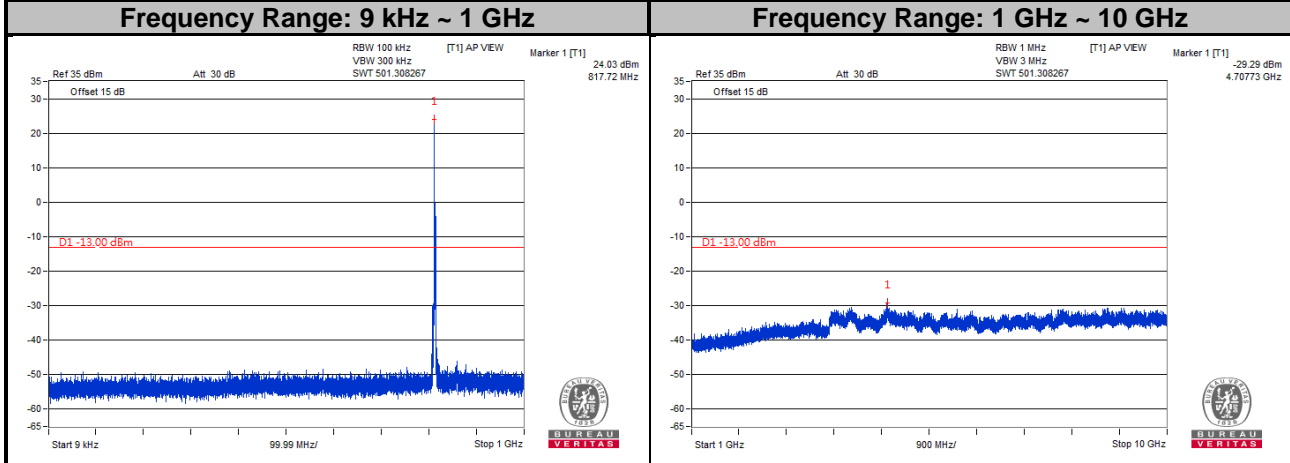

Channel 26775

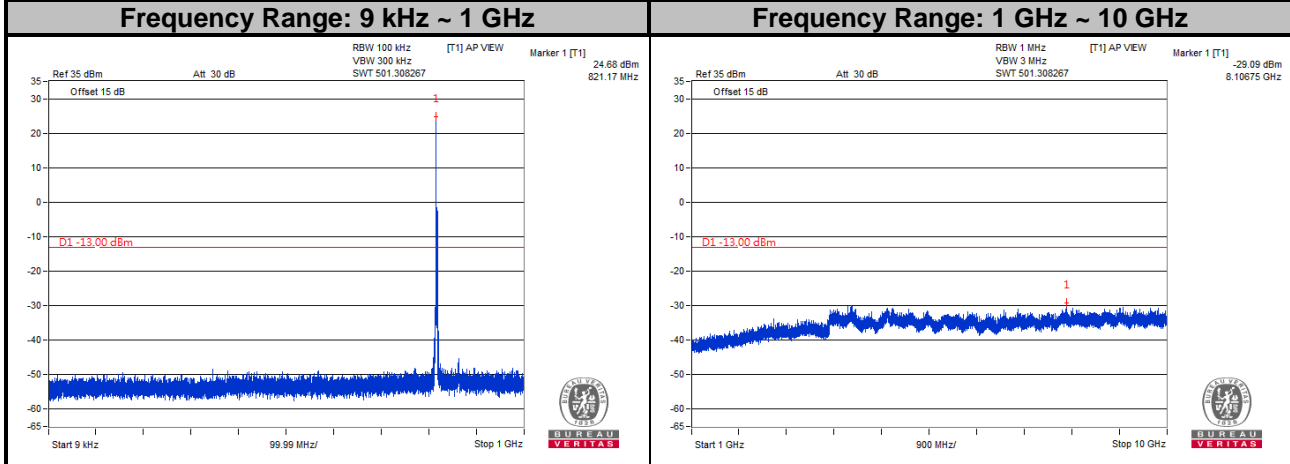

LTE Band 26
Channel Bandwidth: 5 MHz
Channel 26715

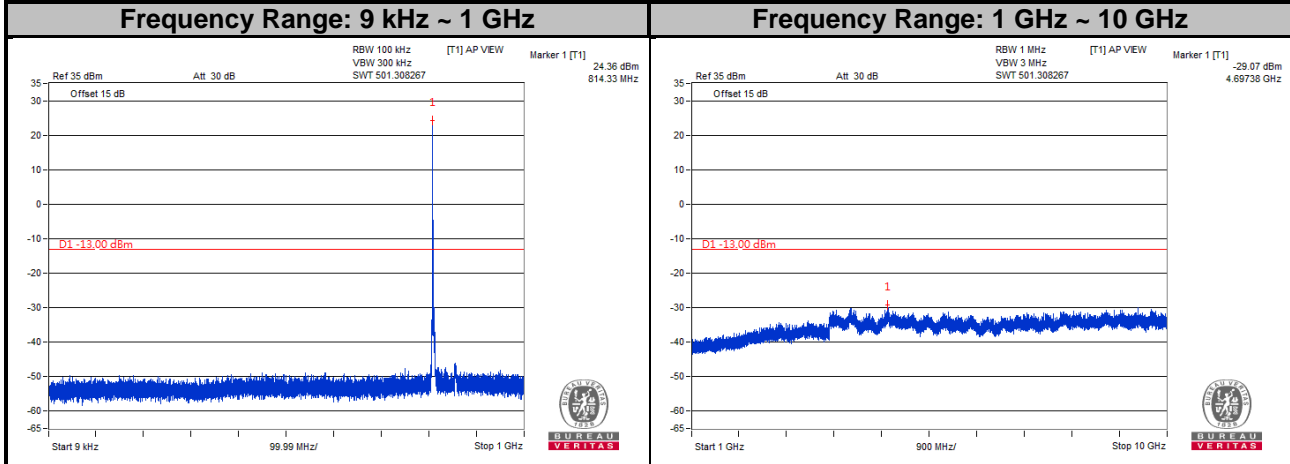

Channel 26740

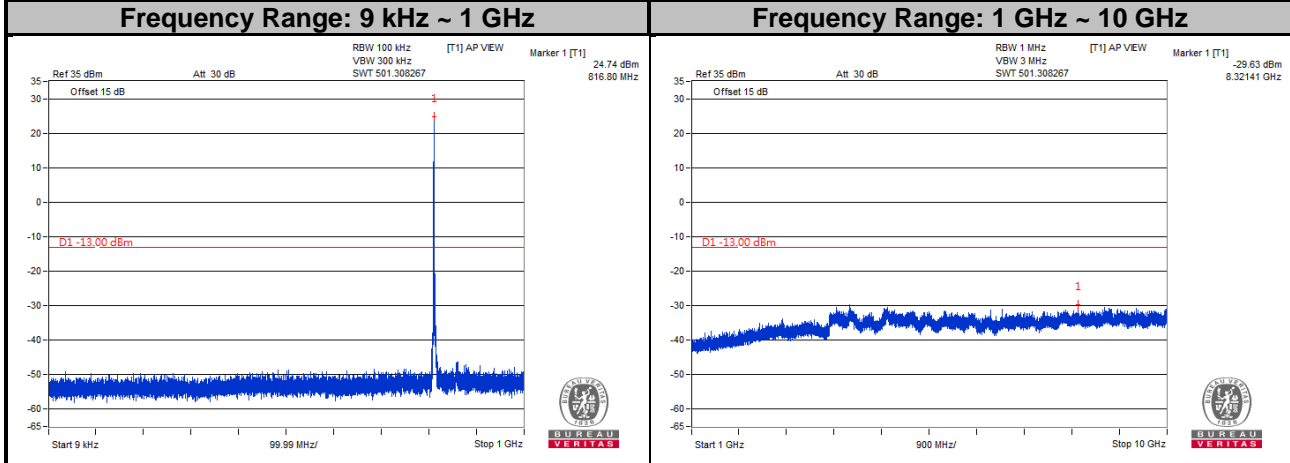

Channel 26765

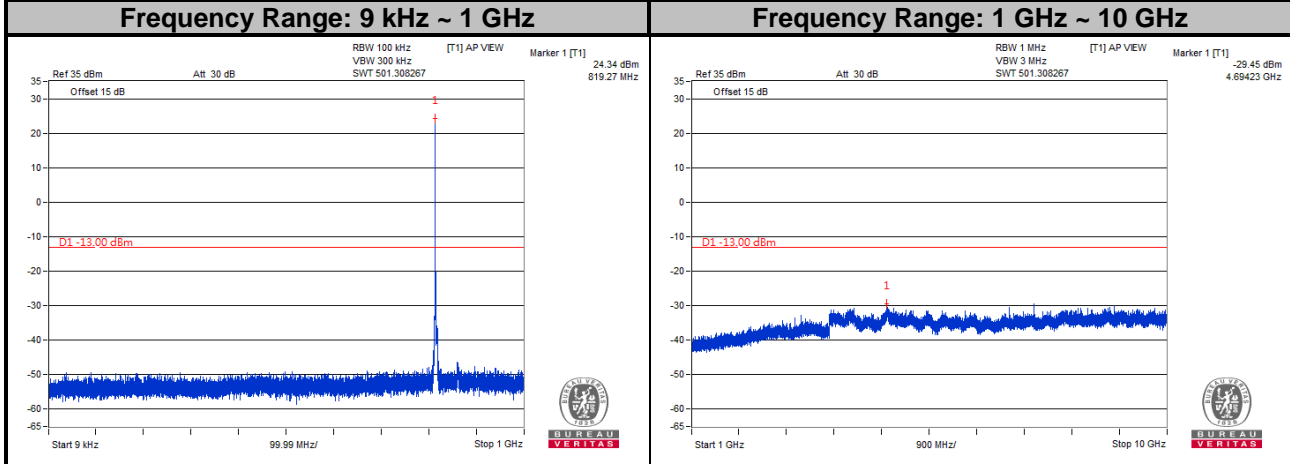

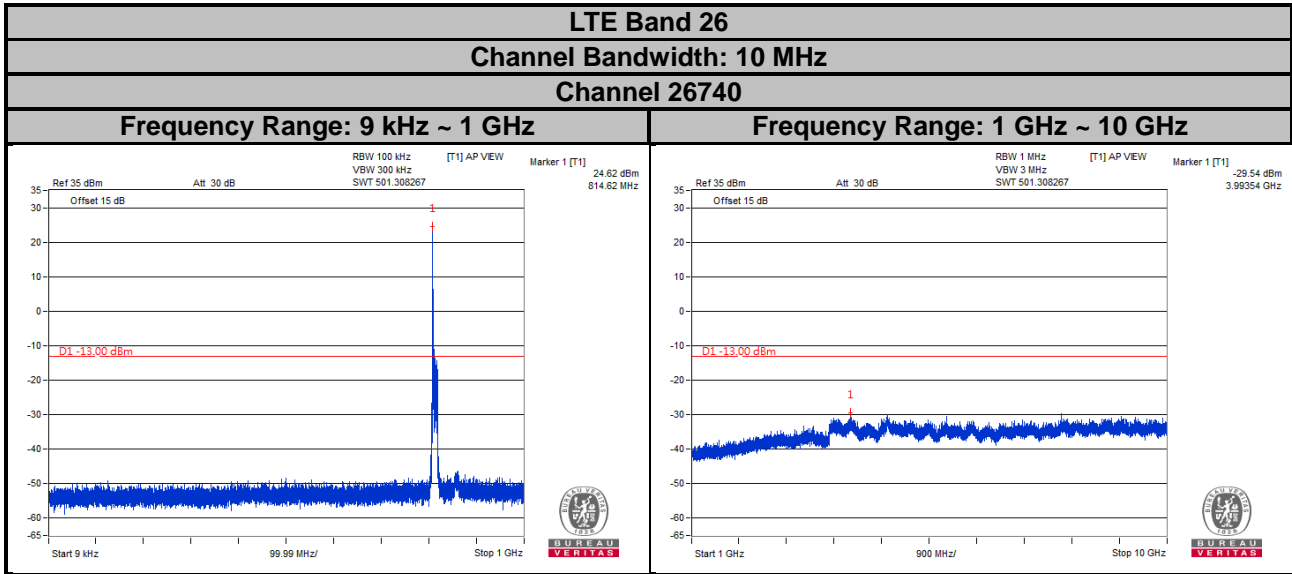

4.7 Radiated Emission Measurement

4.7.1 Limits of Radiated Emission Measurement

- (1) The power of any emission outside a licensee's frequency block shall be attenuated below the transmitter power (P) by at least $43 + 10 \log_{10}(P)$ dB. The limit of emission is equal to -13 dBm.
- (2) For operations in the 758-775 MHz and 788-805 MHz bands, all emissions including harmonics in the band 1559-1610 MHz shall be limited to -70 dBW/MHz equivalent isotropically radiated power (EIRP) for wideband signals, and -80 dBW EIRP for discrete emissions of less than 700 Hz bandwidth.

4.7.2 Test Procedure

- a. Substitution method is used for E.I.R.P measurement. In the semi-anechoic chamber, EUT placed on the 0.8 m (below or equal 1 GHz) and/or 1.5 m (above 1 GHz) height of Turn Table, rotated the table around 360 degrees to search the maximum radiation power and receiver antenna shall be rotated vertical and horizontal polarization and moved height from 1 m to 4 m to find the maximum polar radiated power. The "Read Value" is the spectrum reading the maximum power value.
- b. The substitution horn antenna is substituted for EUT at the same position and signals generator export the CW signal to the substitution antenna via a TX cable. Rotated the Turn Table and moved receiving antenna to find the maximum radiation power. Adjust output power level of S.G to get a Value of spectrum reading equal to "Read Value" of step a. Record the power level of S.G.
- c. $EIRP = \text{Output power level of S.G} - \text{TX cable loss} + \text{Antenna gain of substitution horn}$.
- d. E.R.P power can be calculated form E.I.R.P power by subtracting the gain of dipole, $E.R.P \text{ power} = E.I.P.R \text{ power} - 2.15 \text{ dB}$.

Note: The resolution bandwidth of spectrum analyzer is 1 MHz and the video bandwidth is 3 MHz.

4.7.3 Deviation from Test Standard

No deviation.

4.7.4 Test Setup

<Radiated Emission below or equal 1 GHz>

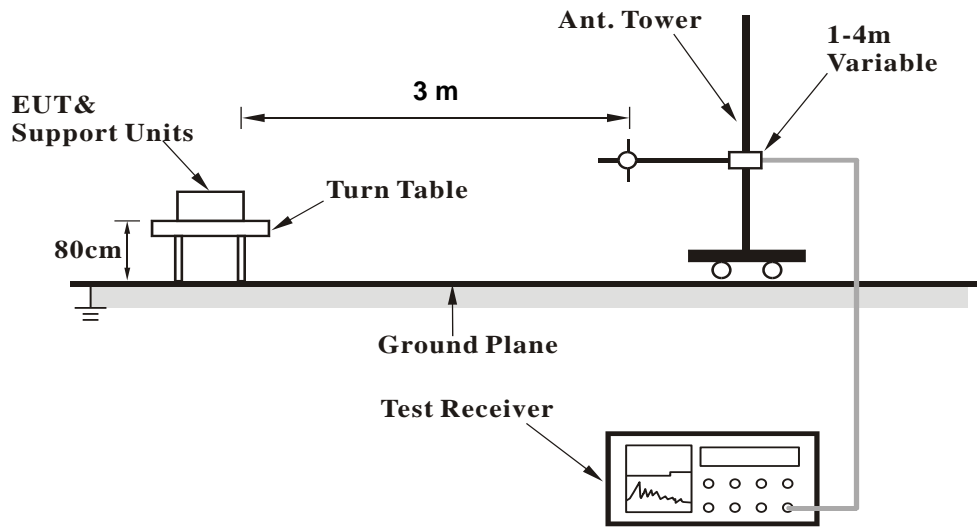

<Radiated Emission above 1 GHz>

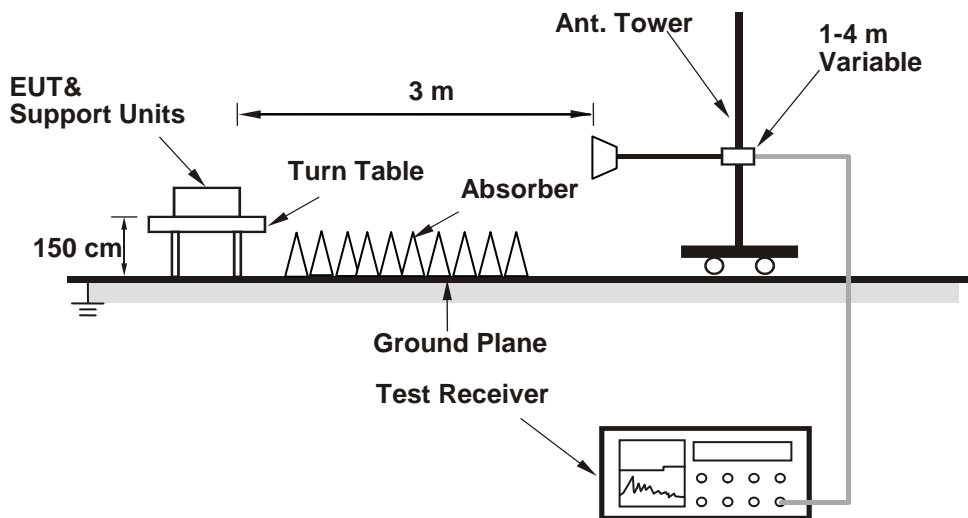

For the actual test configuration, please refer to the attached file (Test Setup Photo).

4.7.5 Test Results

LTE Band 26
 Channel Bandwidth: 5 MHz / QPSK
 Low Channel



Bureau Veritas Consumer Products Services Ltd., Taoyuan Branch

A D T

Data: 3

Date: 2018-07-13

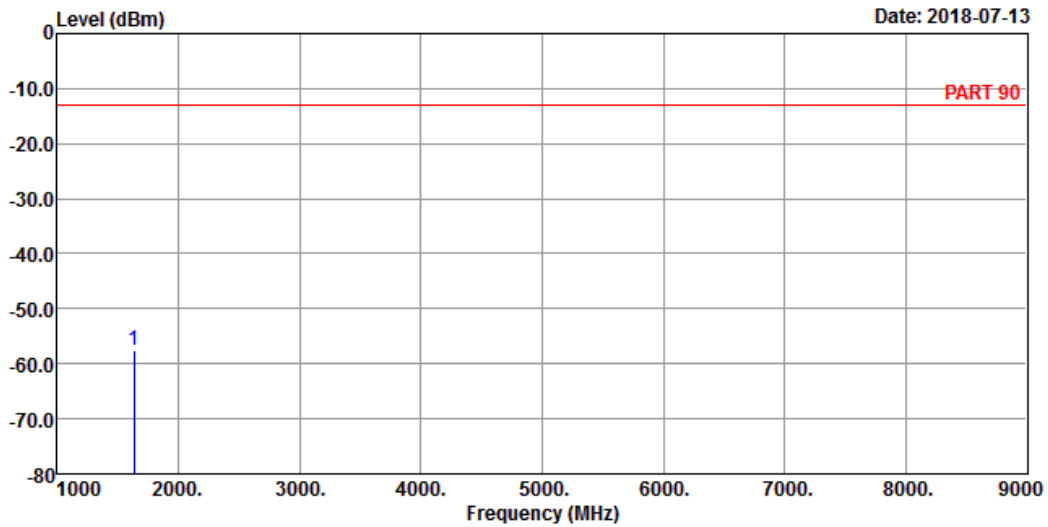

Site : 966 Chamber 5
 Condition: PART 90 HORIZONTAL
 Remak : LTE Band 26 QPSK_5M Link_L-CH
 Tested by: Thomas Wei

Freq	Level	Read Level	Limit Line	Over Limit	Factor	Remark
MHz	dBm	dBm	dBm	dB	dB	

1 pp 1633.00 -57.63 -42.84 -13.00 -44.63 -14.79 Peak



A D T

Data: 4

Date: 2018-07-13

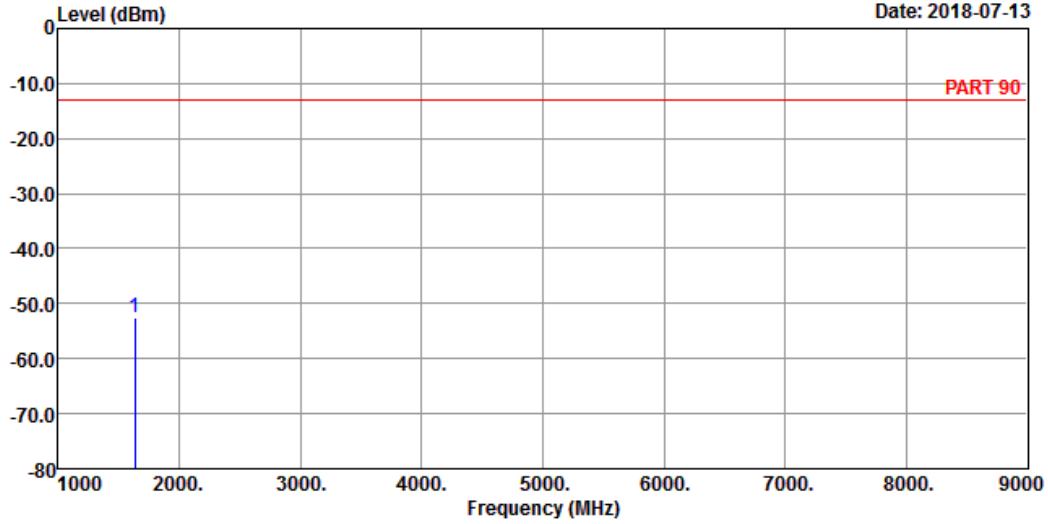

Site : 966 Chamber 5
 Condition: PART 90 VERTICAL
 Remak : LTE Band 26 QPSK_5M Link_L-CH
 Tested by: Thomas Wei

Freq	Level	Read Level	Limit Line	Over Limit	Factor	Remark
MHz	dBm	dBm	dBm	dB	dB	
1 pp 1633.00	-52.65	-37.86	-13.00	-39.65	-14.79	Peak

Middle Channel



Bureau Veritas Consumer Products Services Ltd., Taoyuan Branch

A D T

Data: 3

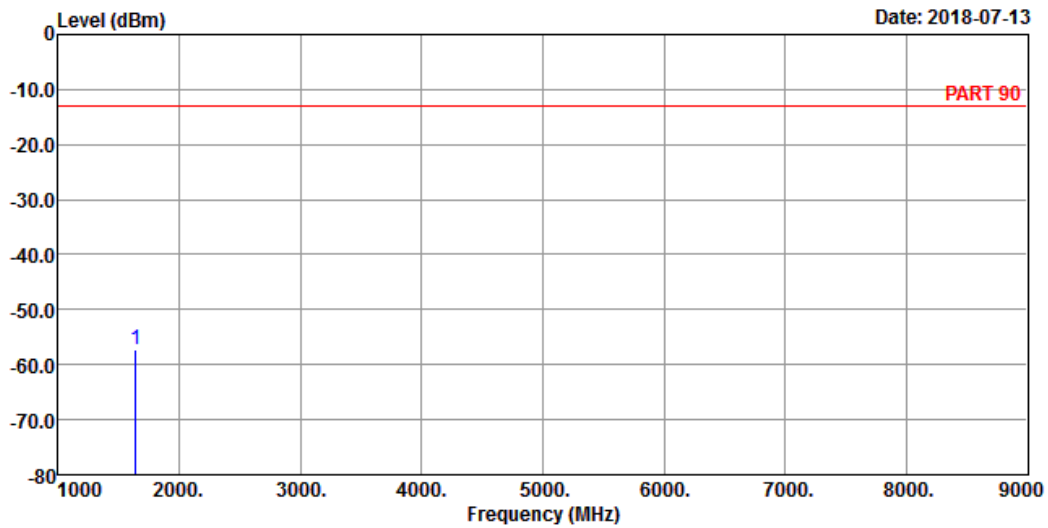

Site : 966 Chamber 5
 Condition: PART 90 HORIZONTAL
 Remak : LTE Band 26 QPSK_5M Link_M-CH
 Tested by: Thomas Wei

Freq	Level	Read Level	Limit Line	Over Limit	Factor	Remark
MHz	dBm	dBm	dBm	dB	dB	
1 pp 1638.00	-57.25	-42.46	-13.00	-44.25	-14.79	Peak



A D T

Data: 4

Date: 2018-07-13

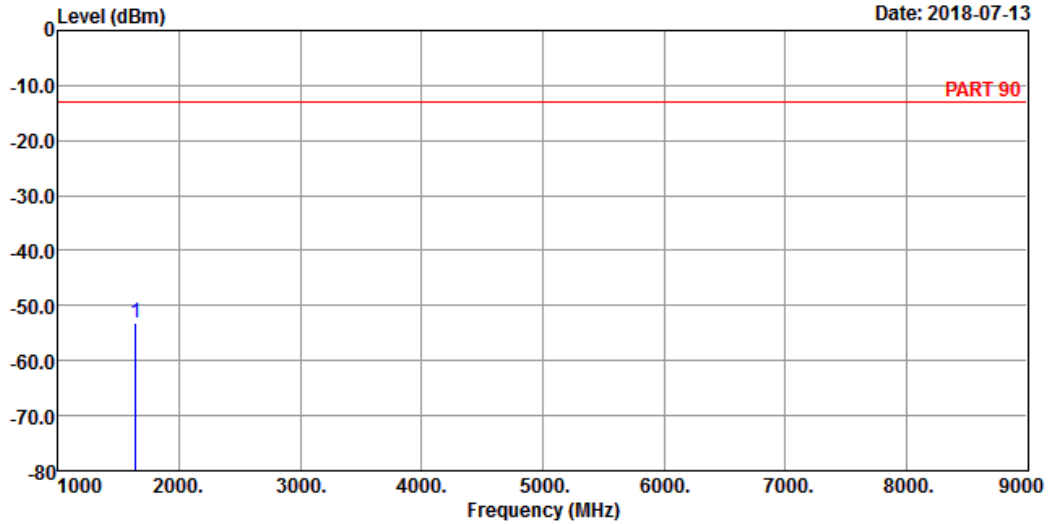

Site : 966 Chamber 5
 Condition: PART 90 VERTICAL
 Remak : LTE Band 26 QPSK_5M Link_M-CH
 Tested by: Thomas Wei

Freq	Level	Read Level	Limit Line	Over Limit	Factor	Remark
MHz	dBm	dBm	dBm	dB	dB	
1 pp 1638.00	-53.01	-38.22	-13.00	-40.01	-14.79	Peak

High Channel



Bureau Veritas Consumer Products Services Ltd., Taoyuan Branch

A D T

Data: 3

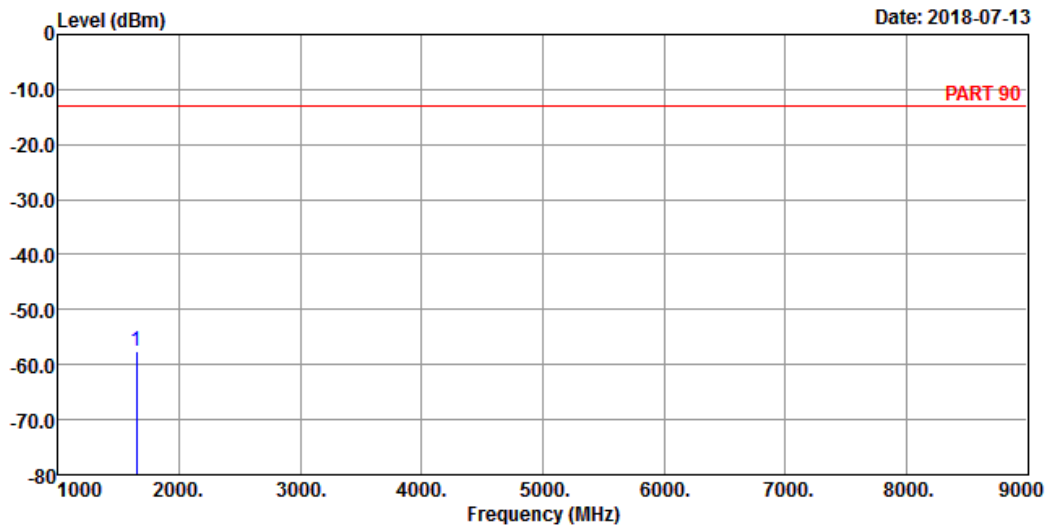

Site : 966 Chamber 5
 Condition: PART 90 HORIZONTAL
 Remak : LTE Band 26 QPSK_5M Link_H-CH
 Tested by: Thomas Wei

Freq	Level	Read Level	Limit Line	Over Limit	Factor	Remark
MHz	dBm	dBm	dBm	dB	dB	
1 pp 1643.00	-57.52	-42.79	-13.00	-44.52	-14.73	Peak



A D T

Data: 4

Date: 2018-07-13

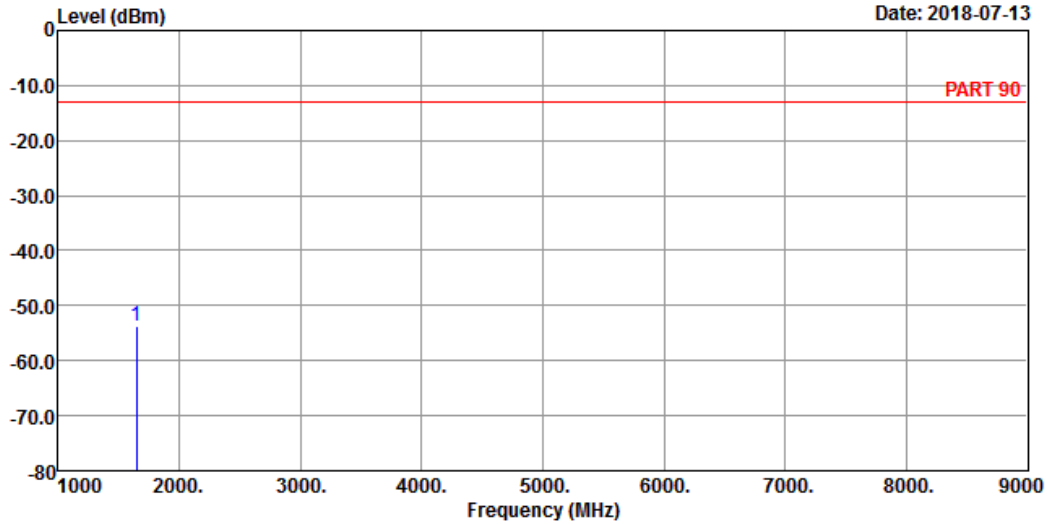

Site : 966 Chamber 5
 Condition: PART 90 VERTICAL
 Remak : LTE Band 26 QPSK_5M Link_H-CH
 Tested by: Thomas Wei

Freq	Level	Read Level	Limit Line	Over Limit	Factor	Remark
MHz	dBm	dBm	dBm	dB	dB	
1 pp 1643.00	-53.62	-38.89	-13.00	-40.62	-14.73	Peak

Channel Bandwidth: 10 MHz / QPSK
Middle Channel



Bureau Veritas Consumer Products Services Ltd., Taoyuan Branch

A D T

Data: 5

Date: 2018-07-10

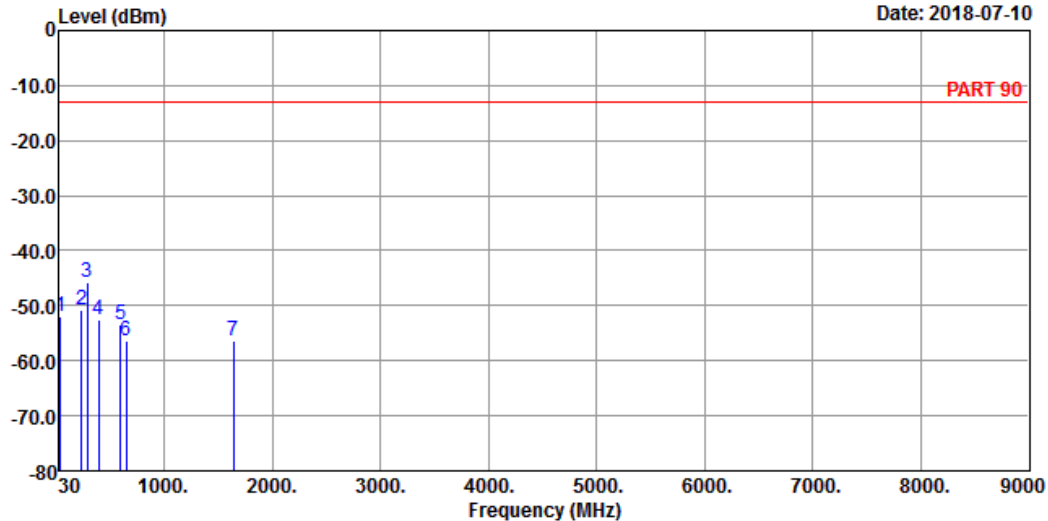

Site : 966 Chamber 5
Condition: PART 90 HORIZONTAL
Remak : LTE Band 26 QPSK_10M Link_M-CH
Tested by: Thomas Wei

	Freq	Level	Read Level	Limit Line	Over Limit	Factor	Remark
	MHz	dBm	dBm	dBm	dB	dB	
1	39.70	-52.03	-52.67	-13.00	-39.03	0.64	Peak
2	234.67	-50.88	-44.26	-13.00	-37.88	-6.62	Peak
3 pp	286.08	-45.83	-39.10	-13.00	-32.83	-6.73	Peak
4	390.84	-52.66	-46.66	-13.00	-39.66	-6.00	Peak
5	598.42	-53.56	-52.73	-13.00	-40.56	-0.83	Peak
6	649.83	-56.37	-55.49	-13.00	-43.37	-0.88	Peak
7	1638.00	-56.30	-41.51	-13.00	-43.30	-14.79	Peak



Bureau Veritas Consumer Products Services Ltd., Taoyuan Branch

A D T

Data: 6

Date: 2018-07-10

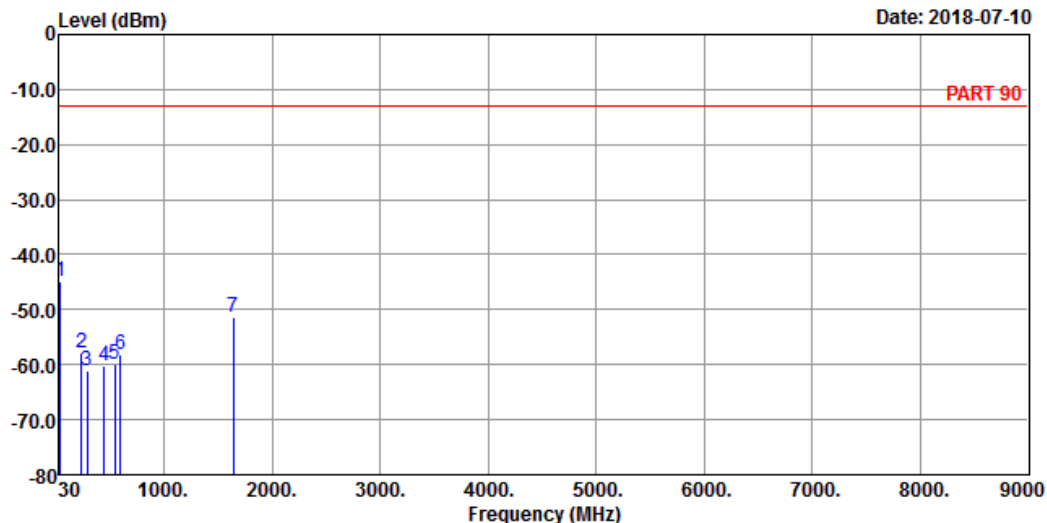

Site : 966 Chamber 5
 Condition: PART 90 VERTICAL
 Remak : LTE Band 26 QPSK_10M Link_M-CH
 Tested by: Thomas Wei

	Freq	Level	Read Level	Limit Line	Over Limit	Factor	Remark
	MHz	dBm	dBm	dBm	dB	dB	
1 pp	42.61	-44.93	-43.99	-13.00	-31.93	-0.94	Peak
2	234.67	-57.86	-51.24	-13.00	-44.86	-6.62	Peak
3	286.08	-61.18	-54.45	-13.00	-48.18	-6.73	Peak
4	442.25	-60.14	-54.53	-13.00	-47.14	-5.61	Peak
5	547.01	-60.04	-57.09	-13.00	-47.04	-2.95	Peak
6	598.42	-58.16	-57.33	-13.00	-45.16	-0.83	Peak
7	1638.00	-51.24	-36.45	-13.00	-38.24	-14.79	Peak

5 Pictures of Test Arrangements

Please refer to the attached file (Test Setup Photo).

Appendix – Information on the Testing Laboratories

We, Bureau Veritas Consumer Products Services (H.K.) Ltd., Taoyuan Branch, were founded in 1988 to provide our best service in EMC, Radio, Telecom and Safety consultation. Our laboratories are FCC recognized accredited test firms and accredited according to ISO/IEC 17025.

If you have any comments, please feel free to contact us at the following:

Linko EMC/RF Lab

Tel: 886-2-26052180

Fax: 886-2-26051924

Hsin Chu EMC/RF/Telecom Lab

Tel: 886-3-6668565

Fax: 886-3-6668323

Hwa Ya EMC/RF/Safety

Tel: 886-3-3183232

Fax: 886-3-3270892

Email: service.adt@tw.bureauveritas.com

Web Site: www.bureauveritas-adt.com

The address and road map of all our labs can be found in our web site also.

--- END ---