

## FCC Test Report

### (PART 24)

**Report No.:** RF190516C01-1

**FCC ID:** B94HNQ20PD

**Test Model:** HSN-Q20C

**Received Date:** May 16, 2019

**Test Date:** May 25 ~ Jun. 05, 2019

**Issued Date:** Jun. 26, 2019

**Applicant:** HP Inc.

**Address:** 3390 East Harmony Road, Fort Collins, Colorado 80528, United States

**Issued By:** Bureau Veritas Consumer Products Services (H.K.) Ltd., Taoyuan Branch

**Lab Address:** No. 47-2, 14th Ling, Chia Pau Vil., Lin Kou Dist., New Taipei City, Taiwan  
( R.O.C )

**Test Location:** No. 19, Hwa Ya 2nd Rd, Wen Hwa Vil, Kwei Shan Dist., Taoyuan City  
33383, Taiwan (R.O.C)

**FCC Registration /  
Designation Number:** 788550 / TW0003



This report is for your exclusive use. Any copying or replication of this report to or for any other person or entity, or use of our name or trademark, is permitted only with our prior written permission. This report sets forth our findings solely with respect to the test samples identified herein. The results set forth in this report are not indicative or representative of the quality or characteristics of the lot from which a test sample was taken or any similar or identical product unless specifically and expressly noted. Our report includes all of the tests requested by you and the results thereof based upon the information that you provided to us. You have 60 days from date of issuance of this report to notify us of any material error or omission caused by our negligence, provided, however, that such notice shall be in writing and shall specifically address the issue you wish to raise. A failure to raise such issue within the prescribed time shall constitute your unqualified acceptance of the completeness of this report, the tests conducted and the correctness of the report contents. Unless specific mention, the uncertainty of measurement has been explicitly taken into account to declare the compliance or non-compliance to the specification. The report must not be used by the client to claim product certification, approval, or endorsement by TAF or any government agencies.

## Table of Contents

<b>Release Control Record</b> .....	<b>4</b>
<b>1 Certificate of Conformity</b> .....	<b>5</b>
<b>2 Summary of Test Results</b> .....	<b>6</b>
2.1 Measurement Uncertainty .....	6
2.2 Test Site and Instruments .....	7
<b>3 General Information</b> .....	<b>7</b>
3.1 General Description of EUT .....	8
3.2 Configuration of System under Test .....	9
3.2.1 Description of Support Units .....	9
3.3 Test Mode Applicability and Tested Channel Detail .....	10
3.4 EUT Operating Conditions .....	13
3.5 General Description of Applied Standards .....	13
<b>4 Test Types and Results</b> .....	<b>14</b>
4.1 Output Power Measurement .....	14
4.1.1 Limits of Output Power Measurement .....	14
4.1.2 Test Procedures .....	14
4.1.3 Test Setup .....	15
4.1.4 Test Results .....	16
4.2 Modulation Characteristics Measurement .....	21
4.2.1 Limits of Modulation Characteristics .....	21
4.2.2 Test Setup .....	21
4.2.3 Test Procedure .....	21
4.2.4 Test Results .....	22
4.3 Frequency Stability Measurement .....	23
4.3.1 Limits of Frequency Stability Measurement .....	23
4.3.2 Test Procedure .....	23
4.3.3 Test Setup .....	23
4.3.4 Test Results .....	24
4.4 Occupied Bandwidth Measurement .....	31
4.4.1 Test Procedure .....	31
4.4.2 Test Setup .....	31
4.4.3 Test Result .....	32
4.5 Band Edge Measurement .....	36
4.5.1 Limits of Band Edge Measurement .....	36
4.5.2 Test Setup .....	36
4.5.3 Test Procedures .....	36
4.5.4 Test Results .....	37
4.6 Peak to Average Ratio .....	44
4.6.1 Limits of Peak to Average Ratio Measurement .....	44
4.6.2 Test Setup .....	44
4.6.3 Test Procedures .....	44
4.6.4 Test Results .....	44
4.7 Conducted Spurious Emissions .....	48
4.7.1 Limits of Conducted Spurious Emissions Measurement .....	48
4.7.2 Test Setup .....	48
4.7.3 Test Procedure .....	48
4.7.4 Test Results .....	49
4.8 Radiated Emission Measurement .....	56
4.8.1 Limits of Radiated Emission Measurement .....	56
4.8.2 Test Procedure .....	56
4.8.3 Deviation from Test Standard .....	56
4.8.4 Test Setup .....	57
4.8.5 Test Results .....	58

<b>5 Pictures of Test Arrangements.....</b>	<b>82</b>
<b>Appendix – Information of the Testing Laboratories .....</b>	<b>83</b>

### Release Control Record

Issue No.	Description	Date Issued
RF190516C01-1	Original Release	Jun. 26, 2019

## 1 Certificate of Conformity

**Product:** Notebook Computer

**Brand:** HP

**Test Model:** HSN-Q20C

**Sample Status:** Engineering Sample

**Applicant:** HP Inc.

**Test Date:** May 25 ~ Jun. 05, 2019

**Standards:** FCC Part 24, Subpart E

The above equipment has been tested by **Bureau Veritas Consumer Products Services (H.K.) Ltd., Taoyuan Branch**, and found compliance with the requirement of the above standards. The test record, data evaluation & Equipment Under Test (EUT) configurations represented herein are true and accurate accounts of the measurements of the sample's RF characteristics under the conditions specified in this report.

**Prepared by :** Gina Liu, **Date:** Jun. 26, 2019  
Gina Liu / Specialist

**Approved by :** Dylan Chiou, **Date:** Jun. 26, 2019  
Dylan Chiou / Project Engineer

## 2 Summary of Test Results

Applied Standard: FCC Part 24 & Part 2			
FCC Clause	Test Item	Result	Remarks
2.1046 24.232	Effective Isotropic Radiated Power	Pass	Meet the requirement of limit.
2.1047	Modulation Characteristics	Pass	Meet the requirement.
2.1046 24.232(d)	Peak to Average Ratio	Pass	Meet the requirement of limit.
2.1055 24.235	Frequency Stability	Pass	Meet the requirement of limit.
2.1049	Occupied Bandwidth	Pass	Meet the requirement of limit.
24.238	Band Edge Measurements	Pass	Meet the requirement of limit.
2.1051 24.238	Conducted Spurious Emissions	Pass	Meet the requirement of limit.
2.1053 24.238	Radiated Spurious Emissions	Pass	Meet the requirement of limit. Minimum passing margin is -31.62 dB at 5640 MHz.

Note: Determining compliance based on the results of the compliance measurement, not taking into account measurement instrumentation uncertainty.

### 2.1 Measurement Uncertainty

Where relevant, the following measurement uncertainty levels have been estimated for tests performed on the EUT as specified in CISPR 16-4-2:

Measurement	Frequency	Expanded Uncertainty (k=2) (±)
Radiated Emissions up to 1 GHz	9 kHz ~ 30 MHz	3.04 dB
	30 MHz ~ 200 MHz	2.93 dB
	200 MHz ~ 1000 MHz	2.95 dB
Radiated Emissions above 1 GHz	1 GHz ~ 18 GHz	2.26 dB
	18 GHz ~ 40 GHz	1.94 dB

## 2.2 Test Site and Instruments

Description & Manufacturer	Model No.	Serial No.	Date of Calibration	Due Date of Calibration
Test Receiver Agilent	N9038A	MY51210203	Mar. 18, 2019	Mar. 17, 2020
Spectrum Analyzer Agilent	N9010A	MY52220314	Dec. 13, 2018	Dec. 12, 2019
Spectrum Analyzer ROHDE & SCHWARZ	FSU43	101261	Apr. 15, 2019	Apr. 14, 2020
HORN Antenna SCHWARZBECK	BBHA 9120 D	9120D-969	Nov. 25, 2018	Nov. 24, 2019
BILOG Antenna SCHWARZBECK	VULB9168	9168-472	Nov. 23, 2018	Nov. 22, 2019
Double Ridge Guide Horn Antenna EMCO	3115	5619	Nov. 25, 2018	Nov. 24, 2019
BILOG Antenna SCHWARZBECK	VULB 9168	9168-153	Nov. 23, 2018	Nov. 22, 2019
Fixed Attenuator WORKEN	MDCS18N-10	MDCS18N-10-01	Apr. 15, 2019	Apr. 14, 2020
MXG Vector signal generator Agilent	N5182B	MY53050430	Nov. 19, 2018	Nov. 18, 2019
Preamplifier EMCI	EMC 012645	980115	Oct. 12, 2018	Oct. 11, 2019
Preamplifier EMCI	EMC 330H	980112	Oct. 12, 2018	Oct. 11, 2019
RF Coaxial Cable HUBER+SUHNNER	EMC104-SM-SM-800 0&3000	140811+170717	Oct. 12, 2018	Oct. 11, 2019
RF Coaxial Cable HUBER+SUHNNER	SUCOFLEX 104	EMC104-SM-SM-1 000(140807)	Oct. 12, 2018	Oct. 11, 2019
RF Coaxial Cable WOKEN	8D-FB	Cable-Ch10-01	Oct. 12, 2018	Oct. 11, 2019
Boresight Antenna Fixture	FBA-01	FBA-SIP01	NA	NA
Software BV ADT	E3 6.120103	NA	NA	NA
Antenna Tower MF	MFA-440H	NA	NA	NA
Turn Table MF	MFT-201SS	NA	NA	NA
Antenna Tower & Turn Table Controller MF	MF-7802	NA	NA	NA
Radio Communication Analyzer Anritsu	MT8821C	6261806803	Jan. 22, 2019	Jan. 21, 2020
Radio Communication Analyzer Anritsu	MT8820C	6201300640	Aug. 16, 2017	Aug. 15, 2019
Temperature & Humidity Chamber	GTH-120-40-CP-AR	MAA1306-019	Sep. 05, 2018	Sep. 04, 2019
DC Power Supply Topward	33010D	807748	NA	NA

Note: 1. The calibration interval of the above test instruments is 12 / 24 months and the calibrations are traceable to NML/ROC and NIST/USA.

2. The test was performed in HwaYa Chamber 10.

### 3 General Information

#### 3.1 General Description of EUT

<b>Product</b>	Notebook Computer	
<b>Brand</b>	HP	
<b>Test Model</b>	HSN-Q20C	
<b>Status of EUT</b>	Engineering Sample	
<b>Power Supply Rating</b>	5 or 9 or 12 or 15 or 20 Vdc (Adapter)	
<b>Modulation Type</b>	WCDMA	QPSK
	LTE	QPSK, 16QAM
<b>Frequency Range</b>	WCDMA	1852.4 ~ 1907.6 MHz
	LTE Band 2 (Channel Bandwidth: 1.4 MHz)	1850.7 ~ 1909.3 MHz
	LTE Band 2 (Channel Bandwidth: 3 MHz)	1851.5 ~ 1908.5 MHz
	LTE Band 2 (Channel Bandwidth: 5 MHz)	1852.5 ~ 1907.5 MHz
	LTE Band 2 (Channel Bandwidth: 10 MHz)	1855.0 ~ 1905.0 MHz
	LTE Band 2 (Channel Bandwidth: 15 MHz)	1857.5 ~ 1902.5 MHz
	LTE Band 2 (Channel Bandwidth: 20 MHz)	1860.0 ~ 1900.0 MHz
<b>Max. EIRP Power</b>	WCDMA	43.45 mW
	LTE Band 2 (Channel Bandwidth: 1.4 MHz)	33.96 mW
	LTE Band 2 (Channel Bandwidth: 3 MHz)	36.56 mW
	LTE Band 2 (Channel Bandwidth: 5 MHz)	38.55 mW
	LTE Band 2 (Channel Bandwidth: 10 MHz)	41.50 mW
	LTE Band 2 (Channel Bandwidth: 15 MHz)	43.65 mW
	LTE Band 2 (Channel Bandwidth: 20 MHz)	46.03 mW
<b>Emission Designator</b>	WCDMA	4M08F9W
	LTE Band 2 (Channel Bandwidth: 1.4 MHz)	1M09G7D
	LTE Band 2 (Channel Bandwidth: 3 MHz)	2M70G7D
	LTE Band 2 (Channel Bandwidth: 5 MHz)	4M50G7D
	LTE Band 2 (Channel Bandwidth: 10 MHz)	8M99G7D
	LTE Band 2 (Channel Bandwidth: 15 MHz)	13M5G7D
	LTE Band 2 (Channel Bandwidth: 20 MHz)	18M0G7D
<b>Antenna Type</b>	Couple Antenna with -6.19 dBi gain	
<b>Accessory Device</b>	Refer to Note as below	
<b>Data Cable Supplied</b>	N/A	

Note:

1. The WWAN module (Brand: Fibocom, Model: L850-GL) was installed in the EUT.
2. The EUT contains following accessory devices.

Product	Brand	Model	Description
Adapter	hp	TPN-TA02	I/P: 100-240 Vac, 50-60 Hz, 1.6 A O/P: 5 Vdc, 3 A or 9 Vdc, 3 A or 12 Vdc, 5 A or 15 Vdc, 4.33 A or 20 Vdc, 3.25 A

3. The above EUT information is declared by manufacturer and for more detailed features description, please refers to the manufacturer's specifications or user's manual.



### 3.2 Configuration of System under Test

#### <Radiated Emission Test>

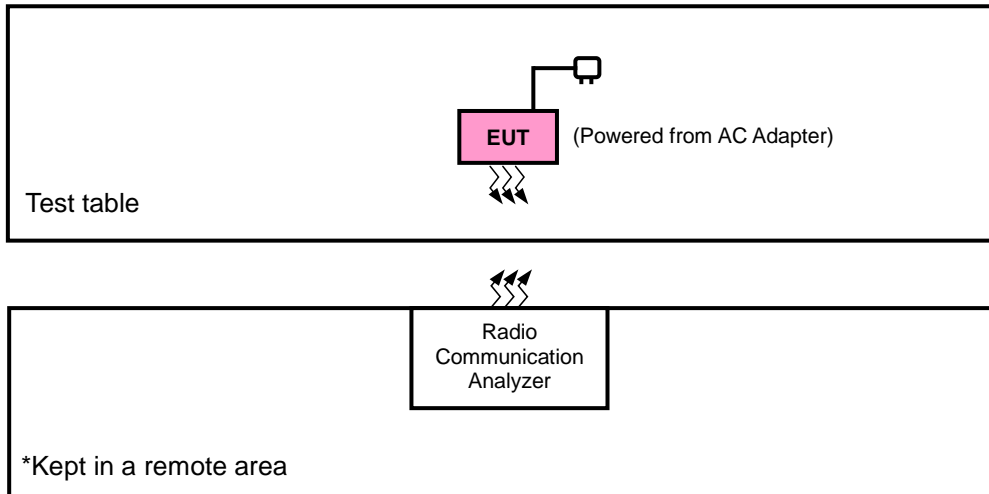

#### <E.I.R.P. Test>

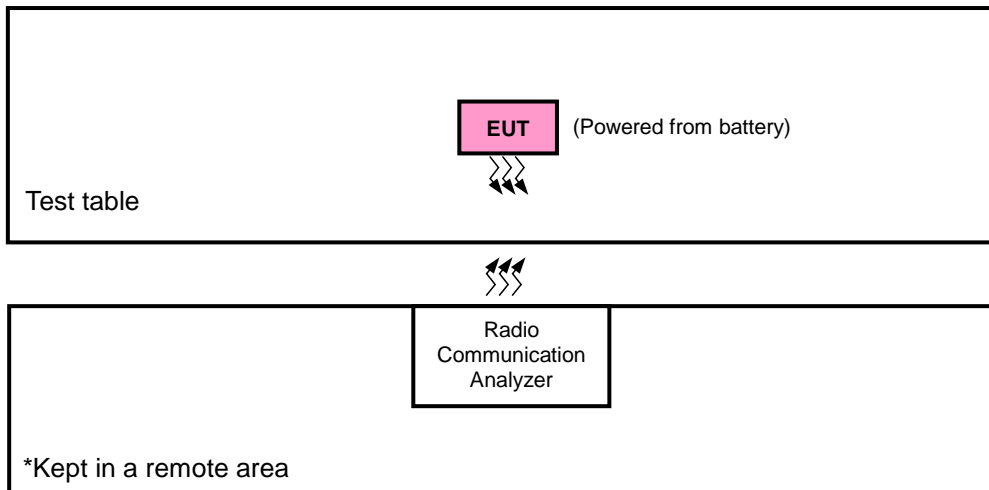

#### 3.2.1 Description of Support Units

The EUT has been tested as an independent unit together with other necessary accessories or support units.

### 3.3 Test Mode Applicability and Tested Channel Detail

Pre-Scan has been conducted to determine the worst-case mode from all possible combinations between available modulations, data rates, XYZ axis and NB mode, and antenna ports.

The worst case was found when positioned as the table below. Following channel(s) was (were) selected for the final test as listed below:

Band	EIRP	Radiated Emission
WCDMA	NB mode	Z -axis
LTE Band 2	NB mode	NB mode

#### WCDMA

EUT Configure Mode	Test Item	Available Channel	Tested Channel	Mode
-	EIRP	9262 to 9538	9262, 9400, 9538	WCDMA
-	Modulation Characteristics	9262 to 9538	9400	WCDMA
-	Frequency Stability	9262 to 9538	9262, 9538	WCDMA
-	Occupied Bandwidth	9262 to 9538	9262, 9400, 9538	WCDMA
-	Band Edge	9262 to 9538	9262, 9538	WCDMA
-	Peak to Average Ratio	9262 to 9538	9262, 9400, 9538	WCDMA
-	Conducted Emission	9262 to 9538	9262, 9400, 9538	WCDMA
-	Radiated Emission	9262 to 9538	9262, 9400, 9538	WCDMA

### LTE Band 2

EUT Configure Mode	Test Item	Available Channel	Tested Channel	Channel Bandwidth	Modulation	Mode
-	EIRP	18607 to 19193	18607, 18900, 19193	1.4 MHz	QPSK, 16QAM	1 RB / 5 RB Offset
		18615 to 19185	18615, 18900, 19185	3 MHz	QPSK, 16QAM	1 RB / 7 RB Offset
		18625 to 19175	18625, 18900, 19175	5 MHz	QPSK, 16QAM	1 RB / 0 RB Offset
		18650 to 19150	18650, 18900, 19150	10 MHz	QPSK, 16QAM	1 RB / 0 RB Offset
		18675 to 19125	18675, 18900, 19125	15 MHz	QPSK, 16QAM	1 RB / 0 RB Offset
		18700 to 19100	18700, 18900, 19100	20 MHz	QPSK, 16QAM	1 RB / 50 RB Offset
-	Modulation Characteristics	18700 to 19100	18900	20 MHz	QPSK, 16QAM	100 RB / 0 RB Offset
-	Frequency Stability	18607 to 19193	18607, 19193	1.4 MHz	QPSK	1 RB / 0 RB Offset
		18615 to 19185	18615, 19185	3 MHz	QPSK	1 RB / 0 RB Offset
		18625 to 19175	18625, 19175	5 MHz	QPSK	1 RB / 0 RB Offset
		18650 to 19150	18650, 19150	10 MHz	QPSK	1 RB / 0 RB Offset
		18675 to 19125	18675, 19125	15 MHz	QPSK	1 RB / 0 RB Offset
		18700 to 19100	18700, 19100	20 MHz	QPSK	1 RB / 0 RB Offset
-	Occupied Bandwidth	18607 to 19193	18607, 18900, 19193	1.4 MHz	QPSK, 16QAM	6 RB / 0 RB Offset
		18615 to 19185	18615, 18900, 19185	3 MHz	QPSK, 16QAM	15 RB / 0 RB Offset
		18625 to 19175	18625, 18900, 19175	5 MHz	QPSK, 16QAM	25 RB / 0 RB Offset
		18650 to 19150	18650, 18900, 19150	10 MHz	QPSK, 16QAM	50 RB / 0 RB Offset
		18675 to 19125	18675, 18900, 19125	15 MHz	QPSK, 16QAM	75 RB / 0 RB Offset
		18700 to 19100	18700, 18900, 19100	20 MHz	QPSK, 16QAM	100 RB / 0 RB Offset
-	Peak to Average Ratio	18607 to 19193	18607, 18900, 19193	1.4 MHz	QPSK, 16QAM	1 RB / 5 RB Offset
		18615 to 19185	18615, 18900, 19185	3 MHz	QPSK, 16QAM	1 RB / 7 RB Offset
		18625 to 19175	18625, 18900, 19175	5 MHz	QPSK, 16QAM	1 RB / 0 RB Offset
		18650 to 19150	18650, 18900, 19150	10 MHz	QPSK, 16QAM	1 RB / 0 RB Offset
		18675 to 19125	18675, 18900, 19125	15 MHz	QPSK, 16QAM	1 RB / 0 RB Offset
		18700 to 19100	18700, 18900, 19100	20 MHz	QPSK, 16QAM	1 RB / 50 RB Offset
-	Band Edge	18607 to 19193	18607	1.4 MHz	QPSK	1 RB / 0 RB Offset
			19193	1.4 MHz	QPSK	6 RB / 0 RB Offset
		18615 to 19185	18615	3 MHz	QPSK	1 RB / 0 RB Offset
			19185	3 MHz	QPSK	15 RB / 0 RB Offset
		18625 to 19175	18625	5 MHz	QPSK	1 RB / 24 RB Offset
			19175	5 MHz	QPSK	25 RB / 0 RB Offset
		18650 to 19150	18650	10 MHz	QPSK	1 RB / 0 RB Offset
			19150	10 MHz	QPSK	50 RB / 0 RB Offset
		18675 to 19125	18675	15 MHz	QPSK	1 RB / 49 RB Offset
			19125	15 MHz	QPSK	75 RB / 0 RB Offset
		18700 to 19100	18700	20 MHz	QPSK	1 RB / 74 RB Offset
			19100	20 MHz	QPSK	75 RB / 0 RB Offset
		18700 to 19100	18700	20 MHz	QPSK	1 RB / 0 RB Offset
			19100	20 MHz	QPSK	100 RB / 0 RB Offset
		18700 to 19100	18700	20 MHz	QPSK	1 RB / 99 RB Offset
			19100	20 MHz	QPSK	100 RB / 0 RB Offset

EUT Configure Mode	Test Item	Available Channel	Tested Channel	Channel Bandwidth	Modulation	Mode
-	Conducted Emission	18607 to 19193	18607, 18900, 19193	1.4 MHz	QPSK	1 RB / 5 RB Offset
		18615 to 19185	18615, 18900, 19185	3 MHz	QPSK	1 RB / 7 RB Offset
		18625 to 19175	18625, 18900, 19175	5 MHz	QPSK	1 RB / 0 RB Offset
		18650 to 19150	18650, 18900, 19150	10 MHz	QPSK	1 RB / 0 RB Offset
		18675 to 19125	18675, 18900, 19125	15 MHz	QPSK	1 RB / 0 RB Offset
		18700 to 19100	18700, 18900, 19100	20 MHz	QPSK	1 RB / 50 RB Offset
-	Radiated Emission	18607 to 19193	18607, 18900, 19193	1.4 MHz	QPSK	1 RB / 5 RB Offset
		18625 to 19175	18625, 18900, 19175	5 MHz	QPSK	1 RB / 0 RB Offset
		18700 to 19100	18700, 18900, 19100	20 MHz	QPSK	1 RB / 50 RB Offset

**Note:**

1. This device was tested under all bandwidths, RB configurations and modulations. The worst case was found in QPSK modulation.
2. For radiated emission above 1 GHz, according to 3GPP 36.521 Section 6.6.3.1.4, choose the lowest, 5 MHz & highest channel bandwidth for final test.

**Test Condition:**

Test Item	Environmental Conditions	Input Power	Tested By
EIRP	26 deg. C, 58 % RH	120 Vac, 60 Hz	Getaz Yang
Modulation Characteristics	26 deg. C, 58 % RH	120 Vac, 60 Hz	Gavin Wu
Frequency Stability	26 deg. C, 58 % RH	120 Vac, 60 Hz	Gavin Wu
Occupied Bandwidth	26 deg. C, 58 % RH	120 Vac, 60 Hz	Gavin Wu
Band Edge	26 deg. C, 58 % RH	120 Vac, 60 Hz	Gavin Wu
Peak to Average Ratio	26 deg. C, 58 % RH	120 Vac, 60 Hz	Gavin Wu
Conducted Emission	26 deg. C, 58 % RH	120 Vac, 60 Hz	Gavin Wu
Radiated Emission	25 deg. C, 65 % RH	120 Vac, 60 Hz	Getaz Yang, Thomas Wei

### **3.4 EUT Operating Conditions**

The EUT makes a call to the communication simulator. The communication simulator station system controlled a EUT to export maximum output power under transmission mode and specific channel frequency

### **3.5 General Description of Applied Standards**

The EUT is a RF Product. According to the specifications of the manufacturer, it must comply with the requirements of the following standards:

**FCC 47 CFR Part 2**

**FCC 47 CFR Part 24**

**KDB 971168 D01 Power Meas License Digital Systems v03r01**

**ANSI/TIA/EIA-603-E 2016**

**ANSI 63.26-2015**

**ANSI 63.2 -1996**

**NOTE:** All test items have been performed and recorded as per the above standards.

## 4 Test Types and Results

### 4.1 Output Power Measurement

#### 4.1.1 Limits of Output Power Measurement

Mobile / Portable station are limited to 2 watts e.i.r.p.

#### 4.1.2 Test Procedures

##### **EIRP / ERP Measurement:**

- a. All measurements were done at low, middle and high operational frequency range. RBW and VBW is 5 MHz for WCDMA, and 10 MHz for LTE mode.
- b. Substitution method is used for E.I.R.P measurement. In the semi-anechoic chamber, EUT placed on the 0.8 m (below or equal 1 GHz) and/or 1.5 m (above 1 GHz) height of Turn Table, rotated the table around 360 degrees to search the maximum radiation power and receiver antenna shall be rotated vertical and horizontal polarization and moved height from 1 m to 4 m to find the maximum polar radiated power. The "Read Value" is the spectrum reading the maximum power value.
- c. The substitution horn antenna is substituted for EUT at the same position and signals generator export the CW signal to the substitution antenna via a tx cable. Rotated the Turn Table and moved receiving antenna to find the maximum radiation power. Adjust output power level of S.G to get a Value of spectrum reading equal to "Read Value" of step b. Record the power level of S.G.
- d.  $EIRP = \text{Output power level of S.G} - \text{TX cable loss} + \text{Antenna gain of substitution horn}$ . E.R.P power can be calculated form E.I.R.P power by subtracting the gain of dipole,  $E.R.P \text{ power} = E.I.R.P \text{ power} - 2.15 \text{ dB}$ .

##### **Conducted Power Measurement:**

The EUT was set up for the maximum power with WCDMA, and LTE link data modulation and link up with simulator. Set the EUT to transmit under low, middle and high channel and record the power level shown on simulator.

### 4.1.3 Test Setup

#### EIRP / ERP Measurement:

<Radiated Emission below or equal 1 GHz>

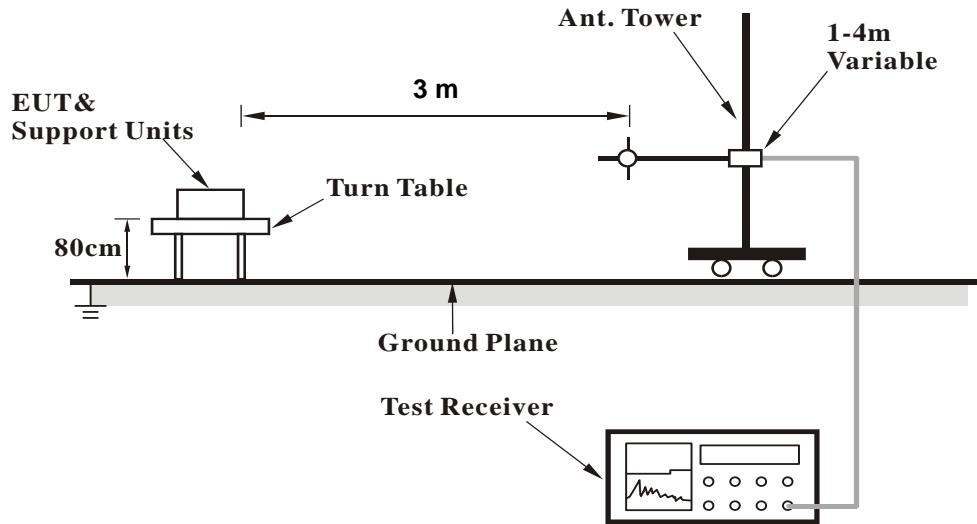

<Radiated Emission above 1 GHz>

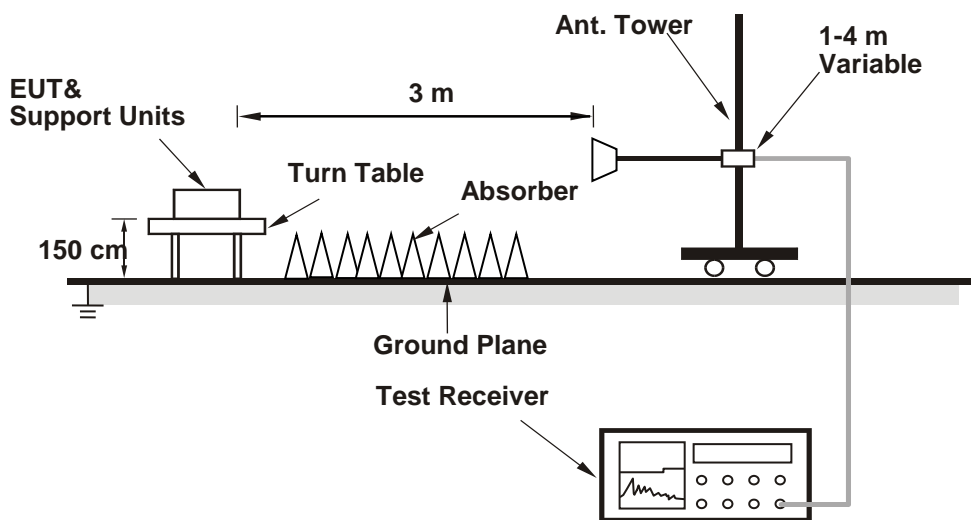

For the actual test configuration, please refer to the attached file (Test Setup Photo).

#### Conducted Power Measurement:

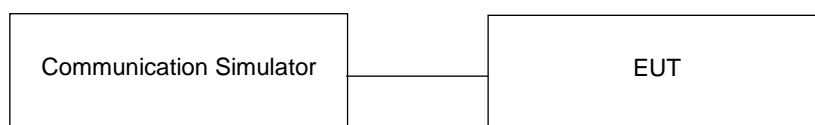

#### 4.1.4 Test Results

#### Conducted Output Power (dBm)

Band	WCDMA Band II			3GPP MPR (dB)
	Channel	9262	9400	
Frequency (MHz)	1852.4	1880.0	1907.6	
RMC 12.2K	23.43	23.42	23.26	-
HSDPA Subtest-1	23.42	23.40	23.22	0
HSDPA Subtest-2	22.54	22.53	22.39	0
HSDPA Subtest-3	22.09	22.05	21.85	0.5
HSDPA Subtest-4	21.83	21.79	21.56	0.5
DC-HSDPA Subtest-1	23.41	23.35	23.22	0
DC-HSDPA Subtest-2	22.50	22.47	22.36	0
DC-HSDPA Subtest-3	21.99	21.95	21.71	0.5
DC-HSDPA Subtest-4	21.72	21.67	21.62	0.5
HSUPA Subtest-1	22.56	22.45	22.20	0
HSUPA Subtest-2	20.41	20.27	20.06	2
HSUPA Subtest-3	21.11	21.07	21.06	1
HSUPA Subtest-4	20.54	20.53	20.27	2
HSUPA Subtest-5	22.62	22.50	22.25	0

LTE Band 2																	
BW	MCS Index	RB Size	RB Offset	Low	Mid	High	3GPP MPR (dB)	BW	MCS Index	RB Size	RB Offset	Low	Mid	High	3GPP MPR (dB)		
				Channel	18700	18900						19100	Channel	18675		18900	19125
				Frequency (MHz)	1860.0	1880.0						1900.0	Frequency (MHz)	1857.5		1880.0	1902.5
20M	QPSK	1	0	22.96	22.91	22.89	0	15M	QPSK	1	0	22.94	22.83	22.83	0		
		1	50	22.97	22.94	22.91	0			1	37	22.87	22.84	22.87	0		
		1	99	22.95	22.90	22.85	0			1	74	22.91	22.88	22.82	0		
		50	0	21.92	21.87	21.86	1			36	0	21.92	21.82	21.82	1		
		50	25	21.97	21.95	21.91	1			36	19	21.94	21.87	21.83	1		
		50	50	21.94	21.92	21.89	1			36	39	21.91	21.82	21.85	1		
	16QAM	100	0	21.94	21.92	21.90	1		75	0	21.90	21.86	21.81	1			
		1	0	21.86	21.85	21.81	1		16QAM	1	0	21.92	21.74	21.78	1		
		1	50	21.96	21.84	21.84	1			1	37	21.87	21.84	21.81	1		
		1	99	21.87	21.84	21.82	1			1	74	21.77	21.83	21.80	1		
		50	0	20.92	20.87	20.85	2			36	0	20.87	20.76	20.72	2		
		50	25	20.91	20.92	20.91	2			36	19	20.85	20.90	20.87	2		
50	50	20.94	20.89	20.83	2	36	39	20.88		20.77	20.77	2					
100	0	20.84	20.87	20.81	2	75	0	20.82	20.77	20.77	2						
10M	QPSK	1	0	22.90	22.84	22.72	0	5M	QPSK	1	0	22.94	22.70	22.65	0		
		1	24	22.81	22.83	22.87	0			1	12	22.84	22.72	22.66	0		
		1	49	22.75	22.77	22.67	0			1	24	22.87	22.80	22.71	0		
		25	0	21.71	21.66	21.70	1			12	0	21.75	21.79	21.76	1		
		25	12	21.84	21.77	21.89	1			12	6	21.72	21.86	21.74	1		
		25	25	21.92	21.79	21.84	1			12	13	21.87	21.69	21.75	1		
	16QAM	50	0	21.75	21.92	21.78	1		25	0	21.77	21.78	21.64	1			
		1	0	21.92	21.76	21.66	1		16QAM	1	0	21.74	21.71	21.78	1		
		1	24	21.80	21.65	21.64	1			1	12	21.89	21.83	21.67	1		
		1	49	21.81	21.67	21.67	1			1	24	21.75	21.68	21.53	1		
		25	0	20.73	20.64	20.77	2			12	0	20.67	20.59	20.57	2		
		25	12	20.87	20.90	20.66	2			12	6	20.84	20.85	20.75	2		
25	25	20.83	20.78	20.81	2	12	13	20.81		20.87	20.72	2					
50	0	20.74	20.62	20.66	2	25	0	20.83	20.70	20.74	2						
3M	QPSK	1	0	22.86	22.79	22.75	0	1.4M	QPSK	1	0	22.87	22.72	22.69	0		
		1	7	22.91	22.87	22.74	0			1	2	22.76	22.84	22.71	0		
		1	14	22.86	22.65	22.69	0			1	5	22.91	22.84	22.67	0		
		8	0	21.82	21.83	21.72	1			3	0	22.85	22.70	22.73	0		
		8	3	21.84	21.79	21.79	1			3	1	22.81	22.74	22.72	0		
		8	7	21.82	21.79	21.80	1			3	3	22.83	22.77	22.78	0		
	16QAM	15	0	21.78	21.79	21.71	1		6	0	21.92	21.75	21.77	1			
		1	0	21.68	21.84	21.69	1		16QAM	1	0	21.76	21.86	21.75	1		
		1	7	21.78	21.83	21.84	1			1	2	21.70	21.86	21.79	1		
		1	14	21.72	21.71	21.71	1			1	5	21.83	21.70	21.65	1		
		8	0	20.85	20.71	20.67	2			3	0	21.82	21.59	21.62	1		
		8	3	20.72	20.76	20.71	2			3	1	21.85	21.87	21.79	1		
8	7	20.81	20.73	20.77	2	3	3	21.71		21.73	21.69	1					
15	0	20.72	20.81	20.69	2	6	0	20.79	20.67	20.79	2						



**EIRP Power (dBm)**

WCDMA							
Plane	Channel	Frequency (MHz)	Reading (dBm)	Correction Factor (dB)	EIRP (dBm)	EIRP (mW)	Polarization (H/V)
NB	9262	1852.4	-26.94	36.57	9.63	9.18	H
	9400	1880.0	-27.66	37.22	9.56	9.04	
	9538	1907.6	-27.71	37.18	9.47	8.85	
	9262	1852.4	-21.27	37.65	16.38	43.45	V
	9400	1880.0	-21.28	37.58	16.30	42.66	
	9538	1907.6	-21.21	37.48	16.27	42.36	

Note: EIRP (dBm) = Reading (dBm) + Correction Factor (dB)

LTE Band 2							
Channel Bandwidth: 1.4 MHz / QPSK							
Plane	Channel	Frequency (MHz)	Reading (dBm)	Correction Factor (dB)	EIRP (dBm)	EIRP (mW)	Polarization (H/V)
NB	18607	1850.7	-28.33	36.57	8.24	6.67	H
	18900	1880.0	-29.24	37.22	7.98	6.28	
	19193	1909.3	-29.22	37.18	7.96	6.25	
	18607	1850.7	-22.34	37.65	15.31	33.96	V
	18900	1880.0	-22.29	37.58	15.29	33.81	
	19193	1909.3	-22.26	37.48	15.22	33.27	
Channel Bandwidth: 1.4 MHz / 16QAM							
NB	18607	1850.7	-29.54	36.57	7.03	5.05	H
	18900	1880.0	-30.21	37.22	7.01	5.02	
	19193	1909.3	-30.20	37.18	6.98	4.99	
	18607	1850.7	-23.31	37.65	14.34	27.16	V
	18900	1880.0	-23.39	37.58	14.19	26.24	
	19193	1909.3	-23.36	37.48	14.12	25.82	

Note: EIRP (dBm) = Reading (dBm) + Correction Factor (dB)

LTE Band 2							
Channel Bandwidth: 3 MHz / QPSK							
Plane	Channel	Frequency (MHz)	Reading (dBm)	Correction Factor (dB)	EIRP (dBm)	EIRP (mW)	Polarization (H/V)
NB	18615	1851.5	-28.11	36.57	8.46	7.01	H
	18900	1880.0	-28.96	37.22	8.26	6.70	
	19185	1908.5	-28.96	37.18	8.22	6.64	
	V	18615	1851.5	-22.02	37.65	15.63	36.56
		18900	1880.0	-21.99	37.58	15.59	36.22
		19185	1908.5	-21.93	37.48	15.55	35.89
Channel Bandwidth: 3 MHz / 16QAM							
NB	18615	1851.5	-29.23	36.57	7.34	5.42	H
	18900	1880.0	-29.91	37.22	7.31	5.38	
	19185	1908.5	-29.91	37.18	7.27	5.33	
	V	18615	1851.5	-23.05	37.65	14.60	28.84
		18900	1880.0	-23.08	37.58	14.50	28.18
		19185	1908.5	-23.14	37.48	14.34	27.16

Note: EIRP (dBm) = Reading (dBm) + Correction Factor (dB)

LTE Band 2							
Channel Bandwidth: 5 MHz / QPSK							
Plane	Channel	Frequency (MHz)	Reading (dBm)	Correction Factor (dB)	EIRP (dBm)	EIRP (mW)	Polarization (H/V)
NB	18625	1852.5	-27.80	36.57	8.77	7.53	H
	18900	1880.0	-28.66	37.22	8.56	7.18	
	19175	1907.5	-28.66	37.18	8.52	7.11	
	V	18625	1852.5	-21.79	37.65	15.86	38.55
		18900	1880.0	-21.74	37.58	15.84	38.37
		19175	1907.5	-21.67	37.48	15.81	38.11
Channel Bandwidth: 5 MHz / 16QAM							
NB	18625	1852.5	-28.94	36.57	7.63	5.79	H
	18900	1880.0	-29.63	37.22	7.59	5.74	
	19175	1907.5	-29.63	37.18	7.55	5.69	
	V	18625	1852.5	-22.75	37.65	14.90	30.90
		18900	1880.0	-22.83	37.58	14.75	29.85
		19175	1907.5	-22.81	37.48	14.67	29.31

Note: EIRP (dBm) = Reading (dBm) + Correction Factor (dB)

LTE Band 2							
Channel Bandwidth: 10 MHz / QPSK							
Plane	Channel	Frequency (MHz)	Reading (dBm)	Correction Factor (dB)	EIRP (dBm)	EIRP (mW)	Polarization (H/V)
NB	18650	1855.0	-27.59	36.57	8.98	7.91	H
	18900	1880.0	-28.28	37.22	8.94	7.83	
	19150	1905.0	-28.36	37.18	8.82	7.62	
	18650	1855.0	-21.47	37.65	16.18	41.50	V
	18900	1880.0	-21.44	37.58	16.14	41.11	
	19150	1905.0	-21.47	37.48	16.01	39.90	
Channel Bandwidth: 10 MHz / 16QAM							
NB	18650	1855.0	-28.68	36.57	7.89	6.15	H
	18900	1880.0	-29.40	37.22	7.82	6.05	
	19150	1905.0	-29.37	37.18	7.81	6.04	
	18650	1855.0	-22.55	37.65	15.10	32.36	V
	18900	1880.0	-22.51	37.58	15.07	32.14	
	19150	1905.0	-22.59	37.48	14.89	30.83	

Note: EIRP (dBm) = Reading (dBm) + Correction Factor (dB)

LTE Band 2							
Channel Bandwidth: 15 MHz / QPSK							
Plane	Channel	Frequency (MHz)	Reading (dBm)	Correction Factor (dB)	EIRP (dBm)	EIRP (mW)	Polarization (H/V)
NB	18675	1857.5	-27.25	36.57	9.32	8.55	H
	18900	1880.0	-27.98	37.22	9.24	8.39	
	19125	1902.5	-28.05	37.18	9.13	8.18	
	18675	1857.5	-21.25	37.65	16.40	43.65	V
	18900	1880.0	-21.23	37.58	16.35	43.15	
	19125	1902.5	-21.19	37.48	16.29	42.56	
Channel Bandwidth: 15 MHz / 16QAM							
NB	18675	1857.5	-28.46	36.57	8.11	6.47	H
	18900	1880.0	-29.16	37.22	8.06	6.40	
	19125	1902.5	-29.13	37.18	8.05	6.38	
	18675	1857.5	-22.26	37.65	15.39	34.59	V
	18900	1880.0	-22.29	37.58	15.29	33.81	
	19125	1902.5	-22.32	37.48	15.16	32.81	

Note: EIRP (dBm) = Reading (dBm) + Correction Factor (dB)

LTE Band 2							
Channel Bandwidth: 20 MHz / QPSK							
Plane	Channel	Frequency (MHz)	Reading (dBm)	Correction Factor (dB)	EIRP (dBm)	EIRP (mW)	Polarization (H/V)
NB	18700	1860.0	-27.02	36.57	9.55	9.02	H
	18900	1880.0	-27.73	37.22	9.49	8.89	
	19100	1900.0	-27.81	37.18	9.37	8.65	
	18700	1860.0	-21.02	37.65	16.63	46.03	V
	18900	1880.0	-20.98	37.58	16.60	45.71	
	19100	1900.0	-20.94	37.48	16.54	45.08	
Channel Bandwidth: 20 MHz / 16QAM							
NB	18700	1860.0	-28.20	36.57	8.37	6.87	H
	18900	1880.0	-28.91	37.22	8.31	6.78	
	19100	1900.0	-28.92	37.18	8.26	6.70	
	18700	1860.0	-21.98	37.65	15.67	36.90	V
	18900	1880.0	-22.06	37.58	15.52	35.65	
	19100	1900.0	-22.11	37.48	15.37	34.43	

Note: EIRP (dBm) = Reading (dBm) + Correction Factor (dB)

## 4.2 Modulation Characteristics Measurement

### 4.2.1 Limits of Modulation Characteristics

N/A

### 4.2.2 Test Setup



### 4.2.3 Test Procedure

Connect the EUT to Communication Simulator via the antenna connector. The frequency band is set as EUT supported Modulation and Channels, the EUT output is matched with 50 ohm load, the waveform quality and constellation of the EUT was tested.

### 4.2.4 Test Results

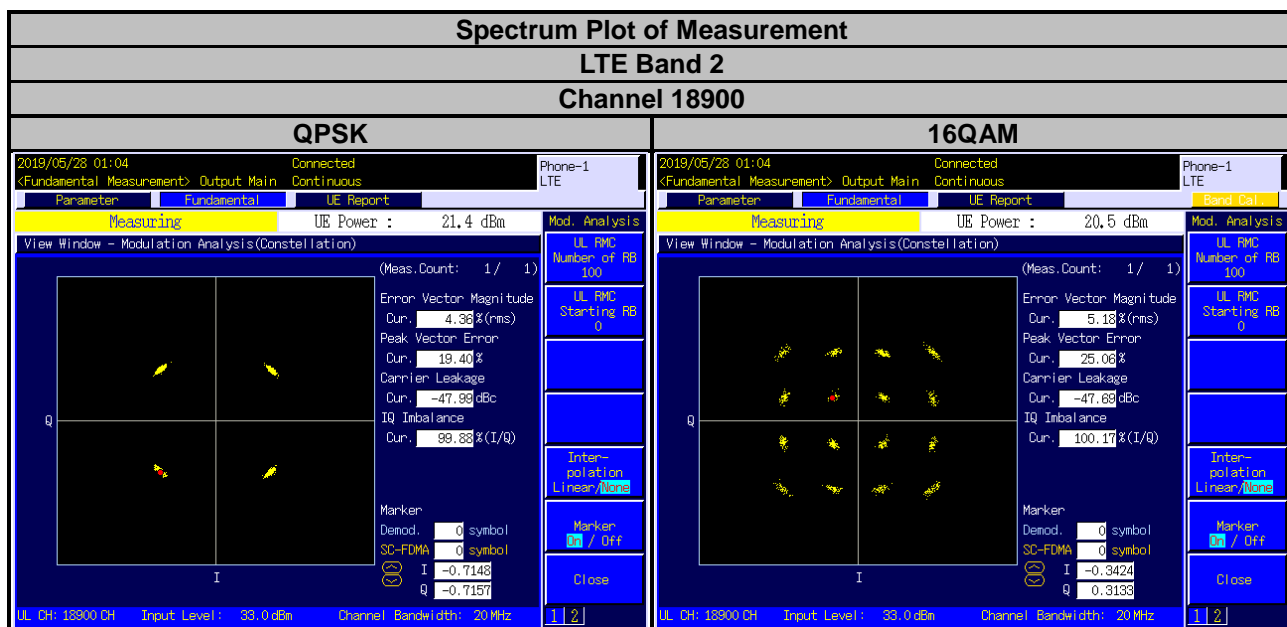
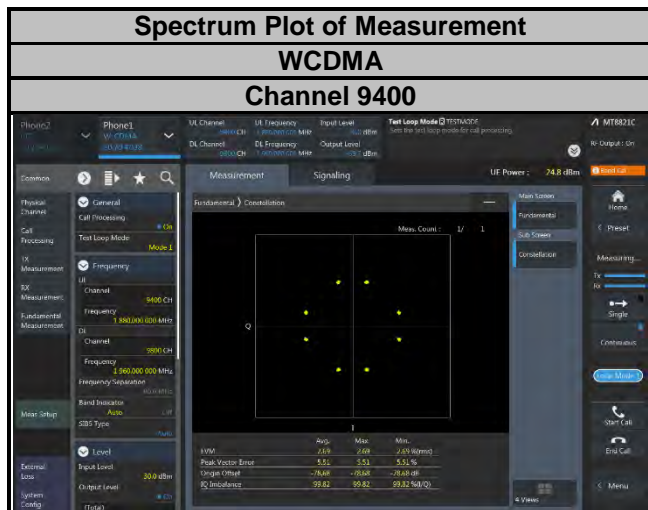

### 4.3 Frequency Stability Measurement

#### 4.3.1 Limits of Frequency Stability Measurement

The frequency stability shall be sufficient to ensure that the fundamental emission stays within the authorized frequency block.

#### 4.3.2 Test Procedure

- Device is placed at the oven room. The oven room could control the temperatures and humidity. Power warm up is at least 15 min and power applied should perform before recording frequency error.
- EUT is connected the external power supply to control the DC input power. The test voltage range is from minimum to maximum working voltage. Each step shall be record the frequency error rate.
- The temperature range step is 10 degrees in this test items. All temperature levels shall be hold the  $\pm 0.5^{\circ}\text{C}$  during the measurement testing. The each temperature step shall be at least 0.5 hours, consider the EUT could be test under the stability condition.

**NOTE:** The frequency error was recorded frequency error from the communication simulator.

#### 4.3.3 Test Setup

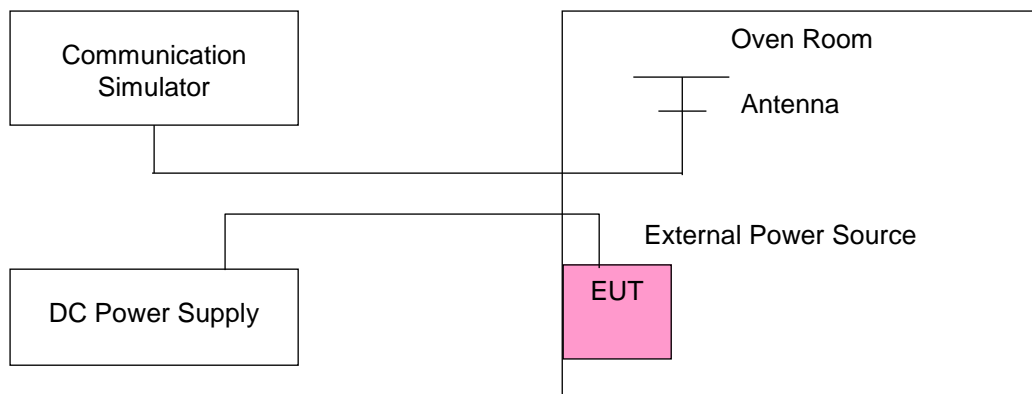

#### 4.3.4 Test Results

##### Frequency Error vs. Voltage

Voltage (Volts)	WCDMA			
	Low Channel		High Channel	
	Frequency (MHz)	Frequency Error (ppm)	Frequency (MHz)	Frequency Error (ppm)
120	1852.400003	0.002	1907.600001	0.001
102	1852.400003	0.001	1907.600001	0.001
138	1852.400004	0.002	1907.600004	0.002

**Note:** The applicant defined the normal working voltage of the battery is from 102 Vac to 138 Vac.

##### Frequency Error vs. Temperature

Temp. (°C)	WCDMA			
	Low Channel		High Channel	
	Frequency (MHz)	Frequency Error (ppm)	Frequency (MHz)	Frequency Error (ppm)
-30	1852.400001	0.001	1907.600001	0.001
-20	1852.400003	0.002	1907.600003	0.002
-10	1852.400003	0.002	1907.600003	0.001
0	1852.400003	0.002	1907.600003	0.001
10	1852.399997	-0.002	1907.599997	-0.001
20	1852.399997	-0.002	1907.599996	-0.002
30	1852.399996	-0.002	1907.599996	-0.002
40	1852.399999	-0.001	1907.599997	-0.002
50	1852.399999	-0.001	1907.599997	-0.002



## Frequency Error vs. Voltage

Voltage (Volts)	LTE Band 2			
	Channel Bandwidth: 1.4 MHz			
	Low Channel		High Channel	
	Frequency (MHz)	Frequency Error (ppm)	Frequency (MHz)	Frequency Error (ppm)
120	1850.700002	0.001	1909.300000	0.001
102	1850.700004	0.002	1909.300002	0.001
138	1850.700002	0.001	1909.300004	0.002

**Note:** The applicant defined the normal working voltage of the battery is from 102 Vac to 138 Vac.

## Frequency Error vs. Temperature

Temp. (°C)	LTE Band 2			
	Channel Bandwidth: 1.4 MHz			
	Low Channel		High Channel	
	Frequency (MHz)	Frequency Error (ppm)	Frequency (MHz)	Frequency Error (ppm)
-30	1850.700001	0.001	1909.300004	0.002
-20	1850.700001	0.001	1909.300003	0.001
-10	1850.700003	0.001	1909.300001	0.001
0	1850.700002	0.001	1909.300003	0.002
10	1850.700001	0.001	1909.300004	0.002
20	1850.699997	-0.002	1909.299996	-0.002
30	1850.699997	-0.002	1909.299999	-0.001
40	1850.699997	-0.002	1909.299997	-0.002
50	1850.699999	-0.001	1909.299996	-0.002

## Frequency Error vs. Voltage

Voltage (Volts)	LTE Band 2			
	Channel Bandwidth: 3 MHz			
	Low Channel		High Channel	
	Frequency (MHz)	Frequency Error (ppm)	Frequency (MHz)	Frequency Error (ppm)
120	1850.700003	0.002	1909.300000	0.001
102	1850.700003	0.001	1909.300002	0.001
138	1850.700002	0.001	1909.300002	0.001

**Note:** The applicant defined the normal working voltage of the battery is from 102 Vac to 138 Vac.

## Frequency Error vs. Temperature

Temp. (°C)	LTE Band 2			
	Channel Bandwidth: 3 MHz			
	Low Channel		High Channel	
	Frequency (MHz)	Frequency Error (ppm)	Frequency (MHz)	Frequency Error (ppm)
-30	1850.700002	0.001	1909.300001	0.001
-20	1850.700002	0.001	1909.300001	0.001
-10	1850.700001	0.001	1909.300002	0.001
0	1850.700003	0.001	1909.300002	0.001
10	1850.700001	0.001	1909.300003	0.002
20	1850.699998	-0.001	1909.299996	-0.002
30	1850.699996	-0.002	1909.299998	-0.001
40	1850.699999	-0.001	1909.299997	-0.002
50	1850.699997	-0.001	1909.299998	-0.001

Frequency Error vs. Voltage

Voltage (Volts)	LTE Band 2			
	Channel Bandwidth: 5 MHz			
	Low Channel		High Channel	
	Frequency (MHz)	Frequency Error (ppm)	Frequency (MHz)	Frequency Error (ppm)
120	1850.700003	0.002	1909.300000	0.002
102	1850.700004	0.002	1909.300002	0.001
138	1850.700003	0.001	1909.300001	0.001

**Note:** The applicant defined the normal working voltage of the battery is from 102 Vac to 138 Vac.

Frequency Error vs. Temperature

Temp. (°C)	LTE Band 2			
	Channel Bandwidth: 5 MHz			
	Low Channel		High Channel	
	Frequency (MHz)	Frequency Error (ppm)	Frequency (MHz)	Frequency Error (ppm)
-30	1850.700002	0.001	1909.300002	0.001
-20	1850.700004	0.002	1909.300004	0.002
-10	1850.700002	0.001	1909.300001	0.001
0	1850.700003	0.002	1909.300002	0.001
10	1850.700002	0.001	1909.300001	0.001
20	1850.699997	-0.002	1909.299997	-0.002
30	1850.699996	-0.002	1909.299997	-0.002
40	1850.699999	-0.001	1909.299999	-0.001
50	1850.699997	-0.002	1909.299999	-0.001

Frequency Error vs. Voltage

Voltage (Volts)	LTE Band 2			
	Channel Bandwidth: 10 MHz			
	Low Channel		High Channel	
	Frequency (MHz)	Frequency Error (ppm)	Frequency (MHz)	Frequency Error (ppm)
120	1850.700002	0.001	1909.300000	0.001
102	1850.700004	0.002	1909.300002	0.001
138	1850.700002	0.001	1909.300003	0.001

**Note:** The applicant defined the normal working voltage of the battery is from 102 Vac to 138 Vac.

Frequency Error vs. Temperature

Temp. (°C)	LTE Band 2			
	Channel Bandwidth: 10 MHz			
	Low Channel		High Channel	
	Frequency (MHz)	Frequency Error (ppm)	Frequency (MHz)	Frequency Error (ppm)
-30	1850.700002	0.001	1909.300002	0.001
-20	1850.700003	0.002	1909.300002	0.001
-10	1850.700003	0.002	1909.300003	0.001
0	1850.700002	0.001	1909.300002	0.001
10	1850.700003	0.001	1909.300003	0.002
20	1850.699999	-0.001	1909.299997	-0.002
30	1850.699998	-0.001	1909.299998	-0.001
40	1850.699997	-0.002	1909.299997	-0.002
50	1850.699998	-0.001	1909.299998	-0.001

## Frequency Error vs. Voltage

Voltage (Volts)	LTE Band 2			
	Channel Bandwidth: 15 MHz			
	Low Channel		High Channel	
	Frequency (MHz)	Frequency Error (ppm)	Frequency (MHz)	Frequency Error (ppm)
120	1850.700002	0.001	1909.300000	0.002
102	1850.700001	0.001	1909.300003	0.001
138	1850.700004	0.002	1909.300004	0.002

**Note:** The applicant defined the normal working voltage of the battery is from 102 Vac to 138 Vac.

## Frequency Error vs. Temperature

Temp. (°C)	LTE Band 2			
	Channel Bandwidth: 15 MHz			
	Low Channel		High Channel	
	Frequency (MHz)	Frequency Error (ppm)	Frequency (MHz)	Frequency Error (ppm)
-30	1850.700003	0.002	1909.300003	0.002
-20	1850.700003	0.002	1909.300001	0.001
-10	1850.700002	0.001	1909.300003	0.001
0	1850.700002	0.001	1909.300002	0.001
10	1850.700004	0.002	1909.300003	0.001
20	1850.699998	-0.001	1909.299998	-0.001
30	1850.699997	-0.002	1909.299996	-0.002
40	1850.699998	-0.001	1909.299998	-0.001
50	1850.699997	-0.002	1909.299998	-0.001

## Frequency Error vs. Voltage

Voltage (Volts)	LTE Band 2			
	Channel Bandwidth: 20 MHz			
	Low Channel		High Channel	
	Frequency (MHz)	Frequency Error (ppm)	Frequency (MHz)	Frequency Error (ppm)
120	1850.700001	0.001	1909.300000	0.002
102	1850.700002	0.001	1909.300003	0.002
138	1850.700004	0.002	1909.300004	0.002

**Note:** The applicant defined the normal working voltage of the battery is from 102 Vac to 138 Vac.

## Frequency Error vs. Temperature

Temp. (°C)	LTE Band 2			
	Channel Bandwidth: 20 MHz			
	Low Channel		High Channel	
	Frequency (MHz)	Frequency Error (ppm)	Frequency (MHz)	Frequency Error (ppm)
-30	1850.700001	0.001	1909.300001	0.001
-20	1850.700004	0.002	1909.300002	0.001
-10	1850.700004	0.002	1909.300001	0.001
0	1850.700003	0.002	1909.300003	0.001
10	1850.700002	0.001	1909.300002	0.001
20	1850.699998	-0.001	1909.299997	-0.002
30	1850.699999	-0.001	1909.299997	-0.002
40	1850.699997	-0.002	1909.299996	-0.002
50	1850.699996	-0.002	1909.299998	-0.001

## 4.4 Occupied Bandwidth Measurement

### 4.4.1 Test Procedure

The EUT makes a call to the communication simulator. All measurements were done at low, middle and high operational frequency range. The communication simulator station system controlled a EUT to export maximum output power under transmission mode and specific channel frequency. Use OBW measurement function of Spectrum analyzer to measure 99 % occupied bandwidth.

### 4.4.2 Test Setup

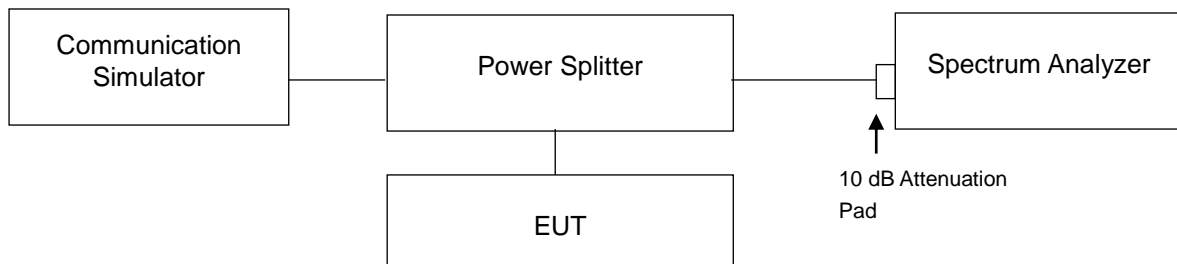

### 4.4.3 Test Result

WCDMA			
Channel	Frequency (MHz)	99 % Occupied Bandwidth (MHz)	26 dB Bandwidth (MHz)
9262	1852.4	4.077	4.648
9400	1880.0	4.084	4.638
9538	1907.6	4.073	4.638

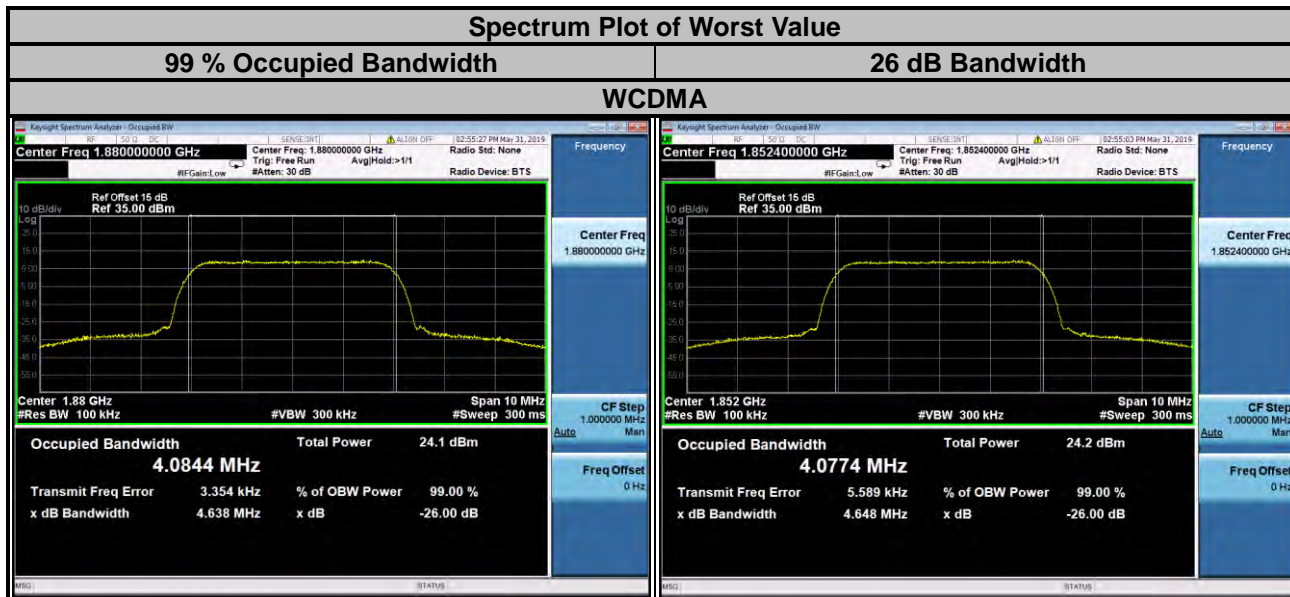



LTE Band 2					
Channel Bandwidth: 1.4 MHz					
Channel	Frequency (MHz)	99 % Occupied Bandwidth (MHz)		26 dB Bandwidth (MHz)	
		QPSK	16QAM	QPSK	16QAM
18607	1850.7	1.094	1.091	1.304	1.305
18900	1880.0	1.092	1.092	1.308	1.302
19193	1909.3	1.092	1.092	1.305	1.299

Channel Bandwidth: 3 MHz					
Channel	Frequency (MHz)	99 % Occupied Bandwidth (MHz)		26 dB Bandwidth (MHz)	
		QPSK	16QAM	QPSK	16QAM
18615	1851.5	2.703	2.698	2.986	3.003
18900	1880.0	2.703	2.700	2.988	2.987
19185	1908.5	2.704	2.701	2.980	2.983



LTE Band 2					
Channel Bandwidth: 5 MHz					
Channel	Frequency (MHz)	99 % Occupied Bandwidth (MHz)		26 dB Bandwidth (MHz)	
		QPSK	16QAM	QPSK	16QAM
18625	1852.5	4.494	4.497	4.929	4.905
18900	1880.0	4.498	4.496	4.921	4.908
19175	1907.5	4.494	4.495	4.928	4.891

Channel Bandwidth: 10 MHz					
Channel	Frequency (MHz)	99 % Occupied Bandwidth (MHz)		26 dB Bandwidth (MHz)	
		QPSK	16QAM	QPSK	16QAM
18650	1855.0	8.982	8.986	9.949	9.880
18900	1880.0	8.992	8.987	10.060	9.920
19150	1905.0	8.988	8.982	9.931	9.899



LTE Band 2					
Channel Bandwidth: 15 MHz					
Channel	Frequency (MHz)	99 % Occupied Bandwidth (MHz)		26 dB Bandwidth (MHz)	
		QPSK	16QAM	QPSK	16QAM
18675	1857.5	13.469	13.461	14.410	14.320
18900	1880.0	13.475	13.473	14.350	14.360
19125	1902.5	13.468	13.464	14.320	14.330

Channel Bandwidth: 20 MHz					
Channel	Frequency (MHz)	99 % Occupied Bandwidth (MHz)		26 dB Bandwidth (MHz)	
		QPSK	16QAM	QPSK	16QAM
18700	1860.0	17.949	17.951	19.080	19.100
18900	1880.0	17.987	17.979	19.120	19.110
19100	1900.0	17.967	17.962	19.080	19.090



## 4.5 Band Edge Measurement

### 4.5.1 Limits of Band Edge Measurement

Power of any emission outside of the authorized operating frequency ranges must be attenuated below the transmitting power (P) by a factor of at least  $43 + 10 \log(P)$  dB. In the 1 MHz bands immediately outside and adjacent to the frequency block a resolution bandwidth of at least one percent of the emission bandwidth of the fundamental emission of the transmitter may be employed.

### 4.5.2 Test Setup

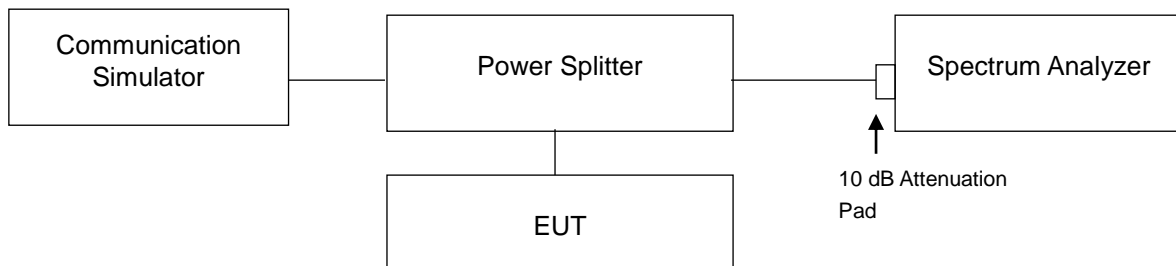

### 4.5.3 Test Procedures

- All measurements were done at low and high operational frequency range.
- The center frequency of spectrum is the band edge frequency and span is 5 MHz. RB of the spectrum is 47 kHz and VB of the spectrum is 150 kHz (WCDMA).
- The center frequency of spectrum is the band edge frequency and span is 1 MHz. RB of the spectrum is 15 kHz and VB of the spectrum is 51 kHz (LTE Bandwidth 1.4 MHz).
- The center frequency of spectrum is the band edge frequency and span is 1 MHz. RB of the spectrum is 30 kHz and VB of the spectrum is 100 kHz (LTE Bandwidth 3 MHz).
- The center frequency of spectrum is the band edge frequency and span is 1 MHz. RB of the spectrum is 51 kHz and VB of the spectrum is 160 kHz (LTE Bandwidth 5 MHz).
- The center frequency of spectrum is the band edge frequency and span is 1 MHz. RB of the spectrum is 100 kHz and VB of the spectrum is 300 kHz (LTE Bandwidth 10 MHz).
- The center frequency of spectrum is the band edge frequency and span is 1 MHz. RB of the spectrum is 150 kHz and VB of the spectrum is 470 kHz (LTE Bandwidth 15 MHz).
- The center frequency of spectrum is the band edge frequency and span is 1 MHz. RB of the spectrum is 200 kHz and VB of the spectrum is 1 MHz (LTE Bandwidth 20 MHz).
- Record the max trace plot into the test report.

### 4.5.4 Test Results

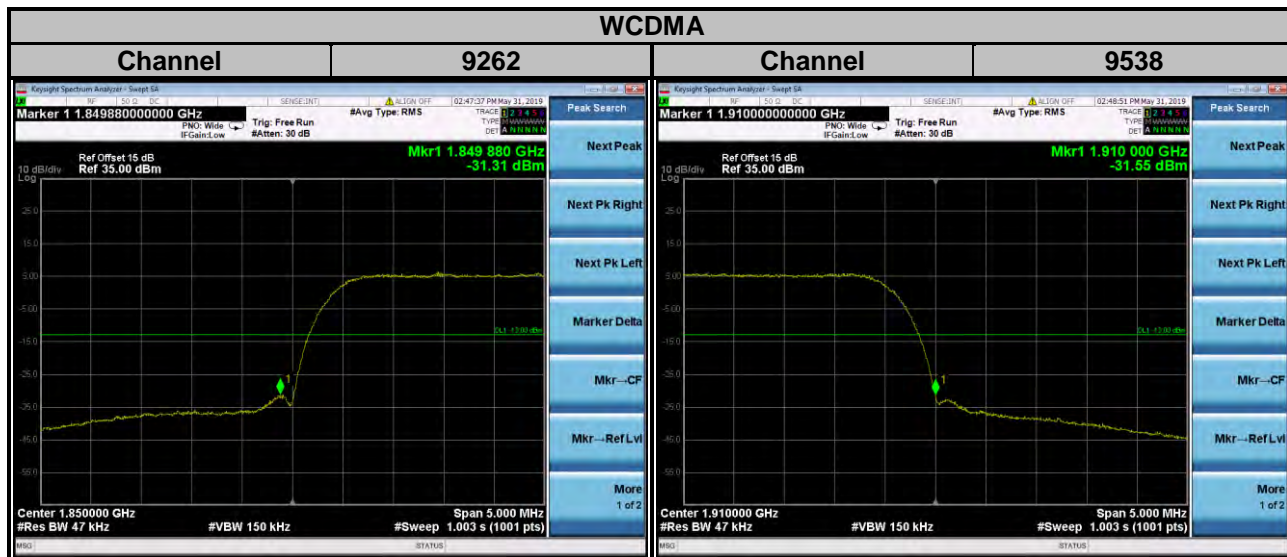

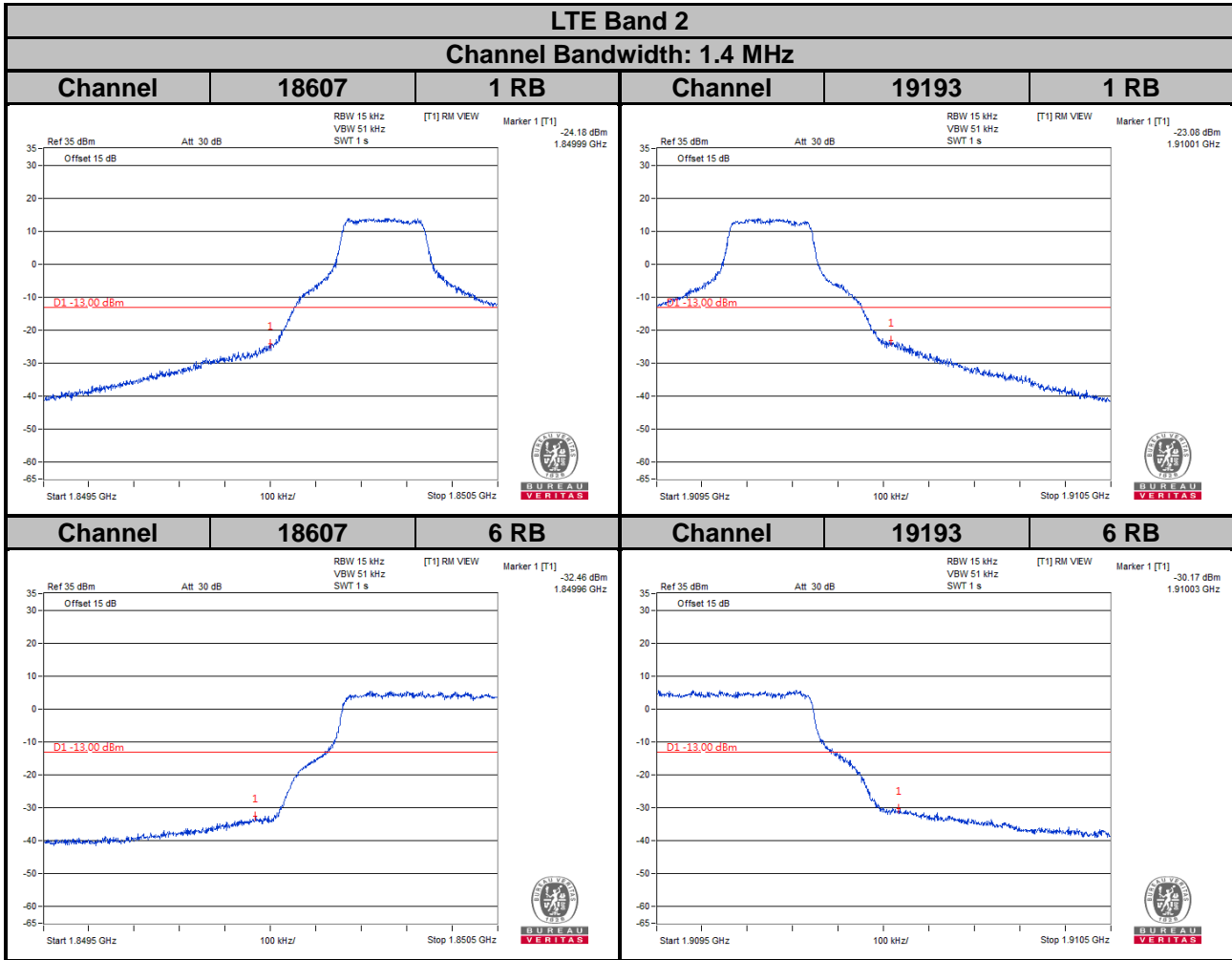

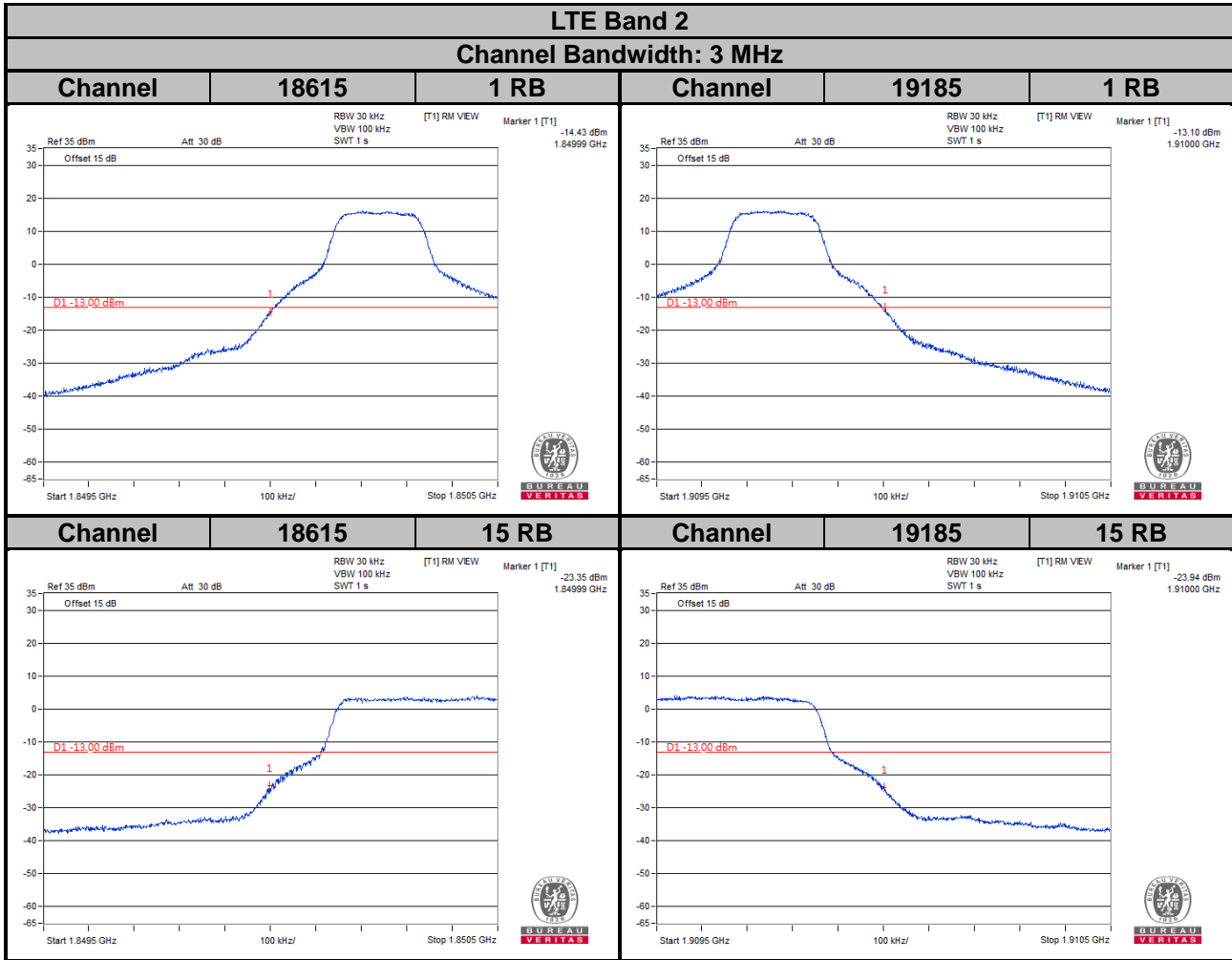

**LTE Band 2**  
**Channel Bandwidth: 5 MHz**

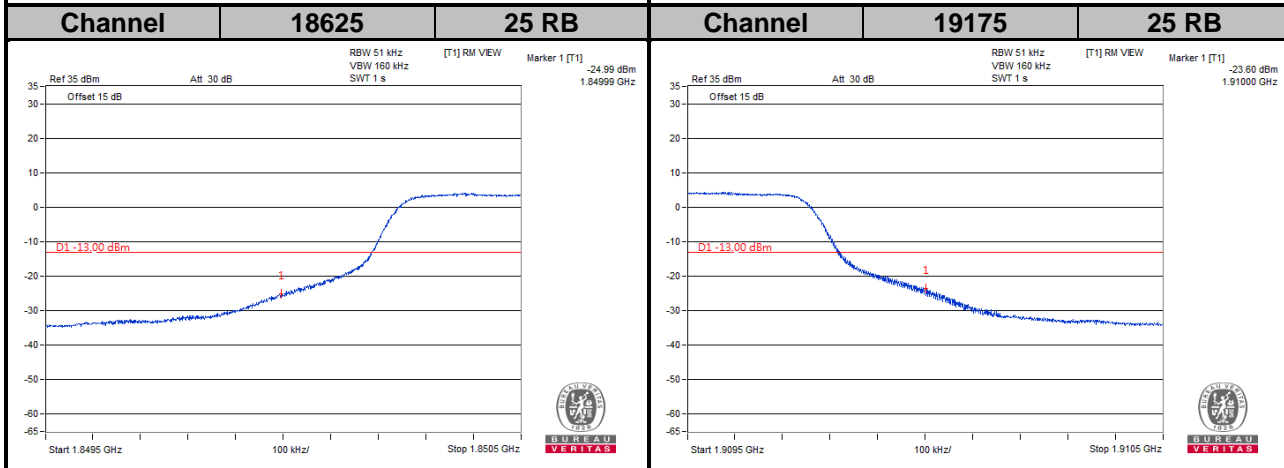
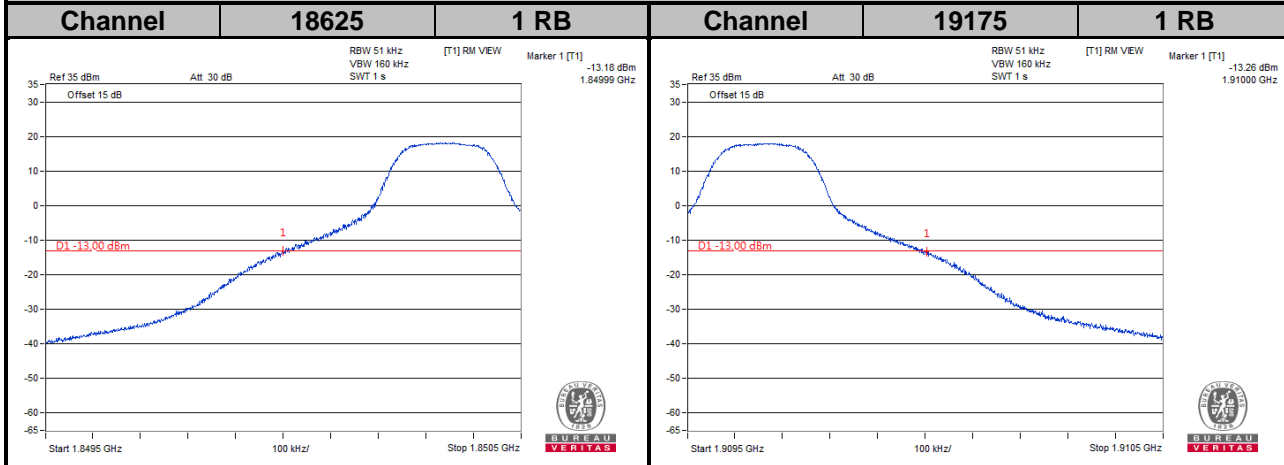



**LTE Band 2**  
**Channel Bandwidth: 10 MHz**

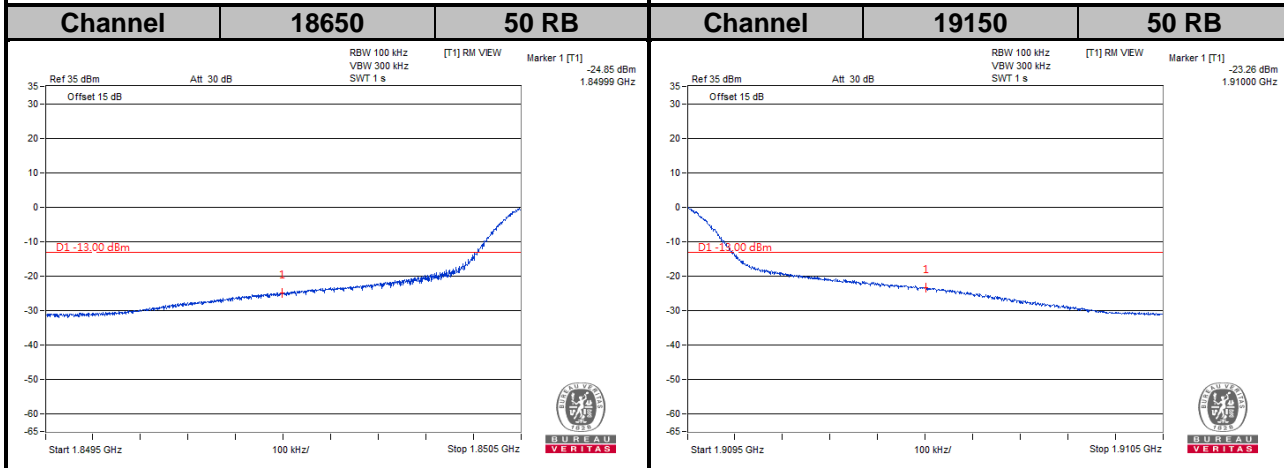
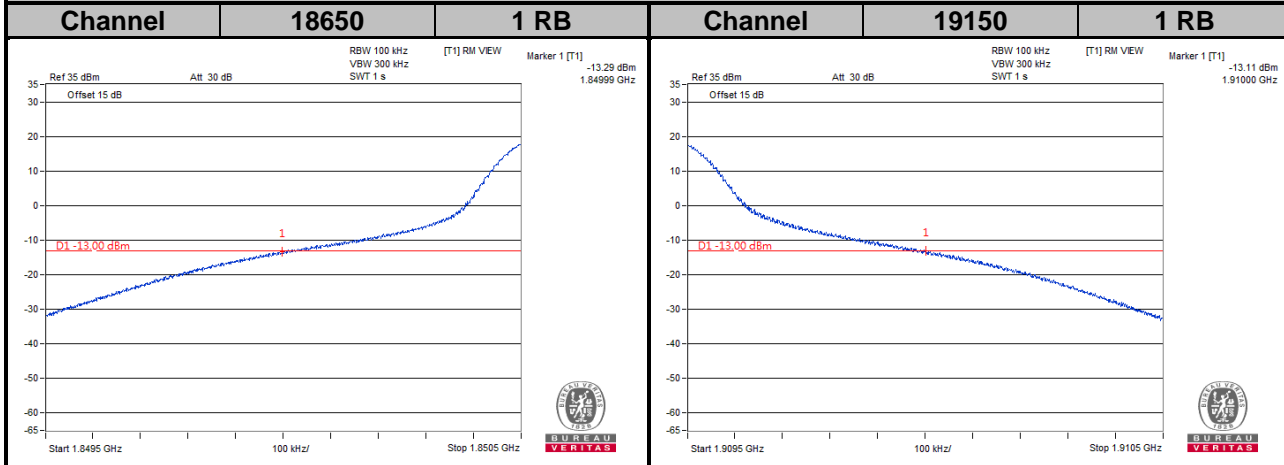

**LTE Band 2**  
**Channel Bandwidth: 15 MHz**

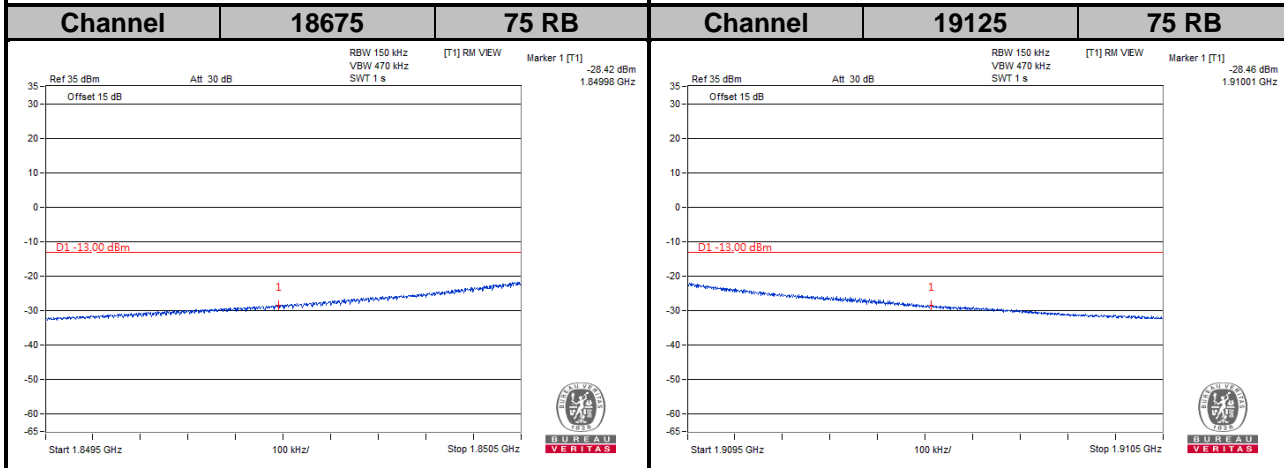
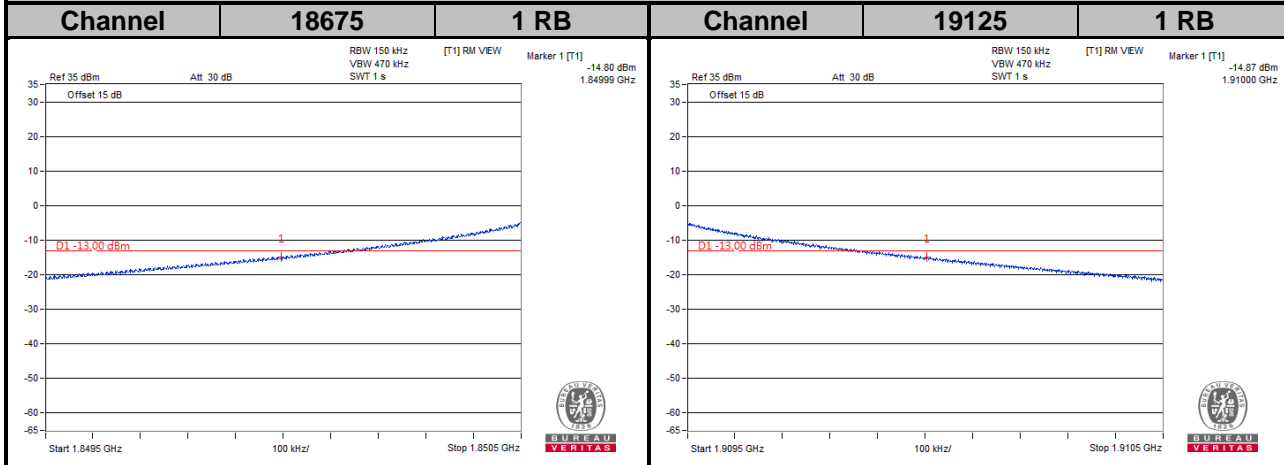

**LTE Band 2**  
**Channel Bandwidth: 20 MHz**

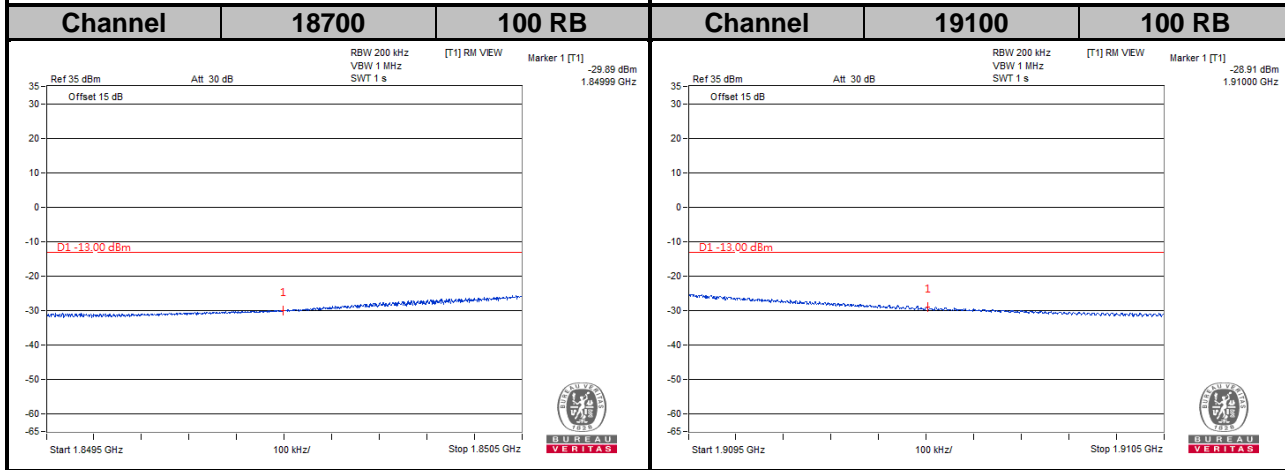
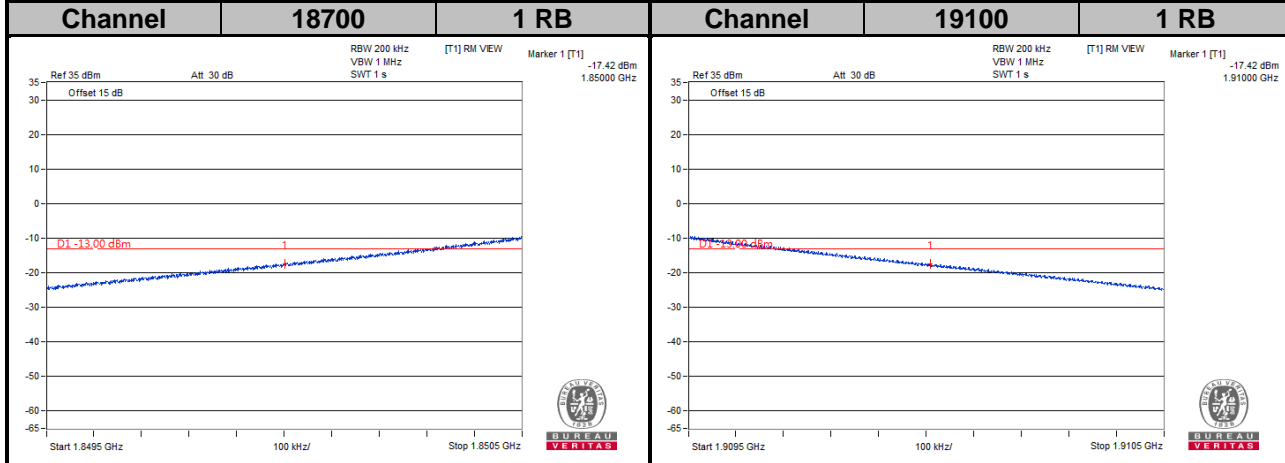

## 4.6 Peak to Average Ratio

### 4.6.1 Limits of Peak to Average Ratio Measurement

In measuring transmissions in this band using an average power technique, the peak to-average ratio (PAR) of the transmission may not exceed 13 dB.

### 4.6.2 Test Setup

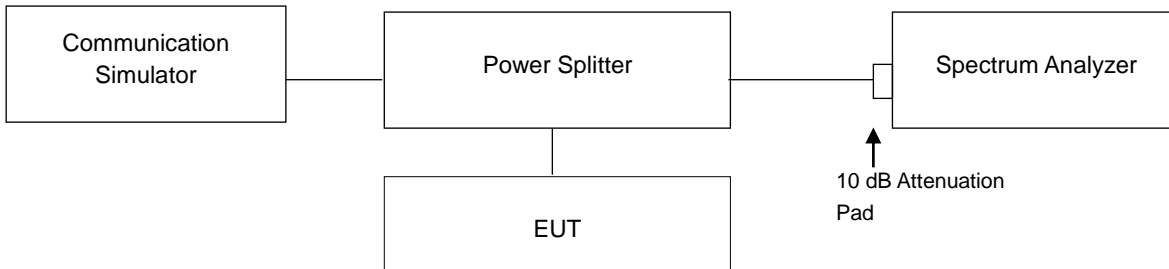

### 4.6.3 Test Procedures

1. Set resolution/measurement bandwidth  $\geq$  signal's occupied bandwidth;
2. Set the number of counts to a value that stabilizes the measured CCDF curve;
3. Record the maximum PAPR level associated with a probability of 0.1 %.

### 4.6.4 Test Results

Channel	Frequency (MHz)	Peak to Average Ratio (dB)
		WCDMA
9262	1852.4	3.43
9400	1880.0	3.43
9538	1907.6	3.38

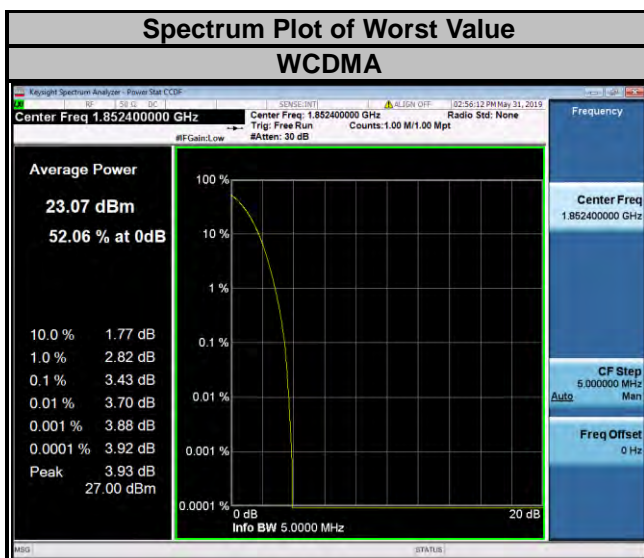

LTE Band 2							
Channel Bandwidth: 1.4 MHz				Channel Bandwidth: 3 MHz			
Channel	Frequency (MHz)	Peak to Average Ratio (dB)		Channel	Frequency (MHz)	Peak to Average Ratio (dB)	
		QPSK	16QAM			QPSK	16QAM
18607	1850.7	5.87	6.89	18615	1851.5	5.99	6.84
18900	1880.0	6.04	6.27	18900	1880.0	6.18	6.26
19193	1909.3	5.15	5.71	19185	1908.5	5.44	6.13

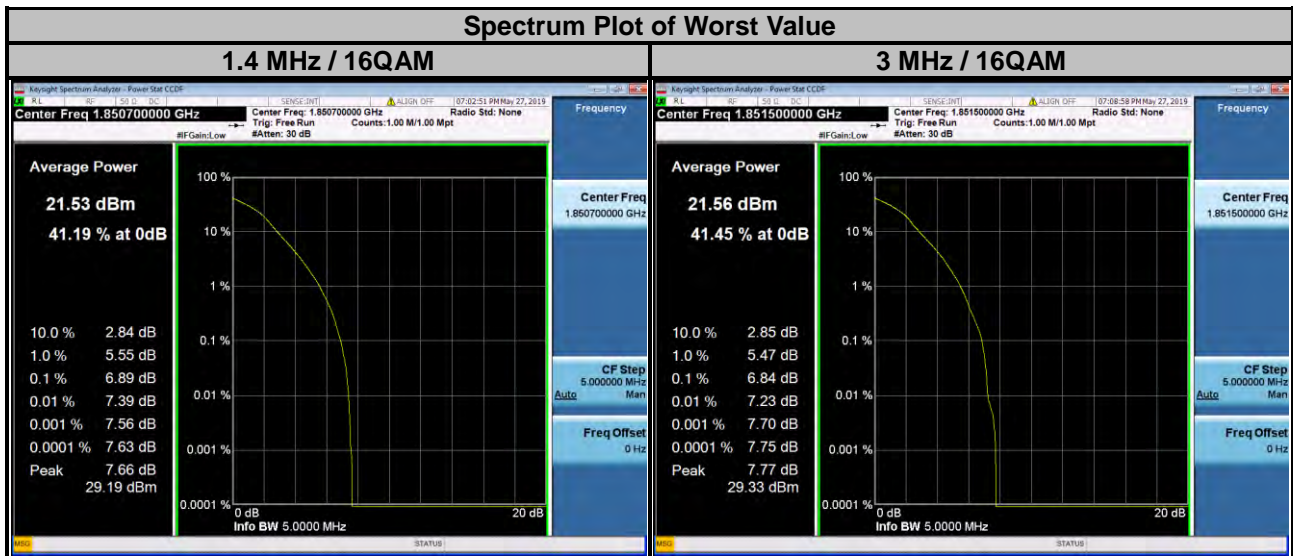

LTE Band 2							
Channel Bandwidth: 5 MHz				Channel Bandwidth: 10 MHz			
Channel	Frequency (MHz)	Peak to Average Ratio (dB)		Channel	Frequency (MHz)	Peak to Average Ratio (dB)	
		QPSK	16QAM			QPSK	16QAM
18625	1852.5	5.90	6.61	18650	1855.0	5.95	6.61
18900	1880.0	5.93	6.08	18900	1880.0	6.11	6.29
19175	1907.5	5.68	6.32	19150	1905.0	5.84	6.80

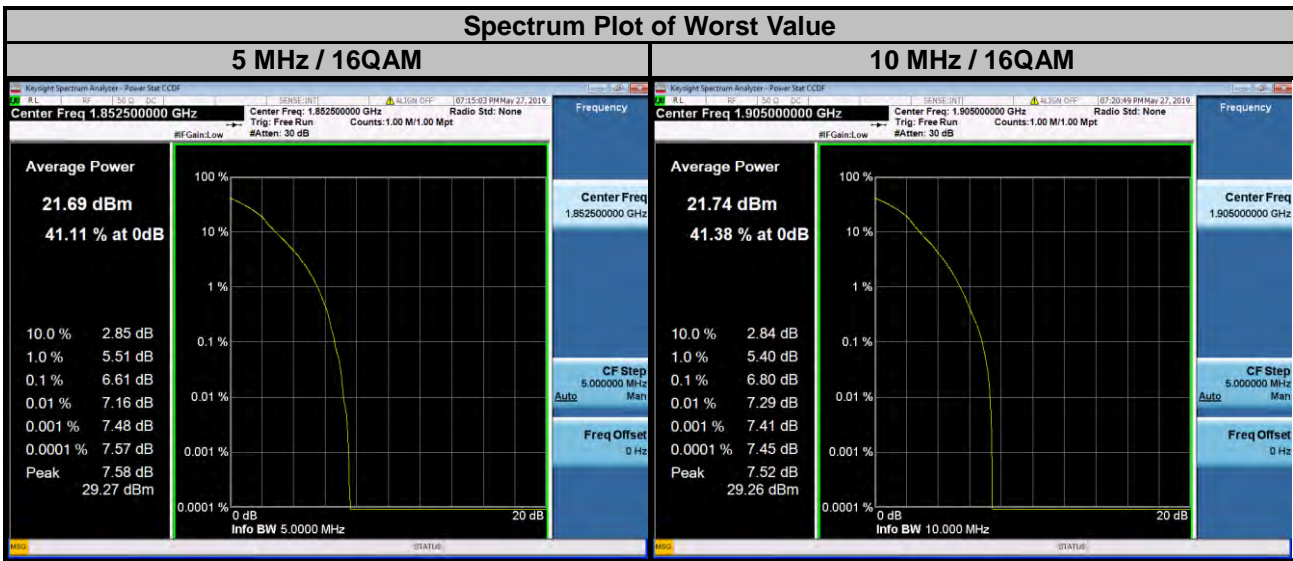

LTE Band 2							
Channel Bandwidth: 15 MHz				Channel Bandwidth: 20 MHz			
Channel	Frequency (MHz)	Peak to Average Ratio (dB)		Channel	Frequency (MHz)	Peak to Average Ratio (dB)	
		QPSK	16QAM			QPSK	16QAM
18675	1857.5	6.03	6.83	18700	1860.0	6.16	6.78
18900	1880.0	6.10	6.25	18900	1880.0	6.22	6.92
19125	1902.5	5.96	6.78	19100	1900.0	6.02	6.57

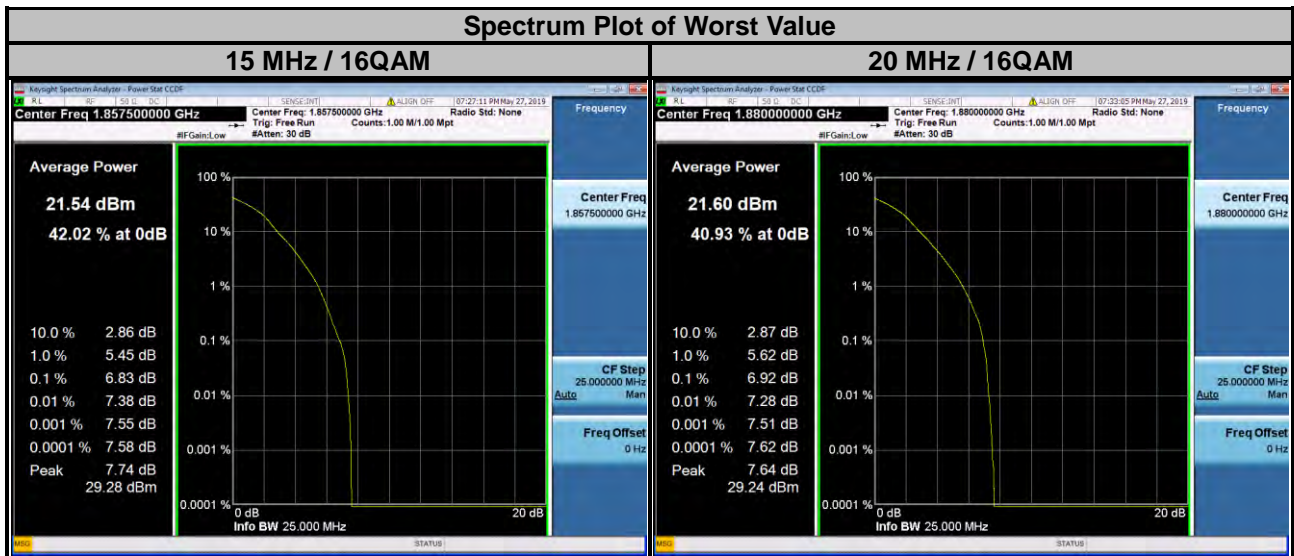

## 4.7 Conducted Spurious Emissions

### 4.7.1 Limits of Conducted Spurious Emissions Measurement

The power of any emission outside of the authorized operating frequency ranges must be attenuated below the transmitting power (P) by a factor of at least  $43 + 10 \log(P)$  dB. The emission limit equal to -13 dBm.

### 4.7.2 Test Setup

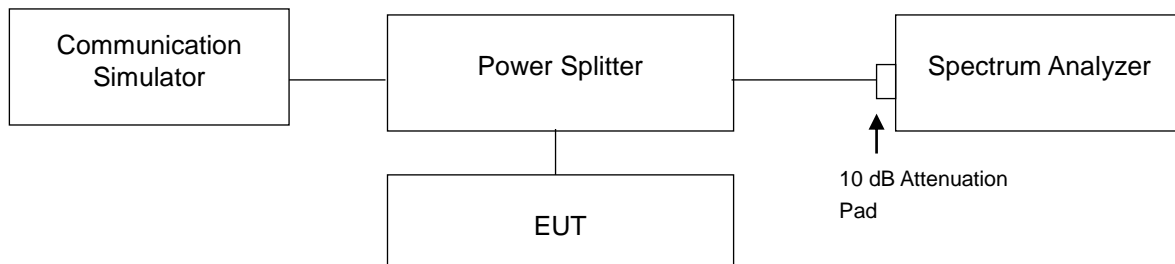

### 4.7.3 Test Procedure

- The EUT makes a phone call to the communication simulator. All measurements were done at low, middle and high operational frequency range.
- Measuring frequency range is from 9 kHz to 1 GHz. 10 dB attenuation pad is connected with spectrum. RBW = 100 kHz and VBW = 300 kHz is used for WCDMA conducted emission measurement. RBW = 300 kHz and VBW = 1 MHz is used for LTE conducted emission measurement.
- Measuring frequency range is from 1 GHz to 20 GHz. 10 dB attenuation pad is connected with spectrum. RBW = 1 MHz and VBW = 3 MHz is used for conducted emission measurement.
- Spectrum RBW settings are referenced to ANSI 63.2-1996 section 8.2.2 and ANSI 63.26 section 5.7.2.



### 4.7.4 Test Results

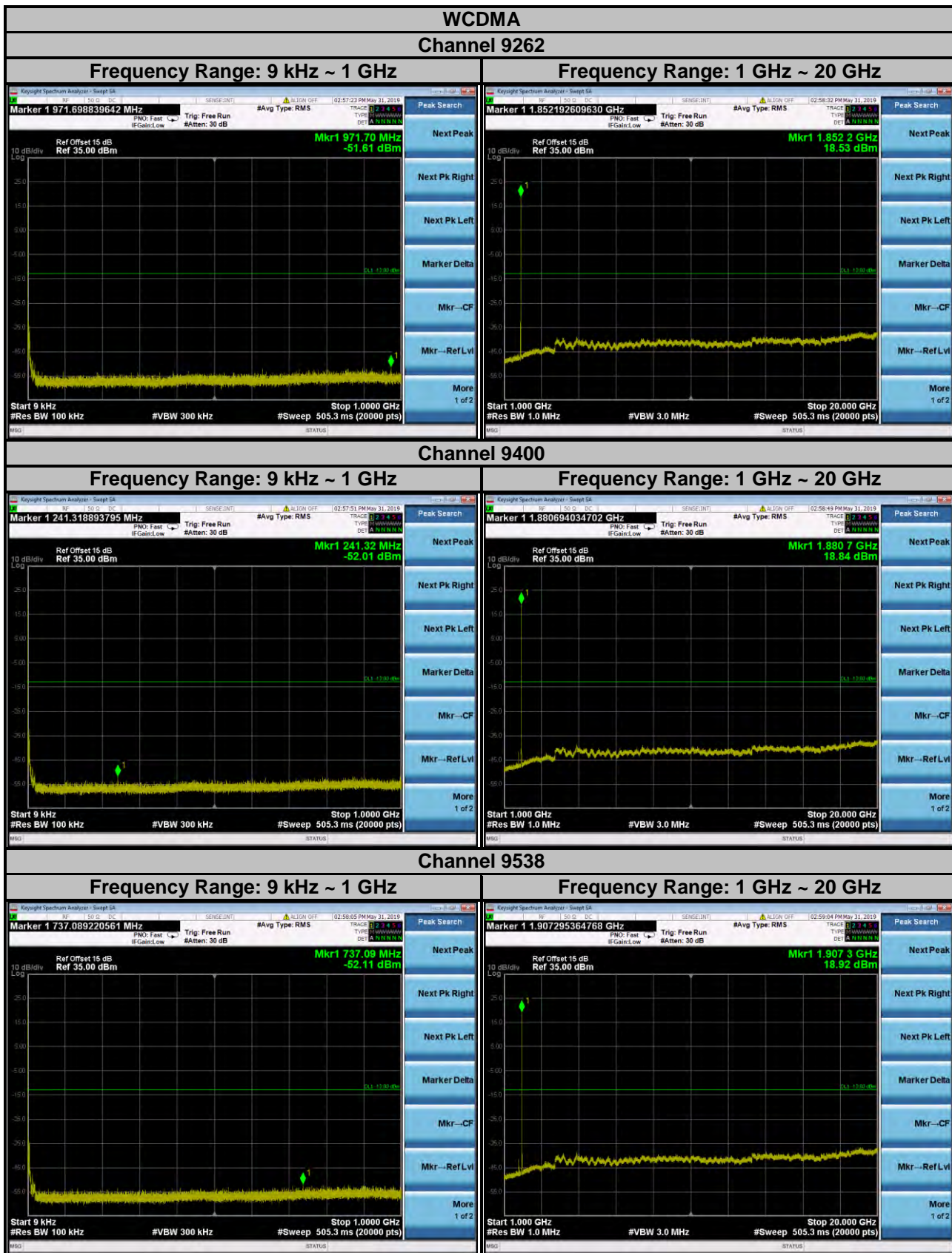

Note: The signal over the limit in 9 kHz is from spectrum analyzer.

**LTE Band 2**  
**Channel Bandwidth: 1.4 MHz**  
**Channel 18607**

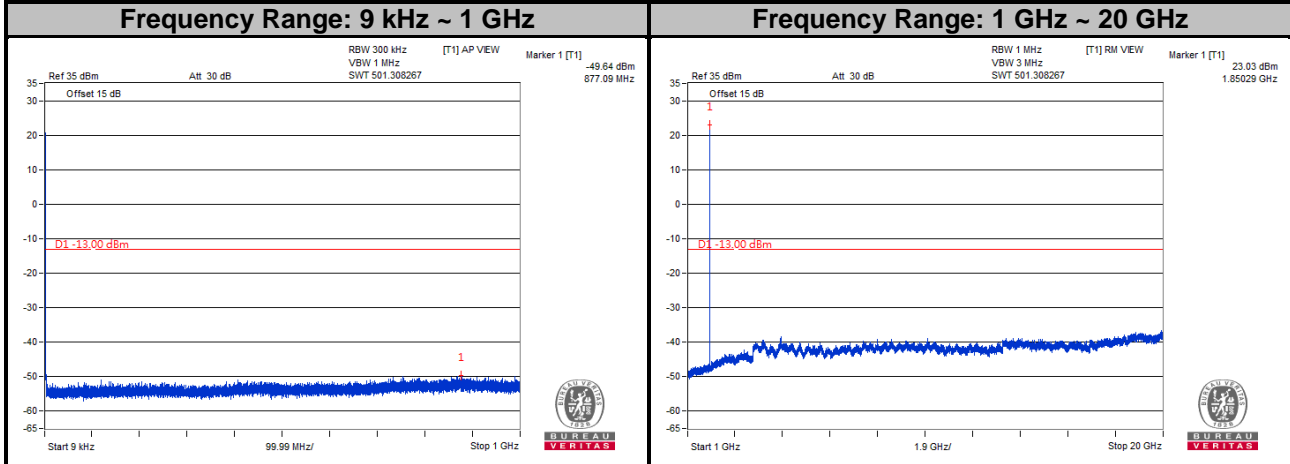

**Channel 18900**

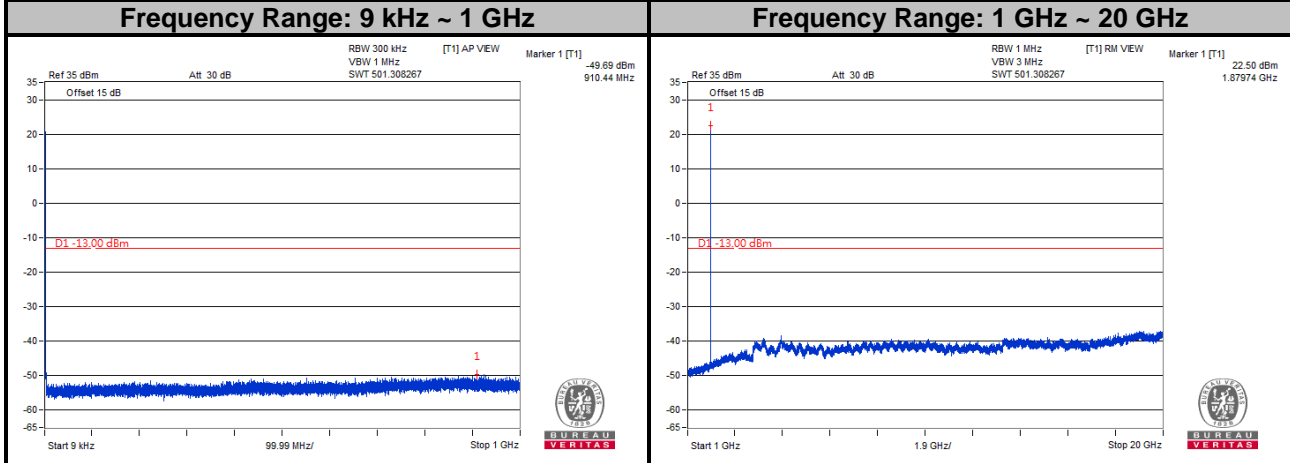

**Channel 19193**

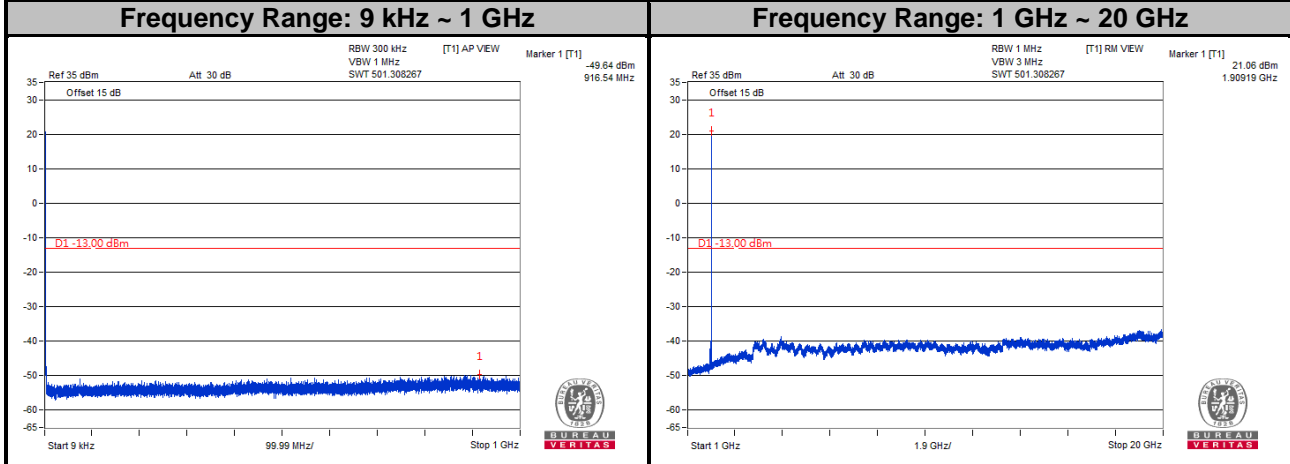

Note: The signal over the limit in 9 kHz is from spectrum analyzer.

**LTE Band 2**  
**Channel Bandwidth: 3 MHz**  
**Channel 18615**

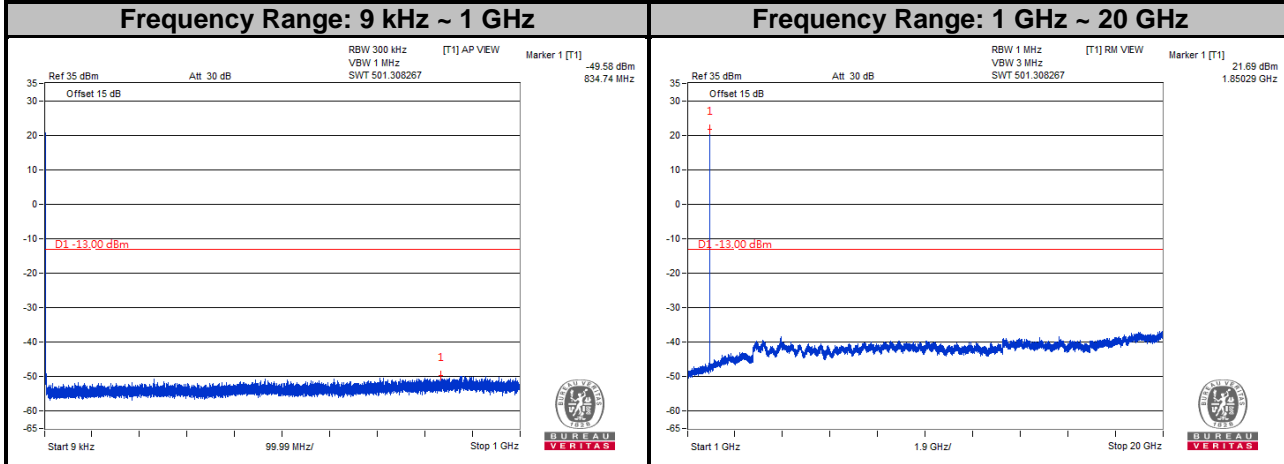

**Channel 18900**

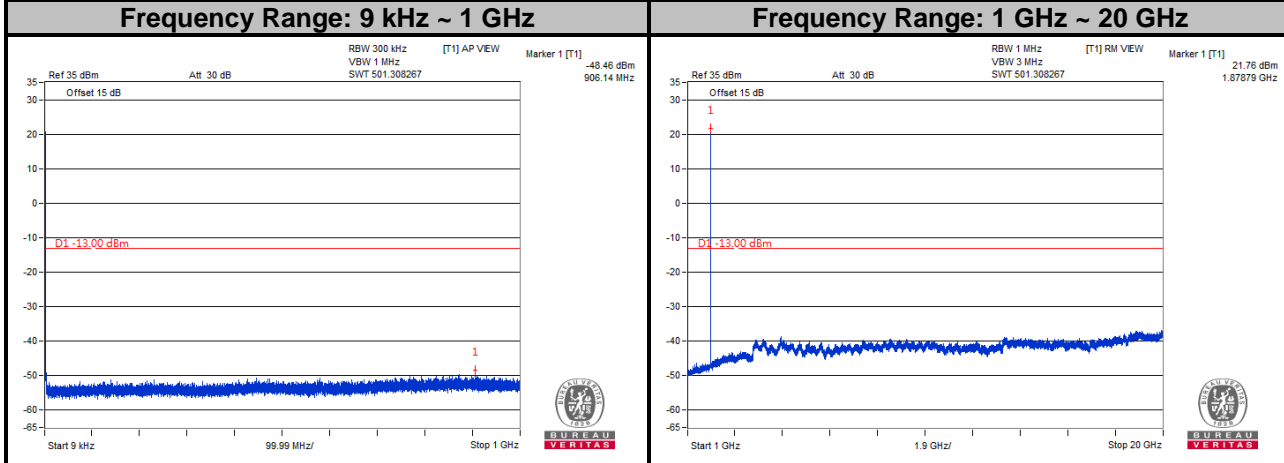

**Channel 19185**

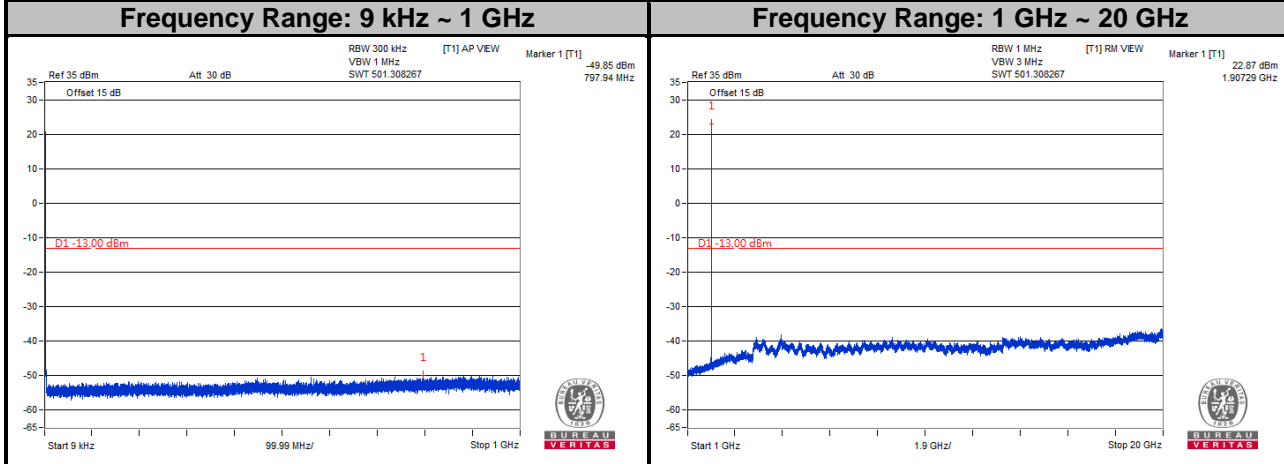

Note: The signal over the limit in 9 kHz is from spectrum analyzer.

**LTE Band 2**  
**Channel Bandwidth: 5 MHz**  
**Channel 18625**

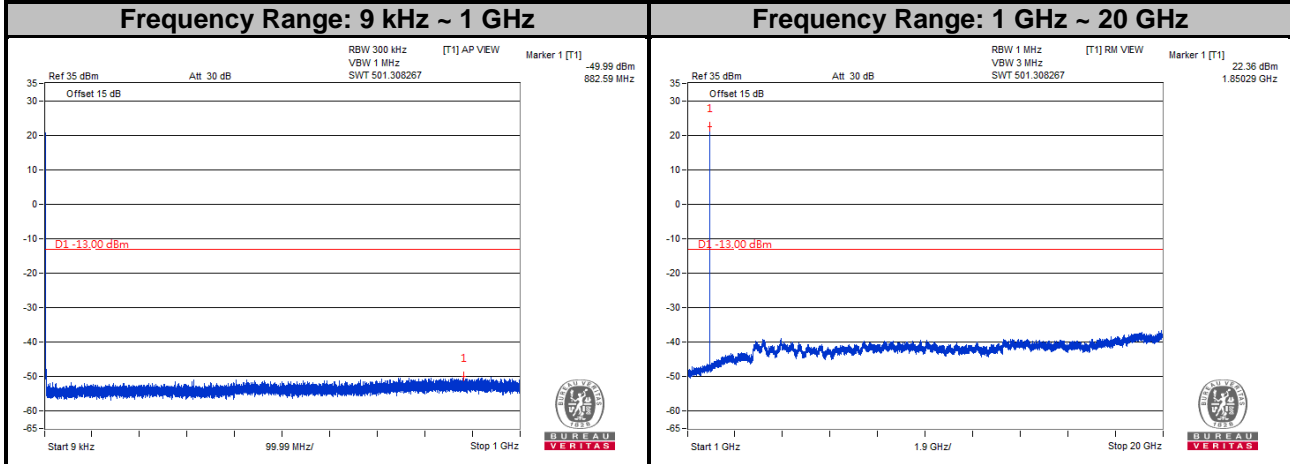

**Channel 18900**

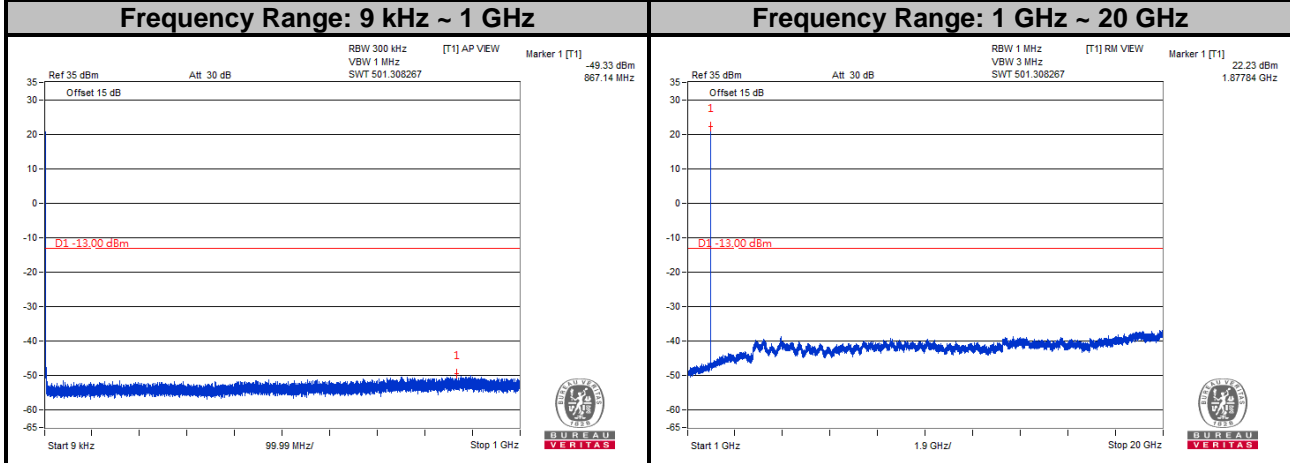

**Channel 19175**

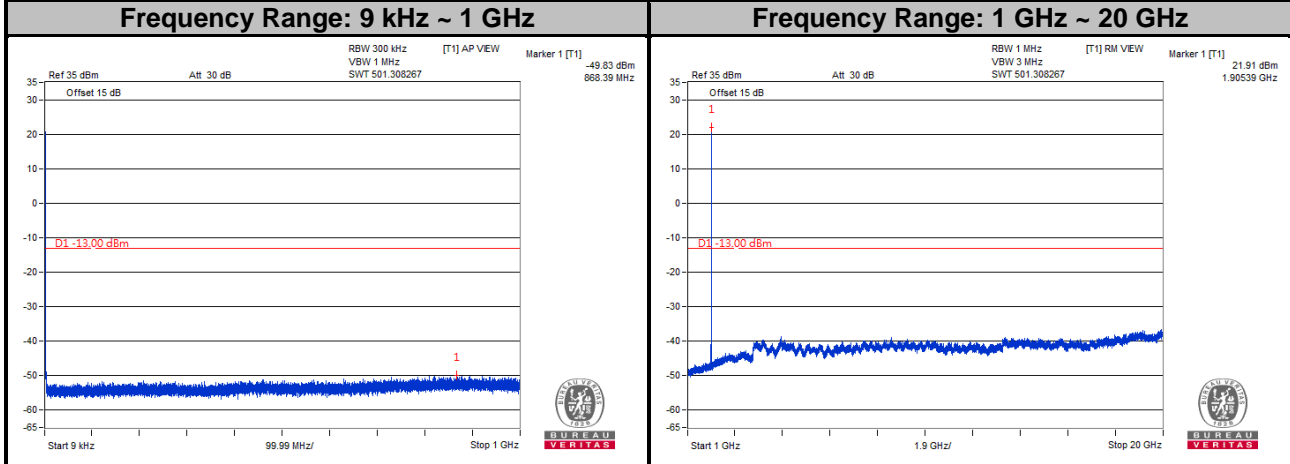

Note: The signal over the limit in 9 kHz is from spectrum analyzer.

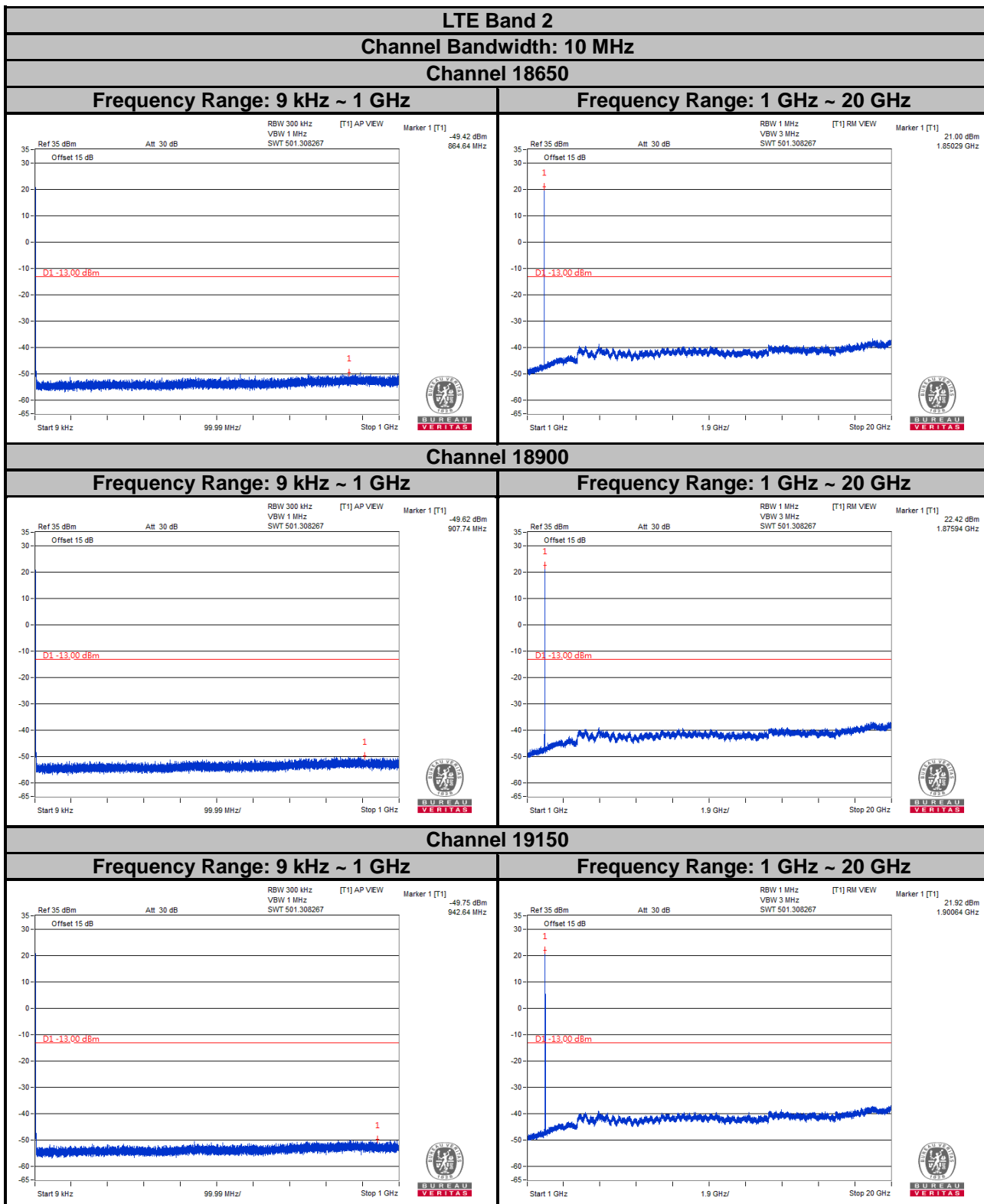

Note: The signal over the limit in 9 kHz is from spectrum analyzer.

**LTE Band 2**  
**Channel Bandwidth: 15 MHz**  
**Channel 18675**

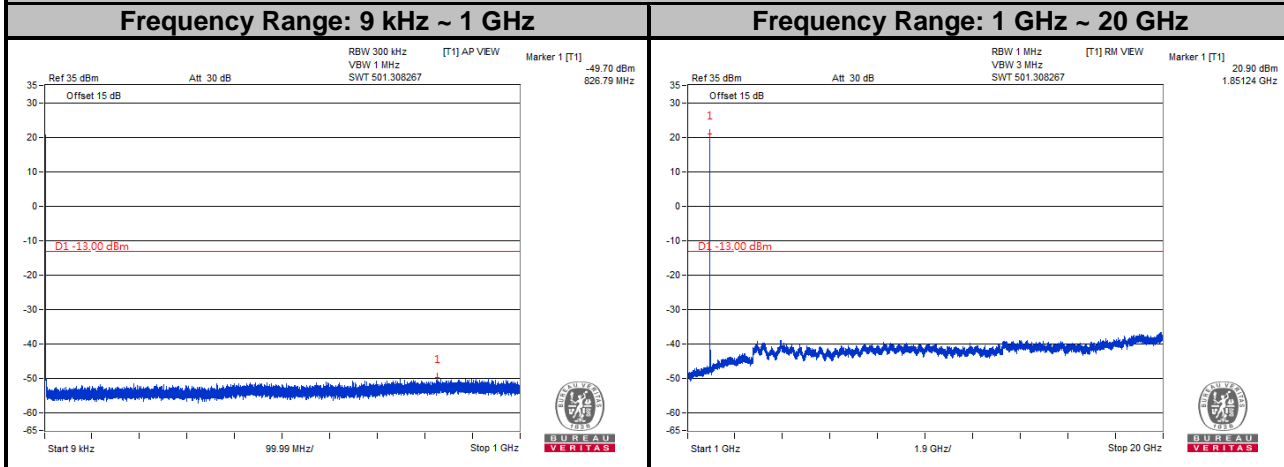

**Channel 18900**

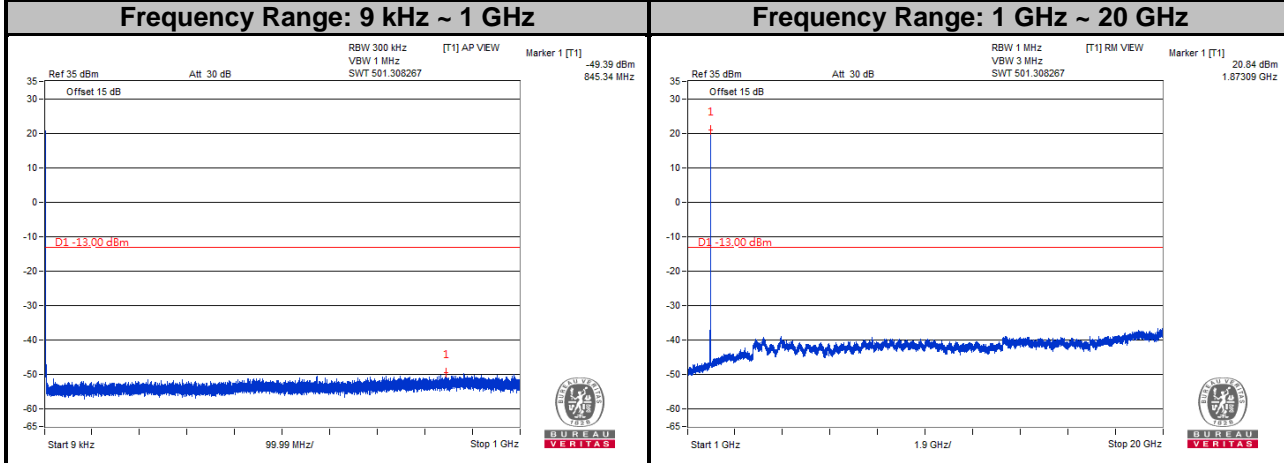

**Channel 19125**

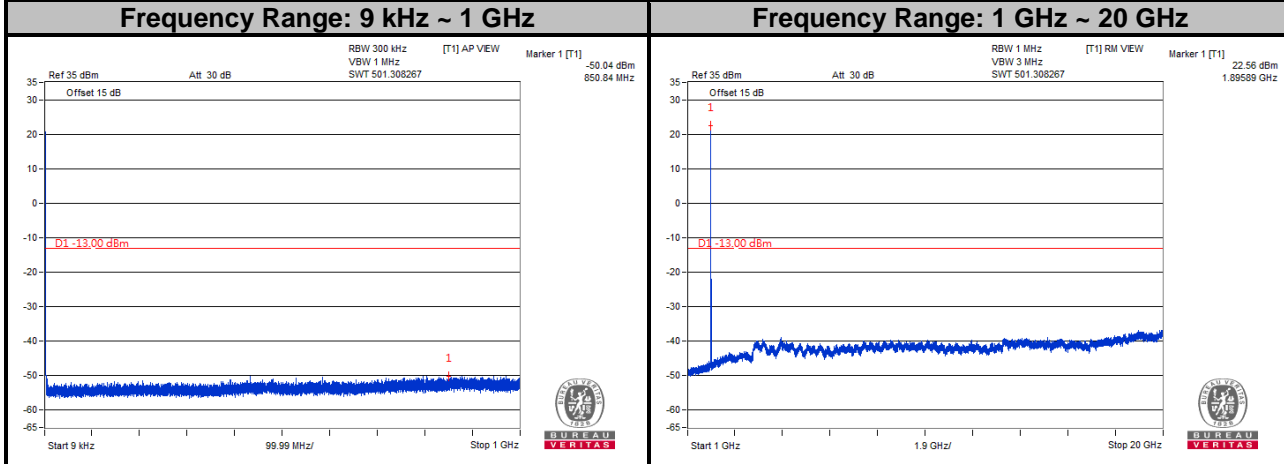

Note: The signal over the limit in 9 kHz is from spectrum analyzer.

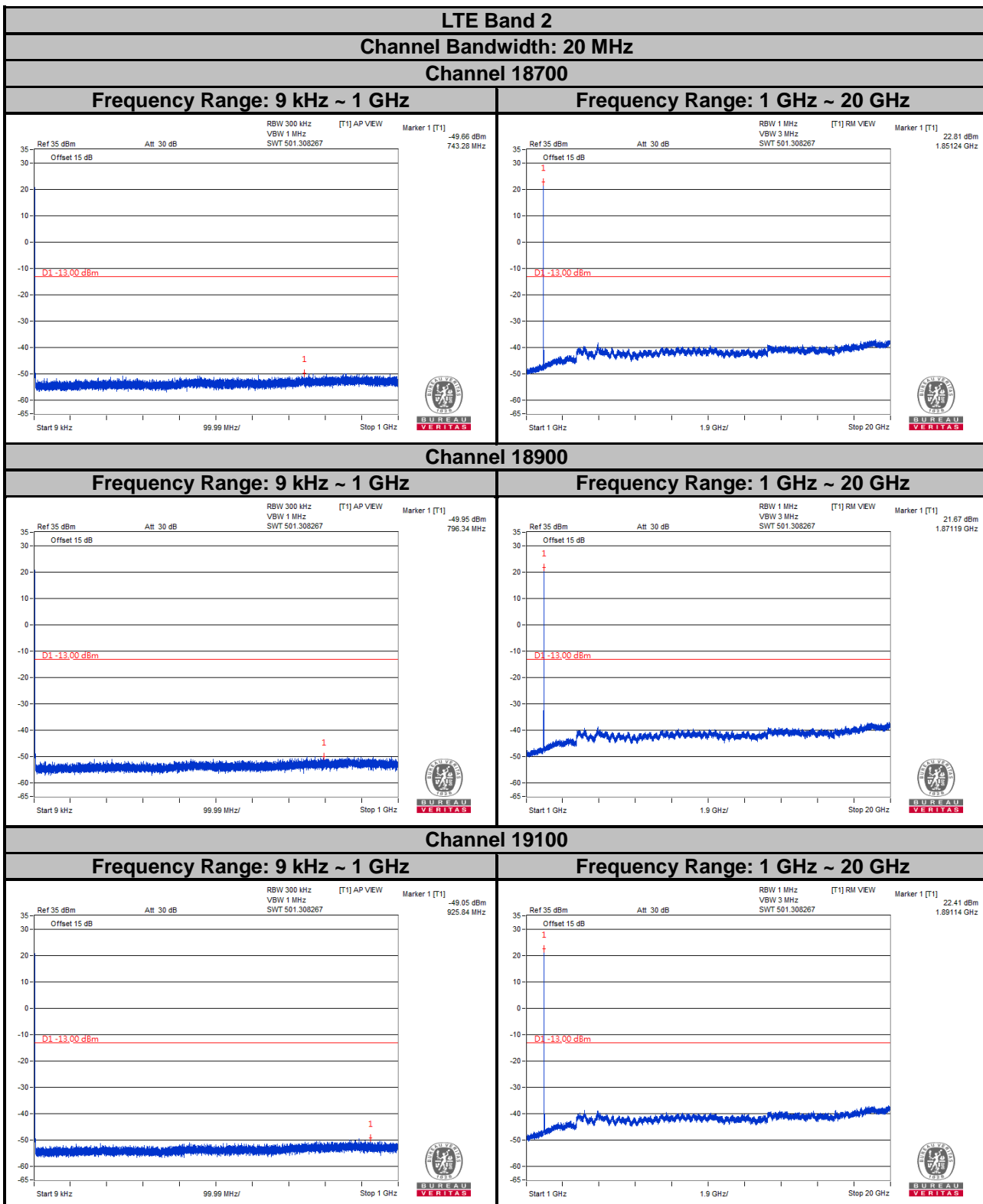

Note: The signal over the limit in 9 kHz is from spectrum analyzer.

## 4.8 Radiated Emission Measurement

### 4.8.1 Limits of Radiated Emission Measurement

The power of any emission outside of the authorized operating frequency ranges must be attenuated below the transmitting power (P) by a factor of at least  $43 + 10 \log(P)$  dB. The emission limit is equal to -13 dBm.

### 4.8.2 Test Procedure

- a. Substitution method is used for E.I.R.P measurement. In the semi-anechoic chamber, EUT placed on the 0.8 m (below or equal 1 GHz) and/or 1.5 m (above 1 GHz) height of Turn Table, rotated the table around 360 degrees to search the maximum radiation power and receiver antenna shall be rotated vertical and horizontal polarization and moved height from 1 m to 4 m to find the maximum polar radiated power. The "Read Value" is the spectrum reading the maximum power value.
- b. The substitution horn antenna is substituted for EUT at the same position and signals generator export the CW signal to the substitution antenna via a TX cable. Rotated the Turn Table and moved receiving antenna to find the maximum radiation power. Adjust output power level of S.G to get a Value of spectrum reading equal to "Read Value" of step a. Record the power level of S.G.
- c.  $EIRP = \text{Output power level of S.G} - \text{TX cable loss} + \text{Antenna gain of substitution horn}$ .
- d. E.R.P power can be calculated form E.I.R.P power by subtracting the gain of dipole,  $E.R.P \text{ power} = E.I.R.P \text{ power} - 2.15 \text{ dB}$ .

**NOTE:** The resolution bandwidth and video bandwidth of test receiver/spectrum analyzer is 1 MHz/3 MHz.

### 4.8.3 Deviation from Test Standard

No deviation.



#### 4.8.4 Test Setup

##### <Radiated Emission below or equal 1 GHz>

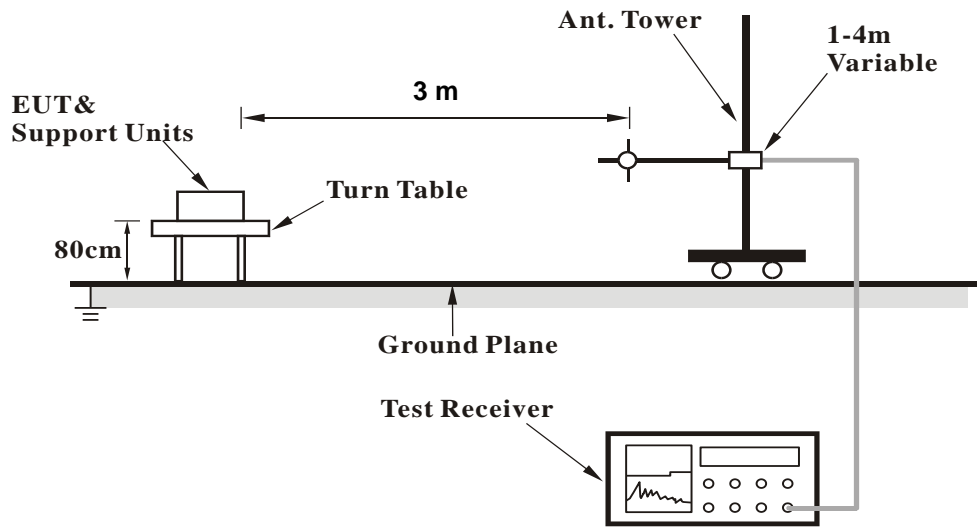

##### <Radiated Emission above 1 GHz>

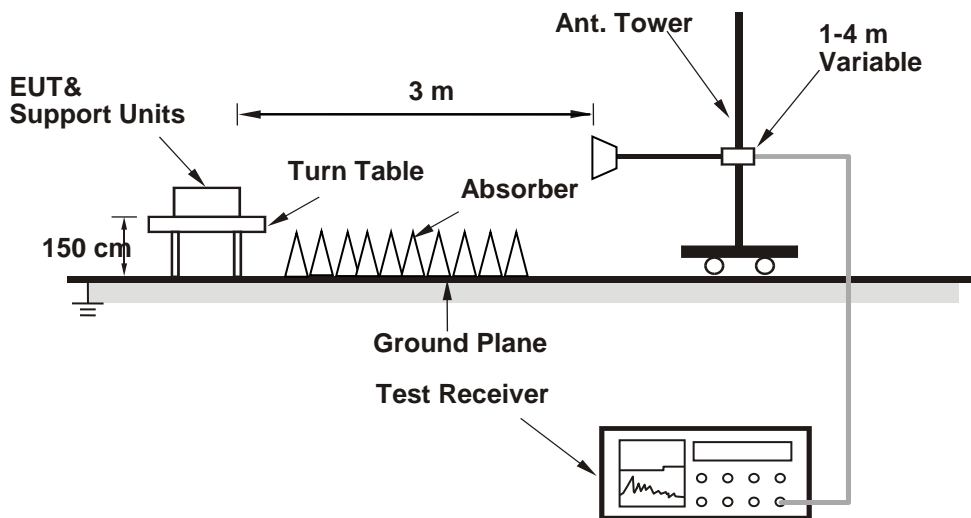

For the actual test configuration, please refer to the attached file (Test Setup Photo).

4.8.5 Test Results

WCDMA:

Low Channel



Bureau Veritas Consumer Products Services Ltd., Taoyuan Branch

A D T

Data: 3

Date: 06-05-2019

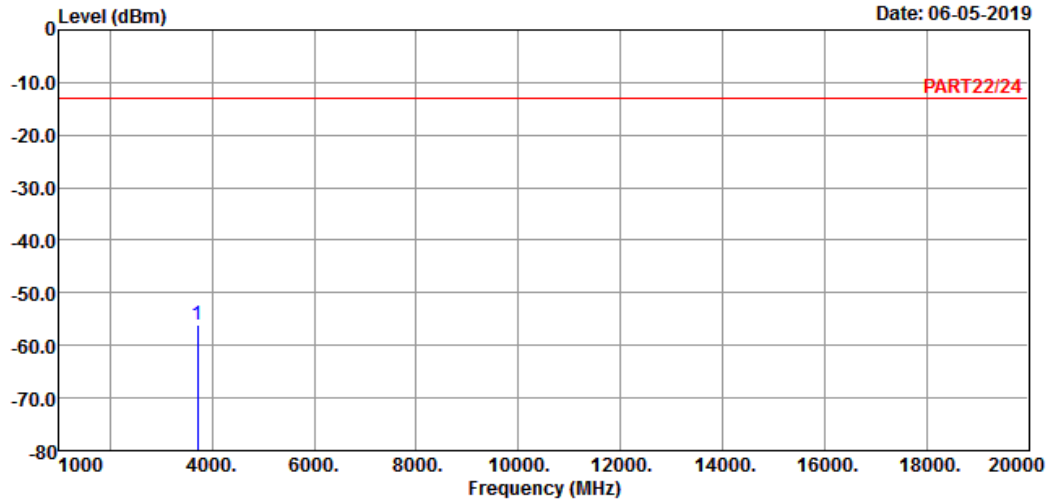

Site : 966 Chamber 5  
 Condition: PART22/24 HORIZONTAL  
 Remak : WCDMA Band 2 Link\_L-CH  
 Tested by: Thomas Wei

Freq	Level	Read Level	Limit	Line Factor	Over Limit	Remark
MHz	dBm	dBm	dBm	dB	dB	
1 pp 3704.80	-55.99	-49.06	-13.00	-6.93	-42.99	Peak



Bureau Veritas Consumer Products Services Ltd., Taoyuan Branch

A D T

Data: 4

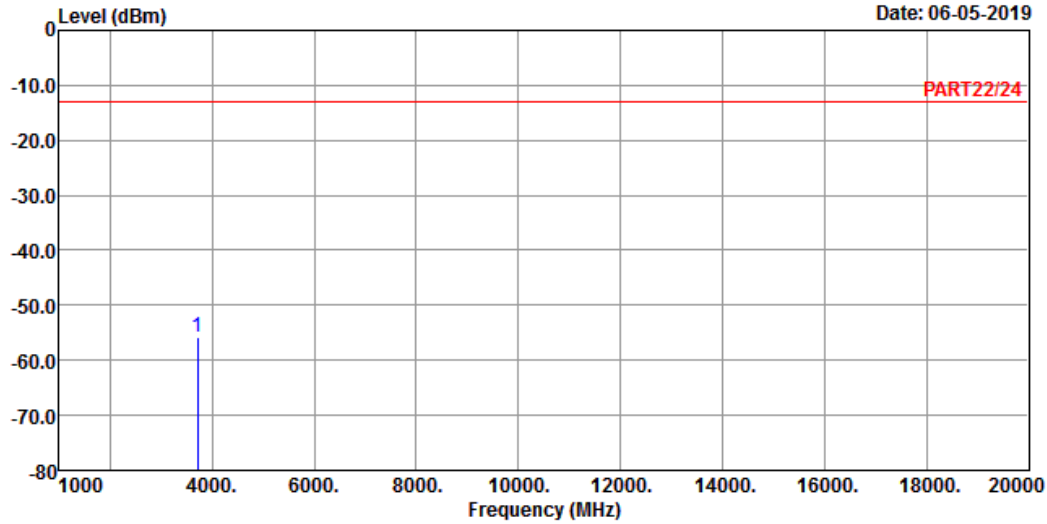

Site : 966 Chamber 5  
 Condition: PART22/24 VERTICAL  
 Remak : WCDMA Band 2 Link\_L-CH  
 Tested by: Thomas Wei

Freq	Level	Read Level	Limit	Over	Remark
MHz	dBm	dBm	dBm	dB	dB
1 pp 3704.80	-55.75	-48.82	-13.00	-6.93	-42.75 Peak

Middle Channel



Bureau Veritas Consumer Products Services Ltd., Taoyuan Branch

A D T

Data: 5

Date: 06-05-2019

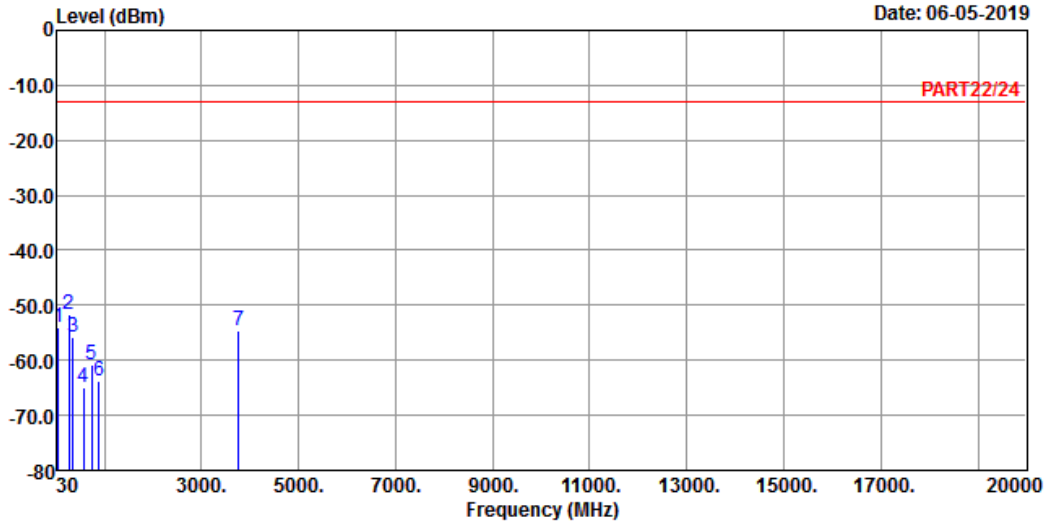

Site : 966 Chamber 5  
 Condition: PART22/24 HORIZONTAL  
 Remak : WCDMA Band 2 Link\_M-CH  
 Tested by: Thomas Wei

	Freq	Level	Read Level	Limit	Line	Factor	Over	Limit	Remark
	MHz	dBm	dBm	dBm		dB	dB	dB	
1	52.31	-53.99	-48.45	-13.00		-5.54	-40.99		Peak
2 pp	271.53	-51.69	-45.26	-13.00		-6.43	-38.69		Peak
3	354.95	-55.81	-49.60	-13.00		-6.21	-42.81		Peak
4	573.20	-64.95	-63.07	-13.00		-1.88	-51.95		Peak
5	730.34	-60.85	-61.35	-13.00		0.50	-47.85		Peak
6	888.45	-63.75	-64.26	-13.00		0.51	-50.75		Peak
7	3760.00	-54.59	-47.94	-13.00		-6.65	-41.59		Peak



Bureau Veritas Consumer Products Services Ltd., Taoyuan Branch

A D T

Data: 6

Date: 06-05-2019

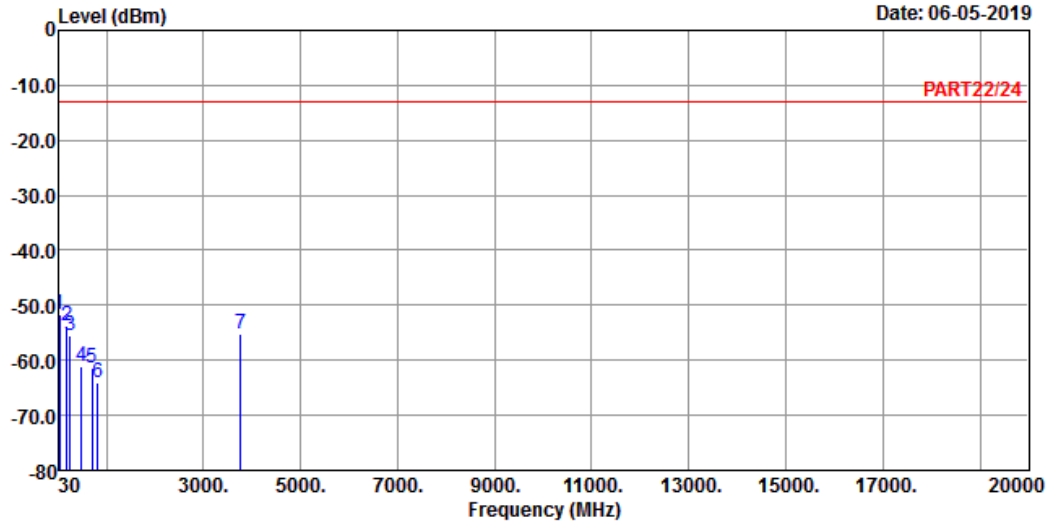

Site : 966 Chamber 5  
 Condition: PART22/24 VERTICAL  
 Remak : WCDMA Band 2 Link\_M-CH  
 Tested by: Thomas Wei

	Freq	Level	Read Level	Limit	Line	Factor	Over Limit	Remark
	MHz	dBm	dBm	dBm		dB	dB	
1 pp	42.61	-51.52	-50.58	-13.00		-0.94	-38.52	Peak
2	180.35	-53.83	-46.43	-13.00		-7.40	-40.83	Peak
3	260.86	-55.58	-49.37	-13.00		-6.21	-42.58	Peak
4	481.05	-61.10	-56.13	-13.00		-4.97	-48.10	Peak
5	701.24	-61.37	-61.29	-13.00		-0.08	-48.37	Peak
6	825.40	-64.12	-64.63	-13.00		0.51	-51.12	Peak
7	3760.00	-55.29	-48.64	-13.00		-6.65	-42.29	Peak

High Channel



Bureau Veritas Consumer Products Services Ltd., Taoyuan Branch

A D T

Data: 3

Date: 06-05-2019

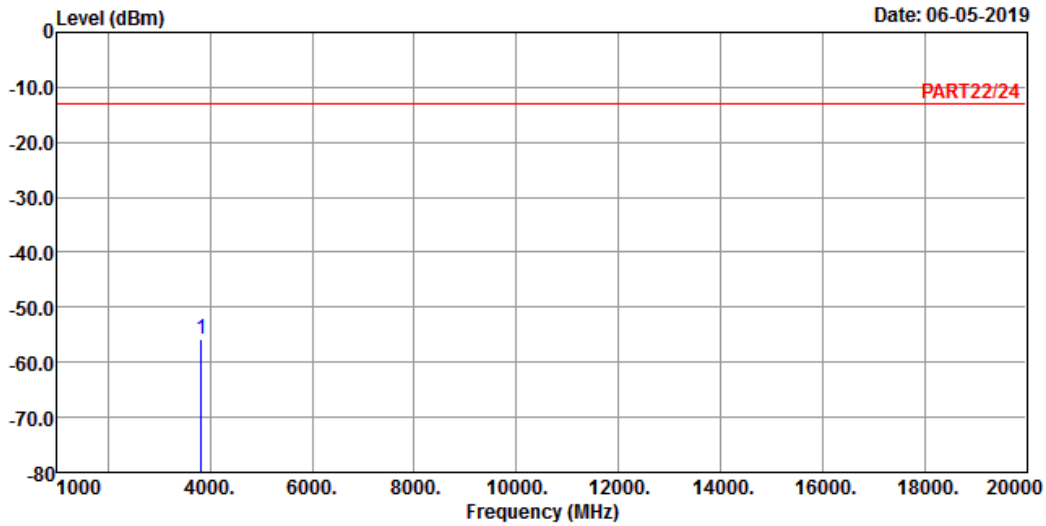

Site : 966 Chamber 5  
 Condition: PART22/24 HORIZONTAL  
 Remak : WCDMA Band 2 Link\_H-CH  
 Tested by: Thomas Wei

Freq	Level	Read Level	Limit	Line Factor	Over Limit	Remark
MHz	dBm	dBm	dBm	dB	dB	

1 pp 3817.50 -55.80 -49.40 -13.00 -6.40 -42.80 Peak



Bureau Veritas Consumer Products Services Ltd., Taoyuan Branch

A D T

Data: 4

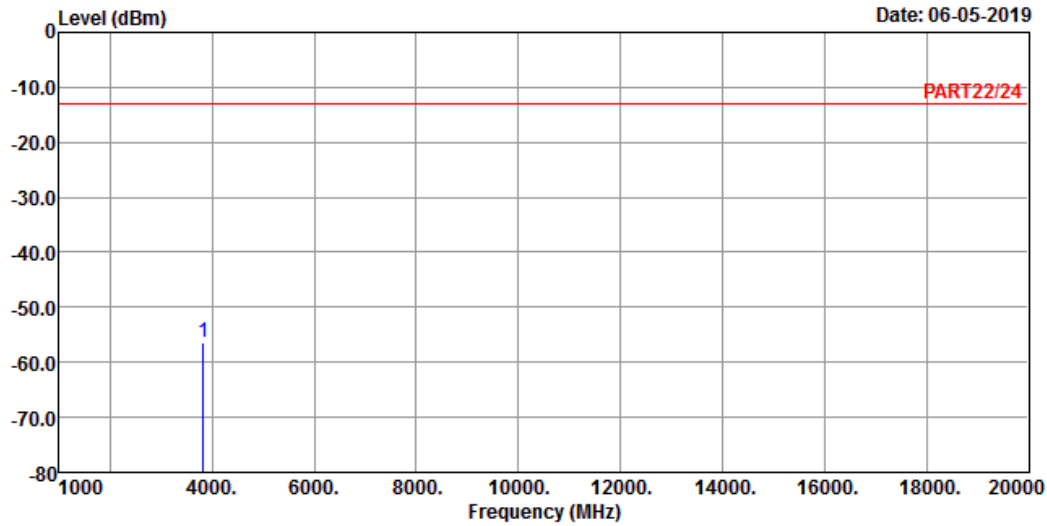

Date: 06-05-2019

Site : 966 Chamber 5  
 Condition: PART22/24 VERTICAL  
 Remak : WCDMA Band 2 Link\_H-CH  
 Tested by: Thomas Wei

Freq	Level	Read Level	Limit	Over	Remark
MHz	dBm	dBm	dBm	dB	dB
1 pp 3817.50	-56.24	-49.84	-13.00	-6.40	-43.24 Peak

LTE Band 2  
 Channel Bandwidth: 1.4 MHz / QPSK  
 Low Channel



Bureau Veritas Consumer Products Services Ltd., Taoyuan Branch

A D T

Data: 3

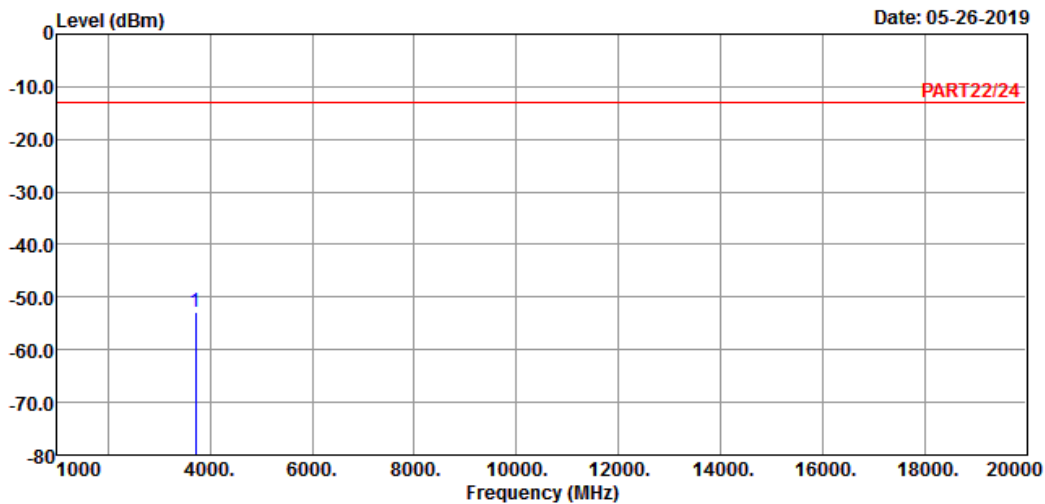

Site : 966 Chamber 5  
 Condition: PART22/24 HORIZONTAL  
 Remak : LTE Band 2 QPSK\_1.4M Link\_L-CH  
 Tested by: Getaz Yang

Freq	Level	Read Level	Limit	Line Factor	Over Limit	Remark
MHz	dBm	dBm	dBm	dB	dB	
1 pp 3710.40	-52.89	-46.02	-13.00	-6.87	-39.89	Peak





Bureau Veritas Consumer Products Services Ltd., Taoyuan Branch

A D T

Data: 4

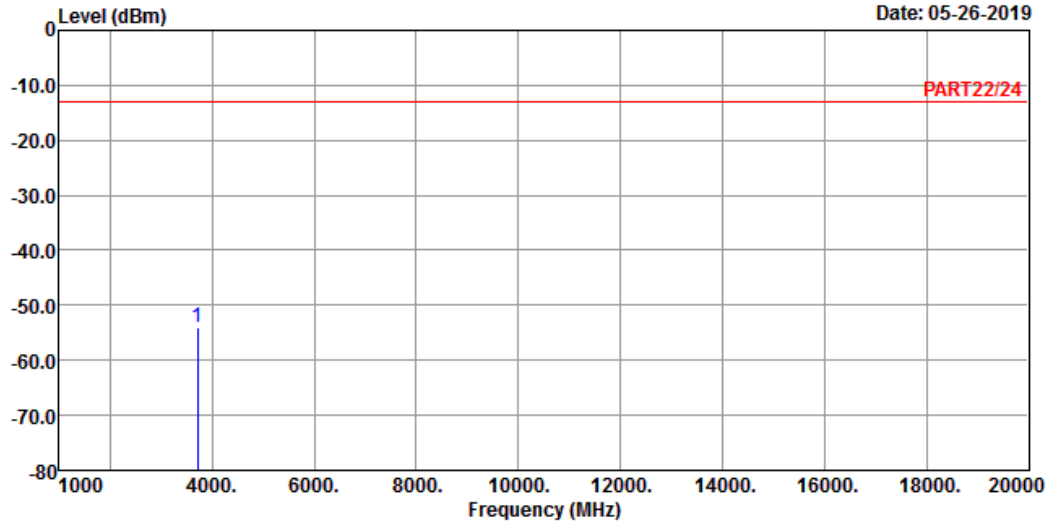

Site : 966 Chamber 5  
 Condition: PART22/24 VERTICAL  
 Remark : LTE Band 2 QPSK\_1.4M Link\_L-CH  
 Tested by: Getaz Yang

Freq	Level	Read Level	Limit	Line Factor	Over Limit	Remark
MHz	dBm	dBm	dBm	dB	dB	
1 pp 3710.40	-54.00	-47.13	-13.00	-6.87	-41.00	Peak

Middle Channel



Bureau Veritas Consumer Products Services Ltd., Taoyuan Branch

A D T

Data: 3

Date: 05-26-2019

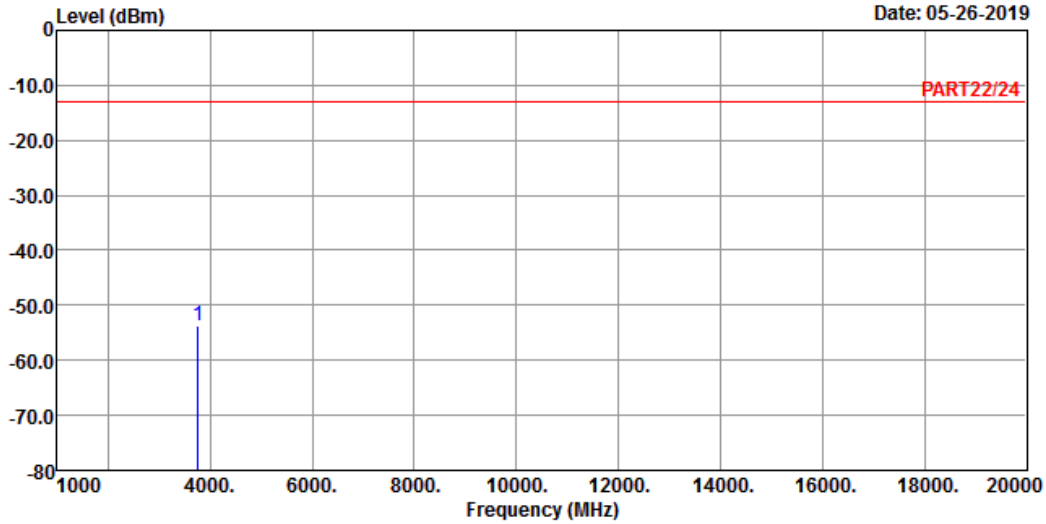

Site : 966 Chamber 5  
 Condition: PART22/24 HORIZONTAL  
 Remak : LTE Band 2 QPSK\_1.4M Link\_M-CH  
 Tested by: Getaz Yang

Freq	Level	Read Level	Limit	Line Factor	Over Limit	Remark
MHz	dBm	dBm	dBm	dB	dB	

1 pp 3760.00 -53.60 -46.95 -13.00 -6.65 -40.60 Peak



Bureau Veritas Consumer Products Services Ltd., Taoyuan Branch

A D T

Data: 4

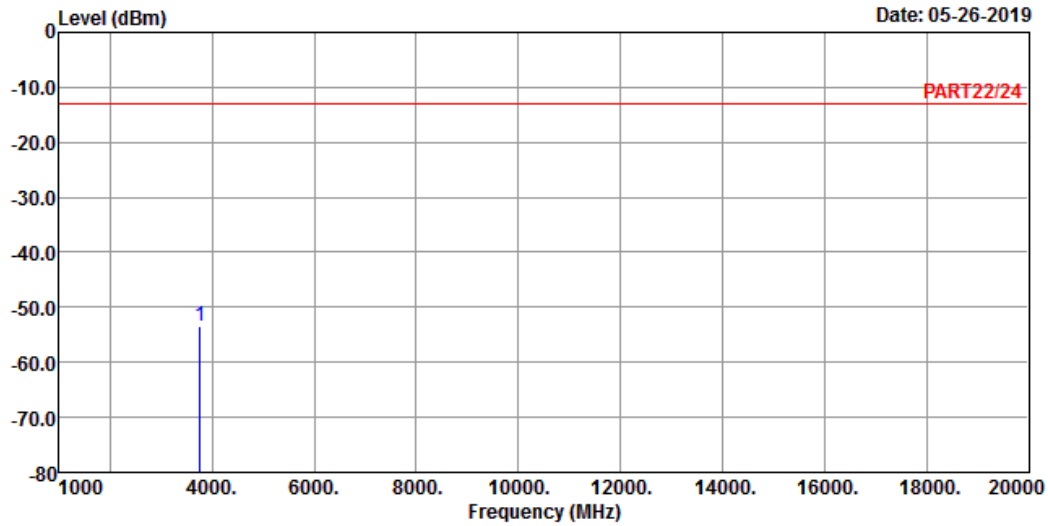

Site : 966 Chamber 5  
 Condition: PART22/24 VERTICAL  
 Remark : LTE Band 2 QPSK\_1.4M Link\_M-CH  
 Tested by: Getaz Yang

Freq	Level	Read Level	Limit	Line Factor	Over Limit	Remark
MHz	dBm	dBm	dBm	dB	dB	
1 pp 3760.00	-53.35	-46.70	-13.00	-6.65	-40.35	Peak

# High Channel



Bureau Veritas Consumer Products Services Ltd., Taoyuan Branch

A D T

Data: 3

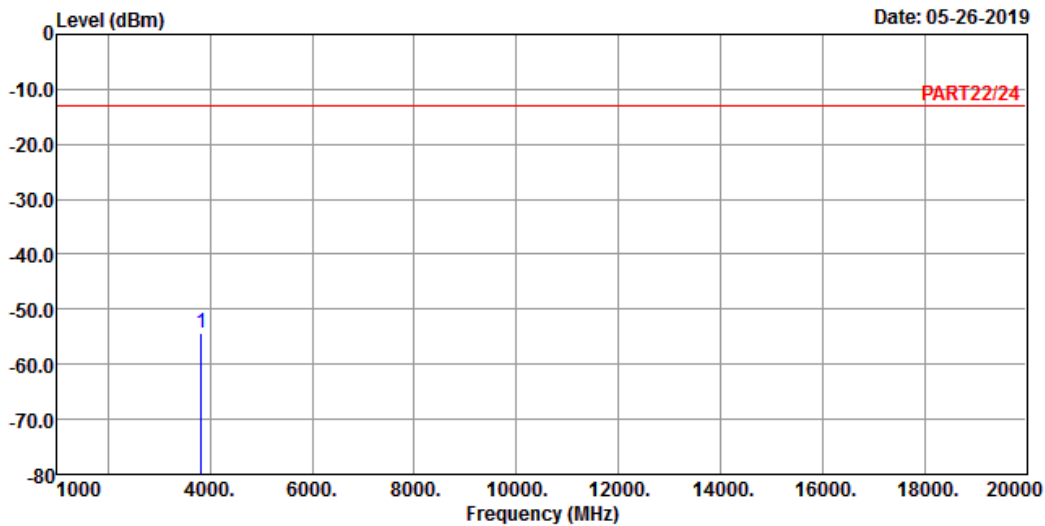

Site : 966 Chamber 5  
 Condition: PART22/24 HORIZONTAL  
 Remak : LTE Band 2 QPSK\_1.4M Link\_H-CH  
 Tested by: Getaz Yang

Freq	Level	Read Level	Limit	Line Factor	Over Limit	Remark
MHz	dBm	dBm	dBm	dB	dB	

1 pp 3818.60 -54.25 -47.85 -13.00 -6.40 -41.25 Peak



Bureau Veritas Consumer Products Services Ltd., Taoyuan Branch

A D T

Data: 4

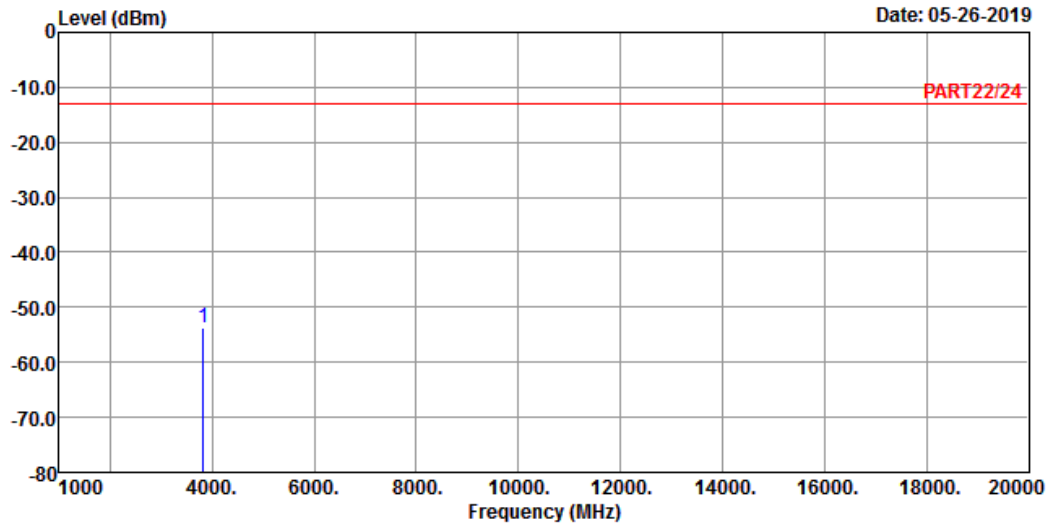

Site : 966 Chamber 5  
 Condition: PART22/24 VERTICAL  
 Remark : LTE Band 2 QPSK\_1.4M Link\_H-CH  
 Tested by: Getaz Yang

Freq	Level	Read Level	Limit	Line Factor	Over Limit	Remark
MHz	dBm	dBm	dBm	dB	dB	
1 pp 3818.60	-53.69	-47.29	-13.00	-6.40	-40.69	Peak

Channel Bandwidth: 5 MHz / QPSK  
Low Channel



Bureau Veritas Consumer Products Services Ltd., Taoyuan Branch

A D T

Data: 3

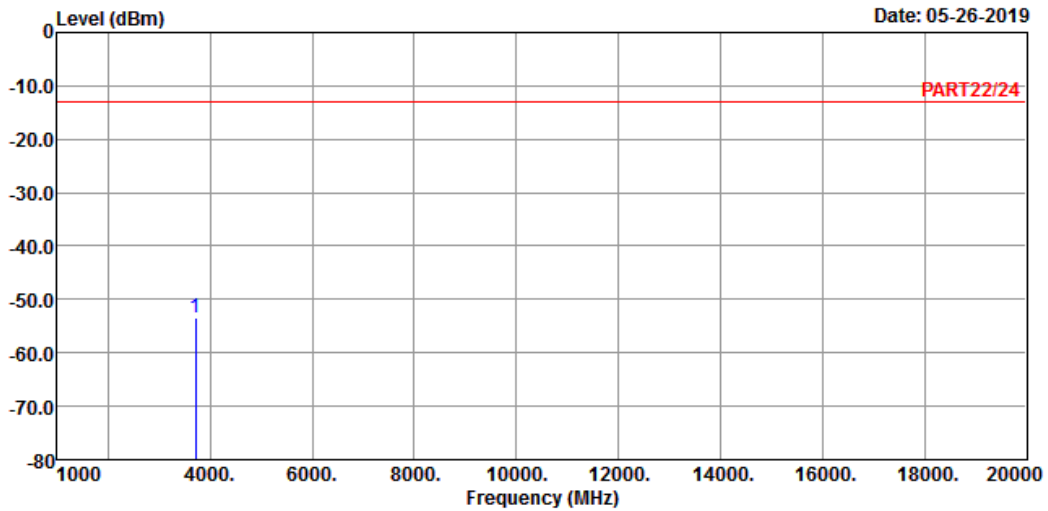

Site : 966 Chamber 5  
Condition: PART22/24 HORIZONTAL  
Remak : LTE Band 2 QPSK\_5M Link\_L-CH  
Tested by: Getaz Yang

Freq	Level	Read Level	Limit	Over	Remark
MHz	dBm	dBm	dBm	dB	
1 pp 3705.00	-53.38	-46.45	-13.00	-6.93	-40.38 Peak



Bureau Veritas Consumer Products Services Ltd., Taoyuan Branch

A D T

Data: 4

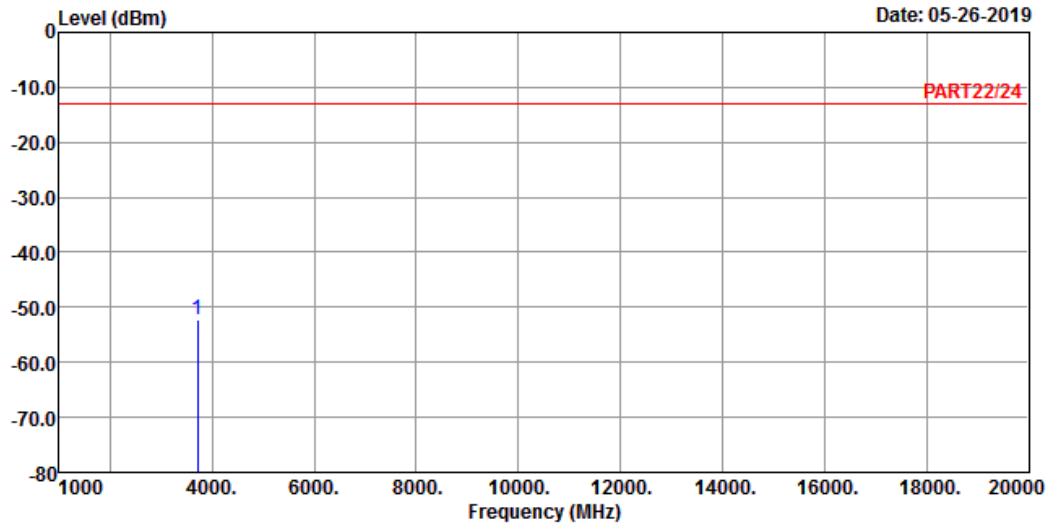

Site : 966 Chamber 5  
 Condition: PART22/24 VERTICAL  
 Remark : LTE Band 2 QPSK\_5M Link\_L-CH  
 Tested by: Getaz Yang

Freq	Level	Read Level	Limit	Line Factor	Over Limit	Remark
MHz	dBm	dBm	dBm	dB	dB	
1 pp 3705.00	-52.29	-45.36	-13.00	-6.93	-39.29	Peak

Middle Channel



Bureau Veritas Consumer Products Services Ltd., Taoyuan Branch

A D T

Data: 3

Date: 05-26-2019

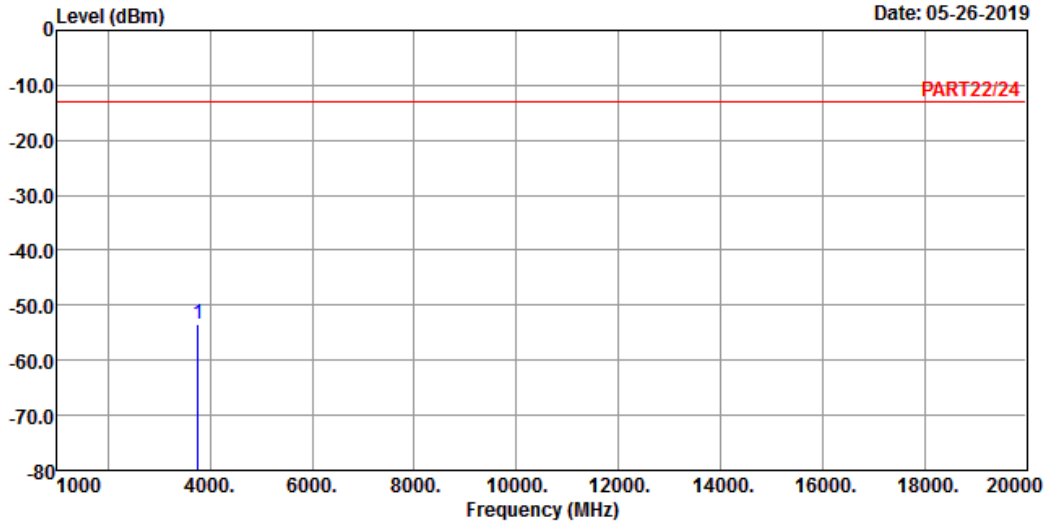

Site : 966 Chamber 5  
 Condition: PART22/24 HORIZONTAL  
 Remak : LTE Band 2 QPSK\_5M Link\_M-CH  
 Tested by: Getaz Yang

Freq	Level	Read Level	Limit	Line Factor	Over Limit	Remark
MHz	dBm	dBm	dBm	dB	dB	

1 pp 3760.00 -53.51 -46.86 -13.00 -6.65 -40.51 Peak





Bureau Veritas Consumer Products Services Ltd., Taoyuan Branch

A D T

Data: 4

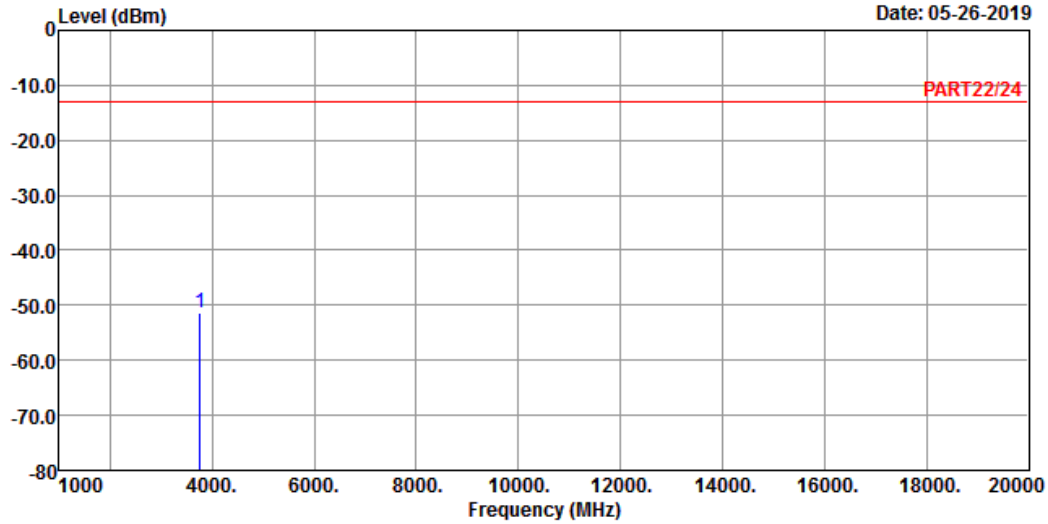

Site : 966 Chamber 5  
 Condition: PART22/24 VERTICAL  
 Remark : LTE Band 2 QPSK\_5M Link\_M-CH  
 Tested by: Getaz Yang

Freq	Level	Read Level	Limit	Line Factor	Over Limit	Remark
MHz	dBm	dBm	dBm	dB	dB	
1 pp 3760.00	-51.29	-44.64	-13.00	-6.65	-38.29	Peak

High Channel



Bureau Veritas Consumer Products Services Ltd., Taoyuan Branch

A D T

Data: 3

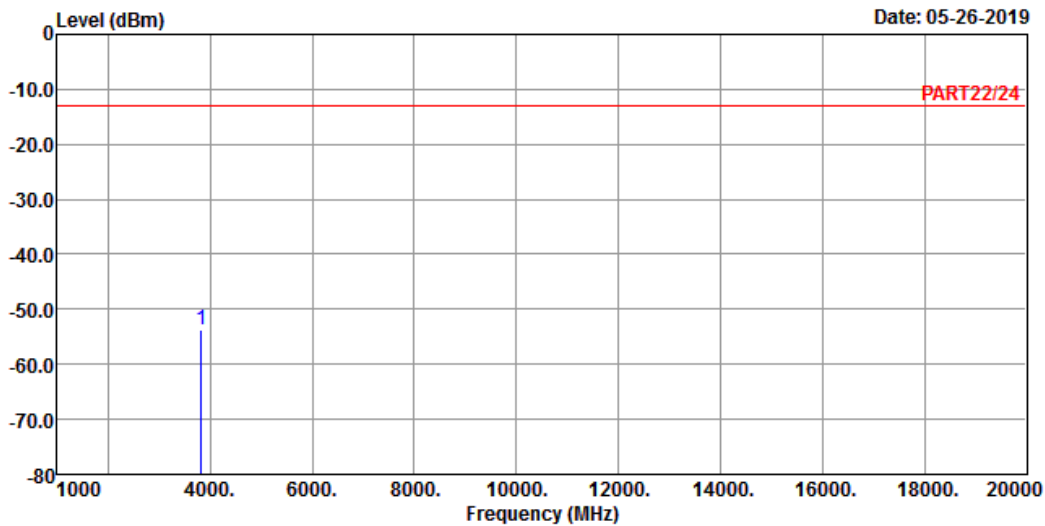

Site : 966 Chamber 5  
 Condition: PART22/24 HORIZONTAL  
 Remak : LTE Band 2 QPSK\_5M Link\_H-CH  
 Tested by: Getaz Yang

Freq	Level	Read Level	Limit	Line Factor	Over Limit	Remark
MHz	dBm	dBm	dBm	dB	dB	

1 pp 3815.00 -53.72 -47.32 -13.00 -6.40 -40.72 Peak



Bureau Veritas Consumer Products Services Ltd., Taoyuan Branch

A D T

Data: 4

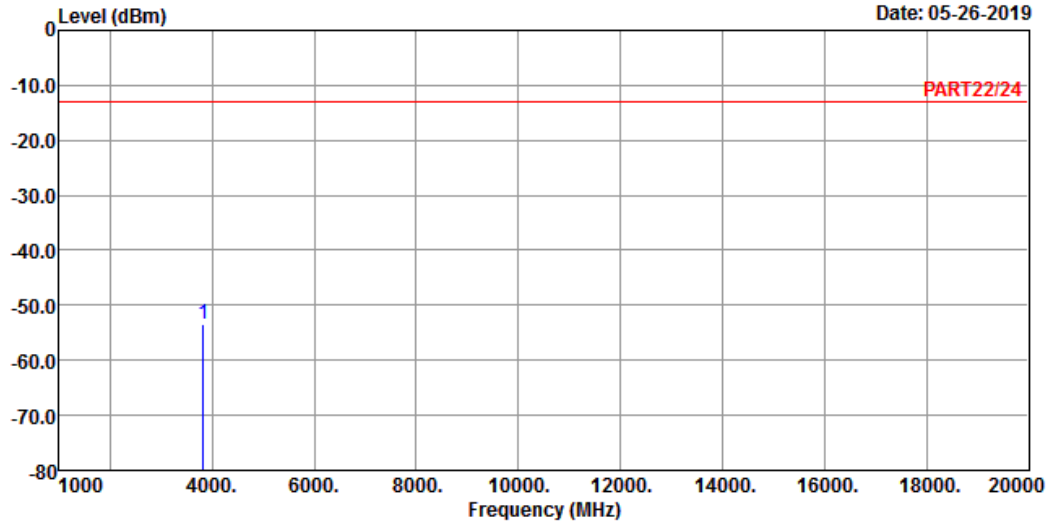

Site : 966 Chamber 5  
 Condition: PART22/24 VERTICAL  
 Remark : LTE Band 2 QPSK\_5M Link\_H-CH  
 Tested by: Getaz Yang

Freq	Level	Read Level	Limit	Line Factor	Over Limit	Remark
MHz	dBm	dBm	dBm	dB	dB	
1 pp 3815.00	-53.38	-46.98	-13.00	-6.40	-40.38	Peak

Channel Bandwidth: 20 MHz / QPSK  
Low Channel



Bureau Veritas Consumer Products Services Ltd., Taoyuan Branch

A D T

Data: 3

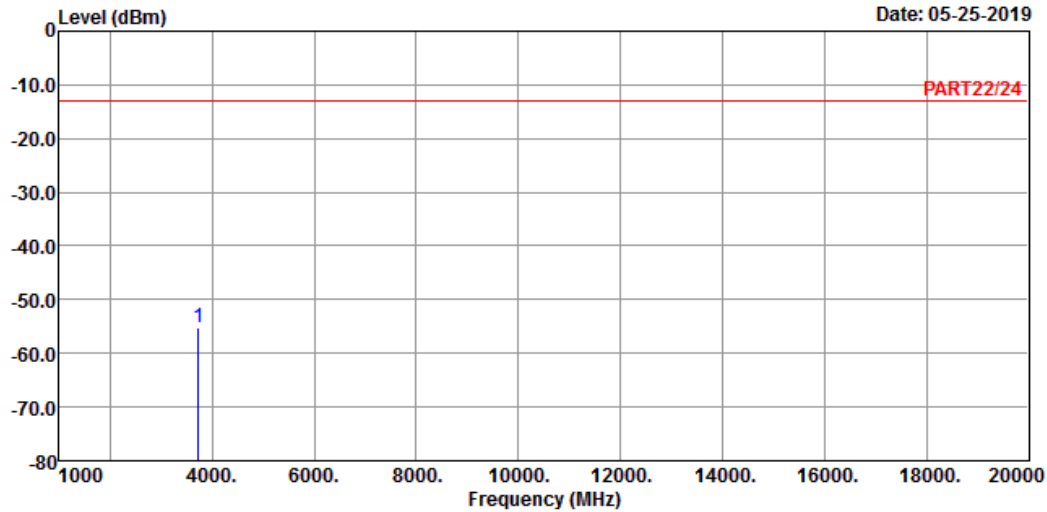

Site : 966 Chamber 5  
Condition: PART22/24 HORIZONTAL  
Remak : LTE Band 2 QPSK\_20M Link\_L-CH  
Tested by: Thomas Wei

Freq	Level	Read Level	Limit	Line Factor	Over Limit	Remark
MHz	dBm	dBm	dBm	dB	dB	
1 pp 3720.00	-55.17	-48.35	-13.00	-6.82	-42.17	Peak



Bureau Veritas Consumer Products Services Ltd., Taoyuan Branch

A D T

Data: 4

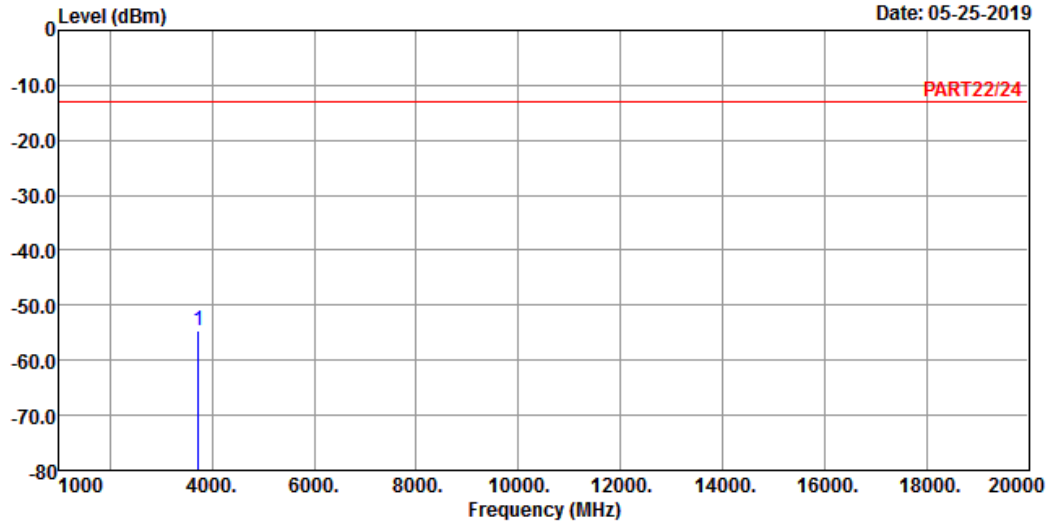

Site : 966 Chamber 5  
 Condition: PART22/24 VERTICAL  
 Remak : LTE Band 2 QPSK\_20M Link\_L-CH  
 Tested by: Thomas Wei

Freq	Level	Read Level	Limit	Over	Remark
MHz	dBm	dBm	dBm	dB	dB
1 pp 3720.00	-54.74	-47.92	-13.00	-6.82	-41.74 Peak

Middle Channel



Bureau Veritas Consumer Products Services Ltd., Taoyuan Branch

A D T

Data: 5

Date: 05-25-2019

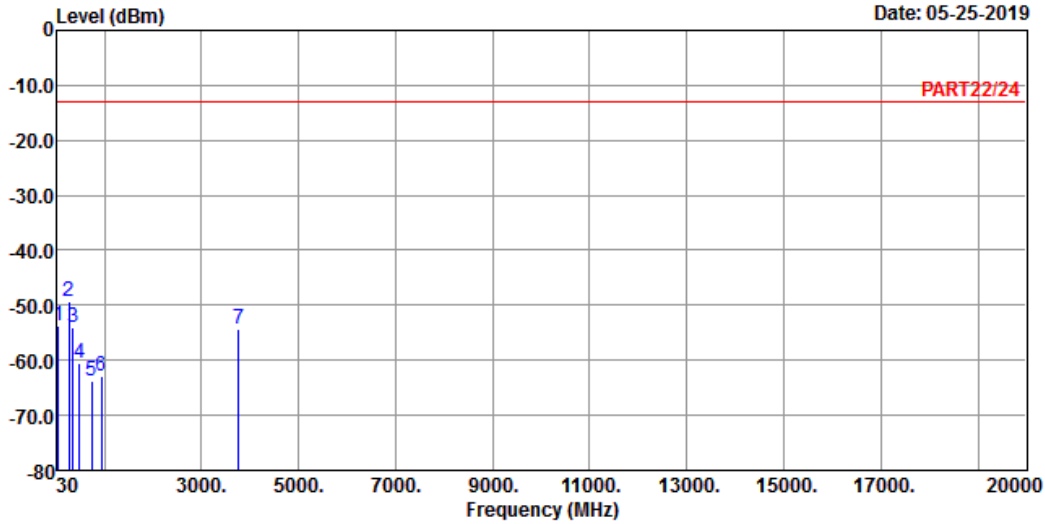

Site : 966 Chamber 5  
 Condition: PART22/24 HORIZONTAL  
 Remak : LTE Band 2 QPSK\_20M Link\_M-CH  
 Tested by: Thomas Wei

	Freq	Level	Read Level	Limit	Line	Factor	Over	Limit	Remark
	MHz	dBm	dBm	dBm		dB	dB	dB	
1	43.58	-53.85	-52.38	-13.00		-1.47	-40.85		Peak
2 pp	265.71	-49.40	-43.09	-13.00		-6.31	-36.40		Peak
3	355.92	-54.06	-47.86	-13.00		-6.20	-41.06		Peak
4	487.84	-60.54	-55.69	-13.00		-4.85	-47.54		Peak
5	739.07	-63.66	-64.33	-13.00		0.67	-50.66		Peak
6	932.10	-62.74	-64.11	-13.00		1.37	-49.74		Peak
7	3760.00	-54.23	-47.58	-13.00		-6.65	-41.23		Peak



Bureau Veritas Consumer Products Services Ltd., Taoyuan Branch

A D T

Data: 6

Date: 05-25-2019

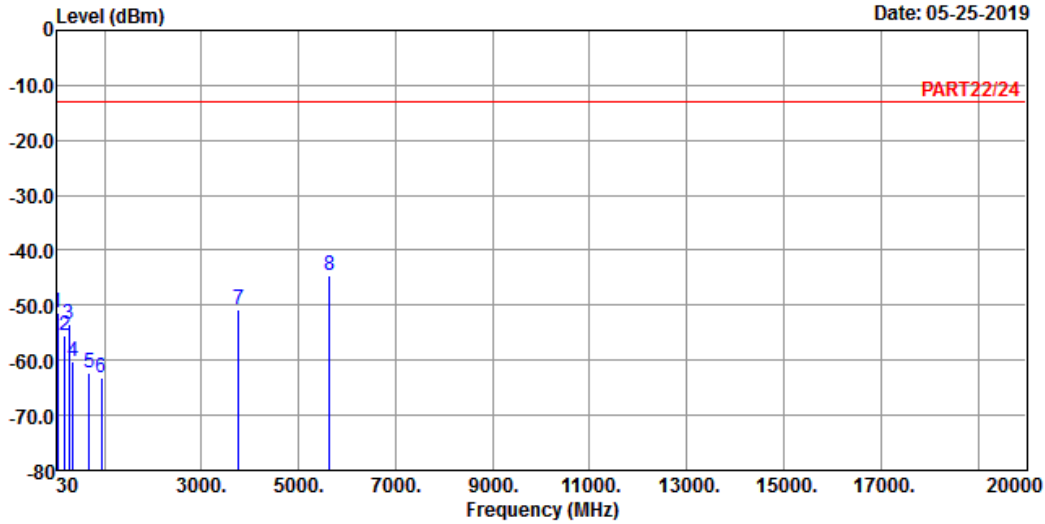

Site : 966 Chamber 5  
 Condition: PART22/24 VERTICAL  
 Remak : LTE Band 2 QPSK\_20M Link\_M-CH  
 Tested by: Thomas Wei

	Freq	Level	Read Level	Limit	Line Factor	Over Limit	Remark
	MHz	dBm	dBm	dBm	dB	dB	
1	42.61	-51.25	-50.31	-13.00	-0.94	-38.25	Peak
2	177.44	-55.62	-48.73	-13.00	-6.89	-42.62	Peak
3	261.83	-53.54	-47.31	-13.00	-6.23	-40.54	Peak
4	354.95	-60.29	-54.08	-13.00	-6.21	-47.29	Peak
5	687.66	-62.42	-62.12	-13.00	-0.30	-49.42	Peak
6	934.04	-63.31	-64.72	-13.00	1.41	-50.31	Peak
7	3760.00	-50.74	-44.09	-13.00	-6.65	-37.74	Peak
8 pp	5640.00	-44.62	-42.76	-13.00	-1.86	-31.62	Peak

# High Channel



Bureau Veritas Consumer Products Services Ltd., Taoyuan Branch

A D T

Data: 3

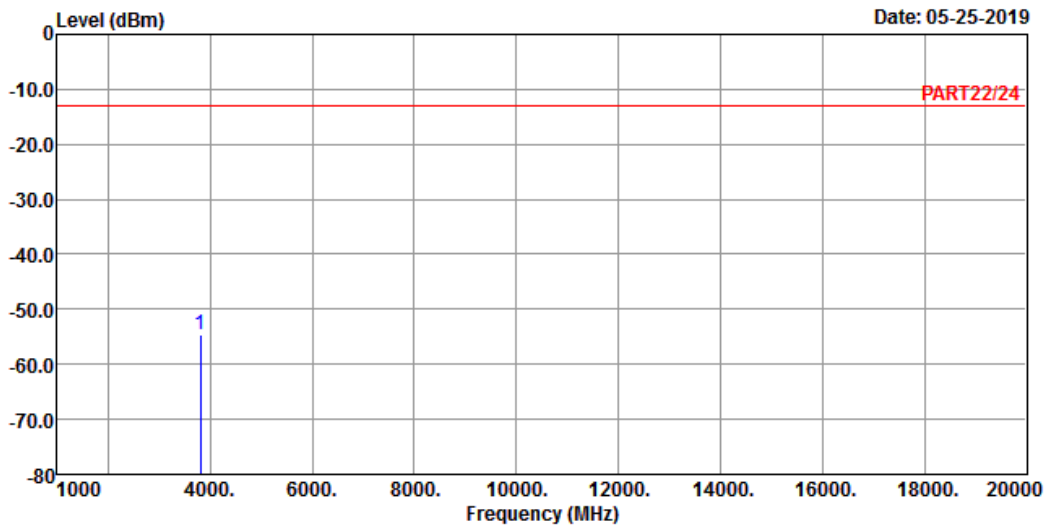

Site : 966 Chamber 5  
 Condition: PART22/24 HORIZONTAL  
 Remak : LTE Band 2 QPSK\_20M Link\_H-CH  
 Tested by: Thomas Wei

Freq	Level	Read Level	Limit	Line Factor	Over Limit	Remark
MHz	dBm	dBm	dBm	dB	dB	

1 pp 3800.00 -54.50 -48.07 -13.00 -6.43 -41.50 Peak





Bureau Veritas Consumer Products Services Ltd., Taoyuan Branch

A D T

Data: 4

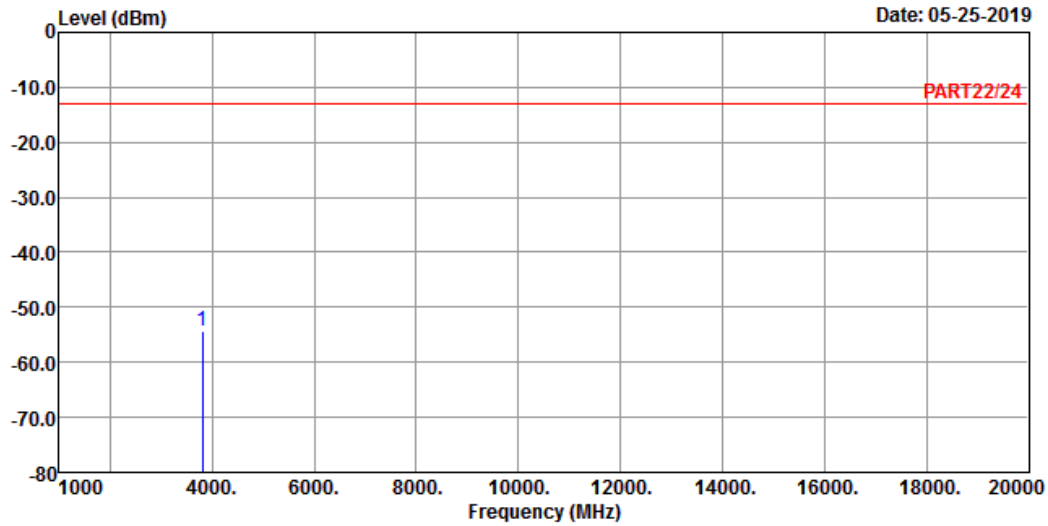

Site : 966 Chamber 5  
 Condition: PART22/24 VERTICAL  
 Remak : LTE Band 2 QPSK\_20M Link\_H-CH  
 Tested by: Thomas Wei

Freq	Level	Read Level	Limit	Line Factor	Over Limit	Remark
MHz	dBm	dBm	dBm	dB	dB	
1 pp 3800.00	-54.39	-47.96	-13.00	-6.43	-41.39	Peak

## 5 Pictures of Test Arrangements

Please refer to the attached file (Test Setup Photo).

## Appendix – Information of the Testing Laboratories

We, Bureau Veritas Consumer Products Services (H.K.) Ltd., Taoyuan Branch, were founded in 1988 to provide our best service in EMC, Radio, Telecom and Safety consultation. Our laboratories are FCC recognized accredited test firms and accredited according to ISO/IEC 17025.

If you have any comments, please feel free to contact us at the following:

**Lin Kou EMC/RF Lab**

Tel: 886-2-26052180

Fax: 886-2-26051924

**Hsin Chu EMC/RF/Telecom Lab**

Tel: 886-3-6668565

Fax: 886-3-6668323

**Hwa Ya EMC/RF/Safety Lab**

Tel: 886-3-3183232

Fax: 886-3-3270892

**Email:** [service.adt@tw.bureauveritas.com](mailto:service.adt@tw.bureauveritas.com)

**Web Site:** [www.bureauveritas-adt.com](http://www.bureauveritas-adt.com)

The address and road map of all our labs can be found in our web site also.

--- END ---