

## FCC Test Report

### (PART 27)

**Report No.:** RF180125C14-13

**FCC ID:** B94HNQ10CZV

**Test Model:** HSN-Q10C

**Received Date:** Feb. 05, 2018

**Test Date:** Mar. 29, 2018 ~ May 21, 2018

**Issued Date:** Jun. 01, 2018

**Applicant:** HP Inc.

**Address:** 3390 East Harmony Road, Fort Collins, Colorado 80528, United States

**Issued By:** Bureau Veritas Consumer Products Services (H.K.) Ltd., Taoyuan Branch

**Lab Address:** No. 47-2, 14th Ling, Chia Pau Vil., Lin Kou Dist., New Taipei City, Taiwan ( R.O.C )

**Test Location (1):** No. 19, Hwa Ya 2nd Rd, Wen Hwa Vil, Kwei Shan Dist., Taoyuan City 33383, Taiwan (R.O.C)

**Test Location (2):** No.215, Sec. 3, Beixin Rd., Xindian Dist., New Taipei City 231, Taiwan, R.O.C

**FCC Registration /  
Designation Number:** 427177 / TW0011



This report is for your exclusive use. Any copying or replication of this report to or for any other person or entity, or use of our name or trademark, is permitted only with our prior written permission. This report sets forth our findings solely with respect to the test samples identified herein. The results set forth in this report are not indicative or representative of the quality or characteristics of the lot from which a test sample was taken or any similar or identical product unless specifically and expressly noted. Our report includes all of the tests requested by you and the results thereof based upon the information that you provided to us. You have 60 days from date of issuance of this report to notify us of any material error or omission caused by our negligence, provided, however, that such notice shall be in writing and shall specifically address the issue you wish to raise. A failure to raise such issue within the prescribed time shall constitute your unqualified acceptance of the completeness of this report, the tests conducted and the correctness of the report contents. Unless specific mention, the uncertainty of measurement has been explicitly taken into account to declare the compliance or non-compliance to the specification. The report must not be used by the client to claim product certification, approval, or endorsement by TAF or any government agencies

## Table of Contents

<b>Release Control Record .....</b>	<b>3</b>
<b>1 Certificate of Conformity .....</b>	<b>4</b>
<b>2 Summary of Test Results .....</b>	<b>5</b>
2.1 Measurement Uncertainty .....	5
2.2 Test Site And Instruments .....	6
<b>3 General Information .....</b>	<b>7</b>
3.1 General Description of EUT .....	7
3.2 Configuration of System Under Test .....	8
3.2.1 Description of Support Units .....	8
3.3 Test Mode Applicability and Tested Channel Detail .....	9
3.4 EUT Operating Conditions .....	10
3.5 General Description of Applied Standards .....	10
<b>4 Test Types and Results .....</b>	<b>11</b>
4.1 Output Power Measurement .....	11
4.1.1 Limits of Output Power Measurement .....	11
4.1.2 Test Procedures .....	11
4.1.3 Test Setup .....	12
4.1.4 Test Results .....	13
4.2 Frequency Stability Measurement .....	15
4.2.1 Limits of Frequency Stability Measurement .....	15
4.2.2 Test Procedure .....	15
4.2.3 Test Setup .....	15
4.2.4 Test Results .....	16
4.3 Occupied Bandwidth Measurement .....	18
4.3.1 Limits of Occupied Bandwidth Measurement .....	18
4.3.2 Test Procedure .....	18
4.3.3 Test Setup .....	18
4.3.4 Test Result .....	19
4.4 Band Edge Measurement .....	20
4.4.1 Limits of Band Edge Measurement .....	20
4.4.2 Test Setup .....	20
4.4.3 Test Procedures .....	20
4.4.4 Test Results .....	21
4.5 Conducted Spurious Emissions .....	23
4.5.1 Limits of Conducted Spurious Emissions Measurement .....	23
4.5.2 Test Setup .....	23
4.5.3 Test Procedure .....	23
4.5.4 Test Results .....	24
4.6 Radiated Emission Measurement .....	28
4.6.1 Limits of Radiated Emission Measurement .....	28
4.6.2 Test Procedure .....	28
4.6.3 Deviation from Test Standard .....	28
4.6.4 Test Setup .....	29
4.6.5 Test Results .....	30
<b>5 Pictures of Test Arrangements .....</b>	<b>38</b>
<b>Appendix – Information on the Testing Laboratories .....</b>	<b>39</b>

### Release Control Record

Issue No.	Description	Date Issued
RF180125C14-13	Original Release	Jun. 01, 2018

## 1 Certificate of Conformity

**Product:** Notebook Computer  
**Brand:** HP  
**Test Model:** HSN-Q10C  
**Sample Status:** Production Unit  
**Applicant:** HP Inc.  
**Test Date:** Mar. 29, 2018 ~ May 21, 2018  
**Standards:** FCC Part 27, Subpart C

The above equipment has been tested by **Bureau Veritas Consumer Products Services (H.K.) Ltd., Taoyuan Branch**, and found compliance with the requirement of the above standards. The test record, data evaluation & Equipment Under Test (EUT) configurations represented herein are true and accurate accounts of the measurements of the sample's RF characteristics under the conditions specified in this report.

**Prepared by :** Evonne Liu, **Date:** Jun. 01, 2018  
Evonne Liu / Specialist

**Approved by :** Dylan Chiou, **Date:** Jun. 01, 2018  
Dylan Chiou / Project Engineer

## 2 Summary of Test Results

Applied Standard: FCC Part 27 & Part 2			
FCC Clause	Test Item	Result	Remarks
2.1046 27.50(a)(3)	Equivalent Isotropic Radiated Power	Pass	Meet the requirement of limit.
2.1055 27.54	Frequency Stability	Pass	Meet the requirement of limit.
2.1049	Occupied Bandwidth	Pass	Meet the requirement of limit.
2.1051 27.53(a)(4)	Band Edge Measurements	Pass	Meet the requirement of limit.
2.1051 27.53(a)(4)	Conducted Spurious Emissions	Pass	Meet the requirement of limit.
2.1053 27.53(a)(4)	Radiated Spurious Emissions	Pass	Meet the requirement of limit. Minimum passing margin is -3.23 dB at 4620 MHz.

### 2.1 Measurement Uncertainty

Where relevant, the following measurement uncertainty levels have been estimated for tests performed on the EUT as specified in CISPR 16-4-2:

Measurement	Frequency	Expanded Uncertainty (k=2) (±)
Conducted Emissions at mains ports	150 kHz ~ 30 MHz	2.44 dB
Radiated Emissions up to 1 GHz	30 MHz ~ 200 MHz	2.0153 dB
	200 MHz ~ 1000 MHz	2.0224 dB
Radiated Emissions above 1 GHz	1 GHz ~ 18 GHz	1.0121 dB
	18 GHz ~ 40 GHz	1.1508 dB

## 2.2 Test Site And Instruments

Description & Manufacturer	Model No.	Serial No.	Date of Calibration	Due Date of Calibration
Test Receiver Agilent Technologies	N9038A	MY52260177	Jul. 05, 2017	Jul. 04, 2018
Spectrum Analyzer ROHDE & SCHWARZ	FSU43	101261	Jan. 11, 2018	Jan. 10, 2019
Double Ridge Guide Horn Antenna EMCO	3115	5619	Nov. 30, 2017	Nov. 29, 2018
HORN Antenna ETS	3117	00034128	Dec. 14, 2017	Dec. 13, 2018
BILOG Antenna SCHWARZBECK	VULB 9168	9168-153	Dec. 06, 2017	Dec. 05, 2018
Fixed Attenuator Mini-Circuits	BW-N10W5+	NA	Jul. 07, 2017	Jul. 06, 2018
Preamplifier Agilent	310N	187226	Jun. 23, 2017	Jun. 22, 2018
Preamplifier Agilent	83017A	MY39501357	Jun. 23, 2017	Jun. 22, 2018
RF signal cable ETS-LINDGREN	5D-FB	Cable-CH1-01(RF C-SMS-100-SMS- 120+RFC-SMS-1 00-SMS-400)	Jun. 23, 2017	Jun. 22, 2018
RF signal cable ETS-LINDGREN	8D-FB	Cable-CH1-02(RF C-SMS-100-SMS- 24)	Jun. 23, 2017	Jun. 22, 2018
Software BV ADT	E3 8.130425b	NA	NA	NA
Antenna Tower MF	NA	NA	NA	NA
Turn Table MF	NA	NA	NA	NA
Antenna Tower & Turn Table Controller MF	MF-7802	NA	NA	NA
Radio Communication Analyzer Anritsu	MT8820C	6201010284	Dec. 28, 2017	Dec. 27, 2018
Temperature & Humidity Chamber	GTH-120-40-CP-AR	MAA1306-019	Sep. 08, 2017	Sep. 07, 2018
DC Power Supply Topward	33010D	807748	Oct. 25, 2016	Oct. 24, 2018
Digital Multimeter Fluke	87-III	70360742	Jun. 30, 2017	Jun. 29, 2018

- Note: 1. The calibration interval of the above test instruments is 12 / 24 months and the calibrations are traceable to NML/ROC and NIST/USA.
2. The test was performed in HsinTien Chamber 1.
3. The horn antenna and preamplifier (model: 83017A) are used only for the measurement of emission frequency above 1 GHz if tested.
4. The IC Site Registration No. is IC7450I-1.

### 3 General Information

#### 3.1 General Description of EUT

<b>Product</b>	Notebook Computer	
<b>Brand</b>	HP	
<b>Test Model</b>	HSN-Q10C	
<b>Status of EUT</b>	Production Unit	
<b>Power Supply Rating</b>	20 or 15 or 12 or 9 or 5 Vdc (Adapter)	
<b>Modulation Type</b>	QPSK, 16QAM	
<b>Frequency Range</b>	LTE Band 30 (Channel Bandwidth: 5 MHz)	2307.5 ~ 2312.5 MHz
	LTE Band 30 (Channel Bandwidth: 10 MHz)	2310 MHz
<b>Max. EIRP Power</b>	LTE Band 30 (Channel Bandwidth: 5 MHz)	75.53 mW
	LTE Band 30 (Channel Bandwidth: 10 MHz)	45.47 mW
<b>Emission Designator</b>	LTE Band 30 (Channel Bandwidth: 5 MHz)	4M49G7D
	LTE Band 30 (Channel Bandwidth: 10 MHz)	8M96W7D
<b>Antenna Type</b>	Refer to Note as below	
<b>Accessory Device</b>	Refer to Note as below	
<b>Data Cable Supplied</b>	Refer to Note as below	

Note:

1. The WWAN module (Brand: FOXCONN, Model: T77W676) was installed in the EUT.
2. The EUT contains following accessory devices.

Product	Brand	Model	Description
Adapter	hp	TPN-LA12	I/P: 100-240 Vac, 50-60 Hz, 1.6 A O/P: 20 Vdc, 3.25 A, 15 Vdc, 4.33 A, 12 Vdc, 5 A, 9 Vdc, 3 A, 5 Vdc, 3 A

3. The antenna information is listed as below.

Ant. Type	Manuf.	Parts Number	Antenna Gain							
			LTE 2 / LTE 25 / WCDMA Band II	LTE 4 / LTE 66 / WCDMA Band IV	LTE 5 / LTE 26 / WCDMA Band V	LTE 7	LTE 12 / LTE 17	LTE 13	LTE 30	LTE 41
PIFA	INPAQ	Main Ant.: DQ6LB020017 (WA-P-LTE8LTE12LBLB-02-001) Aux Ant.: DQ6LB020017 (WA-P-LTE8LTE12LBLB-02-001)	-6.19	-5.79	-5.86	-4.9	-5.21	-4.32	-3.68	-4.9

Antenna Type	Vendor	Part Number	Antenna Gain (dBi)			
			Laptop PC Mode			
			WLAN 2.4GHz	WLAN 5.2GHz	WLAN 5.5GHz	WLAN 5.8GHz
PIFA	INPAQ	WLAN Main Antenna: DQ6LB020509 (WA-P-LBLB-02-059) WLAN Aux Antenna: DQ6LB020509 (WA-P-LBLB-02-059)	1.66	0.54	0.56	-0.21
			Tablet PC Mode			
			WLAN 2.4GHz	WLAN 5.2GHz	WLAN 5.5GHz	WLAN 5.8GHz
			-0.36	3.36	2.21	3.08

4. The above EUT information is declared by manufacturer and for more detailed features description, please refers to the manufacturer's specifications or user's manual.

### 3.2 Configuration of System Under Test

#### <Radiated Emission Test>

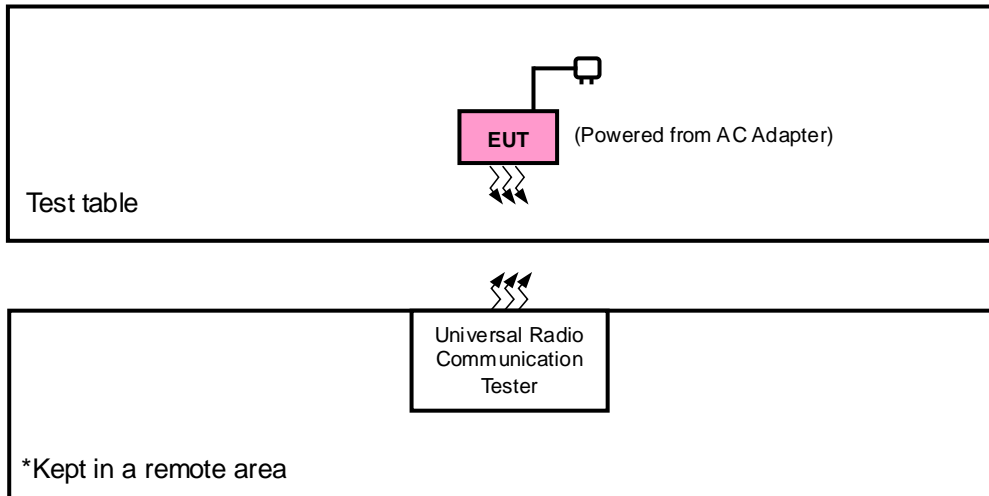

#### <E.I.R.P. Test>

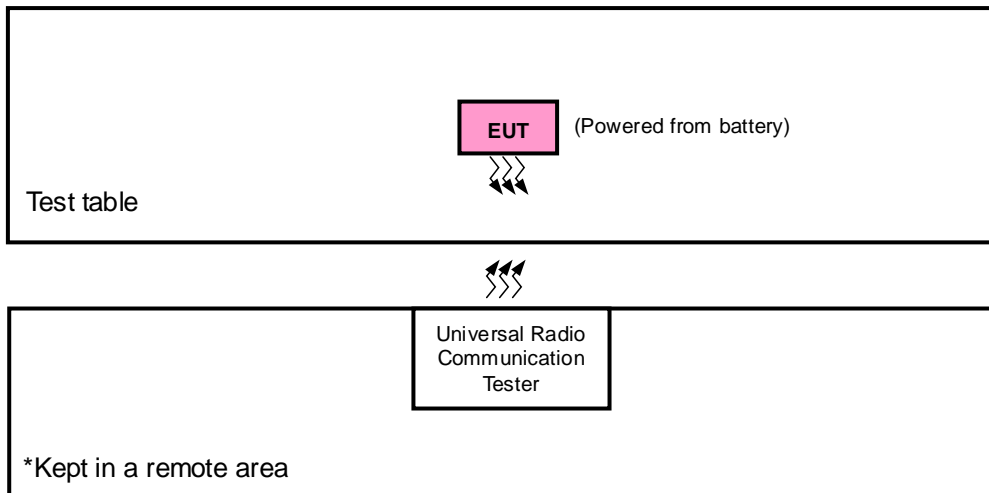

#### 3.2.1 Description of Support Units

The EUT has been tested as an independent unit together with other necessary accessories or support units.



### 3.3 Test Mode Applicability and Tested Channel Detail

Pre-Scan has been conducted to determine the worst-case mode from all possible combinations between available modulations, data rates, XYZ axis and antenna ports

The worst case was found when positioned on X-plane for EIRP and radiated emission. Following channel(s) was (were) selected for the final test as listed below:

EUT Configure Mode	Test Item	Available Channel	Tested Channel	Channel Bandwidth	Modulation	Mode
-	EIRP	27685 to 27735	27685, 27710, 27735	5 MHz	QPSK, 16QAM	1 RB / 24 RB Offset
		27710	27710	10 MHz	QPSK, 16QAM	1 RB / 49 RB Offset
-	Frequency Stability	27685 to 27735	27685, 27735	5 MHz	QPSK	1 RB / 24 RB Offset
		27710	27710	10 MHz	QPSK	1 RB / 49 RB Offset
-	Occupied Bandwidth	27685 to 27735	27685, 27710, 27735	5 MHz	QPSK, 16QAM	25 RB / 0 RB Offset
		27710	27710	10 MHz	QPSK, 16QAM	50 RB / 0 RB Offset
-	Band Edge	27685 to 27735	27685, 27710, 27735	5 MHz	QPSK, 16QAM	25 RB / 0 RB Offset
		27710	27710	10 MHz	QPSK, 16QAM	50 RB / 0 RB Offset
-	Conducted Emission	27685 to 27735	27685, 27710, 27735	5 MHz	QPSK	1 RB / 24 RB Offset
		27710	27710	10 MHz	QPSK	1 RB / 49 RB Offset
-	Radiated Emission	27685 to 27735	27685, 27710, 27735	5 MHz	QPSK	1 RB / 24 RB Offset
		27710	27710	10 MHz	QPSK	1 RB / 49 RB Offset

**Note:** This device was tested under all bandwidths, RB configurations and modulations. The worst case was found in QPSK modulation.

#### Test Condition:

Test Item	Environmental Conditions	Input Power	Tested By
EIRP	25 deg. C, 65 % RH	6.54 Vdc	Charles Hsiao
Frequency Stability	25 deg. C, 65 % RH	6.54 Vdc	Wayne Lin
Occupied Bandwidth	25 deg. C, 65 % RH	6.54 Vdc	Wayne Lin
Band Edge	25 deg. C, 65 % RH	6.54 Vdc	Wayne Lin
Conducted Emission	25 deg. C, 65 % RH	6.54 Vdc	Wayne Lin
Radiated Emission	25 deg. C, 65 % RH	120 Vac, 60 Hz	Charles Hsiao

### **3.4 EUT Operating Conditions**

The EUT makes a call to the communication simulator. The communication simulator station system controlled a EUT to export maximum output power under transmission mode and specific channel frequency

### **3.5 General Description of Applied Standards**

The EUT is a RF Product. According to the specifications of the manufacturer, it must comply with the requirements of the following standards:

**FCC 47 CFR Part 2**

**FCC 47 CFR Part 27**

**KDB 971168 D01 Power Meas License Digital Systems v02r02**

**ANSI/TIA/EIA-603-E 2016**

**ANSI 63.26-2015**

**NOTE:** All test items have been performed and recorded as per the above standards.

## 4 Test Types and Results

### 4.1 Output Power Measurement

#### 4.1.1 Limits of Output Power Measurement

Mobile and portable stations. (i) For mobile and portable stations transmitting in the 2305-2315 MHz band or the 2350-2360 MHz band, the average EIRP must not exceed 50 milliwatts within any 1 megahertz of authorized bandwidth, except that for mobile and portable stations compliant with 3GPP LTE standards or another advanced mobile broadband protocol that avoids concentrating energy at the edge of the operating band the average EIRP must not exceed 250 milliwatts within any 5 megahertz of authorized bandwidth but may exceed 50 milliwatts within any 1 megahertz of authorized bandwidth. For mobile and portable stations using time division duplexing (TDD) technology, the duty cycle must not exceed 38 percent in the 2305-2315 MHz and 2350-2360 MHz bands. Mobile and portable stations using FDD technology are restricted to transmitting in the 2305-2315 MHz band. Power averaging shall not include intervals in which the transmitter is off.

#### 4.1.2 Test Procedures

##### **EIRP Measurement:**

- a. All measurements were done at low, middle and high operational frequency range. RBW is 5 MHz and VBW is 15 MHz for LTE mode.
- b. Substitution method is used for E.I.R.P measurement. In the semi-anechoic chamber, EUT placed on the 0.8 m (below or equal 1 GHz) and/or 1.5 m (above 1 GHz) height of Turn Table, rotated the table around 360 degrees to search the maximum radiation power and receiver antenna shall be rotated vertical and horizontal polarization and moved height from 1 m to 4 m to find the maximum polar radiated power. The "Read Value" is the spectrum reading the maximum power value.
- c. The substitution horn antenna is substituted for EUT at the same position and signals generator export the CW signal to the substitution antenna via a tx cable. Rotated the Turn Table and moved receiving antenna to find the maximum radiation power. Adjust output power level of S.G to get a Value of spectrum reading equal to "Read Value" of step b. Record the power level of S.G.
- d.  $EIRP = \text{Output power level of S.G} - \text{TX cable loss} + \text{Antenna gain of substitution horn}.$

##### **Conducted Power Measurement:**

- a. The EUT was set up for the maximum power with LTE link data modulation and link up with simulator.
- b. Set the EUT to transmit under low, middle and high channel and record the power level shown on simulator.

### 4.1.3 Test Setup

#### EIRP / ERP Measurement:

<Radiated Emission below or equal 1 GHz>

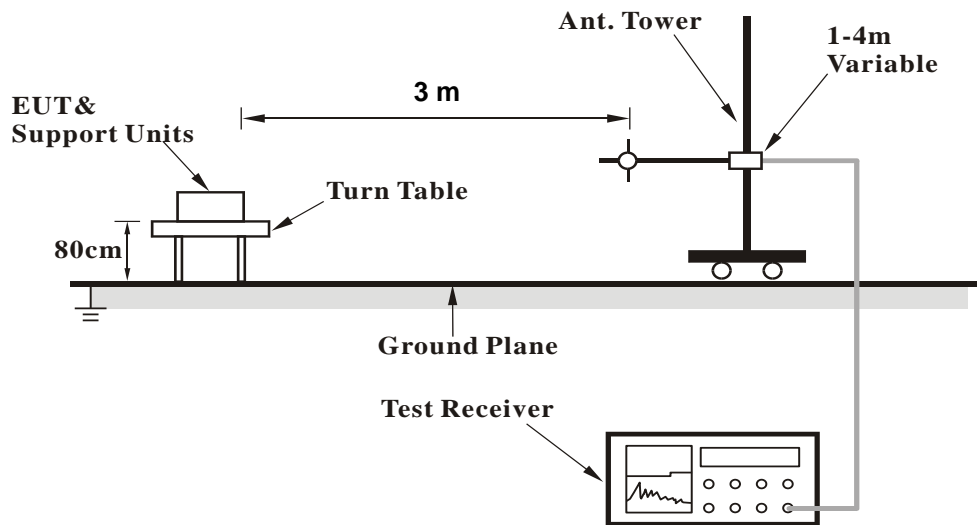

<Radiated Emission above 1 GHz>

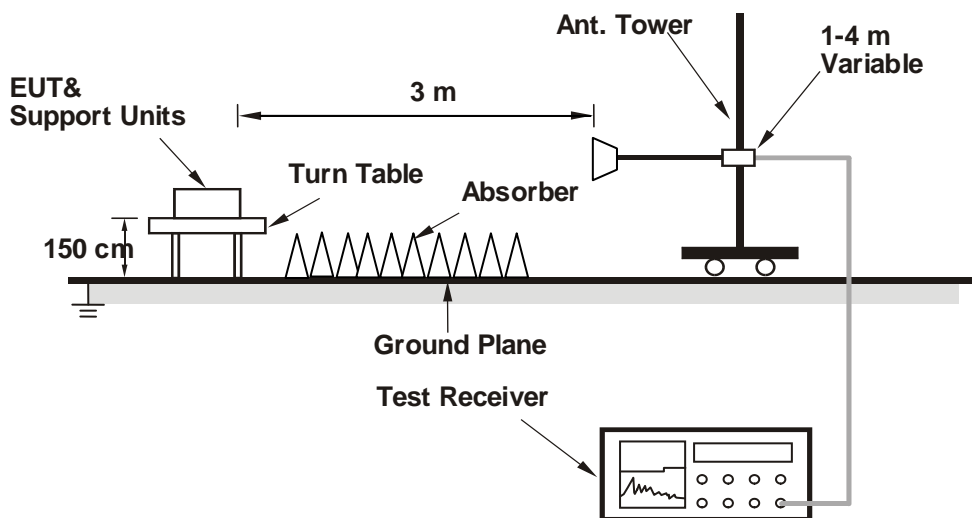

For the actual test configuration, please refer to the attached file (Test Setup Photo).

#### Conducted Power Measurement:

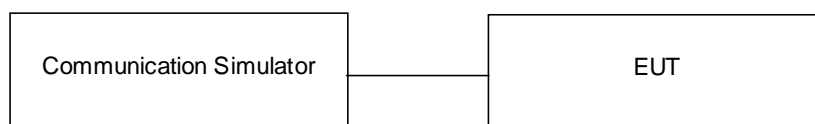

## 4.1.4 Test Results

LTE Band 30															
BW	MCS Index	RB Size	RB Offset		Mid		3GPP MPR (dB)	BW	MCS Index	RB Size	RB Offset	Low	Mid	High	3GPP MPR (dB)
		Channel			27710					Channel		27685	27710	27735	
		Frequency (MHz)			2310.0					Frequency (MHz)		2307.5	2310.0	2312.5	
10M	QPSK	1	0		23.69		0	5M	QPSK	1	0	23.57	23.61	23.59	0
		1	24		23.43		0			1	12	23.31	23.35	23.33	0
		1	49		23.34		0			1	24	23.22	23.26	23.24	0
		25	0		22.45		1			12	0	22.33	22.37	22.35	1
		25	12		22.44		1			12	6	22.32	22.36	22.34	1
		25	25		22.43		1			12	13	22.31	22.35	22.33	1
		50	0		22.41		1			25	0	22.29	22.33	22.31	1
	16QAM	1	0		22.67		1		16QAM	1	0	22.51	22.52	22.52	1
		1	24		22.41		1			1	12	22.28	22.28	22.25	1
		1	49		22.32		1			1	24	22.21	22.23	22.19	1
		25	0		21.43		2			12	0	21.24	21.37	21.32	2
		25	12		21.42		2			12	6	21.30	21.34	21.29	2
		25	25		21.41		2			12	13	21.30	21.26	21.28	2
		50	0		21.39		2			25	0	21.19	21.28	21.27	2

**EIRP Power (dBm)**

LTE Band 30							
Channel Bandwidth: 5 MHz / QPSK							
Plane	Channel	Frequency (MHz)	LVL (dBm)	Correction Factor (dB)	EIRP (dBm)	EIRP (mW)	Polarization (H/V)
X	27685	2307.5	-25.72	44.24	18.52	71.09	H
	27710	2310.0	-25.68	44.20	18.52	71.07	
	27735	2312.5	-26.02	44.80	18.78	75.53	
	27685	2307.5	-28.80	44.19	15.39	34.60	V
	27710	2310.0	-28.65	44.09	15.44	34.98	
	27735	2312.5	-29.09	44.50	15.41	34.75	
Channel Bandwidth: 5 MHz / 16QAM							
X	27685	2307.5	-26.80	44.24	17.44	55.44	H
	27710	2310.0	-26.68	44.20	17.52	56.45	
	27735	2312.5	-27.72	44.80	17.08	51.06	
	27685	2307.5	-29.64	44.19	14.55	28.52	V
	27710	2310.0	-29.58	44.09	14.51	28.24	
	27735	2312.5	-30.01	44.50	14.49	28.11	

LTE Band 30							
Channel Bandwidth: 10 MHz / QPSK							
Plane	Channel	Frequency (MHz)	LVL (dBm)	Correction Factor (dB)	EIRP (dBm)	EIRP (mW)	Polarization (H/V)
X	27710	2310.0	-27.62	44.20	16.58	45.47	H
	27710	2310.0	-30.77	44.09	13.32	21.47	V
Channel Bandwidth: 10 MHz / 16QAM							
X	27710	2310.0	-28.66	44.20	15.54	35.78	H
	27710	2310.0	-31.69	44.09	12.40	17.37	V

## 4.2 Frequency Stability Measurement

### 4.2.1 Limits of Frequency Stability Measurement

The frequency stability shall be sufficient to ensure that the fundamental emissions stay within the authorized bands of operation.

### 4.2.2 Test Procedure

- Device is placed at the oven room. The oven room could control the temperatures and humidity. Power warm up is at least 15 min and power applied should perform before recording frequency error.
- EUT is connected the external power supply to control the DC input power. The test voltage range is from minimum to maximum working voltage. Each step shall be record the frequency error rate.
- The temperature range step is 10 degrees in this test items. All temperature levels shall be hold the  $\pm 0.5$  °C during the measurement testing. The each temperature step shall be at least 0.5 hours, consider the EUT could be test under the stability condition.

**Note:** The frequency error was recorded frequency error from the communication simulator.

### 4.2.3 Test Setup

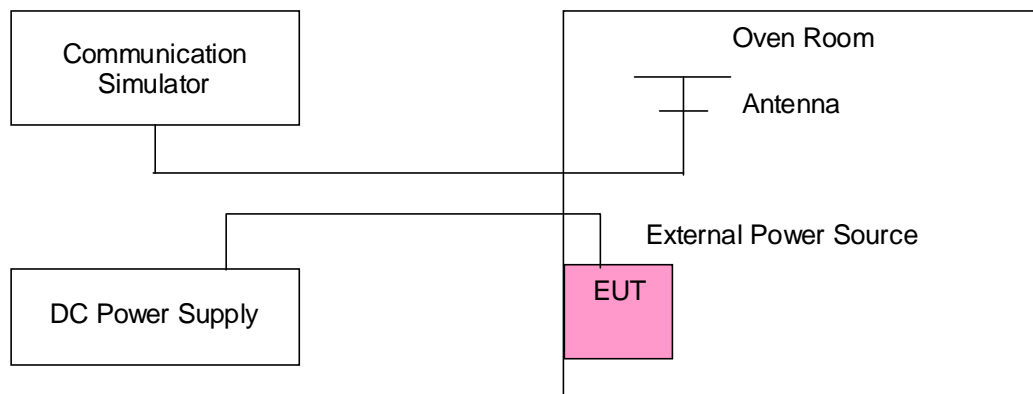

#### 4.2.4 Test Results

##### Frequency Error vs. Voltage

Voltage (Volts)	LTE Band 30				Limit (ppm)
	Channel Bandwidth: 5 MHz				
	Low Channel		High Channel		
	Frequency (MHz)	Frequency Error (ppm)	Frequency (MHz)	Frequency Error (ppm)	
7.7	2307.500003	0.001	2312.500003	0.001	2.5
6.54	2307.500001	0.001	2312.500001	0.000	2.5
8.85	2307.500004	0.002	2312.500004	0.002	2.5

**Note:** The applicant defined the normal working voltage of the battery is from 6.54 Vdc to 8.85 Vdc.

##### Frequency Error vs. Temperature

Temp. (°C)	LTE Band 30				Limit (ppm)
	Channel Bandwidth: 5 MHz				
	Low Channel		High Channel		
	Frequency (MHz)	Frequency Error (ppm)	Frequency (MHz)	Frequency Error (ppm)	
-30	2307.500002	0.001	2312.500004	0.002	2.5
-20	2307.500002	0.001	2312.500004	0.002	2.5
-10	2307.500002	0.001	2312.500004	0.002	2.5
0	2307.500002	0.001	2312.500004	0.002	2.5
10	2307.500003	0.001	2312.500002	0.001	2.5
20	2307.499998	-0.001	2312.499998	-0.001	2.5
30	2307.499998	-0.001	2312.499999	-0.001	2.5
40	2307.499998	-0.001	2312.499998	-0.001	2.5
50	2307.499997	-0.001	2312.499997	-0.001	2.5



Frequency Error vs. Voltage

Voltage (Volts)	LTE Band 30		Limit (ppm)
	Channel Bandwidth: 10 MHz		
	Frequency (MHz)	Frequency Error (ppm)	
7.7	2310.000002	0.001	2.5
6.54	2310.000003	0.001	2.5
8.85	2310.000004	0.002	2.5

**Note:** The applicant defined the normal working voltage of the battery is from 6.54 Vdc to 8.85 Vdc.

Frequency Error vs. Temperature

Temp. (°C)	LTE Band 30		Limit (ppm)
	Channel Bandwidth: 10 MHz		
	Frequency (MHz)	Frequency Error (ppm)	
-30	2310.000004	0.002	2.5
-20	2310.000003	0.001	2.5
-10	2310.000001	0.000	2.5
0	2310.000001	0.001	2.5
10	2310.000003	0.001	2.5
20	2309.999997	-0.001	2.5
30	2309.999999	-0.001	2.5
40	2309.999997	-0.001	2.5
50	2309.999999	-0.001	2.5

### 4.3 Occupied Bandwidth Measurement

#### 4.3.1 Limits of Occupied Bandwidth Measurement

The width of a frequency band such that, below the lower and above the upper frequency limits, the mean powers emitted are each equal to a specified percentage 0.5 % of the total mean power of a given emission.

#### 4.3.2 Test Procedure

- The conducted occupied bandwidth used the power splitter via EUT RF power connector between simulation base station and spectrum analyzer.
- Use OBW measurement function of Spectrum analyzer to measure 99 % occupied bandwidth.

#### 4.3.3 Test Setup

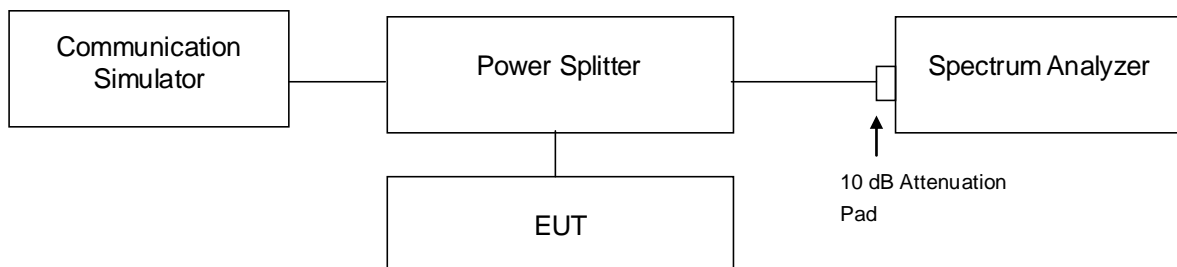

4.3.4 Test Result

LTE Band 30							
Channel Bandwidth: 5 MHz				Channel Bandwidth: 10 MHz			
Channel	Frequency (MHz)	99 % Occupied Bandwidth (MHz)		Channel	Frequency (MHz)	99 % Occupied Bandwidth (MHz)	
		QPSK	16QAM			QPSK	16QAM
27685	2307.5	4.4879	4.4879	27710	2310.0	8.9512	8.9567
27710	2310.0	4.4875	4.4874				
27735	2312.5	4.4852	4.4855				

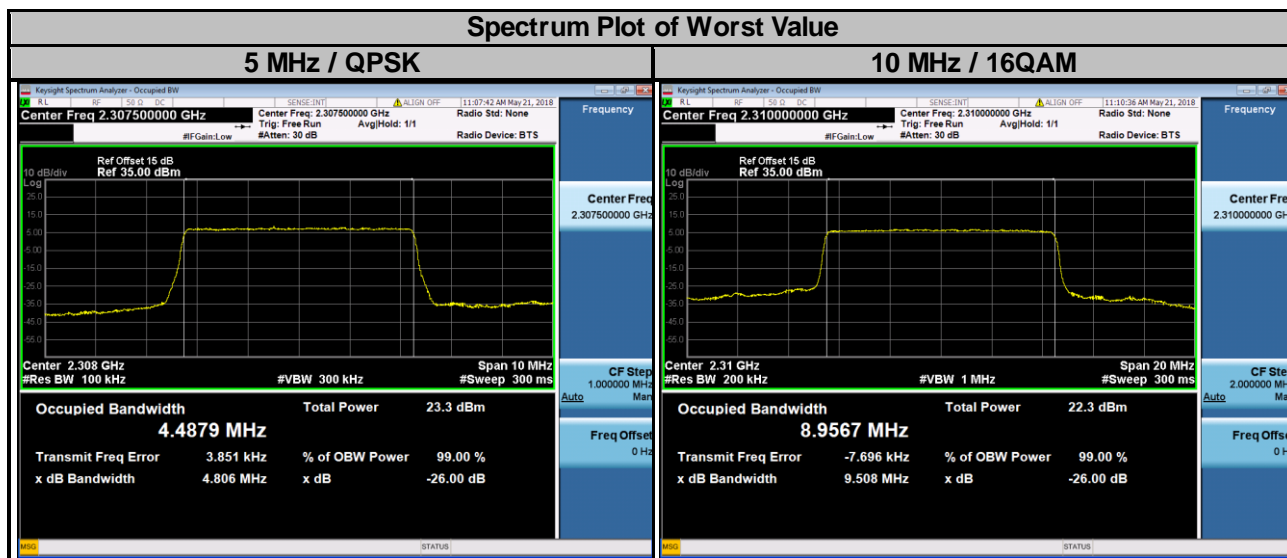

## 4.4 Band Edge Measurement

### 4.4.1 Limits of Band Edge Measurement

According to FCC 27.53(a) (4) For mobile and portable stations operating in the 2305-2315 MHz and 2350-2360 MHz bands:

- (i) By a factor of not less than:  $43 + 10 \log (P)$  dB on all frequencies between 2305 and 2320 MHz and on all frequencies between 2345 and 2360 MHz that are outside the licensed band(s) of operation, not less than  $55 + 10 \log (P)$  dB on all frequencies between 2320 and 2324 MHz and on all frequencies between 2341 and 2345 MHz, not less than  $61 + 10 \log (P)$  dB on all frequencies between 2324 and 2328 MHz and on all frequencies between 2337 and 2341 MHz, and not less than  $67 + 10 \log (P)$  dB on all frequencies between 2328 and 2337 MHz;
- (ii) By a factor of not less than  $43 + 10 \log (P)$  dB on all frequencies between 2300 and 2305 MHz,  $55 + 10 \log (P)$  dB on all frequencies between 2296 and 2300 MHz,  $61 + 10 \log (P)$  dB on all frequencies between 2292 and 2296 MHz,  $67 + 10 \log (P)$  dB on all frequencies between 2288 and 2292 MHz, and  $70 + 10 \log (P)$  dB below 2288 MHz;
- (iii) By a factor of not less than  $43 + 10 \log (P)$  dB on all frequencies between 2360 and 2365 MHz, and not less than  $70 + 10 \log (P)$  dB above 2365 MHz.

### 4.4.2 Test Setup

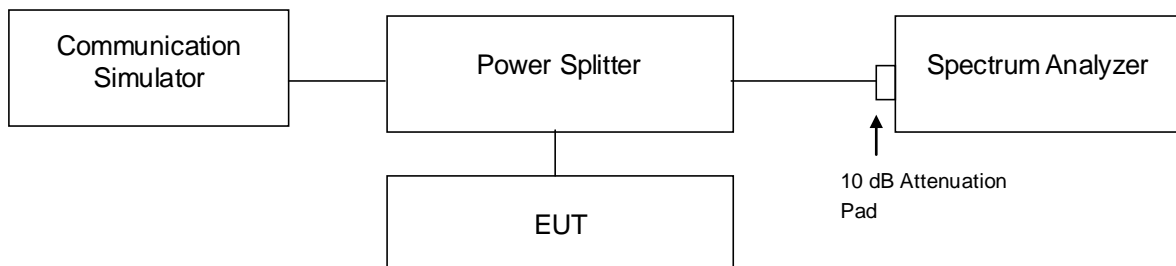

### 4.4.3 Test Procedures

- a. The EUT was set up for the maximum peak power with LTE link data modulation. The power was measured with R&S Spectrum Analyzer. All measurements were done at 2 channels (low and high operational frequency range).
- b. The band edge measurement used the power splitter via EUT RF power connector between simulation base station and spectrum analyzer.
- c. Measuring frequency range is from 2200 MHz to 2395 MHz for LTE Band 30. 10 dB attenuation pad is connected with spectrum. RBW = 1 MHz and VBW = 3 MHz are used for conducted emission measurement.
- d. Record the max trace plot into the test report.

#### 4.4.4 Test Results

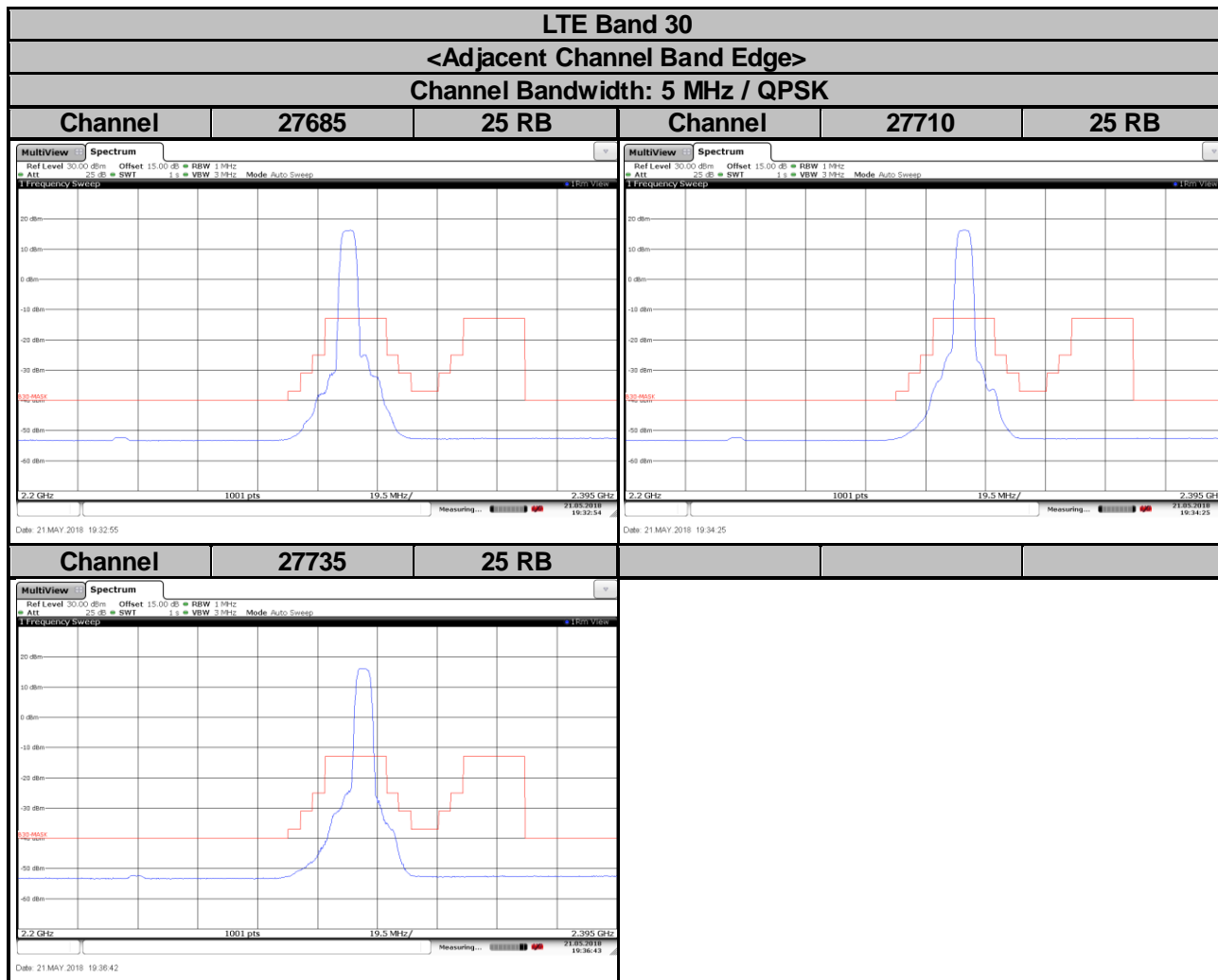

**LTE Band 30**  
**<Adjacent Channel Band Edge>**  
**Channel Bandwidth: 5 MHz / 16QAM**

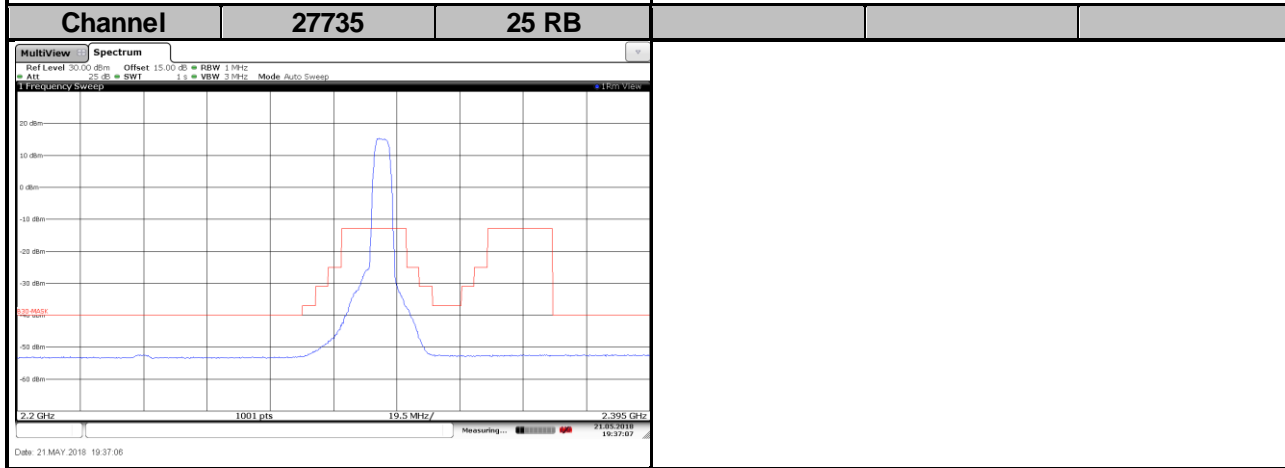
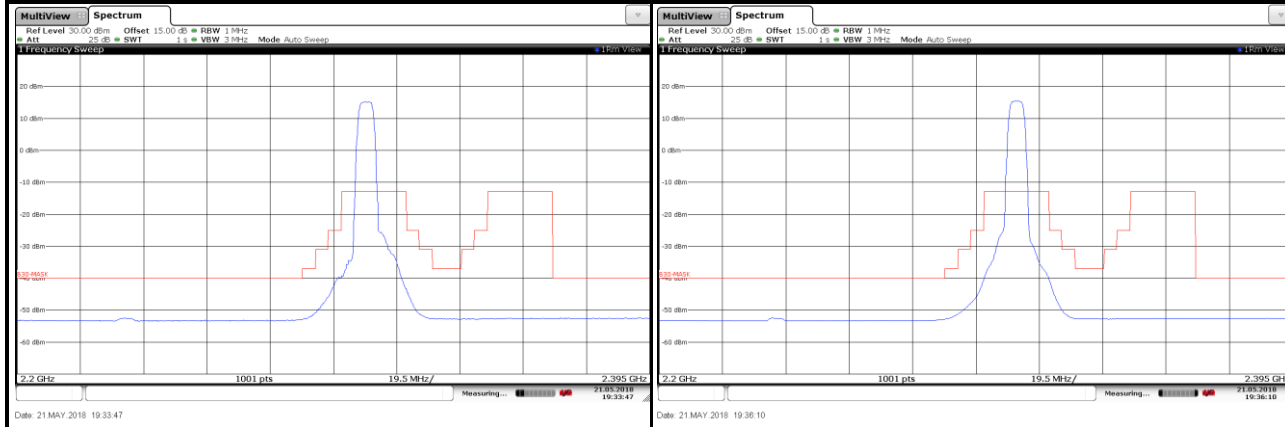

**LTE Band 30**  
**Channel Bandwidth: 10 MHz / QPSK**      **Channel Bandwidth: 10 MHz / 16QAM**

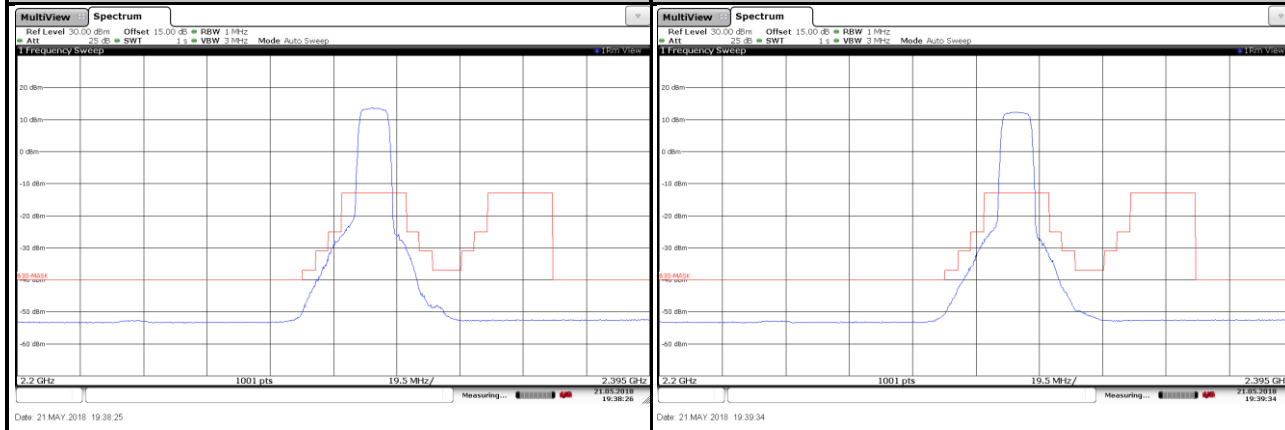

## 4.5 Conducted Spurious Emissions

### 4.5.1 Limits of Conducted Spurious Emissions Measurement

The power of any emission outside a licensee's frequency block shall be attenuated below the transmitter power (P) by at least  $70 + 10 \log_{10}(P)$  dB. The limit of emission is equal to -40 dBm.

### 4.5.2 Test Setup

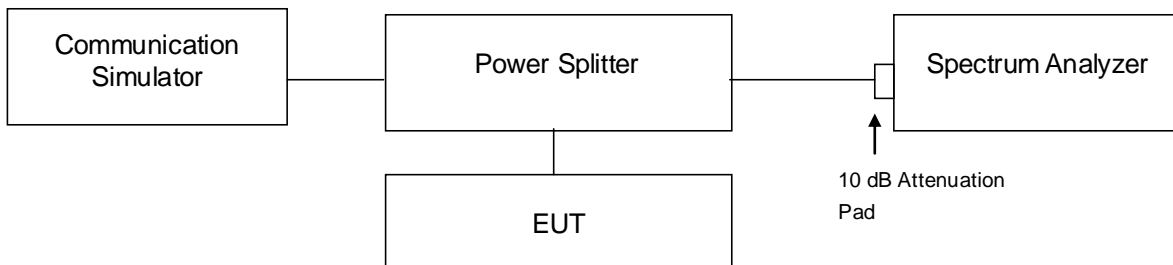

### 4.5.3 Test Procedure

- The EUT makes a phone call to the communication simulator. All measurements were done at low, middle and high operational frequency range.
- Measuring frequency range is from 30 MHz to 23.5 GHz for LTE Band 30. 10 dB attenuation pad is connected with spectrum. RBW = 1 MHz and VBW = 3 MHz are used for conducted emission measurement.

#### 4.5.4 Test Results

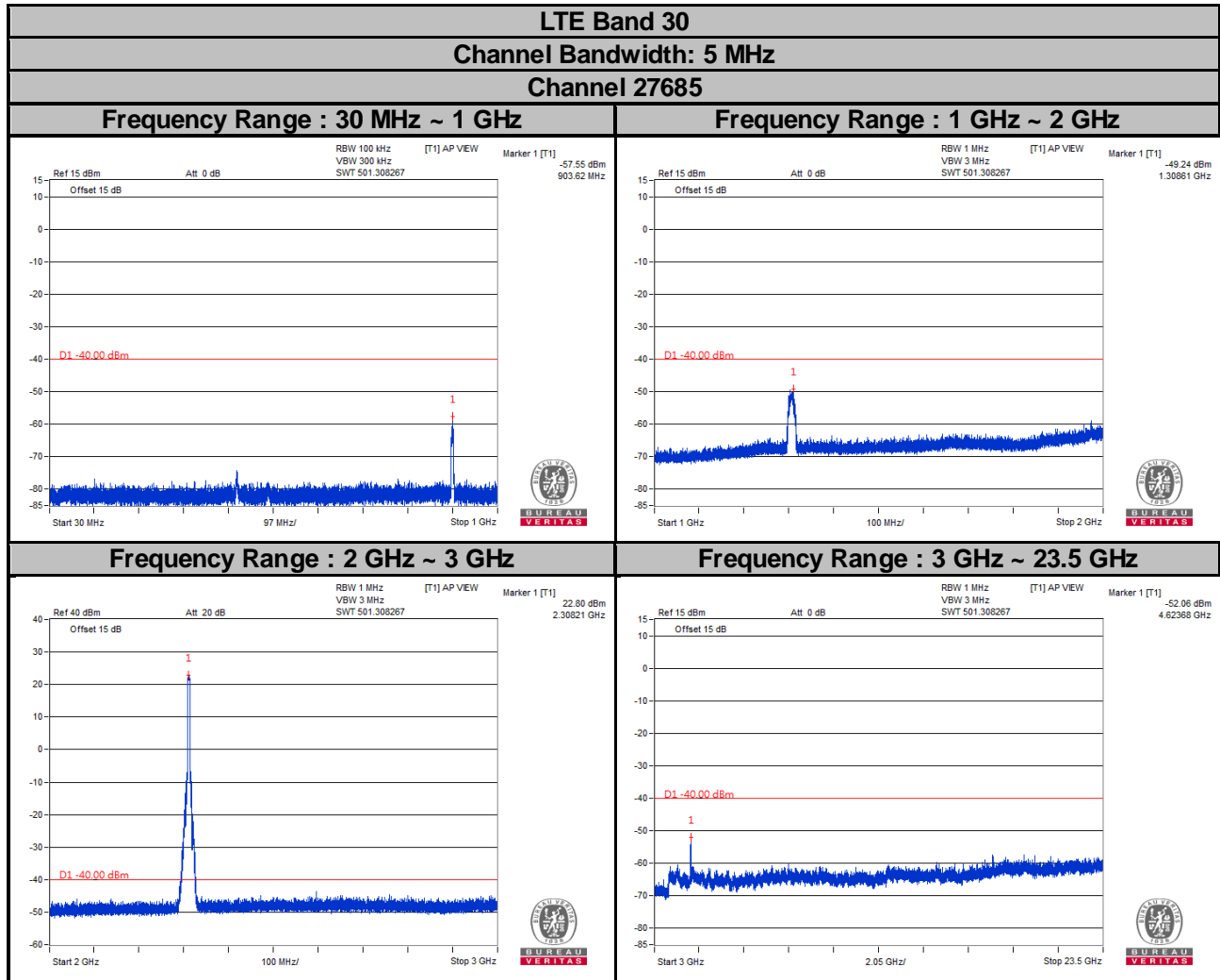



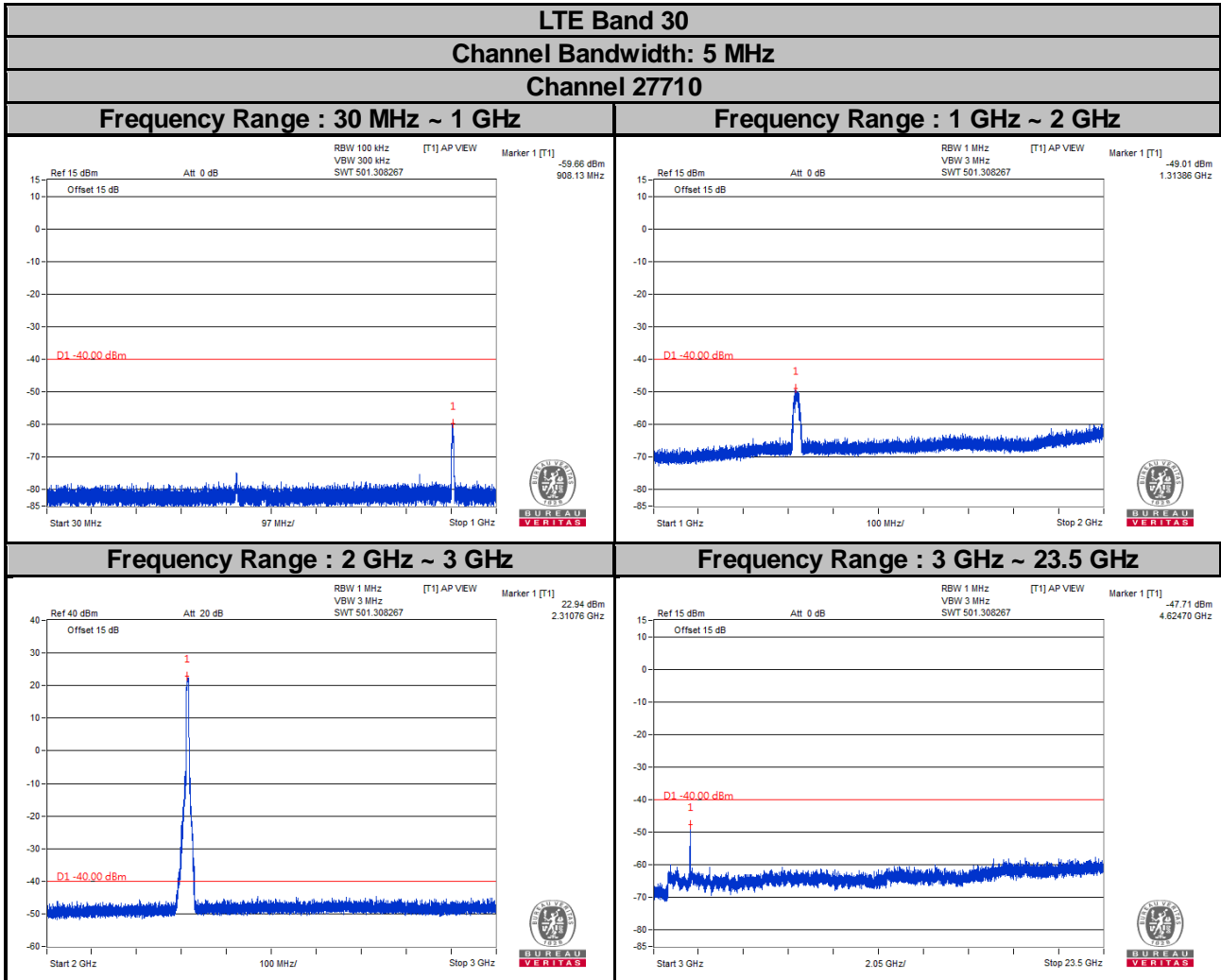

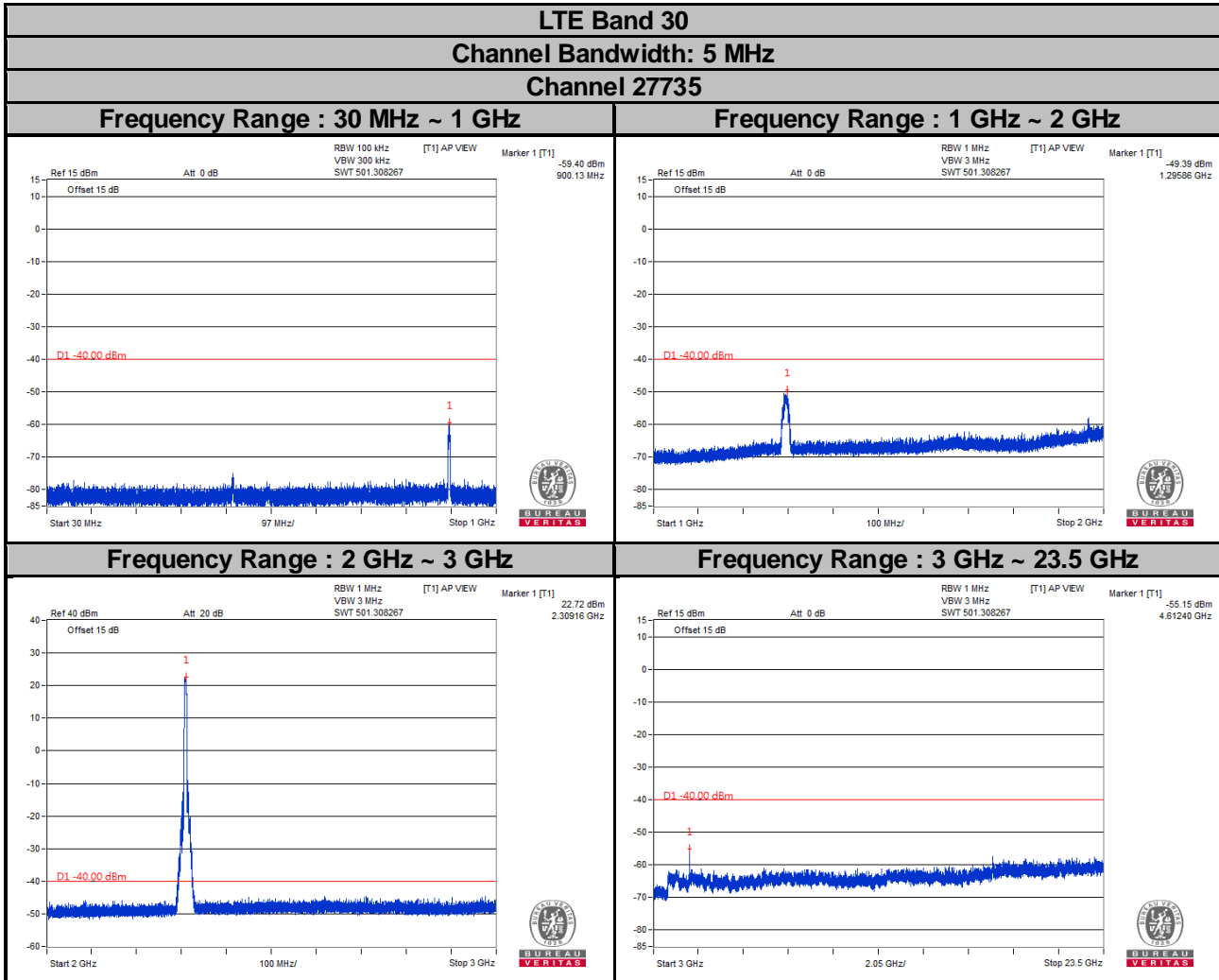

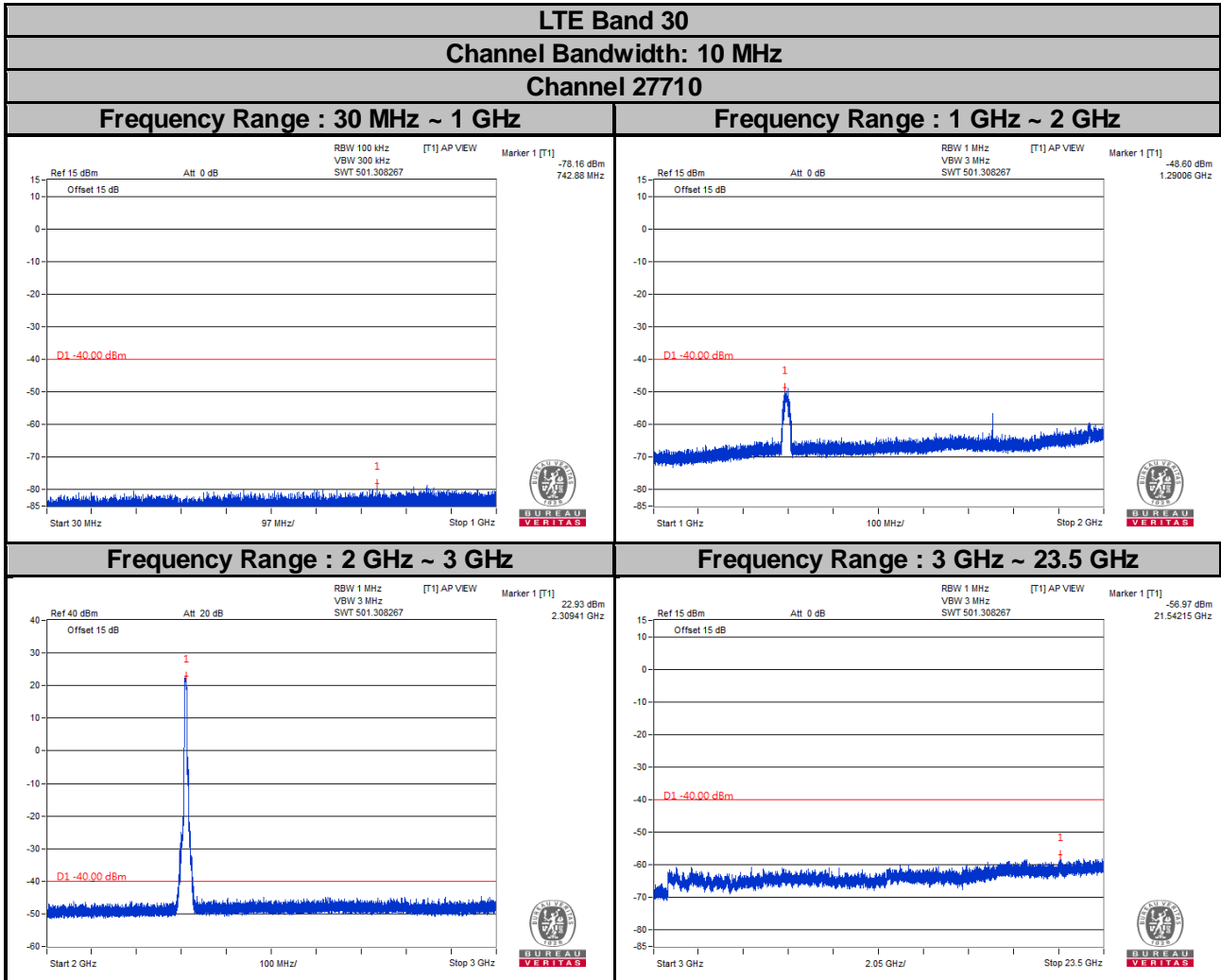

## 4.6 Radiated Emission Measurement

### 4.6.1 Limits of Radiated Emission Measurement

The power of any emission outside a licensee's frequency block shall be attenuated below the transmitter power (P) by at least  $70 + 10 \log_{10}(P)$  dB. The limit of emission is equal to -40 dBm.

### 4.6.2 Test Procedure

- a. Substitution method is used for E.I.R.P measurement. In the semi-anechoic chamber, EUT placed on the 0.8 m (below or equal 1 GHz) and/or 1.5 m (above 1 GHz) height of Turn Table, rotated the table around 360 degrees to search the maximum radiation power and receiver antenna shall be rotated vertical and horizontal polarization and moved height from 1 m to 4 m to find the maximum polar radiated power. The "Read Value" is the spectrum reading the maximum power value.
- b. The substitution horn antenna is substituted for EUT at the same position and signals generator export the CW signal to the substitution antenna via a TX cable. Rotated the Turn Table and moved receiving antenna to find the maximum radiation power. Adjust output power level of S.G to get a Value of spectrum reading equal to "Read Value " of step a. Record the power level of S.G
- c. EIRP = Output power level of S.G – TX cable loss + Antenna gain of substitution horn.
- d. E.R.P power can be calculated form E.I.R.P power by subtracting the gain of dipole, E.R.P power = E.I.P.R power - 2.15 dB.

**Note:** The resolution bandwidth of spectrum analyzer is 1 MHz and the video bandwidth is 3 MHz.

### 4.6.3 Deviation from Test Standard

No deviation.

#### 4.6.4 Test Setup

##### <Radiated Emission below or equal 1 GHz>

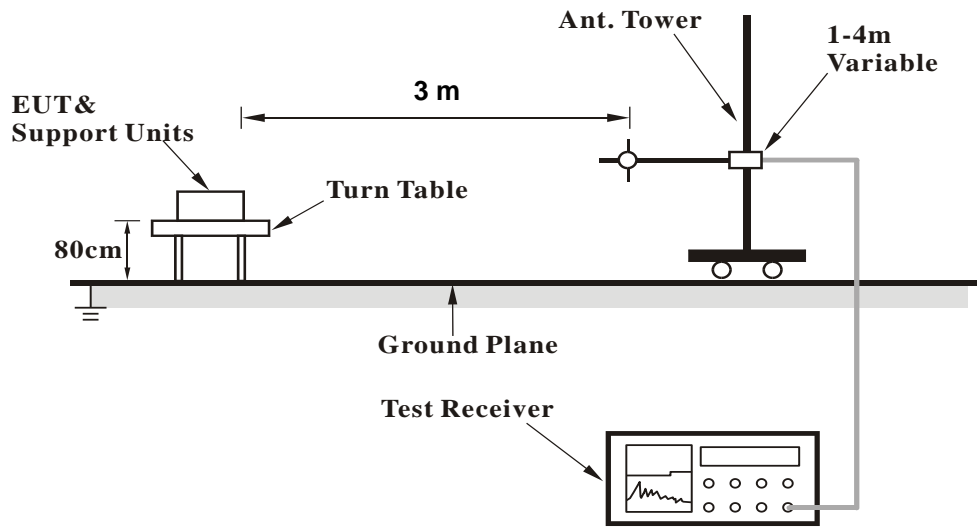

##### <Radiated Emission above 1 GHz>

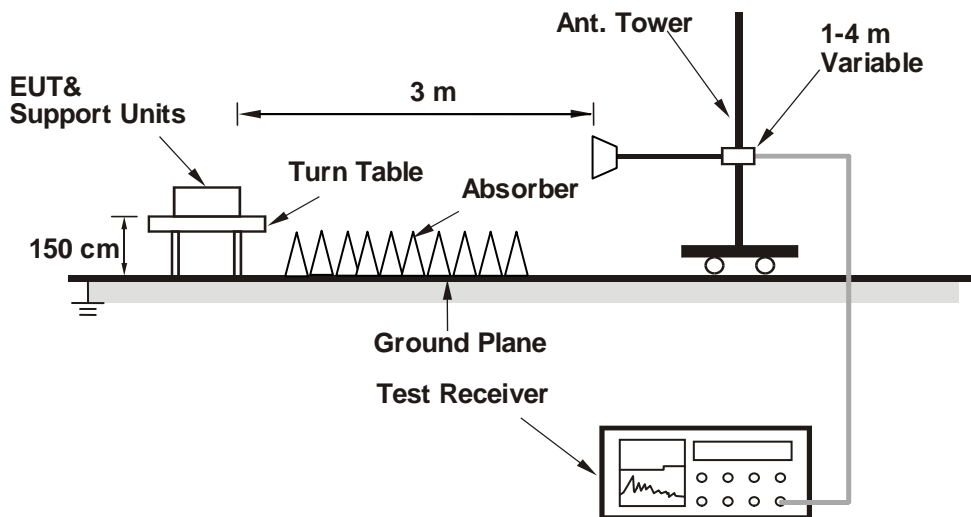

For the actual test configuration, please refer to the attached file (Test Setup Photo).

4.6.5 Test Results

LTE Band 30

Channel Bandwidth: 5 MHz / QPSK

Low Channel



Bureau Veritas Consumer Products Services Ltd., Taoyuan Branch

A D T

Data: 9

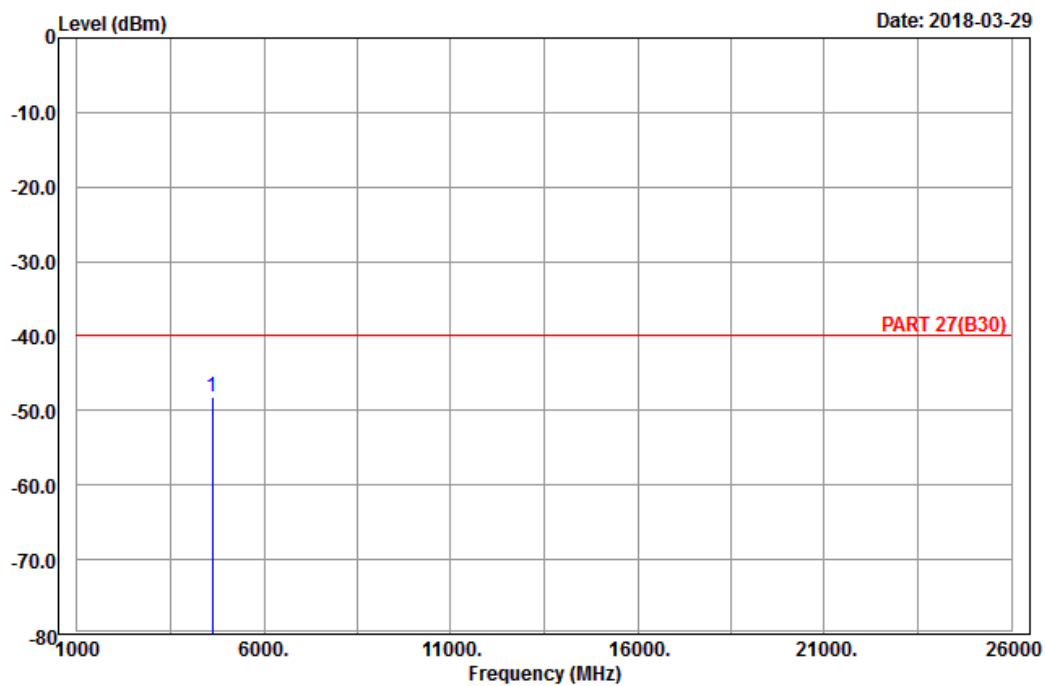

Site : 966 chamber 1  
 Condition: PART 27(B30) Horizontal  
 Remark : LTE\_Band 30\_Link\_CH27685  
 Tested by: Charles Hsiao

	Read	Limit	Over			
Freq	Level	Level	Line	Limit	Factor	Remark
MHz	dBm	dBm	dBm	dB	dB	
1 pp 4615.00	-48.17	-66.60	-40.00	-8.17	18.43	Peak



A D T

Data: 10

Date: 2018-03-29

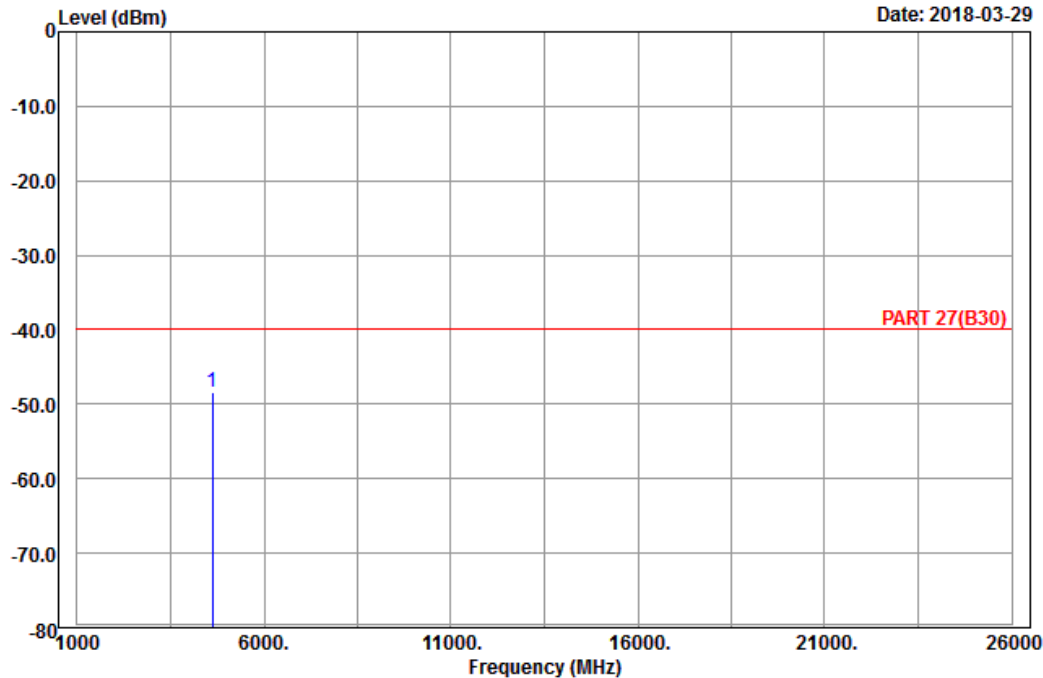

Site : 966 chamber 1  
 Condition: PART 27(B30) Vertical  
 Remark : LTE\_Band 30\_Link\_CH27685  
 Tested by: Charles Hsiao

	Freq	Level	Read Level	Limit Line	Over Limit	Factor	Remark
	MHz	dBm	dBm	dBm	dB	dB	
1	pp 4615.00	-48.50	-66.93	-40.00	-8.50	18.43	Peak

Middle Channel



Bureau Veritas Consumer Products Services Ltd., Taoyuan Branch

A D T

Data: 9

Date: 2018-04-04

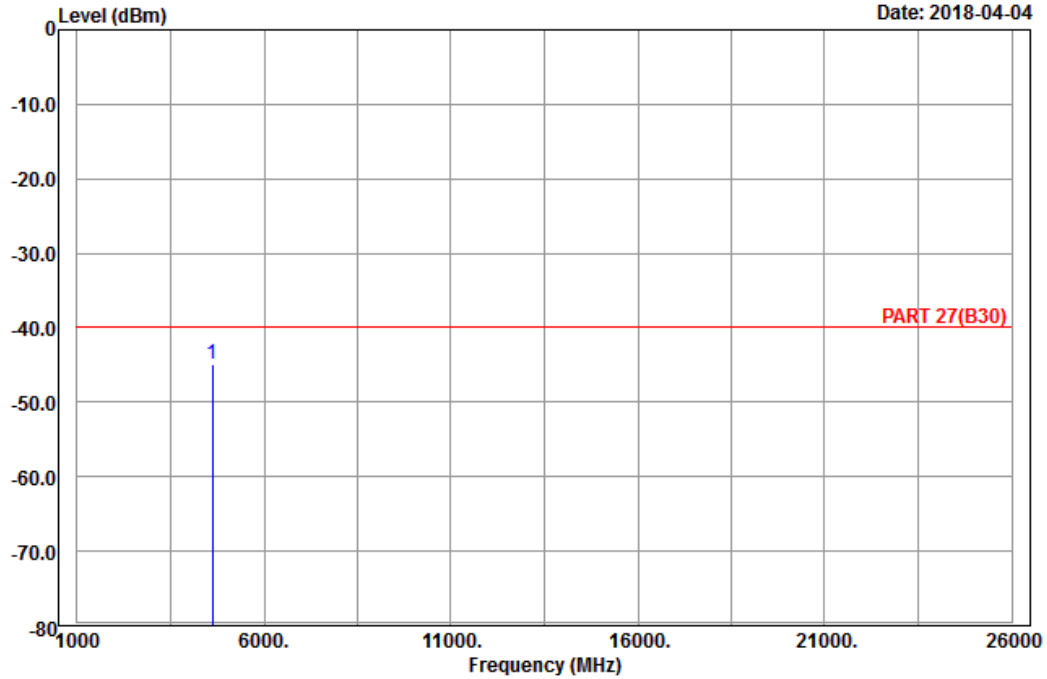

Site : 966 chamber 1  
 Condition: PART 27(B30) Horizontal  
 Remark : LTE\_Band 30\_Link\_CH27710  
 Tested by: Charles Hsiao

	Read	Limit	Over			
Freq	Level	Level	Line	Limit	Factor	Remark
MHz	dBm	dBm	dBm	dB	dB	
1 pp 4620.00	-44.81	-63.24	-40.00	-4.81	18.43	Peak





Bureau Veritas Consumer Products Services Ltd., Taoyuan Branch

A D T

Data: 10

Date: 2018-04-04

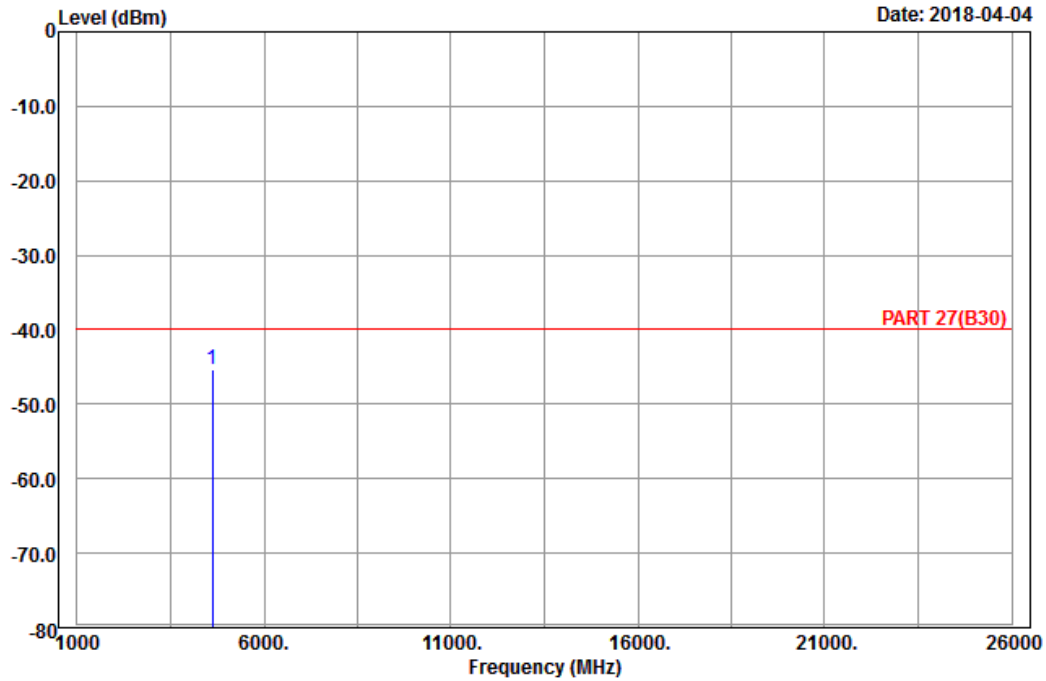

Site : 966 chamber 1  
 Condition: PART 27(B30) Vertical  
 Remark : LTE\_Band 30\_Link\_CH27710  
 Tested by: Charles Hsiao

	Read	Limit	Over			
Freq	Level	Level	Line	Limit	Factor	Remark
MHz	dBm	dBm	dBm	dB	dB	
1 pp 4620.00	-45.31	-63.74	-40.00	-5.31	18.43	Peak

# High Channel



Bureau Veritas Consumer Products Services Ltd., Taoyuan Branch

A D T

Data: 9

Date: 2018-03-29

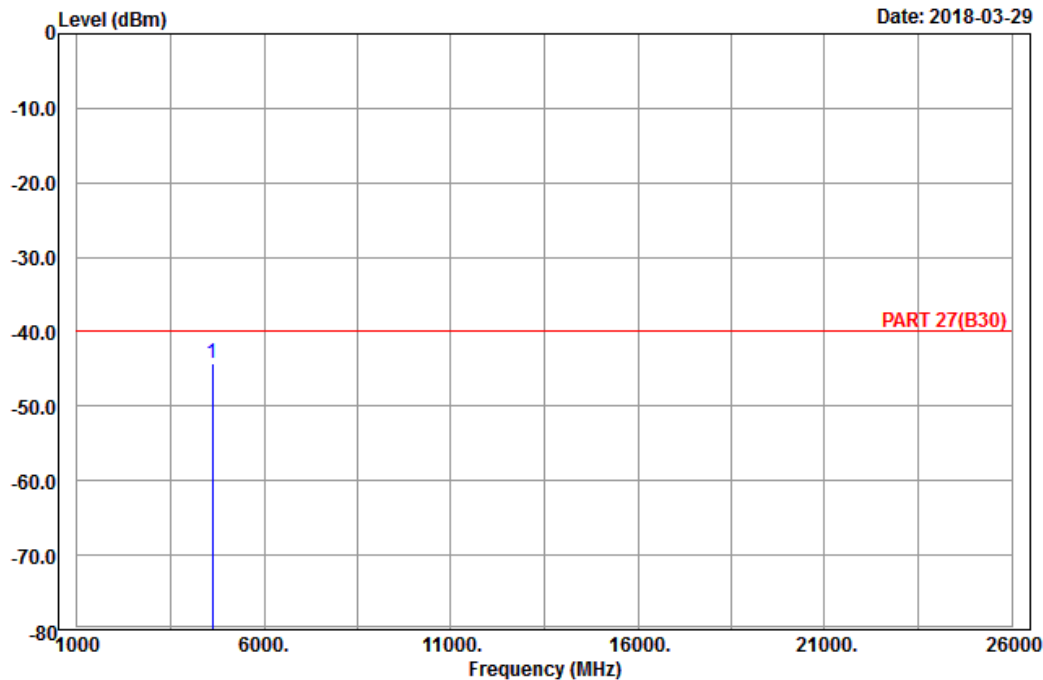

Site : 966 chamber 1  
 Condition: PART 27(B30) Horizontal  
 Remark : LTE\_Band 30\_Link\_CH27735  
 Tested by: Charles Hsiao

	Read	Limit	Over			
Freq	Level	Level	Line	Limit	Factor	Remark
MHz	dBm	dBm	dBm	dB	dB	
1 pp 4625.00	-44.22	-62.65	-40.00	-4.22	18.43	Peak



Bureau Veritas Consumer Products Services Ltd., Taoyuan Branch

A D T

Data: 10

Date: 2018-03-29

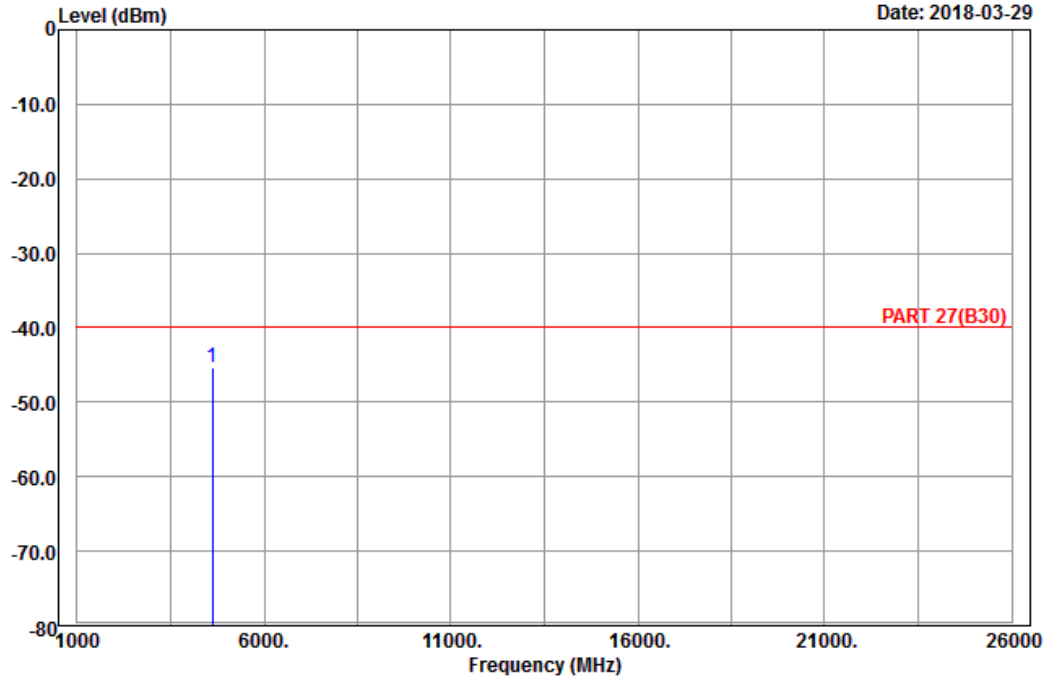

Site : 966 chamber 1  
 Condition: PART 27(B30) Vertical  
 Remark : LTE\_Band 30\_Link\_CH27735  
 Tested by: Charles Hsiao

	Read	Limit	Over			
Freq	Level	Level	Line	Limit	Factor	Remark
MHz	dBm	dBm	dBm	dB	dB	
1 pp 4625.00	-45.25	-63.68	-40.00	-5.25	18.43	Peak

Channel Bandwidth: 10 MHz / QPSK



Bureau Veritas Consumer Products Services Ltd., Taoyuan Branch

A D T

Data: 13

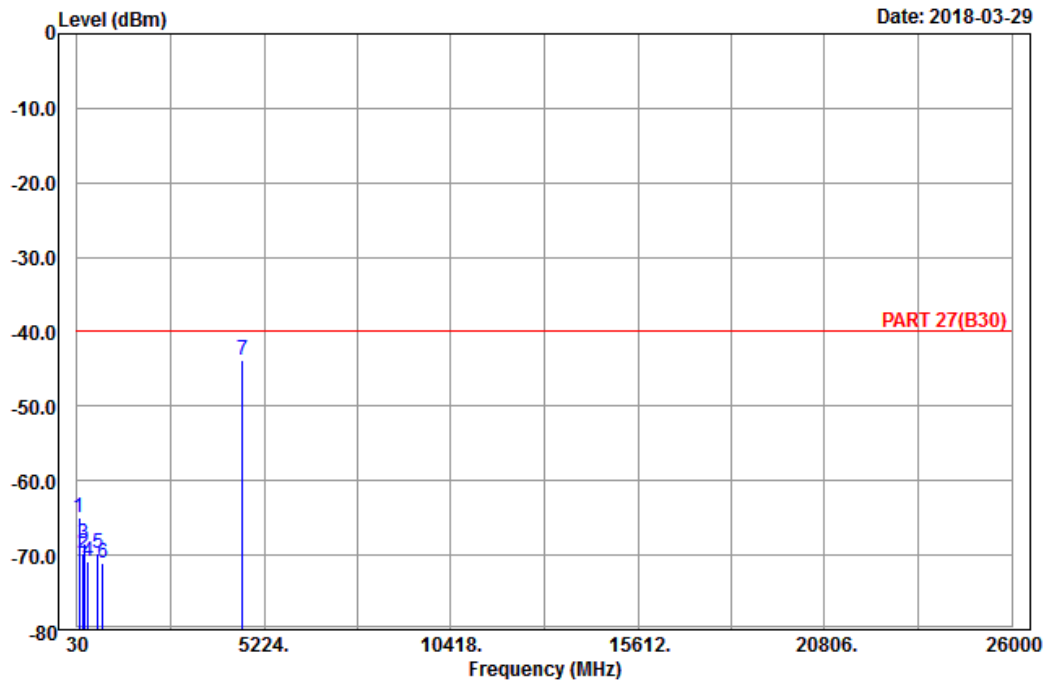

Site : 966 chamber 1  
 Condition: PART 27(B30) Horizontal  
 Remark : LTE\_Band 30\_Link\_CH27710  
 Tested by: Charles Hsiao

	Read	Limit	Over				
Freq	Level	Level	Line	Limit	Factor	Remark	
MHz	dBm	dBm	dBm	dB	dB		
1	96.42	-65.05	-54.71	-40.00	-25.05	-10.34	Peak
2	210.36	-69.86	-63.82	-40.00	-29.86	-6.04	Peak
3	216.57	-68.45	-62.49	-40.00	-28.45	-5.96	Peak
4	331.50	-70.90	-65.31	-40.00	-30.90	-5.59	Peak
5	612.20	-69.65	-69.94	-40.00	-29.65	0.29	Peak
6	738.90	-70.96	-69.85	-40.00	-30.96	-1.11	Peak
7 pp	4620.00	-43.73	-62.16	-40.00	-3.73	18.43	Peak



A D T

Data: 14

Date: 2018-03-29

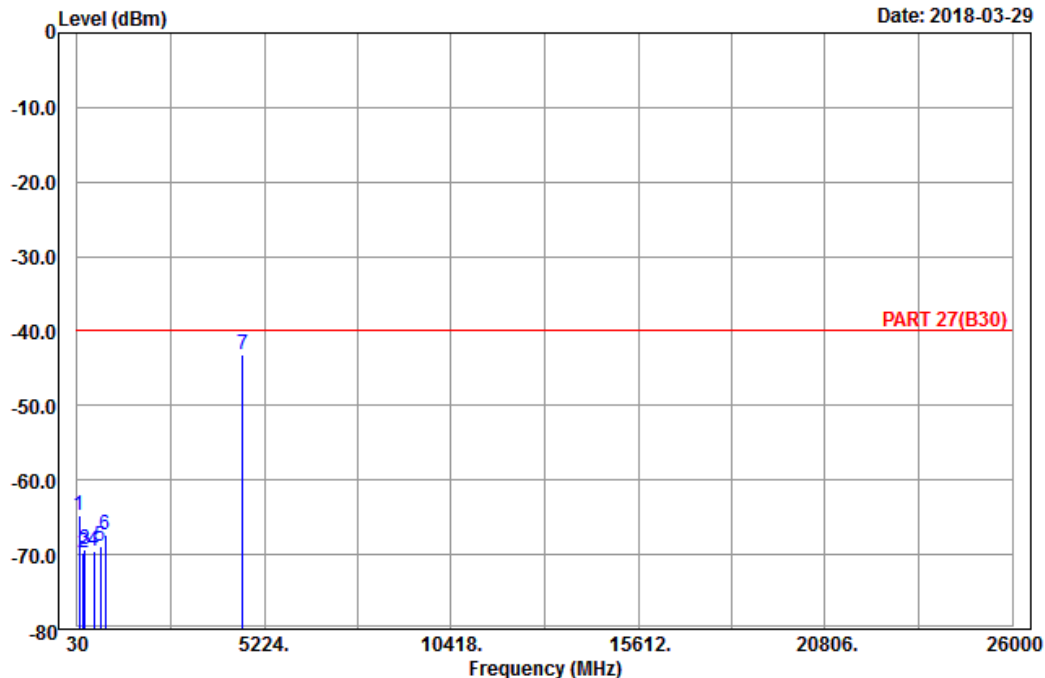

Site : 966 chamber 1  
 Condition: PART 27(B30) Vertical  
 Remark : LTE\_Band 30\_Link\_CH27710  
 Tested by: Charles Hsiao

	Freq	Level	Read Level	Limit	Over	Factor	Remark
	MHz	dBm	dBm	dBm	dB	dB	
1	85.35	-64.67	-53.45	-40.00	-24.67	-11.22	Peak
2	207.93	-69.69	-63.61	-40.00	-29.69	-6.08	Peak
3	243.30	-69.43	-63.83	-40.00	-29.43	-5.60	Peak
4	498.80	-69.46	-64.23	-40.00	-29.46	-5.23	Peak
5	678.70	-68.80	-68.53	-40.00	-28.80	-0.27	Peak
6	811.00	-67.38	-69.27	-40.00	-27.38	1.89	Peak
7 pp	4620.00	-43.23	-61.66	-40.00	-3.23	18.43	Peak

## 5 Pictures of Test Arrangements

Please refer to the attached file (Test Setup Photo).

## Appendix – Information on the Testing Laboratories

We, Bureau Veritas Consumer Products Services (H.K.) Ltd., Taoyuan Branch, were founded in 1988 to provide our best service in EMC, Radio, Telecom and Safety consultation. Our laboratories are FCC recognized accredited test firms and accredited according to ISO/IEC 17025.

If you have any comments, please feel free to contact us at the following:

**Linko EMC/RF Lab**

Tel: 886-2-26052180

Fax: 886-2-26051924

**Hsin Chu EMC/RF/Telecom Lab**

Tel: 886-3-6668565

Fax: 886-3-6668323

**Hwa Ya EMC/RF/Safety**

Tel: 886-3-3183232

Fax: 886-3-3270892

**Email:** [service.adt@tw.bureauveritas.com](mailto:service.adt@tw.bureauveritas.com)

**Web Site:** [www.bureauveritas-adt.com](http://www.bureauveritas-adt.com)

The address and road map of all our labs can be found in our web site also.

--- END ---