

RF Exposure report



The following samples were submitted and identified on behalf of the client as:

Product Name Notebook Computer
Brand Name HP
Model No. HSN-I61C
Applicant HP Inc.
1501 Page Mill Road, Palo Alto CA 94304 USA
Standards IEEE/ANSI C95.1-1992, IEEE 1528-2013
FCC ID B94HNI61CPA
Date of EUT Receipt Nov. 16, 2023
Date of Test(s) Dec. 05, 2023 ~ Dec. 10, 2023
Date of Issue Mar. 05, 2024

In the configuration tested, the EUT complied with the standards specified above.

Remarks:

This report details the results of the testing carried out on one sample, the results contained in this test report do not relate to other samples of the same product. The manufacturer should ensure that all products in series production are in conformity with the product sample detailed in this report.

This report may only be reproduced and distributed in full. If the product in this report is used in any configuration other than that detailed in the report, the manufacturer must ensure the new system complies with all relevant standards. Any mention of SGS Taiwan Ltd. Central RF Lab or testing done by SGS Taiwan Ltd. Central RF Lab in connection with distribution or use of the product described in this report must be approved by SGS Taiwan Ltd. Central RF Lab in writing.

Signed on behalf of SGS

Clerk / Cindy Chou	PM / Afu Chen	Approved By / John Yeh

Date: Mar. 05, 2024

Unless otherwise stated the results shown in this test report refer only to the sample(s) tested and such sample(s) are retained for 90 days only.

除非另有說明，此報告結果僅對測試之樣品負責，同時此樣品僅保留90天。本報告未經本公司書面許可，不可部份複製。

This document is issued by the Company subject to its General Conditions of Service printed overleaf, available on request or accessible at <http://www.sgs.com.tw/Terms-and-Conditions> and for electronic format documents, subject to Terms and Conditions for Electronic Documents at <http://www.sgs.com.tw/Terms-and-Conditions>. Attention is drawn to the limitation of liability, indemnification and jurisdiction issues defined therein. Any holder of this document is advised that information contained hereon reflects the Company's findings at the time of its intervention only and within the limits of Client's instructions, if any. The Company's sole responsibility is to its Client and this document does not exonerate parties to a transaction from exercising all their rights and obligations under the transaction documents. This document cannot be reproduced except in full, without prior written approval of the Company. Any unauthorized alteration, forgery or falsification of the content or appearance of this document is unlawful and offenders may be prosecuted to the fullest extent of the law.

Revision History

Report Number	Revision	Description	Issue Date	Revised By	Remark
TESA2311000705EN	00	Initial creation of document	Mar. 05, 2024	Cindy Chou	

Note:

1. The mark " * " is the revised version of the report due to comments submitted by the certification.
2. Measurement results in the original test report TESA2311000704EN, 231128-04.TR02 and 231128-04.TR03 are partially leveraged in this test report.
3. The data for this test report WWAN leverages the measurements from the original test report TESA2311000704EN.
4. The data for this test report WLAN(2.4G / 5G) leverages the measurements from the original test report 231128-04.TR02.
5. The data for this test report WLAN(6E) leverages the measurements from the original test report 231128-04.TR03.

Unless otherwise stated the results shown in this test report refer only to the sample(s) tested and such sample(s) are retained for 90 days only.

除非另有說明，此報告結果僅對測試之樣品負責，同時此樣品僅保留90天。本報告未經本公司書面許可，不可部份複製。

This document is issued by the Company subject to its General Conditions of Service printed overleaf, available on request or accessible at <http://www.sgs.com.tw/Terms-and-Conditions> and for electronic format documents, subject to Terms and Conditions for Electronic Documents at <http://www.sgs.com.tw/Terms-and-Conditions>. Attention is drawn to the limitation of liability, indemnification and jurisdiction issues defined therein. Any holder of this document is advised that information contained hereon reflects the Company's findings at the time of its intervention only and within the limits of Client's instructions, if any. The Company's sole responsibility is to its Client and this document does not exonerate parties to a transaction from exercising all their rights and obligations under the transaction documents. This document cannot be reproduced except in full, without prior written approval of the Company. Any unauthorized alteration, forgery or falsification of the content or appearance of this document is unlawful and offenders may be prosecuted to the fullest extent of the law.

Contents

1	GENERAL INFORMATION	4
1.1	Test Methodology	4
1.2	Description of EUT.....	5
1.3	Maximum value	6
1.4	Antenna Information.....	6
2	MEASUREMENT SYSTEM	7
2.1	Test Facility	7
2.2	SAR System	8
3	SAR SYSTEM VERIFICATION	11
3.1	Tissue Simulating Liquid.....	11
3.2	Tissue Simulant Liquid measurement	11
3.3	Measurement results of Tissue Simulant Liquid.....	11
3.4	The composition of the tissue simulating liquid:.....	13
3.5	System check.....	13
3.6	System check results	14
4	TEST CONFIGURATIONS	15
4.1	Test Environment.....	15
4.2	Test Note.....	15
4.3	Test position.....	18
4.4	Power verification of device mode	20
4.5	Test limit	23
5	MAXIMUM OUTPUT POWER	26
5.1	GSM/GPRS/EDGE	26
5.2	FDD CAT.M1	30
6	SUMMARY OF RESULTS	56
6.1	Decision rules	56
6.2	Summary of SAR Results.....	56
6.3	Reporting statements of conformity	58
6.4	Conclusion	58
7	SIMULTANEOUS TRANSMISSION ANALYSIS	59
7.1	Simultaneous Transmission Scenarios:	59
7.2	Estimated SAR calculation	60
7.3	SPLSR evaluation and analysis.....	60
7.4	Conclusion	127
8	INSTRUMENTS LIST	128
9	UNCERTAINTY BUDGET	129
10	SAR MEASUREMENT RESULTS	130
11	SAR SYSTEM CHECK RESULTS	154
12	APPENDIXES	160
12.1	SAR_Appendix A Photographs	160
12.2	SAR_Appendix B DAE & Probe Cal. Certificate	160
12.3	SAR_Appendix C Phantom Description & Dipole Cal. Certificate	160

Unless otherwise stated the results shown in this test report refer only to the sample(s) tested and such sample(s) are retained for 90 days only.

除非另有說明，此報告結果僅對測試之樣品負責，同時此樣品僅保留90天。本報告未經本公司書面許可，不可部份複製。

This document is issued by the Company subject to its General Conditions of Service printed overleaf, available on request or accessible at <http://www.sgs.com.tw/Terms-and-Conditions> and for electronic format documents, subject to Terms and Conditions for Electronic Documents at <http://www.sgs.com.tw/Terms-and-Conditions>. Attention is drawn to the limitation of liability, indemnification and jurisdiction issues defined therein. Any holder of this document is advised that information contained hereon reflects the Company's findings at the time of its intervention only and within the limits of Client's instructions, if any. The Company's sole responsibility is to its Client and this document does not exonerate parties to a transaction from exercising all their rights and obligations under the transaction documents. This document cannot be reproduced except in full, without prior written approval of the Company. Any unauthorized alteration, forgery or falsification of the content or appearance of this document is unlawful and offenders may be prosecuted to the fullest extent of the law.

1 GENERAL INFORMATION

1.1 Test Methodology

The SAR testing method and procedure for this device is in accordance with the following standards:

IEEE/ANSI C95.1-1992

IEEE 1528-2013

KDB447498D01v06

KDB865664D01v01r04

KDB865664D02v01r02

KDB616217D04v01r02

KDB941225D01v03r01

KDB941225D05v02r05

Unless otherwise stated the results shown in this test report refer only to the sample(s) tested and such sample(s) are retained for 90 days only.
除非另有說明，此報告結果僅對測試之樣品負責，同時此樣品僅保留90天。本報告未經本公司書面許可，不可部份複製。

This document is issued by the Company subject to its General Conditions of Service printed overleaf, available on request or accessible at <http://www.sgs.com.tw/Terms-and-Conditions> and for electronic format documents, subject to Terms and Conditions for Electronic Documents at <http://www.sgs.com.tw/Terms-and-Conditions>. Attention is drawn to the limitation of liability, indemnification and jurisdiction issues defined therein. Any holder of this document is advised that information contained hereon reflects the Company's findings at the time of its intervention only and within the limits of Client's instructions, if any. The Company's sole responsibility is to its Client and this document does not exonerate parties to a transaction from exercising all their rights and obligations under the transaction documents. This document cannot be reproduced except in full, without prior written approval of the Company. Any unauthorized alteration, forgery or falsification of the content or appearance of this document is unlawful and offenders may be prosecuted to the fullest extent of the law.

1.2 Description of EUT

Product Name	Notebook Computer	
Brand Name	HP	
Model No.	HSN-I61C	
FCC ID	B94HNI61CPA	
Integrated WWAN Module	Brand Name: Fibocom Model Name: FB520	
Integrated WLAN Module	Brand Name: Intel Model Name: BE200NGW	
Duty Cycle	GSM (DTM multi class B)	1/8.3
	GPRS (support multi class 12 max)	1/2 (1Dn4UP) 1/2.76 (1Dn3UP) 1/4.1 (1Dn2UP) 1/8.3 (1Dn1UP)
	EDGE (support multi class 12 max)	1/2 (1Dn4UP) 1/2.76 (1Dn3UP) 1/4.1 (1Dn2UP) 1/8.3 (1Dn1UP)
	CAT.M1 FDD	0.3
Supported radios (TX Frequency Range, MHz)	GSM850	824-849
	GSM1900	1850-1910
	CAT.M1 FDD Band 2	1850-1910
	CAT.M1 FDD Band 4	1710-1755
	CAT.M1 FDD Band 5	824-849
	CAT.M1 FDD Band 12	699-716
	CAT.M1 FDD Band 13	777-787
	CAT.M1 FDD Band 14	788-798
	CAT.M1 FDD Band 25	1850-1915
	CAT.M1 FDD Band 26	814-849
	CAT.M1 FDD Band 66	1710-1780
CAT.M1 FDD Band 85	698-716	

Unless otherwise stated the results shown in this test report refer only to the sample(s) tested and such sample(s) are retained for 90 days only.

除非另有說明，此報告結果僅對測試之樣品負責，同時此樣品僅保留90天。本報告未經本公司書面許可，不可部份複製。

This document is issued by the Company subject to its General Conditions of Service printed overleaf, available on request or accessible at <http://www.sgs.com.tw/Terms-and-Conditions> and for electronic format documents, subject to Terms and Conditions for Electronic Documents at <http://www.sgs.com.tw/Terms-and-Conditions>. Attention is drawn to the limitation of liability, indemnification and jurisdiction issues defined therein. Any holder of this document is advised that information contained herein reflects the Company's findings at the time of its intervention only and within the limits of Client's instructions, if any. The Company's sole responsibility is to its Client and this document does not exonerate parties to a transaction from exercising all their rights and obligations under the transaction documents. This document cannot be reproduced except in full, without prior written approval of the Company. Any unauthorized alteration, forgery or falsification of the content or appearance of this document is unlawful and offenders may be prosecuted to the fullest extent of the law.

1.3 Maximum value

Vendor1

Summary of Maximum SAR Value	
Mode	Highest SAR 1g (W/kg)
GPRS850 <1Dn4Up>	1.05

Vendor2

Summary of Maximum SAR Value	
Mode	Highest SAR 1g (W/kg)
GPRS850 <1Dn4Up>	1.19

1.4 Antenna Information

Laptop mode_WWAN

Vendor	Vendor1									
Antenna	Ant5									
Part Number	6036B0346901(00-3302702850)									
Frequency(MHz)	85	12	13	14	26	5	4	66	2	25
	698~716	699~716	777~787	788~798	814~849	824~849	1710~1755	1710~1780	1850~1910	1850~1915
Gain (dBi)	-0.31	-0.31	-0.46	-0.79	-1.59	-1.59	0.41	0.41	0.56	0.56
Note: Antenna information is provided by the applicant.										

Tablet mode_WWAN

Vendor	Vendor1									
Antenna	Ant5									
Part Number	6036B0346901(00-3302702850)									
Frequency(MHz)	85	12	13	14	26	5	4	66	2	25
	698~716	699~716	777~787	788~798	814~849	824~849	1710~1755	1710~1780	1850~1910	1850~1915
Gain (dBi)	-4.27	-4.27	-4.51	-4.98	-5.88	-5.92	-1.71	-1.71	-1.74	-1.74
Note: Antenna information is provided by the applicant.										

Laptop mode_WWAN

Vendor	Vendor2									
Antenna	Ant5									
Part Number	6036B0345901(81ELBA15.G02)									
Frequency(MHz)	85	12	13	14	26	5	4	66	2	25
	698~716	699~716	777~787	788~798	814~849	824~849	1710~1755	1710~1780	1850~1910	1850~1915
Gain (dBi)	-1.56	-1.56	-1.44	-1.07	-1.16	-1.33	-0.43	-0.43	0.14	0.14
Note: Antenna information is provided by the applicant.										

Tablet mode_WWAN

Vendor	Vendor2									
Antenna	Ant5									
Part Number	6036B0345901(81ELBA15.G02)									
Frequency(MHz)	85	12	13	14	26	5	4	66	2	25
	698~716	699~716	777~787	788~798	814~849	824~849	1710~1755	1710~1780	1850~1910	1850~1915
Gain (dBi)	-6.10	-6.10	-6.15	-6.59	-5.12	-5.12	-1.36	-1.36	-0.34	-0.34
Note: Antenna information is provided by the applicant.										

Unless otherwise stated the results shown in this test report refer only to the sample(s) tested and such sample(s) are retained for 90 days only.

除非另有說明，此報告結果僅對測試之樣品負責，同時此樣品僅保留90天。本報告未經本公司書面許可，不可部份複製。

This document is issued by the Company subject to its General Conditions of Service printed overleaf, available on request or accessible at <http://www.sgs.com.tw/Terms-and-Conditions> and for electronic format documents, subject to Terms and Conditions for Electronic Documents at <http://www.sgs.com.tw/Terms-and-Conditions>. Attention is drawn to the limitation of liability, indemnification and jurisdiction issues defined therein. Any holder of this document is advised that information contained hereon reflects the Company's findings at the time of its intervention only and within the limits of Client's instructions, if any. The Company's sole responsibility is to its Client and this document does not exonerate parties to a transaction from exercising all their rights and obligations under the transaction documents. This document cannot be reproduced except in full, without prior written approval of the Company. Any unauthorized alteration, forgery or falsification of the content or appearance of this document is unlawful and offenders may be prosecuted to the fullest extent of the law.

2 MEASUREMENT SYSTEM

2.1 Test Facility

Laboratory	Test Site Address	Test Site Name	FCC Designation number	IC CAB identifier
SGS Taiwan Ltd. Central RF Lab. (TAF code 3702)	1F, No. 8, Alley 15, Lane 120, Sec. 1, NeiHu Road, NeiHu District, Taipei City, 11493, Taiwan.	SAR 2	TW0029	TW3702
		SAR 6		
		SAR 8		
	No. 2, Keji 1st Rd., Guishan Township, Taoyuan County, 33383, Taiwan	SAR 1	TW0028	
		SAR 4		
	No.134, Wu Kung Road, New Taipei Industrial Park, Wuku District, New Taipei City, Taiwan	SAR 3	TW0027	
SAR 7				

Note: Test site name is remarked on the equipment list in each section of this report as an indication where measurements occurred in specific test site and address.

Unless otherwise stated the results shown in this test report refer only to the sample(s) tested and such sample(s) are retained for 90 days only.

除非另有說明，此報告結果僅對測試之樣品負責，同時此樣品僅保留90天。本報告未經本公司書面許可，不可部份複製。

This document is issued by the Company subject to its General Conditions of Service printed overleaf, available on request or accessible at <http://www.sgs.com.tw/Terms-and-Conditions> and for electronic format documents, subject to Terms and Conditions for Electronic Documents at <http://www.sgs.com.tw/Terms-and-Conditions>. Attention is drawn to the limitation of liability, indemnification and jurisdiction issues defined therein. Any holder of this document is advised that information contained hereon reflects the Company's findings at the time of its intervention only and within the limits of Client's instructions, if any. The Company's sole responsibility is to its Client and this document does not exonerate parties to a transaction from exercising all their rights and obligations under the transaction documents. This document cannot be reproduced except in full, without prior written approval of the Company. Any unauthorized alteration, forgery or falsification of the content or appearance of this document is unlawful and offenders may be prosecuted to the fullest extent of the law.

SGS Taiwan Ltd. | No.134,Wu Kung Road, New Taipei Industrial Park, Wuku District, New Taipei City, Taiwan/新北市五股區新北產業園區五工路 134 號

EX3DV4 E-Field Probe

Construction	Symmetrical design with triangular core Built-in shielding against static charges PEEK enclosure material (resistant to organic solvents, e.g., DGBE)	
Calibration	Basic Broad Band Calibration in air Conversion Factors (CF) for HSL 750/835/1750/1900 MHz Additional CF for other liquids and frequencies upon request	
Frequency	10 MHz to > 6 GHz	
Directivity	± 0.3 dB in HSL (rotation around probe axis) ± 0.5 dB in tissue material (rotation normal to probe axis)	
Dynamic Range	10 µW/g to > 100 mW/g Linearity: ± 0.2 dB (noise: typically < 1 µW/g)	
Dimensions	Tip diameter: 2.5 mm	
Application	High precision dosimetric measurements in any exposure scenario (e.g., very strong gradient fields). Only probe which enables compliance testing for frequencies up to 6 GHz with precision of better 30%.	

Unless otherwise stated the results shown in this test report refer only to the sample(s) tested and such sample(s) are retained for 90 days only.

除非另有說明，此報告結果僅對測試之樣品負責，同時此樣品僅保留90天。本報告未經本公司書面許可，不可部份複製。

This document is issued by the Company subject to its General Conditions of Service printed overleaf, available on request or accessible at <http://www.sgs.com.tw/Terms-and-Conditions> and for electronic format documents, subject to Terms and Conditions for Electronic Documents at <http://www.sgs.com.tw/Terms-and-Conditions>. Attention is drawn to the limitation of liability, indemnification and jurisdiction issues defined therein. Any holder of this document is advised that information contained hereon reflects the Company's findings at the time of its intervention only and within the limits of Client's instructions, if any. The Company's sole responsibility is to its Client and this document does not exonerate parties to a transaction from exercising all their rights and obligations under the transaction documents. This document cannot be reproduced except in full, without prior written approval of the Company. Any unauthorized alteration, forgery or falsification of the content or appearance of this document is unlawful and offenders may be prosecuted to the fullest extent of the law.

SGS Taiwan Ltd. No.134,Wu Kung Road, New Taipei Industrial Park, Wuku District, New Taipei City, Taiwan/新北市五股區新北產業園區五工路 134 號

PHANTOM (ELI)

Model	ELI	
Construction	The ELI phantom is used for compliance testing of handheld and body-mounted wireless devices in the frequency range of 30 MHz to 6 GHz. ELI is fully compatible with the IEC 62209-2 standard and all known tissue simulating liquids. ELI has been optimized regarding its performance and can be integrated into our standard phantom tables. A cover prevents evaporation of the liquid. Reference markings on the phantom allow installation of the complete setup, including all predefined phantom positions and measurement grids, by teaching three points. The phantom is compatible with all SPEAG dosimetric probes and dipoles.	
Shell Thickness	2 ± 0.2 mm	
Filling Volume	Approx. 30 liters	
Dimensions	Major axis: 600 mm Minor axis: 400 mm	

DEVICE HOLDER

Construction	The device holder (Supporter) for Notebook is made by POM (polyoxymethylene resin), which is non-metal and non-conductive. The height can be adjusted to fit varies kind of notebooks.	 <p style="text-align: center;">Device Holder</p>
--------------	--	---

Unless otherwise stated the results shown in this test report refer only to the sample(s) tested and such sample(s) are retained for 90 days only.

除非另有說明，此報告結果僅對測試之樣品負責，同時此樣品僅保留90天。本報告未經本公司書面許可，不可部份複製。

This document is issued by the Company subject to its General Conditions of Service printed overleaf, available on request or accessible at <http://www.sgs.com.tw/Terms-and-Conditions> and for electronic format documents, subject to Terms and Conditions for Electronic Documents at <http://www.sgs.com.tw/Terms-and-Conditions>. Attention is drawn to the limitation of liability, indemnification and jurisdiction issues defined therein. Any holder of this document is advised that information contained hereon reflects the Company's findings at the time of its intervention only and within the limits of Client's instructions, if any. The Company's sole responsibility is to its Client and this document does not exonerate parties to a transaction from exercising all their rights and obligations under the transaction documents. This document cannot be reproduced except in full, without prior written approval of the Company. Any unauthorized alteration, forgery or falsification of the content or appearance of this document is unlawful and offenders may be prosecuted to the fullest extent of the law.

3 SAR SYSTEM VERIFICATION

3.1 Tissue Simulating Liquid

For the measurement of the field distribution inside the SAM phantom with DASY, the phantom must be filled with homogeneous tissue simulating liquid. For head SAR testing, the liquid height from the ear rint (ERP) of the phantom to the liquid top surface is larger than 15cm. For body SAR testing, the liquid height from the center of the flat phantom to the liquid top surface is larger than 15cm.

3.2 Tissue Simulant Liquid measurement

The dielectric properties for this Head-simulant fluid were measured by using the SPEAG Dielectric Assessment Kit (DAKS-3.5)

All dielectric parameters of tissue simulates were measured within 24 hours of SAR measurements. The measured conductivity and permittivity are all within $\pm 5\%$ of the target values.

3.3 Measurement results of Tissue Simulant Liquid

Measured Frequency (MHz)	Target Dielectric Constant, ϵ_r	Target Conductivity, σ (S/m)	Measured Dielectric Constant, ϵ_r	Measured Conductivity, σ (S/m)	% dev ϵ_r	% dev σ	Limit	Measurement Date	Liquid Temp. (°C)	Ambient Temp (°C)
700.5	42.164	0.887	43.812	0.860	3.91%	-3.01%	$\pm 5\%$	Dec. 06, 2023	21.8	22.1
701.5	42.159	0.887	43.753	0.863	3.78%	-2.68%	$\pm 5\%$	Dec. 06, 2023	21.8	22.1
707	42.129	0.887	43.685	0.865	3.69%	-2.49%	$\pm 5\%$	Dec. 06, 2023	21.8	22.1
707.5	42.127	0.887	43.681	0.866	3.69%	-2.39%	$\pm 5\%$	Dec. 06, 2023	21.8	22.1
713.5	42.095	0.888	43.636	0.869	3.66%	-2.09%	$\pm 5\%$	Dec. 06, 2023	21.8	22.1
750	41.900	0.890	43.490	0.907	3.79%	1.91%	$\pm 5\%$	Dec. 06, 2023	21.8	22.1
779.5	41.761	0.893	43.395	0.911	3.91%	1.96%	$\pm 5\%$	Dec. 06, 2023	21.8	22.1
782	41.749	0.894	43.388	0.926	3.92%	3.61%	$\pm 5\%$	Dec. 06, 2023	21.8	22.1
784.5	41.738	0.894	43.379	0.928	3.93%	3.80%	$\pm 5\%$	Dec. 06, 2023	21.8	22.1
790.5	41.709	0.895	43.334	0.935	3.90%	4.50%	$\pm 5\%$	Dec. 06, 2023	21.8	22.1
793	41.698	0.895	43.315	0.937	3.88%	4.69%	$\pm 5\%$	Dec. 06, 2023	21.8	22.1
795.5	41.686	0.895	43.302	0.938	3.88%	4.76%	$\pm 5\%$	Dec. 06, 2023	21.8	22.1
700.5	42.164	0.887	43.752	0.865	3.77%	-2.45%	$\pm 5\%$	Dec. 05, 2023	22.0	22.3
701.5	42.159	0.887	43.723	0.867	3.71%	-2.23%	$\pm 5\%$	Dec. 05, 2023	22.0	22.3
707	42.129	0.887	43.675	0.872	3.67%	-1.71%	$\pm 5\%$	Dec. 05, 2023	22.0	22.3
707.5	42.127	0.887	43.631	0.873	3.57%	-1.60%	$\pm 5\%$	Dec. 05, 2023	22.0	22.3
713.5	42.095	0.888	43.566	0.875	3.50%	-1.42%	$\pm 5\%$	Dec. 05, 2023	22.0	22.3
750	41.900	0.890	43.507	0.901	3.84%	1.24%	$\pm 5\%$	Dec. 05, 2023	22.0	22.3
779.5	41.761	0.893	43.325	0.908	3.74%	1.63%	$\pm 5\%$	Dec. 05, 2023	22.0	22.3
782	41.749	0.894	43.218	0.915	3.52%	2.38%	$\pm 5\%$	Dec. 05, 2023	22.0	22.3
784.5	41.738	0.894	43.189	0.918	3.48%	2.68%	$\pm 5\%$	Dec. 05, 2023	22.0	22.3
790.5	41.709	0.895	43.154	0.920	3.46%	2.82%	$\pm 5\%$	Dec. 05, 2023	22.0	22.3
793	41.698	0.895	43.125	0.922	3.42%	3.01%	$\pm 5\%$	Dec. 05, 2023	22.0	22.3
795.5	41.686	0.895	43.112	0.926	3.42%	3.42%	$\pm 5\%$	Dec. 05, 2023	22.0	22.3

Unless otherwise stated the results shown in this test report refer only to the sample(s) tested and such sample(s) are retained for 90 days only.

除非另有說明，此報告結果僅對測試之樣品負責，同時此樣品僅保留90天。本報告未經本公司書面許可，不可部份複製。

This document is issued by the Company subject to its General Conditions of Service printed overleaf, available on request or accessible at <http://www.sgs.com.tw/Terms-and-Conditions> and for electronic format documents, subject to Terms and Conditions for Electronic Documents at <http://www.sgs.com.tw/Terms-and-Conditions>. Attention is drawn to the limitation of liability, indemnification and jurisdiction issues defined therein. Any holder of this document is advised that information contained hereon reflects the Company's findings at the time of its intervention only and within the limits of Client's instructions, if any. The Company's sole responsibility is to its Client and this document does not exonerate parties to a transaction from exercising all their rights and obligations under the transaction documents. This document cannot be reproduced except in full, without prior written approval of the Company. Any unauthorized alteration, forgery or falsification of the content or appearance of this document is unlawful and offenders may be prosecuted to the fullest extent of the law.

816.5	41.587	0.898	40.360	0.870	-2.95%	-3.10%	± 5%	Dec. 08, 2023	21.9	22.2
824.2	41.551	0.899	40.322	0.877	-2.96%	-2.42%	± 5%	Dec. 08, 2023	21.9	22.2
826.5	41.540	0.899	40.313	0.881	-2.95%	-2.00%	± 5%	Dec. 08, 2023	21.9	22.2
831.5	41.516	0.900	40.264	0.887	-3.02%	-1.40%	± 5%	Dec. 08, 2023	21.9	22.2
835	41.500	0.900	40.251	0.891	-3.01%	-1.00%	± 5%	Dec. 08, 2023	21.9	22.2
836.5	41.500	0.902	40.247	0.893	-3.02%	-0.96%	± 5%	Dec. 08, 2023	21.9	22.2
836.6	41.500	0.902	40.242	0.894	-3.03%	-0.86%	± 5%	Dec. 08, 2023	21.9	22.2
846.5	41.500	0.912	40.205	0.905	-3.12%	-0.81%	± 5%	Dec. 08, 2023	21.9	22.2
848.8	41.500	0.915	40.181	0.908	-3.18%	-0.75%	± 5%	Dec. 08, 2023	21.9	22.2
816.5	41.587	0.898	40.641	0.873	-2.27%	-2.76%	± 5%	Dec. 07, 2023	21.7	21.9
824.2	41.551	0.899	40.633	0.880	-2.21%	-2.08%	± 5%	Dec. 07, 2023	21.7	21.9
826.5	41.540	0.899	40.624	0.884	-2.21%	-1.67%	± 5%	Dec. 07, 2023	21.7	21.9
831.5	41.516	0.900	40.615	0.890	-2.17%	-1.07%	± 5%	Dec. 07, 2023	21.7	21.9
835	41.500	0.900	40.562	0.894	-2.26%	-0.67%	± 5%	Dec. 07, 2023	21.7	21.9
836.5	41.500	0.902	40.558	0.896	-2.27%	-0.62%	± 5%	Dec. 07, 2023	21.7	21.9
836.6	41.500	0.902	40.543	0.897	-2.31%	-0.52%	± 5%	Dec. 07, 2023	21.7	21.9
846.5	41.500	0.912	40.536	0.908	-2.32%	-0.48%	± 5%	Dec. 07, 2023	21.7	21.9
848.8	41.500	0.915	40.512	0.911	-2.38%	-0.42%	± 5%	Dec. 07, 2023	21.7	21.9
1712.5	40.125	1.350	38.723	1.290	-3.49%	-4.44%	± 5%	Dec. 09, 2023	22.2	22.5
1732.5	40.096	1.361	38.703	1.305	-3.48%	-4.14%	± 5%	Dec. 09, 2023	22.2	22.5
1745	40.079	1.369	38.695	1.313	-3.45%	-4.06%	± 5%	Dec. 09, 2023	22.2	22.5
1750	40.071	1.371	38.667	1.318	-3.50%	-3.90%	± 5%	Dec. 09, 2023	22.2	22.5
1752.5	40.068	1.373	38.656	1.320	-3.52%	-3.85%	± 5%	Dec. 09, 2023	22.2	22.5
1777.5	40.032	1.387	38.604	1.340	-3.57%	-3.40%	± 5%	Dec. 09, 2023	22.2	22.5
1850.2	40.000	1.400	38.538	1.362	-3.66%	-2.71%	± 5%	Dec. 10, 2023	21.7	22.0
1852.5	40.000	1.400	38.502	1.389	-3.74%	-0.79%	± 5%	Dec. 10, 2023	21.7	22.0
1880	40.000	1.400	38.469	1.422	-3.83%	1.57%	± 5%	Dec. 10, 2023	21.7	22.0
1882.5	40.000	1.400	38.465	1.421	-3.84%	1.50%	± 5%	Dec. 10, 2023	21.7	22.0
1900	40.000	1.400	38.455	1.426	-3.86%	1.86%	± 5%	Dec. 10, 2023	21.7	22.0
1907.5	40.000	1.400	38.454	1.441	-3.87%	2.93%	± 5%	Dec. 10, 2023	21.7	22.0
1909.8	40.000	1.400	38.450	1.442	-3.87%	3.00%	± 5%	Dec. 10, 2023	21.7	22.0
1912.5	40.000	1.400	38.449	1.444	-3.88%	3.14%	± 5%	Dec. 10, 2023	21.7	22.0

Unless otherwise stated the results shown in this test report refer only to the sample(s) tested and such sample(s) are retained for 90 days only.

除非另有說明，此報告結果僅對測試之樣品負責，同時此樣品僅保留90天。本報告未經本公司書面許可，不可部份複製。

This document is issued by the Company subject to its General Conditions of Service printed overleaf, available on request or accessible at <http://www.sgs.com.tw/Terms-and-Conditions> and for electronic format documents, subject to Terms and Conditions for Electronic Documents at <http://www.sgs.com.tw/Terms-and-Conditions>. Attention is drawn to the limitation of liability, indemnification and jurisdiction issues defined therein. Any holder of this document is advised that information contained hereon reflects the Company's findings at the time of its intervention only and within the limits of Client's instructions, if any. The Company's sole responsibility is to its Client and this document does not exonerate parties to a transaction from exercising all their rights and obligations under the transaction documents. This document cannot be reproduced except in full, without prior written approval of the Company. Any unauthorized alteration, forgery or falsification of the content or appearance of this document is unlawful and offenders may be prosecuted to the fullest extent of the law.

3.4 The composition of the tissue simulating liquid:

Simulating Liquids for 600 MHz -10 GHz, Manufactured by SPEAG:

Broad-band head tissue simulating liquids	SPEAG Product	Frequency range (MHz)	Main Ingredients
	HBBL600-10000V6	600 - 10000	Water, Oil

3.5 System check

The microwave circuit arrangement for system check is sketched in below. The daily system accuracy verification occurs within the flat section of the SAM phantom and ELI phantom. A SAR measurement was performed to see if the measured SAR was within +/- 10% from the target SAR values.

The tests were conducted on the same days as the measurement of the DUT. The obtained results from the system accuracy verification are displayed with SAR values normalized to 1W forward power delivered to the dipole.

During the tests, the liquid depth from the center of the flat phantom to the liquid top surface was 15 cm above in all the cases. It is seen that the system is operating within its specification, as the results are within acceptable tolerance of the reference values.

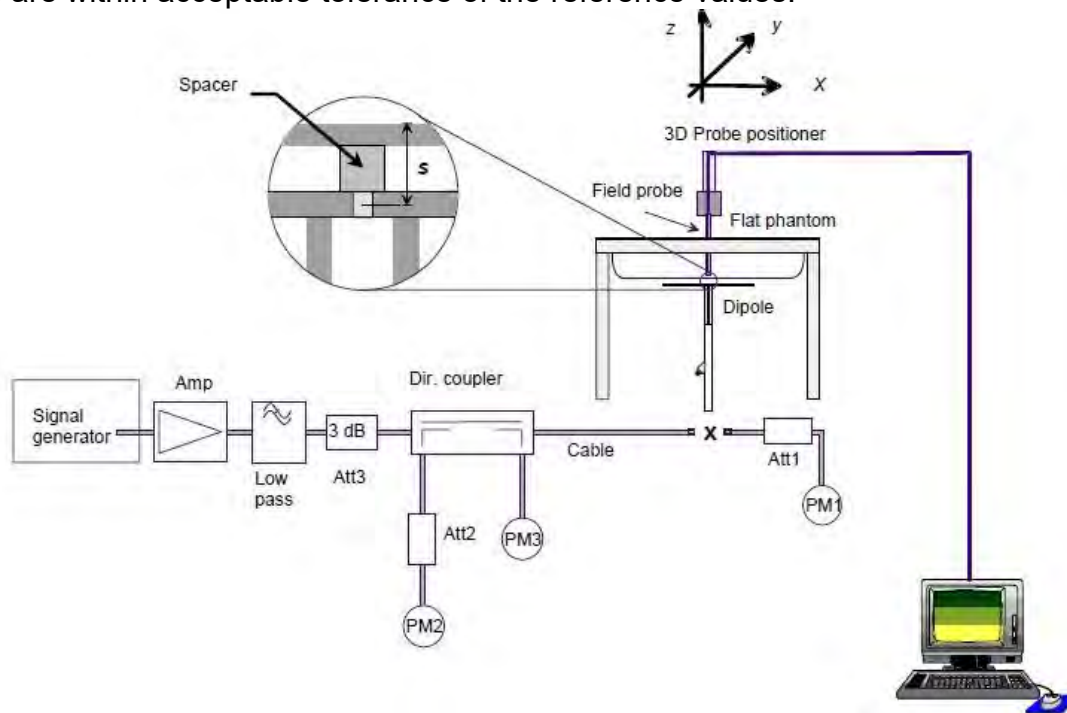

The block diagram of system check

Unless otherwise stated the results shown in this test report refer only to the sample(s) tested and such sample(s) are retained for 90 days only.

除非另有說明，此報告結果僅對測試之樣品負責，同時此樣品僅保留90天。本報告未經本公司書面許可，不可部份複製。

This document is issued by the Company subject to its General Conditions of Service printed overleaf, available on request or accessible at <http://www.sgs.com.tw/Terms-and-Conditions> and for electronic format documents, subject to Terms and Conditions for Electronic Documents at <http://www.sgs.com.tw/Terms-and-Conditions>. Attention is drawn to the limitation of liability, indemnification and jurisdiction issues defined therein. Any holder of this document is advised that information contained hereon reflects the Company's findings at the time of its intervention only and within the limits of Client's instructions, if any. The Company's sole responsibility is to its Client and this document does not exonerate parties to a transaction from exercising all their rights and obligations under the transaction documents. This document cannot be reproduced except in full, without prior written approval of the Company. Any unauthorized alteration, forgery or falsification of the content or appearance of this document is unlawful and offenders may be prosecuted to the fullest extent of the law.

3.6 System check results

Validation Kit	S/N	Frequency (MHz)	1W Target 1g-SAR (W/kg)	pin=250mW Measured 1g-SAR (W/kg)	Normalized to 1W 1g-SAR (W/kg)	Deviation (%)	Limit	Measurement Date
D750V3	1015	750	8.63	2.13	8.52	-1.27	± 10%	Dec.05,2023
D750V3	1015	750	8.63	2.07	8.28	-4.06	± 10%	Dec.06,2023
D835V2	4d063	835	9.53	2.38	9.52	-0.10	± 10%	Dec.07,2023
D835V2	4d063	835	9.53	2.34	9.36	-1.78	± 10%	Dec.08,2023
D1750V2	1008	1750	36.4	9.02	36.08	-0.88	± 10%	Dec.09,2023
D1900V2	5d056	1900	40.5	9.84	39.36	-2.81	± 10%	Dec.10,2023

Unless otherwise stated the results shown in this test report refer only to the sample(s) tested and such sample(s) are retained for 90 days only.

除非另有說明，此報告結果僅對測試之樣品負責，同時此樣品僅保留90天。本報告未經本公司書面許可，不可部份複製。

This document is issued by the Company subject to its General Conditions of Service printed overleaf, available on request or accessible at <http://www.sgs.com.tw/Terms-and-Conditions> and for electronic format documents, subject to Terms and Conditions for Electronic Documents at <http://www.sgs.com.tw/Terms-and-Conditions>. Attention is drawn to the limitation of liability, indemnification and jurisdiction issues defined therein. Any holder of this document is advised that information contained hereon reflects the Company's findings at the time of its intervention only and within the limits of Client's instructions, if any. The Company's sole responsibility is to its Client and this document does not exonerate parties to a transaction from exercising all their rights and obligations under the transaction documents. This document cannot be reproduced except in full, without prior written approval of the Company. Any unauthorized alteration, forgery or falsification of the content or appearance of this document is unlawful and offenders may be prosecuted to the fullest extent of the law.

4 TEST CONFIGURATIONS

4.1 Test Environment

Ambient Temperature: 22±2° C

Tissue Simulating Liquid: 22±2° C

4.2 Test Note

- **General:** Measurements are performed respectively on the lowest, middle and highest channels of the operating band(s).
- **General:** The EUT is set to maximum power level during all tests, and at the beginning of each test the battery is fully charged.
- **General:** During the SAR testing, the DASY system checks power drift by comparing the e-field strength of one specific location measured at the beginning with that measured at the end of the SAR testing.
- **General:** According to KDB447498D01v06, testing of other required channels is not required when the reported 1-g SAR for the highest output channel is ≤ 0.8 W/kg, when the transmission band is ≤ 100 MHz.
- **General:** According to KDB865664D01v01r04, SAR measurement variability must be assessed for each frequency band. When the original highest measured SAR is ≥ 0.8 W/kg, repeated that measurement once. Perform a second repeated measurement only if the ratio of largest to smallest SAR for the original and first repeated measurements is > 1.20 or when the original or repeated measurement is ≥ 1.45 W/kg (~ 10% from the 1-g SAR limit).

- **General:** Based on KDB447498D01v06 4.3.1 c), SAR test exclusion threshold for NFC (13.56MHz) shall be

- a) For test separation distances ≤ 50 mm, the power threshold determined by the equation in 4.3.1 c) 1) for 50 mm and 100 MHz is multiplied by ½
- b) The power threshold at 50mm/100 MHz in 4.3.1 b) is multiplied by [1 + log(100/f(MHz))] where f is 13.56MHz
- c) The power threshold in 4.3.1 b) is [Power allowed at numeric threshold for 50 mm in 4.3.1 a)] + [(test separation distance – 50 mm)·(f(MHz)/150)] mW, for 100 MHz to 1500 MHz where test separation distance is 50mm, frequency is 100MHz.
- d) Power allowed at numeric threshold for 50 mm in 4.3.1 a) is [3/√f(GHz)]·(test separation distance)

Hence, SAR test exclusion threshold is calculated in reverse sequence:

d) : $[3/\sqrt{0.1}] \cdot 50 = 474.3416\text{mW}$

c) : $474.3416 + (50-50) \cdot (100/150) = 474.3416\text{mW}$

b) : $474.3416 \cdot [1 + \log(100/13.56)] = 885.9470\text{mW}$

a) : $885.9470 \cdot 0.5 = 442.974\text{mW}$

Step c):

Frequency (MHz)	E-FIELD dBuV/m	Test Distance (m)	EIRP (dBm)	EIRP (mW)	Threshold (mW)
13.56	76.18	3	-18.978	0.013	442.974

Unless otherwise stated the results shown in this test report refer only to the sample(s) tested and such sample(s) are retained for 90 days only.

除非另有說明，此報告結果僅對測試之樣品負責，同時此樣品僅保留90天。本報告未經本公司書面許可，不可部份複製。

This document is issued by the Company subject to its General Conditions of Service printed overleaf, available on request or accessible at <http://www.sgs.com.tw/Terms-and-Conditions> and for electronic format documents, subject to Terms and Conditions for Electronic Documents at <http://www.sgs.com.tw/Terms-and-Conditions>. Attention is drawn to the limitation of liability, indemnification and jurisdiction issues defined therein. Any holder of this document is advised that information contained herein reflects the Company's findings at the time of its intervention only and within the limits of Client's instructions, if any. The Company's sole responsibility is to its Client and this document does not exonerate parties to a transaction from exercising all their rights and obligations under the transaction documents. This document cannot be reproduced except in full, without prior written approval of the Company. Any unauthorized alteration, forgery or falsification of the content or appearance of this document is unlawful and offenders may be prosecuted to the fullest extent of the law.

Note:

$$\text{EIRP (dBm)} = (\text{E-FIELD (dBuV/m)} + 20 \log(d(m)) - 104.7)$$

$$\text{EIRP (mW)} = (10^{(\text{EIRP (dBm)} / 10)})$$

Therefore, NFC is SAR excluded.

GSM: SAR test reduction for GPRS/EDGE mode is determined by the source-based time-averaged output power. The data mode with highest specified time-averaged output power should be tested for SAR compliance.

LTE: LTE modes test according to **KDB 941225D05v02r05**.

a. Per Section 5.2.1, the largest channel bandwidth and measure SAR for QPSK with 1 RB allocation.

- Using the RB offset and required test channel combination with the highest maximum output power for RB offsets at the upper edge, middle and lower edge of each required test channel.

- When the reported SAR is ≤ 0.8 W/kg, testing of the remaining RB offset configurations and required test channels is not required for 1 RB allocation; otherwise, SAR is required for the remaining required test channels and only for the RB offset configuration with the highest output power for that channel.

- When the reported SAR of a required test channel is > 1.45 W/kg, SAR is required for all three RB offset configurations for that required test channel.

b. Per Section 5.2.2, the largest channel bandwidth and measure SAR for QPSK with 50% RB allocation

- The procedures required for 1 RB allocation in 5.2.1 are applied to measure the SAR for QPSK with 50% RB allocation.

c. Per Section 5.2.3, the largest channel bandwidth and measure SAR for QPSK with 100% RB allocation

- For QPSK with 100% RB allocation, SAR is not required when the highest maximum output power for 100 % RB allocation is less than the highest maximum output power in 50% and 1 RB allocations and the highest reported SAR for 1 RB and 50% RB allocation in 5.2.1 and 5.2.2 are ≤ 0.8 W/kg.

- Otherwise, SAR is measured for the highest output power channel and if the reported SAR is > 1.45 W/kg, the remaining required test channels must also be tested.

d. Per Section 5.2.4, Higher order modulations

- For each modulation besides QPSK; e.g., 16-QAM, 64-QAM, apply the QPSK procedures in sections 5.2.1, 5.2.2 and 5.2.3 to determine the QAM configurations that may need SAR measurement. For each configuration identified as required for

Unless otherwise stated the results shown in this test report refer only to the sample(s) tested and such sample(s) are retained for 90 days only.

除非另有說明，此報告結果僅對測試之樣品負責，同時此樣品僅保留90天。本報告未經本公司書面許可，不可部份複製。

This document is issued by the Company subject to its General Conditions of Service printed overleaf, available on request or accessible at <http://www.sgs.com.tw/Terms-and-Conditions> and for electronic format documents, subject to Terms and Conditions for Electronic Documents at <http://www.sgs.com.tw/Terms-and-Conditions>. Attention is drawn to the limitation of liability, indemnification and jurisdiction issues defined therein. Any holder of this document is advised that information contained hereon reflects the Company's findings at the time of its intervention only and within the limits of Client's instructions, if any. The Company's sole responsibility is to its Client and this document does not exonerate parties to a transaction from exercising all their rights and obligations under the transaction documents. This document cannot be reproduced except in full, without prior written approval of the Company. Any unauthorized alteration, forgery or falsification of the content or appearance of this document is unlawful and offenders may be prosecuted to the fullest extent of the law.

testing, SAR is required only when the highest maximum output power for the configuration in the higher order modulation is $> \frac{1}{2}$ dB higher than the same configuration in QPSK or when the reported SAR for the QPSK configuration is > 1.45 W/kg.

e. Per Section 5.3, other channel bandwidth standalone SAR test requirements

For the other channel bandwidths used by the device in a frequency band, apply all the procedures required for the largest channel bandwidth in section 5.2 to determine the channels and RB configurations that need SAR testing and only measure SAR when the highest maximum output power of a configuration requiring testing in the smaller channel bandwidth is $> \frac{1}{2}$ dB higher than the equivalent channel configurations in the largest channel bandwidth configuration or the reported SAR of a configuration for the largest channel bandwidth is > 1.45 W/kg. The equivalent channel configuration for the RB allocation, RB offset and modulation etc. is determined for the smaller channel bandwidth according to the same number of RB allocated in the largest channel bandwidth.

Unless otherwise stated the results shown in this test report refer only to the sample(s) tested and such sample(s) are retained for 90 days only.

除非另有說明，此報告結果僅對測試之樣品負責，同時此樣品僅保留90天。本報告未經本公司書面許可，不可部份複製。

This document is issued by the Company subject to its General Conditions of Service printed overleaf, available on request or accessible at <http://www.sgs.com.tw/Terms-and-Conditions> and for electronic format documents, subject to Terms and Conditions for Electronic Documents at <http://www.sgs.com.tw/Terms-and-Conditions>. Attention is drawn to the limitation of liability, indemnification and jurisdiction issues defined therein. Any holder of this document is advised that information contained hereon reflects the Company's findings at the time of its intervention only and within the limits of Client's instructions, if any. The Company's sole responsibility is to its Client and this document does not exonerate parties to a transaction from exercising all their rights and obligations under the transaction documents. This document cannot be reproduced except in full, without prior written approval of the Company. Any unauthorized alteration, forgery or falsification of the content or appearance of this document is unlawful and offenders may be prosecuted to the fullest extent of the law.

4.3 Test position

Laptop mode SAR test position (0mm)

For laptop PC, according to KDB 616217 D04, SAR evaluation is required for the bottom surface of the keyboard. This EUT was tested in the base of EUT directly against the flat phantom. The required minimum test separation distance for incorporating transmitters and antennas into laptop computer display is determined with the display screen opened at an angle of 90° to the keyboard compartment.

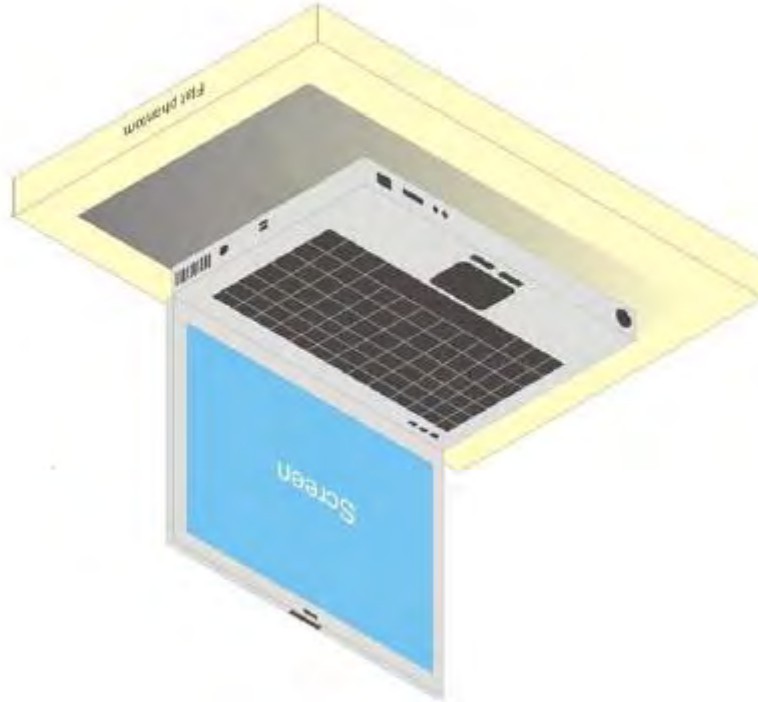

Illustration for Laptop Setup

Unless otherwise stated the results shown in this test report refer only to the sample(s) tested and such sample(s) are retained for 90 days only.

除非另有說明，此報告結果僅對測試之樣品負責，同時此樣品僅保留90天。本報告未經本公司書面許可，不可部份複製。

This document is issued by the Company subject to its General Conditions of Service printed overleaf, available on request or accessible at <http://www.sgs.com.tw/Terms-and-Conditions> and for electronic format documents, subject to Terms and Conditions for Electronic Documents at <http://www.sgs.com.tw/Terms-and-Conditions>. Attention is drawn to the limitation of liability, indemnification and jurisdiction issues defined therein. Any holder of this document is advised that information contained hereon reflects the Company's findings at the time of its intervention only and within the limits of Client's instructions, if any. The Company's sole responsibility is to its Client and this document does not exonerate parties to a transaction from exercising all their rights and obligations under the transaction documents. This document cannot be reproduced except in full, without prior written approval of the Company. Any unauthorized alteration, forgery or falsification of the content or appearance of this document is unlawful and offenders may be prosecuted to the fullest extent of the law.

Tablet mode SAR test position (0mm)

For full-size tablet, according to KDB 616217 D04, SAR evaluation is required for back surface and edges of the devices. The back surface and edges of the tablet are tested with the tablet touching the phantom. Exposures from antennas through the front surface of the display section of a tablet are generally limited to the user’s hands. Exposures to hands for typical consumer transmitters used in tablets are not expected to exceed the extremity SAR limit; therefore, SAR evaluation for the front surface of tablet display screens are generally not necessary. When voice mode is supported on a tablet and it is limited to speaker mode or headset operations only, additional SAR testing for this type of voice use is not required.

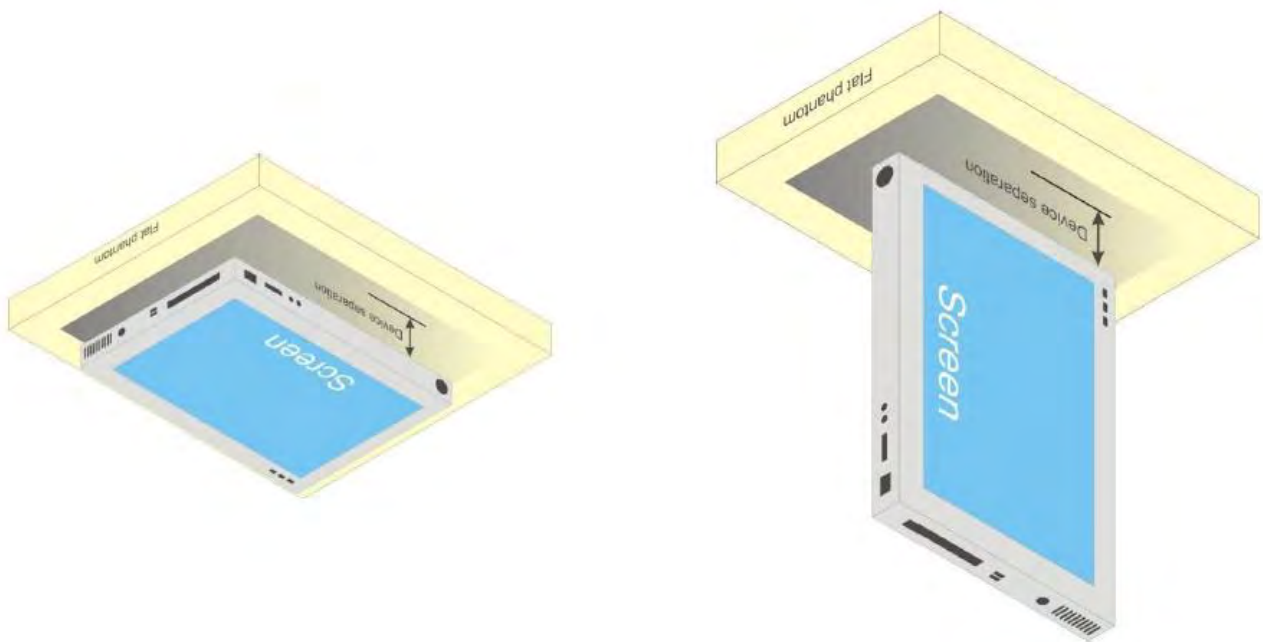

Illustration for Tablet Setup

Unless otherwise stated the results shown in this test report refer only to the sample(s) tested and such sample(s) are retained for 90 days only.
 除非另有說明，此報告結果僅對測試之樣品負責，同時此樣品僅保留90天。本報告未經本公司書面許可，不可部份複製。

This document is issued by the Company subject to its General Conditions of Service printed overleaf, available on request or accessible at <http://www.sgs.com.tw/Terms-and-Conditions> and for electronic format documents, subject to Terms and Conditions for Electronic Documents at <http://www.sgs.com.tw/Terms-and-Conditions>. Attention is drawn to the limitation of liability, indemnification and jurisdiction issues defined therein. Any holder of this document is advised that information contained hereon reflects the Company’s findings at the time of its intervention only and within the limits of Client’s instructions, if any. The Company’s sole responsibility is to its Client and this document does not exonerate parties to a transaction from exercising all their rights and obligations under the transaction documents. This document cannot be reproduced except in full, without prior written approval of the Company. Any unauthorized alteration, forgery or falsification of the content or appearance of this document is unlawful and offenders may be prosecuted to the fullest extent of the law.

4.4 Power verification of device mode

The device is a convertible laptop computer with predefined single fixed power to each device modes. For the device modes verification, the measured conducted output power is monitored qualitatively to identify the triggering characteristics and recorded quantitatively.

Results and conclusion

The measured output power versus lid angle is tabulated in the following table based on the guidance from 2019-11 TCB workshop, and the triggering verification complies with the device mode / power level declared by the manufacturer.

Unless otherwise stated the results shown in this test report refer only to the sample(s) tested and such sample(s) are retained for 90 days only.
除非另有說明，此報告結果僅對測試之樣品負責，同時此樣品僅保留90天。本報告未經本公司書面許可，不可部份複製。

This document is issued by the Company subject to its General Conditions of Service printed overleaf, available on request or accessible at <http://www.sgs.com.tw/Terms-and-Conditions> and for electronic format documents, subject to Terms and Conditions for Electronic Documents at <http://www.sgs.com.tw/Terms-and-Conditions>. Attention is drawn to the limitation of liability, indemnification and jurisdiction issues defined therein. Any holder of this document is advised that information contained hereon reflects the Company's findings at the time of its intervention only and within the limits of Client's instructions, if any. The Company's sole responsibility is to its Client and this document does not exonerate parties to a transaction from exercising all their rights and obligations under the transaction documents. This document cannot be reproduced except in full, without prior written approval of the Company. Any unauthorized alteration, forgery or falsification of the content or appearance of this document is unlawful and offenders may be prosecuted to the fullest extent of the law.

WWAN	Flat	190°	24.85	21.80	11.23	12.43	14.62	12.31	13.58	13.60	12.02	15.18	12.24	19.08	
		200°	24.73	21.71	11.21	12.46	14.85	12.37	13.55	13.65	12.14	15.06	12.25	18.95	
		205°	24.73	21.79	11.20	12.50	14.81	12.42	13.58	13.54	12.03	15.16	12.29	19.01	
		208°	24.76	21.89	11.12	12.53	14.82	12.50	13.57	13.67	12.05	15.08	12.36	18.84	
		203°	24.71	21.88	11.17	12.54	14.92	12.49	13.51	13.60	12.05	15.22	12.38	19.01	
		202°	24.71	21.88	11.17	12.48	14.82	12.48	13.58	13.61	12.05	15.15	12.38	19.02	
		201°	24.85	21.73	11.17	12.47	14.93	12.42	13.69	13.60	11.99	15.12	12.33	18.94	
		206°	27.89	24.68	20.12	20.39	20.02	20.83	20.12	20.22	20.22	20.51	19.61	20.28	20.19
		204°	27.81	24.66	20.16	20.31	19.98	20.01	20.01	20.26	20.37	19.66	20.22	20.16	
		203°	27.77	24.66	20.14	20.42	20.05	19.99	20.01	20.27	20.50	19.74	20.21	20.20	
	202°	27.88	24.66	20.11	20.46	19.96	19.99	20.06	20.25	20.59	19.73	20.27	20.17		
	201°	27.88	24.79	20.17	20.48	20.02	20.09	19.96	20.30	20.55	19.80	20.37	20.05		
	200°	24.81	21.80	11.16	12.41	15.00	12.42	13.68	13.61	12.04	15.19	12.29	19.92		
	198°	24.77	21.78	11.30	12.42	14.84	12.42	13.54	13.55	12.14	15.22	12.33	19.04		
	198°	24.74	21.83	11.28	12.46	14.86	12.47	13.68	13.59	12.02	15.08	12.32	19.01		
	197°	24.89	21.74	11.11	12.49	14.98	12.37	13.69	13.57	12.01	15.07	12.26	18.97		
	196°	24.99	21.65	11.28	12.49	14.92	12.37	13.61	13.53	11.97	15.14	12.34	18.97		
	195°	24.79	21.87	11.20	12.47	14.87	12.50	13.67	13.69	12.04	15.14	12.29	19.09		
	185°	24.82	21.77	11.26	12.41	14.95	12.36	13.35	13.57	12.09	15.07	12.21	18.97		
	175°	24.63	21.76	11.14	12.50	14.97	12.32	13.63	13.60	11.99	15.09	12.27	19.05		
	165°	24.77	21.76	11.29	12.31	14.98	12.34	13.60	13.60	12.03	15.11	12.34	19.07		
	155°	24.83	21.77	11.11	12.36	14.83	12.40	13.39	13.68	12.03	15.12	12.37	19.07		
	145°	24.85	21.79	11.27	12.49	14.99	12.49	13.61	13.69	12.07	15.06	12.39	19.10		
	135°	24.71	21.78	11.22	12.45	14.91	12.49	13.66	13.67	12.07	15.24	12.26	19.08		
	Laptop	120°	27.80	24.66	20.17	20.48	19.91	19.93	20.11	20.23	20.45	19.80	20.31	20.19	
	Flat	130°	24.84	21.72	11.16	12.41	14.98	12.49	13.63	13.66	12.00	15.24	12.27	19.03	
		129°	27.89	24.67	20.03	20.49	20.00	20.15	20.18	20.44	19.72	20.34	20.14	20.16	
		128°	27.77	24.72	20.06	20.31	20.09	20.03	20.11	20.24	20.53	19.70	20.26	20.16	
		127°	27.76	24.72	20.16	20.48	19.97	20.08	20.12	20.27	20.44	19.63	20.26	20.19	
		126°	27.73	24.77	20.20	20.36	20.06	19.97	20.09	20.24	20.43	19.66	20.24	20.19	
		125°	27.83	24.80	20.12	20.45	20.06	19.94	20.12	20.19	20.50	19.63	20.28	20.15	
		115°	27.71	24.69	20.04	20.44	19.93	20.04	20.07	20.27	20.51	19.79	20.40	20.12	
		105°	27.78	24.78	20.05	20.00	20.00	19.95	20.05	20.26	20.45	19.76	20.36	20.04	
		95°	27.87	24.63	20.15	20.44	19.95	20.04	20.02	20.12	20.47	19.73	20.24	20.03	
		85°	27.73	24.71	20.16	20.39	19.95	19.92	19.97	20.21	20.46	19.63	20.30	20.17	
	75°	27.80	24.73	20.08	20.49	19.98	20.02	20.11	20.30	20.53	19.68	20.30	20.10		
	65°	27.90	24.77	20.06	20.40	20.04	19.98	20.10	20.11	20.46	19.64	20.28	20.03		
	55°	27.78	24.71	20.17	20.32	20.01	20.04	20.23	20.45	20.45	19.61	20.33	20.15		
	45°	27.74	24.62	20.09	20.39	19.92	20.03	20.11	20.49	19.76	20.34	20.24	20.15		
	35°	27.80	24.79	20.08	20.48	19.98	20.02	20.04	20.23	20.59	19.65	20.22	20.15		
	25°	n/a	n/a	n/a	n/a	n/a	n/a	n/a	n/a	n/a	n/a	n/a	n/a	n/a	
	Lid close	30°	n/a	n/a	n/a	n/a	n/a	n/a	n/a	n/a	n/a	n/a	n/a	n/a	
		35°	27.85	24.77	20.18	20.31	20.06	20.01	20.06	20.18	20.47	19.74	20.39	20.11	
		34°	27.71	24.78	20.11	20.50	20.10	19.96	20.15	20.17	20.51	19.76	20.32	20.11	
		33°	27.79	24.69	20.09	20.48	20.09	20.05	20.29	20.52	19.73	20.27	20.24	20.14	
		32°	27.78	24.75	20.09	20.45	20.10	19.99	20.13	20.11	20.46	19.76	20.25	20.13	
		31°	27.80	24.75	20.09	20.45	20.05	20.04	20.14	20.25	20.50	19.74	20.22	20.06	
		30°	n/a	n/a	n/a	n/a	n/a	n/a	n/a	n/a	n/a	n/a	n/a	n/a	n/a
		28°	n/a	n/a	n/a	n/a	n/a	n/a	n/a	n/a	n/a	n/a	n/a	n/a	n/a
		27°	n/a	n/a	n/a	n/a	n/a	n/a	n/a	n/a	n/a	n/a	n/a	n/a	n/a
		26°	n/a	n/a	n/a	n/a	n/a	n/a	n/a	n/a	n/a	n/a	n/a	n/a	n/a
	Lid close	25°	n/a	n/a	n/a	n/a	n/a	n/a	n/a	n/a	n/a	n/a	n/a	n/a	
		24°	n/a	n/a	n/a	n/a	n/a	n/a	n/a	n/a	n/a	n/a	n/a	n/a	
		23°	n/a	n/a	n/a	n/a	n/a	n/a	n/a	n/a	n/a	n/a	n/a	n/a	
		22°	n/a	n/a	n/a	n/a	n/a	n/a	n/a	n/a	n/a	n/a	n/a	n/a	
		21°	n/a	n/a	n/a	n/a	n/a	n/a	n/a	n/a	n/a	n/a	n/a	n/a	
		20°	n/a	n/a	n/a	n/a	n/a	n/a	n/a	n/a	n/a	n/a	n/a	n/a	
		19°	n/a	n/a	n/a	n/a	n/a	n/a	n/a	n/a	n/a	n/a	n/a	n/a	
		18°	n/a	n/a	n/a	n/a	n/a	n/a	n/a	n/a	n/a	n/a	n/a	n/a	
		17°	n/a	n/a	n/a	n/a	n/a	n/a	n/a	n/a	n/a	n/a	n/a	n/a	
		0°	n/a	n/a	n/a	n/a	n/a	n/a	n/a	n/a	n/a	n/a	n/a	n/a	

Unless otherwise stated the results shown in this test report refer only to the sample(s) tested and such sample(s) are retained for 90 days only.

除非另有說明，此報告結果僅對測試之樣品負責，同時此樣品僅保留90天。本報告未經本公司書面許可，不可部份複製。

This document is issued by the Company subject to its General Conditions of Service printed overleaf, available on request or accessible at <http://www.sgs.com.tw/Terms-and-Conditions> and for electronic format documents, subject to Terms and Conditions for Electronic Documents at <http://www.sgs.com.tw/Terms-and-Conditions>. Attention is drawn to the limitation of liability, indemnification and jurisdiction issues defined therein. Any holder of this document is advised that information contained hereon reflects the Company's findings at the time of its intervention only and within the limits of Client's instructions, if any. The Company's sole responsibility is to its Client and this document does not exonerate parties to a transaction from exercising all their rights and obligations under the transaction documents. This document cannot be reproduced except in full, without prior written approval of the Company. Any unauthorized alteration, forgery or falsification of the content or appearance of this document is unlawful and offenders may be prosecuted to the fullest extent of the law.

4.5 Test limit

[§ 2.1093\(d\)\(1\)](#)

Applications for equipment authorization of portable RF sources subject to routine environmental evaluation must contain a statement confirming compliance with the limits specified in [§ 1.1310](#) as part of their application. Technical information showing the basis for this statement must be submitted to the Commission upon request. The SAR limits specified in [§ 1.1310\(a\)](#) through [\(c\) of this chapter](#) shall be used for evaluation of portable devices transmitting in the frequency range from 100 kHz to 6 GHz. Portable devices that transmit at frequencies above 6 GHz shall be evaluated in terms of the MPE limits specified in Table 1 to [§ 1.1310\(e\)\(1\)](#). A minimum separation distance applicable to the operating configurations and exposure conditions of the device shall be used for the evaluation. In general, maximum time-averaged power levels must be used for evaluation. All unlicensed personal communications service (PCS) devices and unlicensed NII devices shall be subject to the limits for general population/uncontrolled exposure.

Radiofrequency radiation exposure limits.

[§ 1.1310\(a\)](#)

Specific absorption rate (SAR) shall be used to evaluate the environmental impact of human exposure to radiofrequency (RF) radiation as specified in § 1.1307(b) within the frequency range of 100 kHz to 6 GHz (inclusive).

[§ 1.1310\(b\)](#)

The SAR limits for occupational/controlled exposure are 0.4 W/kg, as averaged over the whole body, and a peak spatial-average SAR of 8 W/kg, averaged over any 1 gram of tissue (defined as a tissue volume in the shape of a cube). Exceptions are the parts of the human body treated as extremities, such as hands, wrists, feet, ankles, and pinnae, where the peak spatial-average SAR limit for occupational/controlled exposure is 20 W/kg, averaged over any 10 grams of tissue (defined as a tissue volume in the shape of a cube). Exposure may be averaged over a time period not to exceed 6 minutes to determine compliance with occupational/controlled SAR limits.

[§ 1.1310\(c\)](#)

The SAR limits for general population/uncontrolled exposure are 0.08 W/kg, as averaged over the whole body, and a peak spatial-average SAR of 1.6 W/kg, averaged over any 1 gram of tissue (defined as a tissue volume in the shape of a cube). Exceptions are the parts of the human body treated as extremities, such as hands, wrists, feet, ankles, and pinnae, where the peak spatial-average SAR limit is 4 W/kg, averaged over any 10 grams of tissue (defined as a tissue volume in the shape of a cube). Exposure may be averaged over a time period not to exceed 30 minutes to determine compliance with general population/uncontrolled SAR limits.

Note to paragraphs (a) through (c):

SAR is a measure of the rate of energy absorption due to exposure to RF electromagnetic energy. These SAR limits to be used for evaluation are based generally on criteria published by the American National Standards Institute (ANSI) for localized SAR in [Section 4.2](#) of "IEEE Standard for Safety Levels with Respect to Human Exposure to Radio Frequency Electromagnetic Fields, 3 kHz to 300 GHz," ANSI/IEEE Std C95.1-1992, copyright 1992 by the Institute of Electrical and Electronics Engineers, Inc., New York, New York 10017. These criteria for SAR evaluation are similar to those recommended by the National Council on Radiation Protection and Measurements (NCRP) in "Biological Effects and Exposure Criteria for Radiofrequency Electromagnetic Fields," NCRP Report No. 86, [Section 17.4.5](#), copyright 1986 by NCRP, Bethesda, Maryland 20814. Limits for whole body SAR and peak spatial-average SAR are based

Unless otherwise stated the results shown in this test report refer only to the sample(s) tested and such sample(s) are retained for 90 days only.

除非另有說明，此報告結果僅對測試之樣品負責，同時此樣品僅保留90天。本報告未經本公司書面許可，不可部份複製。

This document is issued by the Company subject to its General Conditions of Service printed overleaf, available on request or accessible at <http://www.sgs.com.tw/Terms-and-Conditions> and for electronic format documents, subject to Terms and Conditions for Electronic Documents at <http://www.sgs.com.tw/Terms-and-Conditions>. Attention is drawn to the limitation of liability, indemnification and jurisdiction issues defined therein. Any holder of this document is advised that information contained herein reflects the Company's findings at the time of its intervention only and within the limits of Client's instructions, if any. The Company's sole responsibility is to its Client and this document does not exonerate parties to a transaction from exercising all their rights and obligations under the transaction documents. This document cannot be reproduced except in full, without prior written approval of the Company. Any unauthorized alteration, forgery or falsification of the content or appearance of this document is unlawful and offenders may be prosecuted to the fullest extent of the law.

on recommendations made in both of these documents. The MPE limits in Table 1 are based generally on criteria published by the NCRP in "Biological Effects and Exposure Criteria for Radiofrequency Electromagnetic Fields," NCRP Report No. 86, Sections 17.4.1, 17.4.1.1, 17.4.2 and 17.4.3, copyright 1986 by NCRP, Bethesda, Maryland 20814. In the frequency range from 100 MHz to 1500 MHz, these MPE exposure limits for field strength and power density are also generally based on criteria recommended by the ANSI in [Section 4.1](#) of "IEEE Standard for Safety Levels with Respect to Human Exposure to Radio Frequency Electromagnetic Fields, 3 kHz to 300 GHz," ANSI/IEEE Std C95.1-1992, copyright 1992 by the Institute of Electrical and Electronics Engineers, Inc., New York, New York 10017.

Portable devices that transmit at frequencies above 6 GHz shall be evaluated in terms of the MPE limits specified in Table 1 to [§ 1.1310\(e\)\(1\)](#).

According to ANSI/IEEE C95.1-1992, the criteria listed in the following Table shall be used to evaluate the environmental impact of human exposure to radio frequency (RF) radiation as specified in §1.1310.

Peak Spatially Averaged Power Density was evaluated over a circular area of 4cm² per interim FCC Guidance for near-field power density evaluations per October 2018 TCB Workshop notes

Unless otherwise stated the results shown in this test report refer only to the sample(s) tested and such sample(s) are retained for 90 days only.
除非另有說明，此報告結果僅對測試之樣品負責，同時此樣品僅保留90天。本報告未經本公司書面許可，不可部份複製。

This document is issued by the Company subject to its General Conditions of Service printed overleaf, available on request or accessible at <http://www.sgs.com.tw/Terms-and-Conditions> and for electronic format documents, subject to Terms and Conditions for Electronic Documents at <http://www.sgs.com.tw/Terms-and-Conditions>. Attention is drawn to the limitation of liability, indemnification and jurisdiction issues defined therein. Any holder of this document is advised that information contained hereon reflects the Company's findings at the time of its intervention only and within the limits of Client's instructions, if any. The Company's sole responsibility is to its Client and this document does not exonerate parties to a transaction from exercising all their rights and obligations under the transaction documents. This document cannot be reproduced except in full, without prior written approval of the Company. Any unauthorized alteration, forgery or falsification of the content or appearance of this document is unlawful and offenders may be prosecuted to the fullest extent of the law.

Frequency range (MHz)	Electric field strength (V/m)	Magnetic field strength (A/m)	Power density (mW/cm ²)	Averaging time (minutes)
(i) Limits for Occupational/Controlled Exposure				
0.3-3.0	614	1.63	*(100)	≤6
3.0-30	1842/f	4.89/f	*(900/f ²)	<6
30-300	61.4	0.163	1.0	<6
300-1,500			f/300	<6
1,500-100,000			5	<6
(ii) Limits for General Population/Uncontrolled Exposure				
0.3-1.34	614	1.63	*(100)	<30
1.34-30	824/f	2.19/f	*(180/f ²)	<30
30-300	27.5	0.073	0.2	<30
300-1,500			f/1500	<30
1,500-100,000			1.0	<30

f = frequency in MHz. * = Plane-wave equivalent power density.

Table 1 to § 1.1310(e)(1) - Limits for Maximum Permissible Exposure (MPE)

Unless otherwise stated the results shown in this test report refer only to the sample(s) tested and such sample(s) are retained for 90 days only.

除非另有說明，此報告結果僅對測試之樣品負責，同時此樣品僅保留90天。本報告未經本公司書面許可，不可部份複製。

This document is issued by the Company subject to its General Conditions of Service printed overleaf, available on request or accessible at <http://www.sgs.com.tw/Terms-and-Conditions> and for electronic format documents, subject to Terms and Conditions for Electronic Documents at <http://www.sgs.com.tw/Terms-and-Conditions>. Attention is drawn to the limitation of liability, indemnification and jurisdiction issues defined therein. Any holder of this document is advised that information contained hereon reflects the Company's findings at the time of its intervention only and within the limits of Client's instructions, if any. The Company's sole responsibility is to its Client and this document does not exonerate parties to a transaction from exercising all their rights and obligations under the transaction documents. This document cannot be reproduced except in full, without prior written approval of the Company. Any unauthorized alteration, forgery or falsification of the content or appearance of this document is unlawful and offenders may be prosecuted to the fullest extent of the law.

5 MAXIMUM OUTPUT POWER

5.1 GSM/GPRS/EDGE

FULL

Burst average power						
Max. Rated Avg. Power + Max. Tolerance (dBm)			34	31	29	28
			1Dn1UP Multi- class 8	1Dn2UP Multi- class 10	1Dn3UP Multi- class 11	1Dn4UP Multi- class 12
EUT mode	Frequency (MHz)	CH	Avg. (dBm)	Avg. (dBm)	Avg. (dBm)	Avg. (dBm)
GPRS 850 (GMSK)	824.2	128	32.70	29.33	28.31	27.31
	836.6	190	33.15	30.17	28.99	27.99
	848.8	251	32.39	29.01	28.86	27.13
Source-based time average power						
GPRS 850 (GMSK)	824.2	128	23.67	23.31	24.05	24.30
	836.6	190	24.12	24.15	24.73	24.98
	848.8	251	23.36	22.99	24.60	21.44
The division factor compared to the number of TX time slot						
Division factor			1 TX time slot	2 TX time slot	3 TX time slot	4 TX time slot
			-9.03	-6.02	-4.26	-3.01
Burst average power						
Max. Rated Avg. Power + Max. Tolerance (dBm)			28	25	23	22
			1Dn1UP Multi- class 8	1Dn2UP Multi- class 10	1Dn3UP Multi- class 11	1Dn4UP Multi- class 12
EUT mode	Frequency (MHz)	CH	Avg. (dBm)	Avg. (dBm)	Avg. (dBm)	Avg. (dBm)
EDGE 850 (8PSK)	824.2	128	27.30	24.02	22.62	21.63
	836.6	190	27.58	24.37	22.91	21.95
	848.8	251	26.73	23.73	22.27	21.52
Source-based time average power						
EDGE 850 (8PSK)	824.2	128	18.27	18.00	18.36	18.62
	836.6	190	18.55	18.35	18.65	18.94
	848.8	251	17.70	17.71	18.01	18.51
The division factor compared to the number of TX time slot						
Division factor			1 TX time slot	2 TX time slot	3 TX time slot	4 TX time slot
			-9.03	-6.02	-4.26	-3.01

Unless otherwise stated the results shown in this test report refer only to the sample(s) tested and such sample(s) are retained for 90 days only.

除非另有說明，此報告結果僅對測試之樣品負責，同時此樣品僅保留90天。本報告未經本公司書面許可，不可部份複製。

This document is issued by the Company subject to its General Conditions of Service printed overleaf, available on request or accessible at <http://www.sgs.com.tw/Terms-and-Conditions> and for electronic format documents, subject to Terms and Conditions for Electronic Documents at <http://www.sgs.com.tw/Terms-and-Conditions>. Attention is drawn to the limitation of liability, indemnification and jurisdiction issues defined therein. Any holder of this document is advised that information contained hereon reflects the Company's findings at the time of its intervention only and within the limits of Client's instructions, if any. The Company's sole responsibility is to its Client and this document does not exonerate parties to a transaction from exercising all their rights and obligations under the transaction documents. This document cannot be reproduced except in full, without prior written approval of the Company. Any unauthorized alteration, forgery or falsification of the content or appearance of this document is unlawful and offenders may be prosecuted to the fullest extent of the law.

Burst average power						
Max. Rated Avg. Power + Max. Tolerance (dBm)			31	28	26	25
			1Dn1UP Multi- class 8	1Dn2UP Multi- class 10	1Dn3UP Multi- class 11	1Dn4UP Multi- class 12
EUT mode	Frequency (MHz)	CH	Avg. (dBm)	Avg. (dBm)	Avg. (dBm)	Avg. (dBm)
GPRS 1900 (GMSK)	1850.2	512	29.51	27.76	25.95	24.82
	1880	661	29.41	27.60	25.79	24.77
	1909.8	810	29.34	27.41	25.66	24.71
Source-based time average power						
GPRS 1900 (GMSK)	1850.2	512	20.48	21.74	21.69	21.81
	1880	661	20.38	21.58	21.53	21.76
	1909.8	810	20.31	21.39	21.40	21.70
The division factor compared to the number of TX time slot						
Division factor			1 TX time slot	2 TX time slot	3 TX time slot	4 TX time slot
			-9.03	-6.02	-4.26	-3.01
Burst average power						
Max. Rated Avg. Power + Max. Tolerance (dBm)			27	24	22	21
			1Dn1UP Multi- class 8	1Dn2UP Multi- class 10	1Dn3UP Multi- class 11	1Dn4UP Multi- class 12
EUT mode	Frequency (MHz)	CH	Avg. (dBm)	Avg. (dBm)	Avg. (dBm)	Avg. (dBm)
EDGE 1900 (8PSK)	1850.2	512	25.80	23.32	21.41	20.39
	1880	661	25.68	23.14	21.40	20.26
	1909.8	810	25.86	23.31	21.60	20.51
Source-based time average power						
EDGE 1900 (8PSK)	1850.2	512	16.77	17.30	17.15	17.38
	1880	661	16.65	17.12	17.14	17.25
	1909.8	810	16.83	17.29	17.34	17.50
The division factor compared to the number of TX time slot						
Division factor			1 TX time slot	2 TX time slot	3 TX time slot	4 TX time slot
			-9.03	-6.02	-4.26	-3.01

Unless otherwise stated the results shown in this test report refer only to the sample(s) tested and such sample(s) are retained for 90 days only.

除非另有說明，此報告結果僅對測試之樣品負責，同時此樣品僅保留90天。本報告未經本公司書面許可，不可部份複製。

This document is issued by the Company subject to its General Conditions of Service printed overleaf, available on request or accessible at <http://www.sgs.com.tw/Terms-and-Conditions> and for electronic format documents, subject to Terms and Conditions for Electronic Documents at <http://www.sgs.com.tw/Terms-and-Conditions>. Attention is drawn to the limitation of liability, indemnification and jurisdiction issues defined therein. Any holder of this document is advised that information contained hereon reflects the Company's findings at the time of its intervention only and within the limits of Client's instructions, if any. The Company's sole responsibility is to its Client and this document does not exonerate parties to a transaction from exercising all their rights and obligations under the transaction documents. This document cannot be reproduced except in full, without prior written approval of the Company. Any unauthorized alteration, forgery or falsification of the content or appearance of this document is unlawful and offenders may be prosecuted to the fullest extent of the law.

REDUCED

Burst average power						
Max. Rated Avg. Power + Max. Tolerance (dBm)			31	28	26	25
			1Dn1UP Multi- class 8	1Dn2UP Multi- class 10	1Dn3UP Multi- class 11	1Dn4UP Multi- class 12
EUT mode	Frequency (MHz)	CH	Avg. (dBm)	Avg. (dBm)	Avg. (dBm)	Avg. (dBm)
GPRS 850 (GMSK)	824.2	128	30.20	27.23	25.31	24.51
	836.6	190	30.65	27.67	25.99	24.99
	848.8	251	30.33	27.21	25.86	24.23
Source-based time average power						
GPRS 850 (GMSK)	824.2	128	21.17	21.21	21.05	21.50
	836.6	190	21.62	21.65	21.73	21.98
	848.8	251	21.30	21.19	21.60	21.44
The division factor compared to the number of TX time slot						
Division factor			1 TX time slot	2 TX time slot	3 TX time slot	4 TX time slot
			-9.03	-6.02	-4.26	-3.01
Burst average power						
Max. Rated Avg. Power + Max. Tolerance (dBm)			28	25	23	22
			1Dn1UP Multi- class 8	1Dn2UP Multi- class 10	1Dn3UP Multi- class 11	1Dn4UP Multi- class 12
EUT mode	Frequency (MHz)	CH	Avg. (dBm)	Avg. (dBm)	Avg. (dBm)	Avg. (dBm)
EDGE 850 (8PSK)	824.2	128	27.30	24.02	22.62	21.63
	836.6	190	27.58	24.37	22.91	21.95
	848.8	251	26.73	23.73	22.27	21.52
Source-based time average power						
EDGE 850 (8PSK)	824.2	128	18.27	18.00	18.36	18.62
	836.6	190	18.55	18.35	18.65	18.94
	848.8	251	17.70	17.71	18.01	18.51
The division factor compared to the number of TX time slot						
Division factor			1 TX time slot	2 TX time slot	3 TX time slot	4 TX time slot
			-9.03	-6.02	-4.26	-3.01

Unless otherwise stated the results shown in this test report refer only to the sample(s) tested and such sample(s) are retained for 90 days only.

除非另有說明，此報告結果僅對測試之樣品負責，同時此樣品僅保留90天。本報告未經本公司書面許可，不可部份複製。

This document is issued by the Company subject to its General Conditions of Service printed overleaf, available on request or accessible at <http://www.sgs.com.tw/Terms-and-Conditions> and for electronic format documents, subject to Terms and Conditions for Electronic Documents at <http://www.sgs.com.tw/Terms-and-Conditions>. Attention is drawn to the limitation of liability, indemnification and jurisdiction issues defined therein. Any holder of this document is advised that information contained hereon reflects the Company's findings at the time of its intervention only and within the limits of Client's instructions, if any. The Company's sole responsibility is to its Client and this document does not exonerate parties to a transaction from exercising all their rights and obligations under the transaction documents. This document cannot be reproduced except in full, without prior written approval of the Company. Any unauthorized alteration, forgery or falsification of the content or appearance of this document is unlawful and offenders may be prosecuted to the fullest extent of the law.

Burst average power						
Max. Rated Avg. Power + Max. Tolerance (dBm)			26	23	21	20
			1Dn1UP Multi- class 8	1Dn2UP Multi- class 10	1Dn3UP Multi- class 11	1Dn4UP Multi- class 12
EUT mode	Frequency (MHz)	CH	Avg. (dBm)	Avg. (dBm)	Avg. (dBm)	Avg. (dBm)
GPRS 1900 (GMSK)	1850.2	512	25.51	22.74	20.86	19.82
	1880	661	25.41	22.52	20.77	19.77
	1909.8	810	25.34	22.39	20.63	19.65
Source-based time average power						
GPRS 1900 (GMSK)	1850.2	512	16.48	16.72	16.60	16.81
	1880	661	16.38	16.50	16.51	16.76
	1909.8	810	16.31	16.37	16.37	16.64
The division factor compared to the number of TX time slot						
Division factor			1 TX time slot	2 TX time slot	3 TX time slot	4 TX time slot
			-9.03	-6.02	-4.26	-3.01
Burst average power						
Max. Rated Avg. Power + Max. Tolerance (dBm)			26	23	21	20
			1Dn1UP Multi- class 8	1Dn2UP Multi- class 10	1Dn3UP Multi- class 11	1Dn4UP Multi- class 12
EUT mode	Frequency (MHz)	CH	Avg. (dBm)	Avg. (dBm)	Avg. (dBm)	Avg. (dBm)
EDGE 1900 (8PSK)	1850.2	512	25.80	22.32	20.50	19.39
	1880	661	25.71	22.15	20.44	19.30
	1909.8	810	25.63	22.31	20.68	19.52
Source-based time average power						
EDGE 1900 (8PSK)	1850.2	512	16.77	16.30	16.24	16.38
	1880	661	16.68	16.13	16.18	16.29
	1909.8	810	16.60	16.29	16.42	16.51
The division factor compared to the number of TX time slot						
Division factor			1 TX time slot	2 TX time slot	3 TX time slot	4 TX time slot
			-9.03	-6.02	-4.26	-3.01

Unless otherwise stated the results shown in this test report refer only to the sample(s) tested and such sample(s) are retained for 90 days only.

除非另有說明，此報告結果僅對測試之樣品負責，同時此樣品僅保留90天。本報告未經本公司書面許可，不可部份複製。

This document is issued by the Company subject to its General Conditions of Service printed overleaf, available on request or accessible at <http://www.sgs.com.tw/Terms-and-Conditions> and for electronic format documents, subject to Terms and Conditions for Electronic Documents at <http://www.sgs.com.tw/Terms-and-Conditions>. Attention is drawn to the limitation of liability, indemnification and jurisdiction issues defined therein. Any holder of this document is advised that information contained hereon reflects the Company's findings at the time of its intervention only and within the limits of Client's instructions, if any. The Company's sole responsibility is to its Client and this document does not exonerate parties to a transaction from exercising all their rights and obligations under the transaction documents. This document cannot be reproduced except in full, without prior written approval of the Company. Any unauthorized alteration, forgery or falsification of the content or appearance of this document is unlawful and offenders may be prosecuted to the fullest extent of the law.

5.2 FDD CAT.M1

Tablet mode

LTE Band 2_Cat.M1									
BW(MHz)	Modulation	RB Size	RB Offset	Narrowband Index	Conducted power (dBm)			Target Power + Max. Tolerance (dBm)	MPR Allowed per 3GPP(dB)
Frequency (MHz)					1852.5	1880	1907.5		
Channel					18625	18900	19175		
5	QPSK	1	0	0	11.45	11.48	11.41	12.00	0
		1	5	0	11.40	11.33	11.31	12.00	0
		1	0	1	11.26	11.42	11.28	12.00	0
		1	5	1	11.39	11.34	11.35	12.00	0
		1	0	3	11.35	11.33	11.30	12.00	0
		1	5	3	11.28	11.31	11.29	12.00	0
		3	0	0	11.37	11.41	11.31	12.00	0
		3	3	3	11.35	11.35	11.30	12.00	0
		6	0	0	11.32	11.31	11.26	12.00	0
	6	0	1	11.33	11.36	11.30	12.00	0	
	6	0	3	11.37	11.41	11.24	12.00	0	
	16-QAM	1	0	0	11.34	11.43	11.31	12.00	0
		1	5	0	11.35	11.31	11.32	12.00	0
		1	0	1	11.40	11.35	11.25	12.00	0
		1	5	1	11.32	11.38	11.25	12.00	0
		1	0	3	11.30	11.39	11.32	12.00	0
		1	5	3	11.38	11.32	11.27	12.00	0
		3	0	0	11.40	11.38	11.25	12.00	0
3		3	3	11.29	11.34	11.33	12.00	0	
5		0	0	11.38	11.37	11.27	12.00	0	
5	0	1	11.30	11.41	11.20	12.00	0		
5	0	3	11.33	11.32	11.22	12.00	0		
BW(MHz)	Modulation	RB Size	RB Offset	Narrowband Index	Conducted power (dBm)			Target Power + Max. Tolerance (dBm)	MPR Allowed per 3GPP(dB)
Frequency (MHz)					1851.5	1880	1908.5		
Channel					18615	18900	19185		
3	QPSK	1	0	0	11.33	11.41	11.30	12.00	0
		1	5	0	11.27	11.37	11.28	12.00	0
		1	0	1	11.31	11.33	11.34	12.00	0
		1	5	1	11.33	11.37	11.23	12.00	0
		3	3	0	11.42	11.31	11.21	12.00	0
		3	3	1	11.32	11.40	11.33	12.00	0
		6	0	0	11.26	11.42	11.35	12.00	0
		6	0	1	11.25	11.34	11.28	12.00	0
		16-QAM	1	0	0	11.30	11.35	11.31	12.00
	1		5	0	11.35	11.35	11.35	12.00	0
	1		0	1	11.29	11.28	11.30	12.00	0
	1		5	1	11.34	11.37	11.26	12.00	0
	3		0	0	11.28	11.40	11.33	12.00	0
	3		3	1	11.36	11.40	11.24	12.00	0
	5		0	0	11.37	11.36	11.28	12.00	0
	5		0	1	11.27	11.33	11.36	12.00	0

Unless otherwise stated the results shown in this test report refer only to the sample(s) tested and such sample(s) are retained for 90 days only.

除非另有說明，此報告結果僅對測試之樣品負責，同時此樣品僅保留90天。本報告未經本公司書面許可，不可部份複製。

This document is issued by the Company subject to its General Conditions of Service printed overleaf, available on request or accessible at <http://www.sgs.com.tw/Terms-and-Conditions> and for electronic format documents, subject to Terms and Conditions for Electronic Documents at <http://www.sgs.com.tw/Terms-and-Conditions>. Attention is drawn to the limitation of liability, indemnification and jurisdiction issues defined therein. Any holder of this document is advised that information contained hereon reflects the Company's findings at the time of its intervention only and within the limits of Client's instructions, if any. The Company's sole responsibility is to its Client and this document does not exonerate parties to a transaction from exercising all their rights and obligations under the transaction documents. This document cannot be reproduced except in full, without prior written approval of the Company. Any unauthorized alteration, forgery or falsification of the content or appearance of this document is unlawful and offenders may be prosecuted to the fullest extent of the law.

BW(MHz)	Modulation	RB Size	RB Offset	Narrowband Index	Conducted power (dBm)			Target Power + Max. Tolerance (dBm)	MPR Allowed per 3GPP(dB)
					Frequency (MHz)	1850.7	1880		
Channel					18607	18900	19193		
1.4	QPSK	1	0	0	11.31	11.39	11.35	12.00	0
		1	5	0	11.39	11.31	11.30	12.00	0
		3	3	0	11.29	11.36	11.25	12.00	0
		6	0	0	11.37	11.37	11.31	12.00	0
	16-QAM	1	0	0	11.42	11.37	11.33	12.00	0
		1	5	0	11.25	11.35	11.29	12.00	0
		3	0	0	11.32	11.41	11.28	12.00	0
		5	0	0	11.41	11.40	11.23	12.00	0
LTE Band 4_Cat.M1									
BW(MHz)	Modulation	RB Size	RB Offset	Narrowband Index	Conducted power (dBm)			Target Power + Max. Tolerance (dBm)	MPR Allowed per 3GPP(dB)
					Frequency (MHz)	1712.5	1732.5		
Channel					19975	20175	20375		
5	QPSK	1	0	0	12.48	12.58	12.66	13.00	0
		1	5	0	12.39	12.40	12.52	13.00	0
		1	0	1	12.36	12.46	12.60	13.00	0
		1	5	1	12.33	12.42	12.54	13.00	0
		1	0	3	12.37	12.50	12.55	13.00	0
		1	5	3	12.41	12.48	12.55	13.00	0
		3	0	0	12.34	12.48	12.55	13.00	0
		3	3	3	12.42	12.43	12.48	13.00	0
		6	0	0	12.36	12.51	12.58	13.00	0
	6	0	1	12.39	12.48	12.52	13.00	0	
	6	0	3	12.43	12.54	12.58	13.00	0	
	16-QAM	1	0	0	12.39	12.52	12.51	13.00	0
		1	5	0	12.41	12.50	12.48	13.00	0
		1	0	1	12.39	12.46	12.49	13.00	0
		1	5	1	12.38	12.42	12.51	13.00	0
		1	0	3	12.39	12.42	12.55	13.00	0
		1	5	3	12.38	12.46	12.48	13.00	0
3		0	0	12.32	12.52	12.57	13.00	0	
3		3	3	12.34	12.48	12.51	13.00	0	
5	0	0	12.27	12.45	12.51	13.00	0		
5	0	1	12.35	12.47	12.62	13.00	0		
5	0	3	12.42	12.48	12.48	13.00	0		

Unless otherwise stated the results shown in this test report refer only to the sample(s) tested and such sample(s) are retained for 90 days only.

除非另有說明，此報告結果僅對測試之樣品負責，同時此樣品僅保留90天。本報告未經本公司書面許可，不可部份複製。

This document is issued by the Company subject to its General Conditions of Service printed overleaf, available on request or accessible at <http://www.sgs.com.tw/Terms-and-Conditions> and for electronic format documents, subject to Terms and Conditions for Electronic Documents at <http://www.sgs.com.tw/Terms-and-Conditions>. Attention is drawn to the limitation of liability, indemnification and jurisdiction issues defined therein. Any holder of this document is advised that information contained hereon reflects the Company's findings at the time of its intervention only and within the limits of Client's instructions, if any. The Company's sole responsibility is to its Client and this document does not exonerate parties to a transaction from exercising all their rights and obligations under the transaction documents. This document cannot be reproduced except in full, without prior written approval of the Company. Any unauthorized alteration, forgery or falsification of the content or appearance of this document is unlawful and offenders may be prosecuted to the fullest extent of the law.

BW(MHz)	Modulation	RB Size	RB Offset	Narrowband Index	Conducted power (dBm)			Target Power + Max. Tolerance (dBm)	MPR Allowed per 3GPP(dB)	
Frequency (MHz)					1711.5	1732.5	1753.5			
Channel					19965	20175	20385			
3	QPSK	1	0	0	12.44	12.43	12.56	13.00	0	
		1	5	0	12.32	12.49	12.56	13.00	0	
		1	0	1	12.44	12.50	12.57	13.00	0	
		1	5	1	12.33	12.44	12.49	13.00	0	
		3	3	0	12.35	12.47	12.53	13.00	0	
		3	3	1	12.36	12.48	12.51	13.00	0	
		6	0	0	12.30	12.47	12.59	13.00	0	
	16-QAM	6	0	1	12.34	12.42	12.51	13.00	0	
		1	0	0	12.40	12.52	12.52	13.00	0	
		1	5	0	12.35	12.51	12.54	13.00	0	
		1	0	1	12.40	12.46	12.58	13.00	0	
		1	5	1	12.37	12.43	12.53	13.00	0	
		3	0	0	12.31	12.52	12.60	13.00	0	
		3	3	1	12.36	12.46	12.56	13.00	0	
		5	0	0	12.35	12.53	12.48	13.00	0	
		5	0	1	12.43	12.55	12.51	13.00	0	
BW(MHz)	Modulation	RB Size	RB Offset	Narrowband Index	Conducted power (dBm)			Target Power + Max. Tolerance (dBm)	MPR Allowed per 3GPP(dB)	
Frequency (MHz)					1710.7	1732.5	1754.3			
Channel					19957	20175	20393			
1.4	QPSK	1	0	0	12.39	12.43	12.55	13.00	0	
		1	5	0	12.34	12.43	12.55	13.00	0	
		3	3	0	12.32	12.40	12.52	13.00	0	
		6	0	0	12.33	12.49	12.51	13.00	0	
	16-QAM	1	0	0	12.36	12.47	12.56	13.00	0	
		1	5	0	12.36	12.52	12.55	13.00	0	
		3	0	0	12.42	12.45	12.54	13.00	0	
				5	0	12.40	12.51	12.52	13.00	0

Unless otherwise stated the results shown in this test report refer only to the sample(s) tested and such sample(s) are retained for 90 days only.

除非另有說明，此報告結果僅對測試之樣品負責，同時此樣品僅保留90天。本報告未經本公司書面許可，不可部份複製。

This document is issued by the Company subject to its General Conditions of Service printed overleaf, available on request or accessible at <http://www.sgs.com.tw/Terms-and-Conditions> and for electronic format documents, subject to Terms and Conditions for Electronic Documents at <http://www.sgs.com.tw/Terms-and-Conditions>. Attention is drawn to the limitation of liability, indemnification and jurisdiction issues defined therein. Any holder of this document is advised that information contained hereon reflects the Company's findings at the time of its intervention only and within the limits of Client's instructions, if any. The Company's sole responsibility is to its Client and this document does not exonerate parties to a transaction from exercising all their rights and obligations under the transaction documents. This document cannot be reproduced except in full, without prior written approval of the Company. Any unauthorized alteration, forgery or falsification of the content or appearance of this document is unlawful and offenders may be prosecuted to the fullest extent of the law.

LTE Band 5_Cat.M1									
BW(MHz)	Modulation	RB Size	RB Offset	Narrowband Index	Conducted power (dBm)			Target Power + Max. Tolerance (dBm)	MPR Allowed per 3GPP(dB)
Frequency (MHz)					826.5	836.5	846.5		
Channel					20425	20525	20625		
5	QPSK	1	0	0	15.16	15.18	15.11	16.00	0
		1	5	0	15.03	15.06	15.04	16.00	0
		1	0	1	15.06	15.08	15.01	16.00	0
		1	5	1	14.98	15.08	15.06	16.00	0
		1	0	3	15.01	15.06	14.94	16.00	0
		1	5	3	15.04	15.12	14.97	16.00	0
		3	0	0	15.08	15.06	15.02	16.00	0
		3	3	3	15.01	15.11	14.98	16.00	0
		6	0	0	15.06	15.01	14.93	16.00	0
	6	0	1	14.98	15.12	15.04	16.00	0	
	6	0	3	15.10	15.09	15.02	16.00	0	
	16-QAM	1	0	0	14.95	15.12	14.96	16.00	0
		1	5	0	15.03	15.03	15.06	16.00	0
		1	0	1	15.04	15.06	15.01	16.00	0
		1	5	1	15.01	15.05	15.00	16.00	0
		1	0	3	15.09	15.06	14.99	16.00	0
		1	5	3	15.05	15.11	14.97	16.00	0
		3	0	0	14.98	15.04	15.05	16.00	0
3		3	3	15.01	15.09	15.00	16.00	0	
5		0	0	15.06	15.10	15.02	16.00	0	
5	0	1	15.08	15.03	15.03	16.00	0		
5	0	3	15.01	15.04	14.96	16.00	0		
BW(MHz)	Modulation	RB Size	RB Offset	Narrowband Index	Conducted power (dBm)			Target Power + Max. Tolerance (dBm)	MPR Allowed per 3GPP(dB)
Frequency (MHz)					825.5	836.5	847.5		
Channel					20415	20525	20635		
3	QPSK	1	0	0	15.08	15.07	15.01	16.00	0
		1	5	0	15.00	15.15	15.06	16.00	0
		1	0	1	15.09	15.07	14.99	16.00	0
		1	5	1	15.04	15.07	15.05	16.00	0
		3	3	0	15.02	15.10	14.99	16.00	0
		3	3	1	15.03	15.03	15.00	16.00	0
		6	0	0	15.04	15.02	15.03	16.00	0
		6	0	1	15.06	15.08	15.00	16.00	0
		16-QAM	1	0	0	15.05	15.03	14.97	16.00
	1		5	0	15.05	15.09	14.99	16.00	0
	1		0	1	15.09	15.12	14.97	16.00	0
	1		5	1	15.11	15.10	14.91	16.00	0
	3		0	0	15.09	15.09	14.94	16.00	0
	3		3	1	15.04	15.13	15.00	16.00	0
	5		0	0	15.07	15.06	15.00	16.00	0
	5		0	1	15.01	15.05	15.02	16.00	0

Unless otherwise stated the results shown in this test report refer only to the sample(s) tested and such sample(s) are retained for 90 days only.

除非另有說明，此報告結果僅對測試之樣品負責，同時此樣品僅保留90天。本報告未經本公司書面許可，不可部份複製。

This document is issued by the Company subject to its General Conditions of Service printed overleaf, available on request or accessible at <http://www.sgs.com.tw/Terms-and-Conditions> and for electronic format documents, subject to Terms and Conditions for Electronic Documents at <http://www.sgs.com.tw/Terms-and-Conditions>. Attention is drawn to the limitation of liability, indemnification and jurisdiction issues defined therein. Any holder of this document is advised that information contained hereon reflects the Company's findings at the time of its intervention only and within the limits of Client's instructions, if any. The Company's sole responsibility is to its Client and this document does not exonerate parties to a transaction from exercising all their rights and obligations under the transaction documents. This document cannot be reproduced except in full, without prior written approval of the Company. Any unauthorized alteration, forgery or falsification of the content or appearance of this document is unlawful and offenders may be prosecuted to the fullest extent of the law.

BW(MHz)	Modulation	RB Size	RB Offset	Narrowband Index	Conducted power (dBm)			Target Power + Max. Tolerance (dBm)	MPR Allowed per 3GPP(dB)
Frequency (MHz)					1710.7	1732.5	1754.3		
Channel					19957	20175	20393		
1.4	QPSK	1	0	0	14.99	15.08	14.96	16.00	0
		1	5	0	15.01	15.11	15.05	16.00	0
		3	3	0	15.03	15.06	15.03	16.00	0
		6	0	0	15.03	15.02	15.00	16.00	0
	16-QAM	1	0	0	15.02	15.10	14.94	16.00	0
		1	5	0	15.10	15.04	15.00	16.00	0
		3	0	0	15.09	15.11	15.00	16.00	0
		5	0	0	15.01	15.00	14.96	16.00	0
LTE Band 12_Cat.M1									
BW(MHz)	Modulation	RB Size	RB Offset	Narrowband Index	Conducted power (dBm)			Target Power + Max. Tolerance (dBm)	MPR Allowed per 3GPP(dB)
Frequency (MHz)					701.5	707.5	713.5		
Channel					23035	23095	23155		
5	QPSK	1	0	0	12.64	12.65	12.58	13.50	0
		1	5	0	12.52	12.55	12.52	13.50	0
		1	0	1	12.55	12.51	12.47	13.50	0
		1	5	1	12.60	12.53	12.46	13.50	0
		1	0	3	12.56	12.51	12.47	13.50	0
		1	5	3	12.55	12.52	12.39	13.50	0
		3	0	0	12.46	12.62	12.42	13.50	0
		3	3	3	12.47	12.51	12.42	13.50	0
		6	0	0	12.57	12.50	12.50	13.50	0
	6	0	1	12.55	12.53	12.48	13.50	0	
	6	0	3	12.50	12.56	12.46	13.50	0	
	16-QAM	1	0	0	12.54	12.55	12.42	13.50	0
		1	5	0	12.56	12.49	12.49	13.50	0
		1	0	1	12.57	12.55	12.54	13.50	0
		1	5	1	12.57	12.47	12.49	13.50	0
		1	0	3	12.49	12.51	12.49	13.50	0
		1	5	3	12.50	12.56	12.53	13.50	0
		3	0	0	12.51	12.52	12.42	13.50	0
3		3	3	12.57	12.48	12.47	13.50	0	
5		0	0	12.46	12.51	12.44	13.50	0	
5	0	1	12.48	12.57	12.41	13.50	0		
5	0	3	12.50	12.60	12.46	13.50	0		

Unless otherwise stated the results shown in this test report refer only to the sample(s) tested and such sample(s) are retained for 90 days only.

除非另有說明，此報告結果僅對測試之樣品負責，同時此樣品僅保留90天。本報告未經本公司書面許可，不可部份複製。

This document is issued by the Company subject to its General Conditions of Service printed overleaf, available on request or accessible at <http://www.sgs.com.tw/Terms-and-Conditions> and for electronic format documents, subject to Terms and Conditions for Electronic Documents at <http://www.sgs.com.tw/Terms-and-Conditions>. Attention is drawn to the limitation of liability, indemnification and jurisdiction issues defined therein. Any holder of this document is advised that information contained hereon reflects the Company's findings at the time of its intervention only and within the limits of Client's instructions, if any. The Company's sole responsibility is to its Client and this document does not exonerate parties to a transaction from exercising all their rights and obligations under the transaction documents. This document cannot be reproduced except in full, without prior written approval of the Company. Any unauthorized alteration, forgery or falsification of the content or appearance of this document is unlawful and offenders may be prosecuted to the fullest extent of the law.

BW(MHz)	Modulation	RB Size	RB Offset	Narrowband Index	Conducted power (dBm)			Target Power + Max. Tolerance (dBm)	MPR Allowed per 3GPP(dB)
					Frequency (MHz)	700.5	707.5		
Channel					23025	23095	23165		
3	QPSK	1	0	0	12.55	12.51	12.45	13.50	0
		1	5	0	12.45	12.54	12.53	13.50	0
		1	0	1	12.58	12.50	12.50	13.50	0
		1	5	1	12.47	12.49	12.40	13.50	0
		3	3	0	12.50	12.53	12.50	13.50	0
		3	3	1	12.55	12.48	12.45	13.50	0
		6	0	0	12.51	12.50	12.42	13.50	0
	6	0	1	12.54	12.52	12.48	13.50	0	
	16-QAM	1	0	0	12.47	12.54	12.50	13.50	0
		1	5	0	12.48	12.54	12.43	13.50	0
		1	0	1	12.52	12.47	12.54	13.50	0
		1	5	1	12.52	12.60	12.46	13.50	0
		3	0	0	12.57	12.56	12.47	13.50	0
		3	3	1	12.52	12.51	12.50	13.50	0
5		0	0	12.54	12.52	12.54	13.50	0	
5	0	1	12.58	12.56	12.39	13.50	0		
BW(MHz)	Modulation	RB Size	RB Offset	Narrowband Index	Conducted power (dBm)			Target Power + Max. Tolerance (dBm)	MPR Allowed per 3GPP(dB)
					Frequency (MHz)	699.7	707.5		
Channel					23017	23095	23173		
1.4	QPSK	1	0	0	12.45	12.47	12.50	13.50	0
		1	5	0	12.47	12.55	12.41	13.50	0
		3	3	0	12.51	12.61	12.51	13.50	0
		6	0	0	12.60	12.54	12.47	13.50	0
	16-QAM	1	0	0	12.59	12.61	12.46	13.50	0
		1	5	0	12.56	12.53	12.42	13.50	0
		3	0	0	12.49	12.53	12.47	13.50	0
		3	0	0	12.49	12.60	12.53	13.50	0
		5	0	0	12.49	12.60	12.53	13.50	0

Unless otherwise stated the results shown in this test report refer only to the sample(s) tested and such sample(s) are retained for 90 days only.

除非另有說明，此報告結果僅對測試之樣品負責，同時此樣品僅保留90天。本報告未經本公司書面許可，不可部份複製。

This document is issued by the Company subject to its General Conditions of Service printed overleaf, available on request or accessible at <http://www.sgs.com.tw/Terms-and-Conditions> and for electronic format documents, subject to Terms and Conditions for Electronic Documents at <http://www.sgs.com.tw/Terms-and-Conditions>. Attention is drawn to the limitation of liability, indemnification and jurisdiction issues defined therein. Any holder of this document is advised that information contained hereon reflects the Company's findings at the time of its intervention only and within the limits of Client's instructions, if any. The Company's sole responsibility is to its Client and this document does not exonerate parties to a transaction from exercising all their rights and obligations under the transaction documents. This document cannot be reproduced except in full, without prior written approval of the Company. Any unauthorized alteration, forgery or falsification of the content or appearance of this document is unlawful and offenders may be prosecuted to the fullest extent of the law.

LTE Band 13_Cat.M1									
BW(MHz)	Modulation	RB Size	RB Offset	Narrowband Index	Conducted power (dBm)			Target Power + Max. Tolerance (dBm)	MPR Allowed per 3GPP(dB)
Frequency (MHz)					779.5	782	784.5		
Channel					23205	23230	23255		
5	QPSK	1	0	0	13.88	13.87	13.89	14.50	0
		1	5	0	13.82	13.74	13.77	14.50	0
		1	0	1	13.77	13.72	13.74	14.50	0
		1	5	1	13.77	13.76	13.78	14.50	0
		1	0	3	13.79	13.77	13.74	14.50	0
		1	5	3	13.70	13.66	13.85	14.50	0
		3	0	0	13.80	13.74	13.70	14.50	0
		3	3	3	13.72	13.71	13.79	14.50	0
		6	0	0	13.73	13.77	13.81	14.50	0
		6	0	1	13.75	13.72	13.82	14.50	0
	6	0	3	13.73	13.76	13.84	14.50	0	
	16-QAM	1	0	0	13.76	13.77	13.79	14.50	0
		1	5	0	13.83	13.68	13.77	14.50	0
		1	0	1	13.83	13.66	13.81	14.50	0
		1	5	1	13.75	13.70	13.80	14.50	0
		1	0	3	13.77	13.79	13.82	14.50	0
		1	5	3	13.79	13.72	13.81	14.50	0
		3	0	0	13.69	13.80	13.77	14.50	0
		3	3	3	13.81	13.82	13.72	14.50	0
		5	0	0	13.77	13.68	13.78	14.50	0
5		0	1	13.80	13.79	13.76	14.50	0	
		5	0	3	13.74	13.78	13.74	14.50	0

Unless otherwise stated the results shown in this test report refer only to the sample(s) tested and such sample(s) are retained for 90 days only.

除非另有說明，此報告結果僅對測試之樣品負責，同時此樣品僅保留90天。本報告未經本公司書面許可，不可部份複製。

This document is issued by the Company subject to its General Conditions of Service printed overleaf, available on request or accessible at <http://www.sgs.com.tw/Terms-and-Conditions> and for electronic format documents, subject to Terms and Conditions for Electronic Documents at <http://www.sgs.com.tw/Terms-and-Conditions>. Attention is drawn to the limitation of liability, indemnification and jurisdiction issues defined therein. Any holder of this document is advised that information contained hereon reflects the Company's findings at the time of its intervention only and within the limits of Client's instructions, if any. The Company's sole responsibility is to its Client and this document does not exonerate parties to a transaction from exercising all their rights and obligations under the transaction documents. This document cannot be reproduced except in full, without prior written approval of the Company. Any unauthorized alteration, forgery or falsification of the content or appearance of this document is unlawful and offenders may be prosecuted to the fullest extent of the law.

LTE Band 14_Cat.M1									
BW(MHz)	Modulation	RB Size	RB Offset	Narrowband Index	Conducted power (dBm)			Target Power + Max. Tolerance (dBm)	MPR Allowed per 3GPP(dB)
Frequency (MHz)					790.5	793	795.5		
Channel					23305	23330	23355		
5	QPSK	1	0	0	13.84	13.82	13.80	14.50	0
		1	5	0	13.68	13.76	13.64	14.50	0
		1	0	1	13.76	13.66	13.65	14.50	0
		1	5	1	13.77	13.73	13.74	14.50	0
		1	0	3	13.73	13.69	13.66	14.50	0
		1	5	3	13.68	13.73	13.72	14.50	0
		3	0	0	13.68	13.70	13.76	14.50	0
		3	3	3	13.73	13.71	13.73	14.50	0
		6	0	0	13.69	13.66	13.69	14.50	0
		6	0	1	13.67	13.69	13.60	14.50	0
	6	0	3	13.70	13.65	13.69	14.50	0	
	16-QAM	1	0	0	13.67	13.70	13.59	14.50	0
		1	5	0	13.77	13.78	13.65	14.50	0
		1	0	1	13.76	13.66	13.71	14.50	0
		1	5	1	13.74	13.69	13.69	14.50	0
		1	0	3	13.73	13.76	13.67	14.50	0
		1	5	3	13.70	13.68	13.70	14.50	0
		3	0	0	13.80	13.73	13.69	14.50	0
		3	3	3	13.66	13.74	13.65	14.50	0
		5	0	0	13.66	13.72	13.64	14.50	0
5		0	1	13.72	13.69	13.74	14.50	0	
5	0	3	13.74	13.64	13.71	14.50	0		

Unless otherwise stated the results shown in this test report refer only to the sample(s) tested and such sample(s) are retained for 90 days only.

除非另有說明，此報告結果僅對測試之樣品負責，同時此樣品僅保留90天。本報告未經本公司書面許可，不可部份複製。

This document is issued by the Company subject to its General Conditions of Service printed overleaf, available on request or accessible at <http://www.sgs.com.tw/Terms-and-Conditions> and for electronic format documents, subject to Terms and Conditions for Electronic Documents at <http://www.sgs.com.tw/Terms-and-Conditions>. Attention is drawn to the limitation of liability, indemnification and jurisdiction issues defined therein. Any holder of this document is advised that information contained hereon reflects the Company's findings at the time of its intervention only and within the limits of Client's instructions, if any. The Company's sole responsibility is to its Client and this document does not exonerate parties to a transaction from exercising all their rights and obligations under the transaction documents. This document cannot be reproduced except in full, without prior written approval of the Company. Any unauthorized alteration, forgery or falsification of the content or appearance of this document is unlawful and offenders may be prosecuted to the fullest extent of the law.

LTE Band 25_Cat.M1									
BW(MHz)	Modulation	RB Size	RB Offset	Narrowband Index	Conducted power (dBm)			Target Power + Max. Tolerance (dBm)	MPR Allowed per 3GPP(dB)
Frequency (MHz)					1852.5	1882.5	1912.5		
Channel					26065	26365	26665		
5	QPSK	1	0	0	11.79	11.91	12.21	12.50	0
		1	5	0	11.71	11.82	12.03	12.50	0
		1	0	1	11.67	11.75	12.12	12.50	0
		1	5	1	11.67	11.77	12.09	12.50	0
		1	0	3	11.73	11.77	12.04	12.50	0
		1	5	3	11.62	11.79	12.09	12.50	0
		3	0	0	11.72	11.73	12.10	12.50	0
		3	3	3	11.70	11.84	12.12	12.50	0
		6	0	0	11.67	11.81	12.08	12.50	0
	6	0	1	11.59	11.82	12.14	12.50	0	
	6	0	3	11.66	11.82	12.11	12.50	0	
	16-QAM	1	0	0	11.60	11.78	12.06	12.50	0
		1	5	0	11.67	11.84	12.10	12.50	0
		1	0	1	11.65	11.84	12.10	12.50	0
		1	5	1	11.64	11.83	12.11	12.50	0
		1	0	3	11.63	11.80	12.16	12.50	0
		1	5	3	11.62	11.86	12.04	12.50	0
		3	0	0	11.68	11.76	12.06	12.50	0
3		3	3	11.66	11.87	12.10	12.50	0	
5		0	0	11.64	11.71	12.12	12.50	0	
5	0	1	11.68	11.71	12.02	12.50	0		
5	0	3	11.71	11.76	12.00	12.50	0		
BW(MHz)	Modulation	RB Size	RB Offset	Narrowband Index	Conducted power (dBm)			Target Power + Max. Tolerance (dBm)	MPR Allowed per 3GPP(dB)
Frequency (MHz)					1851.5	1882.5	1913.5		
Channel					26055	26365	26675		
3	QPSK	1	0	0	11.72	11.73	12.08	12.50	0
		1	5	0	11.68	11.86	12.08	12.50	0
		1	0	1	11.65	11.78	12.11	12.50	0
		1	5	1	11.74	11.82	12.05	12.50	0
		3	3	0	11.67	11.70	12.04	12.50	0
		3	3	1	11.66	11.78	12.07	12.50	0
		6	0	0	11.69	11.77	12.13	12.50	0
		6	0	1	11.65	11.72	12.06	12.50	0
		16-QAM	1	0	0	11.61	11.83	12.10	12.50
	1		5	0	11.75	11.78	12.02	12.50	0
	1		0	1	11.64	11.82	12.12	12.50	0
	1		5	1	11.65	11.79	12.10	12.50	0
	3		0	0	11.65	11.76	12.03	12.50	0
	3		3	1	11.69	11.81	12.03	12.50	0
	5		0	0	11.66	11.77	12.02	12.50	0
	5		0	1	11.69	11.74	12.08	12.50	0

Unless otherwise stated the results shown in this test report refer only to the sample(s) tested and such sample(s) are retained for 90 days only.

除非另有說明，此報告結果僅對測試之樣品負責，同時此樣品僅保留90天。本報告未經本公司書面許可，不可部份複製。

This document is issued by the Company subject to its General Conditions of Service printed overleaf, available on request or accessible at <http://www.sgs.com.tw/Terms-and-Conditions> and for electronic format documents, subject to Terms and Conditions for Electronic Documents at <http://www.sgs.com.tw/Terms-and-Conditions>. Attention is drawn to the limitation of liability, indemnification and jurisdiction issues defined therein. Any holder of this document is advised that information contained hereon reflects the Company's findings at the time of its intervention only and within the limits of Client's instructions, if any. The Company's sole responsibility is to its Client and this document does not exonerate parties to a transaction from exercising all their rights and obligations under the transaction documents. This document cannot be reproduced except in full, without prior written approval of the Company. Any unauthorized alteration, forgery or falsification of the content or appearance of this document is unlawful and offenders may be prosecuted to the fullest extent of the law.

BW(MHz)	Modulation	RB Size	RB Offset	Narrowband Index	Conducted power (dBm)			Target Power + Max. Tolerance (dBm)	MPR Allowed per 3GPP(dB)
Frequency (MHz)					1850.7	1882.5	1914.3		
Channel					26047	26365	26683		
1.4	QPSK	1	0	0	11.65	11.72	12.07	12.50	0
		1	5	0	11.69	11.75	12.10	12.50	0
		3	3	0	11.71	11.73	12.16	12.50	0
		6	0	0	11.71	11.80	12.11	12.50	0
	16-QAM	1	0	0	11.66	11.83	12.10	12.50	0
		1	5	0	11.73	11.78	12.12	12.50	0
		3	0	0	11.64	11.79	12.11	12.50	0
		5	0	0	11.69	11.76	12.12	12.50	0

LTE Band 26_Cat.M1_FCC

BW(MHz)	Modulation	RB Size	RB Offset	Narrowband Index	Conducted power (dBm)			Target Power + Max. Tolerance (dBm)	MPR Allowed per 3GPP(dB)
Frequency (MHz)					816.5	831.5	846.5		
Channel					26715	26865	27015		
5	QPSK	1	0	0	14.96	15.27	15.01	16.00	0
		1	5	0	14.83	15.12	14.94	16.00	0
		1	0	1	14.79	15.16	14.84	16.00	0
		1	5	1	14.83	15.08	14.90	16.00	0
		1	0	3	14.87	15.21	14.88	16.00	0
		1	5	3	14.79	15.17	14.84	16.00	0
		3	0	0	14.82	15.13	14.85	16.00	0
		3	3	3	14.83	15.23	14.85	16.00	0
		6	0	0	14.85	15.13	14.89	16.00	0
		6	0	1	14.84	15.16	14.91	16.00	0
	16-QAM	6	0	3	14.87	15.21	14.91	16.00	0
		1	0	0	14.87	15.06	14.94	16.00	0
		1	5	0	14.88	15.24	14.87	16.00	0
		1	0	1	14.81	15.19	14.94	16.00	0
		1	5	1	14.85	15.15	14.83	16.00	0
		1	0	3	14.90	15.17	14.87	16.00	0
		1	5	3	14.78	15.18	14.89	16.00	0
		3	0	0	14.83	15.21	14.90	16.00	0
		3	3	3	14.89	15.16	14.86	16.00	0
		5	0	0	14.79	15.12	14.93	16.00	0
5	0	1	14.88	15.12	14.89	16.00	0		
5	0	3	14.87	15.10	14.86	16.00	0		

Unless otherwise stated the results shown in this test report refer only to the sample(s) tested and such sample(s) are retained for 90 days only.

除非另有說明，此報告結果僅對測試之樣品負責，同時此樣品僅保留90天。本報告未經本公司書面許可，不可部份複製。

This document is issued by the Company subject to its General Conditions of Service printed overleaf, available on request or accessible at <http://www.sgs.com.tw/Terms-and-Conditions> and for electronic format documents, subject to Terms and Conditions for Electronic Documents at <http://www.sgs.com.tw/Terms-and-Conditions>. Attention is drawn to the limitation of liability, indemnification and jurisdiction issues defined therein. Any holder of this document is advised that information contained hereon reflects the Company's findings at the time of its intervention only and within the limits of Client's instructions, if any. The Company's sole responsibility is to its Client and this document does not exonerate parties to a transaction from exercising all their rights and obligations under the transaction documents. This document cannot be reproduced except in full, without prior written approval of the Company. Any unauthorized alteration, forgery or falsification of the content or appearance of this document is unlawful and offenders may be prosecuted to the fullest extent of the law.

BW(MHz)	Modulation	RB Size	RB Offset	Narrowband Index	Conducted power (dBm)			Target Power + Max. Tolerance (dBm)	MPR Allowed per 3GPP(dB)
					Frequency (MHz)				
					Channel				
3	QPSK	1	0	0	14.87	15.22	14.89	16.00	0
		1	5	0	14.83	15.14	14.98	16.00	0
		1	0	1	14.79	15.09	14.84	16.00	0
		1	5	1	14.86	15.15	14.89	16.00	0
		3	3	0	14.82	15.17	14.93	16.00	0
		3	3	1	14.92	15.13	14.86	16.00	0
		6	0	0	14.88	15.17	14.90	16.00	0
		6	0	1	14.86	15.09	14.91	16.00	0
	16-QAM	1	0	0	14.84	15.16	14.86	16.00	0
		1	5	0	14.90	15.09	14.86	16.00	0
		1	0	1	14.86	15.20	14.84	16.00	0
		1	5	1	14.85	15.15	14.88	16.00	0
		3	0	0	14.91	15.06	14.97	16.00	0
		3	3	1	14.85	15.22	14.82	16.00	0
		5	0	0	14.86	15.14	14.94	16.00	0
		5	0	1	14.82	15.12	14.90	16.00	0
BW(MHz)	Modulation	RB Size	RB Offset	Narrowband Index	Conducted power (dBm)			Target Power + Max. Tolerance (dBm)	MPR Allowed per 3GPP(dB)
					Frequency (MHz)				
					Channel				
1.4	QPSK	1	0	0	14.85	15.14	14.84	16.00	0
		1	5	0	14.81	15.13	14.91	16.00	0
		3	3	0	14.91	15.14	14.93	16.00	0
		6	0	0	14.90	15.17	14.91	16.00	0
	16-QAM	1	0	0	14.91	15.17	14.86	16.00	0
		1	5	0	14.88	15.13	14.91	16.00	0
		3	0	0	14.85	15.13	14.95	16.00	0
		5	0	0	14.84	15.17	14.87	16.00	0

Unless otherwise stated the results shown in this test report refer only to the sample(s) tested and such sample(s) are retained for 90 days only.

除非另有說明，此報告結果僅對測試之樣品負責，同時此樣品僅保留90天。本報告未經本公司書面許可，不可部份複製。

This document is issued by the Company subject to its General Conditions of Service printed overleaf, available on request or accessible at <http://www.sgs.com.tw/Terms-and-Conditions> and for electronic format documents, subject to Terms and Conditions for Electronic Documents at <http://www.sgs.com.tw/Terms-and-Conditions>. Attention is drawn to the limitation of liability, indemnification and jurisdiction issues defined therein. Any holder of this document is advised that information contained hereon reflects the Company's findings at the time of its intervention only and within the limits of Client's instructions, if any. The Company's sole responsibility is to its Client and this document does not exonerate parties to a transaction from exercising all their rights and obligations under the transaction documents. This document cannot be reproduced except in full, without prior written approval of the Company. Any unauthorized alteration, forgery or falsification of the content or appearance of this document is unlawful and offenders may be prosecuted to the fullest extent of the law.

LTE Band 66_Cat.M1										
BW(MHz)	Modulation	RB Size	RB Offset	Narrowband Index	Conducted power (dBm)			Target Power + Max. Tolerance (dBm)	MPR Allowed per 3GPP(dB)	
Frequency (MHz)					1712.5	1745	1777.5			
Channel					131997	132322	132647			
5	QPSK	1	0	0	12.39	12.31	12.49	13.00	0	
		1	5	0	12.26	12.12	12.45	13.00	0	
		1	0	1	12.27	12.25	12.34	13.00	0	
		1	5	1	12.25	12.18	12.37	13.00	0	
		1	0	3	12.27	12.18	12.38	13.00	0	
		1	5	3	12.25	12.17	12.38	13.00	0	
		3	0	0	12.26	12.19	12.44	13.00	0	
		3	3	3	12.22	12.16	12.37	13.00	0	
		6	0	0	12.27	12.15	12.42	13.00	0	
		6	0	1	12.29	12.15	12.41	13.00	0	
	16-QAM	6	0	3	12.29	12.17	12.41	13.00	0	
		1	0	0	12.26	12.12	12.32	13.00	0	
		1	5	0	12.30	12.16	12.37	13.00	0	
		1	0	1	12.31	12.16	12.38	13.00	0	
		1	5	1	12.33	12.28	12.30	13.00	0	
		1	0	3	12.30	12.14	12.40	13.00	0	
		1	5	3	12.28	12.21	12.39	13.00	0	
		3	0	0	12.23	12.17	12.40	13.00	0	
		3	3	3	12.28	12.27	12.42	13.00	0	
		5	0	0	12.28	12.19	12.41	13.00	0	
5	0	1	12.30	12.26	12.45	13.00	0			
5	0	3	12.24	12.11	12.43	13.00	0			
BW(MHz)	Modulation	RB Size	RB Offset	Narrowband Index	Conducted power (dBm)			Target Power + Max. Tolerance (dBm)	MPR Allowed per 3GPP(dB)	
Frequency (MHz)					1711.5	1745	1778.5			
Channel					131987	132322	132657			
3	QPSK	1	0	0	12.24	12.12	12.35	13.00	0	
		1	5	0	12.28	12.25	12.35	13.00	0	
		1	0	1	12.28	12.28	12.33	13.00	0	
		1	5	1	12.34	12.15	12.33	13.00	0	
		3	3	0	12.18	12.19	12.33	13.00	0	
		3	3	1	12.20	12.23	12.38	13.00	0	
		6	0	0	12.30	12.21	12.32	13.00	0	
		6	0	1	12.25	12.27	12.37	13.00	0	
		16-QAM	1	0	0	12.26	12.20	12.41	13.00	0
			1	5	0	12.34	12.24	12.35	13.00	0
	1		0	1	12.23	12.23	12.43	13.00	0	
	1		5	1	12.23	12.22	12.39	13.00	0	
	3		0	0	12.28	12.21	12.33	13.00	0	
	3		3	1	12.25	12.10	12.38	13.00	0	
	5		0	0	12.30	12.15	12.38	13.00	0	
	5		0	1	12.25	12.16	12.43	13.00	0	

Unless otherwise stated the results shown in this test report refer only to the sample(s) tested and such sample(s) are retained for 90 days only.

除非另有說明，此報告結果僅對測試之樣品負責，同時此樣品僅保留90天。本報告未經本公司書面許可，不可部份複製。

This document is issued by the Company subject to its General Conditions of Service printed overleaf, available on request or accessible at <http://www.sgs.com.tw/Terms-and-Conditions> and for electronic format documents, subject to Terms and Conditions for Electronic Documents at <http://www.sgs.com.tw/Terms-and-Conditions>. Attention is drawn to the limitation of liability, indemnification and jurisdiction issues defined therein. Any holder of this document is advised that information contained hereon reflects the Company's findings at the time of its intervention only and within the limits of Client's instructions, if any. The Company's sole responsibility is to its Client and this document does not exonerate parties to a transaction from exercising all their rights and obligations under the transaction documents. This document cannot be reproduced except in full, without prior written approval of the Company. Any unauthorized alteration, forgery or falsification of the content or appearance of this document is unlawful and offenders may be prosecuted to the fullest extent of the law.

BW(MHz)	Modulation	RB Size	RB Offset	Narrowband Index	Conducted power (dBm)			Target Power + Max. Tolerance (dBm)	MPR Allowed per 3GPP(dB)
					Frequency (MHz)	1710.7	1745		
Channel					131979	132322	132665		
1.4	QPSK	1	0	0	12.31	12.13	12.32	13.00	0
		1	5	0	12.20	12.19	12.33	13.00	0
		3	3	0	12.32	12.22	12.42	13.00	0
		6	0	0	12.31	12.23	12.43	13.00	0
	16-QAM	1	0	0	12.24	12.26	12.40	13.00	0
		1	5	0	12.28	12.16	12.32	13.00	0
		3	0	0	12.31	12.14	12.38	13.00	0
		5	0	0	12.20	12.20	12.45	13.00	0
LTE Band 85_Cat.M1									
BW(MHz)	Modulation	RB Size	RB Offset	Narrowband Index	Conducted power (dBm)			Target Power + Max. Tolerance (dBm)	MPR Allowed per 3GPP(dB)
					Frequency (MHz)	700.5	707		
Channel					134027	134092	134157		
5	QPSK	1	0	0	19.20	19.22	19.15	20.00	0
		1	5	0	19.13	19.13	19.07	20.00	0
		1	0	1	19.13	19.10	19.06	20.00	0
		1	5	1	19.12	19.10	19.00	20.00	0
		1	0	3	19.12	19.02	18.97	20.00	0
		1	5	3	19.08	19.08	19.09	20.00	0
		3	0	0	19.04	19.08	19.04	20.00	0
		3	3	3	19.06	19.07	19.08	20.00	0
		6	0	0	19.15	19.09	19.07	20.00	0
	16-QAM	6	0	1	19.01	19.16	19.00	20.00	0
		6	0	3	19.09	19.14	18.97	20.00	0
		1	0	0	19.08	19.08	19.00	20.00	0
		1	5	0	19.07	19.14	19.06	20.00	0
		1	0	1	19.06	19.03	19.03	20.00	0
		1	5	1	19.11	19.10	19.07	20.00	0
		1	0	3	19.14	19.14	18.95	20.00	0
		1	5	3	19.04	19.05	18.97	20.00	0
		3	0	0	19.12	19.15	19.09	20.00	0
3	3	3	19.07	19.06	18.94	20.00	0		
5	0	0	19.07	19.12	19.03	20.00	0		
5	0	1	19.15	19.12	19.07	20.00	0		
5	0	3	19.05	19.14	19.06	20.00	0		

Unless otherwise stated the results shown in this test report refer only to the sample(s) tested and such sample(s) are retained for 90 days only.

除非另有說明，此報告結果僅對測試之樣品負責，同時此樣品僅保留90天。本報告未經本公司書面許可，不可部份複製。

This document is issued by the Company subject to its General Conditions of Service printed overleaf, available on request or accessible at <http://www.sgs.com.tw/Terms-and-Conditions> and for electronic format documents, subject to Terms and Conditions for Electronic Documents at <http://www.sgs.com.tw/Terms-and-Conditions>. Attention is drawn to the limitation of liability, indemnification and jurisdiction issues defined therein. Any holder of this document is advised that information contained hereon reflects the Company's findings at the time of its intervention only and within the limits of Client's instructions, if any. The Company's sole responsibility is to its Client and this document does not exonerate parties to a transaction from exercising all their rights and obligations under the transaction documents. This document cannot be reproduced except in full, without prior written approval of the Company. Any unauthorized alteration, forgery or falsification of the content or appearance of this document is unlawful and offenders may be prosecuted to the fullest extent of the law.

Notebook mode

LTE Band 2_Cat.M1									
BW(MHz)	Modulation	RB Size	RB Offset	Narrowband Index	Conducted power (dBm)			Target Power + Max. Tolerance (dBm)	MPR Allowed per 3GPP(dB)
Frequency (MHz)					1852.5	1880	1907.5		
Channel					18625	18900	19175		
5	QPSK	1	0	0	20.14	20.37	20.51	21.50	0
		1	5	0	20.07	20.20	20.41	21.50	0
		1	0	1	20.08	20.19	20.37	21.50	0
		1	5	1	20.06	20.18	20.39	21.50	0
		1	0	3	20.00	20.25	20.44	21.50	0
		1	5	3	20.07	20.29	20.47	21.50	0
		3	0	0	20.04	20.31	20.40	21.50	0
		3	3	3	20.01	20.22	20.38	21.50	0
		6	0	0	19.07	19.21	19.39	20.50	0-1
	6	0	1	19.08	19.25	19.43	20.50	0-1	
	6	0	3	18.97	19.29	19.43	20.50	0-1	
	16-QAM	1	0	0	20.07	20.20	20.37	21.50	0
		1	5	0	20.06	20.26	20.41	21.50	0
		1	0	1	20.01	20.16	20.34	21.50	0
		1	5	1	20.06	20.30	20.39	21.50	0
		1	0	3	20.07	20.26	20.43	21.50	0
		1	5	3	20.04	20.24	20.40	21.50	0
		3	0	0	20.02	20.29	20.45	21.50	0
3		3	3	20.03	20.24	20.36	21.50	0	
5		0	0	19.08	19.27	19.42	20.50	0-1	
5	0	1	18.97	19.28	19.48	20.50	0-1		
5	0	3	19.02	19.30	19.32	20.50	0-1		
BW(MHz)	Modulation	RB Size	RB Offset	Narrowband Index	Conducted power (dBm)			Target Power + Max. Tolerance (dBm)	MPR Allowed per 3GPP(dB)
Frequency (MHz)					1851.5	1880	1908.5		
Channel					18615	18900	19185		
3	QPSK	1	0	0	20.09	20.21	20.42	21.50	0
		1	5	0	19.94	20.28	20.44	21.50	0
		1	0	1	20.07	20.26	20.38	21.50	0
		1	5	1	20.05	20.29	20.41	21.50	0
		3	3	0	20.03	20.25	20.36	21.50	0
		3	3	1	20.02	20.23	20.37	21.50	0
		6	0	0	18.99	19.24	19.37	20.50	0-1
		6	0	1	19.01	19.22	19.42	20.50	0-1
		16-QAM	1	0	0	20.09	20.24	20.40	21.50
	1		5	0	20.07	20.28	20.45	21.50	0
	1		0	1	19.96	20.18	20.34	21.50	0
	1		5	1	20.06	20.25	20.38	21.50	0
	3		0	0	20.10	20.18	20.39	21.50	0
	3		3	1	20.04	20.33	20.42	21.50	0
	5		0	0	19.02	19.23	19.31	20.50	0-1
	5		0	1	19.05	19.16	19.38	20.50	0-1

Unless otherwise stated the results shown in this test report refer only to the sample(s) tested and such sample(s) are retained for 90 days only.

除非另有說明，此報告結果僅對測試之樣品負責，同時此樣品僅保留90天。本報告未經本公司書面許可，不可部份複製。

This document is issued by the Company subject to its General Conditions of Service printed overleaf, available on request or accessible at <http://www.sgs.com.tw/Terms-and-Conditions> and for electronic format documents, subject to Terms and Conditions for Electronic Documents at <http://www.sgs.com.tw/Terms-and-Conditions>. Attention is drawn to the limitation of liability, indemnification and jurisdiction issues defined therein. Any holder of this document is advised that information contained hereon reflects the Company's findings at the time of its intervention only and within the limits of Client's instructions, if any. The Company's sole responsibility is to its Client and this document does not exonerate parties to a transaction from exercising all their rights and obligations under the transaction documents. This document cannot be reproduced except in full, without prior written approval of the Company. Any unauthorized alteration, forgery or falsification of the content or appearance of this document is unlawful and offenders may be prosecuted to the fullest extent of the law.

BW(MHz)	Modulation	RB Size	RB Offset	Narrowband Index	Conducted power (dBm)			Target Power + Max. Tolerance (dBm)	MPR Allowed per 3GPP(dB)
					Frequency (MHz)	1850.7	1880		
Channel					18607	18900	19193		
1.4	QPSK	1	0	0	20.05	20.22	20.40	21.50	0
		1	5	0	19.95	20.27	20.34	21.50	0
		3	3	0	20.07	20.33	20.40	21.50	0
		6	0	0	19.06	19.22	19.41	20.50	0-1
	16-QAM	1	0	0	20.09	20.26	20.42	21.50	0
		1	5	0	19.96	20.20	20.38	21.50	0
		3	0	0	20.08	20.29	20.35	21.50	0
		5	0	19.04	19.30	19.36	20.50	0-1	
LTE Band 4_Cat.M1									
BW(MHz)	Modulation	RB Size	RB Offset	Narrowband Index	Conducted power (dBm)			Target Power + Max. Tolerance (dBm)	MPR Allowed per 3GPP(dB)
					Frequency (MHz)	1712.5	1732.5		
Channel					19975	20175	20375		
5	QPSK	1	0	0	20.61	20.65	20.62	21.50	0
		1	5	0	20.45	20.53	20.46	21.50	0
		1	0	1	20.51	20.50	20.42	21.50	0
		1	5	1	20.41	20.45	20.51	21.50	0
		1	0	3	20.42	20.52	20.50	21.50	0
		1	5	3	20.45	20.49	20.50	21.50	0
		3	0	0	20.50	20.55	20.55	21.50	0
		3	3	3	20.55	20.54	20.49	21.50	0
		6	0	0	19.46	19.58	19.41	20.50	0-1
	6	0	1	19.47	19.53	19.43	20.50	0-1	
	6	0	3	19.48	19.53	19.50	20.50	0-1	
	16-QAM	1	0	0	20.47	20.58	20.49	21.50	0
		1	5	0	20.52	20.59	20.48	21.50	0
		1	0	1	20.49	20.45	20.44	21.50	0
		1	5	1	20.49	20.54	20.50	21.50	0
		1	0	3	20.49	20.53	20.42	21.50	0
		1	5	3	20.50	20.54	20.46	21.50	0
		3	0	0	20.49	20.48	20.44	21.50	0
3		3	3	20.53	20.48	20.49	21.50	0	
5		0	0	19.52	19.48	19.52	20.50	0-1	
5	0	1	19.49	19.53	19.41	20.50	0-1		
5	0	3	19.44	19.58	19.55	20.50	0-1		

Unless otherwise stated the results shown in this test report refer only to the sample(s) tested and such sample(s) are retained for 90 days only.

除非另有說明，此報告結果僅對測試之樣品負責，同時此樣品僅保留90天。本報告未經本公司書面許可，不可部份複製。

This document is issued by the Company subject to its General Conditions of Service printed overleaf, available on request or accessible at <http://www.sgs.com.tw/Terms-and-Conditions> and for electronic format documents, subject to Terms and Conditions for Electronic Documents at <http://www.sgs.com.tw/Terms-and-Conditions>. Attention is drawn to the limitation of liability, indemnification and jurisdiction issues defined therein. Any holder of this document is advised that information contained hereon reflects the Company's findings at the time of its intervention only and within the limits of Client's instructions, if any. The Company's sole responsibility is to its Client and this document does not exonerate parties to a transaction from exercising all their rights and obligations under the transaction documents. This document cannot be reproduced except in full, without prior written approval of the Company. Any unauthorized alteration, forgery or falsification of the content or appearance of this document is unlawful and offenders may be prosecuted to the fullest extent of the law.

BW(MHz)	Modulation	RB Size	RB Offset	Narrowband Index	Conducted power (dBm)			Target Power + Max. Tolerance (dBm)	MPR Allowed per 3GPP(dB)
Frequency (MHz)					1711.5	1732.5	1753.5		
Channel					19965	20175	20385		
3	QPSK	1	0	0	20.54	20.55	20.52	21.50	0
		1	5	0	20.52	20.53	20.49	21.50	0
		1	0	1	20.46	20.59	20.52	21.50	0
		1	5	1	20.48	20.56	20.42	21.50	0
		3	3	0	20.51	20.57	20.52	21.50	0
		3	3	1	20.49	20.50	20.43	21.50	0
		6	0	0	19.57	19.55	19.56	20.50	0-1
	6	0	1	19.52	19.60	19.48	20.50	0-1	
	16-QAM	1	0	0	20.55	20.47	20.44	21.50	0
		1	5	0	20.46	20.49	20.56	21.50	0
		1	0	1	20.51	20.51	20.51	21.50	0
		1	5	1	20.49	20.55	20.49	21.50	0
		3	0	0	20.50	20.55	20.57	21.50	0
		3	3	1	20.44	20.57	20.41	21.50	0
5		0	0	19.55	19.50	19.45	20.50	0-1	
5	0	1	19.49	19.56	19.52	20.50	0-1		
BW(MHz)	Modulation	RB Size	RB Offset	Narrowband Index	Conducted power (dBm)			Target Power + Max. Tolerance (dBm)	MPR Allowed per 3GPP(dB)
Frequency (MHz)					1710.7	1732.5	1754.3		
Channel					19957	20175	20393		
1.4	QPSK	1	0	0	20.45	20.53	20.47	21.50	0
		1	5	0	20.58	20.56	20.47	21.50	0
		3	3	0	20.48	20.58	20.52	21.50	0
		6	0	0	19.42	19.50	19.47	20.50	0-1
	16-QAM	1	0	0	20.44	20.52	20.45	21.50	0
		1	5	0	20.47	20.58	20.49	21.50	0
		3	0	0	20.49	20.48	20.51	21.50	0
		5	0	0	19.46	19.52	19.57	20.50	0-1

Unless otherwise stated the results shown in this test report refer only to the sample(s) tested and such sample(s) are retained for 90 days only.

除非另有說明，此報告結果僅對測試之樣品負責，同時此樣品僅保留90天。本報告未經本公司書面許可，不可部份複製。

This document is issued by the Company subject to its General Conditions of Service printed overleaf, available on request or accessible at <http://www.sgs.com.tw/Terms-and-Conditions> and for electronic format documents, subject to Terms and Conditions for Electronic Documents at <http://www.sgs.com.tw/Terms-and-Conditions>. Attention is drawn to the limitation of liability, indemnification and jurisdiction issues defined therein. Any holder of this document is advised that information contained hereon reflects the Company's findings at the time of its intervention only and within the limits of Client's instructions, if any. The Company's sole responsibility is to its Client and this document does not exonerate parties to a transaction from exercising all their rights and obligations under the transaction documents. This document cannot be reproduced except in full, without prior written approval of the Company. Any unauthorized alteration, forgery or falsification of the content or appearance of this document is unlawful and offenders may be prosecuted to the fullest extent of the law.

LTE Band 5_Cat.M1									
BW(MHz)	Modulation	RB Size	RB Offset	Narrowband Index	Conducted power (dBm)			Target Power + Max. Tolerance (dBm)	MPR Allowed per 3GPP(dB)
Frequency (MHz)					826.5	836.5	846.5		
Channel					20425	20525	20625		
5	QPSK	1	0	0	20.24	19.91	19.93	21.50	0
		1	5	0	20.14	19.81	19.82	21.50	0
		1	0	1	20.07	19.80	19.73	21.50	0
		1	5	1	20.12	19.77	19.78	21.50	0
		1	0	3	20.18	19.83	19.80	21.50	0
		1	5	3	20.05	19.79	19.79	21.50	0
		3	0	0	20.13	19.80	19.81	21.50	0
		3	3	3	20.10	19.76	19.78	21.50	0
		6	0	0	19.17	18.77	18.82	20.50	0-1
	6	0	1	19.18	18.82	18.82	20.50	0-1	
	6	0	3	19.15	18.78	18.82	20.50	0-1	
	16-QAM	1	0	0	20.13	19.77	19.75	21.50	0
		1	5	0	20.10	19.78	19.75	21.50	0
		1	0	1	20.16	19.87	19.77	21.50	0
		1	5	1	20.15	19.74	19.87	21.50	0
		1	0	3	20.21	19.77	19.81	21.50	0
		1	5	3	20.11	19.75	19.81	21.50	0
		3	0	0	20.12	19.87	19.76	21.50	0
3		3	3	20.09	19.82	19.82	21.50	0	
5		0	0	19.17	18.81	18.81	20.50	0-1	
5	0	1	19.08	18.72	18.79	20.50	0-1		
5	0	3	19.16	18.74	18.76	20.50	0-1		
BW(MHz)	Modulation	RB Size	RB Offset	Narrowband Index	Conducted power (dBm)			Target Power + Max. Tolerance (dBm)	MPR Allowed per 3GPP(dB)
Frequency (MHz)					825.5	836.5	847.5		
Channel					20415	20525	20635		
3	QPSK	1	0	0	20.15	19.77	19.73	21.50	0
		1	5	0	20.16	19.86	19.76	21.50	0
		1	0	1	20.13	19.74	19.84	21.50	0
		1	5	1	20.08	19.82	19.81	21.50	0
		3	3	0	20.05	19.83	19.80	21.50	0
		3	3	1	20.17	19.81	19.76	21.50	0
	16-QAM	6	0	0	19.21	18.73	18.81	20.50	0-1
		6	0	1	19.06	18.81	18.82	20.50	0-1
		1	0	0	20.08	19.79	19.85	21.50	0
		1	5	0	20.18	19.77	19.82	21.50	0
		1	0	1	20.10	19.75	19.89	21.50	0
		1	5	1	20.12	19.82	19.86	21.50	0
		3	0	0	20.10	19.73	19.82	21.50	0
		3	3	1	20.09	19.80	19.79	21.50	0
		5	0	0	19.17	18.70	18.80	20.50	0-1
		5	0	1	19.12	18.77	18.75	20.50	0-1

Unless otherwise stated the results shown in this test report refer only to the sample(s) tested and such sample(s) are retained for 90 days only.

除非另有說明，此報告結果僅對測試之樣品負責，同時此樣品僅保留90天。本報告未經本公司書面許可，不可部份複製。

This document is issued by the Company subject to its General Conditions of Service printed overleaf, available on request or accessible at <http://www.sgs.com.tw/Terms-and-Conditions> and for electronic format documents, subject to Terms and Conditions for Electronic Documents at <http://www.sgs.com.tw/Terms-and-Conditions>. Attention is drawn to the limitation of liability, indemnification and jurisdiction issues defined therein. Any holder of this document is advised that information contained hereon reflects the Company's findings at the time of its intervention only and within the limits of Client's instructions, if any. The Company's sole responsibility is to its Client and this document does not exonerate parties to a transaction from exercising all their rights and obligations under the transaction documents. This document cannot be reproduced except in full, without prior written approval of the Company. Any unauthorized alteration, forgery or falsification of the content or appearance of this document is unlawful and offenders may be prosecuted to the fullest extent of the law.

BW(MHz)	Modulation	RB Size	RB Offset	Narrowband Index	Conducted power (dBm)			Target Power + Max. Tolerance (dBm)	MPR Allowed per 3GPP(dB)
					Frequency (MHz)	1710.7	1732.5		
Channel					19957	20175	20393		
1.4	QPSK	1	0	0	20.11	19.76	19.81	21.50	0
		1	5	0	20.06	19.88	19.85	21.50	0
		3	3	0	20.10	19.77	19.73	21.50	0
		6	0	0	19.11	18.76	18.88	20.50	0-1
	16-QAM	1	0	0	20.15	19.78	19.87	21.50	0
		1	5	0	20.14	19.85	19.78	21.50	0
		3	0	0	20.11	19.77	19.86	21.50	0
		5	0	0	19.12	18.82	18.78	20.50	0-1
LTE Band 12_Cat.M1									
BW(MHz)	Modulation	RB Size	RB Offset	Narrowband Index	Conducted power (dBm)			Target Power + Max. Tolerance (dBm)	MPR Allowed per 3GPP(dB)
					Frequency (MHz)	701.5	707.5		
Channel					23035	23095	23155		
5	QPSK	1	0	0	20.27	20.22	19.92	21.50	0
		1	5	0	20.09	20.10	19.76	21.50	0
		1	0	1	20.11	20.05	19.81	21.50	0
		1	5	1	20.09	20.17	19.86	21.50	0
		1	0	3	20.17	20.14	19.73	21.50	0
		1	5	3	20.16	20.13	19.79	21.50	0
		3	0	0	20.15	20.10	19.75	21.50	0
		3	3	3	20.15	20.09	19.82	21.50	0
		6	0	0	19.19	19.12	18.85	20.50	0-1
	6	0	1	19.15	19.13	18.77	20.50	0-1	
	6	0	3	19.11	19.14	18.83	20.50	0-1	
	16-QAM	1	0	0	20.13	20.12	19.81	21.50	0
		1	5	0	20.21	20.16	19.88	21.50	0
		1	0	1	20.12	20.11	19.80	21.50	0
		1	5	1	20.14	20.11	19.79	21.50	0
		1	0	3	20.20	20.13	19.80	21.50	0
		1	5	3	20.22	20.06	19.84	21.50	0
		3	0	0	20.18	20.06	19.77	21.50	0
3		3	3	20.13	20.15	19.79	21.50	0	
5		0	0	19.15	19.02	18.83	20.50	0-1	
5	0	1	19.06	19.13	18.79	20.50	0-1		
5	0	3	19.18	19.03	18.77	20.50	0-1		

Unless otherwise stated the results shown in this test report refer only to the sample(s) tested and such sample(s) are retained for 90 days only.

除非另有說明，此報告結果僅對測試之樣品負責，同時此樣品僅保留90天。本報告未經本公司書面許可，不可部份複製。

This document is issued by the Company subject to its General Conditions of Service printed overleaf, available on request or accessible at <http://www.sgs.com.tw/Terms-and-Conditions> and for electronic format documents, subject to Terms and Conditions for Electronic Documents at <http://www.sgs.com.tw/Terms-and-Conditions>. Attention is drawn to the limitation of liability, indemnification and jurisdiction issues defined therein. Any holder of this document is advised that information contained hereon reflects the Company's findings at the time of its intervention only and within the limits of Client's instructions, if any. The Company's sole responsibility is to its Client and this document does not exonerate parties to a transaction from exercising all their rights and obligations under the transaction documents. This document cannot be reproduced except in full, without prior written approval of the Company. Any unauthorized alteration, forgery or falsification of the content or appearance of this document is unlawful and offenders may be prosecuted to the fullest extent of the law.

BW(MHz)	Modulation	RB Size	RB Offset	Narrowband Index	Conducted power (dBm)			Target Power + Max. Tolerance (dBm)	MPR Allowed per 3GPP(dB)
Frequency (MHz)					700.5	707.5	714.5		
Channel					23025	23095	23165		
3	QPSK	1	0	0	20.14	20.15	19.78	21.50	0
		1	5	0	20.19	20.16	19.76	21.50	0
		1	0	1	20.22	20.14	19.76	21.50	0
		1	5	1	20.18	20.14	19.77	21.50	0
		3	3	0	20.12	20.15	19.76	21.50	0
		3	3	1	20.14	20.13	19.73	21.50	0
		6	0	0	19.15	19.11	18.75	20.50	0-1
	6	0	1	19.16	19.05	18.87	20.50	0-1	
	16-QAM	1	0	0	20.20	20.03	19.73	21.50	0
		1	5	0	20.15	20.06	19.76	21.50	0
		1	0	1	20.06	20.14	19.78	21.50	0
		1	5	1	20.13	20.10	19.77	21.50	0
		3	0	0	20.19	20.08	19.76	21.50	0
		3	3	1	20.24	20.15	19.87	21.50	0
5		0	0	19.13	19.10	18.77	20.50	0-1	
5	0	1	19.16	19.16	18.88	20.50	0-1		
BW(MHz)	Modulation	RB Size	RB Offset	Narrowband Index	Conducted power (dBm)			Target Power + Max. Tolerance (dBm)	MPR Allowed per 3GPP(dB)
Frequency (MHz)					699.7	707.5	715.3		
Channel					23017	23095	23173		
1.4	QPSK	1	0	0	20.11	20.08	19.74	21.50	0
		1	5	0	20.22	20.07	19.80	21.50	0
		3	3	0	20.12	20.12	19.84	21.50	0
		6	0	0	19.14	19.18	18.82	20.50	0-1
	16-QAM	1	0	0	20.11	20.11	19.89	21.50	0
		1	5	0	20.11	20.11	19.88	21.50	0
		3	0	0	20.17	20.11	19.79	21.50	0
		5	0	0	19.23	19.03	18.84	20.50	0-1

Unless otherwise stated the results shown in this test report refer only to the sample(s) tested and such sample(s) are retained for 90 days only.

除非另有說明，此報告結果僅對測試之樣品負責，同時此樣品僅保留90天。本報告未經本公司書面許可，不可部份複製。

This document is issued by the Company subject to its General Conditions of Service printed overleaf, available on request or accessible at <http://www.sgs.com.tw/Terms-and-Conditions> and for electronic format documents, subject to Terms and Conditions for Electronic Documents at <http://www.sgs.com.tw/Terms-and-Conditions>. Attention is drawn to the limitation of liability, indemnification and jurisdiction issues defined therein. Any holder of this document is advised that information contained hereon reflects the Company's findings at the time of its intervention only and within the limits of Client's instructions, if any. The Company's sole responsibility is to its Client and this document does not exonerate parties to a transaction from exercising all their rights and obligations under the transaction documents. This document cannot be reproduced except in full, without prior written approval of the Company. Any unauthorized alteration, forgery or falsification of the content or appearance of this document is unlawful and offenders may be prosecuted to the fullest extent of the law.

LTE Band 13_Cat.M1									
BW(MHz)	Modulation	RB Size	RB Offset	Narrowband Index	Conducted power (dBm)			Target Power + Max. Tolerance (dBm)	MPR Allowed per 3GPP(dB)
Frequency (MHz)					779.5	782	784.5		
Channel					23205	23230	23255		
5	QPSK	1	0	0	20.25	20.22	20.21	21.50	0
		1	5	0	20.10	20.11	20.08	21.50	0
		1	0	1	20.13	20.20	20.16	21.50	0
		1	5	1	20.12	20.18	20.12	21.50	0
		1	0	3	20.11	20.19	20.09	21.50	0
		1	5	3	20.14	20.18	20.15	21.50	0
		3	0	0	20.11	20.15	20.06	21.50	0
		3	3	3	20.11	20.12	20.16	21.50	0
		6	0	0	19.16	19.18	19.13	20.50	0-1
	6	0	1	19.14	19.08	19.07	20.50	0-1	
	6	0	3	19.16	19.14	19.14	20.50	0-1	
	16-QAM	1	0	0	20.19	20.09	20.08	21.50	0
		1	5	0	20.13	20.13	20.00	21.50	0
		1	0	1	20.13	20.08	20.08	21.50	0
		1	5	1	20.13	20.07	20.11	21.50	0
		1	0	3	20.08	20.11	20.09	21.50	0
		1	5	3	20.10	20.15	20.13	21.50	0
		3	0	0	20.15	20.19	20.02	21.50	0
		3	3	3	20.10	20.12	20.06	21.50	0
		5	0	0	19.13	19.16	19.08	20.50	0-1
5		0	1	19.13	19.13	19.16	20.50	0-1	
5		0	3	19.21	19.12	19.18	20.50	0-1	

Unless otherwise stated the results shown in this test report refer only to the sample(s) tested and such sample(s) are retained for 90 days only.

除非另有說明，此報告結果僅對測試之樣品負責，同時此樣品僅保留90天。本報告未經本公司書面許可，不可部份複製。

This document is issued by the Company subject to its General Conditions of Service printed overleaf, available on request or accessible at <http://www.sgs.com.tw/Terms-and-Conditions> and for electronic format documents, subject to Terms and Conditions for Electronic Documents at <http://www.sgs.com.tw/Terms-and-Conditions>. Attention is drawn to the limitation of liability, indemnification and jurisdiction issues defined therein. Any holder of this document is advised that information contained hereon reflects the Company's findings at the time of its intervention only and within the limits of Client's instructions, if any. The Company's sole responsibility is to its Client and this document does not exonerate parties to a transaction from exercising all their rights and obligations under the transaction documents. This document cannot be reproduced except in full, without prior written approval of the Company. Any unauthorized alteration, forgery or falsification of the content or appearance of this document is unlawful and offenders may be prosecuted to the fullest extent of the law.

LTE Band 14_Cat.M1									
BW(MHz)	Modulation	RB Size	RB Offset	Narrowband Index	Conducted power (dBm)			Target Power + Max. Tolerance (dBm)	MPR Allowed per 3GPP(dB)
Frequency (MHz)					790.5	793	795.5		
Channel					23305	23330	23355		
5	QPSK	1	0	0	20.38	20.34	20.31	21.50	0
		1	5	0	20.20	20.16	20.16	21.50	0
		1	0	1	20.24	20.28	20.18	21.50	0
		1	5	1	20.29	20.26	20.21	21.50	0
		1	0	3	20.23	20.16	20.19	21.50	0
		1	5	3	20.26	20.18	20.14	21.50	0
		3	0	0	20.24	20.25	20.19	21.50	0
		3	3	3	20.21	20.26	20.12	21.50	0
		6	0	0	19.19	19.20	19.26	20.50	0-1
		6	0	1	19.21	19.23	19.21	20.50	0-1
	6	0	3	19.33	19.16	19.13	20.50	0-1	
	16-QAM	1	0	0	20.22	20.14	20.17	21.50	0
		1	5	0	20.32	20.20	20.15	21.50	0
		1	0	1	20.26	20.22	20.15	21.50	0
		1	5	1	20.30	20.28	20.20	21.50	0
		1	0	3	20.23	20.18	20.21	21.50	0
		1	5	3	20.22	20.21	20.12	21.50	0
		3	0	0	20.24	20.16	20.20	21.50	0
		3	3	3	20.31	20.21	20.25	21.50	0
		5	0	0	19.26	19.27	19.21	20.50	0-1
5		0	1	19.24	19.20	19.20	20.50	0-1	
5	0	3	19.31	19.17	19.21	20.50	0-1		

Unless otherwise stated the results shown in this test report refer only to the sample(s) tested and such sample(s) are retained for 90 days only.

除非另有說明，此報告結果僅對測試之樣品負責，同時此樣品僅保留90天。本報告未經本公司書面許可，不可部份複製。

This document is issued by the Company subject to its General Conditions of Service printed overleaf, available on request or accessible at <http://www.sgs.com.tw/Terms-and-Conditions> and for electronic format documents, subject to Terms and Conditions for Electronic Documents at <http://www.sgs.com.tw/Terms-and-Conditions>. Attention is drawn to the limitation of liability, indemnification and jurisdiction issues defined therein. Any holder of this document is advised that information contained hereon reflects the Company's findings at the time of its intervention only and within the limits of Client's instructions, if any. The Company's sole responsibility is to its Client and this document does not exonerate parties to a transaction from exercising all their rights and obligations under the transaction documents. This document cannot be reproduced except in full, without prior written approval of the Company. Any unauthorized alteration, forgery or falsification of the content or appearance of this document is unlawful and offenders may be prosecuted to the fullest extent of the law.

LTE Band 25_Cat.M1									
BW(MHz)	Modulation	RB Size	RB Offset	Narrowband Index	Conducted power (dBm)			Target Power + Max. Tolerance (dBm)	MPR Allowed per 3GPP(dB)
Frequency (MHz)					1852.5	1882.5	1912.5		
Channel					26065	26365	26665		
5	QPSK	1	0	0	20.36	20.47	20.77	21.50	0
		1	5	0	20.21	20.41	20.69	21.50	0
		1	0	1	20.15	20.37	20.73	21.50	0
		1	5	1	20.25	20.30	20.70	21.50	0
		1	0	3	20.24	20.29	20.61	21.50	0
		1	5	3	20.25	20.41	20.71	21.50	0
		3	0	0	20.24	20.41	20.67	21.50	0
		3	3	3	20.27	20.36	20.73	21.50	0
		6	0	0	19.29	19.40	19.66	20.50	0-1
	6	0	1	19.28	19.33	19.66	20.50	0-1	
	6	0	3	19.27	19.35	19.70	20.50	0-1	
	16-QAM	1	0	0	20.25	20.27	20.63	21.50	0
		1	5	0	20.30	20.40	20.60	21.50	0
		1	0	1	20.21	20.34	20.66	21.50	0
		1	5	1	20.17	20.28	20.68	21.50	0
		1	0	3	20.25	20.28	20.72	21.50	0
		1	5	3	20.22	20.33	20.66	21.50	0
		3	0	0	20.24	20.37	20.65	21.50	0
3		3	3	20.24	20.41	20.58	21.50	0	
5		0	0	19.16	19.33	19.69	20.50	0-1	
5	0	1	19.29	19.29	19.61	20.50	0-1		
5	0	3	19.20	19.43	19.58	20.50	0-1		
BW(MHz)	Modulation	RB Size	RB Offset	Narrowband Index	Conducted power (dBm)			Target Power + Max. Tolerance (dBm)	MPR Allowed per 3GPP(dB)
Frequency (MHz)					1851.5	1882.5	1913.5		
Channel					26055	26365	26675		
3	QPSK	1	0	0	20.25	20.28	20.67	21.50	0
		1	5	0	20.33	20.36	20.63	21.50	0
		1	0	1	20.20	20.29	20.63	21.50	0
		1	5	1	20.26	20.36	20.59	21.50	0
		3	3	0	20.18	20.36	20.66	21.50	0
		3	3	1	20.25	20.36	20.62	21.50	0
	16-QAM	6	0	0	19.24	19.31	19.62	20.50	0-1
		6	0	1	19.15	19.34	19.60	20.50	0-1
		1	0	0	20.23	20.36	20.69	21.50	0
		1	5	0	20.25	20.27	20.65	21.50	0
		1	0	1	20.20	20.36	20.63	21.50	0
		1	5	1	20.28	20.28	20.68	21.50	0
	16-QAM	3	0	0	20.25	20.37	20.67	21.50	0
		3	3	1	20.28	20.33	20.67	21.50	0
		5	0	0	19.30	19.42	19.64	20.50	0-1
		5	0	1	19.21	19.34	19.68	20.50	0-1

Unless otherwise stated the results shown in this test report refer only to the sample(s) tested and such sample(s) are retained for 90 days only.

除非另有說明，此報告結果僅對測試之樣品負責，同時此樣品僅保留90天。本報告未經本公司書面許可，不可部份複製。

This document is issued by the Company subject to its General Conditions of Service printed overleaf, available on request or accessible at <http://www.sgs.com.tw/Terms-and-Conditions> and for electronic format documents, subject to Terms and Conditions for Electronic Documents at <http://www.sgs.com.tw/Terms-and-Conditions>. Attention is drawn to the limitation of liability, indemnification and jurisdiction issues defined therein. Any holder of this document is advised that information contained hereon reflects the Company's findings at the time of its intervention only and within the limits of Client's instructions, if any. The Company's sole responsibility is to its Client and this document does not exonerate parties to a transaction from exercising all their rights and obligations under the transaction documents. This document cannot be reproduced except in full, without prior written approval of the Company. Any unauthorized alteration, forgery or falsification of the content or appearance of this document is unlawful and offenders may be prosecuted to the fullest extent of the law.

BW(MHz)	Modulation	RB Size	RB Offset	Narrowband Index	Conducted power (dBm)			Target Power + Max. Tolerance (dBm)	MPR Allowed per 3GPP(dB)
Frequency (MHz)					1850.7	1882.5	1914.3		
Channel					26047	26365	26683		
1.4	QPSK	1	0	0	20.23	20.32	20.62	21.50	0
		1	5	0	20.27	20.30	20.67	21.50	0
		3	3	0	20.18	20.34	20.68	21.50	0
		6	0	0	19.25	19.26	19.67	20.50	0-1
	16-QAM	1	0	0	20.30	20.37	20.56	21.50	0
		1	5	0	20.31	20.30	20.58	21.50	0
		3	0	0	20.24	20.35	20.68	21.50	0
		5	0	0	19.17	19.34	19.64	20.50	0-1
LTE Band 26_Cat.M1_FCC									
BW(MHz)	Modulation	RB Size	RB Offset	Narrowband Index	Conducted power (dBm)			Target Power + Max. Tolerance (dBm)	MPR Allowed per 3GPP(dB)
Frequency (MHz)					816.5	831.5	846.5		
Channel					26715	26865	27015		
5	QPSK	1	0	0	19.74	19.89	19.76	21.50	0
		1	5	0	19.70	19.82	19.55	21.50	0
		1	0	1	19.61	19.82	19.63	21.50	0
		1	5	1	19.61	19.78	19.62	21.50	0
		1	0	3	19.67	19.79	19.64	21.50	0
		1	5	3	19.63	19.76	19.62	21.50	0
		3	0	0	19.58	19.72	19.70	21.50	0
		3	3	3	19.54	19.83	19.66	21.50	0
		6	0	0	18.62	18.78	18.66	20.50	0-1
	6	0	1	18.57	18.81	18.63	20.50	0-1	
	6	0	3	18.57	18.81	18.69	20.50	0-1	
	16-QAM	1	0	0	19.68	19.77	19.64	21.50	0
		1	5	0	19.56	19.78	19.60	21.50	0
		1	0	1	19.62	19.78	19.65	21.50	0
		1	5	1	19.67	19.70	19.60	21.50	0
		1	0	3	19.61	19.69	19.64	21.50	0
		1	5	3	19.61	19.74	19.65	21.50	0
		3	0	0	19.54	19.73	19.62	21.50	0
		3	3	3	19.59	19.77	19.72	21.50	0
5		0	0	18.69	18.75	18.62	20.50	0-1	
5		0	1	18.60	18.76	18.65	20.50	0-1	
		5	0	3	18.55	18.74	18.55	20.50	0-1

Unless otherwise stated the results shown in this test report refer only to the sample(s) tested and such sample(s) are retained for 90 days only.

除非另有說明，此報告結果僅對測試之樣品負責，同時此樣品僅保留90天。本報告未經本公司書面許可，不可部份複製。

This document is issued by the Company subject to its General Conditions of Service printed overleaf, available on request or accessible at <http://www.sgs.com.tw/Terms-and-Conditions> and for electronic format documents, subject to Terms and Conditions for Electronic Documents at <http://www.sgs.com.tw/Terms-and-Conditions>. Attention is drawn to the limitation of liability, indemnification and jurisdiction issues defined therein. Any holder of this document is advised that information contained hereon reflects the Company's findings at the time of its intervention only and within the limits of Client's instructions, if any. The Company's sole responsibility is to its Client and this document does not exonerate parties to a transaction from exercising all their rights and obligations under the transaction documents. This document cannot be reproduced except in full, without prior written approval of the Company. Any unauthorized alteration, forgery or falsification of the content or appearance of this document is unlawful and offenders may be prosecuted to the fullest extent of the law.

BW(MHz)	Modulation	RB Size	RB Offset	Narrowband Index	Conducted power (dBm)			Target Power + Max. Tolerance (dBm)	MPR Allowed per 3GPP(dB)
					Frequency (MHz)				
					Channel				
3	QPSK	1	0	0	19.55	19.76	19.63	21.50	0
		1	5	0	19.67	19.74	19.63	21.50	0
		1	0	1	19.66	19.75	19.63	21.50	0
		1	5	1	19.59	19.76	19.56	21.50	0
		3	3	0	19.67	19.77	19.65	21.50	0
		3	3	1	19.69	19.78	19.58	21.50	0
		6	0	0	18.68	18.76	18.67	20.50	0-1
		6	0	1	18.62	18.82	18.57	20.50	0-1
	16-QAM	1	0	0	19.58	19.85	19.61	21.50	0
		1	5	0	19.57	19.82	19.64	21.50	0
		1	0	1	19.60	19.83	19.59	21.50	0
		1	5	1	19.67	19.77	19.64	21.50	0
		3	0	0	19.69	19.83	19.71	21.50	0
		3	3	1	19.56	19.78	19.69	21.50	0
		5	0	0	18.68	18.79	18.56	20.50	0-1
		5	0	1	18.56	18.77	18.68	20.50	0-1
BW(MHz)	Modulation	RB Size	RB Offset	Narrowband Index	Conducted power (dBm)			Target Power + Max. Tolerance (dBm)	MPR Allowed per 3GPP(dB)
					Frequency (MHz)				
					Channel				
1.4	QPSK	1	0	0	19.66	19.84	19.59	21.50	0
		1	5	0	19.55	19.70	19.62	21.50	0
		3	3	0	19.65	19.78	19.61	21.50	0
		6	0	0	18.59	18.73	18.72	20.50	0-1
	16-QAM	1	0	0	19.69	19.72	19.65	21.50	0
		1	5	0	19.60	19.85	19.71	21.50	0
		3	0	0	19.59	19.76	19.62	21.50	0
		5	0	0	18.58	18.78	18.67	20.50	0-1

Unless otherwise stated the results shown in this test report refer only to the sample(s) tested and such sample(s) are retained for 90 days only.

除非另有說明，此報告結果僅對測試之樣品負責，同時此樣品僅保留90天。本報告未經本公司書面許可，不可部份複製。

This document is issued by the Company subject to its General Conditions of Service printed overleaf, available on request or accessible at <http://www.sgs.com.tw/Terms-and-Conditions> and for electronic format documents, subject to Terms and Conditions for Electronic Documents at <http://www.sgs.com.tw/Terms-and-Conditions>. Attention is drawn to the limitation of liability, indemnification and jurisdiction issues defined therein. Any holder of this document is advised that information contained hereon reflects the Company's findings at the time of its intervention only and within the limits of Client's instructions, if any. The Company's sole responsibility is to its Client and this document does not exonerate parties to a transaction from exercising all their rights and obligations under the transaction documents. This document cannot be reproduced except in full, without prior written approval of the Company. Any unauthorized alteration, forgery or falsification of the content or appearance of this document is unlawful and offenders may be prosecuted to the fullest extent of the law.

LTE Band 66_Cat.M1									
BW(MHz)	Modulation	RB Size	RB Offset	Narrowband Index	Conducted power (dBm)			Target Power + Max. Tolerance (dBm)	MPR Allowed per 3GPP(dB)
Frequency (MHz)					1712.5	1745	1777.5		
Channel					131997	132322	132647		
5	QPSK	1	0	0	20.25	20.29	20.52	21.50	0
		1	5	0	20.18	20.13	20.42	21.50	0
		1	0	1	20.16	20.14	20.38	21.50	0
		1	5	1	20.09	20.15	20.40	21.50	0
		1	0	3	20.16	20.08	20.48	21.50	0
		1	5	3	20.13	20.15	20.40	21.50	0
		3	0	0	20.20	20.23	20.34	21.50	0
		3	3	3	20.10	20.18	20.43	21.50	0
		6	0	0	19.13	19.23	19.39	20.50	0-1
	6	0	1	19.08	19.19	19.35	20.50	0-1	
	6	0	3	19.11	19.18	19.41	20.50	0-1	
	16-QAM	1	0	0	20.19	20.15	20.35	21.50	0
		1	5	0	20.11	20.16	20.44	21.50	0
		1	0	1	20.12	20.25	20.38	21.50	0
		1	5	1	20.04	20.12	20.42	21.50	0
		1	0	3	20.11	20.23	20.44	21.50	0
		1	5	3	20.13	20.20	20.36	21.50	0
		3	0	0	20.12	20.14	20.45	21.50	0
3		3	3	20.14	20.14	20.37	21.50	0	
5		0	0	19.10	19.17	19.44	20.50	0-1	
5	0	1	19.17	19.18	19.40	20.50	0-1		
5	0	3	19.14	19.13	19.40	20.50	0-1		
BW(MHz)	Modulation	RB Size	RB Offset	Narrowband Index	Conducted power (dBm)			Target Power + Max. Tolerance (dBm)	MPR Allowed per 3GPP(dB)
Frequency (MHz)					1711.5	1745	1778.5		
Channel					131987	132322	132657		
3	QPSK	1	0	0	20.04	20.18	20.41	21.50	0
		1	5	0	20.14	20.17	20.44	21.50	0
		1	0	1	20.13	20.09	20.43	21.50	0
		1	5	1	20.07	20.17	20.36	21.50	0
		3	3	0	20.17	20.17	20.36	21.50	0
		3	3	1	20.16	20.19	20.36	21.50	0
	16-QAM	6	0	0	19.10	19.15	19.35	20.50	0-1
		6	0	1	19.20	19.14	19.41	20.50	0-1
		1	0	0	20.17	20.10	20.40	21.50	0
		1	5	0	20.13	20.20	20.38	21.50	0
		1	0	1	20.12	20.22	20.45	21.50	0
		1	5	1	20.11	20.15	20.40	21.50	0
	16-QAM	3	0	0	20.13	20.23	20.39	21.50	0
		3	3	1	20.08	20.17	20.42	21.50	0
		5	0	0	19.06	19.20	19.36	20.50	0-1
		5	0	1	19.13	19.11	19.48	20.50	0-1

Unless otherwise stated the results shown in this test report refer only to the sample(s) tested and such sample(s) are retained for 90 days only.

除非另有說明，此報告結果僅對測試之樣品負責，同時此樣品僅保留90天。本報告未經本公司書面許可，不可部份複製。

This document is issued by the Company subject to its General Conditions of Service printed overleaf, available on request or accessible at <http://www.sgs.com.tw/Terms-and-Conditions> and for electronic format documents, subject to Terms and Conditions for Electronic Documents at <http://www.sgs.com.tw/Terms-and-Conditions>. Attention is drawn to the limitation of liability, indemnification and jurisdiction issues defined therein. Any holder of this document is advised that information contained hereon reflects the Company's findings at the time of its intervention only and within the limits of Client's instructions, if any. The Company's sole responsibility is to its Client and this document does not exonerate parties to a transaction from exercising all their rights and obligations under the transaction documents. This document cannot be reproduced except in full, without prior written approval of the Company. Any unauthorized alteration, forgery or falsification of the content or appearance of this document is unlawful and offenders may be prosecuted to the fullest extent of the law.

BW(MHz)	Modulation	RB Size	RB Offset	Narrowband Index	Conducted power (dBm)			Target Power + Max. Tolerance (dBm)	MPR Allowed per 3GPP(dB)
					Frequency (MHz)	1710.7	1745		
Channel					131979	132322	132665		
1.4	QPSK	1	0	0	20.09	20.14	20.34	21.50	0
		1	5	0	20.12	20.19	20.36	21.50	0
		3	3	0	20.17	20.14	20.43	21.50	0
		6	0	0	19.11	19.12	19.39	20.50	0-1
	16-QAM	1	0	0	20.14	20.21	20.41	21.50	0
		1	5	0	20.20	20.08	20.38	21.50	0
		3	0	0	20.08	20.16	20.37	21.50	0
		5	0	0	19.20	19.17	19.38	20.50	0-1
LTE Band 85_Cat.M1									
BW(MHz)	Modulation	RB Size	RB Offset	Narrowband Index	Conducted power (dBm)			Target Power + Max. Tolerance (dBm)	MPR Allowed per 3GPP(dB)
					Frequency (MHz)	700.5	707		
Channel					134027	134092	134157		
5	QPSK	1	0	0	20.11	20.22	20.01	21.50	0
		1	5	0	19.99	20.11	19.86	21.50	0
		1	0	1	20.06	20.15	19.86	21.50	0
		1	5	1	20.01	20.03	19.87	21.50	0
		1	0	3	19.99	20.07	19.87	21.50	0
		1	5	3	19.94	20.08	19.92	21.50	0
		3	0	0	19.98	20.08	19.92	21.50	0
		3	3	3	20.05	20.08	19.90	21.50	0
		6	0	0	19.03	19.15	18.93	20.50	0-1
	16-QAM	6	0	1	19.02	19.01	18.91	20.50	0-1
		6	0	3	18.97	19.15	18.92	20.50	0-1
		1	0	0	20.00	20.10	19.93	21.50	0
		1	5	0	19.95	20.03	19.91	21.50	0
		1	0	1	20.02	20.03	19.88	21.50	0
		1	5	1	19.98	20.07	19.94	21.50	0
		1	0	3	19.92	20.11	19.89	21.50	0
		1	5	3	20.02	20.10	19.96	21.50	0
		3	0	0	19.99	20.12	19.85	21.50	0
3	3	3	19.93	20.10	19.94	21.50	0		
5	0	0	18.95	19.05	18.95	20.50	0-1		
5	0	1	19.05	19.09	18.92	20.50	0-1		
5	0	3	18.95	19.13	18.88	20.50	0-1		

Unless otherwise stated the results shown in this test report refer only to the sample(s) tested and such sample(s) are retained for 90 days only.

除非另有說明，此報告結果僅對測試之樣品負責，同時此樣品僅保留90天。本報告未經本公司書面許可，不可部份複製。

This document is issued by the Company subject to its General Conditions of Service printed overleaf, available on request or accessible at <http://www.sgs.com.tw/Terms-and-Conditions> and for electronic format documents, subject to Terms and Conditions for Electronic Documents at <http://www.sgs.com.tw/Terms-and-Conditions>. Attention is drawn to the limitation of liability, indemnification and jurisdiction issues defined therein. Any holder of this document is advised that information contained hereon reflects the Company's findings at the time of its intervention only and within the limits of Client's instructions, if any. The Company's sole responsibility is to its Client and this document does not exonerate parties to a transaction from exercising all their rights and obligations under the transaction documents. This document cannot be reproduced except in full, without prior written approval of the Company. Any unauthorized alteration, forgery or falsification of the content or appearance of this document is unlawful and offenders may be prosecuted to the fullest extent of the law.

6 SUMMARY OF RESULTS

6.1 Decision rules

Reported measurement data comply with Test Methodology in section 1.1.

Determining compliance shall be based on the results of the compliance measurement, not taking into account measurement instrumentation uncertainty.

6.2 Summary of SAR Results

WWAN_Vendor1

Band	Position	Distance (mm)	Channel	Freq. (MHz)	Max. Rated Avg. Power + Max. Tolerance (dBm)	Measured Avg. Power (dBm)	Scaling	Averaged SAR over 1g (W/kg)		ID
								Measured	Reported	
GPRS850 <1Dn4Up>	Back Surface	0	190	836.6	25.0	24.99	100.23%	0.063	0.063	-
GPRS850 <1Dn4Up>	Top Edge	0	128	824.2	25.0	24.51	111.94%	0.798	0.893	-
GPRS850 <1Dn4Up>	Top Edge	0	190	836.6	25.0	24.99	100.23%	0.887	0.889	-
GPRS850 <1Dn4Up>	Top Edge	0	251	848.8	25.0	24.23	119.40%	0.882	1.053	001
GPRS850 <1Dn4Up>	Right Edge	0	190	836.6	25.0	24.99	100.23%	0.072	0.072	-
GPRS1900 <1Dn4Up>	Back Surface	0	512	1850.2	20.0	19.82	104.23%	0.081	0.084	-
GPRS1900 <1Dn4Up>	Top Edge	0	512	1850.2	20.0	19.82	104.23%	0.863	0.900	-
GPRS1900 <1Dn4Up>	Top Edge	0	661	1880	20.0	19.77	105.44%	0.891	0.939	002
GPRS1900 <1Dn4Up>	Top Edge	0	810	1909.8	20.0	19.65	108.39%	0.833	0.903	-
GPRS1900 <1Dn4Up>	Right Edge	0	512	1850.2	20.0	19.82	104.23%	0.090	0.094	-

Mode	Bandwidth (MHz)	Modulation	RB Size	RB start	Narrowband Index	Position	Distance (mm)	Channel	Freq. (MHz)	Max. Rated Avg. Power + Max. Tolerance (dBm)	Measured Avg. Power (dBm)	Scaling	Averaged SAR over 1g (W/kg)		ID
													Measured	Reported	
CAT.M1 Band 2	5MHz	QPSK	1	0	0	Back Surface	0	18900	1880	12.00	11.48	112.72%	0.004	0.005	-
CAT.M1 Band 2			1	0	0	Top Edge	0	18625	1852.5	12.00	11.45	113.50%	0.052	0.059	-
CAT.M1 Band 2			1	0	0	Top Edge	0	18900	1880	12.00	11.48	112.72%	0.069	0.078	003
CAT.M1 Band 2			1	0	0	Top Edge	0	19175	1907.5	12.00	11.41	114.55%	0.061	0.070	-
CAT.M1 Band 2			1	0	0	Right Edge	0	18900	1880	12.00	11.48	112.72%	0.008	0.009	-
CAT.M1 Band 4	5MHz	QPSK	1	0	0	Back Surface	0	20375	1752.5	13.00	12.66	108.14%	0.008	0.009	-
CAT.M1 Band 4			1	0	0	Top Edge	0	19975	1712.5	13.00	12.48	112.72%	0.061	0.069	-
CAT.M1 Band 4			1	0	0	Top Edge	0	20175	1732.5	13.00	12.58	110.15%	0.069	0.076	-
CAT.M1 Band 4			1	0	0	Top Edge	0	20375	1752.5	13.00	12.66	108.14%	0.072	0.078	004
CAT.M1 Band 4			1	0	0	Right Edge	0	20375	1752.5	13.00	12.66	108.14%	0.011	0.012	-
CAT.M1 Band 5	5MHz	QPSK	1	0	0	Back Surface	0	20525	836.5	16.00	15.18	120.78%	0.007	0.008	-
CAT.M1 Band 5			1	0	0	Top Edge	0	20425	826.5	16.00	15.16	121.34%	0.041	0.050	-
CAT.M1 Band 5			1	0	0	Top Edge	0	20525	836.5	16.00	15.18	120.78%	0.048	0.057	005
CAT.M1 Band 5			1	0	0	Top Edge	0	20625	846.5	16.00	15.11	122.74%	0.036	0.044	-
CAT.M1 Band 5			1	0	0	Right Edge	0	20525	836.5	16.00	15.18	120.78%	0.011	0.013	-
CAT.M1 Band 12	5MHz	QPSK	1	0	0	Back Surface	0	23095	707.5	13.50	12.65	121.62%	0.004	0.005	-
CAT.M1 Band 12			1	0	0	Top Edge	0	23035	701.5	13.50	12.64	121.90%	0.032	0.039	-
CAT.M1 Band 12			1	0	0	Top Edge	0	23095	707.5	13.50	12.65	121.62%	0.037	0.045	006
CAT.M1 Band 12			1	0	0	Top Edge	0	23155	713.5	13.50	12.58	123.59%	0.029	0.036	-
CAT.M1 Band 12			1	0	0	Right Edge	0	23095	707.5	13.50	12.65	121.62%	0.010	0.012	-
CAT.M1 Band 13	5MHz	QPSK	1	0	0	Back Surface	0	23255	784.5	14.50	13.89	115.08%	0.006	0.007	-
CAT.M1 Band 13			1	0	0	Top Edge	0	23205	779.5	14.50	13.88	115.35%	0.043	0.050	-
CAT.M1 Band 13			1	0	0	Top Edge	0	23230	782	14.50	13.87	115.61%	0.049	0.057	-
CAT.M1 Band 13			1	0	0	Top Edge	0	23255	784.5	14.50	13.89	115.08%	0.052	0.060	007
CAT.M1 Band 13			1	0	0	Right Edge	0	23255	784.5	14.50	13.89	115.08%	0.012	0.014	-
CAT.M1 Band 14	5MHz	QPSK	1	0	0	Back Surface	0	23305	790.5	14.50	13.84	116.41%	0.008	0.009	-
CAT.M1 Band 14			1	0	0	Top Edge	0	23305	790.5	14.50	13.84	116.41%	0.045	0.048	008
CAT.M1 Band 14			1	0	0	Top Edge	0	23330	793	14.50	13.82	116.95%	0.041	0.048	-
CAT.M1 Band 14			1	0	0	Top Edge	0	23355	795.5	14.50	13.80	117.49%	0.038	0.045	-
CAT.M1 Band 14			1	0	0	Right Edge	0	23305	790.5	14.50	13.84	116.41%	0.014	0.016	-
CAT.M1 Band 25	5MHz	QPSK	1	0	0	Back Surface	0	26665	1912.5	12.50	12.21	106.91%	0.012	0.013	-
CAT.M1 Band 25			1	0	0	Top Edge	0	26065	1852.5	12.50	11.79	117.76%	0.072	0.085	-
CAT.M1 Band 25			1	0	0	Top Edge	0	26365	1882.5	12.50	11.91	114.55%	0.079	0.090	-
CAT.M1 Band 25			1	0	0	Top Edge	0	26665	1912.5	12.50	12.21	106.91%	0.084	0.089	009
CAT.M1 Band 25			1	0	0	Right Edge	0	26665	1912.5	12.50	12.21	106.91%	0.019	0.020	-
CAT.M1 Band 26_FCC	5MHz	QPSK	1	0	0	Back Surface	0	26865	831.5	16.00	15.27	118.30%	0.006	0.007	-
CAT.M1 Band 26_FCC			1	0	0	Top Edge	0	26715	816.5	16.00	14.96	127.06%	0.042	0.053	-
CAT.M1 Band 26_FCC			1	0	0	Top Edge	0	26865	831.5	16.00	15.27	118.30%	0.047	0.056	010
CAT.M1 Band 26_FCC			1	0	0	Top Edge	0	27015	846.5	16.00	15.01	125.60%	0.041	0.051	-
CAT.M1 Band 26_FCC			1	0	0	Right Edge	0	26865	831.5	16.00	15.27	118.30%	0.010	0.012	-
CAT.M1 Band 66	5MHz	QPSK	1	0	0	Back Surface	0	132647	1777.5	13.00	12.49	112.46%	0.007	0.008	-
CAT.M1 Band 66			1	0	0	Top Edge	0	131997	1712.5	13.00	12.39	115.08%	0.073	0.084	-
CAT.M1 Band 66			1	0	0	Top Edge	0	132322	1745	13.00	12.31	117.22%	0.088	0.103	-
CAT.M1 Band 66			1	0	0	Top Edge	0	132647	1777.5	13.00	12.49	112.46%	0.092	0.104	012
CAT.M1 Band 66			1	0	0	Right Edge	0	132647	1777.5	13.00	12.49	112.46%	0.013	0.015	-
CAT.M1 Band 85	5MHz	QPSK	1	0	0	Back Surface	0	134092	707	20.00	19.22	119.67%	0.021	0.026	-
CAT.M1 Band 85			1	0	0	Top Edge	0	134027	700.5	20.00	19.20	120.23%	0.161	0.194	-
CAT.M1 Band 85			1	0	0	Top Edge	0	134092	707	20.00	19.22	119.67%	0.179	0.214	013
CAT.M1 Band 85			1	0	0	Top Edge	0	134157	713.5	20.00	19.15	121.62%	0.173	0.210	-
CAT.M1 Band 85			1	0	0	Right Edge	0	134092	707	20.00	19.22	119.67%	0.029	0.035	-

Unless otherwise stated the results shown in this test report refer only to the sample(s) tested and such sample(s) are retained for 90 days only.

除非另有說明，此報告結果僅對測試之樣品負責，同時此樣品僅保留90天。本報告未經本公司書面許可，不可部份複製。

This document is issued by the Company subject to its General Conditions of Service printed overleaf, available on request or accessible at <http://www.sgs.com.tw/Terms-and-Conditions> and for electronic format documents, subject to Terms and Conditions for Electronic Documents at <http://www.sgs.com.tw/Terms-and-Conditions>. Attention is drawn to the limitation of liability, indemnification and jurisdiction issues defined therein. Any holder of this document is advised that information contained hereon reflects the Company's findings at the time of its intervention only and within the limits of Client's instructions, if any. The Company's sole responsibility is to its Client and this document does not exonerate parties to a transaction from exercising all their rights and obligations under the transaction documents. This document cannot be reproduced except in full, without prior written approval of the Company. Any unauthorized alteration, forgery or falsification of the content or appearance of this document is unlawful and offenders may be prosecuted to the fullest extent of the law.

WWAN_Vendor2

Band	Position	Distance (mm)	Channel	Freq. (MHz)	Max. Rated Avg. Power + Max. Tolerance (dBm)	Measured Avg. Power (dBm)	Scaling	Averaged SAR over 1g (W/kg)		ID
								Measured	Reported	
GPRS850 <1Dn4Up>	Back Surface	0	190	836.6	25.0	24.99	100.23%	0.067	0.067	-
GPRS850 <1Dn4Up>	Top Edge	0	128	824.2	25.0	24.51	111.94%	0.984	1.102	-
GPRS850 <1Dn4Up>	Top Edge	0	190	836.6	25.0	24.99	100.23%	0.932	0.934	-
GPRS850 <1Dn4Up>	Top Edge	0	251	848.8	25.0	24.23	119.40%	1.000	1.194	014
GPRS850 <1Dn4Up>	Right Edge	0	190	836.6	25.0	24.99	100.23%	0.151	0.151	-
GPRS1900 <1Dn4Up>	Back Surface	0	512	1850.2	20.0	19.82	104.23%	0.086	0.090	-
GPRS1900 <1Dn4Up>	Top Edge	0	512	1850.2	20.0	19.82	104.23%	0.908	0.946	-
GPRS1900 <1Dn4Up>	Top Edge	0	661	1880	20.0	19.77	105.44%	0.969	1.022	015
GPRS1900 <1Dn4Up>	Top Edge	0	810	1909.8	20.0	19.65	108.39%	0.930	1.008	-
GPRS1900 <1Dn4Up>	Right Edge	0	512	1850.2	20.0	19.82	104.23%	0.088	0.092	-

Mode	Bandwidth (MHz)	Modulation	RB Size	RB start	Narrowband Index	Position	Distance (mm)	Channel	Freq. (MHz)	Max. Rated Avg. Power + Max. Tolerance (dBm)	Measured Avg. Power (dBm)	Scaling	Averaged SAR over 1g (W/kg)		ID
													Measured	Reported	
CAT.M1 Band 2	5MHz	QPSK	1	0	0	Back Surface	0	18900	1880	12.00	11.48	112.72%	0.008	0.009	-
CAT.M1 Band 2			1	0	0	Top Edge	0	18625	1852.5	12.00	11.45	113.50%	0.073	0.083	-
CAT.M1 Band 2			1	0	0	Top Edge	0	18900	1880	12.00	11.48	112.72%	0.080	0.090	016
CAT.M1 Band 2			1	0	0	Top Edge	0	19175	1907.5	12.00	11.41	114.55%	0.072	0.082	-
CAT.M1 Band 2			1	0	0	Right Edge	0	18900	1880	12.00	11.48	112.72%	0.012	0.014	-
CAT.M1 Band 4	5MHz	QPSK	1	0	0	Back Surface	0	20375	1752.5	13.00	12.66	108.14%	0.009	0.010	-
CAT.M1 Band 4			1	0	0	Top Edge	0	19975	1712.5	13.00	12.48	112.72%	0.091	0.103	017
CAT.M1 Band 4			1	0	0	Top Edge	0	20175	1732.5	13.00	12.58	110.15%	0.078	0.086	-
CAT.M1 Band 4			1	0	0	Top Edge	0	20375	1752.5	13.00	12.66	108.14%	0.084	0.091	-
CAT.M1 Band 4			1	0	0	Right Edge	0	20375	1752.5	13.00	12.66	108.14%	0.013	0.014	-
CAT.M1 Band 5	5MHz	QPSK	1	0	0	Back Surface	0	20525	836.5	16.00	15.18	120.78%	0.009	0.011	-
CAT.M1 Band 5			1	0	0	Top Edge	0	20425	826.5	16.00	15.16	121.34%	0.064	0.078	018
CAT.M1 Band 5			1	0	0	Top Edge	0	20525	836.5	16.00	15.18	120.78%	0.061	0.074	-
CAT.M1 Band 5			1	0	0	Top Edge	0	20625	846.5	16.00	15.11	122.74%	0.063	0.077	-
CAT.M1 Band 5			1	0	0	Right Edge	0	20525	836.5	16.00	15.18	120.78%	0.016	0.019	-
CAT.M1 Band 12	5MHz	QPSK	1	0	0	Back Surface	0	23095	707.5	13.50	12.65	121.62%	0.005	0.006	-
CAT.M1 Band 12			1	0	0	Top Edge	0	23035	701.5	13.50	12.64	121.90%	0.035	0.043	-
CAT.M1 Band 12			1	0	0	Top Edge	0	23095	707.5	13.50	12.65	121.62%	0.039	0.047	-
CAT.M1 Band 12			1	0	0	Top Edge	0	23155	713.5	13.50	12.58	123.99%	0.040	0.050	019
CAT.M1 Band 12			1	0	0	Right Edge	0	23095	707.5	13.50	12.65	121.62%	0.011	0.013	-
CAT.M1 Band 13	5MHz	QPSK	1	0	0	Back Surface	0	23255	784.5	14.50	13.89	115.08%	0.008	0.009	-
CAT.M1 Band 13			1	0	0	Top Edge	0	23205	779.5	14.50	13.88	115.35%	0.049	0.057	-
CAT.M1 Band 13			1	0	0	Top Edge	0	23230	782	14.50	13.87	115.61%	0.046	0.053	-
CAT.M1 Band 13			1	0	0	Top Edge	0	23255	784.5	14.50	13.89	115.08%	0.057	0.066	020
CAT.M1 Band 13			1	0	0	Right Edge	0	23255	784.5	14.50	13.89	115.08%	0.015	0.017	-
CAT.M1 Band 14	5MHz	QPSK	1	0	0	Back Surface	0	23305	790.5	14.50	13.84	116.41%	0.006	0.007	-
CAT.M1 Band 14			1	0	0	Top Edge	0	23305	790.5	14.50	13.84	116.41%	0.058	0.067	021
CAT.M1 Band 14			1	0	0	Top Edge	0	23330	793	14.50	13.82	116.95%	0.044	0.051	-
CAT.M1 Band 14			1	0	0	Top Edge	0	23355	795.5	14.50	13.80	117.49%	0.048	0.056	-
CAT.M1 Band 14			1	0	0	Right Edge	0	23305	790.5	14.50	13.84	116.41%	0.009	0.010	-
CAT.M1 Band 25	5MHz	QPSK	1	0	0	Back Surface	0	26665	1912.5	12.50	12.21	106.91%	0.008	0.009	-
CAT.M1 Band 25			1	0	0	Top Edge	0	26065	1852.5	12.50	11.79	117.76%	0.085	0.100	-
CAT.M1 Band 25			1	0	0	Top Edge	0	26365	1882.5	12.50	11.91	114.55%	0.090	0.103	022
CAT.M1 Band 25			1	0	0	Top Edge	0	26665	1912.5	12.50	12.21	106.91%	0.086	0.092	-
CAT.M1 Band 25			1	0	0	Right Edge	0	26665	1912.5	12.50	12.21	106.91%	0.010	0.011	-
CAT.M1 Band 26_FCC	5MHz	QPSK	1	0	0	Back Surface	0	26865	831.5	16.00	15.27	118.30%	0.009	0.011	-
CAT.M1 Band 26_FCC			1	0	0	Top Edge	0	26715	816.5	16.00	14.96	127.06%	0.064	0.081	023
CAT.M1 Band 26_FCC			1	0	0	Top Edge	0	26865	831.5	16.00	15.27	118.30%	0.058	0.069	-
CAT.M1 Band 26_FCC			1	0	0	Top Edge	0	27015	846.5	16.00	15.01	125.60%	0.060	0.075	-
CAT.M1 Band 26_FCC			1	0	0	Right Edge	0	26865	831.5	16.00	15.27	118.30%	0.012	0.014	-
CAT.M1 Band 66	5MHz	QPSK	1	0	0	Back Surface	0	132647	1777.5	13.00	12.49	112.46%	0.012	0.013	-
CAT.M1 Band 66			1	0	0	Top Edge	0	131997	1712.5	13.00	12.39	115.08%	0.108	0.124	-
CAT.M1 Band 66			1	0	0	Top Edge	0	132322	1745	13.00	12.31	117.22%	0.104	0.122	-
CAT.M1 Band 66			1	0	0	Top Edge	0	132647	1777.5	13.00	12.49	112.46%	0.111	0.125	025
CAT.M1 Band 66			1	0	0	Right Edge	0	132647	1777.5	13.00	12.49	112.46%	0.018	0.020	-
CAT.M1 Band 85	5MHz	QPSK	1	0	0	Back Surface	0	134092	707	20.00	19.22	119.67%	0.026	0.031	-
CAT.M1 Band 85			1	0	0	Top Edge	0	134027	700.5	20.00	19.20	120.23%	0.190	0.228	-
CAT.M1 Band 85			1	0	0	Top Edge	0	134092	707	20.00	19.22	119.67%	0.217	0.260	026
CAT.M1 Band 85			1	0	0	Top Edge	0	134157	713.5	20.00	19.15	121.62%	0.200	0.243	-
CAT.M1 Band 85			1	0	0	Right Edge	0	134092	707	20.00	19.22	119.67%	0.029	0.035	-

Note:

Reported SAR = measured SAR * Power scaling * Duty cycle scaling

Unless otherwise stated the results shown in this test report refer only to the sample(s) tested and such sample(s) are retained for 90 days only.

除非另有說明，此報告結果僅對測試之樣品負責，同時此樣品僅保留90天。本報告未經本公司書面許可，不可部份複製。

This document is issued by the Company subject to its General Conditions of Service printed overleaf, available on request or accessible at <http://www.sgs.com.tw/Terms-and-Conditions> and for electronic format documents, subject to Terms and Conditions for Electronic Documents at <http://www.sgs.com.tw/Terms-and-Conditions>. Attention is drawn to the limitation of liability, indemnification and jurisdiction issues defined therein. Any holder of this document is advised that information contained hereon reflects the Company's findings at the time of its intervention only and within the limits of Client's instructions, if any. The Company's sole responsibility is to its Client and this document does not exonerate parties to a transaction from exercising all their rights and obligations under the transaction documents. This document cannot be reproduced except in full, without prior written approval of the Company. Any unauthorized alteration, forgery or falsification of the content or appearance of this document is unlawful and offenders may be prosecuted to the fullest extent of the law.

6.3 Reporting statements of conformity

The conformity statement in this report is based solely on the test results, measurement uncertainty is excluded.

6.4 Conclusion

The device is compliant because all the standalone results are less than their corresponding criteria.

Unless otherwise stated the results shown in this test report refer only to the sample(s) tested and such sample(s) are retained for 90 days only.

除非另有說明，此報告結果僅對測試之樣品負責，同時此樣品僅保留90天。本報告未經本公司書面許可，不可部份複製。

This document is issued by the Company subject to its General Conditions of Service printed overleaf, available on request or accessible at <http://www.sgs.com.tw/Terms-and-Conditions> and for electronic format documents, subject to Terms and Conditions for Electronic Documents at <http://www.sgs.com.tw/Terms-and-Conditions>. Attention is drawn to the limitation of liability, indemnification and jurisdiction issues defined therein. Any holder of this document is advised that information contained hereon reflects the Company's findings at the time of its intervention only and within the limits of Client's instructions, if any. The Company's sole responsibility is to its Client and this document does not exonerate parties to a transaction from exercising all their rights and obligations under the transaction documents. This document cannot be reproduced except in full, without prior written approval of the Company. Any unauthorized alteration, forgery or falsification of the content or appearance of this document is unlawful and offenders may be prosecuted to the fullest extent of the law.

SGS Taiwan Ltd.

No.134,Wu Kung Road, New Taipei Industrial Park, Wuku District, New Taipei City, Taiwan/新北市五股區新北產業園區五工路 134 號

台灣檢驗科技股份有限公司

t (886-2) 2299-3279

f (886-2) 2298-0488

www.sgs.com.tw

Member of SGS Group

7 SIMULTANEOUS TRANSMISSION ANALYSIS

7.1 Simultaneous Transmission Scenarios:

Simultaneous Transmit Configurations	Body
WWAN + WLAN 2.4GHz Ant2 + BT Ant1	Yes
WWAN + WLAN 2.4GHz Ant2 + WLAN 2.4GHz Ant1	Yes
WWAN + WLAN 5GHz Ant2 + BT Ant1	Yes
WWAN + WLAN 5GHz Ant2 + WLAN 5GHz Ant1	Yes
WWAN + WLAN 5GHz Ant2 + WLAN 5GHz Ant1 + BT Ant1	Yes
WWAN + WLAN 6GHz Ant2 + BT Ant1	Yes
WWAN + WLAN 6GHz Ant2 + WLAN 6GHz Ant1	Yes
WWAN + WLAN 6GHz Ant2 + WLAN 6GHz Ant1 + BT Ant1	Yes

All of WLAN/BT SAR data can be referred to Intel SAR test report, Report No.: 231128-04.TR02 and 231128-04.TR03, and these results are used for simultaneous transmission analysis.

Unless otherwise stated the results shown in this test report refer only to the sample(s) tested and such sample(s) are retained for 90 days only.

除非另有說明，此報告結果僅對測試之樣品負責，同時此樣品僅保留90天。本報告未經本公司書面許可，不可部份複製。

This document is issued by the Company subject to its General Conditions of Service printed overleaf, available on request or accessible at <http://www.sgs.com.tw/Terms-and-Conditions> and for electronic format documents, subject to Terms and Conditions for Electronic Documents at <http://www.sgs.com.tw/Terms-and-Conditions>. Attention is drawn to the limitation of liability, indemnification and jurisdiction issues defined therein. Any holder of this document is advised that information contained hereon reflects the Company's findings at the time of its intervention only and within the limits of Client's instructions, if any. The Company's sole responsibility is to its Client and this document does not exonerate parties to a transaction from exercising all their rights and obligations under the transaction documents. This document cannot be reproduced except in full, without prior written approval of the Company. Any unauthorized alteration, forgery or falsification of the content or appearance of this document is unlawful and offenders may be prosecuted to the fullest extent of the law.

7.2 Estimated SAR calculation

According to KDB447498 D01v06 – When standalone SAR test exclusion applies to an antenna that transmits simultaneously with other antennas, the standalone SAR must be estimated according to following to determine simultaneous transmission SAR test exclusion:

$$\text{Estimated SAR} = \frac{\text{Max. tune up power (mW)}}{\text{Min. test separation distance(mm)}} \times \frac{\sqrt{f(\text{GHz})}}{7.5}$$

If the minimum test separation distance is < 5mm, a distance of 5mm is used for estimated SAR calculation. When the test separation distance is >50mm, the 0.4W/kg is used for SAR-1g.

7.3 SPLSR evaluation and analysis

Per KDB447498D01, when the sum of SAR is larger than the limit, SAR test exclusion is determined by the SAR sum to peak location separation ratio(SPLSR).

The simultaneous transmitting antennas in each operating mode and exposure condition combination must be considered one pair at a time to determine the SAR to peak location separation ratio to qualify for test exclusion.

The ratio is determined by $(\text{SAR1} + \text{SAR2})^{1.5}/R_i$, rounded to two decimal digits, and must be ≤ 0.04 for all antenna pairs in the configuration to qualify for 1-g SAR test exclusion.

SAR1 and SAR2 are the highest reported or estimated SAR for each antenna in the pair, and R_i is the separation distance between the peak SAR locations for the antenna pair in mm.

When standalone test exclusion applies, SAR is estimated; the peak location is assumed to be at the feed-point or geometric center of the antenna.

Unless otherwise stated the results shown in this test report refer only to the sample(s) tested and such sample(s) are retained for 90 days only.

除非另有說明，此報告結果僅對測試之樣品負責，同時此樣品僅保留90天。本報告未經本公司書面許可，不可部份複製。

This document is issued by the Company subject to its General Conditions of Service printed overleaf, available on request or accessible at <http://www.sgs.com.tw/Terms-and-Conditions> and for electronic format documents, subject to Terms and Conditions for Electronic Documents at <http://www.sgs.com.tw/Terms-and-Conditions>. Attention is drawn to the limitation of liability, indemnification and jurisdiction issues defined therein. Any holder of this document is advised that information contained hereon reflects the Company's findings at the time of its intervention only and within the limits of Client's instructions, if any. The Company's sole responsibility is to its Client and this document does not exonerate parties to a transaction from exercising all their rights and obligations under the transaction documents. This document cannot be reproduced except in full, without prior written approval of the Company. Any unauthorized alteration, forgery or falsification of the content or appearance of this document is unlawful and offenders may be prosecuted to the fullest extent of the law.



Simultaneous Transmission Combination

Vendor1

WWAN Band	Exposure Position	1 WWAN 1g SAR (W/kg)	Reported SAR								Scenario 1	Scenario 2	Scenario 3	Scenario 4	Scenario 5	Scenario 6	Scenario 7	Scenario 8
			2 2.4GHz WLAN Ant 1 1g SAR (W/kg)	3 2.4GHz WLAN Ant 2 1g SAR (W/kg)	4 5GHz WLAN Ant 1 1g SAR (W/kg)	5 5GHz WLAN Ant 2 1g SAR (W/kg)	6 Bluetooth Ant 1 1g SAR (W/kg)	7 8GHz WLAN Ant 1 1g SAR (W/kg)	8 8GHz WLAN Ant 2 1g SAR (W/kg)	1+2+3	1+3+6	1+4+5	1+6+8	1+4+5+6	1+7+8	1+6+8	1+6+7+8	
			ZSAR-1.6															
GPRS850 <1Dn4Up>	Back Surface	0	0.063															
	Top Edge	0	1.053	0.540	1.190	1.190	1.450	0.340	1.060	1.370	2.258	2.563	3.055	2.343	3.033	2.453	2.763	3.623
	Right Edge	0	0.072								0.072	0.072	0.072	0.072	0.072	0.072	0.072	0.072
GPRS1900 <1Dn4Up>	Back Surface	0	0.084															
	Top Edge	0	0.939	0.540	1.190	1.190	1.450	0.340	1.060	1.370	2.689	2.469	3.579	2.729	3.919	3.389	2.649	3.709
	Right Edge	0	0.094								0.094	0.094	0.094	0.094	0.094	0.094	0.094	0.094
CAT.M1 Band 2	Back Surface	0	0.005															
	Top Edge	0	0.076	0.540	1.190	1.190	1.450	0.340	1.060	1.370	1.906	1.906	2.716	1.906	3.006	2.506	1.706	2.846
	Right Edge	0	0.009								0.009	0.009	0.009	0.009	0.009	0.009	0.009	0.009
CAT.M1 Band 4	Back Surface	0	0.009															
	Top Edge	0	0.078	0.540	1.190	1.190	1.450	0.340	1.060	1.370	1.808	1.638	2.718	1.868	3.058	2.508	1.708	2.848
	Right Edge	0	0.012								0.012	0.012	0.012	0.012	0.012	0.012	0.012	0.012
CAT.M1 Band 5	Back Surface	0	0.008															
	Top Edge	0	0.057	0.540	1.190	1.190	1.450	0.340	1.060	1.370	1.707	1.587	2.697	1.847	3.017	2.517	1.717	2.857
	Right Edge	0	0.013								0.013	0.013	0.013	0.013	0.013	0.013	0.013	0.013
CAT.M1 Band 12	Back Surface	0	0.005															
	Top Edge	0	0.045	0.540	1.190	1.190	1.450	0.340	1.060	1.370	1.779	1.575	2.685	1.835	3.025	2.475	1.765	2.815
	Right Edge	0	0.012								0.012	0.012	0.012	0.012	0.012	0.012	0.012	0.012
CAT.M1 Band 13	Back Surface	0	0.007															
	Top Edge	0	0.060	0.540	1.190	1.190	1.450	0.340	1.060	1.370	1.759	1.590	2.700	1.940	2.950	2.470	1.770	2.890
	Right Edge	0	0.014								0.014	0.014	0.014	0.014	0.014	0.014	0.014	0.014
CAT.M1 Band 14	Back Surface	0	0.009															
	Top Edge	0	0.063	0.540	1.190	1.190	1.450	0.340	1.060	1.370	1.783	1.583	2.693	1.843	3.033	2.483	1.783	2.823
	Right Edge	0	0.016								0.016	0.016	0.016	0.016	0.016	0.016	0.016	0.016
CAT.M1 Band 25	Back Surface	0	0.013															
	Top Edge	0	0.089	0.540	1.190	1.190	1.450	0.340	1.060	1.370	1.919	1.610	2.729	1.970	3.069	2.619	1.799	2.859
	Right Edge	0	0.020								0.020	0.020	0.020	0.020	0.020	0.020	0.020	0.020
CAT.M1 Band 26 FCC	Back Surface	0	0.007															
	Top Edge	0	0.056	0.540	1.190	1.190	1.450	0.340	1.060	1.370	1.768	1.586	2.696	1.846	3.036	2.486	1.768	2.826
	Right Edge	0	0.012								0.012	0.012	0.012	0.012	0.012	0.012	0.012	0.012
CAT.M1 Band 66	Back Surface	0	0.008															
	Top Edge	0	0.104	0.540	1.190	1.190	1.450	0.340	1.060	1.370	2.054	1.634	2.744	1.834	3.064	2.514	1.814	2.874
	Right Edge	0	0.015								0.015	0.015	0.015	0.015	0.015	0.015	0.015	0.015
CAT.M1 Band 85	Back Surface	0	0.026															
	Top Edge	0	0.214	0.540	1.190	1.190	1.450	0.340	1.060	1.370	1.944	1.744	2.854	2.004	3.194	2.544	1.844	2.904
	Right Edge	0	0.035								0.035	0.035	0.035	0.035	0.035	0.035	0.035	0.035

Unless otherwise stated the results shown in this test report refer only to the sample(s) tested and such sample(s) are retained for 90 days only.

除非另有說明，此報告結果僅對測試之樣品負責，同時此樣品僅保留90天。本報告未經本公司書面許可，不可部份複製。

This document is issued by the Company subject to its General Conditions of Service printed overleaf, available on request or accessible at <http://www.sgs.com.tw/Terms-and-Conditions> and for electronic format documents, subject to Terms and Conditions for Electronic Documents at <http://www.sgs.com.tw/Terms-and-Conditions>. Attention is drawn to the limitation of liability, indemnification and jurisdiction issues defined therein. Any holder of this document is advised that information contained hereon reflects the Company's findings at the time of its intervention only and within the limits of Client's instructions, if any. The Company's sole responsibility is to its Client and this document does not exonerate parties to a transaction from exercising all their rights and obligations under the transaction documents. This document cannot be reproduced except in full, without prior written approval of the Company. Any unauthorized alteration, forgery or falsification of the content or appearance of this document is unlawful and offenders may be prosecuted to the fullest extent of the law.

SPLSR Vendor1

Scenario 1:									
Position	Conditions	SAR Value (W/kg)	Coordinates (cm)			ΣSAR (W/kg)	Peak Location Separation Distance (mm)	SPLSR	Simultaneous Transmission SAR Test
			x	y	z				
Top edge	WLAN 2.4G Ant1	0.540	-0.43	-12.27	-0.30	-	-	-	-
	GPRS 850	1.053	-0.45	10.69	-0.31	1.593	229.60	0.009	SPLSR ≤ 0.04, Not required
	GPRS 1900	0.939	-0.30	9.92	-0.32	1.479	221.90	0.008	SPLSR ≤ 0.04, Not required
	CAT.M1 Band 2	0.078	-0.44	10.07	-0.30	0.618	223.40	0.002	SPLSR ≤ 0.04, Not required
	CAT.M1 Band 4	0.078	-0.45	9.76	-0.31	0.618	220.30	0.002	SPLSR ≤ 0.04, Not required
	CAT.M1 Band 5	0.057	-0.61	10.85	-0.31	0.597	231.21	0.002	SPLSR ≤ 0.04, Not required
	CAT.M1 Band 12	0.045	-0.45	8.45	-0.31	0.585	207.20	0.002	SPLSR ≤ 0.04, Not required
	CAT.M1 Band 13	0.060	-0.45	10.85	-0.31	0.600	231.20	0.002	SPLSR ≤ 0.04, Not required
	CAT.M1 Band 14	0.053	-0.45	10.85	-0.31	0.593	231.20	0.002	SPLSR ≤ 0.04, Not required
	CAT.M1 Band 25	0.089	-0.44	10.21	-0.31	0.629	224.80	0.002	SPLSR ≤ 0.04, Not required
	CAT.M1 Band 26_FCC	0.056	-0.61	10.85	-0.30	0.596	231.21	0.002	SPLSR ≤ 0.04, Not required
	CAT.M1 Band 66	0.104	-0.45	9.76	-0.31	0.644	220.30	0.002	SPLSR ≤ 0.04, Not required
CAT.M1 Band 85	0.214	-0.45	8.45	-0.31	0.754	207.20	0.003	SPLSR ≤ 0.04, Not required	

Unless otherwise stated the results shown in this test report refer only to the sample(s) tested and such sample(s) are retained for 90 days only.

除非另有說明，此報告結果僅對測試之樣品負責，同時此樣品僅保留90天。本報告未經本公司書面許可，不可部份複製。

This document is issued by the Company subject to its General Conditions of Service printed overleaf, available on request or accessible at <http://www.sgs.com.tw/Terms-and-Conditions>, and for electronic format documents, subject to Terms and Conditions for Electronic Documents at <http://www.sgs.com.tw/Terms-and-Conditions>. Attention is drawn to the limitation of liability, indemnification and jurisdiction issues defined therein. Any holder of this document is advised that information contained hereon reflects the Company's findings at the time of its intervention only and within the limits of Client's instructions, if any. The Company's sole responsibility is to its Client and this document does not exonerate parties to a transaction from exercising all their rights and obligations under the transaction documents. This document cannot be reproduced except in full, without prior written approval of the Company. Any unauthorized alteration, forgery or falsification of the content or appearance of this document is unlawful and offenders may be prosecuted to the fullest extent of the law.

WLAN 2.4G Ant1 to GPRS 850

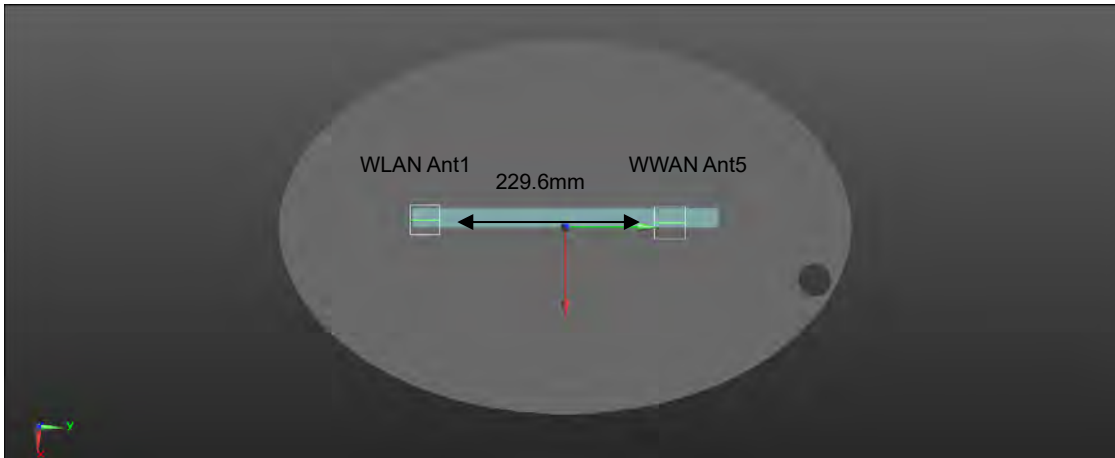

WLAN 2.4G Ant1 to GPRS 1900

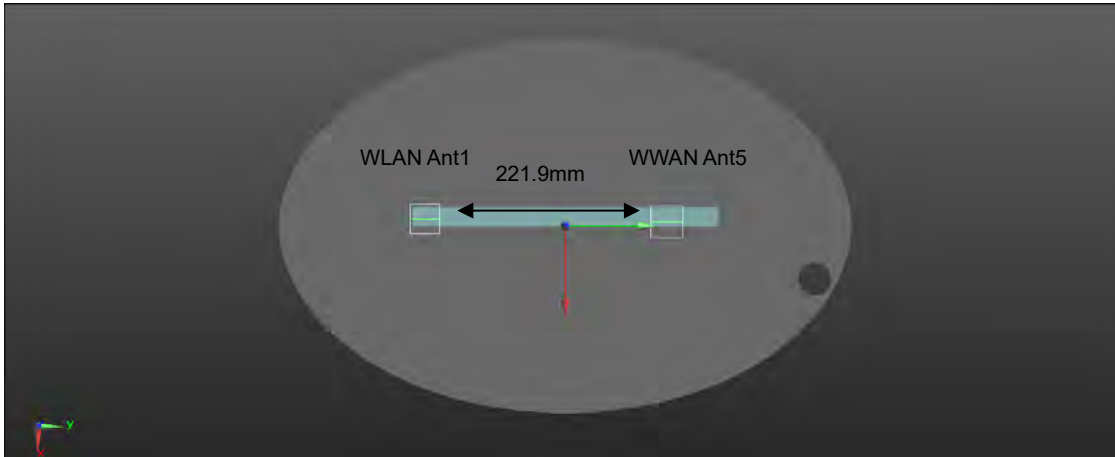

WLAN 2.4G Ant1 to CAT.M1 Band2

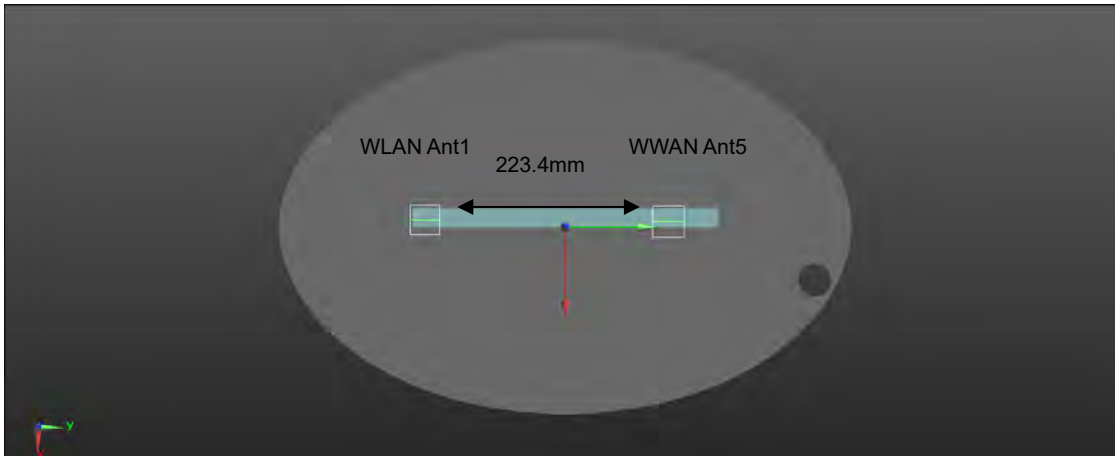

Unless otherwise stated the results shown in this test report refer only to the sample(s) tested and such sample(s) are retained for 90 days only.

除非另有說明，此報告結果僅對測試之樣品負責，同時此樣品僅保留90天。本報告未經本公司書面許可，不可部份複製。

This document is issued by the Company subject to its General Conditions of Service printed overleaf, available on request or accessible at <http://www.sgs.com.tw/Terms-and-Conditions> and for electronic format documents, subject to Terms and Conditions for Electronic Documents at <http://www.sgs.com.tw/Terms-and-Conditions>. Attention is drawn to the limitation of liability, indemnification and jurisdiction issues defined therein. Any holder of this document is advised that information contained hereon reflects the Company's findings at the time of its intervention only and within the limits of Client's instructions, if any. The Company's sole responsibility is to its Client and this document does not exonerate parties to a transaction from exercising all their rights and obligations under the transaction documents. This document cannot be reproduced except in full, without prior written approval of the Company. Any unauthorized alteration, forgery or falsification of the content or appearance of this document is unlawful and offenders may be prosecuted to the fullest extent of the law.

WLAN 2.4G Ant1 to CAT.M1 Band4

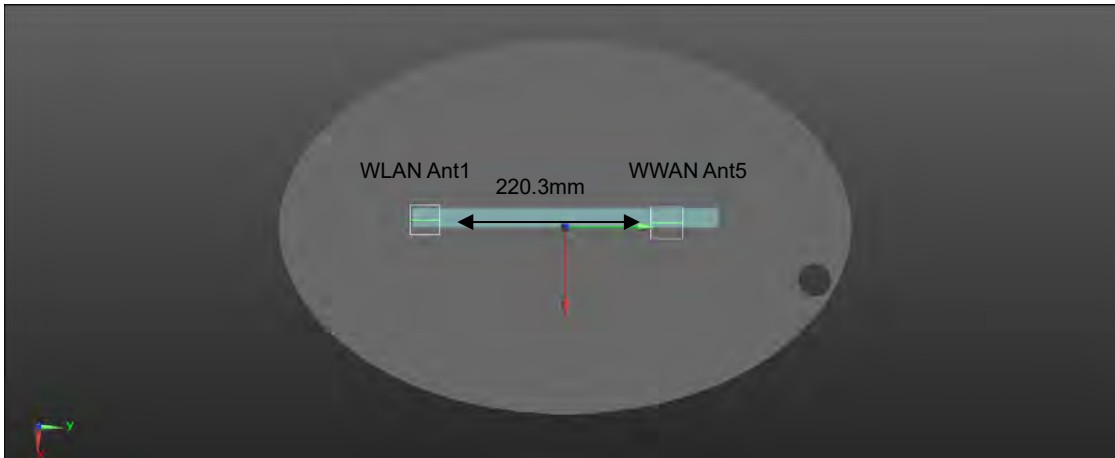

WLAN 2.4G Ant1 to CAT.M1 Band5

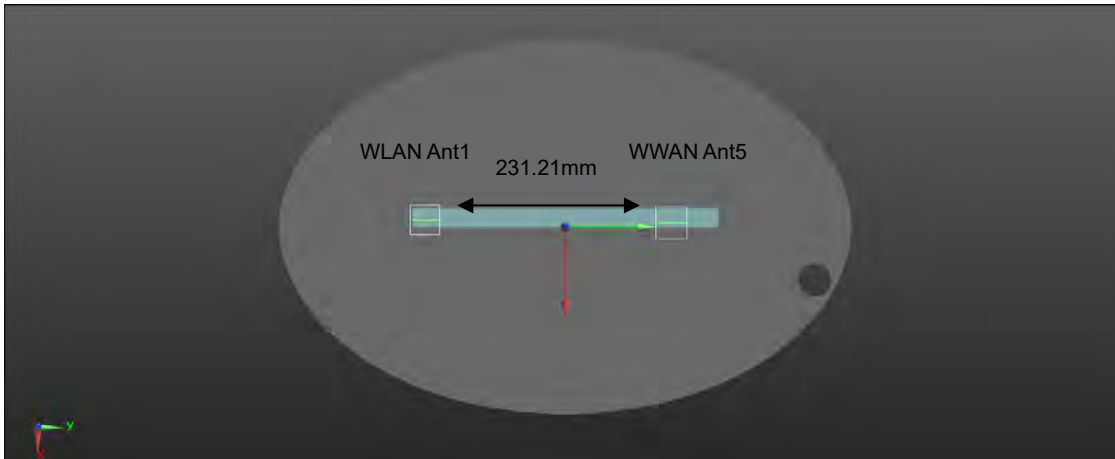

WLAN 2.4G Ant1 to CAT.M1 Band12

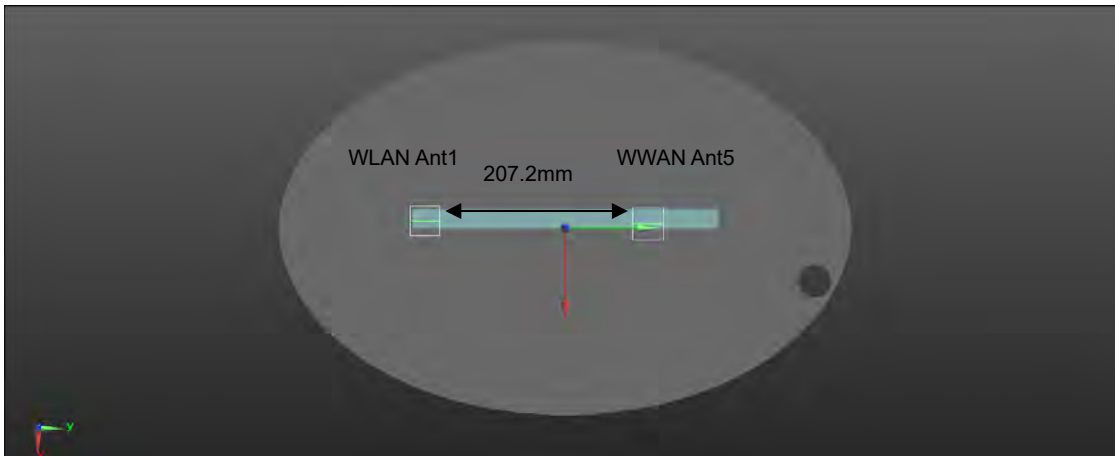

Unless otherwise stated the results shown in this test report refer only to the sample(s) tested and such sample(s) are retained for 90 days only.

除非另有說明，此報告結果僅對測試之樣品負責，同時此樣品僅保留90天。本報告未經本公司書面許可，不可部份複製。

This document is issued by the Company subject to its General Conditions of Service printed overleaf, available on request or accessible at <http://www.sgs.com.tw/Terms-and-Conditions> and for electronic format documents, subject to Terms and Conditions for Electronic Documents at <http://www.sgs.com.tw/Terms-and-Conditions>. Attention is drawn to the limitation of liability, indemnification and jurisdiction issues defined therein. Any holder of this document is advised that information contained hereon reflects the Company's findings at the time of its intervention only and within the limits of Client's instructions, if any. The Company's sole responsibility is to its Client and this document does not exonerate parties to a transaction from exercising all their rights and obligations under the transaction documents. This document cannot be reproduced except in full, without prior written approval of the Company. Any unauthorized alteration, forgery or falsification of the content or appearance of this document is unlawful and offenders may be prosecuted to the fullest extent of the law.

WLAN 2.4G Ant1 to CAT.M1 Band13

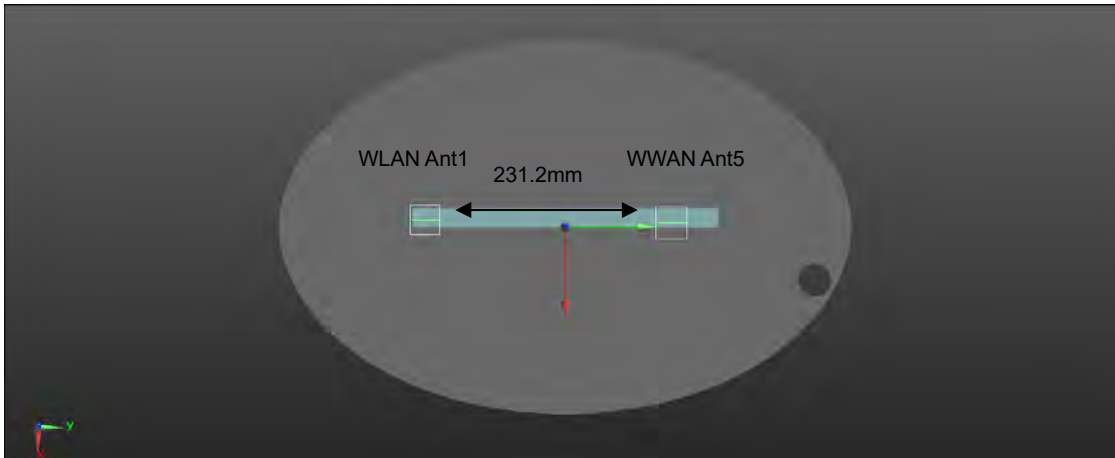

WLAN 2.4G Ant1 to CAT.M1 Band14

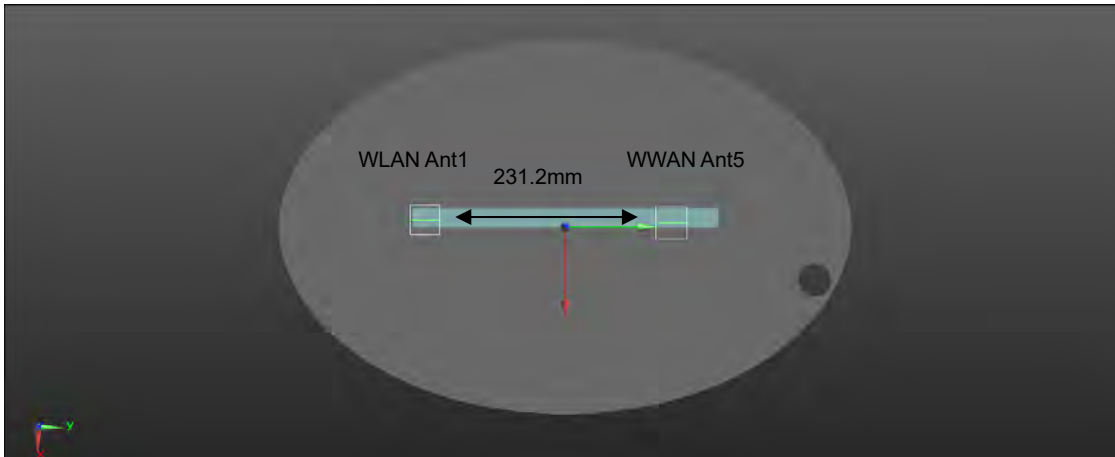

WLAN 2.4G Ant1 to CAT.M1 Band25

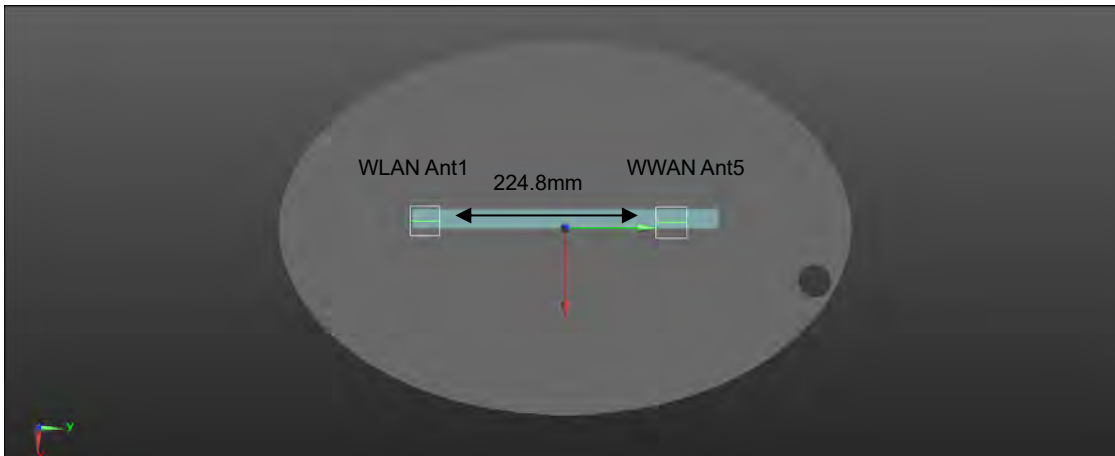

Unless otherwise stated the results shown in this test report refer only to the sample(s) tested and such sample(s) are retained for 90 days only.

除非另有說明，此報告結果僅對測試之樣品負責，同時此樣品僅保留90天。本報告未經本公司書面許可，不可部份複製。

This document is issued by the Company subject to its General Conditions of Service printed overleaf, available on request or accessible at <http://www.sgs.com.tw/Terms-and-Conditions> and for electronic format documents, subject to Terms and Conditions for Electronic Documents at <http://www.sgs.com.tw/Terms-and-Conditions>. Attention is drawn to the limitation of liability, indemnification and jurisdiction issues defined therein. Any holder of this document is advised that information contained hereon reflects the Company's findings at the time of its intervention only and within the limits of Client's instructions, if any. The Company's sole responsibility is to its Client and this document does not exonerate parties to a transaction from exercising all their rights and obligations under the transaction documents. This document cannot be reproduced except in full, without prior written approval of the Company. Any unauthorized alteration, forgery or falsification of the content or appearance of this document is unlawful and offenders may be prosecuted to the fullest extent of the law.

WLAN 2.4G Ant1 to CAT.M1 Band26 FCC

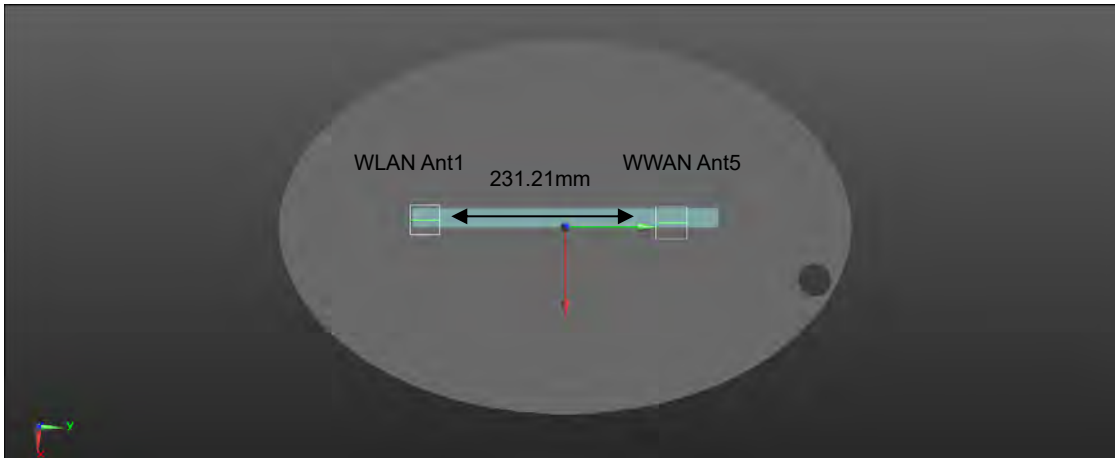

WLAN 2.4G Ant1 to CAT.M1 Band66

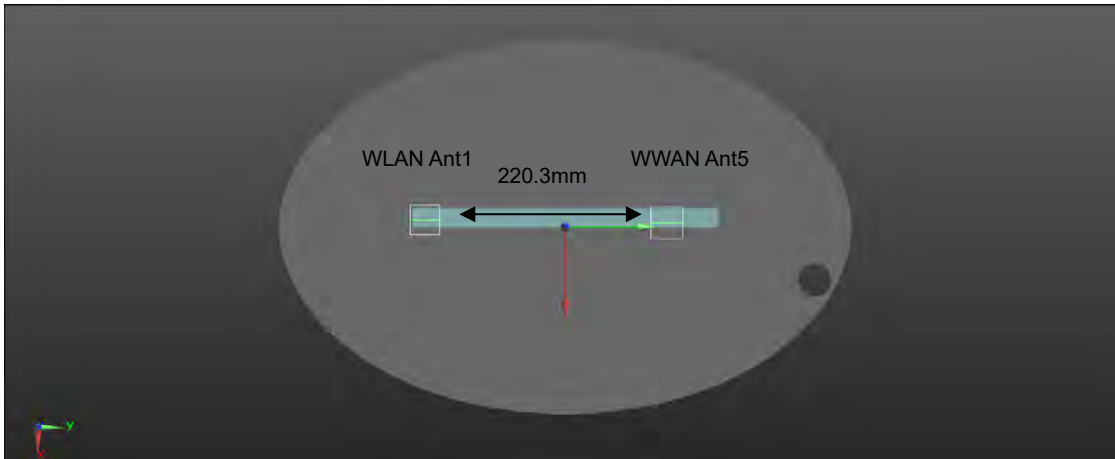

WLAN 2.4G Ant1 to CAT.M1 Band85

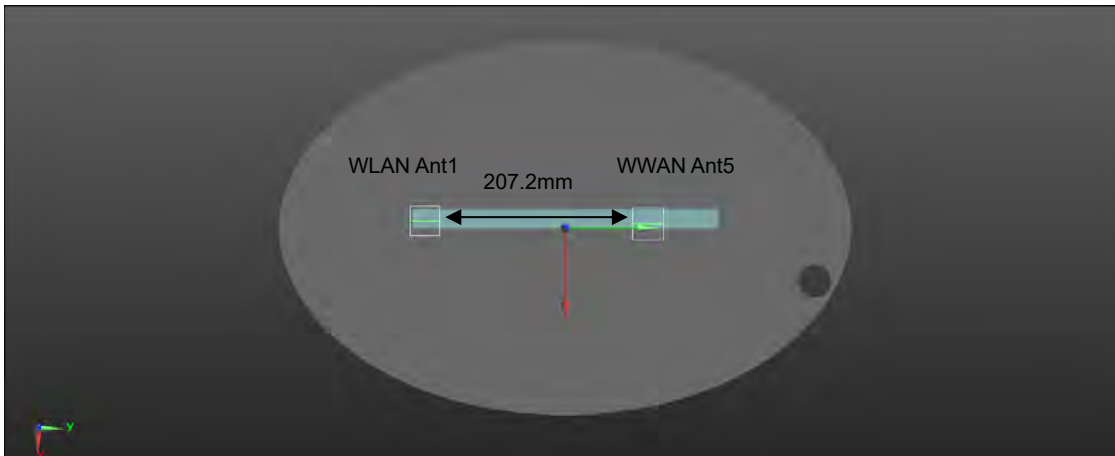

Unless otherwise stated the results shown in this test report refer only to the sample(s) tested and such sample(s) are retained for 90 days only.

除非另有說明，此報告結果僅對測試之樣品負責，同時此樣品僅保留90天。本報告未經本公司書面許可，不可部份複製。

This document is issued by the Company subject to its General Conditions of Service printed overleaf, available on request or accessible at <http://www.sgs.com.tw/Terms-and-Conditions> and for electronic format documents, subject to Terms and Conditions for Electronic Documents at <http://www.sgs.com.tw/Terms-and-Conditions>. Attention is drawn to the limitation of liability, indemnification and jurisdiction issues defined therein. Any holder of this document is advised that information contained hereon reflects the Company's findings at the time of its intervention only and within the limits of Client's instructions, if any. The Company's sole responsibility is to its Client and this document does not exonerate parties to a transaction from exercising all their rights and obligations under the transaction documents. This document cannot be reproduced except in full, without prior written approval of the Company. Any unauthorized alteration, forgery or falsification of the content or appearance of this document is unlawful and offenders may be prosecuted to the fullest extent of the law.

Scenario 1:									
Position	Conditions	SAR Value (W/kg)	Coordinates (cm)			ΣSAR (W/kg)	Peak Location Separation Distance (mm)	SPLSR	Simultaneous Transmission SAR Test
			x	y	z				
Top edge	WLAN 2.4G Ant2	1.190	-0.53	-5.36	0.33	-	-	-	-
	GPRS 850	1.053	-0.45	10.69	-0.31	2.243	160.63	0.021	SPLSR ≤ 0.04, Not required
	GPRS 1900	0.939	-0.30	9.92	-0.32	2.129	152.95	0.020	SPLSR ≤ 0.04, Not required
	CAT.M1 Band 2	0.078	-0.44	10.07	-0.30	1.268	154.43	0.009	SPLSR ≤ 0.04, Not required
	CAT.M1 Band 4	0.078	-0.45	9.76	-0.31	1.268	151.33	0.009	SPLSR ≤ 0.04, Not required
	CAT.M1 Band 5	0.057	-0.61	10.85	-0.31	1.247	162.23	0.009	SPLSR ≤ 0.04, Not required
	CAT.M1 Band 12	0.045	-0.45	8.45	-0.31	1.235	138.25	0.010	SPLSR ≤ 0.04, Not required
	CAT.M1 Band 13	0.060	-0.45	10.85	-0.31	1.250	162.23	0.009	SPLSR ≤ 0.04, Not required
	CAT.M1 Band 14	0.053	-0.45	10.85	-0.31	1.243	162.23	0.009	SPLSR ≤ 0.04, Not required
	CAT.M1 Band 25	0.089	-0.44	10.21	-0.31	1.279	155.83	0.009	SPLSR ≤ 0.04, Not required
	CAT.M1 Band 26_FCC	0.056	-0.61	10.85	-0.30	1.246	162.22	0.009	SPLSR ≤ 0.04, Not required
	CAT.M1 Band 66	0.104	-0.45	9.76	-0.31	1.294	151.34	0.010	SPLSR ≤ 0.04, Not required
	CAT.M1 Band 85	0.214	-0.45	8.45	-0.31	1.404	138.25	0.012	SPLSR ≤ 0.04, Not required

Unless otherwise stated the results shown in this test report refer only to the sample(s) tested and such sample(s) are retained for 90 days only.

除非另有說明，此報告結果僅對測試之樣品負責，同時此樣品僅保留90天。本報告未經本公司書面許可，不可部份複製。

This document is issued by the Company subject to its General Conditions of Service printed overleaf, available on request or accessible at <http://www.sgs.com.tw/Terms-and-Conditions>, and for electronic format documents, subject to Terms and Conditions for Electronic Documents at <http://www.sgs.com.tw/Terms-and-Conditions>. Attention is drawn to the limitation of liability, indemnification and jurisdiction issues defined therein. Any holder of this document is advised that information contained hereon reflects the Company's findings at the time of its intervention only and within the limits of Client's instructions, if any. The Company's sole responsibility is to its Client and this document does not exonerate parties to a transaction from exercising all their rights and obligations under the transaction documents. This document cannot be reproduced except in full, without prior written approval of the Company. Any unauthorized alteration, forgery or falsification of the content or appearance of this document is unlawful and offenders may be prosecuted to the fullest extent of the law.

WLAN 2.4G Ant2 to GPRS 850

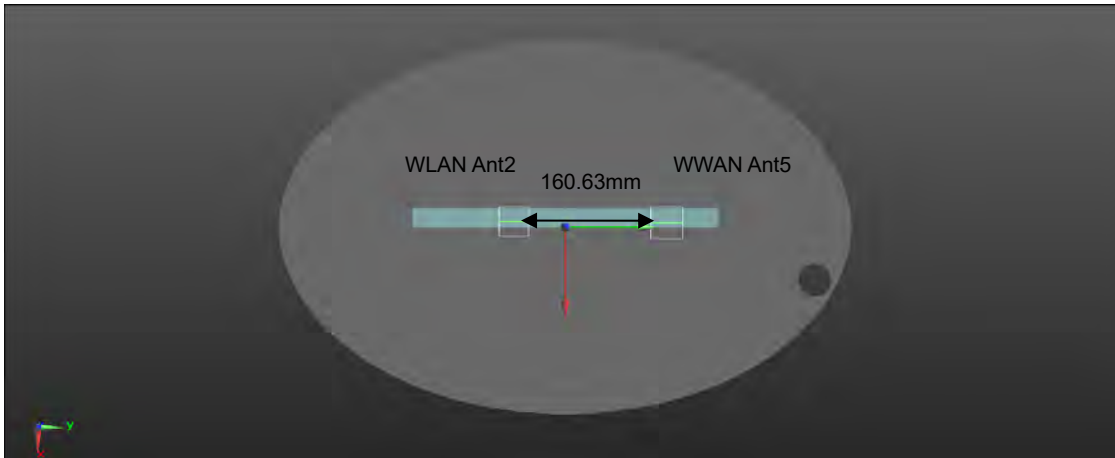

WLAN 2.4G Ant2 to GPRS 1900

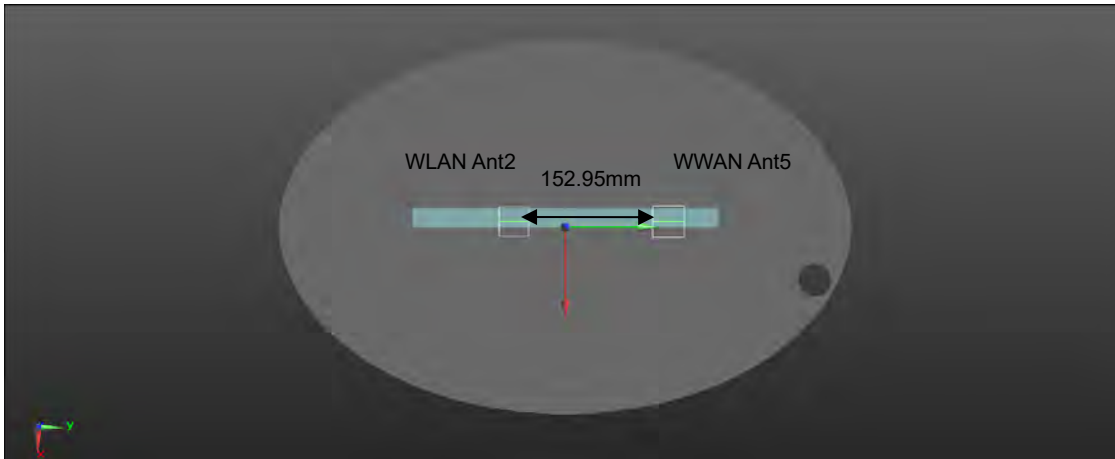

WLAN 2.4G Ant2 to CAT.M1 Band2

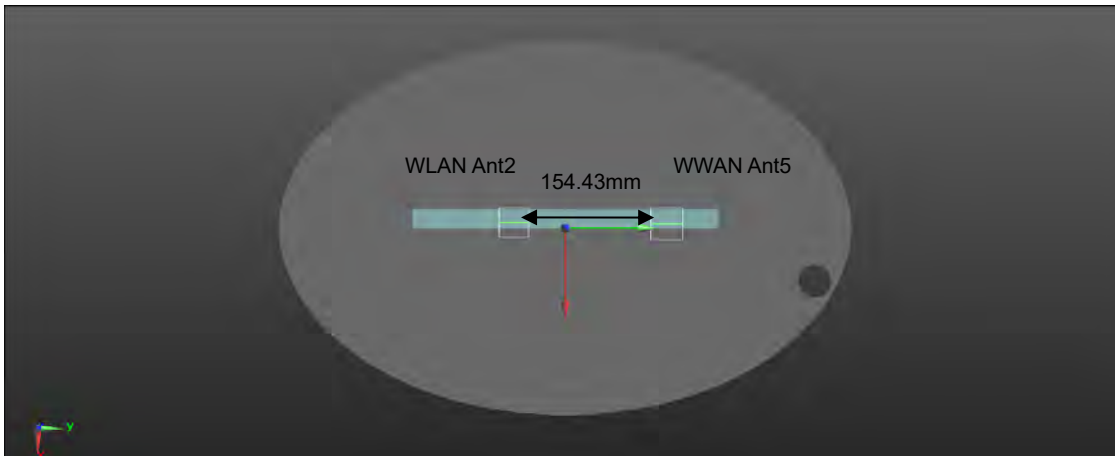

Unless otherwise stated the results shown in this test report refer only to the sample(s) tested and such sample(s) are retained for 90 days only.

除非另有說明，此報告結果僅對測試之樣品負責，同時此樣品僅保留90天。本報告未經本公司書面許可，不可部份複製。

This document is issued by the Company subject to its General Conditions of Service printed overleaf, available on request or accessible at <http://www.sgs.com.tw/Terms-and-Conditions> and for electronic format documents, subject to Terms and Conditions for Electronic Documents at <http://www.sgs.com.tw/Terms-and-Conditions>. Attention is drawn to the limitation of liability, indemnification and jurisdiction issues defined therein. Any holder of this document is advised that information contained hereon reflects the Company's findings at the time of its intervention only and within the limits of Client's instructions, if any. The Company's sole responsibility is to its Client and this document does not exonerate parties to a transaction from exercising all their rights and obligations under the transaction documents. This document cannot be reproduced except in full, without prior written approval of the Company. Any unauthorized alteration, forgery or falsification of the content or appearance of this document is unlawful and offenders may be prosecuted to the fullest extent of the law.

WLAN 2.4G Ant2 to CAT.M1 Band4

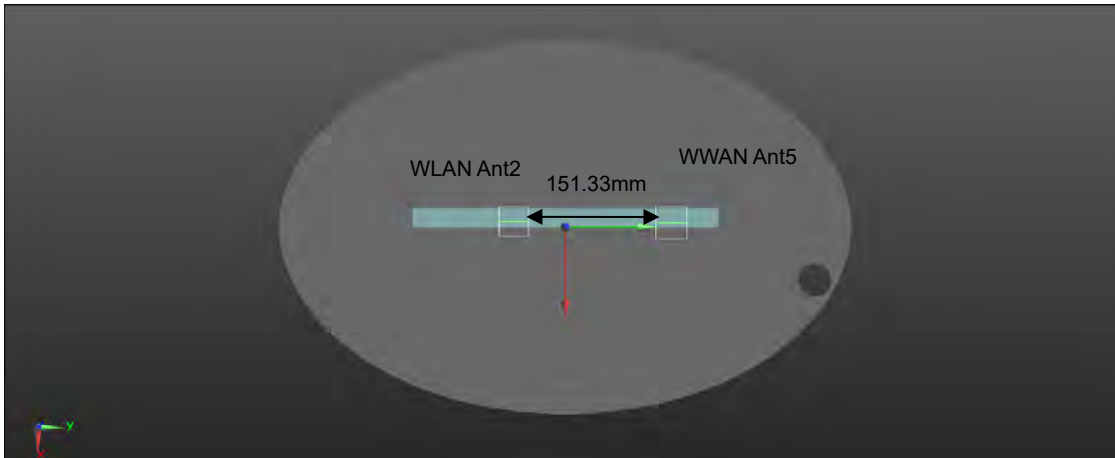

WLAN 2.4G Ant2 to CAT.M1 Band5

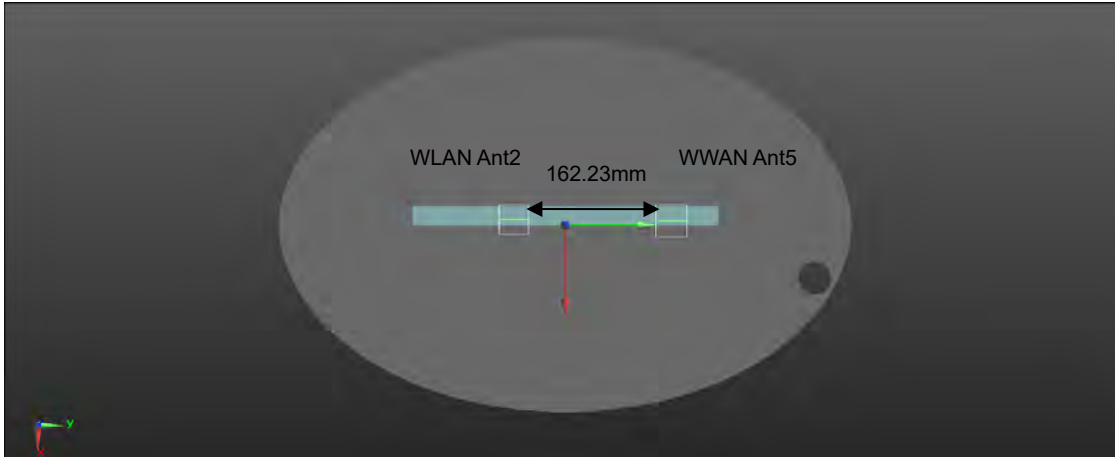

WLAN 2.4G Ant2 to CAT.M1 Band12

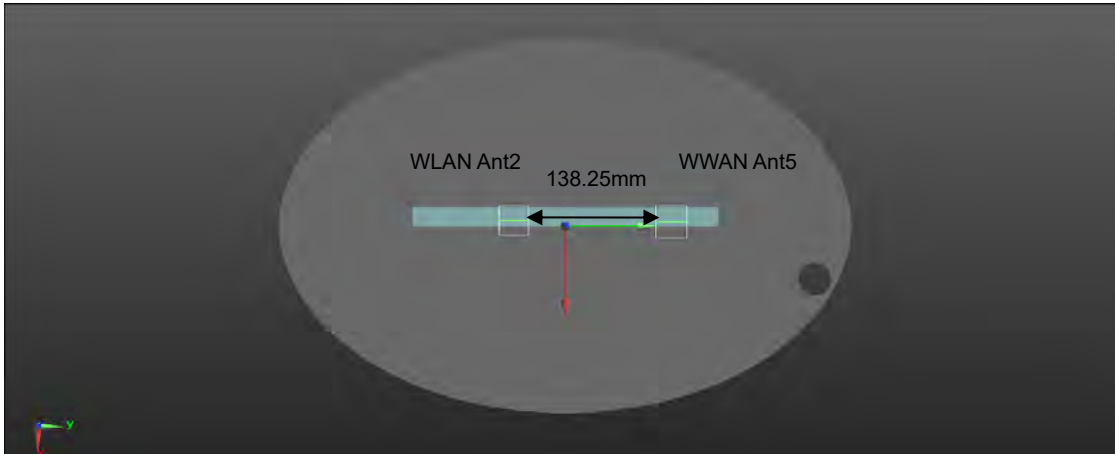

Unless otherwise stated the results shown in this test report refer only to the sample(s) tested and such sample(s) are retained for 90 days only.

除非另有說明，此報告結果僅對測試之樣品負責，同時此樣品僅保留90天。本報告未經本公司書面許可，不可部份複製。

This document is issued by the Company subject to its General Conditions of Service printed overleaf, available on request or accessible at <http://www.sgs.com.tw/Terms-and-Conditions> and for electronic format documents, subject to Terms and Conditions for Electronic Documents at <http://www.sgs.com.tw/Terms-and-Conditions>. Attention is drawn to the limitation of liability, indemnification and jurisdiction issues defined therein. Any holder of this document is advised that information contained hereon reflects the Company's findings at the time of its intervention only and within the limits of Client's instructions, if any. The Company's sole responsibility is to its Client and this document does not exonerate parties to a transaction from exercising all their rights and obligations under the transaction documents. This document cannot be reproduced except in full, without prior written approval of the Company. Any unauthorized alteration, forgery or falsification of the content or appearance of this document is unlawful and offenders may be prosecuted to the fullest extent of the law.

WLAN 2.4G Ant2 to CAT.M1 Band13

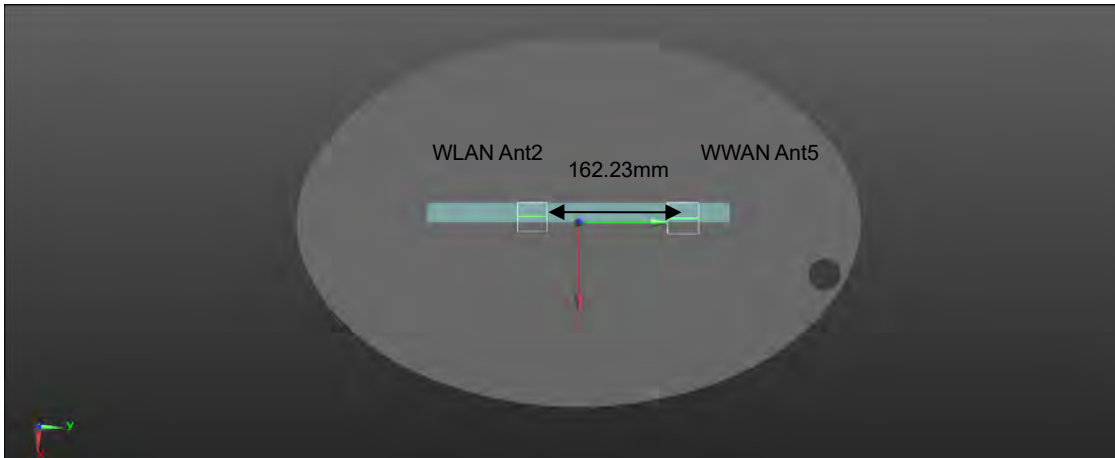

WLAN 2.4G Ant2 to CAT.M1 Band14

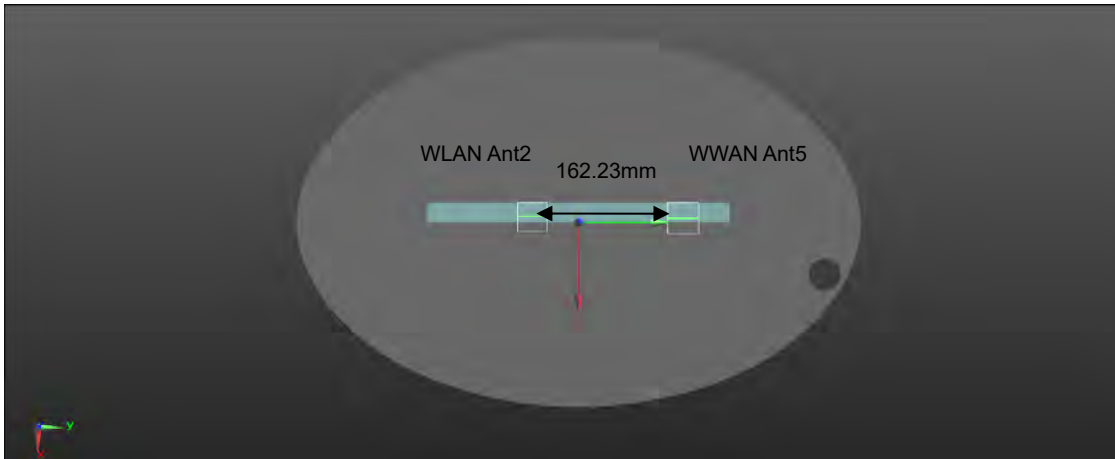

WLAN 2.4G Ant2 to CAT.M1 Band25

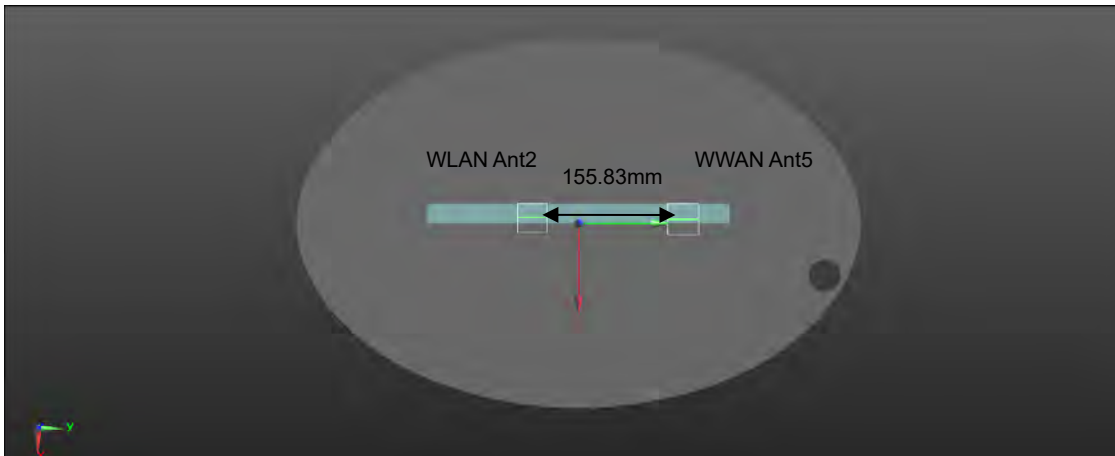

Unless otherwise stated the results shown in this test report refer only to the sample(s) tested and such sample(s) are retained for 90 days only.

除非另有說明，此報告結果僅對測試之樣品負責，同時此樣品僅保留90天。本報告未經本公司書面許可，不可部份複製。

This document is issued by the Company subject to its General Conditions of Service printed overleaf, available on request or accessible at <http://www.sgs.com.tw/Terms-and-Conditions> and for electronic format documents, subject to Terms and Conditions for Electronic Documents at <http://www.sgs.com.tw/Terms-and-Conditions>. Attention is drawn to the limitation of liability, indemnification and jurisdiction issues defined therein. Any holder of this document is advised that information contained hereon reflects the Company's findings at the time of its intervention only and within the limits of Client's instructions, if any. The Company's sole responsibility is to its Client and this document does not exonerate parties to a transaction from exercising all their rights and obligations under the transaction documents. This document cannot be reproduced except in full, without prior written approval of the Company. Any unauthorized alteration, forgery or falsification of the content or appearance of this document is unlawful and offenders may be prosecuted to the fullest extent of the law.

WLAN 2.4G Ant2 to CAT.M1 Band26 FCC

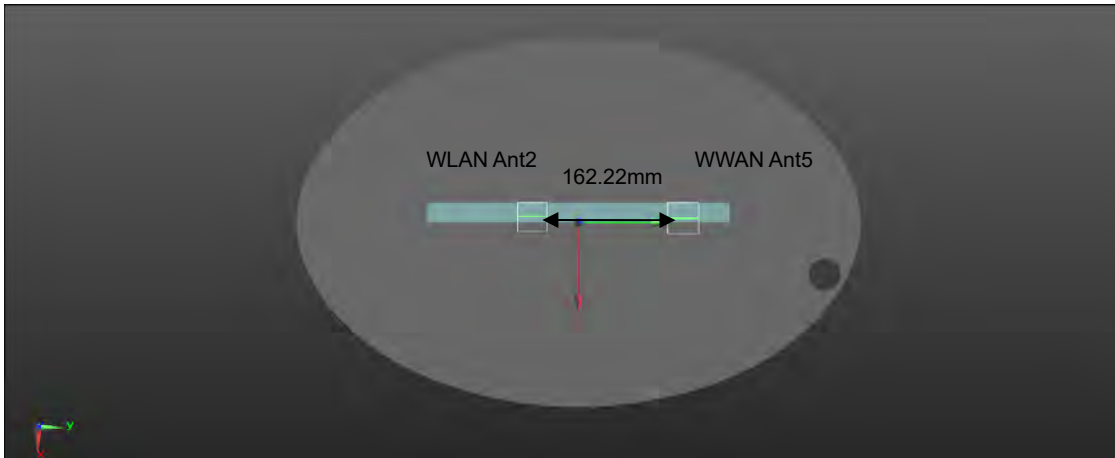

WLAN 2.4G Ant2 to CAT.M1 Band66

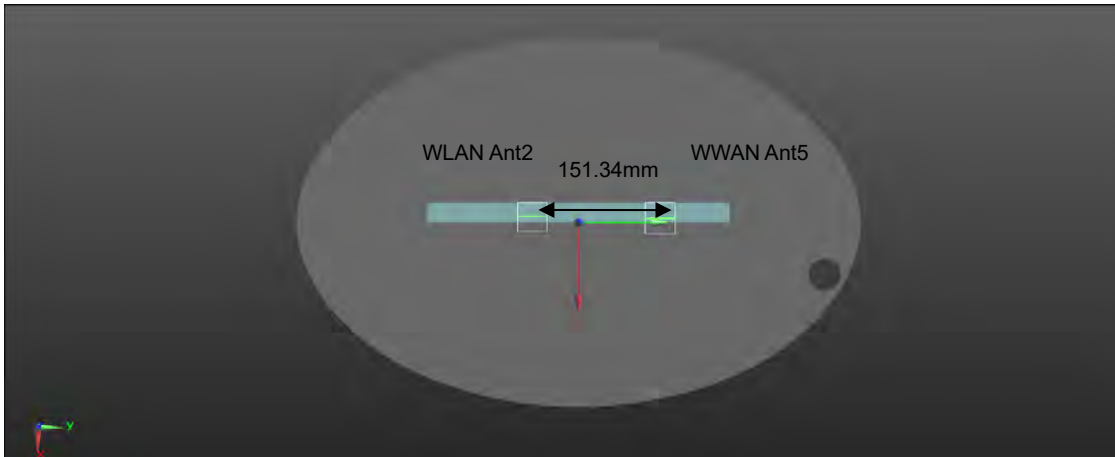

WLAN 2.4G Ant2 to CAT.M1 Band85

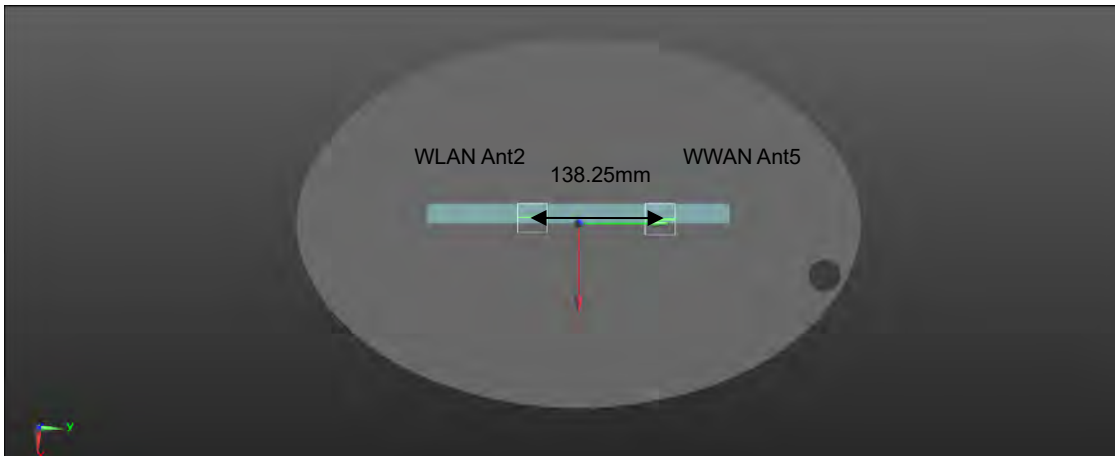

Unless otherwise stated the results shown in this test report refer only to the sample(s) tested and such sample(s) are retained for 90 days only.

除非另有說明，此報告結果僅對測試之樣品負責，同時此樣品僅保留90天。本報告未經本公司書面許可，不可部份複製。

This document is issued by the Company subject to its General Conditions of Service printed overleaf, available on request or accessible at <http://www.sgs.com.tw/Terms-and-Conditions> and for electronic format documents, subject to Terms and Conditions for Electronic Documents at <http://www.sgs.com.tw/Terms-and-Conditions>. Attention is drawn to the limitation of liability, indemnification and jurisdiction issues defined therein. Any holder of this document is advised that information contained hereon reflects the Company's findings at the time of its intervention only and within the limits of Client's instructions, if any. The Company's sole responsibility is to its Client and this document does not exonerate parties to a transaction from exercising all their rights and obligations under the transaction documents. This document cannot be reproduced except in full, without prior written approval of the Company. Any unauthorized alteration, forgery or falsification of the content or appearance of this document is unlawful and offenders may be prosecuted to the fullest extent of the law.

Scenario 1									
Position	Conditions	SAR Value (W/kg)	Coordinates (cm)			ΣSAR (W/kg)	Peak Location Separation Distance (mm)	SPLSR	Simultaneous Transmission SAR Test
			x	y	z				
Top edge	BT Ant 1	0.340	-0.74	-14.09	-0.31	-	-	-	-
	GPRS 850	1.053	-0.42	10.69	-0.31	1.393	247.82	0.007	SPLSR ≤ 0.04, Not required
	GPRS 1900	0.939	-0.30	9.92	-0.32	1.279	240.14	0.006	SPLSR ≤ 0.04, Not required
	CAT.M1 Band 2	0.078	-0.44	10.07	-0.30	0.418	241.62	0.000	SPLSR ≤ 0.04, Not required
	CAT.M1 Band 4	0.078	-0.45	9.76	-0.31	0.418	238.52	0.000	SPLSR ≤ 0.04, Not required
	CAT.M1 Band 25	0.089	-0.44	10.21	-0.31	0.429	243.02	0.000	SPLSR ≤ 0.04, Not required
	CAT.M1 Band 66	0.104	-0.45	9.76	-0.31	0.444	238.52	0.000	SPLSR ≤ 0.04, Not required
	CAT.M1 Band 85	0.214	-0.45	8.45	-0.31	0.554	225.42	0.000	SPLSR ≤ 0.04, Not required

Unless otherwise stated the results shown in this test report refer only to the sample(s) tested and such sample(s) are retained for 90 days only.

除非另有說明，此報告結果僅對測試之樣品負責，同時此樣品僅保留90天。本報告未經本公司書面許可，不可部份複製。

This document is issued by the Company subject to its General Conditions of Service printed overleaf, available on request or accessible at <http://www.sgs.com.tw/Terms-and-Conditions>, and for electronic format documents, subject to Terms and Conditions for Electronic Documents at <http://www.sgs.com.tw/Terms-and-Conditions>. Attention is drawn to the limitation of liability, indemnification and jurisdiction issues defined therein. Any holder of this document is advised that information contained hereon reflects the Company's findings at the time of its intervention only and within the limits of Client's instructions, if any. The Company's sole responsibility is to its Client and this document does not exonerate parties to a transaction from exercising all their rights and obligations under the transaction documents. This document cannot be reproduced except in full, without prior written approval of the Company. Any unauthorized alteration, forgery or falsification of the content or appearance of this document is unlawful and offenders may be prosecuted to the fullest extent of the law.

BT to GPRS850

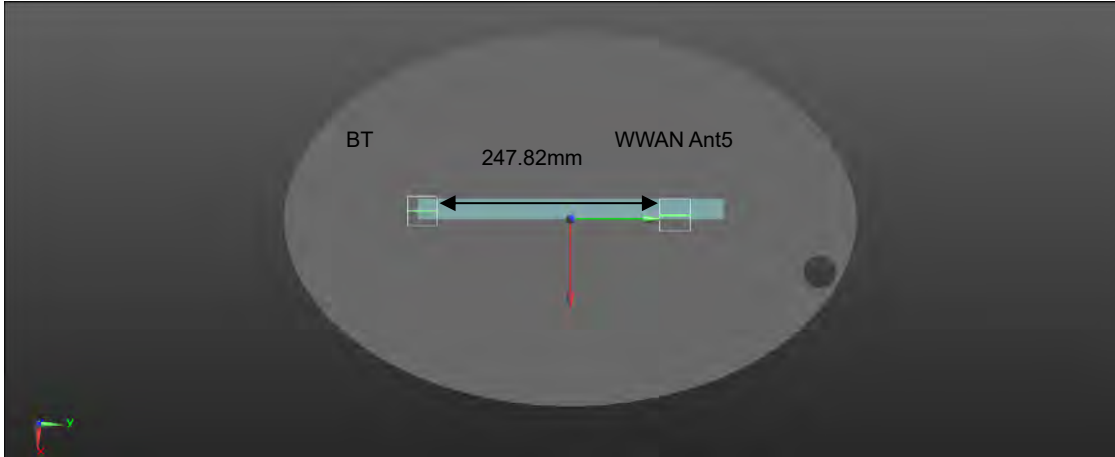

BT to GPRS1900

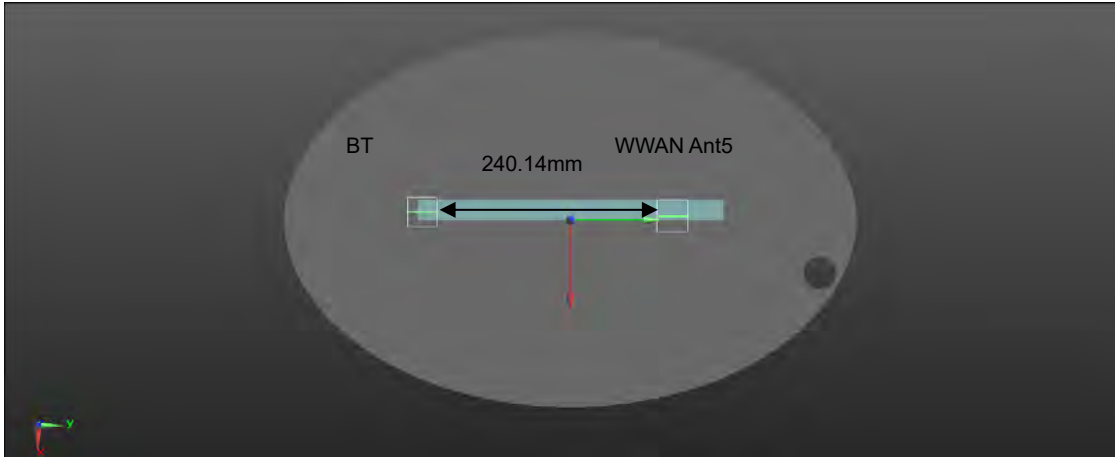

BT to CAT.M1 Band 2

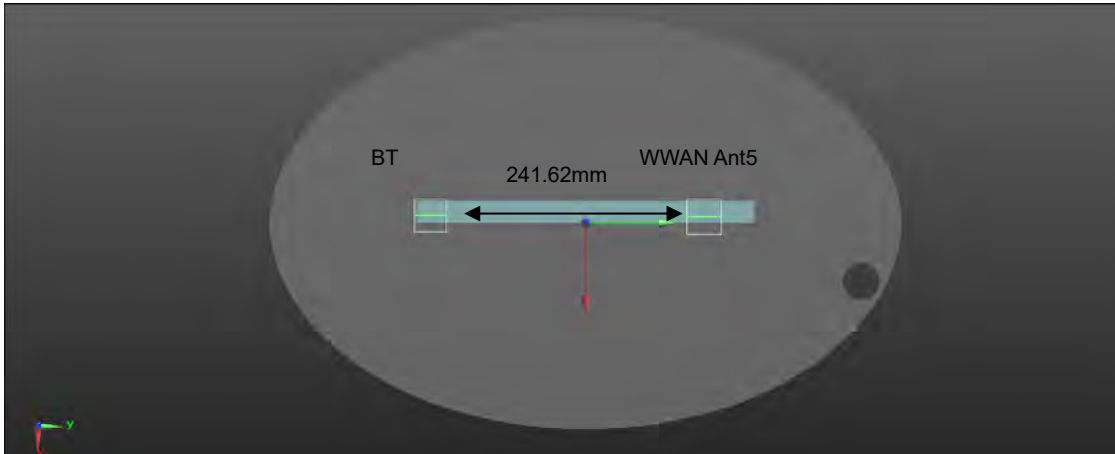

Unless otherwise stated the results shown in this test report refer only to the sample(s) tested and such sample(s) are retained for 90 days only.

除非另有說明，此報告結果僅對測試之樣品負責，同時此樣品僅保留90天。本報告未經本公司書面許可，不可部份複製。

This document is issued by the Company subject to its General Conditions of Service printed overleaf, available on request or accessible at <http://www.sgs.com.tw/Terms-and-Conditions> and for electronic format documents, subject to Terms and Conditions for Electronic Documents at <http://www.sgs.com.tw/Terms-and-Conditions>. Attention is drawn to the limitation of liability, indemnification and jurisdiction issues defined therein. Any holder of this document is advised that information contained hereon reflects the Company's findings at the time of its intervention only and within the limits of Client's instructions, if any. The Company's sole responsibility is to its Client and this document does not exonerate parties to a transaction from exercising all their rights and obligations under the transaction documents. This document cannot be reproduced except in full, without prior written approval of the Company. Any unauthorized alteration, forgery or falsification of the content or appearance of this document is unlawful and offenders may be prosecuted to the fullest extent of the law.

BT to CAT.M1 Band 4

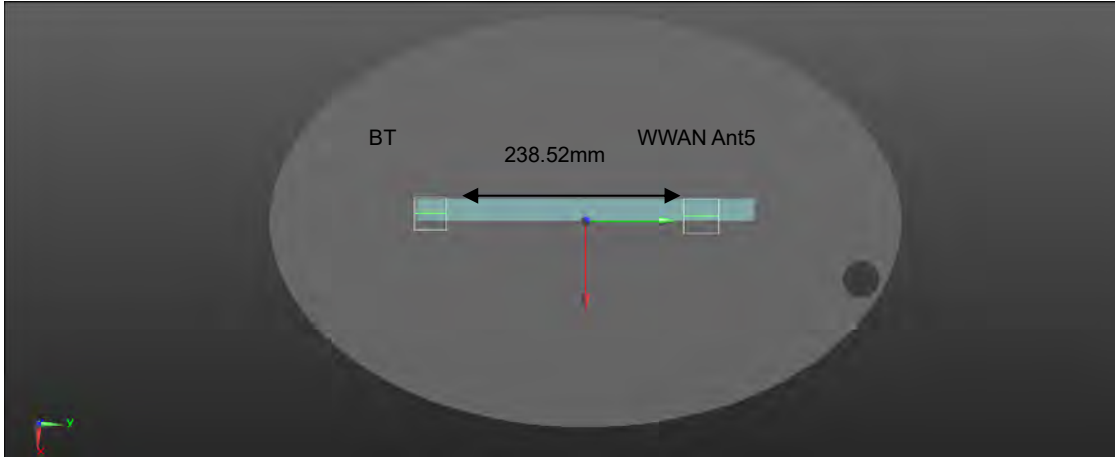

BT to CAT.M1 Band 25

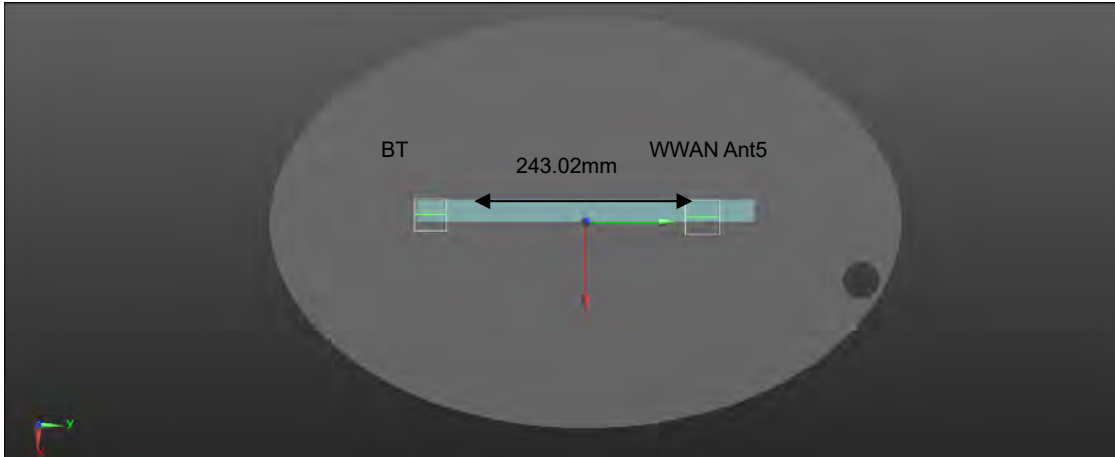

BT to CAT.M1 Band 66

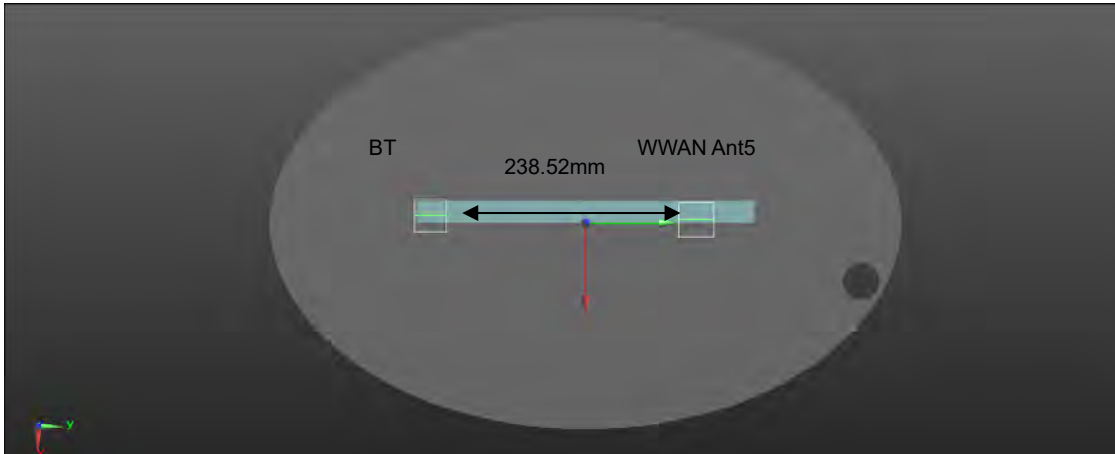

Unless otherwise stated the results shown in this test report refer only to the sample(s) tested and such sample(s) are retained for 90 days only.

除非另有說明，此報告結果僅對測試之樣品負責，同時此樣品僅保留90天。本報告未經本公司書面許可，不可部份複製。

This document is issued by the Company subject to its General Conditions of Service printed overleaf, available on request or accessible at <http://www.sgs.com.tw/Terms-and-Conditions> and for electronic format documents, subject to Terms and Conditions for Electronic Documents at <http://www.sgs.com.tw/Terms-and-Conditions>. Attention is drawn to the limitation of liability, indemnification and jurisdiction issues defined therein. Any holder of this document is advised that information contained hereon reflects the Company's findings at the time of its intervention only and within the limits of Client's instructions, if any. The Company's sole responsibility is to its Client and this document does not exonerate parties to a transaction from exercising all their rights and obligations under the transaction documents. This document cannot be reproduced except in full, without prior written approval of the Company. Any unauthorized alteration, forgery or falsification of the content or appearance of this document is unlawful and offenders may be prosecuted to the fullest extent of the law.

BT to CAT.M1 Band 85

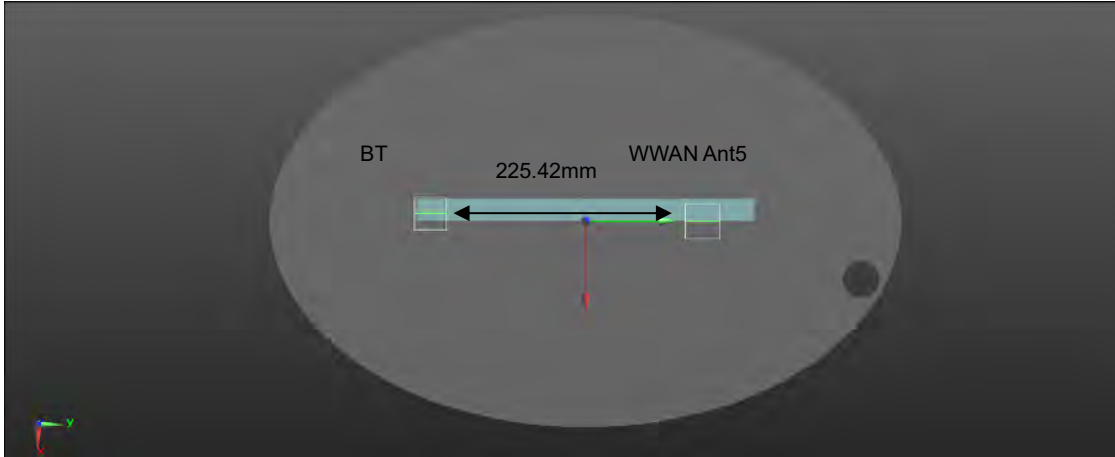

Unless otherwise stated the results shown in this test report refer only to the sample(s) tested and such sample(s) are retained for 90 days only.

除非另有說明，此報告結果僅對測試之樣品負責，同時此樣品僅保留90天。本報告未經本公司書面許可，不可部份複製。

This document is issued by the Company subject to its General Conditions of Service printed overleaf, available on request or accessible at <http://www.sgs.com.tw/Terms-and-Conditions> and for electronic format documents, subject to Terms and Conditions for Electronic Documents at <http://www.sgs.com.tw/Terms-and-Conditions>. Attention is drawn to the limitation of liability, indemnification and jurisdiction issues defined therein. Any holder of this document is advised that information contained hereon reflects the Company's findings at the time of its intervention only and within the limits of Client's instructions, if any. The Company's sole responsibility is to its Client and this document does not exonerate parties to a transaction from exercising all their rights and obligations under the transaction documents. This document cannot be reproduced except in full, without prior written approval of the Company. Any unauthorized alteration, forgery or falsification of the content or appearance of this document is unlawful and offenders may be prosecuted to the fullest extent of the law.

Scenario 2:									
Position	Conditions	SAR Value (W/kg)	Coordinates (cm)			ΣSAR (W/kg)	Peak Location Separation Distance (mm)	SPLSR	Simultaneous Transmission SAR Test
			x	y	z				
Top edge	WLAN 5G Ant1+ BT	1.530	-0.74	-14.09	-0.31	-	-	-	-
	GPRS 850	1.053	-0.45	10.69	-0.31	2.583	247.82	0.017	SPLSR ≤ 0.04, Not required
	GPRS 1900	0.939	-0.30	9.92	-0.32	2.469	240.14	0.016	SPLSR ≤ 0.04, Not required
	CAT.M1 Band 2	0.078	-0.44	10.07	-0.30	1.608	241.62	0.008	SPLSR ≤ 0.04, Not required
	CAT.M1 Band 4	0.078	-0.45	9.76	-0.31	1.608	238.52	0.009	SPLSR ≤ 0.04, Not required
	CAT.M1 Band 5	0.057	-0.61	10.85	-0.31	1.587	249.40	0.008	SPLSR ≤ 0.04, Not required
	CAT.M1 Band 12	0.045	-0.45	8.45	-0.31	1.575	225.42	0.009	SPLSR ≤ 0.04, Not required
	CAT.M1 Band 13	0.060	-0.45	10.85	-0.31	1.590	249.42	0.008	SPLSR ≤ 0.04, Not required
	CAT.M1 Band 14	0.053	-0.45	10.85	-0.31	1.583	249.42	0.008	SPLSR ≤ 0.04, Not required
	CAT.M1 Band 25	0.089	-0.44	10.21	-0.31	1.619	243.02	0.008	SPLSR ≤ 0.04, Not required
	CAT.M1 Band 26_FCC	0.056	-0.61	10.85	-0.30	1.586	249.40	0.008	SPLSR ≤ 0.04, Not required
	CAT.M1 Band 66	0.104	-0.45	9.76	-0.31	1.634	238.52	0.009	SPLSR ≤ 0.04, Not required
	CAT.M1 Band 85	0.214	-0.45	8.45	-0.31	1.744	225.42	0.010	SPLSR ≤ 0.04, Not required

Unless otherwise stated the results shown in this test report refer only to the sample(s) tested and such sample(s) are retained for 90 days only.

除非另有說明，此報告結果僅對測試之樣品負責，同時此樣品僅保留90天。本報告未經本公司書面許可，不可部份複製。

This document is issued by the Company subject to its General Conditions of Service printed overleaf, available on request or accessible at <http://www.sgs.com.tw/Terms-and-Conditions>, and for electronic format documents, subject to Terms and Conditions for Electronic Documents at <http://www.sgs.com.tw/Terms-and-Conditions>. Attention is drawn to the limitation of liability, indemnification and jurisdiction issues defined therein. Any holder of this document is advised that information contained hereon reflects the Company's findings at the time of its intervention only and within the limits of Client's instructions, if any. The Company's sole responsibility is to its Client and this document does not exonerate parties to a transaction from exercising all their rights and obligations under the transaction documents. This document cannot be reproduced except in full, without prior written approval of the Company. Any unauthorized alteration, forgery or falsification of the content or appearance of this document is unlawful and offenders may be prosecuted to the fullest extent of the law.

WLAN 5G Ant1+BT to GPRS850

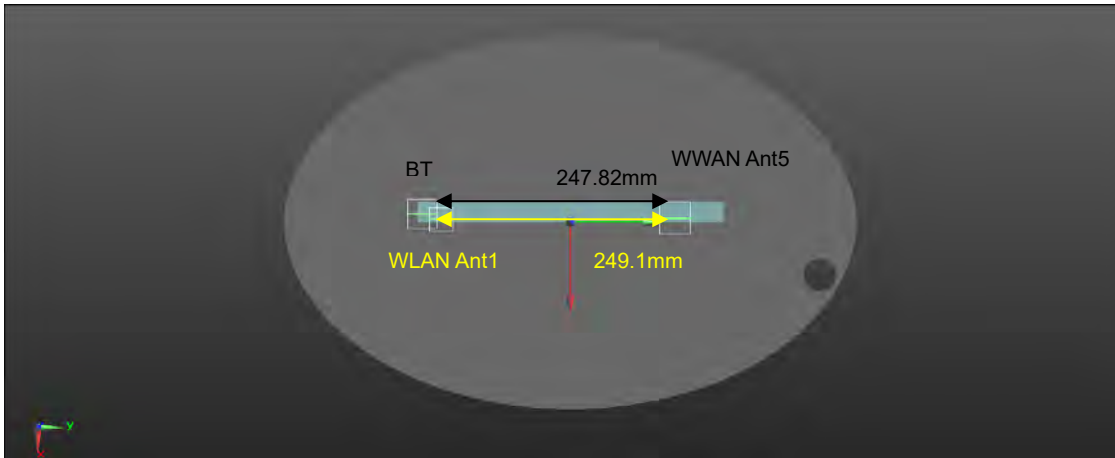

WLAN 5G Ant1+BT to GPRS1900

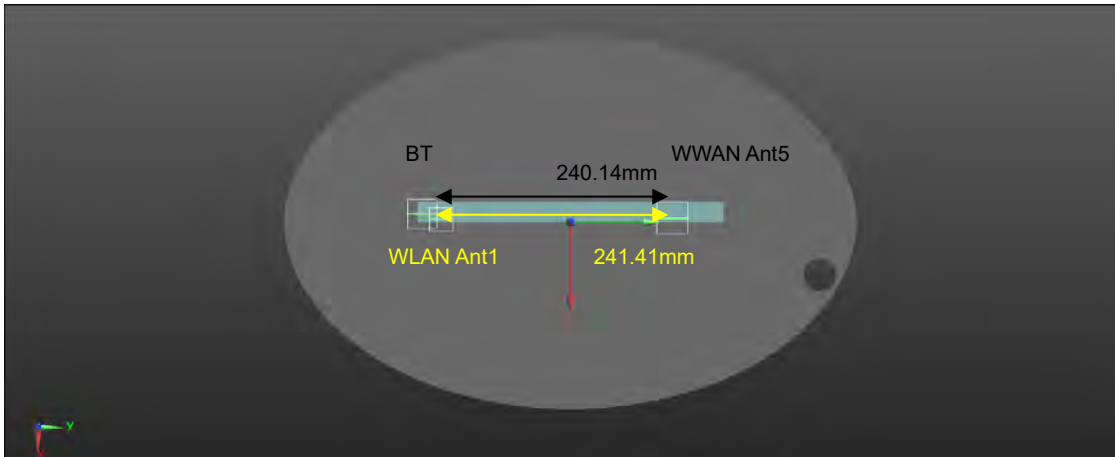

WLAN 5G Ant1+BT to CAT.M1 Band2

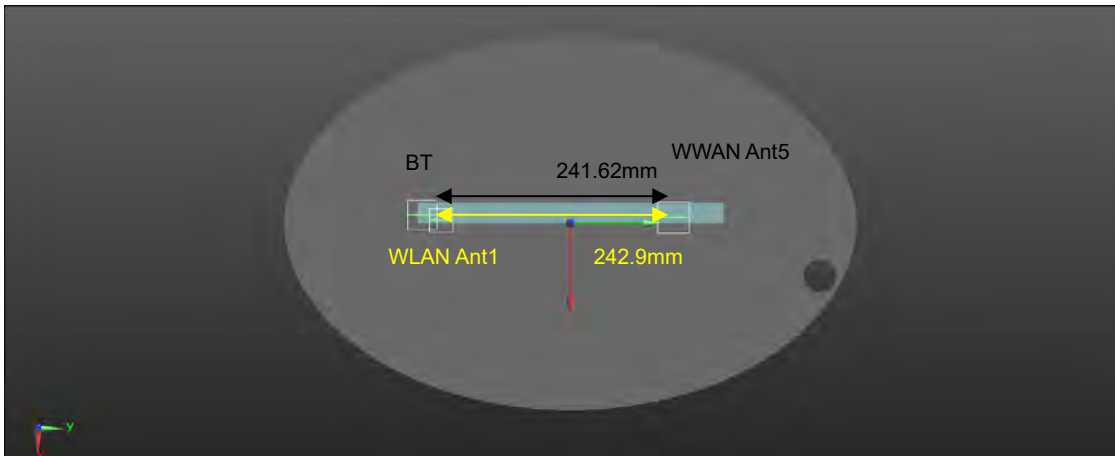

Unless otherwise stated the results shown in this test report refer only to the sample(s) tested and such sample(s) are retained for 90 days only.

除非另有說明，此報告結果僅對測試之樣品負責，同時此樣品僅保留90天。本報告未經本公司書面許可，不可部份複製。

This document is issued by the Company subject to its General Conditions of Service printed overleaf, available on request or accessible at <http://www.sgs.com.tw/Terms-and-Conditions> and for electronic format documents, subject to Terms and Conditions for Electronic Documents at <http://www.sgs.com.tw/Terms-and-Conditions>. Attention is drawn to the limitation of liability, indemnification and jurisdiction issues defined therein. Any holder of this document is advised that information contained hereon reflects the Company's findings at the time of its intervention only and within the limits of Client's instructions, if any. The Company's sole responsibility is to its Client and this document does not exonerate parties to a transaction from exercising all their rights and obligations under the transaction documents. This document cannot be reproduced except in full, without prior written approval of the Company. Any unauthorized alteration, forgery or falsification of the content or appearance of this document is unlawful and offenders may be prosecuted to the fullest extent of the law.

WLAN 5G Ant1+BT to CAT.M1 Band4



WLAN 5G Ant1+BT to CAT.M1 Band5

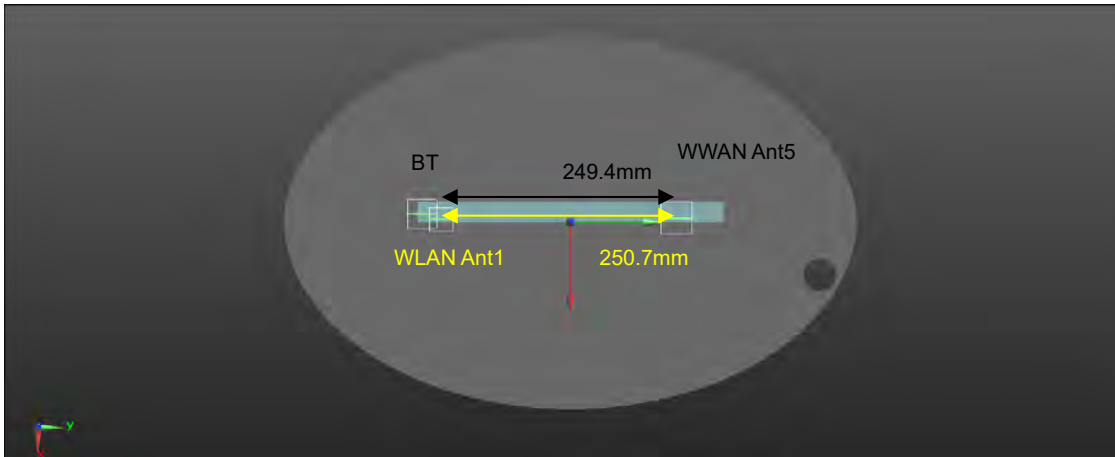

WLAN 5G Ant1+BT to CAT.M1 Band12

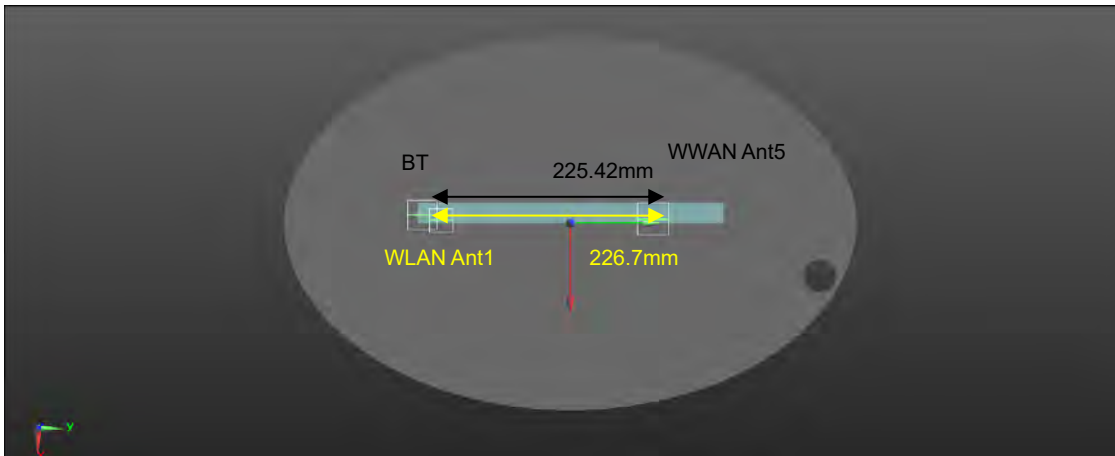

Unless otherwise stated the results shown in this test report refer only to the sample(s) tested and such sample(s) are retained for 90 days only.

除非另有說明，此報告結果僅對測試之樣品負責，同時此樣品僅保留90天。本報告未經本公司書面許可，不可部份複製。

This document is issued by the Company subject to its General Conditions of Service printed overleaf, available on request or accessible at <http://www.sgs.com.tw/Terms-and-Conditions> and for electronic format documents, subject to Terms and Conditions for Electronic Documents at <http://www.sgs.com.tw/Terms-and-Conditions>. Attention is drawn to the limitation of liability, indemnification and jurisdiction issues defined therein. Any holder of this document is advised that information contained hereon reflects the Company's findings at the time of its intervention only and within the limits of Client's instructions, if any. The Company's sole responsibility is to its Client and this document does not exonerate parties to a transaction from exercising all their rights and obligations under the transaction documents. This document cannot be reproduced except in full, without prior written approval of the Company. Any unauthorized alteration, forgery or falsification of the content or appearance of this document is unlawful and offenders may be prosecuted to the fullest extent of the law.

WLAN 5G Ant1+BT to CAT.M1 Band13

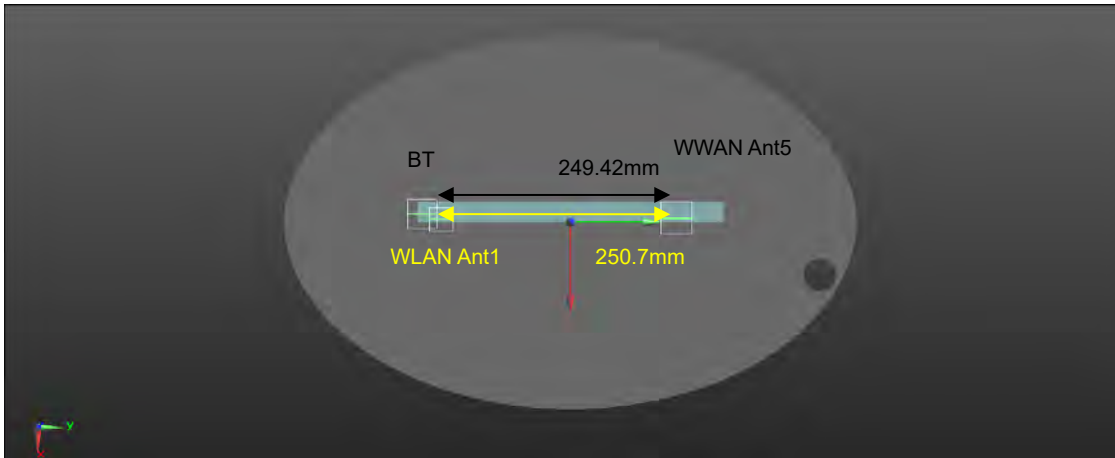

WLAN 5G Ant1+BT to CAT.M1 Band14

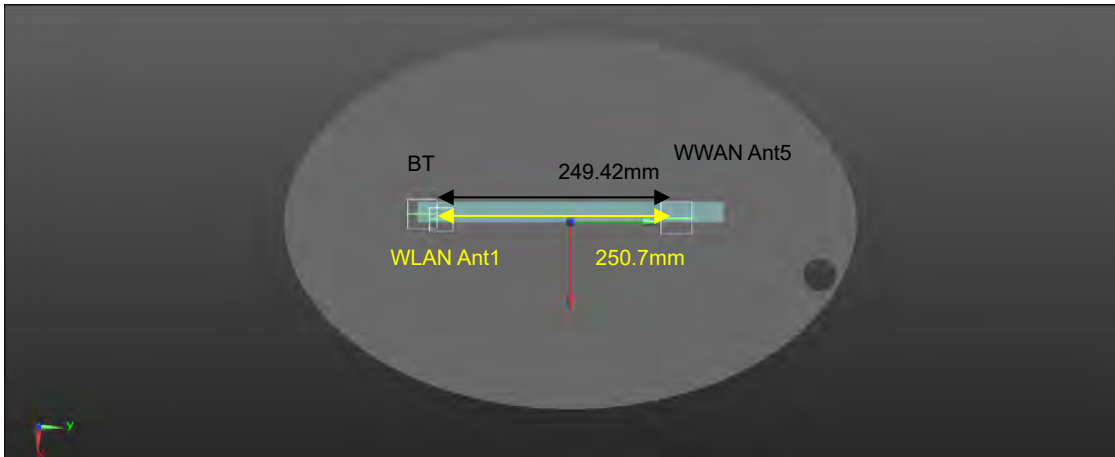

WLAN 5G Ant1+BT to CAT.M1 Band25

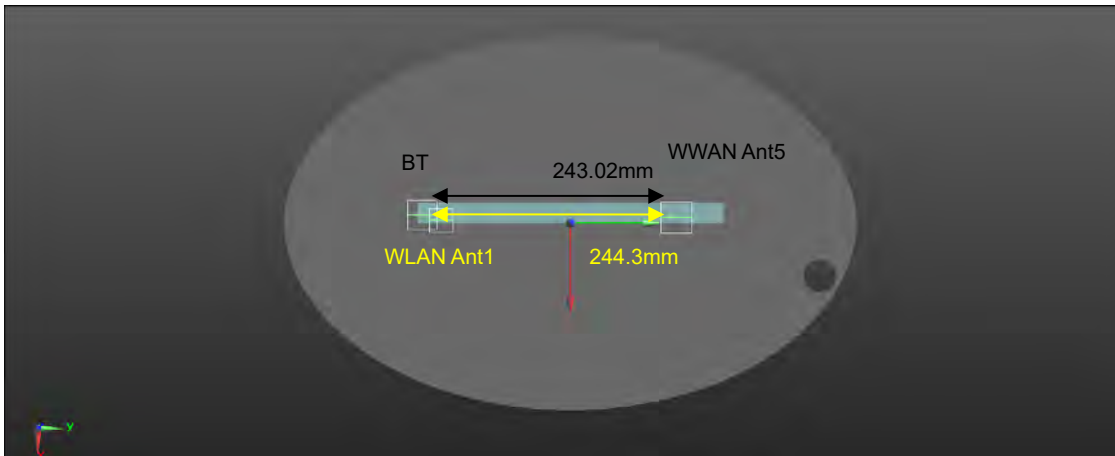

Unless otherwise stated the results shown in this test report refer only to the sample(s) tested and such sample(s) are retained for 90 days only.

除非另有說明，此報告結果僅對測試之樣品負責，同時此樣品僅保留90天。本報告未經本公司書面許可，不可部份複製。

This document is issued by the Company subject to its General Conditions of Service printed overleaf, available on request or accessible at <http://www.sgs.com.tw/Terms-and-Conditions> and for electronic format documents, subject to Terms and Conditions for Electronic Documents at <http://www.sgs.com.tw/Terms-and-Conditions>. Attention is drawn to the limitation of liability, indemnification and jurisdiction issues defined therein. Any holder of this document is advised that information contained hereon reflects the Company's findings at the time of its intervention only and within the limits of Client's instructions, if any. The Company's sole responsibility is to its Client and this document does not exonerate parties to a transaction from exercising all their rights and obligations under the transaction documents. This document cannot be reproduced except in full, without prior written approval of the Company. Any unauthorized alteration, forgery or falsification of the content or appearance of this document is unlawful and offenders may be prosecuted to the fullest extent of the law.

WLAN 5G Ant1+BT to CAT.M1 Band26 FCC

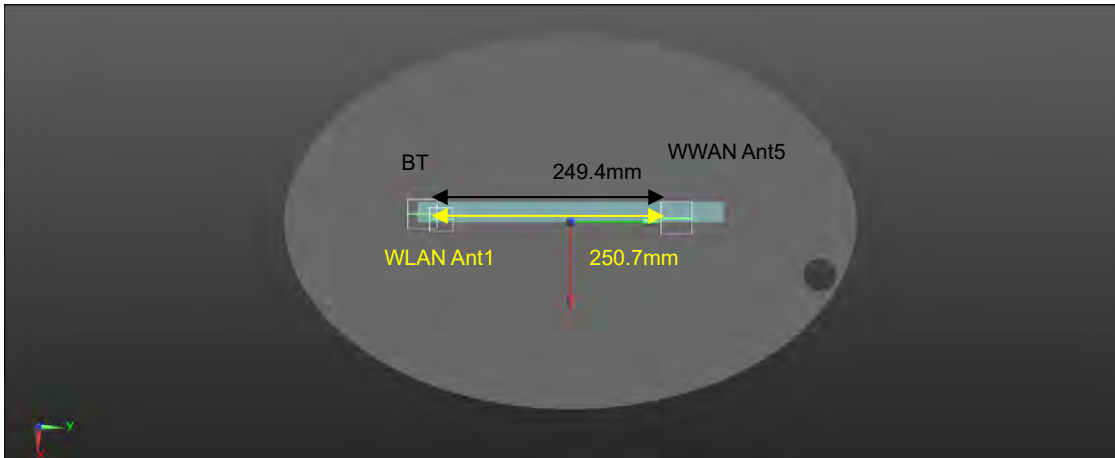

WLAN 5G Ant1+BT to CAT.M1 Band66

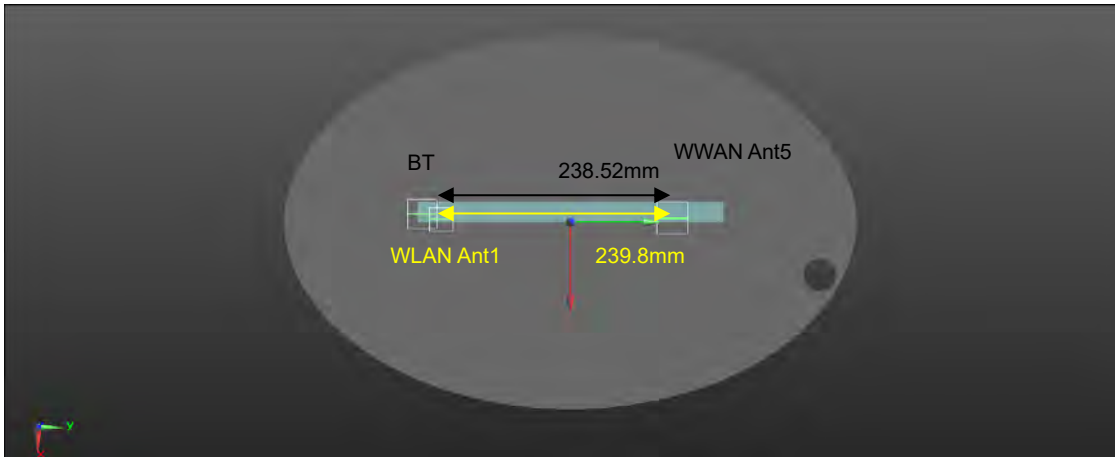

WLAN 5G Ant1+BT to CAT.M1 Band85

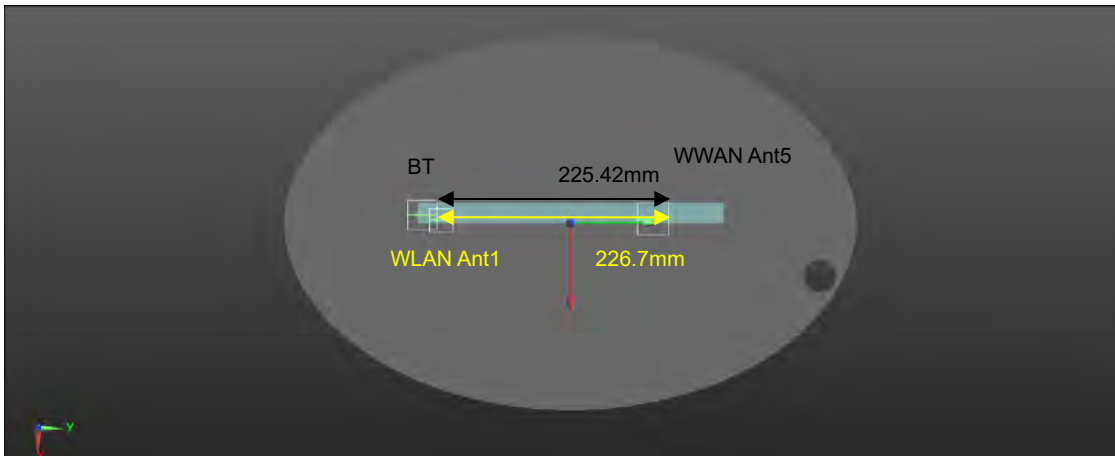

Unless otherwise stated the results shown in this test report refer only to the sample(s) tested and such sample(s) are retained for 90 days only.

除非另有說明，此報告結果僅對測試之樣品負責，同時此樣品僅保留90天。本報告未經本公司書面許可，不可部份複製。

This document is issued by the Company subject to its General Conditions of Service printed overleaf, available on request or accessible at <http://www.sgs.com.tw/Terms-and-Conditions> and for electronic format documents, subject to Terms and Conditions for Electronic Documents at <http://www.sgs.com.tw/Terms-and-Conditions>. Attention is drawn to the limitation of liability, indemnification and jurisdiction issues defined therein. Any holder of this document is advised that information contained hereon reflects the Company's findings at the time of its intervention only and within the limits of Client's instructions, if any. The Company's sole responsibility is to its Client and this document does not exonerate parties to a transaction from exercising all their rights and obligations under the transaction documents. This document cannot be reproduced except in full, without prior written approval of the Company. Any unauthorized alteration, forgery or falsification of the content or appearance of this document is unlawful and offenders may be prosecuted to the fullest extent of the law.

Scenario 2:									
Position	Conditions	SAR Value (W/kg)	Coordinates (cm)			ΣSAR (W/kg)	Peak Location Separation Distance (mm)	SPLSR	Simultaneous Transmission SAR Test
			x	y	z				
Top edge	WLAN 5G Ant2	1.450	-0.42	-5.29	-0.33	-	-	-	-
	GPRS 850	1.053	-0.45	10.69	-0.31	2.503	159.80	0.025	SPLSR ≤ 0.04, Not required
	GPRS 1900	0.939	-0.30	9.92	-0.32	2.389	152.10	0.024	SPLSR ≤ 0.04, Not required
	CAT.M1 Band 2	0.078	-0.44	10.07	-0.30	1.528	153.60	0.012	SPLSR ≤ 0.04, Not required
	CAT.M1 Band 4	0.078	-0.45	9.76	-0.31	1.528	150.50	0.013	SPLSR ≤ 0.04, Not required
	CAT.M1 Band 5	0.057	-0.61	10.85	-0.31	1.507	161.41	0.011	SPLSR ≤ 0.04, Not required
	CAT.M1 Band 12	0.045	-0.45	8.45	-0.31	1.495	137.40	0.013	SPLSR ≤ 0.04, Not required
	CAT.M1 Band 13	0.060	-0.45	10.85	-0.31	1.510	161.40	0.011	SPLSR ≤ 0.04, Not required
	CAT.M1 Band 14	0.053	-0.45	10.85	-0.31	1.503	161.40	0.011	SPLSR ≤ 0.04, Not required
	CAT.M1 Band 25	0.089	-0.44	10.21	-0.31	1.539	155.00	0.012	SPLSR ≤ 0.04, Not required
	CAT.M1 Band 26_FCC	0.056	-0.61	10.85	-0.30	1.506	161.41	0.011	SPLSR ≤ 0.04, Not required
	CAT.M1 Band 66	0.104	-0.45	9.76	-0.31	1.554	150.50	0.013	SPLSR ≤ 0.04, Not required
	CAT.M1 Band 85	0.214	-0.45	8.45	-0.31	1.664	137.40	0.016	SPLSR ≤ 0.04, Not required

Unless otherwise stated the results shown in this test report refer only to the sample(s) tested and such sample(s) are retained for 90 days only.

除非另有說明，此報告結果僅對測試之樣品負責，同時此樣品僅保留90天。本報告未經本公司書面許可，不可部份複製。

This document is issued by the Company subject to its General Conditions of Service printed overleaf, available on request or accessible at <http://www.sgs.com.tw/Terms-and-Conditions>, and for electronic format documents, subject to Terms and Conditions for Electronic Documents at <http://www.sgs.com.tw/Terms-and-Conditions>. Attention is drawn to the limitation of liability, indemnification and jurisdiction issues defined therein. Any holder of this document is advised that information contained hereon reflects the Company's findings at the time of its intervention only and within the limits of Client's instructions, if any. The Company's sole responsibility is to its Client and this document does not exonerate parties to a transaction from exercising all their rights and obligations under the transaction documents. This document cannot be reproduced except in full, without prior written approval of the Company. Any unauthorized alteration, forgery or falsification of the content or appearance of this document is unlawful and offenders may be prosecuted to the fullest extent of the law.

WLAN 5G Ant2 to GPRS850

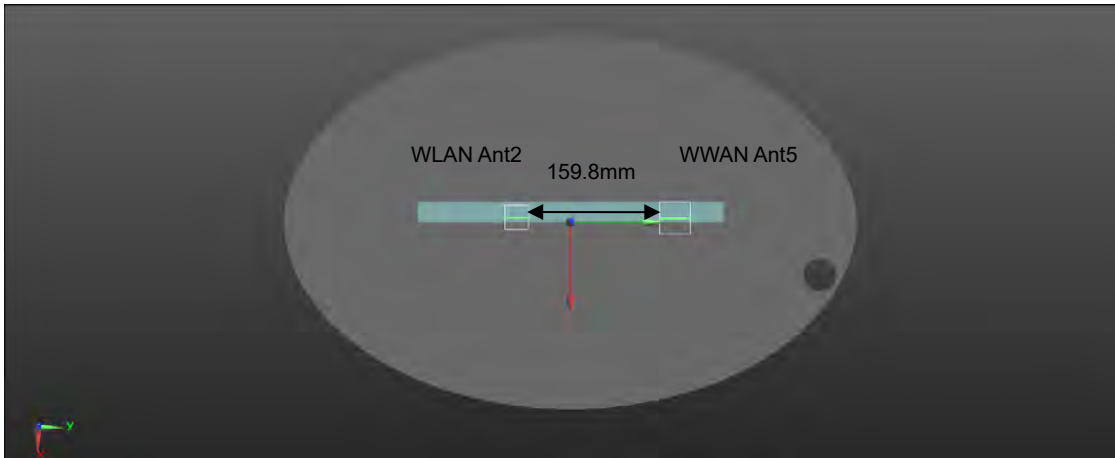

WLAN 5G Ant2 to GPRS1900

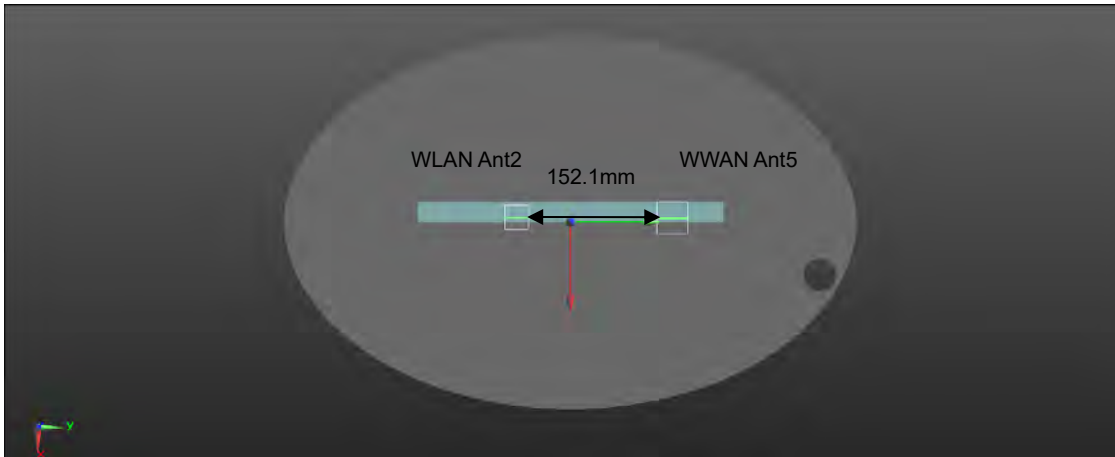

WLAN 5G Ant2 to CAT.M1 Band2

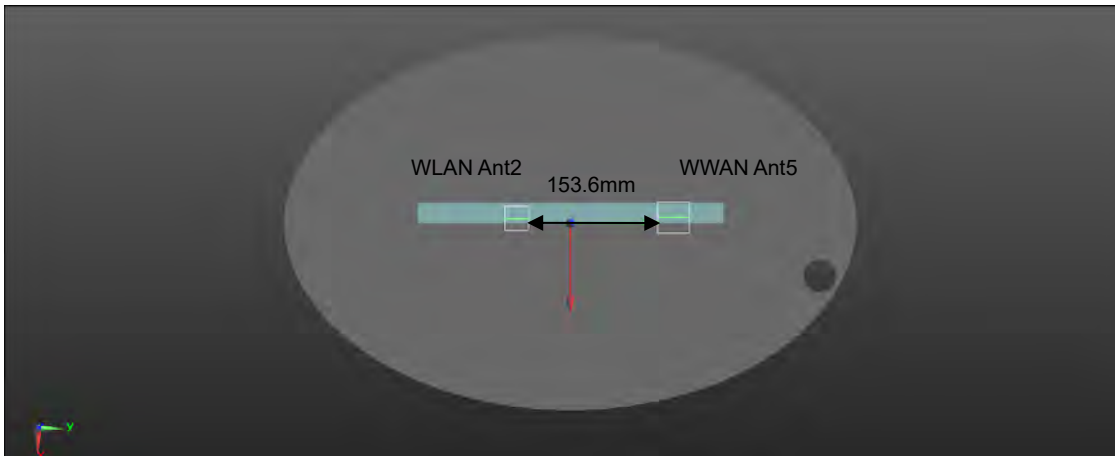

Unless otherwise stated the results shown in this test report refer only to the sample(s) tested and such sample(s) are retained for 90 days only.

除非另有說明，此報告結果僅對測試之樣品負責，同時此樣品僅保留90天。本報告未經本公司書面許可，不可部份複製。

This document is issued by the Company subject to its General Conditions of Service printed overleaf, available on request or accessible at <http://www.sgs.com.tw/Terms-and-Conditions> and for electronic format documents, subject to Terms and Conditions for Electronic Documents at <http://www.sgs.com.tw/Terms-and-Conditions>. Attention is drawn to the limitation of liability, indemnification and jurisdiction issues defined therein. Any holder of this document is advised that information contained hereon reflects the Company's findings at the time of its intervention only and within the limits of Client's instructions, if any. The Company's sole responsibility is to its Client and this document does not exonerate parties to a transaction from exercising all their rights and obligations under the transaction documents. This document cannot be reproduced except in full, without prior written approval of the Company. Any unauthorized alteration, forgery or falsification of the content or appearance of this document is unlawful and offenders may be prosecuted to the fullest extent of the law.

WLAN 5G Ant2 to CAT.M1 Band4

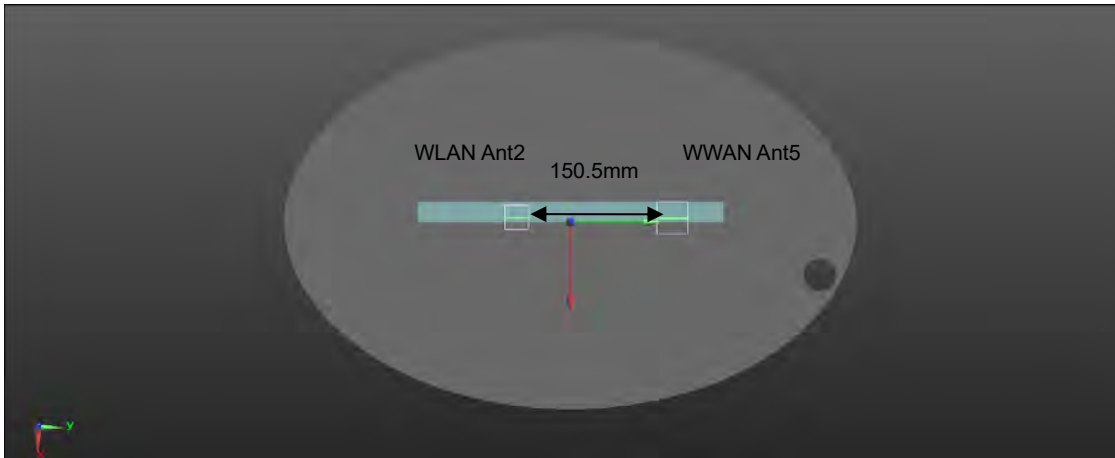

WLAN 5G Ant2 to CAT.M1 Band5

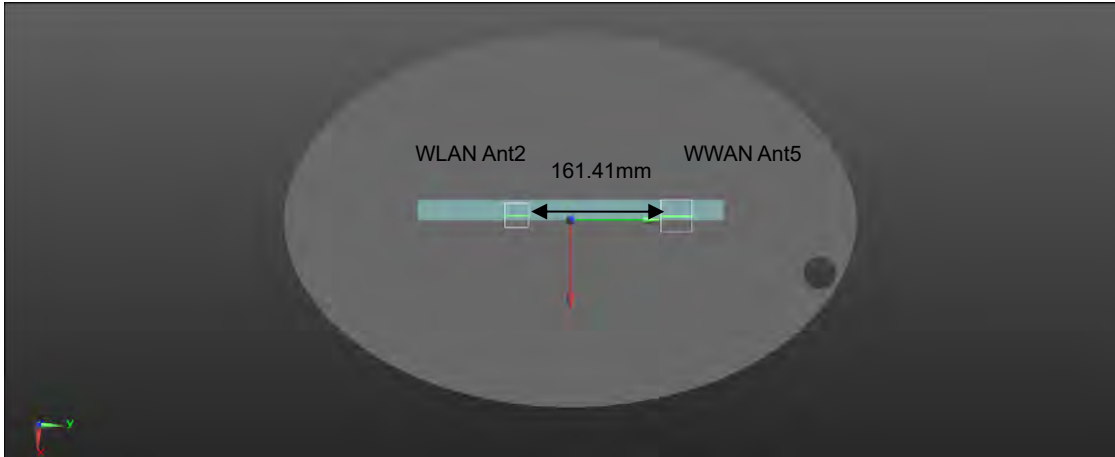

WLAN 5G Ant2 to CAT.M1 Band12

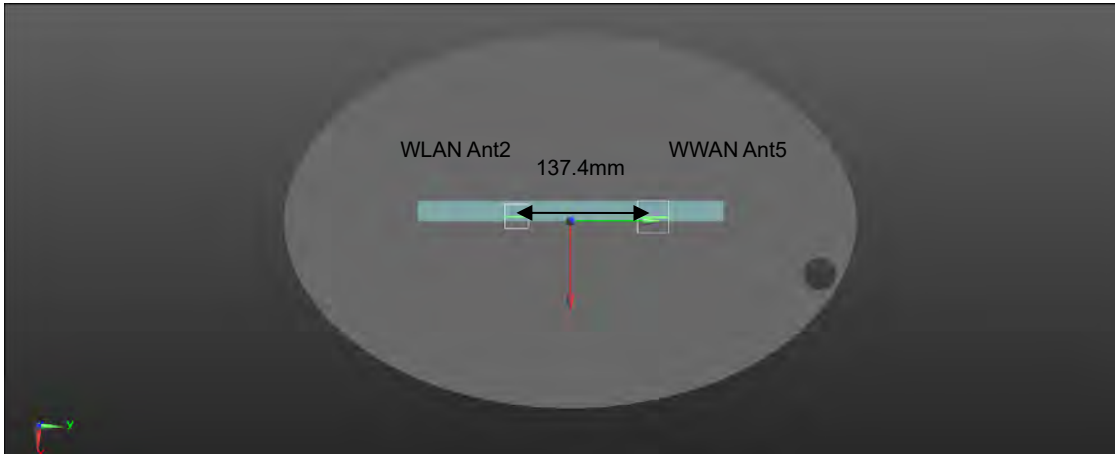

Unless otherwise stated the results shown in this test report refer only to the sample(s) tested and such sample(s) are retained for 90 days only.

除非另有說明，此報告結果僅對測試之樣品負責，同時此樣品僅保留90天。本報告未經本公司書面許可，不可部份複製。

This document is issued by the Company subject to its General Conditions of Service printed overleaf, available on request or accessible at <http://www.sgs.com.tw/Terms-and-Conditions> and for electronic format documents, subject to Terms and Conditions for Electronic Documents at <http://www.sgs.com.tw/Terms-and-Conditions>. Attention is drawn to the limitation of liability, indemnification and jurisdiction issues defined therein. Any holder of this document is advised that information contained hereon reflects the Company's findings at the time of its intervention only and within the limits of Client's instructions, if any. The Company's sole responsibility is to its Client and this document does not exonerate parties to a transaction from exercising all their rights and obligations under the transaction documents. This document cannot be reproduced except in full, without prior written approval of the Company. Any unauthorized alteration, forgery or falsification of the content or appearance of this document is unlawful and offenders may be prosecuted to the fullest extent of the law.

WLAN 5G Ant2 to CAT.M1 Band13

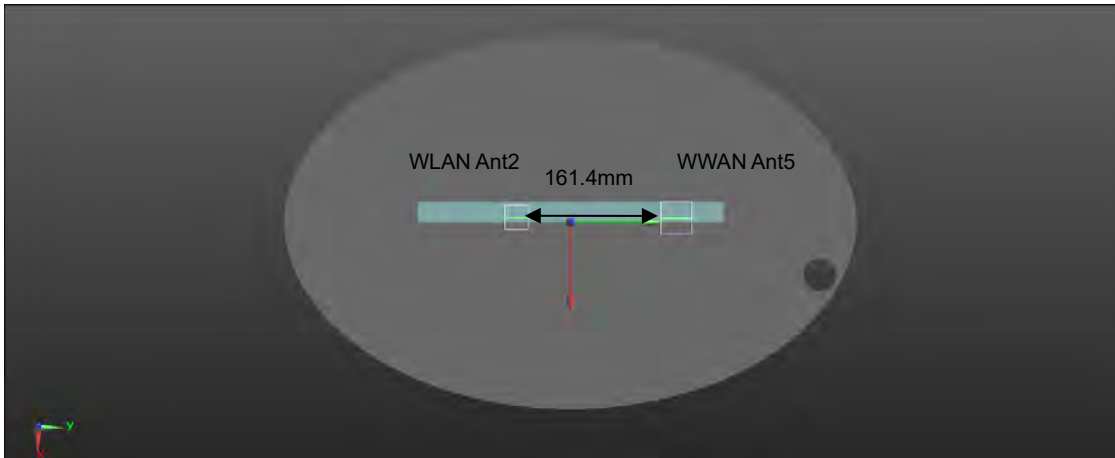

WLAN 5G Ant2 to CAT.M1 Band14

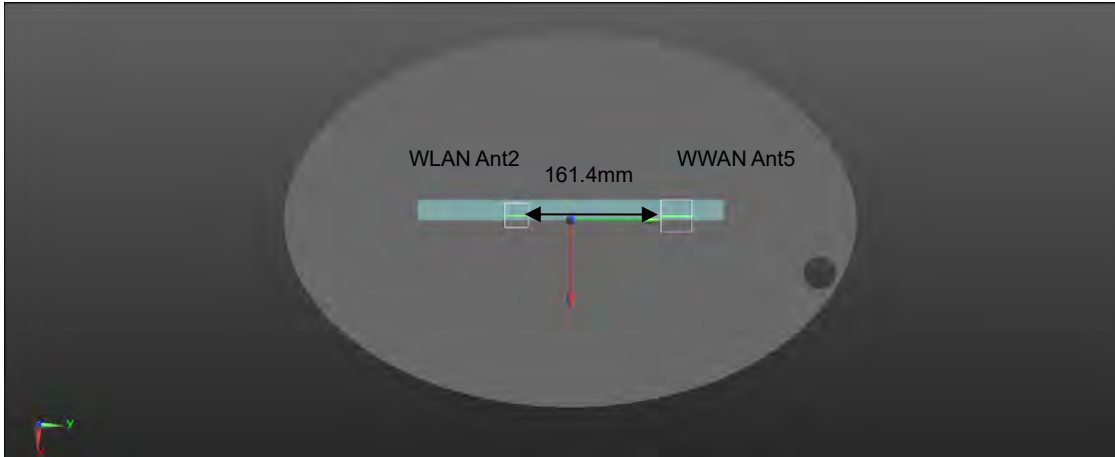

WLAN 5G Ant2 to CAT.M1 Band25

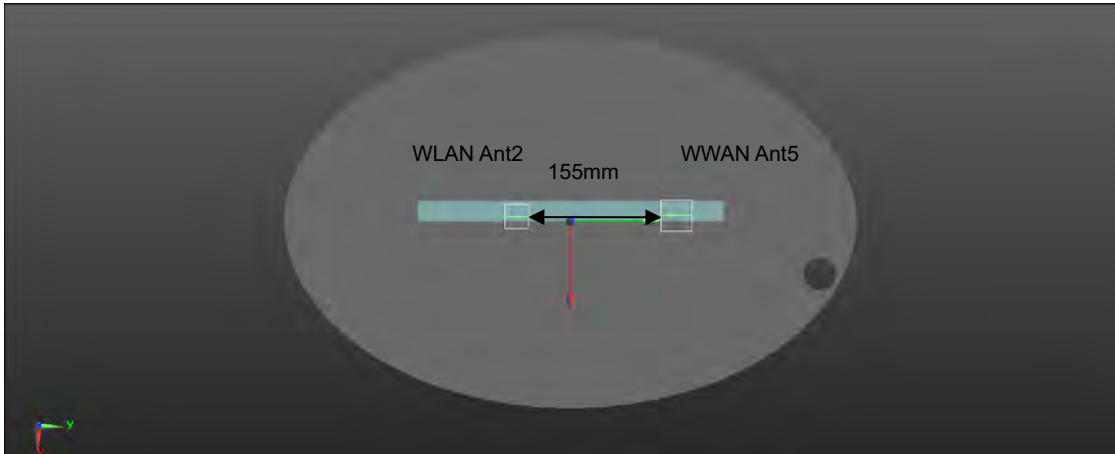

Unless otherwise stated the results shown in this test report refer only to the sample(s) tested and such sample(s) are retained for 90 days only.

除非另有說明，此報告結果僅對測試之樣品負責，同時此樣品僅保留90天。本報告未經本公司書面許可，不可部份複製。

This document is issued by the Company subject to its General Conditions of Service printed overleaf, available on request or accessible at <http://www.sgs.com.tw/Terms-and-Conditions> and for electronic format documents, subject to Terms and Conditions for Electronic Documents at <http://www.sgs.com.tw/Terms-and-Conditions>. Attention is drawn to the limitation of liability, indemnification and jurisdiction issues defined therein. Any holder of this document is advised that information contained hereon reflects the Company's findings at the time of its intervention only and within the limits of Client's instructions, if any. The Company's sole responsibility is to its Client and this document does not exonerate parties to a transaction from exercising all their rights and obligations under the transaction documents. This document cannot be reproduced except in full, without prior written approval of the Company. Any unauthorized alteration, forgery or falsification of the content or appearance of this document is unlawful and offenders may be prosecuted to the fullest extent of the law.

WLAN 5G Ant2 to CAT.M1 Band26 FCC

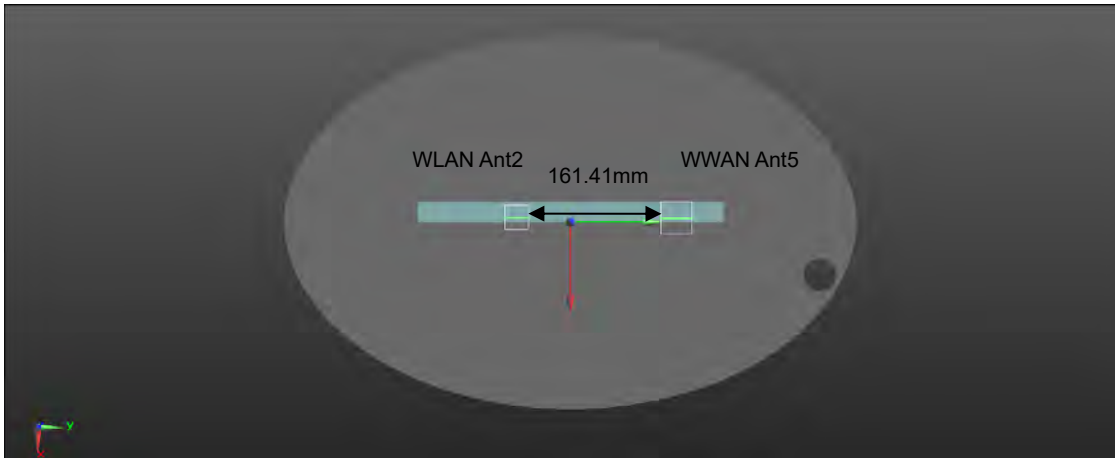

WLAN 5G Ant2 to CAT.M1 Band66

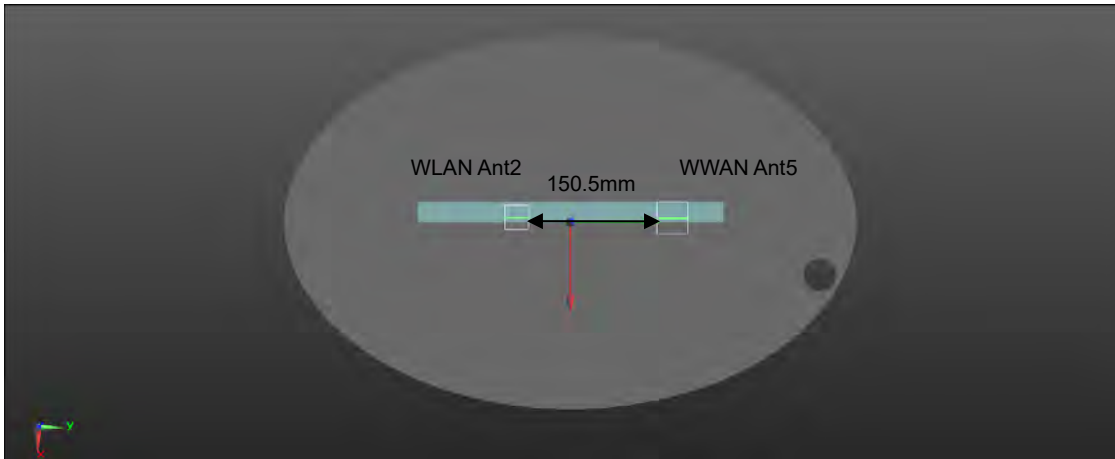

WLAN 5G Ant2 to CAT.M1 Band85

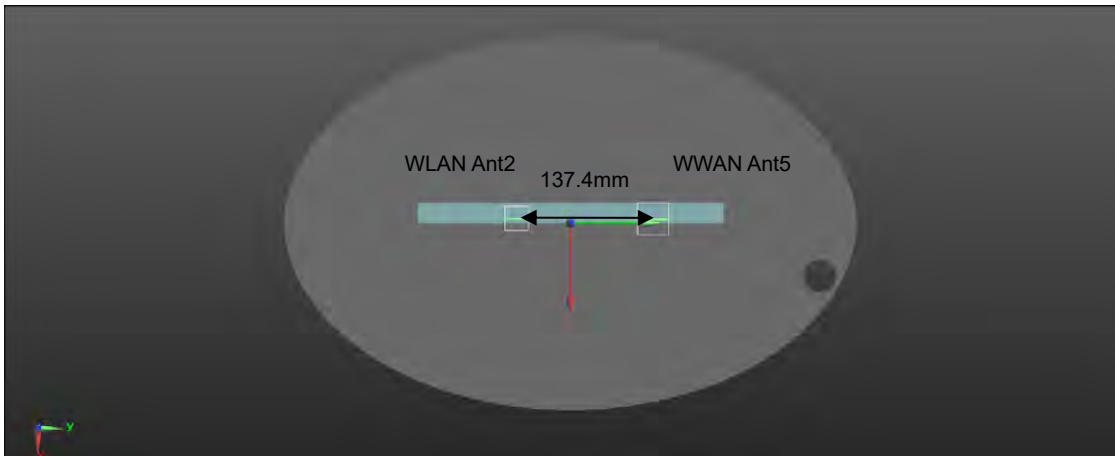

Unless otherwise stated the results shown in this test report refer only to the sample(s) tested and such sample(s) are retained for 90 days only.

除非另有說明，此報告結果僅對測試之樣品負責，同時此樣品僅保留90天。本報告未經本公司書面許可，不可部份複製。

This document is issued by the Company subject to its General Conditions of Service printed overleaf, available on request or accessible at <http://www.sgs.com.tw/Terms-and-Conditions> and for electronic format documents, subject to Terms and Conditions for Electronic Documents at <http://www.sgs.com.tw/Terms-and-Conditions>. Attention is drawn to the limitation of liability, indemnification and jurisdiction issues defined therein. Any holder of this document is advised that information contained hereon reflects the Company's findings at the time of its intervention only and within the limits of Client's instructions, if any. The Company's sole responsibility is to its Client and this document does not exonerate parties to a transaction from exercising all their rights and obligations under the transaction documents. This document cannot be reproduced except in full, without prior written approval of the Company. Any unauthorized alteration, forgery or falsification of the content or appearance of this document is unlawful and offenders may be prosecuted to the fullest extent of the law.

Scenario 3:									
Position	Conditions	SAR Value (W/kg)	Coordinates (cm)			ΣSAR (W/kg)	Peak Location Separation Distance (mm)	SPLSR	Simultaneous Transmission SAR Test
			x	y	z				
Top edge	WLAN 6G Ant1+BT	1.400	-0.69	-13.85	-0.31	-	-	-	-
	GPRS 850	1.053	-0.45	10.69	-0.31	2.453	245.41	0.016	SPLSR ≤ 0.04, Not required
	GPRS 1900	0.939	-0.30	9.92	-0.32	2.339	237.73	0.015	SPLSR ≤ 0.04, Not required
	CAT.M1 Band 2	0.078	-0.44	10.07	-0.30	1.478	239.21	0.008	SPLSR ≤ 0.04, Not required
	CAT.M1 Band 4	0.078	-0.45	9.76	-0.31	1.478	236.11	0.008	SPLSR ≤ 0.04, Not required
	CAT.M1 Band 5	0.057	-0.61	10.85	-0.31	1.457	247.00	0.007	SPLSR ≤ 0.04, Not required
	CAT.M1 Band 12	0.045	-0.45	8.45	-0.31	1.445	223.01	0.008	SPLSR ≤ 0.04, Not required
	CAT.M1 Band 13	0.060	-0.45	10.85	-0.31	1.460	247.01	0.007	SPLSR ≤ 0.04, Not required
	CAT.M1 Band 14	0.053	-0.45	10.85	-0.31	1.453	247.01	0.007	SPLSR ≤ 0.04, Not required
	CAT.M1 Band 25	0.089	-0.44	10.21	-0.31	1.489	240.61	0.008	SPLSR ≤ 0.04, Not required
	CAT.M1 Band 26_FCC	0.056	-0.61	10.85	-0.30	1.456	247.00	0.007	SPLSR ≤ 0.04, Not required
	CAT.M1 Band 66	0.104	-0.45	9.76	-0.31	1.504	236.11	0.008	SPLSR ≤ 0.04, Not required
	CAT.M1 Band 85	0.214	-0.45	8.45	-0.31	1.614	223.01	0.009	SPLSR ≤ 0.04, Not required

Unless otherwise stated the results shown in this test report refer only to the sample(s) tested and such sample(s) are retained for 90 days only.

除非另有說明，此報告結果僅對測試之樣品負責，同時此樣品僅保留90天。本報告未經本公司書面許可，不可部份複製。

This document is issued by the Company subject to its General Conditions of Service printed overleaf, available on request or accessible at <http://www.sgs.com.tw/Terms-and-Conditions>, and for electronic format documents, subject to Terms and Conditions for Electronic Documents at <http://www.sgs.com.tw/Terms-and-Conditions>. Attention is drawn to the limitation of liability, indemnification and jurisdiction issues defined therein. Any holder of this document is advised that information contained hereon reflects the Company's findings at the time of its intervention only and within the limits of Client's instructions, if any. The Company's sole responsibility is to its Client and this document does not exonerate parties to a transaction from exercising all their rights and obligations under the transaction documents. This document cannot be reproduced except in full, without prior written approval of the Company. Any unauthorized alteration, forgery or falsification of the content or appearance of this document is unlawful and offenders may be prosecuted to the fullest extent of the law.

WLAN 6G Ant1+BT to GPRS 850

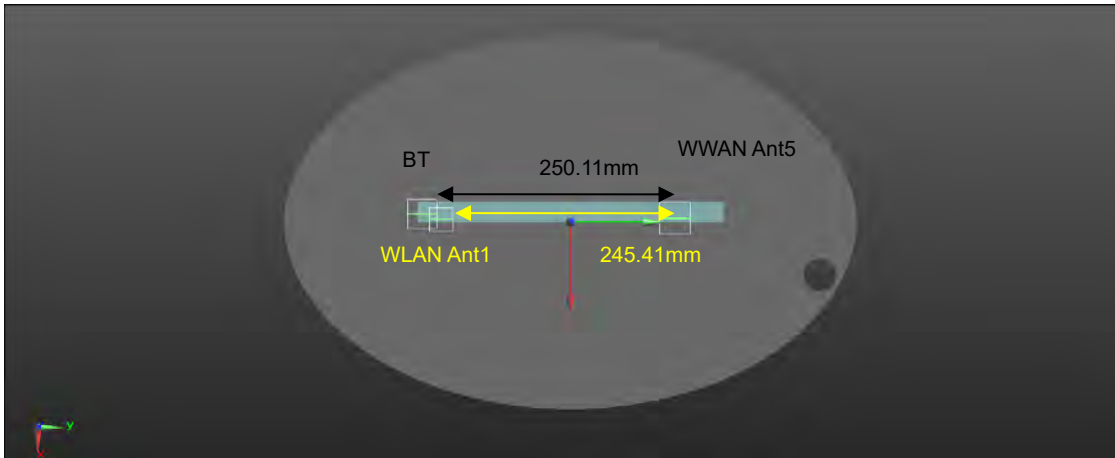

WLAN 6G Ant1+BT to GPRS 1900

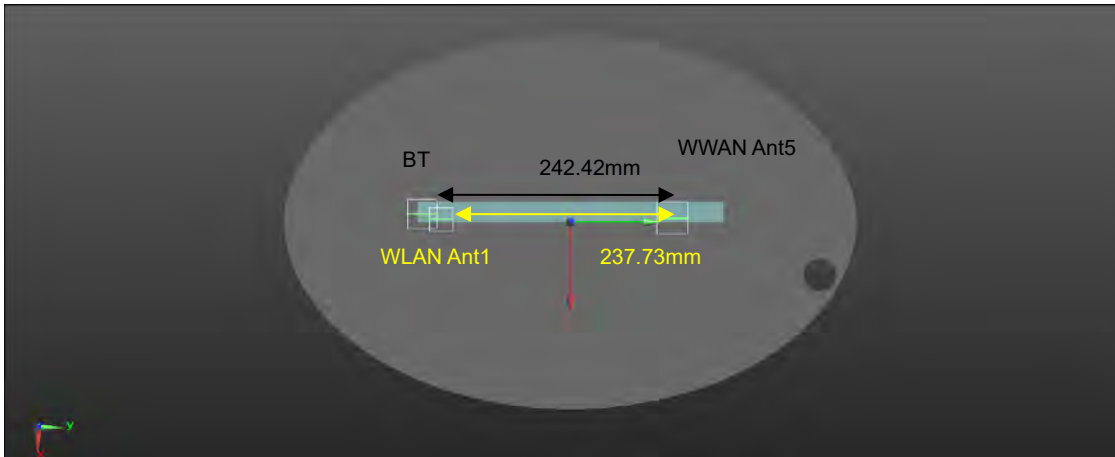

WLAN 6G Ant1+BT to CAT.M1 Band2

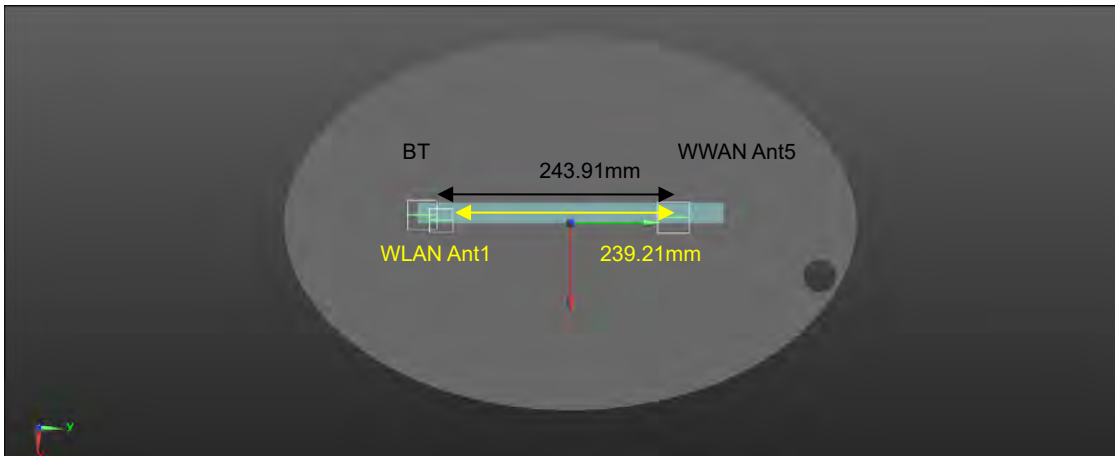

Unless otherwise stated the results shown in this test report refer only to the sample(s) tested and such sample(s) are retained for 90 days only.

除非另有說明，此報告結果僅對測試之樣品負責，同時此樣品僅保留90天。本報告未經本公司書面許可，不可部份複製。

This document is issued by the Company subject to its General Conditions of Service printed overleaf, available on request or accessible at <http://www.sgs.com.tw/Terms-and-Conditions> and for electronic format documents, subject to Terms and Conditions for Electronic Documents at <http://www.sgs.com.tw/Terms-and-Conditions>. Attention is drawn to the limitation of liability, indemnification and jurisdiction issues defined therein. Any holder of this document is advised that information contained hereon reflects the Company's findings at the time of its intervention only and within the limits of Client's instructions, if any. The Company's sole responsibility is to its Client and this document does not exonerate parties to a transaction from exercising all their rights and obligations under the transaction documents. This document cannot be reproduced except in full, without prior written approval of the Company. Any unauthorized alteration, forgery or falsification of the content or appearance of this document is unlawful and offenders may be prosecuted to the fullest extent of the law.

WLAN 6G Ant1+BT to CAT.M1 Band4

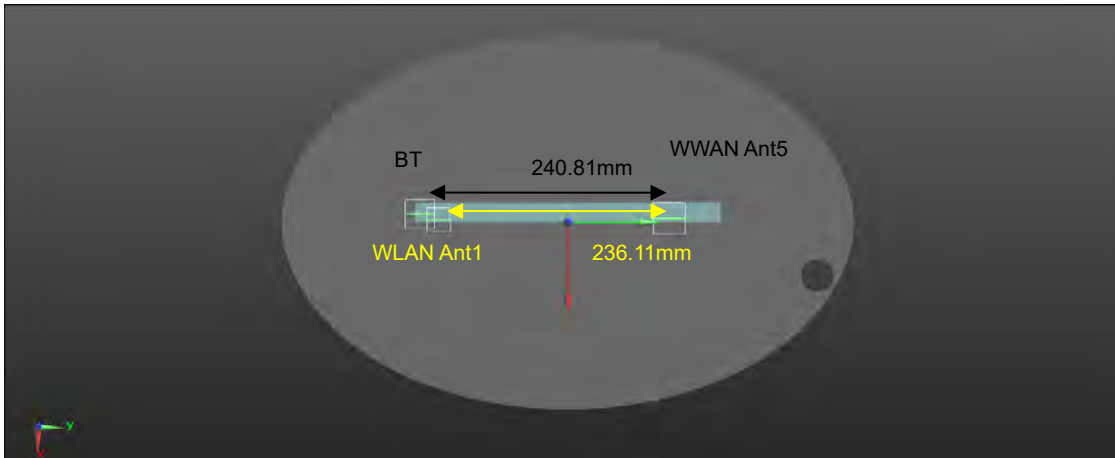

WLAN 6G Ant1+BT to CAT.M1 Band5

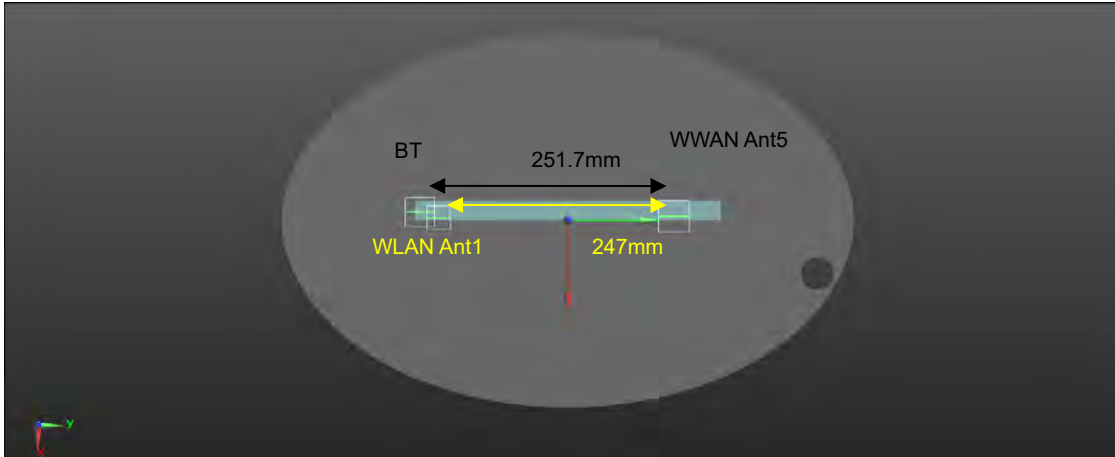

WLAN 6G Ant1+BT to CAT.M1 Band12

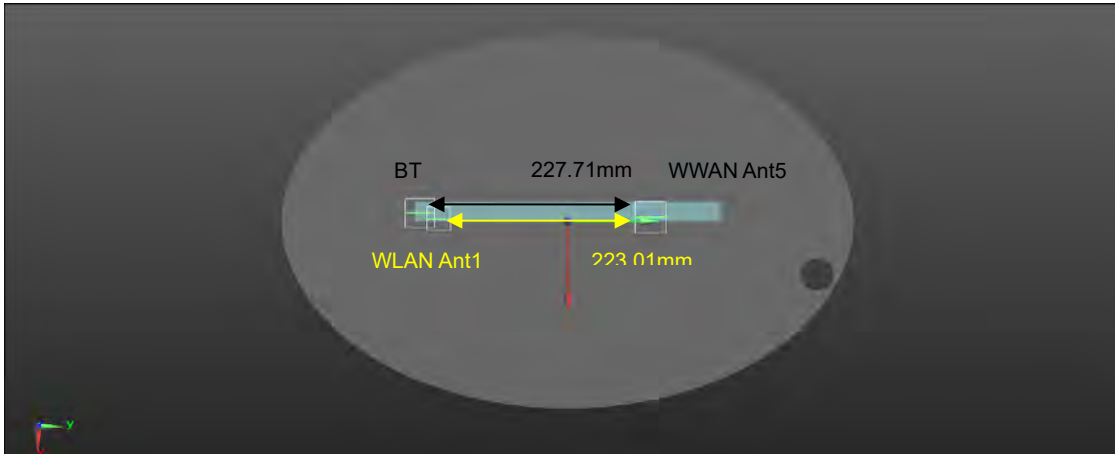

Unless otherwise stated the results shown in this test report refer only to the sample(s) tested and such sample(s) are retained for 90 days only.

除非另有說明，此報告結果僅對測試之樣品負責，同時此樣品僅保留90天。本報告未經本公司書面許可，不可部份複製。

This document is issued by the Company subject to its General Conditions of Service printed overleaf, available on request or accessible at <http://www.sgs.com.tw/Terms-and-Conditions> and for electronic format documents, subject to Terms and Conditions for Electronic Documents at <http://www.sgs.com.tw/Terms-and-Conditions>. Attention is drawn to the limitation of liability, indemnification and jurisdiction issues defined therein. Any holder of this document is advised that information contained hereon reflects the Company's findings at the time of its intervention only and within the limits of Client's instructions, if any. The Company's sole responsibility is to its Client and this document does not exonerate parties to a transaction from exercising all their rights and obligations under the transaction documents. This document cannot be reproduced except in full, without prior written approval of the Company. Any unauthorized alteration, forgery or falsification of the content or appearance of this document is unlawful and offenders may be prosecuted to the fullest extent of the law.

WLAN 6G Ant1+BT to CAT.M1 Band13

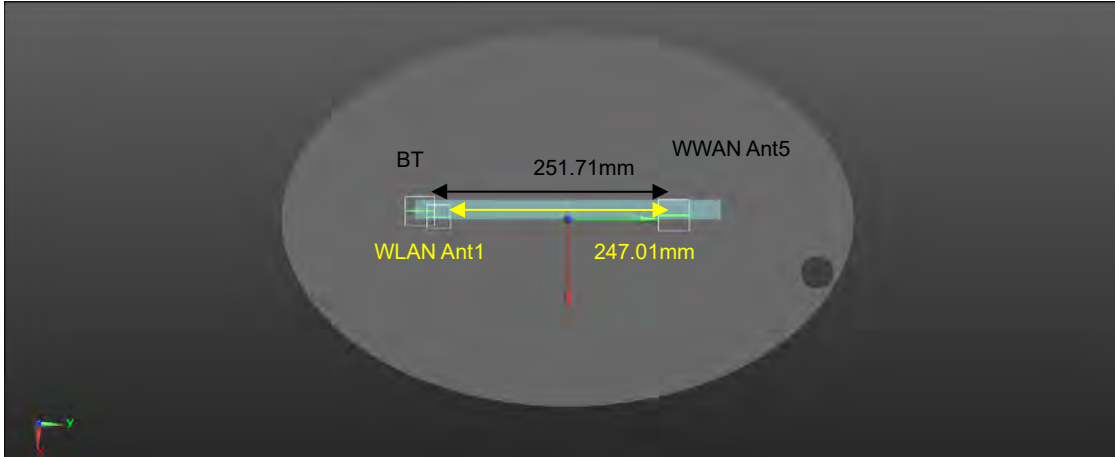

WLAN 6G Ant1+BT to CAT.M1 Band14

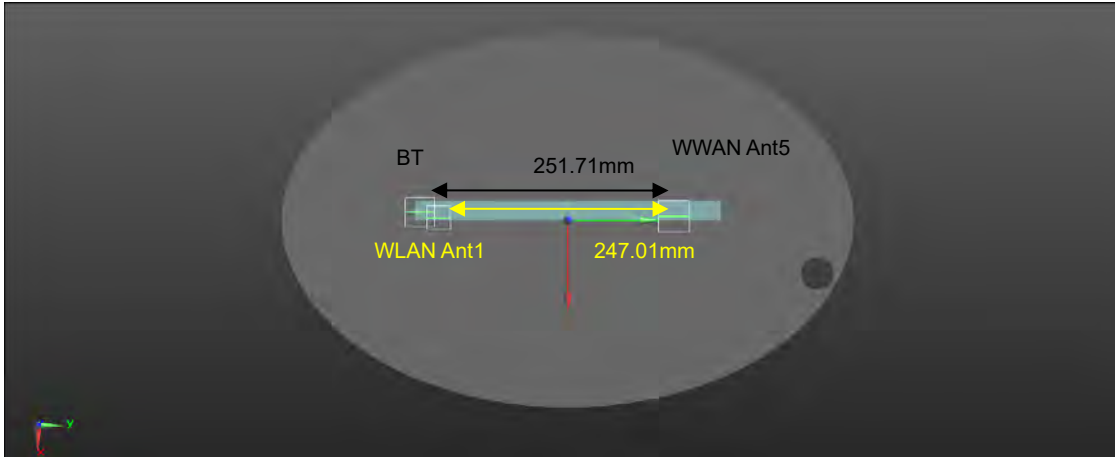

WLAN 6G Ant1+BT to CAT.M1 Band25

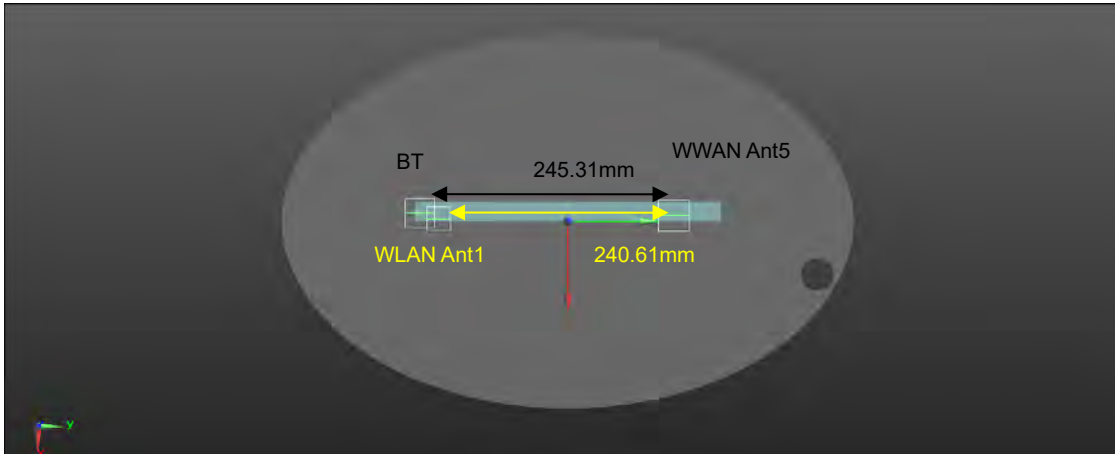

Unless otherwise stated the results shown in this test report refer only to the sample(s) tested and such sample(s) are retained for 90 days only.

除非另有說明，此報告結果僅對測試之樣品負責，同時此樣品僅保留90天。本報告未經本公司書面許可，不可部份複製。

This document is issued by the Company subject to its General Conditions of Service printed overleaf, available on request or accessible at <http://www.sgs.com.tw/Terms-and-Conditions> and for electronic format documents, subject to Terms and Conditions for Electronic Documents at <http://www.sgs.com.tw/Terms-and-Conditions>. Attention is drawn to the limitation of liability, indemnification and jurisdiction issues defined therein. Any holder of this document is advised that information contained hereon reflects the Company's findings at the time of its intervention only and within the limits of Client's instructions, if any. The Company's sole responsibility is to its Client and this document does not exonerate parties to a transaction from exercising all their rights and obligations under the transaction documents. This document cannot be reproduced except in full, without prior written approval of the Company. Any unauthorized alteration, forgery or falsification of the content or appearance of this document is unlawful and offenders may be prosecuted to the fullest extent of the law.

WLAN 6G Ant1+BT to CAT.M1 Band26 FCC

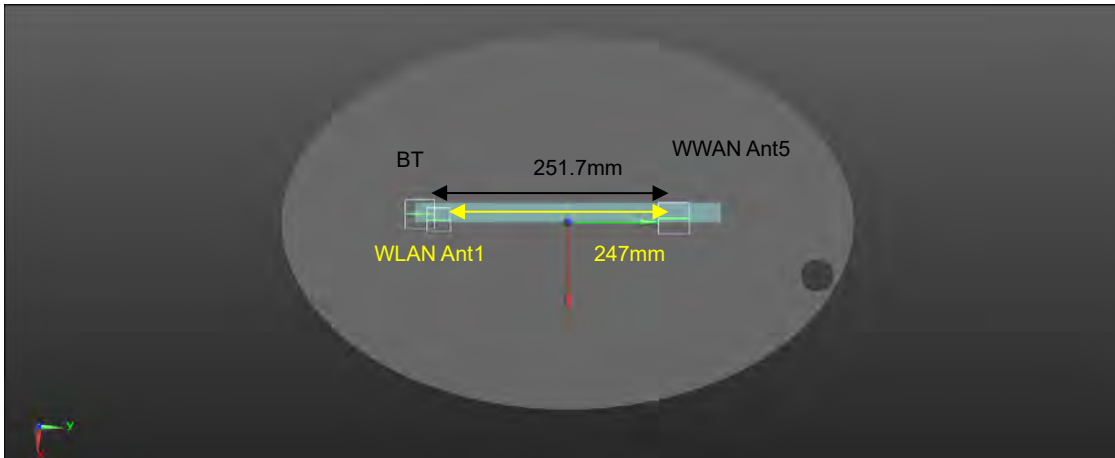

WLAN 6G Ant1+BT to CAT.M1 Band66

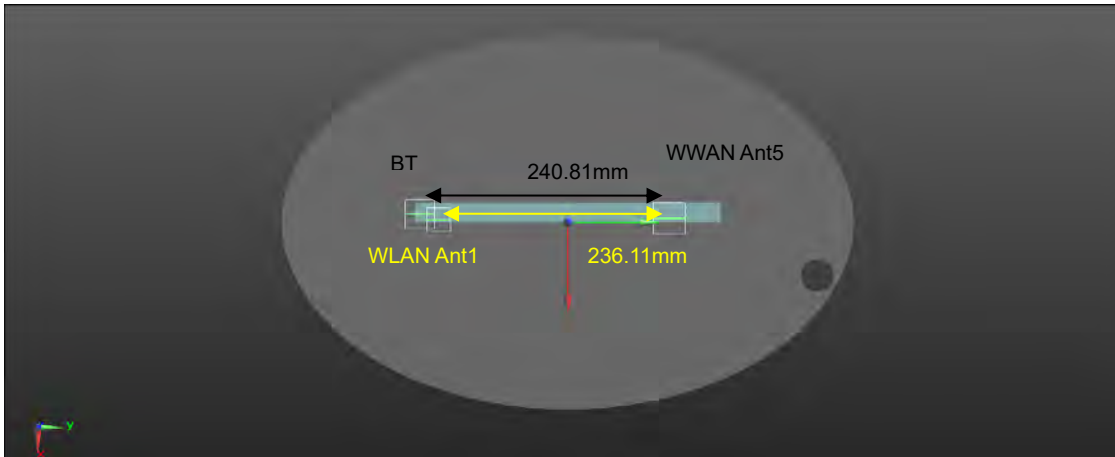

WLAN 6G Ant1+BT to CAT.M1 Band85

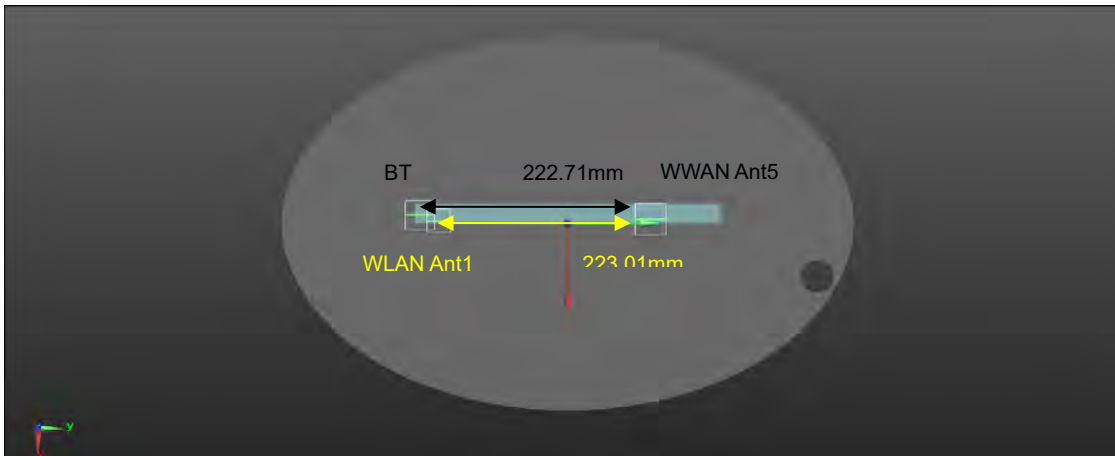

Unless otherwise stated the results shown in this test report refer only to the sample(s) tested and such sample(s) are retained for 90 days only.

除非另有說明，此報告結果僅對測試之樣品負責，同時此樣品僅保留90天。本報告未經本公司書面許可，不可部份複製。

This document is issued by the Company subject to its General Conditions of Service printed overleaf, available on request or accessible at <http://www.sgs.com.tw/Terms-and-Conditions> and for electronic format documents, subject to Terms and Conditions for Electronic Documents at <http://www.sgs.com.tw/Terms-and-Conditions>. Attention is drawn to the limitation of liability, indemnification and jurisdiction issues defined therein. Any holder of this document is advised that information contained hereon reflects the Company's findings at the time of its intervention only and within the limits of Client's instructions, if any. The Company's sole responsibility is to its Client and this document does not exonerate parties to a transaction from exercising all their rights and obligations under the transaction documents. This document cannot be reproduced except in full, without prior written approval of the Company. Any unauthorized alteration, forgery or falsification of the content or appearance of this document is unlawful and offenders may be prosecuted to the fullest extent of the law.

Scenario 3:									
Position	Conditions	SAR Value (W/kg)	Coordinates (cm)			ΣSAR (W/kg)	Peak Location Separation Distance (mm)	SPLSR	Simultaneous Transmission SAR Test
			x	y	z				
Top edge	WLAN 6G Ant2	1.370	-0.53	-5.33	-0.30	-	-	-	-
	GPRS 850	1.053	-0.45	10.69	-0.31	2.423	160.20	0.024	SPLSR ≤ 0.04, Not required
	GPRS 1900	0.939	-0.30	9.92	-0.32	2.309	152.52	0.023	SPLSR ≤ 0.04, Not required
	CAT.M1 Band 2	0.078	-0.44	10.07	-0.30	1.448	154.00	0.011	SPLSR ≤ 0.04, Not required
	CAT.M1 Band 4	0.078	-0.45	9.76	-0.31	1.448	150.90	0.012	SPLSR ≤ 0.04, Not required
	CAT.M1 Band 5	0.057	-0.61	10.85	-0.31	1.427	161.80	0.011	SPLSR ≤ 0.04, Not required
	CAT.M1 Band 12	0.045	-0.45	8.45	-0.31	1.415	137.80	0.012	SPLSR ≤ 0.04, Not required
	CAT.M1 Band 13	0.060	-0.45	10.85	-0.31	1.430	161.80	0.011	SPLSR ≤ 0.04, Not required
	CAT.M1 Band 14	0.053	-0.45	10.85	-0.31	1.423	161.80	0.010	SPLSR ≤ 0.04, Not required
	CAT.M1 Band 25	0.089	-0.44	10.21	-0.31	1.459	155.40	0.011	SPLSR ≤ 0.04, Not required
	CAT.M1 Band 26_FCC	0.056	-0.61	10.85	-0.30	1.426	161.80	0.011	SPLSR ≤ 0.04, Not required
	CAT.M1 Band 66	0.104	-0.45	9.76	-0.31	1.474	150.90	0.012	SPLSR ≤ 0.04, Not required
	CAT.M1 Band 85	0.214	-0.45	8.45	-0.31	1.584	137.80	0.014	SPLSR ≤ 0.04, Not required

Unless otherwise stated the results shown in this test report refer only to the sample(s) tested and such sample(s) are retained for 90 days only.

除非另有說明，此報告結果僅對測試之樣品負責，同時此樣品僅保留90天。本報告未經本公司書面許可，不可部份複製。

This document is issued by the Company subject to its General Conditions of Service printed overleaf, available on request or accessible at <http://www.sgs.com.tw/Terms-and-Conditions>, and for electronic format documents, subject to Terms and Conditions for Electronic Documents at <http://www.sgs.com.tw/Terms-and-Conditions>. Attention is drawn to the limitation of liability, indemnification and jurisdiction issues defined therein. Any holder of this document is advised that information contained hereon reflects the Company's findings at the time of its intervention only and within the limits of Client's instructions, if any. The Company's sole responsibility is to its Client and this document does not exonerate parties to a transaction from exercising all their rights and obligations under the transaction documents. This document cannot be reproduced except in full, without prior written approval of the Company. Any unauthorized alteration, forgery or falsification of the content or appearance of this document is unlawful and offenders may be prosecuted to the fullest extent of the law.

WLAN 6G Ant2 to GPRS 850

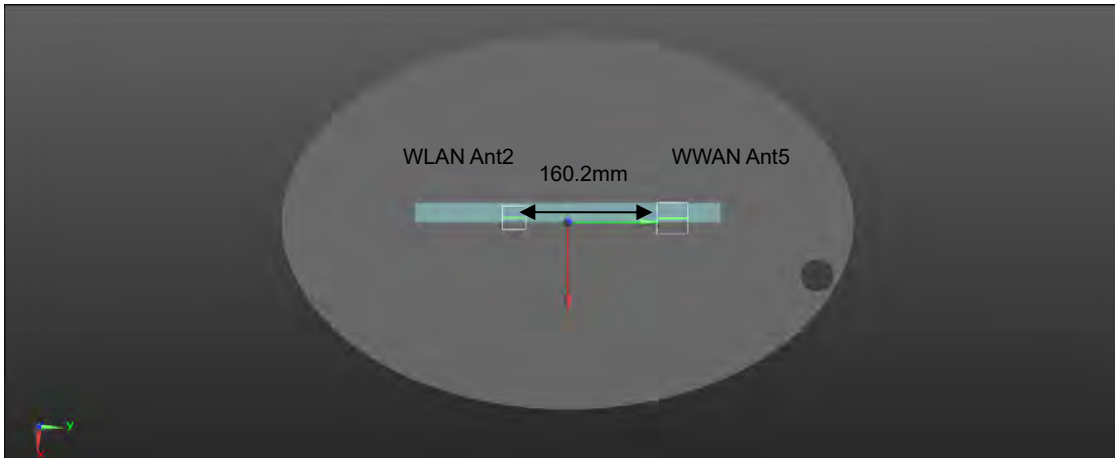

WLAN 6G Ant2 to GPRS 1900

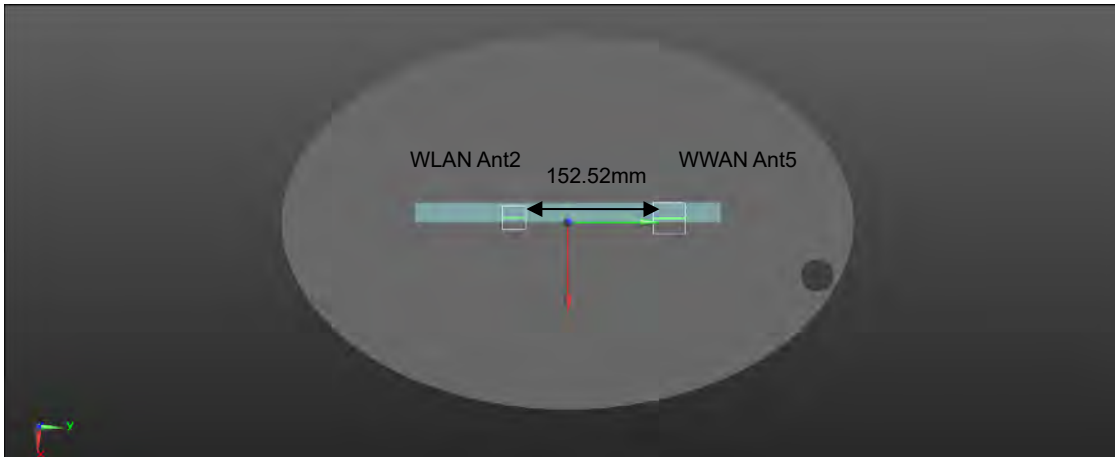

WLAN 6G Ant2 to CAT.M1 Band2

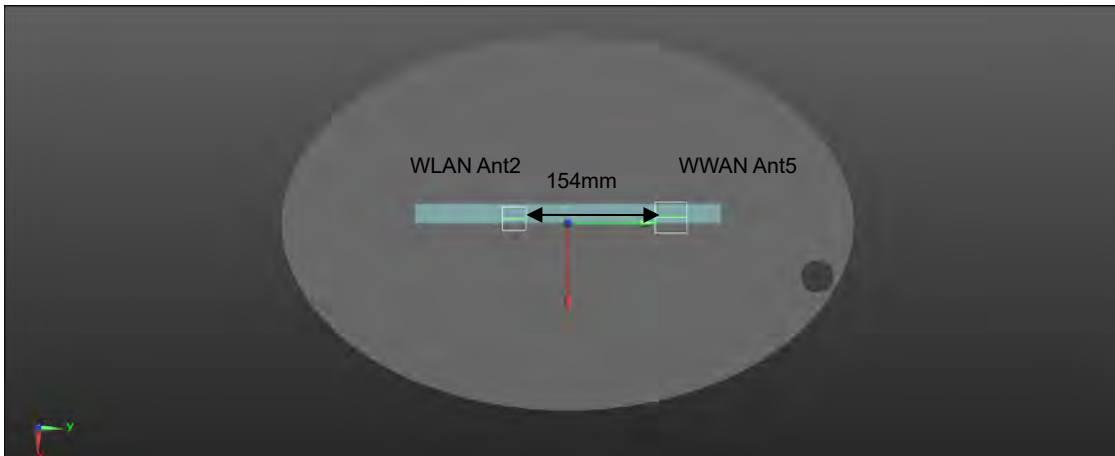

Unless otherwise stated the results shown in this test report refer only to the sample(s) tested and such sample(s) are retained for 90 days only.

除非另有說明，此報告結果僅對測試之樣品負責，同時此樣品僅保留90天。本報告未經本公司書面許可，不可部份複製。

This document is issued by the Company subject to its General Conditions of Service printed overleaf, available on request or accessible at <http://www.sgs.com.tw/Terms-and-Conditions> and for electronic format documents, subject to Terms and Conditions for Electronic Documents at <http://www.sgs.com.tw/Terms-and-Conditions>. Attention is drawn to the limitation of liability, indemnification and jurisdiction issues defined therein. Any holder of this document is advised that information contained hereon reflects the Company's findings at the time of its intervention only and within the limits of Client's instructions, if any. The Company's sole responsibility is to its Client and this document does not exonerate parties to a transaction from exercising all their rights and obligations under the transaction documents. This document cannot be reproduced except in full, without prior written approval of the Company. Any unauthorized alteration, forgery or falsification of the content or appearance of this document is unlawful and offenders may be prosecuted to the fullest extent of the law.

WLAN 6G Ant2 to CAT.M1 Band4

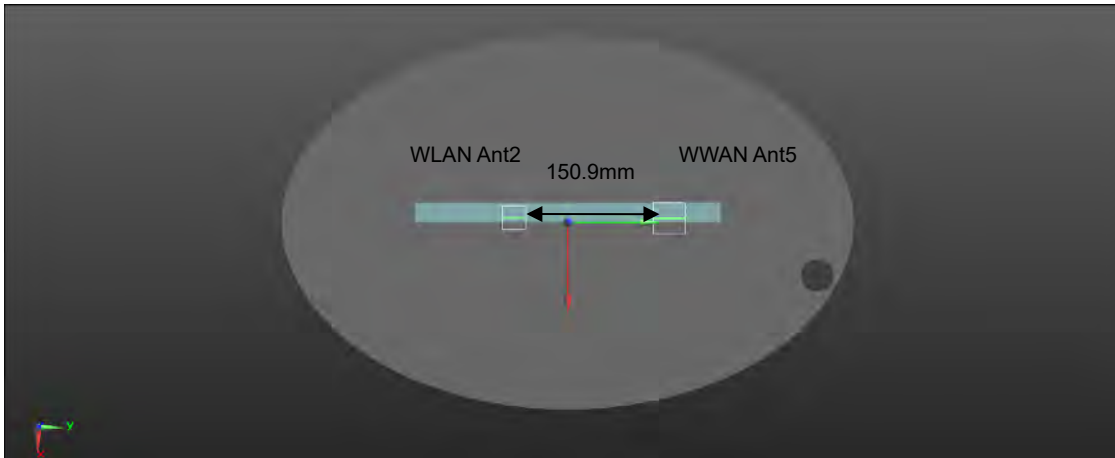

WLAN 6G Ant2 to CAT.M1 Band5

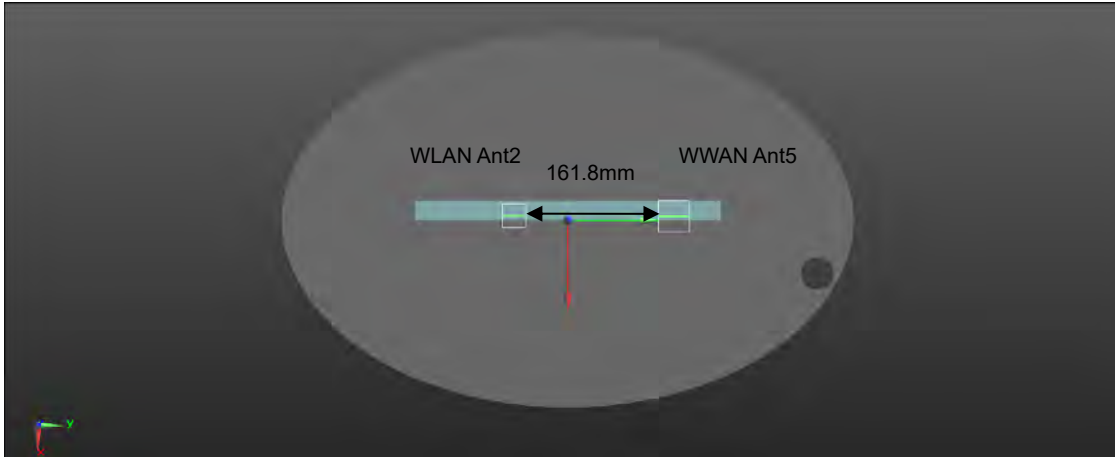

WLAN 6G Ant2 to CAT.M1 Band12

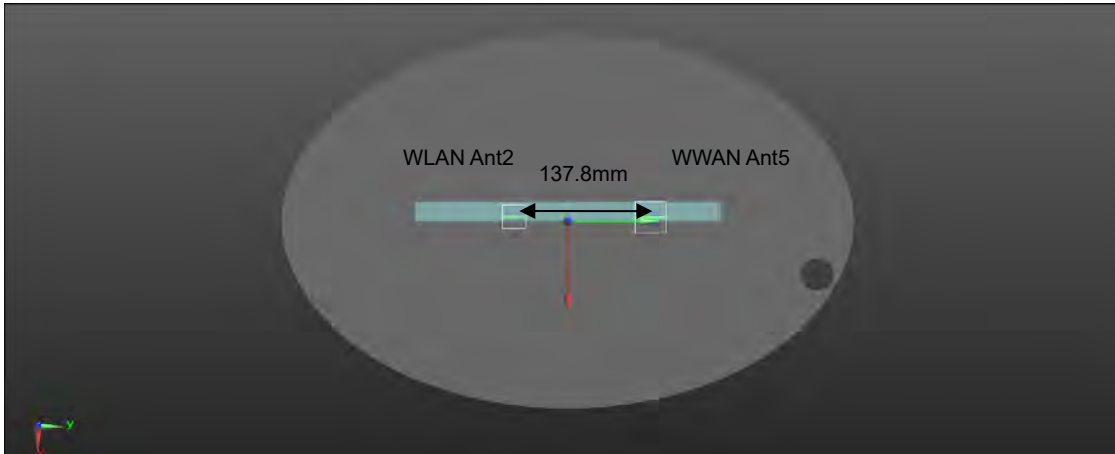

Unless otherwise stated the results shown in this test report refer only to the sample(s) tested and such sample(s) are retained for 90 days only.

除非另有說明，此報告結果僅對測試之樣品負責，同時此樣品僅保留90天。本報告未經本公司書面許可，不可部份複製。

This document is issued by the Company subject to its General Conditions of Service printed overleaf, available on request or accessible at <http://www.sgs.com.tw/Terms-and-Conditions> and for electronic format documents, subject to Terms and Conditions for Electronic Documents at <http://www.sgs.com.tw/Terms-and-Conditions>. Attention is drawn to the limitation of liability, indemnification and jurisdiction issues defined therein. Any holder of this document is advised that information contained hereon reflects the Company's findings at the time of its intervention only and within the limits of Client's instructions, if any. The Company's sole responsibility is to its Client and this document does not exonerate parties to a transaction from exercising all their rights and obligations under the transaction documents. This document cannot be reproduced except in full, without prior written approval of the Company. Any unauthorized alteration, forgery or falsification of the content or appearance of this document is unlawful and offenders may be prosecuted to the fullest extent of the law.

WLAN 6G Ant2 to CAT.M1 Band13

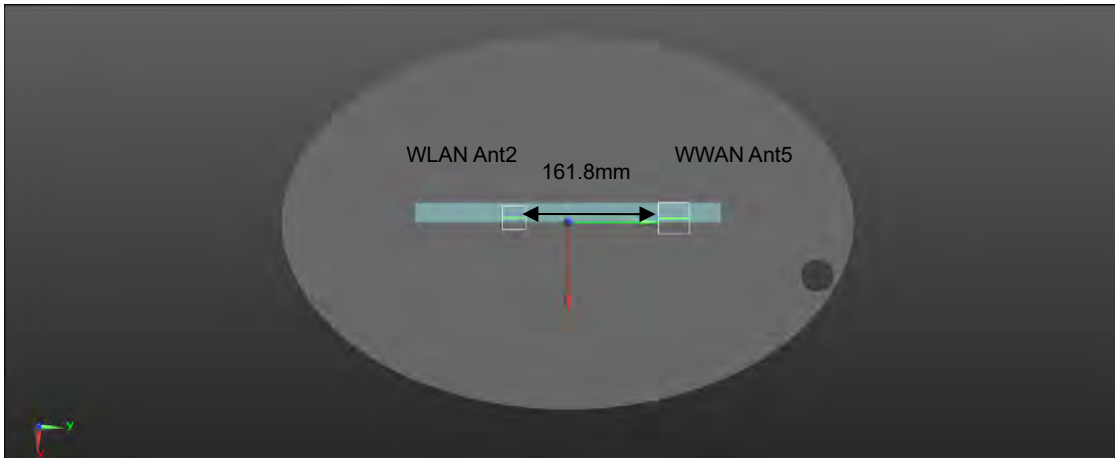

WLAN 6G Ant2 to CAT.M1 Band14

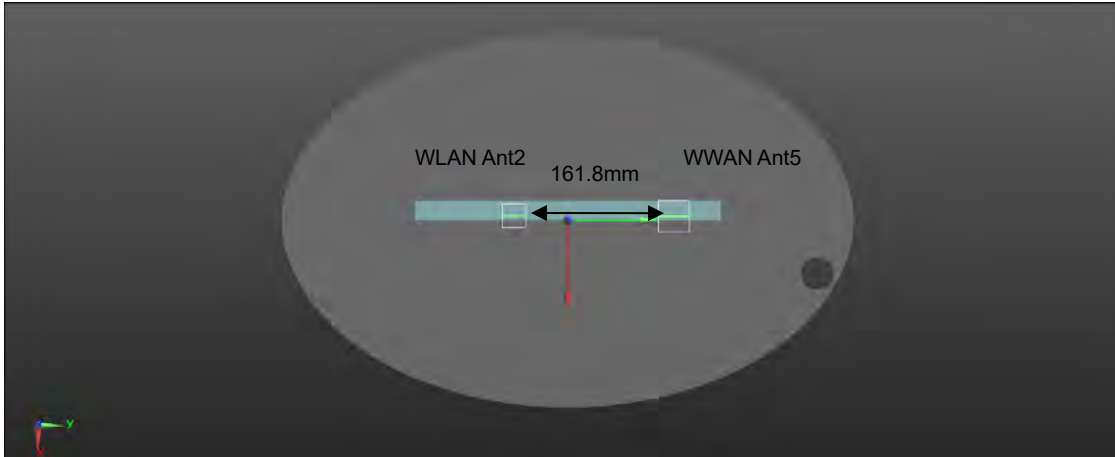

WLAN 6G Ant2 to CAT.M1 Band25

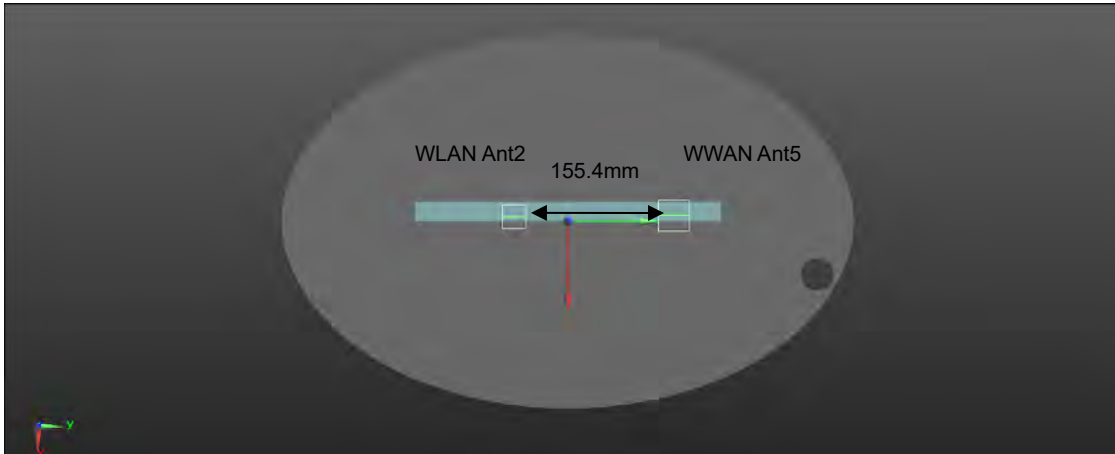

Unless otherwise stated the results shown in this test report refer only to the sample(s) tested and such sample(s) are retained for 90 days only.

除非另有說明，此報告結果僅對測試之樣品負責，同時此樣品僅保留90天。本報告未經本公司書面許可，不可部份複製。

This document is issued by the Company subject to its General Conditions of Service printed overleaf, available on request or accessible at <http://www.sgs.com.tw/Terms-and-Conditions> and for electronic format documents, subject to Terms and Conditions for Electronic Documents at <http://www.sgs.com.tw/Terms-and-Conditions>. Attention is drawn to the limitation of liability, indemnification and jurisdiction issues defined therein. Any holder of this document is advised that information contained hereon reflects the Company's findings at the time of its intervention only and within the limits of Client's instructions, if any. The Company's sole responsibility is to its Client and this document does not exonerate parties to a transaction from exercising all their rights and obligations under the transaction documents. This document cannot be reproduced except in full, without prior written approval of the Company. Any unauthorized alteration, forgery or falsification of the content or appearance of this document is unlawful and offenders may be prosecuted to the fullest extent of the law.

WLAN 6G Ant2 to CAT.M1 Band26 FCC

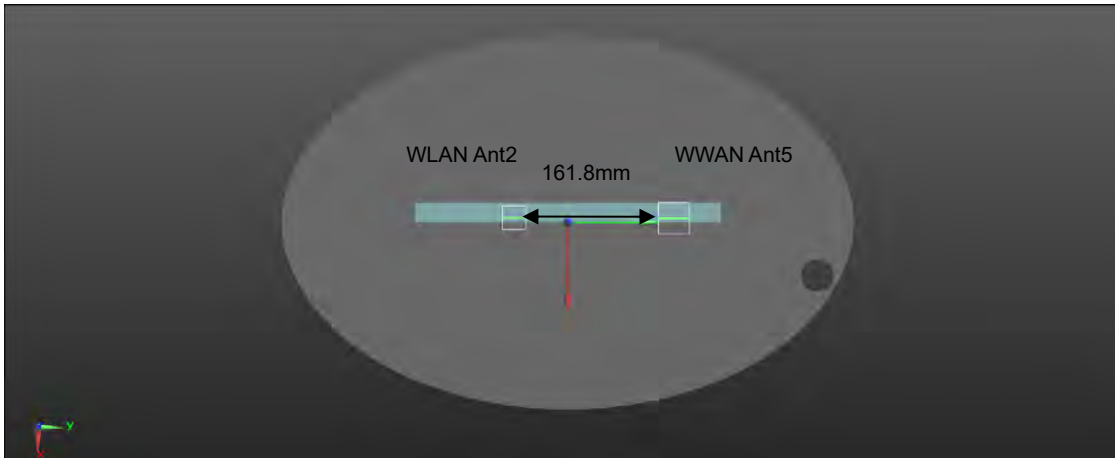

WLAN 6G Ant2 to CAT.M1 Band66

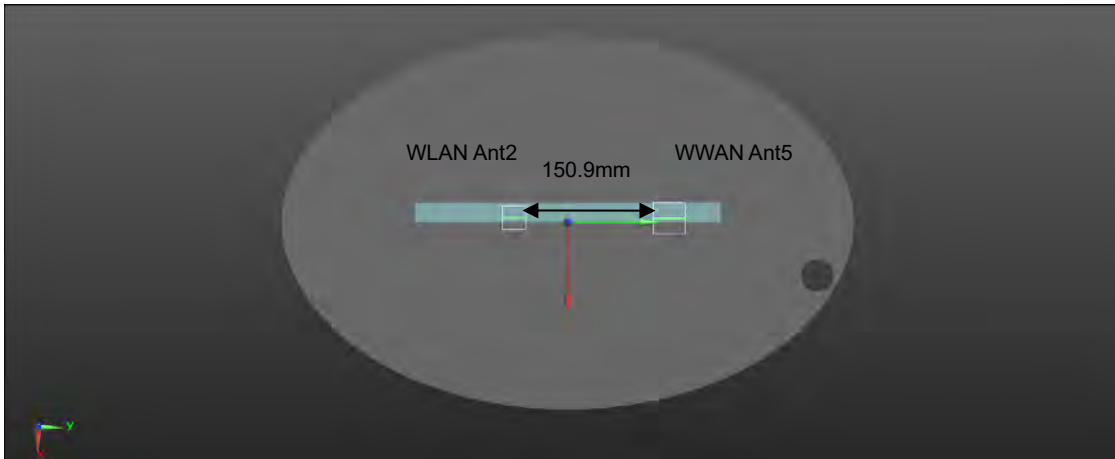

WLAN 6G Ant2 to CAT.M1 Band85

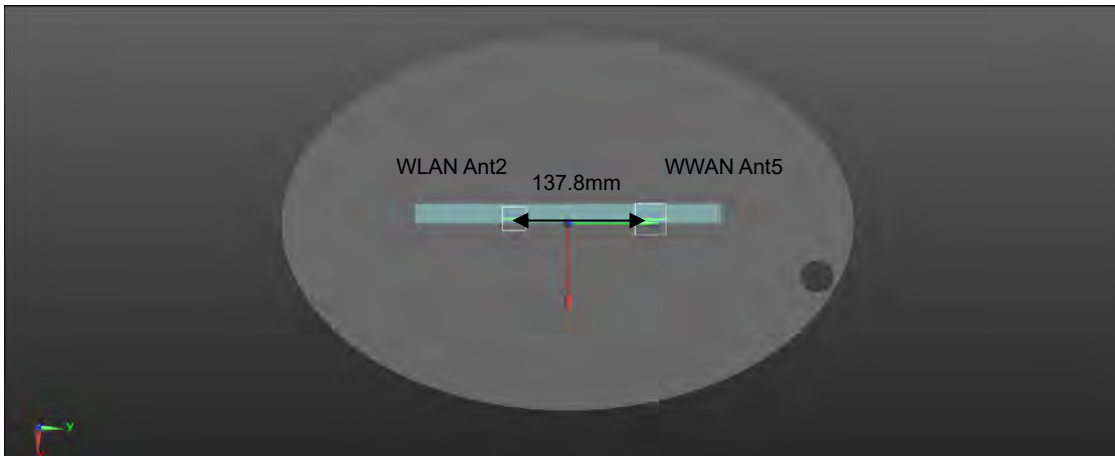

Unless otherwise stated the results shown in this test report refer only to the sample(s) tested and such sample(s) are retained for 90 days only.

除非另有說明，此報告結果僅對測試之樣品負責，同時此樣品僅保留90天。本報告未經本公司書面許可，不可部份複製。

This document is issued by the Company subject to its General Conditions of Service printed overleaf, available on request or accessible at <http://www.sgs.com.tw/Terms-and-Conditions> and for electronic format documents, subject to Terms and Conditions for Electronic Documents at <http://www.sgs.com.tw/Terms-and-Conditions>. Attention is drawn to the limitation of liability, indemnification and jurisdiction issues defined therein. Any holder of this document is advised that information contained hereon reflects the Company's findings at the time of its intervention only and within the limits of Client's instructions, if any. The Company's sole responsibility is to its Client and this document does not exonerate parties to a transaction from exercising all their rights and obligations under the transaction documents. This document cannot be reproduced except in full, without prior written approval of the Company. Any unauthorized alteration, forgery or falsification of the content or appearance of this document is unlawful and offenders may be prosecuted to the fullest extent of the law.

SPLSR Vendor2

Scenario 1:									
Position	Conditions	SAR Value (W/kg)	Coordinates (cm)			ΣSAR (W/kg)	Peak Location Separation Distance (mm)	SPLSR	Simultaneous Transmission SAR Test
			x	y	z				
	WLAN 2.4G Ant1	0.710	-0.40	-12.64	-2.93	-	-	-	-
	GPRS 850	1.194	-0.46	10.70	-0.31	1.904	234.87	0.011	SPLSR ≤ 0.04, Not required
	GPRS 1900	1.022	-0.45	10.85	-0.30	1.732	236.36	0.010	SPLSR ≤ 0.04, Not required
	CAT.M1 Band 2	0.090	-0.28	11.00	-0.30	0.800	237.86	0.003	SPLSR ≤ 0.04, Not required
	CAT.M1 Band 4	0.103	-0.29	10.06	-0.31	0.813	228.52	0.003	SPLSR ≤ 0.04, Not required
	CAT.M1 Band 5	0.078	-0.31	10.69	-0.31	0.788	234.77	0.003	SPLSR ≤ 0.04, Not required
	CAT.M1 Band 12	0.050	-0.31	8.13	-0.31	0.760	209.35	0.003	SPLSR ≤ 0.04, Not required
	CAT.M1 Band 13	0.066	-0.31	10.69	-0.30	0.776	234.77	0.003	SPLSR ≤ 0.04, Not required
	CAT.M1 Band 14	0.067	-0.31	10.69	-0.30	0.777	234.77	0.003	SPLSR ≤ 0.04, Not required
	CAT.M1 Band 25	0.103	-0.29	11.17	-0.31	0.813	239.55	0.003	SPLSR ≤ 0.04, Not required
	CAT.M1 Band 26_FCC	0.081	-0.31	10.69	-0.31	0.791	234.77	0.003	SPLSR ≤ 0.04, Not required
	CAT.M1 Band 66	0.125	-0.30	10.25	-0.30	0.835	230.40	0.003	SPLSR ≤ 0.04, Not required
	CAT.M1 Band 85	0.260	-0.16	10.53	-0.31	0.970	233.19	0.004	SPLSR ≤ 0.04, Not required

Unless otherwise stated the results shown in this test report refer only to the sample(s) tested and such sample(s) are retained for 90 days only.

除非另有說明，此報告結果僅對測試之樣品負責，同時此樣品僅保留90天。本報告未經本公司書面許可，不可部份複製。

This document is issued by the Company subject to its General Conditions of Service printed overleaf, available on request or accessible at <http://www.sgs.com.tw/Terms-and-Conditions>, and for electronic format documents, subject to Terms and Conditions for Electronic Documents at <http://www.sgs.com.tw/Terms-and-Conditions>. Attention is drawn to the limitation of liability, indemnification and jurisdiction issues defined therein. Any holder of this document is advised that information contained hereon reflects the Company's findings at the time of its intervention only and within the limits of Client's instructions, if any. The Company's sole responsibility is to its Client and this document does not exonerate parties to a transaction from exercising all their rights and obligations under the transaction documents. This document cannot be reproduced except in full, without prior written approval of the Company. Any unauthorized alteration, forgery or falsification of the content or appearance of this document is unlawful and offenders may be prosecuted to the fullest extent of the law.

WLAN 2.4G Ant1 to GPRS 850

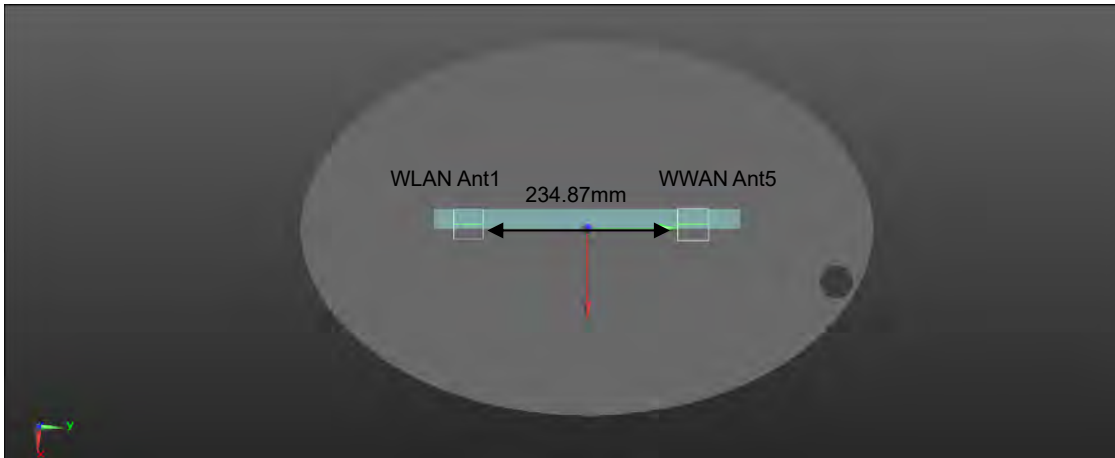

WLAN 2.4G Ant1 to GPRS 1900

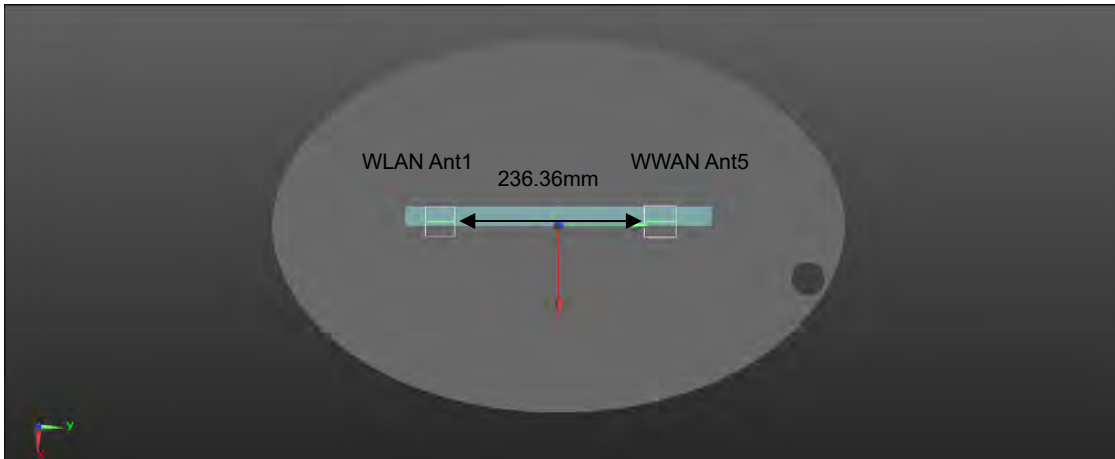

WLAN 2.4G Ant1 to CAT.M1 Band 2

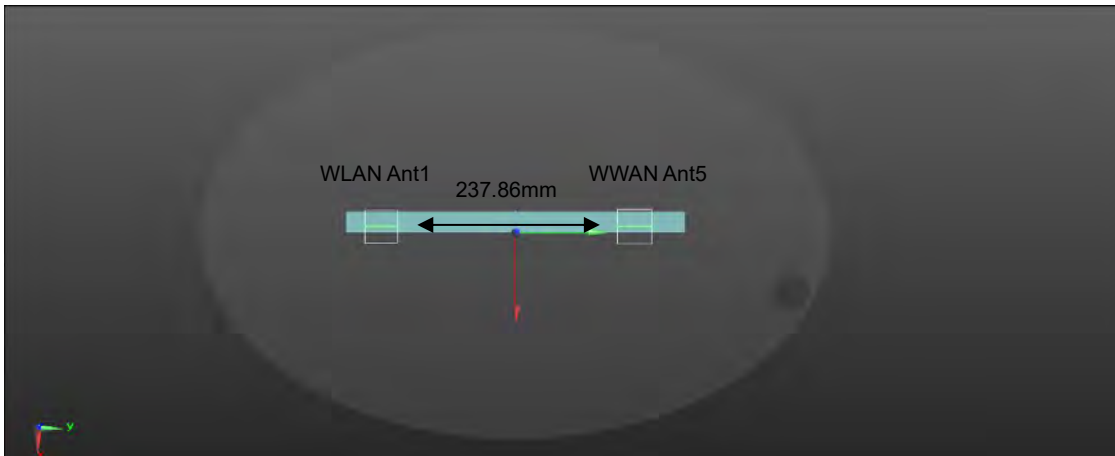

Unless otherwise stated the results shown in this test report refer only to the sample(s) tested and such sample(s) are retained for 90 days only.

除非另有說明，此報告結果僅對測試之樣品負責，同時此樣品僅保留90天。本報告未經本公司書面許可，不可部份複製。

This document is issued by the Company subject to its General Conditions of Service printed overleaf, available on request or accessible at <http://www.sgs.com.tw/Terms-and-Conditions> and for electronic format documents, subject to Terms and Conditions for Electronic Documents at <http://www.sgs.com.tw/Terms-and-Conditions>. Attention is drawn to the limitation of liability, indemnification and jurisdiction issues defined therein. Any holder of this document is advised that information contained hereon reflects the Company's findings at the time of its intervention only and within the limits of Client's instructions, if any. The Company's sole responsibility is to its Client and this document does not exonerate parties to a transaction from exercising all their rights and obligations under the transaction documents. This document cannot be reproduced except in full, without prior written approval of the Company. Any unauthorized alteration, forgery or falsification of the content or appearance of this document is unlawful and offenders may be prosecuted to the fullest extent of the law.

WLAN 2.4G Ant1 to CAT.M1 Band 4

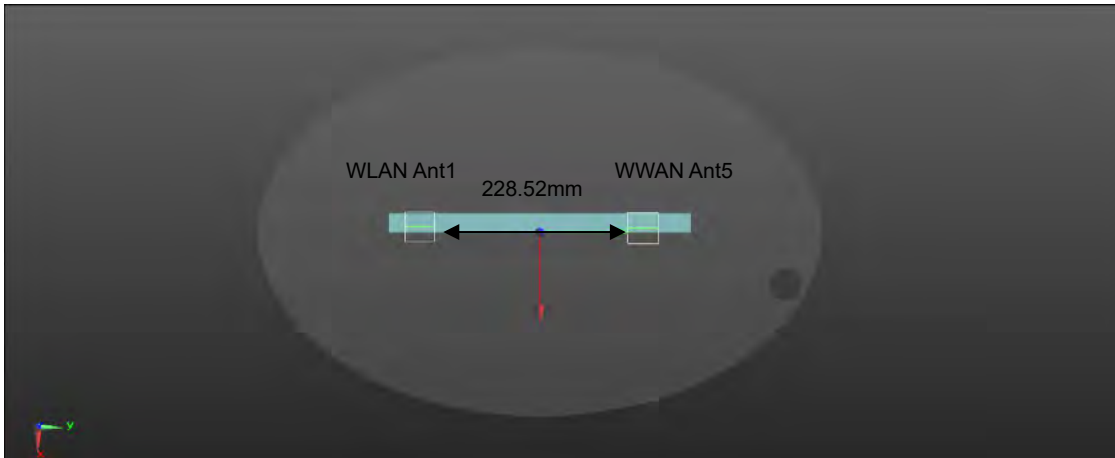

WLAN 2.4G Ant1 to CAT.M1 Band 5

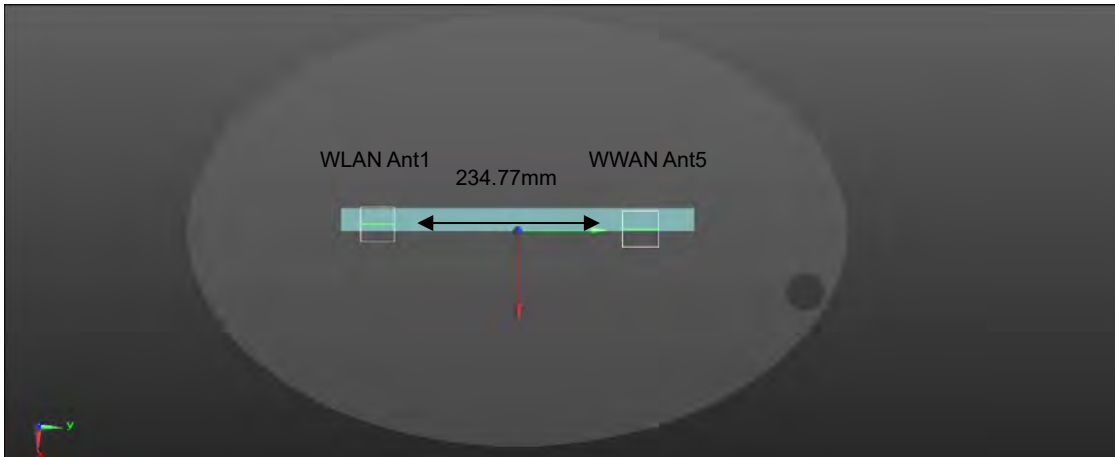

WLAN 2.4G Ant1 to CAT.M1 Band 12

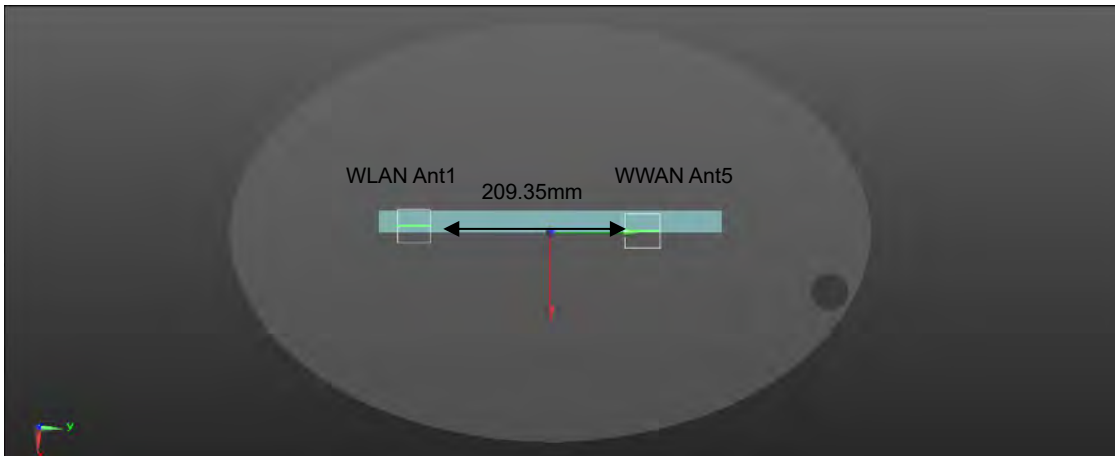

Unless otherwise stated the results shown in this test report refer only to the sample(s) tested and such sample(s) are retained for 90 days only.

除非另有說明，此報告結果僅對測試之樣品負責，同時此樣品僅保留90天。本報告未經本公司書面許可，不可部份複製。

This document is issued by the Company subject to its General Conditions of Service printed overleaf, available on request or accessible at <http://www.sgs.com.tw/Terms-and-Conditions> and for electronic format documents, subject to Terms and Conditions for Electronic Documents at <http://www.sgs.com.tw/Terms-and-Conditions>. Attention is drawn to the limitation of liability, indemnification and jurisdiction issues defined therein. Any holder of this document is advised that information contained hereon reflects the Company's findings at the time of its intervention only and within the limits of Client's instructions, if any. The Company's sole responsibility is to its Client and this document does not exonerate parties to a transaction from exercising all their rights and obligations under the transaction documents. This document cannot be reproduced except in full, without prior written approval of the Company. Any unauthorized alteration, forgery or falsification of the content or appearance of this document is unlawful and offenders may be prosecuted to the fullest extent of the law.

WLAN 2.4G Ant1 to CAT.M1 Band 13

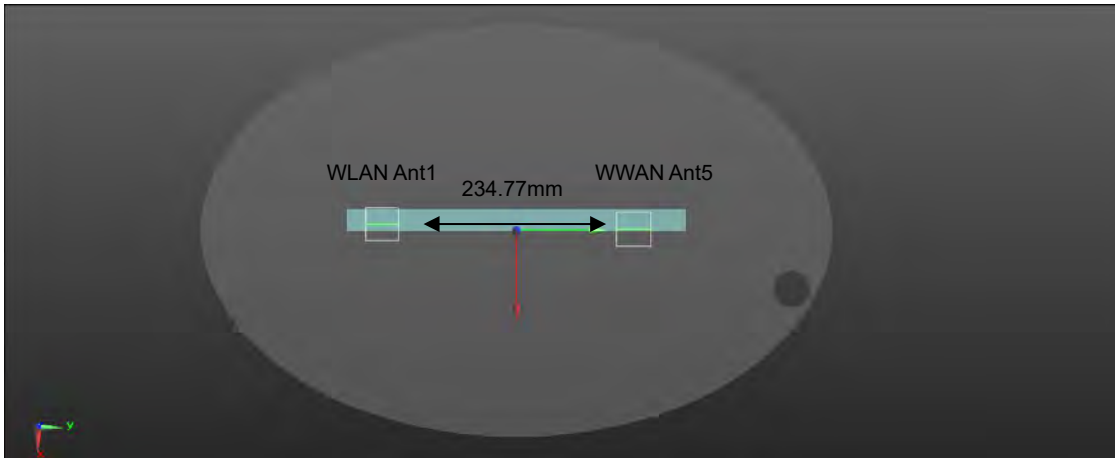

WLAN 2.4G Ant1 to CAT.M1 Band 14

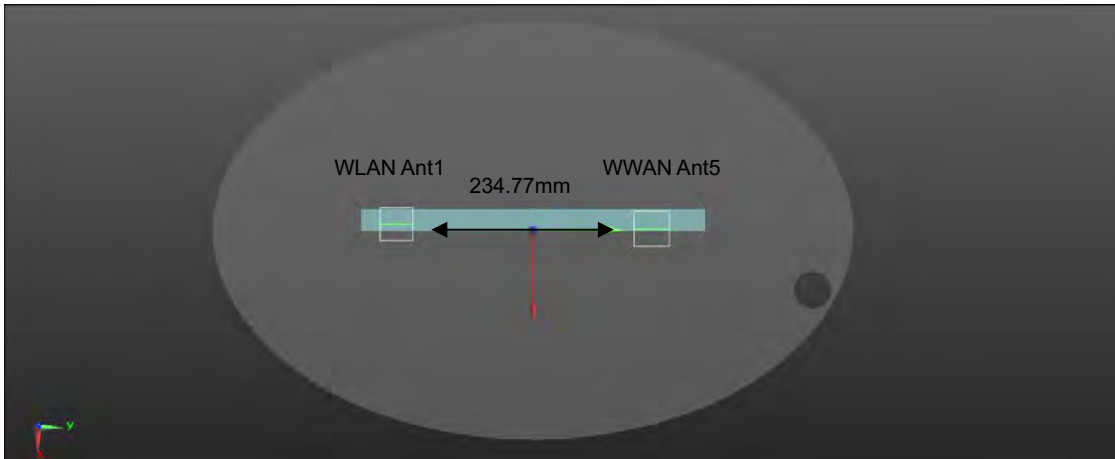

WLAN 2.4G Ant1 to CAT.M1 Band 25

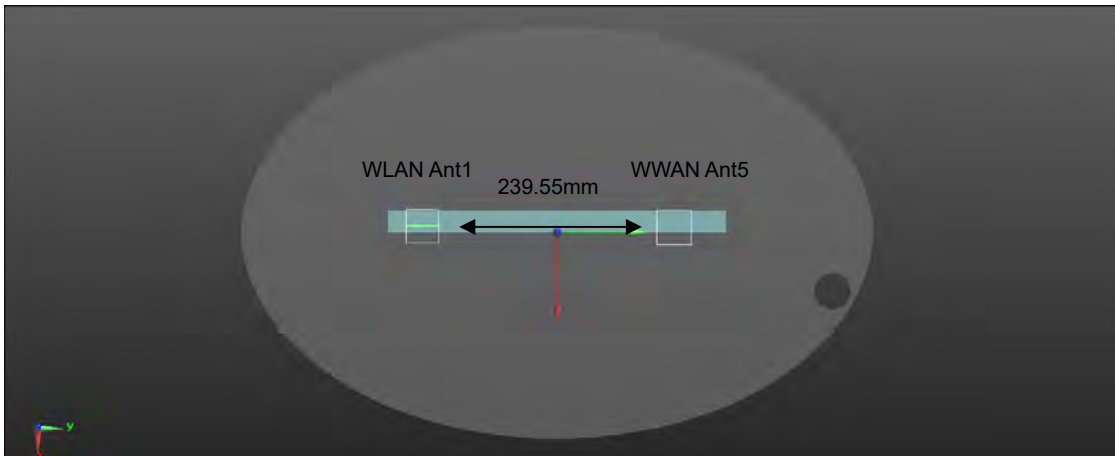

Unless otherwise stated the results shown in this test report refer only to the sample(s) tested and such sample(s) are retained for 90 days only.

除非另有說明，此報告結果僅對測試之樣品負責，同時此樣品僅保留90天。本報告未經本公司書面許可，不可部份複製。

This document is issued by the Company subject to its General Conditions of Service printed overleaf, available on request or accessible at <http://www.sgs.com.tw/Terms-and-Conditions> and for electronic format documents, subject to Terms and Conditions for Electronic Documents at <http://www.sgs.com.tw/Terms-and-Conditions>. Attention is drawn to the limitation of liability, indemnification and jurisdiction issues defined therein. Any holder of this document is advised that information contained hereon reflects the Company's findings at the time of its intervention only and within the limits of Client's instructions, if any. The Company's sole responsibility is to its Client and this document does not exonerate parties to a transaction from exercising all their rights and obligations under the transaction documents. This document cannot be reproduced except in full, without prior written approval of the Company. Any unauthorized alteration, forgery or falsification of the content or appearance of this document is unlawful and offenders may be prosecuted to the fullest extent of the law.

WLAN 2.4G Ant1 to CAT.M1 Band 26 FCC

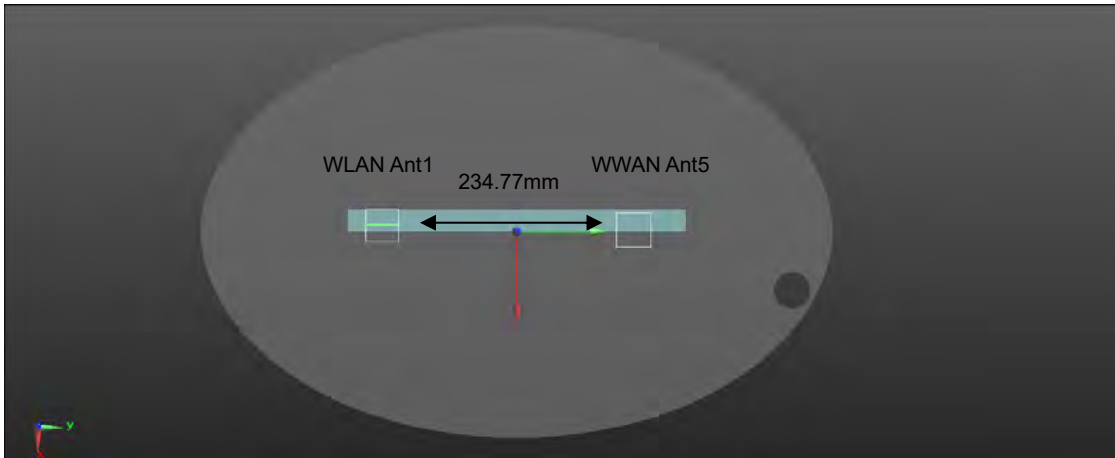

WLAN 2.4G Ant1 to CAT.M1 Band 66

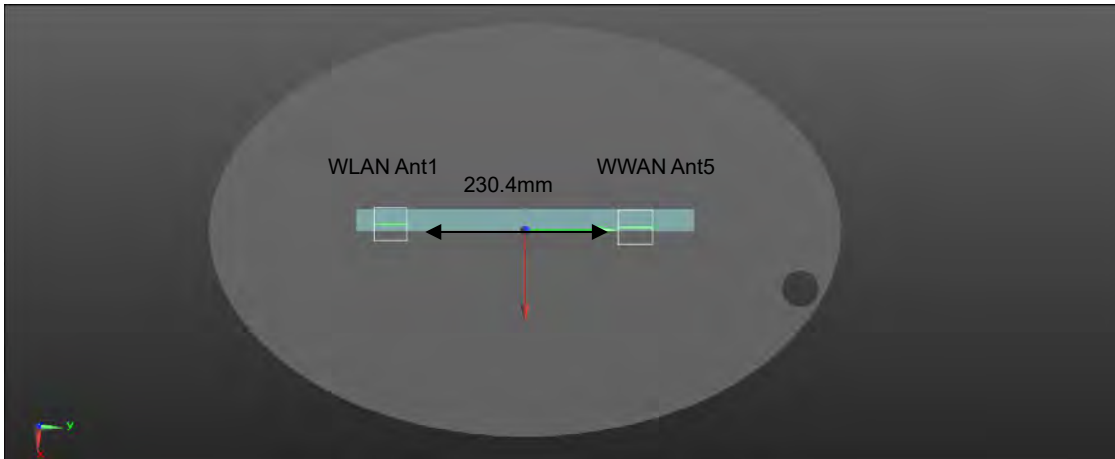

WLAN 2.4G Ant1 to CAT.M1 Band 85

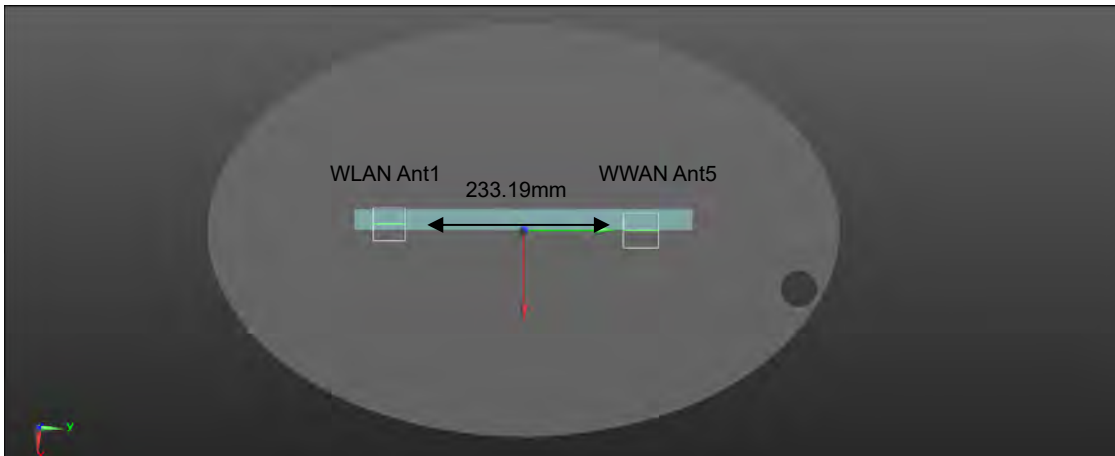

Unless otherwise stated the results shown in this test report refer only to the sample(s) tested and such sample(s) are retained for 90 days only.

除非另有說明，此報告結果僅對測試之樣品負責，同時此樣品僅保留90天。本報告未經本公司書面許可，不可部份複製。

This document is issued by the Company subject to its General Conditions of Service printed overleaf, available on request or accessible at <http://www.sgs.com.tw/Terms-and-Conditions> and for electronic format documents, subject to Terms and Conditions for Electronic Documents at <http://www.sgs.com.tw/Terms-and-Conditions>. Attention is drawn to the limitation of liability, indemnification and jurisdiction issues defined therein. Any holder of this document is advised that information contained hereon reflects the Company's findings at the time of its intervention only and within the limits of Client's instructions, if any. The Company's sole responsibility is to its Client and this document does not exonerate parties to a transaction from exercising all their rights and obligations under the transaction documents. This document cannot be reproduced except in full, without prior written approval of the Company. Any unauthorized alteration, forgery or falsification of the content or appearance of this document is unlawful and offenders may be prosecuted to the fullest extent of the law.

Scenario 1:									
Position	Conditions	SAR Value (W/kg)	Coordinates (cm)			ΣSAR (W/kg)	Peak Location Separation Distance (mm)	SPLSR	Simultaneous Transmission SAR Test
			x	y	z				
Top edge	WLAN 2.4G Ant2	0.940	-0.50	-5.18	-0.32	-	-	-	-
	GPRS 850	1.194	-0.46	10.70	-0.31	2.134	158.80	0.020	SPLSR ≤ 0.04, Not required
	GPRS 1900	1.022	-0.45	10.85	-0.30	1.962	160.30	0.017	SPLSR ≤ 0.04, Not required
	CAT.M1 Band 2	0.090	-0.28	11.00	-0.30	1.030	161.82	0.006	SPLSR ≤ 0.04, Not required
	CAT.M1 Band 4	0.103	-0.29	10.06	-0.31	1.043	152.41	0.007	SPLSR ≤ 0.04, Not required
	CAT.M1 Band 5	0.078	-0.31	10.69	-0.31	1.018	158.71	0.006	SPLSR ≤ 0.04, Not required
	CAT.M1 Band 12	0.050	-0.31	8.13	-0.31	0.990	133.11	0.007	SPLSR ≤ 0.04, Not required
	CAT.M1 Band 13	0.066	-0.31	10.69	-0.30	1.006	158.71	0.006	SPLSR ≤ 0.04, Not required
	CAT.M1 Band 14	0.067	-0.31	10.69	-0.30	1.007	158.71	0.006	SPLSR ≤ 0.04, Not required
	CAT.M1 Band 25	0.103	-0.29	11.17	-0.31	1.043	163.51	0.007	SPLSR ≤ 0.04, Not required
	CAT.M1 Band 26_FCC	0.081	-0.31	10.69	-0.31	1.021	158.71	0.007	SPLSR ≤ 0.04, Not required
	CAT.M1 Band 66	0.125	-0.30	10.25	-0.30	1.065	154.31	0.007	SPLSR ≤ 0.04, Not required
	CAT.M1 Band 85	0.260	-0.16	10.53	-0.31	1.200	157.14	0.008	SPLSR ≤ 0.04, Not required

Unless otherwise stated the results shown in this test report refer only to the sample(s) tested and such sample(s) are retained for 90 days only.

除非另有說明，此報告結果僅對測試之樣品負責，同時此樣品僅保留90天。本報告未經本公司書面許可，不可部份複製。

This document is issued by the Company subject to its General Conditions of Service printed overleaf, available on request or accessible at <http://www.sgs.com.tw/Terms-and-Conditions>, and for electronic format documents, subject to Terms and Conditions for Electronic Documents at <http://www.sgs.com.tw/Terms-and-Conditions>. Attention is drawn to the limitation of liability, indemnification and jurisdiction issues defined therein. Any holder of this document is advised that information contained hereon reflects the Company's findings at the time of its intervention only and within the limits of Client's instructions, if any. The Company's sole responsibility is to its Client and this document does not exonerate parties to a transaction from exercising all their rights and obligations under the transaction documents. This document cannot be reproduced except in full, without prior written approval of the Company. Any unauthorized alteration, forgery or falsification of the content or appearance of this document is unlawful and offenders may be prosecuted to the fullest extent of the law.

WLAN 2.4G Ant2 to GPRS 850



WLAN 2.4G Ant2 to GPRS 1900



WLAN 2.4G Ant2 to CAT.M1 Band 2

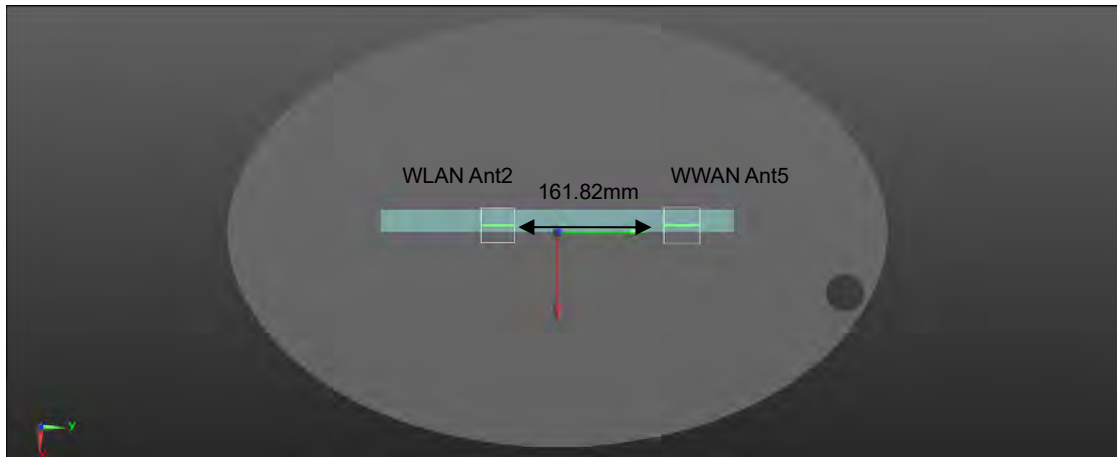

Unless otherwise stated the results shown in this test report refer only to the sample(s) tested and such sample(s) are retained for 90 days only.

除非另有說明，此報告結果僅對測試之樣品負責，同時此樣品僅保留90天。本報告未經本公司書面許可，不可部份複製。

This document is issued by the Company subject to its General Conditions of Service printed overleaf, available on request or accessible at <http://www.sgs.com.tw/Terms-and-Conditions> and for electronic format documents, subject to Terms and Conditions for Electronic Documents at <http://www.sgs.com.tw/Terms-and-Conditions>. Attention is drawn to the limitation of liability, indemnification and jurisdiction issues defined therein. Any holder of this document is advised that information contained hereon reflects the Company's findings at the time of its intervention only and within the limits of Client's instructions, if any. The Company's sole responsibility is to its Client and this document does not exonerate parties to a transaction from exercising all their rights and obligations under the transaction documents. This document cannot be reproduced except in full, without prior written approval of the Company. Any unauthorized alteration, forgery or falsification of the content or appearance of this document is unlawful and offenders may be prosecuted to the fullest extent of the law.

WLAN 2.4G Ant2 to CAT.M1 Band 4

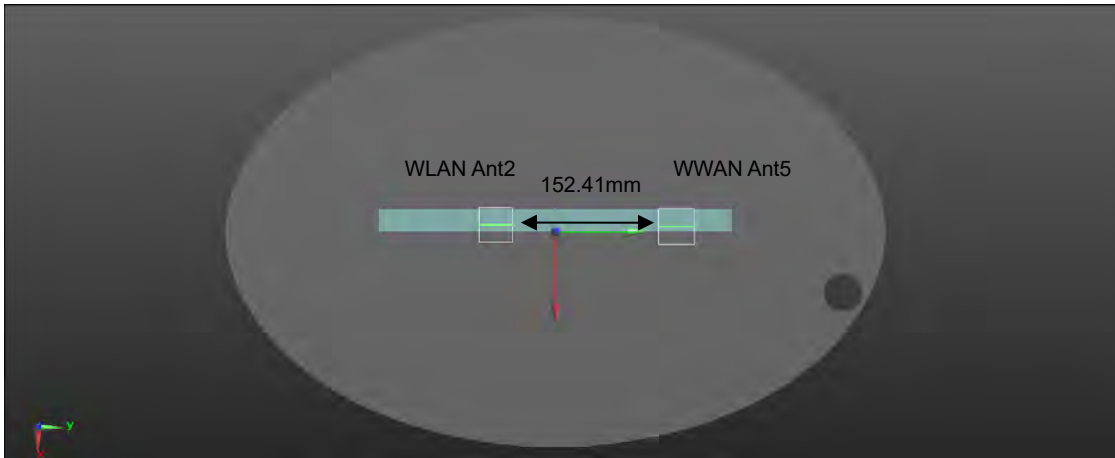

WLAN 2.4G Ant2 to CAT.M1 Band 5

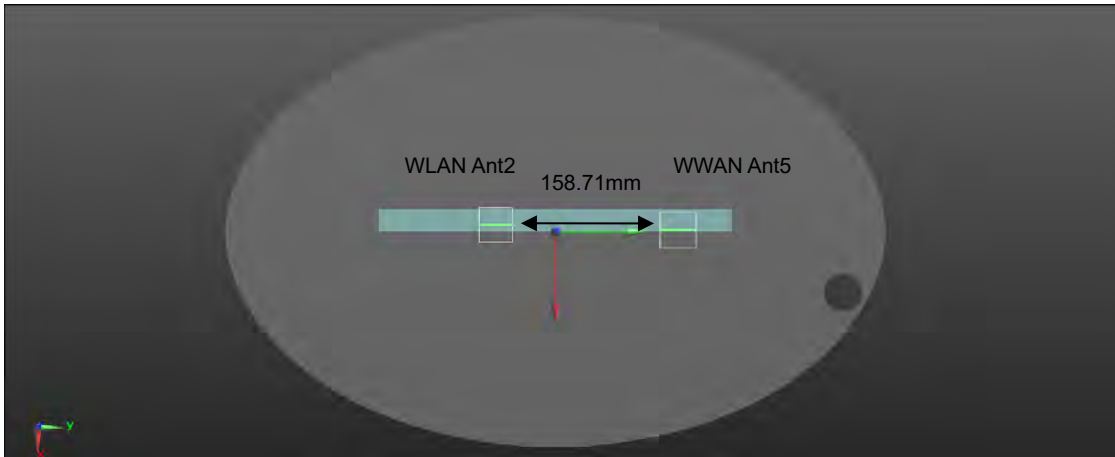

WLAN 2.4G Ant2 to CAT.M1 Band 12

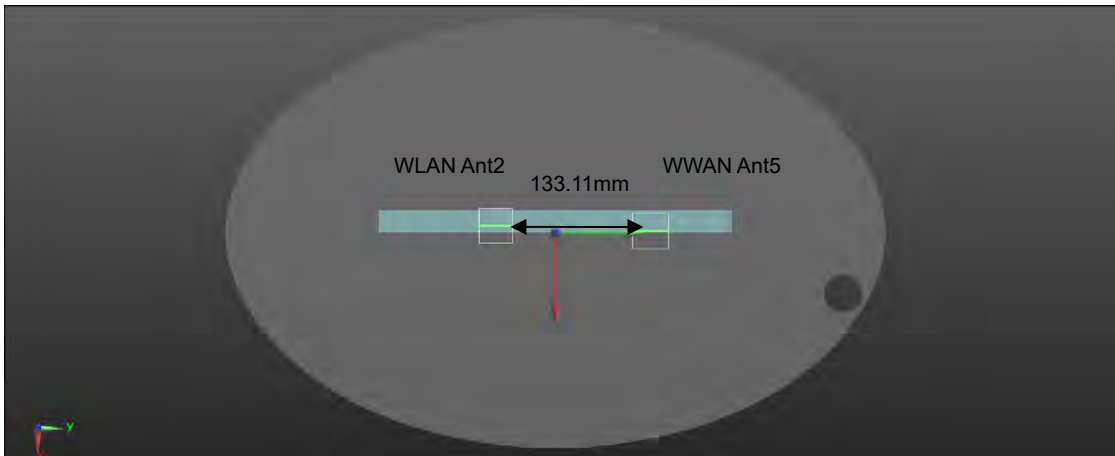

Unless otherwise stated the results shown in this test report refer only to the sample(s) tested and such sample(s) are retained for 90 days only.

除非另有說明，此報告結果僅對測試之樣品負責，同時此樣品僅保留90天。本報告未經本公司書面許可，不可部份複製。

This document is issued by the Company subject to its General Conditions of Service printed overleaf, available on request or accessible at <http://www.sgs.com.tw/Terms-and-Conditions> and for electronic format documents, subject to Terms and Conditions for Electronic Documents at <http://www.sgs.com.tw/Terms-and-Conditions>. Attention is drawn to the limitation of liability, indemnification and jurisdiction issues defined therein. Any holder of this document is advised that information contained hereon reflects the Company's findings at the time of its intervention only and within the limits of Client's instructions, if any. The Company's sole responsibility is to its Client and this document does not exonerate parties to a transaction from exercising all their rights and obligations under the transaction documents. This document cannot be reproduced except in full, without prior written approval of the Company. Any unauthorized alteration, forgery or falsification of the content or appearance of this document is unlawful and offenders may be prosecuted to the fullest extent of the law.

WLAN 2.4G Ant2 to CAT.M1 Band 13

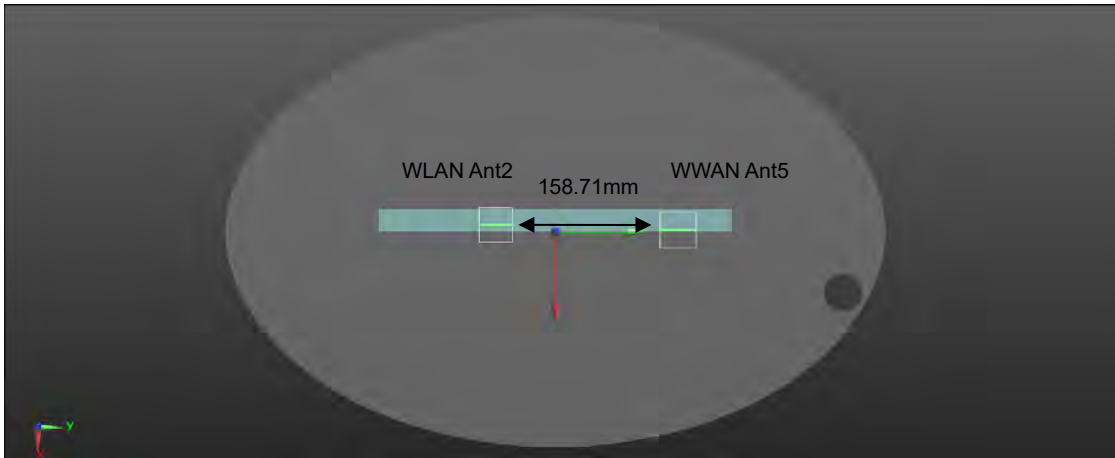

WLAN 2.4G Ant2 to CAT.M1 Band 14

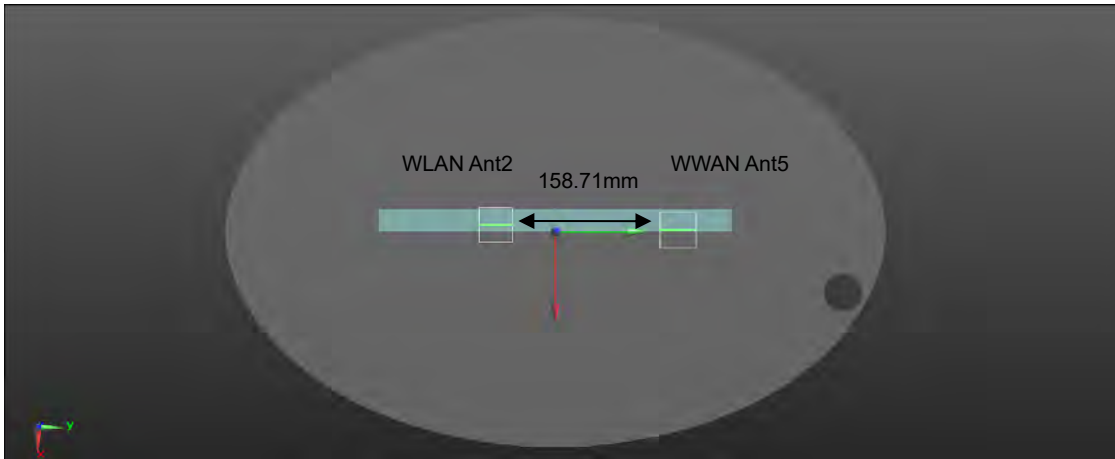

WLAN 2.4G Ant2 to CAT.M1 Band 25

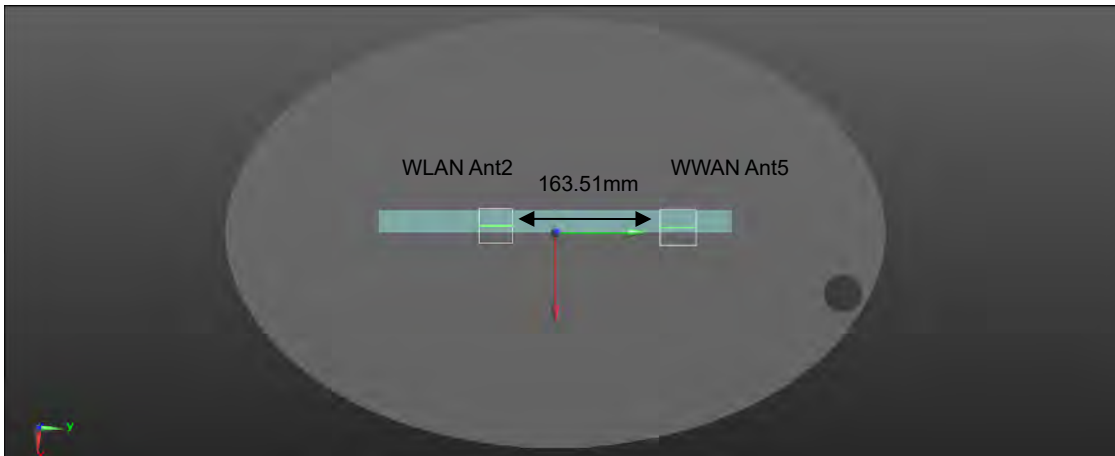

Unless otherwise stated the results shown in this test report refer only to the sample(s) tested and such sample(s) are retained for 90 days only.

除非另有說明，此報告結果僅對測試之樣品負責，同時此樣品僅保留90天。本報告未經本公司書面許可，不可部份複製。

This document is issued by the Company subject to its General Conditions of Service printed overleaf, available on request or accessible at <http://www.sgs.com.tw/Terms-and-Conditions> and for electronic format documents, subject to Terms and Conditions for Electronic Documents at <http://www.sgs.com.tw/Terms-and-Conditions>. Attention is drawn to the limitation of liability, indemnification and jurisdiction issues defined therein. Any holder of this document is advised that information contained hereon reflects the Company's findings at the time of its intervention only and within the limits of Client's instructions, if any. The Company's sole responsibility is to its Client and this document does not exonerate parties to a transaction from exercising all their rights and obligations under the transaction documents. This document cannot be reproduced except in full, without prior written approval of the Company. Any unauthorized alteration, forgery or falsification of the content or appearance of this document is unlawful and offenders may be prosecuted to the fullest extent of the law.

WLAN 2.4G Ant2 to CAT.M1 Band 26 FCC

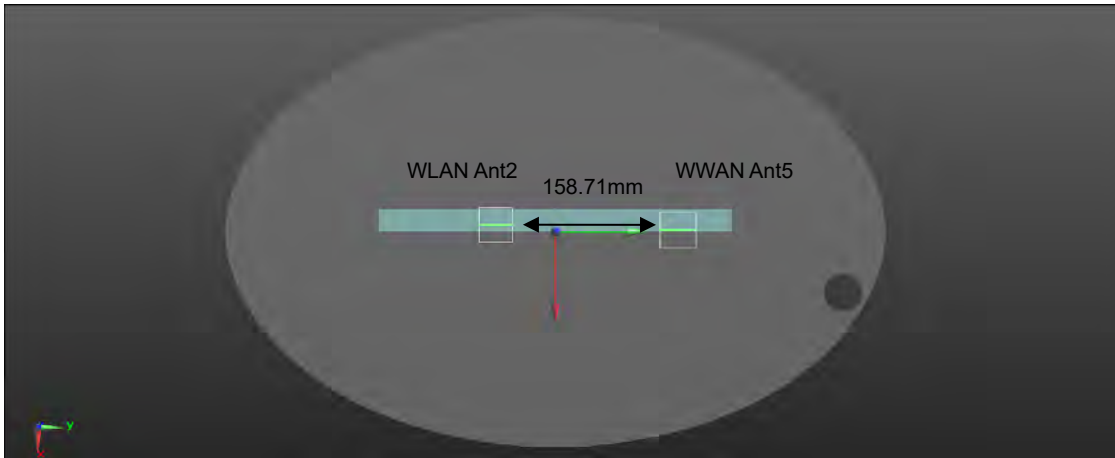

WLAN 2.4G Ant2 to CAT.M1 Band 66

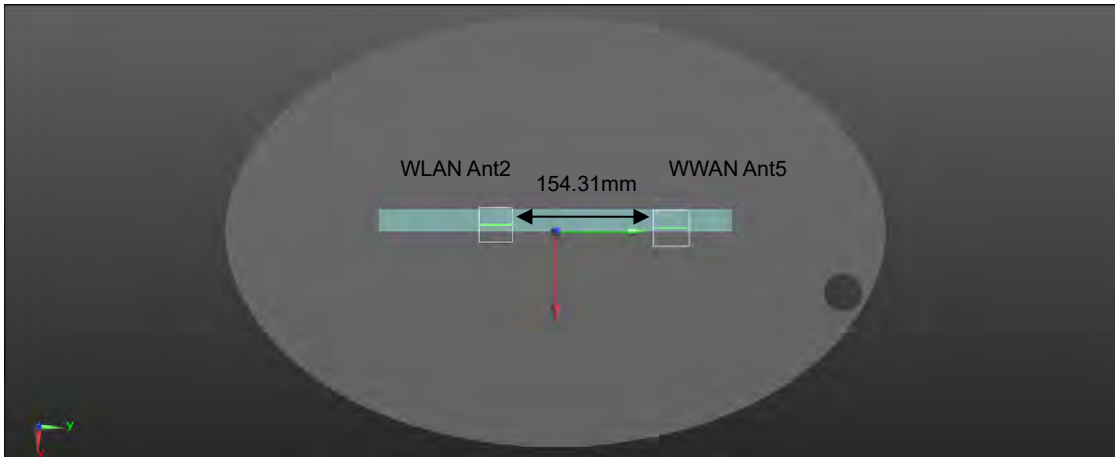

WLAN 2.4G Ant2 to CAT.M1 Band 85

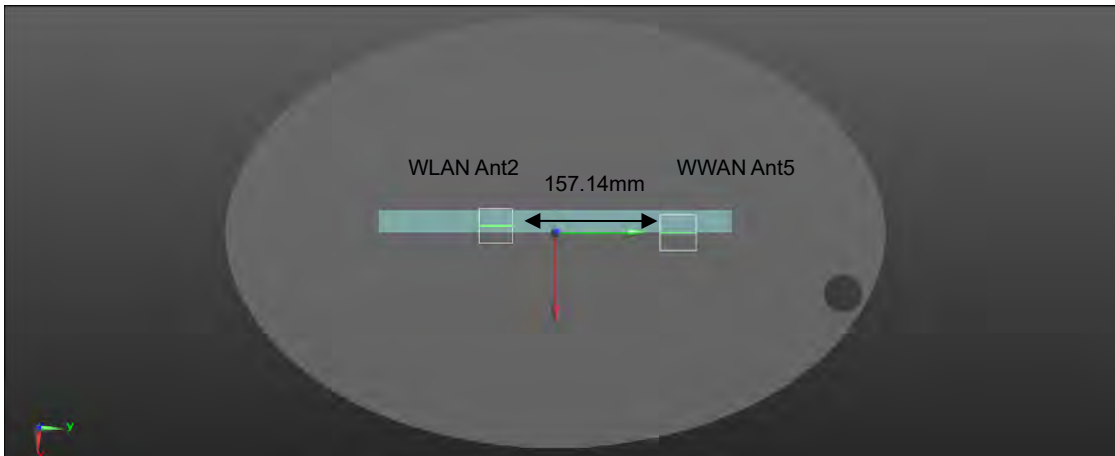

Unless otherwise stated the results shown in this test report refer only to the sample(s) tested and such sample(s) are retained for 90 days only.

除非另有說明，此報告結果僅對測試之樣品負責，同時此樣品僅保留90天。本報告未經本公司書面許可，不可部份複製。

This document is issued by the Company subject to its General Conditions of Service printed overleaf, available on request or accessible at <http://www.sgs.com.tw/Terms-and-Conditions> and for electronic format documents, subject to Terms and Conditions for Electronic Documents at <http://www.sgs.com.tw/Terms-and-Conditions>. Attention is drawn to the limitation of liability, indemnification and jurisdiction issues defined therein. Any holder of this document is advised that information contained hereon reflects the Company's findings at the time of its intervention only and within the limits of Client's instructions, if any. The Company's sole responsibility is to its Client and this document does not exonerate parties to a transaction from exercising all their rights and obligations under the transaction documents. This document cannot be reproduced except in full, without prior written approval of the Company. Any unauthorized alteration, forgery or falsification of the content or appearance of this document is unlawful and offenders may be prosecuted to the fullest extent of the law.

Scenario 1									
Position	Conditions	SAR Value (W/kg)	Coordinates (cm)			ΣSAR (W/kg)	Peak Location Separation Distance (mm)	SPLSR	Simultaneous Transmission SAR Test
			x	y	z				
Top edge	BT Ant 1	0.350	-0.42	-12.80	-0.29	-	-	-	-
	GPRS 850	1.194	-0.46	10.70	-0.31	1.544	235.00	0.008	SPLSR ≤ 0.04, Not required
	GPRS 1900	1.022	-0.45	10.85	-0.30	1.372	236.50	0.007	SPLSR ≤ 0.04, Not required

BT Ant 1 to GPRS 850

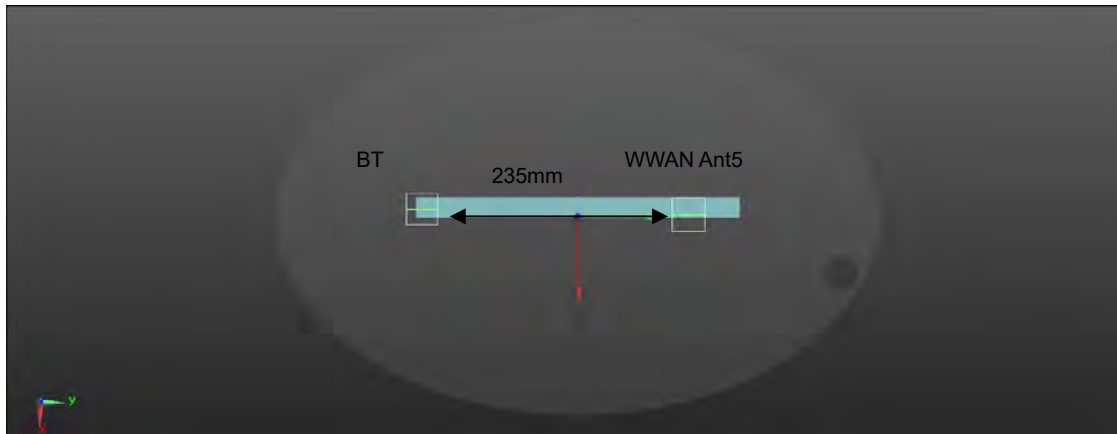

BT Ant 1 to GPRS 1900

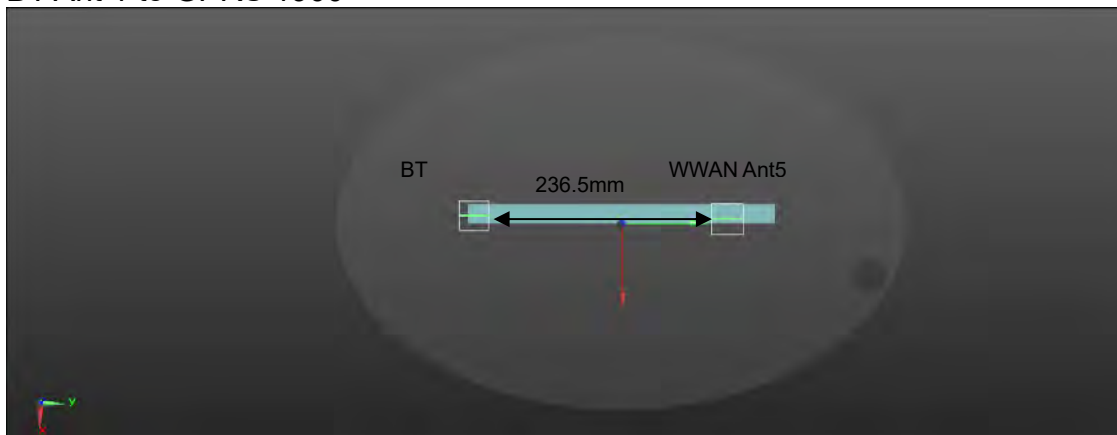

Unless otherwise stated the results shown in this test report refer only to the sample(s) tested and such sample(s) are retained for 90 days only.

除非另有說明，此報告結果僅對測試之樣品負責，同時此樣品僅保留90天。本報告未經本公司書面許可，不可部份複製。

This document is issued by the Company subject to its General Conditions of Service printed overleaf, available on request or accessible at <http://www.sgs.com.tw/Terms-and-Conditions> and for electronic format documents, subject to Terms and Conditions for Electronic Documents at <http://www.sgs.com.tw/Terms-and-Conditions>. Attention is drawn to the limitation of liability, indemnification and jurisdiction issues defined therein. Any holder of this document is advised that information contained hereon reflects the Company's findings at the time of its intervention only and within the limits of Client's instructions, if any. The Company's sole responsibility is to its Client and this document does not exonerate parties to a transaction from exercising all their rights and obligations under the transaction documents. This document cannot be reproduced except in full, without prior written approval of the Company. Any unauthorized alteration, forgery or falsification of the content or appearance of this document is unlawful and offenders may be prosecuted to the fullest extent of the law.

Scenario 2:									
Position	Conditions	SAR Value (W/kg)	Coordinates (cm)			ΣSAR (W/kg)	Peak Location Separation Distance (mm)	SPLSR	Simultaneous Transmission SAR Test
			x	y	z				
Top edge	WLAN 5G Ant1+ BT	1.250	-0.42	-12.80	-0.29	-	-	-	-
	GPRS 850	1.194	-0.46	10.70	-0.31	2.444	235.00	0.016	SPLSR ≤ 0.04, Not required
	GPRS 1900	1.022	-0.45	10.85	-0.30	2.272	236.50	0.014	SPLSR ≤ 0.04, Not required
	CAT.M1 Band 2	0.090	-0.28	11.00	-0.30	1.340	238.00	0.007	SPLSR ≤ 0.04, Not required
	CAT.M1 Band 4	0.103	-0.29	10.06	-0.31	1.353	228.60	0.007	SPLSR ≤ 0.04, Not required
	CAT.M1 Band 5	0.078	-0.31	10.69	-0.31	1.328	234.90	0.007	SPLSR ≤ 0.04, Not required
	CAT.M1 Band 12	0.050	-0.31	8.13	-0.31	1.300	209.30	0.007	SPLSR ≤ 0.04, Not required
	CAT.M1 Band 13	0.066	-0.31	10.69	-0.30	1.316	234.90	0.006	SPLSR ≤ 0.04, Not required
	CAT.M1 Band 14	0.067	-0.31	10.69	-0.30	1.317	234.90	0.006	SPLSR ≤ 0.04, Not required
	CAT.M1 Band 25	0.103	-0.29	11.17	-0.31	1.353	239.70	0.007	SPLSR ≤ 0.04, Not required
	CAT.M1 Band 26_FCC	0.081	-0.31	10.69	-0.31	1.331	234.90	0.007	SPLSR ≤ 0.04, Not required
	CAT.M1 Band 66	0.125	-0.30	10.25	-0.30	1.375	230.50	0.007	SPLSR ≤ 0.04, Not required
	CAT.M1 Band 85	0.260	-0.16	10.53	-0.31	1.510	233.31	0.008	SPLSR ≤ 0.04, Not required

Unless otherwise stated the results shown in this test report refer only to the sample(s) tested and such sample(s) are retained for 90 days only.

除非另有說明，此報告結果僅對測試之樣品負責，同時此樣品僅保留90天。本報告未經本公司書面許可，不可部份複製。

This document is issued by the Company subject to its General Conditions of Service printed overleaf, available on request or accessible at <http://www.sgs.com.tw/Terms-and-Conditions>, and for electronic format documents, subject to Terms and Conditions for Electronic Documents at <http://www.sgs.com.tw/Terms-and-Conditions>. Attention is drawn to the limitation of liability, indemnification and jurisdiction issues defined therein. Any holder of this document is advised that information contained hereon reflects the Company's findings at the time of its intervention only and within the limits of Client's instructions, if any. The Company's sole responsibility is to its Client and this document does not exonerate parties to a transaction from exercising all their rights and obligations under the transaction documents. This document cannot be reproduced except in full, without prior written approval of the Company. Any unauthorized alteration, forgery or falsification of the content or appearance of this document is unlawful and offenders may be prosecuted to the fullest extent of the law.

WLAN 5G Ant1+ BT to GPRS 850

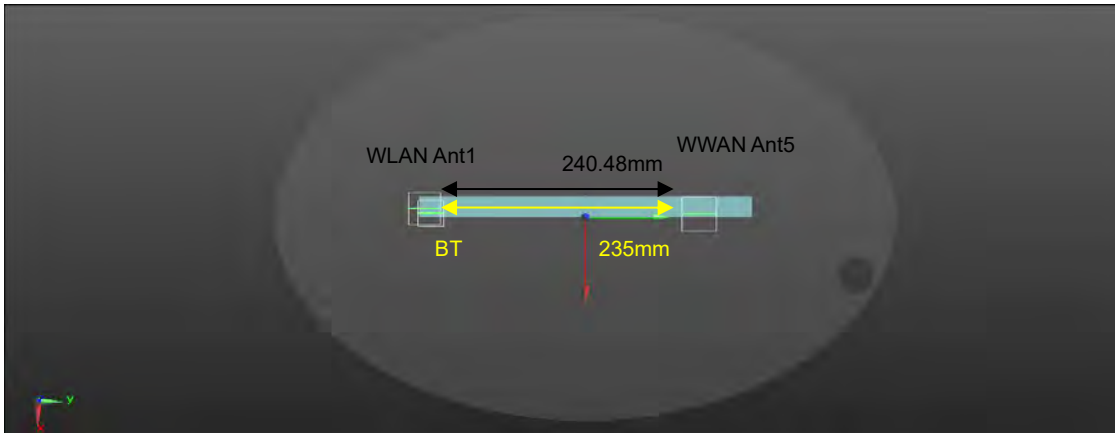

WLAN 5G Ant1+ BT to GPRS 1900



WLAN 5G Ant1+ BT to CAT.M1 Band 2

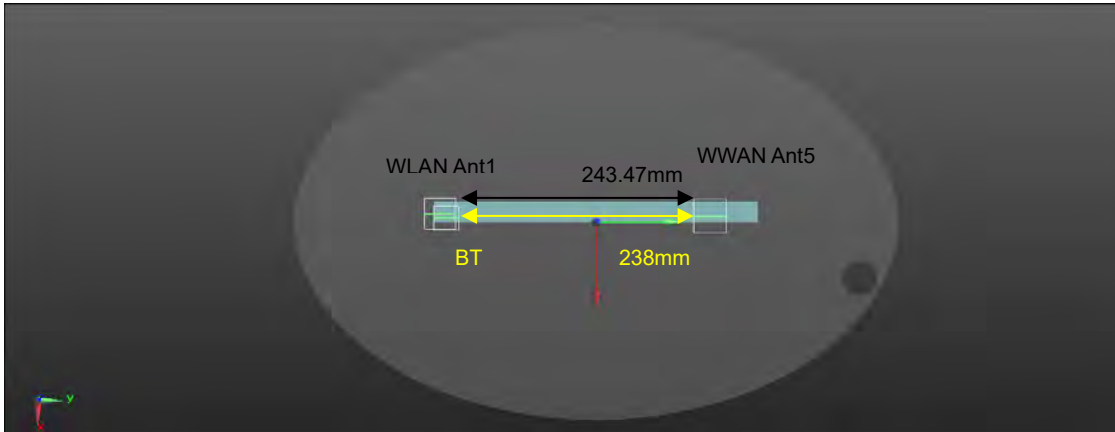

Unless otherwise stated the results shown in this test report refer only to the sample(s) tested and such sample(s) are retained for 90 days only.

除非另有說明，此報告結果僅對測試之樣品負責，同時此樣品僅保留90天。本報告未經本公司書面許可，不可部份複製。

This document is issued by the Company subject to its General Conditions of Service printed overleaf, available on request or accessible at <http://www.sgs.com.tw/Terms-and-Conditions> and for electronic format documents, subject to Terms and Conditions for Electronic Documents at <http://www.sgs.com.tw/Terms-and-Conditions>. Attention is drawn to the limitation of liability, indemnification and jurisdiction issues defined therein. Any holder of this document is advised that information contained hereon reflects the Company's findings at the time of its intervention only and within the limits of Client's instructions, if any. The Company's sole responsibility is to its Client and this document does not exonerate parties to a transaction from exercising all their rights and obligations under the transaction documents. This document cannot be reproduced except in full, without prior written approval of the Company. Any unauthorized alteration, forgery or falsification of the content or appearance of this document is unlawful and offenders may be prosecuted to the fullest extent of the law.

WLAN 5G Ant1+ BT to CAT.M1 Band 4

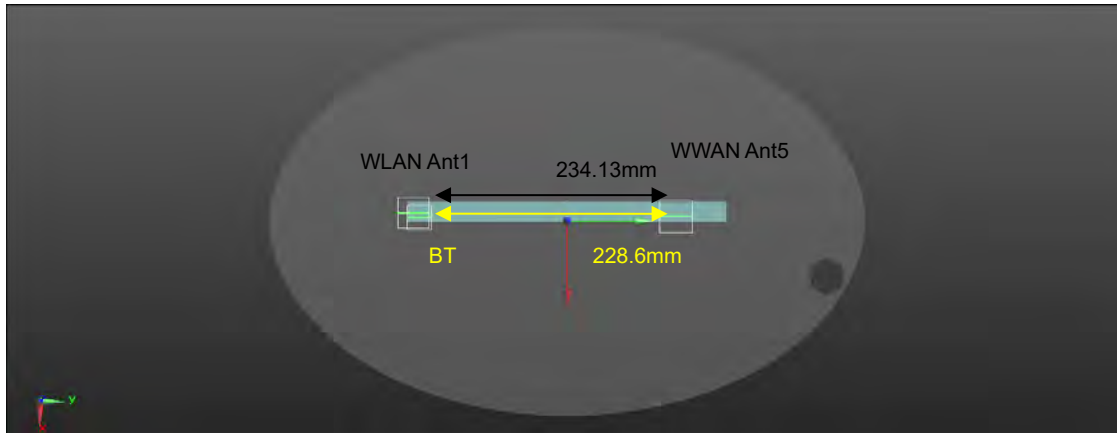

WLAN 5G Ant1+ BT to CAT.M1 Band 5

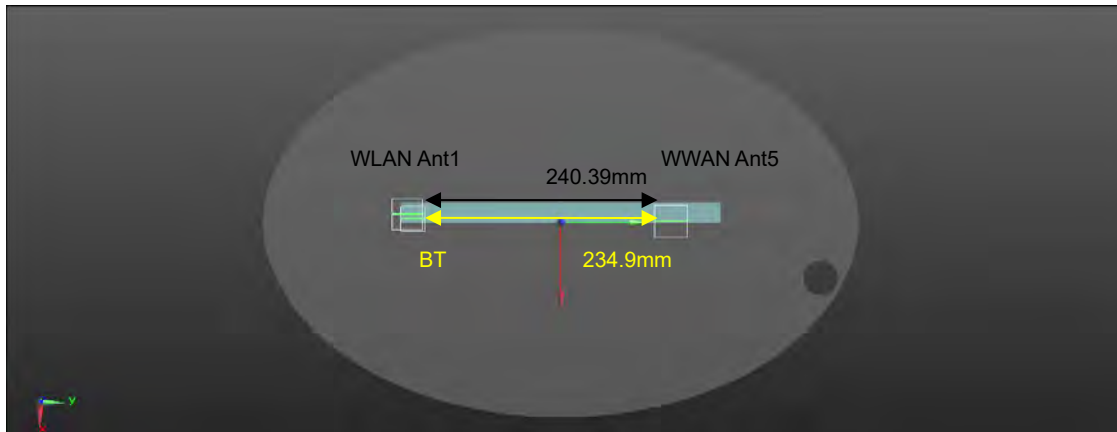

WLAN 5G Ant1+ BT to CAT.M1 Band 12

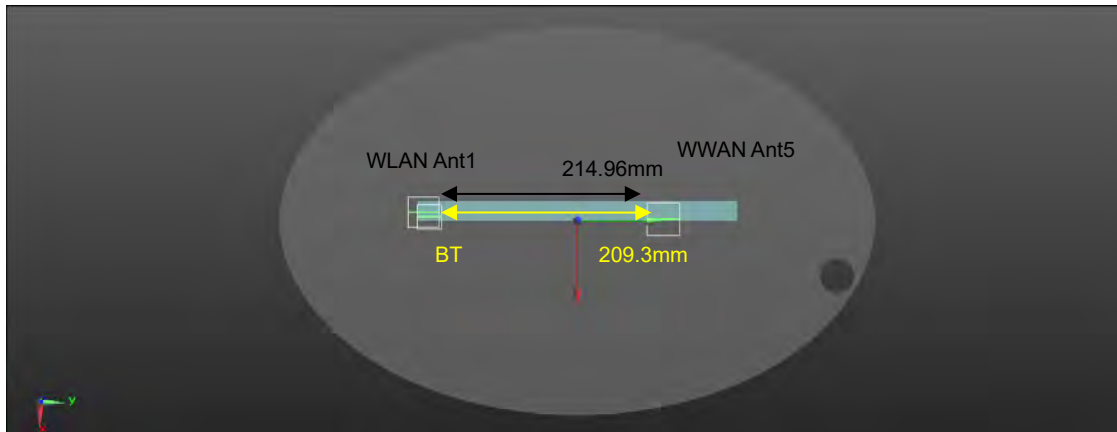

Unless otherwise stated the results shown in this test report refer only to the sample(s) tested and such sample(s) are retained for 90 days only.

除非另有說明，此報告結果僅對測試之樣品負責，同時此樣品僅保留90天。本報告未經本公司書面許可，不可部份複製。

This document is issued by the Company subject to its General Conditions of Service printed overleaf, available on request or accessible at <http://www.sgs.com.tw/Terms-and-Conditions> and for electronic format documents, subject to Terms and Conditions for Electronic Documents at <http://www.sgs.com.tw/Terms-and-Conditions>. Attention is drawn to the limitation of liability, indemnification and jurisdiction issues defined therein. Any holder of this document is advised that information contained hereon reflects the Company's findings at the time of its intervention only and within the limits of Client's instructions, if any. The Company's sole responsibility is to its Client and this document does not exonerate parties to a transaction from exercising all their rights and obligations under the transaction documents. This document cannot be reproduced except in full, without prior written approval of the Company. Any unauthorized alteration, forgery or falsification of the content or appearance of this document is unlawful and offenders may be prosecuted to the fullest extent of the law.

WLAN 5G Ant1+ BT to CAT.M1 Band 13



WLAN 5G Ant1+ BT to CAT.M1 Band 14

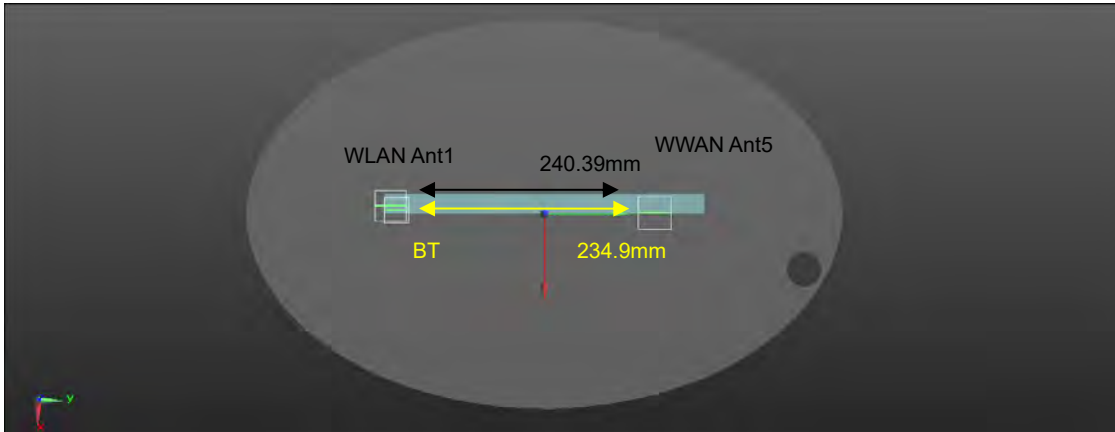

WLAN 5G Ant1+ BT to CAT.M1 Band 25

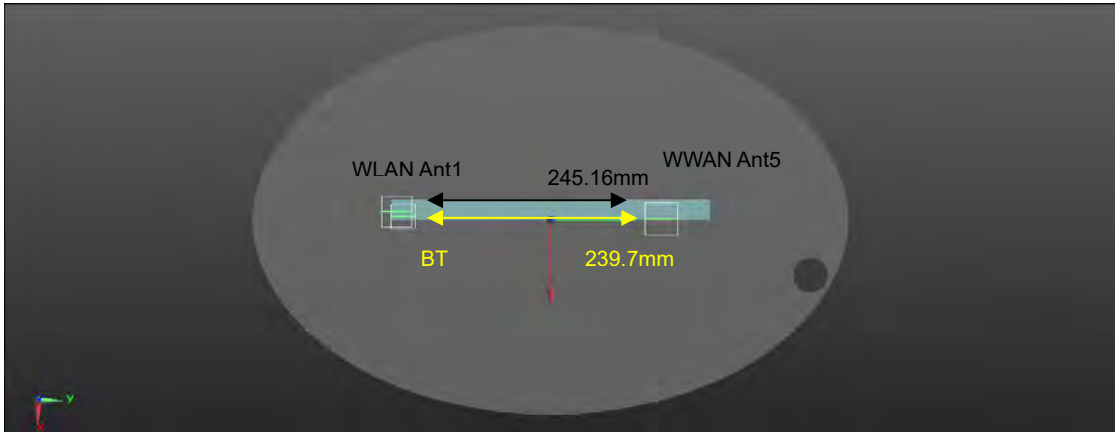

Unless otherwise stated the results shown in this test report refer only to the sample(s) tested and such sample(s) are retained for 90 days only.

除非另有說明，此報告結果僅對測試之樣品負責，同時此樣品僅保留90天。本報告未經本公司書面許可，不可部份複製。

This document is issued by the Company subject to its General Conditions of Service printed overleaf, available on request or accessible at <http://www.sgs.com.tw/Terms-and-Conditions> and for electronic format documents, subject to Terms and Conditions for Electronic Documents at <http://www.sgs.com.tw/Terms-and-Conditions>. Attention is drawn to the limitation of liability, indemnification and jurisdiction issues defined therein. Any holder of this document is advised that information contained hereon reflects the Company's findings at the time of its intervention only and within the limits of Client's instructions, if any. The Company's sole responsibility is to its Client and this document does not exonerate parties to a transaction from exercising all their rights and obligations under the transaction documents. This document cannot be reproduced except in full, without prior written approval of the Company. Any unauthorized alteration, forgery or falsification of the content or appearance of this document is unlawful and offenders may be prosecuted to the fullest extent of the law.

WLAN 5G Ant1+ BT to CAT.M1 Band 26 FCC

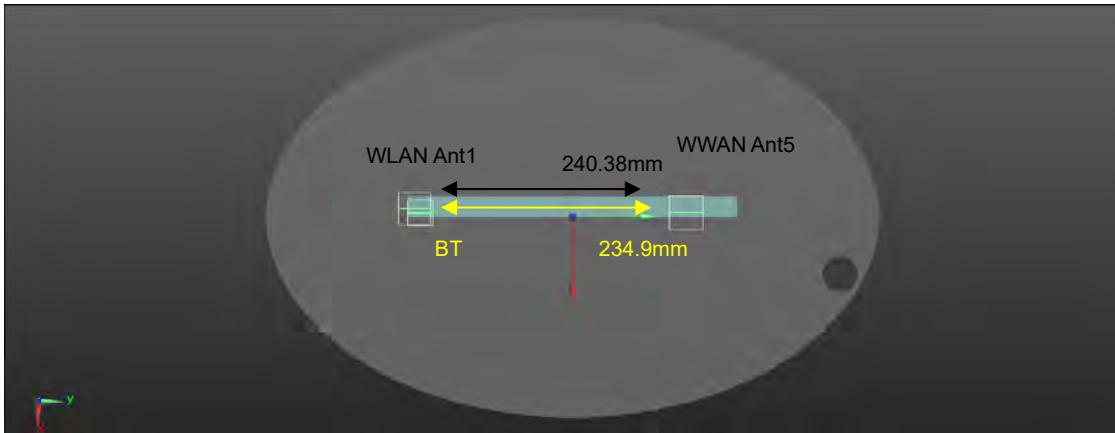

WLAN 5G Ant1+ BT to CAT.M1 Band 66

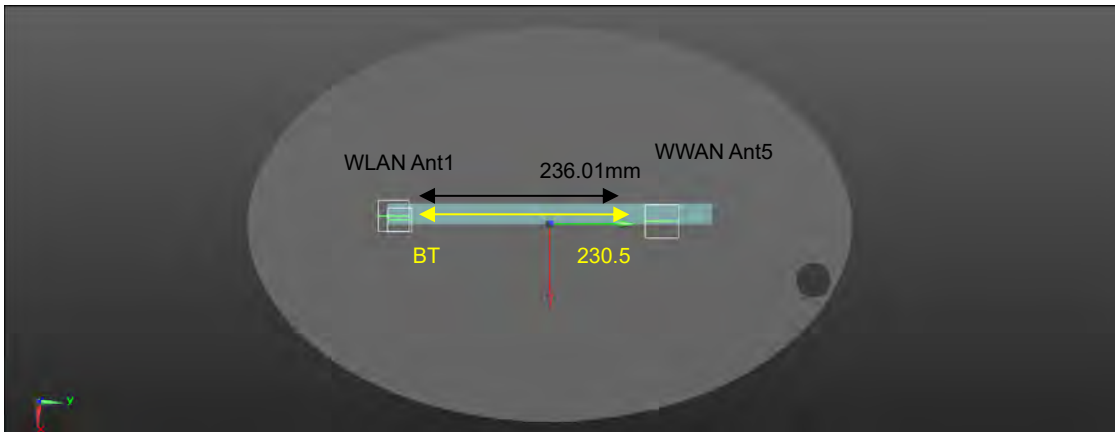

WLAN 5G Ant1+ BT to CAT.M1 Band 85

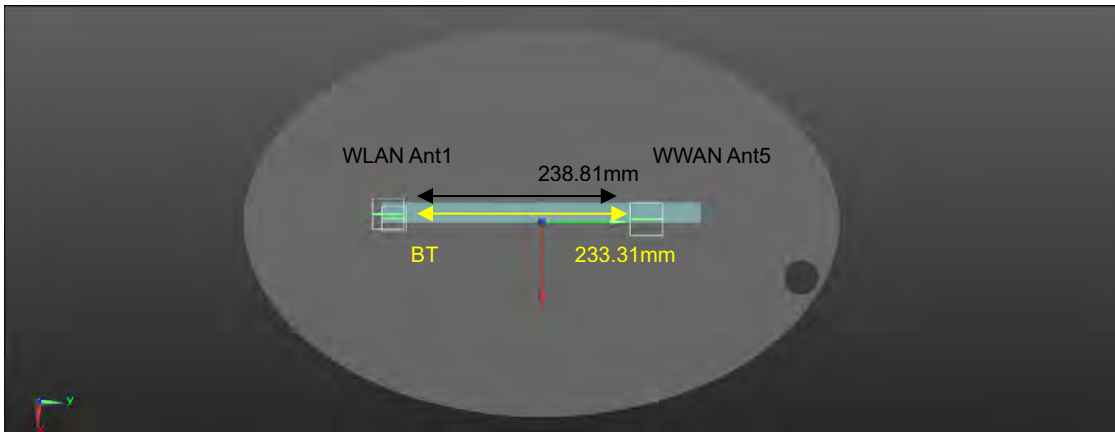

Unless otherwise stated the results shown in this test report refer only to the sample(s) tested and such sample(s) are retained for 90 days only.

除非另有說明，此報告結果僅對測試之樣品負責，同時此樣品僅保留90天。本報告未經本公司書面許可，不可部份複製。

This document is issued by the Company subject to its General Conditions of Service printed overleaf, available on request or accessible at <http://www.sgs.com.tw/Terms-and-Conditions> and for electronic format documents, subject to Terms and Conditions for Electronic Documents at <http://www.sgs.com.tw/Terms-and-Conditions>. Attention is drawn to the limitation of liability, indemnification and jurisdiction issues defined therein. Any holder of this document is advised that information contained hereon reflects the Company's findings at the time of its intervention only and within the limits of Client's instructions, if any. The Company's sole responsibility is to its Client and this document does not exonerate parties to a transaction from exercising all their rights and obligations under the transaction documents. This document cannot be reproduced except in full, without prior written approval of the Company. Any unauthorized alteration, forgery or falsification of the content or appearance of this document is unlawful and offenders may be prosecuted to the fullest extent of the law.

Scenario 2:									
Position	Conditions	SAR Value (W/kg)	Coordinates (cm)			ΣSAR (W/kg)	Peak Location Separation Distance (mm)	SPLSR	Simultaneous Transmission SAR Test
			x	y	z				
Top edge	WLAN 5G Ant2	1.160	-0.48	-5.56	-0.32	-	-	-	-
	GPRS 850	1.194	-0.46	10.70	-0.31	2.354	162.60	0.022	SPLSR ≤ 0.04, Not required
	GPRS 1900	1.022	-0.45	10.85	-0.30	2.182	164.10	0.020	SPLSR ≤ 0.04, Not required
	CAT.M1 Band 2	0.090	-0.28	11.00	-0.30	1.250	165.61	0.008	SPLSR ≤ 0.04, Not required
	CAT.M1 Band 4	0.103	-0.29	10.06	-0.31	1.263	156.21	0.009	SPLSR ≤ 0.04, Not required
	CAT.M1 Band 5	0.078	-0.31	10.69	-0.31	1.238	162.51	0.008	SPLSR ≤ 0.04, Not required
	CAT.M1 Band 12	0.050	-0.31	8.13	-0.31	1.210	136.91	0.010	SPLSR ≤ 0.04, Not required
	CAT.M1 Band 13	0.066	-0.31	10.69	-0.30	1.226	162.51	0.008	SPLSR ≤ 0.04, Not required
	CAT.M1 Band 14	0.067	-0.31	10.69	-0.30	1.227	162.51	0.008	SPLSR ≤ 0.04, Not required
	CAT.M1 Band 25	0.103	-0.29	11.17	-0.31	1.263	167.31	0.008	SPLSR ≤ 0.04, Not required
	CAT.M1 Band 26_FCC	0.081	-0.31	10.69	-0.31	1.241	162.51	0.009	SPLSR ≤ 0.04, Not required
	CAT.M1 Band 66	0.125	-0.30	10.25	-0.30	1.285	158.11	0.009	SPLSR ≤ 0.04, Not required
	CAT.M1 Band 85	0.260	-0.16	10.53	-0.31	1.420	160.93	0.011	SPLSR ≤ 0.04, Not required

Unless otherwise stated the results shown in this test report refer only to the sample(s) tested and such sample(s) are retained for 90 days only.

除非另有說明，此報告結果僅對測試之樣品負責，同時此樣品僅保留90天。本報告未經本公司書面許可，不可部份複製。

This document is issued by the Company subject to its General Conditions of Service printed overleaf, available on request or accessible at <http://www.sgs.com.tw/Terms-and-Conditions>, and for electronic format documents, subject to Terms and Conditions for Electronic Documents at <http://www.sgs.com.tw/Terms-and-Conditions>. Attention is drawn to the limitation of liability, indemnification and jurisdiction issues defined therein. Any holder of this document is advised that information contained hereon reflects the Company's findings at the time of its intervention only and within the limits of Client's instructions, if any. The Company's sole responsibility is to its Client and this document does not exonerate parties to a transaction from exercising all their rights and obligations under the transaction documents. This document cannot be reproduced except in full, without prior written approval of the Company. Any unauthorized alteration, forgery or falsification of the content or appearance of this document is unlawful and offenders may be prosecuted to the fullest extent of the law.

WLAN 5G Ant2 to GPRS 850

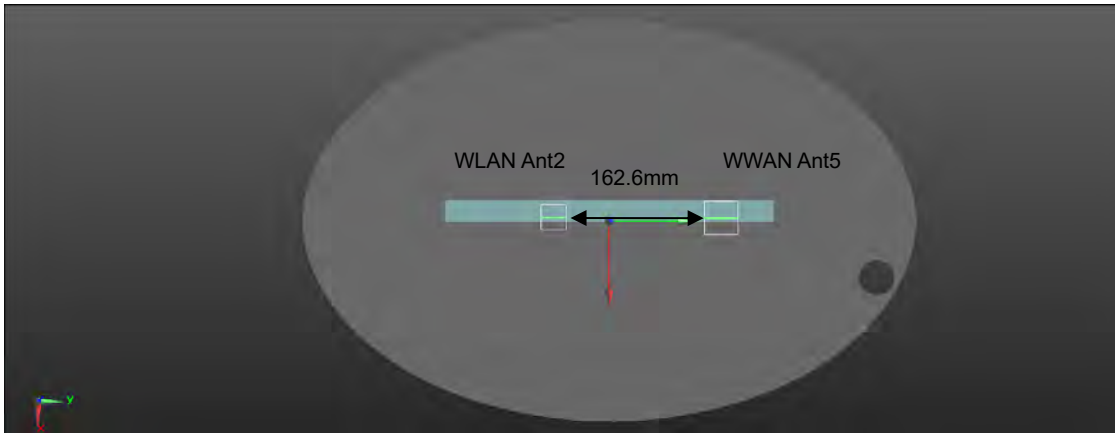

WLAN 5G Ant2 to GPRS 1900

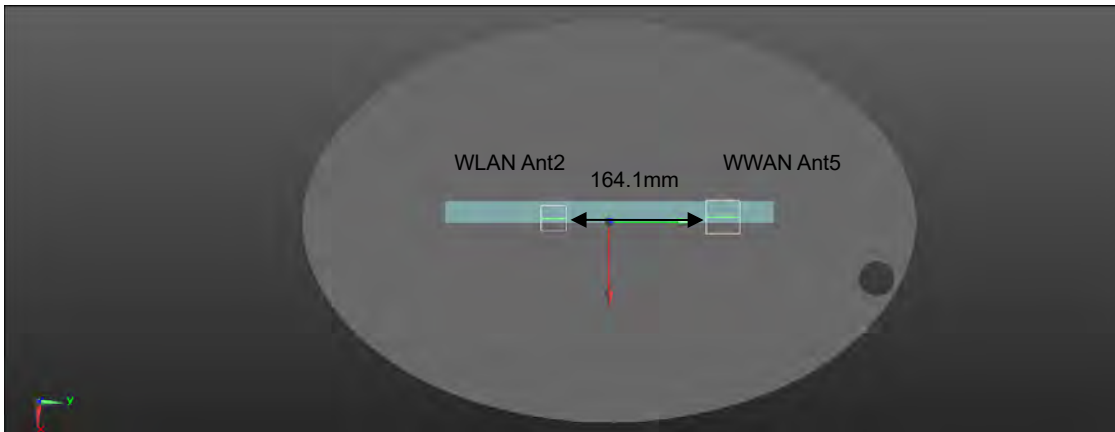

WLAN 5G Ant2 to CAT.M1 Band 2

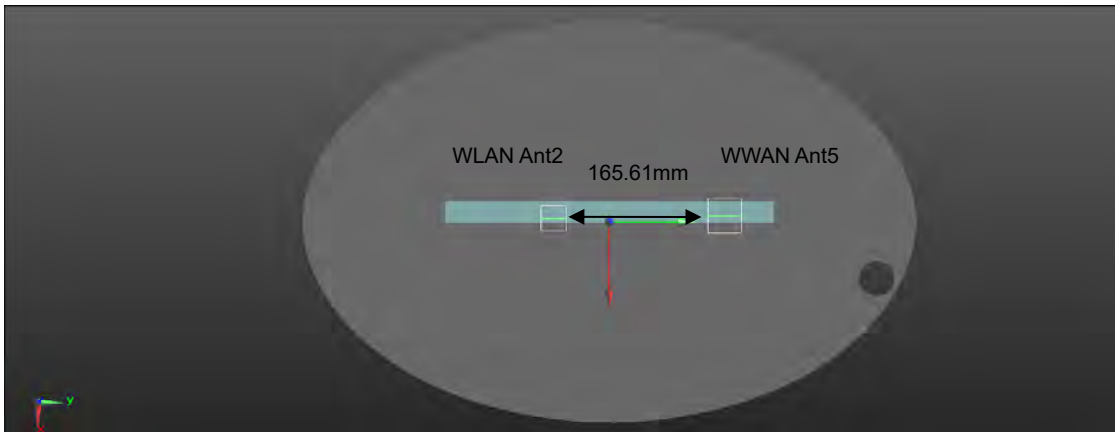

Unless otherwise stated the results shown in this test report refer only to the sample(s) tested and such sample(s) are retained for 90 days only.

除非另有說明，此報告結果僅對測試之樣品負責，同時此樣品僅保留90天。本報告未經本公司書面許可，不可部份複製。

This document is issued by the Company subject to its General Conditions of Service printed overleaf, available on request or accessible at <http://www.sgs.com.tw/Terms-and-Conditions> and for electronic format documents, subject to Terms and Conditions for Electronic Documents at <http://www.sgs.com.tw/Terms-and-Conditions>. Attention is drawn to the limitation of liability, indemnification and jurisdiction issues defined therein. Any holder of this document is advised that information contained hereon reflects the Company's findings at the time of its intervention only and within the limits of Client's instructions, if any. The Company's sole responsibility is to its Client and this document does not exonerate parties to a transaction from exercising all their rights and obligations under the transaction documents. This document cannot be reproduced except in full, without prior written approval of the Company. Any unauthorized alteration, forgery or falsification of the content or appearance of this document is unlawful and offenders may be prosecuted to the fullest extent of the law.

WLAN 5G Ant2 to CAT.M1 Band 4

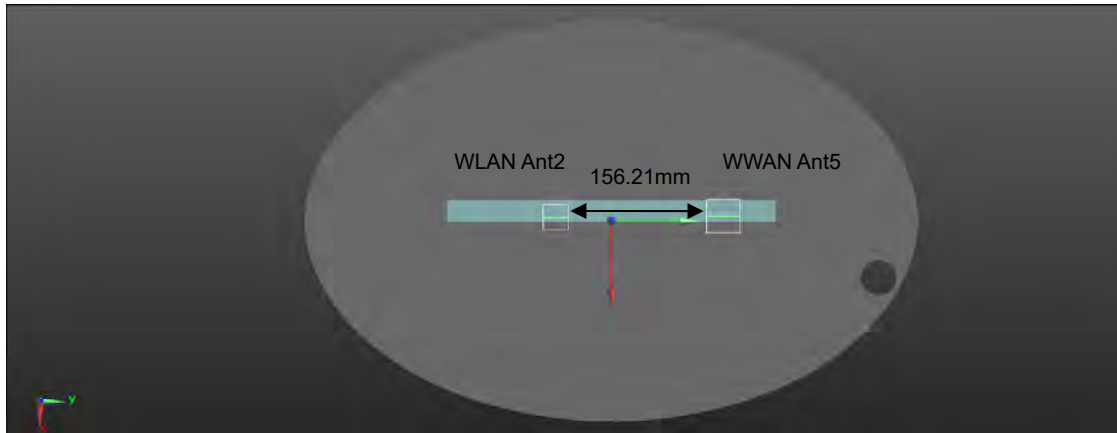

WLAN 5G Ant2 to CAT.M1 Band 5

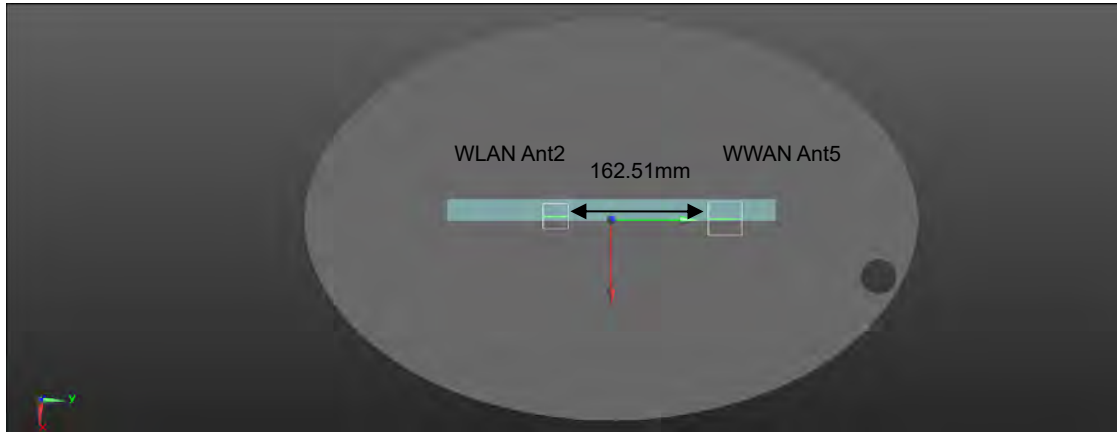

WLAN 5G Ant2 to CAT.M1 Band 12

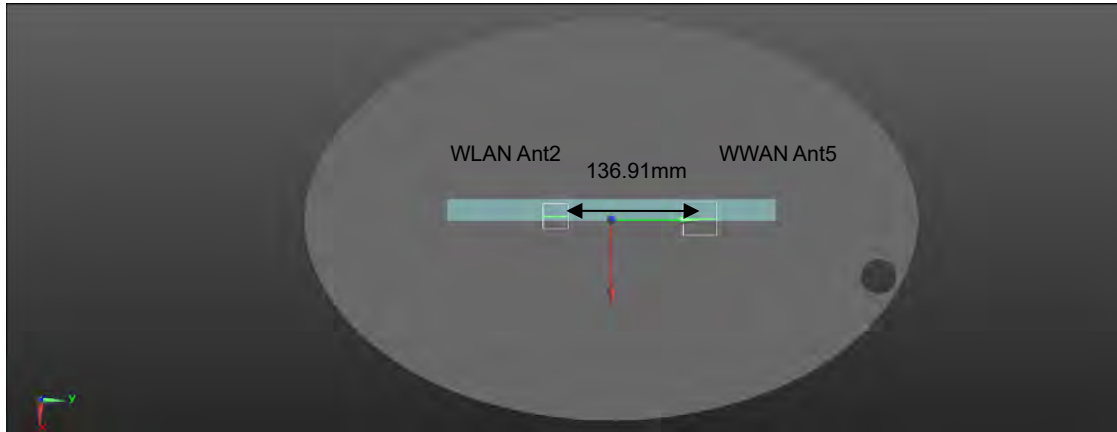

Unless otherwise stated the results shown in this test report refer only to the sample(s) tested and such sample(s) are retained for 90 days only.

除非另有說明，此報告結果僅對測試之樣品負責，同時此樣品僅保留90天。本報告未經本公司書面許可，不可部份複製。

This document is issued by the Company subject to its General Conditions of Service printed overleaf, available on request or accessible at <http://www.sgs.com.tw/Terms-and-Conditions> and for electronic format documents, subject to Terms and Conditions for Electronic Documents at <http://www.sgs.com.tw/Terms-and-Conditions>. Attention is drawn to the limitation of liability, indemnification and jurisdiction issues defined therein. Any holder of this document is advised that information contained hereon reflects the Company's findings at the time of its intervention only and within the limits of Client's instructions, if any. The Company's sole responsibility is to its Client and this document does not exonerate parties to a transaction from exercising all their rights and obligations under the transaction documents. This document cannot be reproduced except in full, without prior written approval of the Company. Any unauthorized alteration, forgery or falsification of the content or appearance of this document is unlawful and offenders may be prosecuted to the fullest extent of the law.

WLAN 5G Ant2 to CAT.M1 Band 13

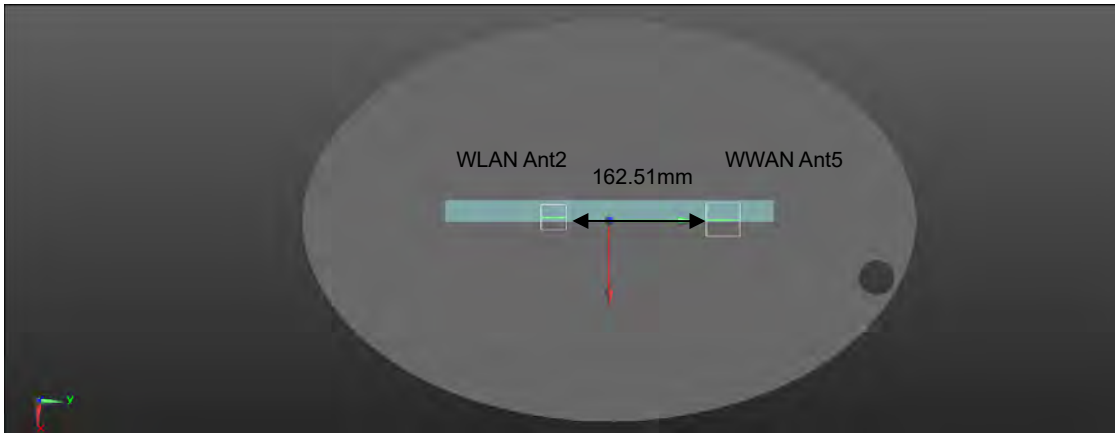

WLAN 5G Ant2 to CAT.M1 Band 14

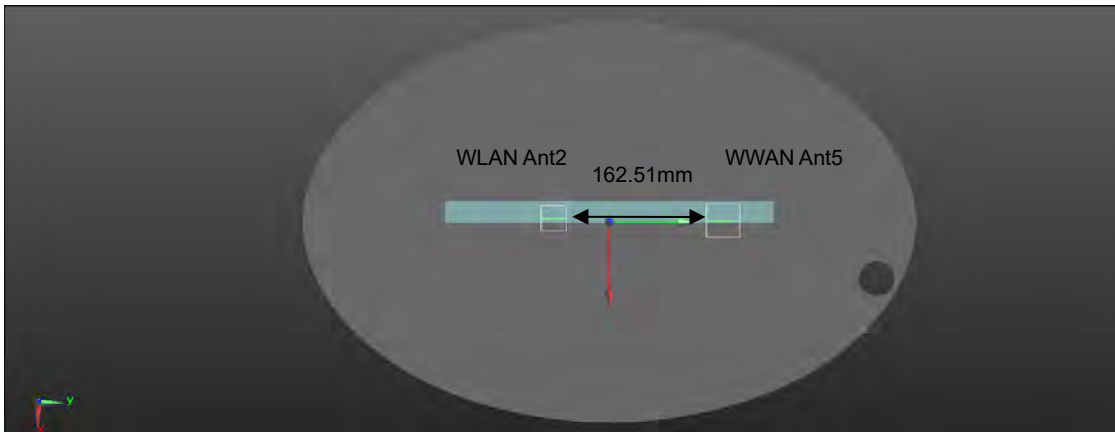

WLAN 5G Ant2 to CAT.M1 Band 25

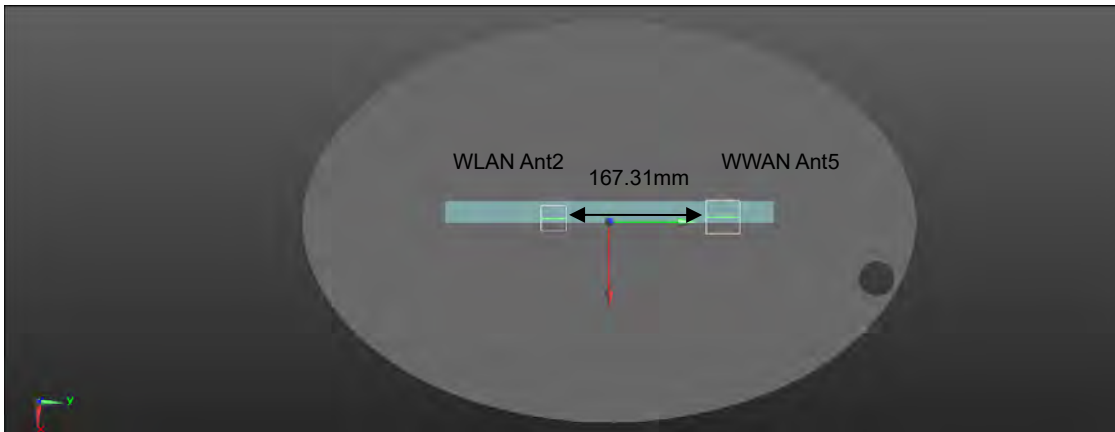

Unless otherwise stated the results shown in this test report refer only to the sample(s) tested and such sample(s) are retained for 90 days only.

除非另有說明，此報告結果僅對測試之樣品負責，同時此樣品僅保留90天。本報告未經本公司書面許可，不可部份複製。

This document is issued by the Company subject to its General Conditions of Service printed overleaf, available on request or accessible at <http://www.sgs.com.tw/Terms-and-Conditions> and for electronic format documents, subject to Terms and Conditions for Electronic Documents at <http://www.sgs.com.tw/Terms-and-Conditions>. Attention is drawn to the limitation of liability, indemnification and jurisdiction issues defined therein. Any holder of this document is advised that information contained hereon reflects the Company's findings at the time of its intervention only and within the limits of Client's instructions, if any. The Company's sole responsibility is to its Client and this document does not exonerate parties to a transaction from exercising all their rights and obligations under the transaction documents. This document cannot be reproduced except in full, without prior written approval of the Company. Any unauthorized alteration, forgery or falsification of the content or appearance of this document is unlawful and offenders may be prosecuted to the fullest extent of the law.

WLAN 5G Ant2 to CAT.M1 Band 26 FCC

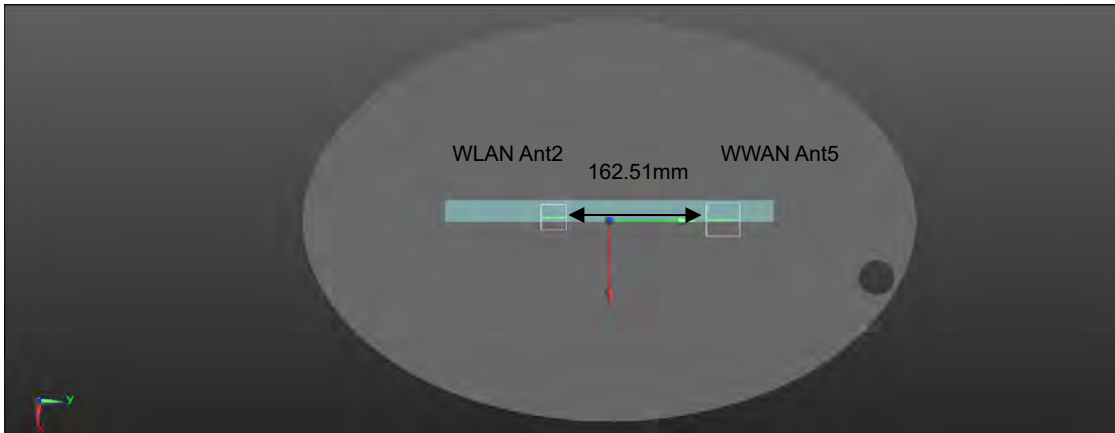

WLAN 5G Ant2 to CAT.M1 Band 66

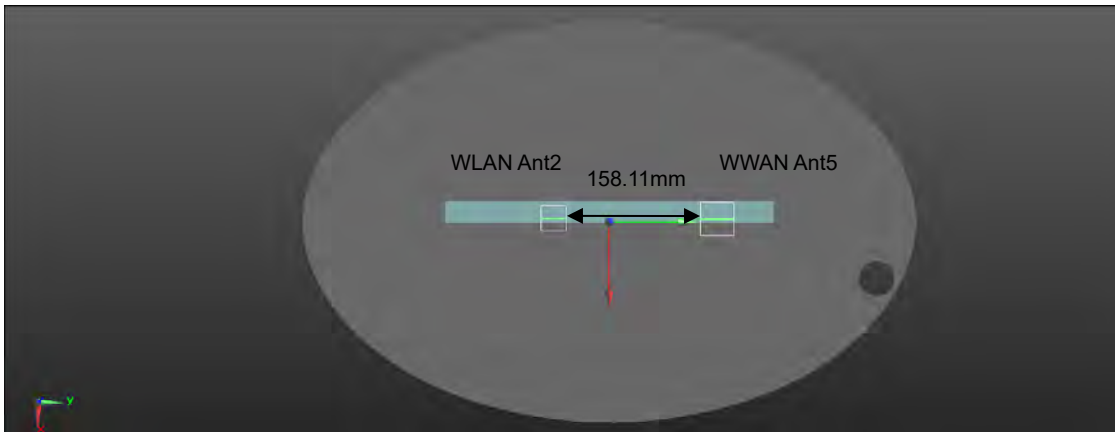

WLAN 5G Ant2 to CAT.M1 Band 85

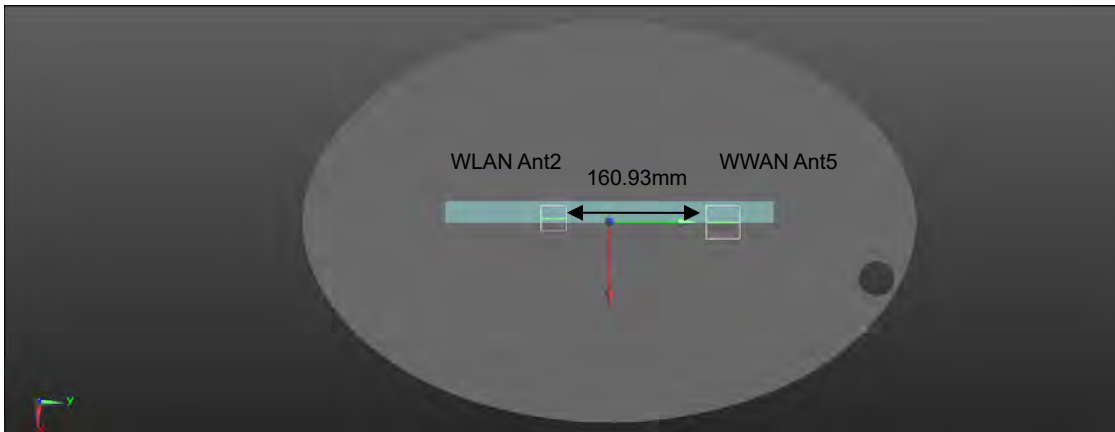

Unless otherwise stated the results shown in this test report refer only to the sample(s) tested and such sample(s) are retained for 90 days only.

除非另有說明，此報告結果僅對測試之樣品負責，同時此樣品僅保留90天。本報告未經本公司書面許可，不可部份複製。

This document is issued by the Company subject to its General Conditions of Service printed overleaf, available on request or accessible at <http://www.sgs.com.tw/Terms-and-Conditions> and for electronic format documents, subject to Terms and Conditions for Electronic Documents at <http://www.sgs.com.tw/Terms-and-Conditions>. Attention is drawn to the limitation of liability, indemnification and jurisdiction issues defined therein. Any holder of this document is advised that information contained hereon reflects the Company's findings at the time of its intervention only and within the limits of Client's instructions, if any. The Company's sole responsibility is to its Client and this document does not exonerate parties to a transaction from exercising all their rights and obligations under the transaction documents. This document cannot be reproduced except in full, without prior written approval of the Company. Any unauthorized alteration, forgery or falsification of the content or appearance of this document is unlawful and offenders may be prosecuted to the fullest extent of the law.

Scenario 3:									
Position	Conditions	SAR Value (W/kg)	Coordinates (cm)			ΣSAR (W/kg)	Peak Location Separation Distance (mm)	SPLSR	Simultaneous Transmission SAR Test
			x	y	z				
Top edge	WLAN 6G Ant1+BT	1.540	-0.43	-12.57	-0.33	-	-	-	-
	GPRS 850	1.194	-0.46	10.70	-0.31	2.734	232.70	0.019	SPLSR ≤ 0.04, Not required
	GPRS 1900	1.022	-0.45	10.85	-0.30	2.562	234.20	0.018	SPLSR ≤ 0.04, Not required
	CAT.M1 Band 2	0.090	-0.28	11.00	-0.30	1.630	235.71	0.009	SPLSR ≤ 0.04, Not required
	CAT.M1 Band 4	0.103	-0.29	10.06	-0.31	1.643	226.30	0.009	SPLSR ≤ 0.04, Not required
	CAT.M1 Band 5	0.078	-0.31	10.69	-0.31	1.618	232.60	0.009	SPLSR ≤ 0.04, Not required
	CAT.M1 Band 12	0.050	-0.31	8.13	-0.31	1.590	207.00	0.010	SPLSR ≤ 0.04, Not required
	CAT.M1 Band 13	0.066	-0.31	10.69	-0.30	1.606	232.60	0.009	SPLSR ≤ 0.04, Not required
	CAT.M1 Band 14	0.067	-0.31	10.69	-0.30	1.607	232.60	0.009	SPLSR ≤ 0.04, Not required
	CAT.M1 Band 25	0.103	-0.29	11.17	-0.31	1.643	237.40	0.009	SPLSR ≤ 0.04, Not required
	CAT.M1 Band 26_FCC	0.081	-0.31	10.69	-0.31	1.621	232.60	0.009	SPLSR ≤ 0.04, Not required
	CAT.M1 Band 66	0.125	-0.30	10.25	-0.30	1.665	228.20	0.009	SPLSR ≤ 0.04, Not required
	CAT.M1 Band 85	0.260	-0.16	10.53	-0.31	1.800	231.02	0.010	SPLSR ≤ 0.04, Not required

Unless otherwise stated the results shown in this test report refer only to the sample(s) tested and such sample(s) are retained for 90 days only.

除非另有說明，此報告結果僅對測試之樣品負責，同時此樣品僅保留90天。本報告未經本公司書面許可，不可部份複製。

This document is issued by the Company subject to its General Conditions of Service printed overleaf, available on request or accessible at <http://www.sgs.com.tw/Terms-and-Conditions>, and for electronic format documents, subject to Terms and Conditions for Electronic Documents at <http://www.sgs.com.tw/Terms-and-Conditions>. Attention is drawn to the limitation of liability, indemnification and jurisdiction issues defined therein. Any holder of this document is advised that information contained hereon reflects the Company's findings at the time of its intervention only and within the limits of Client's instructions, if any. The Company's sole responsibility is to its Client and this document does not exonerate parties to a transaction from exercising all their rights and obligations under the transaction documents. This document cannot be reproduced except in full, without prior written approval of the Company. Any unauthorized alteration, forgery or falsification of the content or appearance of this document is unlawful and offenders may be prosecuted to the fullest extent of the law.

WLAN 6G Ant1+BT to GPRS 850

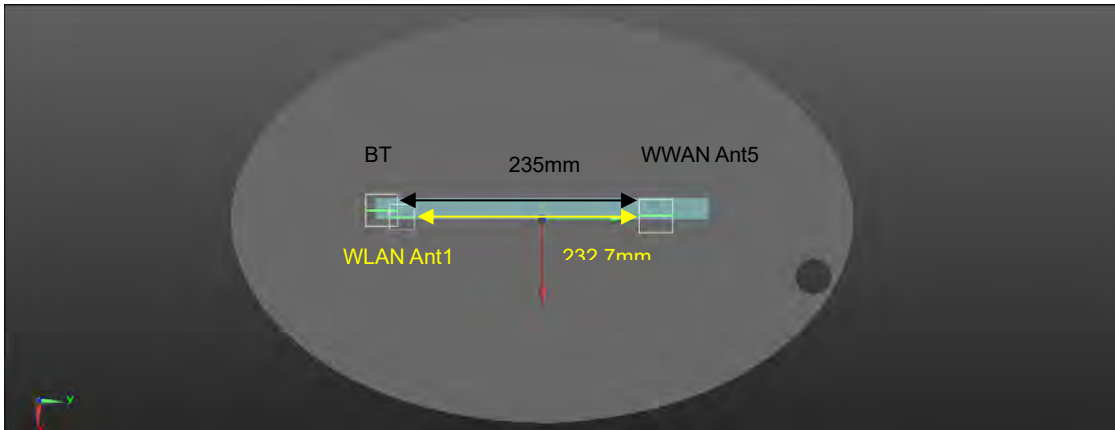

WLAN 6G Ant1+BT to GPRS 1900

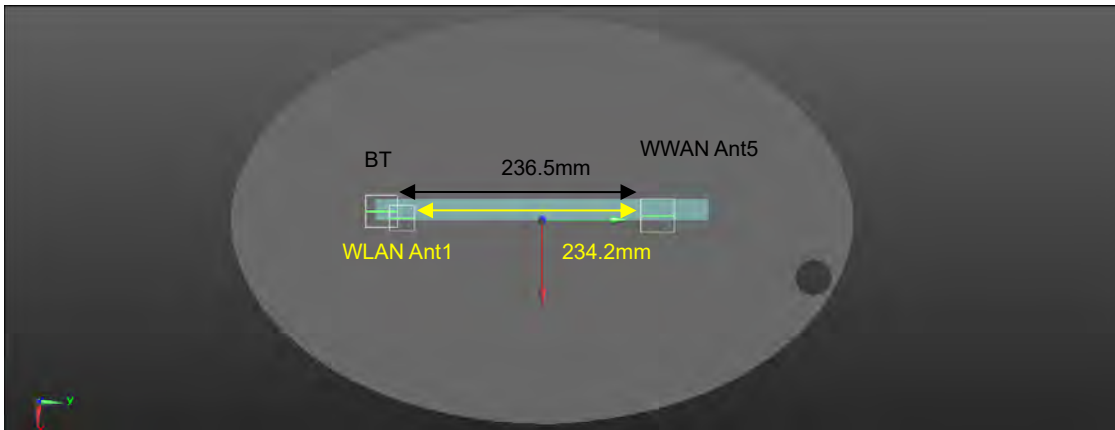

WLAN 6G Ant1+BT to CAT.M1 Band 2

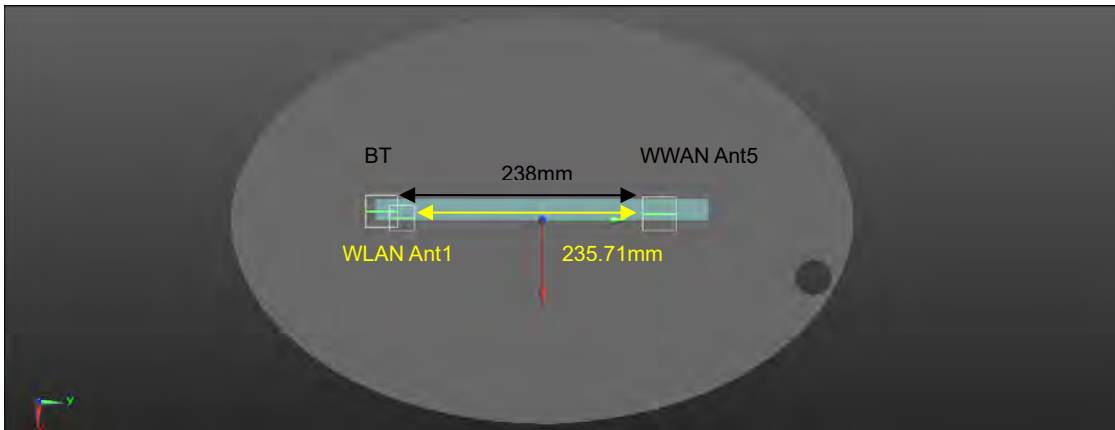

Unless otherwise stated the results shown in this test report refer only to the sample(s) tested and such sample(s) are retained for 90 days only.

除非另有說明，此報告結果僅對測試之樣品負責，同時此樣品僅保留90天。本報告未經本公司書面許可，不可部份複製。

This document is issued by the Company subject to its General Conditions of Service printed overleaf, available on request or accessible at <http://www.sgs.com.tw/Terms-and-Conditions> and for electronic format documents, subject to Terms and Conditions for Electronic Documents at <http://www.sgs.com.tw/Terms-and-Conditions>. Attention is drawn to the limitation of liability, indemnification and jurisdiction issues defined therein. Any holder of this document is advised that information contained hereon reflects the Company's findings at the time of its intervention only and within the limits of Client's instructions, if any. The Company's sole responsibility is to its Client and this document does not exonerate parties to a transaction from exercising all their rights and obligations under the transaction documents. This document cannot be reproduced except in full, without prior written approval of the Company. Any unauthorized alteration, forgery or falsification of the content or appearance of this document is unlawful and offenders may be prosecuted to the fullest extent of the law.

WLAN 6G Ant1+BT to CAT.M1 Band 4

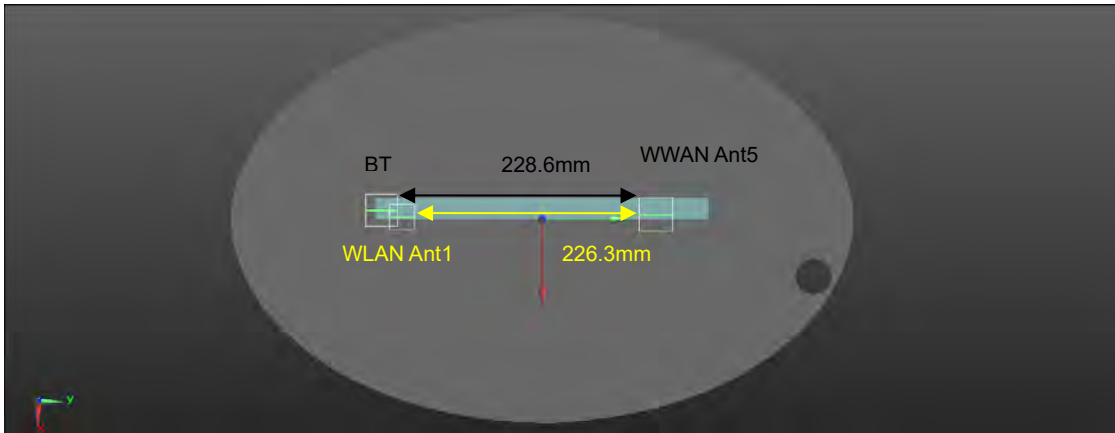

WLAN 6G Ant1+BT to CAT.M1 Band 5

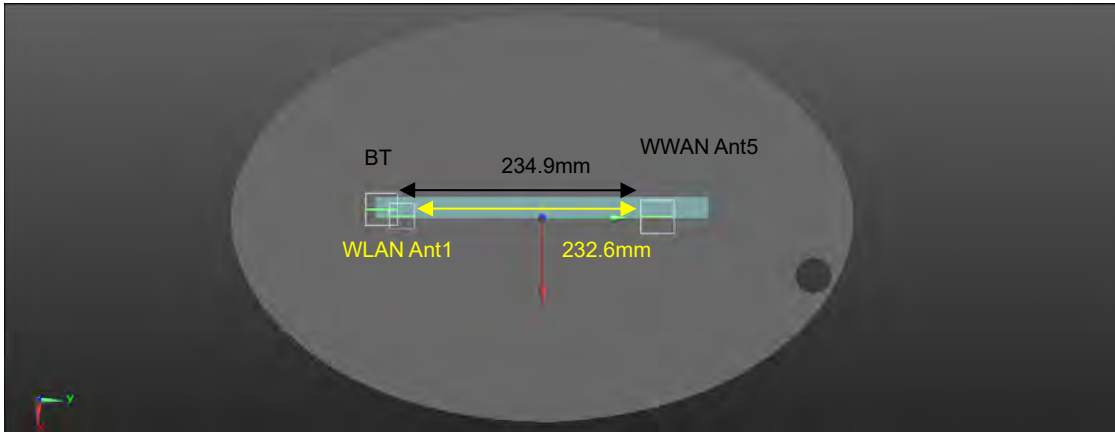

WLAN 6G Ant1+BT to CAT.M1 Band 12

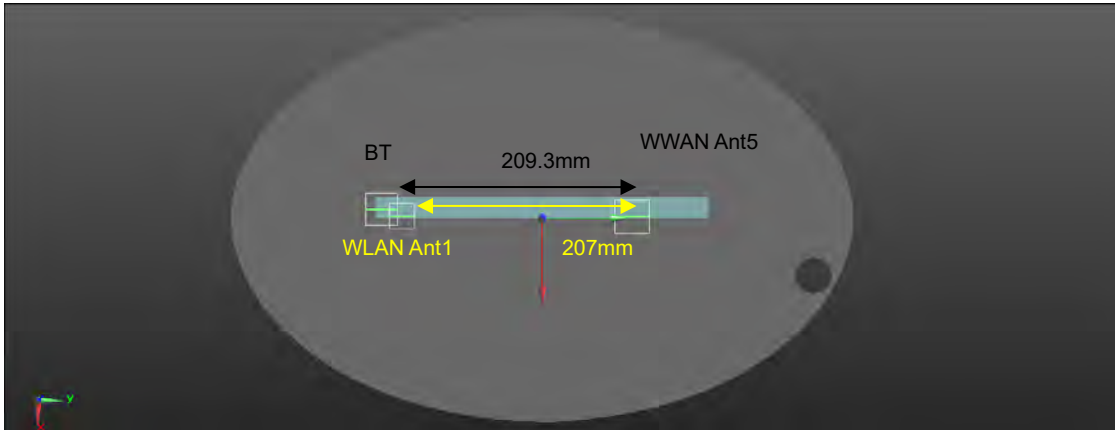

Unless otherwise stated the results shown in this test report refer only to the sample(s) tested and such sample(s) are retained for 90 days only.

除非另有說明，此報告結果僅對測試之樣品負責，同時此樣品僅保留90天。本報告未經本公司書面許可，不可部份複製。

This document is issued by the Company subject to its General Conditions of Service printed overleaf, available on request or accessible at <http://www.sgs.com.tw/Terms-and-Conditions> and for electronic format documents, subject to Terms and Conditions for Electronic Documents at <http://www.sgs.com.tw/Terms-and-Conditions>. Attention is drawn to the limitation of liability, indemnification and jurisdiction issues defined therein. Any holder of this document is advised that information contained hereon reflects the Company's findings at the time of its intervention only and within the limits of Client's instructions, if any. The Company's sole responsibility is to its Client and this document does not exonerate parties to a transaction from exercising all their rights and obligations under the transaction documents. This document cannot be reproduced except in full, without prior written approval of the Company. Any unauthorized alteration, forgery or falsification of the content or appearance of this document is unlawful and offenders may be prosecuted to the fullest extent of the law.

WLAN 6G Ant1+BT to CAT.M1 Band 13

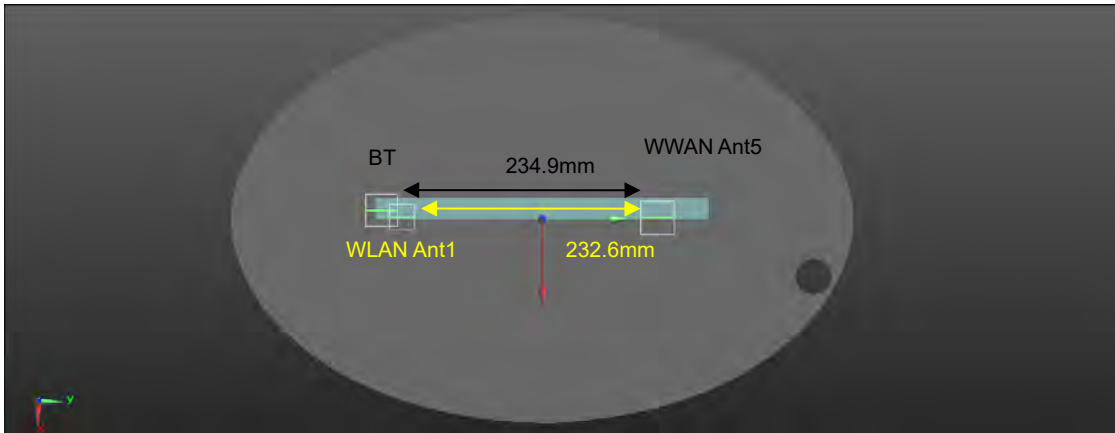

WLAN 6G Ant1+BT to CAT.M1 Band 14

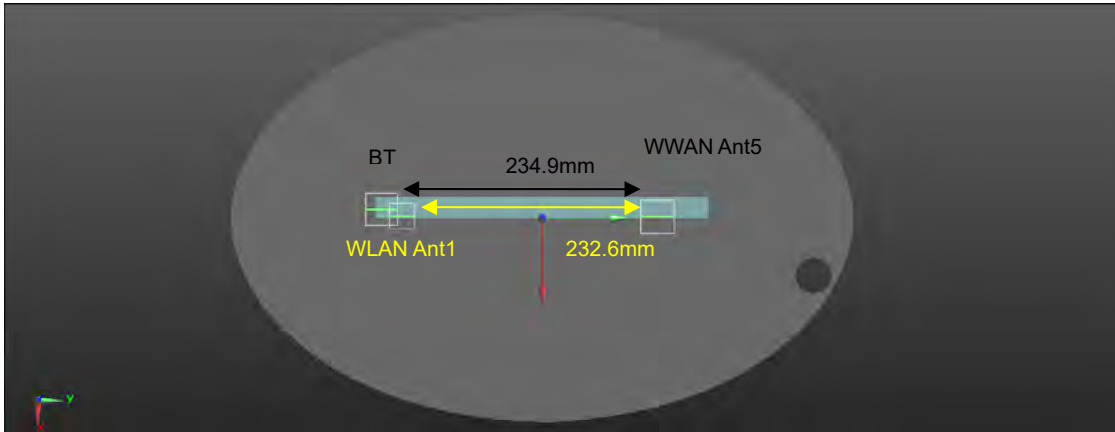

WLAN 6G Ant1+BT to CAT.M1 Band 25

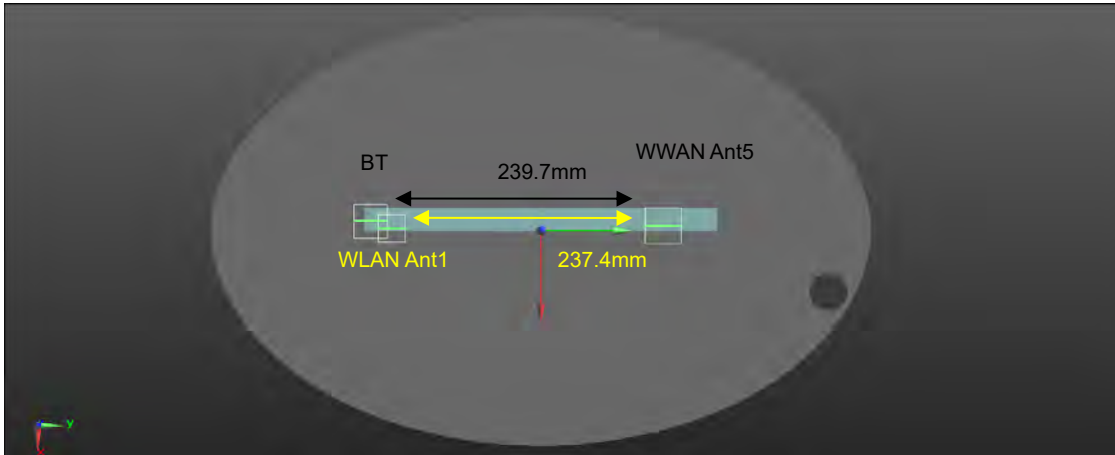

Unless otherwise stated the results shown in this test report refer only to the sample(s) tested and such sample(s) are retained for 90 days only.

除非另有說明，此報告結果僅對測試之樣品負責，同時此樣品僅保留90天。本報告未經本公司書面許可，不可部份複製。

This document is issued by the Company subject to its General Conditions of Service printed overleaf, available on request or accessible at <http://www.sgs.com.tw/Terms-and-Conditions> and for electronic format documents, subject to Terms and Conditions for Electronic Documents at <http://www.sgs.com.tw/Terms-and-Conditions>. Attention is drawn to the limitation of liability, indemnification and jurisdiction issues defined therein. Any holder of this document is advised that information contained hereon reflects the Company's findings at the time of its intervention only and within the limits of Client's instructions, if any. The Company's sole responsibility is to its Client and this document does not exonerate parties to a transaction from exercising all their rights and obligations under the transaction documents. This document cannot be reproduced except in full, without prior written approval of the Company. Any unauthorized alteration, forgery or falsification of the content or appearance of this document is unlawful and offenders may be prosecuted to the fullest extent of the law.

WLAN 6G Ant1+BT to CAT.M1 Band 26 FCC

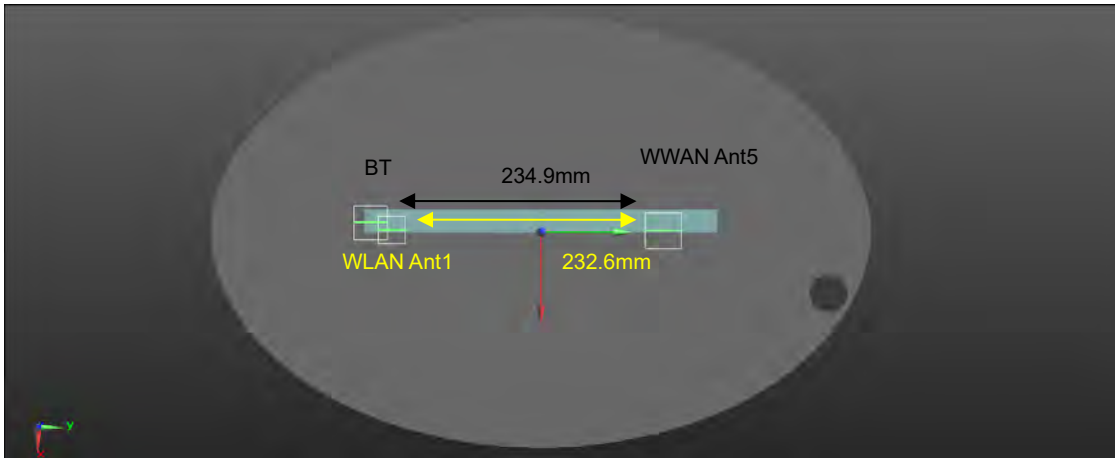

WLAN 6G Ant1+BT to CAT.M1 Band 66

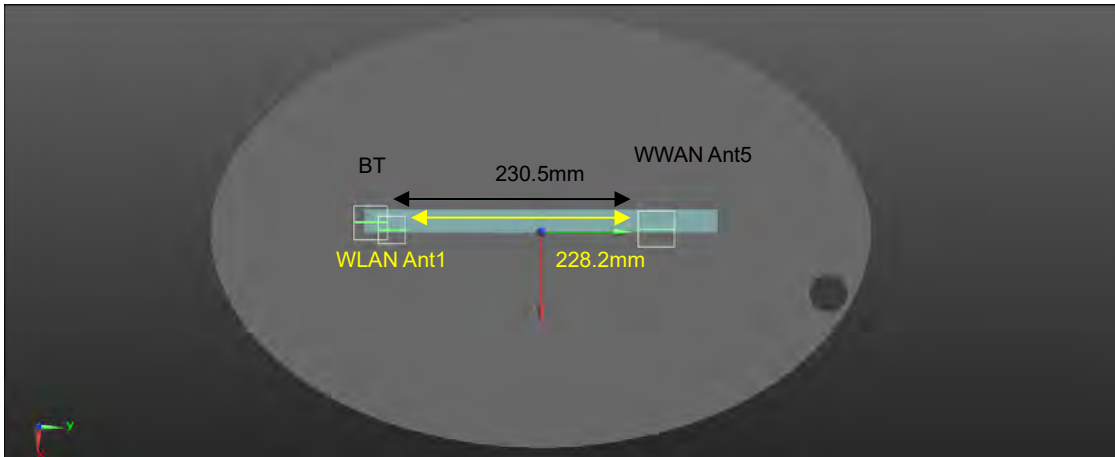

WLAN 6G Ant1+BT to CAT.M1 Band 85

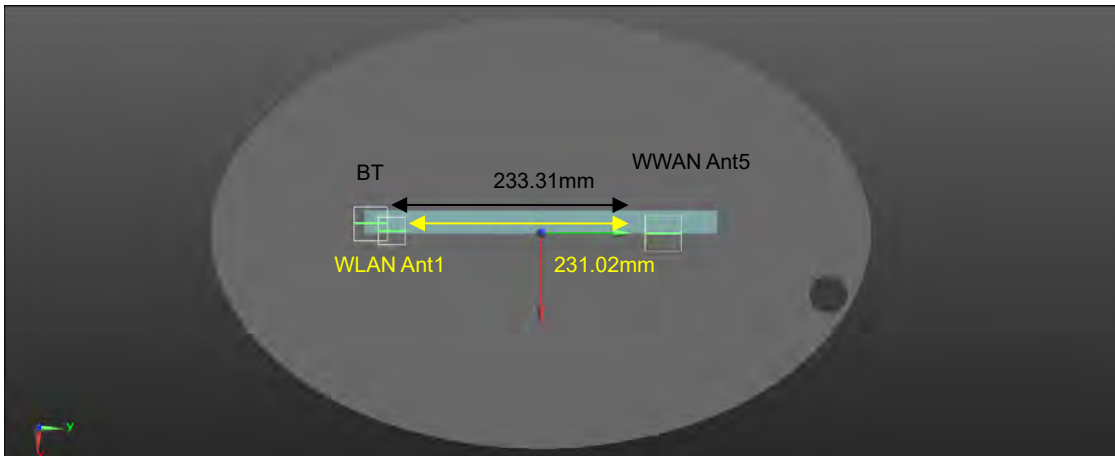

Unless otherwise stated the results shown in this test report refer only to the sample(s) tested and such sample(s) are retained for 90 days only.

除非另有說明，此報告結果僅對測試之樣品負責，同時此樣品僅保留90天。本報告未經本公司書面許可，不可部份複製。

This document is issued by the Company subject to its General Conditions of Service printed overleaf, available on request or accessible at <http://www.sgs.com.tw/Terms-and-Conditions> and for electronic format documents, subject to Terms and Conditions for Electronic Documents at <http://www.sgs.com.tw/Terms-and-Conditions>. Attention is drawn to the limitation of liability, indemnification and jurisdiction issues defined therein. Any holder of this document is advised that information contained hereon reflects the Company's findings at the time of its intervention only and within the limits of Client's instructions, if any. The Company's sole responsibility is to its Client and this document does not exonerate parties to a transaction from exercising all their rights and obligations under the transaction documents. This document cannot be reproduced except in full, without prior written approval of the Company. Any unauthorized alteration, forgery or falsification of the content or appearance of this document is unlawful and offenders may be prosecuted to the fullest extent of the law.

Scenario 3:									
Position	Conditions	SAR Value (W/kg)	Coordinates (cm)			ΣSAR (W/kg)	Peak Location Separation Distance (mm)	SPLSR	Simultaneous Transmission SAR Test
			x	y	z				
Top edge	WLAN 6G Ant2	1.100	-0.46	-5.38	-0.32	-	-	-	-
	GPRS 850	1.194	-0.46	10.70	-0.31	2.294	160.80	0.022	SPLSR ≤ 0.04, Not required
	GPRS 1900	1.022	-0.45	10.85	-0.30	2.122	162.30	0.019	SPLSR ≤ 0.04, Not required
	CAT.M1 Band 2	0.090	-0.28	11.00	-0.30	1.190	163.81	0.008	SPLSR ≤ 0.04, Not required
	CAT.M1 Band 4	0.103	-0.29	10.06	-0.31	1.203	154.41	0.009	SPLSR ≤ 0.04, Not required
	CAT.M1 Band 5	0.078	-0.31	10.69	-0.31	1.178	160.71	0.008	SPLSR ≤ 0.04, Not required
	CAT.M1 Band 12	0.050	-0.31	8.13	-0.31	1.150	135.11	0.009	SPLSR ≤ 0.04, Not required
	CAT.M1 Band 13	0.066	-0.31	10.69	-0.30	1.166	160.71	0.008	SPLSR ≤ 0.04, Not required
	CAT.M1 Band 14	0.067	-0.31	10.69	-0.30	1.167	160.71	0.008	SPLSR ≤ 0.04, Not required
	CAT.M1 Band 25	0.103	-0.29	11.17	-0.31	1.203	165.51	0.008	SPLSR ≤ 0.04, Not required
	CAT.M1 Band 26_FCC	0.081	-0.31	10.69	-0.31	1.181	160.71	0.008	SPLSR ≤ 0.04, Not required
	CAT.M1 Band 66	0.125	-0.30	10.25	-0.30	1.225	156.31	0.009	SPLSR ≤ 0.04, Not required
	CAT.M1 Band 85	0.260	-0.16	10.53	-0.31	1.360	159.13	0.010	SPLSR ≤ 0.04, Not required

Unless otherwise stated the results shown in this test report refer only to the sample(s) tested and such sample(s) are retained for 90 days only.

除非另有說明，此報告結果僅對測試之樣品負責，同時此樣品僅保留90天。本報告未經本公司書面許可，不可部份複製。

This document is issued by the Company subject to its General Conditions of Service printed overleaf, available on request or accessible at <http://www.sgs.com.tw/Terms-and-Conditions>, and for electronic format documents, subject to Terms and Conditions for Electronic Documents at <http://www.sgs.com.tw/Terms-and-Conditions>. Attention is drawn to the limitation of liability, indemnification and jurisdiction issues defined therein. Any holder of this document is advised that information contained hereon reflects the Company's findings at the time of its intervention only and within the limits of Client's instructions, if any. The Company's sole responsibility is to its Client and this document does not exonerate parties to a transaction from exercising all their rights and obligations under the transaction documents. This document cannot be reproduced except in full, without prior written approval of the Company. Any unauthorized alteration, forgery or falsification of the content or appearance of this document is unlawful and offenders may be prosecuted to the fullest extent of the law.

WLAN 6G Ant2 to GPRS 850

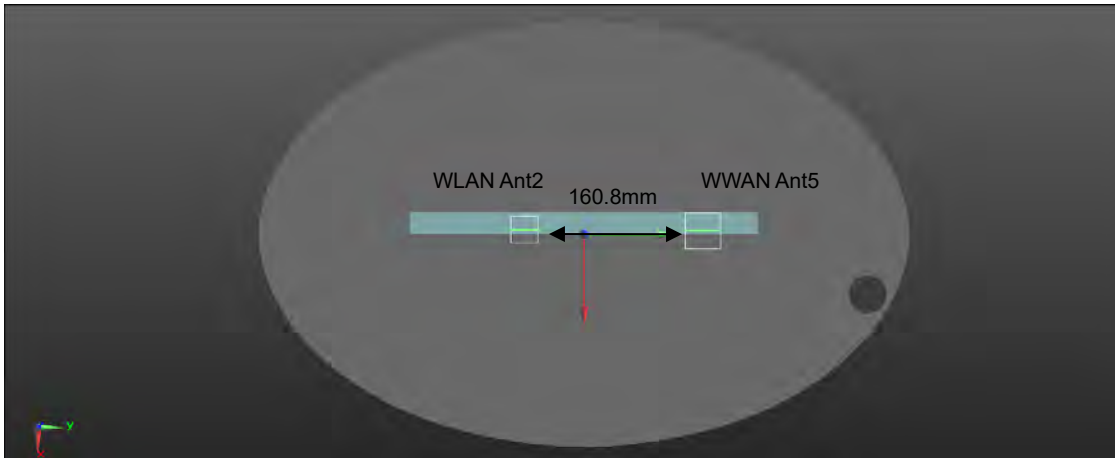

WLAN 6G Ant2 to GPRS 1900

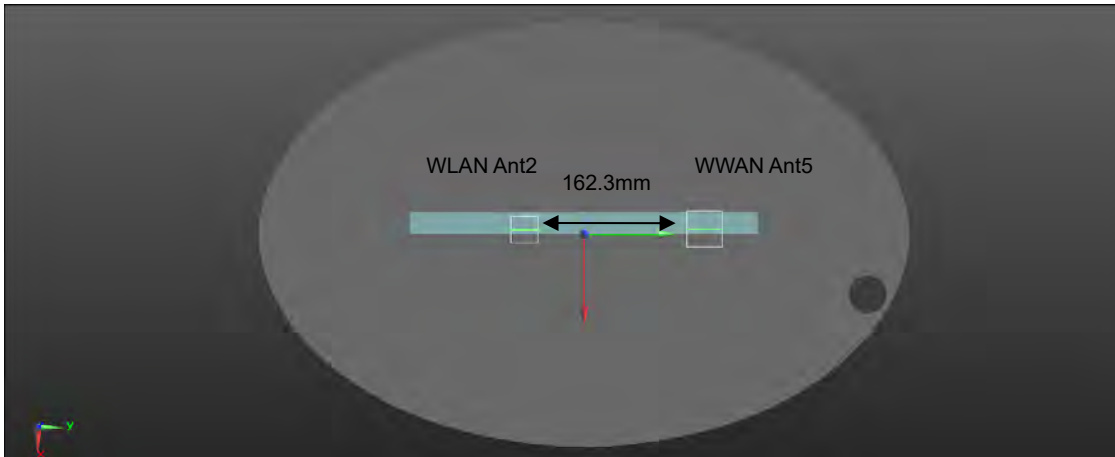

WLAN 6G Ant2 to Cat.M1 Band2

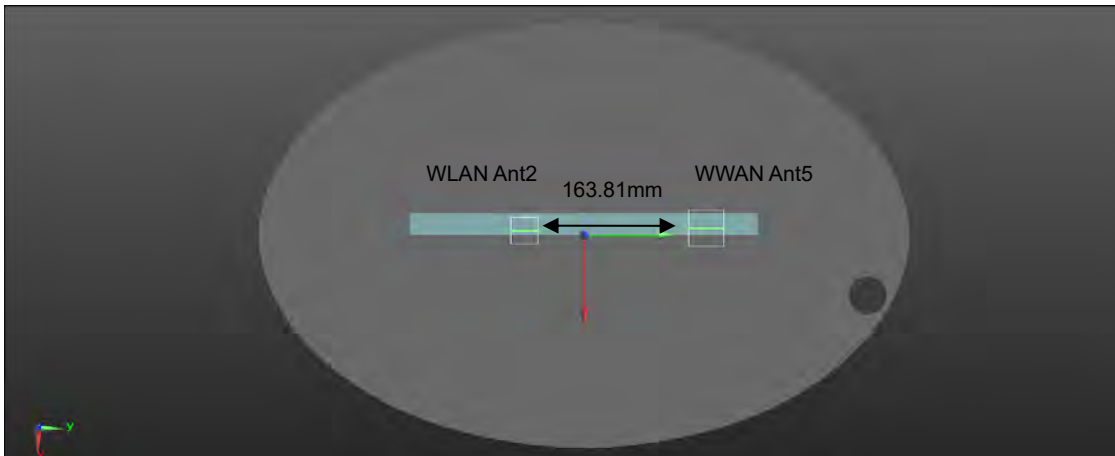

Unless otherwise stated the results shown in this test report refer only to the sample(s) tested and such sample(s) are retained for 90 days only.

除非另有說明，此報告結果僅對測試之樣品負責，同時此樣品僅保留90天。本報告未經本公司書面許可，不可部份複製。

This document is issued by the Company subject to its General Conditions of Service printed overleaf, available on request or accessible at <http://www.sgs.com.tw/Terms-and-Conditions> and for electronic format documents, subject to Terms and Conditions for Electronic Documents at <http://www.sgs.com.tw/Terms-and-Conditions>. Attention is drawn to the limitation of liability, indemnification and jurisdiction issues defined therein. Any holder of this document is advised that information contained hereon reflects the Company's findings at the time of its intervention only and within the limits of Client's instructions, if any. The Company's sole responsibility is to its Client and this document does not exonerate parties to a transaction from exercising all their rights and obligations under the transaction documents. This document cannot be reproduced except in full, without prior written approval of the Company. Any unauthorized alteration, forgery or falsification of the content or appearance of this document is unlawful and offenders may be prosecuted to the fullest extent of the law.

WLAN 6G Ant2 to Cat.M1 Band4



WLAN 6G Ant2 to Cat.M1 Band5

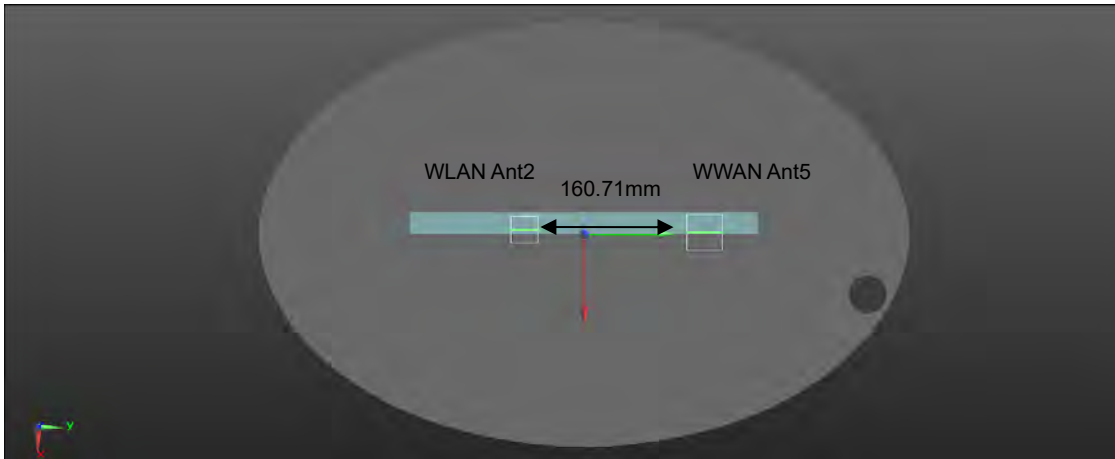

WLAN 6G Ant2 to Cat.M1 Band12

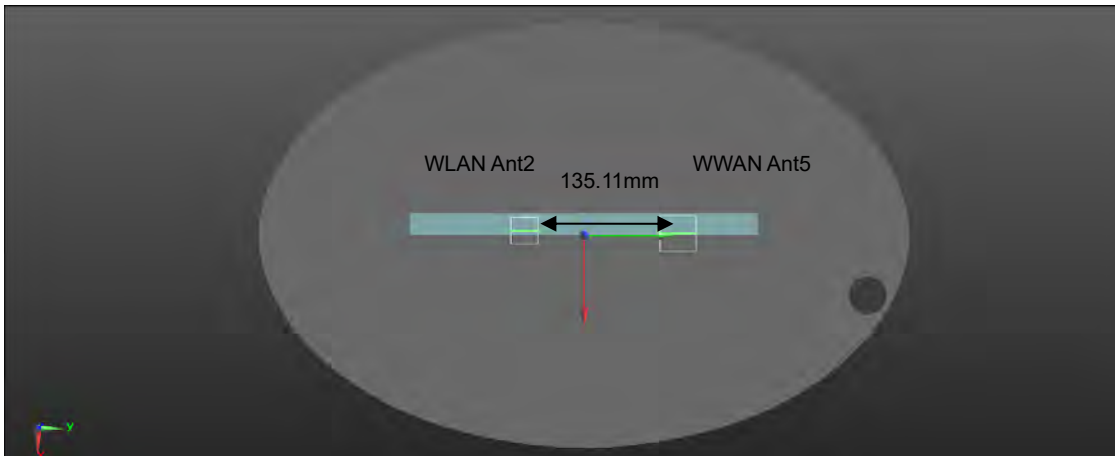

Unless otherwise stated the results shown in this test report refer only to the sample(s) tested and such sample(s) are retained for 90 days only.

除非另有說明，此報告結果僅對測試之樣品負責，同時此樣品僅保留90天。本報告未經本公司書面許可，不可部份複製。

This document is issued by the Company subject to its General Conditions of Service printed overleaf, available on request or accessible at <http://www.sgs.com.tw/Terms-and-Conditions> and for electronic format documents, subject to Terms and Conditions for Electronic Documents at <http://www.sgs.com.tw/Terms-and-Conditions>. Attention is drawn to the limitation of liability, indemnification and jurisdiction issues defined therein. Any holder of this document is advised that information contained hereon reflects the Company's findings at the time of its intervention only and within the limits of Client's instructions, if any. The Company's sole responsibility is to its Client and this document does not exonerate parties to a transaction from exercising all their rights and obligations under the transaction documents. This document cannot be reproduced except in full, without prior written approval of the Company. Any unauthorized alteration, forgery or falsification of the content or appearance of this document is unlawful and offenders may be prosecuted to the fullest extent of the law.

WLAN 6G Ant2 to Cat.M1 Band13



WLAN 6G Ant2 to Cat.M1 Band14

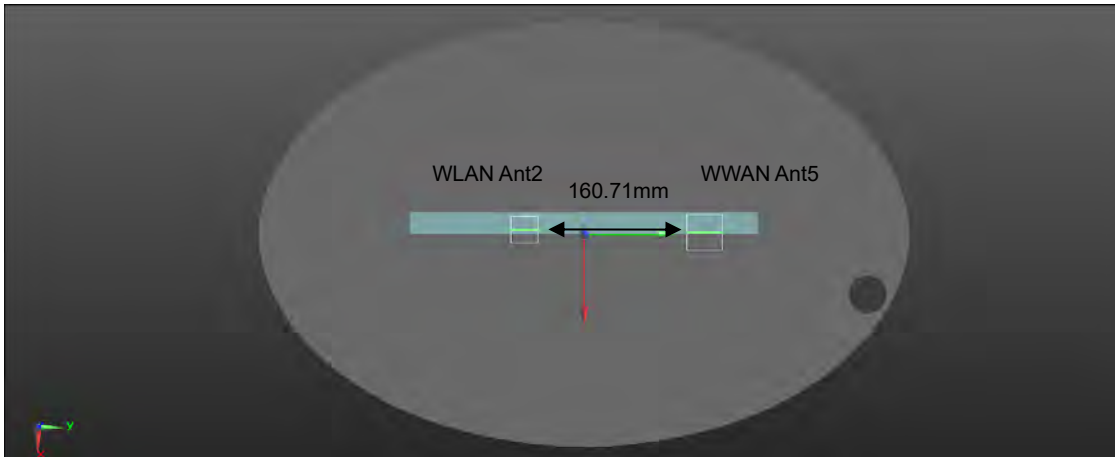

WLAN 6G Ant2 to Cat.M1 Band25

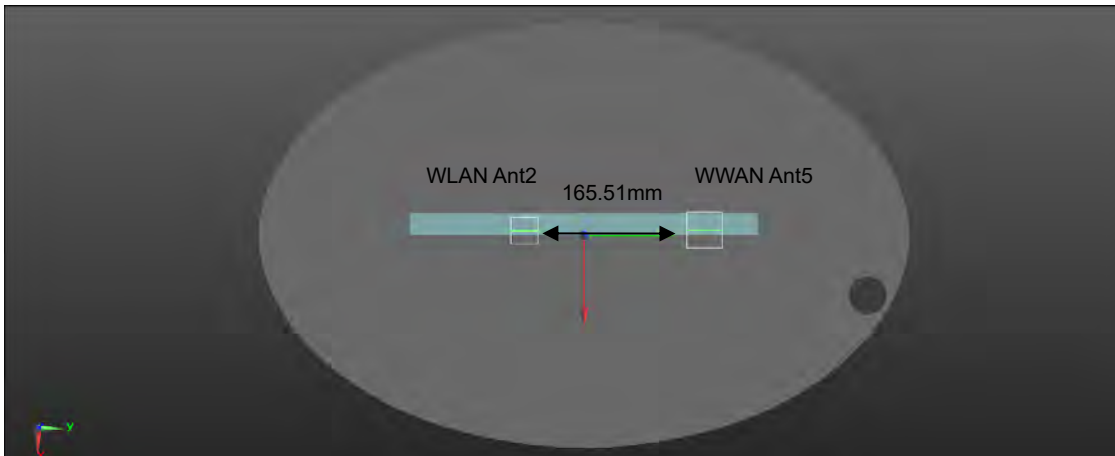

Unless otherwise stated the results shown in this test report refer only to the sample(s) tested and such sample(s) are retained for 90 days only.
 除非另有說明，此報告結果僅對測試之樣品負責，同時此樣品僅保留90天。本報告未經本公司書面許可，不可部份複製。

This document is issued by the Company subject to its General Conditions of Service printed overleaf, available on request or accessible at <http://www.sgs.com.tw/Terms-and-Conditions> and for electronic format documents, subject to Terms and Conditions for Electronic Documents at <http://www.sgs.com.tw/Terms-and-Conditions>. Attention is drawn to the limitation of liability, indemnification and jurisdiction issues defined therein. Any holder of this document is advised that information contained hereon reflects the Company's findings at the time of its intervention only and within the limits of Client's instructions, if any. The Company's sole responsibility is to its Client and this document does not exonerate parties to a transaction from exercising all their rights and obligations under the transaction documents. This document cannot be reproduced except in full, without prior written approval of the Company. Any unauthorized alteration, forgery or falsification of the content or appearance of this document is unlawful and offenders may be prosecuted to the fullest extent of the law.

WLAN 6G Ant2 to Cat.M1 Band26 FCC

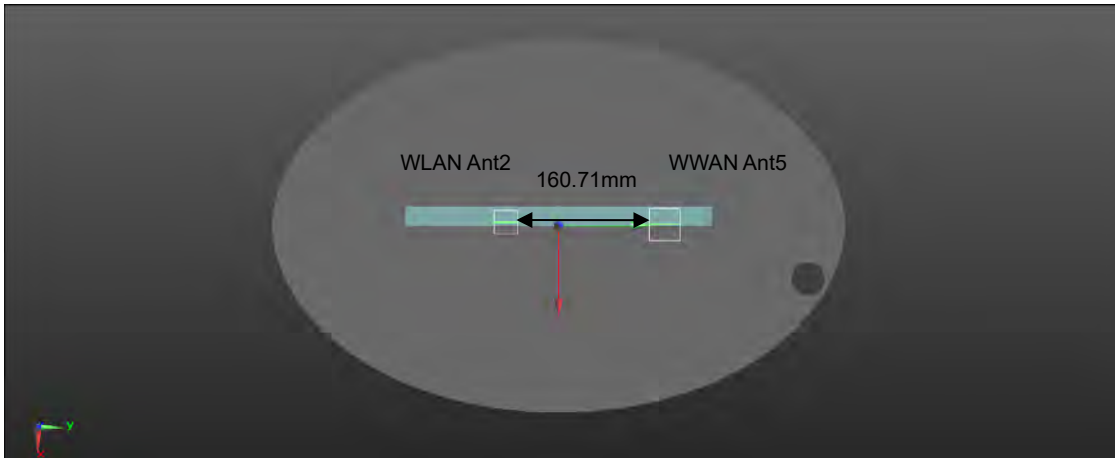

WLAN 6G Ant2 to Cat.M1 Band66

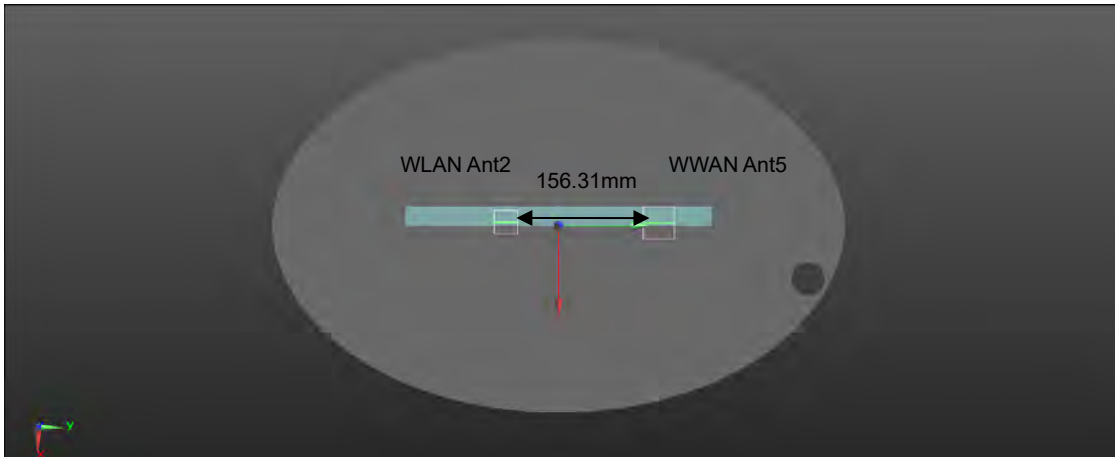

WLAN 6G Ant2 to Cat.M1 Band85

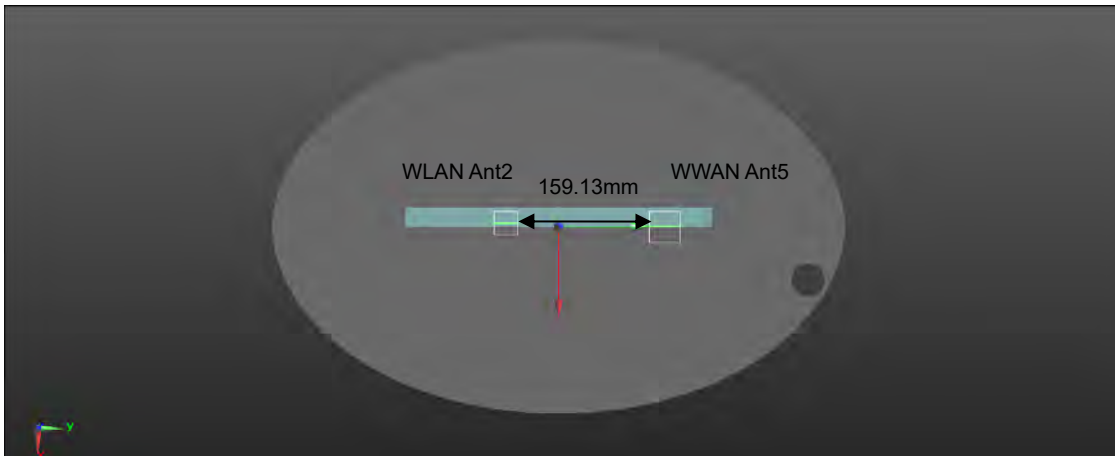

7.4 Conclusion

The simultaneous transmission is compliant because both SAR sum and/or SPLSR are less than their corresponding criteria.

Unless otherwise stated the results shown in this test report refer only to the sample(s) tested and such sample(s) are retained for 90 days only.

除非另有說明，此報告結果僅對測試之樣品負責，同時此樣品僅保留90天。本報告未經本公司書面許可，不可部份複製。

This document is issued by the Company subject to its General Conditions of Service printed overleaf, available on request or accessible at <http://www.sgs.com.tw/Terms-and-Conditions> and for electronic format documents, subject to Terms and Conditions for Electronic Documents at <http://www.sgs.com.tw/Terms-and-Conditions>. Attention is drawn to the limitation of liability, indemnification and jurisdiction issues defined therein. Any holder of this document is advised that information contained hereon reflects the Company's findings at the time of its intervention only and within the limits of Client's instructions, if any. The Company's sole responsibility is to its Client and this document does not exonerate parties to a transaction from exercising all their rights and obligations under the transaction documents. This document cannot be reproduced except in full, without prior written approval of the Company. Any unauthorized alteration, forgery or falsification of the content or appearance of this document is unlawful and offenders may be prosecuted to the fullest extent of the law.

8 INSTRUMENTS LIST

Equipment List					
Manufacturer	Device	Type	Serial number	Date of last calibration	Date of next calibration
SPEAG	Data acquisition Electronics	DAE4	1336	Aug/22/2023	Aug/21/2024
SPEAG	Dosimetric E-Field Probe	EX3DV4	7509	Apr/26/2023	Apr/25/2024
SPEAG	System Validation Dipole	D750V3	1015	Sep/18/2023	Sep/17/2024
SPEAG	System Validation Dipole	D835V2	4d063	Sep/20/2023	Sep/19/2024
SPEAG	System Validation Dipole	D1750V2	1008	Sep/19/2023	Sep/18/2024
SPEAG	System Validation Dipole	D1900V2	5d056	Aug/25/2023	Aug/24/2024
SPEAG	Dielectric Assessment Kit	DAKS-3.5	1053	Feb/27/2023	Feb/26/2024
R&S	MXG Analog Signal Generator	SMB100A03	182012	May/23/2023	May/22/2024
Agilent	Dual-directional coupler	772D	MY46151258	Sep/26/2023	Sep/25/2024
Agilent	Dual-directional coupler	778D	MY46151242	Sep/26/2023	Sep/25/2024
EMCI	Amplifier	EMC 074225P	980155	Calibration not required	Calibration not required
R&S	Power Sensor	NRP18S	101973	Feb/06/2023	Feb/05/2024
R&S	Power Meter	NRX	102191	Feb/06/2023	Feb/05/2024
R&S	Power Sensor	NRP50S	101358	Feb/06/2023	Feb/05/2024
SPEAG	Software	DASY 52 V52.10.4.1527	N/A	Calibration not required	Calibration not required
SPEAG	Phantom	ELI	N/A	Calibration not required	Calibration not required
Anritsu	Radio Communication Test	MT8821C	6262044732	Nov/16/2023	Nov/15/2024
TECPEL	Digital thermometer	DTM-303A	TP131515	Jun/02/2023	Jun/01/2024

Unless otherwise stated the results shown in this test report refer only to the sample(s) tested and such sample(s) are retained for 90 days only.

除非另有說明，此報告結果僅對測試之樣品負責，同時此樣品僅保留90天。本報告未經本公司書面許可，不可部份複製。

This document is issued by the Company subject to its General Conditions of Service printed overleaf, available on request or accessible at <http://www.sgs.com.tw/Terms-and-Conditions> and for electronic format documents, subject to Terms and Conditions for Electronic Documents at <http://www.sgs.com.tw/Terms-and-Conditions>. Attention is drawn to the limitation of liability, indemnification and jurisdiction issues defined therein. Any holder of this document is advised that information contained hereon reflects the Company's findings at the time of its intervention only and within the limits of Client's instructions, if any. The Company's sole responsibility is to its Client and this document does not exonerate parties to a transaction from exercising all their rights and obligations under the transaction documents. This document cannot be reproduced except in full, without prior written approval of the Company. Any unauthorized alteration, forgery or falsification of the content or appearance of this document is unlawful and offenders may be prosecuted to the fullest extent of the law.

9 UNCERTAINTY BUDGET

Measurement Uncertainty evaluation template for DUT SAR test (0.3-3G)

A	c	D	e		f	g	h=c * f / e	i=c * g / e	k
Source of Uncertainty	Tolerance/ Uncertainty	Probability Distributio	Div	Div Value	ci (1g)	ci (10g)	Standard uncertainty	Standard uncertainty	vi, or Veff
Measurement system									
Probe calibration	6.00%	N	1	1	1	1	6.00%	6.00%	∞
<i>Isotropy, Axial</i>	3.50%	R	√3	1.732	1	1	2.02%	2.02%	∞
<i>Isotropy, Hemispherical</i>	9.60%	R	√3	1.732	1	1	5.54%	5.54%	∞
Modulation Response	2.40%	R	√3	1.732	1	1	1.40%	1.40%	∞
Boundary Effect	1.00%	R	√3	1.732	1	1	0.58%	0.58%	∞
Linearity	4.70%	R	√3	1.732	1	1	2.71%	2.71%	∞
Detection Limits	1.00%	R	√3	1.732	1	1	0.58%	0.58%	∞
Readout Electronics	0.30%	N	1	1	1	1	0.30%	0.30%	∞
Response time	0.80%	R	√3	1.732	1	1	0.46%	0.46%	∞
Integration Time	2.60%	R	√3	1.732	1	1	1.50%	1.50%	∞
Measurement drift (class A evaluation)									
RF ambient condition - noise	3.00%	R	√3	1.732	1	1	1.73%	1.73%	∞
RF ambient conditions - reflections	3.00%	R	√3	1.732	1	1	1.73%	1.73%	∞
Probe positioner Mechanical restrictions	0.40%	R	√3	1.732	1	1	0.23%	0.23%	∞
Probe Positioning with respect to phantom shell	2.90%	R	√3	1.732	1	1	1.67%	1.67%	∞
Post-processing	1.00%	R	√3	1.732	1	1	0.58%	0.58%	∞
Max SAR Eval	1.00%	R	√3	1.732	1	1	0.58%	0.58%	∞
Test Sample related									
Test sample positioning	2.90%	N	1	1	1	1	2.90%	2.90%	M-1
Device Holder Uncertainty	3.60%	N	1	1	1	1	3.60%	3.60%	M-1
Drift of output power	5.00%	R	√3	1.732	1	1	2.89%	2.89%	∞
Phantom and Setup									
Phantom Uncertainty	4.00%	R	√3	1.732	1	1	2.31%	2.31%	∞
Liquid permittivity (mea.)	3.93%	N	1	1	0.64	0.43	2.52%	1.69%	M
Liquid Conductivity (mea.)	4.76%	N	1	1	0.6	0.49	2.86%	2.33%	M
Combined standard uncertainty		RSS					12.04%	11.77%	
Expant uncertainty (95% confidence interval), K=2							24.07%	23.53%	

Unless otherwise stated the results shown in this test report refer only to the sample(s) tested and such sample(s) are retained for 90 days only.

除非另有說明，此報告結果僅對測試之樣品負責，同時此樣品僅保留90天。本報告未經本公司書面許可，不可部份複製。

This document is issued by the Company subject to its General Conditions of Service printed overleaf, available on request or accessible at <http://www.sgs.com.tw/Terms-and-Conditions> and for electronic format documents, subject to Terms and Conditions for Electronic Documents at <http://www.sgs.com.tw/Terms-and-Conditions>. Attention is drawn to the limitation of liability, indemnification and jurisdiction issues defined therein. Any holder of this document is advised that information contained hereon reflects the Company's findings at the time of its intervention only and within the limits of Client's instructions, if any. The Company's sole responsibility is to its Client and this document does not exonerate parties to a transaction from exercising all their rights and obligations under the transaction documents. This document cannot be reproduced except in full, without prior written approval of the Company. Any unauthorized alteration, forgery or falsification of the content or appearance of this document is unlawful and offenders may be prosecuted to the fullest extent of the law.

10 SAR MEASUREMENT RESULTS

Date: 2023/12/7

ID: 001

Report No. :TESA2311000704EN

GPRS850(1Dn4Up)_Body_Top Edge_CH 251_0mm

Communication System: GPRS(1Dn4Up); Frequency: 848.8 MHz; Duty cycle= 1:2

Medium parameters used: $f = 849$ MHz; $\sigma = 0.911$ S/m; $\epsilon_r = 40.512$; $\rho = 1000$ kg/m³

Phantom section: Flat Section

Ambient temperature: 21.9°C; Liquid temperature: 21.7°C

DASY5 Configuration:

- Probe: EX3DV4 - SN7509; ConvF(9.51, 9.16, 10) @ 848.8 MHz; Calibrated: 2023/4/26
- Sensor-Surface: 2mm (Mechanical Surface Detection)
- Electronics: DAE4 Sn1336; Calibrated: 2023/8/22
- Phantom: ELI
- DASY52 52.10.4(1527); SEMCAD X 14.6.14(7483)

Area Scan (61x101x1): Interpolated grid: dx=15 mm, dy=15 mm

Maximum value of SAR (interpolated) = 1.05 W/kg

Zoom Scan (5x5x7)/Cube 0: Measurement grid: dx=8mm, dy=8mm, dz=5mm

Reference Value = 14.18 V/m; Power Drift = 0.13 dB

Peak SAR (extrapolated) = 1.54 W/kg

SAR(1 g) = 0.882 W/kg; SAR(10 g) = 0.513 W/kg

Smallest distance from peaks to all points 3 dB below = 8.2 mm

Ratio of SAR at M2 to SAR at M1 = 48.7%

Maximum value of SAR (measured) = 1.19 W/kg

Zoom Scan (5x5x7)/Cube 1: Measurement grid: dx=8mm, dy=8mm, dz=5mm

Reference Value = 14.18 V/m; Power Drift = 0.13 dB

Peak SAR (extrapolated) = 1.53 W/kg

SAR(1 g) = 0.799 W/kg; SAR(10 g) = 0.467 W/kg

Smallest distance from peaks to all points 3 dB below = 8.4 mm

Ratio of SAR at M2 to SAR at M1 = 50.5%

Maximum value of SAR (measured) = 1.17 W/kg

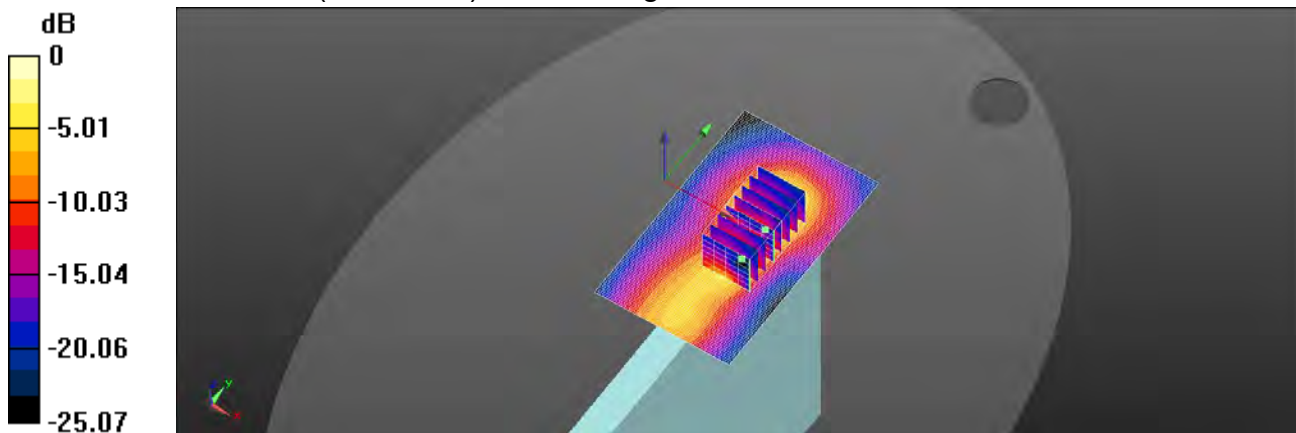

0 dB = 1.05 W/kg = 0.19 dBW/kg

Unless otherwise stated the results shown in this test report refer only to the sample(s) tested and such sample(s) are retained for 90 days only.

除非另有說明，此報告結果僅對測試之樣品負責，同時此樣品僅保留90天。本報告未經本公司書面許可，不可部份複製。

This document is issued by the Company subject to its General Conditions of Service printed overleaf, available on request or accessible at <http://www.sgs.com.tw/Terms-and-Conditions> and for electronic format documents, subject to Terms and Conditions for Electronic Documents at <http://www.sgs.com.tw/Terms-and-Conditions>. Attention is drawn to the limitation of liability, indemnification and jurisdiction issues defined therein. Any holder of this document is advised that information contained hereon reflects the Company's findings at the time of its intervention only and within the limits of Client's instructions, if any. The Company's sole responsibility is to its Client and this document does not exonerate parties to a transaction from exercising all their rights and obligations under the transaction documents. This document cannot be reproduced except in full, without prior written approval of the Company. Any unauthorized alteration, forgery or falsification of the content or appearance of this document is unlawful and offenders may be prosecuted to the fullest extent of the law.

Date: 2023/12/10

ID: 002

Report No. :TESA2311000704EN

GPRS1900(1Dn4Up)_Body_Top Edge_CH 661_0mm

Communication System: GPRS(1Dn4Up); Frequency: 1880 MHz; Duty cycle= 1:2

Medium parameters used: $f = 1880$ MHz; $\sigma = 1.422$ S/m; $\epsilon_r = 38.469$; $\rho = 1000$ kg/m³

Phantom section: Flat Section

Ambient temperature: 22.0°C; Liquid temperature: 21.7°C

DASY5 Configuration:

- Probe: EX3DV4 - SN7509; ConvF(8.12, 8.05, 8.74) @ 1880 MHz; Calibrated: 2023/4/26
- Sensor-Surface: 2mm (Mechanical Surface Detection)
- Electronics: DAE4 Sn1336; Calibrated: 2023/8/22
- Phantom: ELI
- DASY52 52.10.4(1527); SEMCAD X 14.6.14(7483)

Area Scan (61x101x1): Interpolated grid: dx=15 mm, dy=15 mm

Maximum value of SAR (interpolated) = 1.10 W/kg

Zoom Scan (5x5x7)/Cube 0: Measurement grid: dx=8mm, dy=8mm, dz=5mm

Reference Value = 5.413 V/m; Power Drift = 0.18 dB

Peak SAR (extrapolated) = 1.30 W/kg

SAR(1 g) = 0.891 W/kg; SAR(10 g) = 0.563 W/kg

Smallest distance from peaks to all points 3 dB below = 8.4 mm

Ratio of SAR at M2 to SAR at M1 = 52%

Maximum value of SAR (measured) = 1.06 W/kg

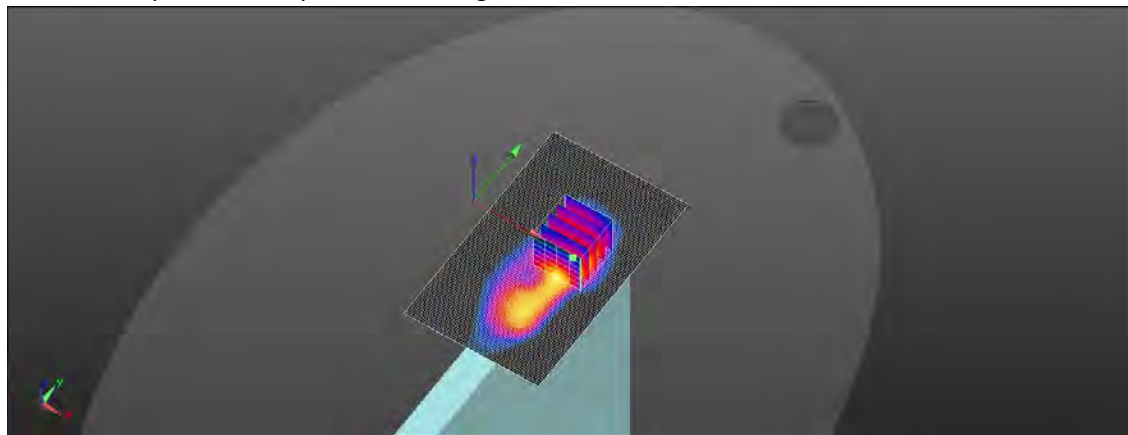
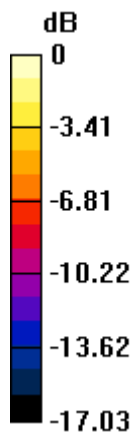

0 dB = 1.06 W/kg = 0.25 dBW/kg

Unless otherwise stated the results shown in this test report refer only to the sample(s) tested and such sample(s) are retained for 90 days only.

除非另有說明，此報告結果僅對測試之樣品負責，同時此樣品僅保留90天。本報告未經本公司書面許可，不可部份複製。

This document is issued by the Company subject to its General Conditions of Service printed overleaf, available on request or accessible at <http://www.sgs.com.tw/Terms-and-Conditions> and for electronic format documents, subject to Terms and Conditions for Electronic Documents at <http://www.sgs.com.tw/Terms-and-Conditions>. Attention is drawn to the limitation of liability, indemnification and jurisdiction issues defined therein. Any holder of this document is advised that information contained hereon reflects the Company's findings at the time of its intervention only and within the limits of Client's instructions, if any. The Company's sole responsibility is to its Client and this document does not exonerate parties to a transaction from exercising all their rights and obligations under the transaction documents. This document cannot be reproduced except in full, without prior written approval of the Company. Any unauthorized alteration, forgery or falsification of the content or appearance of this document is unlawful and offenders may be prosecuted to the fullest extent of the law.

SGS Taiwan Ltd.

No.134,Wu Kung Road, New Taipei Industrial Park, Wuku District, New Taipei City, Taiwan/新北市五股區新北產業園區五工路 134 號

台灣檢驗科技股份有限公司

t (886-2) 2299-3279

f (886-2) 2298-0488

www.sgs.com.tw

Member of SGS Group

Date: 2023/12/10

ID: 003

Report No. :TESA2311000704EN

CAT.M1 Band 2 (5MHz)_Body_Top Edge_CH 18900_QPSK_1-0_Index 0_0mm

Communication System: LTE; Frequency: 1880 MHz; Duty cycle= 1:3.32

Medium parameters used: $f = 1880 \text{ MHz}$; $\sigma = 1.422 \text{ S/m}$; $\epsilon_r = 38.469$; $\rho = 1000 \text{ kg/m}^3$

Phantom section: Flat Section

Ambient temperature: 22.0°C; Liquid temperature: 21.7°C

DASY5 Configuration:

- Probe: EX3DV4 - SN7509; ConvF(8.12, 8.05, 8.74) @ 1880 MHz; Calibrated: 2023/4/26
- Sensor-Surface: 2mm (Mechanical Surface Detection)
- Electronics: DAE4 Sn1336; Calibrated: 2023/8/22
- Phantom: ELI
- DASY52 52.10.4(1527); SEMCAD X 14.6.14(7483)

Area Scan (61x101x1): Interpolated grid: dx=15 mm, dy=15 mm

Maximum value of SAR (interpolated) = 0.207 W/kg

Zoom Scan (5x5x7)/Cube 0: Measurement grid: dx=8mm, dy=8mm, dz=5mm

Reference Value = 3.927 V/m; Power Drift = 0.10 dB

Peak SAR (extrapolated) = 0.141 W/kg

SAR(1 g) = 0.069 W/kg; SAR(10 g) = 0.036 W/kg

Smallest distance from peaks to all points 3 dB below = 8.6 mm

Ratio of SAR at M2 to SAR at M1 = 45.5%

Maximum value of SAR (measured) = 0.102 W/kg

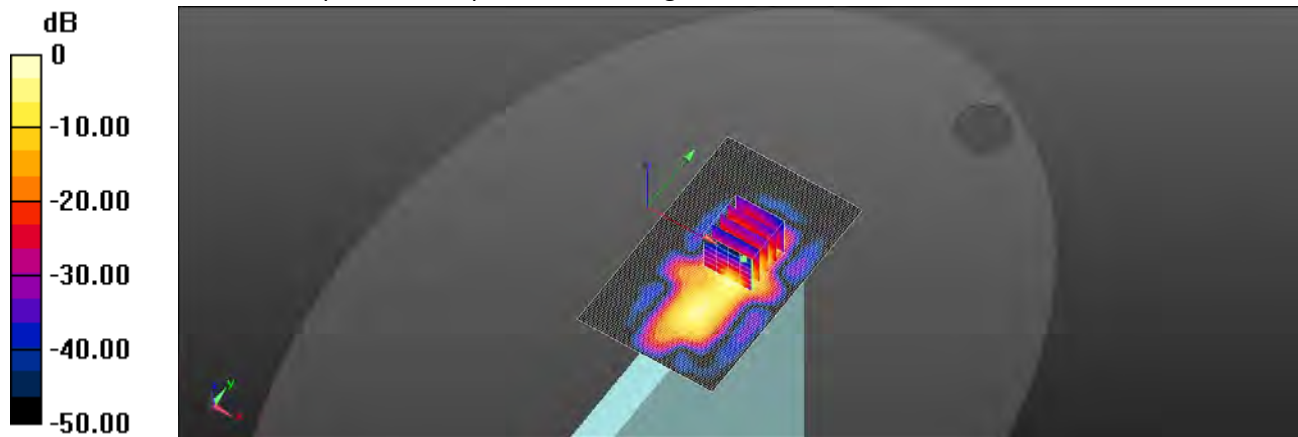

0 dB = 0.207 W/kg = -6.84 dBW/kg

Unless otherwise stated the results shown in this test report refer only to the sample(s) tested and such sample(s) are retained for 90 days only.

除非另有說明，此報告結果僅對測試之樣品負責，同時此樣品僅保留90天。本報告未經本公司書面許可，不可部份複製。

This document is issued by the Company subject to its General Conditions of Service printed overleaf, available on request or accessible at <http://www.sgs.com.tw/Terms-and-Conditions> and for electronic format documents, subject to Terms and Conditions for Electronic Documents at <http://www.sgs.com.tw/Terms-and-Conditions>. Attention is drawn to the limitation of liability, indemnification and jurisdiction issues defined therein. Any holder of this document is advised that information contained hereon reflects the Company's findings at the time of its intervention only and within the limits of Client's instructions, if any. The Company's sole responsibility is to its Client and this document does not exonerate parties to a transaction from exercising all their rights and obligations under the transaction documents. This document cannot be reproduced except in full, without prior written approval of the Company. Any unauthorized alteration, forgery or falsification of the content or appearance of this document is unlawful and offenders may be prosecuted to the fullest extent of the law.

Date: 2023/12/9

ID: 004

Report No. :TESA2311000704EN

CAT.M1 Band 4 (5MHz)_Body_Top Edge_CH 20375_QPSK_1-0_Index 0_0mm

Communication System: LTE; Frequency: 1752.5 MHz; Duty cycle= 1:3.32

Medium parameters used: $f = 1752.5$ MHz; $\sigma = 1.32$ S/m; $\epsilon_r = 38.656$; $\rho = 1000$ kg/m³

Phantom section: Flat Section

Ambient temperature: 22.5°C; Liquid temperature: 22.2°C

DASY5 Configuration:

- Probe: EX3DV4 - SN7509; ConvF(8.6, 8.56, 9.12) @ 1752.5 MHz; Calibrated: 2023/4/26
- Sensor-Surface: 2mm (Mechanical Surface Detection)
- Electronics: DAE4 Sn1336; Calibrated: 2023/8/22
- Phantom: ELI
- DASY52 52.10.4(1527); SEMCAD X 14.6.14(7483)

Area Scan (61x101x1): Interpolated grid: dx=15 mm, dy=15 mm

Maximum value of SAR (interpolated) = 0.143 W/kg

Zoom Scan (5x5x7)/Cube 0: Measurement grid: dx=8mm, dy=8mm, dz=5mm

Reference Value = 3.363 V/m; Power Drift = 0.14 dB

Peak SAR (extrapolated) = 0.157 W/kg

SAR(1 g) = 0.072 W/kg; SAR(10 g) = 0.036 W/kg

Smallest distance from peaks to all points 3 dB below = 8.8 mm

Ratio of SAR at M2 to SAR at M1 = 44.4%

Maximum value of SAR (measured) = 0.127 W/kg

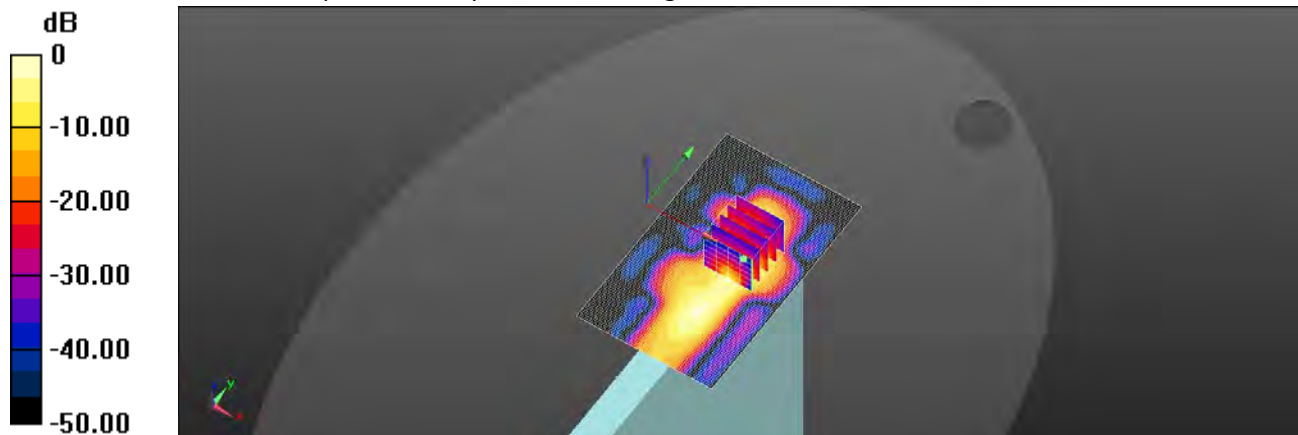

0 dB = 0.143 W/kg = -8.45 dBW/kg

Unless otherwise stated the results shown in this test report refer only to the sample(s) tested and such sample(s) are retained for 90 days only.

除非另有說明，此報告結果僅對測試之樣品負責，同時此樣品僅保留90天。本報告未經本公司書面許可，不可部份複製。

This document is issued by the Company subject to its General Conditions of Service printed overleaf, available on request or accessible at <http://www.sgs.com.tw/Terms-and-Conditions> and for electronic format documents, subject to Terms and Conditions for Electronic Documents at <http://www.sgs.com.tw/Terms-and-Conditions>. Attention is drawn to the limitation of liability, indemnification and jurisdiction issues defined therein. Any holder of this document is advised that information contained hereon reflects the Company's findings at the time of its intervention only and within the limits of Client's instructions, if any. The Company's sole responsibility is to its Client and this document does not exonerate parties to a transaction from exercising all their rights and obligations under the transaction documents. This document cannot be reproduced except in full, without prior written approval of the Company. Any unauthorized alteration, forgery or falsification of the content or appearance of this document is unlawful and offenders may be prosecuted to the fullest extent of the law.

SGS Taiwan Ltd.

No.134,Wu Kung Road, New Taipei Industrial Park, Wuku District, New Taipei City, Taiwan/新北市五股區新北產業園區五工路 134 號

台灣檢驗科技股份有限公司

t (886-2) 2299-3279

f (886-2) 2298-0488

www.sgs.com.tw

Member of SGS Group

Date: 2023/12/7

ID: 005

Report No. :TESA2311000704EN

CAT.M1 Band 5 (5MHz)_Body_Top Edge_CH 20525_QPSK_1-0_Index 0_0mm

Communication System: LTE; Frequency: 836.5 MHz; Duty cycle= 1:3.32

Medium parameters used: $f = 836.5$ MHz; $\sigma = 0.896$ S/m; $\epsilon_r = 40.558$; $\rho = 1000$ kg/m³

Phantom section: Flat Section

Ambient temperature: 21.9°C; Liquid temperature: 21.7°C

DASY5 Configuration:

- Probe: EX3DV4 - SN7509; ConvF(9.51, 9.16, 10) @ 836.5 MHz; Calibrated: 2023/4/26
- Sensor-Surface: 2mm (Mechanical Surface Detection)
- Electronics: DAE4 Sn1336; Calibrated: 2023/8/22
- Phantom: ELI
- DASY52 52.10.4(1527); SEMCAD X 14.6.14(7483)

Area Scan (61x101x1): Interpolated grid: dx=15 mm, dy=15 mm

Maximum value of SAR (interpolated) = 0.0618 W/kg

Zoom Scan (5x5x7)/Cube 0: Measurement grid: dx=8mm, dy=8mm, dz=5mm

Reference Value = 3.415 V/m; Power Drift = 0.15 dB

Peak SAR (extrapolated) = 0.103 W/kg

SAR(1 g) = 0.048 W/kg; SAR(10 g) = 0.025 W/kg

Smallest distance from peaks to all points 3 dB below: Larger than measurement grid

Ratio of SAR at M2 to SAR at M1 = 46.2%

Maximum value of SAR (measured) = 0.0779 W/kg

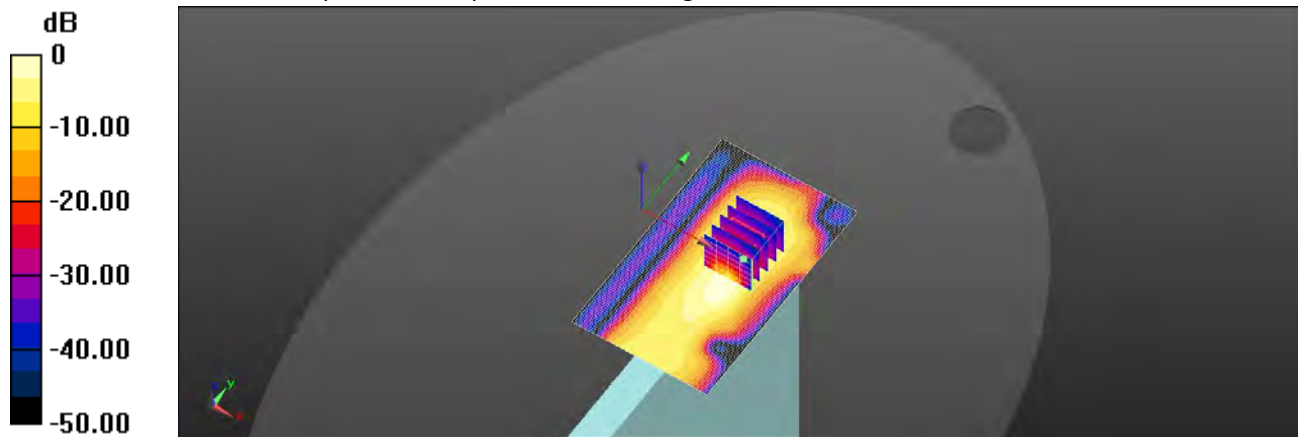

0 dB = 0.0618 W/kg = -12.09 dBW/kg

Unless otherwise stated the results shown in this test report refer only to the sample(s) tested and such sample(s) are retained for 90 days only.

除非另有說明，此報告結果僅對測試之樣品負責，同時此樣品僅保留90天。本報告未經本公司書面許可，不可部份複製。

This document is issued by the Company subject to its General Conditions of Service printed overleaf, available on request or accessible at <http://www.sgs.com.tw/Terms-and-Conditions> and for electronic format documents, subject to Terms and Conditions for Electronic Documents at <http://www.sgs.com.tw/Terms-and-Conditions>. Attention is drawn to the limitation of liability, indemnification and jurisdiction issues defined therein. Any holder of this document is advised that information contained hereon reflects the Company's findings at the time of its intervention only and within the limits of Client's instructions, if any. The Company's sole responsibility is to its Client and this document does not exonerate parties to a transaction from exercising all their rights and obligations under the transaction documents. This document cannot be reproduced except in full, without prior written approval of the Company. Any unauthorized alteration, forgery or falsification of the content or appearance of this document is unlawful and offenders may be prosecuted to the fullest extent of the law.

Date: 2023/12/5

ID: 006

Report No. :TESA2311000704EN

CAT.M1 Band 12 (5MHz)_Body_Top Edge_CH 23095_QPSK_1-0_Index 0_0mm

Communication System: LTE; Frequency: 707.5 MHz; Duty cycle= 1:3.32

Medium parameters used: $f = 708 \text{ MHz}$; $\sigma = 0.873 \text{ S/m}$; $\epsilon_r = 43.631$; $\rho = 1000 \text{ kg/m}^3$

Phantom section: Flat Section

Ambient temperature: 22.3°C; Liquid temperature: 22.0°C

DASY5 Configuration:

- Probe: EX3DV4 - SN7509; ConvF(9.97, 9.73, 10.82) @ 707.5 MHz; Calibrated: 2023/4/26
- Sensor-Surface: 2mm (Mechanical Surface Detection)
- Electronics: DAE4 Sn1336; Calibrated: 2023/8/22
- Phantom: ELI
- DASY52 52.10.4(1527); SEMCAD X 14.6.14(7483)

Area Scan (61x101x1): Interpolated grid: dx=15 mm, dy=15 mm

Maximum value of SAR (interpolated) = 0.0516 W/kg

Zoom Scan (5x5x7)/Cube 0: Measurement grid: dx=8mm, dy=8mm, dz=5mm

Reference Value = 3.919 V/m; Power Drift = 0.16 dB

Peak SAR (extrapolated) = 0.106 W/kg

SAR(1 g) = 0.037 W/kg; SAR(10 g) = 0.019 W/kg

Smallest distance from peaks to all points 3 dB below: Larger than measurement grid

Ratio of SAR at M2 to SAR at M1 = 36.2%

Maximum value of SAR (measured) = 0.0675 W/kg

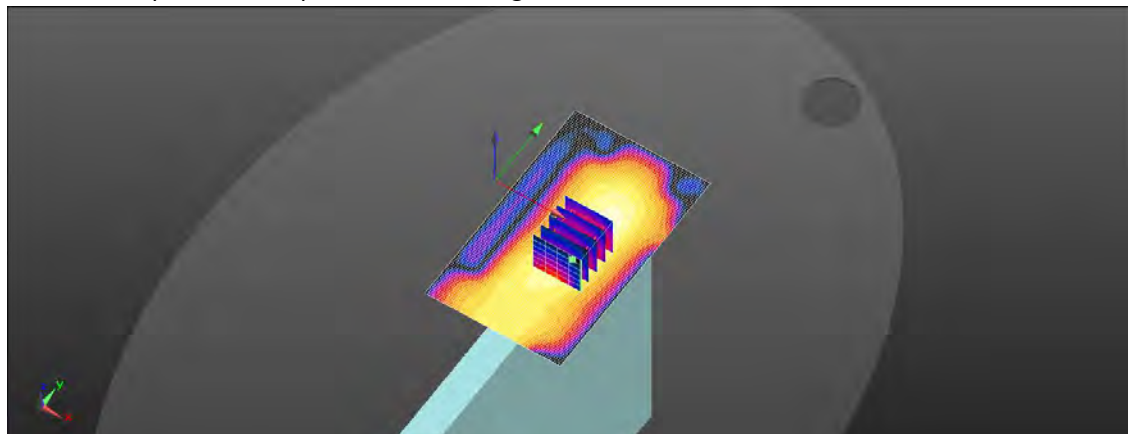
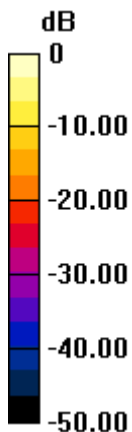

0 dB = 0.0516 W/kg = -12.87 dBW/kg

Unless otherwise stated the results shown in this test report refer only to the sample(s) tested and such sample(s) are retained for 90 days only.

除非另有說明，此報告結果僅對測試之樣品負責，同時此樣品僅保留90天。本報告未經本公司書面許可，不可部份複製。

This document is issued by the Company subject to its General Conditions of Service printed overleaf, available on request or accessible at <http://www.sgs.com.tw/Terms-and-Conditions> and for electronic format documents, subject to Terms and Conditions for Electronic Documents at <http://www.sgs.com.tw/Terms-and-Conditions>. Attention is drawn to the limitation of liability, indemnification and jurisdiction issues defined therein. Any holder of this document is advised that information contained hereon reflects the Company's findings at the time of its intervention only and within the limits of Client's instructions, if any. The Company's sole responsibility is to its Client and this document does not exonerate parties to a transaction from exercising all their rights and obligations under the transaction documents. This document cannot be reproduced except in full, without prior written approval of the Company. Any unauthorized alteration, forgery or falsification of the content or appearance of this document is unlawful and offenders may be prosecuted to the fullest extent of the law.

Date: 2023/12/5

ID: 007

Report No. :TESA2311000704EN

CAT.M1 Band 13 (5MHz)_Body_Top Edge_CH 23255_QPSK_1-0_Index 0_0mm

Communication System: LTE; Frequency: 784.5 MHz; Duty cycle= 1:3.32

Medium parameters used: $f = 784.5$ MHz; $\sigma = 0.918$ S/m; $\epsilon_r = 43.189$; $\rho = 1000$ kg/m³

Phantom section: Flat Section

Ambient temperature: 22.3°C; Liquid temperature: 22.0°C

DASY5 Configuration:

- Probe: EX3DV4 - SN7509; ConvF(9.97, 9.73, 10.82) @ 784.5 MHz; Calibrated: 2023/4/26
- Sensor-Surface: 2mm (Mechanical Surface Detection)
- Electronics: DAE4 Sn1336; Calibrated: 2023/8/22
- Phantom: ELI
- DASY52 52.10.4(1527); SEMCAD X 14.6.14(7483)

Area Scan (61x101x1): Interpolated grid: dx=15 mm, dy=15 mm

Maximum value of SAR (interpolated) = 0.0689 W/kg

Zoom Scan (5x5x7)/Cube 0: Measurement grid: dx=8mm, dy=8mm, dz=5mm

Reference Value = 3.957 V/m; Power Drift = 0.18 dB

Peak SAR (extrapolated) = 0.116 W/kg

SAR(1 g) = 0.052 W/kg; SAR(10 g) = 0.027 W/kg

Smallest distance from peaks to all points 3 dB below: Larger than measurement grid

Ratio of SAR at M2 to SAR at M1 = 44.9%

Maximum value of SAR (measured) = 0.0867 W/kg

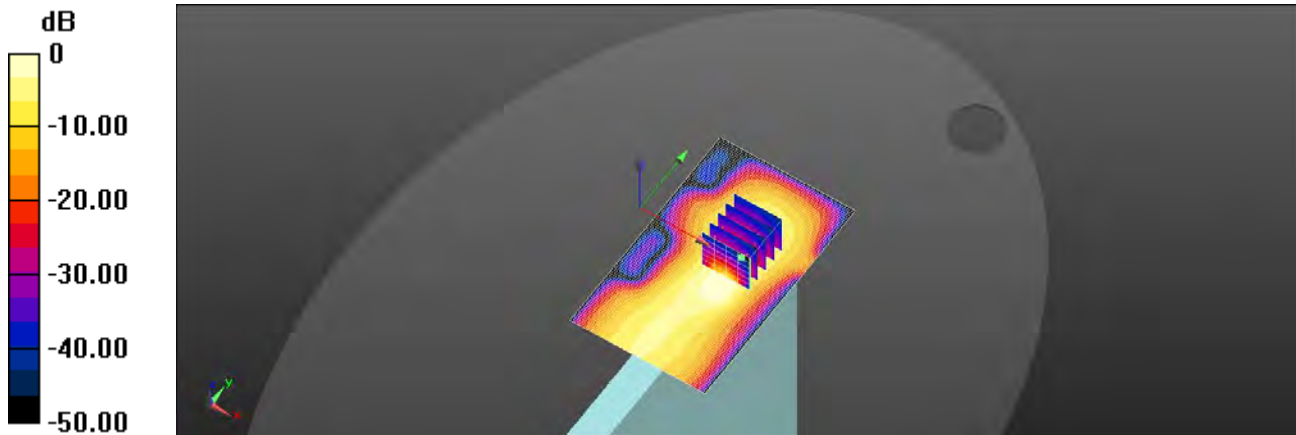

0 dB = 0.0689 W/kg = -11.62 dBW/kg

Unless otherwise stated the results shown in this test report refer only to the sample(s) tested and such sample(s) are retained for 90 days only.

除非另有說明，此報告結果僅對測試之樣品負責，同時此樣品僅保留90天。本報告未經本公司書面許可，不可部份複製。

This document is issued by the Company subject to its General Conditions of Service printed overleaf, available on request or accessible at <http://www.sgs.com.tw/Terms-and-Conditions> and for electronic format documents, subject to Terms and Conditions for Electronic Documents at <http://www.sgs.com.tw/Terms-and-Conditions>. Attention is drawn to the limitation of liability, indemnification and jurisdiction issues defined therein. Any holder of this document is advised that information contained hereon reflects the Company's findings at the time of its intervention only and within the limits of Client's instructions, if any. The Company's sole responsibility is to its Client and this document does not exonerate parties to a transaction from exercising all their rights and obligations under the transaction documents. This document cannot be reproduced except in full, without prior written approval of the Company. Any unauthorized alteration, forgery or falsification of the content or appearance of this document is unlawful and offenders may be prosecuted to the fullest extent of the law.

SGS Taiwan Ltd.

No.134,Wu Kung Road, New Taipei Industrial Park, Wuku District, New Taipei City, Taiwan/新北市五股區新北產業園區五工路 134 號

台灣檢驗科技股份有限公司

t (886-2) 2299-3279

f (886-2) 2298-0488

www.sgs.com.tw

Member of SGS Group

Date: 2023/12/5

ID: 008

Report No. :TESA2311000704EN

CAT.M1 Band 14 (5MHz)_Body_Top Edge_CH 23305_QPSK_1-0_Index 0_0mm

Communication System: LTE; Frequency: 790.5 MHz; Duty cycle= 1:3.32

Medium parameters used: $f = 790.5 \text{ MHz}$; $\sigma = 0.92 \text{ S/m}$; $\epsilon_r = 43.154$; $\rho = 1000 \text{ kg/m}^3$

Phantom section: Flat Section

Ambient temperature: 22.3°C; Liquid temperature: 22.0°C

DASY5 Configuration:

- Probe: EX3DV4 - SN7509; ConvF(9.97, 9.73, 10.82) @ 790.5 MHz; Calibrated: 2023/4/26
- Sensor-Surface: 2mm (Mechanical Surface Detection)
- Electronics: DAE4 Sn1336; Calibrated: 2023/8/22
- Phantom: ELI
- DASY52 52.10.4(1527); SEMCAD X 14.6.14(7483)

Area Scan (61x101x1): Interpolated grid: dx=15 mm, dy=15 mm

Maximum value of SAR (interpolated) = 0.0598 W/kg

Zoom Scan (5x5x7)/Cube 0: Measurement grid: dx=8mm, dy=8mm, dz=5mm

Reference Value = 3.816 V/m; Power Drift = 0.19 dB

Peak SAR (extrapolated) = 0.103 W/kg

SAR(1 g) = 0.045 W/kg; SAR(10 g) = 0.023 W/kg

Smallest distance from peaks to all points 3 dB below: Larger than measurement grid

Ratio of SAR at M2 to SAR at M1 = 44.3%

Maximum value of SAR (measured) = 0.0768 W/kg

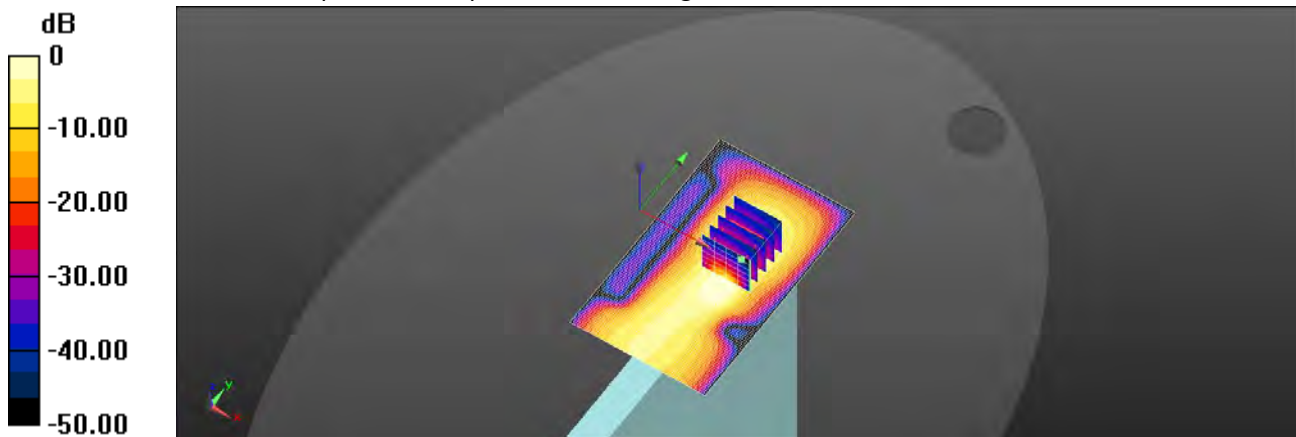

0 dB = 0.0598 W/kg = -12.23 dBW/kg

Unless otherwise stated the results shown in this test report refer only to the sample(s) tested and such sample(s) are retained for 90 days only.

除非另有說明，此報告結果僅對測試之樣品負責，同時此樣品僅保留90天。本報告未經本公司書面許可，不可部份複製。

This document is issued by the Company subject to its General Conditions of Service printed overleaf, available on request or accessible at <http://www.sgs.com.tw/Terms-and-Conditions> and for electronic format documents, subject to Terms and Conditions for Electronic Documents at <http://www.sgs.com.tw/Terms-and-Conditions>. Attention is drawn to the limitation of liability, indemnification and jurisdiction issues defined therein. Any holder of this document is advised that information contained hereon reflects the Company's findings at the time of its intervention only and within the limits of Client's instructions, if any. The Company's sole responsibility is to its Client and this document does not exonerate parties to a transaction from exercising all their rights and obligations under the transaction documents. This document cannot be reproduced except in full, without prior written approval of the Company. Any unauthorized alteration, forgery or falsification of the content or appearance of this document is unlawful and offenders may be prosecuted to the fullest extent of the law.

SGS Taiwan Ltd.

No.134,Wu Kung Road, New Taipei Industrial Park, Wuku District, New Taipei City, Taiwan/新北市五股區新北產業園區五工路 134 號

台灣檢驗科技股份有限公司

t (886-2) 2299-3279

f (886-2) 2298-0488

www.sgs.com.tw

Member of SGS Group

Date: 2023/12/10

ID: 009

Report No. :TESA2311000704EN

CAT.M1 Band 25 (5MHz)_Body_Top Edge_CH 26665_QPSK_1-0_Index 0_0mm

Communication System: LTE; Frequency: 1912.5 MHz; Duty cycle= 1:3.32

Medium parameters used: $f = 1912.5$ MHz; $\sigma = 1.444$ S/m; $\epsilon_r = 38.449$; $\rho = 1000$ kg/m³

Phantom section: Flat Section

Ambient temperature: 22.0°C; Liquid temperature: 21.7°C

DASY5 Configuration:

- Probe: EX3DV4 - SN7509; ConvF(8.12, 8.05, 8.74) @ 1912.5 MHz; Calibrated: 2023/4/26
- Sensor-Surface: 2mm (Mechanical Surface Detection)
- Electronics: DAE4 Sn1336; Calibrated: 2023/8/22
- Phantom: ELI
- DASY52 52.10.4(1527); SEMCAD X 14.6.14(7483)

Area Scan (61x101x1): Interpolated grid: dx=15 mm, dy=15 mm

Maximum value of SAR (interpolated) = 0.218 W/kg

Zoom Scan (5x5x7)/Cube 0: Measurement grid: dx=8mm, dy=8mm, dz=5mm

Reference Value = 3.547 V/m; Power Drift = 0.10 dB

Peak SAR (extrapolated) = 0.162 W/kg

SAR(1 g) = 0.084 W/kg; SAR(10 g) = 0.045 W/kg

Smallest distance from peaks to all points 3 dB below = 8.6 mm

Ratio of SAR at M2 to SAR at M1 = 45.7%

Maximum value of SAR (measured) = 0.125 W/kg

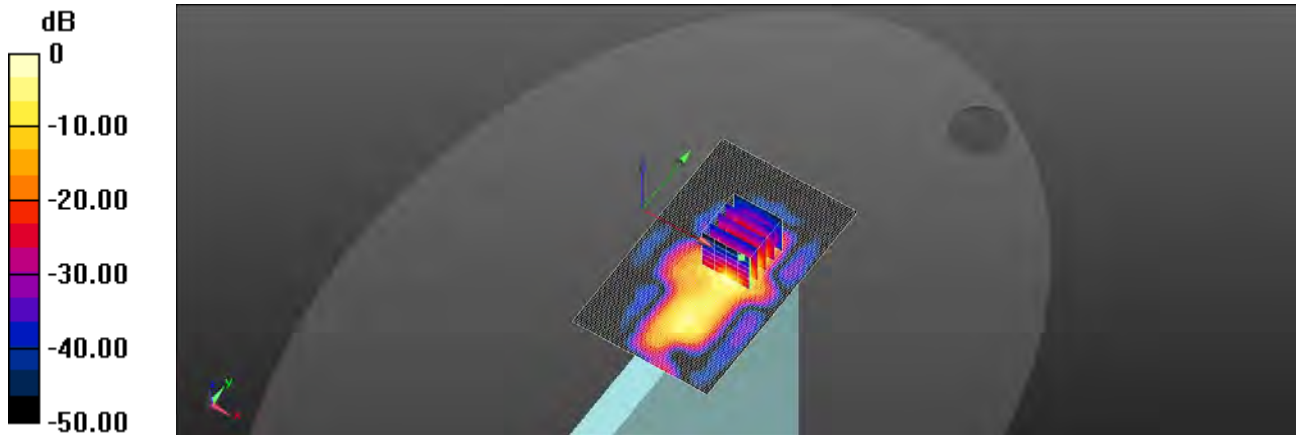

0 dB = 0.218 W/kg = -6.62 dBW/kg

Unless otherwise stated the results shown in this test report refer only to the sample(s) tested and such sample(s) are retained for 90 days only.

除非另有說明，此報告結果僅對測試之樣品負責，同時此樣品僅保留90天。本報告未經本公司書面許可，不可部份複製。

This document is issued by the Company subject to its General Conditions of Service printed overleaf, available on request or accessible at <http://www.sgs.com.tw/Terms-and-Conditions> and for electronic format documents, subject to Terms and Conditions for Electronic Documents at <http://www.sgs.com.tw/Terms-and-Conditions>. Attention is drawn to the limitation of liability, indemnification and jurisdiction issues defined therein. Any holder of this document is advised that information contained hereon reflects the Company's findings at the time of its intervention only and within the limits of Client's instructions, if any. The Company's sole responsibility is to its Client and this document does not exonerate parties to a transaction from exercising all their rights and obligations under the transaction documents. This document cannot be reproduced except in full, without prior written approval of the Company. Any unauthorized alteration, forgery or falsification of the content or appearance of this document is unlawful and offenders may be prosecuted to the fullest extent of the law.

SGS Taiwan Ltd.

No.134,Wu Kung Road, New Taipei Industrial Park, Wuku District, New Taipei City, Taiwan/新北市五股區新北產業園區五工路 134 號

台灣檢驗科技股份有限公司

t (886-2) 2299-3279

f (886-2) 2298-0488

www.sgs.com.tw

Member of SGS Group

Date: 2023/12/7

ID: 010

Report No. :TESA2311000704EN

CAT.M1 Band 26 (5MHz)_Body_Top Edge_CH 26865_QPSK_1-0_Index 0_0mm_FCC

Communication System: LTE; Frequency: 831.5 MHz; Duty cycle= 1:3.32

Medium parameters used: $f = 831.5 \text{ MHz}$; $\sigma = 0.89 \text{ S/m}$; $\epsilon_r = 40.615$; $\rho = 1000 \text{ kg/m}^3$

Phantom section: Flat Section

Ambient temperature: 21.9°C; Liquid temperature: 21.7°C

DASY5 Configuration:

- Probe: EX3DV4 - SN7509; ConvF(9.51, 9.16, 10) @ 831.5 MHz; Calibrated: 2023/4/26
- Sensor-Surface: 2mm (Mechanical Surface Detection)
- Electronics: DAE4 Sn1336; Calibrated: 2023/8/22
- Phantom: ELI
- DASY52 52.10.4(1527); SEMCAD X 14.6.14(7483)

Area Scan (61x101x1): Interpolated grid: dx=15 mm, dy=15 mm

Maximum value of SAR (interpolated) = 0.0616 W/kg

Zoom Scan (5x5x7)/Cube 0: Measurement grid: dx=8mm, dy=8mm, dz=5mm

Reference Value = 3.447 V/m; Power Drift = 0.18 dB

Peak SAR (extrapolated) = 0.105 W/kg

SAR(1 g) = 0.047 W/kg; SAR(10 g) = 0.025 W/kg

Smallest distance from peaks to all points 3 dB below: Larger than measurement grid

Ratio of SAR at M2 to SAR at M1 = 46%

Maximum value of SAR (measured) = 0.0782 W/kg

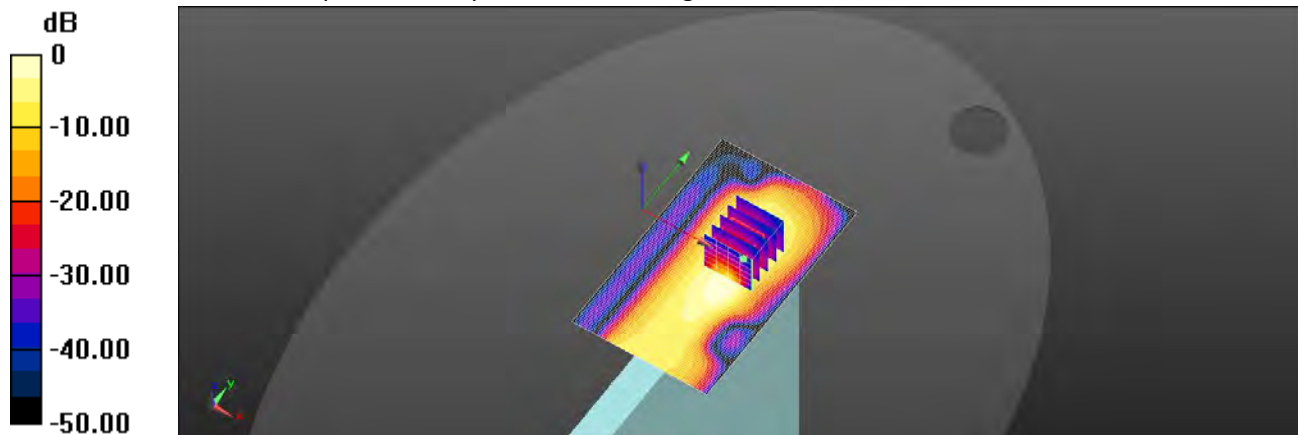

0 dB = 0.0616 W/kg = -12.10 dBW/kg

Unless otherwise stated the results shown in this test report refer only to the sample(s) tested and such sample(s) are retained for 90 days only.

除非另有說明，此報告結果僅對測試之樣品負責，同時此樣品僅保留90天。本報告未經本公司書面許可，不可部份複製。

This document is issued by the Company subject to its General Conditions of Service printed overleaf, available on request or accessible at <http://www.sgs.com.tw/Terms-and-Conditions> and for electronic format documents, subject to Terms and Conditions for Electronic Documents at <http://www.sgs.com.tw/Terms-and-Conditions>. Attention is drawn to the limitation of liability, indemnification and jurisdiction issues defined therein. Any holder of this document is advised that information contained hereon reflects the Company's findings at the time of its intervention only and within the limits of Client's instructions, if any. The Company's sole responsibility is to its Client and this document does not exonerate parties to a transaction from exercising all their rights and obligations under the transaction documents. This document cannot be reproduced except in full, without prior written approval of the Company. Any unauthorized alteration, forgery or falsification of the content or appearance of this document is unlawful and offenders may be prosecuted to the fullest extent of the law.

SGS Taiwan Ltd.

No.134,Wu Kung Road, New Taipei Industrial Park, Wuku District, New Taipei City, Taiwan/新北市五股區新北產業園區五工路 134 號

台灣檢驗科技股份有限公司

t (886-2) 2299-3279

f (886-2) 2298-0488

www.sgs.com.tw

Member of SGS Group

Date: 2023/12/9

ID: 012

Report No. :TESA2311000704EN

CAT.M1 Band 66 (5MHz)_Body_Top Edge_CH 132647_QPSK_1-0_Index 0_0mm

Communication System: LTE; Frequency: 1777.5 MHz; Duty cycle= 1:3.32

Medium parameters used: $f = 1777.5$ MHz; $\sigma = 1.34$ S/m; $\epsilon_r = 38.604$; $\rho = 1000$ kg/m³

Phantom section: Flat Section

Ambient temperature: 22.5°C; Liquid temperature: 22.2°C

DASY5 Configuration:

- Probe: EX3DV4 - SN7509; ConvF(8.6, 8.56, 9.12) @ 1777.5 MHz; Calibrated: 2023/4/26
- Sensor-Surface: 2mm (Mechanical Surface Detection)
- Electronics: DAE4 Sn1336; Calibrated: 2023/8/22
- Phantom: ELI
- DASY52 52.10.4(1527); SEMCAD X 14.6.14(7483)

Area Scan (61x101x1): Interpolated grid: dx=15 mm, dy=15 mm

Maximum value of SAR (interpolated) = 0.147 W/kg

Zoom Scan (5x5x7)/Cube 0: Measurement grid: dx=8mm, dy=8mm, dz=5mm

Reference Value = 3.573 V/m; Power Drift = 0.13 dB

Peak SAR (extrapolated) = 0.191 W/kg

SAR(1 g) = 0.092 W/kg; SAR(10 g) = 0.045 W/kg

Smallest distance from peaks to all points 3 dB below = 8.8 mm

Ratio of SAR at M2 to SAR at M1 = 44.4%

Maximum value of SAR (measured) = 0.161 W/kg

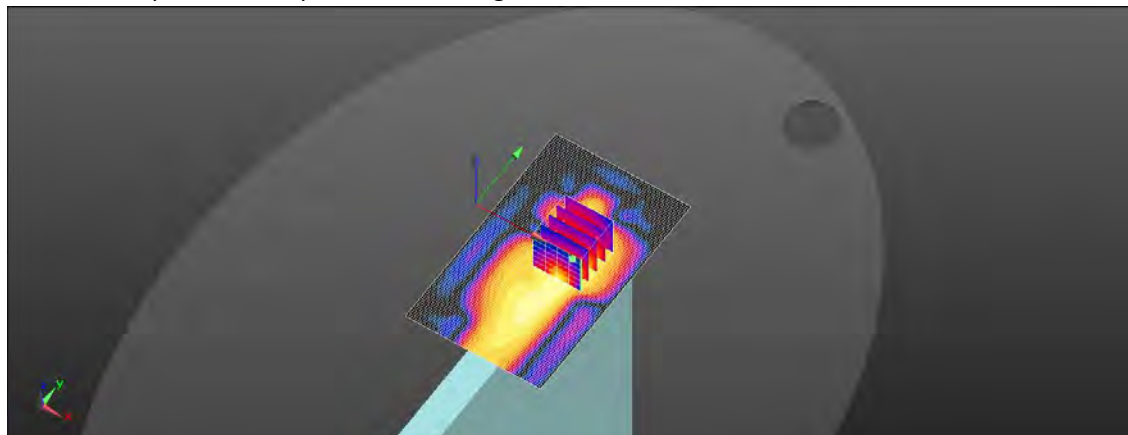
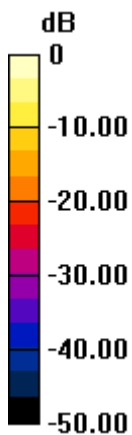

0 dB = 0.147 W/kg = -8.33 dBW/kg

Unless otherwise stated the results shown in this test report refer only to the sample(s) tested and such sample(s) are retained for 90 days only.

除非另有說明，此報告結果僅對測試之樣品負責，同時此樣品僅保留90天。本報告未經本公司書面許可，不可部份複製。

This document is issued by the Company subject to its General Conditions of Service printed overleaf, available on request or accessible at <http://www.sgs.com.tw/Terms-and-Conditions> and for electronic format documents, subject to Terms and Conditions for Electronic Documents at <http://www.sgs.com.tw/Terms-and-Conditions>. Attention is drawn to the limitation of liability, indemnification and jurisdiction issues defined therein. Any holder of this document is advised that information contained hereon reflects the Company's findings at the time of its intervention only and within the limits of Client's instructions, if any. The Company's sole responsibility is to its Client and this document does not exonerate parties to a transaction from exercising all their rights and obligations under the transaction documents. This document cannot be reproduced except in full, without prior written approval of the Company. Any unauthorized alteration, forgery or falsification of the content or appearance of this document is unlawful and offenders may be prosecuted to the fullest extent of the law.

Date: 2023/12/5

ID: 013

Report No. :TESA2311000704EN

CAT.M1 Band 85 (5MHz)_Body_Top Edge_CH 134092_QPSK_1-0_Index 0_0mm

Communication System: LTE; Frequency: 707 MHz; Duty cycle= 1:3.32

Medium parameters used: $f = 707 \text{ MHz}$; $\sigma = 0.872 \text{ S/m}$; $\epsilon_r = 43.675$; $\rho = 1000 \text{ kg/m}^3$

Phantom section: Flat Section

Ambient temperature: 22.3°C; Liquid temperature: 22.0°C

DASY5 Configuration:

- Probe: EX3DV4 - SN7509; ConvF(9.97, 9.73, 10.82) @ 707 MHz; Calibrated: 2023/4/26
- Sensor-Surface: 2mm (Mechanical Surface Detection)
- Electronics: DAE4 Sn1336; Calibrated: 2023/8/22
- Phantom: ELI
- DASY52 52.10.4(1527); SEMCAD X 14.6.14(7483)

Area Scan (61x101x1): Interpolated grid: dx=15 mm, dy=15 mm

Maximum value of SAR (interpolated) = 0.241 W/kg

Zoom Scan (5x5x7)/Cube 0: Measurement grid: dx=8mm, dy=8mm, dz=5mm

Reference Value = 5.085 V/m; Power Drift = 0.14 dB

Peak SAR (extrapolated) = 0.469 W/kg

SAR(1 g) = 0.179 W/kg; SAR(10 g) = 0.093 W/kg

Smallest distance from peaks to all points 3 dB below = 8.4 mm

Ratio of SAR at M2 to SAR at M1 = 39%

Maximum value of SAR (measured) = 0.315 W/kg

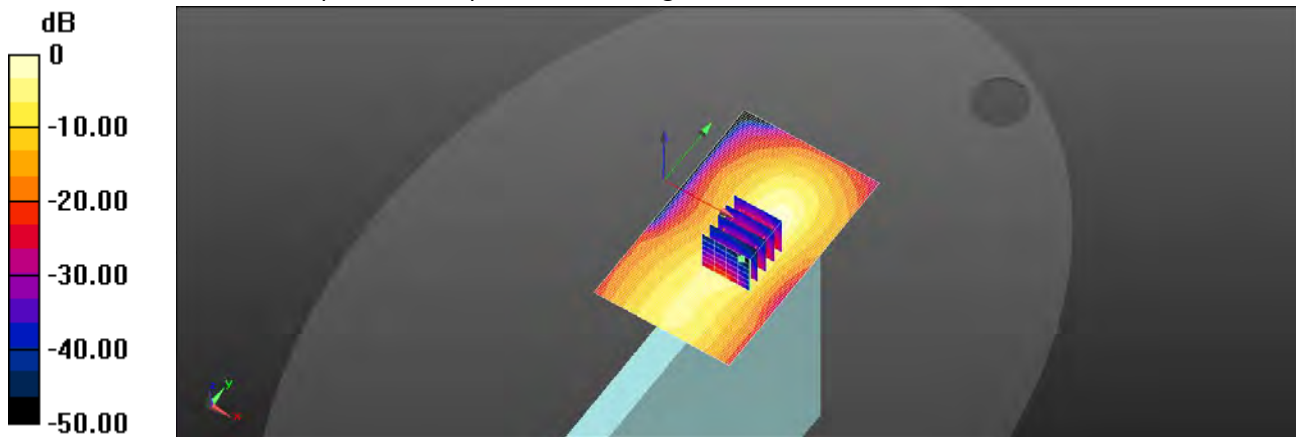

0 dB = 0.241 W/kg = -6.18 dBW/kg

Unless otherwise stated the results shown in this test report refer only to the sample(s) tested and such sample(s) are retained for 90 days only.

除非另有說明，此報告結果僅對測試之樣品負責，同時此樣品僅保留90天。本報告未經本公司書面許可，不可部份複製。

This document is issued by the Company subject to its General Conditions of Service printed overleaf, available on request or accessible at <http://www.sgs.com.tw/Terms-and-Conditions> and for electronic format documents, subject to Terms and Conditions for Electronic Documents at <http://www.sgs.com.tw/Terms-and-Conditions>. Attention is drawn to the limitation of liability, indemnification and jurisdiction issues defined therein. Any holder of this document is advised that information contained hereon reflects the Company's findings at the time of its intervention only and within the limits of Client's instructions, if any. The Company's sole responsibility is to its Client and this document does not exonerate parties to a transaction from exercising all their rights and obligations under the transaction documents. This document cannot be reproduced except in full, without prior written approval of the Company. Any unauthorized alteration, forgery or falsification of the content or appearance of this document is unlawful and offenders may be prosecuted to the fullest extent of the law.

Date: 2023/12/8

ID: 014

Report No. :TESA2311000704EN

GPRS850(1Dn4Up)_Body_Top Edge_CH 251_0mm

Communication System: GPRS(1Dn4Up); Frequency: 848.8 MHz; Duty cycle= 1:2

Medium parameters used: $f = 849$ MHz; $\sigma = 0.908$ S/m; $\epsilon_r = 40.181$; $\rho = 1000$ kg/m³

Phantom section: Flat Section

Ambient temperature: 22.2°C; Liquid temperature: 21.9°C

DASY5 Configuration:

- Probe: EX3DV4 - SN7509; ConvF(9.51, 9.16, 10) @ 848.8 MHz; Calibrated: 2023/4/26
- Sensor-Surface: 2mm (Mechanical Surface Detection)
- Electronics: DAE4 Sn1336; Calibrated: 2023/8/22
- Phantom: ELI
- DASY52 52.10.4(1527); SEMCAD X 14.6.14(7483)

Area Scan (61x101x1): Interpolated grid: dx=15 mm, dy=15 mm

Maximum value of SAR (interpolated) = 1.09 W/kg

Zoom Scan (5x5x7)/Cube 0: Measurement grid: dx=8mm, dy=8mm, dz=5mm

Reference Value = 21.47 V/m; Power Drift = 0.15 dB

Peak SAR (extrapolated) = 1.77 W/kg

SAR(1 g) = 1 W/kg; SAR(10 g) = 0.574 W/kg

Smallest distance from peaks to all points 3 dB below = 8.4 mm

Ratio of SAR at M2 to SAR at M1 = 47.6%

Maximum value of SAR (measured) = 1.37 W/kg

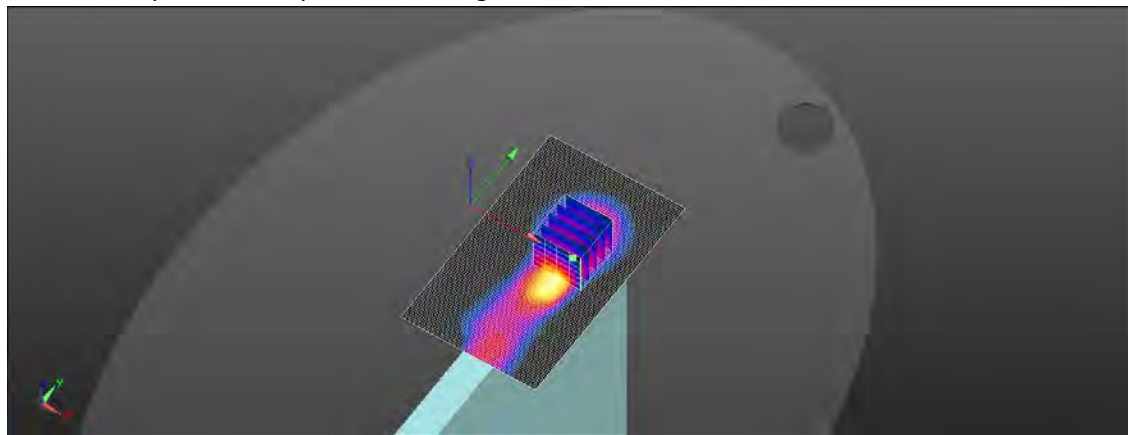
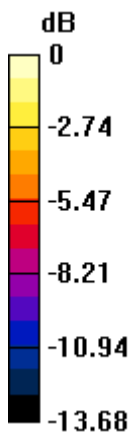

0 dB = 1.37 W/kg = 1.37 dBW/kg

Unless otherwise stated the results shown in this test report refer only to the sample(s) tested and such sample(s) are retained for 90 days only.

除非另有說明，此報告結果僅對測試之樣品負責，同時此樣品僅保留90天。本報告未經本公司書面許可，不可部份複製。

This document is issued by the Company subject to its General Conditions of Service printed overleaf, available on request or accessible at <http://www.sgs.com.tw/Terms-and-Conditions> and for electronic format documents, subject to Terms and Conditions for Electronic Documents at <http://www.sgs.com.tw/Terms-and-Conditions>. Attention is drawn to the limitation of liability, indemnification and jurisdiction issues defined therein. Any holder of this document is advised that information contained hereon reflects the Company's findings at the time of its intervention only and within the limits of Client's instructions, if any. The Company's sole responsibility is to its Client and this document does not exonerate parties to a transaction from exercising all their rights and obligations under the transaction documents. This document cannot be reproduced except in full, without prior written approval of the Company. Any unauthorized alteration, forgery or falsification of the content or appearance of this document is unlawful and offenders may be prosecuted to the fullest extent of the law.

Date: 2023/12/10

ID: 015

Report No. :TESA2311000704EN

GPRS1900(1Dn4Up)_Body_Top Edge_CH 661_0mm

Communication System: GPRS(1Dn4Up); Frequency: 1880 MHz; Duty cycle= 1:2

Medium parameters used: $f = 1880 \text{ MHz}$; $\sigma = 1.422 \text{ S/m}$; $\epsilon_r = 38.469$; $\rho = 1000 \text{ kg/m}^3$

Phantom section: Flat Section

Ambient temperature: 22.0°C; Liquid temperature: 21.7°C

DASY5 Configuration:

- Probe: EX3DV4 - SN7509; ConvF(8.12, 8.05, 8.74) @ 1880 MHz; Calibrated: 2023/4/26
- Sensor-Surface: 2mm (Mechanical Surface Detection)
- Electronics: DAE4 Sn1336; Calibrated: 2023/8/22
- Phantom: ELI
- DASY52 52.10.4(1527); SEMCAD X 14.6.14(7483)

Area Scan (61x101x1): Interpolated grid: dx=15 mm, dy=15 mm

Maximum value of SAR (interpolated) = 1.15 W/kg

Zoom Scan (5x5x7)/Cube 0: Measurement grid: dx=8mm, dy=8mm, dz=5mm

Reference Value = 4.642 V/m; Power Drift = 0.10 dB

Peak SAR (extrapolated) = 1.37 W/kg

SAR(1 g) = 0.969 W/kg; SAR(10 g) = 0.639 W/kg

Smallest distance from peaks to all points 3 dB below = 9.3 mm

Ratio of SAR at M2 to SAR at M1 = 55.2%

Maximum value of SAR (measured) = 1.13 W/kg

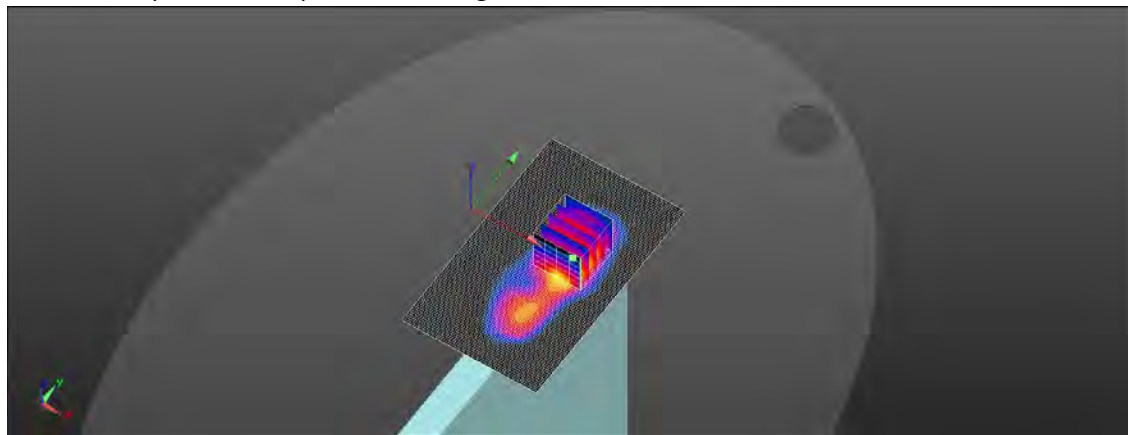
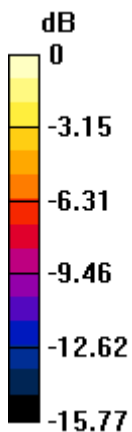

0 dB = 1.13 W/kg = 0.53 dBW/kg

Unless otherwise stated the results shown in this test report refer only to the sample(s) tested and such sample(s) are retained for 90 days only.

除非另有說明，此報告結果僅對測試之樣品負責，同時此樣品僅保留90天。本報告未經本公司書面許可，不可部份複製。

This document is issued by the Company subject to its General Conditions of Service printed overleaf, available on request or accessible at <http://www.sgs.com.tw/Terms-and-Conditions> and for electronic format documents, subject to Terms and Conditions for Electronic Documents at <http://www.sgs.com.tw/Terms-and-Conditions>. Attention is drawn to the limitation of liability, indemnification and jurisdiction issues defined therein. Any holder of this document is advised that information contained hereon reflects the Company's findings at the time of its intervention only and within the limits of Client's instructions, if any. The Company's sole responsibility is to its Client and this document does not exonerate parties to a transaction from exercising all their rights and obligations under the transaction documents. This document cannot be reproduced except in full, without prior written approval of the Company. Any unauthorized alteration, forgery or falsification of the content or appearance of this document is unlawful and offenders may be prosecuted to the fullest extent of the law.

SGS Taiwan Ltd.

No.134,Wu Kung Road, New Taipei Industrial Park, Wuku District, New Taipei City, Taiwan/新北市五股區新北產業園區五工路 134 號

台灣檢驗科技股份有限公司

t (886-2) 2299-3279

f (886-2) 2298-0488

www.sgs.com.tw

Member of SGS Group

Date: 2023/12/10

ID: 016

Report No. :TESA2311000704EN

CAT.M1 Band 2 (5MHz)_Body_Top Edge_CH 18900_QPSK_1-0_Index 0_0mm

Communication System: LTE; Frequency: 1880 MHz; Duty cycle= 1:3.32

Medium parameters used: $f = 1880 \text{ MHz}$; $\sigma = 1.422 \text{ S/m}$; $\epsilon_r = 38.469$; $\rho = 1000 \text{ kg/m}^3$

Phantom section: Flat Section

Ambient temperature: 22.0°C; Liquid temperature: 21.7°C

DASY5 Configuration:

- Probe: EX3DV4 - SN7509; ConvF(8.12, 8.05, 8.74) @ 1880 MHz; Calibrated: 2023/4/26
- Sensor-Surface: 2mm (Mechanical Surface Detection)
- Electronics: DAE4 Sn1336; Calibrated: 2023/8/22
- Phantom: ELI
- DASY52 52.10.4(1527); SEMCAD X 14.6.14(7483)

Area Scan (61x101x1): Interpolated grid: dx=15 mm, dy=15 mm

Maximum value of SAR (interpolated) = 0.191 W/kg

Zoom Scan (5x5x7)/Cube 0: Measurement grid: dx=8mm, dy=8mm, dz=5mm

Reference Value = 3.829 V/m; Power Drift = 0.03 dB

Peak SAR (extrapolated) = 0.139 W/kg

SAR(1 g) = 0.080 W/kg; SAR(10 g) = 0.042 W/kg

Smallest distance from peaks to all points 3 dB below = 8.2 mm

Ratio of SAR at M2 to SAR at M1 = 61.3%

Maximum value of SAR (measured) = 0.105 W/kg

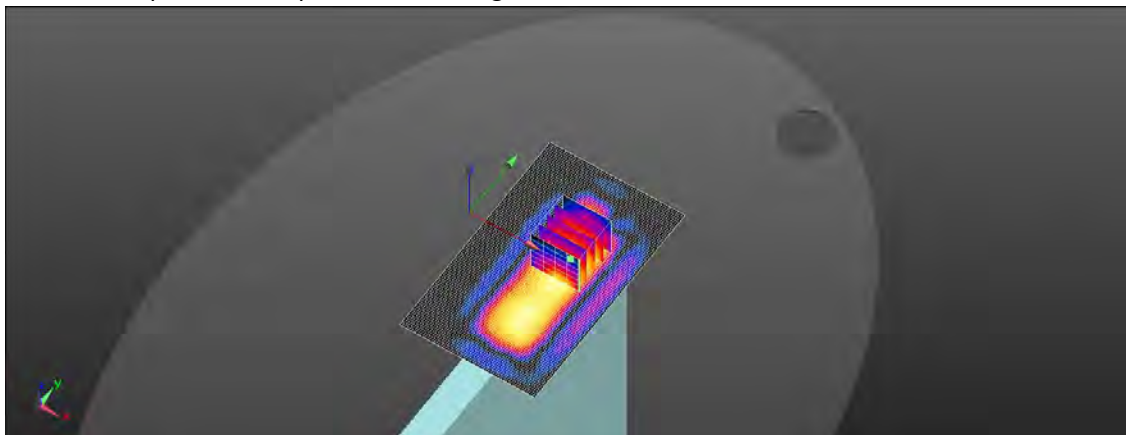
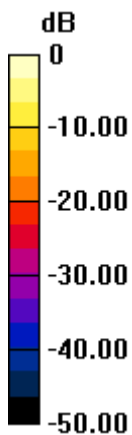

0 dB = 0.191 W/kg = -7.19 dBW/kg

Unless otherwise stated the results shown in this test report refer only to the sample(s) tested and such sample(s) are retained for 90 days only.

除非另有說明，此報告結果僅對測試之樣品負責，同時此樣品僅保留90天。本報告未經本公司書面許可，不可部份複製。

This document is issued by the Company subject to its General Conditions of Service printed overleaf, available on request or accessible at <http://www.sgs.com.tw/Terms-and-Conditions> and for electronic format documents, subject to Terms and Conditions for Electronic Documents at <http://www.sgs.com.tw/Terms-and-Conditions>. Attention is drawn to the limitation of liability, indemnification and jurisdiction issues defined therein. Any holder of this document is advised that information contained hereon reflects the Company's findings at the time of its intervention only and within the limits of Client's instructions, if any. The Company's sole responsibility is to its Client and this document does not exonerate parties to a transaction from exercising all their rights and obligations under the transaction documents. This document cannot be reproduced except in full, without prior written approval of the Company. Any unauthorized alteration, forgery or falsification of the content or appearance of this document is unlawful and offenders may be prosecuted to the fullest extent of the law.

Date: 2023/12/9

ID: 017

Report No. :TESA2311000704EN

CAT.M1 Band 4 (5MHz)_Body_Top Edge_CH 19975_QPSK_1-0_Index 0_0mm

Communication System: LTE; Frequency: 1712.5 MHz; Duty cycle= 1:3.32

Medium parameters used: $f = 1712.5$ MHz; $\sigma = 1.29$ S/m; $\epsilon_r = 38.723$; $\rho = 1000$ kg/m³

Phantom section: Flat Section

Ambient temperature: 22.5°C; Liquid temperature: 22.2°C

DASY5 Configuration:

- Probe: EX3DV4 - SN7509; ConvF(8.6, 8.56, 9.12) @ 1712.5 MHz; Calibrated: 2023/4/26
- Sensor-Surface: 2mm (Mechanical Surface Detection)
- Electronics: DAE4 Sn1336; Calibrated: 2023/8/22
- Phantom: ELI
- DASY52 52.10.4(1527); SEMCAD X 14.6.14(7483)

Area Scan (61x101x1): Interpolated grid: dx=15 mm, dy=15 mm

Maximum value of SAR (interpolated) = 0.194 W/kg

Zoom Scan (5x5x7)/Cube 0: Measurement grid: dx=8mm, dy=8mm, dz=5mm

Reference Value = 4.128 V/m; Power Drift = 0.12 dB

Peak SAR (extrapolated) = 0.175 W/kg

SAR(1 g) = 0.091 W/kg; SAR(10 g) = 0.047 W/kg

Smallest distance from peaks to all points 3 dB below = 8.8 mm

Ratio of SAR at M2 to SAR at M1 = 52%

Maximum value of SAR (measured) = 0.134 W/kg

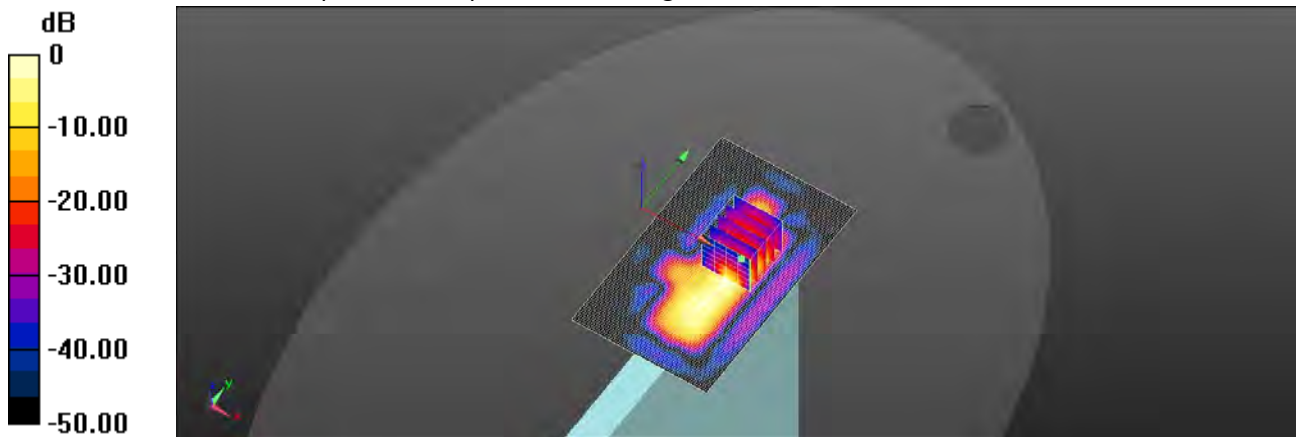

0 dB = 0.194 W/kg = -7.11 dBW/kg

Unless otherwise stated the results shown in this test report refer only to the sample(s) tested and such sample(s) are retained for 90 days only.

除非另有說明，此報告結果僅對測試之樣品負責，同時此樣品僅保留90天。本報告未經本公司書面許可，不可部份複製。

This document is issued by the Company subject to its General Conditions of Service printed overleaf, available on request or accessible at <http://www.sgs.com.tw/Terms-and-Conditions> and for electronic format documents, subject to Terms and Conditions for Electronic Documents at <http://www.sgs.com.tw/Terms-and-Conditions>. Attention is drawn to the limitation of liability, indemnification and jurisdiction issues defined therein. Any holder of this document is advised that information contained hereon reflects the Company's findings at the time of its intervention only and within the limits of Client's instructions, if any. The Company's sole responsibility is to its Client and this document does not exonerate parties to a transaction from exercising all their rights and obligations under the transaction documents. This document cannot be reproduced except in full, without prior written approval of the Company. Any unauthorized alteration, forgery or falsification of the content or appearance of this document is unlawful and offenders may be prosecuted to the fullest extent of the law.

SGS Taiwan Ltd.

No.134,Wu Kung Road, New Taipei Industrial Park, Wuku District, New Taipei City, Taiwan/新北市五股區新北產業園區五工路 134 號

台灣檢驗科技股份有限公司

t (886-2) 2299-3279

f (886-2) 2298-0488

www.sgs.com.tw

Member of SGS Group

Date: 2023/12/8

ID: 018

Report No. :TESA2311000704EN

CAT.M1 Band 5 (5MHz)_Body_Top Edge_CH 20425_QPSK_1-0_Index 0_0mm

Communication System: LTE; Frequency: 826.5 MHz; Duty cycle= 1:3.32

Medium parameters used: $f = 826.5$ MHz; $\sigma = 0.881$ S/m; $\epsilon_r = 40.313$; $\rho = 1000$ kg/m³

Phantom section: Flat Section

Ambient temperature: 22.2°C; Liquid temperature: 21.9°C

DASY5 Configuration:

- Probe: EX3DV4 - SN7509; ConvF(9.51, 9.16, 10) @ 826.5 MHz; Calibrated: 2023/4/26
- Sensor-Surface: 2mm (Mechanical Surface Detection)
- Electronics: DAE4 Sn1336; Calibrated: 2023/8/22
- Phantom: ELI
- DASY52 52.10.4(1527); SEMCAD X 14.6.14(7483)

Area Scan (61x101x1): Interpolated grid: dx=15 mm, dy=15 mm

Maximum value of SAR (interpolated) = 0.0941 W/kg

Zoom Scan (5x5x7)/Cube 0: Measurement grid: dx=8mm, dy=8mm, dz=5mm

Reference Value = 3.304 V/m; Power Drift = 0.16 dB

Peak SAR (extrapolated) = 0.142 W/kg

SAR(1 g) = 0.064 W/kg; SAR(10 g) = 0.032 W/kg

Smallest distance from peaks to all points 3 dB below = 8.4 mm

Ratio of SAR at M2 to SAR at M1 = 45%

Maximum value of SAR (measured) = 0.105 W/kg

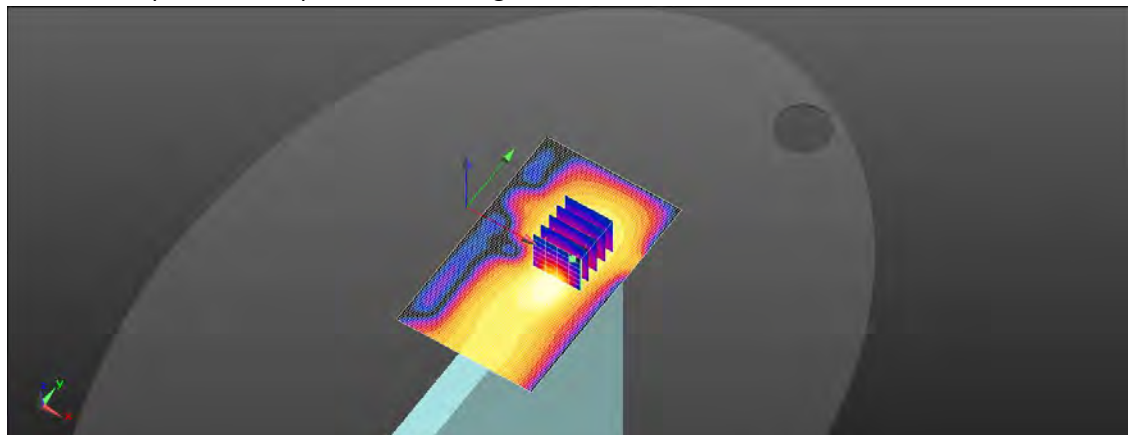
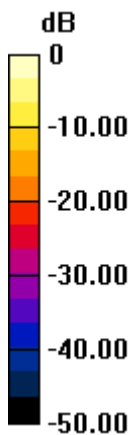

0 dB = 0.0941 W/kg = -10.27 dBW/kg

Unless otherwise stated the results shown in this test report refer only to the sample(s) tested and such sample(s) are retained for 90 days only.

除非另有說明，此報告結果僅對測試之樣品負責，同時此樣品僅保留90天。本報告未經本公司書面許可，不可部份複製。

This document is issued by the Company subject to its General Conditions of Service printed overleaf, available on request or accessible at <http://www.sgs.com.tw/Terms-and-Conditions> and for electronic format documents, subject to Terms and Conditions for Electronic Documents at <http://www.sgs.com.tw/Terms-and-Conditions>. Attention is drawn to the limitation of liability, indemnification and jurisdiction issues defined therein. Any holder of this document is advised that information contained hereon reflects the Company's findings at the time of its intervention only and within the limits of Client's instructions, if any. The Company's sole responsibility is to its Client and this document does not exonerate parties to a transaction from exercising all their rights and obligations under the transaction documents. This document cannot be reproduced except in full, without prior written approval of the Company. Any unauthorized alteration, forgery or falsification of the content or appearance of this document is unlawful and offenders may be prosecuted to the fullest extent of the law.

Date: 2023/12/6

ID: 019

Report No. :TESA2311000704EN

CAT.M1 Band 12 (5MHz)_Body_Top Edge_CH 23155_QPSK_1-0_Index 0_0mm

Communication System: LTE; Frequency: 713.5 MHz; Duty cycle= 1:3.32

Medium parameters used: $f = 713.5 \text{ MHz}$; $\sigma = 0.869 \text{ S/m}$; $\epsilon_r = 43.636$; $\rho = 1000 \text{ kg/m}^3$

Phantom section: Flat Section

Ambient temperature: 22.1°C; Liquid temperature: 21.8°C

DASY5 Configuration:

- Probe: EX3DV4 - SN7509; ConvF(9.97, 9.73, 10.82) @ 713.5 MHz; Calibrated: 2023/4/26
- Sensor-Surface: 2mm (Mechanical Surface Detection)
- Electronics: DAE4 Sn1336; Calibrated: 2023/8/22
- Phantom: ELI
- DASY52 52.10.4(1527); SEMCAD X 14.6.14(7483)

Area Scan (61x101x1): Interpolated grid: dx=15 mm, dy=15 mm

Maximum value of SAR (interpolated) = 0.0639 W/kg

Zoom Scan (5x5x7)/Cube 0: Measurement grid: dx=8mm, dy=8mm, dz=5mm

Reference Value = 3.308 V/m; Power Drift = 0.11 dB

Peak SAR (extrapolated) = 0.110 W/kg

SAR(1 g) = 0.040 W/kg; SAR(10 g) = 0.021 W/kg

Smallest distance from peaks to all points 3 dB below: Larger than measurement grid

Ratio of SAR at M2 to SAR at M1 = 40.1%

Maximum value of SAR (measured) = 0.0666 W/kg

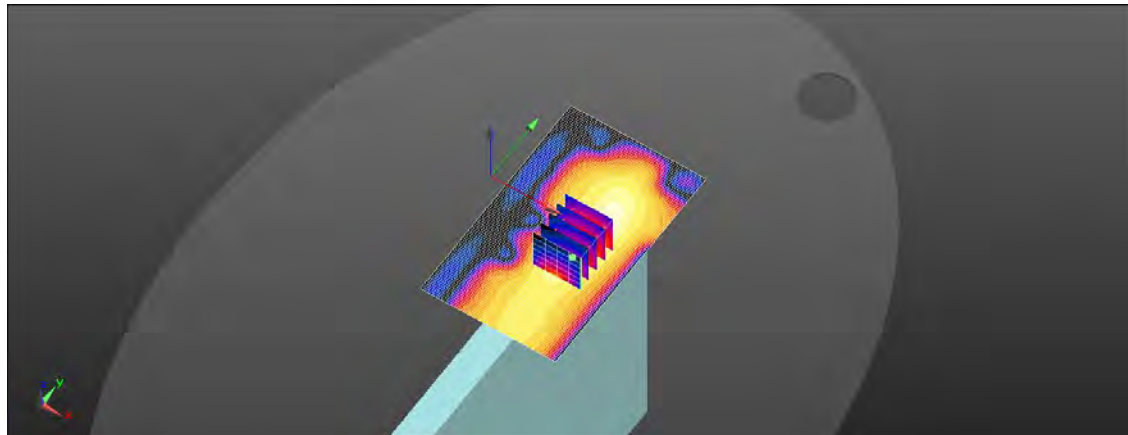
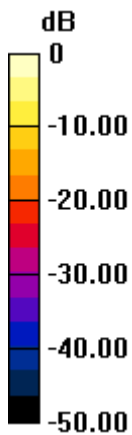

0 dB = 0.0639 W/kg = -11.95 dBW/kg

Unless otherwise stated the results shown in this test report refer only to the sample(s) tested and such sample(s) are retained for 90 days only.

除非另有說明，此報告結果僅對測試之樣品負責，同時此樣品僅保留90天。本報告未經本公司書面許可，不可部份複製。

This document is issued by the Company subject to its General Conditions of Service printed overleaf, available on request or accessible at <http://www.sgs.com.tw/Terms-and-Conditions> and for electronic format documents, subject to Terms and Conditions for Electronic Documents at <http://www.sgs.com.tw/Terms-and-Conditions>. Attention is drawn to the limitation of liability, indemnification and jurisdiction issues defined therein. Any holder of this document is advised that information contained hereon reflects the Company's findings at the time of its intervention only and within the limits of Client's instructions, if any. The Company's sole responsibility is to its Client and this document does not exonerate parties to a transaction from exercising all their rights and obligations under the transaction documents. This document cannot be reproduced except in full, without prior written approval of the Company. Any unauthorized alteration, forgery or falsification of the content or appearance of this document is unlawful and offenders may be prosecuted to the fullest extent of the law.

SGS Taiwan Ltd.

No.134,Wu Kung Road, New Taipei Industrial Park, Wuku District, New Taipei City, Taiwan/新北市五股區新北產業園區五工路 134 號

台灣檢驗科技股份有限公司

t (886-2) 2299-3279

f (886-2) 2298-0488

www.sgs.com.tw

Member of SGS Group

Date: 2023/12/6

ID: 020

Report No. :TESA2311000704EN

CAT.M1 Band 13 (5MHz)_Body_Top Edge_CH 23255_QPSK_1-0_Index 0_0mm

Communication System: LTE; Frequency: 784.5 MHz; Duty cycle= 1:3.32

Medium parameters used: $f = 784.5 \text{ MHz}$; $\sigma = 0.928 \text{ S/m}$; $\epsilon_r = 43.379$; $\rho = 1000 \text{ kg/m}^3$

Phantom section: Flat Section

Ambient temperature: 22.1°C; Liquid temperature: 21.8°C

DASY5 Configuration:

- Probe: EX3DV4 - SN7509; ConvF(9.97, 9.73, 10.82) @ 784.5 MHz; Calibrated: 2023/4/26
- Sensor-Surface: 2mm (Mechanical Surface Detection)
- Electronics: DAE4 Sn1336; Calibrated: 2023/8/22
- Phantom: ELI
- DASY52 52.10.4(1527); SEMCAD X 14.6.14(7483)

Area Scan (61x101x1): Interpolated grid: dx=15 mm, dy=15 mm

Maximum value of SAR (interpolated) = 0.0836 W/kg

Zoom Scan (5x5x7)/Cube 0: Measurement grid: dx=8mm, dy=8mm, dz=5mm

Reference Value = 3.462 V/m; Power Drift = 0.05 dB

Peak SAR (extrapolated) = 0.126 W/kg

SAR(1 g) = 0.057 W/kg; SAR(10 g) = 0.029 W/kg

Smallest distance from peaks to all points 3 dB below: Larger than measurement grid

Ratio of SAR at M2 to SAR at M1 = 45.5%

Maximum value of SAR (measured) = 0.0919 W/kg

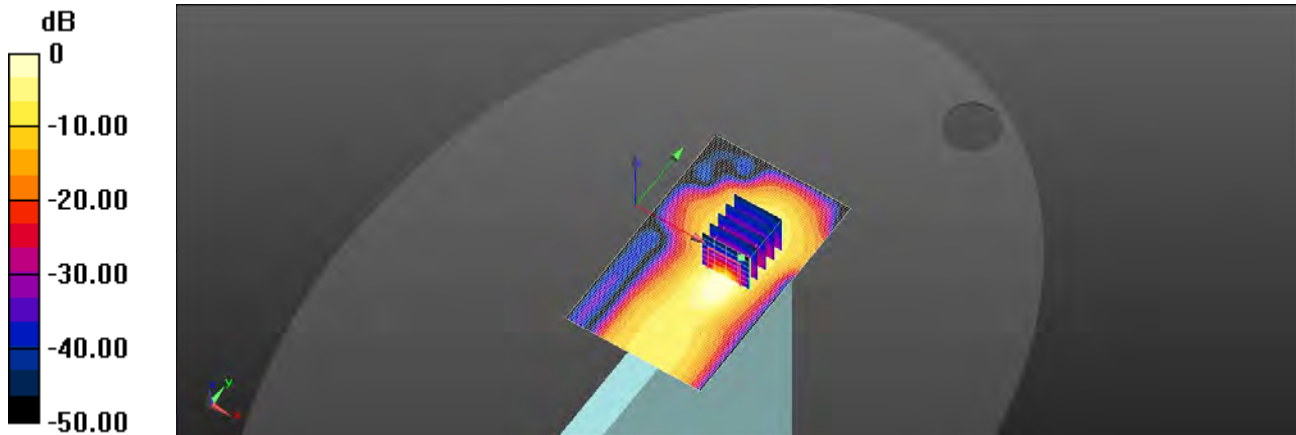

0 dB = 0.0836 W/kg = -10.78 dBW/kg

Unless otherwise stated the results shown in this test report refer only to the sample(s) tested and such sample(s) are retained for 90 days only.

除非另有說明，此報告結果僅對測試之樣品負責，同時此樣品僅保留90天。本報告未經本公司書面許可，不可部份複製。

This document is issued by the Company subject to its General Conditions of Service printed overleaf, available on request or accessible at <http://www.sgs.com.tw/Terms-and-Conditions> and for electronic format documents, subject to Terms and Conditions for Electronic Documents at <http://www.sgs.com.tw/Terms-and-Conditions>. Attention is drawn to the limitation of liability, indemnification and jurisdiction issues defined therein. Any holder of this document is advised that information contained hereon reflects the Company's findings at the time of its intervention only and within the limits of Client's instructions, if any. The Company's sole responsibility is to its Client and this document does not exonerate parties to a transaction from exercising all their rights and obligations under the transaction documents. This document cannot be reproduced except in full, without prior written approval of the Company. Any unauthorized alteration, forgery or falsification of the content or appearance of this document is unlawful and offenders may be prosecuted to the fullest extent of the law.

SGS Taiwan Ltd.

No.134,Wu Kung Road, New Taipei Industrial Park, Wuku District, New Taipei City, Taiwan/新北市五股區新北產業園區五工路 134 號

台灣檢驗科技股份有限公司

t (886-2) 2299-3279

f (886-2) 2298-0488

www.sgs.com.tw

Member of SGS Group

Date: 2023/12/6

ID: 021

Report No. :TESA2311000704EN

CAT.M1 Band 14 (5MHz)_Body_Top Edge_CH 23305_QPSK_1-0_Index 0_0mm

Communication System: LTE; Frequency: 790.5 MHz; Duty cycle= 1:3.32

Medium parameters used: $f = 790.5 \text{ MHz}$; $\sigma = 0.935 \text{ S/m}$; $\epsilon_r = 43.334$; $\rho = 1000 \text{ kg/m}^3$

Phantom section: Flat Section

Ambient temperature: 22.1°C; Liquid temperature: 21.8°C

DASY5 Configuration:

- Probe: EX3DV4 - SN7509; ConvF(9.97, 9.73, 10.82) @ 790.5 MHz; Calibrated: 2023/4/26
- Sensor-Surface: 2mm (Mechanical Surface Detection)
- Electronics: DAE4 Sn1336; Calibrated: 2023/8/22
- Phantom: ELI
- DASY52 52.10.4(1527); SEMCAD X 14.6.14(7483)

Area Scan (61x101x1): Interpolated grid: dx=15 mm, dy=15 mm

Maximum value of SAR (interpolated) = 0.0844 W/kg

Zoom Scan (5x5x7)/Cube 0: Measurement grid: dx=8mm, dy=8mm, dz=5mm

Reference Value = 3.865 V/m; Power Drift = 0.18 dB

Peak SAR (extrapolated) = 0.127 W/kg

SAR(1 g) = 0.058 W/kg; SAR(10 g) = 0.029 W/kg

Smallest distance from peaks to all points 3 dB below: Larger than measurement grid

Ratio of SAR at M2 to SAR at M1 = 45.5%

Maximum value of SAR (measured) = 0.0928 W/kg

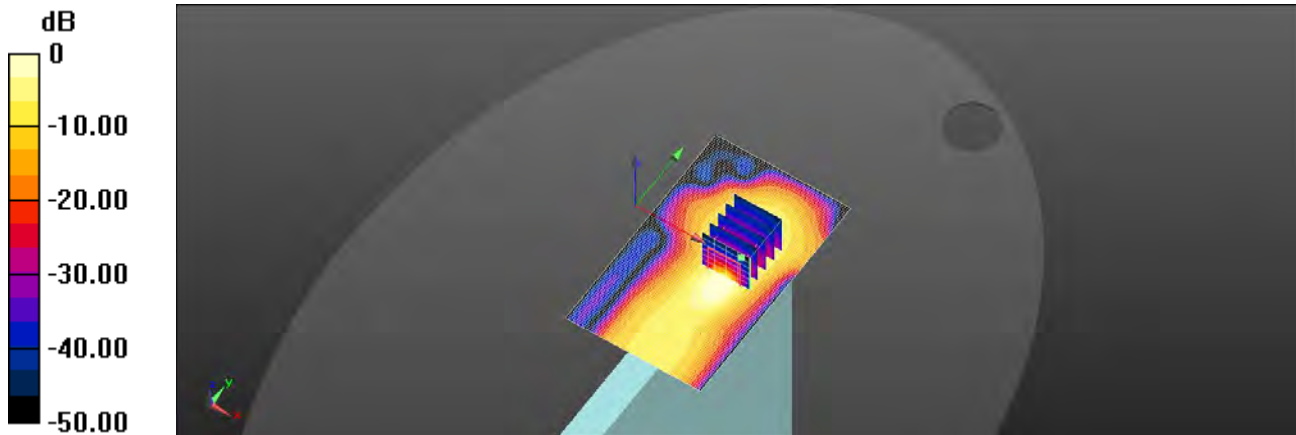

0 dB = 0.0844 W/kg = -10.74 dBW/kg

Unless otherwise stated the results shown in this test report refer only to the sample(s) tested and such sample(s) are retained for 90 days only.

除非另有說明，此報告結果僅對測試之樣品負責，同時此樣品僅保留90天。本報告未經本公司書面許可，不可部份複製。

This document is issued by the Company subject to its General Conditions of Service printed overleaf, available on request or accessible at <http://www.sgs.com.tw/Terms-and-Conditions> and for electronic format documents, subject to Terms and Conditions for Electronic Documents at <http://www.sgs.com.tw/Terms-and-Conditions>. Attention is drawn to the limitation of liability, indemnification and jurisdiction issues defined therein. Any holder of this document is advised that information contained hereon reflects the Company's findings at the time of its intervention only and within the limits of Client's instructions, if any. The Company's sole responsibility is to its Client and this document does not exonerate parties to a transaction from exercising all their rights and obligations under the transaction documents. This document cannot be reproduced except in full, without prior written approval of the Company. Any unauthorized alteration, forgery or falsification of the content or appearance of this document is unlawful and offenders may be prosecuted to the fullest extent of the law.

SGS Taiwan Ltd.

No.134,Wu Kung Road, New Taipei Industrial Park, Wuku District, New Taipei City, Taiwan/新北市五股區新北產業園區五工路 134 號

台灣檢驗科技股份有限公司

t (886-2) 2299-3279

f (886-2) 2298-0488

www.sgs.com.tw

Member of SGS Group

Date: 2023/12/10

ID: 022

Report No. :TESA2311000704EN

CAT.M1 Band 25 (5MHz)_Body_Top Edge_CH 26365_QPSK_1-0_Index 0_0mm

Communication System: LTE; Frequency: 1882.5 MHz; Duty cycle= 1:3.32

Medium parameters used: $f = 1882.5 \text{ MHz}$; $\sigma = 1.421 \text{ S/m}$; $\epsilon_r = 38.465$; $\rho = 1000 \text{ kg/m}^3$

Phantom section: Flat Section

Ambient temperature: 22.0°C; Liquid temperature: 21.7°C

DASY5 Configuration:

- Probe: EX3DV4 - SN7509; ConvF(8.12, 8.05, 8.74) @ 1882.5 MHz; Calibrated: 2023/4/26
- Sensor-Surface: 2mm (Mechanical Surface Detection)
- Electronics: DAE4 Sn1336; Calibrated: 2023/8/22
- Phantom: ELI
- DASY52 52.10.4(1527); SEMCAD X 14.6.14(7483)

Area Scan (61x101x1): Interpolated grid: dx=15 mm, dy=15 mm

Maximum value of SAR (interpolated) = 0.184 W/kg

Zoom Scan (5x5x7)/Cube 0: Measurement grid: dx=8mm, dy=8mm, dz=5mm

Reference Value = 3.832 V/m; Power Drift = 0.12 dB

Peak SAR (extrapolated) = 0.157 W/kg

SAR(1 g) = 0.090 W/kg; SAR(10 g) = 0.047 W/kg

Smallest distance from peaks to all points 3 dB below = 8.2 mm

Ratio of SAR at M2 to SAR at M1 = 56.5%

Maximum value of SAR (measured) = 0.125 W/kg

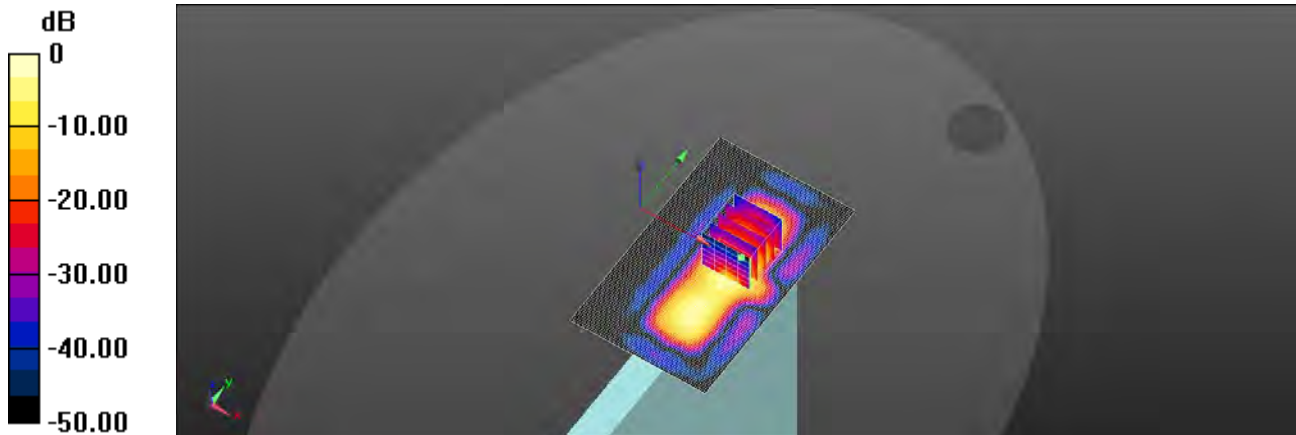

0 dB = 0.184 W/kg = -7.35 dBW/kg

Unless otherwise stated the results shown in this test report refer only to the sample(s) tested and such sample(s) are retained for 90 days only.

除非另有說明，此報告結果僅對測試之樣品負責，同時此樣品僅保留90天。本報告未經本公司書面許可，不可部份複製。

This document is issued by the Company subject to its General Conditions of Service printed overleaf, available on request or accessible at <http://www.sgs.com.tw/Terms-and-Conditions> and for electronic format documents, subject to Terms and Conditions for Electronic Documents at <http://www.sgs.com.tw/Terms-and-Conditions>. Attention is drawn to the limitation of liability, indemnification and jurisdiction issues defined therein. Any holder of this document is advised that information contained hereon reflects the Company's findings at the time of its intervention only and within the limits of Client's instructions, if any. The Company's sole responsibility is to its Client and this document does not exonerate parties to a transaction from exercising all their rights and obligations under the transaction documents. This document cannot be reproduced except in full, without prior written approval of the Company. Any unauthorized alteration, forgery or falsification of the content or appearance of this document is unlawful and offenders may be prosecuted to the fullest extent of the law.

SGS Taiwan Ltd.

No.134,Wu Kung Road, New Taipei Industrial Park, Wuku District, New Taipei City, Taiwan/新北市五股區新北產業園區五工路 134 號

台灣檢驗科技股份有限公司

t (886-2) 2299-3279

f (886-2) 2298-0488

www.sgs.com.tw

Member of SGS Group

Date: 2023/12/8

ID: 023

Report No. :TESA2311000704EN

CAT.M1 Band 26 (5MHz)_Body_Top Edge_CH 26715_QPSK_1-0_Index 0_0mm_FCC

Communication System: LTE; Frequency: 816.5 MHz; Duty cycle= 1:3.32

Medium parameters used: $f = 816.5 \text{ MHz}$; $\sigma = 0.87 \text{ S/m}$; $\epsilon_r = 40.36$; $\rho = 1000 \text{ kg/m}^3$

Phantom section: Flat Section

Ambient temperature: 22.2°C; Liquid temperature: 21.9°C

DASY5 Configuration:

- Probe: EX3DV4 - SN7509; ConvF(9.51, 9.16, 10) @ 816.5 MHz; Calibrated: 2023/4/26
- Sensor-Surface: 2mm (Mechanical Surface Detection)
- Electronics: DAE4 Sn1336; Calibrated: 2023/8/22
- Phantom: ELI
- DASY52 52.10.4(1527); SEMCAD X 14.6.14(7483)

Area Scan (61x101x1): Interpolated grid: dx=15 mm, dy=15 mm

Maximum value of SAR (interpolated) = 0.0949 W/kg

Zoom Scan (5x5x7)/Cube 0: Measurement grid: dx=8mm, dy=8mm, dz=5mm

Reference Value = 3.361 V/m; Power Drift = 0.11 dB

Peak SAR (extrapolated) = 0.141 W/kg

SAR(1 g) = 0.064 W/kg; SAR(10 g) = 0.032 W/kg

Smallest distance from peaks to all points 3 dB below = 8.4 mm

Ratio of SAR at M2 to SAR at M1 = 45.2%

Maximum value of SAR (measured) = 0.104 W/kg

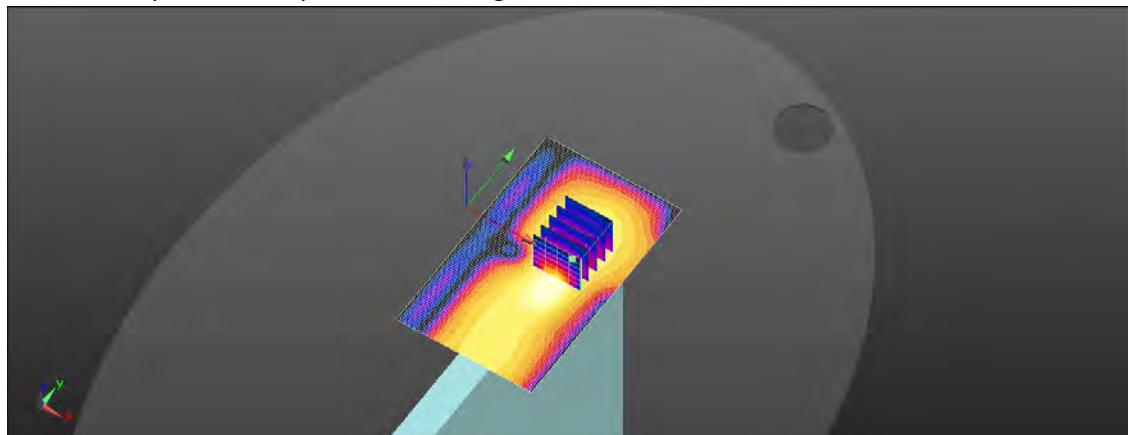
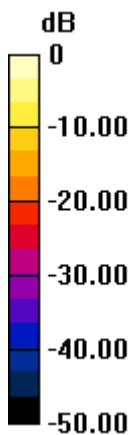

0 dB = 0.0949 W/kg = -10.23 dBW/kg

Unless otherwise stated the results shown in this test report refer only to the sample(s) tested and such sample(s) are retained for 90 days only.

除非另有說明，此報告結果僅對測試之樣品負責，同時此樣品僅保留90天。本報告未經本公司書面許可，不可部份複製。

This document is issued by the Company subject to its General Conditions of Service printed overleaf, available on request or accessible at <http://www.sgs.com.tw/Terms-and-Conditions> and for electronic format documents, subject to Terms and Conditions for Electronic Documents at <http://www.sgs.com.tw/Terms-and-Conditions>. Attention is drawn to the limitation of liability, indemnification and jurisdiction issues defined therein. Any holder of this document is advised that information contained hereon reflects the Company's findings at the time of its intervention only and within the limits of Client's instructions, if any. The Company's sole responsibility is to its Client and this document does not exonerate parties to a transaction from exercising all their rights and obligations under the transaction documents. This document cannot be reproduced except in full, without prior written approval of the Company. Any unauthorized alteration, forgery or falsification of the content or appearance of this document is unlawful and offenders may be prosecuted to the fullest extent of the law.

Date: 2023/12/9

ID: 025

Report No. :TESA2311000704EN

CAT.M1 Band 66 (5MHz)_Body_Top Edge_CH 132647_QPSK_1-0_Index 0_0mm

Communication System: LTE; Frequency: 1777.5 MHz; Duty cycle= 1:3.32

Medium parameters used: $f = 1777.5$ MHz; $\sigma = 1.34$ S/m; $\epsilon_r = 38.604$; $\rho = 1000$ kg/m³

Phantom section: Flat Section

Ambient temperature: 22.5°C; Liquid temperature: 22.2°C

DASY5 Configuration:

- Probe: EX3DV4 - SN7509; ConvF(8.6, 8.56, 9.12) @ 1777.5 MHz; Calibrated: 2023/4/26
- Sensor-Surface: 2mm (Mechanical Surface Detection)
- Electronics: DAE4 Sn1336; Calibrated: 2023/8/22
- Phantom: ELI
- DASY52 52.10.4(1527); SEMCAD X 14.6.14(7483)

Area Scan (61x101x1): Interpolated grid: dx=15 mm, dy=15 mm

Maximum value of SAR (interpolated) = 0.201 W/kg

Zoom Scan (5x5x7)/Cube 0: Measurement grid: dx=8mm, dy=8mm, dz=5mm

Reference Value = 5.189 V/m; Power Drift = 0.14 dB

Peak SAR (extrapolated) = 0.218 W/kg

SAR(1 g) = 0.111 W/kg; SAR(10 g) = 0.057 W/kg

Smallest distance from peaks to all points 3 dB below = 8.6 mm

Ratio of SAR at M2 to SAR at M1 = 49.7%

Maximum value of SAR (measured) = 0.177 W/kg

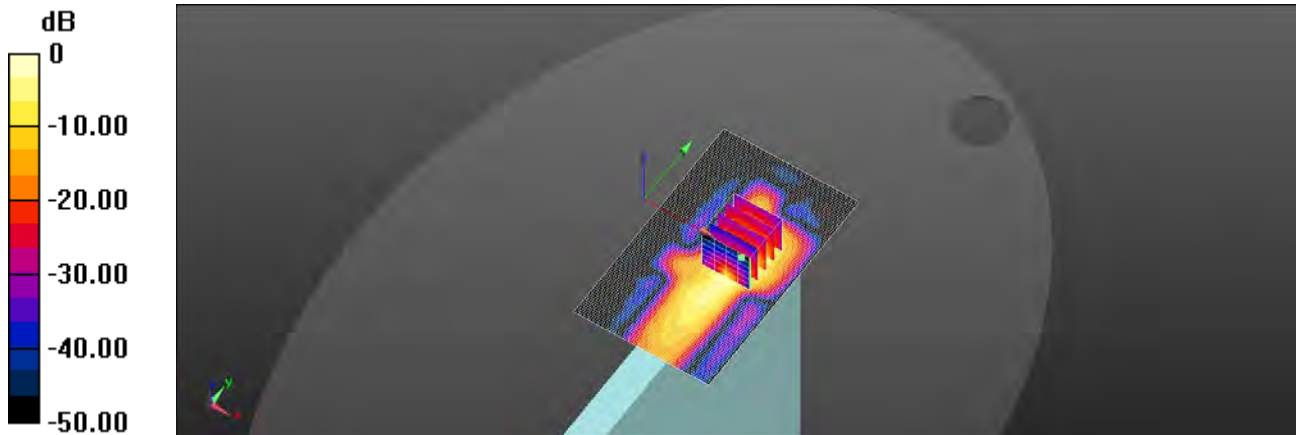

0 dB = 0.201 W/kg = -6.96 dBW/kg

Unless otherwise stated the results shown in this test report refer only to the sample(s) tested and such sample(s) are retained for 90 days only.

除非另有說明，此報告結果僅對測試之樣品負責，同時此樣品僅保留90天。本報告未經本公司書面許可，不可部份複製。

This document is issued by the Company subject to its General Conditions of Service printed overleaf, available on request or accessible at <http://www.sgs.com.tw/Terms-and-Conditions> and for electronic format documents, subject to Terms and Conditions for Electronic Documents at <http://www.sgs.com.tw/Terms-and-Conditions>. Attention is drawn to the limitation of liability, indemnification and jurisdiction issues defined therein. Any holder of this document is advised that information contained hereon reflects the Company's findings at the time of its intervention only and within the limits of Client's instructions, if any. The Company's sole responsibility is to its Client and this document does not exonerate parties to a transaction from exercising all their rights and obligations under the transaction documents. This document cannot be reproduced except in full, without prior written approval of the Company. Any unauthorized alteration, forgery or falsification of the content or appearance of this document is unlawful and offenders may be prosecuted to the fullest extent of the law.

Date: 2023/12/6

ID: 026

Report No. :TESA2311000704EN

CAT.M1 Band 85 (5MHz)_Body_Top Edge_CH 134092_QPSK_1-0_Index 0_0mm

Communication System: LTE; Frequency: 707 MHz; Duty cycle= 1:3.32

Medium parameters used: $f = 707 \text{ MHz}$; $\sigma = 0.865 \text{ S/m}$; $\epsilon_r = 43.685$; $\rho = 1000 \text{ kg/m}^3$

Phantom section: Flat Section

Ambient temperature: 22.1°C; Liquid temperature: 21.8°C

DASY5 Configuration:

- Probe: EX3DV4 - SN7509; ConvF(9.97, 9.73, 10.82) @ 707 MHz; Calibrated: 2023/4/26
- Sensor-Surface: 2mm (Mechanical Surface Detection)
- Electronics: DAE4 Sn1336; Calibrated: 2023/8/22
- Phantom: ELI
- DASY52 52.10.4(1527); SEMCAD X 14.6.14(7483)

Area Scan (61x101x1): Interpolated grid: dx=15 mm, dy=15 mm

Maximum value of SAR (interpolated) = 0.312 W/kg

Zoom Scan (5x5x7)/Cube 0: Measurement grid: dx=8mm, dy=8mm, dz=5mm

Reference Value = 6.453 V/m; Power Drift = 0.19 dB

Peak SAR (extrapolated) = 0.438 W/kg

SAR(1 g) = 0.217 W/kg; SAR(10 g) = 0.115 W/kg

Smallest distance from peaks to all points 3 dB below = 8.2 mm

Ratio of SAR at M2 to SAR at M1 = 52.4%

Maximum value of SAR (measured) = 0.316 W/kg

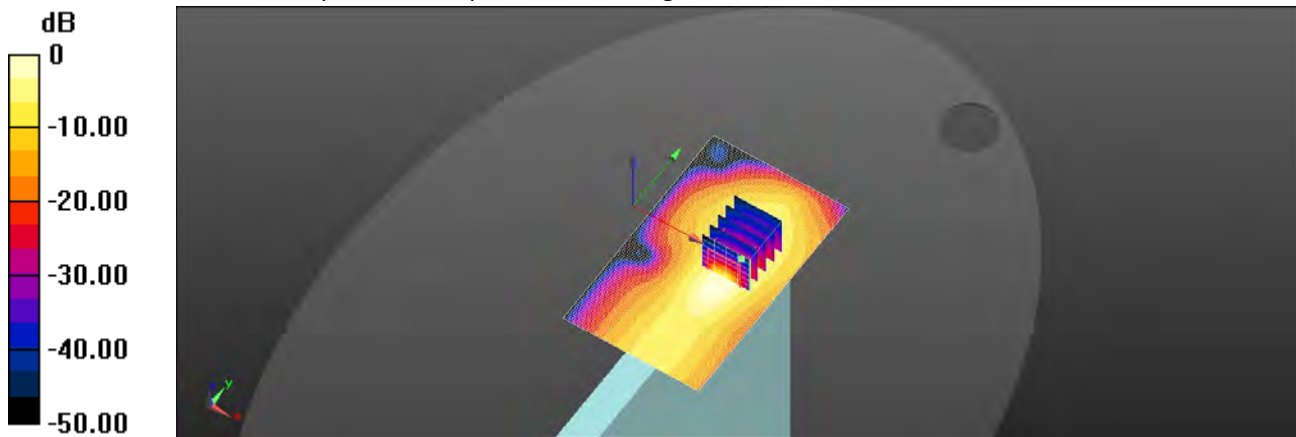

0 dB = 0.312 W/kg = -5.06 dBW/kg

Unless otherwise stated the results shown in this test report refer only to the sample(s) tested and such sample(s) are retained for 90 days only.

除非另有說明，此報告結果僅對測試之樣品負責，同時此樣品僅保留90天。本報告未經本公司書面許可，不可部份複製。

This document is issued by the Company subject to its General Conditions of Service printed overleaf, available on request or accessible at <http://www.sgs.com.tw/Terms-and-Conditions> and for electronic format documents, subject to Terms and Conditions for Electronic Documents at <http://www.sgs.com.tw/Terms-and-Conditions>. Attention is drawn to the limitation of liability, indemnification and jurisdiction issues defined therein. Any holder of this document is advised that information contained hereon reflects the Company's findings at the time of its intervention only and within the limits of Client's instructions, if any. The Company's sole responsibility is to its Client and this document does not exonerate parties to a transaction from exercising all their rights and obligations under the transaction documents. This document cannot be reproduced except in full, without prior written approval of the Company. Any unauthorized alteration, forgery or falsification of the content or appearance of this document is unlawful and offenders may be prosecuted to the fullest extent of the law.

SGS Taiwan Ltd.

No.134,Wu Kung Road, New Taipei Industrial Park, Wuku District, New Taipei City, Taiwan/新北市五股區新北產業園區五工路 134 號

台灣檢驗科技股份有限公司

t (886-2) 2299-3279

f (886-2) 2298-0488

www.sgs.com.tw

Member of SGS Group

11 SAR SYSTEM CHECK RESULTS

Date: 2023/12/5

Report No. :TESA2311000704EN

Dipole 750 MHz_SN:1015 Vendor1

Communication System: CW; Frequency: 750 MHz; Duty cycle= 1:1

Medium parameters used: $f = 750 \text{ MHz}$; $\sigma = 0.901 \text{ S/m}$; $\epsilon_r = 43.507$; $\rho = 1000 \text{ kg/m}^3$

Phantom section: Flat Section

Ambient temperature: 22.3°C; Liquid temperature: 22.0°C

DASY5 Configuration:

- Probe: EX3DV4 - SN7509; ConvF(9.97, 9.73, 10.82) @ 750 MHz; Calibrated: 2023/4/26
- Sensor-Surface: 2mm (Mechanical Surface Detection)
- Electronics: DAE4 Sn1336; Calibrated: 2023/8/22
- Phantom: ELI
- DASY52 52.10.4(1527); SEMCAD X 14.6.14(7483)

Area Scan (41x141x1): Interpolated grid: dx=15 mm, dy=15 mm

Maximum value of SAR (interpolated) = 2.62 W/kg

Zoom Scan (7x7x7)/Cube 0: Measurement grid: dx=5mm, dy=5mm, dz=5mm

Reference Value = 54.62 V/m; Power Drift = 0.02 dB

Peak SAR (extrapolated) = 3.03 W/kg

SAR(1 g) = 2.13 W/kg; SAR(10 g) = 1.43 W/kg

Smallest distance from peaks to all points 3 dB below = 19.1 mm

Ratio of SAR at M2 to SAR at M1 = 70%

Maximum value of SAR (measured) = 2.65 W/kg

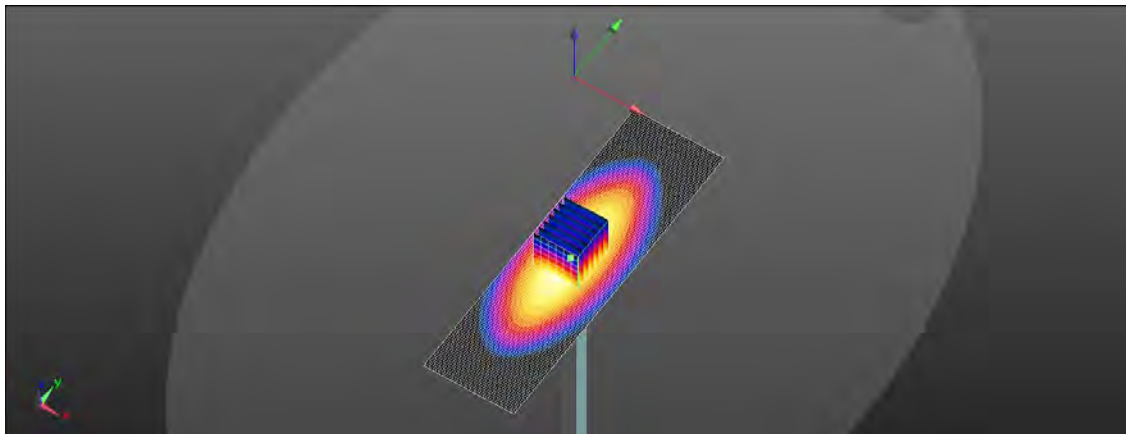
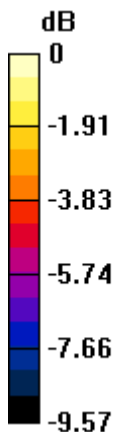

0 dB = 2.65 W/kg = 4.23 dBW/kg

Unless otherwise stated the results shown in this test report refer only to the sample(s) tested and such sample(s) are retained for 90 days only.

除非另有說明，此報告結果僅對測試之樣品負責，同時此樣品僅保留90天。本報告未經本公司書面許可，不可部份複製。

This document is issued by the Company subject to its General Conditions of Service printed overleaf, available on request or accessible at <http://www.sgs.com.tw/Terms-and-Conditions> and for electronic format documents, subject to Terms and Conditions for Electronic Documents at <http://www.sgs.com.tw/Terms-and-Conditions>. Attention is drawn to the limitation of liability, indemnification and jurisdiction issues defined therein. Any holder of this document is advised that information contained hereon reflects the Company's findings at the time of its intervention only and within the limits of Client's instructions, if any. The Company's sole responsibility is to its Client and this document does not exonerate parties to a transaction from exercising all their rights and obligations under the transaction documents. This document cannot be reproduced except in full, without prior written approval of the Company. Any unauthorized alteration, forgery or falsification of the content or appearance of this document is unlawful and offenders may be prosecuted to the fullest extent of the law.

Date: 2023/12/6

Report No. :TESA2311000704EN

Dipole 750 MHz_SN:1015 Vendor2

Communication System: CW; Frequency: 750 MHz; Duty cycle= 1:1

Medium parameters used: $f = 750 \text{ MHz}$; $\sigma = 0.907 \text{ S/m}$; $\epsilon_r = 43.49$; $\rho = 1000 \text{ kg/m}^3$

Phantom section: Flat Section

Ambient temperature: 22.1°C; Liquid temperature: 21.8°C

DASY5 Configuration:

- Probe: EX3DV4 - SN7509; ConvF(9.97, 9.73, 10.82) @ 750 MHz; Calibrated: 2023/4/26
- Sensor-Surface: 2mm (Mechanical Surface Detection)
- Electronics: DAE4 Sn1336; Calibrated: 2023/8/22
- Phantom: ELI
- DASY52 52.10.4(1527); SEMCAD X 14.6.14(7483)

Area Scan (41x141x1): Interpolated grid: dx=15 mm, dy=15 mm

Maximum value of SAR (interpolated) = 2.55 W/kg

Zoom Scan (7x7x7)/Cube 0: Measurement grid: dx=5mm, dy=5mm, dz=5mm

Reference Value = 58.18 V/m; Power Drift = 0.05 dB

Peak SAR (extrapolated) = 2.94 W/kg

SAR(1 g) = 2.07 W/kg; SAR(10 g) = 1.4 W/kg

Smallest distance from peaks to all points 3 dB below = 18.6 mm

Ratio of SAR at M2 to SAR at M1 = 70%

Maximum value of SAR (measured) = 2.57 W/kg

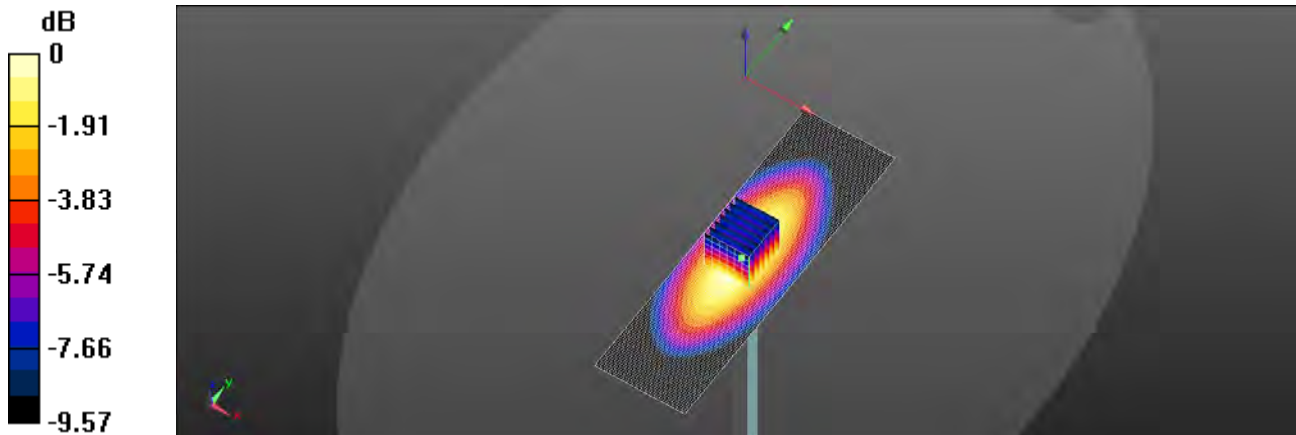

0 dB = 2.57 W/kg = 4.10 dBW/kg

Unless otherwise stated the results shown in this test report refer only to the sample(s) tested and such sample(s) are retained for 90 days only.

除非另有說明，此報告結果僅對測試之樣品負責，同時此樣品僅保留90天。本報告未經本公司書面許可，不可部份複製。

This document is issued by the Company subject to its General Conditions of Service printed overleaf, available on request or accessible at <http://www.sgs.com.tw/Terms-and-Conditions> and for electronic format documents, subject to Terms and Conditions for Electronic Documents at <http://www.sgs.com.tw/Terms-and-Conditions>. Attention is drawn to the limitation of liability, indemnification and jurisdiction issues defined therein. Any holder of this document is advised that information contained hereon reflects the Company's findings at the time of its intervention only and within the limits of Client's instructions, if any. The Company's sole responsibility is to its Client and this document does not exonerate parties to a transaction from exercising all their rights and obligations under the transaction documents. This document cannot be reproduced except in full, without prior written approval of the Company. Any unauthorized alteration, forgery or falsification of the content or appearance of this document is unlawful and offenders may be prosecuted to the fullest extent of the law.

Date: 2023/12/7

Report No. :TESA2311000704EN

Dipole 835 MHz_SN:4d063 Vendor1

Communication System: CW; Frequency: 835 MHz; Duty cycle= 1:1

Medium parameters used: $f = 835 \text{ MHz}$; $\sigma = 0.894 \text{ S/m}$; $\epsilon_r = 40.562$; $\rho = 1000 \text{ kg/m}^3$

Phantom section: Flat Section

Ambient temperature: 21.9°C; Liquid temperature: 21.7°C

DASY5 Configuration:

- Probe: EX3DV4 - SN7509; ConvF(9.51, 9.16, 10) @ 835 MHz; Calibrated: 2023/4/26
- Sensor-Surface: 2mm (Mechanical Surface Detection)
- Electronics: DAE4 Sn1336; Calibrated: 2023/8/22
- Phantom: ELI
- DASY52 52.10.4(1527); SEMCAD X 14.6.14(7483)

Area Scan (81x121x1): Interpolated grid: dx=15 mm, dy=15 mm

Maximum value of SAR (interpolated) = 2.97 W/kg

Zoom Scan (7x7x7)/Cube 0: Measurement grid: dx=5mm, dy=5mm, dz=5mm

Reference Value = 60.83 V/m; Power Drift = 0.08 dB

Peak SAR (extrapolated) = 3.50 W/kg

SAR(1 g) = 2.38 W/kg; SAR(10 g) = 1.58 W/kg

Smallest distance from peaks to all points 3 dB below = 19.4 mm

Ratio of SAR at M2 to SAR at M1 = 67.2%

Maximum value of SAR (measured) = 2.97 W/kg

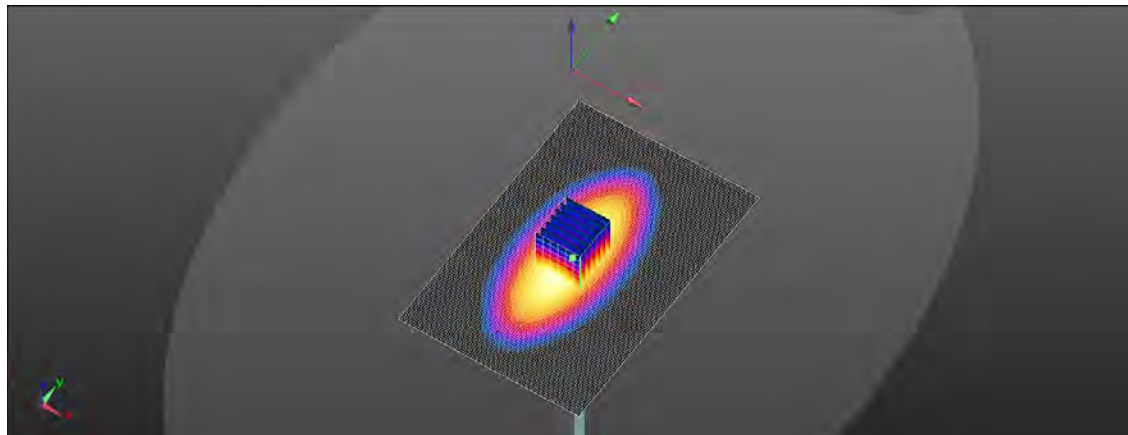
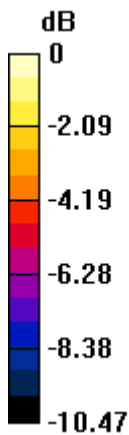

0 dB = 2.97 W/kg = 4.73 dBW/kg

Unless otherwise stated the results shown in this test report refer only to the sample(s) tested and such sample(s) are retained for 90 days only.

除非另有說明，此報告結果僅對測試之樣品負責，同時此樣品僅保留90天。本報告未經本公司書面許可，不可部份複製。

This document is issued by the Company subject to its General Conditions of Service printed overleaf, available on request or accessible at <http://www.sgs.com.tw/Terms-and-Conditions> and for electronic format documents, subject to Terms and Conditions for Electronic Documents at <http://www.sgs.com.tw/Terms-and-Conditions>. Attention is drawn to the limitation of liability, indemnification and jurisdiction issues defined therein. Any holder of this document is advised that information contained hereon reflects the Company's findings at the time of its intervention only and within the limits of Client's instructions, if any. The Company's sole responsibility is to its Client and this document does not exonerate parties to a transaction from exercising all their rights and obligations under the transaction documents. This document cannot be reproduced except in full, without prior written approval of the Company. Any unauthorized alteration, forgery or falsification of the content or appearance of this document is unlawful and offenders may be prosecuted to the fullest extent of the law.

Date: 2023/12/8

Report No. :TESA2311000704EN

Dipole 835 MHz_SN:4d063 Vendor2

Communication System: CW; Frequency: 835 MHz; Duty cycle= 1:1

Medium parameters used: $f = 835 \text{ MHz}$; $\sigma = 0.891 \text{ S/m}$; $\epsilon_r = 40.251$; $\rho = 1000 \text{ kg/m}^3$

Phantom section: Flat Section

Ambient temperature: 22.2°C; Liquid temperature: 21.9°C

DASY5 Configuration:

- Probe: EX3DV4 - SN7509; ConvF(9.51, 9.16, 10) @ 835 MHz; Calibrated: 2023/4/26
- Sensor-Surface: 2mm (Mechanical Surface Detection)
- Electronics: DAE4 Sn1336; Calibrated: 2023/8/22
- Phantom: ELI
- DASY52 52.10.4(1527); SEMCAD X 14.6.14(7483)

Area Scan (81x121x1): Interpolated grid: dx=15 mm, dy=15 mm

Maximum value of SAR (interpolated) = 2.89 W/kg

Zoom Scan (7x7x7)/Cube 0: Measurement grid: dx=5mm, dy=5mm, dz=5mm

Reference Value = 61.73 V/m; Power Drift = -0.03 dB

Peak SAR (extrapolated) = 3.45 W/kg

SAR(1 g) = 2.34 W/kg; SAR(10 g) = 1.55 W/kg

Smallest distance from peaks to all points 3 dB below = 19.8 mm

Ratio of SAR at M2 to SAR at M1 = 66.8%

Maximum value of SAR (measured) = 2.95 W/kg

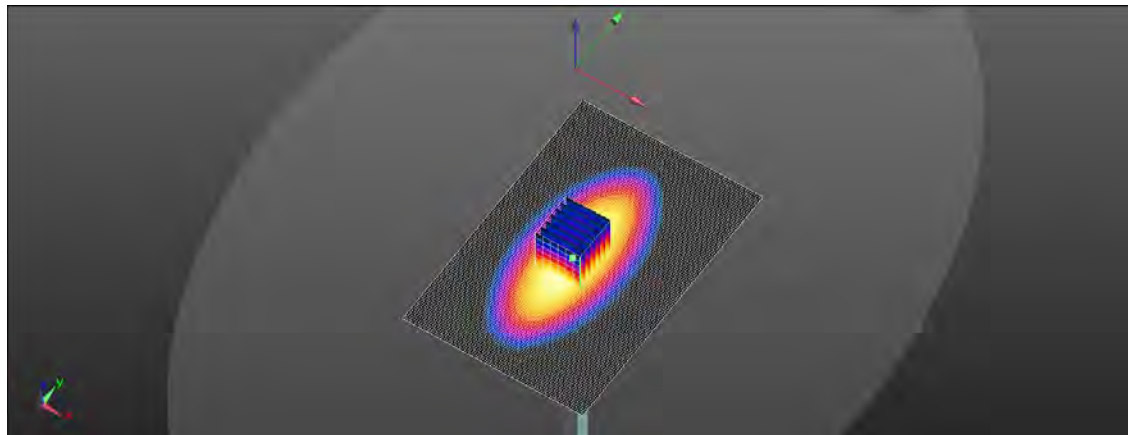
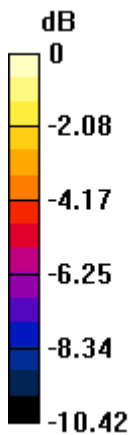

0 dB = 2.95 W/kg = 4.70 dBW/kg

Unless otherwise stated the results shown in this test report refer only to the sample(s) tested and such sample(s) are retained for 90 days only.

除非另有說明，此報告結果僅對測試之樣品負責，同時此樣品僅保留90天。本報告未經本公司書面許可，不可部份複製。

This document is issued by the Company subject to its General Conditions of Service printed overleaf, available on request or accessible at <http://www.sgs.com.tw/Terms-and-Conditions> and for electronic format documents, subject to Terms and Conditions for Electronic Documents at <http://www.sgs.com.tw/Terms-and-Conditions>. Attention is drawn to the limitation of liability, indemnification and jurisdiction issues defined therein. Any holder of this document is advised that information contained hereon reflects the Company's findings at the time of its intervention only and within the limits of Client's instructions, if any. The Company's sole responsibility is to its Client and this document does not exonerate parties to a transaction from exercising all their rights and obligations under the transaction documents. This document cannot be reproduced except in full, without prior written approval of the Company. Any unauthorized alteration, forgery or falsification of the content or appearance of this document is unlawful and offenders may be prosecuted to the fullest extent of the law.

Date: 2023/12/9

Report No. :TESA2311000704EN

Dipole 1750 MHz_SN:1008

Communication System: CW; Frequency: 1750 MHz; Duty cycle= 1:1

Medium parameters used: $f = 1750$ MHz; $\sigma = 1.318$ S/m; $\epsilon_r = 38.667$; $\rho = 1000$ kg/m³

Phantom section: Flat Section

Ambient temperature: 22.5°C; Liquid temperature: 22.2°C

DASY5 Configuration:

- Probe: EX3DV4 - SN7509; ConvF(8.6, 8.56, 9.12) @ 1750 MHz; Calibrated: 2023/4/26
- Sensor-Surface: 2mm (Mechanical Surface Detection)
- Electronics: DAE4 Sn1336; Calibrated: 2023/8/22
- Phantom: ELI
- DASY52 52.10.4(1527); SEMCAD X 14.6.14(7483)

Area Scan (41x71x1): Interpolated grid: dx=15 mm, dy=15 mm

Maximum value of SAR (interpolated) = 13.8 W/kg

Zoom Scan (7x7x7)/Cube 0: Measurement grid: dx=5mm, dy=5mm, dz=5mm

Reference Value = 84.78 V/m; Power Drift = -0.01 dB

Peak SAR (extrapolated) = 17.2 W/kg

SAR(1 g) = 9.02 W/kg; SAR(10 g) = 4.69 W/kg

Smallest distance from peaks to all points 3 dB below = 11 mm

Ratio of SAR at M2 to SAR at M1 = 53.3%

Maximum value of SAR (measured) = 13.2 W/kg

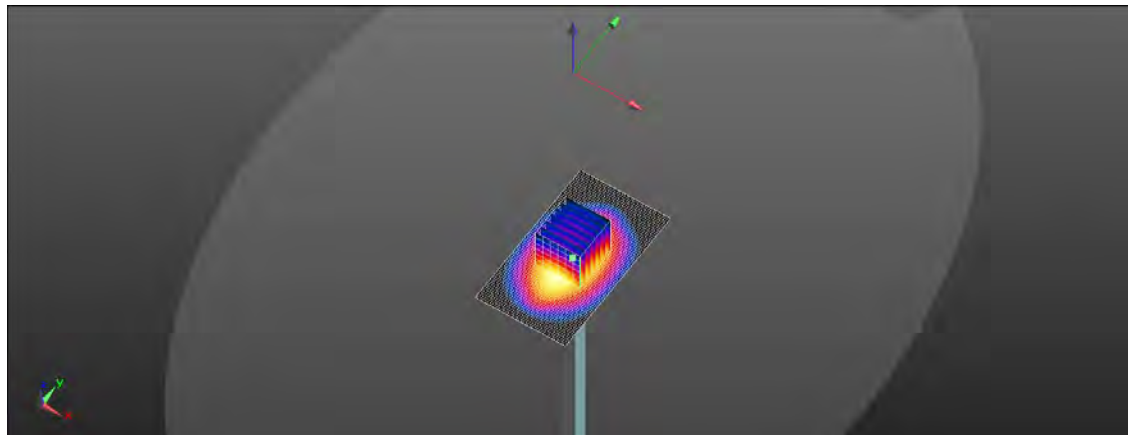
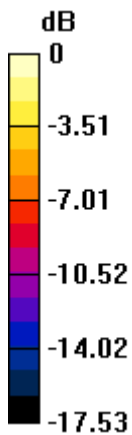

0 dB = 13.2 W/kg = 11.21 dBW/kg

Unless otherwise stated the results shown in this test report refer only to the sample(s) tested and such sample(s) are retained for 90 days only.

除非另有說明，此報告結果僅對測試之樣品負責，同時此樣品僅保留90天。本報告未經本公司書面許可，不可部份複製。

This document is issued by the Company subject to its General Conditions of Service printed overleaf, available on request or accessible at <http://www.sgs.com.tw/Terms-and-Conditions> and for electronic format documents, subject to Terms and Conditions for Electronic Documents at <http://www.sgs.com.tw/Terms-and-Conditions>. Attention is drawn to the limitation of liability, indemnification and jurisdiction issues defined therein. Any holder of this document is advised that information contained hereon reflects the Company's findings at the time of its intervention only and within the limits of Client's instructions, if any. The Company's sole responsibility is to its Client and this document does not exonerate parties to a transaction from exercising all their rights and obligations under the transaction documents. This document cannot be reproduced except in full, without prior written approval of the Company. Any unauthorized alteration, forgery or falsification of the content or appearance of this document is unlawful and offenders may be prosecuted to the fullest extent of the law.

SGS Taiwan Ltd.

No.134,Wu Kung Road, New Taipei Industrial Park, Wuku District, New Taipei City, Taiwan/新北市五股區新北產業園區五工路 134 號

台灣檢驗科技股份有限公司

t (886-2) 2299-3279

f (886-2) 2298-0488

www.sgs.com.tw

Member of SGS Group

Date: 2023/12/10

Report No. :TESA2311000704EN

Dipole 1900 MHz_SN:5d056

Communication System: CW; Frequency: 1900 MHz; Duty cycle= 1:1

Medium parameters used: $f = 1900 \text{ MHz}$; $\sigma = 1.426 \text{ S/m}$; $\epsilon_r = 38.455$; $\rho = 1000 \text{ kg/m}^3$

Phantom section: Flat Section

Ambient temperature: 22.0°C; Liquid temperature: 21.7°C

DASY5 Configuration:

- Probe: EX3DV4 - SN7509; ConvF(8.12, 8.05, 8.74) @ 1900 MHz; Calibrated: 2023/4/26
- Sensor-Surface: 2mm (Mechanical Surface Detection)
- Electronics: DAE4 Sn1336; Calibrated: 2023/8/22
- Phantom: ELI
- DASY52 52.10.4(1527); SEMCAD X 14.6.14(7483)

Area Scan (61x81x1): Interpolated grid: dx=15 mm, dy=15 mm

Maximum value of SAR (interpolated) = 14.3 W/kg

Zoom Scan (7x7x7)/Cube 0: Measurement grid: dx=5mm, dy=5mm, dz=5mm

Reference Value = 112.9 V/m; Power Drift = 0.01 dB

Peak SAR (extrapolated) = 17.4 W/kg

SAR(1 g) = 9.84 W/kg; SAR(10 g) = 5.39 W/kg

Smallest distance from peaks to all points 3 dB below = 10.4 mm

Ratio of SAR at M2 to SAR at M1 = 53.1%

Maximum value of SAR (measured) = 13.5 W/kg

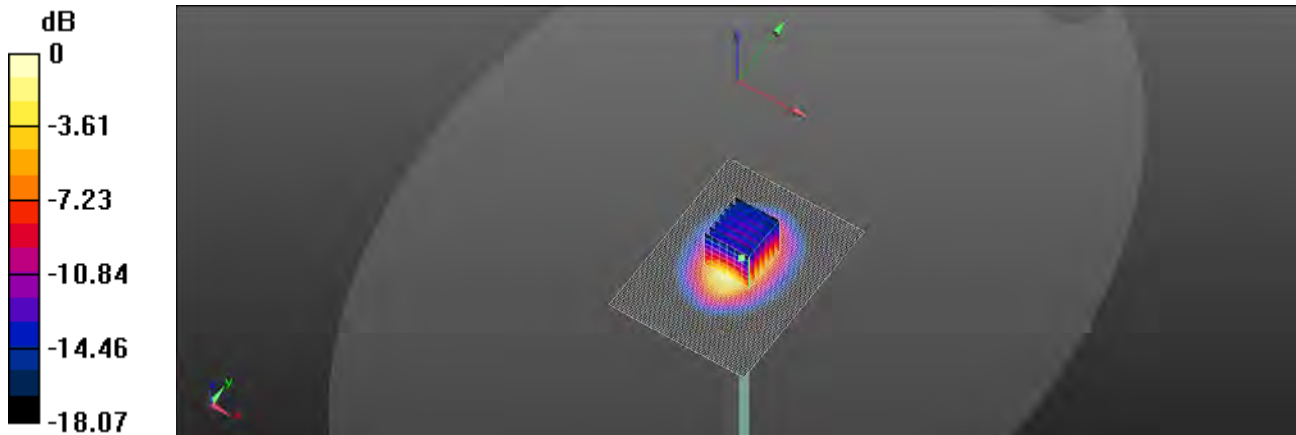

0 dB = 13.5 W/kg = 11.30 dBW/kg

Unless otherwise stated the results shown in this test report refer only to the sample(s) tested and such sample(s) are retained for 90 days only.

除非另有說明，此報告結果僅對測試之樣品負責，同時此樣品僅保留90天。本報告未經本公司書面許可，不可部份複製。

This document is issued by the Company subject to its General Conditions of Service printed overleaf, available on request or accessible at <http://www.sgs.com.tw/Terms-and-Conditions> and for electronic format documents, subject to Terms and Conditions for Electronic Documents at <http://www.sgs.com.tw/Terms-and-Conditions>. Attention is drawn to the limitation of liability, indemnification and jurisdiction issues defined therein. Any holder of this document is advised that information contained hereon reflects the Company's findings at the time of its intervention only and within the limits of Client's instructions, if any. The Company's sole responsibility is to its Client and this document does not exonerate parties to a transaction from exercising all their rights and obligations under the transaction documents. This document cannot be reproduced except in full, without prior written approval of the Company. Any unauthorized alteration, forgery or falsification of the content or appearance of this document is unlawful and offenders may be prosecuted to the fullest extent of the law.

SGS Taiwan Ltd.

No.134,Wu Kung Road, New Taipei Industrial Park, Wuku District, New Taipei City, Taiwan/新北市五股區新北產業園區五工路 134 號

台灣檢驗科技股份有限公司

t (886-2) 2299-3279

f (886-2) 2298-0488

www.sgs.com.tw

Member of SGS Group

Refer to separated files for the following appendixes.**12.1 SAR_Appendix A Photographs****12.2 SAR_Appendix B DAE & Probe Cal. Certificate****12.3 SAR_Appendix C Phantom Description & Dipole Cal. Certificate****- End of report -**

Unless otherwise stated the results shown in this test report refer only to the sample(s) tested and such sample(s) are retained for 90 days only.
除非另有說明，此報告結果僅對測試之樣品負責，同時此樣品僅保留90天。本報告未經本公司書面許可，不可部份複製。

This document is issued by the Company subject to its General Conditions of Service printed overleaf, available on request or accessible at <http://www.sgs.com.tw/Terms-and-Conditions> and for electronic format documents, subject to Terms and Conditions for Electronic Documents at <http://www.sgs.com.tw/Terms-and-Conditions>. Attention is drawn to the limitation of liability, indemnification and jurisdiction issues defined therein. Any holder of this document is advised that information contained hereon reflects the Company's findings at the time of its intervention only and within the limits of Client's instructions, if any. The Company's sole responsibility is to its Client and this document does not exonerate parties to a transaction from exercising all their rights and obligations under the transaction documents. This document cannot be reproduced except in full, without prior written approval of the Company. Any unauthorized alteration, forgery or falsification of the content or appearance of this document is unlawful and offenders may be prosecuted to the fullest extent of the law.