

Regulatory WWAN Antenna Information

(TB Mode)

Platform information						
Brand	ODM	Platform model name	Platform type (ex: regular NB, convertible PC, AIO...etc)			*SAR minimum separation (mm)
HP Inc.	Inventec	HSN-I61C	Convertible PC			1.9mm
Antenna information						Maximum Peak gain
Vendor	Type	Antenna Part number (Ant5 TX/RX)	Antenna Part number (Ant6 RX)	Antenna Part number (Ant7 RX)	Antenna Part number (Ant8 TX/RX)	4500MHz (Ant5 TX/RX)
WNC	PIFA	6036B0345901 (81ELBA15.G02)	6036B0346001 (81ELBA15.G01)	6036B0345601 (81ELBA15.G03)	6036B0345901 (81ELBA15.G02)	3.14dBi
Module information						
Model	Form factor and suffixes (NGW/ HMW AND AN/ NB/ BN....)					
Kavalan	Fibocom FM350-GL WWAN 4x4 5G NR radio module					

Antenna vendor connect person	
Antenna Vendor	WNC
contact person	Annie Lo
E-mail	annie.lo@wnc.com.tw
Tel/Mobile	886-3-666-7799 ext: 3415
Web address	https://www.wnc.com.tw
Address	20 Park Avenue II, Hsinchu Science Park Hsinchu 300, Taiwan

Antenna Sample / Antenna Data Requirements for worldwide regulatory approval

Section	Description of Required OEM / ODM Antenna Information	US / IC	EU	Japan	Taiwan	S.Korea
1A	Part Number for Antenna Assembly	Required	Required	Required	Required	Required
1B	Antenna Manufacturer Name	Required	Required	Required	Required	Required
1C	Description of Antenna Type	Required	N/A	N/A	N/A	N/A
1D	Tx antenna Gain (Peak Gain W/ cable loss) *	Required	Required	Required	Required	Required
2	Dimensioned Photographs and Drawings of Tx and Rx antennas	Required	Required	Required	Required	Required
3	Radiation patterns of antennas loaded in the host platform.	N/A	Required	Required	Required	N/A
4	Platform model name / number - correlated to antenna manufacturer and antenna part number	Required	Required	Desired	Required	Desired
5	Photograph(s) or Drawings showing location of antennas in platform. (S. Korea requires photographs of antennas for approval submission). Taiwan requires pictures of each antenna type shown in the system.	Required	Required	Desired	<u>Required (Photos)</u>	<u>Required (Photos)</u>
6	Mech. drawings / photos with dimensions of antenna locations and distance from end-user (For evaluation of SAR testing requirement).	Required	N/A	N/A	N/A	N/A
7	Photograph(s) or Drawings showing the location of all antennas (WLAN, other) and distance between those transmitting antennas. Information will be used to evaluate whether co-location testing is required.	Required	N/A	N/A	N/A	N/A
8	Local representative contact information for LMA/ PARS process.	Required	N/A	N/A	N/A	N/A

Test location: 1F, No. 8, Alley 15, Lane 120, Sec. 1, NeiHu Road Neihu District, Taipei City 11493, Taiwan
 Testing date: 2023/10/26

Equipment list

Equipment Description	Manufacturer	Identification no.	Current calibration date	Next calibration date
Network analyzer	Agilent	E5071C	2023/01/7	2024/01/6
Measurement software	ETS-Lindgren	EMQuest	N/A	N/A
Multi axis positioning system(MAPSTM)	ETS-Lindgren	EMCO 2115	N/A	N/A
Multi axis positioning system(MAPSTM)	ETS-Lindgren	EMCO 2110	N/A	N/A
MAPSTM controller	ETS-Lindgren	EMCO 2090	N/A	N/A
ETS OTA Chamber	ETS-Lindgren	AMS8500	2023/03/03	2024/03/02
Horn antenna	ETS-Lindgren	3164-10	2023/03/03	2024/03/02

Note: Chamber calibration included full set of implement

Antenna Information

Section 1. Antenna Assembly Specifications

Communication System	Band	Frequency(MHz) from low to high spectrum		1A Part Number for Antenna Assembly	1B Antenna Manufacturer Name	1C Description of Antenna Type	1D Tx Antenna Gain (dBi) Ant5
WCDMA/ LTE/5G NR FR1	1	1920	1980	Ant5 : 81ELBA15.G02	WNC	PIFA	-0.62
WCDMA/ LTE/5G NR FR1	2	1850	1910				-0.34
LTE/5G NR FR1	3	1710	1785				-1.36
WCDMA/ LTE	4	1710	1755				-1.36
WCDMA/ LTE/5G NR FR1	5	824	849				-5.12
LTE/5G NR FR1	7	2500	2570				-3.93
WCDMA/ LTE/5G NR FR1	8	880	915				-5.55
LTE	12	699	716				-6.10
LTE	13	777	787				-6.15
LTE	14	788	798				-6.59
LTE	17	704	716				-6.10
LTE	18	815	830				-6.32
LTE	19	830	845				-5.72
LTE/5G NR FR1	20	832	862				-5.12
LTE/5G NR FR1	25	1850	1915				-0.34
LTE	26	814	849				-5.12
LTE/5G NR FR1	28	703	748				-6.05
LTE/5G NR FR1	30	2305	2315				-1.08
LTE	34	2010	2025				-0.72
LTE/5G NR FR1	38	2570	2620				-3.61
LTE	39	1880	1920				-0.34
LTE/5G NR FR1	40	2300	2400				-1.08
LTE/5G NR FR1	41	2496	2690				-1.76
LTE	42	3400	3600				0.68
LTE	43	3600	3800				1.24
LTE/5G NR FR1	66	1710	1780				-1.36
LTE/5G NR FR1	71	663	698				-7.82
5G NR FR1	77	3300	4200				1.24
5G NR FR1	78	3300	3800	1.24			
5G NR FR1	79	4400	5000	3.14			

Communication System	Band	Frequency(MHz) from low to high spectrum		1A Part Number for Antenna Assembly	1B Antenna Manufacturer Name	1C Description of Antenna Type	1D Tx Antenna Gain (dBi) Ant8
5G NR FR1	1	1920	1980	Ant8 : 81ELBA15.G02	WNC	PIFA	-1.37
LTE/5G NR FR1	2	1850	1910				0.28
5G NR FR1	3	1710	1785				-0.11
LTE	4	1710	1755				-1.28
5G NR FR1	5	824	849				-22.44
LTE/5G NR FR1	7	2500	2570				-1.32
LTE/5G NR FR1	25	1850	1915				0.28
LTE/5G NR FR1	30	2305	2315				-3.73
5G NR FR1	38	2570	2620				0.52
5G NR FR1	40	2300	2400				-2.55
LTE/5G NR FR1	41	2496	2690				1.18
5G NR FR1	48	3550	3700				0.89
LTE/5G NR FR1	66	1710	1780				-0.54
5G NR FR1	77	3300	4200				2.28
5G NR FR1	78	3300	3800				1.49
5G NR FR1	79	4400	5000				0.31

Antenna Peak Gain required being test in system basis.

Ant6 Dimensioned Drawing:

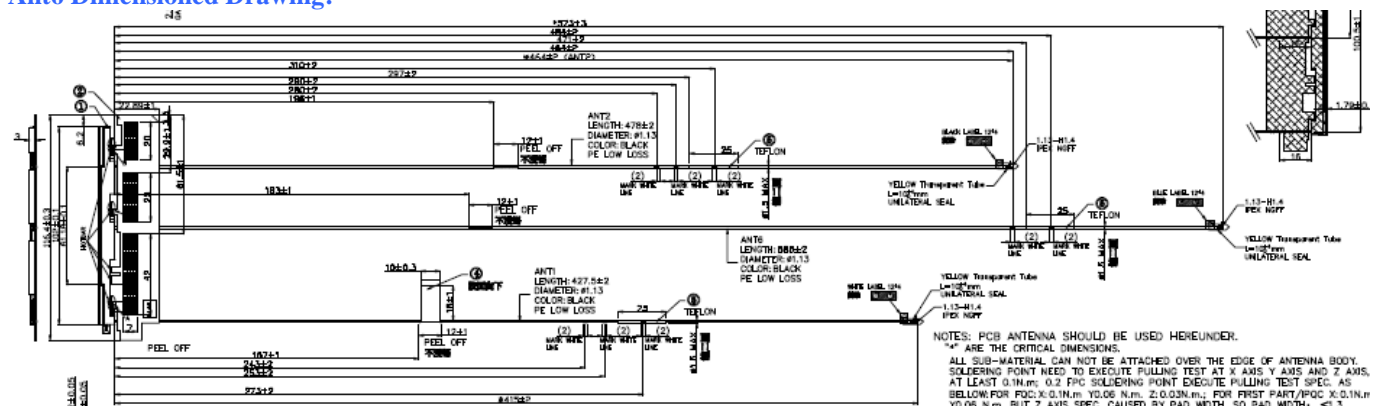

Ant6 Photo:

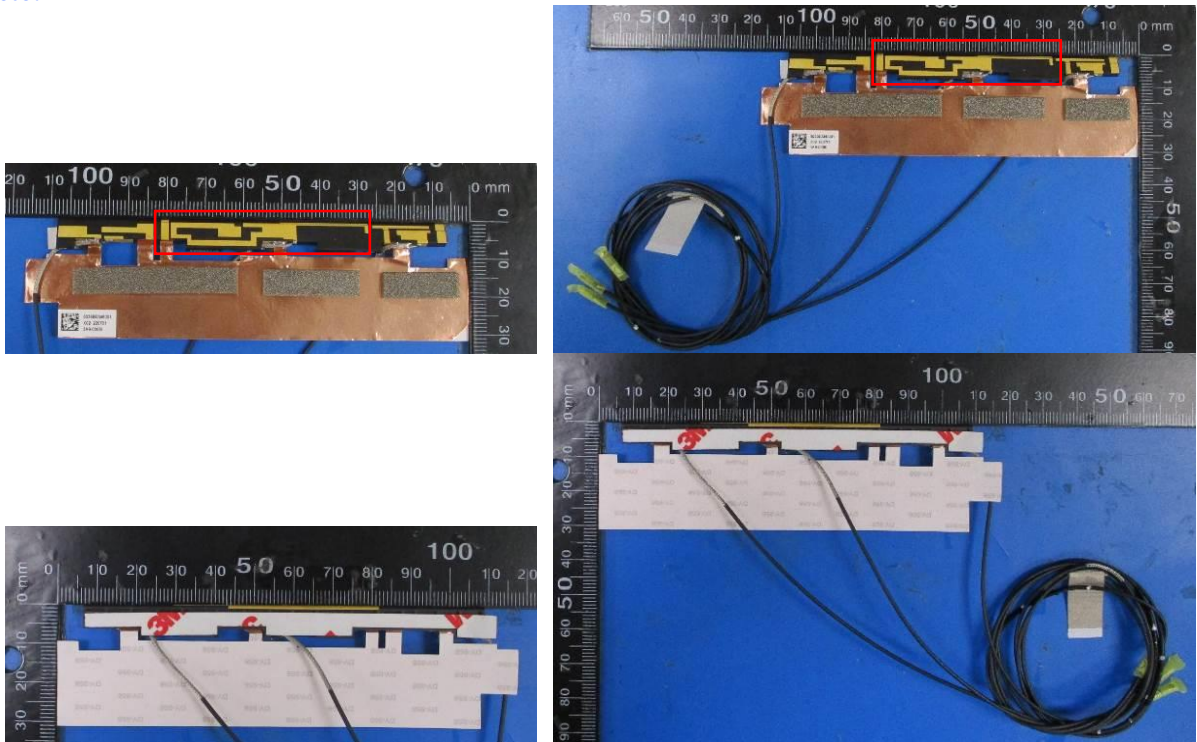

Ant7 Dimensioned Drawing:

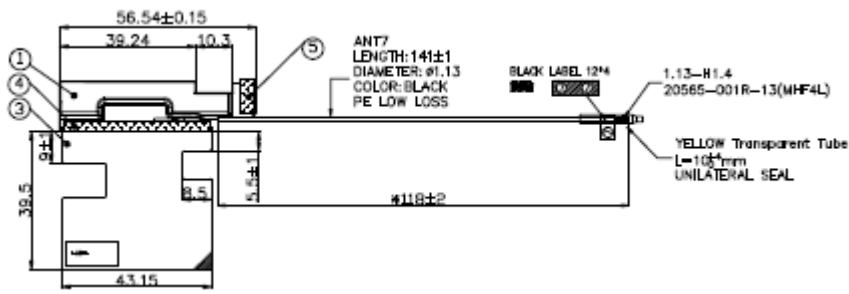

Ant7 Photo:

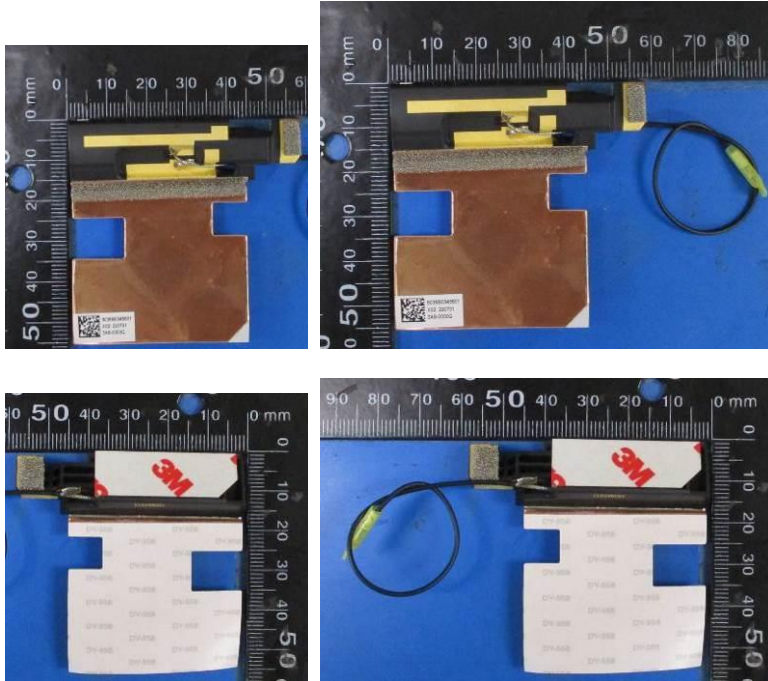

- The listed frequency 2D radiation pattern is required

- [Ant5:](#)

815MHz

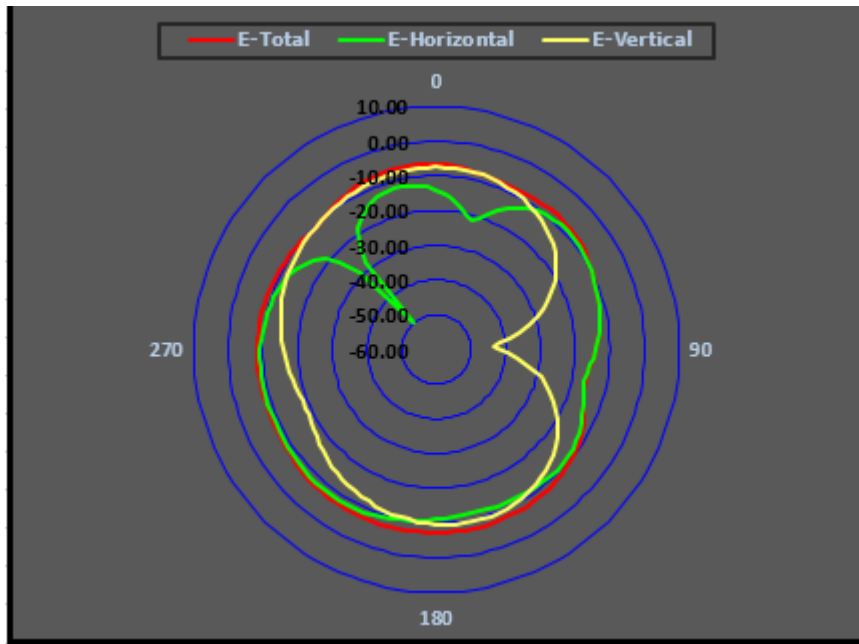

Center Frequency	815MHz
Horizontal (dBi) peak	-8.20
Vertical (dBi) peak	-7.43

832MHz

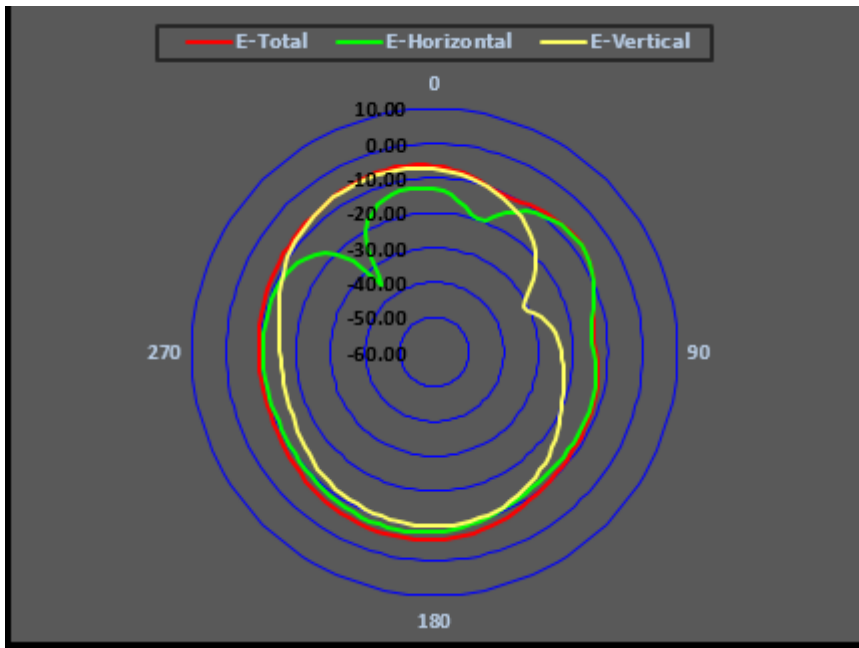

Center Frequency	832MHz
Horizontal (dBi) peak	-7.81
Vertical (dBi) peak	-6.59

837MHz

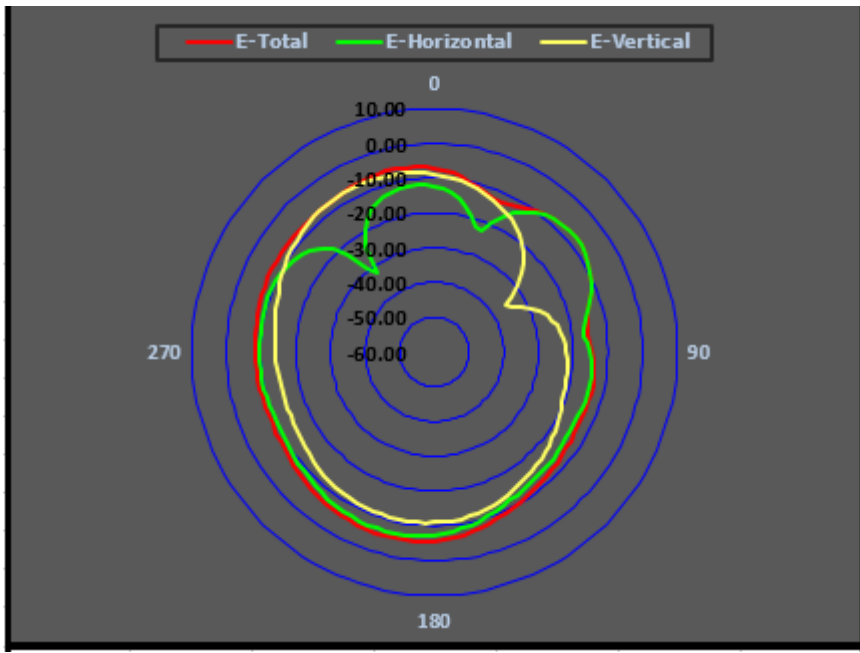

Center Frequency	837MHz
Horizontal (dBi) peak	-6.50
Vertical (dBi) peak	-7.28

845MHz

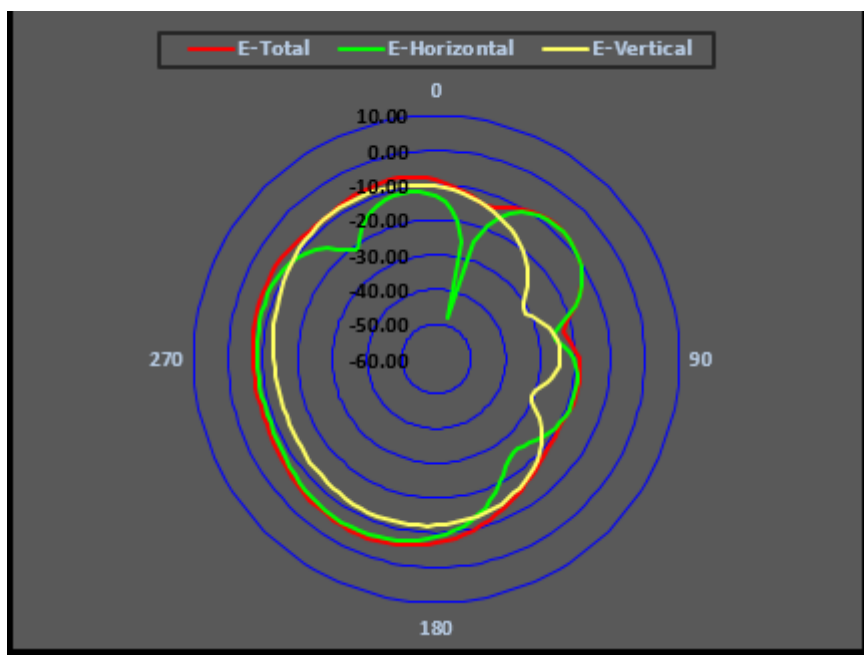

Center Frequency	845MHz
Horizontal (dBi) peak	-5.72
Vertical (dBi) peak	-8.31

849MHz

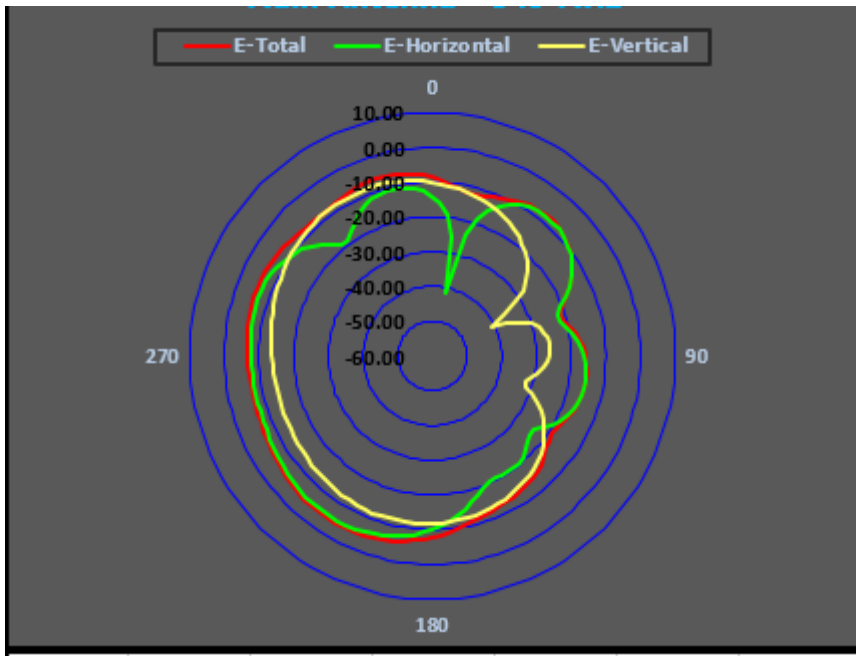

Center Frequency	849MHz
Horizontal (dBi) peak	-5.12
Vertical (dBi) peak	-8.24

880MHz

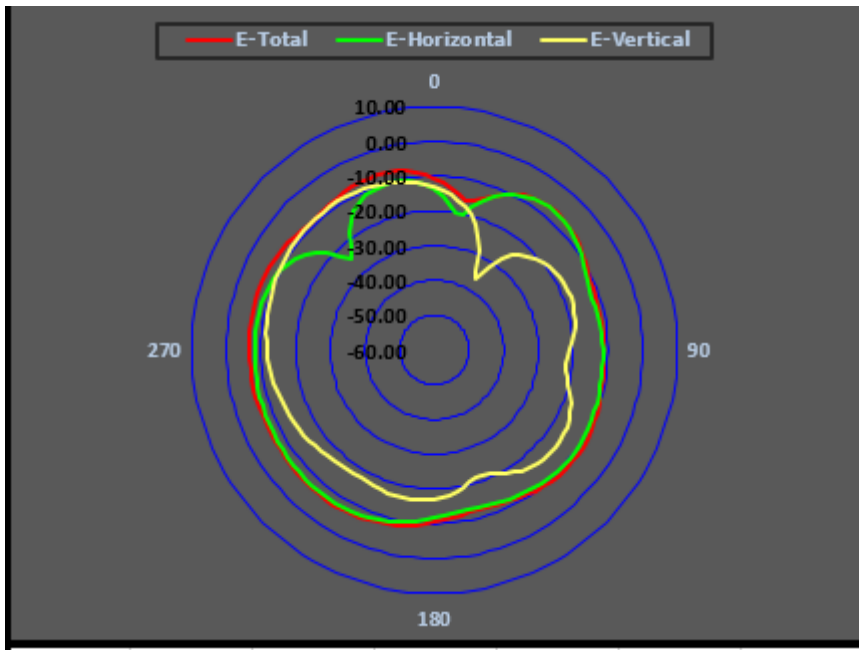

Center Frequency	880MHz
Horizontal (dBi) peak	-7.26
Vertical (dBi) peak	-8.92

894MHz

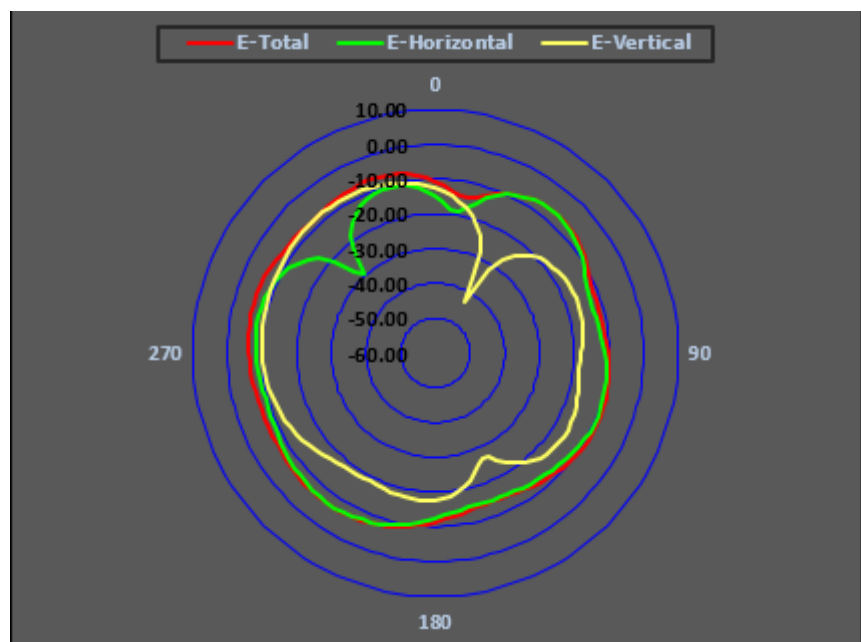

Center Frequency	894MHz
Horizontal (dBi) peak	-6.85
Vertical (dBi) peak	-8.06

915MHz

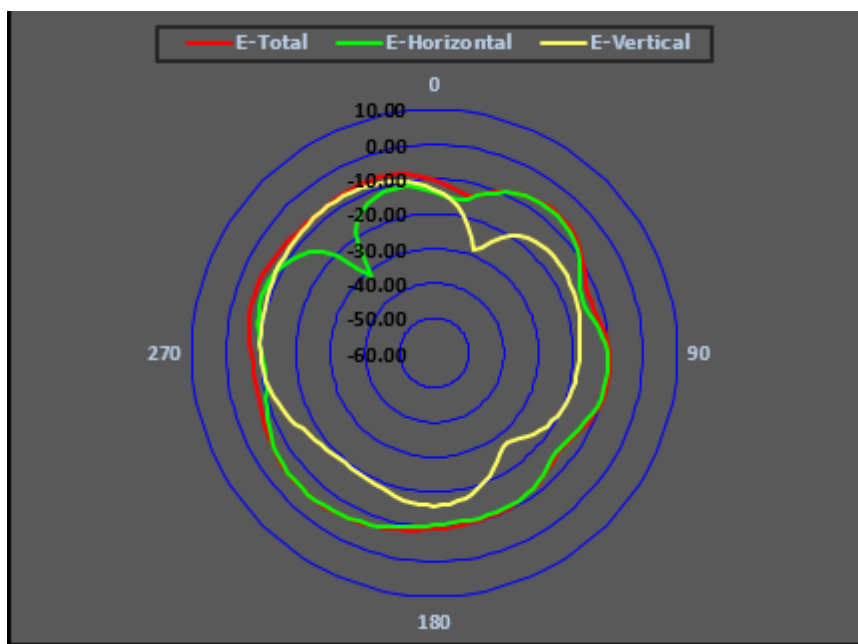

Center Frequency	915MHz
Horizontal (dBi) peak	-5.55
Vertical (dBi) peak	-7.81

1710MHz

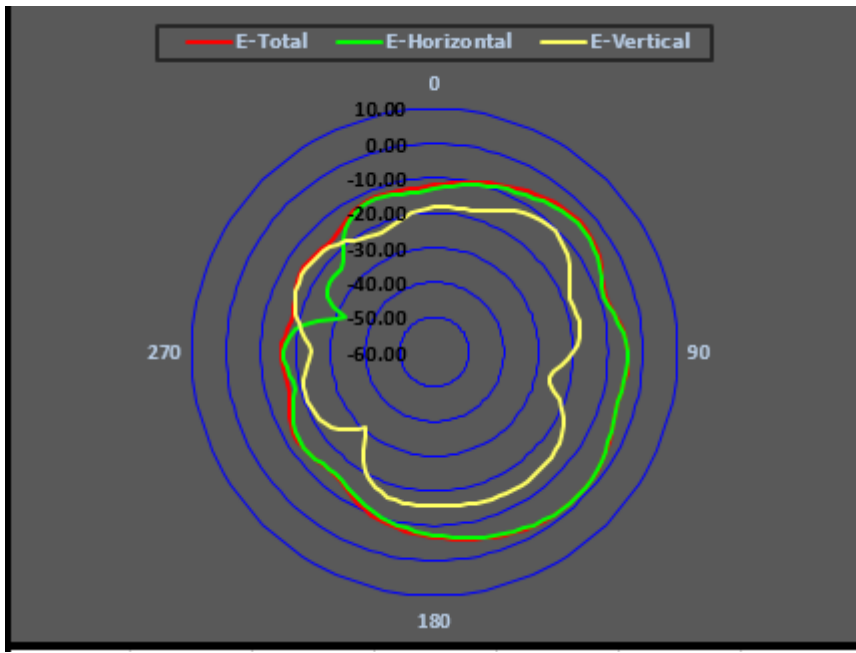

Center Frequency	1710MHz
Horizontal (dBi) peak	-1.58
Vertical (dBi) peak	-10.96

1750MHz

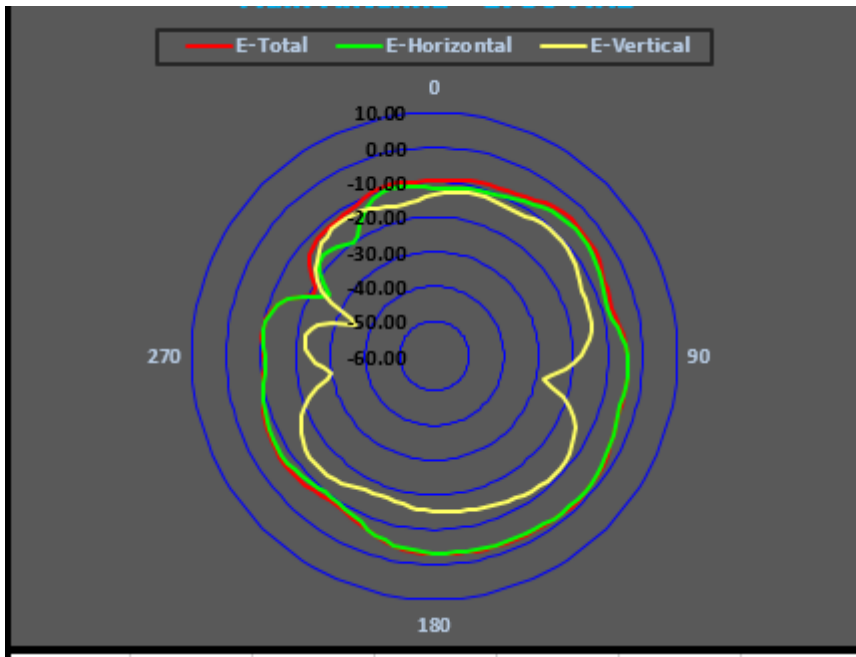

Center Frequency	1750MHz
Horizontal (dBi) peak	-1.65
Vertical (dBi) peak	-10.35

1780MHz

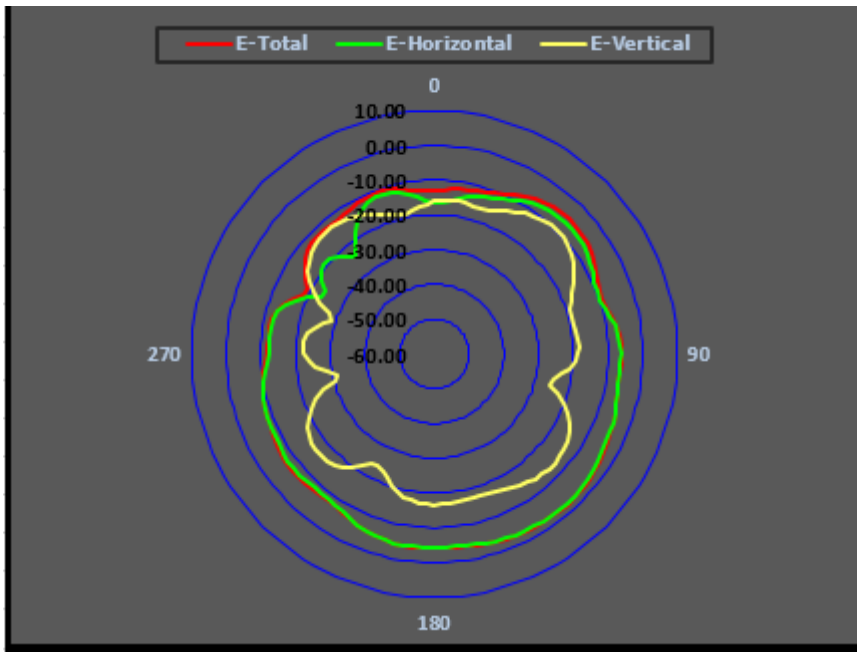

Center Frequency	1780MHz
Horizontal (dBi) peak	-2.41
Vertical (dBi) peak	-9.85

1785MHz

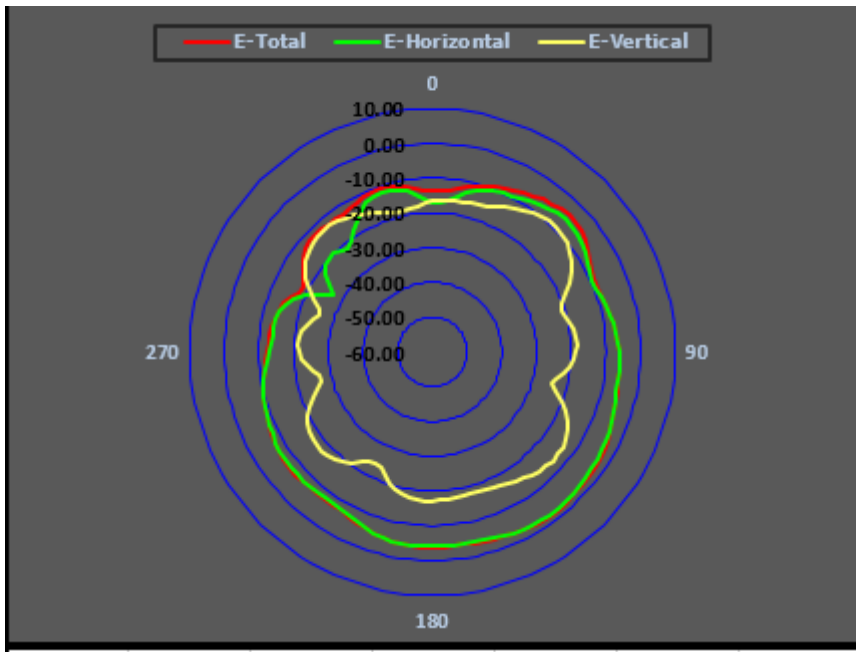

Center Frequency	1785MHz
Horizontal (dBi) peak	-2.12
Vertical (dBi) peak	-9.46

1880MHz

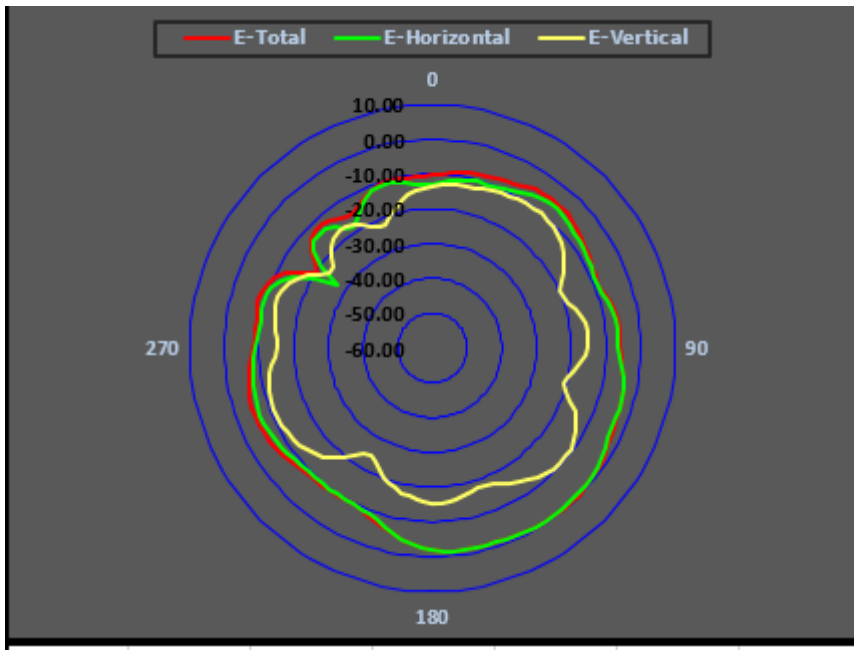

Center Frequency	1880MHz
Horizontal (dBi) peak	-0.34
Vertical (dBi) peak	-10.23

1900MHz

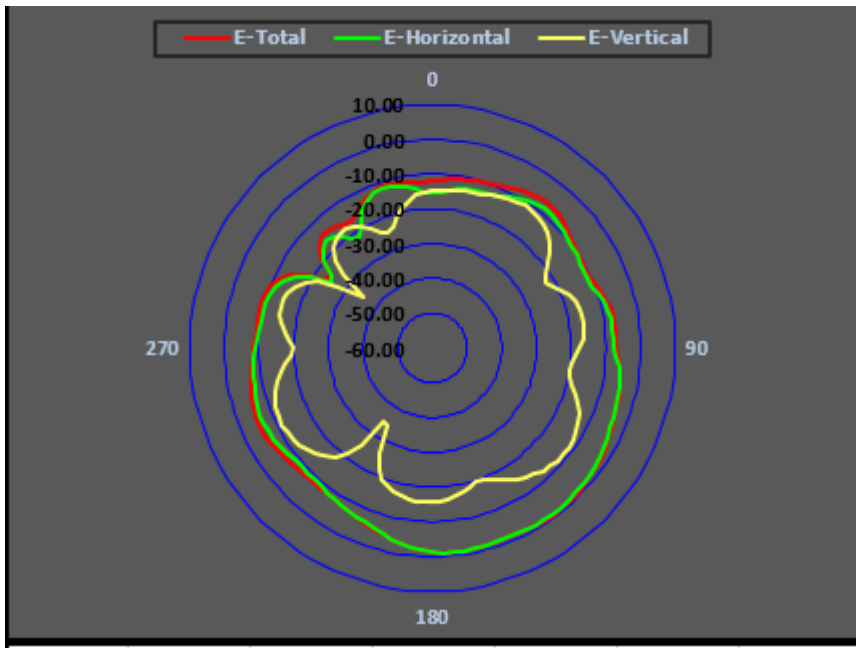

Center Frequency	1900MHz
Horizontal (dBi) peak	-0.87
Vertical (dBi) peak	-11.17

1920MHz

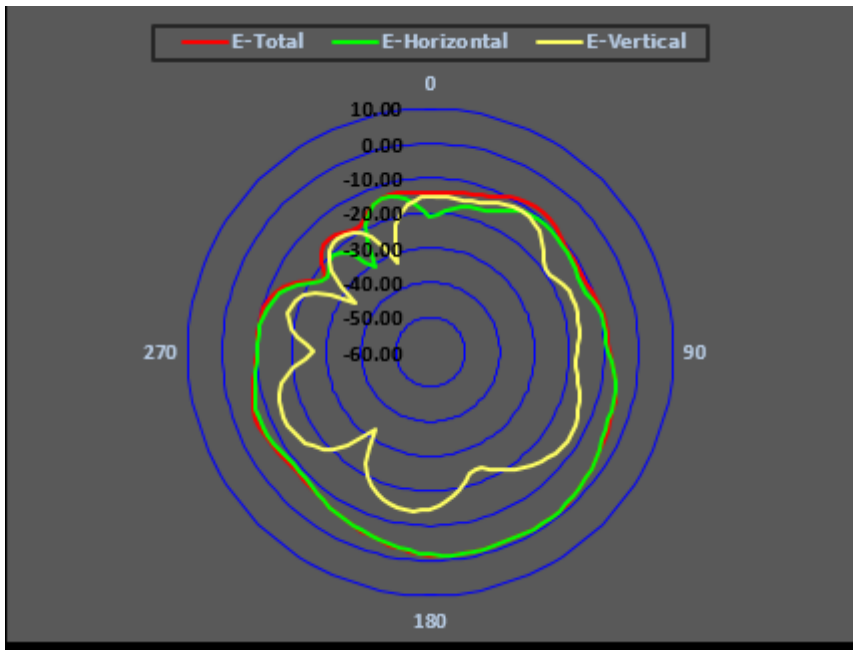

Center Frequency	1920MHz
Horizontal (dBi) peak	-1.02
Vertical (dBi) peak	-11.62

1950MHz

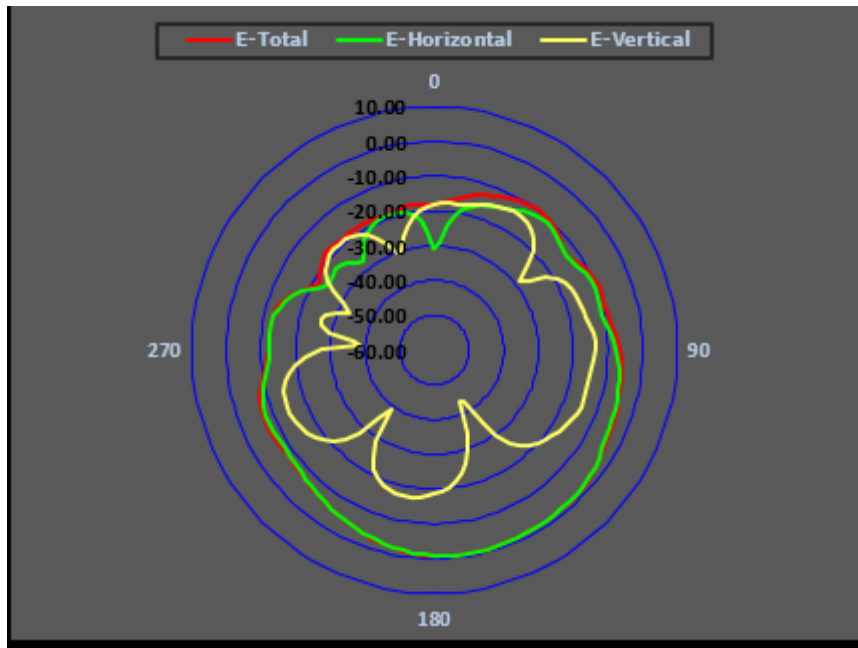

Center Frequency	1950MHz
Horizontal (dBi) peak	-0.62
Vertical (dBi) peak	-13.71

1980MHz

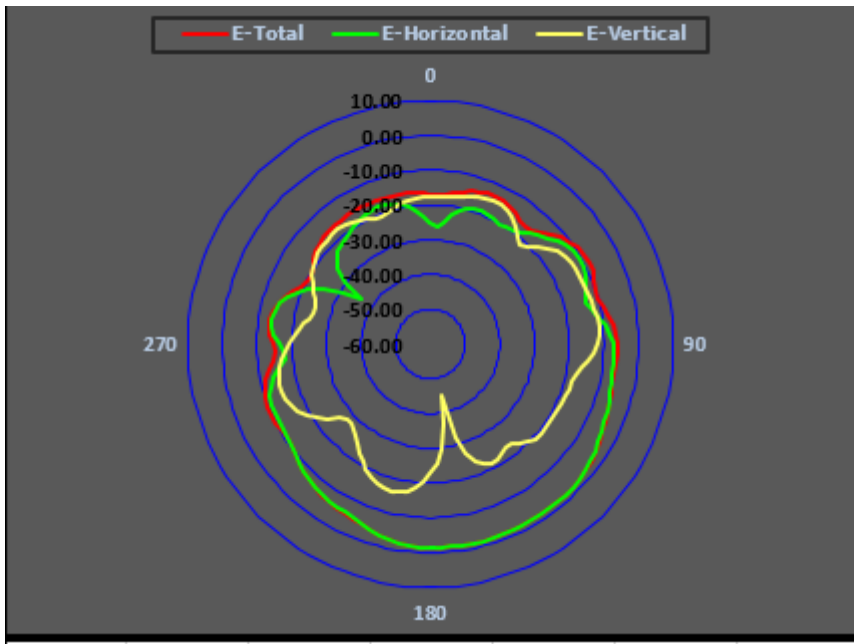

Center Frequency	1980MHz
Horizontal (dBi) peak	-1.34
Vertical (dBi) peak	-11.23

2496MHz

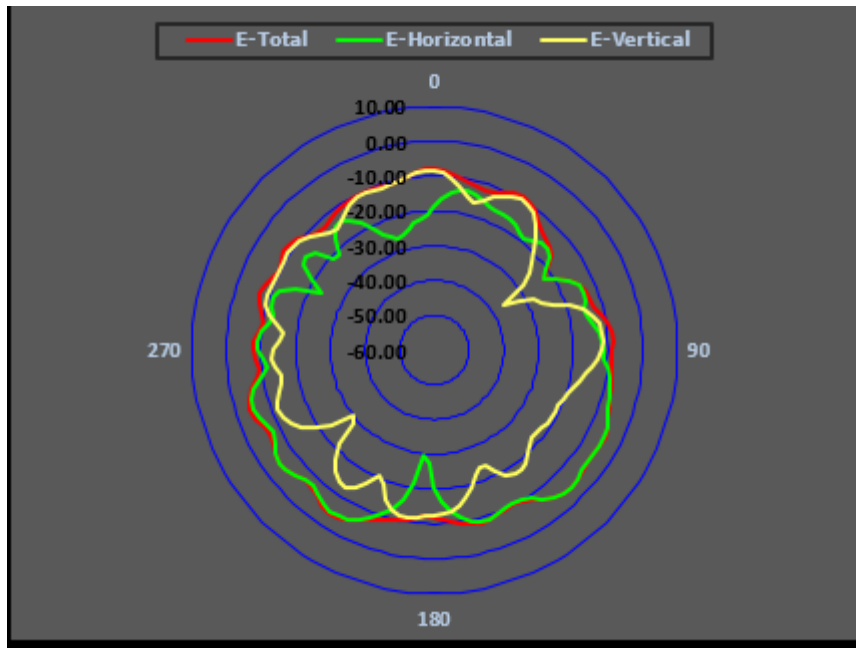

Center Frequency	2496MHz
Horizontal (dBi) peak	-3.98
Vertical (dBi) peak	-8.25

2595MHz

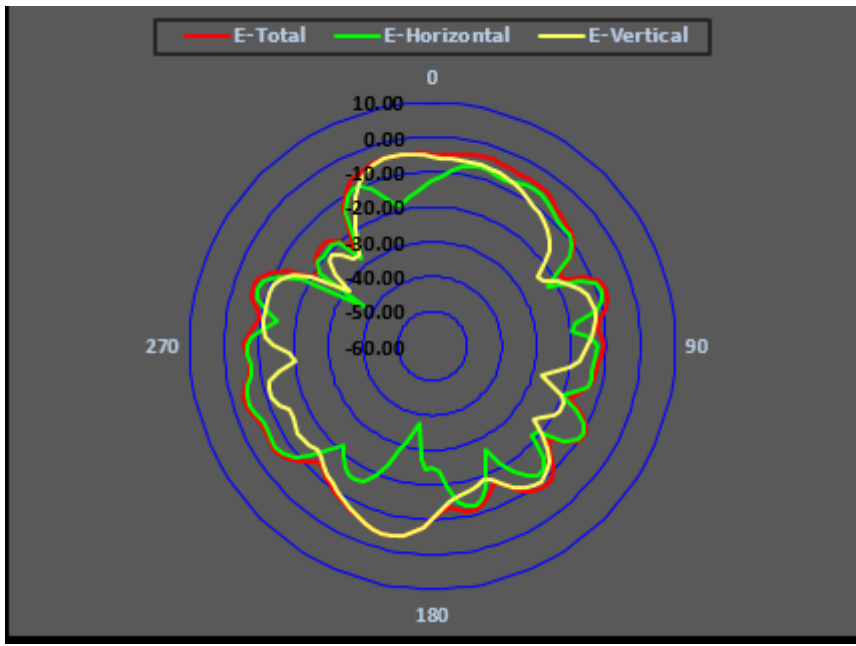

Center Frequency	2595MHz
Horizontal (dBi) peak	-4.55
Vertical (dBi) peak	-4.12

2690MHz

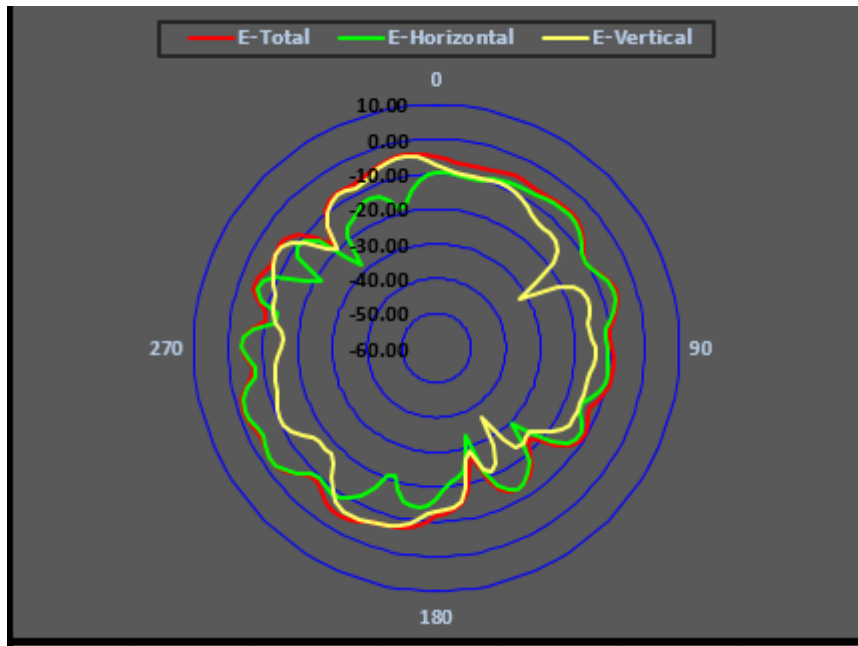

Center Frequency	2690MHz
Horizontal (dBi) peak	-1.76
Vertical (dBi) peak	-4.15

3300MHz

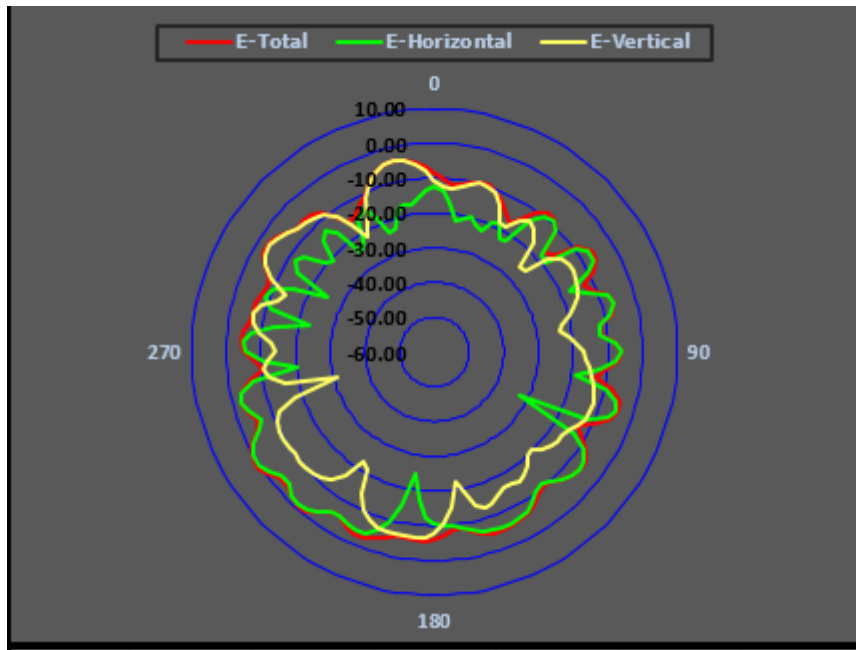

Center Frequency	3300MHz
Horizontal (dBi) peak	0.18
Vertical (dBi) peak	-3.46

3400MHz

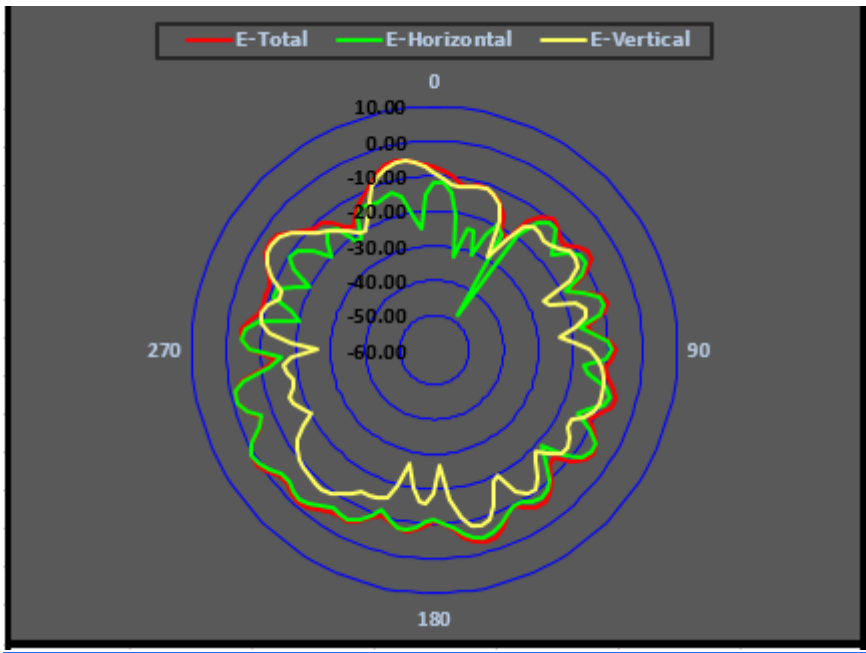

Center Frequency	3400MHz
Horizontal (dBi) peak	0.68
Vertical (dBi) peak	-4.14

3500MHz

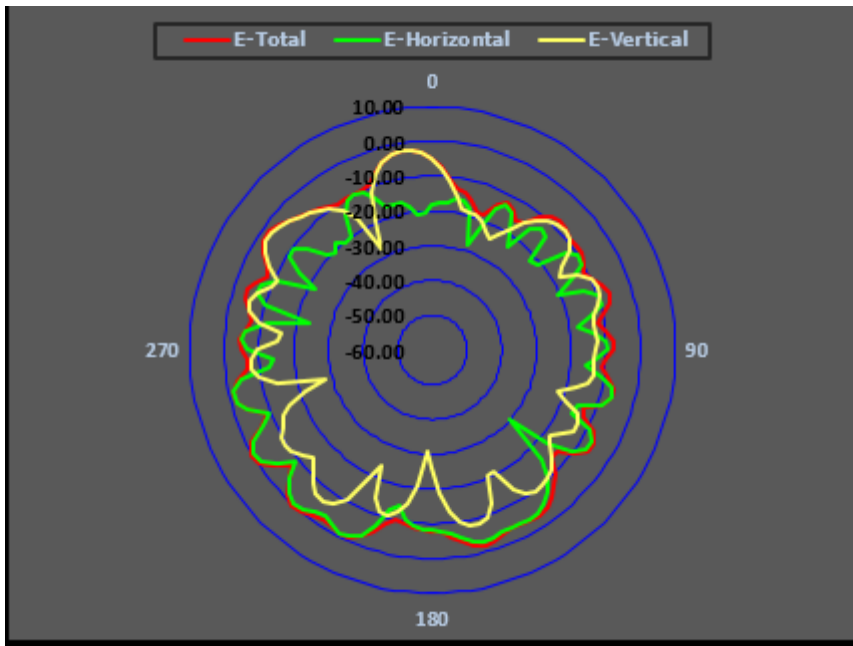

Center Frequency	3500MHz
Horizontal (dBi) peak	-0.21
Vertical (dBi) peak	-1.95

360MHz

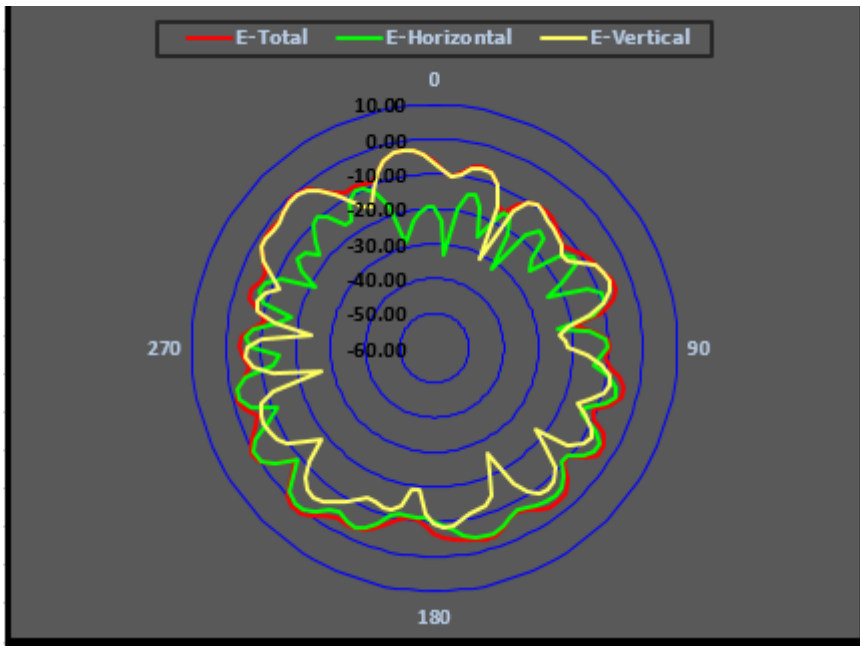

Center Frequency	360MHz
Horizontal (dBi) peak	0.33
Vertical (dBi) peak	-0.88

3750MHz

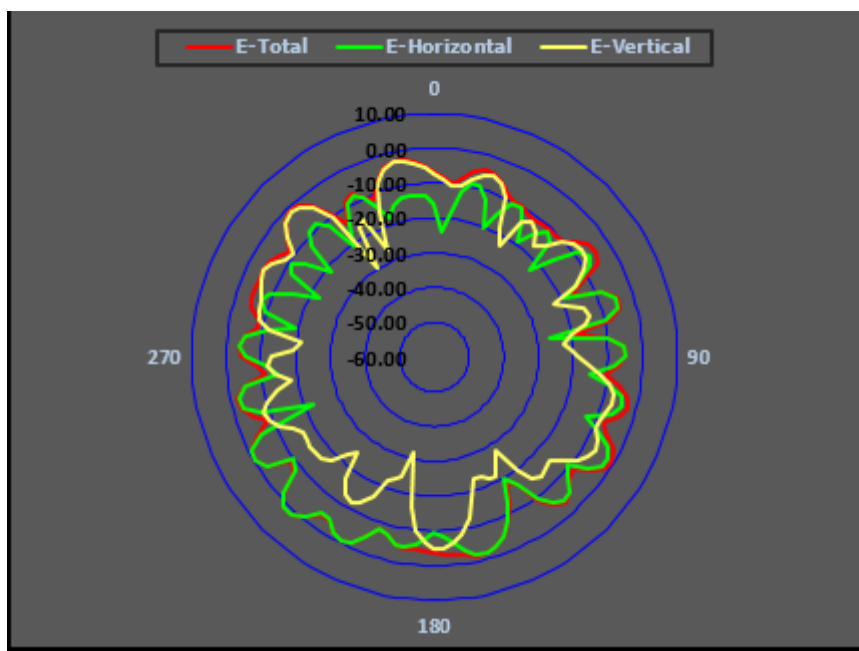

Center Frequency	3750MHz
Horizontal (dBi) peak	1.24
Vertical (dBi) peak	-1.33

4200MHz

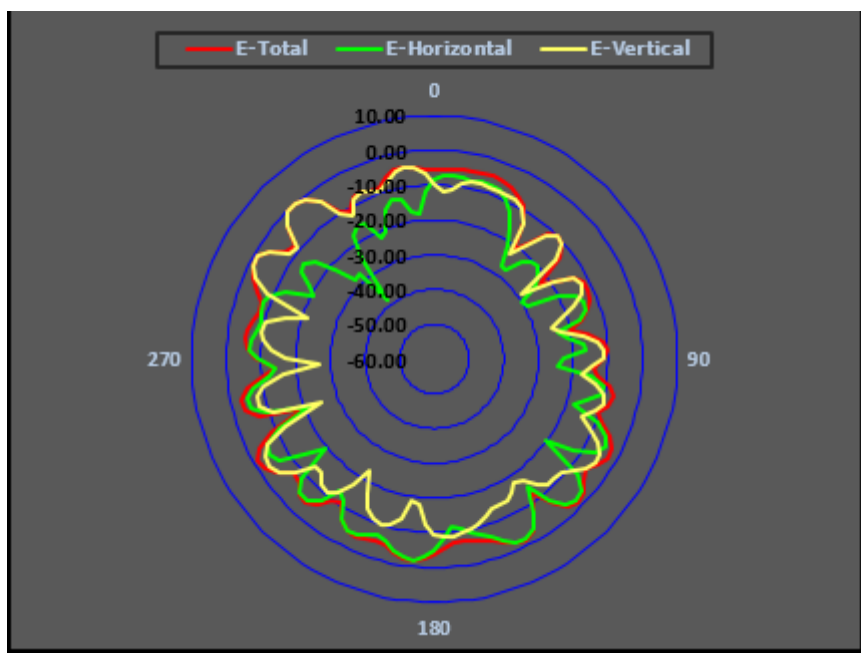

Center Frequency	4200MHz
Horizontal (dBi) peak	-1.83
Vertical (dBi) peak	0.27

4400MHz

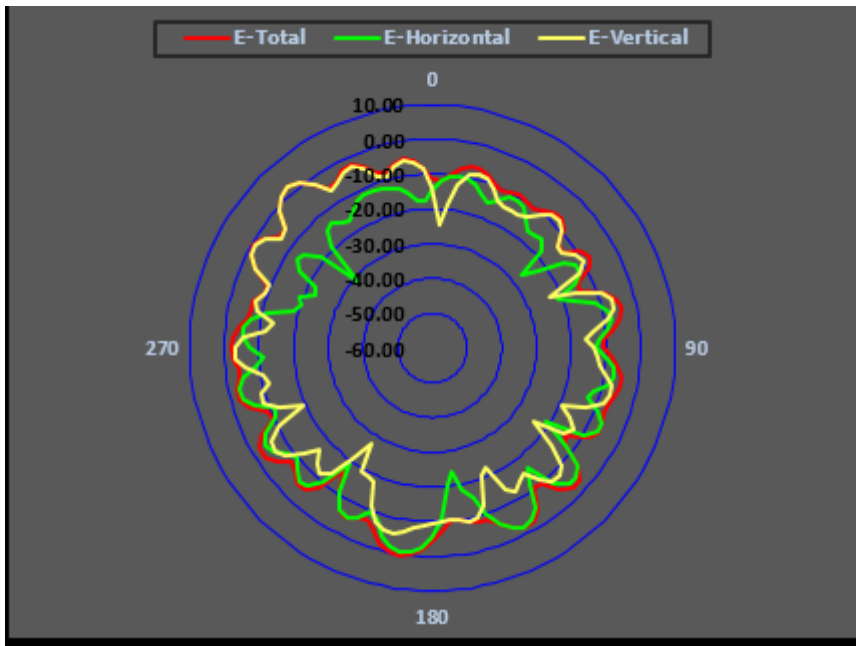

Center Frequency	4400MHz
Horizontal (dBi) peak	-0.71
Vertical (dBi) peak	2.23

4800MHz

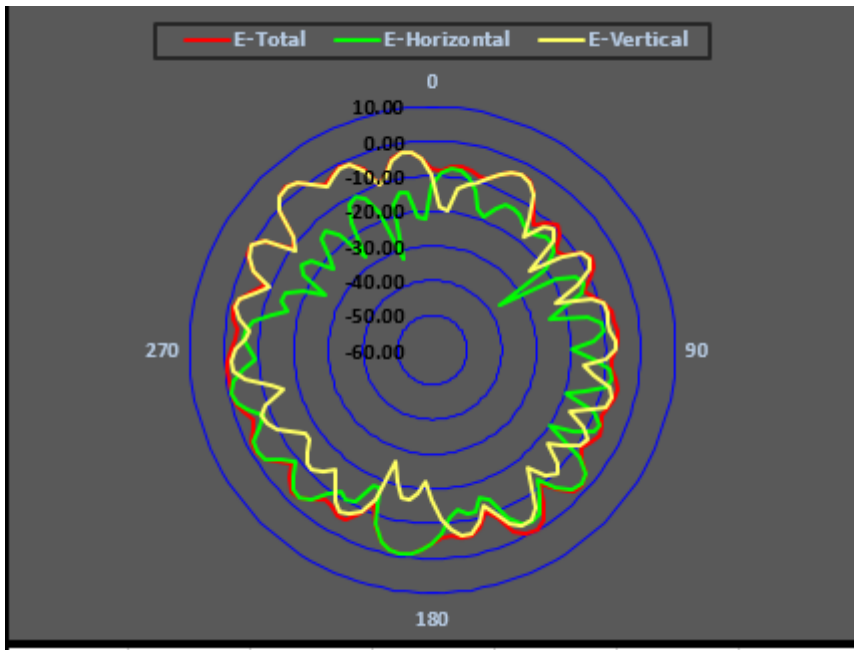

Center Frequency	4800MHz
Horizontal (dBi) peak	-0.71
Vertical (dBi) peak	2.93

5000MHz

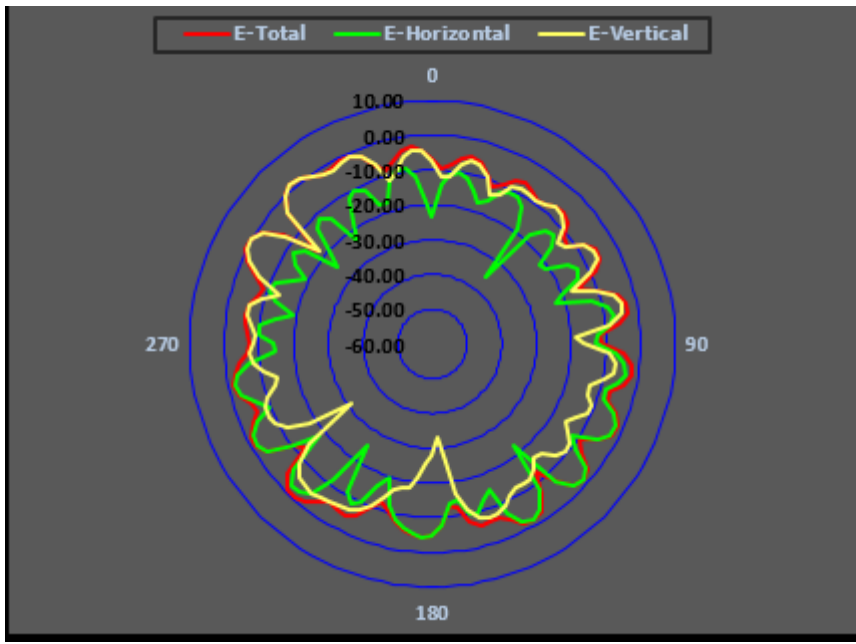

Center Frequency	5000MHz
Horizontal (dBi) peak	-1.38
Vertical (dBi) peak	1.54

● Ant8:

1710 MHz

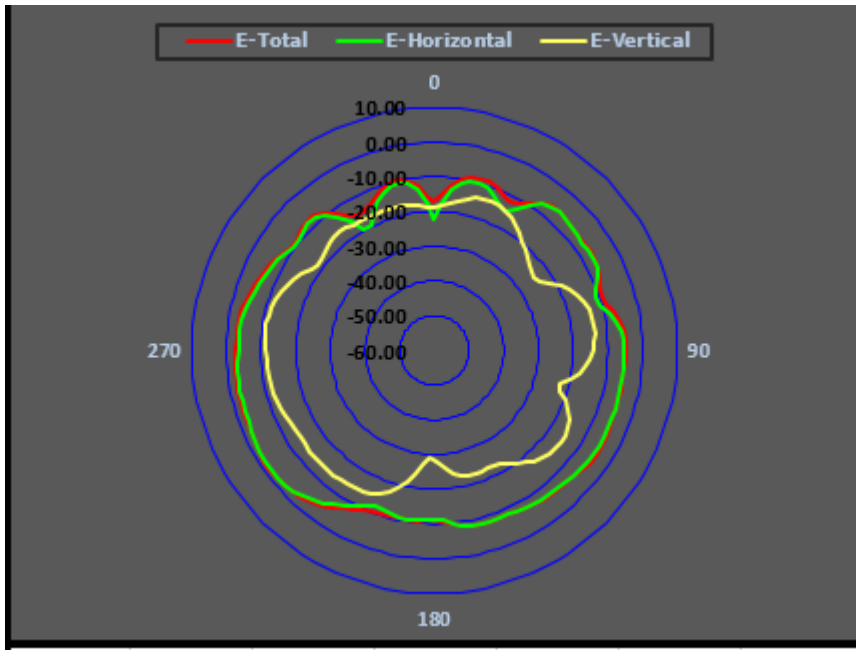

Center Frequency	1710MHz
Horizontal (dBi) peak	-1.53
Vertical (dBi) peak	-10.92

1750 MHz

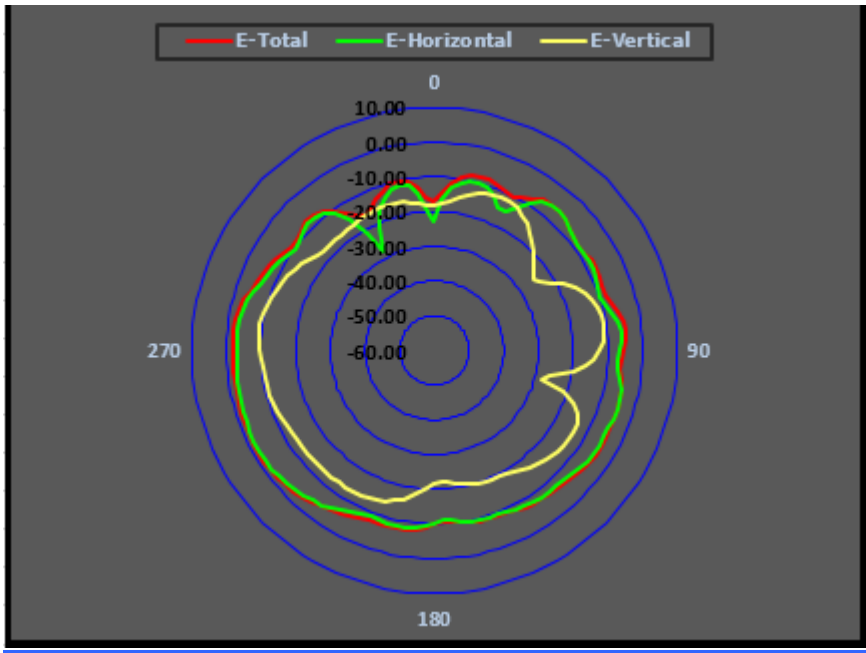

Center Frequency	1750MHz
Horizontal (dBi) peak	-1.54
Vertical (dBi) peak	-9.13

1780 MHz

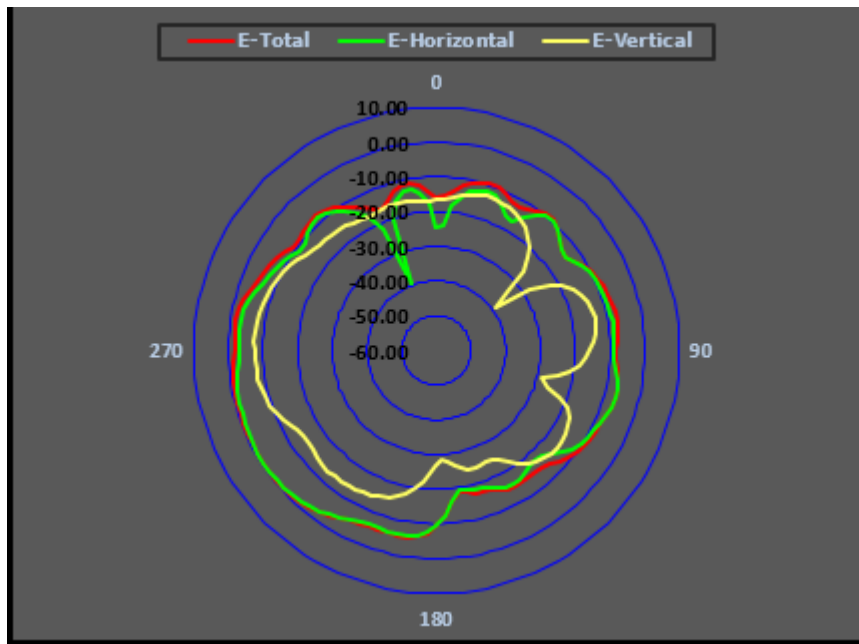

Center Frequency	1780MHz
Horizontal (dBi) peak	-0.54
Vertical (dBi) peak	-7.36

1785 MHz

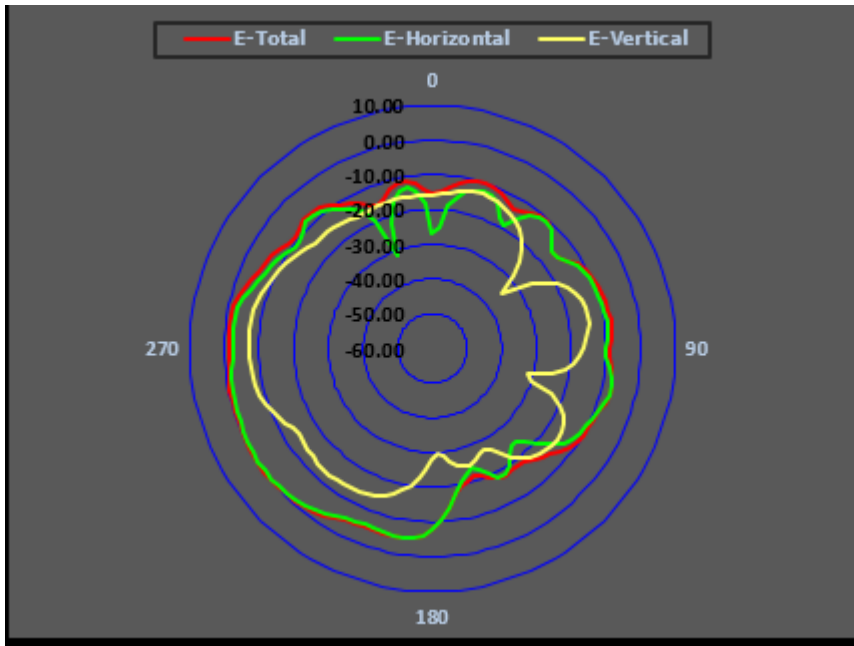

Center Frequency	1785MHz
Horizontal (dBi) peak	-0.11
Vertical (dBi) peak	-6.98

1880 MHz

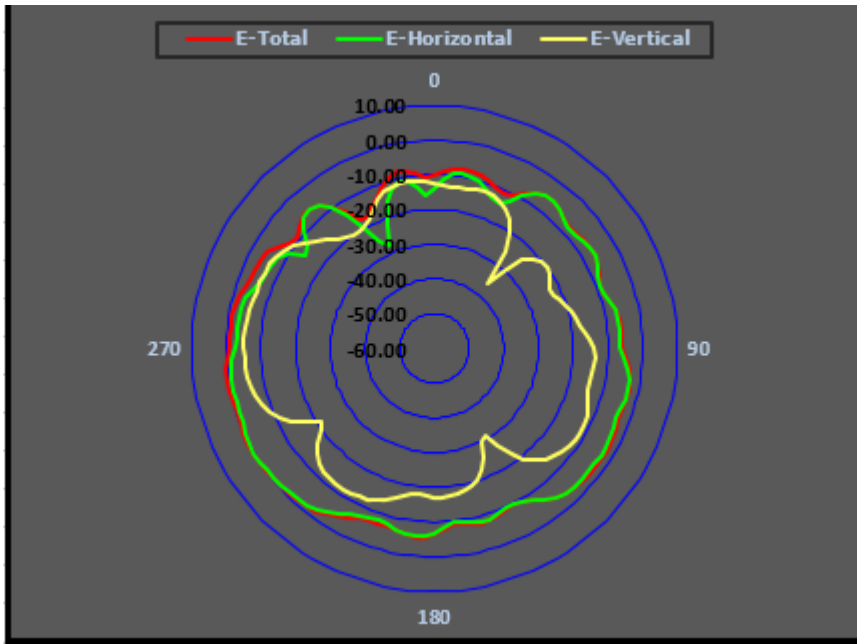

Center Frequency	1880MHz
Horizontal (dBi) peak	0.27
Vertical (dBi) peak	-5.05

1900 MHz

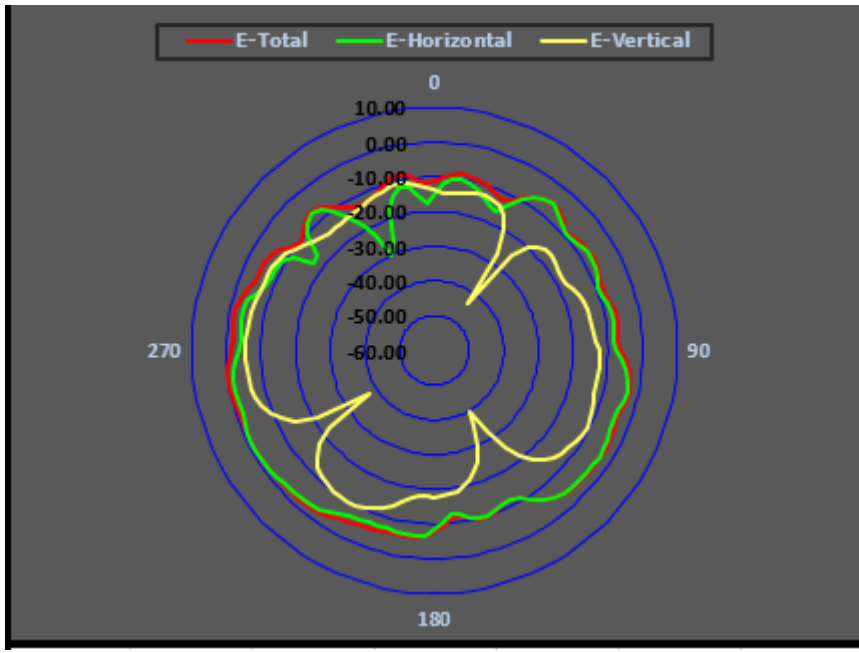

Center Frequency	1900MHz
Horizontal (dBi) peak	-0.86
Vertical (dBi) peak	-5.49

1920 MHz

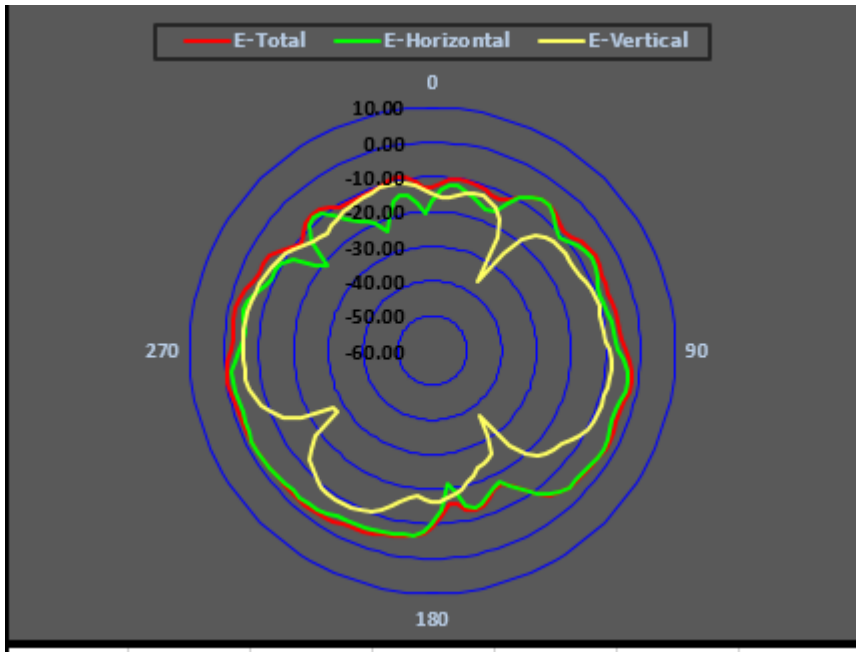

Center Frequency	1920MHz
Horizontal (dBi) peak	-1.53
Vertical (dBi) peak	-5.25

1950 MHz

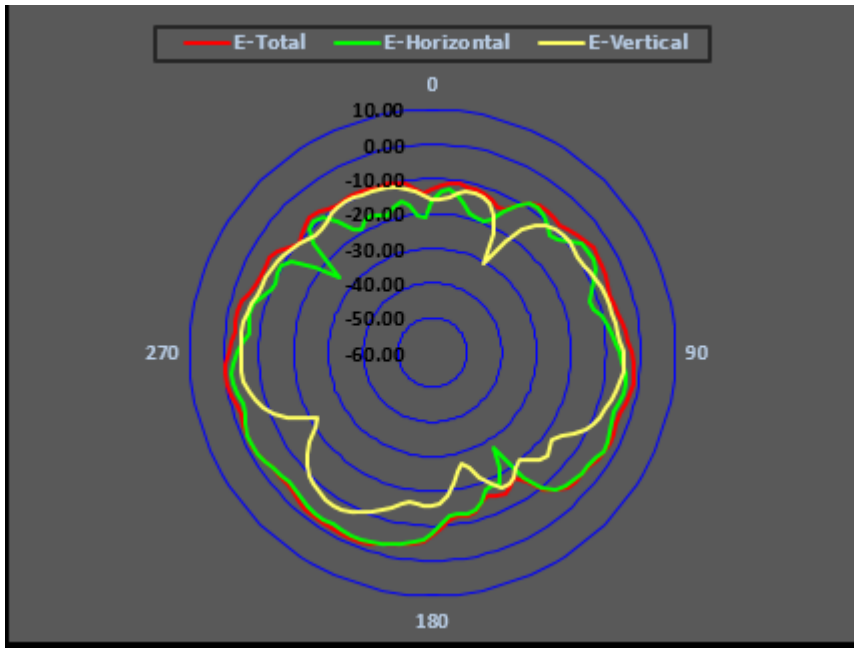

Center Frequency	1950MHz
Horizontal (dBi) peak	-1.44
Vertical (dBi) peak	-4.65

1980 MHz

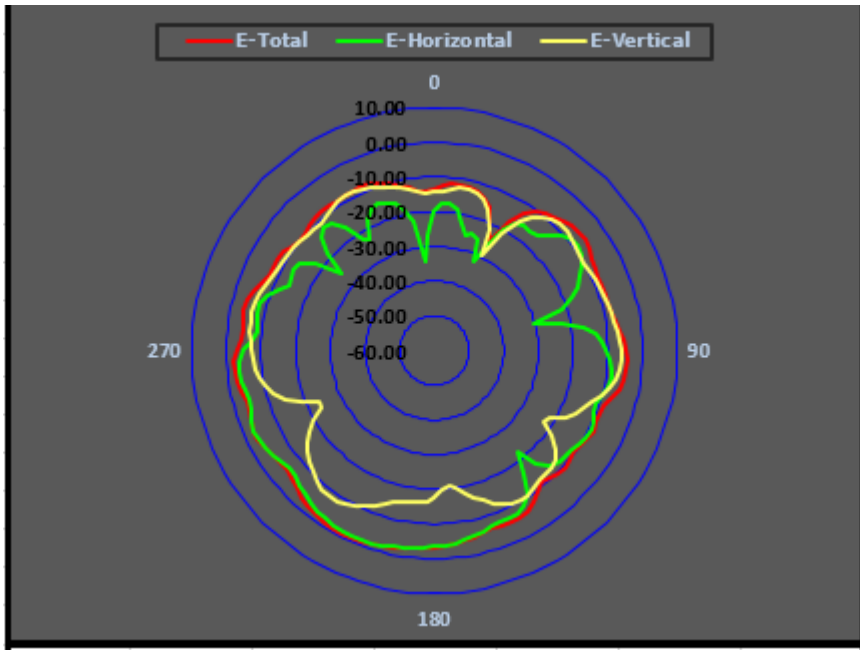

Center Frequency	1980MHz
Horizontal (dBi) peak	-1.37
Vertical (dBi) peak	-6.07

2496 MHz

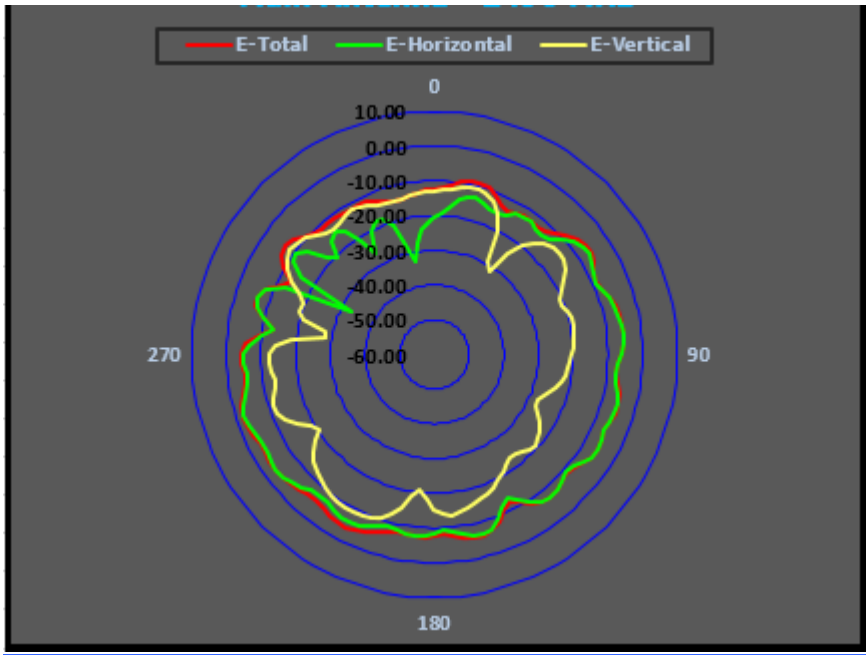

Center Frequency	2496MHz
Horizontal (dBi) peak	-2.28
Vertical (dBi) peak	-8.64

2595 MHz

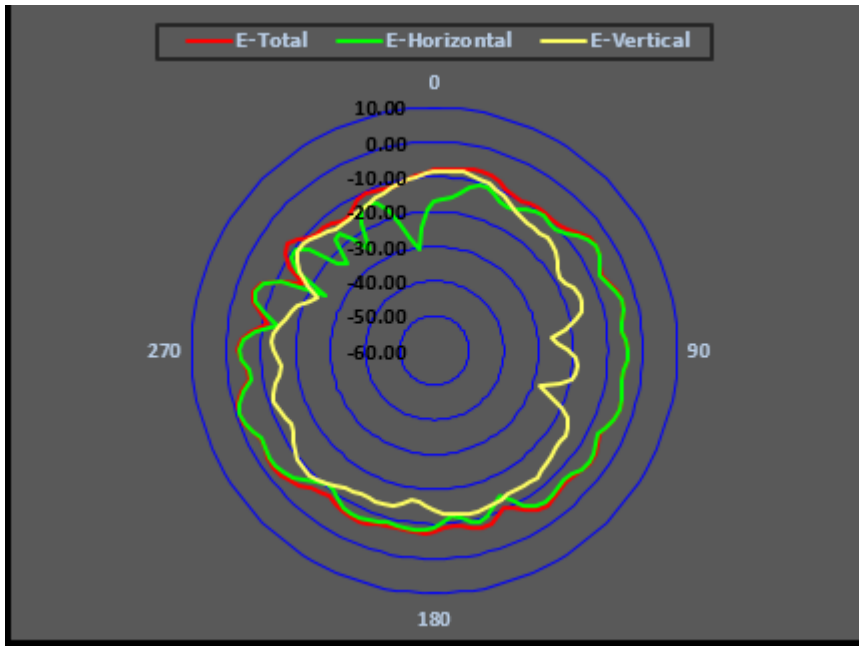

Center Frequency	2595MHz
Horizontal (dBi) peak	-0.93
Vertical (dBi) peak	-8.01

2690 MHz

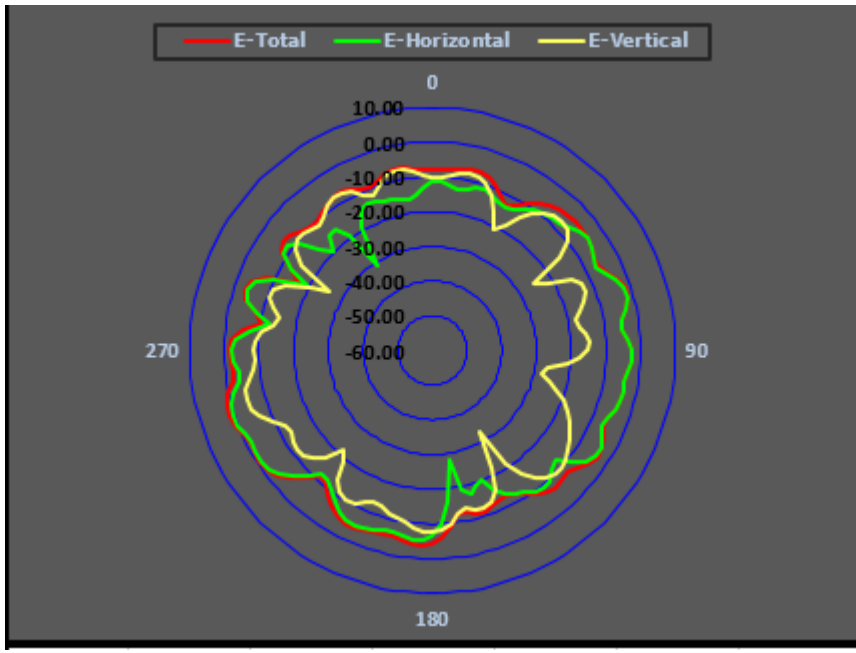

Center Frequency	2690MHz
Horizontal (dBi) peak	0.68
Vertical (dBi) peak	-4.47

3300 MHz

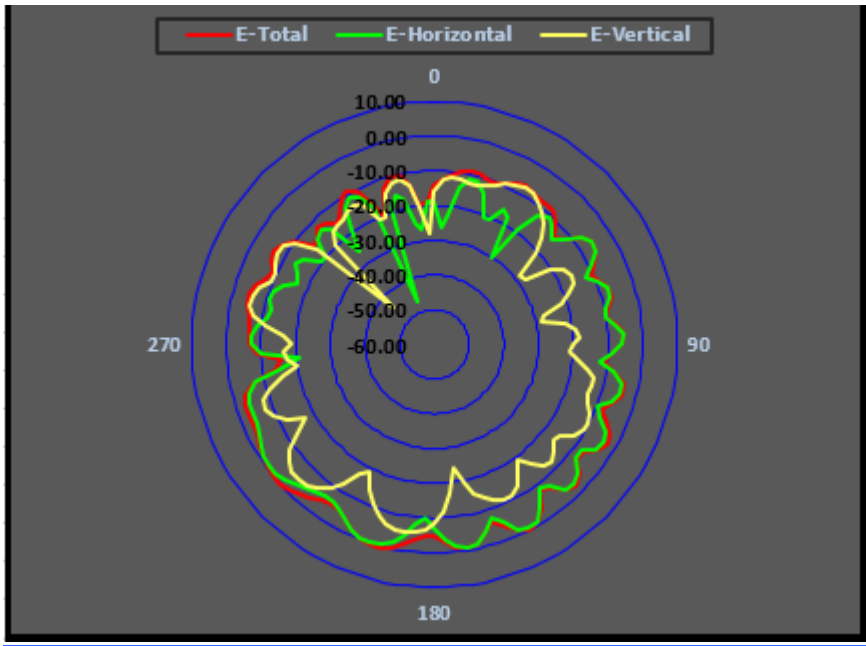

Center Frequency	3300MHz
Horizontal (dBi) peak	0.03
Vertical (dBi) peak	-4.58

3400 MHz

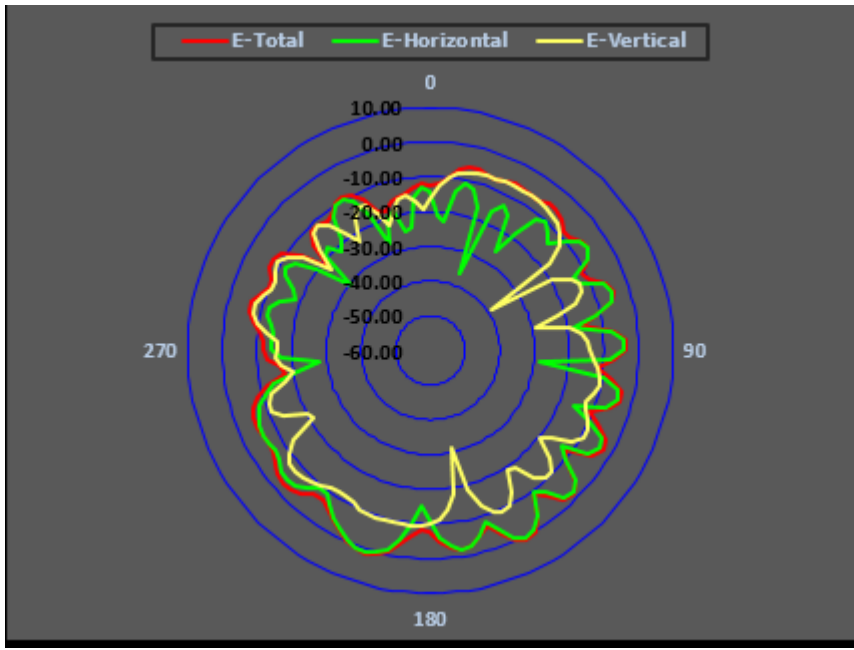

Center Frequency	3400MHz
Horizontal (dBi) peak	1.03
Vertical (dBi) peak	-6.83

3500 MHz

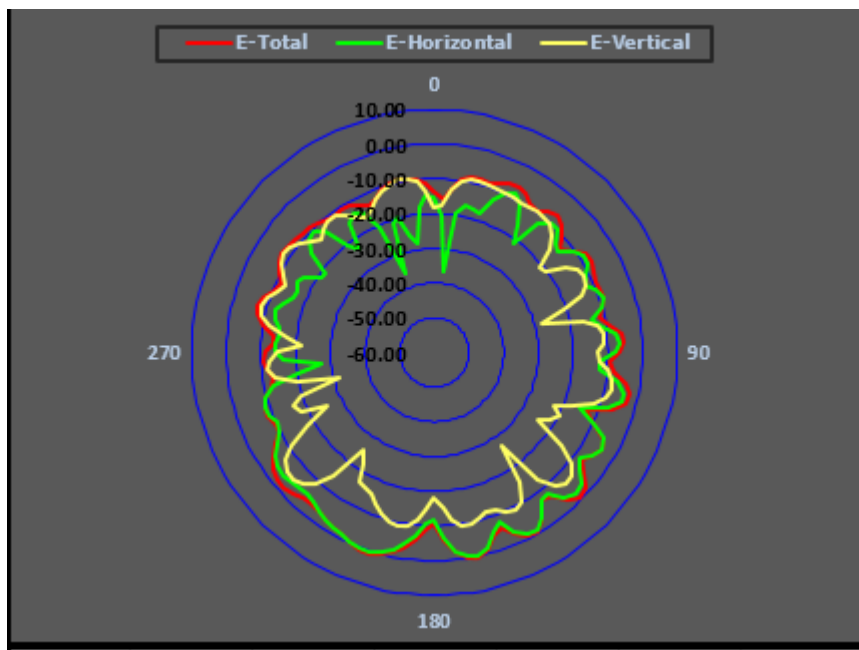

Center Frequency	3500MHz
Horizontal (dBi) peak	0.60
Vertical (dBi) peak	-5.19

3600 MHz

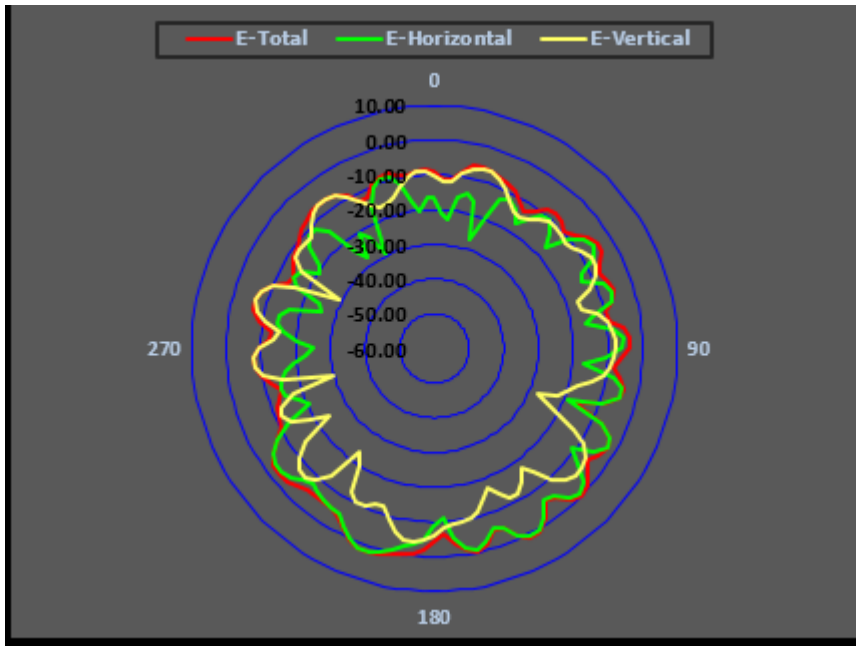

Center Frequency	3600MHz
Horizontal (dBi) peak	0.89
Vertical (dBi) peak	-4.00

3750 MHz

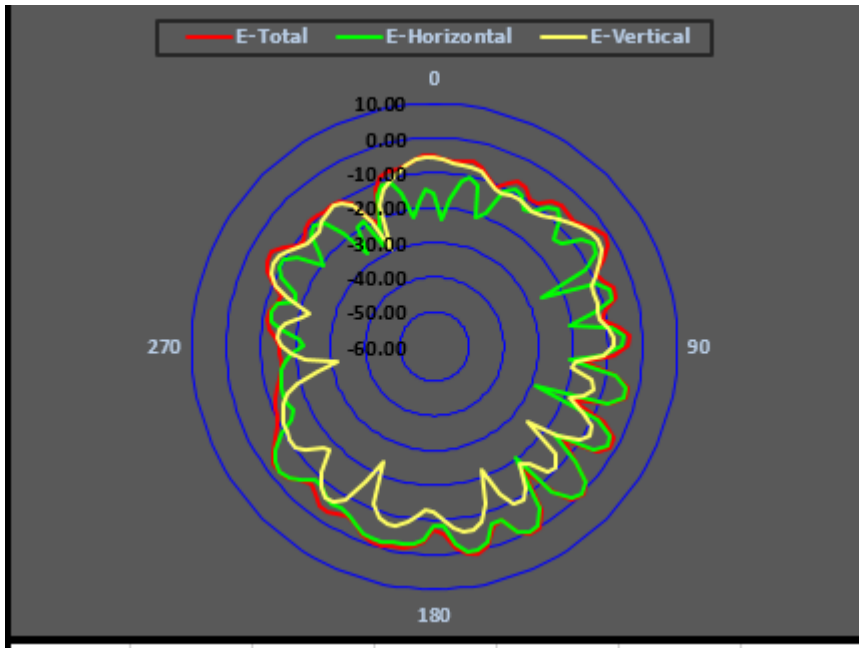

Center Frequency	3750MHz
Horizontal (dBi) peak	0.22
Vertical (dBi) peak	-3.75

4200 MHz

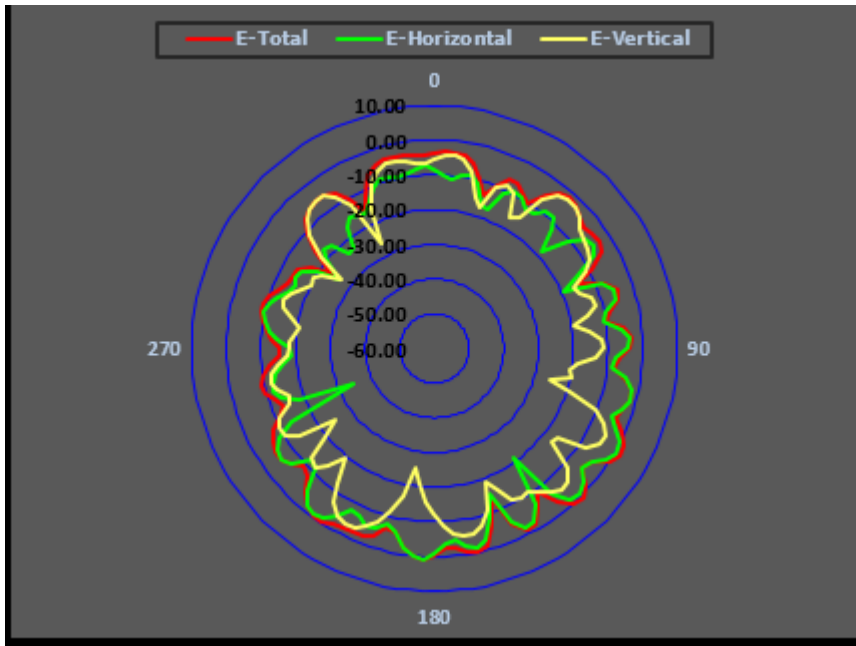

Center Frequency	4200MHz
Horizontal (dBi) peak	0.82
Vertical (dBi) peak	-2.35

4400 MHz

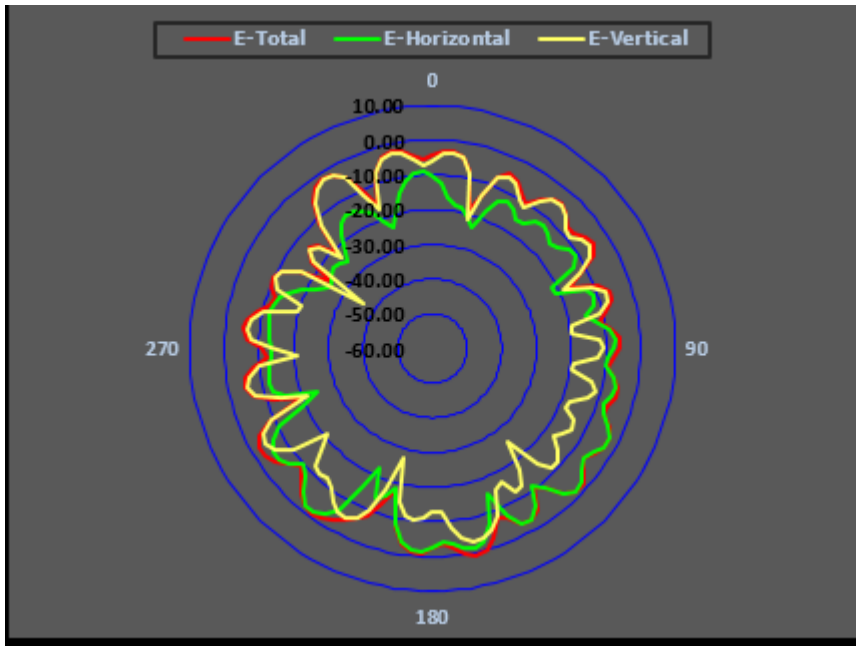

Center Frequency	4400MHz
Horizontal (dBi) peak	-0.95
Vertical (dBi) peak	-1.93

4800 MHz

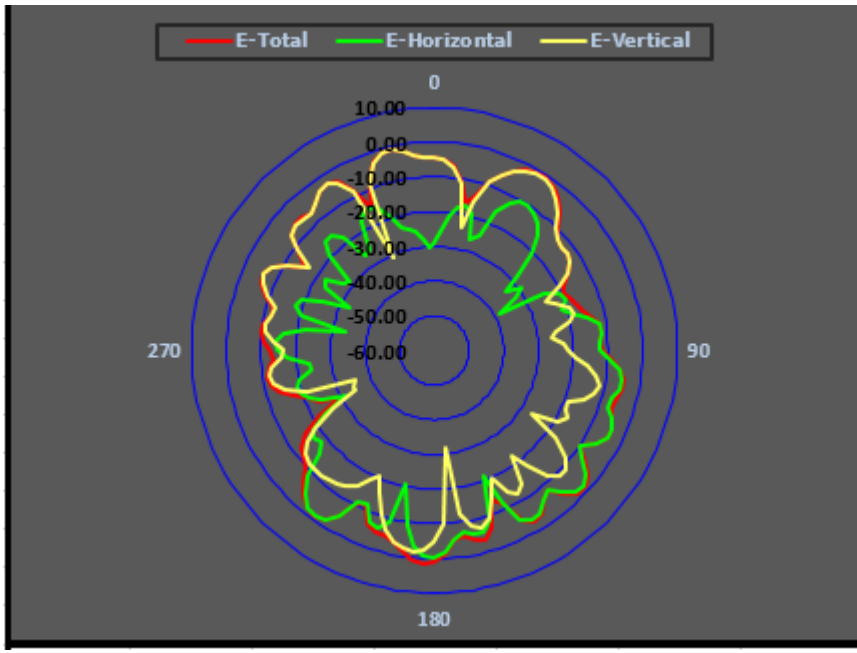

Center Frequency	4800MHz
Horizontal (dBi) peak	-0.53
Vertical (dBi) peak	-0.89

5000 MHz

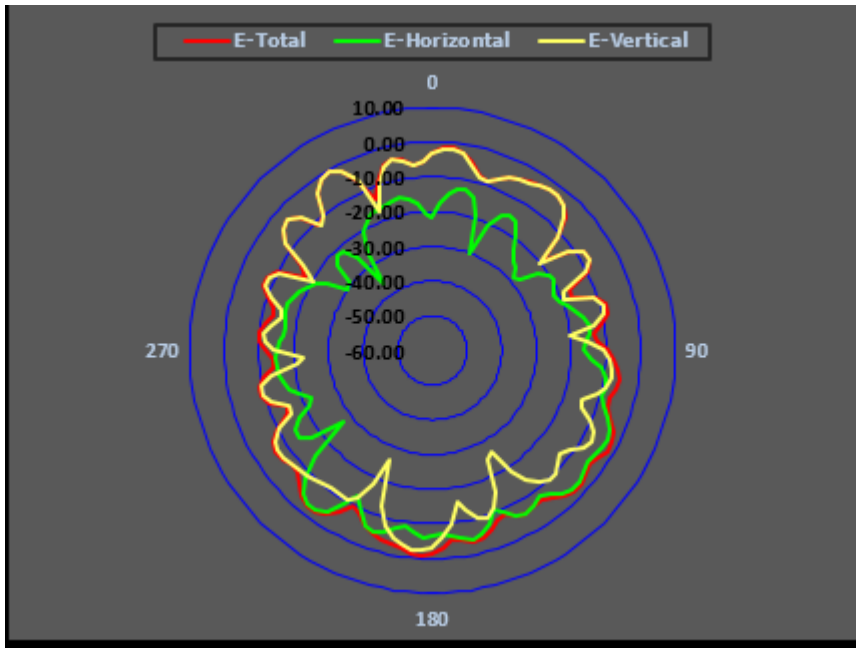

Center Frequency	5000MHz
Horizontal (dBi) peak	-3.02
Vertical (dBi) peak	-0.55

Section 4. Host Platform Information

OEM / ODM Host platform:

Rating Label Photo:

WLAN 1 TX/RX WWAN 6 RX WLAN 2 TX/RX WWAN 8 , WWAN 5

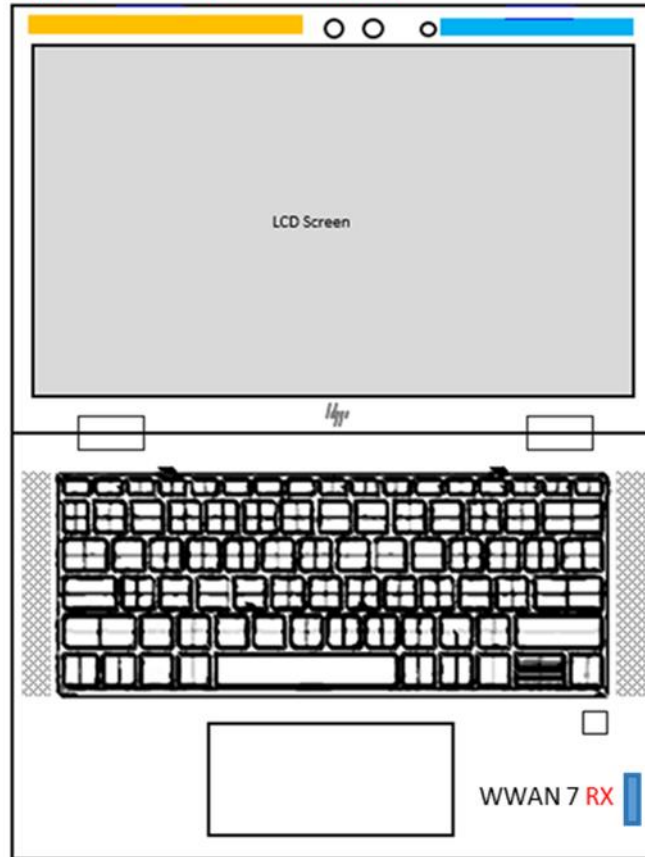

Section 5. Antenna Host Platform Location Information

Include a **dimensioned photo(s) or dimensioned drawing(s)** of Ant5, Ant6, Ant7, Ant8 placements (measurements are not required for receive-only antenna).

Any antenna that transmits must show dimensions to bottom of laptop. Provide a description of the materials that are used for supporting or surrounding transmit antennas; for example, non-conductive plastics vs. conductive coated plastic or metallic materials.

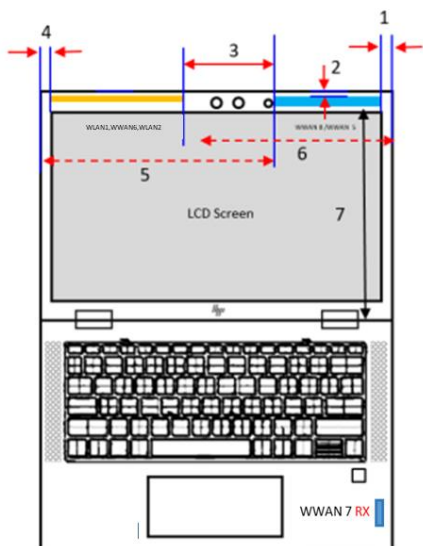
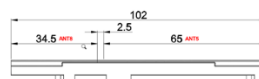
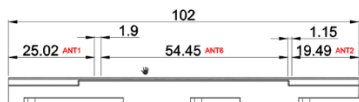
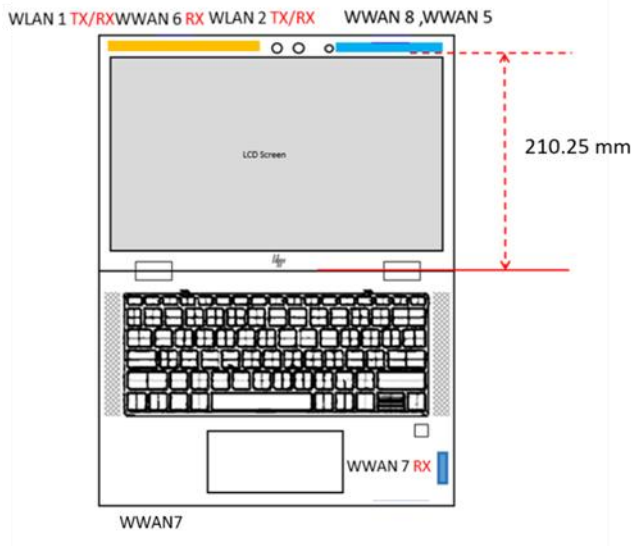

Plot	(mm)
1	13.145
2	1.9
3	84.5
4	12.345
5	198.845
9	199.645
7	210.25

Section 6. Antenna dimensional information for SAR evaluation

Include a **dimensioned photo(s) or dimensioned drawing(s)** showing the distance (mm) between the transmit antennas and the user (excluding hands, wrist, feet, and ankle). For notebook/laptop hosts show lapheld position (example below). For tablet hosts show all orientations including lapheld, primary & secondary portrait, primary & secondary landscape positions. Include a description of any proximity sensors or power throttling implementations that limit or exclude use of any host orientation.

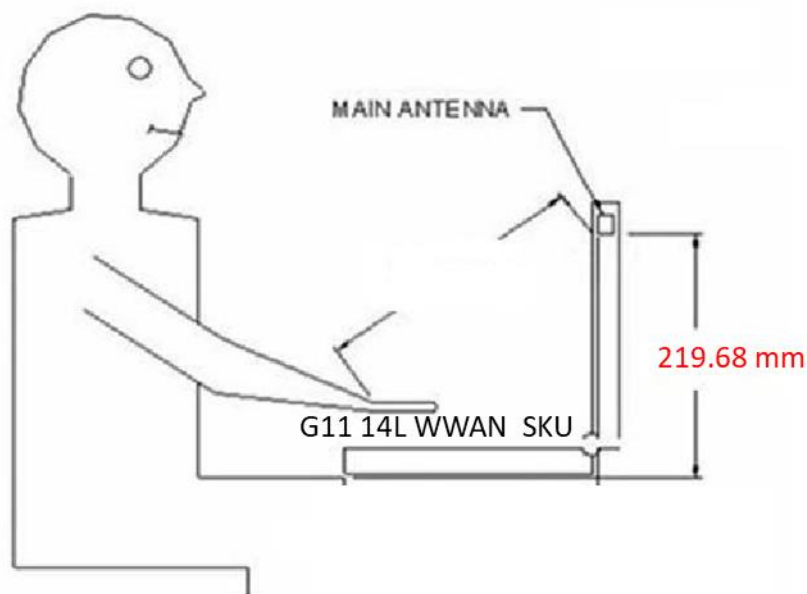
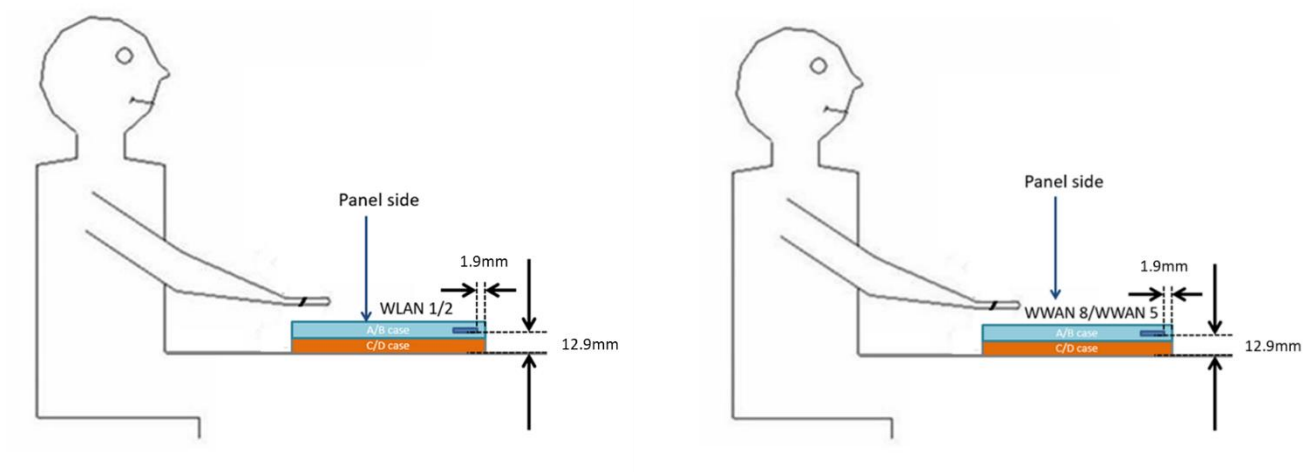

Section 7. Diagram Example of Co-Location Antenna Separation

Include a **dimensioned photo or dimensioned drawing** showing the distance (mm) between **all WLAN transmit antennas** and other co-located radiator transmit antenna such as Bluetooth, WWAN,..

(Note: Due to the evolving rules regarding co-location, each platform will need to be reviewed on a case by case basis)

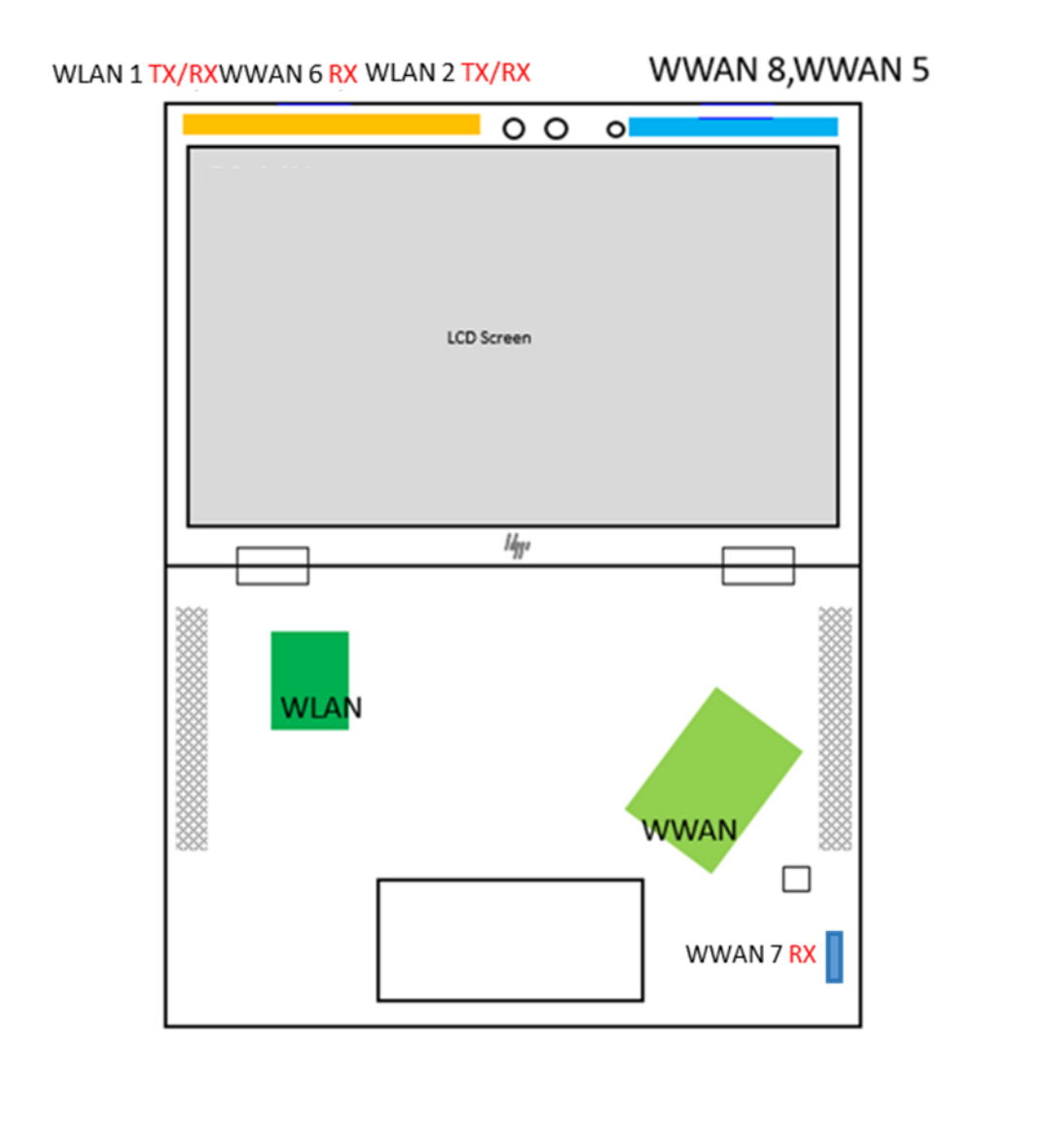

Section 8. Local representative contact information

Local representative contact information is required for regulatory support for target countries below.

	Local company name	Contact name	Phone number	FAX Number	e-Mail Address	Notes
Argentina						
Azerbaijan						
Cambodia						
Indonesia						
Israel						
Malaysia						
Philippines						
Singapore						Telecommunication Equipment Dealer License Required
South Africa						
USA, Canada						
Vietnam						