



TEST REPORT

EUT Description	Wireless Module installed in Convertible PC
Brand Name	Intel® BE200NGW
Model Name	BE200NGW
FCC ID	PD9BE200NG
Date of Test Start/End	2024-01-12 / 2024-02-12
Features	2x2 Wi-Fi - IEEE 802.11be - Bluetooth® (see section 5)
Description	Platform: HSN-I61C + Vendor 1, vendor 2 antenna

Applicant	Intel Corporation SAS
Address	425 Rue de Goa – Le Cargo B6 – 06600 Antibes, FRANCE
Contact Person	Benjamin Lavenant
Telephone/Fax/ Email	Benjamin.lavenant@intel.com

Reference Standards	FCC 47 CFR Part §2.1093 (see section 1)	
RF Exposure Environment	Portable devices - General population/uncontrolled exposure	
	Testing Result	Limit
Maximum Power Density Result & Limit	5.38 W/m ² (4cm ²)	10 W/m ² (4cm ²)
Maximum SAR Result & Limit	1.37 W/kg (1g)	1.6 W/kg (1g)
Min. test separation distance	0mm to phantom, 1.9 mm to antenna edge (SAR), 2mm to probe tip (PD)	

Test Report identification	231128-04.TR03
Revision Control	Rev. 00 This test report revision replaces any previous test report revision. (see section 8)

The test results relate only to the samples tested.

Issued by

Reviewed by

Malika FARIA
(Test Engineer)

Adel LOUNES
(Test Lead Manager)

Intel Corporation S.A.S – WRF Lab
425 rue de Goa – Le Cargo B6 - 06600 Antibes, France
Tel. +33493001400 / Fax +33493001401

Table of Contents

1. Standards, reference documents and applicable test methods	4
2. General conditions, competences and guarantees	4
3. Environmental Conditions	5
4. Test samples	5
5. EUT Features	6
6. Remarks and comments	9
7. Test Verdicts summary	9
8. Document Revision History	9
Annex A. PD Test & System Description	10
A.1 POWER DENSITY DEFINITION	10
A.2 SPEAG FREE SPACE MEASUREMENT SYSTEM	10
A.2.1 Measurement Setup	10
A.2.2 E-Field Measurement Probe	11
A.2.3 Worst Case Linearization Error	12
A.2.4 Data Evaluation	12
A.3 SYSTEM CHECK	13
A.4 TEST EQUIPMENT LIST	14
A.5 MEASUREMENT UNCERTAINTY EVALUATION	15
A.6 RF EXPOSURE LIMITS	16
Annex B. SAR Test & System Description	17
B.1 SAR DEFINITION	17
B.2 SPEAG SAR MEASUREMENT SYSTEM	18
B.2.1 SAR Measurement Setup	18
B.2.2 E-Field Measurement Probe	19
B.2.3 Flat Phantom	19
B.2.4 Device Positioner	20
B.3 DATA EVALUATION	21
B.4 SYSTEM AND LIQUID CHECK	23
B.4.1 System Check	23
B.4.2 Liquid Check	24
B.5 TEST EQUIPMENT LIST	25
B.5.1 Tissue Simulant Liquid	25
B.6 MEASUREMENT UNCERTAINTY EVALUATION	26
B.7 RF EXPOSURE LIMITS	27
Annex C. Test Results	28
C.1 TEST CONDITIONS	28
C.1.1 Test positions relative to the phantom	28
C.1.2 Test signal, Output power and Test Frequencies	28
C.1.3 Evaluation Exclusion and Test Reductions	29
C.2 CONDUCTED POWER MEASUREMENTS	30
C.2.1 WLAN 6-7GHz (U-NII)	30
C.3 TISSUE PARAMETERS MEASUREMENT	32
C.4 SYSTEM CHECK MEASUREMENTS	32
C.4.1 E-Field	32
C.4.2 H-Field	32
C.4.3 Local Power Density	32

C.4.4	Averaged Power Density	33
C.4.5	SAR	33
C.5	TEST RESULTS	34
C.5.1	SAR - 802.11ax/be – 6.2 GHz – U-NII-5.....	34
C.5.2	SAR - 802.11ax/be – 6.5 GHz – U-NII-6.....	34
C.5.3	SAR - 802.11ax/be – 6.7 GHz – U-NII-7.....	35
C.5.4	SAR - 802.11ax/be – 7.0 GHz – U-NII-8.....	35
C.5.5	Power Density - 802.11ax/be – 6.2 GHz – U-NII-5.....	36
C.5.6	Power Density - 802.11ax/be – 6.5 GHz – U-NII-6.....	36
C.5.7	Power Density - 802.11ax/be – 6.7 GHz – U-NII-7.....	36
C.5.8	Power Density - 802.11ax/be – 7.0 GHz – U-NII-8.....	36
C.5.9	Measurement Variability	37
C.5.10	Simultaneous Transmission Evaluation – SAR.....	38
Annex D.	Test System Plots.....	39
Annex E.	TSL Dielectric Parameters.....	53
E.1	HEAD WiFi 6E 7000MHZ.....	53
Annex F.	Calibration Certificates	54
Annex G.	Photographs	55
G.1	TEST SAMPLE	55
G.2	PD TEST POSITIONS.....	58
G.3	SAR TEST POSITION	59
G.4	ANTENNA HOST PLATFORM LOCATION AND ADJACENT EDGE POSITIONS RELATIVE TO THE BODY	60
G.5	PHANTOM LIQUID LEVEL DURING MEASUREMENTS	62

1. Standards, reference documents and applicable test methods

FCC	<ol style="list-style-type: none"> 1. FCC 47 CFR Part §2.1093 – Radiofrequency radiation exposure evaluation: portable devices. 2021-10-01 Edition 2. FCC 47 CFR Part §1.1310 – Radiofrequency radiation exposure limits. Edition October 2021 3. FCC OET KDB 248227 D01 v02r02 - SAR guidance for IEEE 802.11 (Wi-Fi) transmitters. 4. FCC OET KDB 447498 D04 v01 General RF Exposure Guidance v01– RF Exposure Procedures and Equipment Authorization Policies for Mobile and Portable Devices 5. FCC OET KDB 616217 D04 v01r02 - SAR Evaluation Considerations for Laptop, Notebook, Netbook and Tablet Computers. 6. FCC OET KDB 865664 D01 v01r04 - SAR Measurement Requirements for 100 MHz to 6 GHz. 7. FCC OET KDB 865664 D02 v01r02 - RF Exposure Compliance Reporting and Documentation Considerations. 8. IEEE Std 1528-2013 - IEEE Recommended Practice Determining the Peak Spatial-Average Specific Absorption Rate (SAR) in the Human Head from Wireless Communication Devices: Measurement Technique. 9. RF Exposure Policies and Procedures: TCB Workshop – October 2020 10. IEC/IEEE 62209-1528:2020 Measurement procedure for the assessment of specific absorption rate of human exposure to radio frequency fields from hand-held and body-mounted wireless communication devices – Part 1528: Human models, instrumentation, and procedures (Frequency range of 4 MHz to 10 GHz) 11. 987594 D04 UN6GHZ Pre-Approval Guidance Checklist v01 12. SPEAG Application Note – 5G Compliance Testing with DASY6 (5GModule V1.0Beta) 13. SPEAG Application Note – 5G Compliance Testing with DASY6/8 (5GModule V5.0)
-----	---

2. General conditions, competences and guarantees.

- ✓ Intel Corporation SAS Wireless RF Lab (Intel WRF Lab) is an Accredited Test Firm recognized by the FCC, with Designation Number FR0011.
- ✓ Intel WRF Lab only provides testing services and is committed to providing reliable, unbiased test results and interpretations.
- ✓ Intel WRF Lab is liable to the client for the maintenance of the confidentiality of all information related to the item under test and the results of the test.
- ✓ Intel WRF Lab has developed calibration and proficiency programs for its measurement equipment to ensure correlated and reliable results to its customers.
- ✓ This report is only referred to the item that has undergone the test.
- ✓ This report does not imply an approval of the product by the Certification Bodies or competent Authorities.

3. Environmental Conditions

✓ At the site where the measurements were performed the following limits were not exceeded during the tests:

Temperature	19.9°C ±1.8°C
Humidity	44.6 ±11%
Liquid Temperature	20.4°C ±1.5°C

4. Test samples

Sample	Control #	Description	Model	Serial #	Date of receipt	Note
#01	231128-04.S03	Wireless Module installed in Convertible PC	HSN-I61C	0003770DDH	2023-11-28	Vendor 1 antenna
#02	231128-04.S04	Wireless Module installed in Convertible PC	HSN-I61C	0003770D2W	2023-11-28	Vendor 1 antenna
#03	231128-04.S01	Wireless Module installed in Convertible PC	HSN-I61C	0003770D3F	2023-11-28	Vendor 2 antenna

5. EUT Features

The herein information is provided by the customer.

Brand Name	Intel® BE200NGW			
Model Name	BE200NGW			
Software Version	DRTU.05055.23.0.0			
Driver Version	23.0.6.4			
Prototype / Production	Production			
Host Identification	HSN-I61C			
Supported Radios	802.11b/g/n/ax/be	2.4GHz (2400.0 – 2483.5 MHz)		
	802.11a/n/ac/ax/be	5.2GHz (5150.0 – 5350.0 MHz)		
		5.6GHz (5470.0 – 5725.0 MHz)		
		5.8GHz (5725.0 – 5850.0 MHz)		
		5.9GHz (5850.0 – 5895.0 MHz)		
	802.11ax/be	6.0GHz (5925.0 – 7125.0 MHz) *		
	Bluetooth	2.4GHz (2400.0 – 2483.5 MHz)		
Antenna Information	Transmitter	Aux (Ant 1/Tx1)	Main (Ant 2/Tx2)	
	Manufacturer	Vendor 1	Vendor 1	
	Antenna type	PIFA	PIFA	
	Part number	6036B0347001 (00-3302702750)	6036B0347001 (00-3302702750)	
	Transmitter	Aux (Ant 1/Tx1)	Main (Ant 2/Tx2)	
	Manufacturer	Vendor 2	Vendor 2	
	Antenna type	PIFA	PIFA	
	Part number	6036B0346001 (81ELBA15.G01)	6036B0346001 (81ELBA15.G01)	
	See Annex G for more details on antennas location.			
	Simultaneous Transmission Configurations	WLAN 6GHz Main + BT Aux* WLAN 6GHz Main + WLAN 6GHz Aux* WLAN 6GHz Main + WLAN 6GHz Aux + BT Aux* WLAN 2.4GHz Main + BT Aux WLAN 2.4GHz Main + WLAN 2.4GHz Aux WLAN 5GHz Main + BT Aux WLAN 5GHz Main + WLAN 5GHz Aux WLAN 5GHz Main + WLAN 5GHz Aux + BT Aux		
Additional Information	No WWAN transmitter is considered in this report			
	5.60-5.65 GHz band (TDWR) is supported by the device			
	Band gap is supported by the device			

*Only these combinations are treated on this document since this report is limited to WiFi 6E capabilities.

Supported Radios

Mode	Duty Cycle	Modulation	Band	UL Freq Range (MHz)	Measured Max. Conducted Power (dBm)
802.11ax/be	100%	BPSK QPSK 16QAM 64QAM 256QAM	6.2GHz	5955-6415	13.46
802.11ax/be	100%	BPSK QPSK 16QAM 64QAM 256QAM	6.5GHz	6435-6515	12.82
802.11ax/be	100%	BPSK QPSK 16QAM 64QAM 256QAM	6.7GHz	6535-6855	13.49
802.11ax/be	100%	BPSK QPSK 16QAM 64QAM 256QAM	7.0GHz	6875-7125	13.48

NM: Not Measured

Maximum Output power specification + Tune up tolerance limit, specified by the client.

Equipment Class	Mode	BW (MHz)	Notebook config / SISO mode	
			Main/Tx2 (dBm)	Aux/Tx1 (dBm)
U-NII-5	802.11ax/be	20	5.75	5.75
		40	8.75	8.75
		80	11.75	11.75
		160	15.00	15.00
	802.11be	320	17.00	17.00
U-NII-6	802.11ax/be	20	5.75	5.75
		40	8.75	8.75
		80	11.75	11.75
		160	15.00	15.00
U-NII-7	802.11ax/be	20	5.75	5.75
		40	8.75	8.75
		80	11.75	11.75
		160	15.00	15.00
	802.11be	320	17.00	17.00
U-NII-8	802.11ax/be	20	5.75	5.75
		40	8.75	8.75
		80	11.75	11.75
		160	15.00	15.00
	802.11be	320	14.50	14.25

Equipment Class	Mode	BW (MHz)	Tablet config / SISO mode	
			Main/Tx2 (dBm)	Aux/Tx1 (dBm)
U-NII-5	802.11ax/be	20	5.75	5.75
		40	8.75	8.75
		80	11.75	11.75
		160	12.50	13.50
	802.11be	320	12.50	13.50
U-NII-6	802.11ax/be	20	5.75	5.75
		40	8.75	8.75
		80	11.75	11.75
		160	13.50	13.50
U-NII-7	802.11ax/be	20	5.75	5.75
		40	8.75	8.75
		80	11.75	11.75
		160	13.50	13.50
	802.11be	320	13.50	13.50
U-NII-8	802.11ax/be	20	5.75	5.75
		40	8.75	8.75
		80	11.75	11.75
		160	13.50	13.50
	802.11be	320	13.50	13.50

6. Remarks and comments

1. The conducted values are obtained by applying the available power table to the BE200NGW Intel module installed in the HSN-I61C identified in this report, as requested by the customer.
2. Only the plots for the test positions with the highest measured SAR/PD per band/mode are included in Annex C

7. Test Verdicts summary

The statement of conformity to applicable standards in the table below are based on the measured values, without taking into account the measurement uncertainties.

Standard	Band	Highest Reported PS _{tot} avg [W/m ²] 4cm ²	Verdict
802.11ax/be	6.2GHz	5.38	P
802.11ax/be	6.5GHz	2.59	P
802.11ax/be	6.7GHz	3.04	P
802.11ax/be	7.0GHz	4.14	P

Standard	Band	Highest Reported SAR [W/kg]	Verdict
802.11ax/be	6.2GHz	1.37	P
802.11ax/be	6.5GHz	1.19	P
802.11ax/be	6.7GHz	1.33	P
802.11ax/be	7.0GHz	1.28	P

P: Pass

F: Fail

NM: Not Measured

NA: Not Applicable

According to the FCC OET KDB 690783 D01, this is the summary of the values for the Grant Listing:

Highest Reported SAR (1g) (W/kg)		
Exposure Condition	Equipment Class	
	DSS	UNII
Body Worn	0.35	0.87
Simultaneous Tx	Sum-SAR: 1.89 SPLSR: 0.04	Sum-SAR: 1.89 SPLSR: 0.04

Considering the results of the performed test according to FCC 47CFR Part 2.1093 the item under test is IN COMPLIANCE with the requested specifications specified in Section1. Standards, reference documents and applicable test methods

8. Document Revision History

Revision #	Modified by	Revision Details
Rev. 00	M.FARIA	First Issue

Annex A. PD Test & System Description

A.1 Power Density Definition

The power density for an electromagnetic field represents the rate of energy transfer per unit area.

The local power density (i.e. Poynting vector) at a given spatial point is deduced from electromagnetic fields by the following formula:

$$\vec{P}_{local} = \frac{1}{2} \text{Re} (\vec{E} \times \vec{H}^*)$$

Where \vec{E} is the complex electric field peak phasor and \vec{H}^* is the complex conjugate magnetic field peak phasor.

This power density is also called “single-point” or “spot power density”.

Considering that the FCC’s Maximum Permissible Exposure (MPE) limit is applicable on the average power density inside 1cm² area, the single point power densities in the evaluation plane should be averaged inside the 1cm² area.

A.2 SPEAG free space Measurement System

A.2.1 Measurement Setup

The DASY6 system for performing compliance tests consists of the following items:

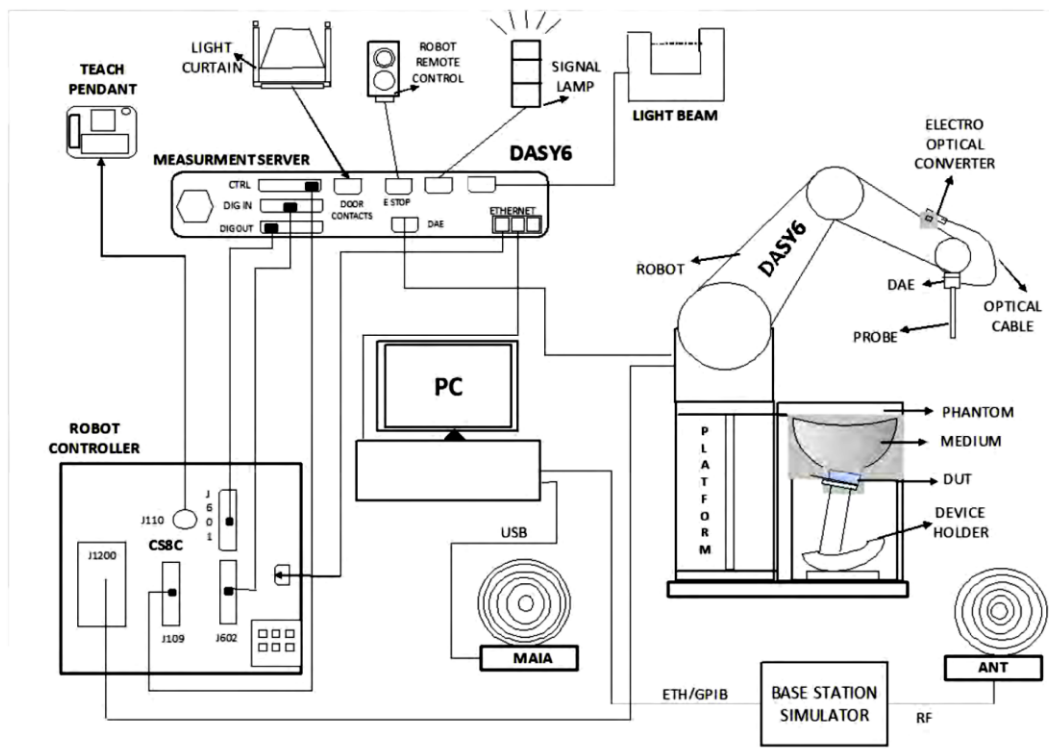

- ✓ A standard high precision 6-axis robot (Stäubli TX/RX family) with controller, teach pendant and software. It includes an arm extension for accommodating the data acquisition electronics (DAE)
- ✓ An mm-wave E-field probe optimized and calibrated for the targeted measurements.
- ✓ A data acquisition electronics (DAE) which performs the signal amplification, signal multiplexing, AD-conversion, offset measurements, mechanical surface detection, collision detection, etc. The signal is optically transmitted to the EOC.
- ✓ The Electro-optical Converter (EOC) performs the conversion from optical to electrical signals for the digital communication to the DAE. The EOC signal is transmitted to the measurement server.
- ✓ The function of the measurement server is to perform the time critical tasks such as signal filtering, control of the robot operation and fast movements interrupts.
- ✓ The Light Beam used is for probe alignment. This improves the (absolute) accuracy of the probe positioning.
- ✓ A computer running Windows professional operating system and the cDASY6 software.
- ✓ Remote control and teach pendant as well as additional circuitry for robot safety such as warning lamps, etc.

A.2.2 E-Field Measurement Probe

The probe consists of two dipoles (0.8 mm length) optimally arranged with different angles (γ_1 and γ_2) to obtain pseudo-vector information, printed on glass substrate protected by high density foam that allows low perturbation of the measured field.

Three or more measurements are taken for different probe rotational angles, deriving the amplitude and polarization information.

The probe's characteristics are:

Frequency Range	750 MHz – 110 GHz
Length	320 mm
Probe tip external diameter	8 mm
Probe's two dipoles length	0.9mm – Diode loaded
Probe's substrate	Quartz 0.9 x 20 x 0.18mm ($\epsilon_r=3.8$)
Distance between diode sensors and probe's tip	1.5 mm
Axial Isotropy	± 0.6 dB
Maximum operating E-field	3000 V/m
Lower E-field detection threshold	5 V/m @ 60 GHz
Minimum Mechanical separation between probe tip and a Surface	0.5mm
Calibration reference point	Diode Sensor

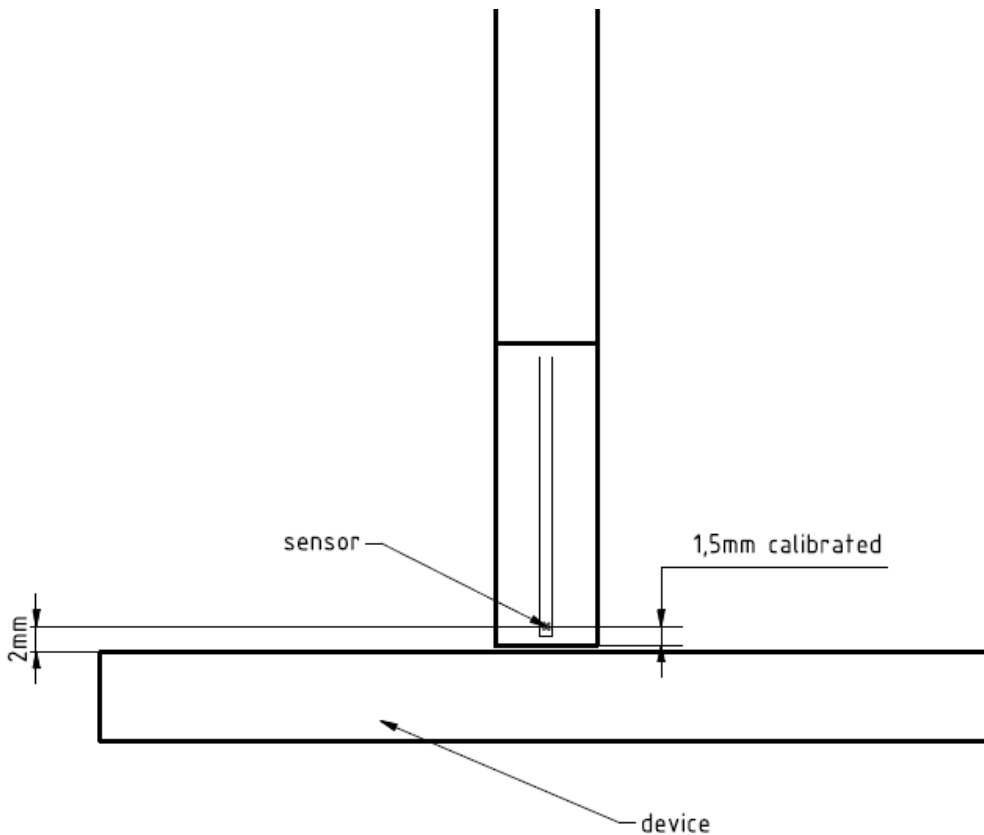

A.2.3 Worst Case Linearization Error

For continuously transmitting signals (100% duty cycle), the worst case linearization error is given by the difference between non linearized voltage and linearized voltage using CW parameters. The error is increasing with the voltage levels. In our particular case, the measured voltages averaged over the signal period are below 1mV. We use 1mV in the below calculation to have the worst case condition. The signal PAR (Peak to Average Ratio) is 6dB and the diode compression point 100mV.

The maximum voltage through the diode is given by:

$$v_{peak} = v_{meas\ avg} \times PAR_{linear}$$

$$v_{peak} = 1 * 4 = 4\ mV$$

The linearized voltage using CW parameter is given by:

$$v_{lin\ peak} = v_{peak} + \frac{v_{peak}^2}{diode\ compression\ point}$$

$$v_{lin\ peak} = 4 + \frac{4^2}{100} = 4.16\ mV$$

The worst case linearization error is:

$$lin\ error = \frac{v_{lin\ peak} - v_{peak}}{v_{peak}} = \frac{4.16 - 4}{4} = 1.04 = 4\%$$

A.2.4 Data Evaluation

A.2.4.1 Scan

The scan involves the measurement of two planes with three different probe rotations. The grid steps are optimized by the software based on the test frequency. The location of the lowest measurement plane is defined by the distance of first measurement layer from device under test (DUT) entered by the user. The DUT location settings can be used to offset the center of the grid.

A.2.4.2 Total Field and Power Flux Density Reconstruction

Computation of the power density in general requires knowledge of the electric (E-) and magnetic (H-) field amplitudes and phases in the plane of incidence. Reconstruction of these quantities from pseudo-vector E-field measurements is feasible, as they are constrained by Maxwell's equations.

The reconstruction algorithm developed by the system manufacturer, together with the ability of the probe to measure extremely close to the source without perturbing the field, permits reconstruction of the E- and H-fields, as well as of the power density, on measurement planes located as near as 0.5mm away in the frequency band of 60 GHz.

The average of the reconstructed power density is evaluated over a circular area in each measurement plane. The area of the circle is defined by the user; the default is 1 cm².

A.3 System Check

The system performance check verifies that the system operates within its specifications. It is recommended that the system performance check be performed prior to any usage of the system in order to guarantee reproducible results. The system performance check uses normal E-field measurements in a simplified setup with a well characterized source. This setup was selected to give a high sensitivity to all parameters that might fail or vary over time. The system check does not intend to replace the calibration of the components, but indicates situations where the system uncertainty is exceeded due to drift or failure.

In the simplified setup for system check, the EUT is replaced by a calibrated source and the power source is replaced by a controlled continuous wave generated by a signal generator. The calibrated source must be placed at the correct distance from the E-field probe according to the calibration certificate.



First, the power meter is connected to the output of the signal generator to measure the forward power at the location of the connector to the system check source. The signal generator is adjusted for the desired forward power to match the system check source calibration setup at the connector as read by power meter. Then the power meter is replaced by the system check source.

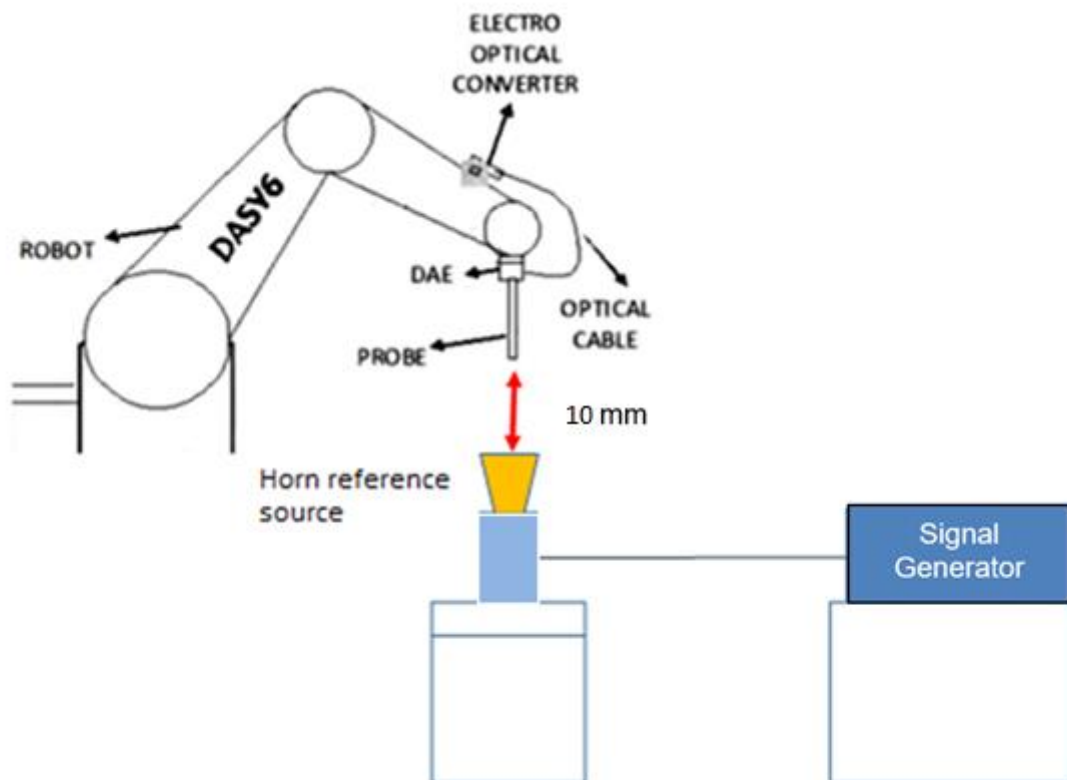

The output power on the reference source is set to 10.0 dBm (10 mW) and the measurement results E, H and Avg PD are compared with the Numerical modeling.

A.4 Test Equipment List

SAR system #4

ID #	Device	Type/Model	Serial Number	Manufacturer	Cal. Date	Cal. Due Date
443-000	E-Field probe 750MHz-110GHz	EUmmWV3	9538	SPEAG	2023-04-24	2024-04-24
003-016	Data Acquisition Electronics	DAEip	1705	SPEAG	2023-04-18	2024-04-18
004-000	6-axis Robot	TX90 XL	F11/5JL2A1/A/01	STAÜBLI	n/a	n/a
004-001	Robot Controller	CS8C	F11/5JL2A1/C/01	STAÜBLI	n/a	n/a
004-005	Measurement Server	DASY6 P/N: SE UMS 028 BB	-	SPEAG	n/a	n/a
004-004	Light Beam Unit	SE UKS 030 AA	1030	Di-soric	n/a	n/a
003-002	5G Phantom	mmWave	NA	SPEAG	n/a	n/a
003-006	Measurement Software	DASYmmW v2.4	9-5ED1AC01	SPEAG	n/a	n/a
004-010	Laptop Holder	P/N SM LH1 001 CD	-	SPEAG	n/a	n/a

Shared equipment

ID #	Device	Type/Model	Serial Number	Manufacturer	Cal. Date	Cal. Due Date
017-001	USB Power Sensor	NRP-Z57	101486	R&S	2022-03-15	2024-03-15
008-025	USB Power Sensor	NRP-Z57	101280	R&S	2022-04-22	2024-04-22
151-000	USB Power Sensor	NRP-Z58	100972	R&S	2022-03-29	2024-03-29
008-025	USB Power Sensor	NRP-Z57	101280	R&S	2022-04-22	2024-04-22
077-000	Coupler	CD0.5-8-20-30	1251-002	Amd-group	2023-02-20	2024-02-20
079-001	RF Cable	ST-18/SMAm/SMAm/48	-	Huber & Suhner	2023-02-20	2024-02-20
078-000	RF Cable	ST-18/SMAm/SMAm/48	-	Huber & Suhner	2023-02-20	2024-02-20
141-000	USB Power Sensor	NRP-Z81	104381	R&S	2022-05-18	2024-05-18
327-000	Temp & Humidity Logger	RA32E-TH1-RAS	RA32-F0DED9	AVTECH	2023-07-12	2025-07-12
129-000	Signal Generator	SMB100A	178212	R&S	2022-12-19	2024-12-19
198-000	0.8-21GHz RF amplifier	TVA-82-213A+	2004003	Mini-Circuits	2023-02-20	2024-02-20
198-000	0.8-21GHz RF amplifier	TVA-82-213A+	2004003	Mini-Circuits	2023-02-20	2024-02-20
008-081	Horn reference antenna	PE9859/SF-15	-	PAsternack	NA	NA
458-000	Measurement Software	SARA V2.3	NA	Intel	NA	NA

A.5 Measurement Uncertainty Evaluation

The system uncertainty evaluation is shown in the table below with a coverage factor of $k = 2$ to indicate a 95% level of confidence:

Table 2: DASY6 Uncertainty Budget in Compliance with IEC/IEEE 63195-1 for the cases indicated in the REFERENCE TABLE						
Error Description	Uncertainty Value (±dB)	Probability Distribution	Div.	(c_i)	Std. Unc. (±dB)	(v_i) v_{eff}
Measurement System						
Probe calibration	0.49	N	1	1	0.49	∞
Hemispherical Isotropy	0.50	R	√3	1	0.29	∞
Linearity	0.20	R	√3	1	0.12	∞
System Detection Limits	0.04	R	√3	1	0.02	∞
Data acquisition	0.03	N	1	1	0.03	∞
Field reconstruction ¹	2	R	√3	1	1.15	∞
Probe Positioning Repeatability	0.04	R	√3	1	0.02	∞
Probe Positioning offset	0.30	R	√3	1	0.17	∞
Amplitude and Phase Noise	0.04	R	√3	1	0.02	∞
Spatial Averaging	0.1	R	√3	1	0.06	∞
Frequency Response	0.2	R	√3	1	0.12	∞
Test Sample Related						
Power Drift	0.21	R	√3	1	0.12	∞
Modulation response	0.40	R	√3	1	0.23	∞
Device holder influence	0.1	R	√3	1	0.06	∞
RF Ambient Noise	0.04	R	√3	1	0.02	∞
RF Ambient Reflections	0.04	R	√3	1	0.02	∞
Combined Std. Uncertainty					1.34 dB	∞
Expanded Std. Uncertainty 95%					2.68 dB	

The REC at distance d must be modified as follows:

$$unc_{\text{REC}} \text{dB} = \begin{cases} 2.35 - 8.75d/\lambda & \text{for } d = 0.04 \dots 0.2\lambda \\ 0.6 & \text{for } d \geq 0.2\lambda \end{cases}$$

1

The minimal distance is 2mm, and the minimal frequency tested is 6 GHz. This corresponds to an MU value of $(2.35 - 8.75 \cdot 0.04) \approx 2$ dB --
 Ref: Speag, DASY6 Module mmWave Manual, February 2022.

A.6 RF Exposure Limits

Power density assessments have been made in line with the requirements of FCC 47CFR Part 2.1093, in particular chapter 1.1310 specifying the MPE limits, on the limitation of exposure of the general population / uncontrolled exposure for portable devices.

Exposure Type	Power density (S)
Limits for Occupational/Controlled Exposure. 1.5GHz – 100GHz	50.0 W/m²
Limits for General Population/ Uncontrolled Exposure. 1.5GHz – 100GHz	10.0 W/m²

Annex B. SAR Test & System Description

B.1 SAR Definition

Specific Absorption rate is defined as the time derivative of the incremental energy (dW) absorbed by (dissipated in) and incremental mass (dm) contained in a volume element (dV) of a given density (ρ).

$$SAR = \frac{d}{dt} \cdot \left(\frac{dW}{dm} \right) = \frac{d}{dt} \cdot \left(\frac{dW}{\rho \cdot dV} \right)$$

SAR is expressed in units of watts per kilogram (W/kg). SAR can be related to the electric field at a point by

$$SAR = \frac{\sigma |E|^2}{\rho}$$

Where:

σ = Conductivity of the tissue (S/m)

ρ = Mass density of the tissue (kg/m³)

E = RMS electric field strength (V/m)

B.2 SPEAG SAR Measurement System

B.2.1 SAR Measurement Setup

The DASY6 system for performing compliance tests consists of the following items:



- ✓ A standard high precision 6-axis robot (Stäubli TX/RX family) with controller, teach pendant and software. It includes an arm extension for accommodating the data acquisition electronics (DAE)
- ✓ An isotropic field probe optimized and calibrated for the targeted measurements.
- ✓ A data acquisition electronics (DAE) which performs the signal amplification, signal multiplexing, AD-conversion, offset measurements, mechanical surface detection, collision detection, etc. The signal is optically transmitted to the EOC.
- ✓ The Electro-optical Converter (EOC) performs the conversion from optical to electrical signals for the digital communication to the DAE. The EOC signal is transmitted to the measurement server.
- ✓ The function of the measurement server is to perform the time critical tasks such as signal filtering, control of the robot operation and fast movements interrupts.
- ✓ The Light Beam used is for probe alignment. This improves the (absolute) accuracy of the probe positioning.
- ✓ A computer running Windows professional operating system and the DASY6 software.
- ✓ Remote control and teach pendant as well as additional circuitry for robot safety such as warning lamps, etc.
- ✓ The phantom, the device holder and other accessories according to the targeted measurement.
- ✓ MAIA is a hardware interface (Antenna) used to evaluate the modulation and audio interference characteristics of RF signals.
- ✓ ANT is an ultra-wideband antenna for use with the base station simulators over 698 MHz to 6GHz for SAR cellular testing (not used for WLAN testing).
- ✓ The base station simulator is an equipment used for SAR cellular tests in order to emulate the cellular signals characteristics and behavior between a regular base station and the equipment under test.
- ✓ Tissue simulating liquid.
- ✓ System Validation dipoles.
- ✓ Network emulator or RF test tool

B.2.2 E-Field Measurement Probe

The probe is constructed using three orthogonal dipole sensors arranged on an interlocking, triangular prism core. The probe has built-in shielding against static charges and is contained within a PEEK cylindrical enclosure material at the tip.



The probe's characteristics are:

Frequency Range	30MHz – 10GHz
Length	337 mm
Probe tip external diameter	2.5 mm
Typical distance between dipoles and the probe tip	1 mm
Axial Isotropy (in human-equivalent liquids)	±0.3 dB
Hemispherical Isotropy (in human-equivalent liquids)	±0.5 dB
Linearity	±0.2 dB
Maximum operating SAR	100 W/kg
Lower SAR detection threshold	0.001 W/kg

B.2.3 Flat Phantom

Phantom for compliance testing of handheld and body-mounted wireless devices in the frequency range of 30 MHz to 6 GHz. ELI is fully compatible with the IEC 62209-2 standard and all known tissue simulating liquids. ELI has been optimized regarding its performance and can be integrated into our standard phantom tables. A cover prevents evaporation of the liquid. Reference markings on the phantom allow installation of the complete setup, including all predefined phantom positions and measurement grids, by teaching three points. The phantom is compatible with all SPEAG dosimetric probes and dipoles.

The phantom's characteristics are:

Material	Vinylester, glass fiber reinforced (VE-GF)
Shell thickness	2 mm ± 0.2 mm
Filling volume	30 Liters approx.
Dimensions	Major axis: 600mm / Minor axis: 400mm

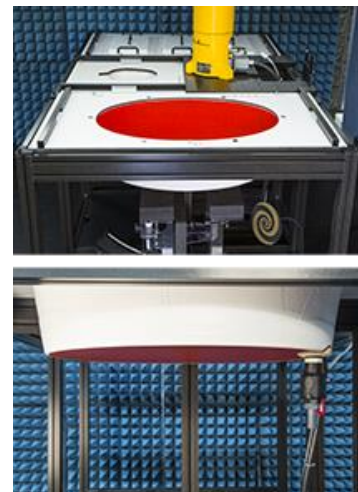

B.2.4 Device Positioner

The SAR in the phantom is approximately inversely proportional to the square of the distance between the source and the liquid surface. For a source at 5 mm distance, a positioning uncertainty of 0.5 mm would produce a SAR uncertainty of 20%. Accurate device positioning is therefore crucial for accurate and repeatable measurements. The positions in which the devices must be measured are defined by the standards.



The DASY device holder is designed to cope with the different positions given in the standard. It has two scales for device rotation (with respect to the body axis) and device inclination (with respect to the line between the ear reference points). The rotation center for both scales is the ear reference point (ERP). Thus the device needs no repositioning when changing the angles.

The DASY device holder is constructed of low-loss POM material having the following dielectric parameters: relative permittivity $\epsilon=3$ and loss tangent $\delta=0.02$. The amount of dielectric material has been reduced in the closest vicinity of the device, since measurements have suggested that the influence of the clamp on the test results could thus be lowered.

A simple but effective and easy-to-use extension for the Mounting Device; facilitates testing of larger devices according to IEC 62209-2 (e.g., laptops, cameras, etc.); lightweight and fits easily on the upper part of the Mounting Device in place of the phone positioner. The extension is fully compatible with the Twin SAM, ELI and other Flat Phantoms.



B.3 Data Evaluation

- **Power Reference measurement**

The robot measures the E field in a specified reference position that can be either the selected section's grid reference point or a user point in this section at 4mm of the inner surface of the phantom, 2mm for frequencies above 3GHz.

- **Area Scan**

Measurement procedures for evaluating SAR from wireless handsets typically start with a coarse measurement grid to determine the approximate location of the local peak SAR values. This is known as the area-scan procedure. The SAR distribution is scanned along the inside surface of one side of the phantom head, at least for an area larger than the projection of the handset and antenna. The distance between the measured points and phantom surface should be less than 8 mm, and should remain constant (with variation less than ± 1 mm) during the entire scan in order to determine the locations of the local peak SAR with sufficient accuracy. The angle between the probe axis and the surface normal line is recommended but not required to be less than 30° . If this angle is larger than 30° and the closest point on the probe-tip housing to the phantom surface is closer than a probe diameter, the boundary effect may become larger and polarization dependent. This additional uncertainty needs to be analyzed and accounted for. To achieve this, modified test procedures and additional uncertainty analyses not described in this recommended practice may be required. The measurement and interpolation point spacing should be chosen such as to allow identification of the local peak locations to within one-half of the linear dimension of a side of the zoom-scan volume. Because a local peak having specific amplitude and steep gradients may produce a lower peak spatial-average SAR compared to peaks with slightly lower amplitude and less steep gradients, it is necessary to evaluate these other peaks as well. However, since the spatial gradients of local SAR peaks are a function of the wavelength inside the tissue-equivalent liquid and the incident magnetic field strength, it is not necessary to evaluate local peaks that are less than 2 dB or more below the global maximum peak. Two-dimensional spline algorithms (Brishoual et al. 2001; Press et al., 1996) are typically used to determine the peaks and gradients within the scanned area. If a peak is found at a distance from the scan border of less than one-half the edge dimension of the desired 1 g or 10 g cube, the measurement area should be enlarged if possible.

- **Zoom Scan**

To evaluate the peak spatial-average SAR values for 1 g or 10 g cubes, fine resolution volume scans, called zoom scans, are performed at the peak SAR locations identified during the area scan. The minimum zoom scan volume size should extend at least 1.5 times the edge dimension of a 1 g cube in all directions from the center of the scan volume, for both 1 g and 10 g peak spatial-average SAR evaluations. Along the phantom curved surfaces, the front face of the volume facing the tissue/liquid interface conforms to the curved boundary, to ensure that all SAR peaks are captured. The back face should be equally distorted to maintain the correct averaging mass. The flatness and orientation of the four side faces are unchanged from that of a cube whose orientation is within $\pm 30^\circ$ of the line normal to the phantom at the center of the cube face next to the phantom surface. The peak local SAR locations that were determined in the area scan (interpolated values) should be used for the centers of the zoom scans. If a scan volume cannot be centered due to proximity of a phantom shape feature, the probe should be tilted to allow scan volume enlargement. If probe tilt is not feasible, the zoom-scan origin may be shifted, but not by more than half of the 1 g or 10 g cube edge dimension.

After the zoom-scan measurement, extrapolations from the closest measured points to the surface, for example along lines parallel to the zoom-scan centerline, and interpolations to a finer resolution between all measured and extrapolated points are performed. Extrapolation algorithm considerations are described in 6.5.3, and 3-D spline methods (Brishoual et al., 2001; Kreyszig, 1983; Press et al., 1996) can be used for interpolation. The peak spatial-average SAR is finally determined by a numerical averaging of the local SAR values in the interpolation grid, using for example a trapezoidal algorithm for the integration (averaging).

In some areas of the phantom, such as the jaw and upper head regions, the angle of the probe with respect to the line normal to the surface may be relatively large, e.g., greater than $\pm 30^\circ$, which could increase the boundary effect error to a larger level. In these cases, during the zoom scan a change in the orientation of the probe, the phantom, or both is recommended but not required for the duration of the zoom scan, so that the angle between the probe axis and the line normal to the surface is within 30° for all measurement points.

- **Power Drift measurement**

The robot re-measures the E-Field in the same reference location measured at the Power Reference. The drift measurement gives the field difference in dB from the first to the last reference reading. This allows a user to monitor the power drift of the device under test that must remain within a maximum variation of $\pm 5\%$.

- **Post-processing**

The procedure for spatial peak SAR evaluation has been implemented according to the IEEE1528 and IEC 62209-1/2 standards. It can be conducted for 1g and 10g.

The software allows evaluations that combine measured data and robot positions, such as:

- ✓ Maximum search
- ✓ Extrapolation
- ✓ Boundary correction
- ✓ Peak search for averaged SAR

Interpolation between the measured points is performed when the resolution of the grid is not fine enough to compute the average SAR over a given mass.

Extrapolation routines are used to obtain SAR values between the lowest measurement points and the inner phantom surface. The extrapolation is determined by the surface detection distance and the probe sensor offset. Several measurements at different distances are necessary for the extrapolation.

B.4 System and Liquid Check

B.4.1 System Check

The system performance check verifies that the system operates within its specifications. System and operator errors can be detected and corrected. It is recommended that the system performance check be performed prior to any usage of the system in order to guarantee reproducible results.

The system performance check uses normal SAR measurements in a simplified setup with a well characterized source. This setup was selected to give a high sensitivity to all parameters that might fail or vary over time. The system check does not intend to replace the calibration of the components, but indicates situations where the system uncertainty is exceeded due to drift or failure.

In the simplified setup for system check, the EUT is replaced by a calibrated dipole and the power source is replaced by a controlled continuous wave generated by a signal generator. The calibrated dipole must be placed beneath the flat phantom section of the phantom at the correct distance.



The equipment setup is shown below:

- ✓ Signal Generator
- ✓ Amplifier
- ✓ Directional coupler
- ✓ Power meter
- ✓ Calibrated dipole

First, the power meter PM1 (including attenuator Att1) is connected to the cable to measure the forward power at the location of the connector (x) to the system check source. The signal generator is adjusted for the desired forward power at the connector as read by power meter PM1 after attenuation Att1 and also as coupled through Att2 to PM2. After connecting the cable to the source, the signal generator is readjusted for the same reading at power meter PM2.

SAR results are normalized to a forward power of 1W to compare the values with the calibration reports results as described at IEC/IEEE 62209-1528:2020 standards.

B.4.2 Liquid Check

The dielectric parameters check is done prior to the use of the tissue simulating liquid. The verification is made by comparing the relative permittivity and conductivity to the values recommended by the applicable standards.

The liquid verification was performed using the following test setup:

- ✓ VNA (Vector Network Analyzer)
- ✓ Open-Short-Load calibration kit
- ✓ RF Cable
- ✓ Open-Ended Coaxial probe
- ✓ DAK software tool
- ✓ SAR Liquid
- ✓ De-ionized water
- ✓ Thermometer

These are the target dielectric properties of the tissue-equivalent liquid material according to the manufacturer's datasheet:

Frequency (MHz)	Head Tissue Simulating Media	
	ϵ_r (F/m)	σ (S/m)
6000	35.07	5.48
6500	34.46	6.07
7000	33.88	6.65

(ϵ_r = relative permittivity, σ = conductivity and $\rho = 1000$ kg/m³)

The measurement system implements a SAR error compensation algorithm as documented IEC/IEEE 62209-1528:2020 to automatically compensate the measured SAR results for deviations between the measured and required tissue dielectric parameters (applied to only scale up the measured SAR, and not downward) so, according to FCC OET KDB 865664 D01, the tolerance for ϵ_r and σ may be relaxed to $\pm 10\%$.

B.5 Test Equipment List

SAR system #5

ID #	Device	Type/Model	Serial Number	Manufacturer	Cal. Date	Cal. Due Date
489-001	Robot Controller	CSE9spe-TX2-60	F/22/0038104/C/001	STAÜBLI	NA	NA
489-004	Measurement Server	DASY8 MS	10079	SPEAG	NA	NA
489-009	Electro Optical Converter	EOC8-60	1033	SPEAG	NA	NA
489-005	Light Beam Unit	LB-85	2068	Di-soric	NA	NA
004-002	Oval Flat Phantom	ELI V8.0	2124	SPEAG	NA	NA
489-010	Measurement Software	DASY8 v16.2	9-457E974A_D8	SPEAG	NA	NA
489-007	Data Acquisition Electronics	DAEip	1706	SPEAG	2023-07-07	2024-07-07
003-007	Dosimetric E-Field probe	EX3DV4	7465	SPEAG	2023-07-11	2024-07-11
489-000	6-Axis Robot	TX260L Speag	F/22/0038104/A/001	STAÜBLI	NA	NA

Shared equipment

ID #	Device	Type/Model	Serial Number	Manufacturer	Cal. Date	Cal. Due Date
151-000	USB Power Sensor	NRP-Z58	100972	R&S	2022-03-29	2024-03-29
008-025	USB Power Sensor	NRP-Z57	101280	R&S	2022-04-22	2024-04-22
099-000	Liquid measurement SW	DAK-3.5 V2.6.0.5	9-2687B491	SPEAG	NA	NA
069-000	Dielectric Probe Kit	DAK-3.5	1037	SPEAG	2023-07-04	2025-07-04
077-000	Coupler	CD0.5-8-20-30	1251-002	Amd-group	2023-02-20	2024-02-20
079-001	RF Cable	CBL-0.5M-SMSM+	226527	Mini-Circuits	2023-02-20	2024-02-20
167-001	RF Cable	CBL-2M-SMSM+	233846	Mini-Circuits	2023-02-20	2024-02-20
130-000	Vector Signal Generator	SMB100A	178217	R&S	2023-07-26	2025-07-26
496-000	Temp & Humidity Logger	RA32E-TH1-RAS	RA32-FC8485	AVTECH	2023-04-20	2025-04-20
339-000	VNA Analyzer	ZNB 40	101740	R&S	2023-05-19	2025-05-19
097-000	System Validation Dipole 7000MHz	D7GHzV2	1008	SPEAG	2022-08-24	2024-08-24
458-000	Measurement Software	SARA V2.3	NA	Intel	NA	NA

B.5.1 Tissue Simulant Liquid

TSL	Manufacturer / Model	Freq Range (MHz)	Main Ingredients
Head WideBand	SPEAG HBBL600-10000V6 Batch 230426-01	600-10000	Ethenediol, Sodium petroleum sulfonate, Hexylene Glycol / 2-Methyl-pentane-2.4-diol, Alkoxyated alcohol

B.6 Measurement Uncertainty Evaluation

The system uncertainty evaluation is shown in the table below with a coverage factor of $k = 2$ to indicate a 95% level of confidence:

SPEAG DASY6 Uncertainty Budget According to IEC/IEEE 62209-1528 (6 GHz - 10 GHz)								
Symbol	Error Description	Uncert. Value	Prob. Dist.	Div.	(ci) 1g	(ci) 10g	Std Unc. (1g)	Std Unc. (10g)
Measurement System Errors								
CF	Probe Calibration	±18.6 %	N	2	1	1	±9.3 %	±9.3 %
CF _{drift}	Probe Calibration Drift	±1.0 %	N	1	1	1	±1.0 %	±1.0 %
LIN	Probe Linearity	±4.7 %	R	√3	1	1	±2.7 %	±2.7 %
BBS	Broadband Signal	±3.0 %	N	2	1	1	±1.5 %	±1.5 %
ISO	Axial Isotropy	±4.7 %	R	√3	0.5	0.5	±1.4 %	±1.4 %
ISO	Hempherical Isotropy	±9.6 %	R	√3	0.5	0.5	±2.8 %	±2.8 %
DAE	Data Acquisition	±0.3 %	N	1	1	1	±0.3 %	±0.3 %
AMB	RF Ambient	±1.8 %	N	1	1	1	±1.8 %	±1.8 %
Δ _{sys}	Probe Positioning	±0.2 %	N	1	0.33	0.33	±0.1 %	±0.1 %
DAT	Data Processing	±3.5 %	N	1	1	1	±3.5 %	±3.5 %
Phantom and Device Errors								
LIQ(σ)	Conductivity (meas.) _{DAK}	±2.5 %	N	1	0.78	0.71	±2.0 %	±1.8 %
LIQ(Tσ)	Conductivity (temp.) _{BB}	±2.4 %	R	√3	0.78	0.71	±1.1 %	±1.0 %
EPS	Phantom Permittivity	±14.0 %	R	√3	0.5	0.5	±4.0 %	±4.0 %
DAS	Distance DUT - TSL	±2.0 %	N	1	2	2	±4.0 %	±4.0 %
H	Device Holder	±3.6 %	N	1	1	1	±3.6 %	±3.6 %
MOD	DUT Modulation _m	±2.4 %	R	√3	1	1	±1.4 %	±1.4 %
TAS	Time-average SAR	±2.6 %	R	√3	1	1	±1.5 %	±1.5 %
RF _{drift}	DUT drift	±5.0 %	N	1	1	1	±2.9 %	±2.9 %
Correction to the SAR results								
C(ε, σ)	Deviation to Target	±1.9 %	N	1	1	0.84	±1.9 %	±1.6 %
C(R)	SAR scaling _p	±0 %	R	√3	1	1	±0 %	±0 %
Combined Std. Uncertainty							±13.7 %	±13.7 %
Expanded STD Uncertainty							±27.5 %	±27.3 %

B.7 RF Exposure Limits

SAR assessments have been made in line with the requirements of FCC 47CFR Part 2.1093 on the limitation of exposure of the general population / uncontrolled exposure for portable devices.

Exposure Type	General Population / Uncontrolled Environment
Peak spatial-average SAR (averaged over any 1 gram of tissue)	1.6 W/kg
Whole body average SAR	0.08 W/kg
Peak spatial-average SAR (extremities) (averaged over any 10 grams of tissue)	4.0 W/kg

Annex C. Test Results

The herein test results were performed by:

Test case measurement	Test Personnel
Conducted measurement	F. Heurtematte
SAR/PD measurement	M.FARIA

C.1 Test Conditions

C.1.1 Test positions relative to the phantom

The device under test was an Intel® Wi-Fi 7 BE200NGW card inside host platform (HSN-I61C) using a set of PIFA antennas. The card was operated utilizing proprietary software (DRTU version DRTU.05055.23.0.0) and each channel was measured using a broadband power meter to determine the maximum average power.

As per the Interim Procedures for UNII 6-7GHz RF Exposure, explained in RF Exposure Policies and Procedures: TCB Workshop – October 2020, the testing has been performed on SAR following IEC/IEEE 62209-1528:2020 and then on Power Density for the highest SAR test configurations.

Considering the antenna location diagrams in Annex G and the test exclusions described before, the surfaces/edges to be measured for each antenna are:

Antenna	Aux	Main
Position	<ul style="list-style-type: none"> • Back face • Top edge • Left edge 	<ul style="list-style-type: none"> • Back face • Top edge

See *G.2 SAR/PD Test positions* section for more information on the tested positions.

C.1.2 Test signal, Output power and Test Frequencies

For 802.11 transmission modes the device was put into operation by using an own control software to program the test mode required to select the continuous transmission with 100% duty cycle.

The output power of the device was set to transmit at maximum power for all tests.

C.1.3 Evaluation Exclusion and Test Reductions

The SAR Test Exclusion Threshold in FCC OET KDB 447498 can be applied to determine SAR test exclusion for adjacent edge configurations. For 100MHz to 6GHz and test separation distances ≤50mm, the 1-g and 10-g SAR test exclusion thresholds are determined by the following formula:

$$\left[\frac{\text{(max. power of channel, including tune – up tolerance, mW)}}{\text{(min. test separation distance, mm)}} \right] \cdot \left[\sqrt{f_{\text{(GHz)}}} \right] \quad (1)$$

≤ 3.0 for 1g SAR, and ≤ 7.5 for 10g extremity SAR

Where:

- f(GHz) is the RF channel transmit frequency in GHz.
- Power and distance are rounded to the nearest mW and mm before calculation
- The result is rounded to one decimal place for comparison
- The values 3.0 and 7.5 are referred to as numeric thresholds

The test exclusions are applicable only when the minimum test separation distance is ≤ 50 mm, and for transmission frequencies between 100 MHz and 6 GHz. When the minimum test separation distance is < 5 mm, a distance of 5 mm is applied to determine SAR test exclusion.

For test separation distances > 50 mm, the 1-g and 10-g SAR test exclusion thresholds are determined using the following formulas:

$$\left(\text{(Power allowed at numeric threshold for 50 mm in (1))} + \text{(test separation distance – 50 mm)} \cdot (f_{\text{MHz}}/150) \right) \text{mW}, \quad (2)$$

for 100MHz to 1500MHz

$$\left(\text{(Power allowed at numeric threshold for 50 mm in (1))} + \text{(test separation distance – 50 mm)} \cdot 10 \right) \text{mW}, \quad (3)$$

for 1500MHz and ≤ 6GHz

WLAN Antenna	Band Name	Output power Notebook mode		Output power Tablet mode		Laptop	Back Face	Top Edge	Right Edge	Left Edge	Bottom Edge	Laptop	Back Face*	Top Edge	Right Edge	Left Edge*	Bottom Edge
		dBm	mW	dBm	mW												
Aux	U-NII-5	13.50	22.39	17.00	50.12	>50	<50	<50	>50	<50	>50	R	R	T	R	R	R
	U-NII-6	13.50	22.39	17.00	50.12	>50	<50	<50	>50	<50	>50	R	R	T	R	R	R
	U-NII-7	13.50	22.39	17.00	50.12	>50	<50	<50	>50	<50	>50	R	R	T	R	R	R
	U-NII-8	13.50	22.39	14.25	26.61	>50	<50	<50	>50	<50	>50	R	R	T	R	R	R
Main	U-NII-5	12.50	17.78	17.00	50.12	>50	<50	<50	>50	>50	>50	R	R	T	R	R	R
	U-NII-6	13.50	22.39	17.00	50.12	>50	<50	<50	>50	>50	>50	R	R	T	R	R	R
	U-NII-7	13.50	22.39	17.00	50.12	>50	<50	<50	>50	>50	>50	R	R	T	R	R	R
	U-NII-8	13.50	22.39	14.50	28.18	>50	<50	<50	>50	>50	>50	R	R	T	R	R	R

T: Tested position
R: Reduced

*Back face and Left edge positions are covered by following modular report:
230526-08.TR66

See Annex G for a more detailed explanation of the separation distance related to the platform.

C.2 Conducted Power Measurements

C.2.1 WLAN 6-7GHz (U-NII)

C.2.1.1 6.2GHz (U-NII-5)

Band	Mode	Data Rate	Ch #	Freq (MHz)	Main			Aux	
					Avg Pwr (dBm)-Vendor 1	Avg Pwr (dBm)-Vendor 2	Declared Max Power (dBm)	Avg Pwr (dBm)	Declared Max Power (dBm)
6GHz	802.11ax20/be20	MCS0	1	5955	NR	NR	5.75	NR1	5.75
			45	6175			5.75		5.75
			93	6415			5.75		5.75
	802.11ax40/be40		3	5965			8.75		8.75
			43	6165			8.75		8.75
			91	6405			8.75		8.75
	802.11ax80/be80		7	5985			11.75		11.75
			39	6145			11.75		11.75
			87	6385			11.75		11.75
	802.11ax160/be160		15	6025			11.98		12.50
			47	6185			11.76		12.50
			79	6345			12.12		12.50
	802.11be320		31	6105	10.99	11.99	12.50	13.30	13.50
	802.11be320-MIMO		31	6105	7.99	8.99	9.50	10.30	10.50
	802.11be320		63	6265	10.98	11.98	12.50	13.46	13.50
	95	6425	11.97	11.97	12.50	13.09	13.50		

Initial test configuration

- NR: Not Required

C.2.1.1 6.5GHz (U-NII-6)

Band	Mode	Data Rate	Ch #	Freq (MHz)	Main		Aux		
					Avg Pwr (dBm)-	Declared Max Power (dBm)	Avg Pwr (dBm)	Declared Max Power (dBm)	
6GHz	802.11ax20/be20	MCS0	97	6435	NR1		5.75	NR1	5.75
			105	6475			5.75		5.75
			113	6515			5.75		5.75
	802.11ax40/be40		99	6445			8.75		8.75
			107	6485			8.75		8.75
			103	6465			11.75		11.75
	802.11ax80/be80		119	6545			11.75		11.75
			802.11ax160/be160	111	6505	12.82	13.50	12.58	13.50

Initial test configuration

- NR: Not Required

C.2.1.1 6.7GHz (U-NII-7)

Band	Mode	Data Rate	Ch #	Freq (MHz)	Main		Aux	
					Avg Pwr (dBm)	Declared Max Power (dBm)	Avg Pwr (dBm)	Declared Max Power (dBm)
6GHz	802.11ax20/be20	MCS0	117	6535	NR1	5.75	NR1	5.75
			149	6695		5.75		5.75
			181	6855		5.75		5.75
	802.11ax40/be40		115	6525		8.75		8.75
			147	6685		8.75		8.75
			179	6845		8.75		8.75
	802.11ax80/be80		135	6625		11.75		11.75
			151	6705		11.75		11.75
			167	6785		11.75		11.75
	802.11ax160/be160		143	6665	13.06	13.50		
			175	6825	12.69	13.50		
	802.11be320		127	6585	13.43	13.50	13.22	13.50
			159	6745	13.49	13.50	13.35	13.50

Initial test configuration

- 1. NR: Not Required

C.2.1.1 7.0GHz (U-NII-8)

Band	Mode	Data Rate	Ch #	Freq (MHz)	Main		Aux	
					Avg Pwr (dBm)	Declared Max Power (dBm)	Avg Pwr (dBm)	Declared Max Power (dBm)
6GHz	802.11ax20/be20	MCS0	185	6875	NR1	5.75	NR1	5.75
			209	6995		5.75		5.75
			233	7115		5.75		5.75
	802.11ax40/be40		187	6885		8.75		8.75
			211	7005		8.75		8.75
			227	7085		8.75		8.75
	802.11ax80/be80		183	6865		11.75		11.75
			199	6945		11.75		11.75
			215	7025		11.75		11.75
	802.11ax160/be160		207	6985	12.57	13.50	13.50	13.50
	802.11be320		191	6905	13.48	13.50	13.48	13.50

Initial test configuration

- 1. NR: Not Required

C.3 Tissue Parameters Measurement

Head TSL

Freq. (MHz)	Target Parameters		Measured TSL Parameters		Deviation (%)		Date
	ϵ' (F/m)	σ (S/m)	ϵ' (F/m)	σ (S/m)	ϵ'	σ	
7000.0	33.88	6.65	33.1	6.89	-2.30	3.61	2024-01-12

See *Annex E* for more details.

C.4 System Check Measurements

C.4.1 E-Field

Frequency	Signal Type	Target E-field (V/m)	Measured E-field (V/m)	Deviation (%)	Date
6.5 GHz	Continuous Wave	60.59	63.55	4.87	2024-01-16

The E-fields presented in the System Check Measurements table are Peak values. The target E-field value is obtained by simulation. The maximum target E-field value at 10 mm with 10 dBm (10 mW) source power is 60.59 V/m. The maximum measured E-field value at 10 mm with 10 dBm (10 mW) is 63.55V/m.

C.4.2 H-Field

Frequency	Signal Type	Target H-field (A/m)	Measured H-field (A/m)	Deviation (%)	Date
6.5 GHz	Continuous Wave	0.17	0.17	0.00	2024-01-16

The H-fields presented in the System Check Measurements table are Peak values. The target H-field value is obtained by simulation. The maximum target H-field value at 10 mm with 10 dBm (10 mW) source power is 0.17 A/m. The maximum measured E-field value at 10 mm with 10 dBm (10 mW) is 0.17 A/m.

C.4.3 Local Power Density

Frequency	Signal Type	Target Local Power Density (W/m ²)	Measured Local Power Density (W/m ²)	Deviation (%)	Date
6.5 GHz	Continuous Wave	5.12	5.36	4.69	2024-01-16

The Local Power Density presented in the System Check Measurements table are Peak values. The target Local Power Density value is obtained by simulation. The maximum target Local Power Density value at 10 mm with 10 dBm (10 mW) source power is 5.12 W/m². The maximum measured E-field value at 10 mm with 10 dBm (10 mW) is 5.36 W/m².

C.4.4 Averaged Power Density

Frequency	Signal Type	Target Spatially Averaged Power Density (W/m ²)	Measured Spatially Averaged Power Density (W/m ²)	Deviation (%)	Date
6.5 GHz	Continuous Wave	4.93	5.10	3.45	2024-01-16

The Spatially Averaged Power Density presented in the System Check Measurements table are Peak values. The target Spatially Averaged Power Density value is obtained by simulation. The maximum target Spatially Averaged Power Density value at 10 mm with 10 dBm (10 mW) source power is 5.10 W/m².

C.4.5 SAR**Head Measurements**

Frequency (MHz)	Average	Target SAR (W/kg)	Measured SAR (W/kg)	Forwarded Power (mW)	Deviation to target (%)	Limit (%)	Date
7000	1g	278.00	280.13	15.85	0.77	±10	2024-01-13
	10g	48.70	51.74		6.24		
	1g	278.00	261.87	79.43	-5.80		2024-01-14
	10g	48.70	48.97		0.56		

C.5 Test Results

C.5.1 SAR - 802.11ax/be – 6.2 GHz – U-NII-5

Antenna Manufacturer	Mode Data Rate	BW (MHz)	Channel Number	Freq (MHz)	Test position mode	Ant	Scaling Factor (dB).	Measured SAR 1g. (W/kg)	Reported SAR 1g (W/kg)	SAR 10g (W/kg)	Estimated epithelial PD (W/m ²)*		No Plot
										Measured	1cm ²	4cm ²	
Vendor 1	802.11be320	320	31	6105	Top edge	MAIN	1.51	0.97	1.37	0.26	9.67	5.52	1
	802.11be320-MIMO	320	31	6105			1.51	0.61	0.87	0.20			
	802.11be320	320	63	6265			1.52	0.87	1.23	0.24			
			95	6425			0.54	1.04	1.18	0.29			
	802.11be320	320	31	6105		AUX	0.20	0.95	1.00	0.24			
	802.11be320-MIMO	320	31	6105			0.20	0.64	0.67	0.15			
	802.11be320	320	63	6265			0.04	0.62	0.62	0.17			
	802.11ax/be MCS0	160	79	6345			0.38	0.97	1.06	0.26			
Vendor 2	802.11be320	320	31	6105	Top edge	MAIN	0.51	0.98	1.10	0.28			
	802.11be320-MIMO	320	31	6105			0.51	0.44	0.49	0.12			
	802.11be320	320	63	6265			0.52	0.90	1.01	0.26			
			31	6105		0.20	1.14	1.19	0.29				
	802.11be320-MIMO	320	31	6105		AUX	0.20	0.44	0.46	0.12			
	802.11be320	320	63	6265			0.04	1.04	1.05	0.25			

* For reference purposes only, not specifically for compliance, the estimated absorbed (epithelial) power density derived from the measured SAR is shown

C.5.2 SAR - 802.11ax/be – 6.5 GHz – U-NII-6

Antenna Manufacturer	Mode Data Rate	BW (MHz)	Channel Number	Freq (MHz)	Test position mode	Ant	Scaling Factor (dB).	Measured SAR 1g. (W/kg)	Reported SAR 1g (W/kg)	SAR 10g (W/kg)	Estimated epithelial PD (W/m ²)*		No Plot
										Measured	1cm ²	4cm ²	
Vendor 1	802.11ax/be MCS0	160	111	6505	Top edge	MAIN	0.68	1.02	1.19	0.30	10.2	6.02	2
						AUX	0.92	0.34	0.43	0.09			
Vendor 2	802.11ax/be MCS0	160	111	6505	Top edge	MAIN	0.68	0.68	0.79	0.21			
						AUX	0.92	0.68	0.84	0.19			

* For reference purposes only, not specifically for compliance, the estimated absorbed (epithelial) power density derived from the measured SAR is shown

C.5.3 SAR - 802.11ax/be – 6.7 GHz – U-NII-7

Antenna Manufacturer	Mode Data Rate	BW (MHz)	Channel Number	Freq (MHz)	Test position mode	Ant	Scaling Factor (dB)	Measured SAR 1g (W/kg)	Reported SAR 1g (W/kg)	SAR 10g (W/kg)	Estimated epithelial PD (W/m ²)*		No Plot
										Measured	1cm ²	4cm ²	
Vendor 1	802.11be 320	320	159	6745	Top edge	MAIN	0.01	1.33	1.33	0.32	13.30	7.62	3
			127	6585			0.07	1.18	1.19	0.30			
			159	6745		AUX	0.15	0.57	0.59	0.18			
	802.11ax/be MCS0	160	143	6665		MAIN	0.44	0.99	1.10	0.27			
			175	6825		MAIN	0.81	0.90	1.08	0.27			
Vendor 2	802.11be 320	320	159	6745	Top edge	MAIN	0.01	0.83	0.83	0.22			
			127	6585			0.07	0.88	0.92	0.23			
			159	6745		AUX	0.15	0.66	0.68	0.16			

* For reference purposes only, not specifically for compliance, the estimated absorbed (epithelial) power density derived from the measured SAR is shown

C.5.4 SAR - 802.11ax/be – 7.0 GHz – U-NII-8

Antenna Manufacturer	Mode Data Rate	BW (MHz)	Channel Number	Freq (MHz)	Test position mode	Ant	Scaling Factor (dB)	Measured SAR 1g (W/kg)	Reported SAR 1g (W/kg)	SAR 10g (W/kg)	Estimated epithelial PD (W/m ²)*		No Plot
										Measured	1cm ²	4cm ²	
Vendor 1	802.11be320	320	191	6905	Top edge	MAIN	0.02	1.27	1.28	0.32	12.70	7.39	4
	802.11ax/be MCS0	160	207	6985		MAIN	0.93	0.94	1.16	0.28			
	802.11be320	320	191	6905		AUX	0.02	0.74	0.74	0.23			
Vendor 2	802.11be320	320	191	6905	Top edge	MAIN	0.02	0.80	0.81	0.21			
						AUX	0.02	0.49	0.49	0.12			

* For reference purposes only, not specifically for compliance, the estimated absorbed (epithelial) power density derived from the measured SAR is shown

C.5.5 Power Density - 802.11ax/be – 6.2 GHz – U-NII-5

Ant.	Mode Data rate	BW (MHz)	Ch #	Freq (MHz)	Position	*Uncertainty Cor. Factor	PStot avg [W/m ²] 1cm ²	**C-PStot avg [W/m ²] 1cm ²	PStot avg [W/m ²] 4cm ²	**C-PStot avg [W/m ²] 4cm ²	EM E [V/m]	EM H [A/m]	Plot #
Vendor 1 Main	802.11be 320	320	31	6105	Top edge	1.55	3.90	6.05	3.07	4.76	63.40	0.22	
			63	6265		1.55	4.66	7.22	3.47	5.38	68.30	0.29	5
Vendor 2 Aux	802.11be 320	320	31	6105		1.55	3.04	3.04	2.02	3.13	59.90	0.19	
			63	6265		1.55	2.54	2.54	2.17	3.36	57.30	0.15	

* The correction factor uncertainty in dB corresponds to the difference between the actual uncertainty and the 30% target value, as per the TCB Workshop Oct 20

**C-PStot = Compensated PStot

C.5.6 Power Density - 802.11ax/be – 6.5 GHz – U-NII-6

Ant.	Mode Data rate	BW (MHz)	Ch #	Freq (MHz)	Position	Uncertainty Cor. Factor	PStot avg [W/m ²] 1cm ²	C-PStot avg [W/m ²] 1cm ²	PStot avg [W/m ²] 4cm ²	C-PStot avg [W/m ²] 4cm ²	EM E [V/m]	EM H [A/m]	Plot #
Vendor 1 Main	802.11ax/be MCS0	160	111	6505	Top edge	1.55	2.12	3.29	1.49	2.31	57.90	0.20	
Vendor 2 Aux	802.11ax/be MCS0	160	111	6505		1.55	2.39	3.70	1.67	2.59	46.30	0.18	6

C.5.7 Power Density - 802.11ax/be – 6.7 GHz – U-NII-7

Ant.	Mode Data rate	BW (MHz)	Ch #	Freq (MHz)	Position	Uncertainty Cor. Factor	PStot avg [W/m ²] 1cm ²	C-PStot avg [W/m ²] 1cm ²	PStot avg [W/m ²] 4cm ²	C-PStot avg [W/m ²] 4cm ²	EM E [V/m]	EM H [A/m]	Plot #
Vendor 1 Main	802.11be 320	320	159	6745	Top edge	1.55	2.59	4.01	1.96	3.04	61.60	0.21	7
Vendor 2 Aux	802.11be 320	320	159	6745		1.55	2.24	3.47	1.82	2.82	53.20	0.16	

C.5.8 Power Density - 802.11ax/be – 7.0 GHz – U-NII-8

Ant.	Mode Data rate	BW (MHz)	Ch #	Freq (MHz)	Position	Uncertainty Cor. Factor	PStot avg [W/m ²] 1cm ²	C-PStot avg [W/m ²] 1cm ²	PStot avg [W/m ²] 4cm ²	C-PStot avg [W/m ²] 4cm ²	EM E [V/m]	EM H [A/m]	Plot #
Vendor 1 Main	802.11be320	320	191	6905	Top edge	1.55	4.03	6.25	2.67	4.14	64.80	0.24	8
Vendor 2 Aux	802.11be320	320	191	6905		1.55	1.36	2.11	1.01	1.57	42.10	0.11	

C.5.9 Measurement Variability

According to FCC OET KDB 865664, SAR Measurement variability is assessed when the maximum initial measured SAR is ≥ 0.8 W/kg for a certain band/mode. If the measured SAR value of the initial repeated measurement is < 1.45 W/kg with $< 20\%$ variation, only one repeated measurement is required to confirm that the results are not expected to have substantial variations.

A second repeated measurement is required only if the measured results for the initial repeated measurement are within 10% of the SAR limit or vary by more than 20%.

A third repeated measurement is required only if the original, first or second repeated measurement ≥ 1.5 W/kg and the ratio of largest to smallest SAR for the original, first and second repeated measurement is > 1.2

Band Mode /	Position	Ch #	Freq. (MHz)	Measured SAR 1g (W/kg)	1st Repeated SAR 1g (W/kg)	2nd Repeated SAR 1g (W/kg)	3rd Repeated SAR 1g (W/kg)	Highest Ratio
6.7GHz / 802.11be - 320 MHz	Top Edge	159	6745	1.33	1.12	NR	NR	1.19

C.5.10 Simultaneous Transmission Evaluation – SAR

According to FCC OET KDB 447498, when the sum of 1g SAR for all simultaneously transmitting antennas in an operating mode and exposure condition combination is within the SAR limit, SAR test exclusion applies to that simultaneous transmission configuration.

All the values stated in the table below are the worst case found for standalone measurement with disregard of the transmission mode or channel where the worst case was found.

Antenna	Position	Highest Reported SAR (1g) (W/kg)		
		WLAN 6GHz		Bluetooth*
Aux	Top edge	1.19***	0.67**	0.35
Main		1.37***	0.87**	

*For Bluetooth see the report 231128-04.TR02

** CH31 is considered for this position as the highest standalone measurement, UNII-5 for Aux and Main transmitters for the simultaneous transmission with MIMO power.

*** This combination requires SISO value for simultaneous considerations.

Position	Simultaneous Tx Antenna Combination		Σ SAR 1g (W/kg)	Limit (W/kg)
	Aux	Main		
Top edge	WLAN 6GHz	WLAN 6GHz	1.54	1.6
	WLAN 6GHz+ BT	WLAN 6GHz	1.89	
	BT	WLAN 6GHz	1.22	

In case the sum of SAR is larger than the limit, SAR test exclusion is determined by the SAR to peak location separation ratio:

Position	Antenna	Reported SAR 1g (W/kg)	Σ SAR 1g (W/kg)	Peak Location (mm) (x,y,z)	SAR to peak location separation ratio	Limit
Top edge	Main WLAN 6GHz	0.87	1.89	(8.1; -55.4; -177.0)	0.04	0.04
	Aux WLAN 6GHz	0.67		(12.1; -128.4; -177.0)		
	Aux BT	0.35		(25.7; -122.6; -177.0)		

Considering the results described above and according to the simultaneous transmission evaluation exclusions described in FCC OET KDB 447498, no enlarged zoom scan measurements are required.

Annex D. Test System Plots

1. U-NII-5 - 802.11be320, CH31, Main-Top edge - Vendor 1 (SAR).....	40
2. U-NII-6 - 802.11ax160/be160, CH111, Main- Top edge - Vendor 1 (SAR)	41
3. U-NII-7 - 802.11be320, CH159, Main- Top edge - Vendor 1 (SAR)	42
4. U-NII-8 - 802.11be320, CH191, Main- Top edge - Vendor 1 (SAR)	43
5. U-NII-5 - 802.11be320, CH63, Main-Vendor 1- Top edge (PD)	44
6. U-NII-6 - 802.11ax160/be160, CH111, Aux-Vendor 2- Top edge (PD).....	45
7. U-NII-7 - 802.11be320, CH159, Main-Vendor 1 -Top edge (PD)	46
8. U-NII-8 - 802.11be320 CH191, Main-Vendor 1-Top edge (PD)	47
9. Power Density System Check From 6500MHz- 2024-01-16	48
10. SAR System Check From 7000MHz- 2024-01-13.....	51
11. SAR System Check From 7000MHz- 2024-01-14.....	52

1. U-NII-5 - 802.11be320, CH31, Main-Top edge - Vendor 1 (SAR)

Device under Test Properties

Model, Manufacturer	Dimensions [mm]	SN	DUT Type
HSN-I61C, HP	220 x 329.0 x 8.0	0003770D2W	Convertible PC

Exposure Conditions

Phantom Section, TSL	Position, Test Distance [mm]	Band	Group, UID	Frequency [MHz], Channel Number	Conversion Factor	TSL Conductivity [S/m]	TSL Permittivity
Flat, HSL	EDGE TOP, 0.00	U-NII-5	WLAN, 11026-AAB	6105.0, 31	5.6	5.74	34.9

Hardware Setup

Phantom	TSL, Measured Date	Probe, Calibration Date	DAE, Calibration Date
ELI V8.0 (20deg probe tilt)	HBBL-600-10000, 2024-Jan-12	EX3DV4 - SN7465, 2023-07-11	DAE4ip Sn1706, 2023-07-07

Scan Setup

	Area Scan	Zoom Scan
Grid Extents [mm]	120.0 x 140.0	22.0 x 22.0 x 22.0
Grid Steps [mm]	10.0 x 10.0	3.4 x 3.4 x 1.4
Sensor Surface [mm]	3.0	1.4
Graded Grid	Yes	Yes
Grading Ratio	1.5	1.4
MAIA	Confirmed by MAIA	Confirmed by MAIA
Surface Detection	VMS + 6p	VMS + 6p
Scan Method	Measured	Measured

Measurement Results

	Area Scan	Zoom Scan
Date	2024-01-14, 20:53	2024-01-14, 21:02
psSAR1g [W/kg]	0.850	0.967
psSAR10g [W/kg]	0.210	0.233
Power Drift [dB]	-0.06	-0.17
Power Scaling	Disabled	Disabled
Scaling Factor		
TSL Correction	Positive Only	Positive Only
M2/M1 [%]		52.0
Dist 3dB Peak [mm]		5.4

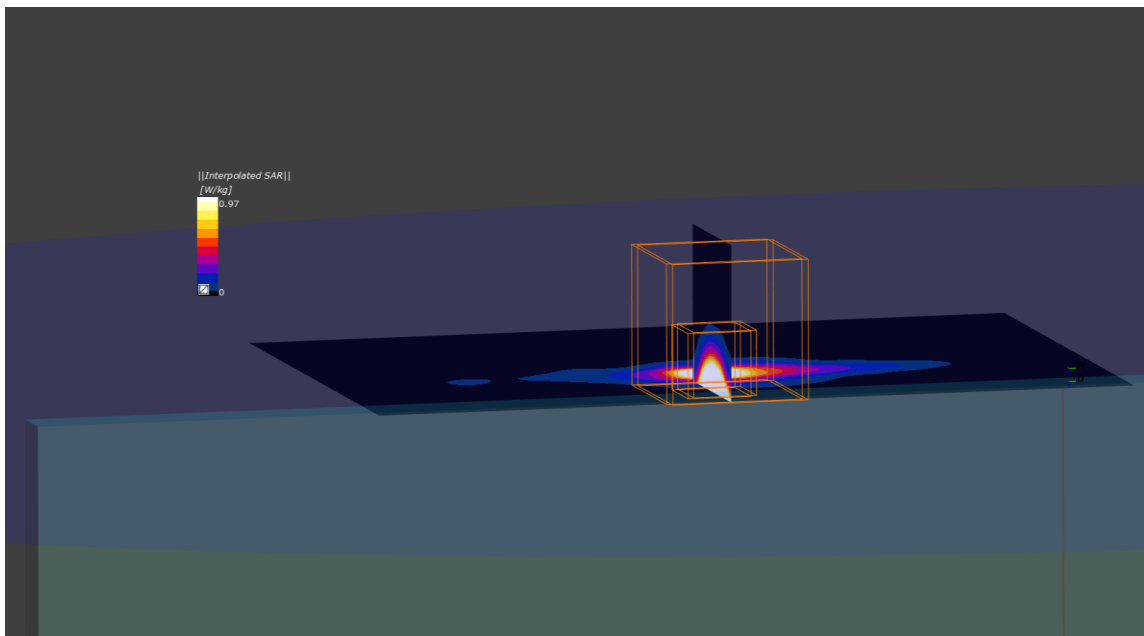

2. U-NII-6 - 802.11ax160/be160, CH111, Main– Top edge - Vendor 1 (SAR)

Device under Test Properties

Model, Manufacturer	Dimensions [mm]	SN	DUT Type
HSN-I61C, HP	220 x 329.0 x 8.0	0003770DDH	Convertible PC

Exposure Conditions

Phantom Section, TSL	Position, Test Distance [mm]	Band	Group, UID	Frequency [MHz], Channel Number	Conversion Factor	TSL Conductivity [S/m]	TSL Permittivity
Flat, HSL	EDGE TOP, 0.00	U-NII-6	WLAN, 10755-AAC	6505.000, 111	5.6	6.31	34.1

Hardware Setup

Phantom	TSL, Measured Date	Probe, Calibration Date	DAE, Calibration Date
ELI V8.0 (20deg probe tilt)	HBBL-600-10000, 2024-Jan-12	EX3DV4 - SN7465, 2023-07-11	DAE4ip Sn1706, 2023-07-07

Scan Setup

	Area Scan	Zoom Scan
Grid Extents [mm]	80.0 x 120.0	22.0 x 22.0 x 22.0
Grid Steps [mm]	10.0 x 10.0	3.4 x 3.4 x 1.4
Sensor Surface [mm]	3.0	1.4
Graded Grid	Yes	Yes
Grading Ratio	1.5	1.4
MAIA	Confirmed by MAIA	Confirmed by MAIA
Surface Detection	VMS + 6p	VMS + 6p
Scan Method	Measured	Measured

Measurement Results

	Area Scan	Zoom Scan
Date	2024-01-13, 22:24	2024-01-13, 22:34
psSAR1g [W/kg]	0.885	1.02
psSAR10g [W/kg]	0.231	0.256
Power Drift [dB]	0.08	0.19
Power Scaling	Disabled	Disabled
Scaling Factor [dB]		
TSL Correction	Positive Only	Positive Only
M2/M1 [%]		50.7
Dist 3dB Peak [mm]		5.7

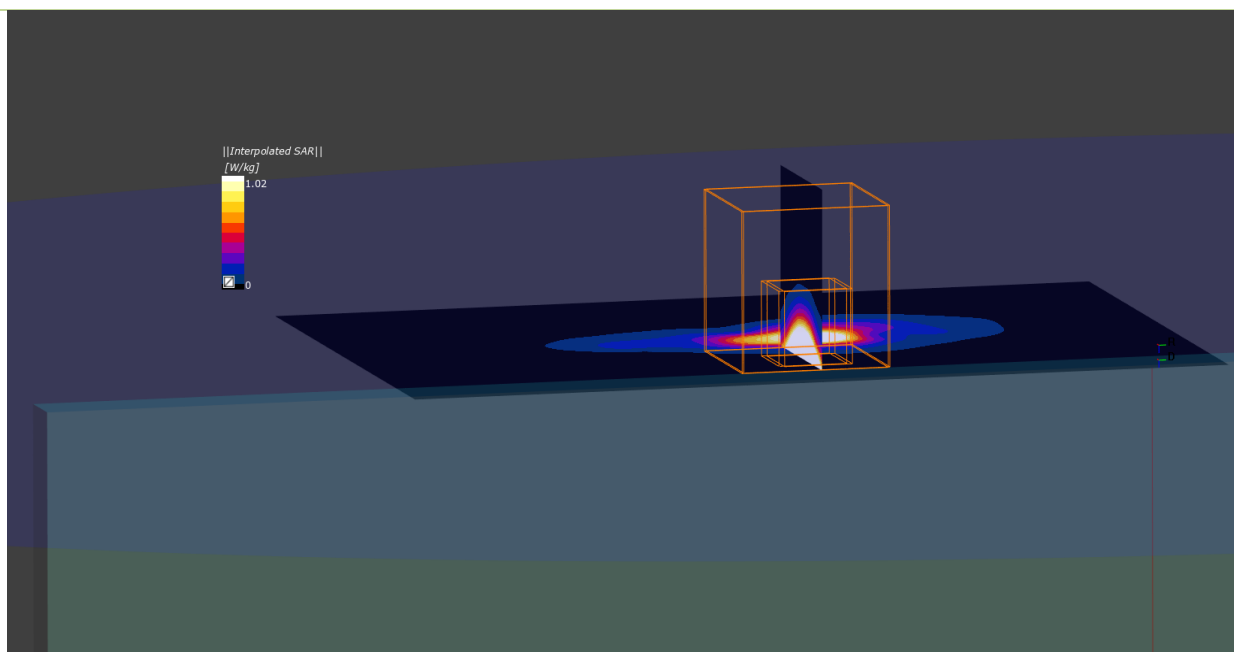

3. U-NII-7 - 802.11be320, CH159, Main– Top edge - Vendor 1 (SAR)

Device under Test Properties

Model, Manufacturer	Dimensions [mm]	SN	DUT Type
HSN-I61C, HP	220 x 329.0 x 8.0	0003770DDH	Convertible PC

Exposure Conditions

Phantom Section, TSL	Position, Test Distance [mm]	Band	Group, UID	Frequency [MHz], Channel Number	Conversion Factor	TSL Conductivity [S/m]	TSL Permittivity
Flat, HSL	EDGE TOP, 0.00	U-NII-7	WLAN, 11026-AAB	6745.0, 159	5.6	6.60	33.5

Hardware Setup

Phantom	TSL, Measured Date	Probe, Calibration Date	DAE, Calibration Date
ELI V8.0 (20deg probe tilt)	HBBL-600-10000, 2024-Jan-12	EX3DV4 - SN7465, 2023-07-11	DAE4ip Sn1706, 2023-07-07

Scan Setup

	Area Scan	Zoom Scan
Grid Extents [mm]	100.0 x 120.0	22.0 x 22.0 x 22.0
Grid Steps [mm]	10.0 x 10.0	3.4 x 3.4 x 1.4
Sensor Surface [mm]	3.0	1.4
Graded Grid	Yes	Yes
Grading Ratio	1.5	1.4
MAIA	Confirmed by MAIA	Confirmed by MAIA
Surface Detection	VMS + 6p	VMS + 6p
Scan Method	Measured	Measured

Measurement Results

	Area Scan	Zoom Scan
Date	2024-01-13, 23:38	2024-01-13, 23:53
psSAR1g [W/kg]	1.18	1.33
psSAR10g [W/kg]	0.300	0.324
Power Drift [dB]	0.11	-0.04
Power Scaling	Disabled	Disabled
Scaling Factor [dB]		
TSL Correction	Positive Only	Positive Only
M2/M1 [%]		49.0
Dist 3dB Peak [mm]		4.6

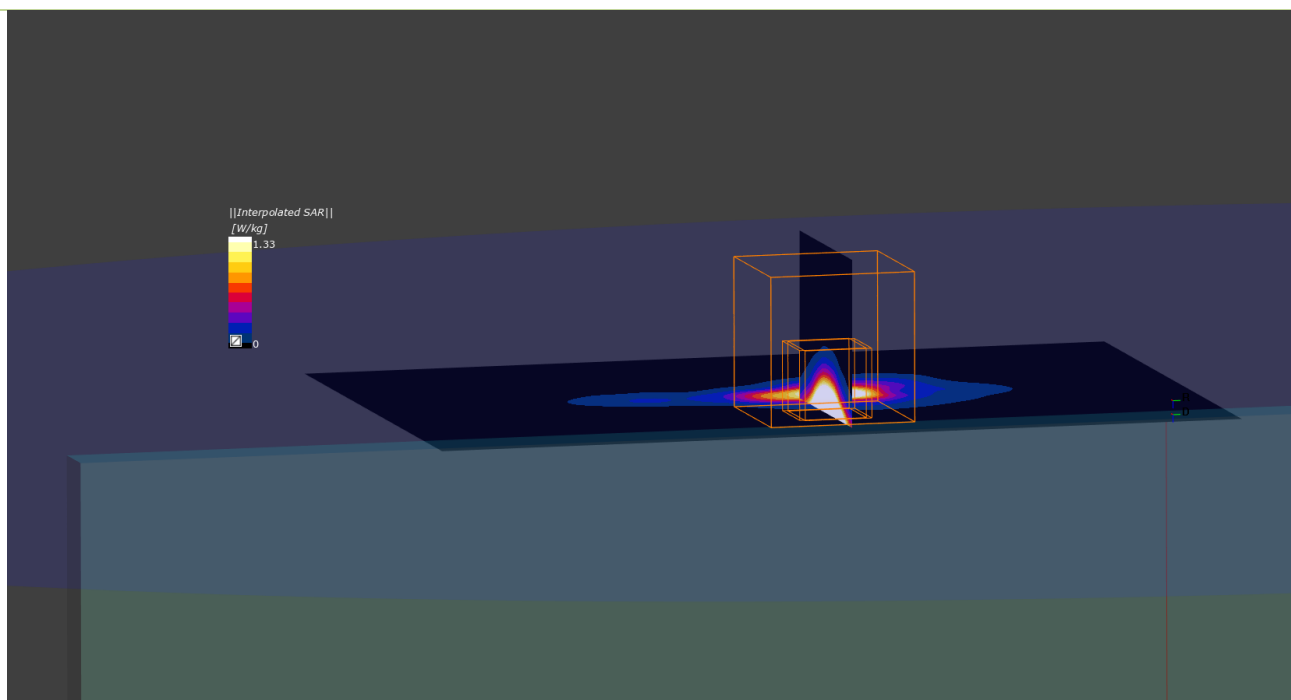

4. U-NII-8 - 802.11be320, CH191, Main- Top edge - Vendor 1 (SAR)

Device under Test Properties

Model, Manufacturer	Dimensions [mm]	SN	DUT Type
HSN-I61C, HP	220 x 329.0 x 8.0	0003770DDH	Convertible PC

Exposure Conditions

Phantom Section, TSL	Position, Test Distance [mm]	Band	Group, UID	Frequency [MHz], Channel Number	Conversion Factor	TSL Conductivity [S/m]	TSL Permittivity
Flat, HSL	EDGE TOP, 0.00	U-NII-8	WLAN, 11026-AAB	6905.0, 191	5.6	6.78	33.3

Hardware Setup

Phantom	TSL, Measured Date	Probe, Calibration Date	DAE, Calibration Date
ELI V8.0 (20deg probe tilt)	HBBL-600-10000, 2024-Jan-12	EX3DV4 - SN7465, 2023-07-11	DAE4ip Sn1706, 2023-07-07

Scan Setup

	Area Scan	Zoom Scan
Grid Extents [mm]	100.0 x 140.0	22.0 x 22.0 x 22.0
Grid Steps [mm]	10.0 x 10.0	3.4 x 3.4 x 1.4
Sensor Surface [mm]	3.0	1.4
Graded Grid	Yes	Yes
Grading Ratio	1.5	1.4
MAIA	Confirmed by MAIA	Confirmed by MAIA
Surface Detection	VMS + 6p	VMS + 6p
Scan Method	Measured	Measured

Measurement Results

	Area Scan	Zoom Scan
Date	2024-01-14, 00:33	2024-01-14, 00:46
psSAR1g [W/kg]	1.15	1.27
psSAR10g [W/kg]	0.295	0.315
Power Drift [dB]	0.14	0.11
Power Scaling	Disabled	Disabled
Scaling Factor [dB]		
TSL Correction	Positive Only	Positive Only
M2/M1 [%]		46.7
Dist 3dB Peak [mm]		4.8

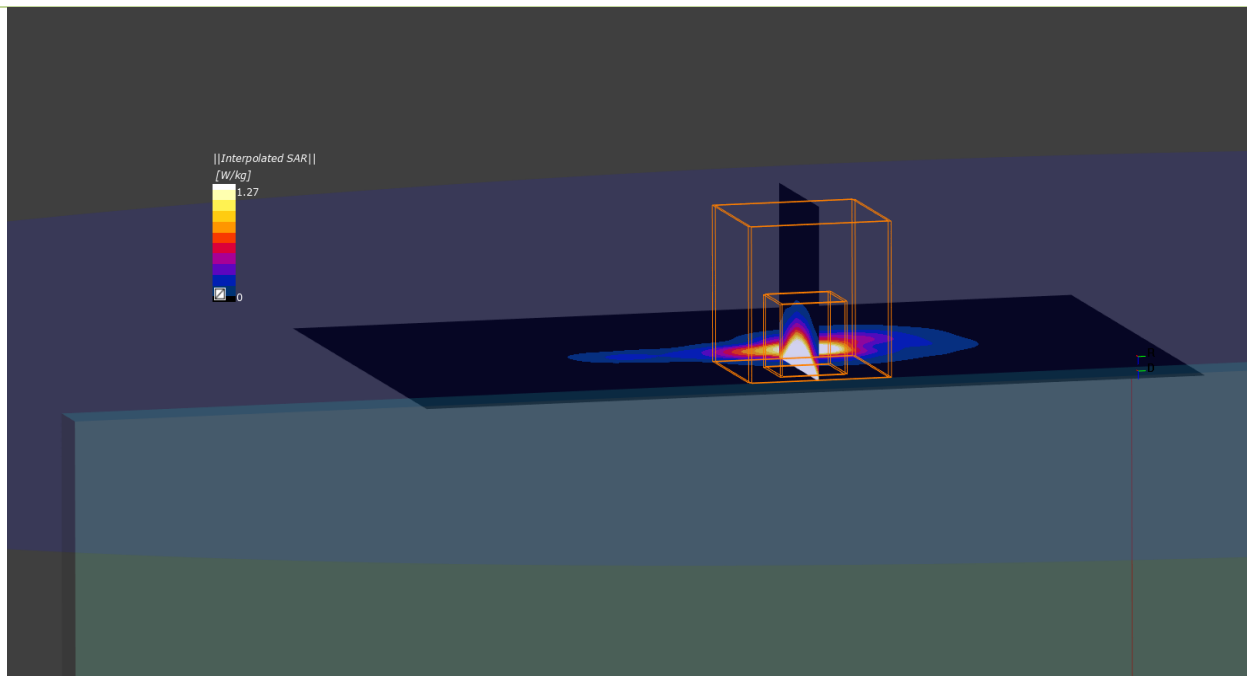

5. U-NII-5 - 802.11be320, CH63, Main-Vendor 1- Top edge (PD)

DUT: HSN-I61C w BE200NGW; Type: Convertible PC

Signal Source: modulation Custom Channel for 802.11be320, level 12.50dBm.

Medium parameters used: $\sigma = 0$ S/m, $\epsilon_r = 1$; $\rho = 0$ kg/m³

Phantom section: Table Section

Measurement Standard: DASYS6 (IEEE/IEC/ANSI C63.19-2011)

DASY Configuration:

- Probe: EUmmW – SN9538; ConvF(1, 1, 1); Calibrated: 2023-04-24;
 - Modulation Compensation:
- Sensor-Surface : 0mm (Fix Surface), z = 2mm
- Electronics: DAE4 Sn1705; Calibrated: 2023-04-18;
- Phantom: Cover; Type: SPEAG Phantom Cover
- cDASY6 5G Module v2.4
- Test Date: 2024-01-22

Distance-2mm:

Measurement Resolution = $\lambda/16$ mm

Measurement Scan area = 120 mm x 120 mm

The plots below show the average PStot (1cm²), PStot (4cm²) the E-field and the H Field

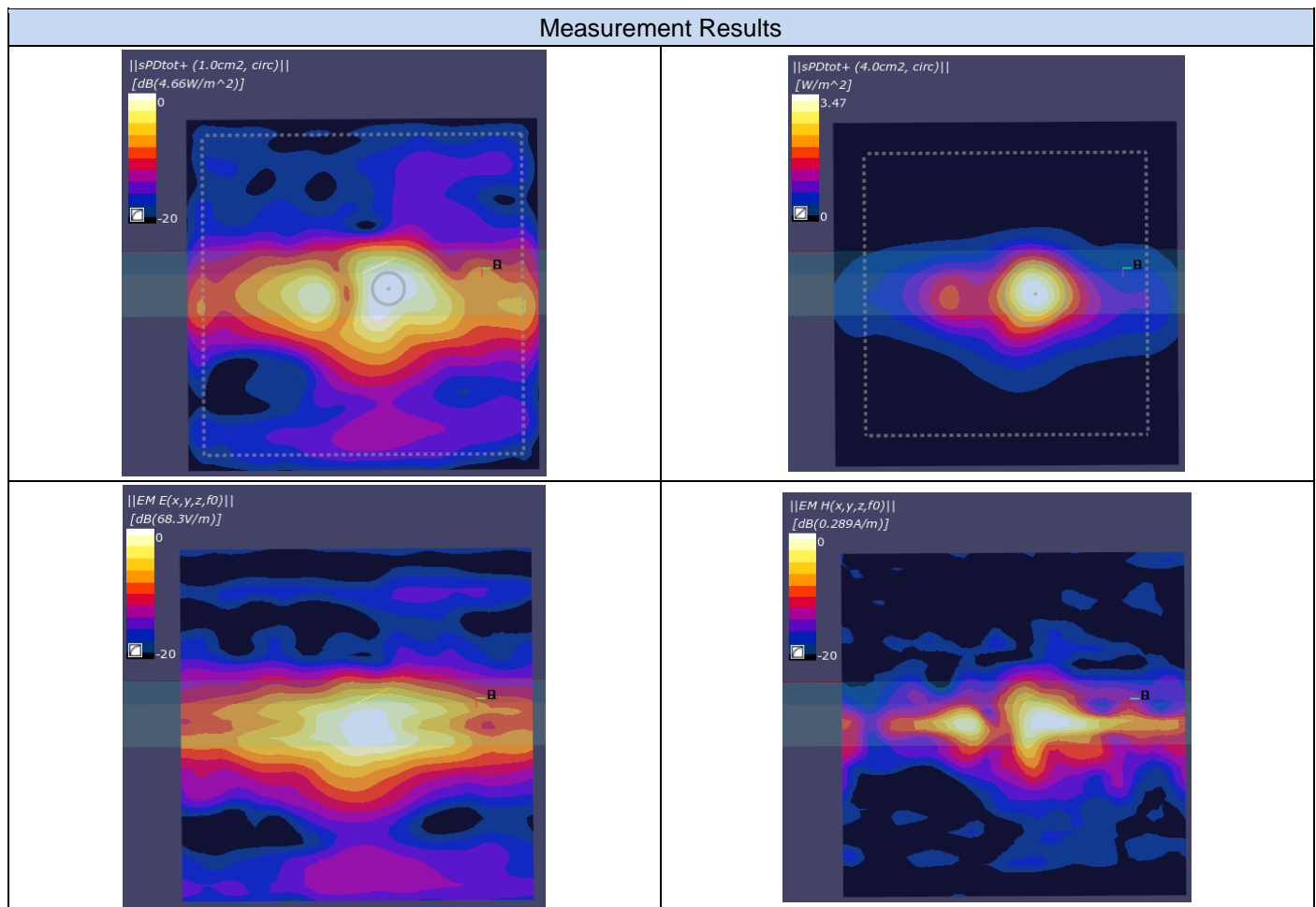

6. U-NII-6 - 802.11ax160/be160, CH111, Aux-Vendor 2- Top edge (PD)

DUT: HSN-I61C w BE200NGW; Type: Convertible PC

Signal Source: modulation Custom Channel for 802.11ax/be160, level 13.50dBm.

Medium parameters used: $\sigma = 0$ S/m, $\epsilon_r = 1$; $\rho = 0$ kg/m³

Phantom section: Table Section

Measurement Standard: DASY6 (IEEE/IEC/ANSI C63.19-2011)

DASY Configuration:

- Probe: EUmmW – SN9538; ConvF(1, 1, 1); Calibrated: 2023-04-24;
 - Modulation Compensation:
- Sensor-Surface : 0mm (Fix Surface), z = 2mm
- Electronics: DAE4 Sn1705; Calibrated: 2023-04-18;
- Phantom: Cover; Type: SPEAG Phantom Cover
- cDASY6 5G Module v2.4
- Test Date: 2024-01-21

Distance-2mm:

Measurement Resolution = $\lambda/16$ mm

Measurement Scan area = 120 mm x 120 mm

The plots below show the average PStot (1cm²), PStot (4cm²) the E-field and the H Field

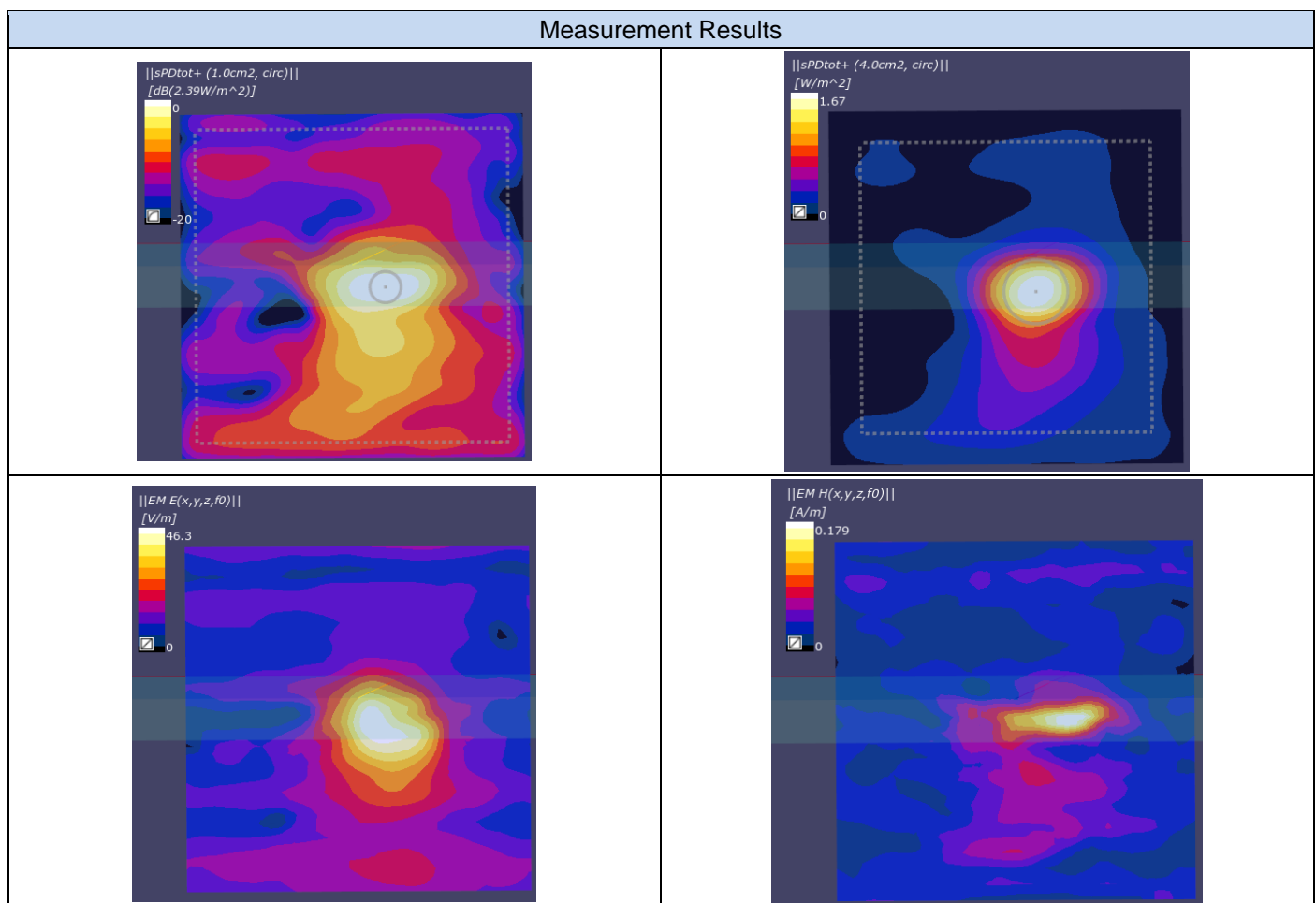

7. U-NII-7 - 802.11be320, CH159, Main-Vendor 1 -Top edge (PD)

DUT: HSN-I61C w BE200NGW; Type: Convertible PC

Signal Source: modulation Custom Channel for 802.11be320, level 13.50dBm.

Medium parameters used: $\sigma = 0$ S/m, $\epsilon_r = 1$; $\rho = 0$ kg/m³

Phantom section: Table Section

Measurement Standard: DASY6 (IEEE/IEC/ANSI C63.19-2011)

DASY Configuration:

- Probe: EUmmW – SN9538; ConvF(1, 1, 1); Calibrated: 2023-04-24;
 - Modulation Compensation:
- Sensor-Surface : 0mm (Fix Surface), z = 2mm
- Electronics: DAE4 Sn1705; Calibrated: 2023-04-18;
- Phantom: Cover; Type: SPEAG Phantom Cover
- cDASY6 5G Module v2.4
- Test Date: 2024-01-23

Distance-2mm:

Measurement Resolution = $\lambda/16$ mm

Measurement Scan area = 120 mm x 120 mm

The plots below show the average PStot (1cm²), PStot (4cm²) the E-field and the H Field

Measurement Results

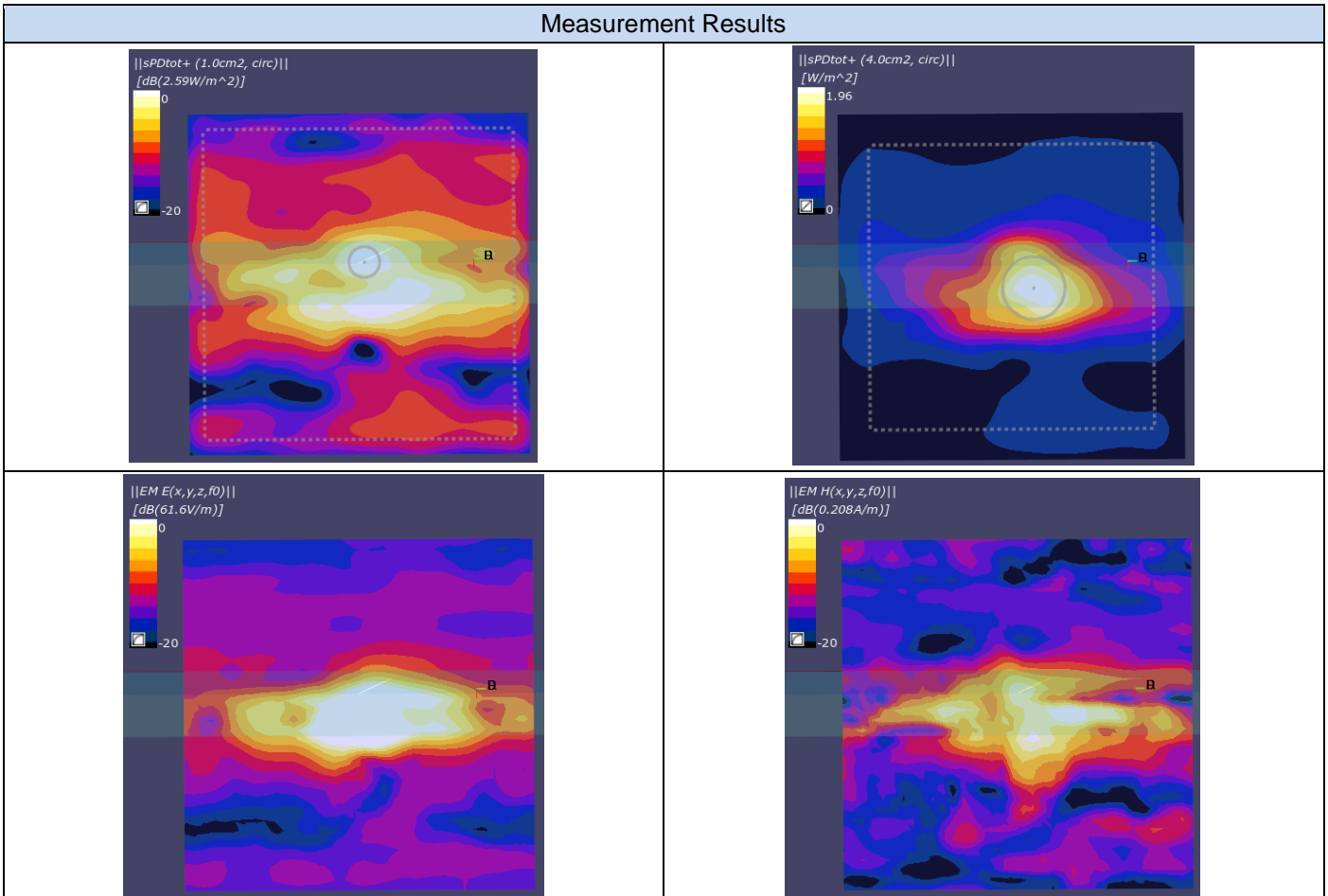

8. U-NII-8 - 802.11be320 CH191, Main-Vendor 1-Top edge (PD)

DUT: HSN-I61C w BE200NGW; Type: Convertible PC

Signal Source: modulation Custom Channel for 802.11be320, level 13.50dBm.

Medium parameters used: $\sigma = 0$ S/m, $\epsilon_r = 1$; $\rho = 0$ kg/m³

Phantom section: Table Section

Measurement Standard: DASYS6 (IEEE/IEC/ANSI C63.19-2011)

DASY Configuration:

- Probe: EUmmW – SN9538; ConvF(1, 1, 1); Calibrated: 2023-04-24;
 - Modulation Compensation:
- Sensor-Surface : 0mm (Fix Surface), z = 2mm
- Electronics: DAE4 Sn1705; Calibrated: 2023-04-18;
- Phantom: Cover; Type: SPEAG Phantom Cover
- cDASY6 5G Module v2.4
- Test Date: 2024-01-23

Distance-2mm:

Measurement Resolution = $\lambda/16$ mm

Measurement Scan area = 120 mm x 120 mm

The plots below show the average PStot (1cm²), PStot (4cm²) the E-field and the H Field

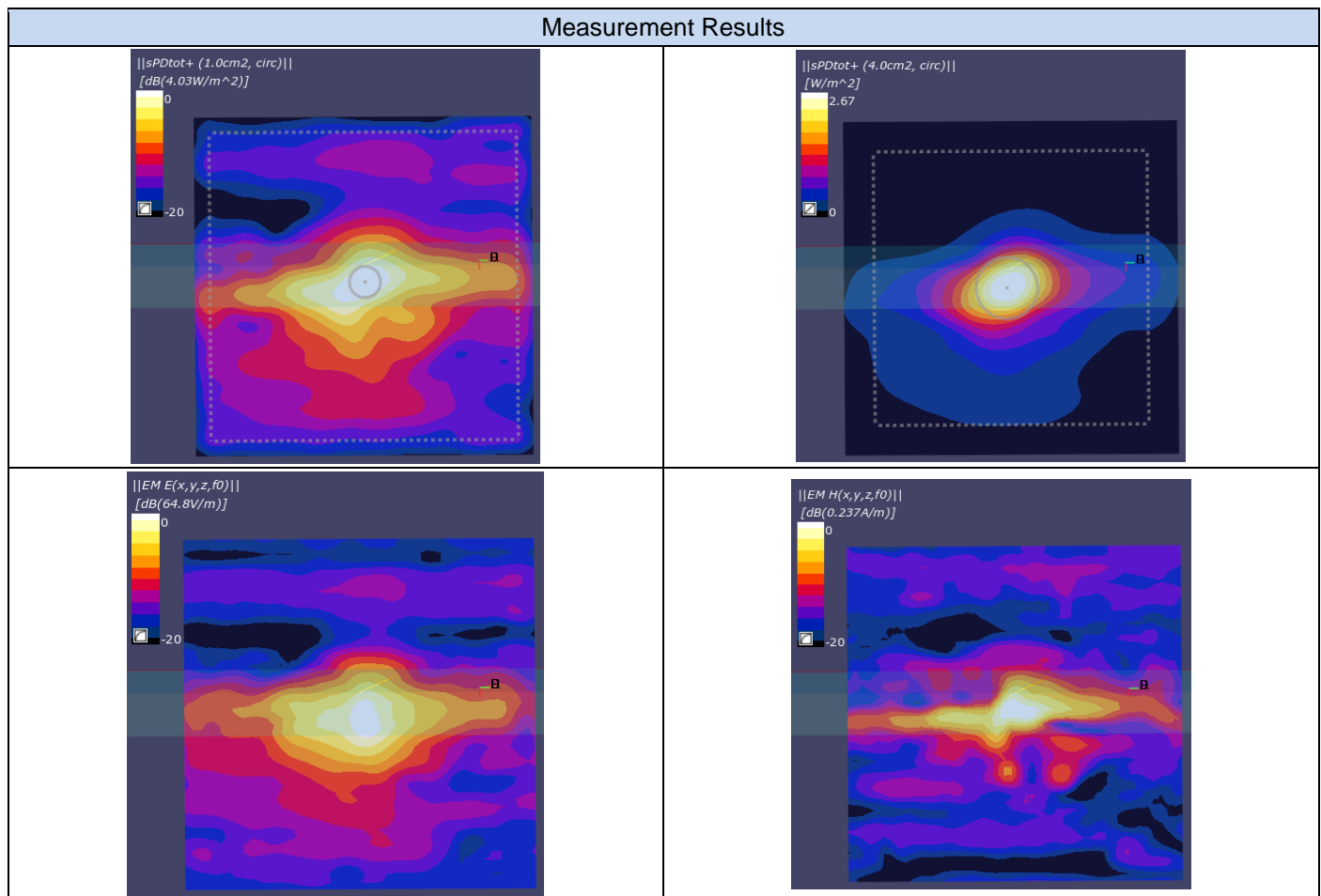

9. Power Density System Check From 6500MHz- 2024-01-16

DUT: Horn reference source; Type: PE9859/SF-15

Signal Source: modulation CW, level 10dBm.

Medium parameters used: $\sigma = 0$ S/m, $\epsilon_r = 1$; $\rho = 0$ kg/m³

Phantom section: Table Section

Measurement Standard: DASYS6 (IEEE/IEC/ANSI C63.19-2011)

DASY Configuration:

- Probe: EUmmW – SN9538; ConvF(1, 1, 1); Calibrated: 2023-04-24;
 - Modulation Compensation:
- Sensor-Surface : 0mm (Fix Surface), z = 10mm
- Electronics: DAE4 Sn1705; Calibrated: 2023-04-18;
- Phantom: Cover; Type: SPEAG Phantom Cover
- cDASY6 5G Module v2.4
- Test Date: 2024-01-16

Distance-10mm/Measure Horn reference source (86.9x63.5):

Measurement Resolution = $\lambda/4$ mm

Measurement Scan area = 200 mm x 200 mm

The plots below show the comparison between the Numerical Modeling results and the system check measurement results in terms of E-field, H Field, single point power density and Avg Power density 1cm².

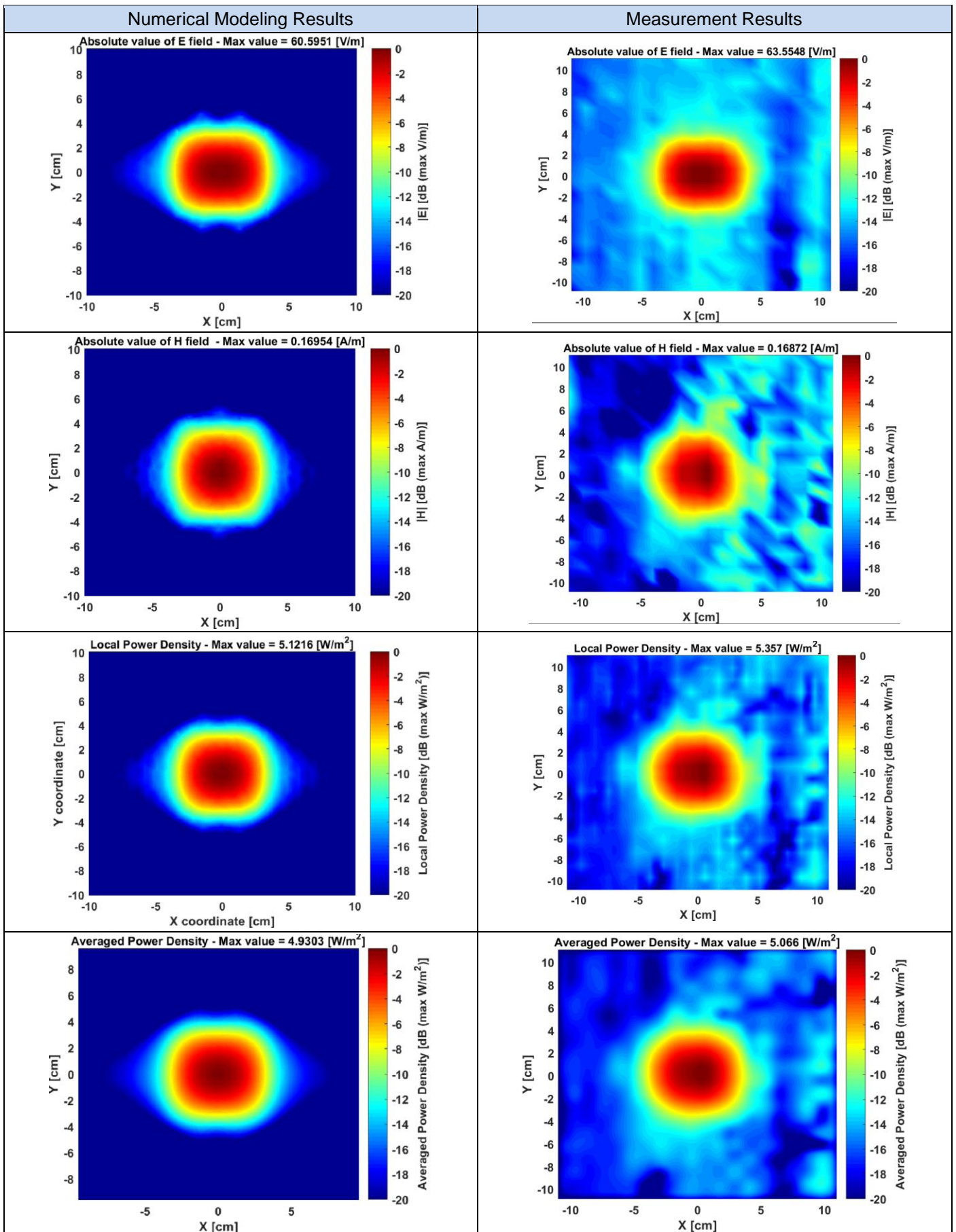

The plots below show the comparison between the numerical modeling and the system check results in terms of normalized E-field distribution and the 1D variation along the two axis of the maximum.

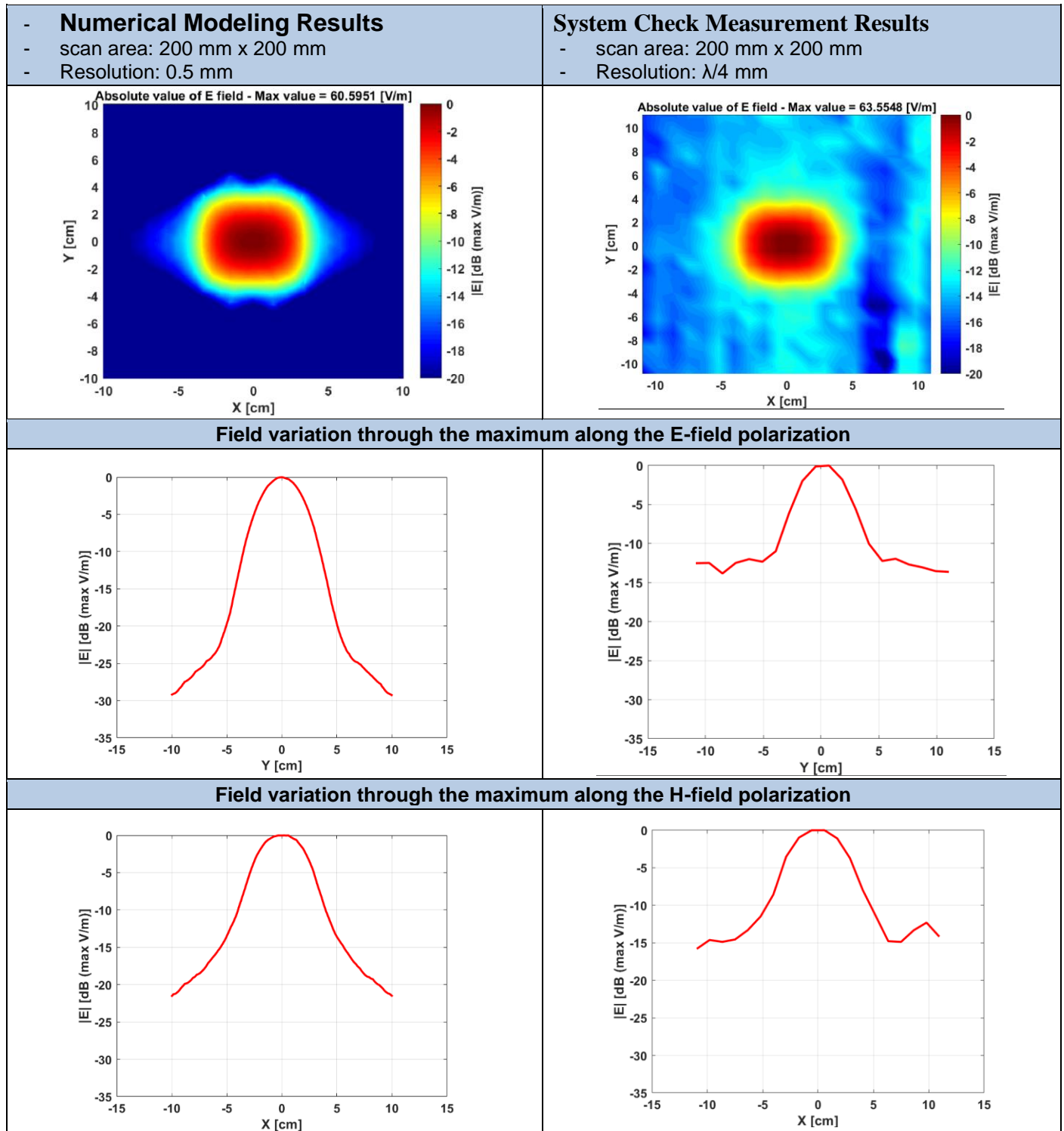

10. SAR System Check From 7000MHz- 2024-01-13

Model, Manufacturer	Dimensions [mm]	SN	DUT Type
D7.0GHzV2, Speag	50.0 x 10.0 x 8.0	1008	Validation Dipole

Exposure Conditions

Phantom Section, TSL	Position, Test Distance [mm]	Band	Group, UID	Frequency [MHz], Channel Number	Conversion Factor	TSL Conductivity [S/m]	TSL Permittivity
Flat, HSL	,		CW, 0--	7000.0, 0	5.6	6.89	33.1

Hardware Setup

Phantom	TSL, Measured Date	Probe, Calibration Date	DAE, Calibration Date
ELI V8.0 (20deg probe tilt)	HBBL-600-10000, 2024-Jan-12	EX3DV4 - SN7465, 2023-07-11	DAE4ip Sn1706, 2023-07-07

Scan Setup

	Area Scan	Zoom Scan
Grid Extents [mm]	45.0 x 90.0	22.0 x 22.0 x 22.0
Grid Steps [mm]	7.5 x 7.5	3.0 x 3.0 x 1.4
Sensor Surface [mm]	3.0	1.4
Graded Grid	Yes	Yes
Grading Ratio	1.5	1.4
MAIA	Confirmed by MAIA	Confirmed by MAIA
Surface Detection	VMS + 6p	VMS + 6p
Scan Method	Measured	Measured

Measurement Results

	Area Scan	Zoom Scan
Date	2024-01-13, 11:08	2024-01-13, 11:19
psSAR1g [W/kg]	3.83	4.44
psSAR10g [W/kg]	0.771	0.816
Power Drift [dB]	0.00	-0.15
Power Scaling	Disabled	Disabled
Scaling Factor [dB]		
TSL Correction	Positive Only	Positive Only
M2/M1 [%]		46.5
Dist 3dB Peak [mm]		4.7

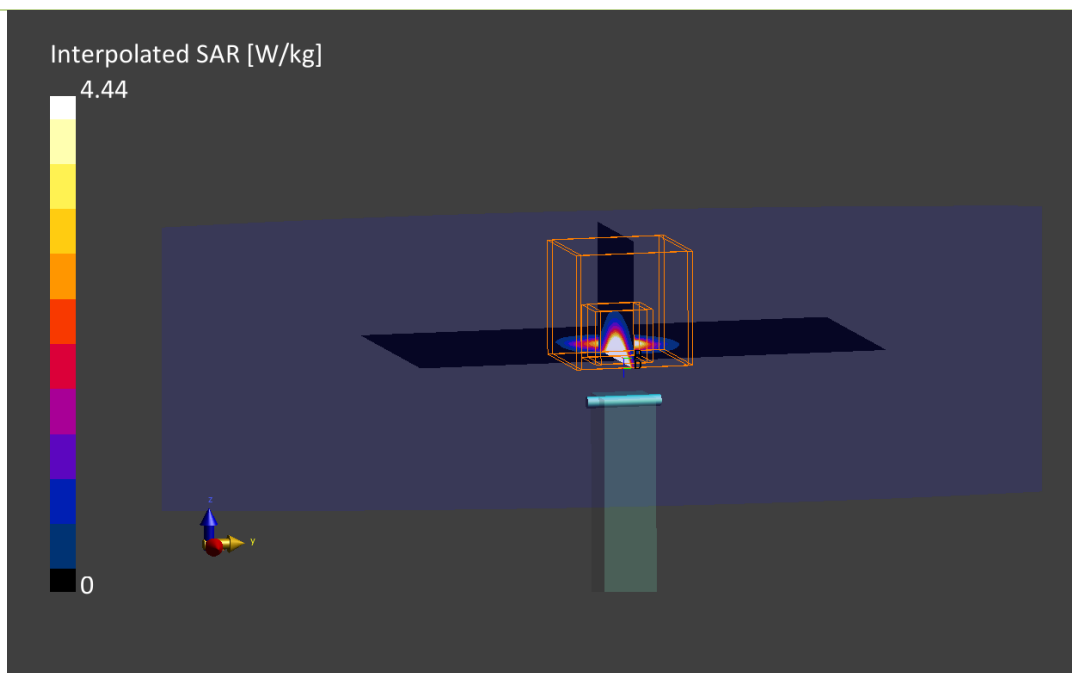

11. SAR System Check From 7000MHz- 2024-01-14

Model, Manufacturer	Dimensions [mm]	SN	DUT Type
D7.0GHzV2, Speag	50.0 x 10.0 x 8.0	1008	Validation Dipole

Exposure Conditions

Phantom Section, TSL	Position, Test Distance [mm]	Band	Group, UID	Frequency [MHz], Channel Number	Conversion Factor	TSL Conductivity [S/m]	TSL Permittivity
Flat, HSL	,		CW, 0--	7000.0, 0	5.6	6.89	33.1

Hardware Setup

Phantom	TSL, Measured Date	Probe, Calibration Date	DAE, Calibration Date
ELI V8.0 (20deg probe tilt)	HBBL-600-10000, 2024-Jan-12	EX3DV4 - SN7465, 2023-07-11	DAE4ip Sn1706, 2023-07-07

Scan Setup

	Area Scan	Zoom Scan
Grid Extents [mm]	45.0 x 90.0	22.0 x 22.0 x 22.0
Grid Steps [mm]	7.5 x 7.5	3.0 x 3.0 x 1.4
Sensor Surface [mm]	3.0	1.4
Graded Grid	Yes	Yes
Grading Ratio	1.5	1.4
MAIA	Confirmed by MAIA	Confirmed by MAIA
Surface Detection	VMS + 6p	VMS + 6p
Scan Method	Measured	Measured

Measurement Results

	Area Scan	Zoom Scan
Date	2024-01-14, 17:26	2024-01-14, 17:35
psSAR1g [W/kg]	18.8	20.8
psSAR10g [W/kg]	3.90	3.89
Power Drift [dB]	0.01	-0.04
Power Scaling	Disabled	Disabled
Scaling Factor [dB]		
TSL Correction	Positive Only	Positive Only
M2/M1 [%]		52.8
Dist 3dB Peak [mm]		4.7

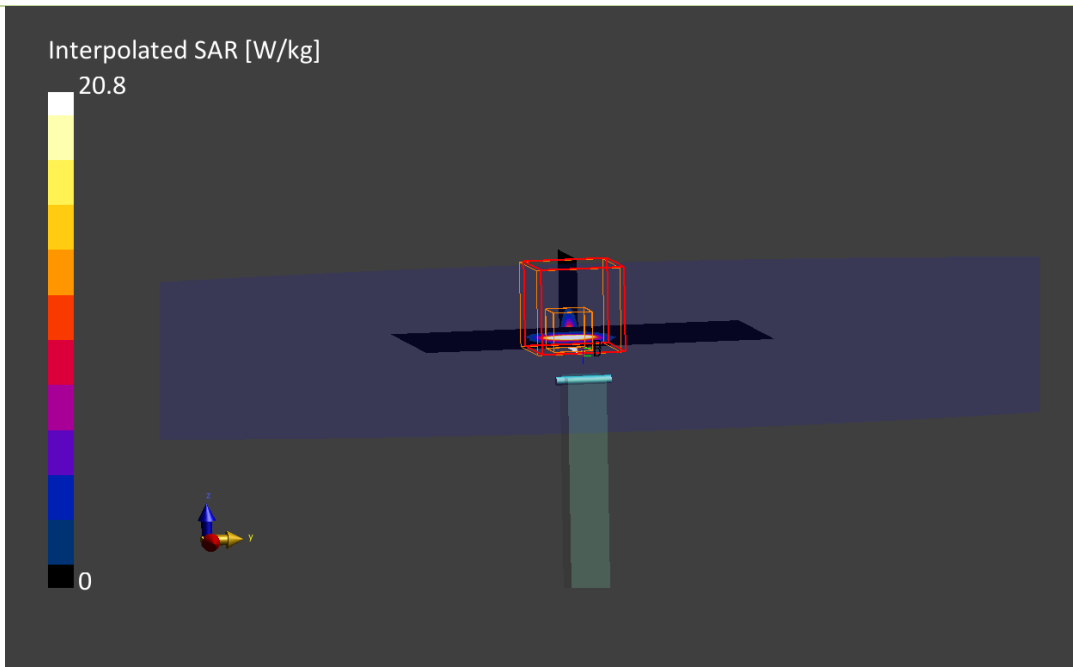

Annex E. TSL Dielectric Parameters

E.1 Head WiFi 6E 7000MHz

Freq.(MHz)	Target		2024-01-12	
	ϵ' (F/m)	σ (S/m)	$\epsilon'1$ (F/m)	$\sigma1$ (S/m)
6000.0	35.07	5.48	34.97	5.59
6050.0	35.01	5.54	34.95	5.67
6100.0	34.95	5.59	34.93	5.74
6150.0	34.89	5.65	34.88	5.81
6200.0	34.83	5.71	34.83	5.87
6250.0	34.77	5.77	34.74	5.93
6300.0	34.70	5.83	34.65	6.00
6350.0	34.64	5.89	34.53	6.08
6400.0	34.58	5.95	34.39	6.16
6450.0	34.52	6.01	34.26	6.23
6500.0	34.46	6.07	34.10	6.31
6550.0	34.40	6.13	33.94	6.38
6600.0	34.34	6.19	33.81	6.45
6650.0	34.29	6.25	33.72	6.51
6700.0	34.23	6.30	33.63	6.57
6750.0	34.17	6.36	33.54	6.63
6800.0	34.11	6.42	33.44	6.69
6850.0	34.05	6.48	33.36	6.73
6900.0	33.99	6.53	33.26	6.78
6950.0	33.94	6.59	33.18	6.84
7000.0	33.88	6.65	33.10	6.89

