

FCC SDoC REPORT

ICES-003 TEST REPORT

Project No. : TM-2211000117P
Applicant : INVENTEC CORPORATION
Address : 66 Hou-Kang st., Shih-Lin District, Taipei, Taiwan, R.O.C.
Manufacturer : INVENTEC CORPORATION
Address : 66 Hou-Kang st., Shih-Lin District, Taipei, Taiwan, R.O.C.

Equipment Under Test (EUT) :

Product Name : Notebook Computer
Brand Name : HP
Model No. : HSN-I59C
Added Model(s) : N/A
Test Voltage : AC 120V, 60Hz
Standards : 47 CFR FCC Part 15 Subpart B
 ICES-003 Issue 7: October 2020
 ANSI C63.4: 2014
Date of Sample Receipt : Nov. 07, 2022
Date of Test : Nov. 08 ~ Dec. 01, 2022
Date of Issue : Dec. 30, 2022

Test Result :	PASS
----------------------	-------------

In the configuration tested, the EUT complied with the standards specified above.

Remarks :

This report details the results of the testing carried out on one sample, the results contained in this test report do not relate to other samples of the same product. The manufacturer should ensure that all products in series production are in conformity with the product sample detailed in this report.

This report may only be reproduced and distributed in full. If the product in this report is used in any configuration other than that detailed in the report, the manufacturer must ensure the new system complies with all relevant standards. Any mention of Compliance Certification Services Inc. or testing done by Compliance Certification Services Inc. in connection with distribution or use of the product described in this report must be approved by Compliance Certification Services Inc. in writing.

Approved By:

Date:

Dec. 30, 2022

Hex Chiang (Asst. Manager)

Unless otherwise stated the results shown in this test report refer only to the sample(s) tested and such sample(s) are retained for 90 days only.

除非另有說明，此報告結果僅對測試之樣品負責，同時此樣品僅保留90天。本報告未經本公司書面許可，不可部份複製。

This document is issued by the Company subject to its General Conditions of Service printed overleaf, available on request or accessible at www.sgs.com/terms_and_conditions.htm and for electronic format documents, subject to Terms and Conditions for Electronic Documents at www.sgs.com/terms_e-document.htm. Attention is drawn to the limitation of liability, indemnification and jurisdiction issues defined therein. Any holder of this document is advised that information contained hereon reflects the Company's findings at the time of its intervention only and within the limits of Client's instructions, if any. The Company's sole responsibility is to its Client and this document does not exonerate parties to a transaction from exercising all their rights and obligations under the transaction documents. This document cannot be reproduced except in full, without prior written approval of the Company. Any unauthorized alteration, forgery or falsification of the content or appearance of this document is unlawful and offenders may be prosecuted to the fullest extent of the law.

Revision History

Revision	Report Number	Description	Issue Date
00	TMWK2211004533KE	Original	Dec. 30, 2022

Unless otherwise stated the results shown in this test report refer only to the sample(s) tested and such sample(s) are retained for 90 days only.

除非另有說明，此報告結果僅對測試之樣品負責，同時此樣品僅保留90天。本報告未經本公司書面許可，不可部份複製。

This document is issued by the Company subject to its General Conditions of Service printed overleaf, available on request or accessible at www.sgs.com/terms_and_conditions.htm and for electronic format documents, subject to Terms and Conditions for Electronic Documents at www.sgs.com/terms_e-document.htm. Attention is drawn to the limitation of liability, indemnification and jurisdiction issues defined therein. Any holder of this document is advised that information contained hereon reflects the Company's findings at the time of its intervention only and within the limits of Client's instructions, if any. The Company's sole responsibility is to its Client and this document does not exonerate parties to a transaction from exercising all their rights and obligations under the transaction documents. This document cannot be reproduced except in full, without prior written approval of the Company. Any unauthorized alteration, forgery or falsification of the content or appearance of this document is unlawful and offenders may be prosecuted to the fullest extent of the law.

Contents

1. GENERAL INFORMATION	4
1.1 APPLICANT & MANUFACTURER INFORMATION	4
1.2 GENERAL DESCRIPTION OF EUT	4
1.3 DETAILS OF EUT	5
1.4 THE WORST CASE OF THE EUT	9
1.5 DESCRIPTION OF SUPPORT UNITS	10
1.6 OPERATION PROCEDURE	13
1.7 TEST SET-UP CONFIGURATION	14
1.8 ACCESSORIES CABLE LIST	16
1.9 MEASUREMENT PROCEDURE	16
1.10 STANDARDS APPLICABLE FOR TESTING	16
1.11 DECISION RULES OF RESULTS	17
1.12 SUMMARY OF RESULTS	17
1.13 REPORTING STATEMENTS OF CONFORMITY	17
2. EMISSION	18
2.1 TEST RESULTS	18
2.2 FREQUENCY RANGE	18
2.3 LIMITS OF CONDUCTED AND RADIATED EMISSION	19
2.3.1 LIMITS OF CONDUCTED EMISSION	19
2.3.2 LIMITS OF RADIATED EMISSIONS	20
2.4. TEST OF CONDUCTED EMISSION	22
2.4.1 TEST EQUIPMENTS	22
2.4.2 MEASUREMENT LEVEL CALCULATION	22
2.4.3 MEASUREMENT DATA:	23
2.5 TEST OF RADIATED EMISSION	27
2.5.1 TEST EQUIPMENTS	27
2.5.2 MEASUREMENT LEVEL CALCULATION	28
2.5.3 MEASUREMENT DATA	29
APPENDIX	45
PHOTOGRAPH OF TESTING GENERAL SET-UP	45
PHOTOGRAPHS OF PRODUCT	51

Unless otherwise stated the results shown in this test report refer only to the sample(s) tested and such sample(s) are retained for 90 days only.

除非另有說明，此報告結果僅對測試之樣品負責，同時此樣品僅保留90天。本報告未經本公司書面許可，不可部份複製。

This document is issued by the Company subject to its General Conditions of Service printed overleaf, available on request or accessible at www.sgs.com/terms_and_conditions.htm and for electronic format documents, subject to Terms and Conditions for Electronic Documents at www.sgs.com/terms_e-document.htm. Attention is drawn to the limitation of liability, indemnification and jurisdiction issues defined therein. Any holder of this document is advised that information contained hereon reflects the Company's findings at the time of its intervention only and within the limits of Client's instructions, if any. The Company's sole responsibility is to its Client and this document does not exonerate parties to a transaction from exercising all their rights and obligations under the transaction documents. This document cannot be reproduced except in full, without prior written approval of the Company. Any unauthorized alteration, forgery or falsification of the content or appearance of this document is unlawful and offenders may be prosecuted to the fullest extent of the law.

1. General Information

1.1 Applicant & Manufacturer Information

Applicant : INVENTEC CORPORATION
Address : 66 Hou-Kang st., Shih-Lin District, Taipei, Taiwan, R.O.C.
Manufacturer : INVENTEC CORPORATION
Address : 66 Hou-Kang st., Shih-Lin District, Taipei, Taiwan, R.O.C.

1.2 General Description of EUT

Product Name : Notebook Computer
Brand Name : HP
Model No. : HSN-I59C
Added Model(s) : N/A
Variant Description : N/A

Unless otherwise stated the results shown in this test report refer only to the sample(s) tested and such sample(s) are retained for 90 days only.

除非另有說明，此報告結果僅對測試之樣品負責，同時此樣品僅保留90天。本報告未經本公司書面許可，不可部份複製。

This document is issued by the Company subject to its General Conditions of Service printed overleaf, available on request or accessible at www.sgs.com/terms_and_conditions.htm and for electronic format documents, subject to Terms and Conditions for Electronic Documents at www.sgs.com/terms_e-document.htm. Attention is drawn to the limitation of liability, indemnification and jurisdiction issues defined therein. Any holder of this document is advised that information contained hereon reflects the Company's findings at the time of its intervention only and within the limits of Client's instructions, if any. The Company's sole responsibility is to its Client and this document does not exonerate parties to a transaction from exercising all their rights and obligations under the transaction documents. This document cannot be reproduced except in full, without prior written approval of the Company. Any unauthorized alteration, forgery or falsification of the content or appearance of this document is unlawful and offenders may be prosecuted to the fullest extent of the law.

1.3 Details of EUT

EUT Power Rating	AC 100 ~ 240V	
Highest operate description	7.1GHz	
AC Adapter	Acbel (hp)	TPN-AA08
	Chicony (hp)	TPN-CA21
		TPN-CA30
	Delta (hp)	TPN-DA20
		TPN-DA26
		TPN-DA24
	Lite-on (hp)	TPN-LA22
TPN-LA23		
Honor (hp)	TPN-HA01	
Adapter Power Rating	For TPN-AA08; TPN-DA20 I/P: 100-240Vac, 50-60Hz, 1.7A O/P: 20.0Vdc, 3.25A/ 15.0Vdc, 4.33A/ 12.0Vdc, 5.0A/ 9.0Vdc, 3.0A/ 5.0V, 3.0A	
	For TPN-CA21; TPN-DA26; TPN-LA22; TPN-LA23; TPN-HA01; TPN-CA30 I/P: 100-240Vac, 50-60Hz, 1.6A O/P: 5Vdc, 3A/ 9Vdc, 3A/ 12Vdc, 5A/ 15Vdc, 4.33A/ 20Vdc, 3.25A	
	For TPN-DA24 I/P: 100-240Vac, 50-60Hz, 1.6A O/P: USB-A O/P: 5Vdc, 2A (10W) USB-C O/P: 5Vdc, 3A (15W) / 9Vdc, 3A / 12Vdc, 5A / 15Vdc, 5A / 20Vdc, 5A (100W)	
AC Power Cord Type	Non-shielded, 1.0m (Detachable) to Power Adapter	
DC Power Cable Type	Non-shielded, 1.8m (Non-Detachable) to Power Adapter	
Memory	DDR 5 6400MHz (32GB/64GB)	
Main Board (RPL)	Inventec	HSN-I59MB
CPU	Intel	i5-1335U 1.30GHZ
		i5-1345U 1.60GHZ
		i7-1355U 1.70GHZ
		i7-1365U 1.80GHZ

Unless otherwise stated the results shown in this test report refer only to the sample(s) tested and such sample(s) are retained for 90 days only.

除非另有說明，此報告結果僅對測試之樣品負責，同時此樣品僅保留90天。本報告未經本公司書面許可，不可部份複製。

This document is issued by the Company subject to its General Conditions of Service printed overleaf, available on request or accessible at www.sgs.com/terms_and_conditions.htm and for electronic format documents, subject to Terms and Conditions for Electronic Documents at www.sgs.com/terms_e-document.htm. Attention is drawn to the limitation of liability, indemnification and jurisdiction issues defined therein. Any holder of this document is advised that information contained hereon reflects the Company's findings at the time of its intervention only and within the limits of Client's instructions, if any. The Company's sole responsibility is to its Client and this document does not exonerate parties to a transaction from exercising all their rights and obligations under the transaction documents. This document cannot be reproduced except in full, without prior written approval of the Company. Any unauthorized alteration, forgery or falsification of the content or appearance of this document is unlawful and offenders may be prosecuted to the fullest extent of the law.

13.5" LCD Panel	IVO	X135NV42
	INX	N135NCG-GT1
	LGD	LP135WU1
	SDC	ATNA35VJ07
Touch Screen	GIS	9AN13505-001
		9AN13504-001
	TPK	T08ALC13504HA
		T08ALC13503HA
eMMC	Hynix	H26M62002JPR (32GB)
	Kingston	EMMC32G-TX29-HP (32GB)
	Phison	HTE5A0MI-32GE (32GB)
	Samsung	KLMBG2JETD-B041 (32GB)
	Western Digital	SDINBDV4-32-1014V (32GB)
SSD	Kingston	OM3PGP4256P-AH (256GB)
	Kioxia	KBG5AZNV256G (256GB)
		KBG50ZNS256G (256GB)
		KXG8AZNV512G (512GB)
		KBG50ZNV512G (512GB)
		KXG80ZNV512G (512GB)
		KXG8AZNV1T02 (1TB)
		KXG80ZNV1T02 (1TB)
	KXG80ZNV2T04 (2TB)	
	Micron	MTFDKKBK256TFK-1BC1AABHA (256GB)
		MTFDKBA512TFH-1BC15ABHA (512GB)
		MTFDKBA512TFK-1BC1AABHA (512GB)
		MTFDKBA512QFM-1BD1AABHA (512GB)
		MTFDKBA512TFH-1BC1AABHA (512GB)
		MTFDKBA1T0TFH-1BC15ABHA (1TB)
		MTFDKBA1T0TFH-1BC1AABHA (1TB)
		MTFDKBA2T0TFH-1BC1AABHA (2TB)
	Samsung	MZVL2512HCJQ-00BH7 (512GB)
		MZVL4512HBLU-00BH1 (512GB)
		MZVL2512HDJD-00BH1 (512GB)
		MZVL2512HDJD-00BH7 (512GB)
		MZVL21T0HCLR-00BH7 (1TB)
		MZVL21T0HDLU-00BH1 (1TB)
MZVL21T0HDLU-00BH7 (1TB)		
MZVL22T0HBLB-00BH1 (2TB)		

Unless otherwise stated the results shown in this test report refer only to the sample(s) tested and such sample(s) are retained for 90 days only.

除非另有說明，此報告結果僅對測試之樣品負責，同時此樣品僅保留90天。本報告未經本公司書面許可，不可部份複製。

This document is issued by the Company subject to its General Conditions of Service printed overleaf, available on request or accessible at www.sgs.com/terms_and_conditions.htm and for electronic format documents, subject to Terms and Conditions for Electronic Documents at www.sgs.com/terms_e-document.htm. Attention is drawn to the limitation of liability, indemnification and jurisdiction issues defined therein. Any holder of this document is advised that information contained hereon reflects the Company's findings at the time of its intervention only and within the limits of Client's instructions, if any. The Company's sole responsibility is to its Client and this document does not exonerate parties to a transaction from exercising all their rights and obligations under the transaction documents. This document cannot be reproduced except in full, without prior written approval of the Company. Any unauthorized alteration, forgery or falsification of the content or appearance of this document is unlawful and offenders may be prosecuted to the fullest extent of the law.

SSD	Western Digital	SDDQNQD-256G-1006 (256GB)
		SDDPTQD-256G-1006 (256GB)
		SDCQNRV-512G-1006 (512GB)
		SDDPNQD-512G-1006 (512GB)
		SDCPNRY-512G-1006 (512GB)
		SDCQNRV-1T00-1006 (1TB)
		SDCPNRY-1T00-1006 (1TB)
		SDCPNRZ-2T00-1006 (2TB)
	SK hynix	HFS512GEJ9X108N (512GB)
		HFS512GEJ9X101N (512GB)
HFS001TEJ9X101N (1TB)		
HFS002TEJ9X101N (2TB)		
SSSTC	CL4-3D256-HP (256GB)	
Solidigm	SSDPFKNU512GZH (512GB)	
Battery Pack	CosMX (hp)	HSTNN-OB2M
		HSTNN-OB2L
	Dynapack (hp)	TPN-DB00
		TPN-DB0N
Wireless LAN+Bluetooth Combo	Intel	AX211D2W
NFC	WNC	XRAV-1
WWAN	Fibocom	L860-GL-16
		FM350-GL
		FB520
CCD	Chicony	CJFME2220004330LH
	TFC	YHE

Unless otherwise stated the results shown in this test report refer only to the sample(s) tested and such sample(s) are retained for 90 days only.

除非另有說明，此報告結果僅對測試之樣品負責，同時此樣品僅保留90天。本報告未經本公司書面許可，不可部份複製。

This document is issued by the Company subject to its General Conditions of Service printed overleaf, available on request or accessible at www.sgs.com/terms_and_conditions.htm and for electronic format documents, subject to Terms and Conditions for Electronic Documents at www.sgs.com/terms_e-document.htm. Attention is drawn to the limitation of liability, indemnification and jurisdiction issues defined therein. Any holder of this document is advised that information contained hereon reflects the Company's findings at the time of its intervention only and within the limits of Client's instructions, if any. The Company's sole responsibility is to its Client and this document does not exonerate parties to a transaction from exercising all their rights and obligations under the transaction documents. This document cannot be reproduced except in full, without prior written approval of the Company. Any unauthorized alteration, forgery or falsification of the content or appearance of this document is unlawful and offenders may be prosecuted to the fullest extent of the law.

Pre-test Mode

Mode	CPU	Memory	Panel	Touch Screen	SSD	eMMC	WLAN+BT	NFC	WWAN	CCD	Battery Pack	Main Board	Adapter	Docking
1	Intel i5-1335U 1.30GHz	32GB DDR5 6400MHz	I/O X135NV42	GIS 9AN13504-001	Kingston OM3PGP4256P-AH (256GB)	N/A	Intel AX211D2W	WNC XRAV-1	Fibocom L860-GL-16	Chicony CJFME222004330LH	CosMX (hp) HSTNN-OB2M	Intevent HSN-159MB	Acbel(hp) TPN-AA08	N/A
2	Intel i5-1345U 1.60GHz	64GB DDR5 6400MHz	INX N135NCG-GT1	GIS 9AN13504-001	Kioxia KBG58ZNV256G (256GB)	N/A	Intel AX211D2W	WNC XRAV-1	Fibocom FM350-GL	TFC YHE	CosMX (hp) HSTNN-OB2L	Intevent HSN-159MB	Chicony(hp) TPN-CA21	N/A
3	Intel i7-1355U 1.70GHz	64GB DDR5 6400MHz	LGD LP135WU1	TPK T08ALC13504HA	Kioxia KBG50ZNS256G (256GB)	N/A	Intel AX211D2W	WNC XRAV-1	Fibocom FB520	TFC YHE	Dynapack (hp) TPN-DB00	Intevent HSN-159MB	Chicony(hp) TPN-CA30	N/A
4	Intel i7-1365U 1.80GHz	64GB DDR5 6400MHz	SDC ATNA35VJ07	TPK T08ALC13503HA	Kioxia KXG8AZNV512G (512GB)	N/A	Intel AX211D2W	WNC XRAV-1	Fibocom FM350-GL	TFC YHE	Dynapack (hp) TPN-DB00	Intevent HSN-159MB	Delta(hp) TPN-DA20	N/A
5	Intel i7-1365U 1.80GHz	64GB DDR5 6400MHz	LGD LP135WU1	GIS 9AN13504-001	Kioxia KBG50ZNV512G (512GB)	N/A	Intel AX211D2W	WNC XRAV-1	Fibocom FM350-GL	TFC YHE	Dynapack (hp) TPN-DB00	Intevent HSN-159MB	Delta(hp) TPN-DA26	N/A
6	Intel i7-1365U 1.80GHz	64GB DDR5 6400MHz	LGD LP135WU1	GIS 9AN13504-001	Kioxia KXG80ZNV512G (512GB)	N/A	Intel AX211D2W	WNC XRAV-1	Fibocom FM350-GL	TFC YHE	Dynapack (hp) TPN-DB00	Intevent HSN-159MB	Delta(hp) TPN-DA24	N/A
7	Intel i7-1365U 1.80GHz	64GB DDR5 6400MHz	LGD LP135WU1	GIS 9AN13504-001	Kioxia KXG8AZNV1T02 (1TB)	N/A	Intel AX211D2W	WNC XRAV-1	Fibocom FM350-GL	TFC YHE	Dynapack (hp) TPN-DB00	Intevent HSN-159MB	Lite-On(hp) TPN-LA22	N/A
8	Intel i7-1365U 1.80GHz	64GB DDR5 6400MHz	LGD LP135WU1	GIS 9AN13504-001	Kioxia KXG80ZNV1T02 (1TB)	N/A	Intel AX211D2W	WNC XRAV-1	Fibocom FM350-GL	TFC YHE	Dynapack (hp) TPN-DB00	Intevent HSN-159MB	Lite-On(hp) TPN-LA23	N/A
9	Intel i7-1365U 1.80GHz	64GB DDR5 6400MHz	LGD LP135WU1	GIS 9AN13504-001	Kioxia KXG80ZNV2T04 (2TB)	N/A	Intel AX211D2W	WNC XRAV-1	Fibocom FM350-GL	TFC YHE	Dynapack (hp) TPN-DB00	Intevent HSN-159MB	Honor (hp) TPN-HA01	N/A
10	Intel i7-1365U 1.80GHz	64GB DDR5 6400MHz	LGD LP135WU1	GIS 9AN13504-001	Micron MTFDKBK256TFK-1BC1AABHA (256GB)	N/A	Intel AX211D2W	WNC XRAV-1	Fibocom FM350-GL	TFC YHE	Dynapack (hp) TPN-DB00	Intevent HSN-159MB	Delta(hp) TPN-DA20	N/A
11	Intel i7-1365U 1.80GHz	64GB DDR5 6400MHz	LGD LP135WU1	GIS 9AN13504-001	Micron MTFDKBA512TFH-1BC15ABHA (512GB)	N/A	Intel AX211D2W	WNC XRAV-1	Fibocom FM350-GL	TFC YHE	Dynapack (hp) TPN-DB00	Intevent HSN-159MB	Delta(hp) TPN-DA20	N/A
12	Intel i7-1365U 1.80GHz	64GB DDR5 6400MHz	LGD LP135WU1	GIS 9AN13504-001	Micron MTFDKBA512TFK-1BC1AABHA (512GB)	N/A	Intel AX211D2W	WNC XRAV-1	Fibocom FM350-GL	TFC YHE	Dynapack (hp) TPN-DB00	Intevent HSN-159MB	Delta(hp) TPN-DA20	N/A
13	Intel i7-1365U 1.80GHz	64GB DDR5 6400MHz	LGD LP135WU1	GIS 9AN13504-001	Micron MTFDKBA512CFM-1BD1AABHA (512GB)	N/A	Intel AX211D2W	WNC XRAV-1	Fibocom FM350-GL	TFC YHE	Dynapack (hp) TPN-DB00	Intevent HSN-159MB	Delta(hp) TPN-DA20	N/A
14	Intel i7-1365U 1.80GHz	64GB DDR5 6400MHz	LGD LP135WU1	GIS 9AN13504-001	Micron MTFDKBA512TFH-1BC1AABHA (512GB)	N/A	Intel AX211D2W	WNC XRAV-1	Fibocom FM350-GL	TFC YHE	Dynapack (hp) TPN-DB00	Intevent HSN-159MB	Delta(hp) TPN-DA20	N/A
15	Intel i7-1365U 1.80GHz	64GB DDR5 6400MHz	LGD LP135WU1	GIS 9AN13504-001	Micron MTFDKBA10T0FH-1BC15ABHA (1TB)	N/A	Intel AX211D2W	WNC XRAV-1	Fibocom FM350-GL	TFC YHE	Dynapack (hp) TPN-DB00	Intevent HSN-159MB	Delta(hp) TPN-DA20	N/A
16	Intel i7-1365U 1.80GHz	64GB DDR5 6400MHz	LGD LP135WU1	GIS 9AN13504-001	Micron MTFDKBA110TFH-1BC1AABHA (1TB)	N/A	Intel AX211D2W	WNC XRAV-1	Fibocom FM350-GL	TFC YHE	Dynapack (hp) TPN-DB00	Intevent HSN-159MB	Delta(hp) TPN-DA20	N/A
17	Intel i7-1365U 1.80GHz	64GB DDR5 6400MHz	LGD LP135WU1	GIS 9AN13504-001	Micron MTFDKBA2T0TFH-1BC1AABHA (2TB)	N/A	Intel AX211D2W	WNC XRAV-1	Fibocom FM350-GL	TFC YHE	Dynapack (hp) TPN-DB00	Intevent HSN-159MB	Delta(hp) TPN-DA20	N/A
18	Intel i7-1365U 1.80GHz	64GB DDR5 6400MHz	LGD LP135WU1	GIS 9AN13504-001	Samsung MZVL22512HDJ-00BH7 (512GB)	N/A	Intel AX211D2W	WNC XRAV-1	Fibocom FM350-GL	TFC YHE	Dynapack (hp) TPN-DB00	Intevent HSN-159MB	Delta(hp) TPN-DA20	N/A
19	Intel i7-1365U 1.80GHz	64GB DDR5 6400MHz	LGD LP135WU1	GIS 9AN13504-001	Samsung MZVL4512HBLU-00BH1 (512GB)	N/A	Intel AX211D2W	WNC XRAV-1	Fibocom FM350-GL	TFC YHE	Dynapack (hp) TPN-DB00	Intevent HSN-159MB	Delta(hp) TPN-DA20	N/A
20	Intel i7-1365U 1.80GHz	64GB DDR5 6400MHz	LGD LP135WU1	GIS 9AN13504-001	Samsung MZVL2512HDJ-00BH1 (512GB)	N/A	Intel AX211D2W	WNC XRAV-1	Fibocom FM350-GL	TFC YHE	Dynapack (hp) TPN-DB00	Intevent HSN-159MB	Delta(hp) TPN-DA20	N/A
21	Intel i7-1365U 1.80GHz	64GB DDR5 6400MHz	LGD LP135WU1	GIS 9AN13504-001	Samsung MZVL2110HCLR-00BH7 (1TB)	N/A	Intel AX211D2W	WNC XRAV-1	Fibocom FM350-GL	TFC YHE	Dynapack (hp) TPN-DB00	Intevent HSN-159MB	Delta(hp) TPN-DA20	N/A
22	Intel i7-1365U 1.80GHz	64GB DDR5 6400MHz	LGD LP135WU1	GIS 9AN13504-001	Samsung MZVL2110HDLU-00BH1 (1TB)	N/A	Intel AX211D2W	WNC XRAV-1	Fibocom FM350-GL	TFC YHE	Dynapack (hp) TPN-DB00	Intevent HSN-159MB	Delta(hp) TPN-DA20	N/A
23	Intel i7-1365U 1.80GHz	64GB DDR5 6400MHz	LGD LP135WU1	GIS 9AN13504-001	Samsung MZVL22T0HBLB-00BH1 (2TB)	N/A	Intel AX211D2W	WNC XRAV-1	Fibocom FM350-GL	TFC YHE	Dynapack (hp) TPN-DB00	Intevent HSN-159MB	Delta(hp) TPN-DA20	N/A
24	Intel i7-1365U 1.80GHz	64GB DDR5 6400MHz	LGD LP135WU1	GIS 9AN13504-001	Western Digital SDDPNOD-256G-1006 (256GB)	N/A	Intel AX211D2W	WNC XRAV-1	Fibocom FM350-GL	TFC YHE	Dynapack (hp) TPN-DB00	Intevent HSN-159MB	Delta(hp) TPN-DA20	N/A
25	Intel i7-1365U 1.80GHz	64GB DDR5 6400MHz	LGD LP135WU1	GIS 9AN13504-001	Western Digital SDDPPTOD-256G-1006 (256GB)	N/A	Intel AX211D2W	WNC XRAV-1	Fibocom FM350-GL	TFC YHE	Dynapack (hp) TPN-DB00	Intevent HSN-159MB	Delta(hp) TPN-DA20	N/A
26	Intel i7-1365U 1.80GHz	64GB DDR5 6400MHz	LGD LP135WU1	GIS 9AN13504-001	Western Digital SDCPNRY-512G-1006 (512GB)	N/A	Intel AX211D2W	WNC XRAV-1	Fibocom FM350-GL	TFC YHE	Dynapack (hp) TPN-DB00	Intevent HSN-159MB	Delta(hp) TPN-DA20	N/A
27	Intel i7-1365U 1.80GHz	64GB DDR5 6400MHz	LGD LP135WU1	GIS 9AN13504-001	Western Digital SDDPNOD-512G-1006 (512GB)	N/A	Intel AX211D2W	WNC XRAV-1	Fibocom FM350-GL	TFC YHE	Dynapack (hp) TPN-DB00	Intevent HSN-159MB	Delta(hp) TPN-DA20	N/A
28	Intel i7-1365U 1.80GHz	64GB DDR5 6400MHz	LGD LP135WU1	GIS 9AN13504-001	Western Digital SDCPNRY-512G-1006 (512GB)	N/A	Intel AX211D2W	WNC XRAV-1	Fibocom FM350-GL	TFC YHE	Dynapack (hp) TPN-DB00	Intevent HSN-159MB	Delta(hp) TPN-DA20	N/A
29	Intel i7-1365U 1.80GHz	64GB DDR5 6400MHz	LGD LP135WU1	GIS 9AN13504-001	Western Digital SDCPNRY-1T00-1006 (1TB)	N/A	Intel AX211D2W	WNC XRAV-1	Fibocom FM350-GL	TFC YHE	Dynapack (hp) TPN-DB00	Intevent HSN-159MB	Delta(hp) TPN-DA20	N/A
30	Intel i7-1365U 1.80GHz	64GB DDR5 6400MHz	LGD LP135WU1	GIS 9AN13504-001	Western Digital SDCPNRY-1T00-1006 (1TB)	N/A	Intel AX211D2W	WNC XRAV-1	Fibocom FM350-GL	TFC YHE	Dynapack (hp) TPN-DB00	Intevent HSN-159MB	Delta(hp) TPN-DA20	N/A
31	Intel i7-1365U 1.80GHz	64GB DDR5 6400MHz	LGD LP135WU1	GIS 9AN13504-001	Western Digital SDCPNRY-2T00-1006 (2TB)	N/A	Intel AX211D2W	WNC XRAV-1	Fibocom FM350-GL	TFC YHE	Dynapack (hp) TPN-DB00	Intevent HSN-159MB	Delta(hp) TPN-DA20	N/A
32	Intel i7-1365U 1.80GHz	64GB DDR5 6400MHz	LGD LP135WU1	GIS 9AN13504-001	SK hynix HFS512GEJ9X108N (512GB)	N/A	Intel AX211D2W	WNC XRAV-1	Fibocom FM350-GL	TFC YHE	Dynapack (hp) TPN-DB00	Intevent HSN-159MB	Delta(hp) TPN-DA20	N/A
33	Intel i7-1365U 1.80GHz	64GB DDR5 6400MHz	LGD LP135WU1	GIS 9AN13504-001	SK hynix HFS512GEJ9X101N (512GB)	N/A	Intel AX211D2W	WNC XRAV-1	Fibocom FM350-GL	TFC YHE	Dynapack (hp) TPN-DB00	Intevent HSN-159MB	Delta(hp) TPN-DA20	N/A
34	Intel i7-1365U 1.80GHz	64GB DDR5 6400MHz	LGD LP135WU1	GIS 9AN13504-001	SK hynix HFS001TEJ9X101N (1TB)	N/A	Intel AX211D2W	WNC XRAV-1	Fibocom FM350-GL	TFC YHE	Dynapack (hp) TPN-DB00	Intevent HSN-159MB	Delta(hp) TPN-DA20	N/A
35	Intel i7-1365U 1.80GHz	64GB DDR5 6400MHz	LGD LP135WU1	GIS 9AN13504-001	SK hynix HFS002TEJ9X101N (2TB)	N/A	Intel AX211D2W	WNC XRAV-1	Fibocom FM350-GL	TFC YHE	Dynapack (hp) TPN-DB00	Intevent HSN-159MB	Delta(hp) TPN-DA20	N/A

Unless otherwise stated the results shown in this test report refer only to the sample(s) tested and such sample(s) are retained for 90 days only.

除非另有說明，此報告結果僅對測試之樣品負責，同時此樣品僅保留90天。本報告未經本公司書面許可，不可部份複製。

This document is issued by the Company subject to its General Conditions of Service printed overleaf, available on request or accessible at www.sgs.com/terms_and_conditions.htm and for electronic format documents, subject to Terms and Conditions for Electronic Documents at www.sgs.com/terms_e-document.htm. Attention is drawn to the limitation of liability, indemnification and jurisdiction issues defined therein. Any holder of this document is advised that information contained hereon reflects the Company's findings at the time of its intervention only and within the limits of Client's instructions, if any. The Company's sole responsibility is to its Client and this document does not exonerate parties to a transaction from exercising all their rights and obligations under the transaction documents. This document cannot be reproduced except in full, without prior written approval of the Company. Any unauthorized alteration, forgery or falsification of the content or appearance of this document is unlawful and offenders may be prosecuted to the fullest extent of the law.

Mode	CPU	Memory	Panel	Touch Screen	SSD	eMMC	WLAN+BT	NFC	WWAN	CCD	Battery Pack	Main Board	Adapter	Docking
36	Intel i7-1365U 1.80GHz	64GB DDR5 6400MHz	LGD LP135WU1	GIS 9AN13504-001	SSSTC CL4-3D256-HP (256GB)	N/A	Intel AX211D2W	WNC XRAV-1	Fibocom FM350-GL	TFC YHE	Dynapack (hp) TPN-DB00	Inventec HSN-159MB	Delta(hp) TPN-DA20	N/A
37	Intel i7-1365U 1.80GHz	64GB DDR5 6400MHz	LGD LP135WU1	GIS 9AN13504-001	Solidigm SSDPFKN0512GZH (512GB)	N/A	Intel AX211D2W	WNC XRAV-1	Fibocom FM350-GL	TFC YHE	Dynapack (hp) TPN-DB00	Inventec HSN-159MB	Delta(hp) TPN-DA20	N/A
38	Intel i7-1365U 1.80GHz	64GB DDR5 6400MHz	LGD LP135WU1	GIS 9AN13504-001	Kioxia KXG80ZNV2T04 (2TB)	Hynix H26M62002JPR (32GB)	Intel AX211D2W	WNC XRAV-1	Fibocom FM350-GL	TFC YHE	Dynapack (hp) TPN-DB00	Inventec HSN-159MB	Delta(hp) TPN-DA20	N/A
39	Intel i7-1365U 1.80GHz	64GB DDR5 6400MHz	LGD LP135WU1	GIS 9AN13504-001	Kioxia KXG80ZNV2T04 (2TB)	Kingston EMMC32G-1X29-HP (32GB)	Intel AX211D2W	WNC XRAV-1	Fibocom FM350-GL	TFC YHE	Dynapack (hp) TPN-DB00	Inventec HSN-159MB	Delta(hp) TPN-DA20	N/A
40	Intel i7-1365U 1.80GHz	64GB DDR5 6400MHz	LGD LP135WU1	GIS 9AN13504-001	Kioxia KXG80ZNV2T04 (2TB)	Phison HTE5A0MI-32GE (32GB)	Intel AX211D2W	WNC XRAV-1	Fibocom FM350-GL	TFC YHE	Dynapack (hp) TPN-DB00	Inventec HSN-159MB	Delta(hp) TPN-DA20	N/A
41	Intel i7-1365U 1.80GHz	64GB DDR5 6400MHz	LGD LP135WU1	GIS 9AN13504-001	Kioxia KXG80ZNV2T04 (2TB)	Samsung KLMBG2JETD-B041 (32GB)	Intel AX211D2W	WNC XRAV-1	Fibocom FM350-GL	TFC YHE	Dynapack (hp) TPN-DB00	Inventec HSN-159MB	Delta(hp) TPN-DA20	N/A
42	Intel i7-1365U 1.80GHz	64GB DDR5 6400MHz	LGD LP135WU1	GIS 9AN13504-001	Kioxia KXG80ZNV2T04 (2TB)	Western Digital SDINBDV4-32-1014V (32GB)	Intel AX211D2W	WNC XRAV-1	Fibocom FM350-GL	TFC YHE	Dynapack (hp) TPN-DB00	Inventec HSN-159MB	Delta(hp) TPN-DA20	N/A
43	Intel i7-1365U 1.80GHz	64GB DDR5 6400MHz	LGD LP135WU1	GIS 9AN13504-001	Western Digital SDCPNRZ-2T00-1006 (2TB)	N/A	Intel AX211D2W	WNC XRAV-1	Fibocom FM350-GL	TFC YHE	Dynapack (hp) TPN-DB00	Inventec HSN-159MB	Delta(hp) TPN-DA20	HP HSN-DX03
44	Intel i7-1365U 1.80GHz	64GB DDR5 6400MHz	LGD LP135WU1	GIS 9AN13504-001	Samsung MZVL2512H0JUB-00BH7 (512GB)	N/A	Intel AX211D2W	WNC XRAV-1	Fibocom FM350-GL	TFC YHE	Dynapack (hp) TPN-DB00	Inventec HSN-159MB	Delta(hp) TPN-DA20	N/A
45	Intel i7-1365U 1.80GHz	64GB DDR5 6400MHz	LGD LP135WU1	GIS 9AN13504-001	Samsung MZVL21T0HDLU-00BH7 (1TB)	N/A	Intel AX211D2W	WNC XRAV-1	Fibocom FM350-GL	TFC YHE	Dynapack (hp) TPN-DB00	Inventec HSN-159MB	Delta(hp) TPN-DA20	N/A

1.4 The worst case of the EUT

EUT will be carried out in the worst case as followings:

Worst Case	
CE	Mode 31, 43 (1920 x 1080 Resolution)
Below 1GHz RE	Mode 31, 43 (1920 x 1080 Resolution)
Above 1GHz RE	Mode 31, 43 (1920 x 1080 Resolution)

Unless otherwise stated the results shown in this test report refer only to the sample(s) tested and such sample(s) are retained for 90 days only.

除非另有說明，此報告結果僅對測試之樣品負責，同時此樣品僅保留90天。本報告未經本公司書面許可，不可部份複製。

This document is issued by the Company subject to its General Conditions of Service printed overleaf, available on request or accessible at www.sgs.com/terms_and_conditions.htm and for electronic format documents, subject to Terms and Conditions for Electronic Documents at www.sgs.com/terms_e-document.htm. Attention is drawn to the limitation of liability, indemnification and jurisdiction issues defined therein. Any holder of this document is advised that information contained hereon reflects the Company's findings at the time of its intervention only and within the limits of Client's instructions, if any. The Company's sole responsibility is to its Client and this document does not exonerate parties to a transaction from exercising all their rights and obligations under the transaction documents. This document cannot be reproduced except in full, without prior written approval of the Company. Any unauthorized alteration, forgery or falsification of the content or appearance of this document is unlawful and offenders may be prosecuted to the fullest extent of the law.

1.5 Description of Support Units

Mode 31:

PRODUCT	MANUFACTURER	MODEL NO.	SERIAL NO.
LCD Monitor	ASUS	MX27U	N/A
LCD Monitor	ASUS	MX27U	N/A
Earphone	APPLE	N/A	N/A
Notebook PC (Remote)	DELL	INSPIRON 640m	CN-0MG532-70166-75G-03AP
Wireless AP (Remote)	ASUS	GT-AXE11000	M3IAJF201439
Mouse	HP	MOAFUO	PSB1030013577
SIM Card	NA	NA	NA
UXM 5G Wireless Test Platform (Remote)	KEYSIGHT	E7515B	N/A
GPS simulator (Remote)	IFR	GPS-101	N/A

Unless otherwise stated the results shown in this test report refer only to the sample(s) tested and such sample(s) are retained for 90 days only.

除非另有說明，此報告結果僅對測試之樣品負責，同時此樣品僅保留90天。本報告未經本公司書面許可，不可部份複製。

This document is issued by the Company subject to its General Conditions of Service printed overleaf, available on request or accessible at www.sgs.com/terms_and_conditions.htm and for electronic format documents, subject to Terms and Conditions for Electronic Documents at www.sgs.com/terms_e-document.htm. Attention is drawn to the limitation of liability, indemnification and jurisdiction issues defined therein. Any holder of this document is advised that information contained hereon reflects the Company's findings at the time of its intervention only and within the limits of Client's instructions, if any. The Company's sole responsibility is to its Client and this document does not exonerate parties to a transaction from exercising all their rights and obligations under the transaction documents. This document cannot be reproduced except in full, without prior written approval of the Company. Any unauthorized alteration, forgery or falsification of the content or appearance of this document is unlawful and offenders may be prosecuted to the fullest extent of the law.

Mode 43:

PRODUCT	MANUFACTURER	MODEL NO.	SERIAL NO.
LCD Monitor	ASUS	MX27U	N/A
LCD Monitor	ASUS	MX27U	N/A
LCD Monitor	ASUS	MX27U	N/A
Earphone	APPLE	N/A	N/A
HDD	WD	My Passport	WXD1E849K9YF
HDD	WD	My Passport	WX21E54RD766
HDD	WD	My Passport	WX91A744F4NL
HDD	WD	My Passport	WXB1AA4EEJ9P
HDD	WD	My Passport	WXA1AA4DRYDJ
HDD	WD	My Passport	WXE1E84CVPPA
HDD	WD	My Passport	WX31A94JJZZX
HDD	WD	My Passport	WX41A946S312
Notebook PC (Remote)	DELL	INSPIRON 640m	CN-0MG532-70166-75G-03AP
Notebook PC (Remote)	Lenovo	ThinkPad T14 Gen 1	PF24WF25
Wireless AP (Remote)	ASUS	GT-AXE11000	M3IAJF201439
Mouse	HP	MOAFUO	PSB1030013577
SIM Card	NA	NA	NA
USB Type C to USB	HP	N/A	N/A
USB Type C to USB	HP	N/A	N/A
USB Type C to USB	HP	N/A	N/A
USB Type C to USB	HP	N/A	N/A
Dock	HP	HSN-IX03	5CG2O8Z5RD
UXM 5G Wireless Test Platform (Remote)	KEYSIGHT	E7515B	N/A
GPS simulator (Remote)	IFR	GPS-101	N/A

Unless otherwise stated the results shown in this test report refer only to the sample(s) tested and such sample(s) are retained for 90 days only.

除非另有說明，此報告結果僅對測試之樣品負責，同時此樣品僅保留90天。本報告未經本公司書面許可，不可部份複製。

This document is issued by the Company subject to its General Conditions of Service printed overleaf, available on request or accessible at www.sgs.com/terms_and_conditions.htm and for electronic format documents, subject to Terms and Conditions for Electronic Documents at www.sgs.com/terms_e-document.htm. Attention is drawn to the limitation of liability, indemnification and jurisdiction issues defined therein. Any holder of this document is advised that information contained hereon reflects the Company's findings at the time of its intervention only and within the limits of Client's instructions, if any. The Company's sole responsibility is to its Client and this document does not exonerate parties to a transaction from exercising all their rights and obligations under the transaction documents. This document cannot be reproduced except in full, without prior written approval of the Company. Any unauthorized alteration, forgery or falsification of the content or appearance of this document is unlawful and offenders may be prosecuted to the fullest extent of the law.

Support Equipment Used in Tested Cable

Mode 31:

Cable Type	Core	Length	Shielding/Non-shielding
Type C Cable (1)	N/A	1.8m	Shielding
Type C Cable (2)	N/A	1.0m	Shielding
HDMI Cable (3)	N/A	1.8m	Shielding
USB Mouse Cable (4)	N/A	1.8m	Shielding
Earphone Cable (5)	N/A	1.8m	Non-Shielding

Mode 43:

Cable Type	Core	Length	Shielding/Non-shielding
Type C Cable (1)	N/A	0.7m	Shielding
HDMI Cable (2)	N/A	1.8m	Shielding
HDMI Cable (3)	N/A	1.8m	Shielding
Display Cable(4)*2	N/A	1.8m	Shielding
Earphone Cable (5)	N/A	1.8m	Non-Shielding
USB type C to USB Cable(6)*4	N/A	0.1m	Shielding
USB HDD Cable (7)*8	N/A	0.6m	Shielding
USB Mouse Cable (8)	N/A	1.8m	Shielding
LAN Cable (9)	N/A	10.0m	Non-Shielding

Unless otherwise stated the results shown in this test report refer only to the sample(s) tested and such sample(s) are retained for 90 days only.

除非另有說明，此報告結果僅對測試之樣品負責，同時此樣品僅保留90天。本報告未經本公司書面許可，不可部份複製。

This document is issued by the Company subject to its General Conditions of Service printed overleaf, available on request or accessible at www.sgs.com/terms_and_conditions.htm and for electronic format documents, subject to Terms and Conditions for Electronic Documents at www.sgs.com/terms_e-document.htm. Attention is drawn to the limitation of liability, indemnification and jurisdiction issues defined therein. Any holder of this document is advised that information contained hereon reflects the Company's findings at the time of its intervention only and within the limits of Client's instructions, if any. The Company's sole responsibility is to its Client and this document does not exonerate parties to a transaction from exercising all their rights and obligations under the transaction documents. This document cannot be reproduced except in full, without prior written approval of the Company. Any unauthorized alteration, forgery or falsification of the content or appearance of this document is unlawful and offenders may be prosecuted to the fullest extent of the law.

1.6 Operation Procedure

Mode 31:

1. Turn on the power of all equipment.
2. The EUT communicates with Notebook PC by Bluetooth radio.
3. The EUT communicates with Wireless AP by WIFI radio.
4. The EUT execute the WINEMC software to send "H" Pattern to display on the screen.
5. Executed "AMCAP2" software to turn-on the Camera.
6. The EUT will receive GPS signal sources and continue to operate.
7. The EUT will receive the 5G UXM signal source and continue to operate.
8. The EUT will receive the NFC RF signal source.
9. Setup the condition for test mode and begin the test.

Mode 43:

1. Turn on the power of all equipment.
2. The EUT communicates with Notebook PC by Bluetooth radio.
3. The EUT communicates with Wireless AP by WIFI radio.
4. The EUT will reads/writes disk through "WINEMC" test software.
5. The EUT execute the WINEMC software to send "H" Pattern to display on the screen.
6. Executed "AMCAP2" software to turn-on the Camera.
7. The EUT will receive GPS signal sources and continue to operate.
8. The EUT will receive the 5G UXM signal source and continue to operate.
9. The EUT will receive the NFC RF signal source.
10. The EUT transfers data to another Notebook PC via LAN Port.
11. Setup the condition for test mode and begin the test.

Unless otherwise stated the results shown in this test report refer only to the sample(s) tested and such sample(s) are retained for 90 days only.

除非另有說明，此報告結果僅對測試之樣品負責，同時此樣品僅保留90天。本報告未經本公司書面許可，不可部份複製。

This document is issued by the Company subject to its General Conditions of Service printed overleaf, available on request or accessible at www.sgs.com/terms_and_conditions.htm and for electronic format documents, subject to Terms and Conditions for Electronic Documents at www.sgs.com/terms_e-document.htm. Attention is drawn to the limitation of liability, indemnification and jurisdiction issues defined therein. Any holder of this document is advised that information contained hereon reflects the Company's findings at the time of its intervention only and within the limits of Client's instructions, if any. The Company's sole responsibility is to its Client and this document does not exonerate parties to a transaction from exercising all their rights and obligations under the transaction documents. This document cannot be reproduced except in full, without prior written approval of the Company. Any unauthorized alteration, forgery or falsification of the content or appearance of this document is unlawful and offenders may be prosecuted to the fullest extent of the law.

1.7 Test Set-Up Configuration

Mode 31:

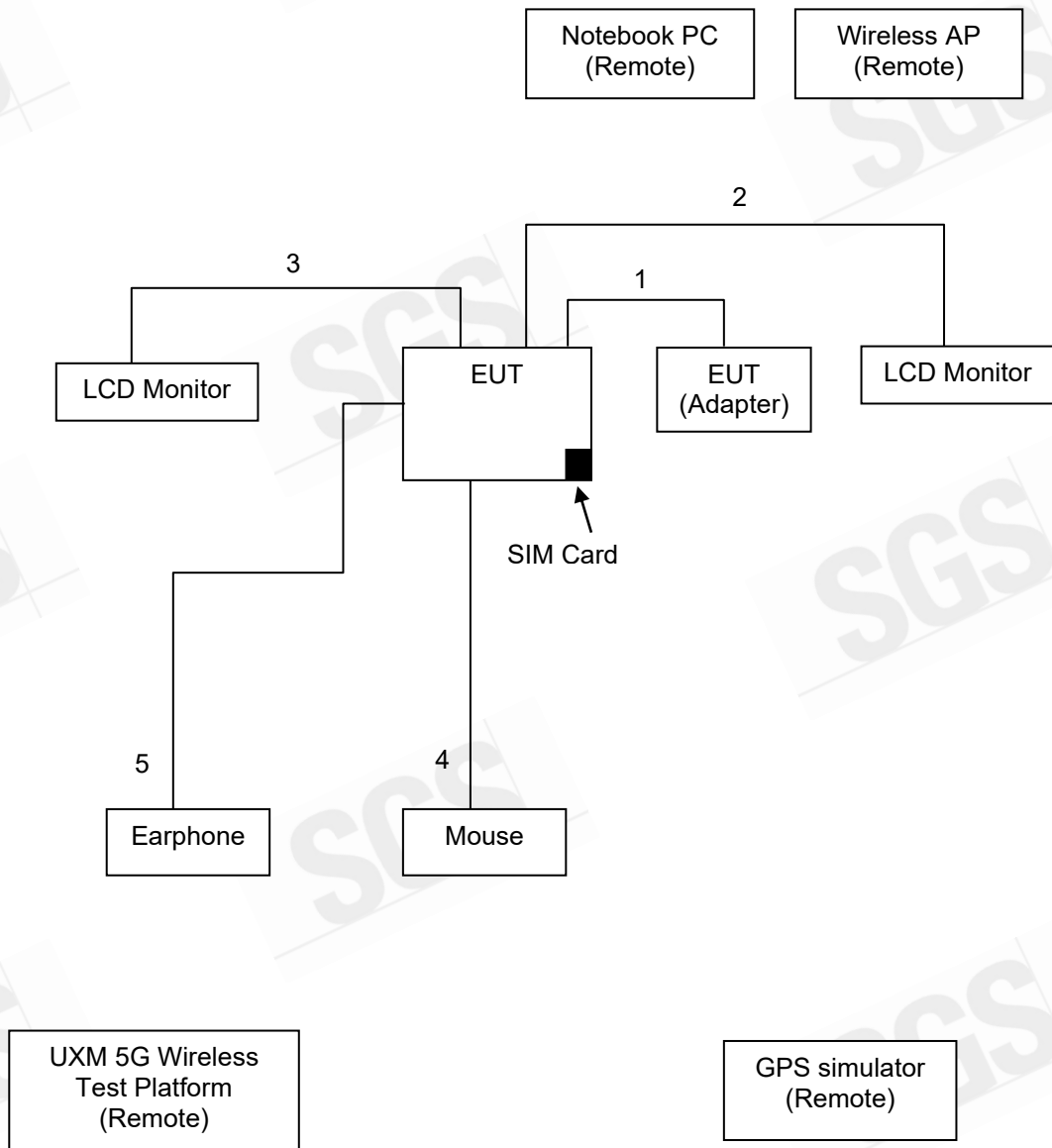

Unless otherwise stated the results shown in this test report refer only to the sample(s) tested and such sample(s) are retained for 90 days only.

除非另有說明，此報告結果僅對測試之樣品負責，同時此樣品僅保留90天。本報告未經本公司書面許可，不可部份複製。

This document is issued by the Company subject to its General Conditions of Service printed overleaf, available on request or accessible at www.sgs.com/terms_and_conditions.htm and for electronic format documents, subject to Terms and Conditions for Electronic Documents at www.sgs.com/terms_e-document.htm. Attention is drawn to the limitation of liability, indemnification and jurisdiction issues defined therein. Any holder of this document is advised that information contained hereon reflects the Company's findings at the time of its intervention only and within the limits of Client's instructions, if any. The Company's sole responsibility is to its Client and this document does not exonerate parties to a transaction from exercising all their rights and obligations under the transaction documents. This document cannot be reproduced except in full, without prior written approval of the Company. Any unauthorized alteration, forgery or falsification of the content or appearance of this document is unlawful and offenders may be prosecuted to the fullest extent of the law.

Mode 43:

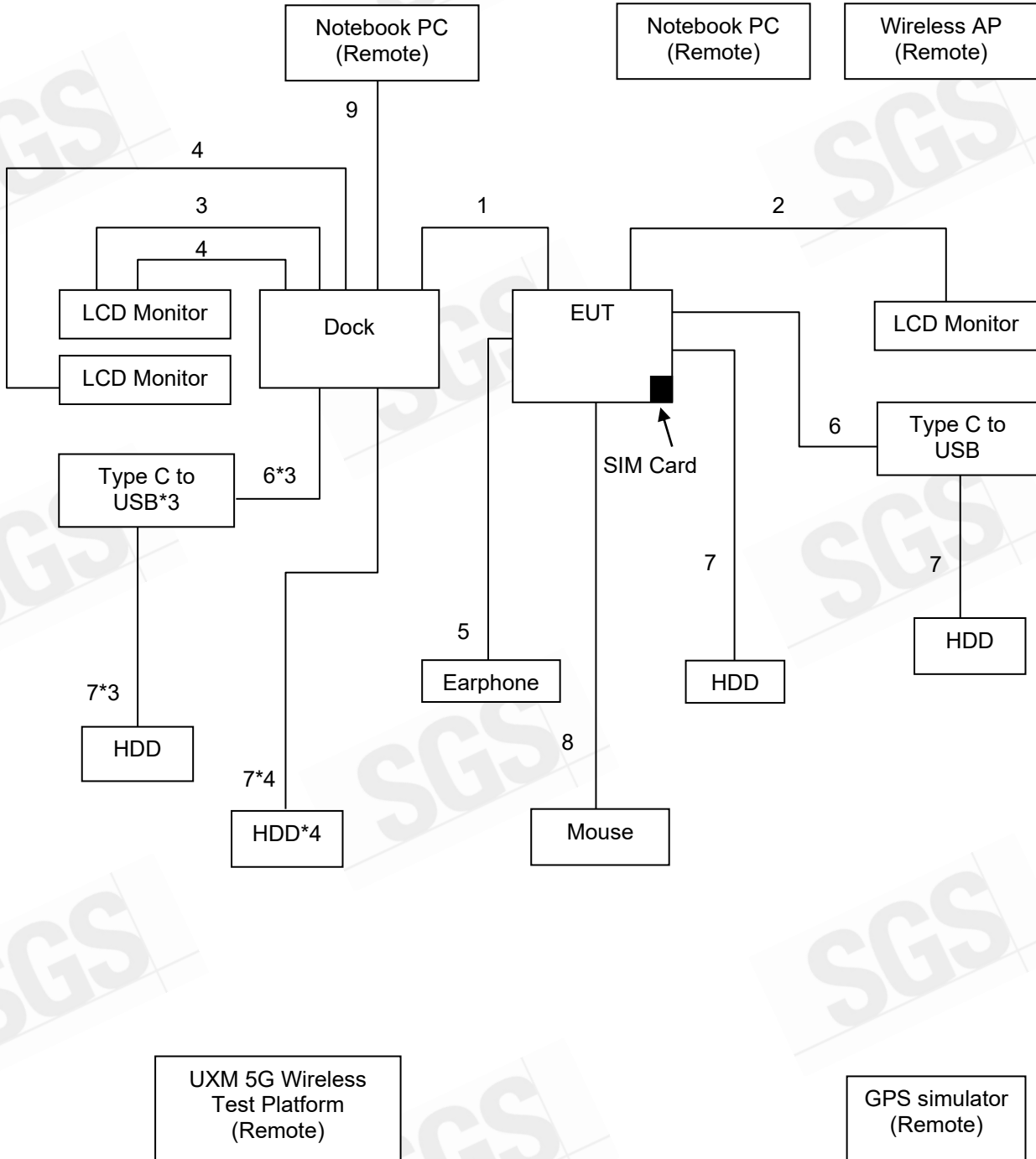

Unless otherwise stated the results shown in this test report refer only to the sample(s) tested and such sample(s) are retained for 90 days only.

除非另有說明，此報告結果僅對測試之樣品負責，同時此樣品僅保留90天。本報告未經本公司書面許可，不可部份複製。

This document is issued by the Company subject to its General Conditions of Service printed overleaf, available on request or accessible at www.sgs.com/terms_and_conditions.htm and for electronic format documents, subject to Terms and Conditions for Electronic Documents at www.sgs.com/terms_e-document.htm. Attention is drawn to the limitation of liability, indemnification and jurisdiction issues defined therein. Any holder of this document is advised that information contained hereon reflects the Company's findings at the time of its intervention only and within the limits of Client's instructions, if any. The Company's sole responsibility is to its Client and this document does not exonerate parties to a transaction from exercising all their rights and obligations under the transaction documents. This document cannot be reproduced except in full, without prior written approval of the Company. Any unauthorized alteration, forgery or falsification of the content or appearance of this document is unlawful and offenders may be prosecuted to the fullest extent of the law.

1.8 Accessories Cable List

See clause 1.3 of this report

1.9 Measurement Procedure

Conducted Emission Testing was performed according to ANSI C63.4:2014 in a shielded room with peripherals placed on a table, 0.8m high over a metal floor. It was located more than required distance away from the shielded room wall.

Radiated Emission Testing was performed according to ANSI C63.4:2014 at the 3/10m semi-anechoic chamber. The EUT was placed on a 0.8m high table along with the peripherals. The turn table was placed 3/10m distance from the antenna. Cables were placed in a position to produce maximum emissions as determined by experimentation, and operation mode was selected for production of maximum emission.

The frequency and amplitude of the worse emissions were measured at varying azimuths, antenna heights and antenna polarities. Maximum emission levels are then reported.

1.10 Standards Applicable for Testing

Tests to be carried out under 47 CFR FCC Part 15 Subpart B/CISPR 22/
ICES-003/ANSI C63.4: 2014

Test Standards	Status
47 CFR FCC Part 15 Subpart B CISPR 22 ICES-003 ANSI C63.4: 2014	Applicable
Deviation from Standard	No deviation

Unless otherwise stated the results shown in this test report refer only to the sample(s) tested and such sample(s) are retained for 90 days only.

除非另有說明，此報告結果僅對測試之樣品負責，同時此樣品僅保留90天。本報告未經本公司書面許可，不可部份複製。

This document is issued by the Company subject to its General Conditions of Service printed overleaf, available on request or accessible at www.sgs.com/terms_and_conditions.htm and for electronic format documents, subject to Terms and Conditions for Electronic Documents at www.sgs.com/terms_e-document.htm. Attention is drawn to the limitation of liability, indemnification and jurisdiction issues defined therein. Any holder of this document is advised that information contained hereon reflects the Company's findings at the time of its intervention only and within the limits of Client's instructions, if any. The Company's sole responsibility is to its Client and this document does not exonerate parties to a transaction from exercising all their rights and obligations under the transaction documents. This document cannot be reproduced except in full, without prior written approval of the Company. Any unauthorized alteration, forgery or falsification of the content or appearance of this document is unlawful and offenders may be prosecuted to the fullest extent of the law.

1.11 Decision Rules of Results

Reported measurement data comply with 47 CFR FCC Part 15 Subpart B and ICES-003.

Determining compliance shall be based on the results of the compliance measurement, not taking into account measurement instrumentation uncertainty.

1.12 Summary of Results

Standard	Test Type	Result
47 CFR FCC Part 15 Subpart B ICES-003 Issue 7: October 2020 ANSI C63.4: 2014	Conducted Emission	PASS
	Radiated Emission	PASS

1.13 Reporting Statements of Conformity

The conformity statement in this report is based solely on the test results, measurement uncertainty is excluded.

Unless otherwise stated the results shown in this test report refer only to the sample(s) tested and such sample(s) are retained for 90 days only.

除非另有說明，此報告結果僅對測試之樣品負責，同時此樣品僅保留90天。本報告未經本公司書面許可，不可部份複製。

This document is issued by the Company subject to its General Conditions of Service printed overleaf, available on request or accessible at www.sgs.com/terms_and_conditions.htm and for electronic format documents, subject to Terms and Conditions for Electronic Documents at www.sgs.com/terms_e-document.htm. Attention is drawn to the limitation of liability, indemnification and jurisdiction issues defined therein. Any holder of this document is advised that information contained hereon reflects the Company's findings at the time of its intervention only and within the limits of Client's instructions, if any. The Company's sole responsibility is to its Client and this document does not exonerate parties to a transaction from exercising all their rights and obligations under the transaction documents. This document cannot be reproduced except in full, without prior written approval of the Company. Any unauthorized alteration, forgery or falsification of the content or appearance of this document is unlawful and offenders may be prosecuted to the fullest extent of the law.

2. EMISSION

2.1 Test Results

Conducted Emission	Pass
Radiated Emission	Pass

2.2 Frequency Range

47 CFR FCC Part 15 Subpart B:

Conducted Emission : 150 kHz - 30 MHz

Radiated Emission : See below table

Highest frequency generated or used in the device or on which the device operates or tunes (MHz)	Upper frequency of measurement range (MHz)
Below 1.705	30
1.705 - 108	1000
108 - 500	2000
500 - 1000	5000
Above 1000	5th harmonic of the highest frequency or 40 GHz, whichever is lower.

ICES-003:

Conducted Emission : 150 kHz - 30 MHz

Radiated Emission : 30 MHz to 5thharmonic of the highest frequency or 40GHz, whichever is lower.

Highest internal frequency (F_x)	Highest measurement frequency
$F_x \leq 108$ MHz	1 GHz
108 MHz < $F_x \leq 500$ MHz	2 GHz
500 MHz < $F_x \leq 1$ GHz	5 GHz
$F_x > 1$ GHz	5 x F_x up to a maximum of 40 GHz

Note: F_x is the highest fundamental frequency generated and/or used in the ITE or digital apparatus under test.

Unless otherwise stated the results shown in this test report refer only to the sample(s) tested and such sample(s) are retained for 90 days only.

除非另有說明，此報告結果僅對測試之樣品負責，同時此樣品僅保留90天。本報告未經本公司書面許可，不可部份複製。

This document is issued by the Company subject to its General Conditions of Service printed overleaf, available on request or accessible at www.sgs.com/terms_and_conditions.htm and for electronic format documents, subject to Terms and Conditions for Electronic Documents at www.sgs.com/terms_e-document.htm. Attention is drawn to the limitation of liability, indemnification and jurisdiction issues defined therein. Any holder of this document is advised that information contained hereon reflects the Company's findings at the time of its intervention only and within the limits of Client's instructions, if any. The Company's sole responsibility is to its Client and this document does not exonerate parties to a transaction from exercising all their rights and obligations under the transaction documents. This document cannot be reproduced except in full, without prior written approval of the Company. Any unauthorized alteration, forgery or falsification of the content or appearance of this document is unlawful and offenders may be prosecuted to the fullest extent of the law.

2.3 Limits of Conducted and Radiated Emission

2.3.1 Limits of Conducted Emission

47 CFR FCC Part 15 Subpart B:

FREQUENCY (MHz)	Class A dB(μ V)		Class B dB(μ V)	
	Quasi - peak	Average	Quasi - peak	Average
0.15 - 0.5	79	66	66 - 56	56 - 46
0.50 - 5.0	73	60	56	46
5.0 - 30.0	73	60	60	50

Note : (1) The lower limit shall apply at the transition frequencies.

(2) The limit decreases linearly with the logarithm of the frequency in the range 0.15 to 0.50 MHz.

(3) All emanation from a class A/B digital device or system, including any network of conductors and apparatus connected there to, shall not exceed the level of field strengths specified above.

ICES-003:

FREQUENCY (MHz)	Class A dB(μ V)		Class B dB(μ V)	
	Quasi-peak	Average	Quasi-peak	Average
0.15 - 0.5	79	66	66 - 56*	56 - 46*
0.50 - 5.0	73	60	56	46
5.0 - 30.0	73	60	60	50

Note: The more stringent limit applies at transition frequencies.

*. The limit level in dB μ V decreases linearly with the logarithm of frequency.

Unless otherwise stated the results shown in this test report refer only to the sample(s) tested and such sample(s) are retained for 90 days only.

除非另有說明，此報告結果僅對測試之樣品負責，同時此樣品僅保留90天。本報告未經本公司書面許可，不可部份複製。

This document is issued by the Company subject to its General Conditions of Service printed overleaf, available on request or accessible at www.sgs.com/terms_and_conditions.htm and for electronic format documents, subject to Terms and Conditions for Electronic Documents at www.sgs.com/terms_e-document.htm. Attention is drawn to the limitation of liability, indemnification and jurisdiction issues defined therein. Any holder of this document is advised that information contained hereon reflects the Company's findings at the time of its intervention only and within the limits of Client's instructions, if any. The Company's sole responsibility is to its Client and this document does not exonerate parties to a transaction from exercising all their rights and obligations under the transaction documents. This document cannot be reproduced except in full, without prior written approval of the Company. Any unauthorized alteration, forgery or falsification of the content or appearance of this document is unlawful and offenders may be prosecuted to the fullest extent of the law.

2.3.2 Limits of Radiated Emissions

47 CFR FCC Part 15 Subpart B Limit:

- Detector Function : Quasi – Peak

FREQUENCY (MHz)	Class A (at 10m)	Class B (at 3m)
	dB(μV/m)	dB(μV/m)
30~88	39	40
88~216	43.5	43.5
216~960	46.4	46
960~1000	49.5	54

- Detector Function : Peak , Average

FREQUENCY (MHz)	Class A dB(μV/m) (at 3 m)		Class B dB(μV/m) (at 3 m)	
	Peak	Average	Peak	Average
Above 1000	80	60	74	54

CISPR 22 Limit:

- Detector Function : Quasi – Peak

FREQUENCY (MHz)	Class A (at 10m)	Class B (at 10m)
	dB(μV/m)	dB(μV/m)
30~230	40	30
230~1000	47	37

Note 1 The lower limit shall apply at the transition frequency.

2 Additional provisions may be required for cases where interference occurs.

Unless otherwise stated the results shown in this test report refer only to the sample(s) tested and such sample(s) are retained for 90 days only.

除非另有說明，此報告結果僅對測試之樣品負責，同時此樣品僅保留90天。本報告未經本公司書面許可，不可部份複製。

This document is issued by the Company subject to its General Conditions of Service printed overleaf, available on request or accessible at www.sgs.com/terms_and_conditions.htm and for electronic format documents, subject to Terms and Conditions for Electronic Documents at www.sgs.com/terms_e-document.htm. Attention is drawn to the limitation of liability, indemnification and jurisdiction issues defined therein. Any holder of this document is advised that information contained hereon reflects the Company's findings at the time of its intervention only and within the limits of Client's instructions, if any. The Company's sole responsibility is to its Client and this document does not exonerate parties to a transaction from exercising all their rights and obligations under the transaction documents. This document cannot be reproduced except in full, without prior written approval of the Company. Any unauthorized alteration, forgery or falsification of the content or appearance of this document is unlawful and offenders may be prosecuted to the fullest extent of the law.

ICES-003 Limit:

- Detector Function : Quasi-peak

Frequency (MHz)	Class A (3 m) dB(μV/m)	Class A (10 m) dB(μV/m)	Class B (3 m) dB(μV/m)	Class B (10 m) dB(μV/m)
30 - 88	50	40	40	30
88 - 216	54	43.5	43.5	33.1
216 - 230	56.9	46.4	46	35.6
230 - 960	57	47	47	37
960 - 1000	60	49.5	54	43.5

Note: The more stringent limit applies at transition frequencies

- Detector Function : Peak, Average

Frequency (MHz)	Class A (3 m) dB(μV/m)		Class B (3 m) dB(μV/m)	
	Peak	Average	Peak	Average
Above 1000	80	60	74	54

Unless otherwise stated the results shown in this test report refer only to the sample(s) tested and such sample(s) are retained for 90 days only.

除非另有說明，此報告結果僅對測試之樣品負責，同時此樣品僅保留90天。本報告未經本公司書面許可，不可部份複製。

This document is issued by the Company subject to its General Conditions of Service printed overleaf, available on request or accessible at www.sgs.com/terms_and_conditions.htm and for electronic format documents, subject to Terms and Conditions for Electronic Documents at www.sgs.com/terms_e-document.htm. Attention is drawn to the limitation of liability, indemnification and jurisdiction issues defined therein. Any holder of this document is advised that information contained hereon reflects the Company's findings at the time of its intervention only and within the limits of Client's instructions, if any. The Company's sole responsibility is to its Client and this document does not exonerate parties to a transaction from exercising all their rights and obligations under the transaction documents. This document cannot be reproduced except in full, without prior written approval of the Company. Any unauthorized alteration, forgery or falsification of the content or appearance of this document is unlawful and offenders may be prosecuted to the fullest extent of the law.

2.4. Test of Conducted Emission

2.4.1 Test Equipments

Conducted Emission Conducted Room No.B EMC					
EQUIPMENT TYPE	Manufacturer	Model Number	Serial Number	Calibration Date	Calibration Due
Cable	EMCI	EMCRG142	190809	2022-04-22	2023-04-21
LISN	SHWARZBECK	NSLK8128	8128-5012	2022-04-22	2023-04-21
LISN	SHWARZBECK	NSLK8127	01022	2022-05-05	2023-05-04
EMI Test Receiver	R&S	ESR3	102915	2021-11-29	2022-11-28
Pulse Limiter	SCHWARZBECK	VTSD 9561-F	00815	2022-02-23	2023-02-22
Software	CCS-3A1-CE				
Compliance Certification Services Inc. (Wugu Laboratory)					
Testing Site: No.139, Wugong Rd., Wugu Dist., New Taipei City, Taiwan.					
Measurement Uncertainty of Conducted Emission					
Expanded uncertainty U _{lab} (k=2) of Conducted Emission is 3.06 dB.					
Expanded uncertainty CISPR 16-4-2:2011+A1:2014+A2:2018 (k=2) of Conducted Emission measurement is 3.44 dB					

2.4.2 Measurement Level Calculation

Factor = LISN insertion loss + Cable loss + Pulse Limiter insertion loss

Measurement Level = Reading Level + Factor

Over (Margin) = Measurement Level – Limit

Unless otherwise stated the results shown in this test report refer only to the sample(s) tested and such sample(s) are retained for 90 days only.

除非另有說明，此報告結果僅對測試之樣品負責，同時此樣品僅保留90天。本報告未經本公司書面許可，不可部份複製。

This document is issued by the Company subject to its General Conditions of Service printed overleaf, available on request or accessible at www.sgs.com/terms_and_conditions.htm and for electronic format documents, subject to Terms and Conditions for Electronic Documents at www.sgs.com/terms_e-document.htm. Attention is drawn to the limitation of liability, indemnification and jurisdiction issues defined therein. Any holder of this document is advised that information contained hereon reflects the Company's findings at the time of its intervention only and within the limits of Client's instructions, if any. The Company's sole responsibility is to its Client and this document does not exonerate parties to a transaction from exercising all their rights and obligations under the transaction documents. This document cannot be reproduced except in full, without prior written approval of the Company. Any unauthorized alteration, forgery or falsification of the content or appearance of this document is unlawful and offenders may be prosecuted to the fullest extent of the law.

2.4.3 Measurement Data:

Model no.	HSN-I59C	Line:	L1
Environmental Conditions	24°C, 46% RH	Tested Date	2022/11/08
Test Mode	Mode 31	Tested By	Thomas Liu
6dB Bandwidth	9 kHz	Identifier number	TCOP CE site 17

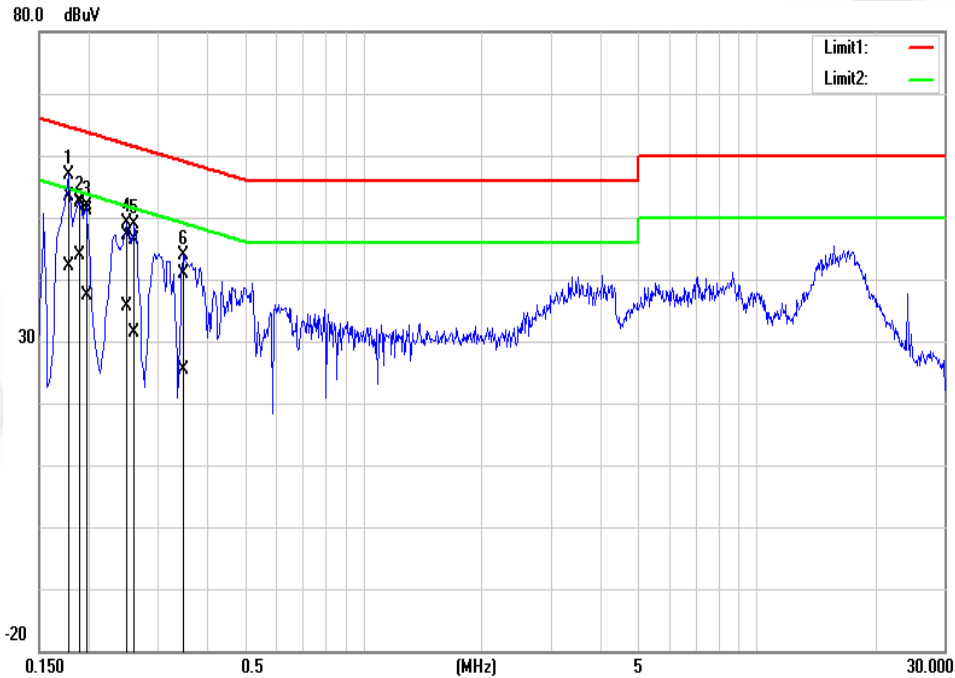

NO.	Frequency (MHz)	Quasi Peak reading (dBuV)	Average reading (dBuV)	Correction factor (dB)	Quasi Peak result (dBuV)	Average result (dBuV)	Quasi Peak limit (dBuV)	Average limit (dBuV)	Quasi Peak margin (dB)	Average margin (dB)	Remark (Pass/Fail)
1	0.1780	43.12	31.93	10.28	53.40	42.21	64.57	54.58	-11.17	-12.37	Pass
2*	0.1900	42.03	33.70	10.28	52.31	43.98	64.03	54.04	-11.72	-10.06	Pass
3	0.1980	40.75	27.18	10.28	51.03	37.46	63.69	53.69	-12.66	-16.23	Pass
4	0.2500	36.97	25.30	10.28	47.25	35.58	61.75	51.76	-14.50	-16.18	Pass
5	0.2620	36.20	21.10	10.28	46.48	31.38	61.36	51.37	-14.88	-19.99	Pass
6	0.3500	30.65	15.19	10.29	40.94	25.48	58.96	48.96	-18.02	-23.48	Pass

Note: L1 = Live Line

Unless otherwise stated the results shown in this test report refer only to the sample(s) tested and such sample(s) are retained for 90 days only.

除非另有說明，此報告結果僅對測試之樣品負責，同時此樣品僅保留90天。本報告未經本公司書面許可，不可部份複製。

This document is issued by the Company subject to its General Conditions of Service printed overleaf, available on request or accessible at www.sgs.com/terms_and_conditions.htm and for electronic format documents, subject to Terms and Conditions for Electronic Documents at www.sgs.com/terms_e-document.htm. Attention is drawn to the limitation of liability, indemnification and jurisdiction issues defined therein. Any holder of this document is advised that information contained hereon reflects the Company's findings at the time of its intervention only and within the limits of Client's instructions, if any. The Company's sole responsibility is to its Client and this document does not exonerate parties to a transaction from exercising all their rights and obligations under the transaction documents. This document cannot be reproduced except in full, without prior written approval of the Company. Any unauthorized alteration, forgery or falsification of the content or appearance of this document is unlawful and offenders may be prosecuted to the fullest extent of the law.

Model no.	HSN-I59C	Line:	N
Environmental Conditions	24°C, 46% RH	Tested Date	2022/11/08
Test Mode	Mode 31	Tested By	Thomas Liu
6dB Bandwidth	9 kHz	Identifier number	TCOP CE site 17

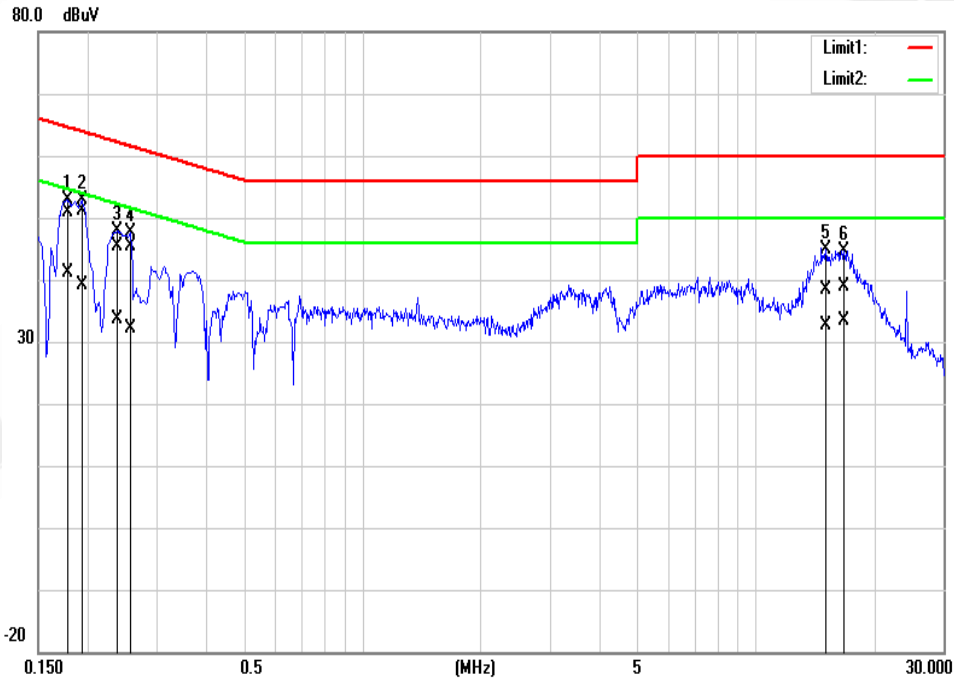

NO.	Frequency (MHz)	Quasi Peak reading (dBuV)	Average reading (dBuV)	Correction factor (dB)	Quasi Peak result (dBuV)	Average result (dBuV)	Quasi Peak limit (dBuV)	Average limit (dBuV)	Quasi Peak margin (dB)	Average margin (dB)	Remark (Pass/Fail)
1	0.1780	40.60	30.89	10.26	50.86	41.15	64.57	54.58	-13.71	-13.43	Pass
2*	0.1940	40.75	28.89	10.26	51.01	39.15	63.86	53.86	-12.85	-14.71	Pass
3	0.2380	35.02	23.42	10.26	45.28	33.68	62.16	52.17	-16.88	-18.49	Pass
4	0.2580	35.09	21.80	10.26	45.35	32.06	61.49	51.50	-16.14	-19.44	Pass
5	15.0780	27.78	22.00	10.61	38.39	32.61	60.00	50.00	-21.61	-17.39	Pass
6	16.7860	28.36	22.68	10.64	39.00	33.32	60.00	50.00	-21.00	-16.68	Pass

Note: N = Neutral Line

Unless otherwise stated the results shown in this test report refer only to the sample(s) tested and such sample(s) are retained for 90 days only.

除非另有說明，此報告結果僅對測試之樣品負責，同時此樣品僅保留90天。本報告未經本公司書面許可，不可部份複製。

This document is issued by the Company subject to its General Conditions of Service printed overleaf, available on request or accessible at www.sgs.com/terms_and_conditions.htm and for electronic format documents, subject to Terms and Conditions for Electronic Documents at www.sgs.com/terms_e-document.htm. Attention is drawn to the limitation of liability, indemnification and jurisdiction issues defined therein. Any holder of this document is advised that information contained hereon reflects the Company's findings at the time of its intervention only and within the limits of Client's instructions, if any. The Company's sole responsibility is to its Client and this document does not exonerate parties to a transaction from exercising all their rights and obligations under the transaction documents. This document cannot be reproduced except in full, without prior written approval of the Company. Any unauthorized alteration, forgery or falsification of the content or appearance of this document is unlawful and offenders may be prosecuted to the fullest extent of the law.

Model no.	HSN-I59C	Line:	L1
Environmental Conditions	22°C, 48% RH	Tested Date	2022/11/08
Test Mode	Mode 43	Tested By	Thomas Liu
6dB Bandwidth	9 kHz	Identifier number	TCOP CE site 17

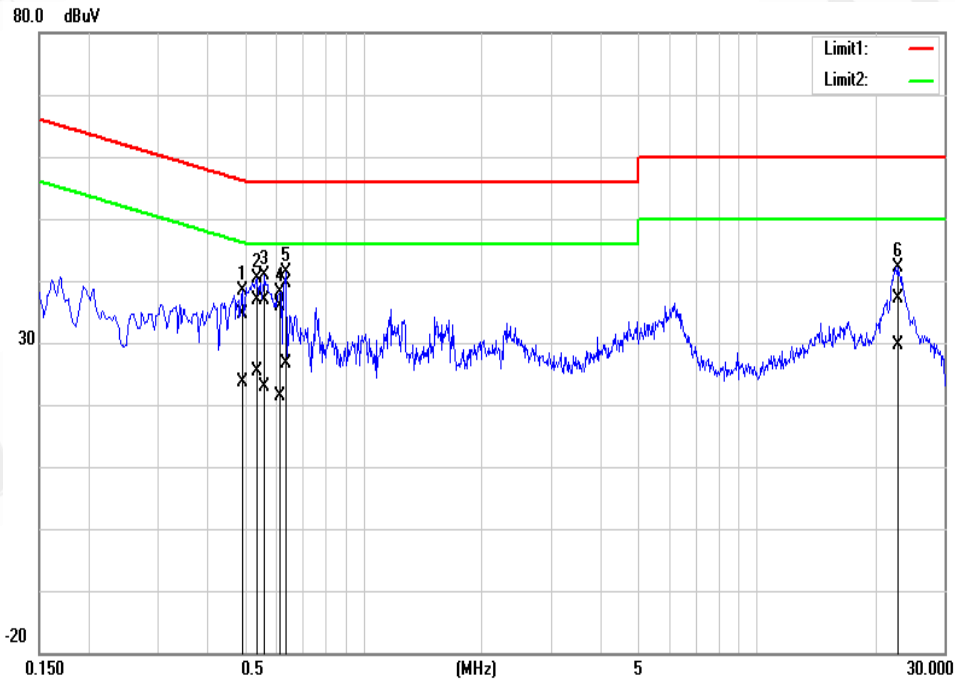

NO.	Frequency (MHz)	Quasi Peak reading (dBuV)	Average reading (dBuV)	Correction factor (dB)	Quasi Peak result (dBuV)	Average result (dBuV)	Quasi Peak limit (dBuV)	Average limit (dBuV)	Quasi Peak margin (dB)	Average margin (dB)	Remark (Pass/Fail)
1	0.4940	24.44	13.35	10.29	34.73	23.64	56.10	46.10	-21.37	-22.46	Pass
2	0.5380	26.47	14.97	10.29	36.76	25.26	56.00	46.00	-19.24	-20.74	Pass
3	0.5620	26.49	12.60	10.29	36.78	22.89	56.00	46.00	-19.22	-23.11	Pass
4	0.6140	25.65	11.07	10.29	35.94	21.36	56.00	46.00	-20.06	-24.64	Pass
5*	0.6340	29.36	16.41	10.29	39.65	26.70	56.00	46.00	-16.35	-19.30	Pass
6	22.8340	26.48	18.88	10.73	37.21	29.61	60.00	50.00	-22.79	-20.39	Pass

Note: L1 = Live Line

Unless otherwise stated the results shown in this test report refer only to the sample(s) tested and such sample(s) are retained for 90 days only.

除非另有說明，此報告結果僅對測試之樣品負責，同時此樣品僅保留90天。本報告未經本公司書面許可，不可部份複製。

This document is issued by the Company subject to its General Conditions of Service printed overleaf, available on request or accessible at www.sgs.com/terms_and_conditions.htm and for electronic format documents, subject to Terms and Conditions for Electronic Documents at www.sgs.com/terms_e-document.htm. Attention is drawn to the limitation of liability, indemnification and jurisdiction issues defined therein. Any holder of this document is advised that information contained hereon reflects the Company's findings at the time of its intervention only and within the limits of Client's instructions, if any. The Company's sole responsibility is to its Client and this document does not exonerate parties to a transaction from exercising all their rights and obligations under the transaction documents. This document cannot be reproduced except in full, without prior written approval of the Company. Any unauthorized alteration, forgery or falsification of the content or appearance of this document is unlawful and offenders may be prosecuted to the fullest extent of the law.

Model no.	HSN-I59C	Line:	N
Environmental Conditions	22°C, 48% RH	Tested Date	2022/11/08
Test Mode	Mode 43	Tested By	Thomas Liu
6dB Bandwidth	9 kHz	Identifier number	TCOP CE site 17

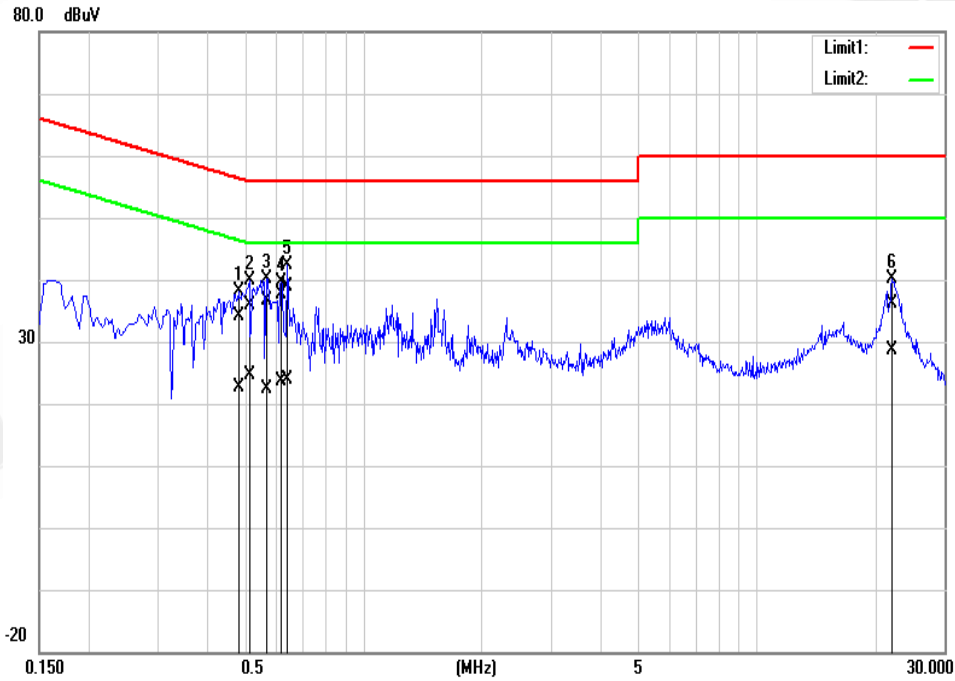

NO.	Frequency (MHz)	Quasi Peak reading (dBuV)	Average reading (dBuV)	Correction factor (dB)	Quasi Peak result (dBuV)	Average result (dBuV)	Quasi Peak limit (dBuV)	Average limit (dBuV)	Quasi Peak margin (dB)	Average margin (dB)	Remark (Pass/Fail)
1	0.4820	23.95	12.35	10.27	34.22	22.62	56.30	46.30	-22.08	-23.68	Pass
2	0.5140	25.71	14.38	10.27	35.98	24.65	56.00	46.00	-20.02	-21.35	Pass
3	0.5700	26.34	12.05	10.27	36.61	22.32	56.00	46.00	-19.39	-23.68	Pass
4	0.6180	27.28	13.42	10.27	37.55	23.69	56.00	46.00	-18.45	-22.31	Pass
5*	0.6419	28.57	13.73	10.27	38.84	24.00	56.00	46.00	-17.16	-22.00	Pass
6	22.1299	25.45	17.85	10.73	36.18	28.58	60.00	50.00	-23.82	-21.42	Pass

Note: N = Neutral Line

Unless otherwise stated the results shown in this test report refer only to the sample(s) tested and such sample(s) are retained for 90 days only.

除非另有說明，此報告結果僅對測試之樣品負責，同時此樣品僅保留90天。本報告未經本公司書面許可，不可部份複製。

This document is issued by the Company subject to its General Conditions of Service printed overleaf, available on request or accessible at www.sgs.com/terms_and_conditions.htm and for electronic format documents, subject to Terms and Conditions for Electronic Documents at www.sgs.com/terms_e-document.htm. Attention is drawn to the limitation of liability, indemnification and jurisdiction issues defined therein. Any holder of this document is advised that information contained hereon reflects the Company's findings at the time of its intervention only and within the limits of Client's instructions, if any. The Company's sole responsibility is to its Client and this document does not exonerate parties to a transaction from exercising all their rights and obligations under the transaction documents. This document cannot be reproduced except in full, without prior written approval of the Company. Any unauthorized alteration, forgery or falsification of the content or appearance of this document is unlawful and offenders may be prosecuted to the fullest extent of the law.

2.5 Test of Radiated Emission

2.5.1 Test Equipments

Below 1GHz

Radiated_Below_1GHz 10m EMC					
EQUIPMENT TYPE	Manufacturer	Model Number	Serial Number	Calibration Date	Calibration Due
EMI Test Receiver	R&S	ESCI	100961	2022-05-11	2023-05-10
EMI Test Receiver	R&S	ESCI	100962	2022-05-19	2023-05-18
Pre-Amplifier	HP	8447D	2944A08150	2022-04-22	2023-04-21
Pre-Amplifier	HP	8447D	2944A07754	2022-04-22	2023-04-21
Bilog Antenna with 5dB Attenuator	TESEQ	CBL 6112D	31674	2022-02-15	2023-02-14
Bilog Antenna with 5dB Attenuator	TESEQ	CBL 6112D	31675	2022-03-11	2023-03-10
Cable	Huber Suhner	SUCOFLEX 104PEA	33948/4PEA	2022-04-22	2023-04-21
Cable	Huber Suhner	SUCOFLEX 104PEA	33949/4PEA	2022-04-22	2023-04-21
Cable	Huber Suhner	SUCOFLEX 104PEA	330029	2022-04-22	2023-04-21
Cable	Huber Suhner	SUCOFLEX 104PEA	24813	2022-04-22	2023-04-21
Turn Table	CCS	CC-T-1F	N/A	N.C.R	N.C.R
Controller	CCS	CC-C-1F	N/A	N.C.R	N.C.R
Antenna Tower	CCS	CC-A-1F	N/A	N.C.R	N.C.R
AC power source	APE	AFC-130	991259	N.C.R	N.C.R
Software	EZ-EMC (CCS-3A1RE)				
Compliance Certification Services Inc. (Wugu Laboratory)					
Testing Site: No.139, Wugong Rd., Wugu Dist., New Taipei City, Taiwan.					
Measurement Uncertainty of Radiated Emission					
Expanded uncertainty U _{lab} (k=2) of Radiated Emission is 4.41 dB. (30MHz-1GHz)					
Expanded uncertainty CISPR 16-4-2:2011+A1:2014+A2:2018 (k=2) of Radiated Emission measurement is 5.22 dB. (30MHz-1GHz)					

Unless otherwise stated the results shown in this test report refer only to the sample(s) tested and such sample(s) are retained for 90 days only.

除非另有說明，此報告結果僅對測試之樣品負責，同時此樣品僅保留90天。本報告未經本公司書面許可，不可部份複製。

This document is issued by the Company subject to its General Conditions of Service printed overleaf, available on request or accessible at www.sgs.com/terms_and_conditions.htm and for electronic format documents, subject to Terms and Conditions for Electronic Documents at www.sgs.com/terms_e-document.htm. Attention is drawn to the limitation of liability, indemnification and jurisdiction issues defined therein. Any holder of this document is advised that information contained hereon reflects the Company's findings at the time of its intervention only and within the limits of Client's instructions, if any. The Company's sole responsibility is to its Client and this document does not exonerate parties to a transaction from exercising all their rights and obligations under the transaction documents. This document cannot be reproduced except in full, without prior written approval of the Company. Any unauthorized alteration, forgery or falsification of the content or appearance of this document is unlawful and offenders may be prosecuted to the fullest extent of the law.

Above 1GHz

Radiated_Above_1GHz 10m EMC					
EQUIPMENT TYPE	Manufacturer	Model Number	Serial Number	Calibration Date	Calibration Due
Horn Antenna	EMCO	3117	00055167	2022-11-25	2023-11-24
Horn Antenna	ETS LINDGREN	3116	00026370	2022-11-24	2023-11-23
Spectrum Analyzer	Agilent	E4446A	MY48250297	2022-08-03	2023-08-02
Pre-Amplifier	EMCI	EMC051845	980040	2022-04-22	2023-04-21
Cable	Huber Suhner	SUCOFLEX 104PEA	33945	2022-04-22	2023-04-21
Cable	Huber Suhner	SUCOFLEX 104PEA	329383	2022-04-22	2023-04-21
Pre-Amplifier	MITEQ	AMF-6F-18004000-37-8P	985646	2022-09-07	2023-09-06
Band Reject Filter	Titan Microwave	T04H30001800070S01	22011402-4	2022-06-29	2023-06-28
Turn Table	CCS	CC-T-1F	N/A	N.C.R	N.C.R
Antenna Tower	Sunol Sciences	TLT2	031010-5	N.C.R	N.C.R
Controller	Sunol Sciences	SC104V	031010-1	N.C.R	N.C.R
AC power source	APE	AFC-130	991259	N.C.R	N.C.R
Software	EZ-EMC (CCS-3A1RE)				
Compliance Certification Services Inc. (Wugu Laboratory)					
Testing Site: No.139, Wugong Rd., Wugu Dist., New Taipei City, Taiwan.					
Measurement Uncertainty of Radiated Emission					
Expanded uncertainty U _{lab} (k=2) of Radiated Emission measurement is 4.97 dB. (1-6GHz)					
Expanded uncertainty U _{lab} (k=2) of Radiated Emission measurement is 5.13 dB. (6-18GHz)					
Expanded uncertainty U _{lab} (k=2) of Radiated Emission measurement is 3.94 dB. (18-40GHz)					
Expanded uncertainty CISPR 16-4-2:2011+A1:2014+A2:2018 (k=2) of Radiated Emission measurement is 5.18 dB. (1-6GHz)					
Expanded uncertainty CISPR 16-4-2:2011+A1:2014+A2:2018 (k=2) of Radiated Emission measurement is 5.48 dB. (6-18GHz)					
Expanded uncertainty CISPR 16-4-2:2011+A1:2014+A2:2018 (k=2) of Radiated Emission measurement is --- dB. (18-40GHz)					

2.5.2 Measurement Level Calculation

Correction Factor = Antenna Factor + Cable loss - Amplifier Gain

Measurement Level = Reading Level + Correction Factor

Over (Margin) = Measurement Level – Limit

Unless otherwise stated the results shown in this test report refer only to the sample(s) tested and such sample(s) are retained for 90 days only.

除非另有說明，此報告結果僅對測試之樣品負責，同時此樣品僅保留90天。本報告未經本公司書面許可，不可部份複製。

This document is issued by the Company subject to its General Conditions of Service printed overleaf, available on request or accessible at www.sgs.com/terms_and_conditions.htm and for electronic format documents, subject to Terms and Conditions for Electronic Documents at www.sgs.com/terms_e-document.htm. Attention is drawn to the limitation of liability, indemnification and jurisdiction issues defined therein. Any holder of this document is advised that information contained hereon reflects the Company's findings at the time of its intervention only and within the limits of Client's instructions, if any. The Company's sole responsibility is to its Client and this document does not exonerate parties to a transaction from exercising all their rights and obligations under the transaction documents. This document cannot be reproduced except in full, without prior written approval of the Company. Any unauthorized alteration, forgery or falsification of the content or appearance of this document is unlawful and offenders may be prosecuted to the fullest extent of the law.

2.5.3 Measurement Data

Below 1GHz

Model no.	HSN-I59C	Test Mode	Mode 31
Environmental Conditions	23°C, 57% RH	Tested Date	2022/11/30
Antenna Pole	Vertical	Antenna Distance	10m
Detector Function	Quasi-peak.	Tested By	Rex Kuo
6dB Bandwidth	120 kHz	Identifier number	TCOP RE site 17
Standard	FCC Part 15 Subpart B		

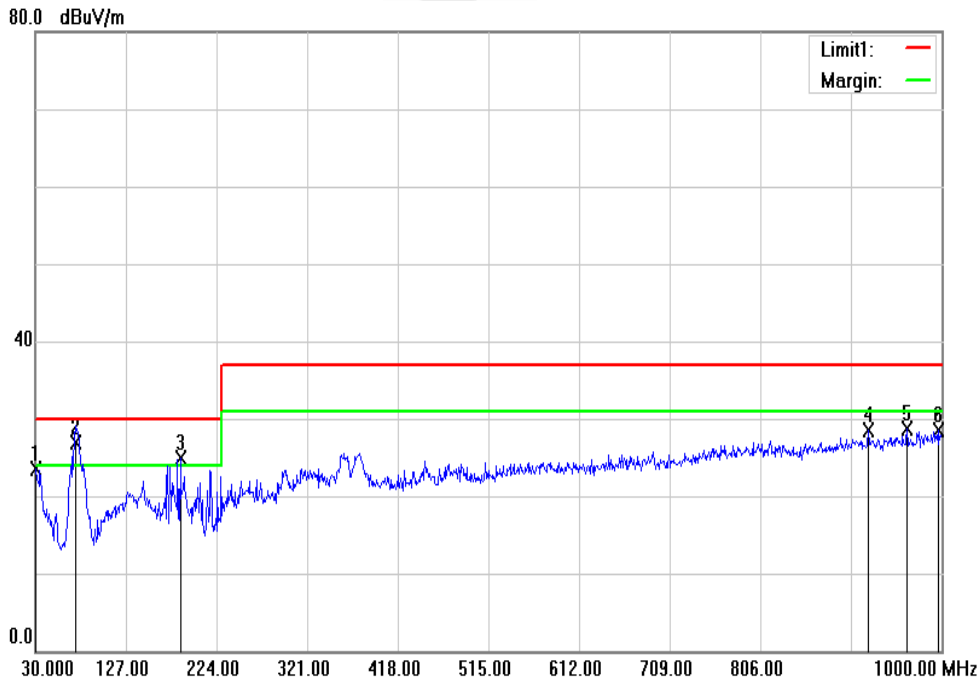

No.	Frequency (MHz)	Reading (dBuV)	Correction Factor (dB/m)	Result (dBuV/m)	Limit (dBuV/m)	Margin (dB)	Height (cm)	Degree (°)	Remark
1	30.9700	26.63	-3.18	23.45	30.00	-6.55	200	0	QP
2	72.6800	41.03	-14.06	26.97	30.00	-3.03	100	235	QP
3	185.2000	34.69	-9.75	24.94	30.00	-5.06	100	139	QP
4	921.4300	23.13	5.31	28.44	37.00	-8.56	300	0	QP
5	963.1400	22.78	5.98	28.76	37.00	-8.24	100	0	QP
6	997.0900	21.87	6.64	28.51	37.00	-8.49	400	0	QP

REMARKS: The other emission levels were very low against the limit.

Unless otherwise stated the results shown in this test report refer only to the sample(s) tested and such sample(s) are retained for 90 days only.

除非另有說明，此報告結果僅對測試之樣品負責，同時此樣品僅保留90天。本報告未經本公司書面許可，不可部份複製。

This document is issued by the Company subject to its General Conditions of Service printed overleaf, available on request or accessible at www.sgs.com/terms_and_conditions.htm and for electronic format documents, subject to Terms and Conditions for Electronic Documents at www.sgs.com/terms_e-document.htm. Attention is drawn to the limitation of liability, indemnification and jurisdiction issues defined therein. Any holder of this document is advised that information contained hereon reflects the Company's findings at the time of its intervention only and within the limits of Client's instructions, if any. The Company's sole responsibility is to its Client and this document does not exonerate parties to a transaction from exercising all their rights and obligations under the transaction documents. This document cannot be reproduced except in full, without prior written approval of the Company. Any unauthorized alteration, forgery or falsification of the content or appearance of this document is unlawful and offenders may be prosecuted to the fullest extent of the law.

Model no.	HSN-I59C	Test Mode	Mode 31
Environmental Conditions	23°C, 57% RH	Tested Date	2022/11/30
Antenna Pole	Horizontal	Antenna Distance	10m
Detector Function	Quasi-peak.	Tested By	Rex Kuo
6dB Bandwidth	120 kHz	Identifier number	TCOP RE site 17
Standard	FCC Part 15 Subpart B		

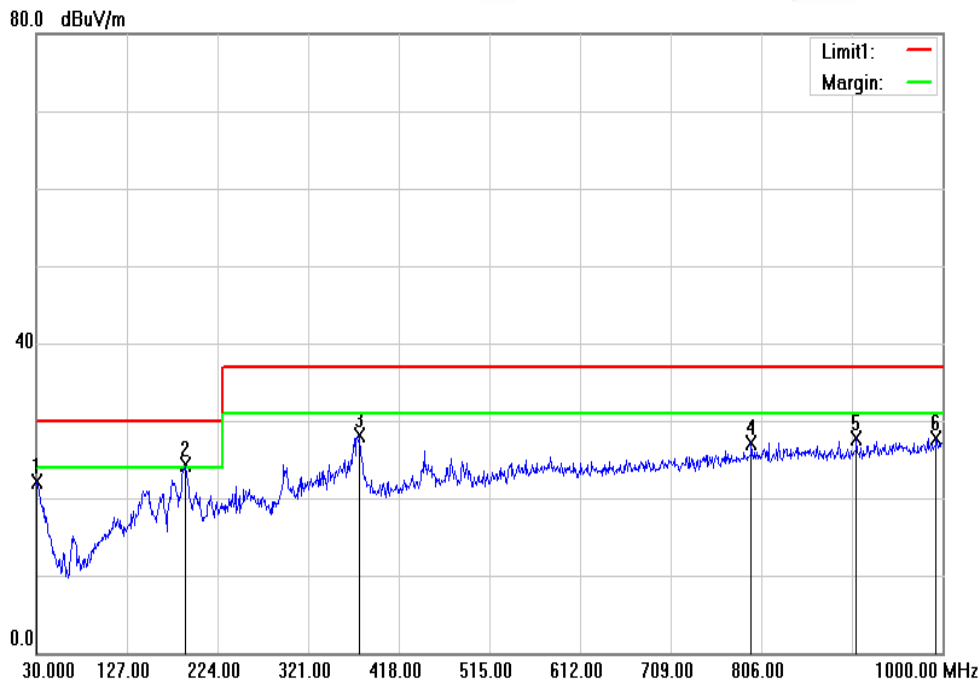

No.	Frequency (MHz)	Reading (dBuV)	Correction Factor (dB/m)	Result (dBuV/m)	Limit (dBuV/m)	Margin (dB)	Height (cm)	Degree (°)	Remark
1	30.9700	25.99	-3.86	22.13	30.00	-7.87	300	263	QP
2	189.0800	35.20	-10.86	24.34	30.00	-5.66	300	360	QP
3	376.2900	32.21	-4.15	28.06	37.00	-8.94	200	360	QP
4	795.3300	25.45	1.61	27.06	37.00	-9.94	100	17	QP
5	907.8500	24.62	3.02	27.64	37.00	-9.36	100	17	QP
6	993.2100	23.69	4.08	27.77	37.00	-9.23	100	0	QP

REMARKS: The other emission levels were very low against the limit.

Unless otherwise stated the results shown in this test report refer only to the sample(s) tested and such sample(s) are retained for 90 days only.

除非另有說明，此報告結果僅對測試之樣品負責，同時此樣品僅保留90天。本報告未經本公司書面許可，不可部份複製。

This document is issued by the Company subject to its General Conditions of Service printed overleaf, available on request or accessible at www.sgs.com/terms_and_conditions.htm and for electronic format documents, subject to Terms and Conditions for Electronic Documents at www.sgs.com/terms_e-document.htm. Attention is drawn to the limitation of liability, indemnification and jurisdiction issues defined therein. Any holder of this document is advised that information contained hereon reflects the Company's findings at the time of its intervention only and within the limits of Client's instructions, if any. The Company's sole responsibility is to its Client and this document does not exonerate parties to a transaction from exercising all their rights and obligations under the transaction documents. This document cannot be reproduced except in full, without prior written approval of the Company. Any unauthorized alteration, forgery or falsification of the content or appearance of this document is unlawful and offenders may be prosecuted to the fullest extent of the law.

Model no.	HSN-I59C	Test Mode	Mode 43
Environmental Conditions	23°C, 57% RH	Tested Date	2022/12/01
Antenna Pole	Vertical	Antenna Distance	10m
Detector Function	Quasi-peak.	Tested By	Rex Kuo
6dB Bandwidth	120 kHz	Identifier number	TCOP RE site 17
Standard	FCC Part 15 Subpart B		

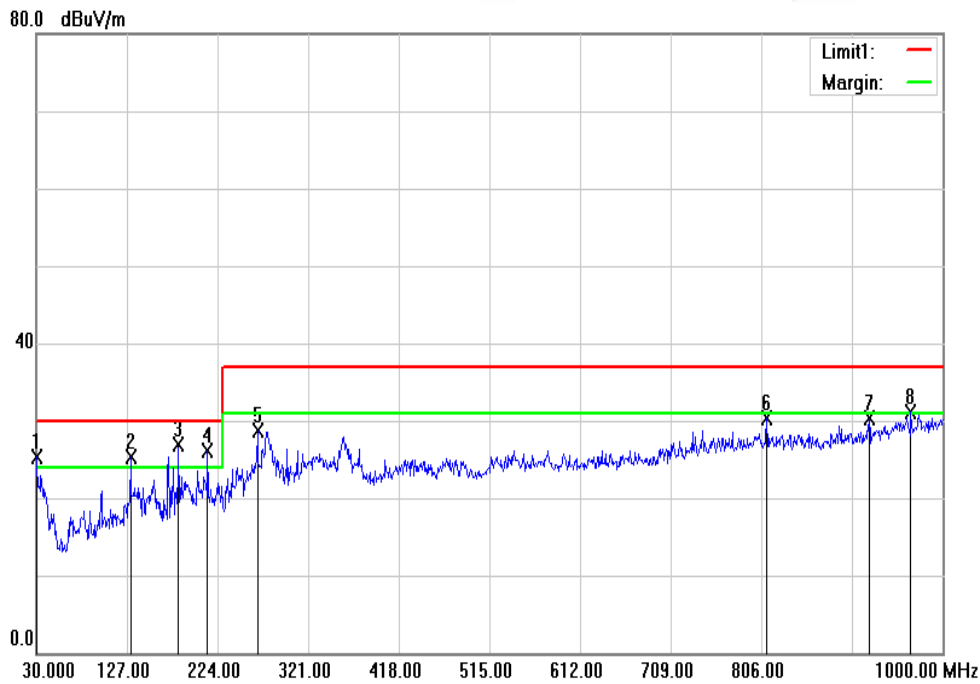

No.	Frequency (MHz)	Reading (dBuV)	Correction Factor (dB/m)	Result (dBuV/m)	Limit (dBuV/m)	Margin (dB)	Height (cm)	Degree (°)	Remark
1	30.0000	28.06	-2.67	25.39	30.00	-4.61	100	160	QP
2	130.8800	33.42	-8.08	25.34	30.00	-4.66	100	359	QP
3	182.2900	36.79	-9.82	26.97	30.00	-3.03	100	160	QP
4	213.3300	35.34	-9.31	26.03	30.00	-3.97	100	6	QP
5	266.6800	33.23	-4.55	28.68	37.00	-8.32	100	0	QP
6	811.8200	26.46	3.86	30.32	37.00	-6.68	200	0	QP
7	921.4300	24.97	5.31	30.28	37.00	-6.72	300	159	QP
8	966.0500	25.04	6.03	31.07	37.00	-5.93	300	159	QP

REMARKS: The other emission levels were very low against the limit.

Unless otherwise stated the results shown in this test report refer only to the sample(s) tested and such sample(s) are retained for 90 days only.

除非另有說明，此報告結果僅對測試之樣品負責，同時此樣品僅保留90天。本報告未經本公司書面許可，不可部份複製。

This document is issued by the Company subject to its General Conditions of Service printed overleaf, available on request or accessible at www.sgs.com/terms_and_conditions.htm and for electronic format documents, subject to Terms and Conditions for Electronic Documents at www.sgs.com/terms_e-document.htm. Attention is drawn to the limitation of liability, indemnification and jurisdiction issues defined therein. Any holder of this document is advised that information contained hereon reflects the Company's findings at the time of its intervention only and within the limits of Client's instructions, if any. The Company's sole responsibility is to its Client and this document does not exonerate parties to a transaction from exercising all their rights and obligations under the transaction documents. This document cannot be reproduced except in full, without prior written approval of the Company. Any unauthorized alteration, forgery or falsification of the content or appearance of this document is unlawful and offenders may be prosecuted to the fullest extent of the law.

Model no.	HSN-I59C	Test Mode	Mode 43
Environmental Conditions	23°C, 57% RH	Tested Date	2022/12/01
Antenna Pole	Horizontal	Antenna Distance	10m
Detector Function	Quasi-peak.	Tested By	Rex Kuo
6dB Bandwidth	120 kHz	Identifier number	TCOP RE site 17
Standard	FCC Part 15 Subpart B		

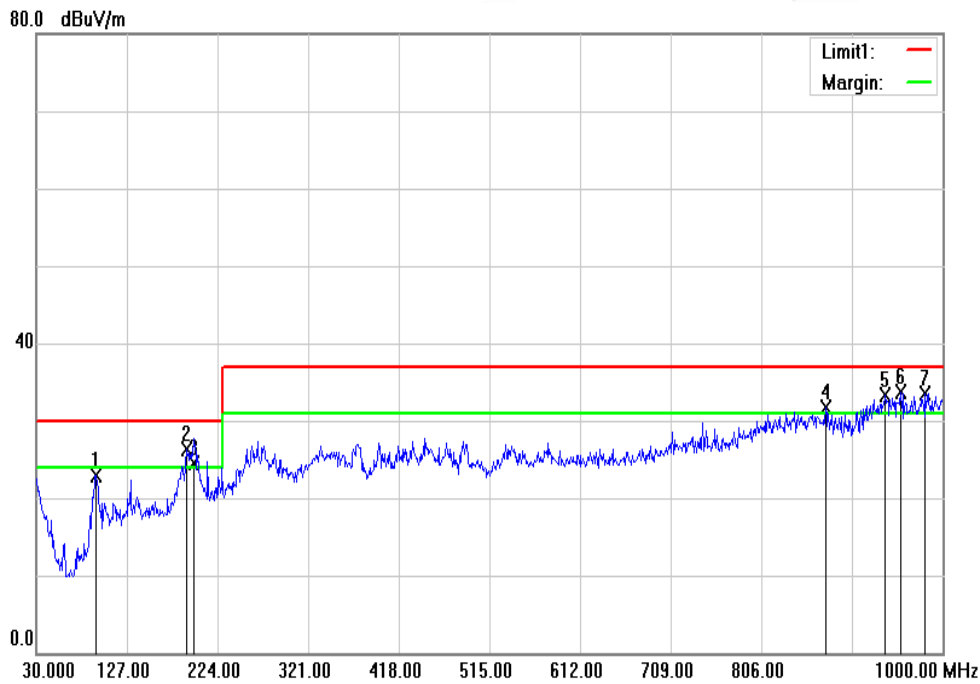

No.	Frequency (MHz)	Reading (dBuV)	Correction Factor (dB/m)	Result (dBuV/m)	Limit (dBuV/m)	Margin (dB)	Height (cm)	Degree (°)	Remark
1	94.0200	34.36	-11.37	22.99	30.00	-7.01	300	211	QP
2	191.0200	37.16	-10.82	26.34	30.00	-3.66	400	186	QP
3	198.7800	35.16	-10.67	24.49	30.00	-5.51	400	186	QP
4	874.8700	29.22	2.57	31.79	37.00	-5.21	100	250	QP
5	938.8900	29.98	3.40	33.38	37.00	-3.62	100	225	QP
6	955.3800	30.01	3.60	33.61	37.00	-3.39	100	225	QP
7	981.5700	29.61	3.93	33.54	37.00	-3.46	100	238	QP

REMARKS: The other emission levels were very low against the limit.

Unless otherwise stated the results shown in this test report refer only to the sample(s) tested and such sample(s) are retained for 90 days only.

除非另有說明，此報告結果僅對測試之樣品負責，同時此樣品僅保留90天。本報告未經本公司書面許可，不可部份複製。

This document is issued by the Company subject to its General Conditions of Service printed overleaf, available on request or accessible at www.sgs.com/terms_and_conditions.htm and for electronic format documents, subject to Terms and Conditions for Electronic Documents at www.sgs.com/terms_e-document.htm. Attention is drawn to the limitation of liability, indemnification and jurisdiction issues defined therein. Any holder of this document is advised that information contained hereon reflects the Company's findings at the time of its intervention only and within the limits of Client's instructions, if any. The Company's sole responsibility is to its Client and this document does not exonerate parties to a transaction from exercising all their rights and obligations under the transaction documents. This document cannot be reproduced except in full, without prior written approval of the Company. Any unauthorized alteration, forgery or falsification of the content or appearance of this document is unlawful and offenders may be prosecuted to the fullest extent of the law.

Model no.	HSN-I59C	Test Mode	Mode 31
Environmental Conditions	23°C, 57% RH	Tested Date	2022/11/30
Antenna Pole	Vertical	Antenna Distance	10m
Detector Function	Quasi-peak.	Tested By	Rex Kuo
6dB Bandwidth	120 kHz	Identifier number	TCOP RE site 17
Standard	ISED ICES-003 Issue 7		

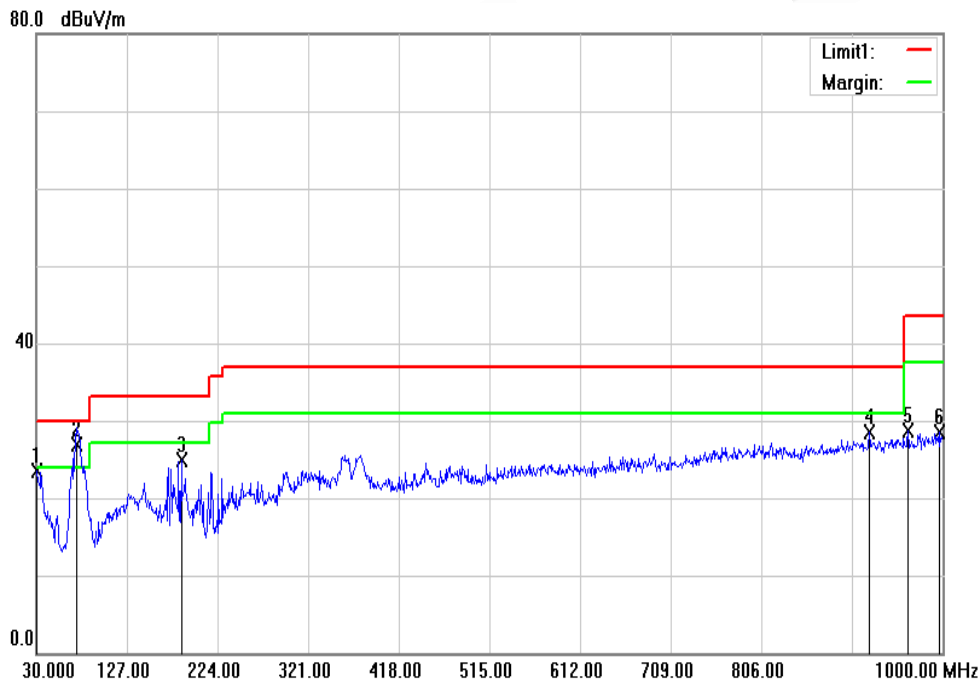

No.	Frequency (MHz)	Reading (dBuV)	Correction Factor (dB/m)	Result (dBuV/m)	Limit (dBuV/m)	Margin (dB)	Height (cm)	Degree (°)	Remark
1	30.9700	26.63	-3.18	23.45	30.00	-6.55	200	0	QP
2	72.6800	41.03	-14.06	26.97	30.00	-3.03	100	235	QP
3	185.2000	34.69	-9.75	24.94	33.10	-8.16	100	139	QP
4	921.4300	23.13	5.31	28.44	37.00	-8.56	300	0	QP
5	963.1400	22.78	5.98	28.76	43.50	-14.74	100	0	QP
6	997.0900	21.87	6.64	28.51	43.50	-14.99	400	0	QP

REMARKS: The other emission levels were very low against the limit.

Unless otherwise stated the results shown in this test report refer only to the sample(s) tested and such sample(s) are retained for 90 days only.

除非另有說明，此報告結果僅對測試之樣品負責，同時此樣品僅保留90天。本報告未經本公司書面許可，不可部份複製。

This document is issued by the Company subject to its General Conditions of Service printed overleaf, available on request or accessible at www.sgs.com/terms_and_conditions.htm and for electronic format documents, subject to Terms and Conditions for Electronic Documents at www.sgs.com/terms_e-document.htm. Attention is drawn to the limitation of liability, indemnification and jurisdiction issues defined therein. Any holder of this document is advised that information contained hereon reflects the Company's findings at the time of its intervention only and within the limits of Client's instructions, if any. The Company's sole responsibility is to its Client and this document does not exonerate parties to a transaction from exercising all their rights and obligations under the transaction documents. This document cannot be reproduced except in full, without prior written approval of the Company. Any unauthorized alteration, forgery or falsification of the content or appearance of this document is unlawful and offenders may be prosecuted to the fullest extent of the law.

Model no.	HSN-I59C	Test Mode	Mode 31
Environmental Conditions	23°C, 57% RH	Tested Date	2022/11/30
Antenna Pole	Horizontal	Antenna Distance	10m
Detector Function	Quasi-peak.	Tested By	Rex Kuo
6dB Bandwidth	120 kHz	Identifier number	TCOP RE site 17
Standard	ISED ICES-003 Issue 7		

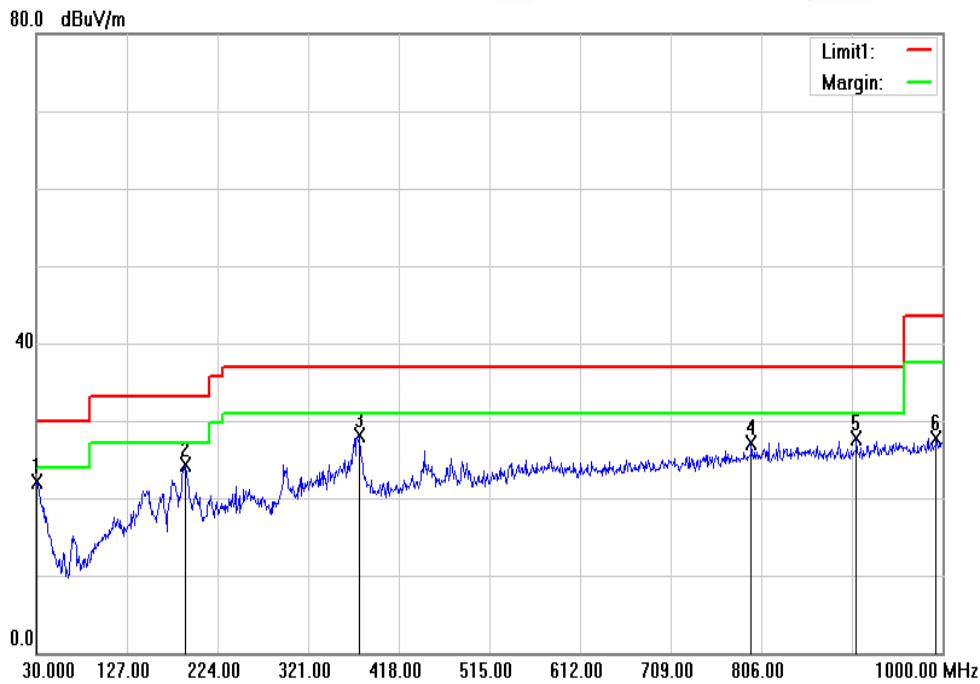

No.	Frequency (MHz)	Reading (dBuV)	Correction Factor (dB/m)	Result (dBuV/m)	Limit (dBuV/m)	Margin (dB)	Height (cm)	Degree (°)	Remark
1	30.9700	25.99	-3.86	22.13	30.00	-7.87	300	263	QP
2	189.0800	35.20	-10.86	24.34	33.10	-8.76	300	360	QP
3	376.2900	32.21	-4.15	28.06	37.00	-8.94	200	360	QP
4	795.3300	25.45	1.61	27.06	37.00	-9.94	100	17	QP
5	907.8500	24.62	3.02	27.64	37.00	-9.36	100	17	QP
6	993.2100	23.69	4.08	27.77	43.50	-15.73	100	0	QP

REMARKS: The other emission levels were very low against the limit.

Unless otherwise stated the results shown in this test report refer only to the sample(s) tested and such sample(s) are retained for 90 days only.

除非另有說明，此報告結果僅對測試之樣品負責，同時此樣品僅保留90天。本報告未經本公司書面許可，不可部份複製。

This document is issued by the Company subject to its General Conditions of Service printed overleaf, available on request or accessible at www.sgs.com/terms_and_conditions.htm and for electronic format documents, subject to Terms and Conditions for Electronic Documents at www.sgs.com/terms_e-document.htm. Attention is drawn to the limitation of liability, indemnification and jurisdiction issues defined therein. Any holder of this document is advised that information contained hereon reflects the Company's findings at the time of its intervention only and within the limits of Client's instructions, if any. The Company's sole responsibility is to its Client and this document does not exonerate parties to a transaction from exercising all their rights and obligations under the transaction documents. This document cannot be reproduced except in full, without prior written approval of the Company. Any unauthorized alteration, forgery or falsification of the content or appearance of this document is unlawful and offenders may be prosecuted to the fullest extent of the law.

Model no.	HSN-I59C	Test Mode	Mode 43
Environmental Conditions	23°C, 57% RH	Tested Date	2022/12/01
Antenna Pole	Vertical	Antenna Distance	10m
Detector Function	Quasi-peak.	Tested By	Rex Kuo
6dB Bandwidth	120 kHz	Identifier number	TCOP RE site 17
Standard	ISED ICES-003 Issue 7		

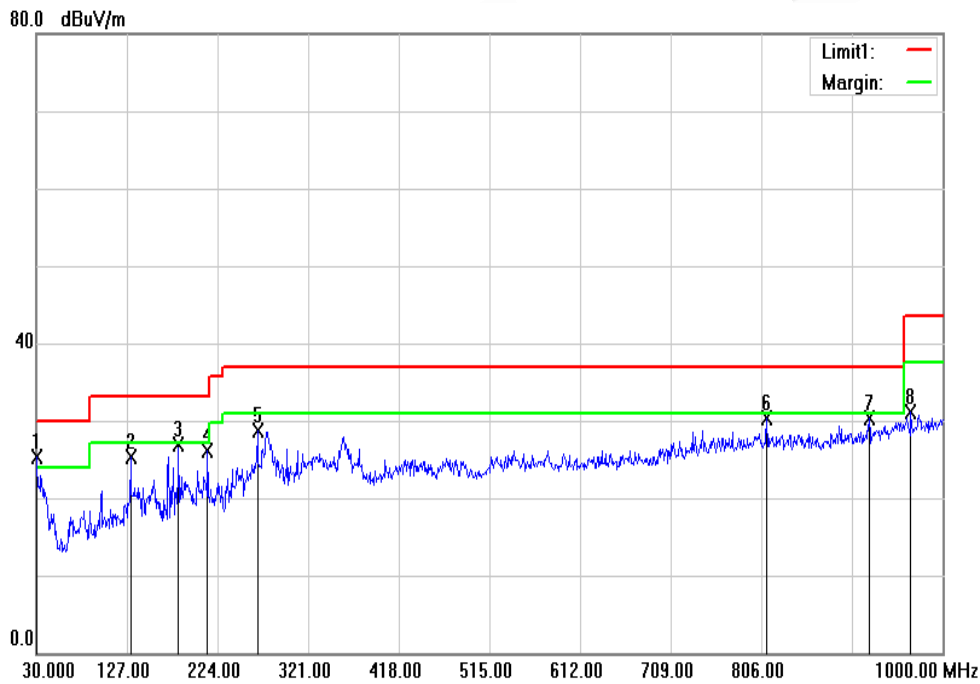

No.	Frequency (MHz)	Reading (dBuV)	Correction Factor (dB/m)	Result (dBuV/m)	Limit (dBuV/m)	Margin (dB)	Height (cm)	Degree (°)	Remark
1	30.0000	28.06	-2.67	25.39	30.00	-4.61	100	160	QP
2	130.8800	33.42	-8.08	25.34	33.10	-7.76	100	359	QP
3	182.2900	36.79	-9.82	26.97	33.10	-6.13	100	160	QP
4	213.3300	35.34	-9.31	26.03	33.10	-7.07	100	6	QP
5	266.6800	33.23	-4.55	28.68	37.00	-8.32	100	0	QP
6	811.8200	26.46	3.86	30.32	37.00	-6.68	200	0	QP
7	921.4300	24.97	5.31	30.28	37.00	-6.72	300	159	QP
8	966.0500	25.04	6.03	31.07	43.50	-12.43	300	159	QP

REMARKS: The other emission levels were very low against the limit.

Unless otherwise stated the results shown in this test report refer only to the sample(s) tested and such sample(s) are retained for 90 days only.

除非另有說明，此報告結果僅對測試之樣品負責，同時此樣品僅保留90天。本報告未經本公司書面許可，不可部份複製。

This document is issued by the Company subject to its General Conditions of Service printed overleaf, available on request or accessible at www.sgs.com/terms_and_conditions.htm and for electronic format documents, subject to Terms and Conditions for Electronic Documents at www.sgs.com/terms_e-document.htm. Attention is drawn to the limitation of liability, indemnification and jurisdiction issues defined therein. Any holder of this document is advised that information contained hereon reflects the Company's findings at the time of its intervention only and within the limits of Client's instructions, if any. The Company's sole responsibility is to its Client and this document does not exonerate parties to a transaction from exercising all their rights and obligations under the transaction documents. This document cannot be reproduced except in full, without prior written approval of the Company. Any unauthorized alteration, forgery or falsification of the content or appearance of this document is unlawful and offenders may be prosecuted to the fullest extent of the law.

Model no.	HSN-I59C	Test Mode	Mode 43
Environmental Conditions	23°C, 57% RH	Tested Date	2022/12/01
Antenna Pole	Horizontal	Antenna Distance	10m
Detector Function	Quasi-peak.	Tested By	Rex Kuo
6dB Bandwidth	120 kHz	Identifier number	TCOP RE site 17
Standard	ISED ICES-003 Issue 7		

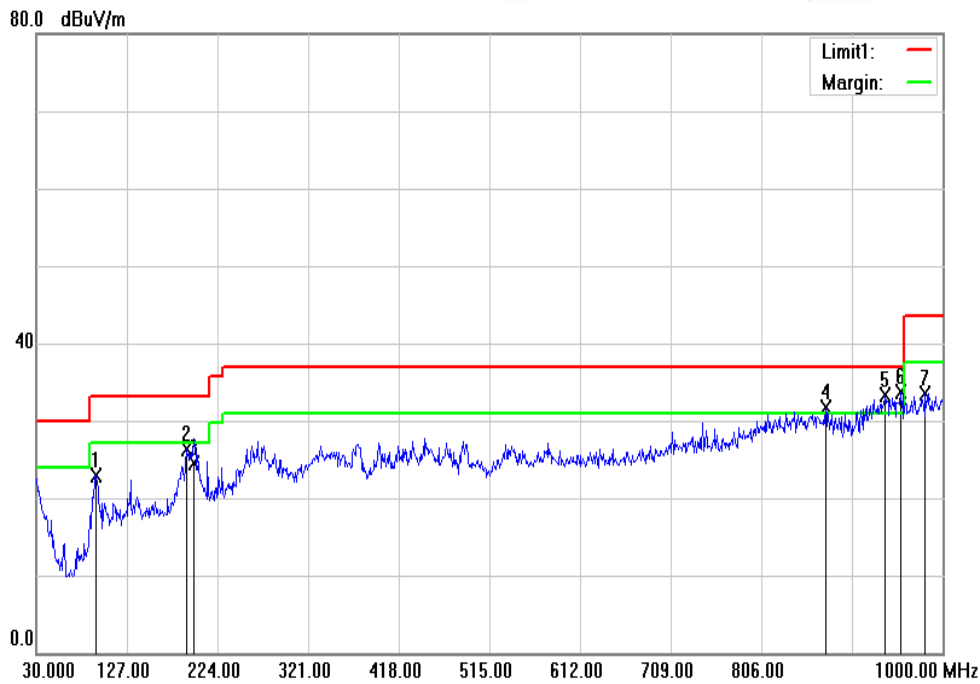

No.	Frequency (MHz)	Reading (dBuV)	Correction Factor (dB/m)	Result (dBuV/m)	Limit (dBuV/m)	Margin (dB)	Height (cm)	Degree (°)	Remark
1	94.0200	34.36	-11.37	22.99	33.10	-10.11	300	211	QP
2	191.0200	37.16	-10.82	26.34	33.10	-6.76	400	186	QP
3	198.7800	35.16	-10.67	24.49	33.10	-8.61	400	186	QP
4	874.8700	29.22	2.57	31.79	37.00	-5.21	100	250	QP
5	938.8900	29.98	3.40	33.38	37.00	-3.62	100	225	QP
6	955.3800	30.01	3.60	33.61	37.00	-3.39	100	225	QP
7	981.5700	29.61	3.93	33.54	43.50	-9.96	100	238	QP

REMARKS: The other emission levels were very low against the limit.

Unless otherwise stated the results shown in this test report refer only to the sample(s) tested and such sample(s) are retained for 90 days only.

除非另有說明，此報告結果僅對測試之樣品負責，同時此樣品僅保留90天。本報告未經本公司書面許可，不可部份複製。

This document is issued by the Company subject to its General Conditions of Service printed overleaf, available on request or accessible at www.sgs.com/terms_and_conditions.htm and for electronic format documents, subject to Terms and Conditions for Electronic Documents at www.sgs.com/terms_e-document.htm. Attention is drawn to the limitation of liability, indemnification and jurisdiction issues defined therein. Any holder of this document is advised that information contained hereon reflects the Company's findings at the time of its intervention only and within the limits of Client's instructions, if any. The Company's sole responsibility is to its Client and this document does not exonerate parties to a transaction from exercising all their rights and obligations under the transaction documents. This document cannot be reproduced except in full, without prior written approval of the Company. Any unauthorized alteration, forgery or falsification of the content or appearance of this document is unlawful and offenders may be prosecuted to the fullest extent of the law.

Above 1GHz

Model no.	HSN-I59C	Test Mode	Mode 31
Environmental Conditions	23°C, 57% RH	Tested Date	2022/12/01
Antenna Pole	Vertical	Antenna Distance	3m
Highest frequency generated or used	7.1GHz	Upper frequency	35.5GHz
Detector Function	Peak & Average	Tested By	Rex Kuo
6dB Bandwidth	1 MHz	Identifier number	TCOP RF site 17

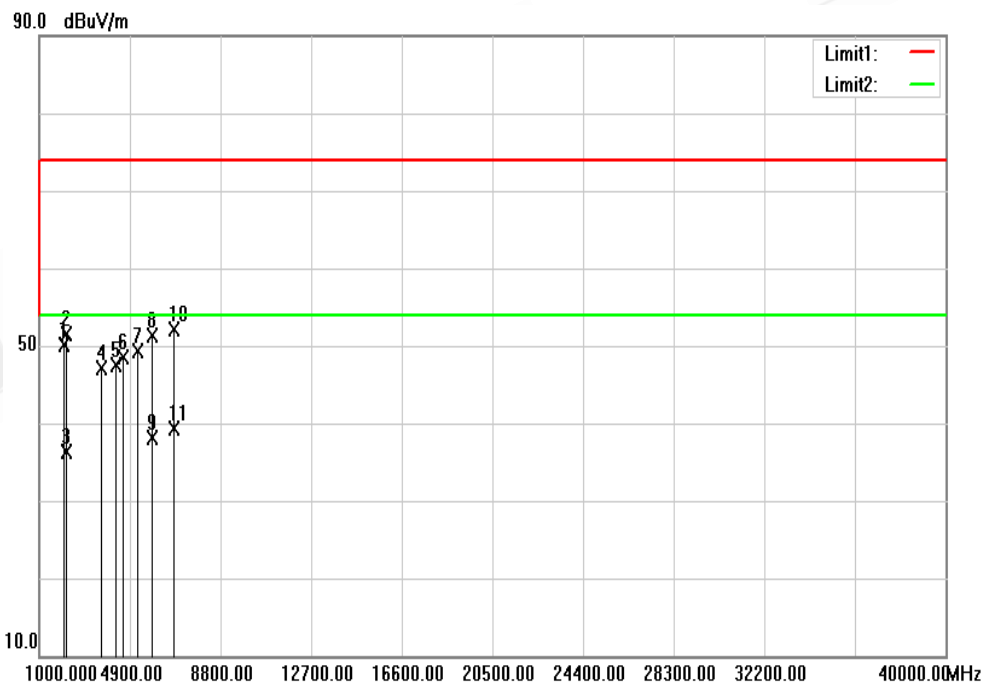

No.	Frequency (MHz)	Reading (dBuV)	Correction Factor (dB/m)	Result (dBuV/m)	Limit (dBuV/m)	Margin (dB)	Height (cm)	Degree (°)	Remark
1	2045.500	63.58	-13.56	50.02	74.00	-23.98	100	218	peak
2	2139.000	64.97	-13.50	51.47	74.00	-22.53	200	235	peak
3	2139.000	49.85	-13.50	36.35	54.00	-17.65	200	235	AVG
4	3643.500	58.10	-11.06	47.04	74.00	-26.96	100	284	peak
5	4247.000	56.73	-9.22	47.51	74.00	-26.49	100	67	peak
6	4595.500	56.38	-7.79	48.59	74.00	-25.41	400	341	peak

Unless otherwise stated the results shown in this test report refer only to the sample(s) tested and such sample(s) are retained for 90 days only.

除非另有說明，此報告結果僅對測試之樣品負責，同時此樣品僅保留90天。本報告未經本公司書面許可，不可部份複製。

This document is issued by the Company subject to its General Conditions of Service printed overleaf, available on request or accessible at www.sgs.com/terms_and_conditions.htm and for electronic format documents, subject to Terms and Conditions for Electronic Documents at www.sgs.com/terms_e-document.htm. Attention is drawn to the limitation of liability, indemnification and jurisdiction issues defined therein. Any holder of this document is advised that information contained hereon reflects the Company's findings at the time of its intervention only and within the limits of Client's instructions, if any. The Company's sole responsibility is to its Client and this document does not exonerate parties to a transaction from exercising all their rights and obligations under the transaction documents. This document cannot be reproduced except in full, without prior written approval of the Company. Any unauthorized alteration, forgery or falsification of the content or appearance of this document is unlawful and offenders may be prosecuted to the fullest extent of the law.

No.	Frequency (MHz)	Reading (dBuV)	Correction Factor (dB/m)	Result (dBuV/m)	Limit (dBuV/m)	Margin (dB)	Height (cm)	Degree (°)	Remark
7	5224.500	56.08	-6.83	49.25	74.00	-24.75	200	360	peak
8	5853.500	56.78	-5.47	51.31	74.00	-22.69	100	246	peak
9	5853.500	43.66	-5.47	38.19	54.00	-15.81	100	246	AVG
10	6754.500	55.98	-3.95	52.03	74.00	-21.97	300	0	peak
11	6754.500	43.34	-3.95	39.39	54.00	-14.61	300	0	AVG

REMARKS:

1. The other emission levels were very low against the limit.
2. Margin (dB) = Result (dBuV/m) – Limit (dBuV/m)

Unless otherwise stated the results shown in this test report refer only to the sample(s) tested and such sample(s) are retained for 90 days only.

除非另有說明，此報告結果僅對測試之樣品負責，同時此樣品僅保留90天。本報告未經本公司書面許可，不可部份複製。

This document is issued by the Company subject to its General Conditions of Service printed overleaf, available on request or accessible at www.sgs.com/terms_and_conditions.htm and for electronic format documents, subject to Terms and Conditions for Electronic Documents at www.sgs.com/terms_e-document.htm. Attention is drawn to the limitation of liability, indemnification and jurisdiction issues defined therein. Any holder of this document is advised that information contained hereon reflects the Company's findings at the time of its intervention only and within the limits of Client's instructions, if any. The Company's sole responsibility is to its Client and this document does not exonerate parties to a transaction from exercising all their rights and obligations under the transaction documents. This document cannot be reproduced except in full, without prior written approval of the Company. Any unauthorized alteration, forgery or falsification of the content or appearance of this document is unlawful and offenders may be prosecuted to the fullest extent of the law.

Model no.	HSN-I59C	Test Mode	Mode 31
Environmental Conditions	23°C, 57% RH	Tested Date	2022/12/01
Antenna Pole	Horizontal	Antenna Distance	3m
Highest frequency generated or used	7.1GHz	Upper frequency	35.5GHz
Detector Function	Peak & Average	Tested By	Rex Kuo
6dB Bandwidth	1 MHz	Identifier number	TCOP RF site 17

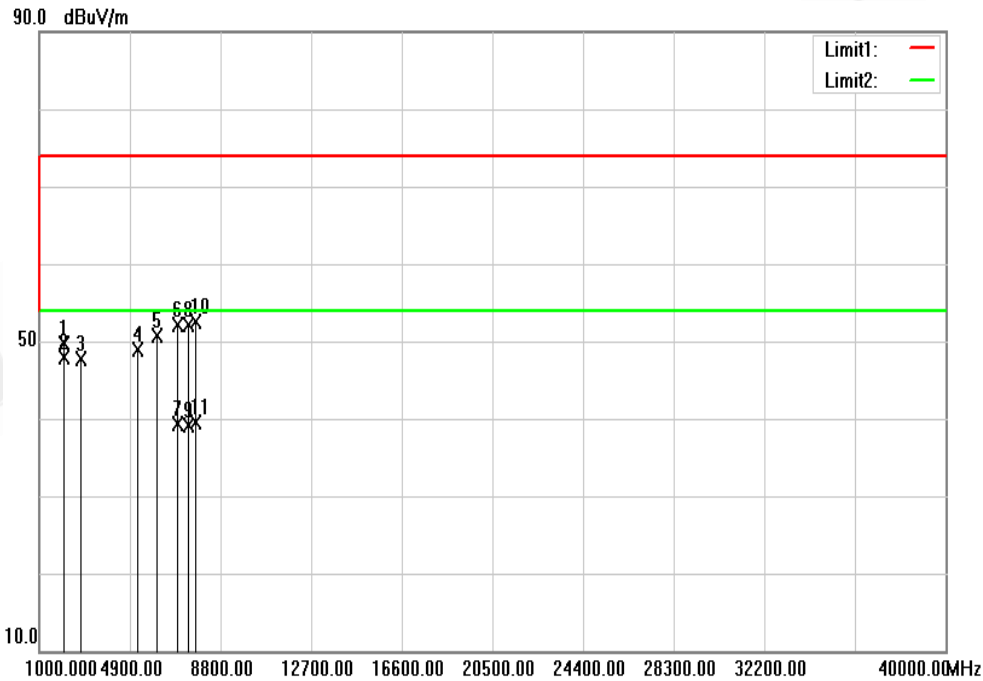

No.	Frequency (MHz)	Reading (dBuV)	Correction Factor (dB/m)	Result (dBuV/m)	Limit (dBuV/m)	Margin (dB)	Height (cm)	Degree (°)	Remark
1	2045.500	63.30	-13.56	49.74	74.00	-24.26	100	228	peak
2	2088.000	61.18	-13.25	47.93	74.00	-26.07	100	275	peak
3	2759.500	60.41	-12.69	47.72	74.00	-26.28	100	190	peak
4	5241.500	55.82	-6.87	48.95	74.00	-25.05	200	75	peak
5	6040.500	55.90	-5.28	50.62	74.00	-23.38	300	303	peak
6	6950.000	55.61	-3.43	52.18	74.00	-21.82	200	320	peak

Unless otherwise stated the results shown in this test report refer only to the sample(s) tested and such sample(s) are retained for 90 days only.

除非另有說明，此報告結果僅對測試之樣品負責，同時此樣品僅保留90天。本報告未經本公司書面許可，不可部份複製。

This document is issued by the Company subject to its General Conditions of Service printed overleaf, available on request or accessible at www.sgs.com/terms_and_conditions.htm and for electronic format documents, subject to Terms and Conditions for Electronic Documents at www.sgs.com/terms_e-document.htm. Attention is drawn to the limitation of liability, indemnification and jurisdiction issues defined therein. Any holder of this document is advised that information contained hereon reflects the Company's findings at the time of its intervention only and within the limits of Client's instructions, if any. The Company's sole responsibility is to its Client and this document does not exonerate parties to a transaction from exercising all their rights and obligations under the transaction documents. This document cannot be reproduced except in full, without prior written approval of the Company. Any unauthorized alteration, forgery or falsification of the content or appearance of this document is unlawful and offenders may be prosecuted to the fullest extent of the law.

No.	Frequency (MHz)	Reading (dBuV)	Correction Factor (dB/m)	Result (dBuV/m)	Limit (dBuV/m)	Margin (dB)	Height (cm)	Degree (°)	Remark
7	6950.000	42.68	-3.43	39.25	54.00	-14.75	200	320	AVG
8	7358.000	55.68	-3.54	52.14	74.00	-21.86	300	11	peak
9	7358.000	42.59	-3.54	39.05	54.00	-14.95	300	11	AVG
10	7723.500	56.10	-3.68	52.42	74.00	-21.58	100	293	peak
11	7723.500	43.22	-3.68	39.54	54.00	-14.46	100	293	AVG

REMARKS:

1. The other emission levels were very low against the limit.
2. Margin (dB) = Result (dBuV/m) – Limit (dBuV/m)

Unless otherwise stated the results shown in this test report refer only to the sample(s) tested and such sample(s) are retained for 90 days only.

除非另有說明，此報告結果僅對測試之樣品負責，同時此樣品僅保留90天。本報告未經本公司書面許可，不可部份複製。

This document is issued by the Company subject to its General Conditions of Service printed overleaf, available on request or accessible at www.sgs.com/terms_and_conditions.htm and for electronic format documents, subject to Terms and Conditions for Electronic Documents at www.sgs.com/terms_e-document.htm. Attention is drawn to the limitation of liability, indemnification and jurisdiction issues defined therein. Any holder of this document is advised that information contained hereon reflects the Company's findings at the time of its intervention only and within the limits of Client's instructions, if any. The Company's sole responsibility is to its Client and this document does not exonerate parties to a transaction from exercising all their rights and obligations under the transaction documents. This document cannot be reproduced except in full, without prior written approval of the Company. Any unauthorized alteration, forgery or falsification of the content or appearance of this document is unlawful and offenders may be prosecuted to the fullest extent of the law.

Model no.	HSN-I59C	Test Mode	Mode 43
Environmental Conditions	23°C, 57% RH	Tested Date	2022/12/01
Antenna Pole	Vertical	Antenna Distance	3m
Highest frequency generated or used	7.1GHz	Upper frequency	35.5GHz
Detector Function	Peak & Average	Tested By	Rex Kuo
6dB Bandwidth	1 MHz	Identifier number	TCOP RF site 17

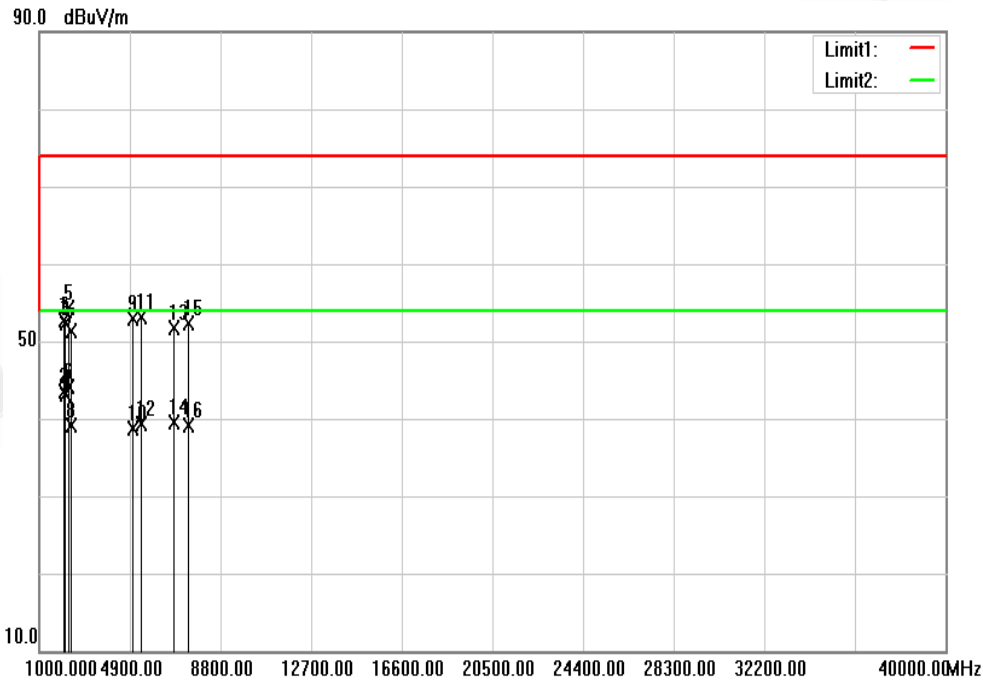

No.	Frequency (MHz)	Reading (dBuV)	Correction Factor (dB/m)	Result (dBuV/m)	Limit (dBuV/m)	Margin (dB)	Height (cm)	Degree (°)	Remark
1	2045.500	66.18	-13.56	52.62	74.00	-21.38	100	256	peak
2	2045.500	56.99	-13.56	43.43	54.00	-10.57	100	256	AVG
3	2088.000	65.47	-13.25	52.22	74.00	-21.78	100	265	peak
4	2088.000	56.37	-13.25	43.12	54.00	-10.88	100	265	AVG
5	2258.000	68.36	-14.15	54.21	74.00	-19.79	100	294	peak
6	2258.000	58.20	-14.15	44.05	54.00	-9.95	100	294	AVG

Unless otherwise stated the results shown in this test report refer only to the sample(s) tested and such sample(s) are retained for 90 days only.

除非另有說明，此報告結果僅對測試之樣品負責，同時此樣品僅保留90天。本報告未經本公司書面許可，不可部份複製。

This document is issued by the Company subject to its General Conditions of Service printed overleaf, available on request or accessible at www.sgs.com/terms_and_conditions.htm and for electronic format documents, subject to Terms and Conditions for Electronic Documents at www.sgs.com/terms_e-document.htm. Attention is drawn to the limitation of liability, indemnification and jurisdiction issues defined therein. Any holder of this document is advised that information contained hereon reflects the Company's findings at the time of its intervention only and within the limits of Client's instructions, if any. The Company's sole responsibility is to its Client and this document does not exonerate parties to a transaction from exercising all their rights and obligations under the transaction documents. This document cannot be reproduced except in full, without prior written approval of the Company. Any unauthorized alteration, forgery or falsification of the content or appearance of this document is unlawful and offenders may be prosecuted to the fullest extent of the law.

No.	Frequency (MHz)	Reading (dBuV)	Correction Factor (dB/m)	Result (dBuV/m)	Limit (dBuV/m)	Margin (dB)	Height (cm)	Degree (°)	Remark
7	2360.000	65.17	-13.79	51.38	74.00	-22.62	200	96	peak
8	2360.000	52.92	-13.79	39.13	54.00	-14.87	200	96	AVG
9	4986.500	60.57	-7.73	52.84	74.00	-21.16	100	208	peak
10	4986.500	46.47	-7.73	38.74	54.00	-15.26	100	208	AVG
11	5394.500	59.83	-6.73	53.10	74.00	-20.90	300	246	peak
12	5394.500	46.02	-6.73	39.29	54.00	-14.71	300	246	AVG
13	6780.000	55.59	-3.88	51.71	74.00	-22.29	100	360	peak
14	6780.000	43.33	-3.88	39.45	54.00	-14.55	100	360	AVG
15	7358.000	55.91	-3.54	52.37	74.00	-21.63	400	161	peak
16	7358.000	42.73	-3.54	39.19	54.00	-14.81	400	161	AVG

REMARKS:

1. The other emission levels were very low against the limit.
2. Margin (dB) = Result (dBuV/m) – Limit (dBuV/m)

Unless otherwise stated the results shown in this test report refer only to the sample(s) tested and such sample(s) are retained for 90 days only.

除非另有說明，此報告結果僅對測試之樣品負責，同時此樣品僅保留90天。本報告未經本公司書面許可，不可部份複製。

This document is issued by the Company subject to its General Conditions of Service printed overleaf, available on request or accessible at www.sgs.com/terms_and_conditions.htm and for electronic format documents, subject to Terms and Conditions for Electronic Documents at www.sgs.com/terms_e-document.htm. Attention is drawn to the limitation of liability, indemnification and jurisdiction issues defined therein. Any holder of this document is advised that information contained hereon reflects the Company's findings at the time of its intervention only and within the limits of Client's instructions, if any. The Company's sole responsibility is to its Client and this document does not exonerate parties to a transaction from exercising all their rights and obligations under the transaction documents. This document cannot be reproduced except in full, without prior written approval of the Company. Any unauthorized alteration, forgery or falsification of the content or appearance of this document is unlawful and offenders may be prosecuted to the fullest extent of the law.

Model no.	HSN-I59C	Test Mode	Mode 43
Environmental Conditions	23°C, 57% RH	Tested Date	2022/12/01
Antenna Pole	Horizontal	Antenna Distance	3m
Highest frequency generated or used	7.1GHz	Upper frequency	35.5GHz
Detector Function	Peak & Average	Tested By	Rex Kuo
6dB Bandwidth	1 MHz	Identifier number	TCOP RF site 17

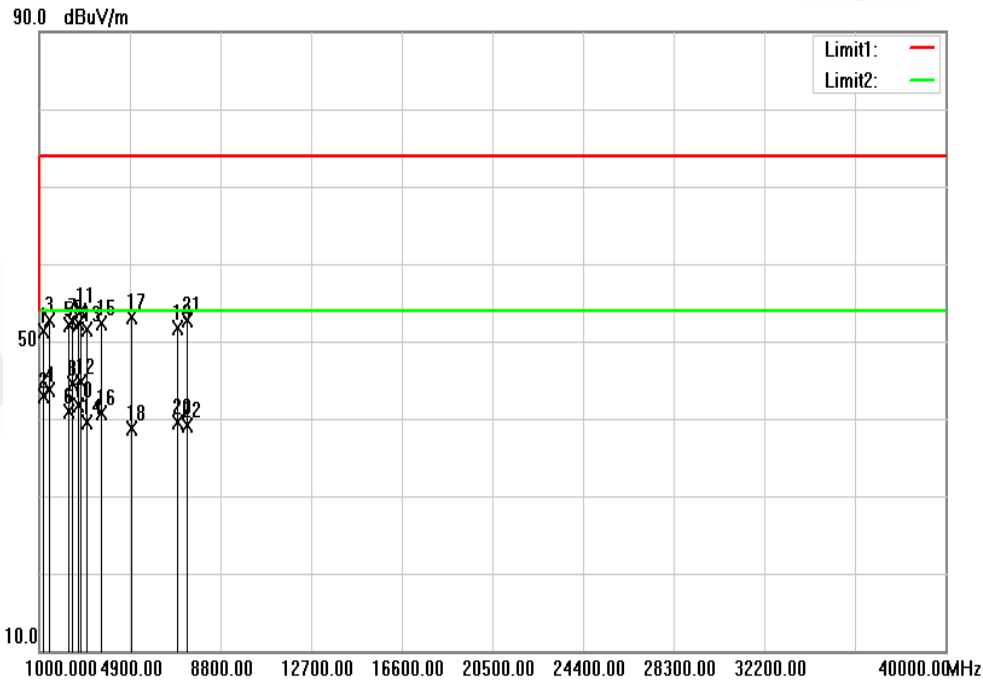

No.	Frequency (MHz)	Reading (dBuV)	Correction Factor (dB/m)	Result (dBuV/m)	Limit (dBuV/m)	Margin (dB)	Height (cm)	Degree (°)	Remark
1	1144.500	68.64	-17.38	51.26	74.00	-22.74	100	142	peak
2	1144.500	60.22	-17.38	42.84	54.00	-11.16	100	142	AVG
3	1399.500	70.94	-18.32	52.62	74.00	-21.38	100	133	peak
4	1399.500	62.08	-18.32	43.76	54.00	-10.24	100	133	AVG
5	2232.500	66.30	-14.17	52.13	74.00	-21.87	200	104	peak
6	2232.500	55.04	-14.17	40.87	54.00	-13.13	200	104	AVG

Unless otherwise stated the results shown in this test report refer only to the sample(s) tested and such sample(s) are retained for 90 days only.

除非另有說明，此報告結果僅對測試之樣品負責，同時此樣品僅保留90天。本報告未經本公司書面許可，不可部份複製。

This document is issued by the Company subject to its General Conditions of Service printed overleaf, available on request or accessible at www.sgs.com/terms_and_conditions.htm and for electronic format documents, subject to Terms and Conditions for Electronic Documents at www.sgs.com/terms_e-document.htm. Attention is drawn to the limitation of liability, indemnification and jurisdiction issues defined therein. Any holder of this document is advised that information contained hereon reflects the Company's findings at the time of its intervention only and within the limits of Client's instructions, if any. The Company's sole responsibility is to its Client and this document does not exonerate parties to a transaction from exercising all their rights and obligations under the transaction documents. This document cannot be reproduced except in full, without prior written approval of the Company. Any unauthorized alteration, forgery or falsification of the content or appearance of this document is unlawful and offenders may be prosecuted to the fullest extent of the law.

No.	Frequency (MHz)	Reading (dBuV)	Correction Factor (dB/m)	Result (dBuV/m)	Limit (dBuV/m)	Margin (dB)	Height (cm)	Degree (°)	Remark
7	2385.500	66.10	-13.60	52.50	74.00	-21.50	400	47	peak
8	2385.500	58.01	-13.60	44.41	54.00	-9.59	400	47	AVG
9	2640.500	65.05	-12.76	52.29	74.00	-21.71	200	349	peak
10	2640.500	54.49	-12.76	41.73	54.00	-12.27	200	349	AVG
11	2759.500	66.67	-12.69	53.98	74.00	-20.02	100	322	peak
12	2759.500	57.41	-12.69	44.72	54.00	-9.28	100	322	AVG
13	2997.500	62.98	-11.51	51.47	74.00	-22.53	200	198	peak
14	2997.500	50.94	-11.51	39.43	54.00	-14.57	200	198	AVG
15	3643.500	63.33	-11.06	52.27	74.00	-21.73	200	321	peak
16	3643.500	51.74	-11.06	40.68	54.00	-13.32	200	321	AVG
17	4978.000	60.91	-7.72	53.19	74.00	-20.81	300	47	peak
18	4978.000	46.45	-7.72	38.73	54.00	-15.27	300	47	AVG
19	6941.500	55.22	-3.46	51.76	74.00	-22.24	200	360	peak
20	6941.500	43.06	-3.46	39.60	54.00	-14.40	200	360	AVG
21	7341.000	56.21	-3.52	52.69	74.00	-21.31	300	38	peak
22	7341.000	42.66	-3.52	39.14	54.00	-14.86	300	38	AVG

REMARKS:

1. The other emission levels were very low against the limit.
2. Margin (dB) = Result (dBuV/m) – Limit (dBuV/m)

Unless otherwise stated the results shown in this test report refer only to the sample(s) tested and such sample(s) are retained for 90 days only.

除非另有說明，此報告結果僅對測試之樣品負責，同時此樣品僅保留90天。本報告未經本公司書面許可，不可部份複製。

This document is issued by the Company subject to its General Conditions of Service printed overleaf, available on request or accessible at www.sgs.com/terms_and_conditions.htm and for electronic format documents, subject to Terms and Conditions for Electronic Documents at www.sgs.com/terms_e-document.htm. Attention is drawn to the limitation of liability, indemnification and jurisdiction issues defined therein. Any holder of this document is advised that information contained hereon reflects the Company's findings at the time of its intervention only and within the limits of Client's instructions, if any. The Company's sole responsibility is to its Client and this document does not exonerate parties to a transaction from exercising all their rights and obligations under the transaction documents. This document cannot be reproduced except in full, without prior written approval of the Company. Any unauthorized alteration, forgery or falsification of the content or appearance of this document is unlawful and offenders may be prosecuted to the fullest extent of the law.

APPENDIX

Photograph of Testing General Set-up

CE Testing Set-up

Model No.: HSN-I59C
Mode_31_+



Mode_31_-

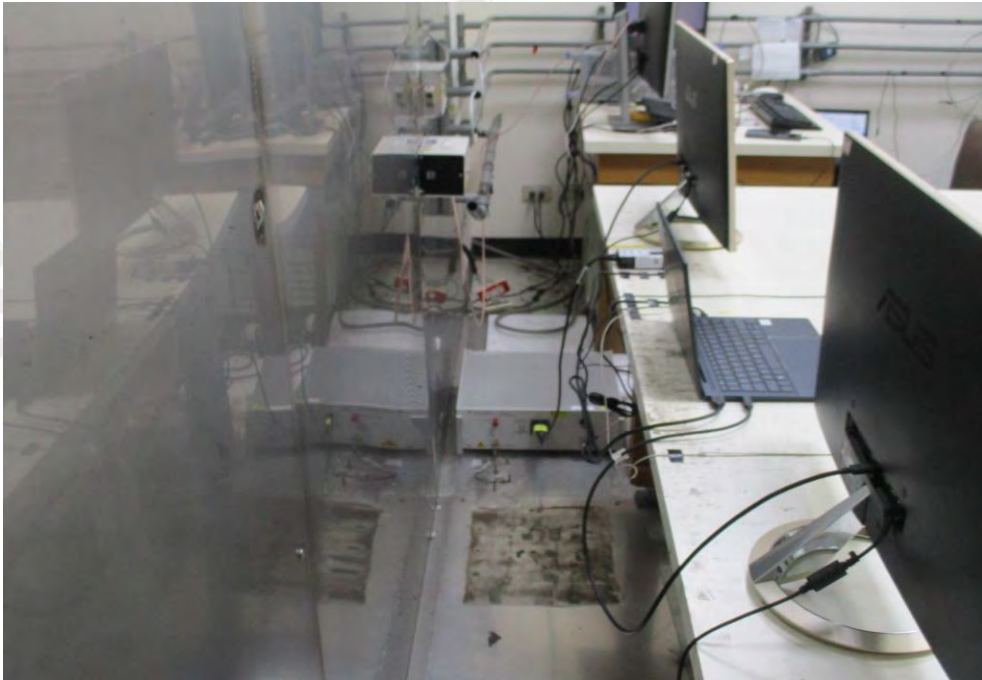

Unless otherwise stated the results shown in this test report refer only to the sample(s) tested and such sample(s) are retained for 90 days only.

除非另有說明，此報告結果僅對測試之樣品負責，同時此樣品僅保留90天。本報告未經本公司書面許可，不可部份複製。

This document is issued by the Company subject to its General Conditions of Service printed overleaf, available on request or accessible at www.sgs.com/terms_and_conditions.htm and for electronic format documents, subject to Terms and Conditions for Electronic Documents at www.sgs.com/terms_e-document.htm. Attention is drawn to the limitation of liability, indemnification and jurisdiction issues defined therein. Any holder of this document is advised that information contained hereon reflects the Company's findings at the time of its intervention only and within the limits of Client's instructions, if any. The Company's sole responsibility is to its Client and this document does not exonerate parties to a transaction from exercising all their rights and obligations under the transaction documents. This document cannot be reproduced except in full, without prior written approval of the Company. Any unauthorized alteration, forgery or falsification of the content or appearance of this document is unlawful and offenders may be prosecuted to the fullest extent of the law.

Model No.: HSN-I59C
Mode_43_+



Mode_43_-



Unless otherwise stated the results shown in this test report refer only to the sample(s) tested and such sample(s) are retained for 90 days only.

除非另有說明，此報告結果僅對測試之樣品負責，同時此樣品僅保留90天。本報告未經本公司書面許可，不可部份複製。

This document is issued by the Company subject to its General Conditions of Service printed overleaf, available on request or accessible at www.sgs.com/terms_and_conditions.htm and for electronic format documents, subject to Terms and Conditions for Electronic Documents at www.sgs.com/terms_e-document.htm. Attention is drawn to the limitation of liability, indemnification and jurisdiction issues defined therein. Any holder of this document is advised that information contained hereon reflects the Company's findings at the time of its intervention only and within the limits of Client's instructions, if any. The Company's sole responsibility is to its Client and this document does not exonerate parties to a transaction from exercising all their rights and obligations under the transaction documents. This document cannot be reproduced except in full, without prior written approval of the Company. Any unauthorized alteration, forgery or falsification of the content or appearance of this document is unlawful and offenders may be prosecuted to the fullest extent of the law.

RE Testing Set-up Below 1GHz

Model No.: HSN-I59C
Mode 31_ +

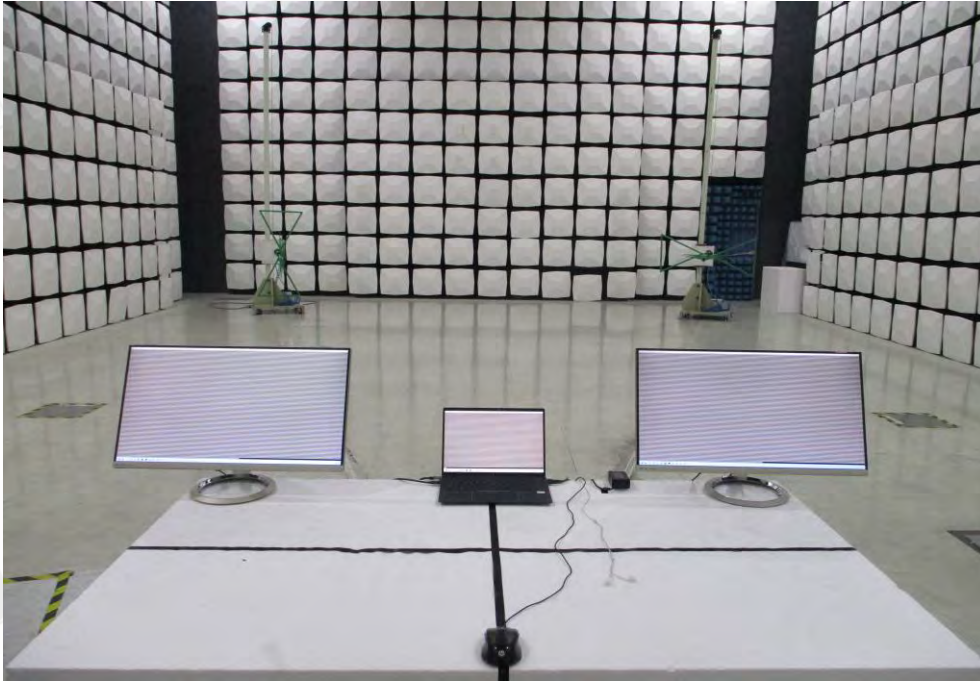

Mode 31_ -

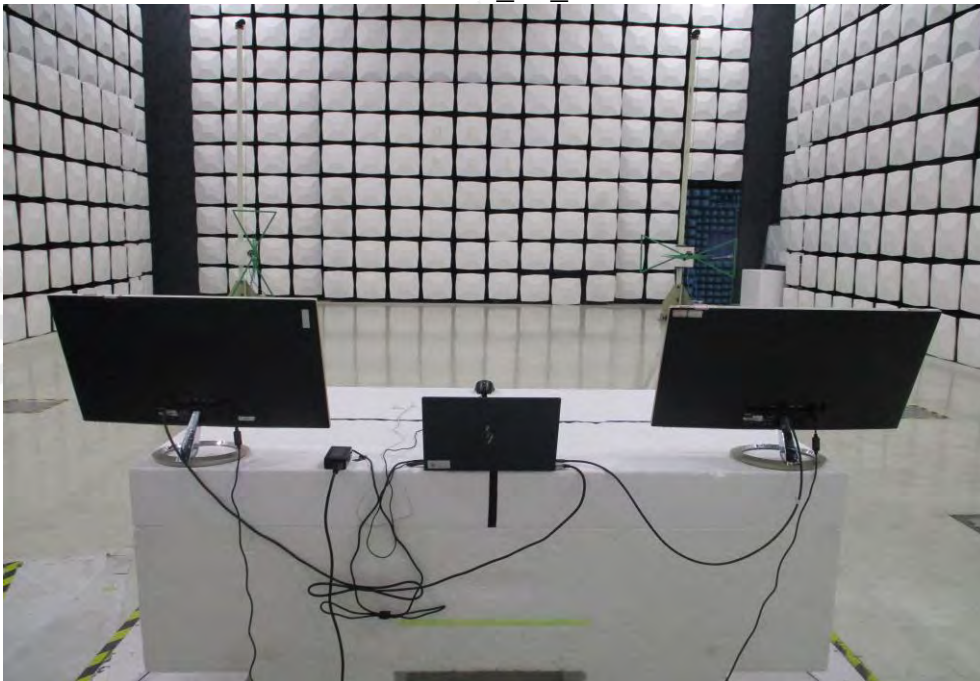

Unless otherwise stated the results shown in this test report refer only to the sample(s) tested and such sample(s) are retained for 90 days only.

除非另有說明，此報告結果僅對測試之樣品負責，同時此樣品僅保留90天。本報告未經本公司書面許可，不可部份複製。

This document is issued by the Company subject to its General Conditions of Service printed overleaf, available on request or accessible at www.sgs.com/terms_and_conditions.htm and for electronic format documents, subject to Terms and Conditions for Electronic Documents at www.sgs.com/terms_e-document.htm. Attention is drawn to the limitation of liability, indemnification and jurisdiction issues defined therein. Any holder of this document is advised that information contained hereon reflects the Company's findings at the time of its intervention only and within the limits of Client's instructions, if any. The Company's sole responsibility is to its Client and this document does not exonerate parties to a transaction from exercising all their rights and obligations under the transaction documents. This document cannot be reproduced except in full, without prior written approval of the Company. Any unauthorized alteration, forgery or falsification of the content or appearance of this document is unlawful and offenders may be prosecuted to the fullest extent of the law.

Model No.: HSN-I59C
Mode_43_+



Mode_43_-



Unless otherwise stated the results shown in this test report refer only to the sample(s) tested and such sample(s) are retained for 90 days only.

除非另有說明，此報告結果僅對測試之樣品負責，同時此樣品僅保留90天。本報告未經本公司書面許可，不可部份複製。

This document is issued by the Company subject to its General Conditions of Service printed overleaf, available on request or accessible at www.sgs.com/terms_and_conditions.htm and for electronic format documents, subject to Terms and Conditions for Electronic Documents at www.sgs.com/terms_e-document.htm. Attention is drawn to the limitation of liability, indemnification and jurisdiction issues defined therein. Any holder of this document is advised that information contained hereon reflects the Company's findings at the time of its intervention only and within the limits of Client's instructions, if any. The Company's sole responsibility is to its Client and this document does not exonerate parties to a transaction from exercising all their rights and obligations under the transaction documents. This document cannot be reproduced except in full, without prior written approval of the Company. Any unauthorized alteration, forgery or falsification of the content or appearance of this document is unlawful and offenders may be prosecuted to the fullest extent of the law.

Above 1GHz

Model No.: HSN-I59C

Mode_31_+



Mode_31_-



Unless otherwise stated the results shown in this test report refer only to the sample(s) tested and such sample(s) are retained for 90 days only.

除非另有說明，此報告結果僅對測試之樣品負責，同時此樣品僅保留90天。本報告未經本公司書面許可，不可部份複製。

This document is issued by the Company subject to its General Conditions of Service printed overleaf, available on request or accessible at www.sgs.com/terms_and_conditions.htm and for electronic format documents, subject to Terms and Conditions for Electronic Documents at www.sgs.com/terms_e-document.htm. Attention is drawn to the limitation of liability, indemnification and jurisdiction issues defined therein. Any holder of this document is advised that information contained hereon reflects the Company's findings at the time of its intervention only and within the limits of Client's instructions, if any. The Company's sole responsibility is to its Client and this document does not exonerate parties to a transaction from exercising all their rights and obligations under the transaction documents. This document cannot be reproduced except in full, without prior written approval of the Company. Any unauthorized alteration, forgery or falsification of the content or appearance of this document is unlawful and offenders may be prosecuted to the fullest extent of the law.

Model No.: HSN-I59C
Mode_43_+

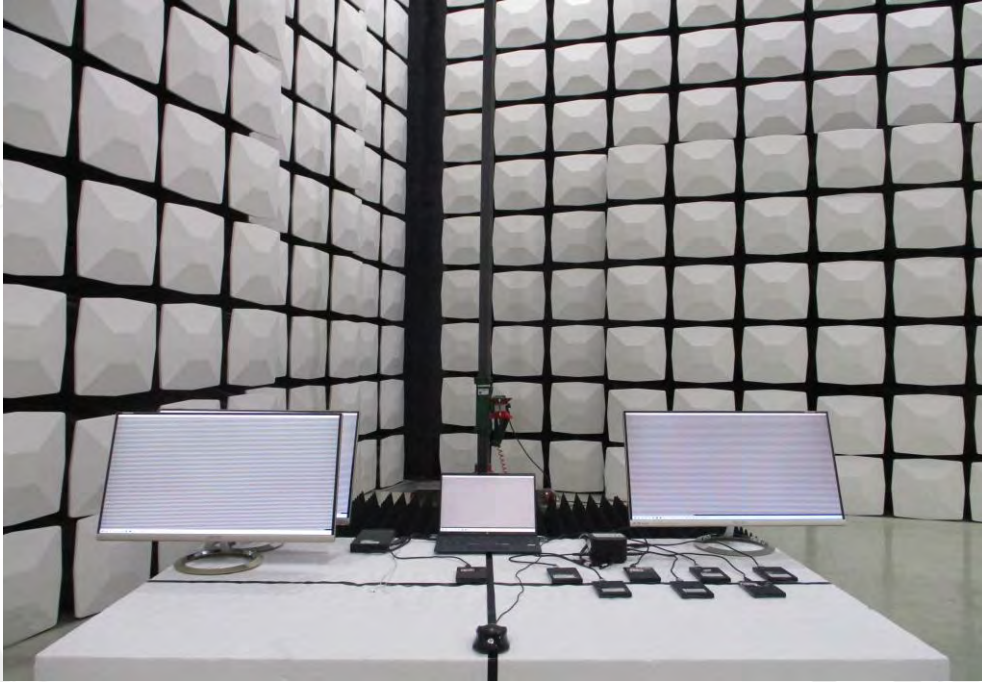

Mode_43_-



Unless otherwise stated the results shown in this test report refer only to the sample(s) tested and such sample(s) are retained for 90 days only.

除非另有說明，此報告結果僅對測試之樣品負責，同時此樣品僅保留90天。本報告未經本公司書面許可，不可部份複製。

This document is issued by the Company subject to its General Conditions of Service printed overleaf, available on request or accessible at www.sgs.com/terms_and_conditions.htm and for electronic format documents, subject to Terms and Conditions for Electronic Documents at www.sgs.com/terms_e-document.htm. Attention is drawn to the limitation of liability, indemnification and jurisdiction issues defined therein. Any holder of this document is advised that information contained hereon reflects the Company's findings at the time of its intervention only and within the limits of Client's instructions, if any. The Company's sole responsibility is to its Client and this document does not exonerate parties to a transaction from exercising all their rights and obligations under the transaction documents. This document cannot be reproduced except in full, without prior written approval of the Company. Any unauthorized alteration, forgery or falsification of the content or appearance of this document is unlawful and offenders may be prosecuted to the fullest extent of the law.

Photographs of Product
Exterior

Model No.: HSN-I59C



Unless otherwise stated the results shown in this test report refer only to the sample(s) tested and such sample(s) are retained for 90 days only.

除非另有說明，此報告結果僅對測試之樣品負責，同時此樣品僅保留90天。本報告未經本公司書面許可，不可部份複製。

This document is issued by the Company subject to its General Conditions of Service printed overleaf, available on request or accessible at www.sgs.com/terms_and_conditions.htm and for electronic format documents, subject to Terms and Conditions for Electronic Documents at www.sgs.com/terms_e-document.htm. Attention is drawn to the limitation of liability, indemnification and jurisdiction issues defined therein. Any holder of this document is advised that information contained hereon reflects the Company's findings at the time of its intervention only and within the limits of Client's instructions, if any. The Company's sole responsibility is to its Client and this document does not exonerate parties to a transaction from exercising all their rights and obligations under the transaction documents. This document cannot be reproduced except in full, without prior written approval of the Company. Any unauthorized alteration, forgery or falsification of the content or appearance of this document is unlawful and offenders may be prosecuted to the fullest extent of the law.

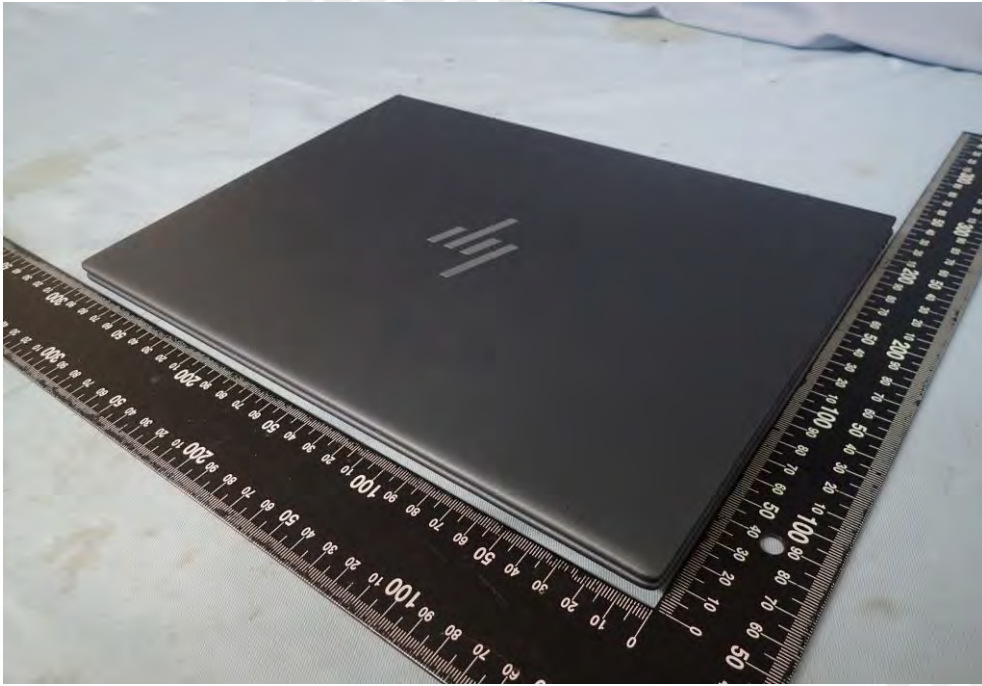

Unless otherwise stated the results shown in this test report refer only to the sample(s) tested and such sample(s) are retained for 90 days only.

除非另有說明，此報告結果僅對測試之樣品負責，同時此樣品僅保留90天。本報告未經本公司書面許可，不可部份複製。

This document is issued by the Company subject to its General Conditions of Service printed overleaf, available on request or accessible at www.sgs.com/terms_and_conditions.htm and for electronic format documents, subject to Terms and Conditions for Electronic Documents at www.sgs.com/terms_e-document.htm. Attention is drawn to the limitation of liability, indemnification and jurisdiction issues defined therein. Any holder of this document is advised that information contained hereon reflects the Company's findings at the time of its intervention only and within the limits of Client's instructions, if any. The Company's sole responsibility is to its Client and this document does not exonerate parties to a transaction from exercising all their rights and obligations under the transaction documents. This document cannot be reproduced except in full, without prior written approval of the Company. Any unauthorized alteration, forgery or falsification of the content or appearance of this document is unlawful and offenders may be prosecuted to the fullest extent of the law.

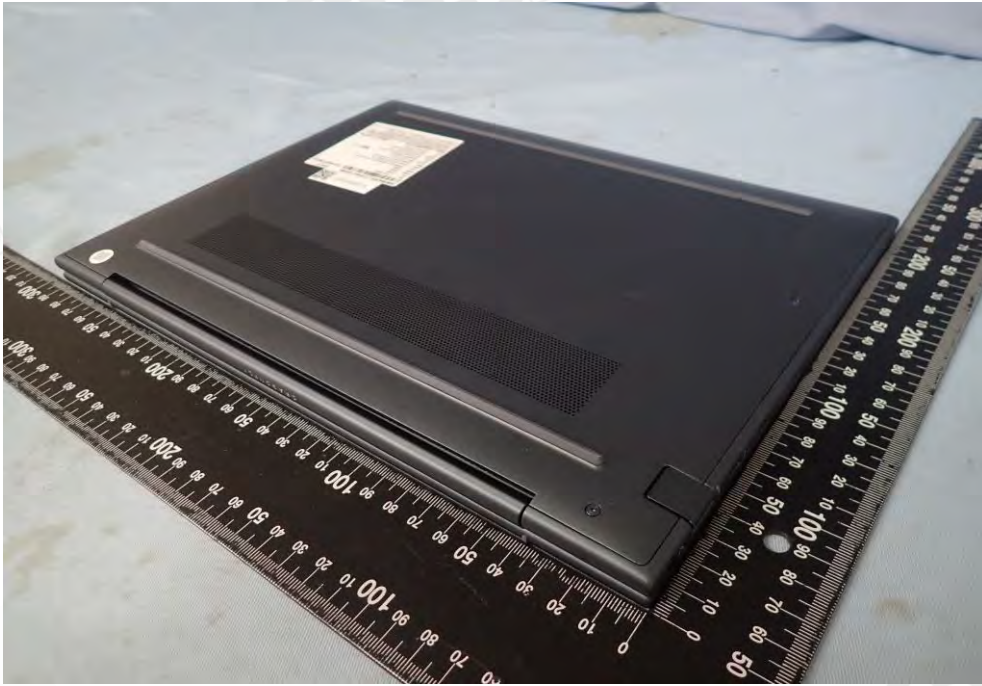

Unless otherwise stated the results shown in this test report refer only to the sample(s) tested and such sample(s) are retained for 90 days only.

除非另有說明，此報告結果僅對測試之樣品負責，同時此樣品僅保留90天。本報告未經本公司書面許可，不可部份複製。

This document is issued by the Company subject to its General Conditions of Service printed overleaf, available on request or accessible at www.sgs.com/terms_and_conditions.htm and for electronic format documents, subject to Terms and Conditions for Electronic Documents at www.sgs.com/terms_e-document.htm. Attention is drawn to the limitation of liability, indemnification and jurisdiction issues defined therein. Any holder of this document is advised that information contained hereon reflects the Company's findings at the time of its intervention only and within the limits of Client's instructions, if any. The Company's sole responsibility is to its Client and this document does not exonerate parties to a transaction from exercising all their rights and obligations under the transaction documents. This document cannot be reproduced except in full, without prior written approval of the Company. Any unauthorized alteration, forgery or falsification of the content or appearance of this document is unlawful and offenders may be prosecuted to the fullest extent of the law.



Unless otherwise stated the results shown in this test report refer only to the sample(s) tested and such sample(s) are retained for 90 days only.

除非另有說明，此報告結果僅對測試之樣品負責，同時此樣品僅保留90天。本報告未經本公司書面許可，不可部份複製。

This document is issued by the Company subject to its General Conditions of Service printed overleaf, available on request or accessible at www.sgs.com/terms_and_conditions.htm and for electronic format documents, subject to Terms and Conditions for Electronic Documents at www.sgs.com/terms_e-document.htm. Attention is drawn to the limitation of liability, indemnification and jurisdiction issues defined therein. Any holder of this document is advised that information contained hereon reflects the Company's findings at the time of its intervention only and within the limits of Client's instructions, if any. The Company's sole responsibility is to its Client and this document does not exonerate parties to a transaction from exercising all their rights and obligations under the transaction documents. This document cannot be reproduced except in full, without prior written approval of the Company. Any unauthorized alteration, forgery or falsification of the content or appearance of this document is unlawful and offenders may be prosecuted to the fullest extent of the law.



Unless otherwise stated the results shown in this test report refer only to the sample(s) tested and such sample(s) are retained for 90 days only.

除非另有說明，此報告結果僅對測試之樣品負責，同時此樣品僅保留90天。本報告未經本公司書面許可，不可部份複製。

This document is issued by the Company subject to its General Conditions of Service printed overleaf, available on request or accessible at www.sgs.com/terms_and_conditions.htm and for electronic format documents, subject to Terms and Conditions for Electronic Documents at www.sgs.com/terms_e-document.htm. Attention is drawn to the limitation of liability, indemnification and jurisdiction issues defined therein. Any holder of this document is advised that information contained hereon reflects the Company's findings at the time of its intervention only and within the limits of Client's instructions, if any. The Company's sole responsibility is to its Client and this document does not exonerate parties to a transaction from exercising all their rights and obligations under the transaction documents. This document cannot be reproduced except in full, without prior written approval of the Company. Any unauthorized alteration, forgery or falsification of the content or appearance of this document is unlawful and offenders may be prosecuted to the fullest extent of the law.

Adapter Model No.: TPN-AA08



Unless otherwise stated the results shown in this test report refer only to the sample(s) tested and such sample(s) are retained for 90 days only.

除非另有說明，此報告結果僅對測試之樣品負責，同時此樣品僅保留90天。本報告未經本公司書面許可，不可部份複製。

This document is issued by the Company subject to its General Conditions of Service printed overleaf, available on request or accessible at www.sgs.com/terms_and_conditions.htm and for electronic format documents, subject to Terms and Conditions for Electronic Documents at www.sgs.com/terms_e-document.htm. Attention is drawn to the limitation of liability, indemnification and jurisdiction issues defined therein. Any holder of this document is advised that information contained hereon reflects the Company's findings at the time of its intervention only and within the limits of Client's instructions, if any. The Company's sole responsibility is to its Client and this document does not exonerate parties to a transaction from exercising all their rights and obligations under the transaction documents. This document cannot be reproduced except in full, without prior written approval of the Company. Any unauthorized alteration, forgery or falsification of the content or appearance of this document is unlawful and offenders may be prosecuted to the fullest extent of the law.



Unless otherwise stated the results shown in this test report refer only to the sample(s) tested and such sample(s) are retained for 90 days only.

除非另有說明，此報告結果僅對測試之樣品負責，同時此樣品僅保留90天。本報告未經本公司書面許可，不可部份複製。

This document is issued by the Company subject to its General Conditions of Service printed overleaf, available on request or accessible at www.sgs.com/terms_and_conditions.htm and for electronic format documents, subject to Terms and Conditions for Electronic Documents at www.sgs.com/terms_e-document.htm. Attention is drawn to the limitation of liability, indemnification and jurisdiction issues defined therein. Any holder of this document is advised that information contained hereon reflects the Company's findings at the time of its intervention only and within the limits of Client's instructions, if any. The Company's sole responsibility is to its Client and this document does not exonerate parties to a transaction from exercising all their rights and obligations under the transaction documents. This document cannot be reproduced except in full, without prior written approval of the Company. Any unauthorized alteration, forgery or falsification of the content or appearance of this document is unlawful and offenders may be prosecuted to the fullest extent of the law.

Adapter Model No.: TPN-CA21



Unless otherwise stated the results shown in this test report refer only to the sample(s) tested and such sample(s) are retained for 90 days only.

除非另有說明，此報告結果僅對測試之樣品負責，同時此樣品僅保留90天。本報告未經本公司書面許可，不可部份複製。

This document is issued by the Company subject to its General Conditions of Service printed overleaf, available on request or accessible at www.sgs.com/terms_and_conditions.htm and for electronic format documents, subject to Terms and Conditions for Electronic Documents at www.sgs.com/terms_e-document.htm. Attention is drawn to the limitation of liability, indemnification and jurisdiction issues defined therein. Any holder of this document is advised that information contained hereon reflects the Company's findings at the time of its intervention only and within the limits of Client's instructions, if any. The Company's sole responsibility is to its Client and this document does not exonerate parties to a transaction from exercising all their rights and obligations under the transaction documents. This document cannot be reproduced except in full, without prior written approval of the Company. Any unauthorized alteration, forgery or falsification of the content or appearance of this document is unlawful and offenders may be prosecuted to the fullest extent of the law.



Unless otherwise stated the results shown in this test report refer only to the sample(s) tested and such sample(s) are retained for 90 days only.

除非另有說明，此報告結果僅對測試之樣品負責，同時此樣品僅保留90天。本報告未經本公司書面許可，不可部份複製。

This document is issued by the Company subject to its General Conditions of Service printed overleaf, available on request or accessible at www.sgs.com/terms_and_conditions.htm and for electronic format documents, subject to Terms and Conditions for Electronic Documents at www.sgs.com/terms_e-document.htm. Attention is drawn to the limitation of liability, indemnification and jurisdiction issues defined therein. Any holder of this document is advised that information contained hereon reflects the Company's findings at the time of its intervention only and within the limits of Client's instructions, if any. The Company's sole responsibility is to its Client and this document does not exonerate parties to a transaction from exercising all their rights and obligations under the transaction documents. This document cannot be reproduced except in full, without prior written approval of the Company. Any unauthorized alteration, forgery or falsification of the content or appearance of this document is unlawful and offenders may be prosecuted to the fullest extent of the law.

Adapter Model No.: TPN-CA30



Unless otherwise stated the results shown in this test report refer only to the sample(s) tested and such sample(s) are retained for 90 days only.

除非另有說明，此報告結果僅對測試之樣品負責，同時此樣品僅保留90天。本報告未經本公司書面許可，不可部份複製。

This document is issued by the Company subject to its General Conditions of Service printed overleaf, available on request or accessible at www.sgs.com/terms_and_conditions.htm and for electronic format documents, subject to Terms and Conditions for Electronic Documents at www.sgs.com/terms_e-document.htm. Attention is drawn to the limitation of liability, indemnification and jurisdiction issues defined therein. Any holder of this document is advised that information contained hereon reflects the Company's findings at the time of its intervention only and within the limits of Client's instructions, if any. The Company's sole responsibility is to its Client and this document does not exonerate parties to a transaction from exercising all their rights and obligations under the transaction documents. This document cannot be reproduced except in full, without prior written approval of the Company. Any unauthorized alteration, forgery or falsification of the content or appearance of this document is unlawful and offenders may be prosecuted to the fullest extent of the law.



Unless otherwise stated the results shown in this test report refer only to the sample(s) tested and such sample(s) are retained for 90 days only.

除非另有說明，此報告結果僅對測試之樣品負責，同時此樣品僅保留90天。本報告未經本公司書面許可，不可部份複製。

This document is issued by the Company subject to its General Conditions of Service printed overleaf, available on request or accessible at www.sgs.com/terms_and_conditions.htm and for electronic format documents, subject to Terms and Conditions for Electronic Documents at www.sgs.com/terms_e-document.htm. Attention is drawn to the limitation of liability, indemnification and jurisdiction issues defined therein. Any holder of this document is advised that information contained hereon reflects the Company's findings at the time of its intervention only and within the limits of Client's instructions, if any. The Company's sole responsibility is to its Client and this document does not exonerate parties to a transaction from exercising all their rights and obligations under the transaction documents. This document cannot be reproduced except in full, without prior written approval of the Company. Any unauthorized alteration, forgery or falsification of the content or appearance of this document is unlawful and offenders may be prosecuted to the fullest extent of the law.

Adapter Model No.: TPN-DA20



Unless otherwise stated the results shown in this test report refer only to the sample(s) tested and such sample(s) are retained for 90 days only.

除非另有說明，此報告結果僅對測試之樣品負責，同時此樣品僅保留90天。本報告未經本公司書面許可，不可部份複製。

This document is issued by the Company subject to its General Conditions of Service printed overleaf, available on request or accessible at www.sgs.com/terms_and_conditions.htm and for electronic format documents, subject to Terms and Conditions for Electronic Documents at www.sgs.com/terms_e-document.htm. Attention is drawn to the limitation of liability, indemnification and jurisdiction issues defined therein. Any holder of this document is advised that information contained hereon reflects the Company's findings at the time of its intervention only and within the limits of Client's instructions, if any. The Company's sole responsibility is to its Client and this document does not exonerate parties to a transaction from exercising all their rights and obligations under the transaction documents. This document cannot be reproduced except in full, without prior written approval of the Company. Any unauthorized alteration, forgery or falsification of the content or appearance of this document is unlawful and offenders may be prosecuted to the fullest extent of the law.



Unless otherwise stated the results shown in this test report refer only to the sample(s) tested and such sample(s) are retained for 90 days only.

除非另有說明，此報告結果僅對測試之樣品負責，同時此樣品僅保留90天。本報告未經本公司書面許可，不可部份複製。

This document is issued by the Company subject to its General Conditions of Service printed overleaf, available on request or accessible at www.sgs.com/terms_and_conditions.htm and for electronic format documents, subject to Terms and Conditions for Electronic Documents at www.sgs.com/terms_e-document.htm. Attention is drawn to the limitation of liability, indemnification and jurisdiction issues defined therein. Any holder of this document is advised that information contained hereon reflects the Company's findings at the time of its intervention only and within the limits of Client's instructions, if any. The Company's sole responsibility is to its Client and this document does not exonerate parties to a transaction from exercising all their rights and obligations under the transaction documents. This document cannot be reproduced except in full, without prior written approval of the Company. Any unauthorized alteration, forgery or falsification of the content or appearance of this document is unlawful and offenders may be prosecuted to the fullest extent of the law.

Adapter Model No.: TPN-DA26



Unless otherwise stated the results shown in this test report refer only to the sample(s) tested and such sample(s) are retained for 90 days only.

除非另有說明，此報告結果僅對測試之樣品負責，同時此樣品僅保留90天。本報告未經本公司書面許可，不可部份複製。

This document is issued by the Company subject to its General Conditions of Service printed overleaf, available on request or accessible at www.sgs.com/terms_and_conditions.htm and for electronic format documents, subject to Terms and Conditions for Electronic Documents at www.sgs.com/terms_e-document.htm. Attention is drawn to the limitation of liability, indemnification and jurisdiction issues defined therein. Any holder of this document is advised that information contained hereon reflects the Company's findings at the time of its intervention only and within the limits of Client's instructions, if any. The Company's sole responsibility is to its Client and this document does not exonerate parties to a transaction from exercising all their rights and obligations under the transaction documents. This document cannot be reproduced except in full, without prior written approval of the Company. Any unauthorized alteration, forgery or falsification of the content or appearance of this document is unlawful and offenders may be prosecuted to the fullest extent of the law.

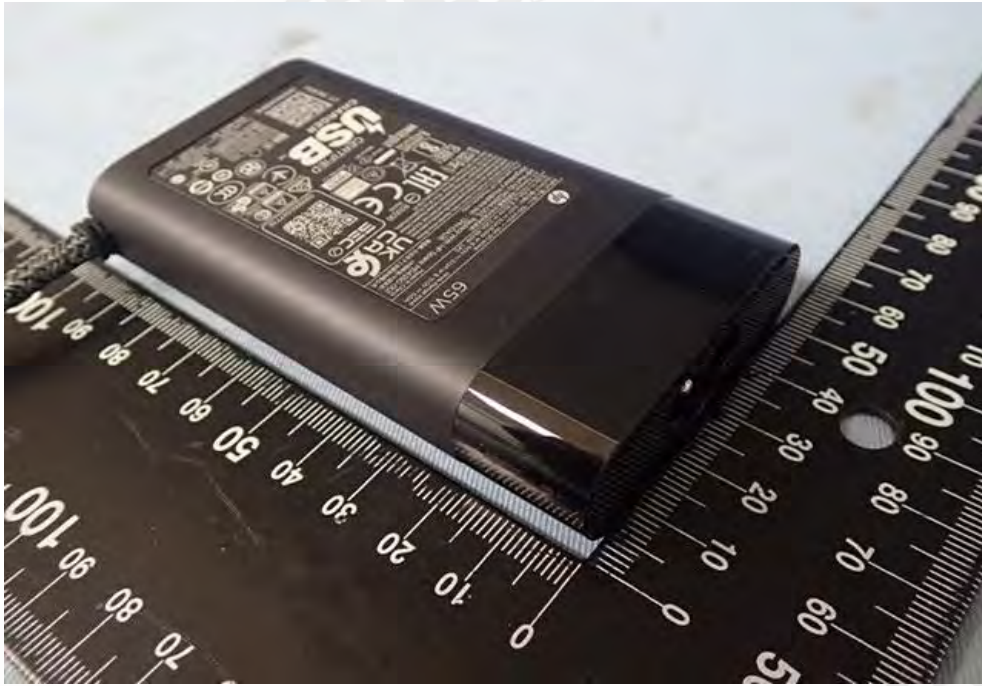

Unless otherwise stated the results shown in this test report refer only to the sample(s) tested and such sample(s) are retained for 90 days only.

除非另有說明，此報告結果僅對測試之樣品負責，同時此樣品僅保留90天。本報告未經本公司書面許可，不可部份複製。

This document is issued by the Company subject to its General Conditions of Service printed overleaf, available on request or accessible at www.sgs.com/terms_and_conditions.htm and for electronic format documents, subject to Terms and Conditions for Electronic Documents at www.sgs.com/terms_e-document.htm. Attention is drawn to the limitation of liability, indemnification and jurisdiction issues defined therein. Any holder of this document is advised that information contained hereon reflects the Company's findings at the time of its intervention only and within the limits of Client's instructions, if any. The Company's sole responsibility is to its Client and this document does not exonerate parties to a transaction from exercising all their rights and obligations under the transaction documents. This document cannot be reproduced except in full, without prior written approval of the Company. Any unauthorized alteration, forgery or falsification of the content or appearance of this document is unlawful and offenders may be prosecuted to the fullest extent of the law.

Adapter Model No.: TPN-DA24

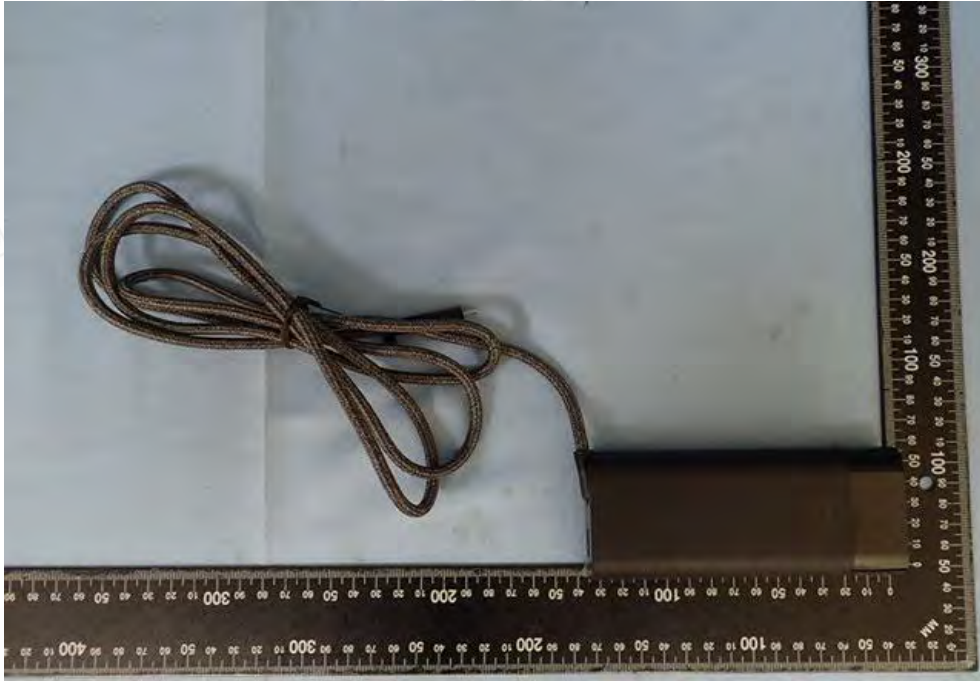

Unless otherwise stated the results shown in this test report refer only to the sample(s) tested and such sample(s) are retained for 90 days only.

除非另有說明，此報告結果僅對測試之樣品負責，同時此樣品僅保留90天。本報告未經本公司書面許可，不可部份複製。

This document is issued by the Company subject to its General Conditions of Service printed overleaf, available on request or accessible at www.sgs.com/terms_and_conditions.htm and for electronic format documents, subject to Terms and Conditions for Electronic Documents at www.sgs.com/terms_e-document.htm. Attention is drawn to the limitation of liability, indemnification and jurisdiction issues defined therein. Any holder of this document is advised that information contained hereon reflects the Company's findings at the time of its intervention only and within the limits of Client's instructions, if any. The Company's sole responsibility is to its Client and this document does not exonerate parties to a transaction from exercising all their rights and obligations under the transaction documents. This document cannot be reproduced except in full, without prior written approval of the Company. Any unauthorized alteration, forgery or falsification of the content or appearance of this document is unlawful and offenders may be prosecuted to the fullest extent of the law.



Unless otherwise stated the results shown in this test report refer only to the sample(s) tested and such sample(s) are retained for 90 days only.
 除非另有說明，此報告結果僅對測試之樣品負責，同時此樣品僅保留90天。本報告未經本公司書面許可，不可部份複製。

This document is issued by the Company subject to its General Conditions of Service printed overleaf, available on request or accessible at www.sgs.com/terms_and_conditions.htm and for electronic format documents, subject to Terms and Conditions for Electronic Documents at www.sgs.com/terms_e-document.htm. Attention is drawn to the limitation of liability, indemnification and jurisdiction issues defined therein. Any holder of this document is advised that information contained hereon reflects the Company's findings at the time of its intervention only and within the limits of Client's instructions, if any. The Company's sole responsibility is to its Client and this document does not exonerate parties to a transaction from exercising all their rights and obligations under the transaction documents. This document cannot be reproduced except in full, without prior written approval of the Company. Any unauthorized alteration, forgery or falsification of the content or appearance of this document is unlawful and offenders may be prosecuted to the fullest extent of the law.

Adapter Model No.: TPN-LA22



Unless otherwise stated the results shown in this test report refer only to the sample(s) tested and such sample(s) are retained for 90 days only.

除非另有說明，此報告結果僅對測試之樣品負責，同時此樣品僅保留90天。本報告未經本公司書面許可，不可部份複製。

This document is issued by the Company subject to its General Conditions of Service printed overleaf, available on request or accessible at www.sgs.com/terms_and_conditions.htm and for electronic format documents, subject to Terms and Conditions for Electronic Documents at www.sgs.com/terms_e-document.htm. Attention is drawn to the limitation of liability, indemnification and jurisdiction issues defined therein. Any holder of this document is advised that information contained hereon reflects the Company's findings at the time of its intervention only and within the limits of Client's instructions, if any. The Company's sole responsibility is to its Client and this document does not exonerate parties to a transaction from exercising all their rights and obligations under the transaction documents. This document cannot be reproduced except in full, without prior written approval of the Company. Any unauthorized alteration, forgery or falsification of the content or appearance of this document is unlawful and offenders may be prosecuted to the fullest extent of the law.



Unless otherwise stated the results shown in this test report refer only to the sample(s) tested and such sample(s) are retained for 90 days only.

除非另有說明，此報告結果僅對測試之樣品負責，同時此樣品僅保留90天。本報告未經本公司書面許可，不可部份複製。

This document is issued by the Company subject to its General Conditions of Service printed overleaf, available on request or accessible at www.sgs.com/terms_and_conditions.htm and for electronic format documents, subject to Terms and Conditions for Electronic Documents at www.sgs.com/terms_e-document.htm. Attention is drawn to the limitation of liability, indemnification and jurisdiction issues defined therein. Any holder of this document is advised that information contained hereon reflects the Company's findings at the time of its intervention only and within the limits of Client's instructions, if any. The Company's sole responsibility is to its Client and this document does not exonerate parties to a transaction from exercising all their rights and obligations under the transaction documents. This document cannot be reproduced except in full, without prior written approval of the Company. Any unauthorized alteration, forgery or falsification of the content or appearance of this document is unlawful and offenders may be prosecuted to the fullest extent of the law.

Adapter Model No.: TPN-LA23



Unless otherwise stated the results shown in this test report refer only to the sample(s) tested and such sample(s) are retained for 90 days only.

除非另有說明，此報告結果僅對測試之樣品負責，同時此樣品僅保留90天。本報告未經本公司書面許可，不可部份複製。

This document is issued by the Company subject to its General Conditions of Service printed overleaf, available on request or accessible at www.sgs.com/terms_and_conditions.htm and for electronic format documents, subject to Terms and Conditions for Electronic Documents at www.sgs.com/terms_e-document.htm. Attention is drawn to the limitation of liability, indemnification and jurisdiction issues defined therein. Any holder of this document is advised that information contained hereon reflects the Company's findings at the time of its intervention only and within the limits of Client's instructions, if any. The Company's sole responsibility is to its Client and this document does not exonerate parties to a transaction from exercising all their rights and obligations under the transaction documents. This document cannot be reproduced except in full, without prior written approval of the Company. Any unauthorized alteration, forgery or falsification of the content or appearance of this document is unlawful and offenders may be prosecuted to the fullest extent of the law.



Unless otherwise stated the results shown in this test report refer only to the sample(s) tested and such sample(s) are retained for 90 days only.

除非另有說明，此報告結果僅對測試之樣品負責，同時此樣品僅保留90天。本報告未經本公司書面許可，不可部份複製。

This document is issued by the Company subject to its General Conditions of Service printed overleaf, available on request or accessible at www.sgs.com/terms_and_conditions.htm and for electronic format documents, subject to Terms and Conditions for Electronic Documents at www.sgs.com/terms_e-document.htm. Attention is drawn to the limitation of liability, indemnification and jurisdiction issues defined therein. Any holder of this document is advised that information contained hereon reflects the Company's findings at the time of its intervention only and within the limits of Client's instructions, if any. The Company's sole responsibility is to its Client and this document does not exonerate parties to a transaction from exercising all their rights and obligations under the transaction documents. This document cannot be reproduced except in full, without prior written approval of the Company. Any unauthorized alteration, forgery or falsification of the content or appearance of this document is unlawful and offenders may be prosecuted to the fullest extent of the law.

Adapter Model No.: TPN-HA01



Unless otherwise stated the results shown in this test report refer only to the sample(s) tested and such sample(s) are retained for 90 days only.

除非另有說明，此報告結果僅對測試之樣品負責，同時此樣品僅保留90天。本報告未經本公司書面許可，不可部份複製。

This document is issued by the Company subject to its General Conditions of Service printed overleaf, available on request or accessible at www.sgs.com/terms_and_conditions.htm and for electronic format documents, subject to Terms and Conditions for Electronic Documents at www.sgs.com/terms_e-document.htm. Attention is drawn to the limitation of liability, indemnification and jurisdiction issues defined therein. Any holder of this document is advised that information contained hereon reflects the Company's findings at the time of its intervention only and within the limits of Client's instructions, if any. The Company's sole responsibility is to its Client and this document does not exonerate parties to a transaction from exercising all their rights and obligations under the transaction documents. This document cannot be reproduced except in full, without prior written approval of the Company. Any unauthorized alteration, forgery or falsification of the content or appearance of this document is unlawful and offenders may be prosecuted to the fullest extent of the law.



**** End of Report ****

Unless otherwise stated the results shown in this test report refer only to the sample(s) tested and such sample(s) are retained for 90 days only.

除非另有說明，此報告結果僅對測試之樣品負責，同時此樣品僅保留90天。本報告未經本公司書面許可，不可部份複製。

This document is issued by the Company subject to its General Conditions of Service printed overleaf, available on request or accessible at www.sgs.com/terms_and_conditions.htm and for electronic format documents, subject to Terms and Conditions for Electronic Documents at www.sgs.com/terms_e-document.htm. Attention is drawn to the limitation of liability, indemnification and jurisdiction issues defined therein. Any holder of this document is advised that information contained hereon reflects the Company's findings at the time of its intervention only and within the limits of Client's instructions, if any. The Company's sole responsibility is to its Client and this document does not exonerate parties to a transaction from exercising all their rights and obligations under the transaction documents. This document cannot be reproduced except in full, without prior written approval of the Company. Any unauthorized alteration, forgery or falsification of the content or appearance of this document is unlawful and offenders may be prosecuted to the fullest extent of the law.