



FCC RF Test Report

APPLICANT : Fibocom Wireless Inc.
EQUIPMENT : LTE Module
BRAND NAME : Fibocom
MODEL NAME : L860-GL-16
FCC ID : ZMOL860GL16
STANDARD : 47 CFR Part 2, 27(M)
CLASSIFICATION : PCS Licensed Transmitter (PCB)

The product was received on Mar. 31, 2021 and completely tested on Apr. 12, 2021. We, Sporton International (Kunshan) Inc., would like to declare that the tested sample has been evaluated in accordance with the procedures given in ANSI C63.26-2015 and shown compliance with the applicable technical standards.

The test results in this report apply exclusively to the tested model / sample. Without written approval of Sporton International (Kunshan) Inc., the test report shall not be reproduced except in full.

Jason Jia

Reviewed by: Jason Jia / Supervisor

Alex Wang

Approved by: Alex Wang / Manager



Sporton International (Kunshan) Inc.

No. 1098, Pengxi North Road, Kunshan Economic Development Zone Jiangsu Province 215300
People's Republic of China



TABLE OF CONTENTS

REVISION HISTORY... 3
SUMMARY OF TEST RESULT ... 4
1 GENERAL DESCRIPTION ... 5
1.1 Applicant ... 5
1.2 Manufacturer ... 5
1.3 Product Feature of Equipment Under Test ... 5
1.4 Product Specification of Equipment Under Test ... 5
1.5 Modification of EUT ... 5
1.6 Maximum Conducted Power, Frequency Tolerance, and Emission Designator ... 6
1.7 Testing Location ... 6
1.8 Test Software ... 6
1.9 Applicable Standards ... 7
2 TEST CONFIGURATION OF EQUIPMENT UNDER TEST ... 8
2.1 Test Mode ... 8
2.2 Connection Diagram of Test System ... 9
2.3 Support Unit used in test configuration and system ... 9
2.4 Measurement Results Explanation Example ... 9
2.5 Frequency List of Low/Middle/High Channels ... 10
3 CONDUCTED TEST ITEMS ... 11
3.1 Measuring Instruments ... 11
3.2 Test Setup ... 11
3.3 Test Result of Conducted Test ... 11
3.4 Conducted Output Power and ERP/EIRP ... 12
3.5 Occupied Bandwidth ... 13
3.6 Conducted Band Edge ... 14
3.7 Conducted Spurious Emission ... 15
3.8 Frequency Stability ... 16
4 RADIATED TEST ITEMS ... 17
4.1 Measuring Instruments ... 17
4.2 Test Setup ... 17
4.3 Test Result of Radiated Test ... 17
4.4 Radiated Spurious Emission ... 18
5 LIST OF MEASURING EQUIPMENT ... 19
6 UNCERTAINTY OF EVALUATION ... 20
APPENDIX A. TEST RESULTS OF CONDUCTED TEST
APPENDIX B. TEST RESULTS OF RADIATED TEST
APPENDIX C. TEST SETUP PHOTOGRAPHS



REVISION HISTORY

REPORT NO.	VERSION	DESCRIPTION	ISSUED DATE
FG003022-02	Rev. 01	Initial issue of report	Apr. 16, 2021



SUMMARY OF TEST RESULT

Report Section	FCC Rule	Description	Limit	Result	Remark
3.4	§2.1046	Conducted Output Power	Reporting Only	PASS	-
	§27.50(h)(2)	Equivalent Isotropic Radiated Power (Band 38)	EIRP < 2Watt	PASS	
3.5	§2.1049	Occupied Bandwidth	Reporting Only	PASS	-
3.6	§27.53(m)(4)	Conducted Band Edge Measurement (Band 38)	§27.53(m)(4)	PASS	-
3.7	§2.1051 §27.53(m)(4)	Conducted Spurious Emission (Band 38)	< 55+10log ₁₀ (P[Watts])	PASS	-
3.8	§2.1055 §27.54	Frequency Stability Temperature & Voltage	Within Authorized Band	PASS	-
4.4	§2.1053 §27.53(m)(4)	Radiated Spurious Emission (Band 38)	< 55+10log ₁₀ (P[Watts])	PASS	Under limit 33.15 dB at 10280.000 MHz

Declaration of Conformity:

The test results with all measurement uncertainty excluded are presented in accordance with the regulation limits or requirements declared by manufacturers.

Comments and Explanations:

The declared of product specification for EUT presented in the report are provided by the manufacturer, and the manufacturer takes all the responsibilities for the accuracy of product specification.



1 General Description

1.1 Applicant

Fibocom Wireless Inc.

1101, Tower A, Building 6, Shenzhen International Innovation Valley, Dashi 1st Rd, Nanshan, Shenzhen, China

1.2 Manufacturer

Fibocom Wireless Inc.

1101, Tower A, Building 6, Shenzhen International Innovation Valley, Dashi 1st Rd, Nanshan, Shenzhen, China

1.3 Product Feature of Equipment Under Test

Product Feature	
Equipment	LTE Module
Brand Name	Fibocom
Model Name	L860-GL-16
FCC ID	ZMOL860GL16
EUT supports Radios application	WCDMA/LTE/GNSS
HW Version	V1.3
SW Version	18601.5001.00.01.02.05
EUT Stage	Identical Prototype

Remark: This is a variant report for L860-GL-16. Add LTE B38C uplink frequency bands based on the original report(Sporton Report Number FG003022C), and LTE B38C for full test.

1.4 Product Specification of Equipment Under Test

Standards-related Product Specification	
Tx Frequency	LTE Band 38 : 2570 MHz ~ 2620 MHz
Rx Frequency	LTE Band 38: 2570 MHz ~ 2620 MHz
Bandwidth	LTE Band 38 : 5MHz / 10MHz / 15MHz / 20MHz
Maximum Output Power to Antenna	LTE Band 38C : 23.57 dBm
Antenna Gain	LTE Band 38 : 4.00 dBi
Type of Modulation	QPSK / 16QAM / 64QAM

1.5 Modification of EUT

No modifications are made to the EUT during all test items.



1.6 Maximum Conducted Power, Frequency Tolerance, and Emission Designator

LTE Band 38 CA	QPSK			16QAM		
BW (MHz)	Emission Designator (99%OBW)	Frequency Tolerance (ppm)	Maximum Conducted power (W)	Emission Designator (99%OBW)	Frequency Tolerance (ppm)	Maximum Conducted power (W)
20MHz+20MHz	37M4G7D	0.0018	0.2275	37M5W7D	-	0.1811

1.7 Testing Location

Sporton International (Kunshan) Inc. is accredited to ISO/IEC 17025:2017 by American Association for Laboratory Accreditation with Certificate Number 5145.02.

Test Firm	Sporton International (Kunshan) Inc.		
Test Site Location	No. 1098, Pengxi North Road, Kunshan Economic Development Zone Jiangsu Province 215300 People's Republic of China TEL : +86-512-57900158 FAX : +86-512-57900958		
Test Site No.	Sporton Site No.	FCC Designation No.	FCC Test Firm Registration No.
	03CH04-KS TH01-KS	CN1257	314309

1.8 Test Software

Item	Site	Manufacturer	Name	Version
1.	03CH04-KS	AUDIX	E3	6.2009-8-24a



1.9 Applicable Standards

According to the specifications of the manufacturer, the EUT must comply with the requirements of the following standards:

- ♦ 47 CFR Part 2, 27(M)
- ♦ ANSI C63.26-2015
- ♦ FCC KDB 971168 D01 Power Meas License Digital Systems v03r01
- ♦ FCC KDB 412172 D01 Determining ERP and EIRP v01r01

Remark: All test items were verified and recorded according to the standards and without any deviation during the test.



2 Test Configuration of Equipment Under Test

2.1 Test Mode

Antenna port conducted and radiated test items listed below are performed according to KDB 971168 D01 Power Meas License Digital Systems v03r01 with maximum output power.

Radiated measurements are performed by rotating the EUT in three different orthogonal test planes to find the maximum emission.

Test Items	Band	Bandwidth (MHz)										Modulation			RB #			Test Channel				
		20+20	20+15	15+20	20+10	10+20	20+5	5+20	15+15	15+10	10+15	QPSK	16QAM	64QAM	1	Half	Full	L	M	H		
Max. Output Power	38C_CA	v	-	-	-	-	-	-	v	-	-	v	v	v	v		v	v	v	v		
26dB and 99% Bandwidth	38C_CA	v	-	-	-	-	-	-	v	-	-	v	v				v	v	v	v		
Conducted Band Edge	38C_CA	v	-	-	-	-	-	-	v	-	-	v	v		v		v	v		v		
Conducted Spurious Emission	38C_CA	v	-	-	-	-	-	-	v	-	-	v	v		v			v	v	v		
E.I.R.P.	38C_CA	v	-	-	-	-	-	-	v	-	-	v	v	v	v			v	v	v		
Radiated Spurious Emission	38C_CA	Worst Case																		v	v	v
Note	<ol style="list-style-type: none"> The mark "v" means that this configuration is chosen for testing The mark "-" means that this bandwidth is not supported. The device is investigated from 30MHz to 10 times of fundamental signal for radiated spurious emission test under different RB size/offset and modulations in exploratory test. Subsequently, only the worst case emissions are reported. Only the max. power (1RB) show in the report. 																					

2.2 Connection Diagram of Test System

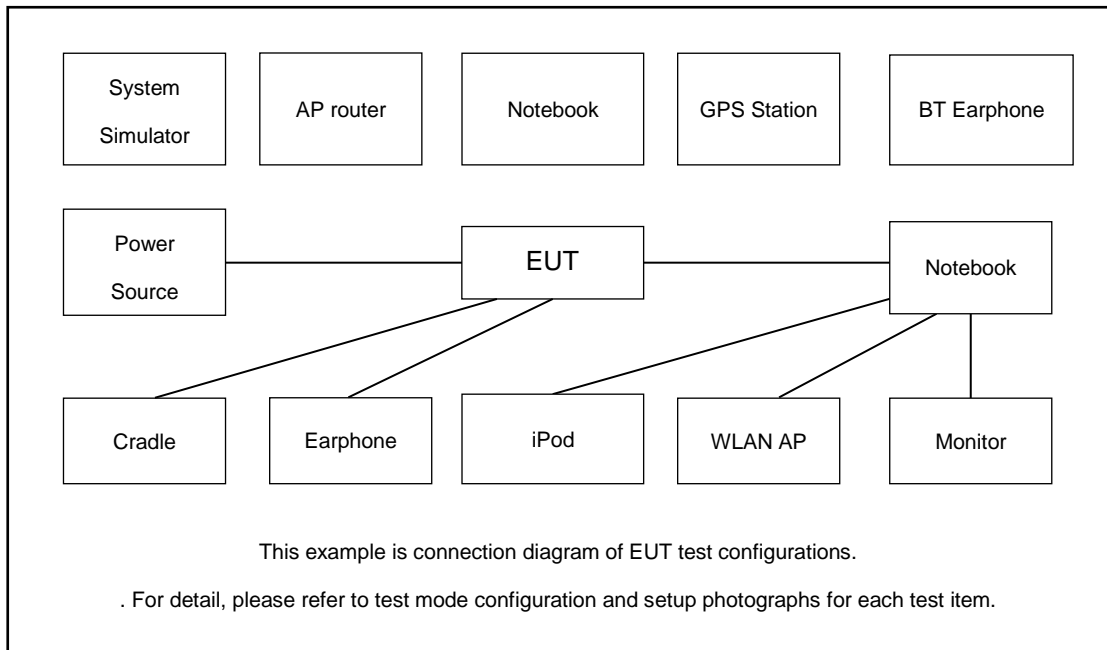

2.3 Support Unit used in test configuration and system

Item	Equipment	Trade Name	Model No.	FCC ID	Data Cable	Power Cord
1.	Power Supply	GWINSTEK	PSS-2002	N/A	N/A	Unshielded, 1.8 m
2.	LTE Base Station	Anritsu	MT8820C	N/A	N/A	Unshielded, 1.8 m

2.4 Measurement Results Explanation Example

For all conducted test items:

The offset level is set in the spectrum analyzer to compensate the RF cable loss and attenuator factor between EUT conducted output port and spectrum analyzer. With the offset compensation, the spectrum analyzer reading level is exactly the EUT RF output level.

The spectrum analyzer offset is derived from RF cable loss and attenuator factor.

Offset = RF cable loss.

Following shows an offset computation example with cable loss 7.72 dB.

Example :

$$\begin{aligned} \text{Offset(dB)} &= \text{RF cable loss(dB)}. \\ &= 7.72 \text{ (dB)} \end{aligned}$$



2.5 Frequency List of Low/Middle/High Channels

LTE Band 38C_CA Channel and Frequency List					
BW [MHz]	Channel/Frequency(MHz)		Lowest	Middle	Highest
20 + 20	PCC	Channel	37850	37901	37952
		Frequency	2580.0	2585.1	2590.2
	SCC	Channel	38048	38099	38150
		Frequency	2599.8	2604.9	2610.0
15+ 15	PCC	Channel	37825	37925	38025
		Frequency	2577.5	2587.5	2597.5
	SCC	Channel	37975	38075	38175
		Frequency	2592.5	2602.5	2612.5

3 Conducted Test Items

3.1 Measuring Instruments

See list of measuring instruments of this test report.

3.2 Test Setup

3.2.1 Conducted Output Power



3.2.2 Peak-to-Average Ratio, Occupied Bandwidth ,Conducted Band-Edge and Conducted Spurious Emission



3.2.3 Frequency Stability

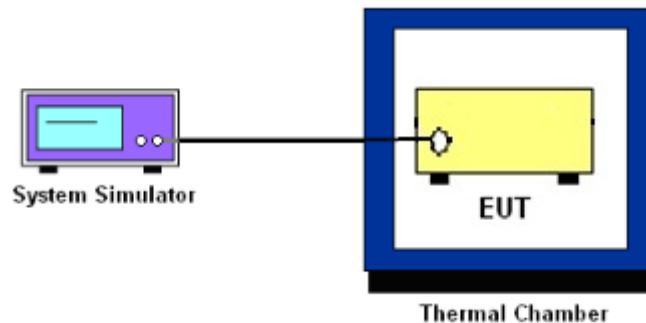

3.3 Test Result of Conducted Test

Please refer to Appendix A.



3.4 Conducted Output Power and ERP/EIRP

3.4.1 Description of the Conducted Output Power Measurement and ERP/EIRP Measurement

A system simulator was used to establish communication with the EUT. Its parameters were set to force the EUT transmitting at maximum output power. The measured power in the radio frequency on the transmitter output terminals shall be reported.

The EIRP of mobile transmitters must not exceed 2 Watts for LTE 38.

According to KDB 412172 D01 Power Approach,

$EIRP = P_T + G_T - L_C$, $ERP = EIRP - 2.15$, where

P_T = transmitter output power in dBm

G_T = gain of the transmitting antenna in dBi

L_C = signal attenuation in the connecting cable between the transmitter and antenna in dB

3.4.2 Test Procedures

1. The testing follows ANSI C63.26 Section 5.2
2. The transmitter output port was connected to the system simulator.
3. Set EUT at maximum power through the system simulator.
4. Select lowest, middle, and highest channels for each band and different modulation.
5. Measure and record the power level from the system simulator.



3.5 Occupied Bandwidth

3.5.1 Description of Occupied Bandwidth Measurement

The occupied bandwidth is the width of a frequency band such that, below the lower and above the upper frequency limits, the mean powers emitted are each equal to a specified percentage 0.5% of the total mean transmitted power.

The 26 dB emission bandwidth is defined as the frequency range between two points, one above and one below the carrier frequency, at which the spectral density of the emission is attenuated 26 dB below the maximum in-band spectral density of the modulated signal. Spectral density (power per unit bandwidth) is to be measured with a detector of resolution bandwidth equal to approximately 1.0% of the emission bandwidth.

3.5.2 Test Procedures

1. The testing follows ANSI C63.26 Section 5.4
2. The EUT was connected to spectrum analyzer and system simulator via a power divider.
3. The spectrum analyzer center frequency is set to the nominal EUT channel center frequency. The span range for the spectrum analyzer shall be between two and five times the anticipated OBW.
4. The nominal resolution bandwidth (RBW) shall be in the range of 1 to 5 % of the anticipated OBW, and the VBW shall be at least 3 times the RBW.
5. Set the detection mode to peak, and the trace mode to max hold.
6. Determine the reference value: Set the EUT to transmit a modulated signal. Allow the trace to stabilize. Set the spectrum analyzer marker to the highest level of the displayed trace.
(this is the reference value)
7. Determine the “-26 dB down amplitude” as equal to (Reference Value – X).
8. Place two markers, one at the lowest and the other at the highest frequency of the envelope of the spectral display such that each marker is at or slightly below the “-X dB down amplitude” determined in step 6. If a marker is below this “-X dB down amplitude” value it shall be placed as close as possible to this value. The OBW is the positive frequency difference between the two markers.
9. Use the 99 % power bandwidth function of the spectrum analyzer and report the measured bandwidth.



3.6 Conducted Band Edge

3.6.1 Description of Conducted Band Edge Measurement

27.53(m)(4)

For mobile digital stations, the attenuation factor shall be not less than $40 + 10 \log (P)$ dB on all frequencies between the channel edge and 5 megahertz from the channel edge, $43 + 10 \log (P)$ dB on all frequencies between 5 megahertz and X megahertz from the channel edge, and $55 + 10 \log (P)$ dB on all frequencies more than X megahertz from the channel edge, where X is the greater of 6 megahertz or the actual emission bandwidth as defined in paragraph (m)(6) of this section. In addition, the attenuation factor shall not be less that $43 + 10 \log (P)$ dB on all frequencies between 2490.5 MHz and 2496 MHz and $55 + 10 \log (P)$ dB at or below 2490.5 MHz. Mobile Satellite Service licensees operating on frequencies below 2495 MHz may also submit a documented interference complaint against BRS licensees operating on channel BRS Channel 1 on the same terms and conditions as adjacent channel BRS or EBS licensees.

3.6.2 Test Procedures

1. The testing follows ANSI C63.26 section 5.7
2. The EUT was connected to spectrum analyzer and system simulator via a power divider.
3. The band edges of low and high channels for the highest RF powers were measured.
4. Set RBW \geq 1% EBW in the 1MHz band immediately outside and adjacent to the band edge.
5. Beyond the 1 MHz band from the band edge, RBW=1MHz was used or a narrower RBW was used and the measured power was integrated over the full required measurement bandwidth of 1 MHz.
6. Set spectrum analyzer with RMS detector.
7. The RF fundamental frequency should be excluded against the limit line in the operating frequency band.
8. Checked that all the results comply with the emission limit line.

Example:

The limit line is derived from $43 + 10\log(P)$ dB below the transmitter power P(Watts)
 $= P(W) - [43 + 10\log(P)]$ (dB)
 $= [30 + 10\log(P)]$ (dBm) - $[43 + 10\log(P)]$ (dB) = -13dBm.

9. For LTE Band 38 , the other 40 dB, and 55 dB have additionally applied same calculation above.



3.7 Conducted Spurious Emission

3.7.1 Description of Conducted Spurious Emission Measurement

The power of any emission outside of the authorized operating frequency ranges must be lower than the transmitter power (P) by a factor of at least $43 + 10 \log (P)$ dB.

For Band38:

The power of any emission outside of the authorized operating frequency ranges must be lower than the transmitter power (P) by a factor of at least $55 + 10 \log (P)$ dB.

It is measured by means of a calibrated spectrum analyzer and scanned from 30 MHz up to a frequency including its 10th harmonic.

3.7.2 Test Procedures

1. The testing follows ANSI C63.26 section 5.7
2. The EUT was connected to spectrum analyzer and system simulator via a power divider.
3. The RF output of EUT was connected to the spectrum analyzer by RF cable and attenuator. The path loss was compensated to the results for each measurement.
4. The middle channel for the highest RF power within the transmitting frequency was measured.
5. The conducted spurious emission for the whole frequency range was taken.
6. Make the measurement with the spectrum analyzer's RBW = 1MHz, VBW = 3MHz.
7. Set spectrum analyzer with RMS detector.
8. Taking the record of maximum spurious emission.
9. The RF fundamental frequency should be excluded against the limit line in the operating frequency band.
10. The limit line is derived from $43 + 10\log(P)$ dB below the transmitter power P(Watts)
= $P(W) - [43 + 10\log(P)]$ (dB)
= $[30 + 10\log(P)]$ (dBm) - $[43 + 10\log(P)]$ (dB)
= -13dBm.
11. For Band 38
The limit line is derived from $55 + 10\log(P)$ dB below the transmitter power P(Watts)
= $P(W) - [55 + 10\log(P)]$ (dB)
= $[30 + 10\log(P)]$ (dBm) - $[55 + 10\log(P)]$ (dB)
= -25dBm.



3.8 Frequency Stability

3.8.1 Description of Frequency Stability Measurement

The frequency stability shall be measured by variation of ambient temperature and variation of primary supply voltage to ensure that the fundamental emission stays within the authorized frequency block. The frequency stability of the transmitter shall be maintained within $\pm 0.00025\%$ ($\pm 2.5\text{ppm}$) of the center frequency.

3.8.2 Test Procedures for Temperature Variation

1. The testing follows ANSI C63.26 section 5.6.4
2. The EUT was set up in the thermal chamber and connected with the system simulator.
3. With power OFF, the temperature was decreased to -30°C and the EUT was stabilized before testing. Power was applied and the maximum change in frequency was recorded within one minute.
4. With power OFF, the temperature was raised in 10°C step up to 50°C . The EUT was stabilized at each step for at least half an hour. Power was applied and the maximum frequency change was recorded within one minute.

3.8.3 Test Procedures for Voltage Variation

1. The testing follows ANSI C63.26 section 5.6.5
2. The EUT was placed in a temperature chamber at $20\pm 5^{\circ}\text{C}$ and connected with the system simulator.
3. The power supply voltage to the EUT was varied from 85% to 115% of the nominal value for other than hand carried battery equipment.
4. For hand carried, battery powered equipment, reduce the primary ac or dc supply voltage to the battery operating end point, which shall be specified by the manufacturer.
5. The variation in frequency was measured for the worst case.

4 Radiated Test Items

4.1 Measuring Instruments

See list of measuring instruments of this test report.

4.2 Test Setup

4.2.1 For radiated test from 30MHz to 1GHz

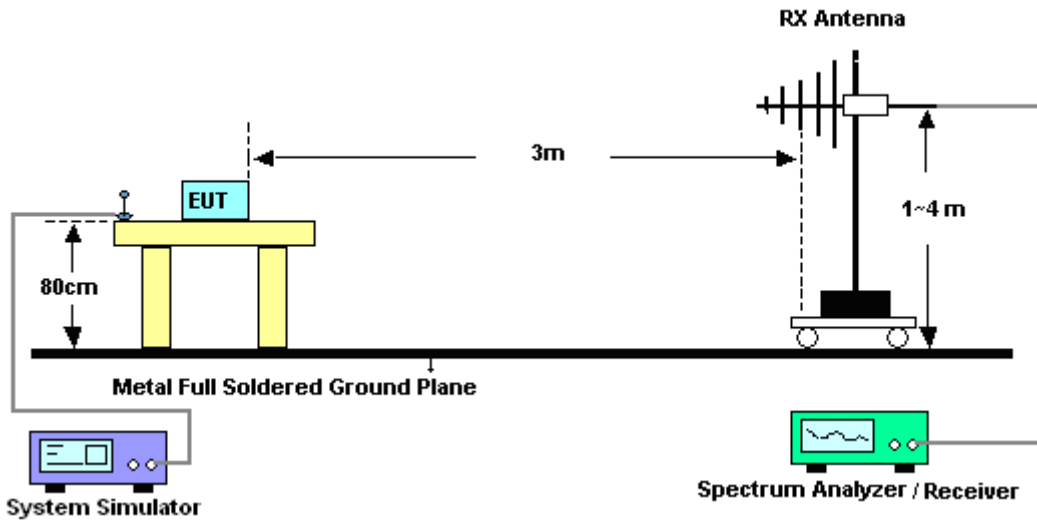

4.2.2 For radiated test above 1GHz

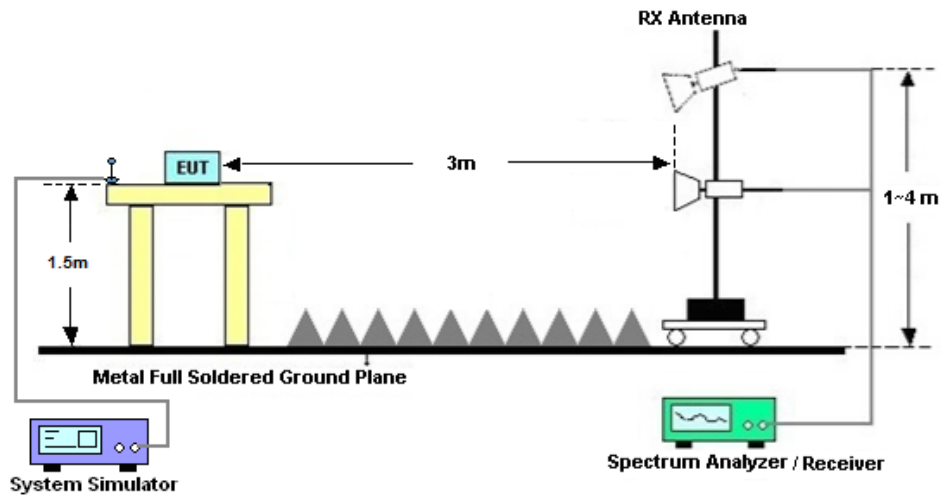

4.3 Test Result of Radiated Test

Please refer to Appendix B.



4.4 Radiated Spurious Emission

4.4.1 Description of Radiated Spurious Emission

The radiated spurious emission was measured by substitution method according to ANSI C63.26. The power of any emission outside of the authorized operating frequency ranges must be attenuated below the transmitter power (P) by a factor of at least $43 + 10 \log (P)$ dB.

For Band 38

The power of any emission outside of the authorized operating frequency ranges must be attenuated below the transmitter power (P) by a factor of at least $55 + 10 \log (P)$ dB.

The spectrum is scanned from 30 MHz up to a frequency including its 10th harmonic.

4.4.2 Test Procedures

1. The testing follows ANSI C63.26 Section 5.5
2. The EUT was placed on a turntable with 0.8 meter height for frequency below 1GHz and 1.5 meter height for frequency above 1GHz respectively above ground.
3. The EUT was set 3 meters from the receiving antenna mounted on the antenna tower.
4. The table was rotated 360 degrees to determine the position of the highest spurious emission.
5. The height of the receiving antenna is varied between 1m to 4m to search the maximum spurious emission for both horizontal and vertical polarizations.
6. During the measurement, the system simulator parameters were set to force the EUT transmitting at maximum output power.
7. Make the measurement with the spectrum analyzer's RBW = 1MHz, VBW = 3MHz, taking the record of maximum spurious emission.
8. A horn antenna was substituted in place of the EUT and was driven by a signal generator.
9. Tune the output power of signal generator to the same emission level with EUT maximum spurious emission.
10. $EIRP (dBm) = S.G. Power - Tx Cable Loss + Tx Antenna Gain$
11. $ERP (dBm) = EIRP - 2.15$
12. The RF fundamental frequency should be excluded against the limit line in the operating frequency band.

The limit line is derived from $43 + 10\log(P)$ dB below the transmitter power P(Watts)
 $= P(W) - [43 + 10\log(P)] (dB)$
 $= [30 + 10\log(P)] (dBm) - [43 + 10\log(P)] (dB)$
 $= -13dBm.$

13. For Band 38:

The limit line is derived from $55 + 10\log(P)$ dB below the transmitter power P(Watts)



5 List of Measuring Equipment

Instrument	Manufacturer	Model No.	Serial No.	Characteristics	Calibration Date	Test Date	Due Date	Remark
Spectrum Analyzer	R&S	FSV40	101040	10Hz~40GHz	Nov. 01, 2020	Apr. 03, 2021	Oct. 31, 2021	Conducted (TH01-KS)
Power divider	STI	STI08-0055	-	0.5~40GHz	Aug. 27, 2020	Apr. 03, 2021	Aug. 26, 2021	Conducted (TH01-KS)
Temperature & humidity chamber	Hongzhan	LP-150U	H2014011440	-40~+150°C 20%~95%RH	Jul. 03, 2020	Apr. 03, 2021	Jul. 02, 2021	Conducted (TH01-KS)
EXA Spectrum Analyzer	Keysight	N9010A	MY55150244	10Hz-44G,MAX 30dB	Apr. 15, 2020	Apr. 12, 2021	Apr. 14, 2021	Radiation (03CH04-KS)
Bilog Antenna	TeseQ	CBL6111D	49922	30MHz-1GHz	Jun. 08, 2020	Apr. 12, 2021	Jun. 07, 2021	Radiation (03CH04-KS)
Horn Antenna	Schwarzbeck	BBHA9120D	1356	1GHz~18GHz	Apr. 20, 2020	Apr. 12, 2021	Apr. 19, 2021	Radiation (03CH04-KS)
SHF-EHF Horn	Com-power	AH-840	101115	18GHz~40GHz	Jan. 06, 2021	Apr. 12, 2021	Jan. 05, 2022	Radiation (03CH04-KS)
Amplifier	SONOMA	310N	187289	9KHz-1GHz	Jan. 06, 2021	Apr. 12, 2021	Jan. 05, 2022	Radiation (03CH04-KS)
Amplifier	MITEQ	EM18G40G GA	060728	18~40GHz	Jan. 07, 2021	Apr. 12, 2021	Jan. 06, 2022	Radiation (03CH04-KS)
high gain Amplifier	MITEQ	AMF-7D-00 101800-30-1 0P	2025788	1Ghz-18Ghz	Jan. 06, 2021	Apr. 12, 2021	Jan. 05, 2022	Radiation (03CH04-KS)
Amplifier	Keysight	83017A	MY57280106	500MHz~26.5GHz	Oct. 14, 2020	Apr. 12, 2021	Oct. 13, 2021	Radiation (03CH04-KS)
AC Power Source	Chroma	61601	F104090004	N/A	NCR	Apr. 12, 2021	NCR	Radiation (03CH04-KS)
Turn Table	ChamPro	EM 1000-T	060762-T	0~360 degree	NCR	Apr. 12, 2021	NCR	Radiation (03CH04-KS)
Antenna Mast	ChamPro	EM 1000-A	060762-A	1 m~4 m	NCR	Apr. 12, 2021	NCR	Radiation (03CH04-KS)

NCR: No Calibration Required



6 Uncertainty of Evaluation

The measurement uncertainties shown below were calculated in accordance with the requirements of ANSI 63.26-2015. All the measurement uncertainty value were shown with a coverage K=2 to indicate 95% level of confidence. The measurement data show herein meets or exceeds the CISPR measurement uncertainty values specified in CISPR 16-4-2 and can be compared directly to specified limit to determine compliance.

Uncertainty of Radiated Emission Measurement (30 MHz ~ 1000 MHz)

Measuring Uncertainty for a Level of Confidence of 95% (U = 2Uc(y))	3.3dB
---	-------

Uncertainty of Radiated Emission Measurement (1 GHz ~ 40 GHz)

Measuring Uncertainty for a Level of Confidence of 95% (U = 2Uc(y))	2.8dB
---	-------



Appendix A. Test Results of Conducted Test

Conducted Output Power(Average power) and EIRP

Combination 20MHz+20MHz (100RB+100RB)							
Channel	Modulation	PCC		SCC		Measured Power	EIRP
		RB Size	RB offset	RB Size	RB offset		
L	QPSK	1	Max	1	0	23.57	0.5715
M	QPSK	1	Max	1	0	23.52	0.5649
H	QPSK	1	Max	1	0	23.55	0.5689
L	16QAM	1	Max	1	0	22.58	0.4550
M	16QAM	1	Max	1	0	22.49	0.4457
H	16QAM	1	Max	1	0	22.44	0.4406
L	64QAM	1	Max	1	0	21.54	0.3581
M	64QAM	1	Max	1	0	21.43	0.3491
H	64QAM	1	Max	1	0	21.46	0.3516
Combination 15MHz+15MHz (75RB+75RB)							
Channel	Modulation	PCC		SCC		Measured Power	EIRP
		RB Size	RB offset	RB Size	RB offset		
L	QPSK	1	Max	1	0	23.43	0.5534
L	16QAM	1	Max	1	0	22.57	0.4539



LTE Band 38C

26dB Bandwidth

Mode	LTE Band 38C : 26dB BW(MHz)	
Mod.	QPSK	16QAM
BW	20MHz+20MHz	20MHz+20MHz
Middle CH	39.8	39.8

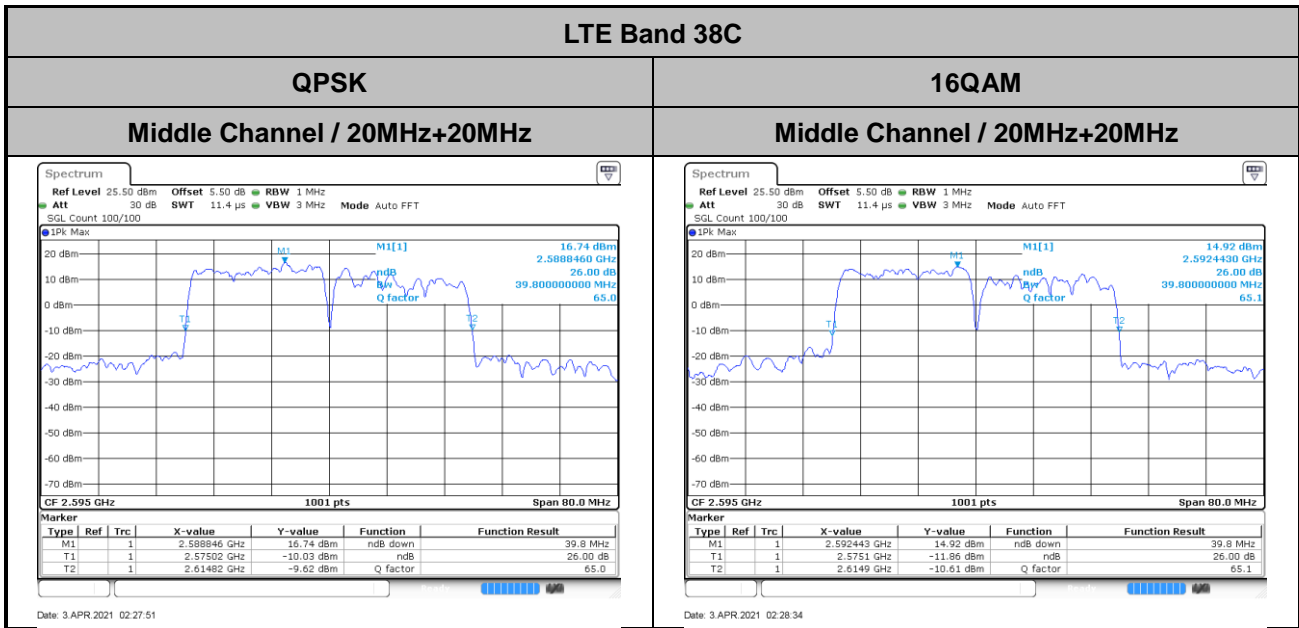



Occupied Bandwidth

Mode	LTE Band 38C : 99%OBW(MHz)	
Mod.	QPSK	16QAM
BW	20MHz+20MHz	20MHz+20MHz
Middle CH	37.40	37.48

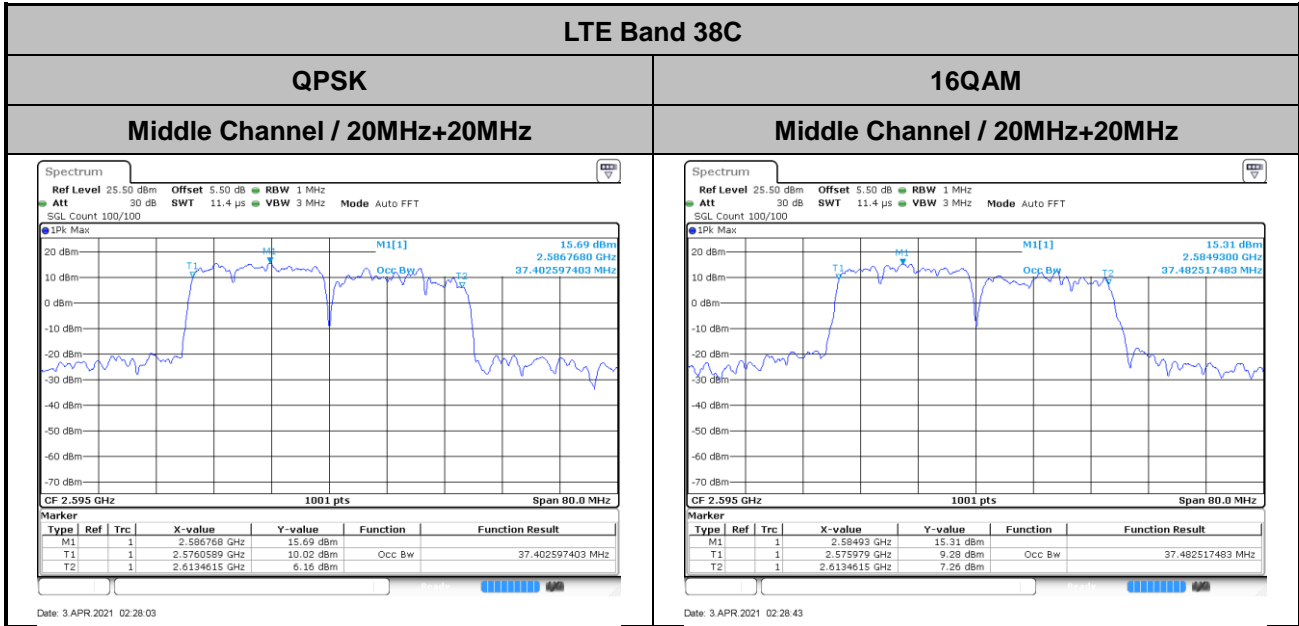



Conducted Band Edge

LTE Band 38C / 15MHz+15MHz

QPSK

Lowest Band Edge / 1RB0 and 1RB74

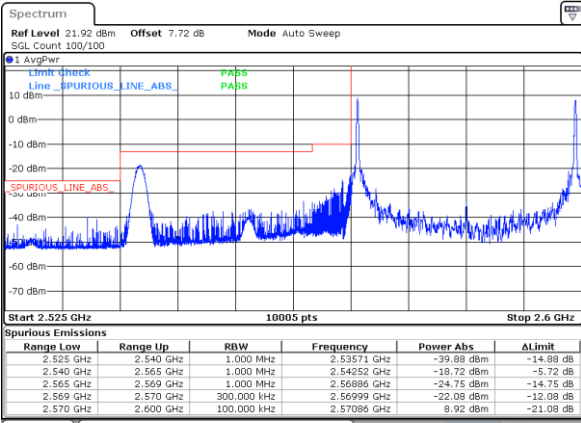

Highest Band Edge / 1RB0 and 1RB74

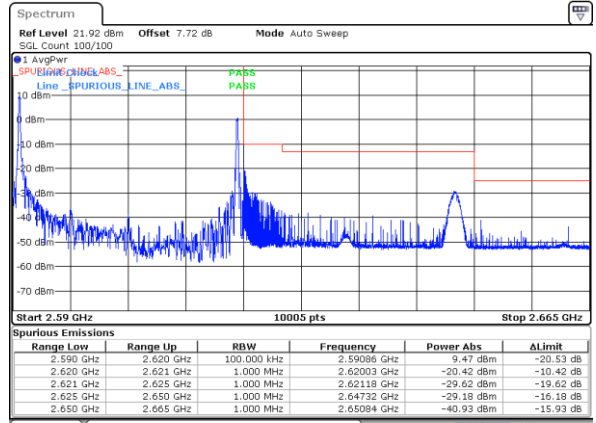

Lowest Band Edge / 1RB74 and 1RB0

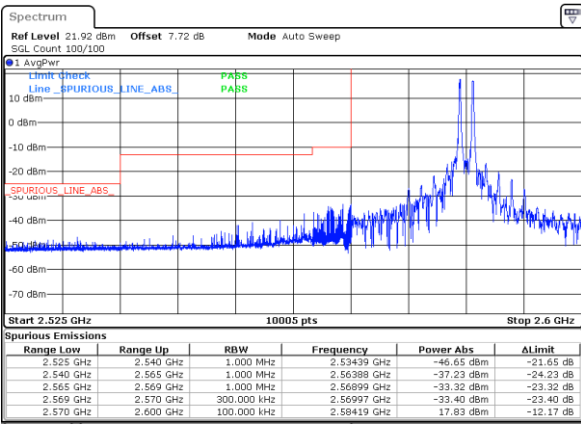

Highest Band Edge / 1RB74 and 1RB0

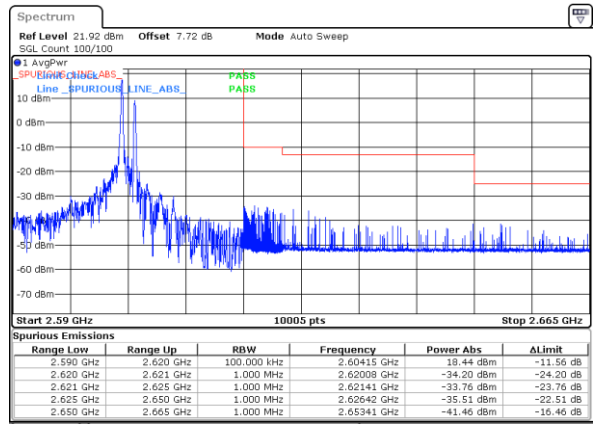

Lowest Band Edge / Full RB

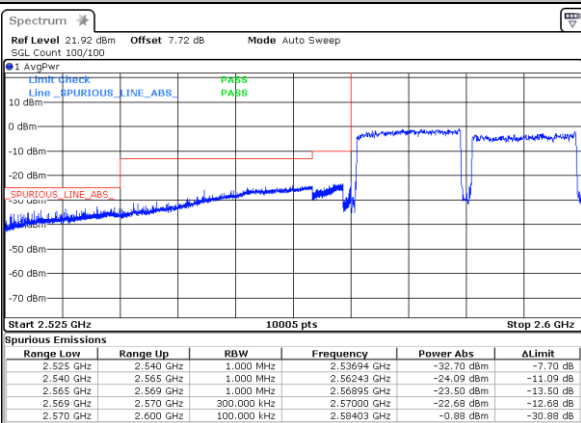

Highest Band Edge / Full RB

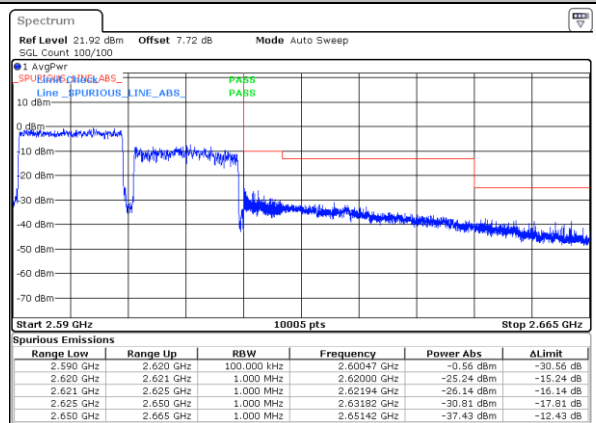



LTE Band 38C / 20MHz+20MHz

QPSK

Lowest Band Edge / 1RB0 and 1RB9

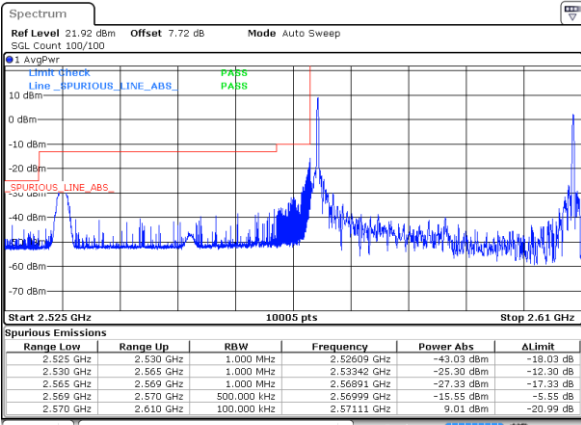

Date: 3 APR 2021 02:19:41

Highest Band Edge / 1RB0 and 1RB9

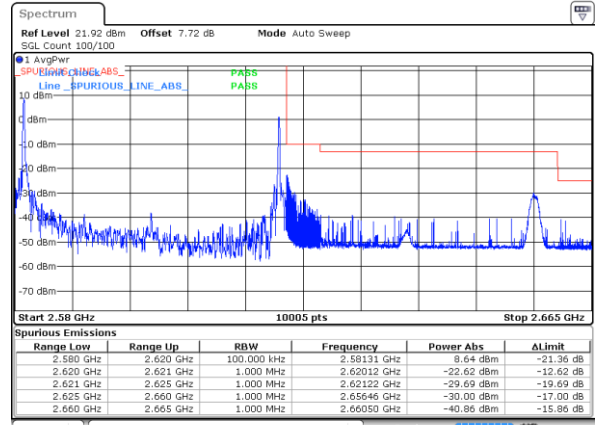

Date: 3 APR 2021 02:32:18

Lowest Band Edge / 1RB99 and 1RB0

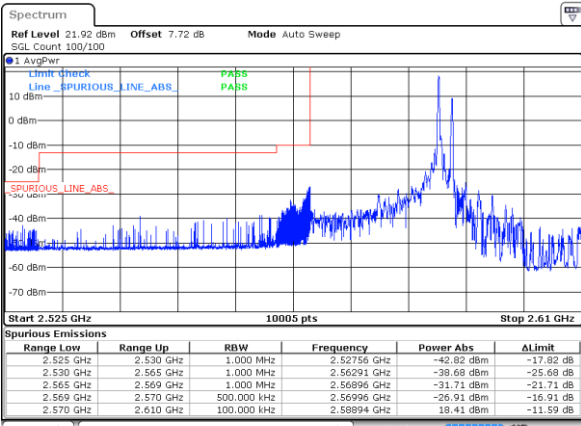

Date: 3 APR 2021 02:21:58

Highest Band Edge / 1RB99 and 1RB0

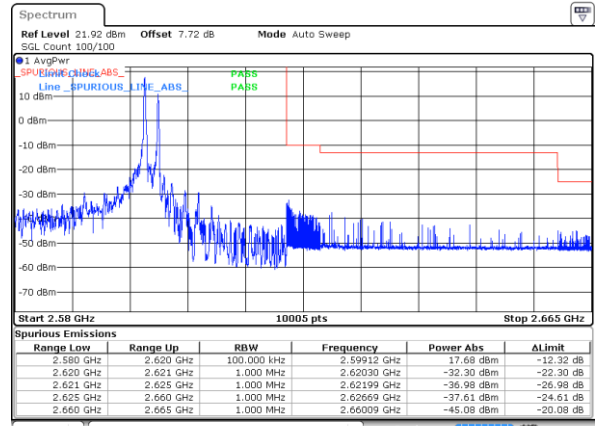

Date: 3 APR 2021 02:34:02

Lowest Band Edge / Full RB

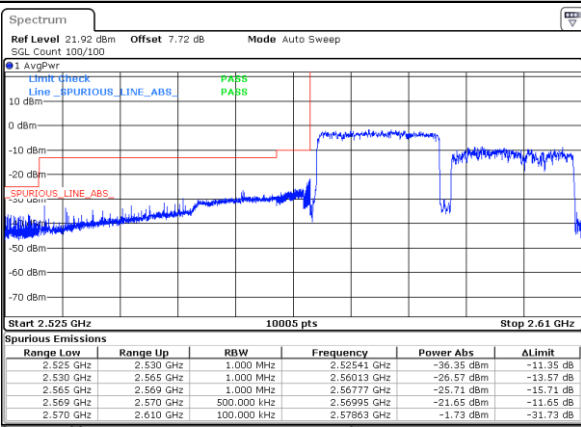

Date: 3 APR 2021 02:16:53

Highest Band Edge / Full RB

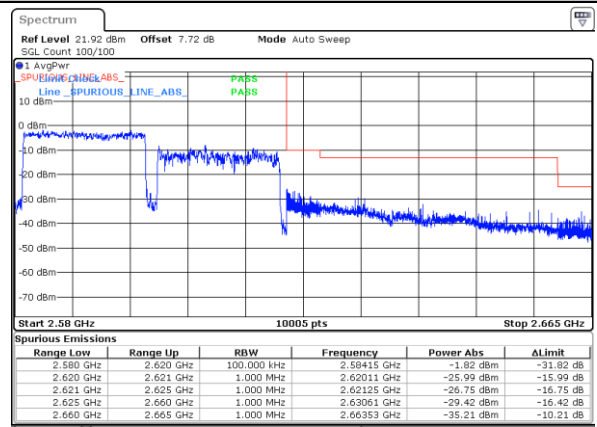

Date: 3 APR 2021 02:31:40



LTE Band 38C / 15MHz+15MHz

16QAM

Lowest Band Edge / 1RB0 and 1RB74

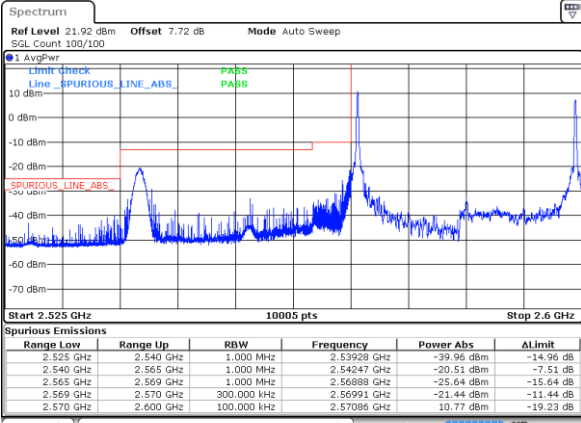

Date: 3 APR 2021 01:26:17

Highest Band Edge / 1RB0 and 1RB74

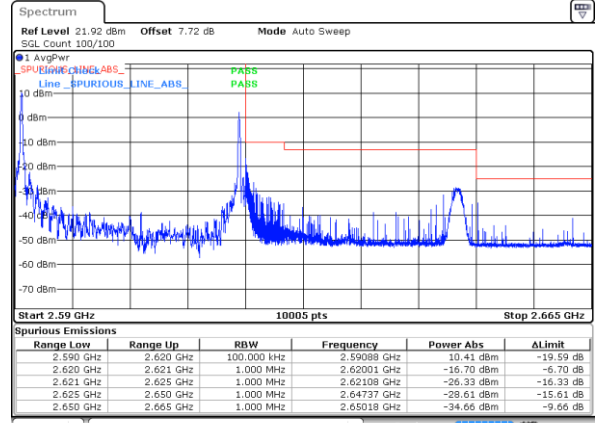

Date: 3 APR 2021 02:08:59

Lowest Band Edge / 1RB74 and 1RB0

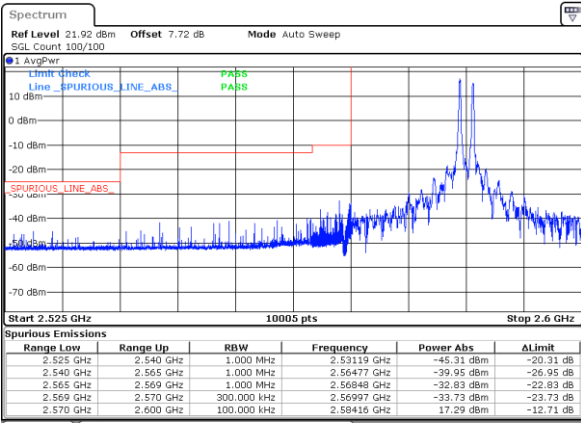

Date: 3 APR 2021 01:28:13

Highest Band Edge / 1RB74 and 1RB0

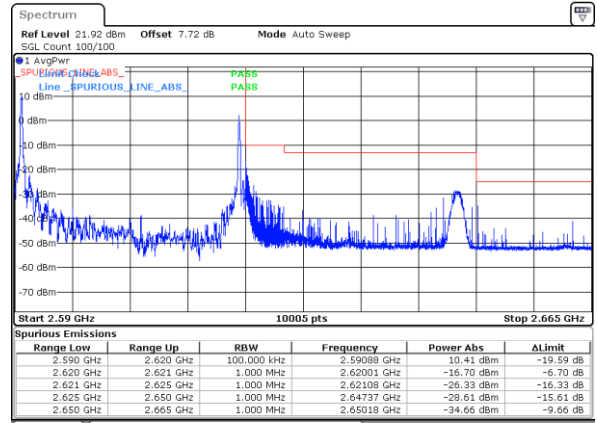

Date: 3 APR 2021 02:08:59

Lowest Band Edge / Full RB

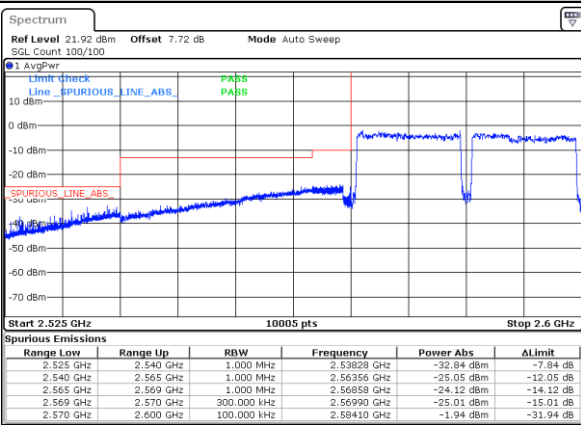

Date: 3 APR 2021 01:25:24

Highest Band Edge / Full RB

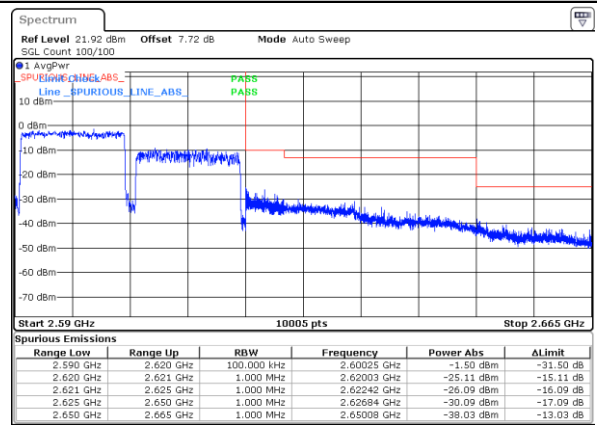

Date: 3 APR 2021 02:12:11



LTE Band 38C / 20MHz+20MHz

16QAM

Lowest Band Edge / 1RB0 and 1RB99

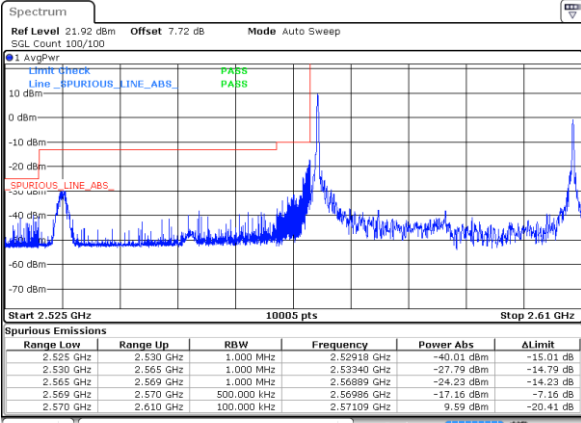

Date: 3 APR 2021 02:19:17

Highest Band Edge / 1RB0 and 1RB99

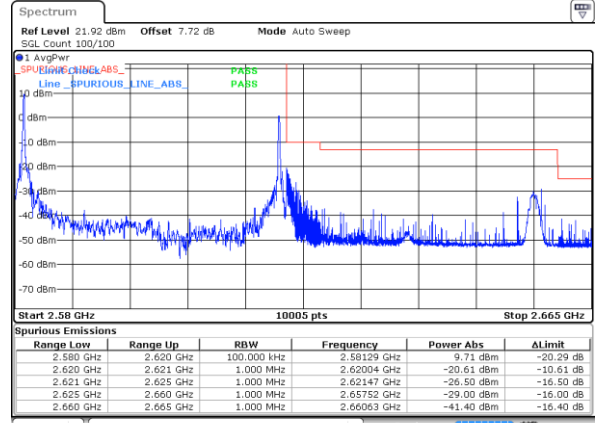

Date: 3 APR 2021 02:32:51

Lowest Band Edge / 1RB99 and 1RB0

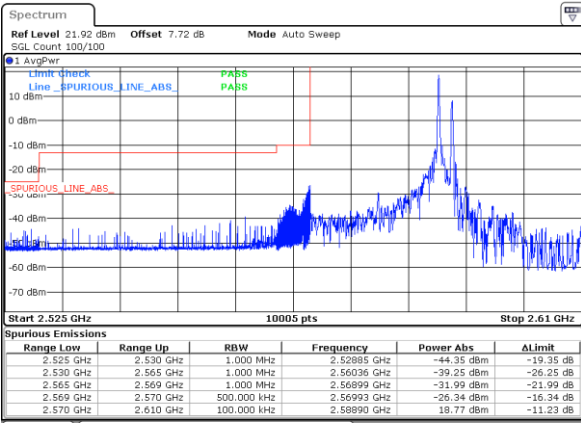

Date: 3 APR 2021 02:22:32

Highest Band Edge / 1RB99 and 1RB0

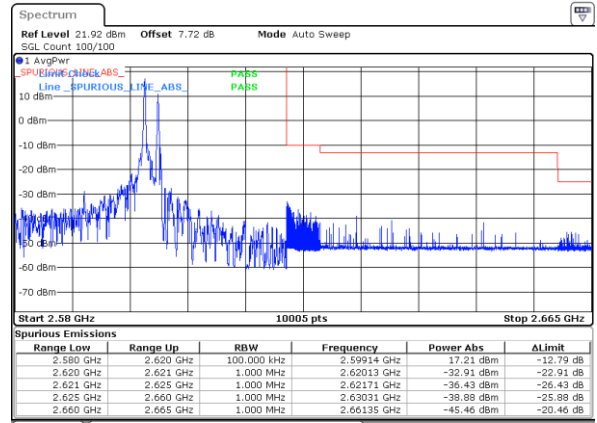

Date: 3 APR 2021 02:33:29

Lowest Band Edge / Full RB

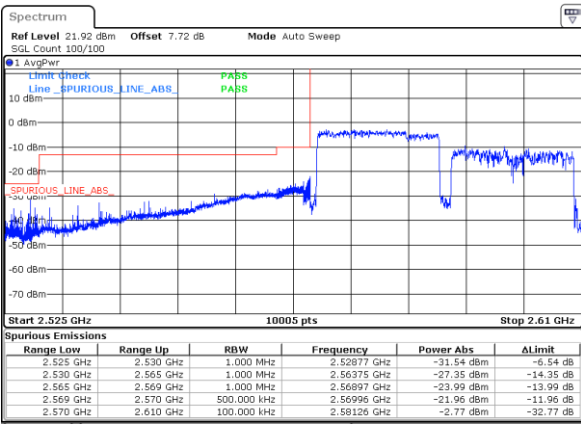

Date: 3 APR 2021 02:18:05

Highest Band Edge / Full RB

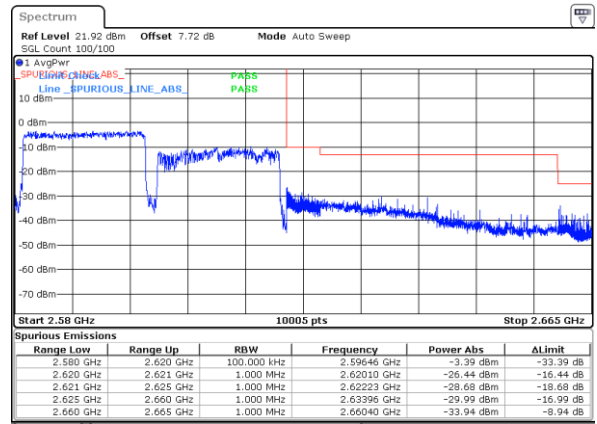

Date: 3 APR 2021 02:31:14



Conducted Spurious Emission

LTE Band 38C / 15MHz+15MHz

QPSK

Lowest Channel / 1RB74 and 1RB0

Middle Channel / 1RB74 and 1RB0

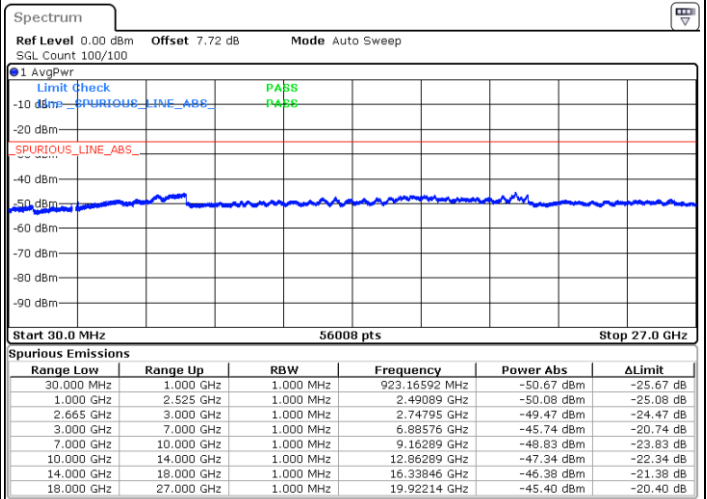
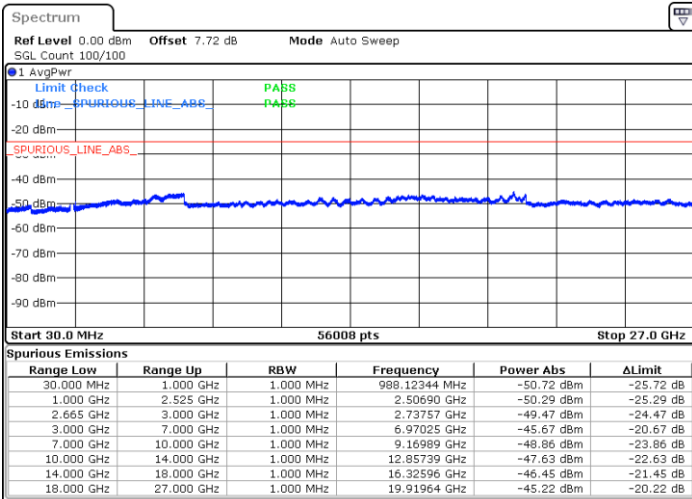

Date: 3 APR 2021 01:30:51

Date: 3 APR 2021 02:14:13

Highest Channel / 1RB74 and 1RB0

N/A

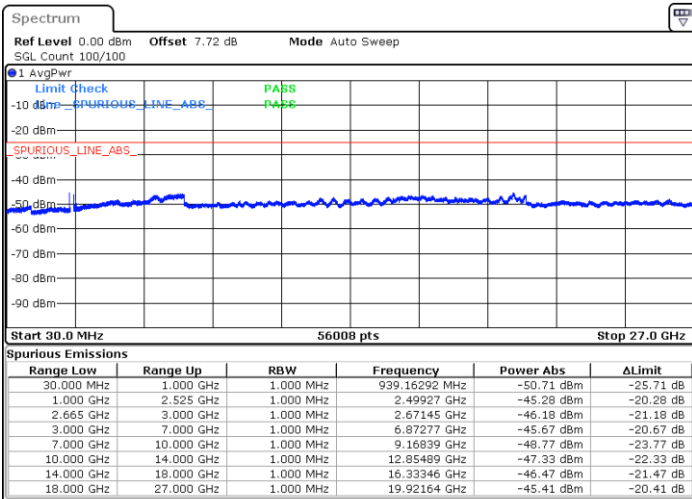

Date: 3 APR 2021 02:06:09



LTE Band 38C / 20MHz+20MHz

QPSK

Lowest Channel / 1RB99 and 1RB0

Middle Channel / 1RB99 and 1RB0

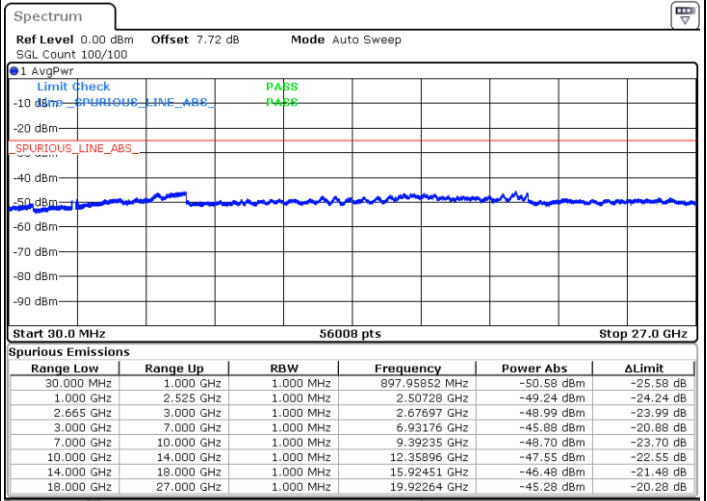
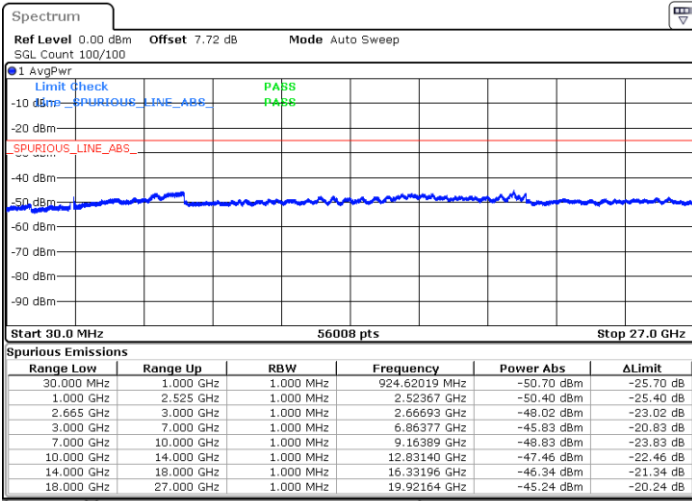

Date: 3 APR 2021 02:21:06

Date: 3 APR 2021 02:24:12

Highest Channel / 1RB99 and 1RB0

N/A

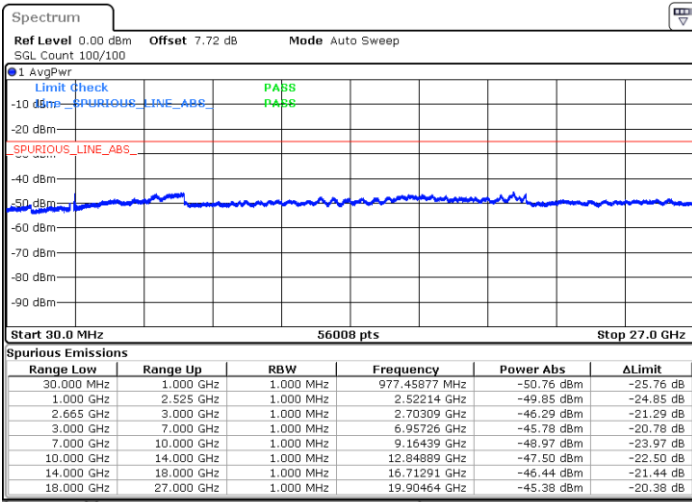

Date: 3 APR 2021 02:34:47



Frequency Stability

Test Conditions		LTE Band 38C (QPSK) / Middle Channel	Limit
Temperature (°C)	Voltage (Volt)	BW 40MHz	Note 2.
		Deviation (ppm)	Result
50	Normal Voltage	0.0000	PASS
40	Normal Voltage	0.0012	
30	Normal Voltage	0.0016	
20(Ref.)	Normal Voltage	0.0000	
10	Normal Voltage	0.0013	
0	Normal Voltage	0.0018	
-10	Normal Voltage	0.0010	
-20	Normal Voltage	0.0003	
-30	Normal Voltage	0.0001	
20	Maximum Voltage	0.0010	
20	Normal Voltage	0.0000	
20	Battery End Point	0.0008	

Note:

1. Normal Voltage =3.3 V ; Battery End Point (BEP) =3.135 V. ; Maximum Voltage =4.4 V.
2. Note: The frequency fundamental emissions stay within the authorized frequency block.



Appendix B. Test Results of Radiated Test

Radiated Spurious Emission

LTE Band 38C_CA / 20M+20M / QPSK								
Channel	Frequency (MHz)	EIRP (dBm)	Limit (dBm)	Over Limit (dB)	S.G. Power (dBm)	TX Cable loss (dB)	TX Antenna Gain (dBi)	Polarization (H/V)
Lowest	5144	-61.60	-25	-36.60	-71.81	3.03	13.24	H
	7712	-60.97	-25	-35.97	-70.42	3.56	13.01	H
	10280	-58.15	-25	-33.15	-67.67	3.92	13.44	H
	5144	-61.84	-25	-36.84	-72.05	3.03	13.24	V
	7712	-61.24	-25	-36.24	-70.69	3.56	13.01	V
	10280	-58.81	-25	-33.81	-68.33	3.92	13.44	V
Middle	5152	-61.58	-25	-36.58	-71.79	3.03	13.24	H
	7728	-61.02	-25	-36.02	-70.47	3.56	13.01	H
	10300	-58.20	-25	-33.20	-67.72	3.92	13.44	H
	5152	-61.62	-25	-36.62	-71.83	3.03	13.24	V
	7728	-60.69	-25	-35.69	-70.14	3.56	13.01	V
	10300	-58.55	-25	-33.55	-68.07	3.92	13.44	V
Highest	5164	-61.81	-25	-36.81	-72.02	3.03	13.24	H
	7744	-60.82	-25	-35.82	-70.27	3.56	13.01	H
	10330	-58.25	-25	-33.25	-67.77	3.92	13.44	H
	5164	-61.76	-25	-36.76	-71.97	3.03	13.24	V
	7744	-60.88	-25	-35.88	-70.33	3.56	13.01	V
	10330	-58.60	-25	-33.60	-68.12	3.92	13.44	V

Remark: Spurious emissions within 30-1000MHz were found more than 20dB below limit line.