

Regulatory WWAN Antenna Information (TB Mode)

Platform information						
Brand	ODM	Platform model name	Platform type (ex: regular NB, convertible PC, AIO...etc)			*SAR minimum separation (mm)
HP Inc.	Inventec	(HSN-I55C)	convertible PC			2.834mm
Antenna information						Maximum Peak gain
Vendor	Type	Antenna Part number (Ant5 TX/RX)	Antenna Part number (Ant6 RX)	Antenna Part number (Ant7 RX)	Antenna Part number (Ant8 TX/RX)	ANT 8 3300 MHz
Hong Bo	PIFA	6036B0317401 (00-3302701450)	6036B0317401 (00-3302701450)	6036B0317301 (00-2602751750)	6036B0317501 (00-2602751850)	1.29 dBi
Module information						
Model	Form factor and suffixes (NGW/ HMW AND AN/ NB/ BN....)					
Kavalan	Fibocom FM350-GL WWAN 4x4 5G NR radio module					

Antenna Sample / Antenna Data Requirements for worldwide regulatory approval

Section	Description of Required OEM / ODM Antenna Information	US / IC	EU	Japan	Taiwan	S.Korea
1A	Part Number for Antenna Assembly	Required	Required	Required	Required	Required
1B	Antenna Manufacturer Name	Required	Required	Required	Required	Required
1C	Description of Antenna Type	Required	N/A	N/A	N/A	N/A
1D	Tx antenna Gain (Peak Gain W/ cable loss) *	Required	Required	Required	Required	Required
2	Dimensioned Photographs and Drawings of Tx and Rx antennas	Required	Required	Required	Required	Required
3	Radiation patterns of antennas loaded in the host platform.	N/A	Required	Required	Required	N/A
4	Platform model name / number - correlated to antenna manufacturer and antenna part number	Required	Required	Desired	Required	Desired
5	Photograph(s) or Drawings showing location of antennas in platform. <u>(S. Korea requires photographs of antennas for approval submission). Taiwan requires pictures of each antenna type shown in the system.</u>	Required	Required	Desired	<u>Required (Photos)</u>	<u>Required (Photos)</u>
6	Mech. drawings / photos with dimensions of antenna locations and distance from end-user (For evaluation of SAR testing requirement).	Required	N/A	N/A	N/A	N/A
7	Photograph(s) or Drawings showing the location of all antennas (WLAN, other) and distance between those transmitting antennas. Information will be used to evaluate whether co-location testing is required.	Required	N/A	N/A	N/A	N/A
8	Local representative contact information for LMA/ PARS process.	Required	N/A	N/A	N/A	N/A

Antenna Information

Section 1. Antenna Assembly Specifications

Communication System	Band	Frequency(MHz) from low to high spectrum		1A Part Number for Antenna Assembly	1B Antenna Manufacturer Name	1C Description of Antenna Type	1D Tx Antenna Gain (dBi) Ant5
WCDMA/ LTE/5G NR FR1	1	1920	1980	Ant5 : 6036B0317401 (00-3302701450)	Hong Bo	PIFA	-0.39
WCDMA/ LTE/5G NR FR1	2	1850	1910				-0.80
LTE/5G NR FR1	3	1710	1785				-1.06
WCDMA/ LTE	4	1710	1755				-1.06
WCDMA/ LTE/5G NR FR1	5	824	849				-9.08
LTE/5G NR FR1	7	2500	2570				-0.66
WCDMA/ LTE/5G NR FR1	8	880	915				-9.07
LTE	12	699	716				-5.46
LTE	13	777	787				-8.09
LTE	14	788	798				-8.21
LTE	17	704	716				-5.46
LTE	18	815	830				-8.82
LTE	19	830	845				-9.04
LTE/5G NR FR1	20	832	862				-9.04
LTE/5G NR FR1	25	1850	1915				-0.80
LTE	26	814	849				-8.82
LTE/5G NR FR1	28	703	748				-5.61
LTE/5G NR FR1	30	2305	2315				-1.33
LTE	34	2010	2025				-1.94
LTE/5G NR FR1	38	2570	2620				-2.32
LTE	39	1880	1920				-0.82
LTE/5G NR FR1	40	2300	2400				-1.28
LTE/5G NR FR1	41	2496	2690				-0.56
LTE	42	3400	3600				-0.83
LTE	43	3600	3800				-0.83
LTE/5G NR FR1	48	3550	3700				-0.25
LTE/5G NR FR1	66	1710	1780				-1.06
LTE/5G NR FR1	71	663	698				-6.10
5G NR FR1	77	3300	4200	-2.81			
5G NR FR1	78	3300	3800	-1.77			
5G NR FR1	79	4400	5000	-3.38			

Communication System	Band	Frequency(MHz) from low to high spectrum		1A Part Number for Antenna Assembly	1B Antenna Manufacturer Name	1C Description of Antenna Type	1D Tx Antenna Gain (dBi) Ant8
5G NR FR1	1	1920	1980	Ant8 : 6036B0317501 (00-2602751850)	Hong Bo	PIFA	-1.89
LTE/5G NR FR1	2	1850	1910				-0.91
5G NR FR1	3	1710	1785				-3.54
LTE	4	1710	1755				-3.49
5G NR FR1	5	824	849				-33.67
LTE/5G NR FR1	7	2500	2570				-4.21
LTE/5G NR FR1	25	1850	1915				-0.91
LTE/5G NR FR1	30	2305	2315				-4.03
5G NR FR1	38	2570	2620				-4.41
5G NR FR1	40	2300	2400				-4.06
LTE/5G NR FR1	41	2496	2690				-4.72
5G NR FR1	48	3550	3700				-2.07
LTE/5G NR FR1	66	1710	1780				-3.49
5G NR FR1	77	3300	4200				1.29
5G NR FR1	78	3300	3800				-0.79
5G NR FR1	79	4400	5000				0.56

- Antenna Peak Gain required being test in system basis.

Section 2. Dimensioned Photos or Drawings of Antennas

	Ant supplier	Part number	Drawing	Photo
Ant5	Hong Bo	6036B0317401 (00-3302701450)	V	V
Ant6	Hong Bo	6036B0317401 (00-3302701450)	V	V
Ant7	Hong Bo	6036B0317301 (00-2602751750)	V	V
Ant8	Hong Bo	6036B0317501 (00-2602751850)	V	V

Ant5 Dimensioned Drawing:

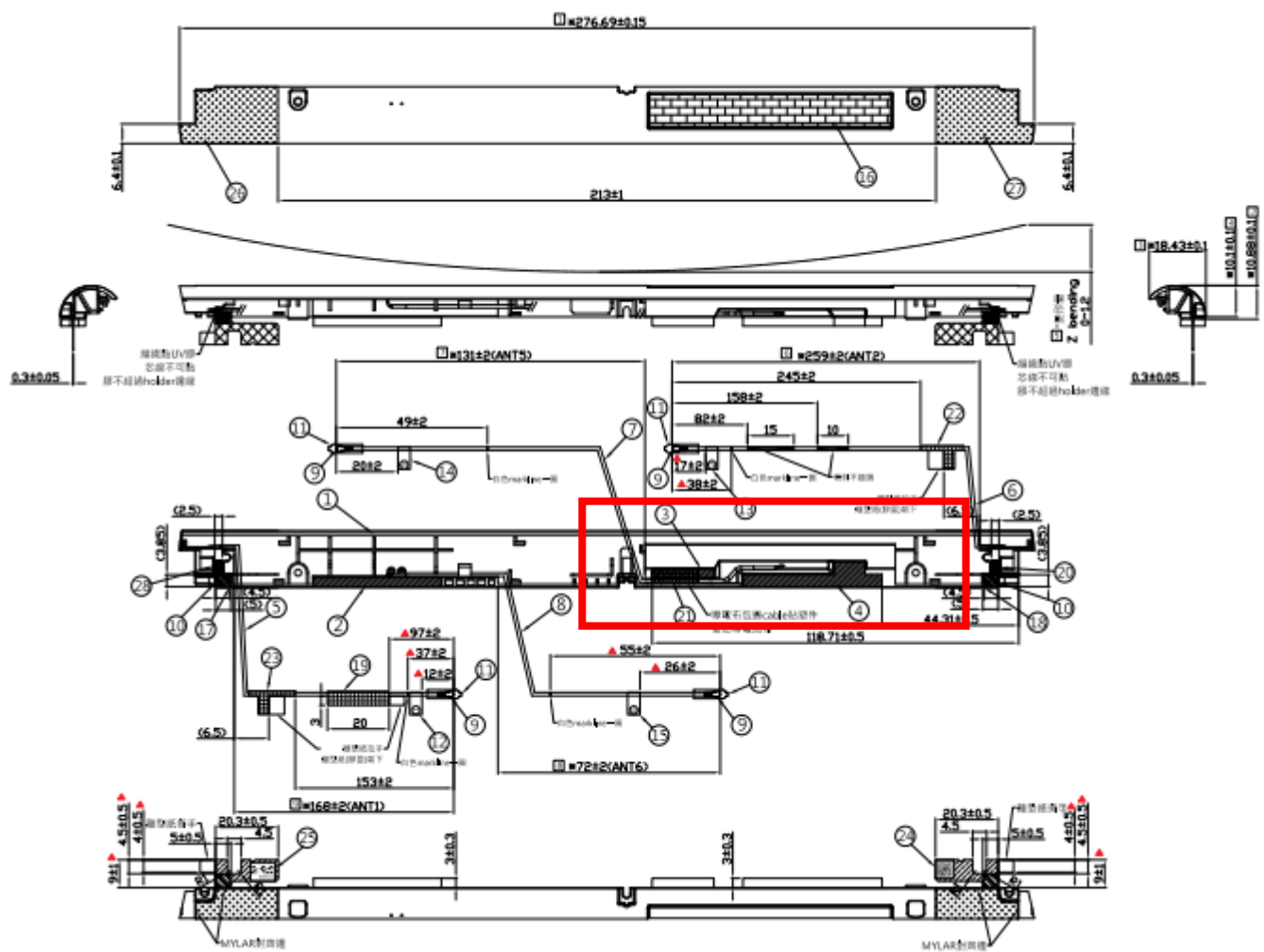

Ant5 Photo:

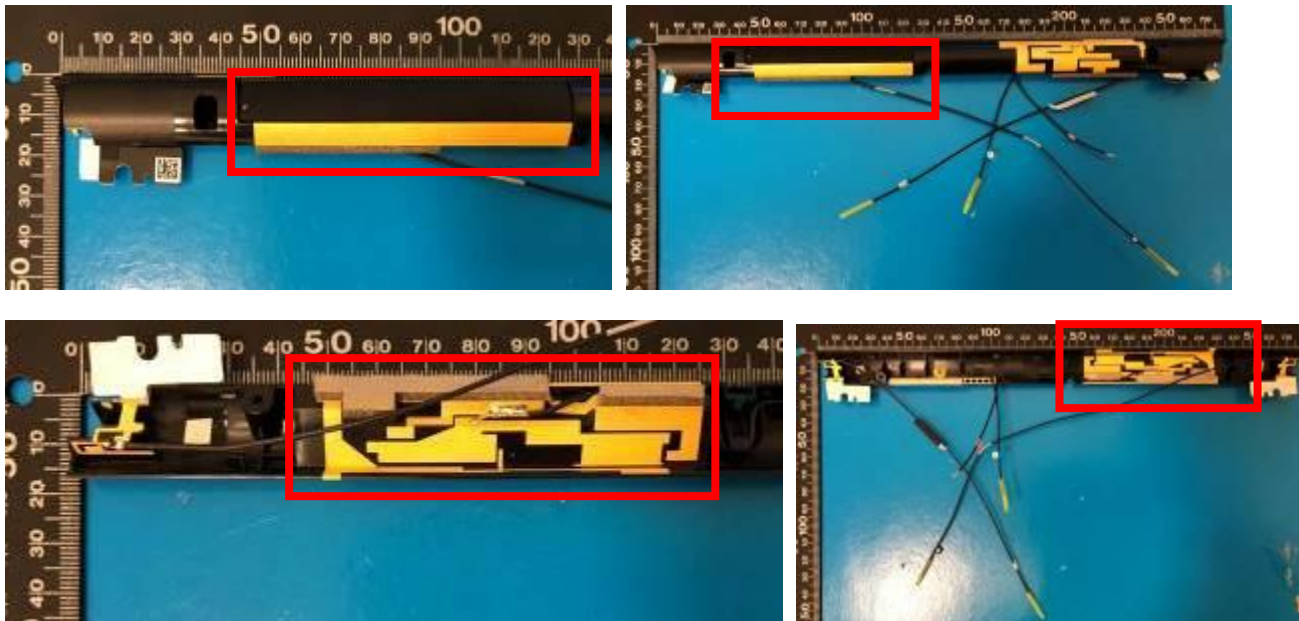

Ant6 Dimensioned Drawing:

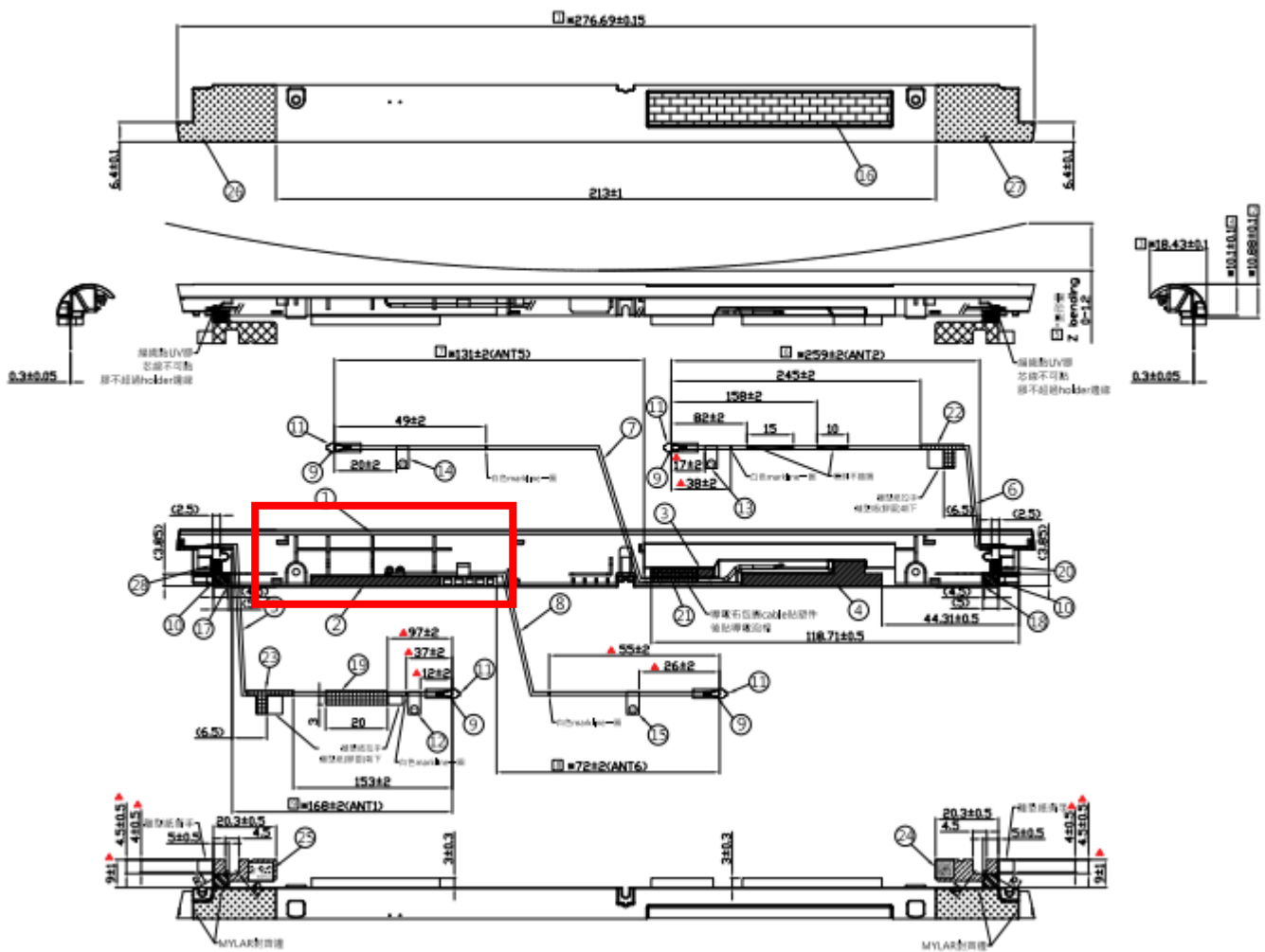

Ant6 Photo:

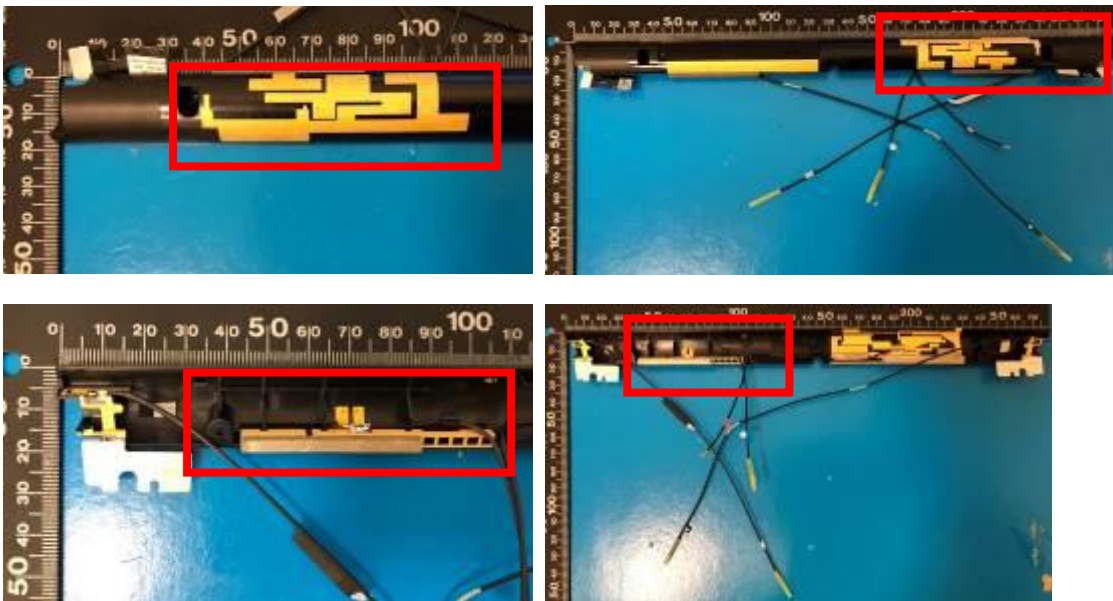

Ant7 Dimensioned Drawing:

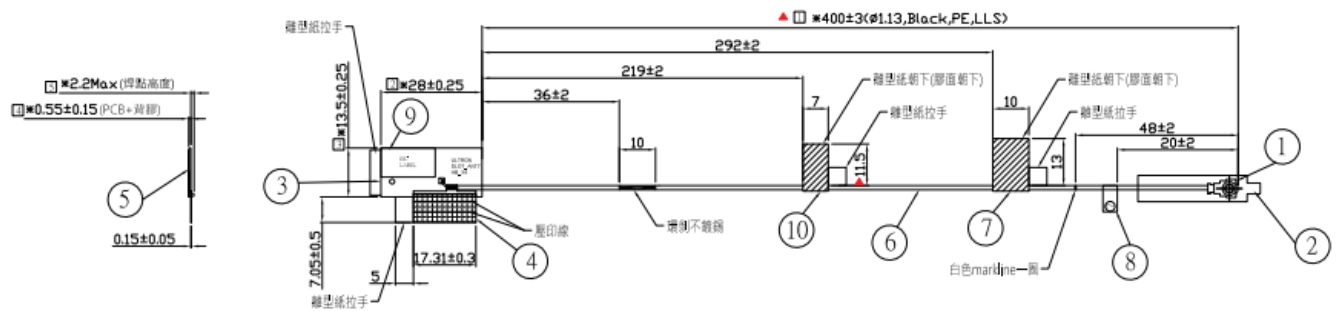

Ant7 Photo:

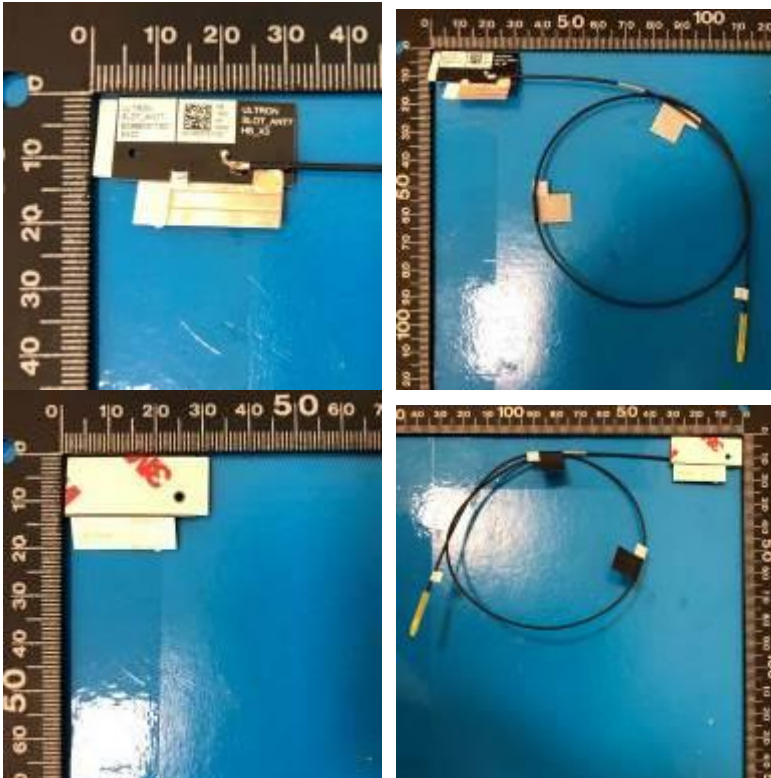

Ant8 Dimensioned Drawing:

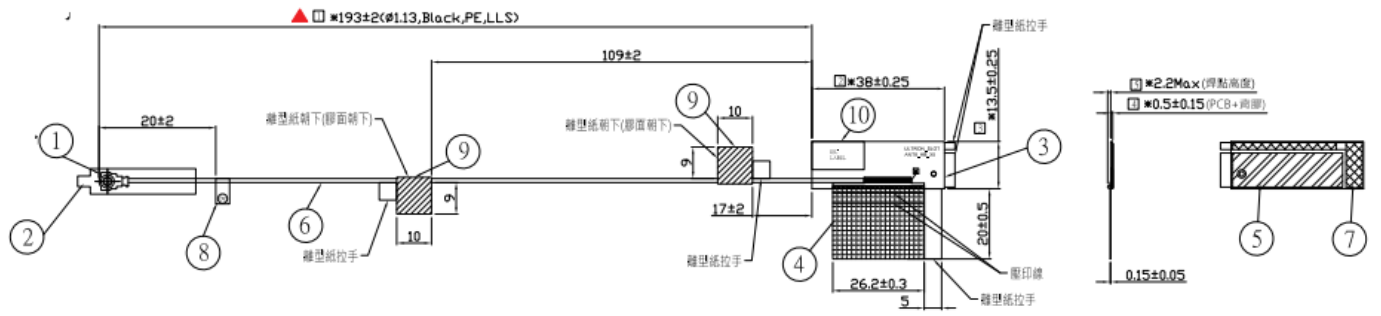

Ant8 Photo:

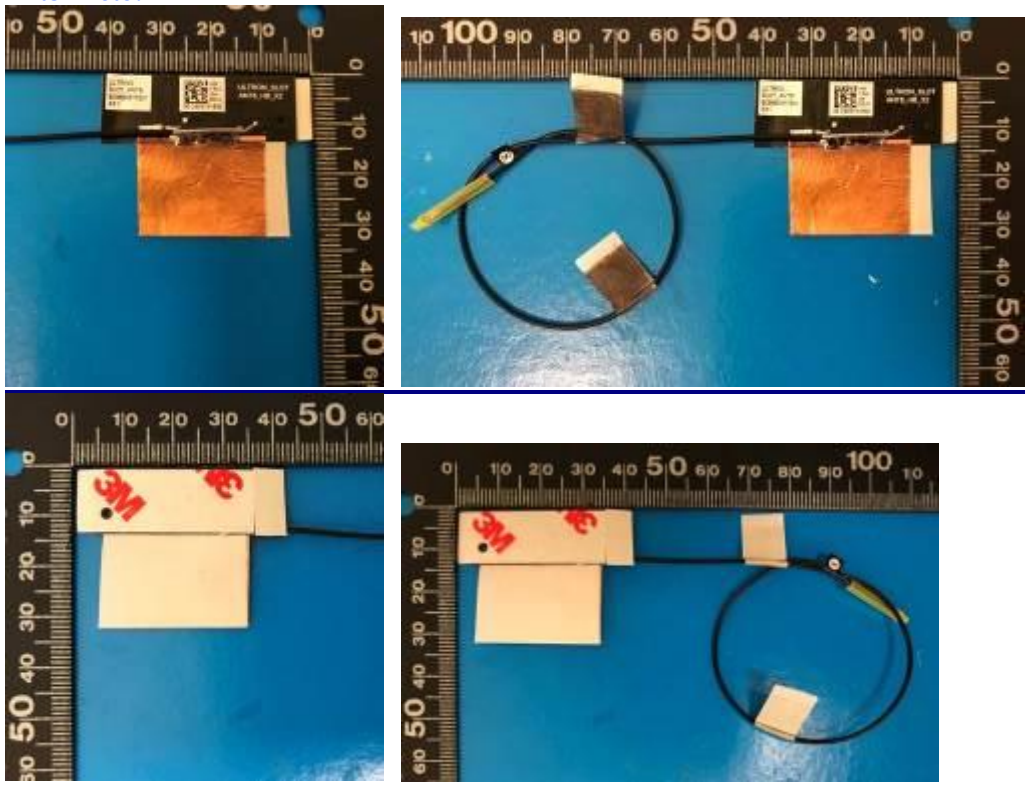

- The listed frequency 2D radiation pattern is required

● **Ant5:**

814MHz

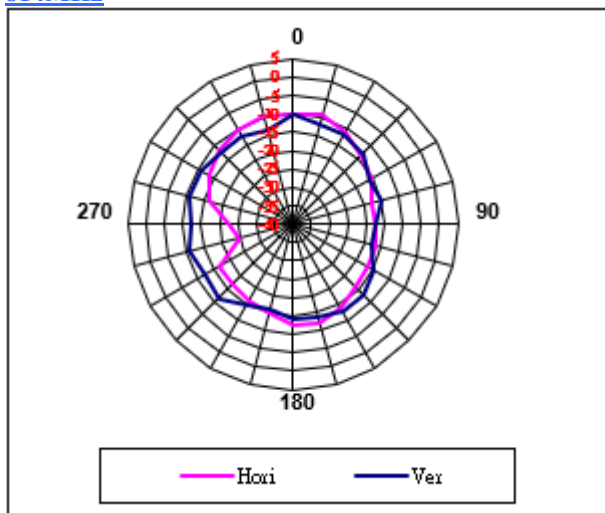

Frequency (MHz)	814
Horizontal peak gain (dBi)	-8.82
Vertical peak gain (dBi)	-10.02

832MHz

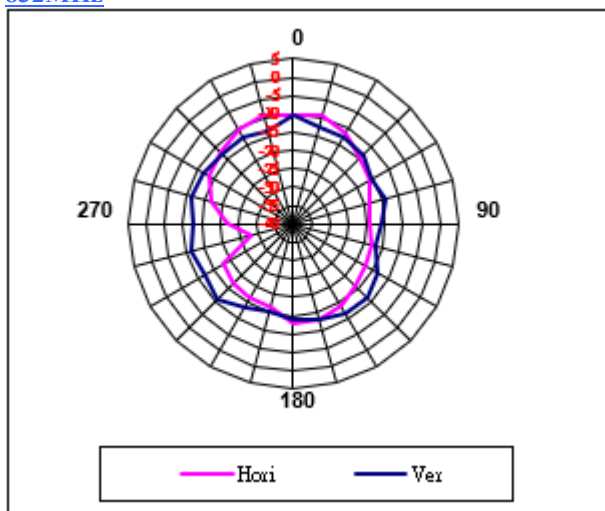

Frequency (MHz)	832
Horizontal peak gain (dBi)	-9.24
Vertical peak gain (dBi)	-10.46

837MHz

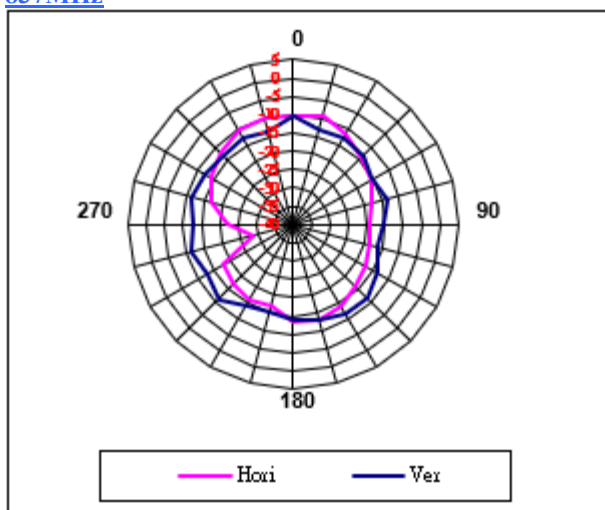

Frequency (MHz)	837
Horizontal peak gain (dBi)	-9.16
Vertical peak gain (dBi)	-10.56

845MHz

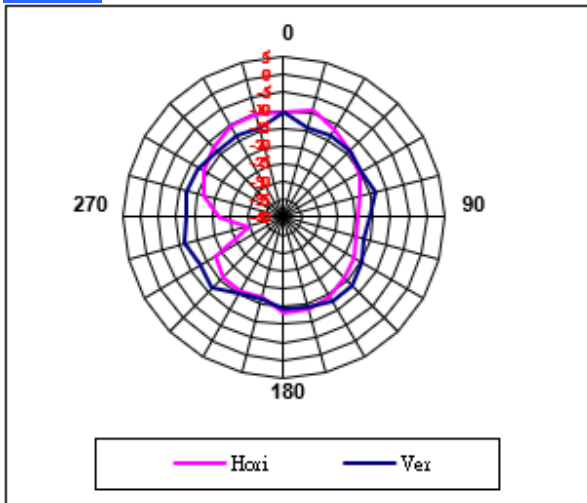

Frequency (MHz)	845
Horizontal peak gain (dBi)	-9.04
Vertical peak gain (dBi)	-10.78

849MHz

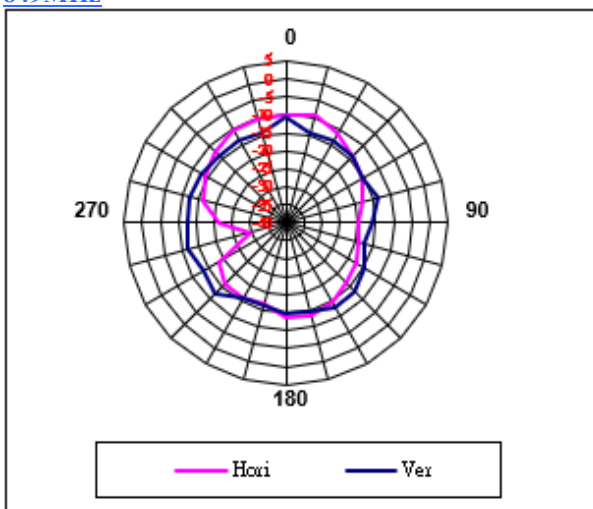

Frequency (MHz)	849
Horizontal peak gain (dBi)	-9.08
Vertical peak gain (dBi)	-10.88

880MHz

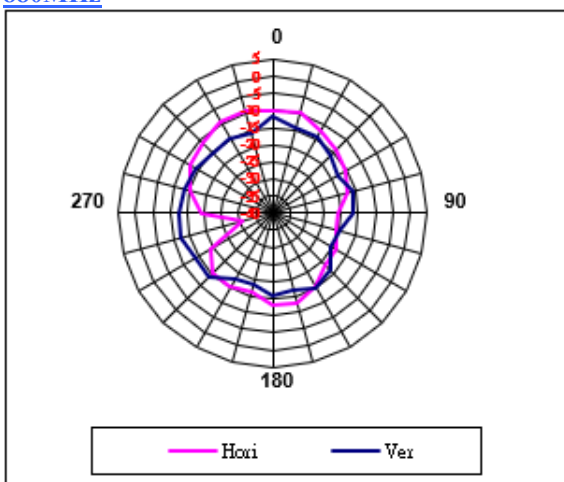

Frequency (MHz)	880
Horizontal peak gain (dBi)	-9.25
Vertical peak gain (dBi)	-11.52

894MHz

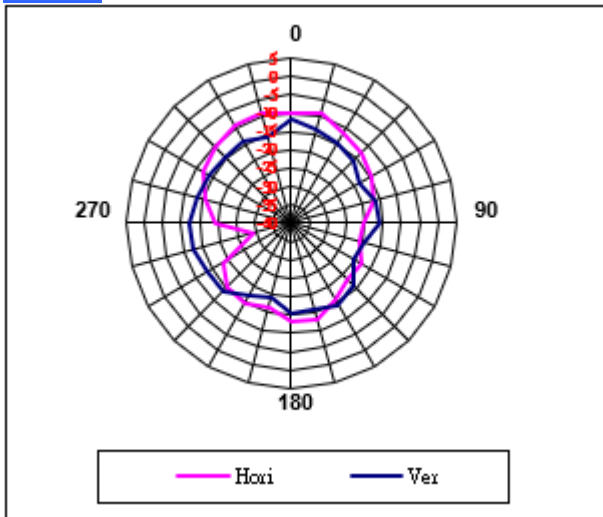

Frequency (MHz)	894
Horizontal peak gain (dBi)	-9.01
Vertical peak gain (dBi)	-11.45

915MHz

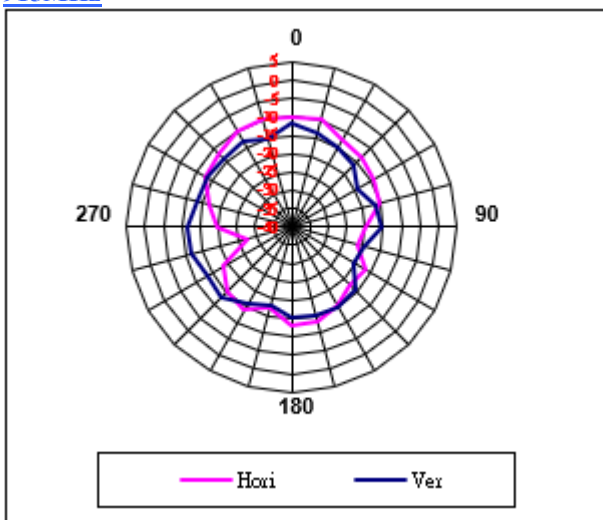

Frequency (MHz)	915
Horizontal peak gain (dBi)	-9.34
Vertical peak gain (dBi)	-11.53

1710MHz

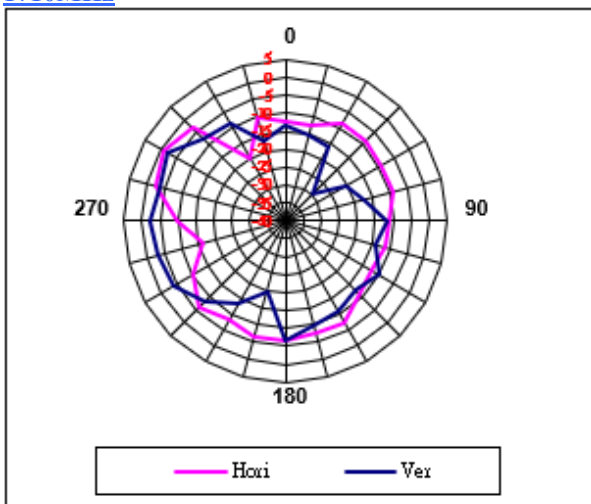

Frequency (MHz)	1710
Horizontal peak gain (dBi)	-1.06
Vertical peak gain (dBi)	-1.84

1750MHz

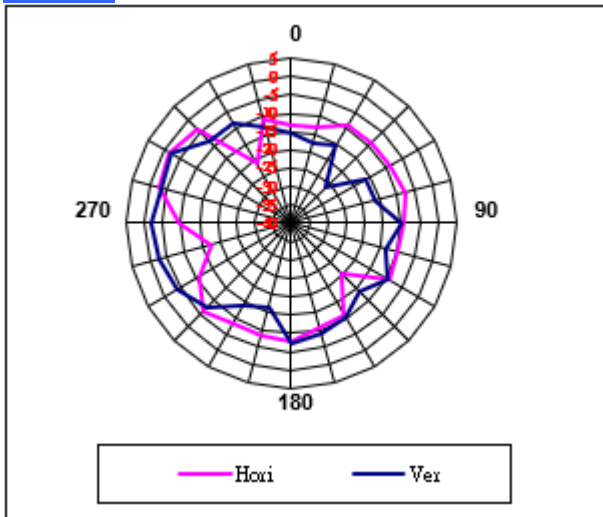

Frequency (MHz)	1750
Horizontal peak gain (dBi)	-1.62
Vertical peak gain (dBi)	-1.97

1780MHz

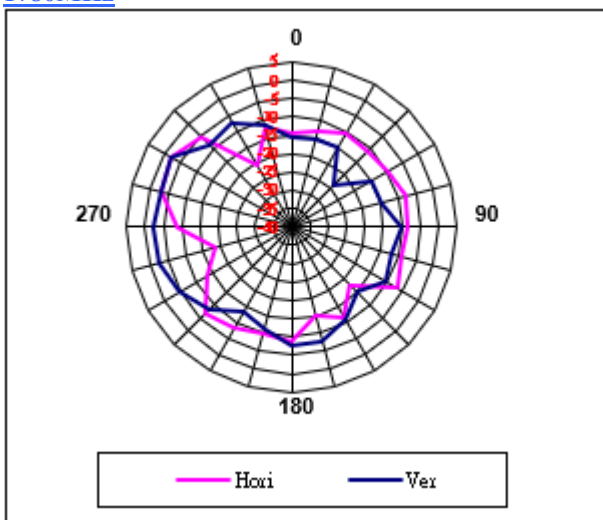

Frequency (MHz)	1780
Horizontal peak gain (dBi)	-2.11
Vertical peak gain (dBi)	-2.03

1785MHz

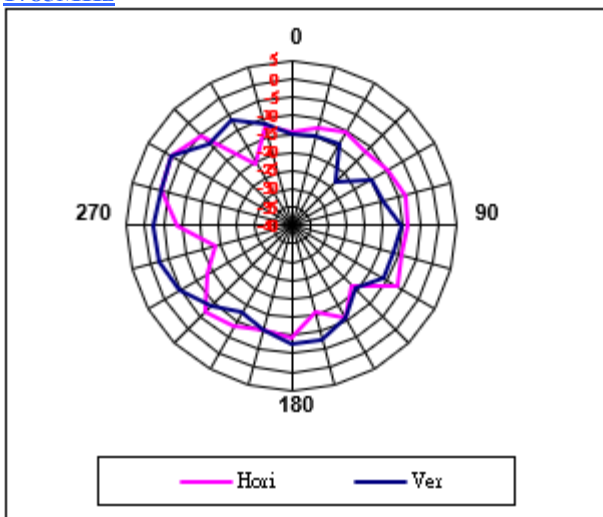

Frequency (MHz)	1785
Horizontal peak gain (dBi)	-2.13
Vertical peak gain (dBi)	-2.10

1880MHz

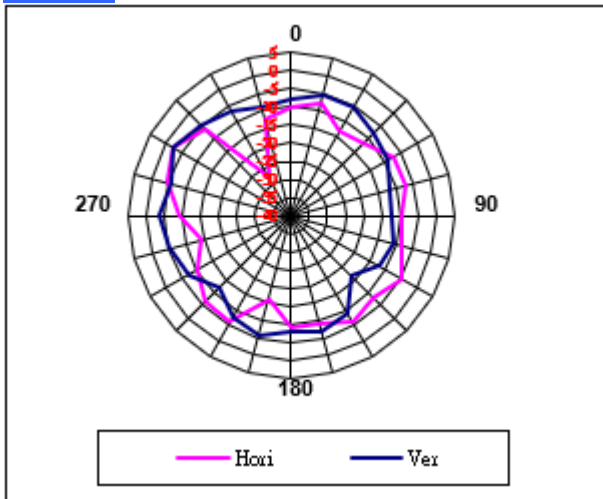

Frequency (MHz)	1880
Horizontal peak gain (dBi)	-2.23
Vertical peak gain (dBi)	-2.07

1900MHz

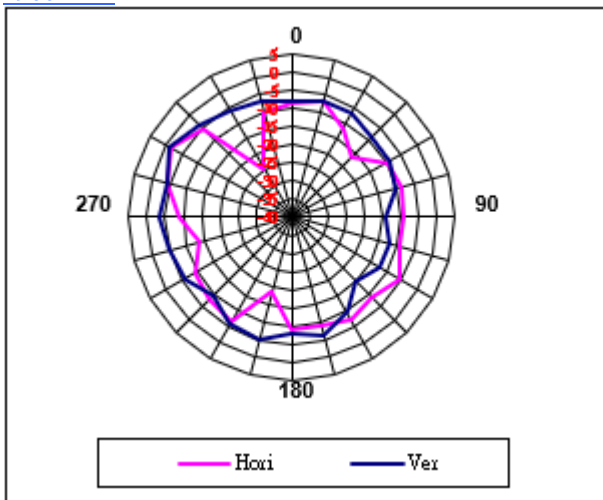

Frequency (MHz)	1900
Horizontal peak gain (dBi)	-1.45
Vertical peak gain (dBi)	-0.99

1920MHz

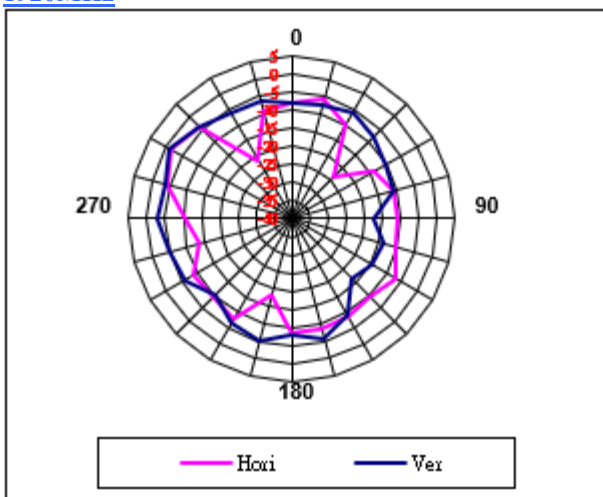

Frequency (MHz)	1920
Horizontal peak gain (dBi)	-1.25
Vertical peak gain (dBi)	-0.82

1950MHz

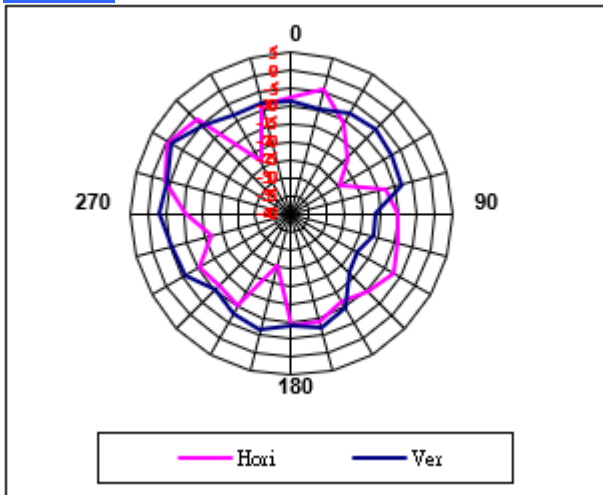

Frequency (MHz)	1950
Horizontal peak gain (dBi)	-0.39
Vertical peak gain (dBi)	-1.13

1980MHz

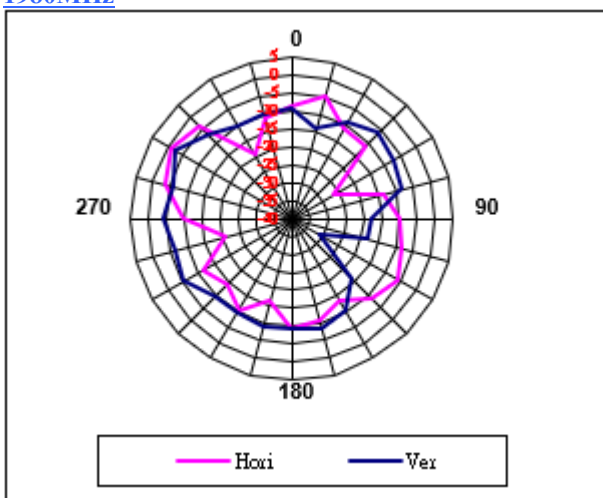

Frequency (MHz)	1980
Horizontal peak gain (dBi)	-1.00
Vertical peak gain (dBi)	-2.31

2496MHz

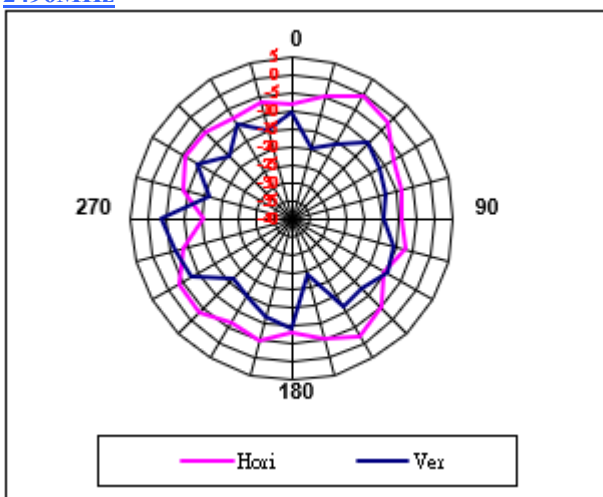

Frequency (MHz)	2496
Horizontal peak gain (dBi)	-0.56
Vertical peak gain (dBi)	-3.58

2595MHz

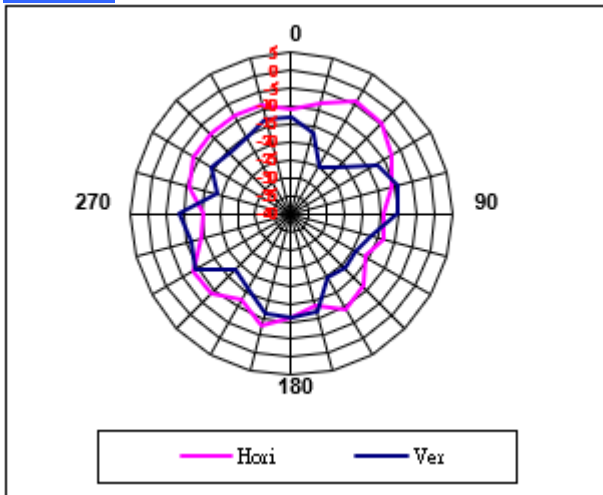

Frequency (MHz)	2595
Horizontal peak gain (dBi)	-3.91
Vertical peak gain (dBi)	-8.86

2690MHz

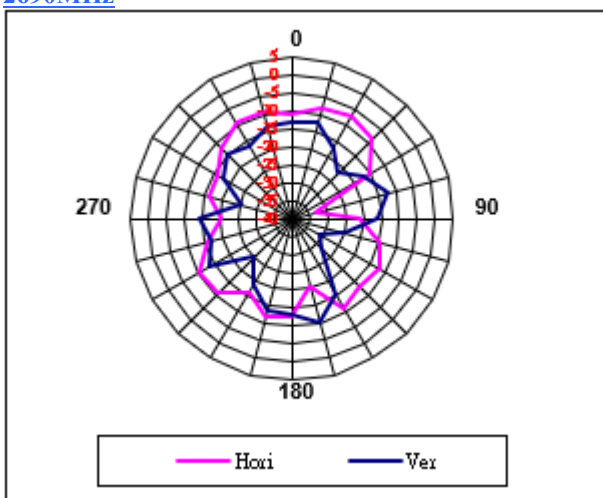

Frequency (MHz)	2690
Horizontal peak gain (dBi)	-6.79
Vertical peak gain (dBi)	-10.02

3300MHz

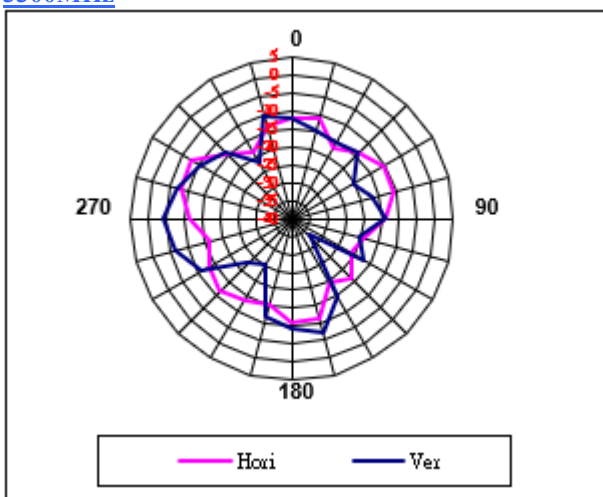

Frequency (MHz)	3300
Horizontal peak gain (dBi)	-7.87
Vertical peak gain (dBi)	-4.20

3400MHz

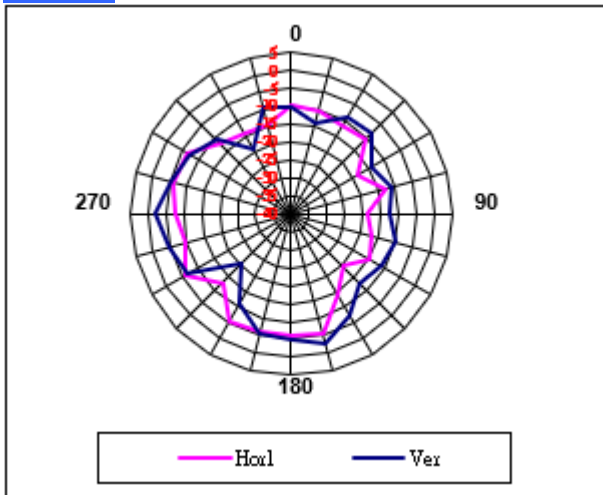

Frequency (MHz)	3400
Horizontal peak gain (dBi)	-5.50
Vertical peak gain (dBi)	-2.16

3500MHz

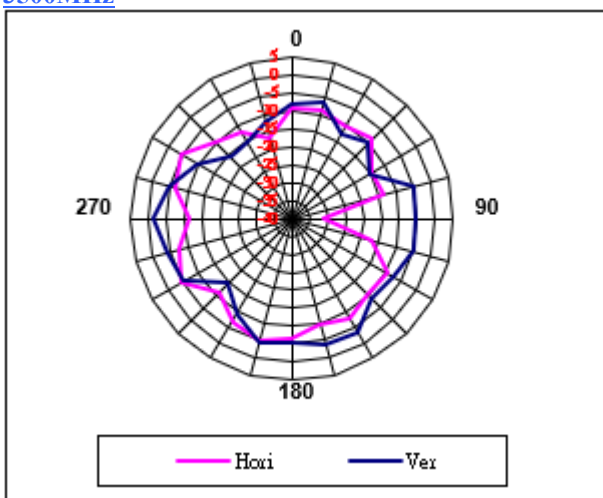

Frequency (MHz)	3500
Horizontal peak gain (dBi)	-4.15
Vertical peak gain (dBi)	-1.20

3600MHz

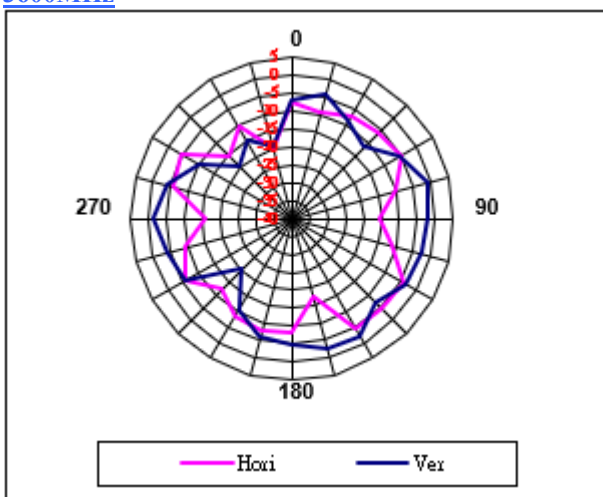

Frequency (MHz)	3600
Horizontal peak gain (dBi)	-4.00
Vertical peak gain (dBi)	-0.83

3750MHz

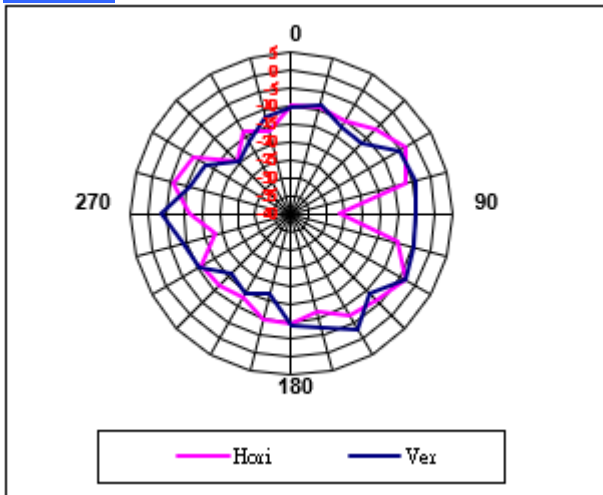

Frequency (MHz)	3750
Horizontal peak gain (dBi)	-3.00
Vertical peak gain (dBi)	-2.81

4200MHz

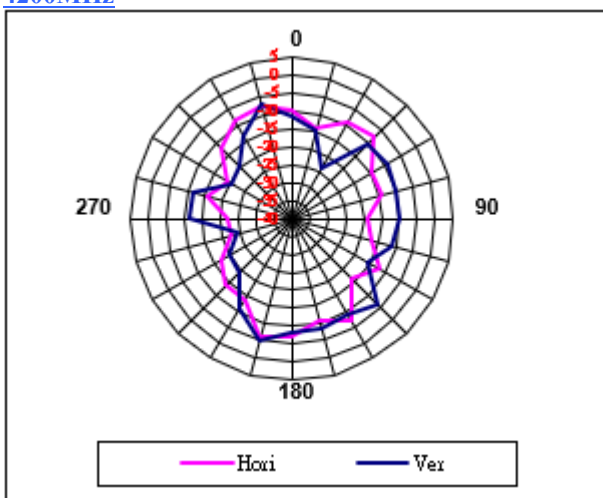

Frequency (MHz)	4200
Horizontal peak gain (dBi)	-6.06
Vertical peak gain (dBi)	-4.94

4400MHz

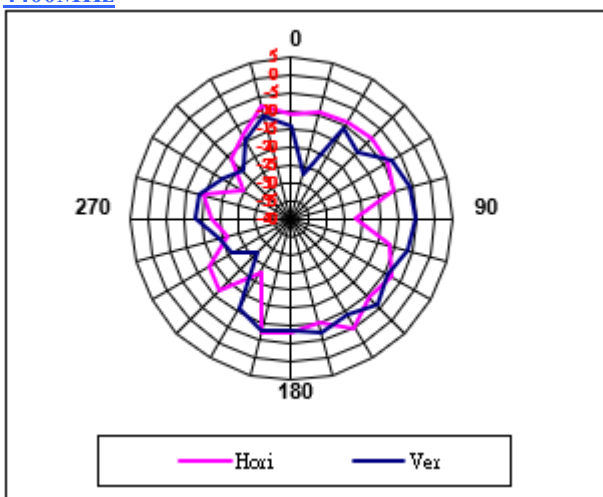

Frequency (MHz)	4400
Horizontal peak gain (dBi)	-4.95
Vertical peak gain (dBi)	-5.21

4800MHz

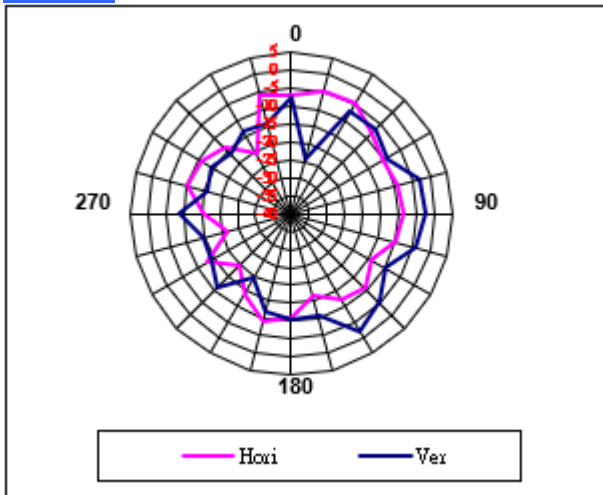

Frequency (MHz)	4800
Horizontal peak gain (dBi)	-4.29
Vertical peak gain (dBi)	-2.02

5000MHz

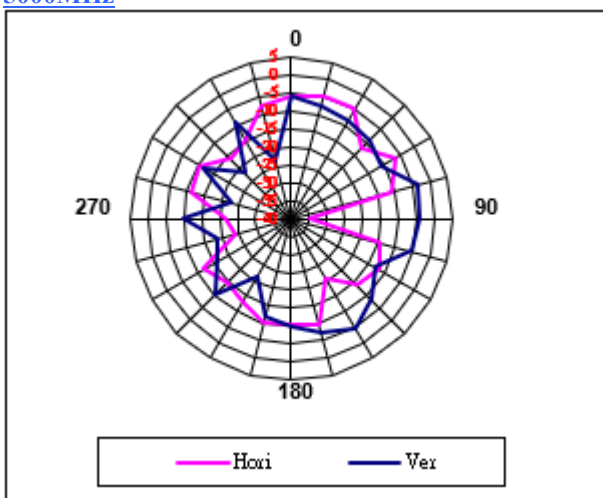

Frequency (MHz)	5000
Horizontal peak gain (dBi)	-4.67
Vertical peak gain (dBi)	-3.38

● **Ant8:**
1710 MHz

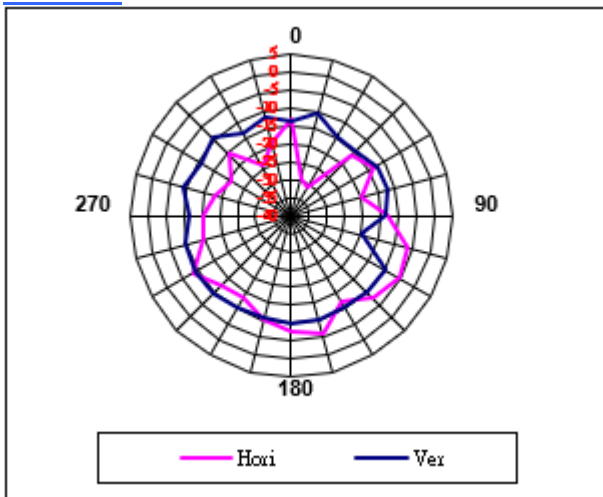

Frequency (MHz)	1710
Horizontal peak gain (dBi)	-5.21
Vertical peak gain (dBi)	-8.93

1750MHz

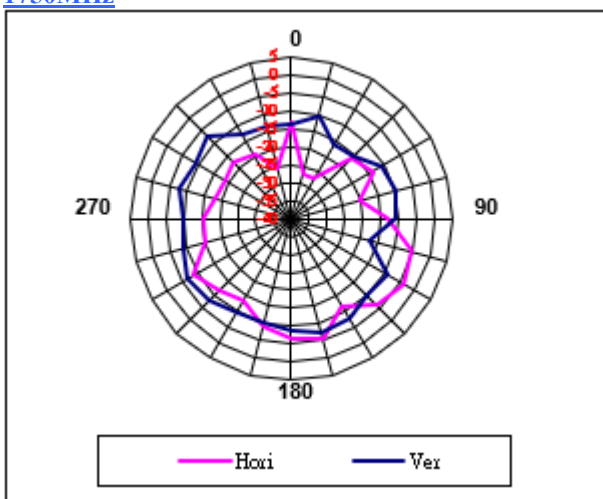

Frequency (MHz)	1750
Horizontal peak gain (dBi)	-3.62
Vertical peak gain (dBi)	-6.65

1780MHz

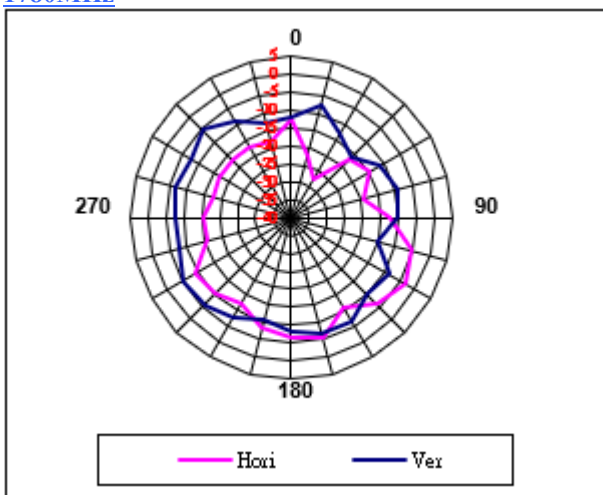

Frequency (MHz)	1780
Horizontal peak gain (dBi)	-3.49
Vertical peak gain (dBi)	-4.97

1785MHz

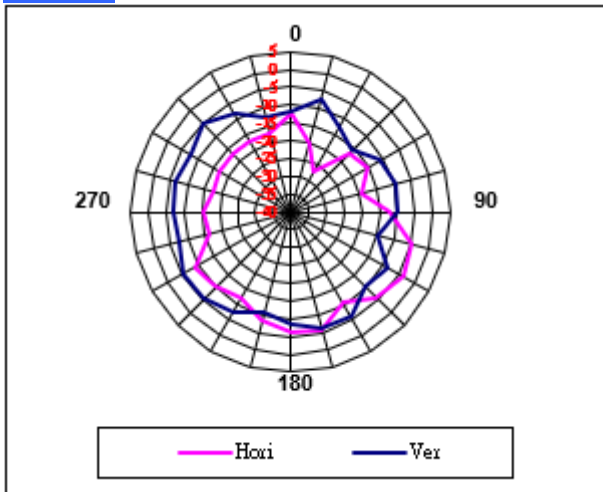

Frequency (MHz)	1785
Horizontal peak gain (dBi)	-3.54
Vertical peak gain (dBi)	-4.78

1880MHz

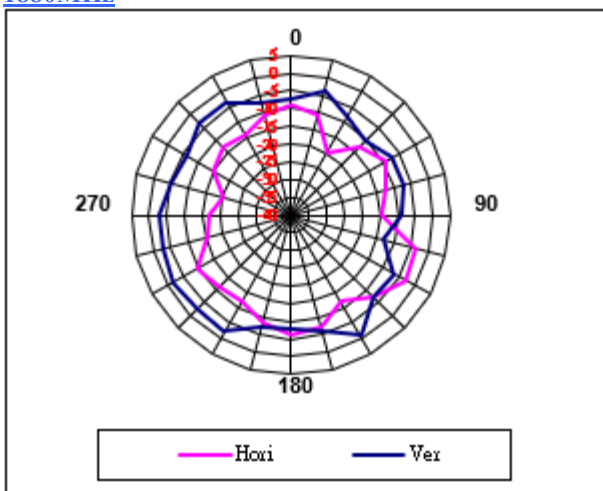

Frequency (MHz)	1880
Horizontal peak gain (dBi)	-2.85
Vertical peak gain (dBi)	-0.93

1900MHz

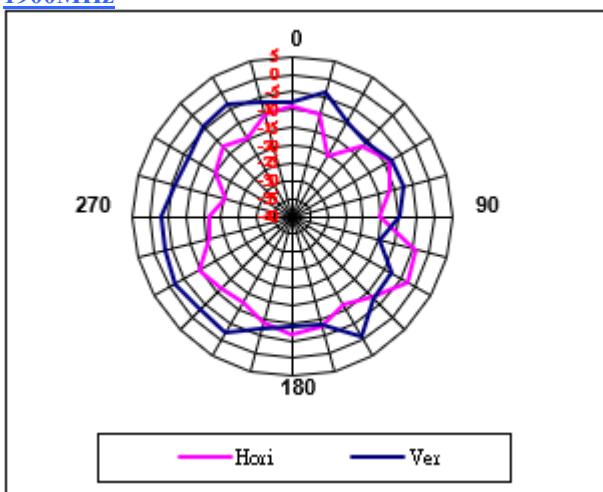

Frequency (MHz)	1900
Horizontal peak gain (dBi)	-2.58
Vertical peak gain (dBi)	-1.23

1920MHz

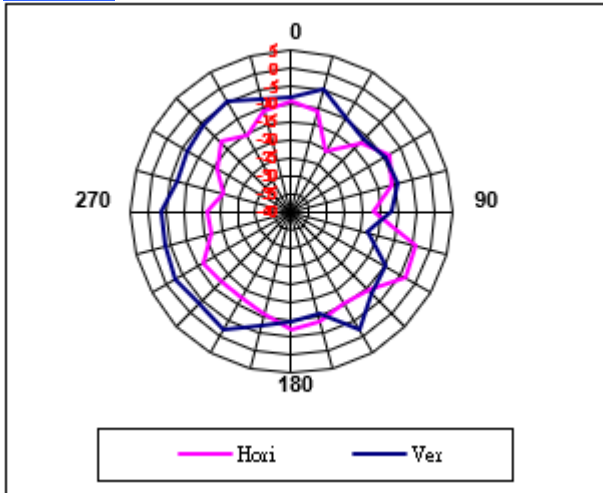

Frequency (MHz)	1920
Horizontal peak gain (dBi)	-3.45
Vertical peak gain (dBi)	-1.89

1950MHz

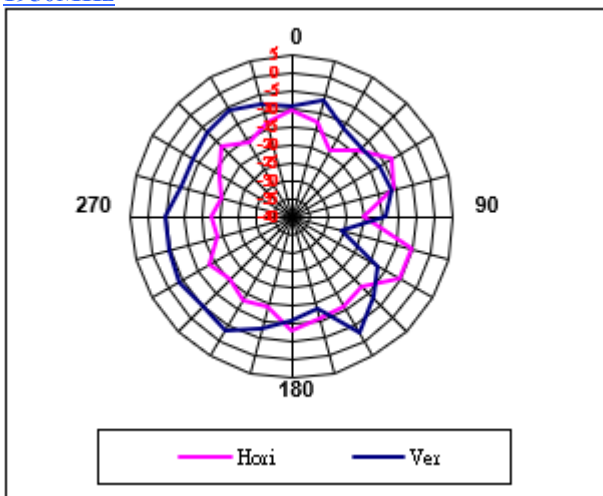

Frequency (MHz)	1950
Horizontal peak gain (dBi)	-5.17
Vertical peak gain (dBi)	-2.47

1980MHz

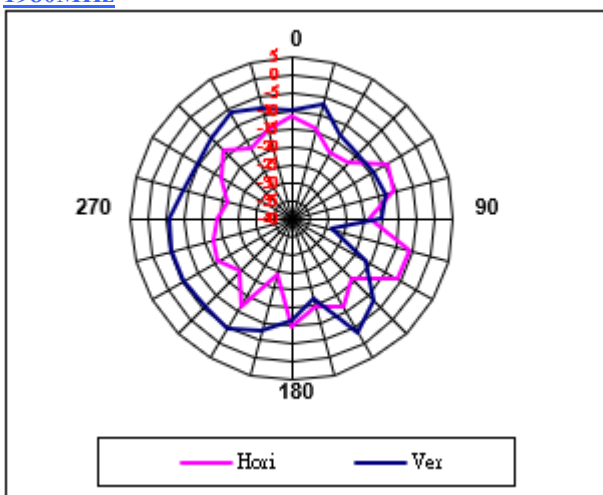

Frequency (MHz)	1980
Horizontal peak gain (dBi)	-6.08
Vertical peak gain (dBi)	-3.44

2496MHz

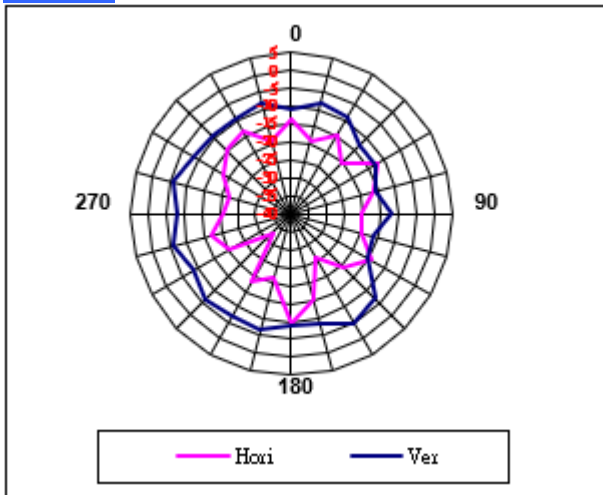

Frequency (MHz)	2496
Horizontal peak gain (dBi)	-9.54
Vertical peak gain (dBi)	-4.92

2595MHz

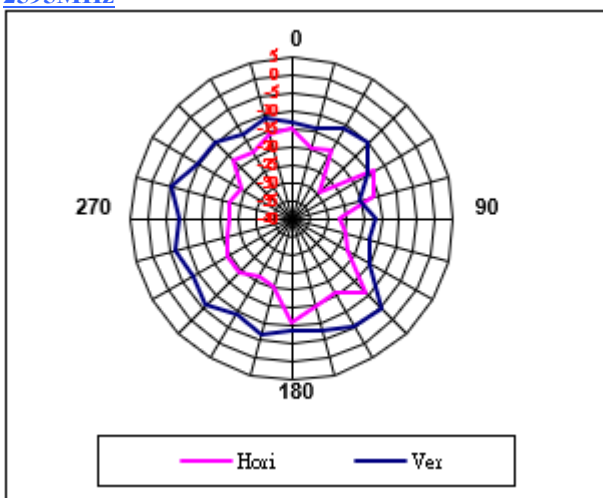

Frequency (MHz)	2595
Horizontal peak gain (dBi)	-10.85
Vertical peak gain (dBi)	-4.68

2690MHz

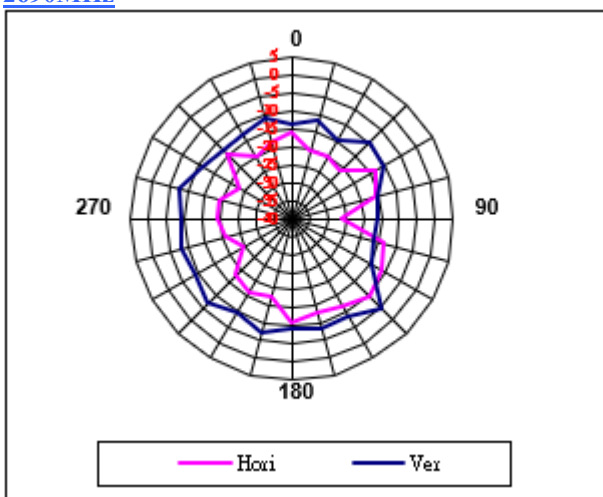

Frequency (MHz)	2690
Horizontal peak gain (dBi)	-9.36
Vertical peak gain (dBi)	-4.89

3300MHz

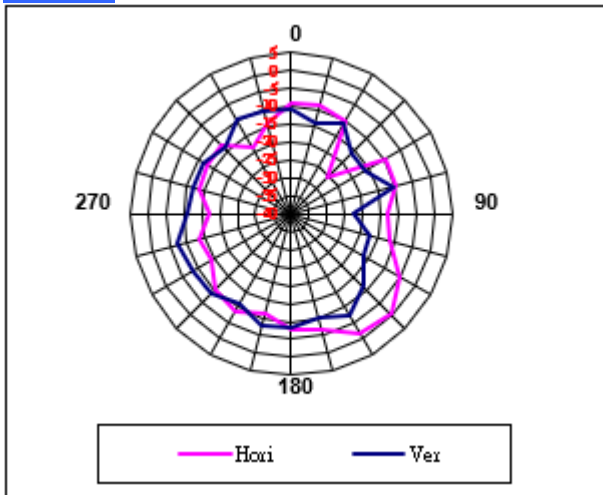

Frequency (MHz)	3300
Horizontal peak gain (dBi)	-0.79
Vertical peak gain (dBi)	-7.36

3400MHz

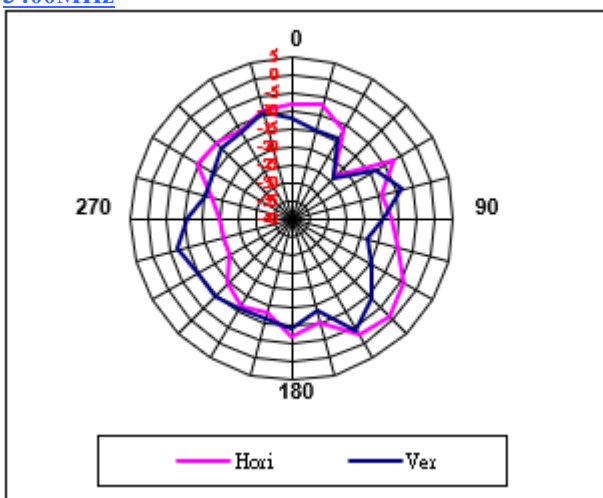

Frequency (MHz)	3400
Horizontal peak gain (dBi)	-1.72
Vertical peak gain (dBi)	-4.09

3500MHz

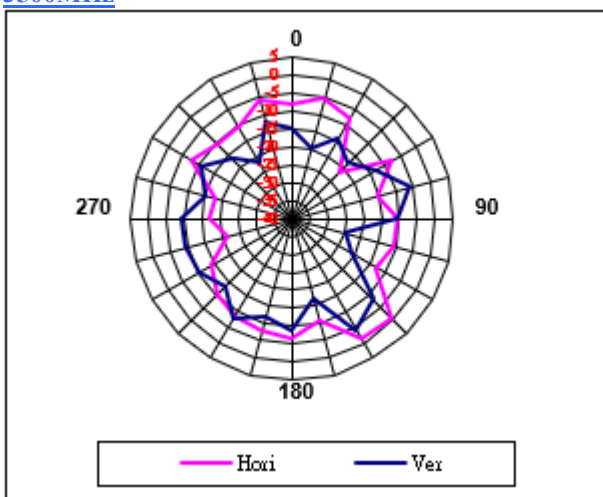

Frequency (MHz)	3500
Horizontal peak gain (dBi)	-0.60
Vertical peak gain (dBi)	-4.05

3600MHz

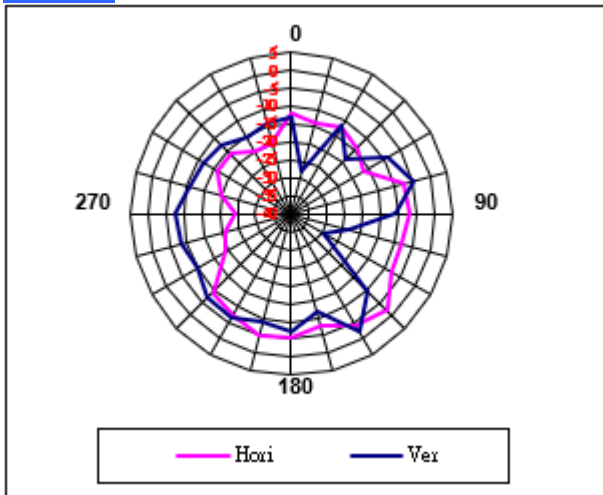

Frequency (MHz)	3600
Horizontal peak gain (dBi)	-2.13
Vertical peak gain (dBi)	-2.40

3750MHz

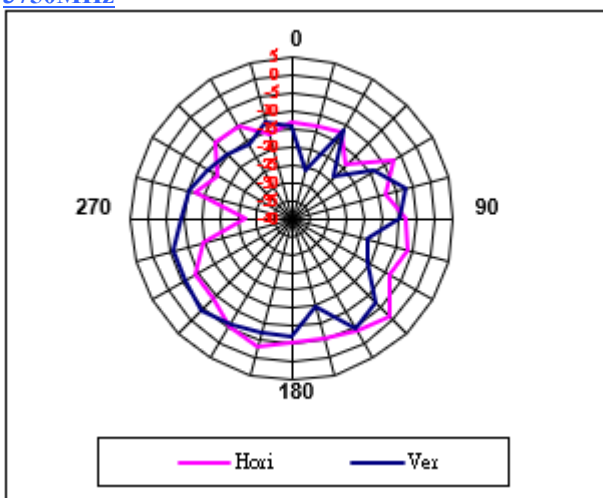

Frequency (MHz)	3750
Horizontal peak gain (dBi)	-1.16
Vertical peak gain (dBi)	-4.13

4200MHz

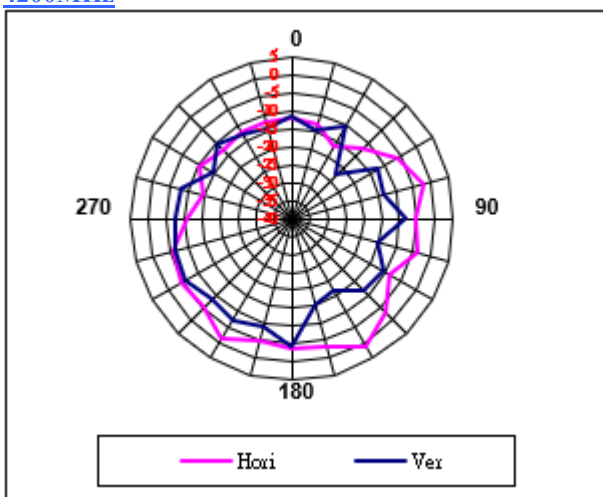

Frequency (MHz)	4200
Horizontal peak gain (dBi)	1.29
Vertical peak gain (dBi)	-4.54

4400MHz

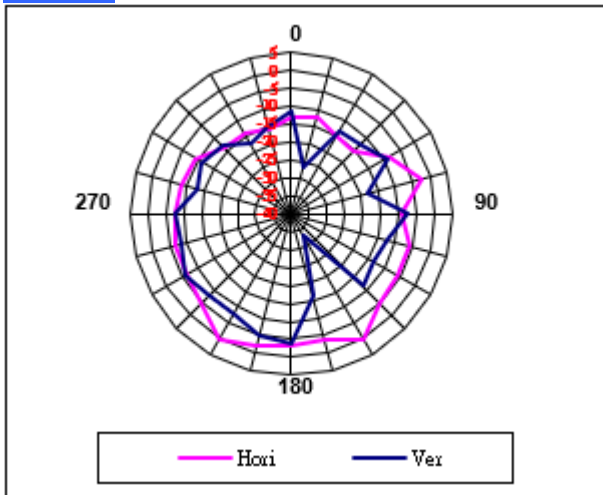

Frequency (MHz)	4400
Horizontal peak gain (dBi)	0.56
Vertical peak gain (dBi)	-3.67

4800MHz

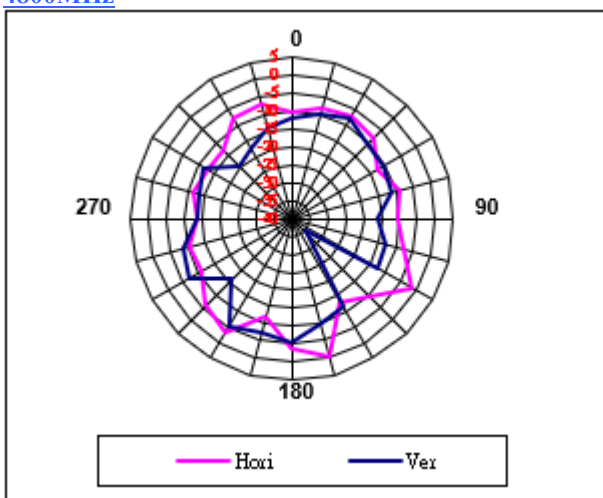

Frequency (MHz)	4800
Horizontal peak gain (dBi)	0.07
Vertical peak gain (dBi)	-5.22

5000MHz

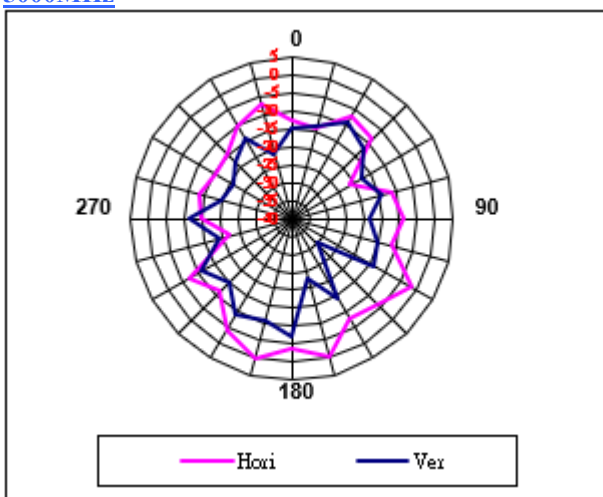

Frequency (MHz)	5000
Horizontal peak gain (dBi)	0.16
Vertical peak gain (dBi)	-7.36

Section 4. Host Platform Information

OEM / ODM Host platform: platform correlated to antenna data

Rating Label Photo:

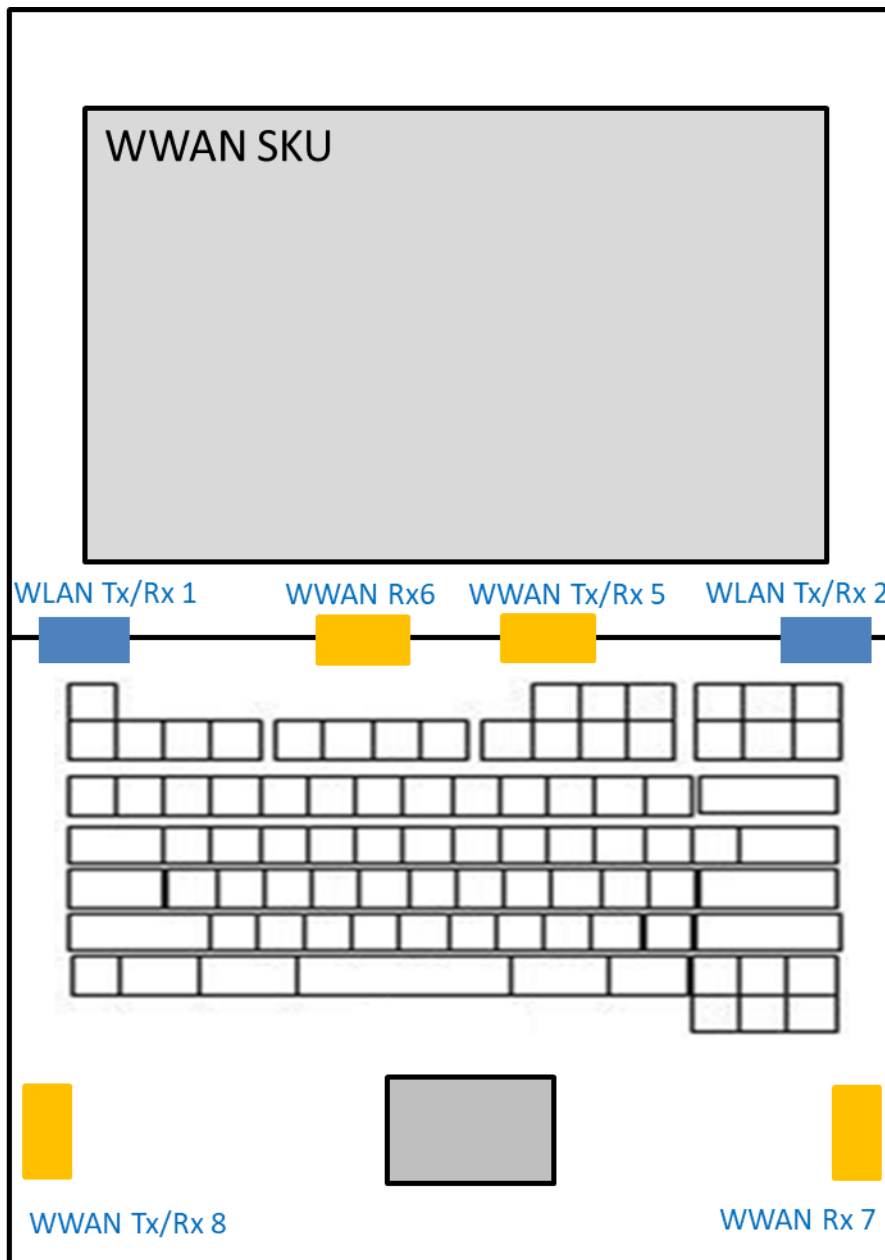

Section 5. Antenna Host Platform Location Information

Include a **dimensioned photo(s) or dimensioned drawing(s)** of Ant5, Ant6, Ant7, Ant8 placements (measurements are not required for receive-only antenna).

Any antenna that transmits must show dimensions to bottom of laptop. Provide a description of the materials that are used for supporting or surrounding transmit antennas; for example, non-conductive plastics vs. conductive coated plastic or metallic materials.

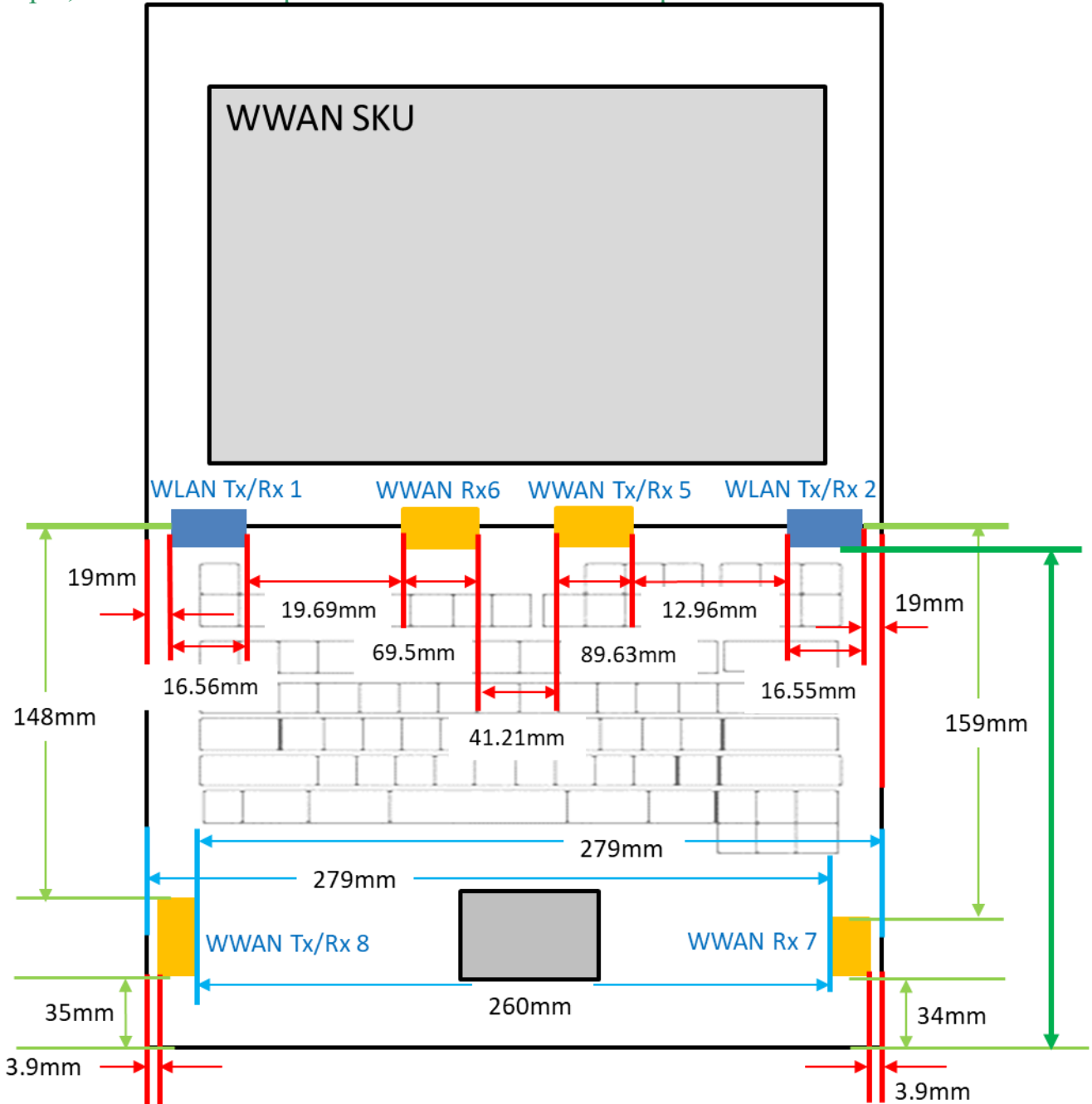

Section 6. Antenna dimensional information for SAR evaluation

Include a **dimensioned photo(s) or dimensioned drawing(s)** showing the distance (mm) between the transmit antennas and the user (excluding hands, wrist, feet, and ankle). For notebook/laptop hosts show lapheld position (example below). For tablet hosts show all orientations including lapheld, primary & secondary portrait, primary & secondary landscape positions. Include a description of any proximity sensors or power throttling implementations that limit or exclude use of any host orientation.

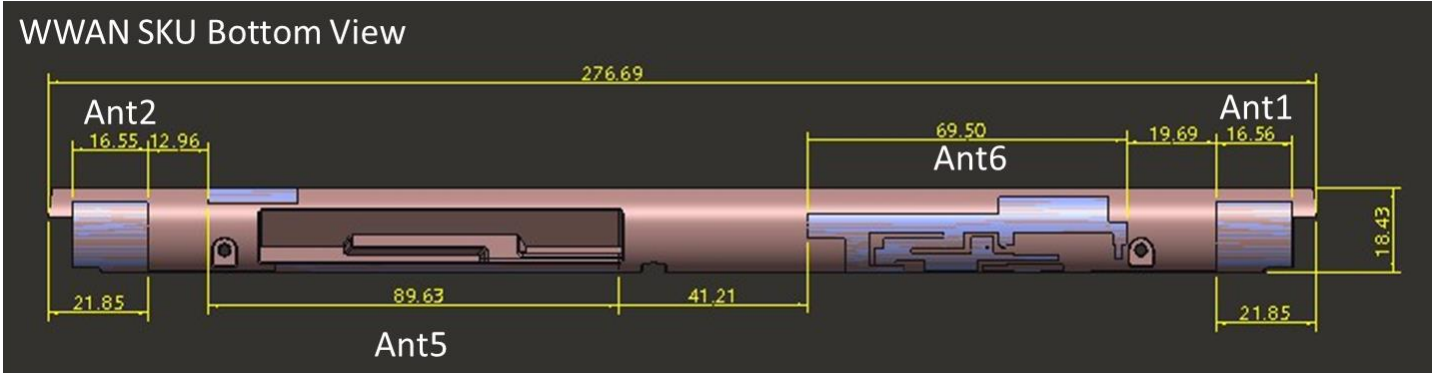

WWAN ANT 5 NB_Mode

WLAN ANT 1/2 NB_Mode

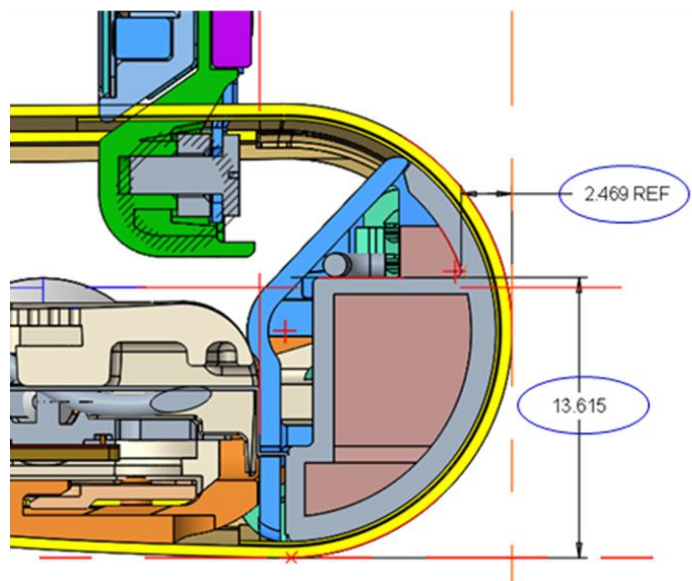
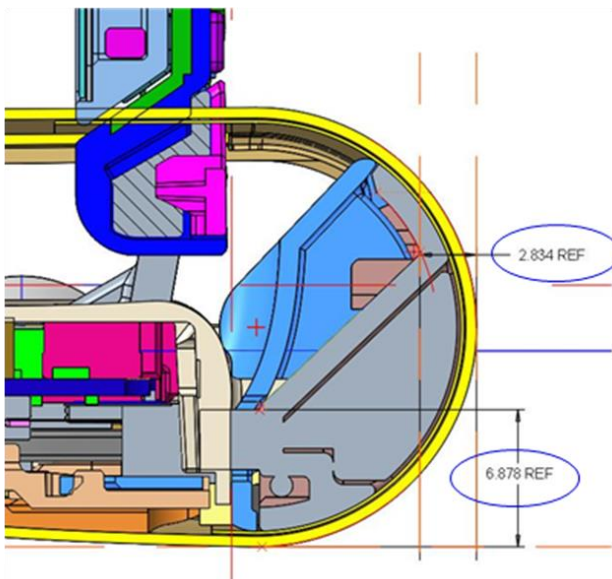

WWAN ANT 8 NB_Mode

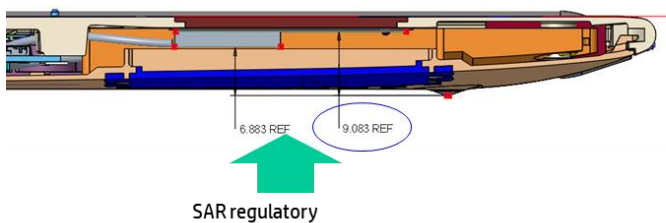

WWAN ANT 5 TB_Mode

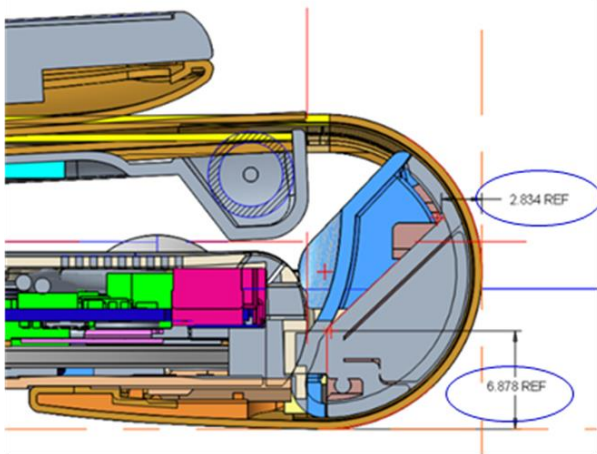

WLAN ANT 1/2 TB_Mode

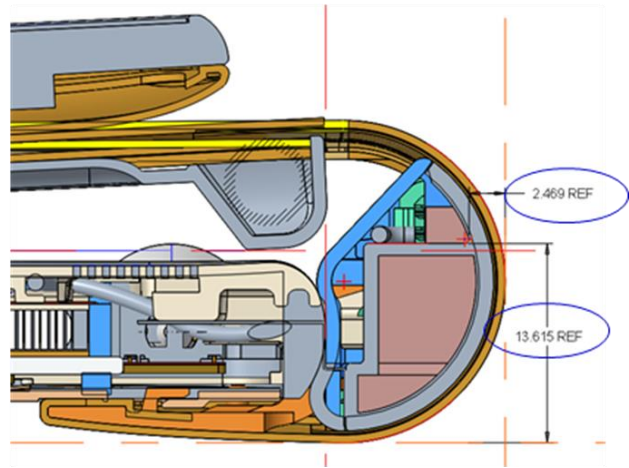

WWAN ANT 8 TB_Mode

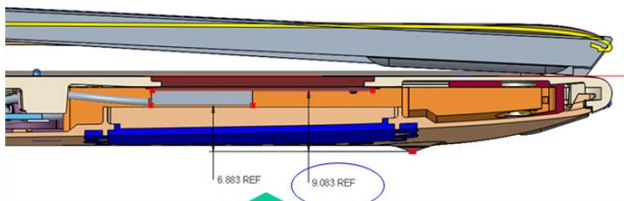

SAR regulatory

WWAN SKU NB Mode

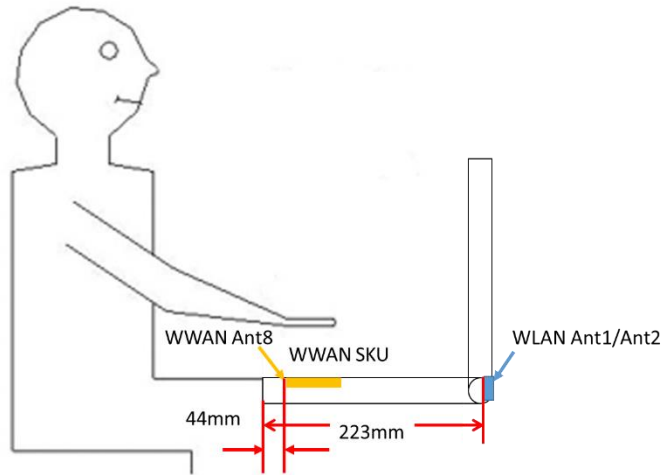
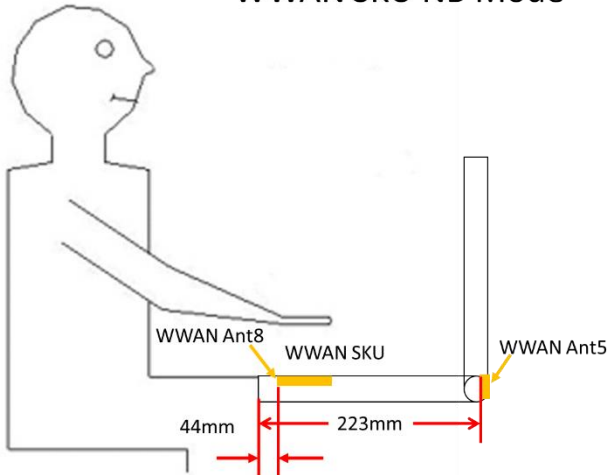

WWAN SKU TB Mode

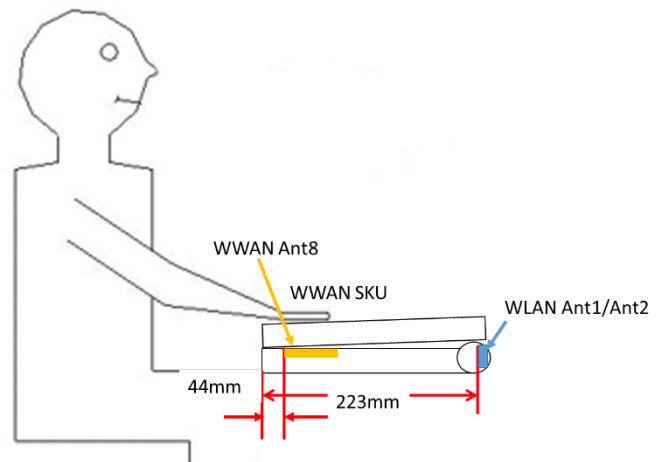
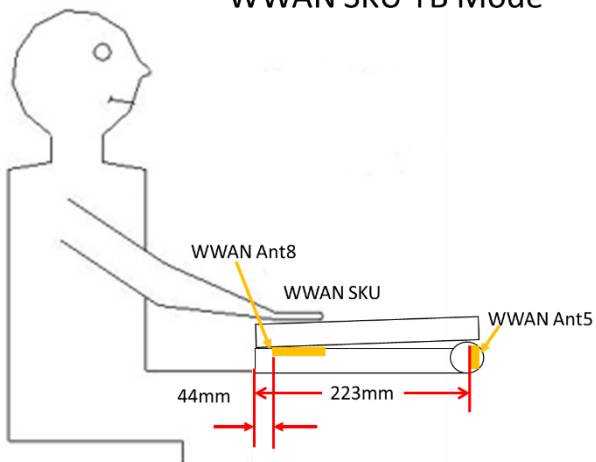

Section 7. Diagram Example of Co-Location Antenna Separation

Include a **dimensioned photo or dimensioned drawing** showing the distance (mm) between **all WLAN transmit antennas** and other co-located radiator transmit antenna such as Bluetooth, WWAN,..

(Note: Due to the evolving rules regarding co-location, each platform will need to be reviewed on a case by case basis)

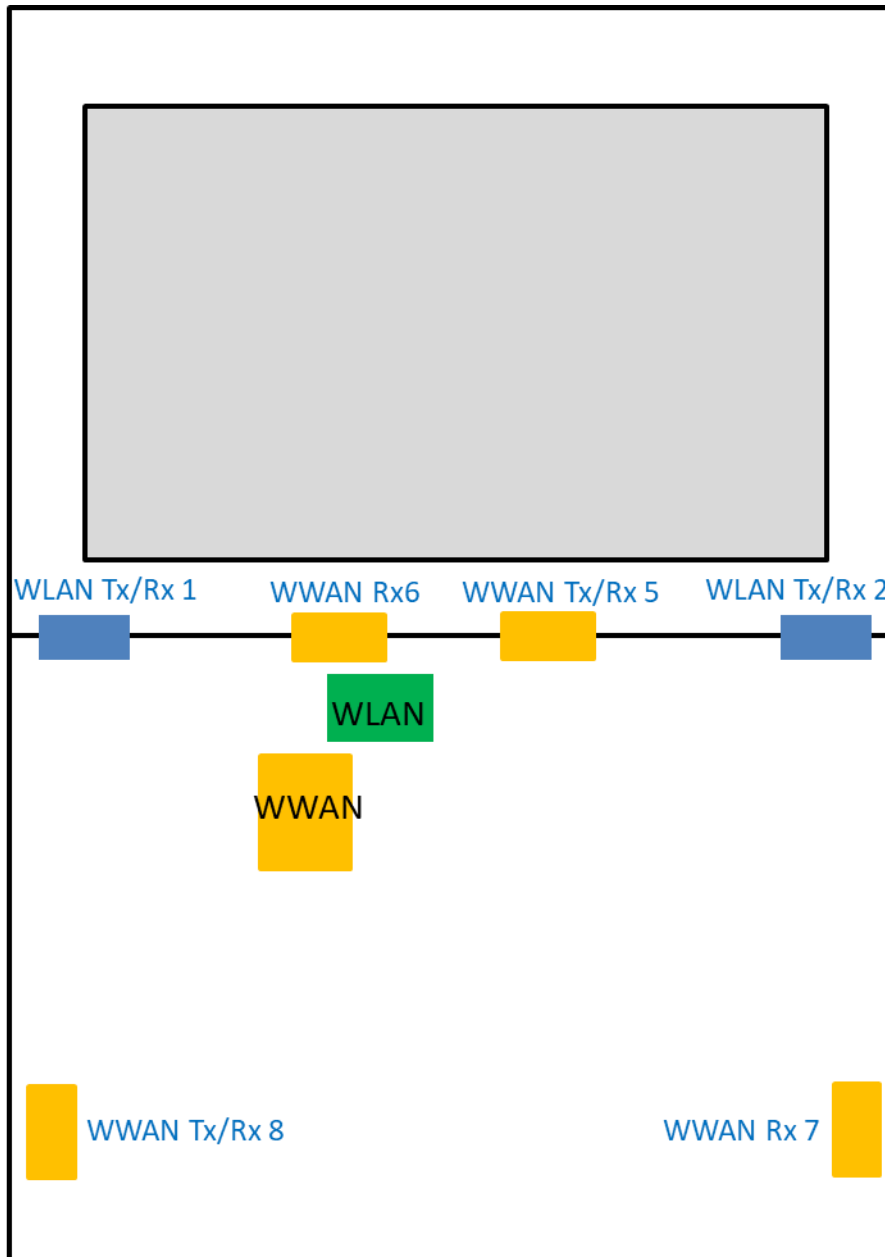

Section 8. Local representative contact information

Local representative contact information is required for regulatory support for target countries below.

	Local company name	Contact name	Phone number	FAX Number	e-Mail Address	Notes
Argentina						
Azerbaijan						
Cambodia						
Indonesia						
Israel						
Malaysia						
Philippines						
Singapore						Telecommunication Equipment Dealer License Required
South Africa						
USA, Canada						
Vietnam						