



FCC RF Test Report

APPLICANT : Fibocom Wireless Inc.
EQUIPMENT : LTE Module
BRAND NAME : Fibocom
MODEL NAME : L860-GL-16
FCC ID : ZMOL860GL16
STANDARD : 47 CFR Part 2, 22(H), 24(E), 27(L)
CLASSIFICATION : PCS Licensed Transmitter (PCB)

The product was received on Oct. 30, 2020 and completely tested on Jan. 30, 2021. We, Sporton International (Kunshan) Inc., would like to declare that the tested sample has been evaluated in accordance with the procedures given in ANSI C63.26-2015 and shown compliance with the applicable technical standards.

The test results in this report apply exclusively to the tested model / sample. Without written approval of Sporton International (Kunshan) Inc., the test report shall not be reproduced except in full.

Reviewed by: Jason Jia / Supervisor

Approved by: James Huang / Manager



Sporton International (Kunshan) Inc.

**No. 1098, Pengxi North Road, Kunshan Economic Development Zone Jiangsu Province 215300
People's Republic of China**



TABLE OF CONTENTS

REVISION HISTORY 3
SUMMARY OF TEST RESULT 4
1 GENERAL DESCRIPTION 5
1.1 Applicant 5
1.2 Manufacturer 5
1.3 Product Feature of Equipment Under Test 5
1.4 Product Specification of Equipment Under Test 6
1.5 Modification of EUT 6
1.6 Maximum Conducted Power, Frequency Tolerance, and Emission Designator 7
1.7 Testing Location 9
1.8 Test Software 9
1.9 Applicable Standards 9
2 TEST CONFIGURATION OF EQUIPMENT UNDER TEST 10
2.1 Test Mode 10
2.2 Connection Diagram of Test System 13
2.3 Support Unit used in test configuration and system 13
2.4 Measurement Results Explanation Example 13
2.5 Frequency List of Low/Middle/High Channels 14
3 CONDUCTED TEST ITEMS 20
3.1 Measuring Instruments 20
3.2 Test Setup 20
3.3 Test Result of Conducted Test 20
3.4 Conducted Output Power and ERP/EIRP 21
3.5 Peak-to-Average Ratio 22
3.6 Occupied Bandwidth 23
3.7 Conducted Band Edge 24
3.8 Conducted Spurious Emission 25
3.9 Frequency Stability 26
4 RADIATED TEST ITEMS 27
4.1 Measuring Instruments 27
4.2 Test Setup 27
4.3 Test Result of Radiated Test 27
4.4 Radiated Spurious Emission 28
5 LIST OF MEASURING EQUIPMENT 29
6 UNCERTAINTY OF EVALUATION 30
APPENDIX A. TEST RESULTS OF CONDUCTED TEST
APPENDIX B. TEST RESULTS OF RADIATED TEST
APPENDIX C. TEST SETUP PHOTOGRAPHS



REVISION HISTORY

REPORT NO.	VERSION	DESCRIPTION	ISSUED DATE
FG003022B	Rev. 01	Initial issue of report	Feb. 07, 2021



SUMMARY OF TEST RESULT

Report Section	FCC Rule	Description	Limit	Result	Remark
3.4	§2.1046	Conducted Output Power	Reporting Only	PASS	-
	§22.913(a)(5)	Effective Radiated Power (Band 5) (Band 26)	ERP < 7 Watt	PASS	-
	§24.232(c)	Equivalent Isotropic Radiated Power (Band 2) (Band 25)	EIRP < 2Watt	PASS	-
	§27.50(d)(4)	Equivalent Isotropic Radiated Power (Band 4) (Band 66)	EIRP < 1Watt	PASS	-
3.5	§24.232(d)	Peak-to-Average Ratio	<13 dB	PASS	-
3.6	§2.1049	Occupied Bandwidth	Reporting Only	PASS	-
3.7	§2.1051 §22.917(a) §24.238(a) §27.53(h)	Conducted Band Edge Measurement (Band 2) (Band 4) (Band 5) (Band 25) (Band 26) (Band 66)	< 43+10log ₁₀ (P[Watts])	PASS	-
3.8	§2.1051 §22.917(a) §24.238(a) §27.53(h)	Conducted Spurious Emission (Band 2) (Band 4) (Band 5) (Band 25) (Band 26) (Band 66)	< 43+10log ₁₀ (P[Watts])	PASS	-
3.9	§2.1055 §22.355	Frequency Stability Temperature & Voltage	< 2.5 ppm for Part 22	PASS	-
	§2.1055 §24.235 §27.54		Within Authorized Band		
4.4	§2.1053 §22.917(a) §24.238(a) §27.53(h)	Radiated Spurious Emission (Band 2) (Band 4) (Band 5) (Band 25) (Band 26) (Band 66)	< 43+10log ₁₀ (P[Watts])	PASS	Under limit 29.21 dB at 9480.000 MHz

Declaration of Conformity:

The test results with all measurement uncertainty excluded are presented in accordance with the regulation limits or requirements declared by manufacturers.

Comments and Explanations:

The declared of product specification for EUT presented in the report are provided by the manufacturer, and the manufacturer takes all the responsibilities for the accuracy of product specification.



1 General Description

1.1 Applicant

Fibocom Wireless Inc.

1101, Tower A, Building 6, Shenzhen International Innovation Valley, Dashi 1st Rd, Nanshan, Shenzhen, China

1.2 Manufacturer

Fibocom Wireless Inc.

1101, Tower A, Building 6, Shenzhen International Innovation Valley, Dashi 1st Rd, Nanshan, Shenzhen, China

1.3 Product Feature of Equipment Under Test

Product Feature	
Equipment	LTE Module
Brand Name	Fibocom
Model Name	L860-GL-16
FCC ID	ZMOL860GL16
EUT supports Radios application	WCDMA/LTE/GNSS
HW Version	V1.3
SW Version	18601.5001.00.01.01.01
EUT Stage	Identical Prototype

1.4 Product Specification of Equipment Under Test

Standards-related Product Specification	
Tx Frequency	LTE Band 2 : 1850 MHz ~ 1910 MHz LTE Band 4 : 1710 MHz ~ 1755 MHz LTE Band 5 : 824 MHz ~ 849 MHz LTE Band 25 : 1850 MHz ~ 1915 MHz LTE Band 26 : 824 MHz ~ 849 MHz LTE Band 66 : 1710 MHz ~ 1780 MHz
Rx Frequency	LTE Band 2 : 1930 MHz ~ 1990 MHz LTE Band 4 : 2110 MHz ~ 2155 MHz LTE Band 5 : 869 MHz ~ 894 MHz LTE Band 25 : 1930 MHz ~ 1995 MHz LTE Band 26 : 869 MHz ~ 894 MHz LTE Band 66 : 2110 MHz~ 2200 MHz
Bandwidth	LTE Band 2 : 1.4MHz / 3MHz / 5MHz / 10MHz / 15MHz / 20MHz LTE Band 4 : 1.4MHz / 3MHz / 5MHz / 10MHz / 15MHz / 20MHz LTE Band 5 : 1.4MHz / 3MHz / 5MHz / 10MHz LTE Band 25 : 1.4MHz / 3MHz / 5MHz / 10MHz / 15MHz / 20MHz LTE Band 26 : 1.4MHz / 3MHz / 5MHz / 10MHz / 15MHz LTE Band 66 : 1.4MHz / 3MHz / 5MHz / 10MHz / 15MHz / 20MHz
Maximum Output Power to Antenna	LTE Band 2 : 23.31 dBm LTE Band 4 : 22.98 dBm LTE Band 5 : 22.92 dBm LTE Band 25 : 23.32 dBm LTE Band 26 : 22.93 dBm LTE Band 66 : 22.99 dBm LTE Band 5B : 23.06 dBm LTE Band 66C : 22.65 dBm LTE Band 66B : 22.98 dBm
Antenna Gain	LTE Band 2 : 4.00 dBi LTE Band 4 : 3.00 dBi LTE Band 5 : 3.00 dBi LTE Band 25 : 4.00 dBi LTE Band 26 : 3.00 dBi LTE Band 66 : 3.00 dBi
Type of Modulation	QPSK / 16QAM / 64QAM

1.5 Modification of EUT

No modifications are made to the EUT during all test items.



1.6 Maximum Conducted Power, Frequency Tolerance, and Emission Designator

LTE Band 2		QPSK			16QAM		
BW (MHz)	Frequency Range (MHz)	Emission Designator (99%OBW)	Frequency Tolerance (ppm)	Maximum Conducted power (W)	Emission Designator (99%OBW)	Frequency Tolerance (ppm)	Maximum Conducted power (W)
20	1860.0 ~ 1900.0	18M5G7D	0.0026	0.2148	18M4W7D	-	0.1832
LTE Band 25		QPSK			16QAM		
BW (MHz)	Frequency Range (MHz)	Emission Designator (99%OBW)	Frequency Tolerance (ppm)	Maximum Conducted power (W)	Emission Designator (99%OBW)	Frequency Tolerance (ppm)	Maximum Conducted power (W)
20	1860.0 ~ 1905.0	18M5G7D	0.0026	0.2148	18M4W7D	-	0.1832
LTE Band 4		QPSK			16QAM		
BW (MHz)	Frequency Range (MHz)	Emission Designator (99%OBW)	Frequency Tolerance (ppm)	Maximum Conducted power (W)	Emission Designator (99%OBW)	Frequency Tolerance (ppm)	Maximum Conducted power (W)
20	1720.0 ~ 1745.0	18M7G7D	0.0022	0.1991	18M7W7D	-	0.1706
LTE Band 5		QPSK			16QAM		
BW (MHz)	Frequency Range (MHz)	Emission Designator (99%OBW)	Frequency Tolerance (ppm)	Maximum Conducted power (W)	Emission Designator (99%OBW)	Frequency Tolerance (ppm)	Maximum Conducted power (W)
10	829.0 ~ 844.0	9M09G7D	0.0093	0.1959	9M09W7D	-	0.1545
LTE Band 26		QPSK			16QAM		
BW (MHz)	Frequency Range (MHz)	Emission Designator (99%OBW)	Frequency Tolerance (ppm)	Maximum Conducted power (W)	Emission Designator (99%OBW)	Frequency Tolerance (ppm)	Maximum Conducted power (W)
10	831.5 ~ 841.5	13M5G7D	0.0093	0.1963	13M6W7D	-	0.1486
CH2676 5	821.5	13M4G7D	-	0.1959	13M4W7D	-	0.1570
LTE Band 66		QPSK			16QAM		
BW (MHz)	Frequency Range (MHz)	Emission Designator (99%OBW)	Frequency Tolerance (ppm)	Maximum Conducted power (W)	Emission Designator (99%OBW)	Frequency Tolerance (ppm)	Maximum Conducted power (W)
20	1720.0 ~ 1770.0	18M7G7D	0.0022	0.1991	18M7W7D	-	0.1706



LTE Band 66C_CA	QPSK			16QAM		
BW (MHz)	Emission Designator (99%OBW)	Frequency Tolerance (ppm)	Maximum Conducted power (W)	Emission Designator (99%OBW)	Frequency Tolerance (ppm)	Maximum Conducted power (W)
20MHz+20MHz	37M9G7D	-	0.1841	37M2W7D	-	0.1545
LTE Band 66B_CA	QPSK			16QAM		
BW (MHz)	Emission Designator (99%OBW)	Frequency Tolerance (ppm)	Maximum Conducted power (W)	Emission Designator (99%OBW)	Frequency Tolerance (ppm)	Maximum Conducted power (W)
15MHz+5MHz	18M6G7D	-	0.1986	18M7W7D	-	0.1892
LTE Band 5B_CA	QPSK			16QAM		
BW (MHz)	Emission Designator (99%OBW)	Frequency Tolerance (ppm)	Maximum Conducted power (W)	Emission Designator (99%OBW)	Frequency Tolerance (ppm)	Maximum Conducted power (W)
10MHz+10MHz	18M7G7D	-	0.2023	18M7W7D	-	0.1832

Note:

1. LTE Band 26 overlaps the entire frequency range of LTE Band 5. Therefore, the test results provided in this report covers Band 5 and the portion of Band 26 subject to Part 22.
2. LTE Band 66 overlaps the entire frequency range of LTE Band 4. Therefore, the test results provided in this report covers Band 66 as well as Band 4.
3. LTE Band 25 overlaps the entire frequency range of LTE Band 2. Therefore, the test results provided in this report covers Band 25 as well as Band 2.
4. Based on engineering evaluation, only the maximum bandwidth and the worst modulation test results are shown in the report.



1.7 Testing Location

Sporton International (Kunshan) Inc. is accredited to ISO/IEC 17025:2017 by American Association for Laboratory Accreditation with Certificate Number 5145.02.

Test Firm	Sporton International (Kunshan) Inc.		
Test Site Location	No. 1098, Pengxi North Road, Kunshan Economic Development Zone Jiangsu Province 215300 People's Republic of China TEL : +86-512-57900158 FAX : +86-512-57900958		
Test Site No.	Sporton Site No.	FCC Designation No.	FCC Test Firm Registration No.
	03CH06-KS TH01-KS	CN1257	314309

1.8 Test Software

Item	Site	Manufacturer	Name	Version
1.	03CH06-KS	AUDIX	E3	6.2009-8-24al

1.9 Applicable Standards

According to the specifications of the manufacturer, the EUT must comply with the requirements of the following standards:

- ♦ 47 CFR Part 2, 22(H), 24(E), 27(L)
- ♦ ANSI C63.26-2015
- ♦ FCC KDB 971168 D01 Power Meas License Digital Systems v03r01
- ♦ FCC KDB 412172 D01 Determining ERP and EIRP v01r01

Remark:

1. All test items were verified and recorded according to the standards and without any deviation during the test.
2. This EUT has also been tested and complied with the requirements of FCC Part 15, Subpart B, recorded in a separate test report.



2 Test Configuration of Equipment Under Test

2.1 Test Mode

Antenna port conducted and radiated test items listed below are performed according to KDB 971168 D01 Power Meas License Digital Systems v03r01 with maximum output power.

Radiated measurements are performed by rotating the EUT in three different orthogonal test planes to find the maximum emission.

Test Items	Band	Bandwidth (MHz)						Modulation			RB #			Test Channel		
		1.4	3	5	10	15	20	QPSK	16QAM	64QAM	1	Half	Full	L	M	H
Max. Output Power	2	v	v	v	v	v	v	v	v	v	v	v	v	v	v	v
	4	v	v	v	v	v	v	v	v	v	v	v	v	v	v	v
	5	v	v	v	v	-	-	v	v	v	v	v	v	v	v	v
	25	v	v	v	v	v	v	v	v	v	v	v	v	v	v	v
	26	v	v	v	v	v	-	v	v	v	v	v	v	v	v	v
	66	v	v	v	v	v	v	v	v	v	v	v	v	v	v	v
Peak-to-Average Ratio	25						v	v	v		v		v	v	v	v
	26				v		-	v	v		v		v	v	v	v
	66						v	v	v		v		v	v	v	v
26dB and 99% Bandwidth	25	v	v	v	v	v	v	v	v				v	v	v	v
	26	v	v	v	v	v	-	v	v				v	v	v	v
	66	v	v	v	v	v	v	v	v				v	v	v	v
Conducted Band Edge	25	v	v	v	v	v	v	v	v		v		v	v		v
	26	v	v	v	v	v	-	v	v		v		v	v		v
	66	v	v	v	v	v	v	v	v		v		v	v		v
Conducted Spurious Emission	25	v	v	v	v	v	v	v	v		v			v	v	v
	26	v	v	v	v	v	-	v	v		v			v	v	v
	66	v	v	v	v	v	v	v	v		v			v	v	v
Frequency Stability	25						v	v					v		v	
	26				v		-	v					v		v	
	66						v	v					v		v	
E.R.P / E.I.R.P	25	v	v	v	v	v	v	v	v		v			v	v	v
	26	v	v	v	v	v	-	v	v		v			v	v	v
	66	v	v	v	v	v	v	v	v		v			v	v	v
Radiated Spurious Emission	25	Worst Case											v	v	v	
	26	Worst Case											v	v	v	



	66	Worst Case											v	v	v
Note	<ol style="list-style-type: none"> The mark "v" means that this configuration is chosen for testing The mark "-" means that this bandwidth is not supported. The device is investigated from 30MHz to 10 times of fundamental signal for radiated spurious emission test under different RB size/offset and modulations in exploratory test. Subsequently, only the worst case emissions are reported. LTE Band 26 overlaps the entire frequency range of LTE Band 5. Therefore, the test results provided in this report covers Band 5 and the portion of Band 26 subject to Part 22. LTE Band 66 overlaps the entire frequency range of LTE Band 4. Therefore, the test results provided in this report covers Band 66 as well as Band 4. LTE Band 25 overlaps the entire frequency range of LTE Band 2. Therefore, the test results provided in this report covers Band 25 as well as Band 2. 														

Test Items	Band	Bandwidth (MHz)					Modulation			RB #			Test Channel		
		3+5	5+3	5+10	10+5	10+10	QPSK	16QAM	64QAM	1	Half	Full	L	M	H
Max. Output Power	5B_CA	v	v	v	v	v	v	v	v	v	v	v	v	v	v
26dB and 99% Bandwidth	5B_CA	v	v	v	v	v	v	v				v			v
Conducted Band Edge	5B_CA	v	v	v	v	v	v	v		v		v	v		v
Conducted Spurious Emission	5B_CA	v	v	v	v	v	v	v		v			v	v	v
E.I.R.P.	5B_CA	v	v	v	v	v	v	v		v			v	v	v
Radiated Spurious Emission	5B_CA	Worst Case											v	v	v
Note	<ol style="list-style-type: none"> The mark "v" means that this configuration is chosen for testing The mark "-" means that this bandwidth is not supported. The device is investigated from 30MHz to 10 times of fundamental signal for radiated spurious emission test under different RB size/offset and modulations in exploratory test. Subsequently, only the worst case emissions are reported. 														

Test Items	Band	Bandwidth (MHz)										Modulation			RB #			Test Channel		
		20+20	20+15	15+20	20+10	10+20	20+5	5+20	15+15	15+10	10+15	QPSK	16QAM	64QAM	1	Half	Full	L	M	H
Max. Output Power	66C_CA	v	v	v	v	v	v	v	v	v	v	v	v	v	v	v	v	v	v	v
26dB and 99% Bandwidth	66C_CA	v	v	v	v	v	v	v	v	v	v	v	v				v			v
Conducted Band Edge	66C_CA	v	v	v	v	v	v	v	v	v	v	v	v		v		v	v		v
Conducted Spurious Emission	66C_CA	v	v	v	v	v	v	v	v	v	v	v	v		v			v	v	v
E.I.R.P.	66C_CA	v	v	v	v	v	v	v	v	v	v	v	v		v			v	v	v



Radiated Spurious Emission	66C_CA	Worst Case										v	v	v
Note	4. The mark "v" means that this configuration is chosen for testing 5. The mark "-" means that this bandwidth is not supported. 6. The device is investigated from 30MHz to 10 times of fundamental signal for radiated spurious emission test under different RB size/offset and modulations in exploratory test. Subsequently, only the worst case emissions are reported.													

Test Items	Band	Bandwidth (MHz)						Modulation			RB #			Test Channel		
		5+5	5+10	5+15	10+10	10+5	15+5	QPSK	16QAM	64QAM	1	Half	Full	L	M	H
Max. Output Power	66B_CA	v	v	v	v	v	v	v	v	v	v	v	v	v	v	v
26dB and 99% Bandwidth	66B_CA	v	v	v	v	v	v	v	v				v	v	v	v
Conducted Band Edge	66B_CA	v	v	v	v	v	v	v	v		v		v	v		v
Conducted Spurious Emission	66B_CA	v	v	v	v	v	v	v	v		v			v	v	v
E.I.R.P.	66B_CA	v	v	v	v	v	v	v	v		v			v	v	v
Radiated Spurious Emission	66B_CA	Worst Case										v	v	v		
Note	1. The mark "v" means that this configuration is chosen for testing 2. The mark "-" means that this bandwidth is not supported. 3. The device is investigated from 30MHz to 10 times of fundamental signal for radiated spurious emission test under different RB size/offset and modulations in exploratory test. Subsequently, only the worst case emissions are reported.															

2.2 Connection Diagram of Test System

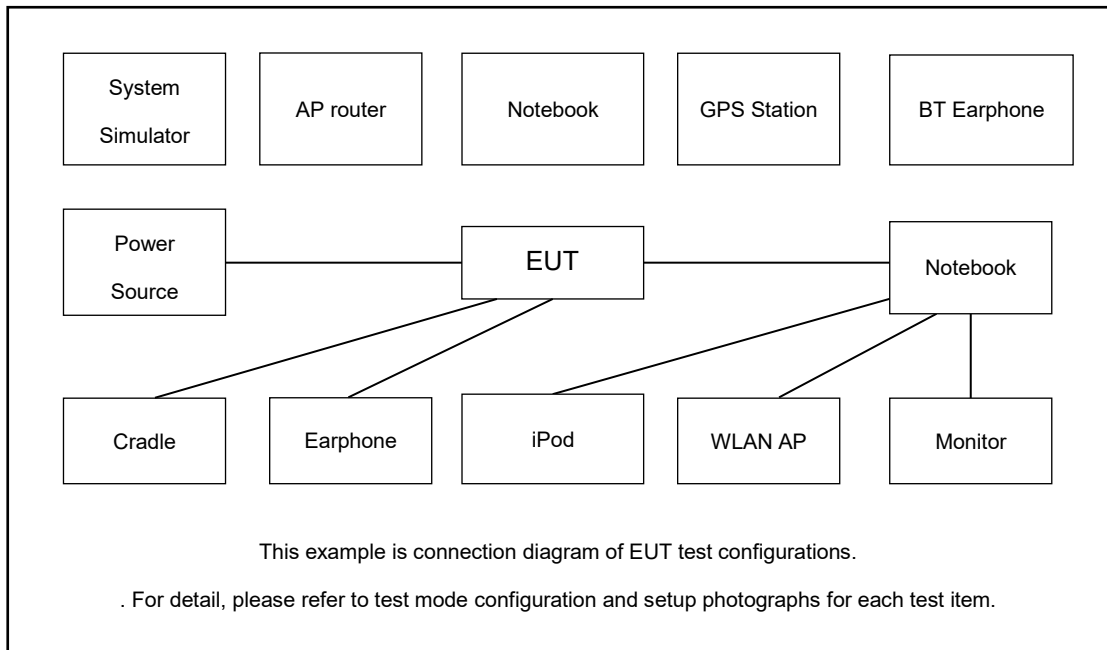

2.3 Support Unit used in test configuration and system

Item	Equipment	Trade Name	Model No.	FCC ID	Data Cable	Power Cord
1.	LTE Base Station	Anritsu	MT8820C	N/A	N/A	Unshielded, 1.8 m
2.	Test jig	N/A	N/A	N/A	N/A	N/A

2.4 Measurement Results Explanation Example

For all conducted test items:

The offset level is set in the spectrum analyzer to compensate the RF cable loss between EUT conducted output port and spectrum analyzer. With the offset compensation, the spectrum analyzer reading level is exactly the EUT RF output level.

The spectrum analyzer offset is derived from RF cable loss.

Offset = RF cable loss.

Following shows an offset computation example with cable loss 5.0 dB.

Example :

$$\begin{aligned} \text{Offset(dB)} &= \text{RF cable loss(dB)}. \\ &= 5.0 \text{ (dB)} \end{aligned}$$



2.5 Frequency List of Low/Middle/High Channels

LTE Band 2 Channel and Frequency List				
BW [MHz]	Channel/Frequency(MHz)	Lowest	Middle	Highest
20	Channel	18700	18900	19100
	Frequency	1860	1880	1900
15	Channel	18675	18900	19125
	Frequency	1857.5	1880	1902.5
10	Channel	18650	18900	19150
	Frequency	1855	1880	1905
5	Channel	18625	18900	19175
	Frequency	1852.5	1880	1907.5
3	Channel	18615	18900	19185
	Frequency	1851.5	1880	1908.5
1.4	Channel	18607	18900	19193
	Frequency	1850.7	1880	1909.3

LTE Band 4 Channel and Frequency List				
BW [MHz]	Channel/Frequency(MHz)	Lowest	Middle	Highest
20	Channel	20050	20175	20300
	Frequency	1720	1732.5	1745
15	Channel	20025	20175	20325
	Frequency	1717.5	1732.5	1747.5
10	Channel	20000	20175	20350
	Frequency	1715	1732.5	1750
5	Channel	19975	20175	20375
	Frequency	1712.5	1732.5	1752.5
3	Channel	19965	20175	20385
	Frequency	1711.5	1732.5	1753.5
1.4	Channel	19957	20175	20393
	Frequency	1710.7	1732.5	1754.3



LTE Band 5 Channel and Frequency List				
BW [MHz]	Channel/Frequency(MHz)	Lowest	Middle	Highest
10	Channel	20450	20525	20600
	Frequency	829	836.5	844
5	Channel	20425	20525	20625
	Frequency	826.5	836.5	846.5
3	Channel	20415	20525	20635
	Frequency	825.5	836.5	847.5
1.4	Channel	20407	20525	20643
	Frequency	824.7	836.5	848.3

LTE Band 25 Channel and Frequency List				
BW [MHz]	Channel/Frequency(MHz)	Lowest	Middle	Highest
20	Channel	26140	26340	26590
	Frequency	1860	1880	1905
15	Channel	26115	26340	26615
	Frequency	1857.5	1880	1907.5
10	Channel	26090	26340	26640
	Frequency	1855	1880	1910
5	Channel	26065	26340	26665
	Frequency	1852.5	1880	1912.5
3	Channel	26055	26340	26675
	Frequency	1851.5	1880	1913.5
1.4	Channel	26047	26340	26683
	Frequency	1850.7	1880	1914.3



LTE Band 26 Channel and Frequency List				
BW [MHz]	Channel/Frequency(MHz)	Lowest	Middle	Highest
15	Channel	26865	26915	26965
	Frequency	831.5	836.5	841.5
10	Channel	26840	26915	26990
	Frequency	829	836.5	844
5	Channel	26815	26915	27015
	Frequency	826.5	836.5	846.5
3	Channel	26805	26915	27025
	Frequency	825.5	836.5	847.5
1.4	Channel	26797	26915	27033
	Frequency	824.7	836.5	848.3

LTE Band 66 Channel and Frequency List				
BW [MHz]	Channel/Frequency(MHz)	Lowest	Middle	Highest
20	Channel	132072	132322	132572
	Frequency	1720	1745	1770
15	Channel	132047	132322	132597
	Frequency	1717.5	1745	1772.5
10	Channel	132022	132322	132622
	Frequency	1715	1745	1775
5	Channel	131997	132322	132647
	Frequency	1712.5	1745	1777.5
3	Channel	131987	132322	132657
	Frequency	1711.5	1745	1778.5
1.4	Channel	131979	132322	132665
	Frequency	1710.7	1745	1779.3



LTE Band 5B_CA Channel and Frequency List					
BW [MHz]	Channel/Frequency(MHz)		Lowest	Middle	Highest
3 + 5	PCC	Channel	20416	20501	20586
		Frequency	825.6	834.1	842.6
	SCC	Channel	20455	20540	20625
		Frequency	829.5	838.0	846.5
5 + 3	PCC	Channel	20425	20510	20595
		Frequency	826.5	835.0	843.5
	SCC	Channel	20464	20549	20634
		Frequency	830.4	838.9	847.4
5 + 10	PCC	Channel	20428	20478	20528
		Frequency	826.8	831.8	836.8
	SCC	Channel	20500	20550	20600
		Frequency	834	839	844
10 + 5	PCC	Channel	20450	20500	20550
		Frequency	829	834	839
	SCC	Channel	20522	20572	20622
		Frequency	836.2	841.2	846.2
10 + 10	PCC	Channel	20450	20476	20501
		Frequency	829	831.6	834.1
	SCC	Channel	20549	20575	20600
		Frequency	838.9	841.5	844



LTE Band 66C_CA Channel and Frequency List					
BW [MHz]	Channel/Frequency(MHz)		Lowest	Middle	Highest
10 + 15	PCC	Channel	132025	132351	132477
		Frequency	1715.3	1747.9	1760.5
	SCC	Channel	132145	132471	132597
		Frequency	1727.3	1759.9	1772.5
15 + 10	PCC	Channel	132047	132373	132499
		Frequency	1717.5	1750.1	1762.7
	SCC	Channel	132167	132493	132619
		Frequency	1729.5	1762.1	1774.7
10 + 20	PCC	Channel	132027	132328	132428
		Frequency	1715.5	1745.6	1755.6
	SCC	Channel	132171	132472	132572
		Frequency	1729.9	1760	1770
20 + 10	PCC	Channel	132072	132373	132473
		Frequency	1720	1750.1	1760.1
	SCC	Channel	132216	132517	132617
		Frequency	1734.4	1764.5	1774.5
15 + 15	PCC	Channel	132047	132347	132447
		Frequency	1717.5	1747.5	1757.5
	SCC	Channel	132197	132497	132597
		Frequency	1732.5	1762.5	1772.5
15 + 20	PCC	Channel	132050	132325	132401
		Frequency	1717.8	1745.3	1752.9
	SCC	Channel	132221	132496	132572
		Frequency	1734.9	1762.4	1770
20 + 15	PCC	Channel	132072	132348	132423
		Frequency	1720	1747.6	1755.1
	SCC	Channel	132243	132519	132594
		Frequency	1737.1	1764.7	1772.2
20 + 5	PCC	Channel	132072	132397	132522
		Frequency	1720	1752.5	1765
	SCC	Channel	132189	132514	132639
		Frequency	1731.7	1764.2	1776.7
5 + 20	PCC	Channel	132005	132330	132455



	SCC	Frequency	1713.3	1745.8	1758.3
		Channel	132122	132447	132572
20 + 20	PCC	Frequency	1725	1757.5	1770
		Channel	132072	132323	132374
	SCC	Frequency	1720	1745.1	1750.2
		Channel	132270	132521	132572
	SCC	Frequency	1739.8	1764.9	1770
		Channel			

LTE Band 66B_CA Channel and Frequency List					
BW [MHz]	Channel/Frequency(MHz)		Lowest	Middle	Highest
5 + 5	PCC	Channel	131997	132398	132599
		Frequency	1712.5	1752.6	1772.7
	SCC	Channel	132045	132446	132647
		Frequency	1717.3	1757.4	1777.5
5 + 10	PCC	Channel	132000	132375	132550
		Frequency	1712.8	1750.3	1767.8
	SCC	Channel	132072	132447	132622
		Frequency	1720	1757.5	1775
10 + 5	PCC	Channel	132022	132397	132572
		Frequency	1715	1752.5	1770
	SCC	Channel	132094	132469	132644
		Frequency	1722.2	1759.7	1777.2
5 + 15	PCC	Channel	132002	132353	132504
		Frequency	1713	1748.1	1763.2
	SCC	Channel	132095	132446	132597
		Frequency	1722.3	1757.4	1772.5
15 + 5	PCC	Channel	132047	132398	132549
		Frequency	1717.5	1752.6	1767.7
	SCC	Channel	132140	132491	132642
		Frequency	1726.8	1761.9	1777
10 + 10	PCC	Channel	132022	132373	132523
		Frequency	1715	1750.1	1765.1
	SCC	Channel	132121	132472	132622
		Frequency	1724.9	1760	1775

3 Conducted Test Items

3.1 Measuring Instruments

See list of measuring instruments of this test report.

3.2 Test Setup

3.2.1 Conducted Output Power

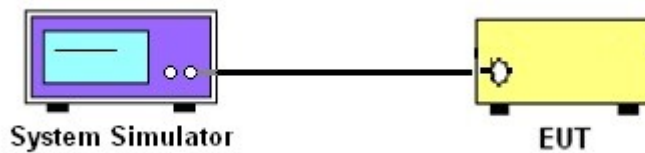

3.2.2 Peak-to-Average Ratio, Occupied Bandwidth ,Conducted Band-Edge and Conducted Spurious Emission

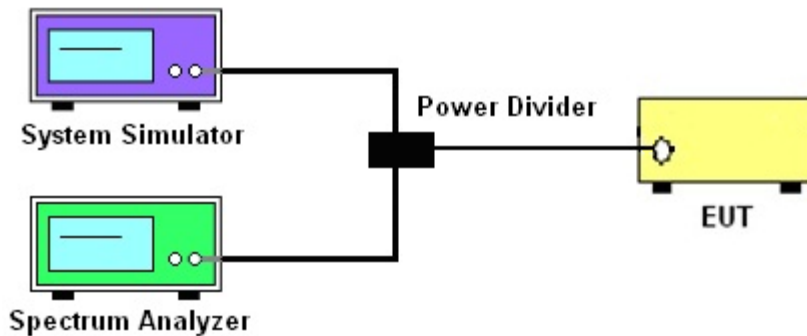

3.2.3 Frequency Stability

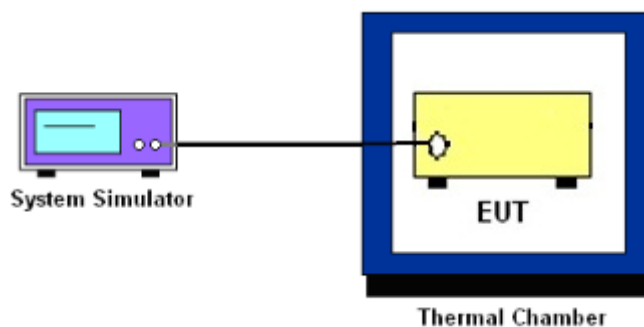

3.3 Test Result of Conducted Test

Please refer to Appendix A.



3.4 Conducted Output Power and ERP/EIRP

3.4.1 Description of the Conducted Output Power Measurement and ERP/EIRP Measurement

A system simulator was used to establish communication with the EUT. Its parameters were set to force the EUT transmitting at maximum output power. The measured power in the radio frequency on the transmitter output terminals shall be reported.

The ERP of mobile transmitters must not exceed 7 Watts for LTE Band 5 and Band 26.

The EIRP of mobile transmitters must not exceed 2 Watts for LTE Band 2 and Band 25.

The EIRP of mobile transmitters must not exceed 1 Watts for LTE Band 4 and Band 66.

According to KDB 412172 D01 Power Approach,

$EIRP = P_T + G_T - L_C$, $ERP = EIRP - 2.15$, where

P_T = transmitter output power in dBm

G_T = gain of the transmitting antenna in dBi

L_C = signal attenuation in the connecting cable between the transmitter and antenna in dB

3.4.2 Test Procedures

1. The testing follows ANSI C63.26 Section 5.2
2. The transmitter output port was connected to the system simulator.
3. Set EUT at maximum power through the system simulator.
4. Select lowest, middle, and highest channels for each band and different modulation.
5. Measure and record the power level from the system simulator.



3.5 Peak-to-Average Ratio

3.5.1 Description of the PAR Measurement

Power Complementary Cumulative Distribution Function (CCDF) curves provide a means for characterizing the power peaks of a digitally modulated signal on a statistical basis. A CCDF curve depicts the probability of the peak signal amplitude exceeding the average power level. Most contemporary measurement instrumentation include the capability to produce CCDF curves for an input signal provided that the instrument's resolution bandwidth can be set wide enough to accommodate the entire input signal bandwidth. In measuring transmissions in this band using an average power technique, the peak-to-average ratio (PAR) of the transmission may not exceed 13 dB.

3.5.2 Test Procedures

1. The testing follows ANSI C63.26 Section 5.2.3.4 (CCDF).
2. The EUT was connected to spectrum and system simulator via a power divider.
3. Set the CCDF (Complementary Cumulative Distribution Function) option in spectrum analyzer.
4. The highest RF powers were measured and recorded the maximum PAPR level associated with a probability of 0.1 %.
5. Record the deviation as Peak to Average Ratio.



3.6 Occupied Bandwidth

3.6.1 Description of Occupied Bandwidth Measurement

The occupied bandwidth is the width of a frequency band such that, below the lower and above the upper frequency limits, the mean powers emitted are each equal to a specified percentage 0.5% of the total mean transmitted power.

The 26 dB emission bandwidth is defined as the frequency range between two points, one above and one below the carrier frequency, at which the spectral density of the emission is attenuated 26 dB below the maximum in-band spectral density of the modulated signal. Spectral density (power per unit bandwidth) is to be measured with a detector of resolution bandwidth equal to approximately 1.0% of the emission bandwidth.

3.6.2 Test Procedures

1. The testing follows ANSI C63.26 Section 5.4
2. The EUT was connected to spectrum analyzer and system simulator via a power divider.
3. The spectrum analyzer center frequency is set to the nominal EUT channel center frequency. The span range for the spectrum analyzer shall be between two and five times the anticipated OBW.
4. The nominal resolution bandwidth (RBW) shall be in the range of 1 to 5 % of the anticipated OBW, and the VBW shall be at least 3 times the RBW.
5. Set the detection mode to peak, and the trace mode to max hold.
6. Determine the reference value: Set the EUT to transmit a modulated signal. Allow the trace to stabilize. Set the spectrum analyzer marker to the highest level of the displayed trace.
(this is the reference value)
7. Determine the “-26 dB down amplitude” as equal to (Reference Value – X).
8. Place two markers, one at the lowest and the other at the highest frequency of the envelope of the spectral display such that each marker is at or slightly below the “-X dB down amplitude” determined in step 6. If a marker is below this “-X dB down amplitude” value it shall be placed as close as possible to this value. The OBW is the positive frequency difference between the two markers.
9. Use the 99 % power bandwidth function of the spectrum analyzer and report the measured bandwidth.



3.7 Conducted Band Edge

3.7.1 Description of Conducted Band Edge Measurement

22.917(a)

For operations in the 824 – 849 MHz band, the FCC limit is $43 + 10\log_{10}(P[\text{Watts}])$ dB below the transmitter power P(Watts) in a 100kHz bandwidth. However, in the 1MHz bands immediately outside and adjacent to the licensee's frequency block, a resolution bandwidth of at least one percent of the emission bandwidth of the fundamental emission of the transmitter may be employed.

24.238 (a)

For operations in the 1850-1910 and 1930-1990 MHz band, the FCC limit is $43 + 10\log_{10}(P[\text{Watts}])$ dB below the transmitter power P(Watts) in a 1MHz bandwidth. However, in the 1 MHz bands immediately outside and adjacent to the frequency block a resolution bandwidth of at least one percent of the emission bandwidth of the fundamental emission of the transmitter may be employed.

27.53 (h)

For operations in the 1710 – 1755 MHz band, the FCC limit is $43 + 10\log_{10}(P[\text{Watts}])$ dB below the transmitter power P(Watts) in a 1 MHz bandwidth. However, in the 1MHz bands immediately outside and adjacent to the licensee's frequency block, a resolution bandwidth of at least one percent of the emission bandwidth of the fundamental emission of the transmitter may be employed.

3.7.2 Test Procedures

1. The testing follows ANSI C63.26 section 5.7
2. The EUT was connected to spectrum analyzer and system simulator via a power divider.
3. The band edges of low and high channels for the highest RF powers were measured.
4. Set RBW \geq 1% EBW in the 1MHz band immediately outside and adjacent to the band edge.
5. Beyond the 1 MHz band from the band edge, RBW=1MHz was used.
6. Set spectrum analyzer with RMS detector.
7. The RF fundamental frequency should be excluded against the limit line in the operating frequency band.
8. Checked that all the results comply with the emission limit line.

Example:

$$\begin{aligned} &\text{The limit line is derived from } 43 + 10\log(P)\text{dB below the transmitter power P(Watts)} \\ &= P(\text{W}) - [43 + 10\log(P)] \text{ (dB)} \\ &= [30 + 10\log(P)] \text{ (dBm)} - [43 + 10\log(P)] \text{ (dB)} = -13\text{dBm}. \end{aligned}$$



3.8 Conducted Spurious Emission

3.8.1 Description of Conducted Spurious Emission Measurement

The power of any emission outside of the authorized operating frequency ranges must be lower than the transmitter power (P) by a factor of at least $43 + 10 \log (P)$ dB.

It is measured by means of a calibrated spectrum analyzer and scanned from 30 MHz up to a frequency including its 10th harmonic.

3.8.2 Test Procedures

1. The testing follows ANSI C63.26 section 5.7
2. The EUT was connected to spectrum analyzer and system simulator via a power divider.
3. The RF output of EUT was connected to the spectrum analyzer by RF cable and attenuator. The path loss was compensated to the results for each measurement.
4. The middle channel for the highest RF power within the transmitting frequency was measured.
5. The conducted spurious emission for the whole frequency range was taken.
6. Make the measurement with the spectrum analyzer's RBW = 1MHz, VBW = 3MHz.
7. Set spectrum analyzer with RMS detector.
8. Taking the record of maximum spurious emission.
9. The RF fundamental frequency should be excluded against the limit line in the operating frequency band.
10. The limit line is derived from $43 + 10\log(P)$ dB below the transmitter power P(Watts)
= P(W)- [43 + 10log(P)] (dB)
= [30 + 10log(P)] (dBm) - [43 + 10log(P)] (dB)
= -13dBm.



3.9 Frequency Stability

3.9.1 Description of Frequency Stability Measurement

The frequency stability shall be measured by variation of ambient temperature and variation of primary supply voltage to ensure that the fundamental emission stays within the authorized frequency block. The frequency stability of the transmitter shall be maintained within $\pm 0.00025\%$ ($\pm 2.5\text{ppm}$) of the center frequency.

3.9.2 Test Procedures for Temperature Variation

1. The testing follows ANSI C63.26 section 5.6.4
2. The EUT was set up in the thermal chamber and connected with the system simulator.
3. With power OFF, the temperature was decreased to -30°C and the EUT was stabilized before testing. Power was applied and the maximum change in frequency was recorded within one minute.
4. With power OFF, the temperature was raised in 10°C step up to 50°C . The EUT was stabilized at each step for at least half an hour. Power was applied and the maximum frequency change was recorded within one minute.

3.9.3 Test Procedures for Voltage Variation

1. The testing follows ANSI C63.26 section 5.6.5
2. The EUT was placed in a temperature chamber at $20\pm 5^{\circ}\text{C}$ and connected with the system simulator.
3. The power supply voltage to the EUT was varied from 85% to 115% of the nominal value for other than hand carried battery equipment.
4. For hand carried, battery powered equipment, reduce the primary ac or dc supply voltage to the battery operating end point, which shall be specified by the manufacturer.
5. The variation in frequency was measured for the worst case.

4 Radiated Test Items

4.1 Measuring Instruments

See list of measuring instruments of this test report.

4.2 Test Setup

4.2.1 For radiated test from 30MHz to 1GHz

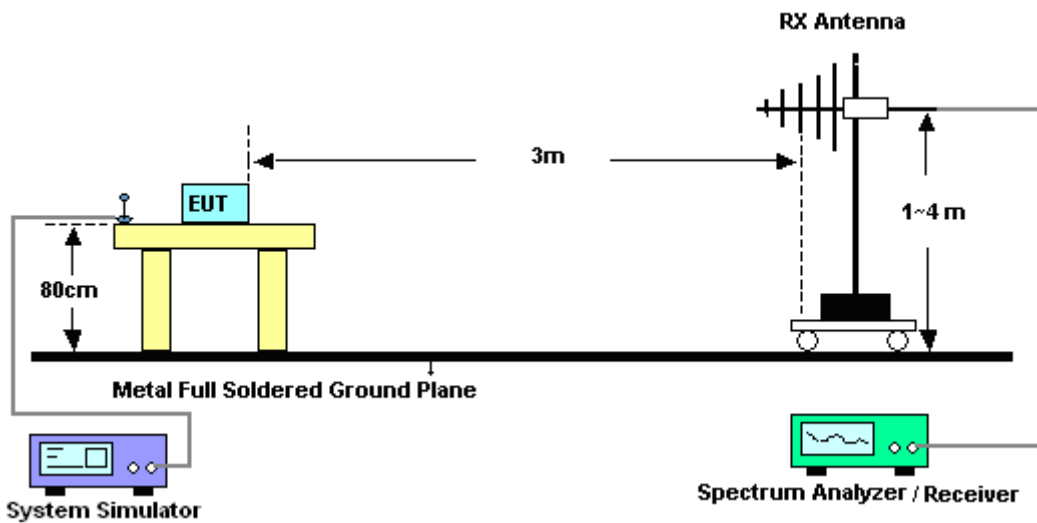

4.2.2 For radiated test above 1GHz

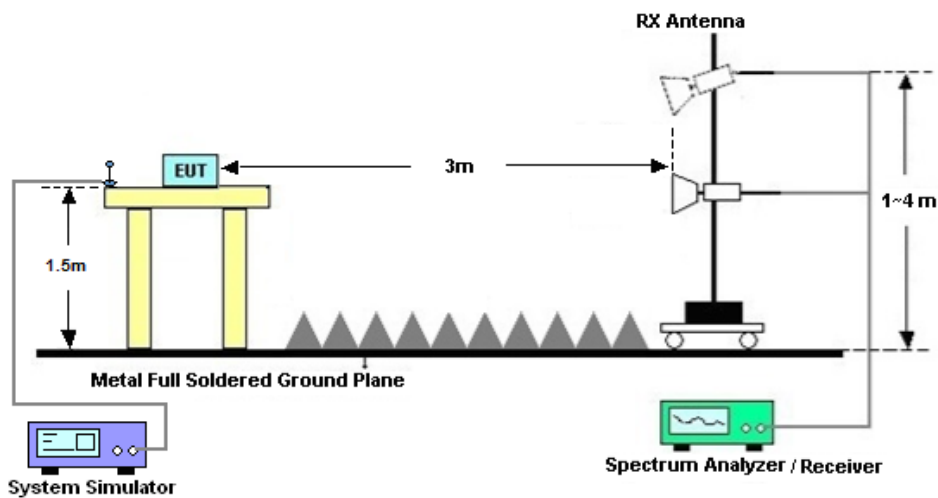

4.3 Test Result of Radiated Test

Please refer to Appendix B.



4.4 Radiated Spurious Emission

4.4.1 Description of Radiated Spurious Emission

The radiated spurious emission was measured by substitution method according to ANSI C63.26. The power of any emission outside of the authorized operating frequency ranges must be attenuated below the transmitter power (P) by a factor of at least $43 + 10 \log (P)$ dB.

The spectrum is scanned from 30 MHz up to a frequency including its 10th harmonic.

4.4.2 Test Procedures

1. The testing follows ANSI C63.26 Section 5.5
2. The EUT was placed on a turntable with 0.8 meter height for frequency below 1GHz and 1.5 meter height for frequency above 1GHz respectively above ground.
3. The EUT was set 3 meters from the receiving antenna mounted on the antenna tower.
4. The table was rotated 360 degrees to determine the position of the highest spurious emission.
5. The height of the receiving antenna is varied between 1m to 4m to search the maximum spurious emission for both horizontal and vertical polarizations.
6. During the measurement, the system simulator parameters were set to force the EUT transmitting at maximum output power.
7. Make the measurement with the spectrum analyzer's RBW = 1MHz, VBW = 3MHz, taking the record of maximum spurious emission.
8. A horn antenna was substituted in place of the EUT and was driven by a signal generator.
9. Tune the output power of signal generator to the same emission level with EUT maximum spurious emission.
10. $EIRP \text{ (dBm)} = S.G. \text{ Power} - Tx \text{ Cable Loss} + Tx \text{ Antenna Gain}$
11. $ERP \text{ (dBm)} = EIRP - 2.15$
12. The RF fundamental frequency should be excluded against the limit line in the operating frequency band.

The limit line is derived from $43 + 10\log(P)$ dB below the transmitter power P(Watts)
= $P(W) - [43 + 10\log(P)] \text{ (dB)}$
= $[30 + 10\log(P)] \text{ (dBm)} - [43 + 10\log(P)] \text{ (dB)}$
= -13dBm.



5 List of Measuring Equipment

Instrument	Manufacturer	Model No.	Serial No.	Characteristics	Calibration Date	Test Date	Due Date	Remark
Spectrum Analyzer	R&S	FSV40	101040	10Hz~40GHz	Nov. 02, 2020	Nov. 27, 2020~Jan. 30, 2021	Nov. 01, 2021	Conducted (TH01-KS)
Thermal Chamber	Ten Billion	TTC-B3S	TBN-960502	-40~+150°C	Oct. 27, 2020	Nov. 27, 2020~Jan. 30, 2021	Oct. 26, 2021	Conducted (TH01-KS)
EXA Spectrum Analyzer	Keysight	N9010A	MY55150208	10Hz-44GHz	Apr. 14, 2020	Jan. 10, 2021	Apr. 13, 2021	Radiation (03CH06-KS)
Bilog Antenna	TeseQ	CBL6111D	49921	30MHz-1GHz	May 29, 2020	Jan. 10, 2021	May 28, 2021	Radiation (03CH06-KS)
Double Ridge Horn Antenna	ETS-Lindgren	3117	00218652	1GHz~18GHz	Apr. 27, 2020	Jan. 10, 2021	Apr. 26, 2021	Radiation (03CH06-KS)
SHF-EHF Horn	Com-power	AH-840	101115	18GHz~40GHz	Nov. 06, 2020	Jan. 10, 2021	Nov. 05, 2021	Radiation (03CH06-KS)
Amplifier	SONOMA	310N	187289	9KHz ~1GHZ	Apr. 14, 2020	Jan. 10, 2021	Apr. 13, 2021	Radiation (03CH06-KS)
Amplifier	MITEQ	EM18G40G GA	060728	18~40GHz	Jan. 07, 2021	Jan. 10, 2021	Jan. 06, 2022	Radiation (03CH06-KS)
high gain Amplifier	MITEQ	AMF-7D-00 101800-30-1 0P	2025788	1Ghz-18Ghz	Jan. 06, 2021	Jan. 10, 2021	Jan. 05, 2022	Radiation (03CH06-KS)
Amplifier	Keysight	83017A	MY53270203	500MHz~26.5GHz	Apr. 15, 2020	Jan. 10, 2021	Apr. 14, 2021	Radiation (03CH06-KS)
AC Power Source	Chroma	61601	F104090004	N/A	NCR	Jan. 10, 2021	NCR	Radiation (03CH06-KS)
Turn Table	ChamPro	EM 1000-T	060762-T	0~360 degree	NCR	Jan. 10, 2021	NCR	Radiation (03CH06-KS)
Antenna Mast	ChamPro	EM 1000-A	060762-A	1 m~4 m	NCR	Jan. 10, 2021	NCR	Radiation (03CH06-KS)



6 Uncertainty of Evaluation

The measurement uncertainties shown below were calculated in accordance with the requirements of ANSI 63.26-2015. All the measurement uncertainty value were shown with a coverage K=2 to indicate 95% level of confidence. The measurement data show herein meets or exceeds the CISPR measurement uncertainty values specified in CISPR 16-4-2 and can be compared directly to specified limit to determine compliance.

Uncertainty of Radiated Emission Measurement (30 MHz ~ 1000 MHz)

Measuring Uncertainty for a Level of Confidence of 95% (U = 2Uc(y))	2.5dB
---	-------

Uncertainty of Radiated Emission Measurement (1 GHz ~ 40 GHz)

Measuring Uncertainty for a Level of Confidence of 95% (U = 2Uc(y))	2.1dB
---	-------



Appendix A. Test Results of Conducted Test

Conducted Output Power(Average power)

LTE Band 2:

BW [MHz]	Modulation	RB Size	RB Offset	Power Low Ch. / Freq.	Power Middle Ch. / Freq.	Power High Ch. / Freq.
Channel				18700	18900	19100
Frequency (MHz)				1860	1880	1900
20	QPSK	1	0	23.23	22.65	23.31
20	QPSK	1	99	22.65	21.86	23.26
20	QPSK	100	0	21.85	21.22	21.65
20	16QAM	1	0	22.66	22.32	22.52
20	64QAM	1	0	21.33	20.89	21.66
Channel				18675	18900	19125
Frequency (MHz)				1857.5	1880	1902.5
15	QPSK	1	0	23.05	22.75	23.15
15	16QAM	1	0	22.65	21.65	22.44
15	64QAM	1	0	21.36	21.23	21.52
Channel				18650	18900	19150
Frequency (MHz)				1855	1880	1905
10	QPSK	1	0	22.79	22.86	22.58
10	16QAM	1	0	22.06	22.18	21.89
10	64QAM	1	0	21.32	20.86	20.73
Channel				18625	18900	19175
Frequency (MHz)				1852.5	1880	1907.5
5	QPSK	1	0	23.11	23.02	22.95
5	16QAM	1	0	22.12	22.23	22.25
5	64QAM	1	0	21.52	21.25	21.36
Channel				18615	18900	19185
Frequency (MHz)				1851.5	1880	1908.5
3	QPSK	1	0	22.96	23.06	23.09
3	16QAM	1	0	22.03	22.32	22.16
3	64QAM	1	0	21.25	21.56	21.36
Channel				18607	18900	19193
Frequency (MHz)				1850.7	1880	1909.3
1.4	QPSK	1	0	23.05	23.16	23.25
1.4	16QAM	1	0	22.32	22.36	22.44
1.4	64QAM	1	0	22.13	21.23	21.25



LTE Band 4:

BW [MHz]	Modulation	RB Size	RB Offset	Power Low Ch. / Freq.	Power Middle Ch. / Freq.	Power High Ch. / Freq.
Channel				20050	20175	20300
Frequency (MHz)				1720	1732.5	1745
20	QPSK	1	0	22.98	22.78	22.89
20	QPSK	1	99	22.63	22.86	22.85
20	QPSK	100	0	21.77	21.79	21.96
20	16QAM	1	0	22.56	22.26	22.56
20	64QAM	1	0	21.65	20.80	21.25
Channel				20025	20175	20325
Frequency (MHz)				1717.5	1732.5	1747.5
15	QPSK	1	0	22.86	22.59	22.79
15	16QAM	1	0	22.38	22.21	21.58
15	64QAM	1	0	21.36	20.65	20.72
Channel				20000	20175	20350
Frequency (MHz)				1715	1732.5	1750
10	QPSK	1	0	22.78	22.60	22.89
10	16QAM	1	0	21.85	21.65	21.98
10	64QAM	1	0	21.18	20.85	21.36
Channel				19975	20175	20375
Frequency (MHz)				1712.5	1732.5	1752.5
5	QPSK	1	0	22.96	22.67	22.96
5	16QAM	1	0	22.16	21.69	22.22
5	64QAM	1	0	21.33	21.21	21.16
Channel				19965	20175	20385
Frequency (MHz)				1711.5	1732.5	1753.5
3	QPSK	1	0	22.82	22.44	22.77
3	16QAM	1	0	21.63	21.63	21.65
3	64QAM	1	0	20.86	20.75	21.18
Channel				19957	20175	20393
Frequency (MHz)				1710.7	1732.5	1754.3
1.4	QPSK	1	0	22.63	22.68	22.78
1.4	16QAM	1	0	21.65	21.75	22.13
1.4	64QAM	1	0	21.23	20.63	21.36



LTE Band 5:

BW [MHz]	Modulation	RB Size	RB Offset	Power Low Ch. / Freq.	Power Middle Ch. / Freq.	Power High Ch. / Freq.
Channel				20450	20525	20600
Frequency (MHz)				829	836.5	844
10	QPSK	1	0	22.86	22.92	22.83
10	QPSK	1	49	22.75	22.73	22.63
10	QPSK	50	0	21.78	21.82	21.83
10	16QAM	1	0	21.85	21.89	21.86
10	64QAM	1	0	21.32	21.26	21.66
Channel				20425	20525	20625
Frequency (MHz)				826.5	836.5	846.5
5	QPSK	1	0	22.78	22.76	22.77
5	16QAM	1	0	21.85	21.88	21.85
5	64QAM	1	0	21.25	21.56	21.36
Channel				20415	20525	20635
Frequency (MHz)				825.5	836.5	847.5
3	QPSK	1	0	22.75	22.78	22.91
3	16QAM	1	0	21.86	21.66	22.22
3	64QAM	1	0	21.65	21.36	21.63
Channel				20407	20525	20643
Frequency (MHz)				824.7	836.5	848.3
1.4	QPSK	1	0	22.78	22.86	22.86
1.4	16QAM	1	0	21.85	21.36	21.63
1.4	64QAM	1	0	20.96	21.26	21.35



LTE Band 25:

BW [MHz]	Modulation	RB Size	RB Offset	Power Low Ch. / Freq.	Power Middle Ch. / Freq.	Power High Ch. / Freq.
Channel				26140	26340	26590
Frequency (MHz)				1860	1880	1905
20	QPSK	1	0	22.77	22.85	23.32
20	QPSK	1	99	22.82	23.06	22.63
20	QPSK	100	0	21.87	22.05	22.13
20	16QAM	1	0	22.01	21.87	22.63
20	64QAM	1	0	21.32	21.23	21.37
Channel				26115	26340	26615
Frequency (MHz)				1857.5	1880	1907.5
15	QPSK	1	0	22.63	22.73	22.85
15	16QAM	1	0	21.68	22.25	21.87
15	64QAM	1	0	20.96	21.21	21.12
Channel				26090	26340	26640
Frequency (MHz)				1855	1880	1910
10	QPSK	1	0	22.72	22.68	22.72
10	16QAM	1	0	21.86	21.82	21.63
10	64QAM	1	0	20.85	21.03	20.85
Channel				26065	26340	26665
Frequency (MHz)				1852.5	1880	1912.5
5	QPSK	1	0	22.63	22.65	23.13
5	16QAM	1	0	22.12	21.85	22.62
5	64QAM	1	0	20.87	20.69	21.36
Channel				26055	26340	26675
Frequency (MHz)				1851.5	1880	1913.5
3	QPSK	1	0	22.63	22.56	22.93
3	16QAM	1	0	21.85	21.86	21.93
3	64QAM	1	0	20.32	20.78	21.32
Channel				26047	26340	26683
Frequency (MHz)				1850.7	1880	1914.3
1.4	QPSK	1	0	22.63	22.63	22.66
1.4	16QAM	1	0	21.56	21.68	21.92
1.4	64QAM	1	0	20.72	20.86	20.68



LTE Band 26:

BW [MHz]	Modulation	RB Size	RB Offset	Power Low Ch. / Freq.	Power Middle Ch. / Freq.	Power High Ch. / Freq.
Channel				26865	26915	26965
Frequency (MHz)				831.5	836.5	841.5
15	QPSK	1	0	22.63	22.66	22.93
15	QPSK	1	74	22.76	22.56	22.63
15	QPSK	75	0	21.86	21.78	21.68
15	16QAM	1	0	20.85	21.72	21.52
15	64QAM	1	0	19.69	20.89	20.23
Channel				26840	26915	26990
Frequency (MHz)				829	836.5	844
10	QPSK	1	0	22.75	22.76	22.73
10	16QAM	1	0	21.36	21.32	21.56
10	64QAM	1	0	20.63	20.53	20.25
Channel				26815	26915	27015
Frequency (MHz)				826.5	836.5	846.5
5	QPSK	1	0	22.63	22.76	22.68
5	16QAM	1	0	21.71	21.35	21.52
5	64QAM	1	0	20.68	20.35	20.36
Channel				26805	26915	27025
Frequency (MHz)				825.5	836.5	847.5
3	QPSK	1	0	22.66	22.77	22.76
3	16QAM	1	0	21.32	21.32	21.36
3	64QAM	1	0	20.85	20.25	20.33
Channel				26797	26915	27033
Frequency (MHz)				824.7	836.5	848.3
1.4	QPSK	1	0	22.69	22.76	22.86
1.4	16QAM	1	0	21.32	21.32	21.63
1.4	64QAM	1	0	20.23	20.32	20.65



LTE Band 66:

BW [MHz]	Modulation	RB Size	RB Offset	Power Low Ch. / Freq.	Power Middle Ch. / Freq.	Power High Ch. / Freq.
Channel				132072	132322	132572
Frequency (MHz)				1720	1745	1770
20	QPSK	1	0	22.99	22.76	22.63
20	QPSK	1	99	22.63	22.85	22.87
20	QPSK	100	0	21.56	21.96	21.79
20	16QAM	1	0	22.32	21.65	21.60
20	64QAM	1	0	21.70	20.82	20.85
Channel				132047	132322	132597
Frequency (MHz)				1717.5	1745	1772.5
15	QPSK	1	0	22.86	22.68	22.36
15	16QAM	1	0	22.12	22.06	21.89
15	64QAM	1	0	21.69	21.16	21.02
Channel				132022	132322	132622
Frequency (MHz)				1715	1745	1775
10	QPSK	1	0	22.78	22.75	22.52
10	16QAM	1	0	21.86	21.65	21.76
10	64QAM	1	0	20.85	20.63	20.56
Channel				131997	132322	132647
Frequency (MHz)				1712.5	1745	1777.5
5	QPSK	1	0	22.85	22.77	22.72
5	16QAM	1	0	21.76	21.63	21.58
5	64QAM	1	0	20.65	20.71	20.36
Channel				131987	132322	132657
Frequency (MHz)				1711.5	1745	1778.5
3	QPSK	1	0	22.77	22.63	22.76
3	16QAM	1	0	21.63	21.68	21.63
3	64QAM	1	0	20.73	20.32	20.58
Channel				131979	132322	132665
Frequency (MHz)				1710.7	1745	1779.3
1.4	QPSK	1	0	22.76	22.73	22.72
1.4	16QAM	1	0	21.32	21.58	21.54
1.4	64QAM	1	0	20.69	20.54	20.57



CA Power

CA_5B									
Combination 10MHz+10MHz (50RB+50RB)									
PCC Channel	SCC Channel	Modulation	PCC		SCC		Total RB Size	Target MPR Level (dB)	Measured Power (dBm)
			RB Size	RB offset	RB Size	RB offset			
20450	20549	QPSK	1	0	1	49	2	≤4.5	12.48
			1	49	1	0	2	≤0	22.5
			50	0	50	0	51	≤3.5	20.67
		16QAM	1	0	1	49	2	≤1	13.21
			1	49	1	0	51	≤3.5	21.93
			1	0	1	49	2	≤3	12.36
20476	20575	QPSK	1	0	1	49	2	≤4.5	12.25
			1	49	1	0	2	≤0	23.06
			50	0	50	0	101	≤3.5	20.58
		16QAM	1	0	1	49	2	≤1	12.64
			1	49	1	0	101	≤3.5	22.63
			1	0	1	49	2	≤3	12.43
20501	20600	QPSK	1	0	1	49	2	≤4.5	12.3
			1	49	1	0	2	≤0	22.57
			50	0	50	0	101	≤3.5	20.64
		16QAM	1	0	1	49	2	≤1	12.1
			1	49	1	0	101	≤3.5	21.65
			1	0	1	49	2	≤3	12.46
64QAM	1	49	1	0	101	≤3.5	21.14		



CA_66B									
Combination 15MHz+5MHz (75RB+25RB)									
PCC Channel	SCC Channel	Modulation	PCC		SCC		Total RB Size	Target MPR Level (dB)	Measured Power (dBm)
			RB Size	RB offset	RB Size	RB offset			
132047	132140	QPSK	1	0	1	24	2	≤4.5	22.15
			1	74	1	0	2	≤0	21.65
			75	0	25	0	101	≤3.5	22.98
		16QAM	1	0	1	24	2	≤1	22.5
			1	74	1	0	101	≤3.5	22.51
			64QAM	1	0	1	24	2	≤3
1	74	1		0	101	≤3.5	22.31		
132398	132491	QPSK	1	0	1	24	2	≤4.5	22.19
			1	74	1	0	2	≤0	22.78
			75	0	25	0	101	≤3.5	22.24
		16QAM	1	0	1	24	2	≤1	22.1
			1	74	1	0	101	≤3.5	22.77
			64QAM	1	0	1	24	2	≤3
1	74	1		0	101	≤3.5	22.5		
132549	132642	QPSK	1	0	1	24	2	≤4.5	22.13
			1	74	1	0	2	≤0	22.65
			75	0	25	0	101	≤3.5	22.01
		16QAM	1	0	1	24	2	≤1	22.16
			1	74	1	0	101	≤3.5	22.57
			64QAM	1	0	1	24	2	≤3
1	74	1		0	101	≤3.5	22.26		



CA_66C									
Combination 20MHz+20MHz (100RB+100RB)									
PCC Channel	SCC Channel	Modulation	PCC		SCC		Total RB Size	Target MPR Level (dB)	Measured Power (dBm)
			RB Size	RB offset	RB Size	RB offset			
132072	132270	QPSK	1	0	1	99	2	≤4.5	13.74
			1	99	1	0	2	≤0	22.36
			100	0	100	0	101	≤3.5	20.51
		16QAM	1	0	1	99	2	≤1	14.13
			1	99	1	0	101	≤3.5	21.32
			64QAM	1	0	1	99	2	≤3
1	99	1		0	101	≤3.5	20.69		
132323	132521	QPSK	1	0	1	99	2	≤4.5	13.42
			1	99	1	0	2	≤0	22.65
			100	0	100	0	101	≤3.5	20.31
		16QAM	1	0	1	99	2	≤1	14.1
			1	99	1	0	101	≤3.5	21.89
			64QAM	1	0	1	99	2	≤3
1	99	1		0	101	≤3.5	20.88		
132374	132572	QPSK	1	0	1	99	2	≤4.5	13.52
			1	99	1	0	2	≤0	22.47
			100	0	100	0	101	≤3.5	20.43
		16QAM	1	0	1	99	2	≤1	13.48
			1	99	1	0	101	≤3.5	21.41
			64QAM	1	0	1	99	2	≤3
1	99	1		0	101	≤3.5	21.12		



ERP/EIRP

LTE Band 25 (GT - LC = 4.00 dB) QPSK									
Bandwidth	1.4M			3M			5M		
Channel	26407	26340	26683	26055	26340	26675	26065	26340	26665
	(Low)	(Mid)	(High)	(Low)	(Mid)	(High)	(Low)	(Mid)	(High)
Frequency (MHz)	1850.7	1880	1914.3	1851.5	1880	1913.5	1852.5	1880	1912.5
Conducted Power (dBm)	22.63	22.63	22.66	22.63	22.56	22.93	22.63	22.65	23.13
Conducted Power (Watts)	0.1832	0.1832	0.1845	0.1832	0.1803	0.1963	0.1832	0.1841	0.2056
EIRP(dBm)	26.63	26.63	26.66	26.63	26.56	26.93	26.63	26.65	27.13
EIRP(Watts)	0.4603	0.4603	0.4634	0.4603	0.4529	0.4932	0.4603	0.4624	0.5164

LTE Band 25 (GT - LC = 4.00 dB) QPSK									
Bandwidth	10M			15M			20M		
Channel	26090	26340	26640	26115	26340	26615	26140	26340	26590
	(Low)	(Mid)	(High)	(Low)	(Mid)	(High)	(Low)	(Mid)	(High)
Frequency (MHz)	1855	1880	1910	1857.5	1880	1907.5	1860	1880	1905
Conducted Power (dBm)	22.72	22.68	22.72	22.63	22.73	22.85	22.77	22.85	23.32
Conducted Power (Watts)	0.1871	0.1854	0.1871	0.1832	0.1875	0.1928	0.1892	0.1928	0.2148
EIRP(dBm)	26.72	26.68	26.72	26.63	26.73	26.85	26.77	26.85	27.32
EIRP(Watts)	0.4699	0.4656	0.4699	0.4603	0.4710	0.4842	0.4753	0.4842	0.5395



LTE Band 25 (GT - LC = 4.00 dB) 16QAM									
Bandwidth	1.4M			3M			5M		
Channel	26407	26340	26683	26055	26340	26675	26065	26340	26665
	(Low)	(Mid)	(High)	(Low)	(Mid)	(High)	(Low)	(Mid)	(High)
Frequency (MHz)	1850.7	1880	1914.3	1851.5	1880	1913.5	1852.5	1880	1912.5
Conducted Power (dBm)	21.56	21.68	21.92	21.85	21.86	21.93	22.12	21.85	22.62
Conducted Power (Watts)	0.1432	0.1472	0.1556	0.1531	0.1535	0.1560	0.1629	0.1531	0.1828
EIRP(dBm)	25.56	25.68	25.92	25.85	25.86	25.93	26.12	25.85	26.62
EIRP(Watts)	0.3597	0.3698	0.3908	0.3846	0.3855	0.3917	0.4093	0.3846	0.4592

LTE Band 25 (GT - LC = 4.00 dB) 16QAM									
Bandwidth	10M			15M			20M		
Channel	26090	26340	26640	26115	26340	26615	26140	26340	26590
	(Low)	(Mid)	(High)	(Low)	(Mid)	(High)	(Low)	(Mid)	(High)
Frequency (MHz)	1855	1880	1910	1857.5	1880	1907.5	1860	1880	1905
Conducted Power (dBm)	21.86	21.82	21.63	21.68	22.25	21.87	22.01	21.87	22.63
Conducted Power (Watts)	0.1535	0.1521	0.1455	0.1472	0.1679	0.1538	0.1589	0.1538	0.1832
EIRP(dBm)	25.86	25.82	25.63	25.68	26.25	25.87	26.01	25.87	26.63
EIRP(Watts)	0.3855	0.3819	0.3656	0.3698	0.4217	0.3864	0.3990	0.3864	0.4603



LTE Band 26 (GT - LC = 3.00 dB) QPSK									
Bandwidth	1.4M			3M			5M		
Channel	26797	26915	27033	26805	26915	27025	26815	26915	27015
	(Low)	(Mid)	(High)	(Low)	(Mid)	(High)	(Low)	(Mid)	(High)
Frequency	824.7	836.5	848.3	825.5	836.5	847.5	826.5	836.5	846.5
(MHz)									
Conducted Power (dBm)	22.69	22.76	22.86	22.66	22.77	22.76	22.63	22.76	22.68
Conducted Power (Watts)	0.1858	0.1888	0.1932	0.1845	0.1892	0.1888	0.1832	0.1888	0.1854
ERP(dBm)	23.54	23.61	23.71	23.51	23.62	23.61	23.48	23.61	23.53
ERP(Watts)	0.2259	0.2296	0.2350	0.2244	0.2301	0.2296	0.2228	0.2296	0.2254

LTE Band 26 (GT - LC = 3.00 dB) QPSK							
Bandwidth	10M			15M			15M
Channel	26840	26915	26990	26865	26915	26965	26765
	(Low)	(Mid)	(High)	(Low)	(Mid)	(High)	(Low)
Frequency	829	836.5	844	831.5	836.5	841.5	821.5
(MHz)							
Conducted Power (dBm)	22.75	22.76	22.73	22.63	22.66	22.93	22.92
Conducted Power (Watts)	0.1884	0.1888	0.1875	0.1832	0.1845	0.1963	0.1959
ERP(dBm)	23.60	23.61	23.58	23.48	23.51	23.78	23.77
ERP(Watts)	0.2291	0.2296	0.2280	0.2228	0.2244	0.2388	0.2382



LTE Band 26 (GT - LC = 3.00 dB) 16QAM									
Bandwidth	1.4M			3M			5M		
Channel	26797	26915	27033	26805	26915	27025	26815	26915	27015
	(Low)	(Mid)	(High)	(Low)	(Mid)	(High)	(Low)	(Mid)	(High)
Frequency	824.7	836.5	848.3	825.5	836.5	847.5	826.5	836.5	846.5
(MHz)									
Conducted Power (dBm)	21.32	21.32	21.63	21.32	21.32	21.36	21.71	21.35	21.52
Conducted Power (Watts)	0.1355	0.1355	0.1455	0.1355	0.1355	0.1368	0.1483	0.1365	0.1419
ERP(dBm)	22.17	22.17	22.48	22.17	22.17	22.21	22.56	22.20	22.37
ERP(Watts)	0.1648	0.1648	0.1770	0.1648	0.1648	0.1663	0.1803	0.1660	0.1726

LTE Band 26 (GT - LC = 3.00 dB) 16QAM							
Bandwidth	10M			15M			15M
Channel	26840	26915	26990	26865	26915	26965	26765
	(Low)	(Mid)	(High)	(Low)	(Mid)	(High)	(Low)
Frequency	829	836.5	844	831.5	836.5	841.5	821.5
(MHz)							
Conducted Power (dBm)	21.36	21.32	21.56	20.85	21.72	21.52	21.96
Conducted Power (Watts)	0.1368	0.1355	0.1432	0.1216	0.1486	0.1419	0.1570
ERP(dBm)	22.21	22.17	22.41	21.70	22.57	22.37	22.81
ERP(Watts)	0.1663	0.1648	0.1742	0.1479	0.1807	0.1726	0.1910



LTE Band 66 (GT - LC = 3.00 dB) QPSK									
Bandwidth	1.4M			3M			5M		
Channel	131979	132322	132665	131987	132322	132657	131997	132322	132647
	(Low)	(Mid)	(High)	(Low)	(Mid)	(High)	(Low)	(Mid)	(High)
Frequency (MHz)	1710.7	1745	1779.3	1711.5	1745	1778.5	1712.5	1745	1777.5
Conducted Power (dBm)	22.76	22.73	22.72	22.77	22.63	22.76	22.85	22.77	22.72
Conducted Power (Watts)	0.1888	0.1875	0.1871	0.1892	0.1832	0.1888	0.1928	0.1892	0.1871
EIRP(dBm)	25.76	25.73	25.72	25.77	25.63	25.76	25.85	25.77	25.72
EIRP(Watts)	0.3767	0.3741	0.3733	0.3776	0.3656	0.3767	0.3846	0.3776	0.3733

LTE Band 66 (GT - LC = 3.00 dB) QPSK									
Bandwidth	10M			15M			20M		
Channel	132022	132322	132622	132047	132322	132597	132072	132322	132572
	(Low)	(Mid)	(High)	(Low)	(Mid)	(High)	(Low)	(Mid)	(Mid)
Frequency (MHz)	1715	1745	1775	1717.5	1745	1772.5	1720	1745	1770
Conducted Power (dBm)	22.78	22.75	22.52	22.86	22.68	22.36	22.99	22.76	22.63
Conducted Power (Watts)	0.1897	0.1884	0.1786	0.1932	0.1854	0.1722	0.1991	0.1888	0.1832
EIRP(dBm)	25.78	25.75	25.52	25.86	25.68	25.36	25.99	25.76	25.63
EIRP(Watts)	0.3784	0.3758	0.3565	0.3855	0.3698	0.3436	0.3972	0.3767	0.3656



LTE Band 66 (GT - LC = 3.00 dB) 16QAM									
Bandwidth	1.4M			3M			5M		
Channel	131979	132322	132665	131987	132322	132657	131997	132322	132647
	(Low)	(Mid)	(High)	(Low)	(Mid)	(High)	(Low)	(Mid)	(High)
Frequency (MHz)	1710.7	1745	1779.3	1711.5	1745	1778.5	1712.5	1745	1777.5
Conducted Power (dBm)	21.32	21.58	21.54	21.63	21.68	21.63	21.76	21.63	21.58
Conducted Power (Watts)	0.1355	0.1439	0.1426	0.1455	0.1472	0.1455	0.1500	0.1455	0.1439
EIRP(dBm)	24.32	24.58	24.54	24.63	24.68	24.63	24.76	24.63	24.58
EIRP(Watts)	0.2704	0.2871	0.2844	0.2904	0.2938	0.2904	0.2992	0.2904	0.2871

LTE Band 66 (GT - LC = 3.00 dB) 16QAM									
Bandwidth	10M			15M			20M		
Channel	132022	132322	132622	132047	132322	132597	132072	132322	132572
	(Low)	(Mid)	(High)	(Low)	(Mid)	(High)	(Low)	(Mid)	(Mid)
Frequency (MHz)	1715	1745	1775	1717.5	1745	1772.5	1720	1745	1770
Conducted Power (dBm)	21.86	21.65	21.76	22.12	22.06	21.89	22.32	21.65	21.60
Conducted Power (Watts)	0.1535	0.1462	0.1500	0.1629	0.1607	0.1545	0.1706	0.1462	0.1445
EIRP(dBm)	24.86	24.65	24.76	25.12	25.06	24.89	25.32	24.65	24.60
EIRP(Watts)	0.3062	0.2917	0.2992	0.3251	0.3206	0.3083	0.3404	0.2917	0.2884



CA EIRP

LTE Band 5B CA (GT - LC = 3.00 dB) QPSK			
Bandwidth	10M+10M		
Channel PCC	20450	20476	20501
	(Low)	(Mid)	(High)
Channel SCC	20549	20575	20600
	(Low)	(Mid)	(High)
Conducted Power (dBm)	20.67	23.06	22.57
Conducted Power (Watts)	0.1167	0.2023	0.1807
ERP(dBm)	21.52	23.91	23.42
ERP(Watts)	0.1419	0.2460	0.2198

LTE Band 5B CA (GT - LC = 3.00 dB) 16QAM			
Bandwidth	10M+10M		
Channel PCC	20450	20476	20501
	(Low)	(Mid)	(High)
Channel SCC	20549	20575	20600
	(Low)	(Mid)	(High)
Conducted Power (dBm)	21.93	22.63	21.65
Conducted Power (Watts)	0.1560	0.1832	0.1462
ERP(dBm)	22.78	23.48	22.50
ERP(Watts)	0.1897	0.2228	0.1778



LTE Band 66C_CA (GT - LC = 3.00 dB) QPSK			
Bandwidth	20M + 20M		
Channel PCC	132005	132330	132455
	(Low)	(Mid)	(High)
Channel SCC	132122	132447	132572
	(Low)	(Mid)	(High)
Conducted Power (dBm)	22.36	22.65	22.47
Conducted Power (Watts)	0.1722	0.1841	0.1766
EIRP(dBm)	25.36	25.65	25.47
EIRP(Watts)	0.3436	0.3673	0.3524

LTE Band 66C_CA (GT - LC = 3.00 dB) 16QAM			
Bandwidth	20M + 20M		
Channel PCC	132005	132330	132455
	(Low)	(Mid)	(High)
Channel SCC	132122	132447	132572
	(Low)	(Mid)	(High)
Conducted Power (dBm)	21.32	21.89	21.41
Conducted Power (Watts)	0.1355	0.1545	0.1384
EIRP(dBm)	24.32	24.89	24.41
EIRP(Watts)	0.2704	0.3083	0.2761



LTE Band 66B_CA (GT - LC = 3.00 dB) QPSK			
Bandwidth	15M + 5M		
Channel PCC	132047	132398	132549
	(Low)	(Mid)	(High)
Channel SCC	132140	132491	132642
	(Low)	(Mid)	(High)
Conducted Power (dBm)	22.98	22.78	22.65
Conducted Power (Watts)	0.1986	0.1897	0.1841
EIRP(dBm)	25.98	25.78	25.65
EIRP(Watts)	0.3963	0.3784	0.3673

LTE Band 66B_CA (GT - LC = 3.00 dB) 16QAM			
Bandwidth	15M + 5M		
Channel PCC	132047	132398	132549
	(Low)	(Mid)	(High)
Channel SCC	132140	132491	132642
	(Low)	(Mid)	(High)
Conducted Power (dBm)	22.51	22.77	22.57
Conducted Power (Watts)	0.1782	0.1892	0.1807
EIRP(dBm)	25.51	25.77	25.57
EIRP(Watts)	0.3556	0.3776	0.3606



LTE Band 25

Peak-to-Average Ratio

Mode	LTE Band 25 / 20MHz				
Mod.	QPSK		16QAM		Limit: 13dB
RB Size	1RB	Full RB	1RB	Full RB	Result
Lowest CH	4.41	5.45	4.93	6.32	PASS
Middle CH	5.33	5.13	5.97	5.94	
Highest CH	5.30	5.19	6.00	6.23	



LTE Band 25 / 20MHz / QPSK

Lowest Channel / 1RB

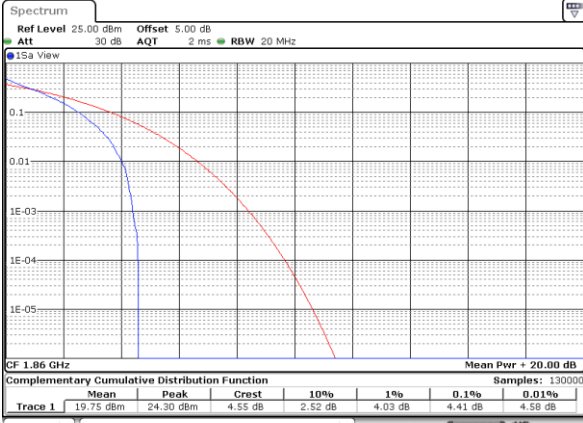

Date: 1 DEC 2020 11:23:00

Lowest Channel / Full RB

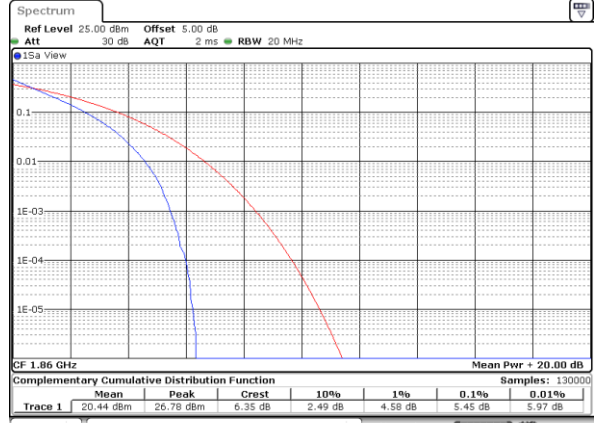

Date: 1 DEC 2020 11:23:29

Middle Channel / 1RB

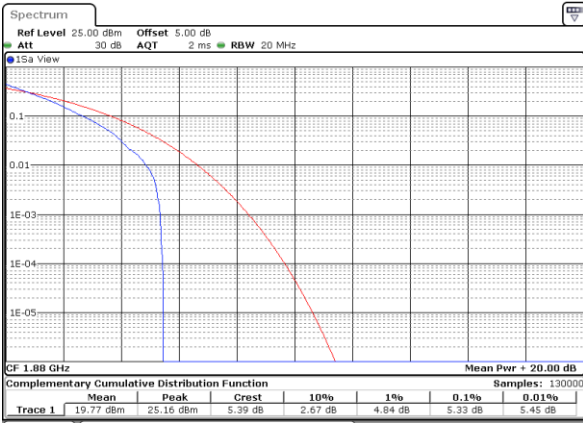

Date: 1 DEC 2020 11:24:08

Middle Channel / Full RB

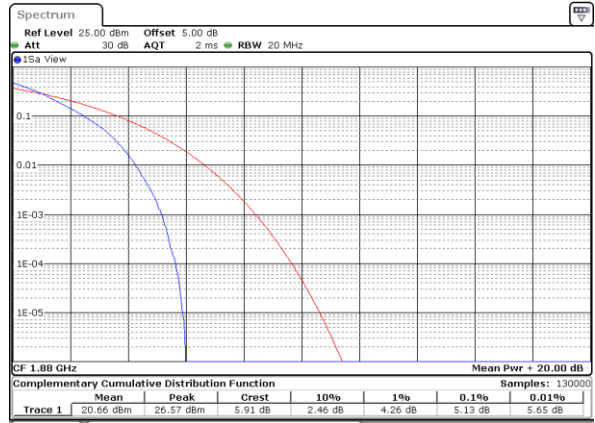

Date: 1 DEC 2020 11:23:38

Highest Channel / 1RB

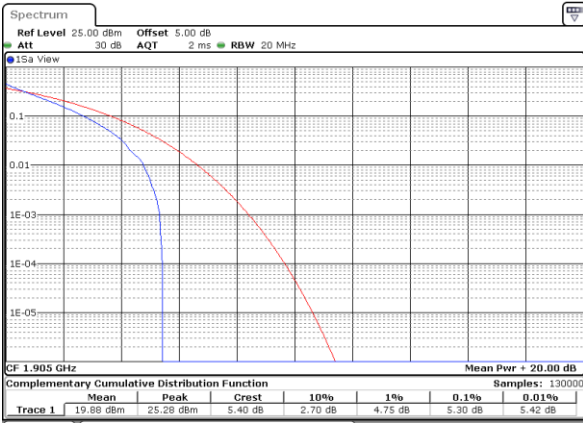

Date: 1 DEC 2020 11:30:48

Highest Channel / Full RB

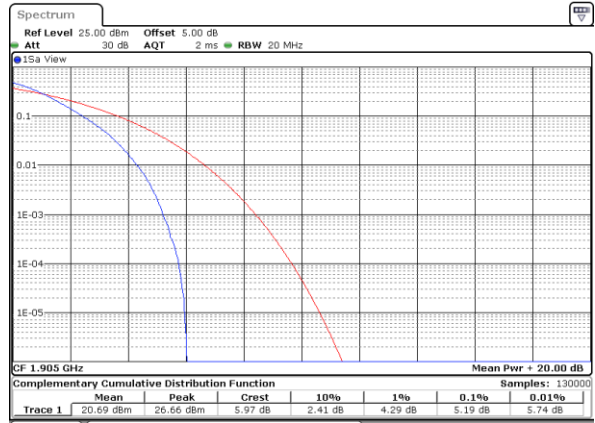

Date: 1 DEC 2020 11:31:18



LTE Band 25 / 20MHz / 16QAM

Lowest Channel / 1RB

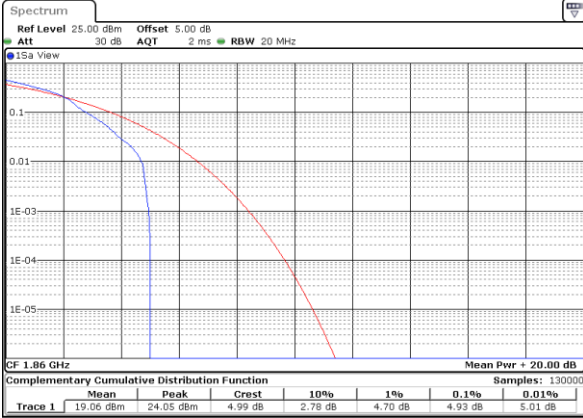

Date: 1 DEC 2020 11:23:10

Lowest Channel / Full RB

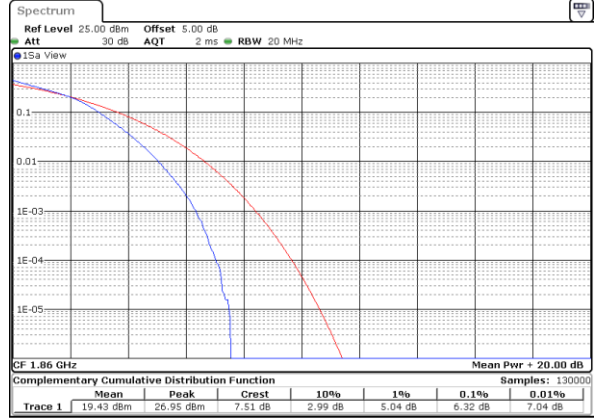

Date: 1 DEC 2020 11:23:19

Middle Channel / 1RB

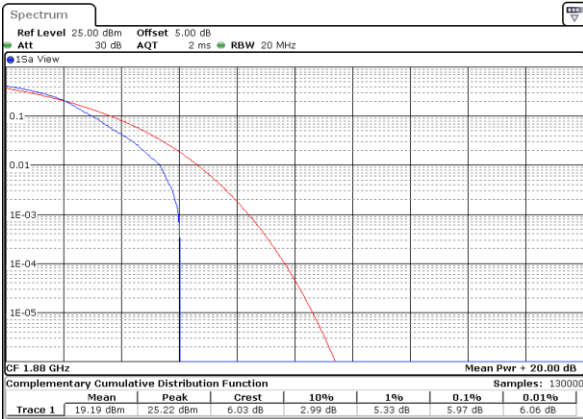

Date: 1 DEC 2020 11:23:57

Middle Channel / Full RB

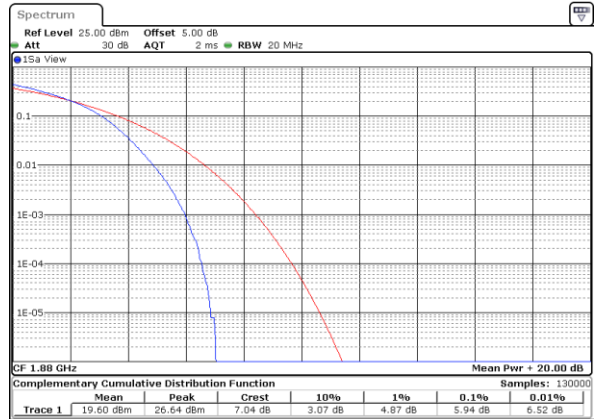

Date: 1 DEC 2020 11:23:47

Highest Channel / 1RB

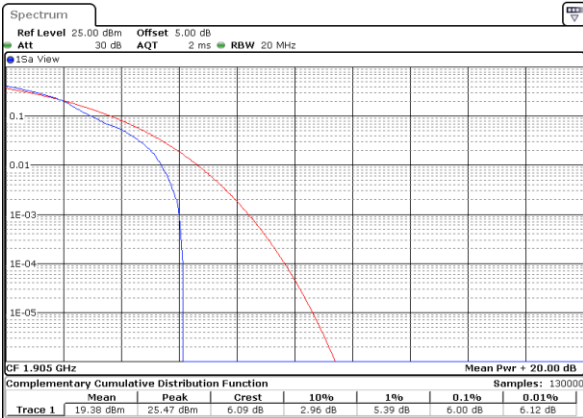

Date: 1 DEC 2020 11:30:58

Highest Channel / Full RB

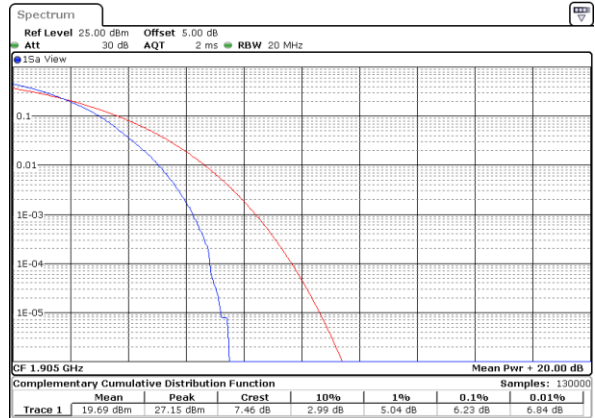

Date: 1 DEC 2020 11:31:08



26dB Bandwidth

Mode	LTE Band 25 : 26dB BW(MHz)											
	1.4MHz		3MHz		5MHz		10MHz		15MHz		20MHz	
BW	QPSK	16QAM	QPSK	16QAM	QPSK	16QAM	QPSK	16QAM	QPSK	16QAM	QPSK	16QAM
Lowest CH	1.24	1.25	3.03	3.03	4.92	4.95	9.81	9.81	14.54	15.29	20.22	20.46
Middle CH	1.25	1.25	3.00	3.03	4.89	4.91	9.87	9.87	14.42	14.99	20.46	20.62
Highest CH	1.24	1.25	3.05	3.06	4.91	4.90	9.73	9.97	14.57	14.78	20.42	20.46



LTE Band 25

Lowest Channel / 1.4MHz / QPSK

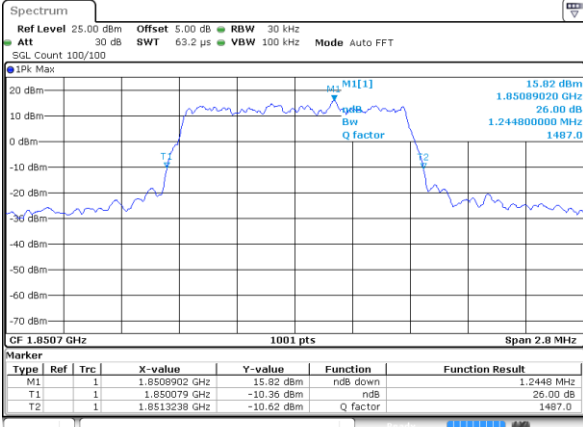

Date: 27 NOV 2020 17:21:46

Lowest Channel / 1.4MHz / 16QAM

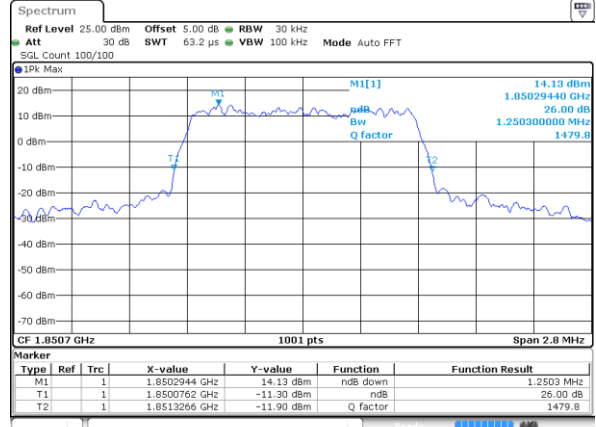

Date: 27 NOV 2020 17:22:06

Middle Channel / 1.4MHz / QPSK

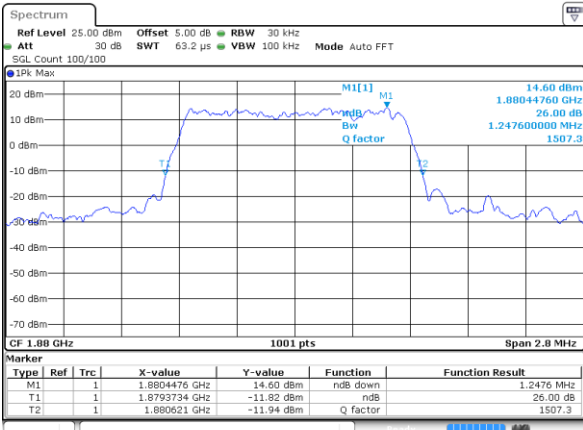

Date: 27 NOV 2020 17:22:26

Middle Channel / 1.4MHz / 16QAM

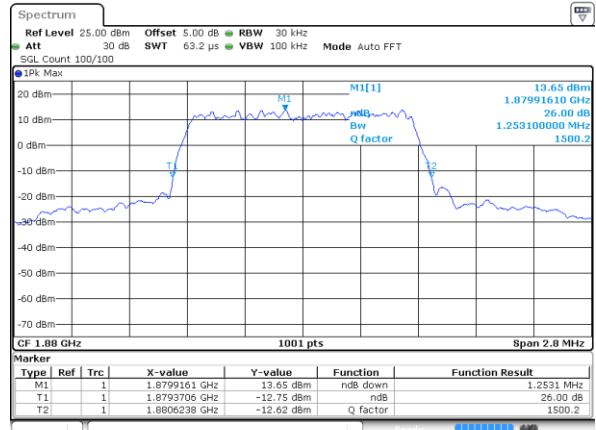

Date: 27 NOV 2020 17:22:46

Highest Channel / 1.4MHz / QPSK

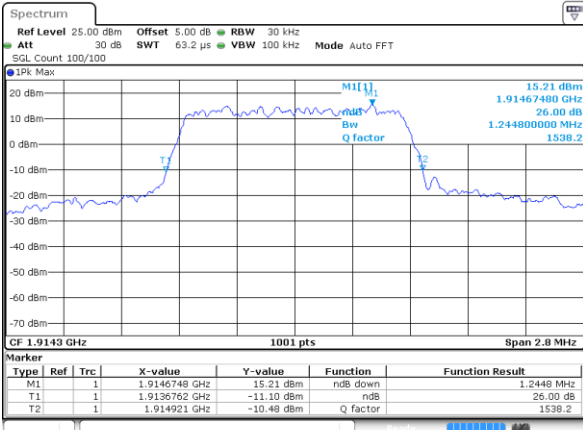

Date: 27 NOV 2020 17:23:06

Highest Channel / 1.4MHz / 16QAM

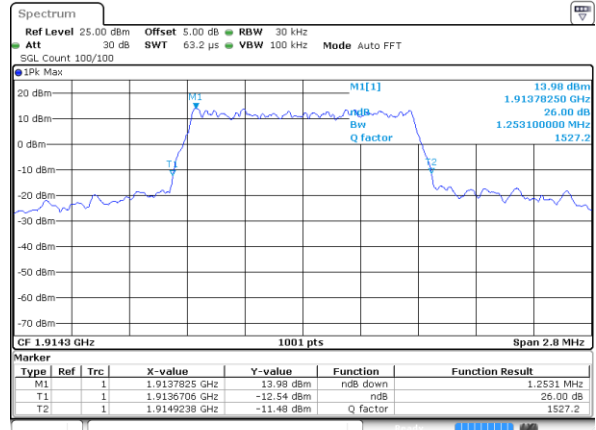

Date: 27 NOV 2020 17:23:25



LTE Band 25

Lowest Channel / 3MHz / QPSK

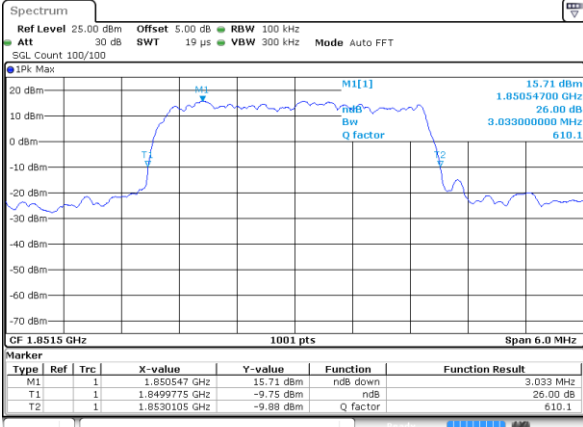

Date: 27 NOV 2020 17:50:14

Lowest Channel / 3MHz / 16QAM

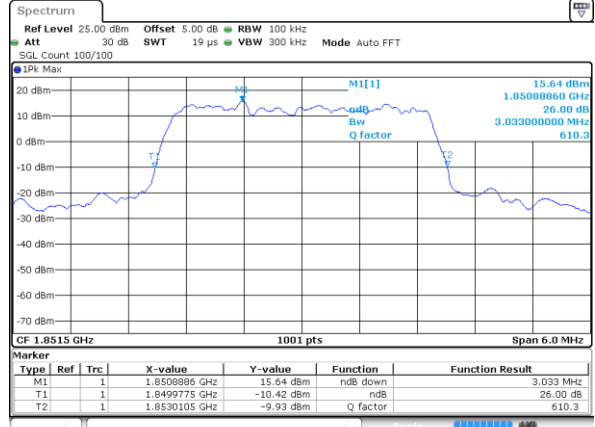

Date: 27 NOV 2020 17:50:34

Middle Channel / 3MHz / QPSK

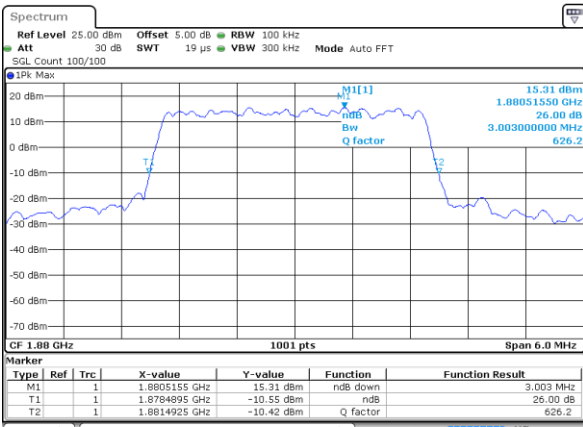

Date: 27 NOV 2020 17:50:54

Middle Channel / 3MHz / 16QAM

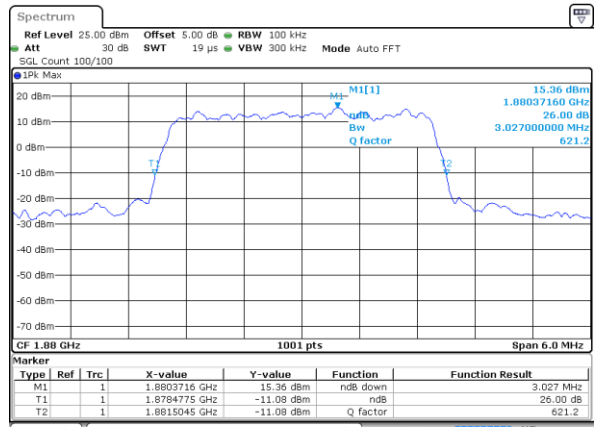

Date: 27 NOV 2020 17:51:14

Highest Channel / 3MHz / QPSK

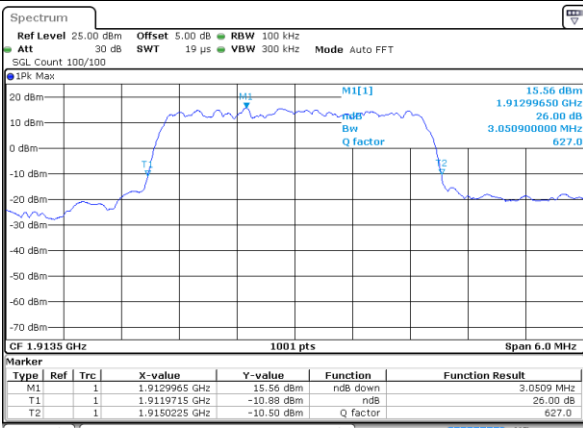

Date: 27 NOV 2020 17:51:34

Highest Channel / 3MHz / 16QAM

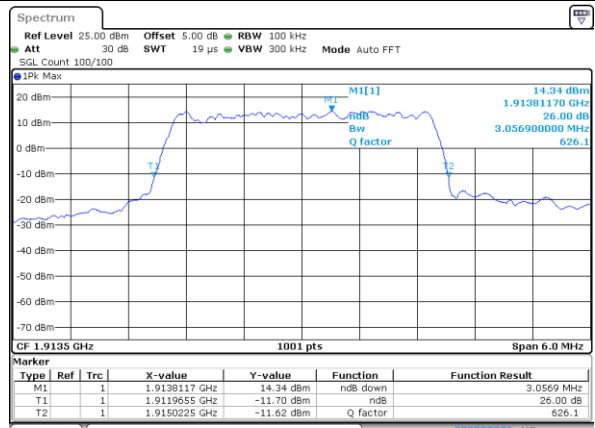

Date: 27 NOV 2020 17:51:53



LTE Band 25

Lowest Channel / 5MHz / QPSK

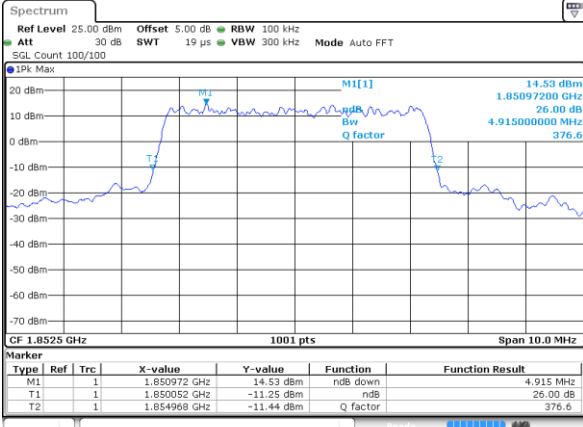

Date: 27 NOV 2020 18:07:31

Lowest Channel / 5MHz / 16QAM

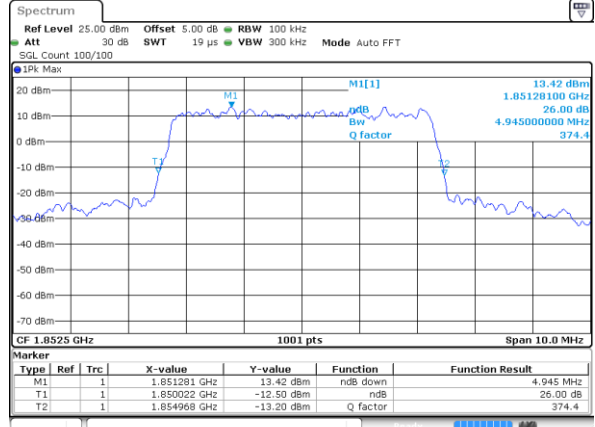

Date: 27 NOV 2020 18:07:50

Middle Channel / 5MHz / QPSK

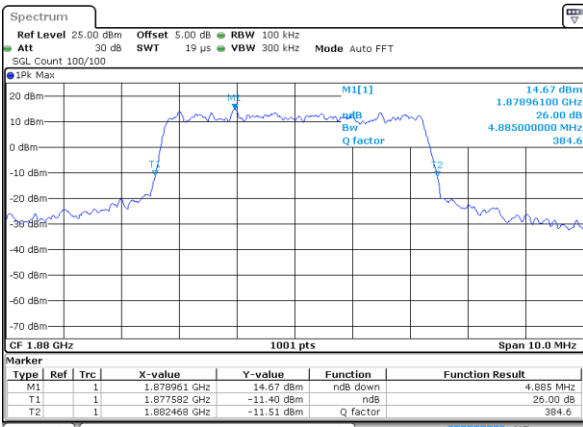

Date: 27 NOV 2020 18:16:37

Middle Channel / 5MHz / 16QAM

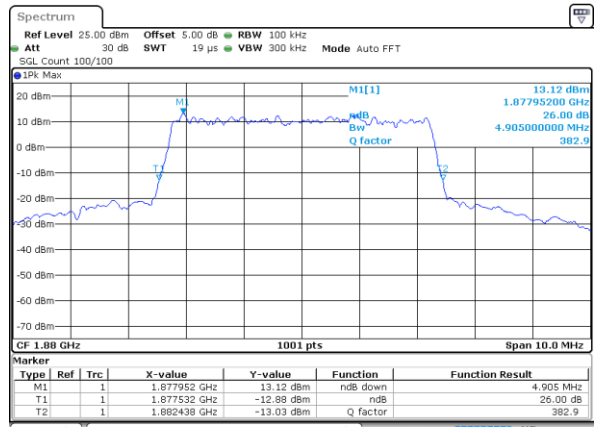

Date: 27 NOV 2020 18:16:18

Highest Channel / 5MHz / QPSK

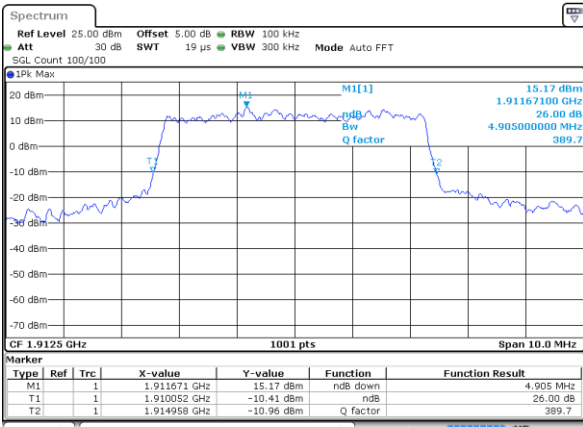

Date: 27 NOV 2020 18:16:57

Highest Channel / 5MHz / 16QAM

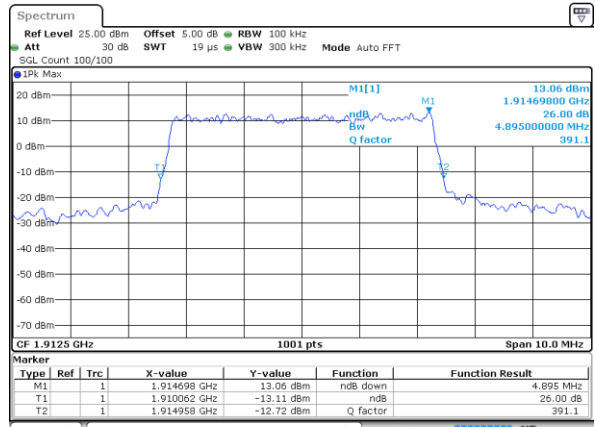

Date: 27 NOV 2020 18:17:17



LTE Band 25

Lowest Channel / 10MHz / QPSK

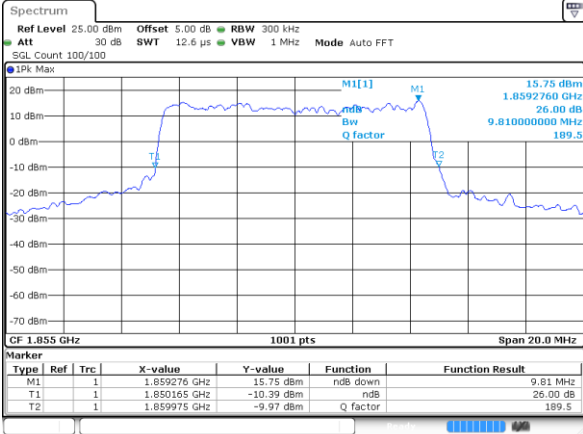

Date: 27 NOV 2020 18:24:55

Lowest Channel / 10MHz / 16QAM

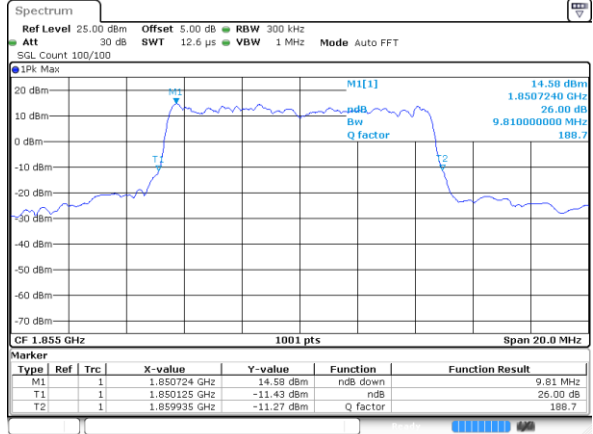

Date: 27 NOV 2020 18:25:15

Middle Channel / 10MHz / QPSK

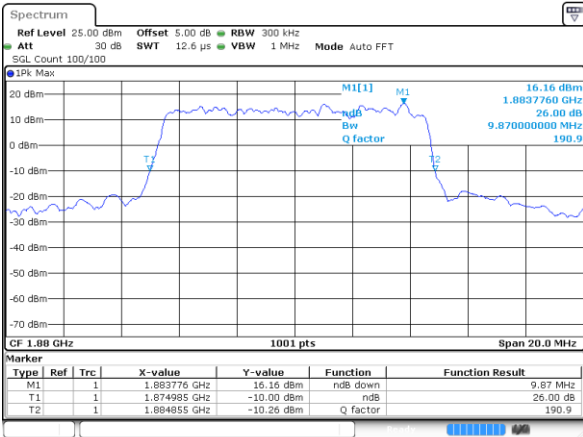

Date: 27 NOV 2020 18:34:02

Middle Channel / 10MHz / 16QAM

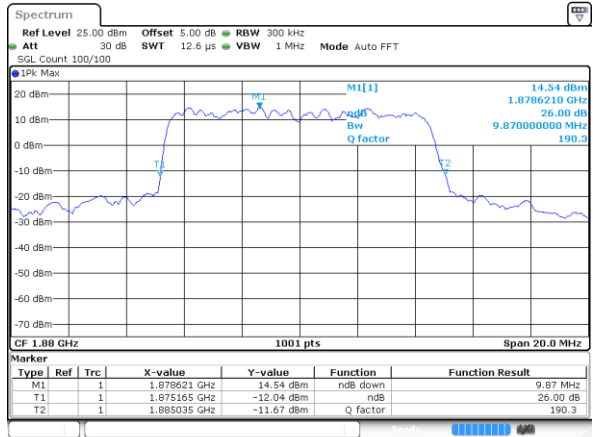

Date: 27 NOV 2020 18:33:42

Highest Channel / 10MHz / QPSK

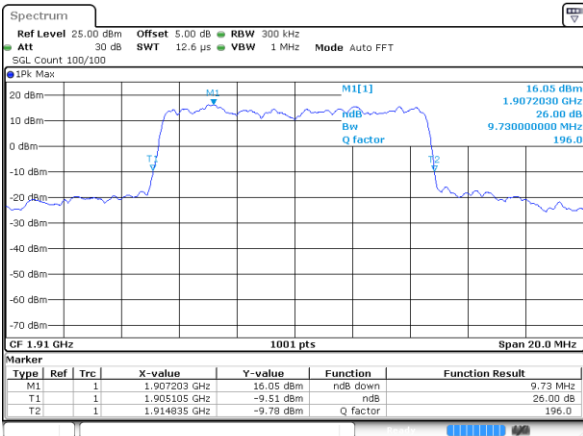

Date: 27 NOV 2020 18:34:22

Highest Channel / 10MHz / 16QAM

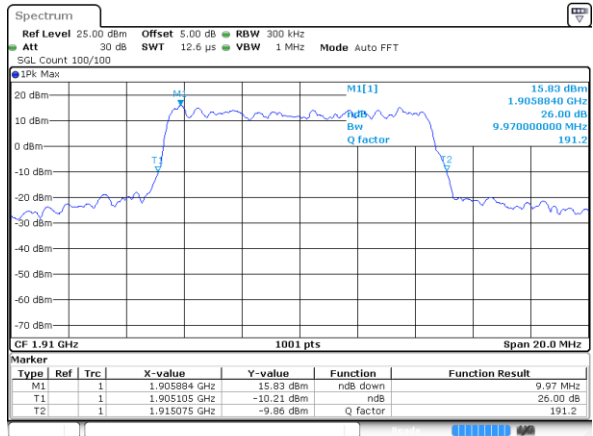

Date: 27 NOV 2020 18:34:42



LTE Band 25

Lowest Channel / 15MHz / QPSK

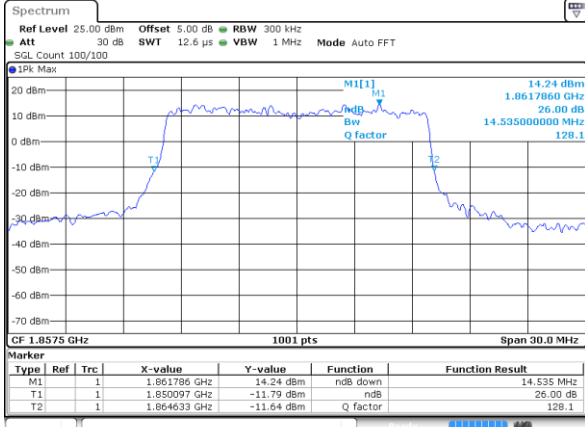

Date: 27 NOV 2020 18:42:33

Lowest Channel / 15MHz / 16QAM

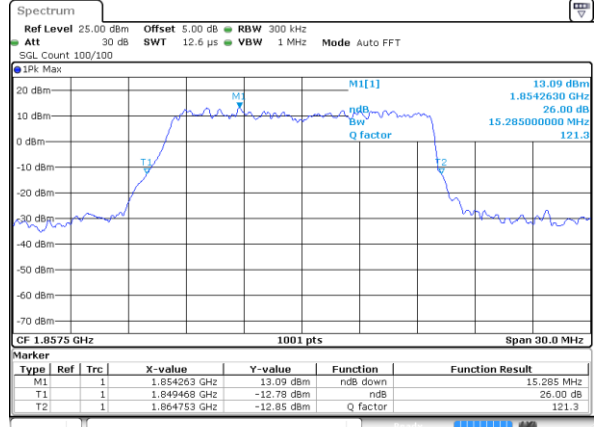

Date: 27 NOV 2020 18:42:53

Middle Channel / 15MHz / QPSK

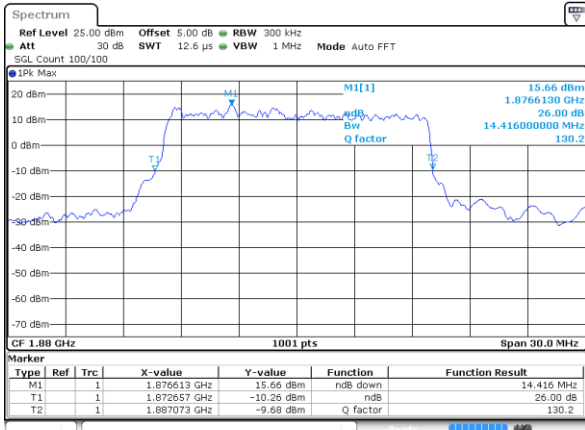

Date: 27 NOV 2020 18:51:40

Middle Channel / 15MHz / 16QAM

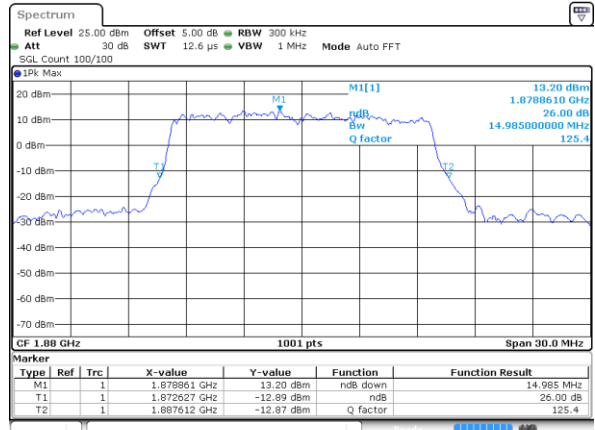

Date: 27 NOV 2020 18:51:21

Highest Channel / 15MHz / QPSK

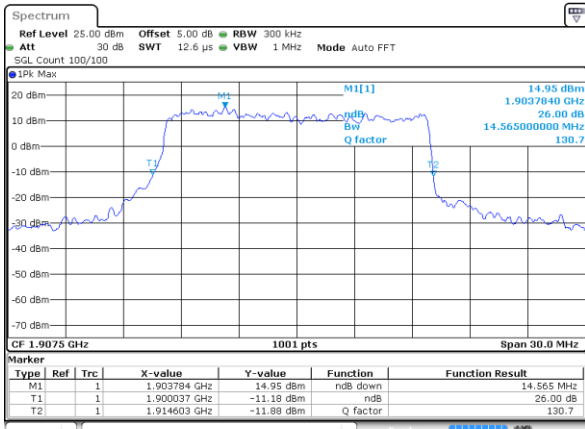

Date: 27 NOV 2020 18:52:00

Highest Channel / 15MHz / 16QAM

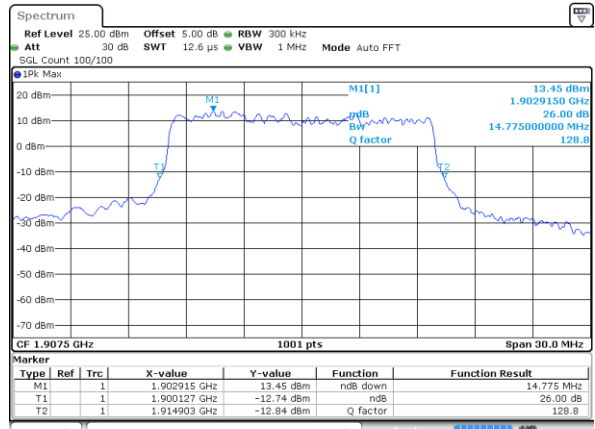

Date: 27 NOV 2020 18:52:20



LTE Band 25

Lowest Channel / 20MHz / QPSK

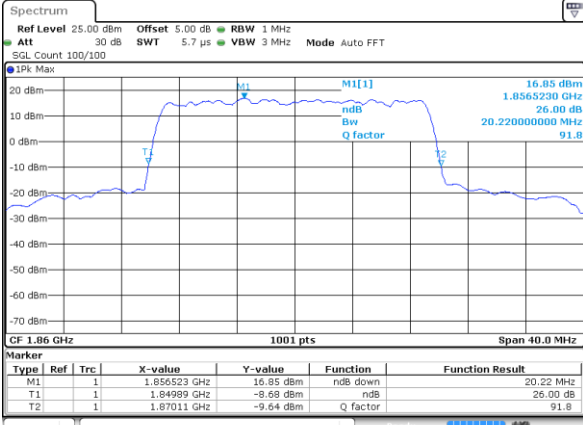

Date: 27 NOV 2020 19:00:10

Lowest Channel / 20MHz / 16QAM

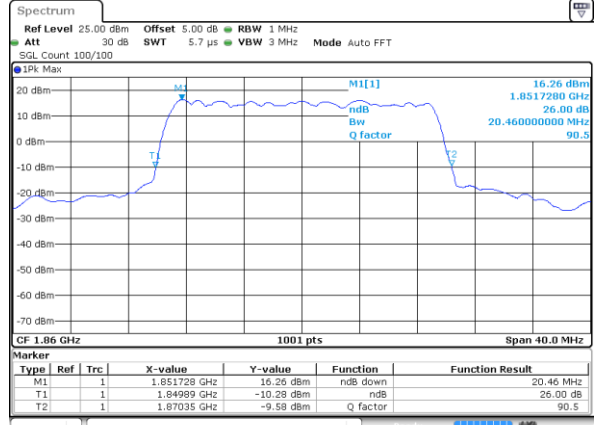

Date: 27 NOV 2020 19:00:30

Middle Channel / 20MHz / QPSK

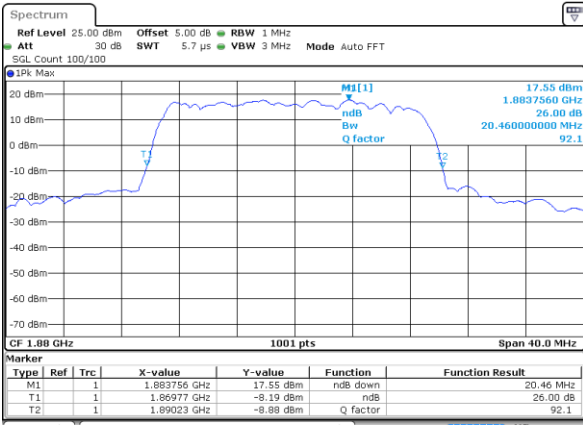

Date: 27 NOV 2020 19:09:17

Middle Channel / 20MHz / 16QAM

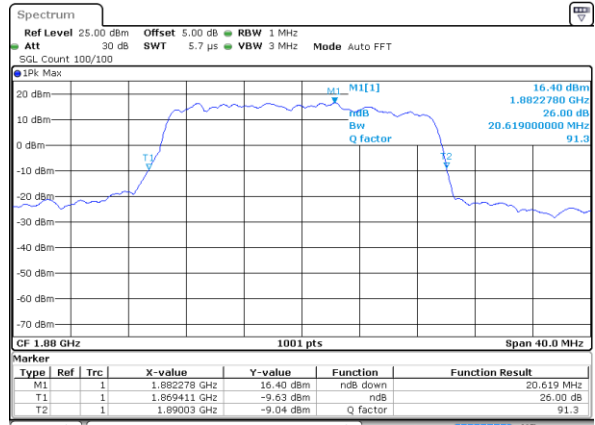

Date: 27 NOV 2020 19:08:57

Highest Channel / 20MHz / QPSK

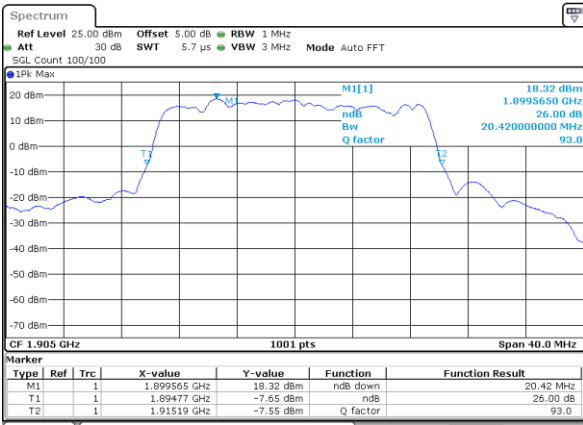

Date: 27 NOV 2020 19:09:37

Highest Channel / 20MHz / 16QAM

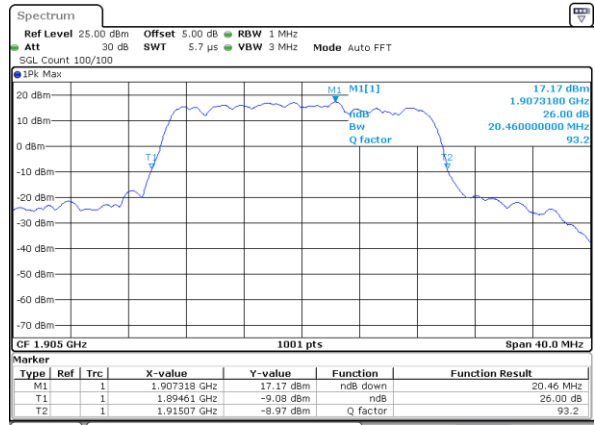

Date: 27 NOV 2020 19:09:56



Occupied Bandwidth

Mode	LTE Band 25 : 99%OBW(MHz)											
	1.4MHz		3MHz		5MHz		10MHz		15MHz		20MHz	
BW												
Mod.	QPSK	16QAM	QPSK	16QAM	QPSK	16QAM	QPSK	16QAM	QPSK	16QAM	QPSK	16QAM
Lowest CH	1.09	1.10	2.75	2.70	4.51	4.48	9.09	9.01	13.49	13.40	18.50	18.38
Middle CH	1.10	1.11	2.73	2.73	4.51	4.50	9.05	9.01	13.46	13.40	18.22	18.26
Highest CH	1.09	1.09	2.73	2.72	4.50	4.50	9.15	9.09	13.49	13.52	18.30	18.38



LTE Band 25

Lowest Channel / 1.4MHz / QPSK

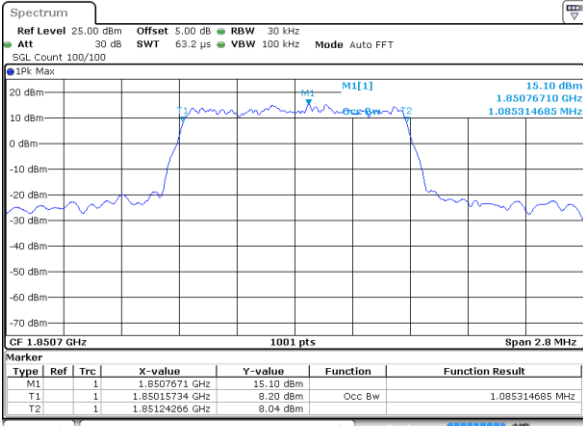

Date: 27 NOV 2020 17:21:36

Lowest Channel / 1.4MHz / 16QAM

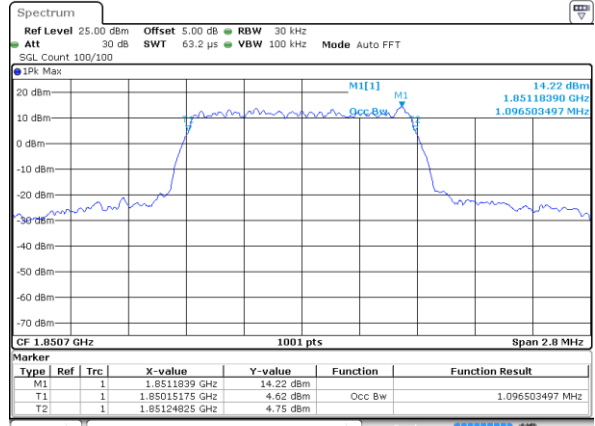

Date: 27 NOV 2020 17:21:56

Middle Channel / 1.4MHz / QPSK

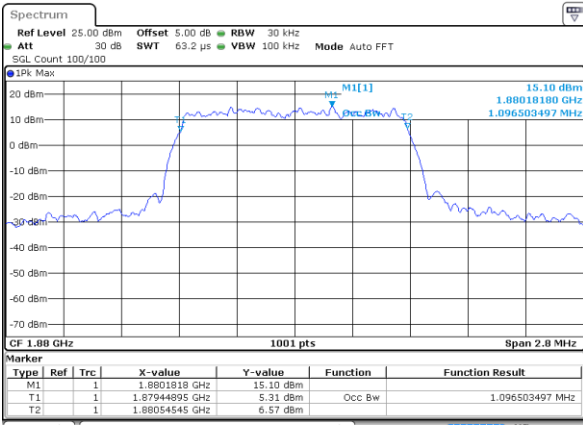

Date: 27 NOV 2020 17:22:16

Middle Channel / 1.4MHz / 16QAM

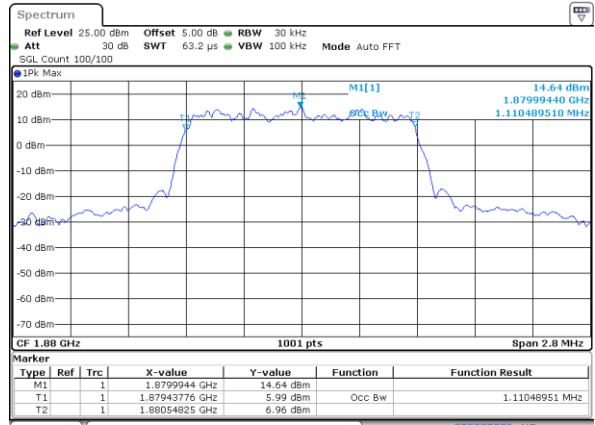

Date: 27 NOV 2020 17:22:36

Highest Channel / 1.4MHz / QPSK

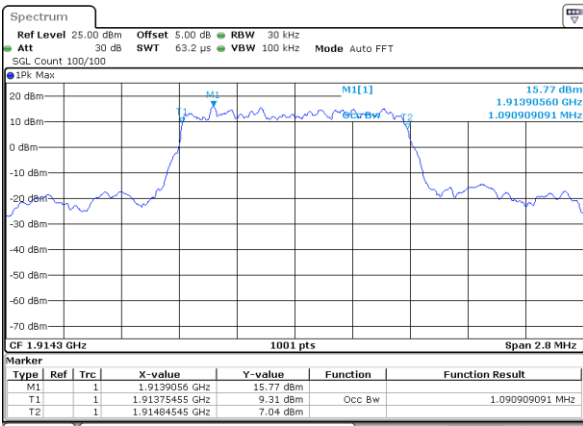

Date: 27 NOV 2020 17:22:56

Highest Channel / 1.4MHz / 16QAM

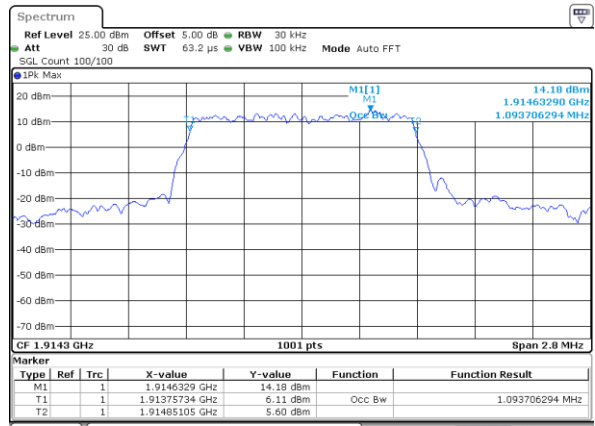

Date: 27 NOV 2020 17:23:15



LTE Band 25

Lowest Channel / 3MHz / QPSK

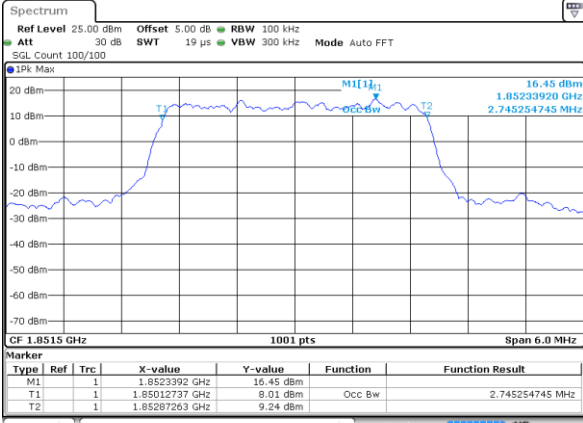

Date: 27 NOV 2020 17:50:04

Lowest Channel / 3MHz / 16QAM

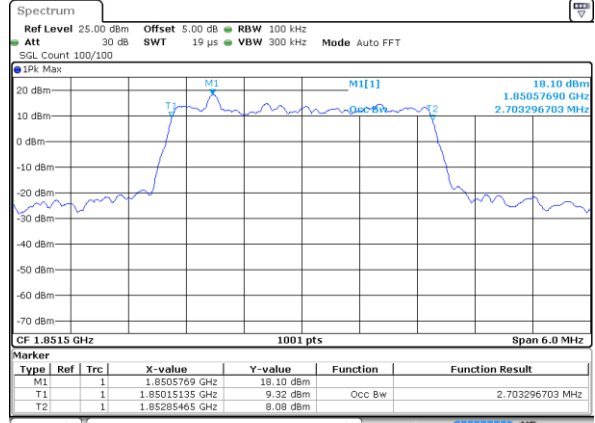

Date: 27 NOV 2020 17:50:24

Middle Channel / 3MHz / QPSK

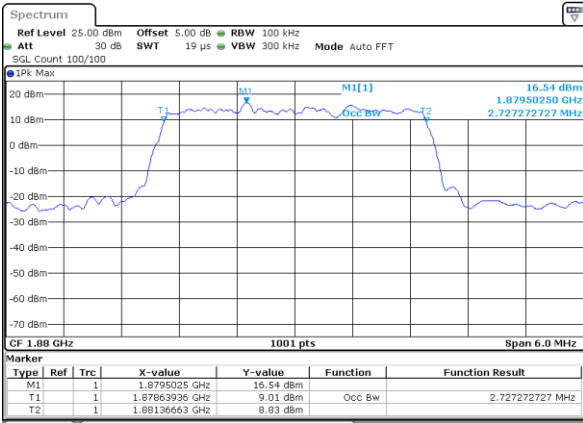

Date: 27 NOV 2020 17:50:44

Middle Channel / 3MHz / 16QAM

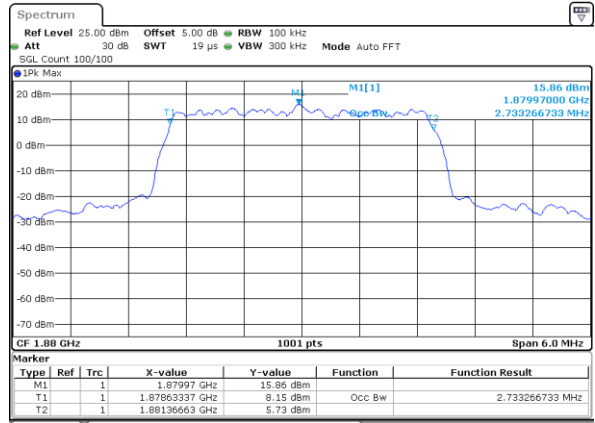

Date: 27 NOV 2020 17:51:04

Highest Channel / 3MHz / QPSK

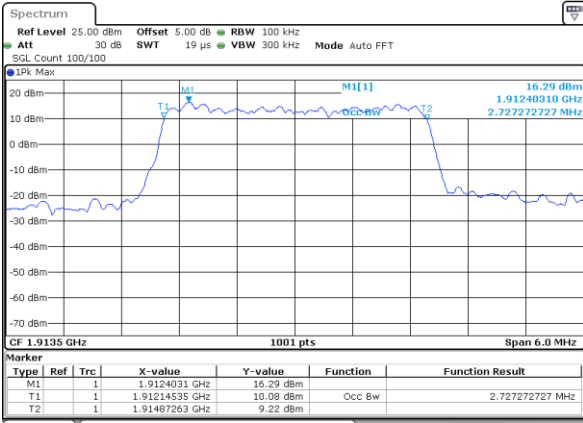

Date: 27 NOV 2020 17:51:24

Highest Channel / 3MHz / 16QAM

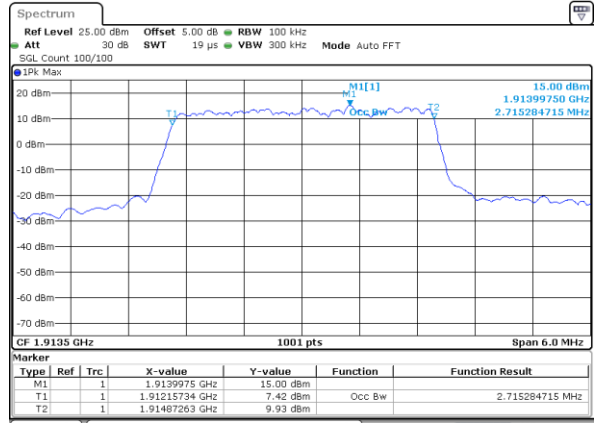

Date: 27 NOV 2020 17:51:44



LTE Band 25

Lowest Channel / 5MHz / QPSK

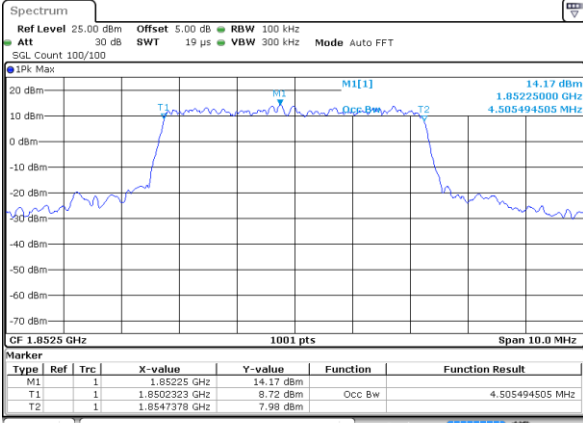

Date: 27 NOV 2020 18:07:21

Lowest Channel / 5MHz / 16QAM

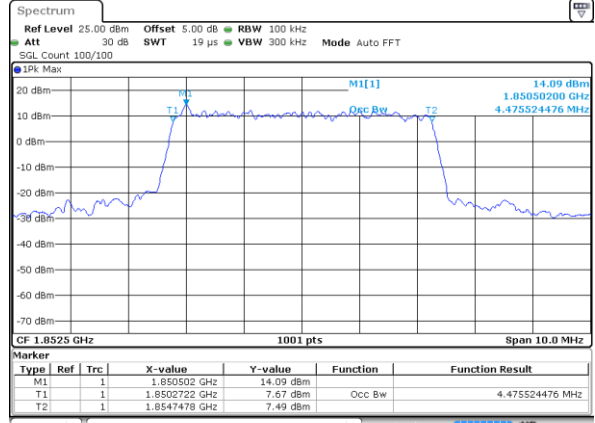

Date: 27 NOV 2020 18:07:41

Middle Channel / 5MHz / QPSK

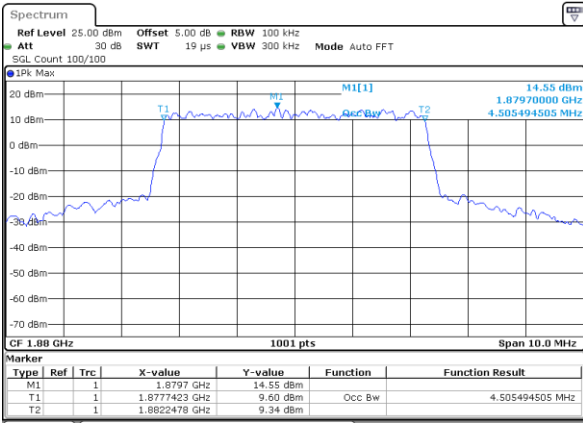

Date: 27 NOV 2020 18:16:28

Middle Channel / 5MHz / 16QAM

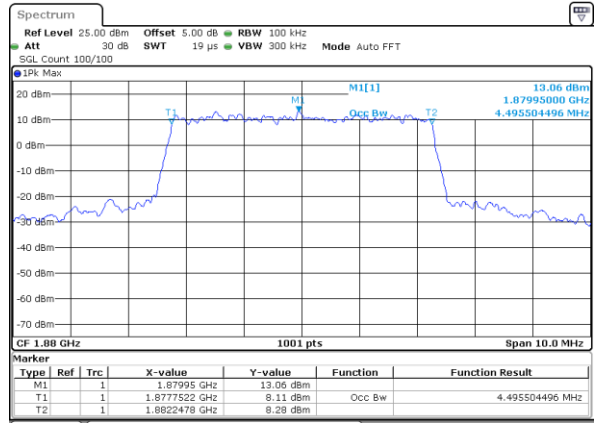

Date: 27 NOV 2020 18:16:08

Highest Channel / 5MHz / QPSK

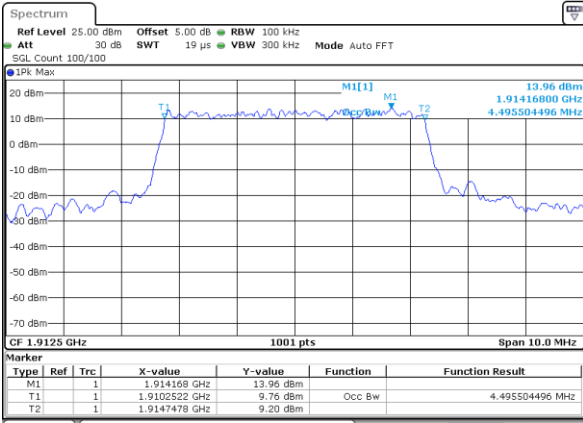

Date: 27 NOV 2020 18:16:47

Highest Channel / 5MHz / 16QAM

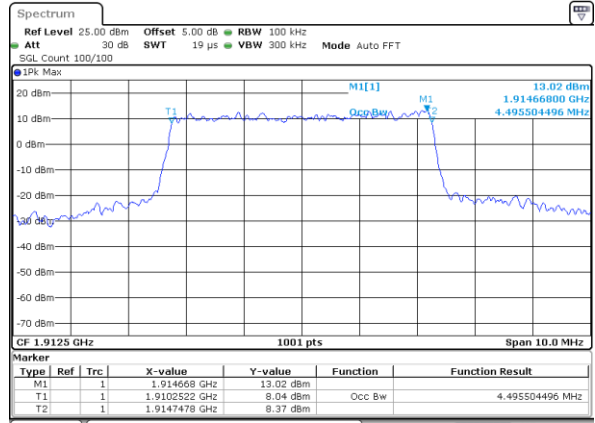

Date: 27 NOV 2020 18:17:07



LTE Band 25

Lowest Channel / 10MHz / QPSK

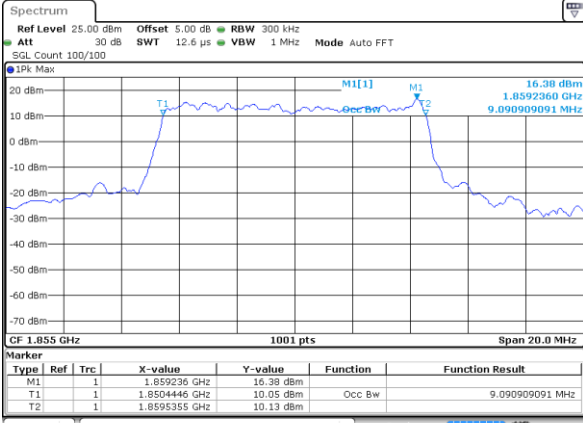

Date: 27 NOV 2020 18:24:45

Lowest Channel / 10MHz / 16QAM

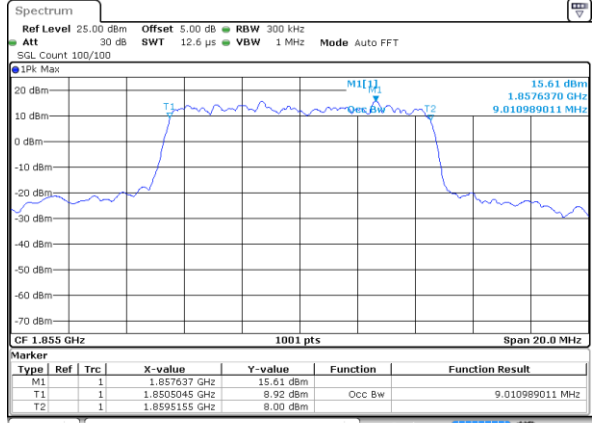

Date: 27 NOV 2020 18:25:05

Middle Channel / 10MHz / QPSK

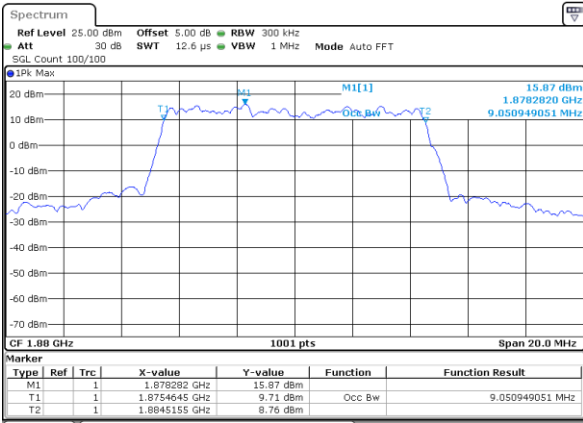

Date: 27 NOV 2020 18:33:52

Middle Channel / 10MHz / 16QAM

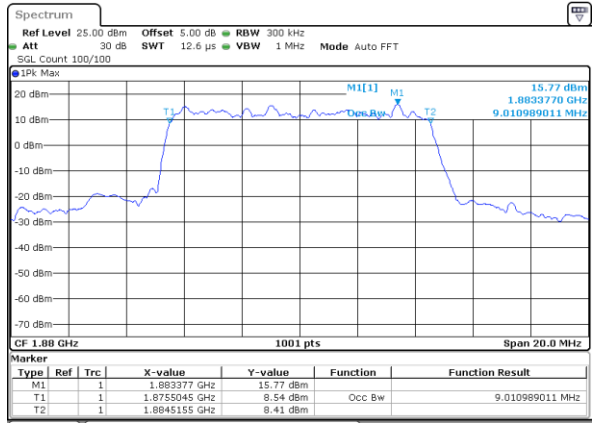

Date: 27 NOV 2020 18:33:32

Highest Channel / 10MHz / QPSK

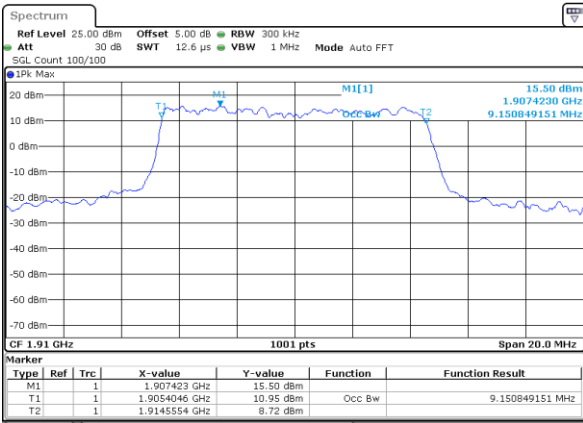

Date: 27 NOV 2020 18:34:12

Highest Channel / 10MHz / 16QAM

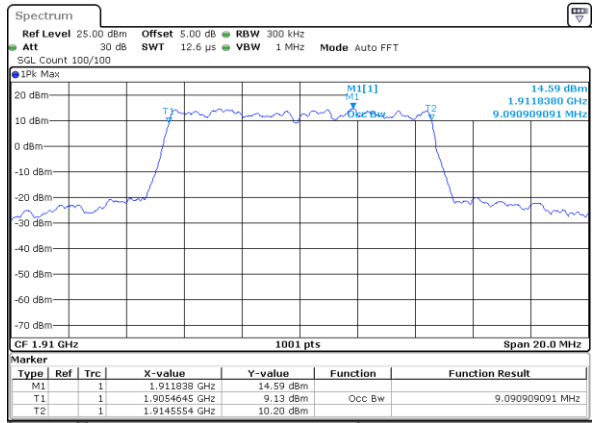

Date: 27 NOV 2020 18:34:32



LTE Band 25

Lowest Channel / 15MHz / QPSK

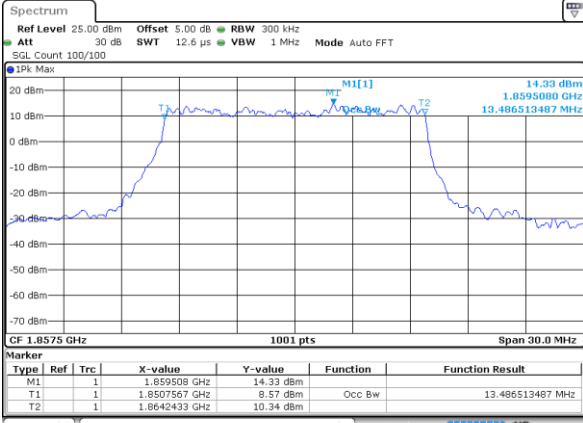

Date: 27 NOV 2020 18:42:23

Lowest Channel / 15MHz / 16QAM

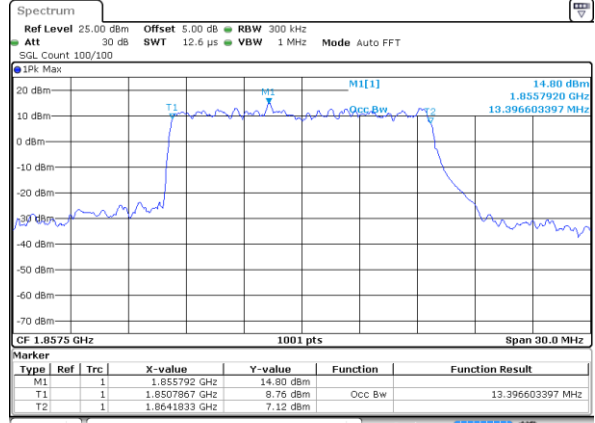

Date: 27 NOV 2020 18:42:43

Middle Channel / 15MHz / QPSK

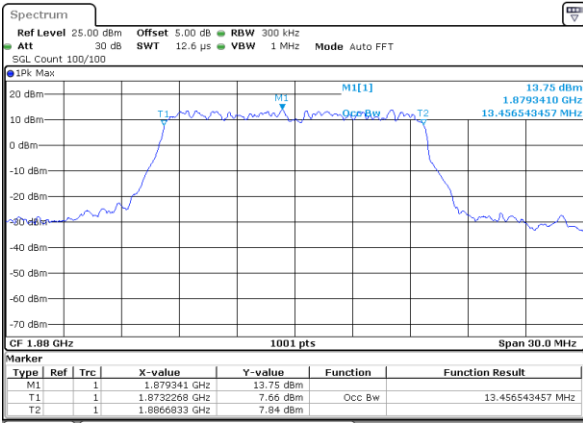

Date: 27 NOV 2020 18:51:31

Middle Channel / 15MHz / 16QAM

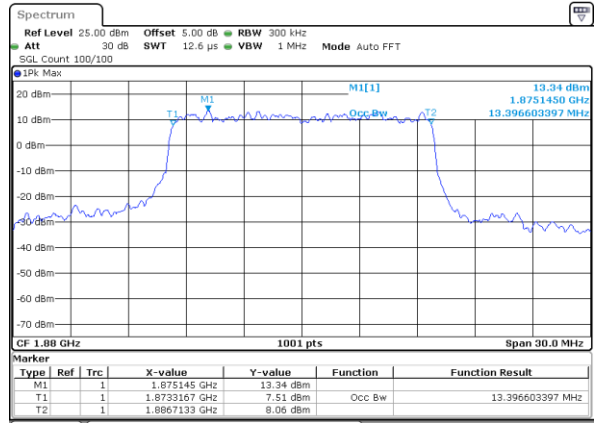

Date: 27 NOV 2020 18:51:11

Highest Channel / 15MHz / QPSK

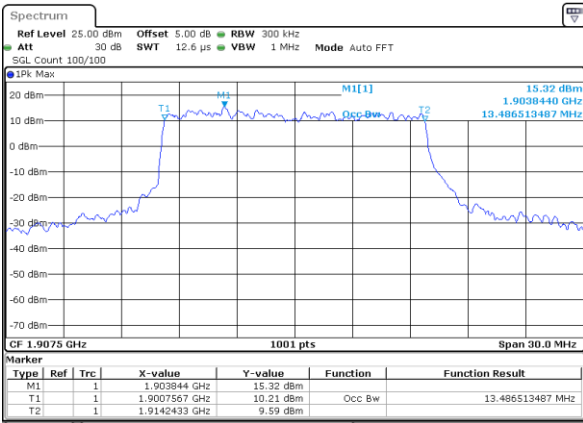

Date: 27 NOV 2020 18:51:50

Highest Channel / 15MHz / 16QAM

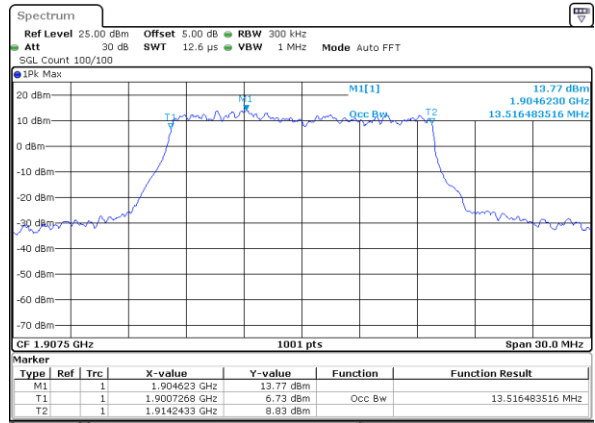

Date: 27 NOV 2020 18:52:10



LTE Band 25

Lowest Channel / 20MHz / QPSK

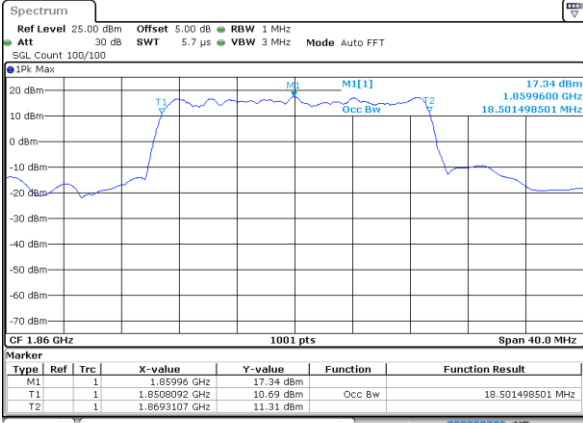

Date: 27 NOV 2020 19:00:00

Lowest Channel / 20MHz / 16QAM

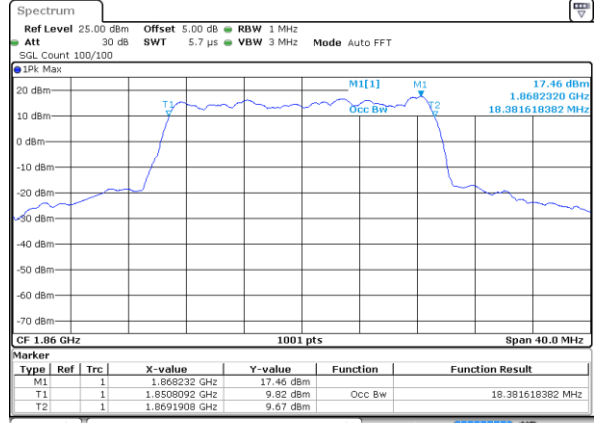

Date: 27 NOV 2020 19:00:20

Middle Channel / 20MHz / QPSK

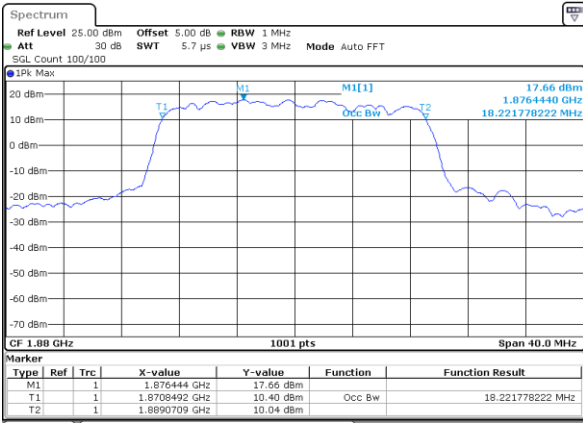

Date: 27 NOV 2020 19:09:07

Middle Channel / 20MHz / 16QAM

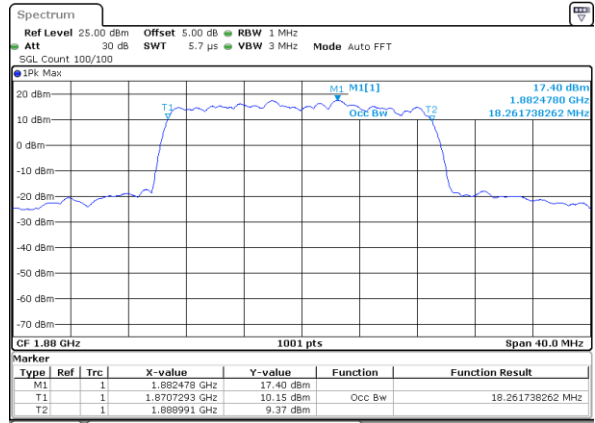

Date: 27 NOV 2020 19:08:47

Highest Channel / 20MHz / QPSK

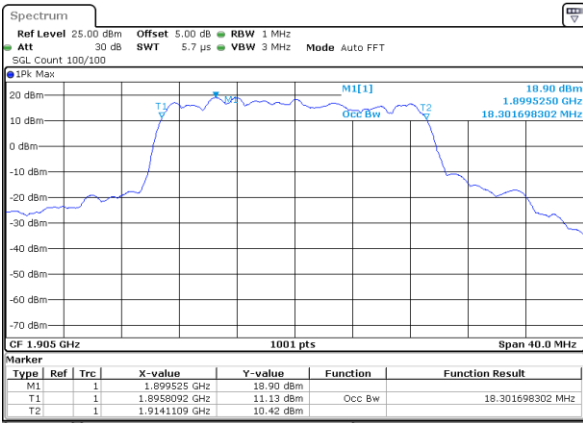

Date: 27 NOV 2020 19:09:27

Highest Channel / 20MHz / 16QAM

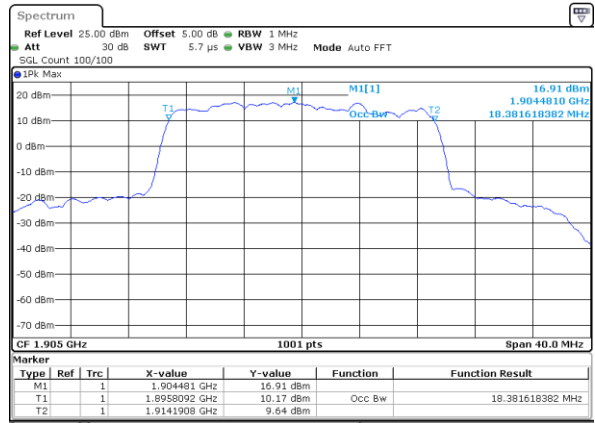

Date: 27 NOV 2020 19:09:46



Conducted Band Edge

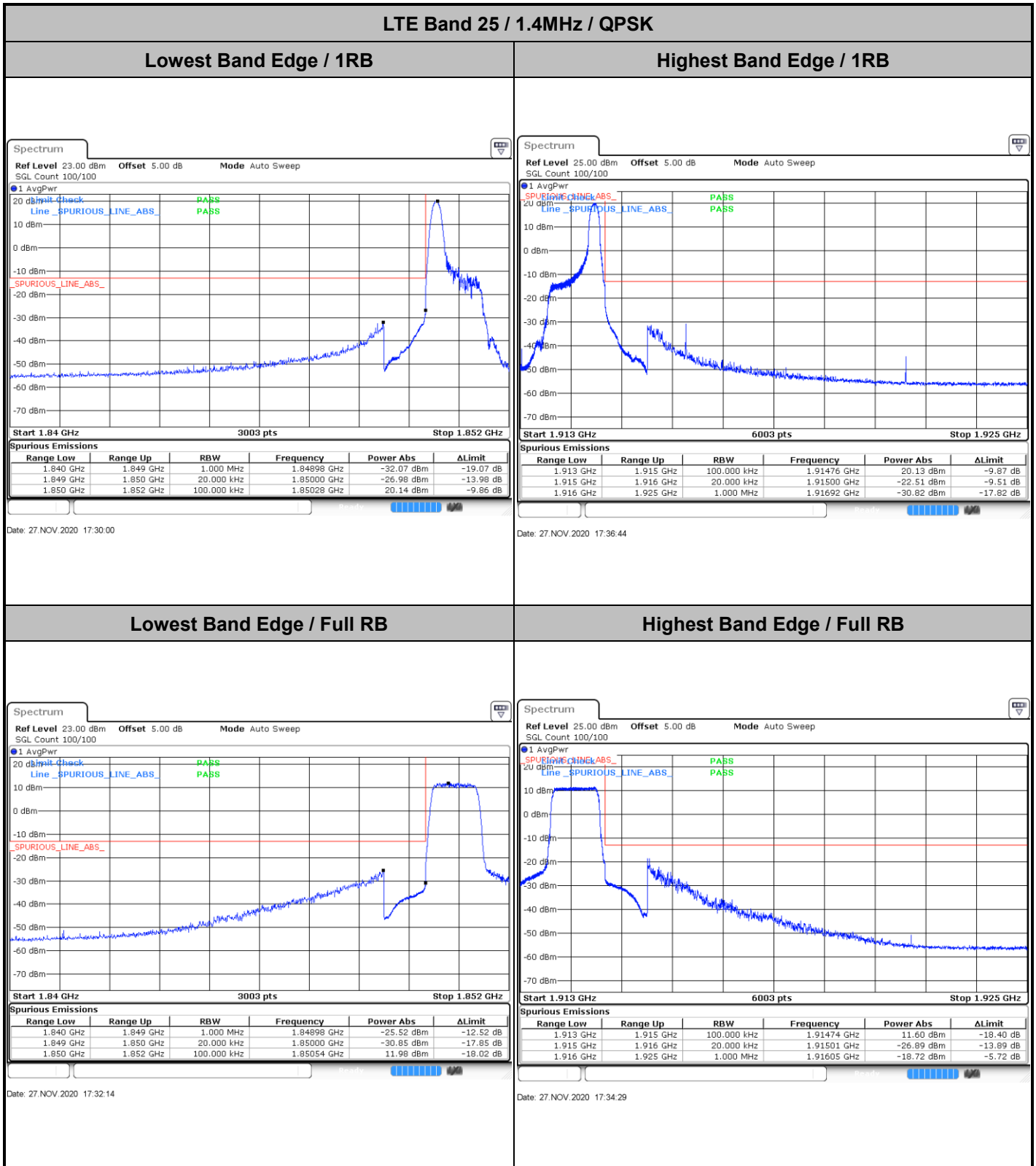



LTE Band 25 / 1.4MHz / 16QAM

Lowest Band Edge / 1 RB

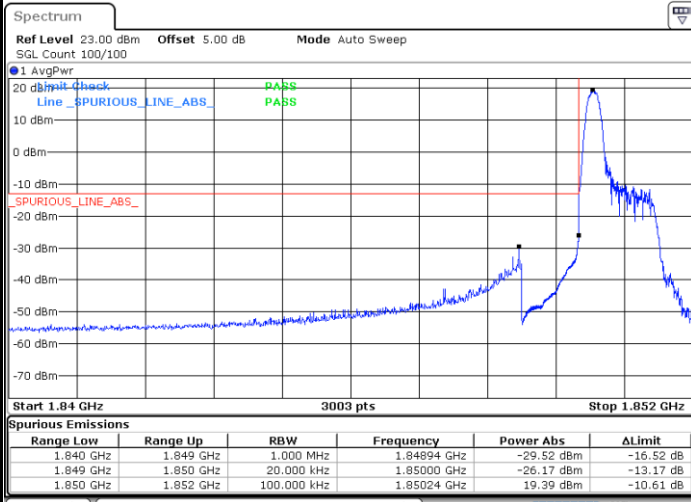

Date: 27.NOV.2020 17:31:07

Highest Band Edge / 1 RB

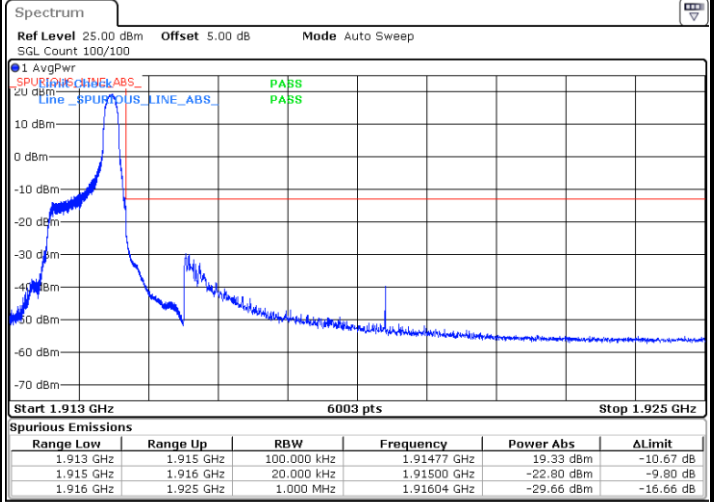

Date: 27.NOV.2020 17:37:52

Lowest Band Edge / Full RB

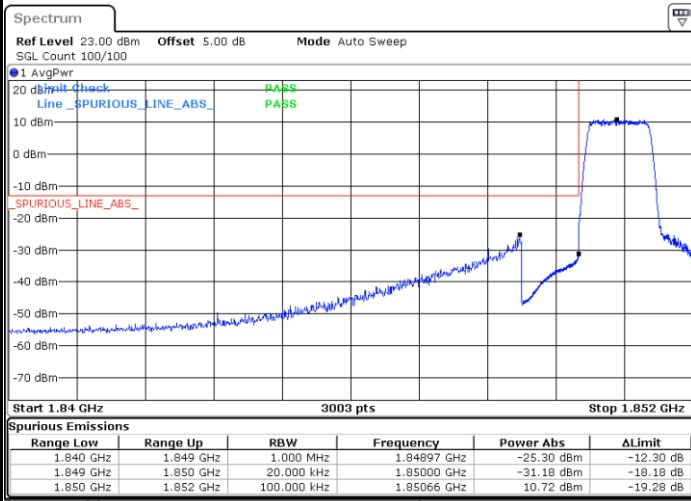

Date: 27.NOV.2020 17:33:22

Highest Band Edge / Full RB

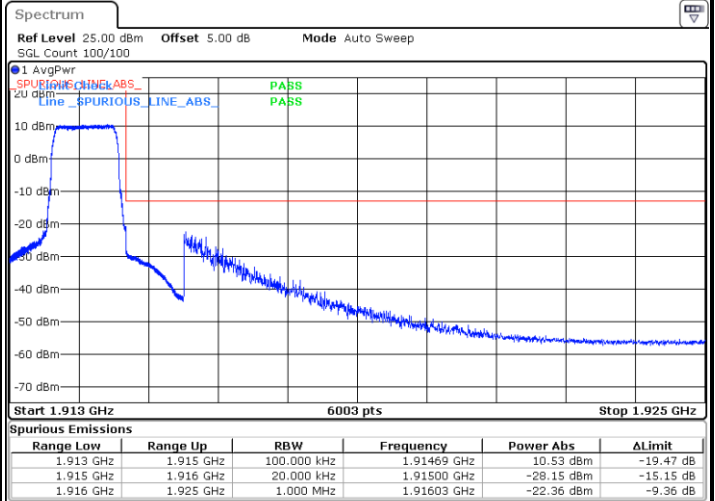

Date: 27.NOV.2020 17:35:37



LTE Band 25 / 3MHz / QPSK

Lowest Band Edge / 1RB

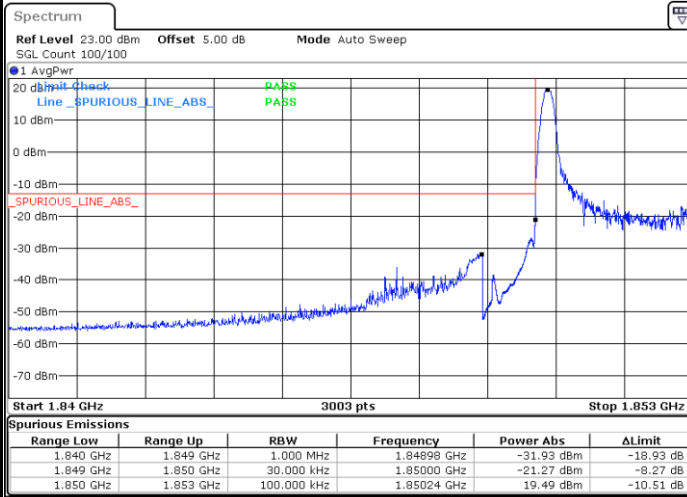

Date: 27.NOV.2020 17:55:16

Highest Band Edge / 1 RB

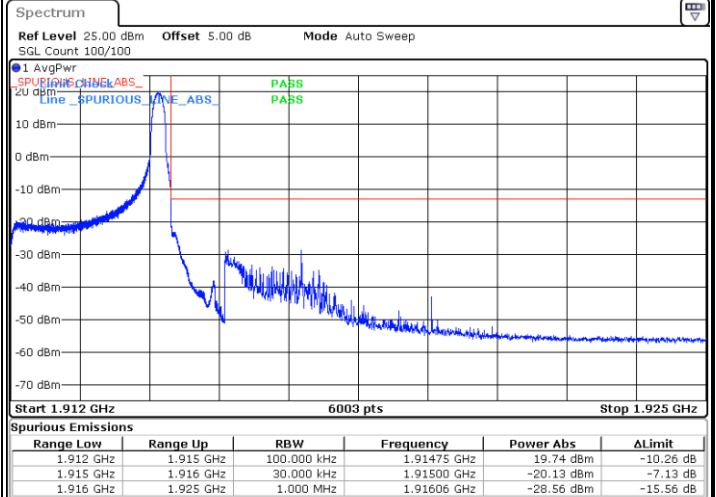

Date: 27.NOV.2020 17:57:31

Lowest Band Edge / Full RB

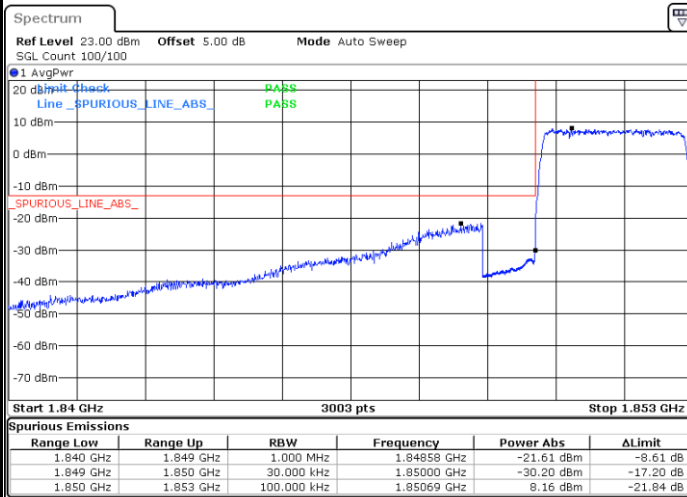

Date: 27.NOV.2020 17:53:01

Highest Band Edge / Full RB

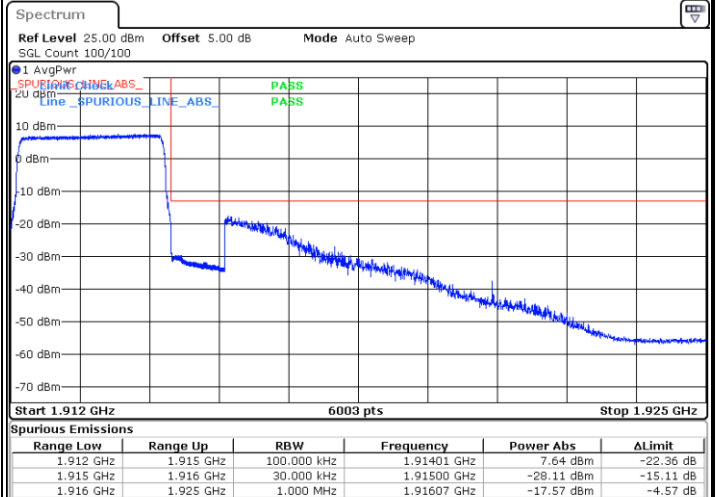

Date: 27.NOV.2020 17:58:46