



TEST REPORT

EUT Description	Convertible PC
Brand Name	HP
Model Name	HSN-I47C
FCC ID	B94HNI47CPD
Date of Test Start/End	2021-09-02 / 2021-09-07
Features	WWAN (LTE, UMTS), WLAN, BT (see section 6)
Description	Platform: HSN-I47C + WNC antenna

Applicant	HP Inc.
Address	1501 Page Mill Road, Palo Alto CA 94304 USA
Contact Person	Sam Lin
Telephone/Fax/ Email	+886 2 37896331/sam.lin2@hp.com

Reference Standards	FCC 47 CFR Part §2.1093 (see section 1)	
RF Exposure Environment	Portable devices - General population/uncontrolled exposure	
	SAR Result	SAR Limit
Maximum SAR Result & Limit	1.43 W/kg (1g)	1.6 W/kg (1g)
Min. test separation distance	0mm to phantom, 6.5mm to antenna edge	

Test Report identification	210817-02.TR03
Revision Control	Rev. 01 This test report revision replaces any previous test report revision (see section 9)

The test results relate only to the samples tested.
Reference to accreditation shall be used only by full reproduction of test report.

Issued by

Reviewed by

Robin LUCIANI
(Test Engineer Lead)

Ines KHARRAT
(Technical Officer)

Intel Corporation S.A.S – WRF Lab
425 rue de Goa – Le Cargo B6 - 06600 Antibes, France
Tel. +33493001400 / Fax +33493001401

Table of Contents

1. Standards, reference documents and applicable test methods	4
2. General conditions, competences and guarantees	4
3. Preface	5
4. Environmental Conditions	6
5. Test samples	6
6. EUT Features	7
7. Remarks and comments	10
8. Test Verdicts summary	10
9. Document Revision History	10
Annex A. Test & System Description	11
A.1 SAR DEFINITION	11
A.2 SPEAG SAR MEASUREMENT SYSTEM	12
A.2.1 SAR Measurement Setup	12
A.2.2 E-Field Measurement Probe	13
A.2.3 SAM Phantom	13
A.2.4 Flat Phantom	14
A.2.5 Device Positioner	14
A.3 DATA EVALUATION	15
A.4 SYSTEM AND LIQUID CHECK	17
A.4.1 System Check	17
A.4.2 Liquid Check	18
A.5 TEST EQUIPMENT LIST	19
A.5.1 SAR System #2	19
A.5.2 Shared Instrumentation	19
A.5.3 Tissue Simulant Liquid	19
A.6 MEASUREMENT UNCERTAINTY EVALUATION	20
A.7 RF EXPOSURE LIMITS	21
Annex B. Test Results	22
B.1 TEST CONDITIONS	22
B.1.1 Test SAR Test positions relative to the phantom	22
B.1.2 Test signal, Output power and Test Frequencies	23
B.1.3 Evaluation Exclusion and Test Reductions	24
B.2 CONDUCTED POWER MEASUREMENTS – TABLET MODE	28
B.2.1 WCDMA/ HSPA/ DC-HSPA	28
B.2.2 LTE	31
B.3 TISSUE PARAMETERS MEASUREMENT	52
B.4 SYSTEM CHECK MEASUREMENTS	52
B.5 SAR TABLET TEST RESULTS	53
B.5.1 WCDMA	53
B.5.2 LTE	54
B.5.3 SAR Measurement Variability	57
B.5.4 Simultaneous Transmission SAR Evaluation	58
Annex C. Test System Plots	61
Annex D. TSL Dielectric Parameters	82
D.1 BODY 600MHZ-900MHZ	82

D.2	BODY 1700MHZ-2000MHZ	84
D.3	BODY 2300MHZ-2700MHZ	86
Annex E.	Calibration Certificates	88
Annex F.	Photographs	90
F.1	TEST SAMPLES	90
F.2	TEST POSITIONS.....	91
F.3	ANTENNA HOST PLATFORM LOCATION AND ADJACENT EDGE POSITIONS RELATIVE TO THE BODY	92
F.4	PHANTOM LIQUID LEVEL DURING MEASUREMENTS	93

1. Standards, reference documents and applicable test methods

FCC

1. FCC Title 47 CFR Part §2.1093 – Radiofrequency radiation exposure evaluation: portable devices. 2019-10-01 Edition
2. FCC OET KDB 447498 D01 v06 – RF Exposure Procedures and Equipment Authorization Policies for Mobile and Portable Devices.
3. FCC OET KDB 616217 D04 v01r02 – SAR Evaluation Considerations for Laptop, Notebook, Netbook and Tablet Computers.
4. FCC OET KDB 865664 D01 v01r04 – SAR Measurement Requirements for 100 MHz to 6 GHz.
5. FCC OET KDB 865664 D02 v01r02 – RF Exposure Compliance Reporting and Documentation Considerations.
6. FCC OET KDB 941225 D05 v02r05 – SAR Evaluation Considerations for LTE Devices.
7. FCC OET KDB 941225 D01 v03r01 – 3G SAR Measurement Procedures.
8. IEEE Std 1528-2013 – IEEE Recommended Practice Determining the Peak Spatial-Average Specific Absorption Rate (SAR) in the Human Head from Wireless Communication Devices: Measurement Techniques...

2. General conditions, competences and guarantees

- ✓ Tests performed under FCC standards identified in section 1 are covered by A2LA accreditation.
- ✓ Intel Corporation SAS Wireless RF Lab (Intel WRF Lab) is an ISO/IEC 17025:2017 laboratory accredited by the American Association for Laboratory Accreditation (A2LA) with the certificate number 3478.01.
- ✓ Intel Corporation SAS Wireless RF Lab (Intel WRF Lab) is an Accredited Test Firm recognized by the FCC, with Designation Number FR0011.
- ✓ Intel WRF Lab declines any responsibility with respect to the identified information provided by the customer and that may affect the validity of results.
- ✓ Intel WRF Lab only provides testing services and is committed to providing reliable, unbiased test results and interpretations.
- ✓ Intel WRF Lab is liable to the client for the maintenance of the confidentiality of all information related to the item under test and the results of the test.
- ✓ Intel WRF Lab has developed calibration and proficiency programs for its measurement equipment to ensure correlated and reliable results to its customers.
- ✓ This report is only referred to the item that has undergone the test.
- ✓ This report does not imply an approval of the product by the Certification Bodies or competent Authorities.

3. Preface

The HSN-I47C Convertible PC includes the Time Averaging SAR (TAS) concept. The TAS algorithm is implemented in the Intel XMM 7360 Cellular Modem, which is incorporated in the HSN-I47C cellular module (FCC ID: ZMOL850GL).

The implementation details and TAS operating characteristics are described in a separated document [1]. The validation of algorithm operations is performed by Intel Corporation according to the range of commonly used accessible control parameters used for typical host products. The validation results are reported in document [2].

The FCC SAR limit is a time averaged exposure metric. At host level, the normally required SAR test procedures are applicable for SAR compliance testing at upper-threshold values of the algorithm, which is the maximum output power level for continuous time-averaging operations TAS algorithm enforces. The reliability of this has been demonstrated by results in the Algorithm Validation Test Report [2].

The model supports simultaneous transmission of WWAN, BT and WLAN. The TAS algorithm is only applied to WWAN cellular module. The WLAN / BT SAR evaluation is presented in the documents [3].

The SAR evaluation of WWAN is performed in this report as well as the RF exposure assessment for simultaneous transmission of WWAN, WLAN and BT.

[1] 190214_TAS_Operational_Report_XMM7360_KDB_Rev04

[2] 171110-01.TR02 - TAS_Validation_report_Rev02

[3] 210817-02.TR02 - HSN-I47C, SAR WLAN_AX201NGW, FCC_ISED WNC_HB

4. Environmental Conditions

✓ At the site where the measurements were performed the following limits were not exceeded during the tests:

Temperature	21.5°C ± 2°C
Humidity	40.5% ± 20%
Liquid Temperature	21°C ± 2°C

5. Test samples

Sample	Control #	Description	Model	Serial #	Date of receipt
#01	210817-02.S09	Convertible PC	HSN-I47C	0001760970	2021-08-02

6. EUT Features

Brand Name	HP
Model Name	HSN-I47C
Prototype / Production	Production
Host Identification	HSN-I47C

Supported radios

The module is a data only DUT supporting UMTS and LTE, without carrier aggregation. The applicable frequency bands and operating modes are identified in the following table, where North America bands are shown in **bold**.

WWAN:

Mode	Bands	Supported Tx Mode			
		WCDMA	HSDPA	HSUPA	DC-HSDPA
WCDMA / HSPA+	FDD I (1920.0 – 1980.0 MHz)	✓	✓	✓	✓
	FDD II (1850.0 – 1910.0 MHz)	✓	✓	✓	✓
	FDD IV (1710.0 – 1755.0 MHz)	✓	✓	✓	✓
	FDD V (824.0 – 849.0 MHz)	✓	✓	✓	✓
	FDD VIII (880.0 – 915.0 MHz)	✓	✓	✓	✓

FDD/TDD	Band	Modulation	Bandwidth					
			1.4	3	5	10	15	20
LTE FDD	Band 1 (1920.0 – 1980.0 MHz)	QPSK/16QAM			✓	✓	✓	✓
	Band 2 (1850.0 – 1910.0 MHz)	QPSK/16QAM	✓	✓	✓	✓	✓	✓
	Band 3 (1710.0 – 1785.0 MHz)	QPSK/16QAM	✓	✓	✓	✓	✓	✓
	Band 4 (1710.0 – 1755.0 MHz)	QPSK/16QAM	✓	✓	✓	✓	✓	✓
	Band 5 (824.0 – 849.0 MHz)	QPSK/16QAM	✓	✓	✓	✓		
	Band 7 (2500.0 – 2570.0 MHz)	QPSK/16QAM			✓	✓	✓	✓
	Band 8 (880.0 – 915.0 MHz)	QPSK/16QAM	✓	✓	✓	✓		
	Band 11 (1427.9 – 1447.9 MHz)	QPSK/16QAM			✓	✓		
	Band 12 (699.0 – 716.0 MHz)	QPSK/16QAM	✓	✓	✓	✓		
	Band 13 (777.0 – 787.0 MHz)	QPSK/16QAM			✓	✓		
	Band 17 (704.0 – 716.0 MHz)	QPSK/16QAM			✓	✓		
	Band 18 (815.0 – 830.0 MHz)	QPSK/16QAM			✓	✓	✓	
	Band 19 (830.0 – 845.0 MHz)	QPSK/16QAM			✓	✓	✓	
	Band 20 (832.0 – 862.0 MHz)	QPSK/16QAM			✓	✓	✓	✓
	Band 21 (1447.9 – 1462.9 MHz)	QPSK/16QAM			✓	✓	✓	
	Band 26 (814.0 – 849.0 MHz)	QPSK/16QAM	✓	✓	✓	✓	✓	
	Band 28 (703.0 – 748.0 MHz)	QPSK/16QAM		✓	✓	✓	✓	✓
	Band 30 (2305.0 – 2315.0 MHz)	QPSK/16QAM			✓	✓		
	Band 66 (1710.0 – 1780.0 MHz)	QPSK/16QAM	✓	✓	✓	✓	✓	✓
LTE TDD	Band 38 (2570.0 – 2620.0 MHz)	QPSK/16QAM			✓	✓	✓	✓
	Band 39 (1880.0 – 1920.0 MHz)	QPSK/16QAM			✓	✓	✓	✓
	Band 40 (2300.0 – 2400.0 MHz)	QPSK/16QAM			✓	✓	✓	✓
	Band 41 (2496.0 – 2690.0 MHz)	QPSK/16QAM			✓	✓	✓	✓

WLAN

Mode	UL Freq Range
802.11b/g/n/ax	2.4GHz (2400.0 – 2483.5 MHz)
802.11a/n/ac/ax	5.2GHz (5150.0 – 5250.0 MHz) 5.3GHz (5250.0 – 5350.0 MHz) 5.6GHz (5470.0 – 5725.0 MHz) 5.8GHz (5725.0 – 5850.0 MHz)
Bluetooth & BLE v5.1	2.4GHz (2400.0 – 2483.5 MHz)

Antenna Information “information provided by the applicant”

The DUT has 1 WWAN TX antenna:

- WWAN Main Tx1 Antenna: WNC, PIFA antenna.
P/N : 6036B0315701 (81EABL15.G50)

See Annex *F* for more details on antennas location.

Simultaneous Transmission Configurations

WWAN Main + WLAN 2.4GHz Main + BT Aux
 WWAN Main + WLAN 2.4GHz Main + WLAN 2.4GHz Aux
 WWAN Main + WLAN 5GHz Main + BT Aux
 WWAN Main + WLAN 5GHz Main + WLAN 5GHz Aux
 WWAN Main + WLAN 5GHz Main + WLAN 5GHz Aux + BT Aux

WLAN transmitter is considered in this report just for the simultaneous transmission evaluation with the WWAN module (See section B.5.4)

Additional information

- 5.60-5.65 GHz band (TDWR) is supported by the device
- Band gap is supported by the device
- Two different power settings are implemented in the DUT:
 - Max power for Notebook mode
 - Reduced power for Tablet mode
- The DUT does not support VoLTE, so Head Exposure is not considered for LTE and WCDMA modes. Maximum Power Reduction (MPR) is implemented according to 3GPP, and it is a permanent feature, built-in by design:

Modulation	Channel bandwidth / #RB						MPR (dB)
	1.4 MHz	3.0 MHz	5 MHz	10 MHz	15 MHz	20 MHz	
QPSK	> 5	> 4	> 8	> 12	> 16	> 18	≤ 1
16 QAM	≤ 5	≤ 4	≤ 8	≤ 12	≤ 16	≤ 18	≤ 1
16 QAM	> 5	> 4	> 8	> 12	> 16	> 18	≤ 2
64 QAM	≤ 5	≤ 4	≤ 8	≤ 12	≤ 16	≥ 18	≤ 2
64 QAM	> 5	> 4	> 8	> 12	> 16	> 18	≤ 3
256 QAM	≥ 1						≤ 5

A-MPR (additional MPR) was disabled during SAR testing

The following table indicates the power levels and tolerance for each mode:

Maximum Output power specification + Tune up tolerance

Mode	Technology	Bands	Class	Nominal (dBm)	Tolerance dB	Lower Tolerance (dBm)	Upper Tolerance (dBm)
Tablet	WCDMA/HSPA	FDD II (1850.0 – 1910.0 MHz)	3	22.00	±1	21.00	23.00
	WCDMA/HSPA	FDD IV (1710.0 – 1755.0 MHz)	3	20.00	±1	19.00	21.00
	WCDMA/HSPA	FDD V (824.0 – 849.0 MHz)	3	22.00	±1	21.00	23.00
	LTE	Band 2 (1850.0 – 1910.0 MHz)	3	22.00	±1	21.00	23.00
	LTE	Band 4 (1710.0 – 1755.0 MHz)	3	20.00	±1	19.00	21.00
	LTE	Band 5 (824.0 – 849.0 MHz)	3	22.00	±1	21.00	23.00
	LTE	Band 7 (2500.0 – 2570.0 MHz)	3	17.00	±1	16.00	18.00
	LTE	Band 12 (699.0 – 716.0 MHz)	3	22.00	±1	21.00	23.00
	LTE	Band 13 (777.0 – 787.0 MHz)	3	22.00	±1	21.00	23.00
	LTE	Band 17 (704.0 – 716.0 MHz)	3	22.00	±1	21.00	23.00
	LTE	Band 26 (814.0 – 849.0 MHz)	3	22.00	±1	21.00	23.00
	LTE	Band 30 (2305.0 – 2315.0 MHz)	3	22.00	±1	21.00	23.00
	LTE	Band 66 (1710.0 – 1780.0 MHz)	3	20.00	±1	19.00	21.00
	LTE	Band 38 (2570.0 – 2620.0 MHz)	3	20.00	±1	19.00	21.00
LTE	Band 41 (2496.0 – 2690.0 MHz)	3	19.50	±1	18.50	20.50	

As mentioned in Section 3, the SAR compliance testing is performed at upper-threshold values of the algorithm, which is the maximum output power level for continuous time-averaging operations TAS algorithm enforces.

In TAS operation, the control parameters including the upper-threshold value are stored in NVM. They are inaccessible to the normal users and no other interface is available for changing these control parameters.

The table below shows the upper-threshold values used as continuous power for SAR testing as well as the different TAS parameters defined in [1] and [2] to be embedded in the host:

Mode	Technology	Bands	Class	Nominal Full Power (dBm)	Upper Threshold (dBm)	Lower Threshold (dBm)	DPR_ON Power (dBm)
Tablet	WCDMA/HSPA	FDD II (1850.0 – 1910.0 MHz)	3	23.5	22.00	21.00	20.00
	WCDMA/HSPA	FDD IV (1710.0 – 1755.0 MHz)	3	23.5	20.00	19.00	18.00
	WCDMA/HSPA	FDD V (824.0 – 849.0 MHz)	3	23.5	22.00	21.00	20.00
	LTE	Band 2 (1850.0 – 1910.0 MHz)	3	23	22.00	21.00	20.00
	LTE	Band 4 (1710.0 – 1755.0 MHz)	3	23	20.00	19.00	18.00
	LTE	Band 5 (824.0 – 849.0 MHz)	3	23	22.00	21.00	20.00
	LTE	Band 7 (2500.0 – 2570.0 MHz)	3	23	17.00	16.00	15.00
	LTE	Band 12 (699.0 – 716.0 MHz)	3	23	22.00	21.00	20.00
	LTE	Band 13 (777.0 – 787.0 MHz)	3	23	22.00	21.00	20.00
	LTE	Band 17 (704.0 – 716.0 MHz)	3	23	22.00	21.00	20.00
	LTE	Band 26 (814.0 – 849.0 MHz)	3	23	22.00	21.00	20.00
	LTE	Band 30 (2305.0 – 2315.0 MHz)	3	23	22.00	21.00	20.00
	LTE	Band 66 (1710.0 – 1780.0 MHz)	3	23	20.00	19.00	18.00
	LTE	Band 38 (2570.0 – 2620.0 MHz)	3	23	20.00	19.00	18.00
LTE	Band 41 (2496.0 – 2690.0 MHz)	3	23	19.50	18.50	17.50	

SAR compliance is demonstrated with the *Reported SAR*:

$$\text{Reported SAR} = \text{measured } 1g\text{SAR @ Reported Upper Threshold} < \text{FCC SAR limit}$$

$$\text{Where, Reported Upper Threshold} = \text{Upper Threshold (stored in NVM)} + \text{Tolerance}$$

7. Remarks and comments

- Only the plots for the test positions with the highest measured SAR per band/mode are included in Annex C as required per FCC OET KDB 865664 D02, paragraph 2.3.h.

8. Test Verdicts summary

The statement of conformity to applicable standards in the table below are based on the measured values, without taking into account the measurement uncertainties.

Mode	Band (UL)	Highest Reported SAR (1g) (W/kg)	Verdict
WCDMA	FDD II (1850.0 – 1910.0 MHz)	1.08	P
	FDD IV (1710.0 – 1755.0 MHz)	0.89	P
	FDD V (824.0 – 849.0 MHz)	0.75	P
LTE FDD	Band 2 (1850.0 – 1910.0 MHz)	1.43	P
	Band 4 (1710.0 – 1755.0 MHz)	NM	NA
	Band 5 (824.0 – 849.0 MHz)	NM	NA
	Band 7 (2500.0 – 2570.0 MHz)	1.01	P
	Band 12 (699.0 – 716.0 MHz)	0.73	P
	Band 13 (777.0 – 787.0 MHz)	0.58	P
	Band 17 (704.0 – 716.0 MHz)	NM	NA
	Band 26 (814.0 – 849.0 MHz)	0.75	P
	Band 30 (2305.0 – 2315.0 MHz)	1.34	P
	Band 66 (1710.0 – 1780.0 MHz)	0.86	P
LTE TDD	Band 38 (2570.0 – 2620.0 MHz)	1.12	P
	Band 41 (2496.0 – 2690.0 MHz)	1.07	P

P: Pass
 F: Fail
 NM: Not Measured
 NA: Not Applicable

According to the FCC OET KDB 690783 D01, this is the summary of the values for the Grant Listing:

Exposure Condition	Highest Reported SAR (1g) (W/kg)			
	Equipment Class			
	PCE	DTS	DSS	U-NII
Body Worn	1.43	0.30	0.02	1.11
Simultaneous Tx	Sum-SAR: 3.02 SPLSR: 0.02	Sum-SAR: 1.92 SPLSR: 0.02	Sum-SAR: 3.02 SPLSR: 0.02	Sum-SAR: 3.02 SPLSR: 0.02

Considering the results of the performed test according to FCC 47CFR Part 2.1093 the item under test is IN COMPLIANCE with the requested specifications specified in Section1. Standards, reference documents and applicable test methods

9. Document Revision History

Revision #	Modified by	Revision Details
Rev. 00	R. LUCIANI	First Issue
Rev.01	I.KHARRAT	As per ACB request, the reference to 9560NGW module has been removed from the report

Annex A. Test & System Description

A.1 SAR Definition

Specific Absorption rate is defined as the time derivative of the incremental energy (dW) absorbed by (dissipated in) and incremental mass (dm) contained in a volume element (dV) of a given density (ρ).

$$SAR = \frac{d}{dt} \cdot \left(\frac{dW}{dm} \right) = \frac{d}{dt} \cdot \left(\frac{dW}{\rho \cdot dV} \right)$$

SAR is expressed in units of watts per kilogram (W/kg). SAR can be related to the electric field at a point by

$$SAR = \frac{\sigma |E|^2}{\rho}$$

Where:

σ = Conductivity of the tissue (S/m)

ρ = Mass density of the tissue (kg/m³)

E = RMS electric field strength (V/m)

A.2 SPEAG SAR Measurement System

A.2.1 SAR Measurement Setup

The DASY6 system for performing compliance tests consists of the following items:

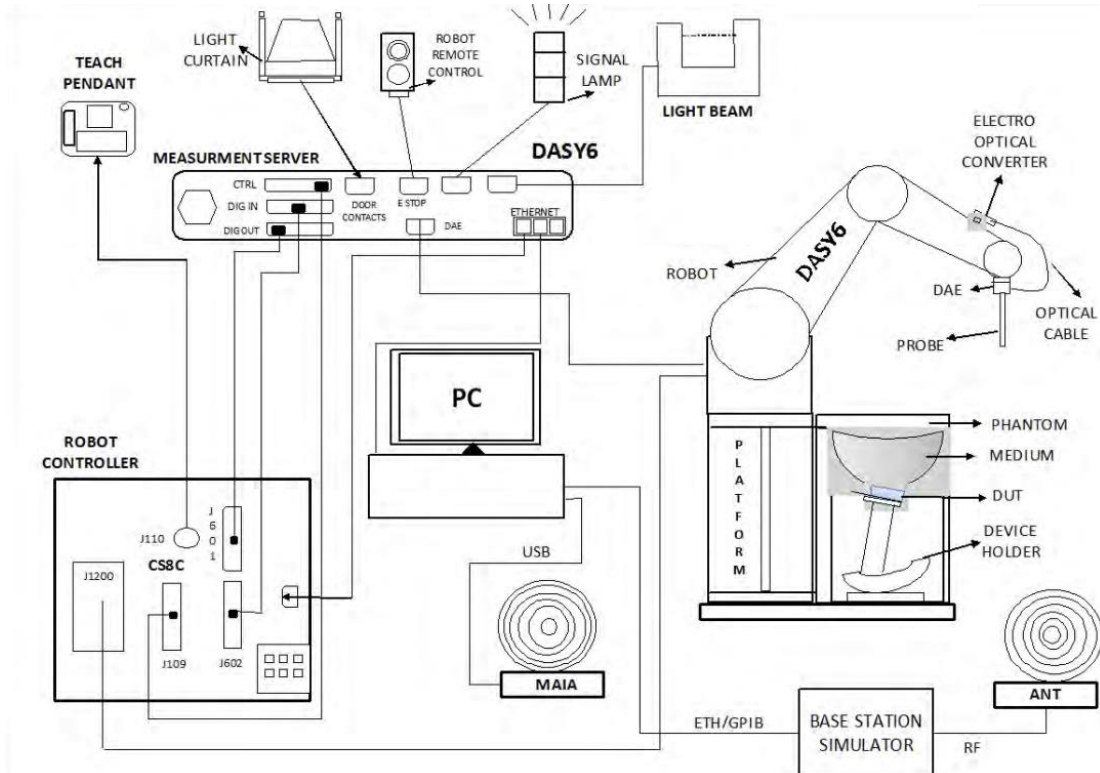

- ✓ A standard high precision 6-axis robot (Stäubli TX/RX family) with controller, teach pendant and software. It includes an arm extension for accommodating the data acquisition electronics (DAE)
- ✓ An isotropic field probe optimized and calibrated for the targeted measurements.
- ✓ A data acquisition electronics (DAE) which performs the signal amplification, signal multiplexing, AD-conversion, offset measurements, mechanical surface detection, collision detection, etc. The unit is battery powered with standard or rechargeable batteries. The signal is optically transmitted to the EOC.
- ✓ The Electro-optical Converter (EOC) performs the conversion from optical to electrical signals for the digital communication to the DAE. The EOC signal is transmitted to the measurement server.
- ✓ The function of the measurement server is to perform the time critical tasks such as signal filtering, control of the robot operation and fast movements interrupts.
- ✓ The Light Beam used is for probe alignment. This improves the (absolute) accuracy of the probe positioning.
- ✓ A computer running Win7 professional operating system and the DASY6 software.
- ✓ Remote control and teach pendant as well as additional circuitry for robot safety such as warning lamps, etc.
- ✓ The phantom, the device holder and other accessories according to the targeted measurement.
- ✓ MAIA is a hardware interface (Antenna) used to evaluate the modulation and audio interference characteristics of RF signals.
- ✓ ANT is an ultra-wideband antenna for use with the base station simulators over 698 MHz to 6GHz.
- ✓ The base station simulator is an equipment used for SAR cellular tests in order to emulate the cellular signals characteristics and behavior between a regular base station and the equipment under test.
- ✓ Tissue simulating liquid.
- ✓ System Validation dipoles.
- ✓ Network emulator.

A.2.2 E-Field Measurement Probe

The probe is constructed using three orthogonal dipole sensors arranged on an interlocking, triangular prism core. The probe has built-in shielding against static charges and is contained within a PEEK cylindrical enclosure material at the tip.



The probe's characteristics are:

Frequency Range	30MHz – 6GHz
Length	337 mm
Probe tip external diameter	2.5 mm
Typical distance between dipoles and the probe tip	1 mm
Axial Isotropy (in human-equivalent liquids)	±0.3 dB
Hemispherical Isotropy (in human-equivalent liquids)	±0.5 dB
Linearity	±0.2 dB
Maximum operating SAR	100 W/kg
Lower SAR detection threshold	0.001 W/kg

A.2.3 SAM Phantom

The shell corresponds to the specifications of the Specific Anthropomorphic Mannequin (SAM) phantom defined in IEEE 1528 and IEC 62209-1. It enables the dosimetric evaluation of left and right hand phone usage as well as body mounted usage at the flat phantom region. A cover prevents evaporation of the liquid. Reference markings on the phantom allow the complete setup of all predefined phantom positions and measurement grids by teaching three points with the robot.

The phantom's characteristics are:

Material	Vinylester, glass fiber reinforced (VE-GF)
Shell thickness	2 mm ± 0.2 mm
Shell thickness at ERP	6 ± 0.2 mm
Filling volume	25 Liters
Dimensions	Length: 1000mm / Width: 500mm

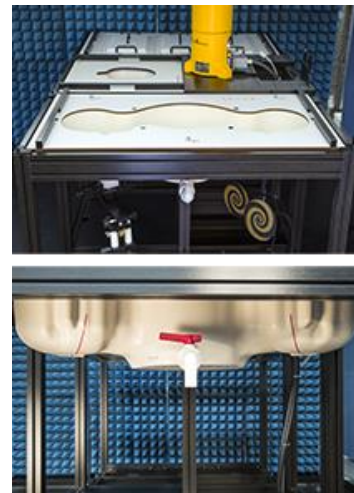

A.2.4 Flat Phantom

Phantom for compliance testing of handheld and body-mounted wireless devices in the frequency range of 30 MHz to 6 GHz. ELI is fully compatible with the IEC 62209-2 standard and all known tissue simulating liquids. ELI has been optimized regarding its performance and can be integrated into our standard phantom tables. A cover prevents evaporation of the liquid. Reference markings on the phantom allow installation of the complete setup, including all predefined phantom positions and measurement grids, by teaching three points. The phantom is compatible with all SPEAG dosimetric probes and dipoles.

The phantom's characteristics are:

Material	Vinylester, glass fiber reinforced (VE-GF)
Shell thickness	2 mm ± 0.2 mm
Filling volume	30 Liters approx.
Dimensions	Major axis: 600mm / Minor axis: 400mm

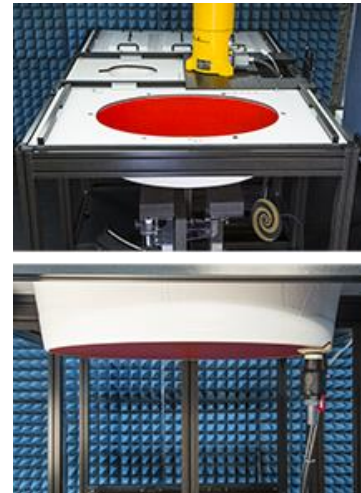

A.2.5 Device Positioner

The SAR in the phantom is approximately inversely proportional to the square of the distance between the source and the liquid surface. For a source at 5 mm distance, a positioning uncertainty of 0.5 mm would produce a SAR uncertainty of 20%. Accurate device positioning is therefore crucial for accurate and repeatable measurements. The positions in which the devices must be measured are defined by the standards.



The DASY device holder is designed to cope with the different positions given in the standard. It has two scales for device rotation (with respect to the body axis) and device inclination (with respect to the line between the ear reference points). The rotation center for both scales is the ear reference point (ERP). Thus the device needs no repositioning when changing the angles.

The DASY device holder is constructed of low-loss POM material having the following dielectric parameters: relative permittivity $\epsilon=3$ and loss tangent $\delta=0.02$. The amount of dielectric material has been reduced in the closest vicinity of the device, since measurements have suggested that the influence of the clamp on the test results could thus be lowered.

A simple but effective and easy-to-use extension for the Mounting Device; facilitates testing of larger devices according to IEC 62209-2 (e.g., laptops, cameras, etc.); lightweight and fits easily on the upper part of the Mounting Device in place of the phone positioner. The extension is fully compatible with the Twin SAM, ELI and other Flat Phantoms.

A.3 Data Evaluation

- **Power Reference measurement**

The robot measures the E field in a specified reference position that can be either the selected section's grid reference point or a user point in this section at 4mm of the inner surface of the phantom, 2mm for frequencies above 3GHz.

- **Area Scan**

Measurement procedures for evaluating SAR from wireless handsets typically start with a coarse measurement grid to determine the approximate location of the local peak SAR values. This is known as the area-scan procedure. The SAR distribution is scanned along the inside surface of one side of the phantom head, at least for an area larger than the projection of the handset and antenna. The distance between the measured points and phantom surface should be less than 8 mm, and should remain constant (with variation less than ± 1 mm) during the entire scan in order to determine the locations of the local peak SAR with sufficient accuracy. The angle between the probe axis and the surface normal line is recommended but not required to be less than 30° . If this angle is larger than 30° and the closest point on the probe-tip housing to the phantom surface is closer than a probe diameter, the boundary effect may become larger and polarization dependent. This additional uncertainty needs to be analyzed and accounted for. To achieve this, modified test procedures and additional uncertainty analyses not described in this recommended practice may be required. The measurement and interpolation point spacing should be chosen such as to allow identification of the local peak locations to within one-half of the linear dimension of a side of the zoom-scan volume. Because a local peak having specific amplitude and steep gradients may produce a lower peak spatial-average SAR compared to peaks with slightly lower amplitude and less steep gradients, it is necessary to evaluate these other peaks as well. However, since the spatial gradients of local SAR peaks are a function of the wavelength inside the tissue-equivalent liquid and the incident magnetic field strength, it is not necessary to evaluate local peaks that are less than 2 dB or more below the global maximum peak. Two-dimensional spline algorithms (Brishoual et al. 2001; Press et al., 1996) are typically used to determine the peaks and gradients within the scanned area. If a peak is found at a distance from the scan border of less than one-half the edge dimension of the desired 1 g or 10 g cube, the measurement area should be enlarged if possible.

- **Zoom Scan**

To evaluate the peak spatial-average SAR values for 1 g or 10 g cubes, fine resolution volume scans, called zoom scans, are performed at the peak SAR locations identified during the area scan. The minimum zoom scan volume size should extend at least 1.5 times the edge dimension of a 1 g cube in all directions from the center of the scan volume, for both 1 g and 10 g peak spatial-average SAR evaluations. Along the phantom curved surfaces, the front face of the volume facing the tissue/liquid interface conforms to the curved boundary, to ensure that all SAR peaks are captured. The back face should be equally distorted to maintain the correct averaging mass. The flatness and orientation of the four side faces are unchanged from that of a cube whose orientation is within $\pm 30^\circ$ of the line normal to the phantom at the center of the cube face next to the phantom surface. The peak local SAR locations that were determined in the area scan (interpolated values) should be used for the centers of the zoom scans. If a scan volume cannot be centered due to proximity of a phantom shape feature, the probe should be tilted to allow scan volume enlargement. If probe tilt is not feasible, the zoom-scan origin may be shifted, but not by more than half of the 1 g or 10 g cube edge dimension.

After the zoom-scan measurement, extrapolations from the closest measured points to the surface, for example along lines parallel to the zoom-scan centerline, and interpolations to a finer resolution between all measured and extrapolated points are performed. Extrapolation algorithm considerations are described in 6.5.3, and 3-D spline methods (Brishoual et al., 2001; Kreyszig, 1983; Press et al., 1996) can be used for interpolation. The peak spatial-average SAR is finally determined by a numerical averaging of the local SAR values in the interpolation grid, using for example a trapezoidal algorithm for the integration (averaging).

In some areas of the phantom, such as the jaw and upper head regions, the angle of the probe with respect to the line normal to the surface may be relatively large, e.g., greater than $\pm 30^\circ$, which could increase the boundary effect error to a larger level. In these cases, during the zoom scan a change in the orientation of the probe, the phantom, or both is recommended but not required for the duration of the zoom scan, so that the angle between the probe axis and the line normal to the surface is within 30° for all measurement points.

- **Power Drift measurement**

The robot re-measures the E-Field in the same reference location measured at the Power Reference. The drift measurement gives the field difference in dB from the first to the last reference reading. This allows a user to monitor the power drift of the device under test that must remain within a maximum variation of $\pm 5\%$.

- **Post-processing**

The procedure for spatial peak SAR evaluation has been implemented according to the IEEE1528 and IEC 62209-1/2 standards. It can be conducted for 1g and 10g.

The software allows evaluations that combine measured data and robot positions, such as:

- ✓ Maximum search
- ✓ Extrapolation
- ✓ Boundary correction
- ✓ Peak search for averaged SAR

Interpolation between the measured points is performed when the resolution of the grid is not fine enough to compute the average SAR over a given mass.

Extrapolation routines are used to obtain SAR values between the lowest measurement points and the inner phantom surface. The extrapolation is determined by the surface detection distance and the probe sensor offset. Several measurements at different distances are necessary for the extrapolation.

A.4 System and Liquid Check

A.4.1 System Check

The system performance check verifies that the system operates within its specifications. System and operator errors can be detected and corrected. It is recommended that the system performance check be performed prior to any usage of the system in order to guarantee reproducible results.

The system performance check uses normal SAR measurements in a simplified setup with a well characterized source. This setup was selected to give a high sensitivity to all parameters that might fail or vary over time. The system check does not intend to replace the calibration of the components, but indicates situations where the system uncertainty is exceeded due to drift or failure.

In the simplified setup for system check, the EUT is replaced by a calibrated dipole and the power source is replaced by a controlled continuous wave generated by a signal generator. The calibrated dipole must be placed beneath the flat phantom section of the phantom at the correct distance.

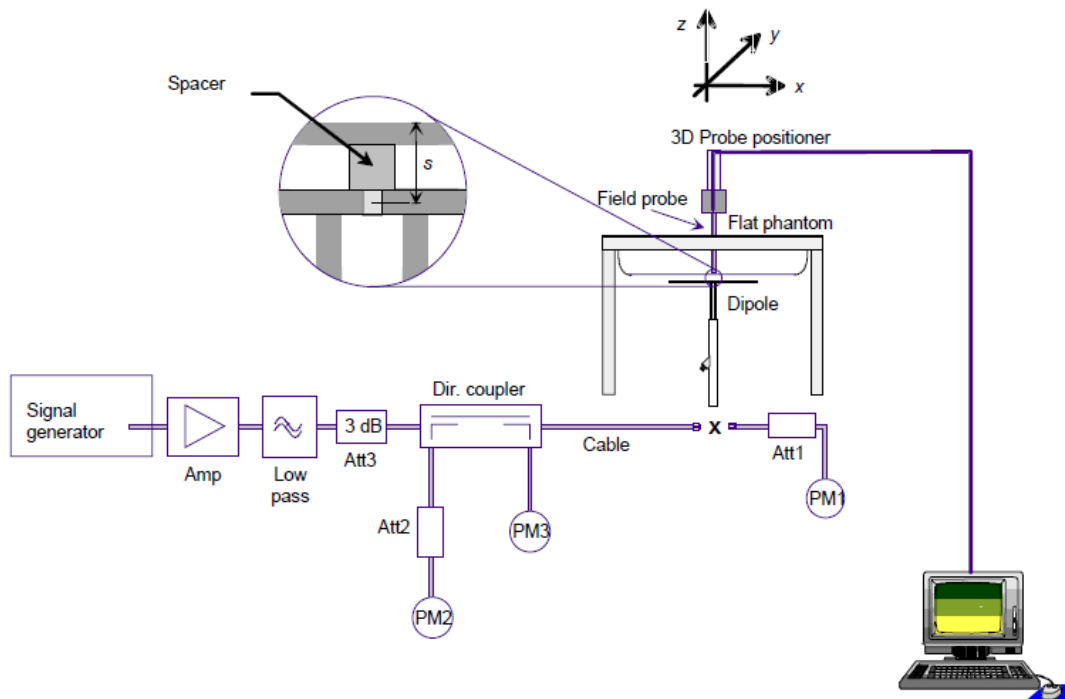

The equipment setup is shown below:

- ✓ Signal Generator
- ✓ Amplifier
- ✓ Directional coupler
- ✓ Power meter
- ✓ Calibrated dipole

First, the power meter PM1 (including attenuator Att1) is connected to the cable to measure the forward power at the location of the connector (x) to the system check source. The signal generator is adjusted for the desired forward power at the connector as read by power meter PM1 after attenuation Att1 and also as coupled through Att2 to PM2. After connecting the cable to the source, the signal generator is readjusted for the same reading at power meter PM2.

SAR results are normalized to a forward power of 1W to compare the values with the calibration reports results as described at IEEE 1528 and IEC 62209 standards.

A.4.2 Liquid Check

The dielectric parameters check is done prior to the use of the tissue simulating liquid. The verification is made by comparing the relative permittivity and conductivity to the values recommended by the applicable standards.

The liquid verification was performed using the following test setup:

- ✓ VNA (Vector Network Analyzer)
- ✓ Open-Short-Load calibration kit
- ✓ RF Cable
- ✓ Open-Ended Coaxial probe
- ✓ DAK software tool
- ✓ SAR Liquid
- ✓ De-ionized water
- ✓ Thermometer

These are the target dielectric properties of the tissue-equivalent liquid material as defined in FCC OET KDB 865664 D01.

Frequency (MHz)	Body SAR	
	ϵ_r (F/m)	σ (S/m)
150	61.9	0.80
300	58.2	0.92
450	56.7	0.94
835	55.2	0.97
900	55.0	1.05
1450	54.0	1.30
1800-2000	53.3	1.52
2450	52.7	1.95
3000	52.0	2.73
5800	48.2	6.00

(ϵ_r = relative permittivity, σ = conductivity and ρ = 1000 kg/m³)

The measurement system implement a SAR error compensation algorithm as documented in IEEE Std 1528-2013 (equivalent to draft standard IEEE P1528-2011) to automatically compensate the measured SAR results for deviations between the measured and required tissue dielectric parameters (applied to only scale up the measured SAR, and not downward) so, according to FCC OET KDB 865664 D01, the tolerance for ϵ_r and σ may be relaxed to $\pm 10\%$.

A.5 Test Equipment List

A.5.1 SAR System #2

ID #	Device	Type/Model	Serial Number	Manufacturer	Cal. Date	Cal. Due Date
002-008	Data Acquisition Electronics	DAE4	1429	SPEAG	2021-05-11	2022-05-11
002-009	Dosimetric E-Field probe	EX3DV4	3978	SPEAG	2021-05-22	2022-05-22
002-000	6-axis Robot	TX60 L	F16/55FXA1/A/01	STAÜBLI	NA	NA
002-001	Robot Controller	CS8C	F16/55FXA1/C/01	STAÜBLI	NA	NA
002-002	Measurement Server	DASY6 P/N: SE UMS 028 BB	1489	SPEAG	NA	NA
002-003	Electro-Optical Converter	EOC60	1098	SPEAG	NA	NA
002-004	Light Beam Unit	SE UKS 030 AA	-	Di-soric	NA	NA
002-005	Oval Flat Phantom	ELI v8.0	2048	SPEAG	NA	NA
002-007	Measurement SW	DASY v6.14	9-5DEE27C2	SPEAG	NA	NA
002-006	Laptop Holder	P/N SM LH1 001 CD	-	SPEAG	NA	NA

A.5.2 Shared Instrumentation

ID #	Device	Type/Model	Serial Number	Manufacturer	Cal. Date	Cal. Due Date
123-000	USB Power Sensor	NRP-Z81	102278	R&S	2021-04-13	2023-04-13
124-000	USB Power Sensor	NRP-Z81	102279	R&S	2021-04-13	2023-04-13
135-000	Network Emulator	CMW500	152721	R&S	2020-03-26	2022-03-26
126-000	Vector Signal Generator	ESG E4438C	MY45092885	Agilent	2021-05-27	2023-05-27
099-000	Liquid measurement SW	DAK-3.5 V2.6.0.5	9-2687B491	SPEAG	NA	NA
339-000	Vector Network Analyzer	ZNB 40	101740	R&S	2020-07-10	2022-07-10
071-000	750 MHz System Validation Dipole	D750V3	1136	SPEAG	2021-01-21	2023-01-21
072-000	835 MHz System Validation Dipole	D835V2	4d192	SPEAG	2021-01-21	2023-01-21
073-000	1750 MHz System Validation Dipole	D1750V2	1133	SPEAG	2021-01-14	2023-01-14
074-000	1900 MHz System Validation Dipole	D1900V2	5d197	SPEAG	2021-01-14	2023-01-14
075-000	2300 MHz System Validation Dipole	D2300V2	1046	SPEAG	2021-01-13	2023-01-13
076-000	2600 MHz System Validation Dipole	D2600V2	1100	SPEAG	2021-01-13	2023-01-13
327-000	Temperature & Humidity Logger	RA32E-TH1-RAS	RA32-F0DED9	AVTECH	2021-03-09	2023-03-09
095-000	Thermometer	925	34822881	Testo	2019-11-19	2021-11-19

A.5.3 Tissue Simulant Liquid

TSL	Manufacturer / Model	Freq Range (MHz)	Main Ingredients
Body WideBand	SPEAG MBBL600-6000V6 Batch 160603-01	600-6000	Ethanediol, Sodium petroleum sulfonate, Hexylene Glycol / 2-Methyl-pentane-2.4-diol, Alkoxylated alcohol

A.6 Measurement Uncertainty Evaluation

The system uncertainty evaluation is shown in the table below with a coverage factor of $k = 2$ to indicate a 95% level of confidence:

SPEAG DASY6 Uncertainty Budget								
According to IEC/IEEE 62209-1528 (4 MHz - 6 GHz)								
including IEEE 1528-2013 and IEC 62209-1/2016, IEC 62209-2/2010								
Symbol	Error Description	Uncert. Value	Prob Dist.	Div.	(ci) 1g	(ci) 10g	Std Unc. (1g)	Std Unc. (10g)
Measurement System Errors								
CF	Probe Calibration	±14.0 %	N	2	1	1	±7.0 %	±7.0 %
CF _{drift}	Probe Calibration Drift	±1.0 %	N	1	1	1	±1.0 %	±1.0 %
LIN	Probe Linearity	±4.7 %	R	√3	1	1	±2.7 %	±2.7 %
BBS	Broadband Signal	±3.0 %	N	2	1	1	±1.5 %	±1.5 %
ISO	Axial Isotropy	±4.7 %	R	√3	0.5	0.5	±1.4 %	±1.4 %
ISO	Hemispherical Isotropy	±9.6 %	R	√3	0.5	0.5	±2.8 %	±2.8 %
DAE	Data Acquisition	±0.3 %	N	1	1	1	±0.3 %	±0.3 %
AMB	RF Ambient	±1.8 %	N	1	1	1	±1.8 %	±1.8 %
Δ _{sys}	Probe Positioning	±0.2 %	N	1	0.33	0.33	±0.1 %	±0.1 %
DAT	Data Processing	±2.3 %	N	1	1	1	±2.3 %	±2.3 %
Phantom and Device Errors								
LIQ(σ)	Conductivity (meas.) _{DAK}	±2.5 %	N	1	0.78	0.71	±2.0 %	±1.8 %
LIQ(Tσ)	Conductivity (temp.) _{BB}	±3.4 %	R	√3	0.78	0.71	±1.5 %	±1.4 %
EPS	Phantom Permittivity	±14.0 %	R	√3	0.25	0.25	±2.0 %	±2.0 %
DAS	Distance DUT - TSL	±2.0 %	N	1	2	2	±4.0 %	±4.0 %
H	Device Holder	±3.6 %	N	1	1	1	±3.6 %	±3.6 %
MOD	DUT Modulation _m	±2.4 %	R	√3	1	1	±1.4 %	±1.4 %
TAS	Time-average SAR	±2.6 %	R	√3	1	1	±1.5 %	±1.5 %
RF _{drift}	DUT drift	±5.0 %	N	1	1	1	±2.9 %	±2.9 %
Correction to the SAR results								
C(ε, σ)	Deviation to Target	±1.9 %	N	1	1	0.84	±1.9 %	±1.6 %
Combined Std. Uncertainty							±11.5 %	±11.4 %
Expanded STD Uncertainty							±23.1 %	±22.9 %

A.7 RF Exposure Limits

SAR assessments have been made in line with the requirements of FCC 47 CFR Part 2.1093 on the limitation of exposure of the general population / uncontrolled exposure for portable devices.

Exposure Type	General Population / Uncontrolled Environment
Peak spatial-average SAR (averaged over any 1 gram of tissue)	1.6 W/kg
Whole body average SAR	0.08 W/kg
Peak spatial-average SAR (extremities) (averaged over any 10 grams of tissue)	4.0 W/kg

Annex B. Test Results

The herein test results were performed by:

Test case measurement	Test Personnel
SAR measurement	R. Luciani
Conducted measurement	F. Heurtematte

B.1 Test Conditions

B.1.1 Test SAR Test positions relative to the phantom

The device under test was a Convertible PC, HSN-I47C with a INTEL XMM 7360 card inside. The card was operated utilizing proprietary software, and each channel was measured using a communication tester to determine the maximum average power.

The device has 2 power settings:

- Notebook mode
- Tablet mode

See section 6 for details about power values for the configuration

See Annex F.3 for information about the tablet configuration

Due to the SAR evaluations exclusions described in section B.1.3.1, the laptop position is not required

In the same manner the required test positions analysis is done considering the two possible user configurations and power levels for each one

Tablet mode

According to FCC OET KDB 616217 D04, the back surface and edges of the tablet should be tested for SAR compliance with the tablet touching the phantom. The SAR Test Exclusion Threshold in FCC OET KDB 447498 D01 can be applied to determine SAR test exclusion for adjacent edge configurations. (See section 6 for power specifications)

The reduced power values shown on section 6 and the closest distance from the antenna to an adjacent tablet edge is used to determine if SAR testing is required for the adjacent edges, with the adjacent edge positioned against the phantom and the edge containing the antenna positioned perpendicular to the phantom.

Considering the antenna location diagrams in Annex F and the test exclusions described before, the surfaces/edges to be measured for each antenna are:

Tablet	WWAN Main
Position	<ul style="list-style-type: none"> • Top Edge • Back Face • Right Edge

See B.1.3.1 for a more detailed list of the applied reductions.

See F.2 *Test position* section for more information on the tested positions.

B.1.2 Test signal, Output power and Test Frequencies

B.1.2.1 LTE TDD consideration

According to KDB 941225 D05 SAR for LTE Devices, for Time-Division Duplex (TDD) systems, SAR must be tested using a fixed periodic duty factor according to the highest transmission duty factor implemented for the device and supported by the defined 3GPP LTE TDD configurations.

LTE TDD Bands support 3GPP TS 36.211 section 4.2 for Type 2 Frame structure and table 2 for uplink-downlink configurations and table 1 for special subframe configurations

Table 1

Special subframe configuration	Normal cyclic prefix in downlink			Extended cyclic prefix in downlink		
	DwPTS	UpPTS		DwPTS	UpPTS	
		Normal cyclic prefix in uplink	Extended cyclic prefix in uplink		Normal cyclic prefix in uplink	Extended cyclic prefix in uplink
0	6592 T _S	(1+X) 2192 T _S	(1+X) 2560 T _S	7680 · T _S	(1+X) 2192 T _S	(1+X) 2560 T _S
1	19760 T _S			20480 T _S		
2	21952 T _S			23040 T _S		
3	24144 T _S			25600 T _S		
4	26336 T _S			7680 T _S		
5	6592 T _S	(2+X) 2192 T _S	(2+X) 2560 T _S	20480 T _S	(2+X) 2192 T _S	(2+X) 2560 T _S
6	19760 T _S			23040 T _S		
7	21952 T _S			12800 T _S		
8	24144 T _S			-		
9	13168 T _S			-		
10	13168 T _S	13150 T _S	12800 T _S	-	-	-

Table2

Uplink-Downlink Config.	Downlink-to-Uplink Switch-point Periodicity	Subframe Number										Calculated Duty Cycle (%)
		0	1	2	3	4	5	6	7	8	9	
0	5 ms	D	S	U	U	U	D	S	U	U	U	63.3%
1	5 ms	D	S	U	U	D	D	S	U	U	D	43.3%
2	5 ms	D	S	U	D	D	D	S	U	D	D	23.3%
3	10 ms	D	S	U	U	U	D	D	D	D	D	31.7%
4	10 ms	D	S	U	U	D	D	D	D	D	D	21.7%
5	10 ms	D	S	U	D	D	D	D	D	D	D	11.7%
6	5 ms	D	S	U	U	U	D	S	U	U	D	53.3%

Calculated duty cycle = Extended cyclic prefix in uplink *(TS)*# of S + # of U / period

The configuration used for SAR testing was the number 0 which corresponds to the highest duty cycle (Power Class 3)

B.1.3 Evaluation Exclusion and Test Reductions

B.1.3.1 SAR evaluation exclusion

The SAR Test Exclusion Threshold in FCC OET KDB 447498 D01 v06 can be applied to determine SAR test exclusion for adjacent edge configurations. For 100MHz to 6GHz and test separation distances ≤50mm, the 1-g and 10-g SAR test exclusion thresholds are determined by the following formula:

$$[(\text{max. power of channel, including tune – up tolerance, mW}) / (\text{min. test separation distance, mm})] \cdot \sqrt{f_{(\text{GHz})}} \tag{1}$$

≤ 3.0 for 1g SAR, and ≤ 7.5 for 10g extremity SAR

Where:

- f(GHz) is the RF channel transmit frequency in GHz
- Power and distance are rounded to the nearest mW and mm before calculation
- The result is rounded to one decimal place for comparison
- The values 3.0 and 7.5 are referred to as numeric thresholds

The test exclusions are applicable only when the minimum test separation distance is ≤ 50 mm, and for transmission frequencies between 100 MHz and 6 GHz. When the minimum test separation distance is < 5 mm, a distance of 5 mm is applied to determine SAR test exclusion.

For test separation distances > 50 mm, the 1-g and 10-g SAR test exclusion thresholds are determined using the following formulas:

$$((\text{Power allowed at numeric threshold for 50 mm in (1)}) + (\text{test separation distance} - 50 \text{ mm}) \cdot (f_{\text{MHz}}/150)) \text{mW}, \tag{2}$$

for 100MHz to 1500MHz

$$((\text{Power allowed at numeric threshold for 50 mm in (1)}) + (\text{test separation distance} - 50 \text{ mm}) \cdot 10) \text{mW}, \tag{3}$$

for 1500MHz and ≤ 6GHz

Test Exclusion

Antenna	Band Name	Output power		Laptop	Back Face	Top Edge	Bottom Edge	Left Edge	Right Edge	Laptop	Back Face	Top Edge	Bottom Edge	Left Edge	Right Edge
		dBm	mW												
WWAN Main	FDD II	23.0	199.5	>50	<50	<50	>50	>50	<50	R	T	T	R	R	T
	FDD IV	21.0	125.9	>50	<50	<50	>50	>50	<50	R	T	T	R	R	T
	FDD V	23.0	199.5	>50	<50	<50	>50	>50	<50	R	T	T	R	R	T
	LTE 2	23.0	199.5	>50	<50	<50	>50	>50	<50	R	T	T	R	R	T
	LTE 4	21.0	125.9	>50	<50	<50	>50	>50	<50	R	R	R	R	R	R
	LTE 5	23.0	199.5	>50	<50	<50	>50	>50	<50	R	R	R	R	R	R
	LTE 7	18.0	63.1	>50	<50	<50	>50	>50	<50	R	T	T	R	R	T
	LTE 12	23.0	199.5	>50	<50	<50	>50	>50	<50	R	T	T	R	R	T
	LTE 13	23.0	199.5	>50	<50	<50	>50	>50	<50	R	T	T	R	R	T
	LTE 17	23.0	199.5	>50	<50	<50	>50	>50	<50	R	R	R	R	R	R
	LTE 26	23.0	199.5	>50	<50	<50	>50	>50	<50	R	T	T	R	R	T
	LTE 30	23.0	199.5	>50	<50	<50	>50	>50	<50	R	T	T	R	R	T
	LTE 38	21.0	125.9	>50	<50	<50	>50	>50	<50	R	T	T	R	R	T
	LTE 41	20.5	112.2	>50	<50	<50	>50	>50	<50	R	T	T	R	R	T
LTE 66	21.0	125.9	>50	<50	<50	>50	>50	<50	R	T	T	R	R	T	

T: Tested position
R: Reduced

See Annex F for a more detailed explanation of the separation distance related to the platform.

In order to evaluate SAR test exclusion for laptop and tablet user positions in which the separation distance passes the 50mm limit, equations (2) and (3) are used with the corresponding frequencies for each band, the user distances for the two positions and with the power values described on Section 6. The table below shows all cellular bands evaluated in this report grouped by frequency band, separation distances and the corresponding Power threshold in mW for each combination (distance and frequency)

Bands	Freq	Separation distance to the body on mm										
		60	70	80	90	100	110	160	170	190	200	
LTE 12,13, 17	750	223	273	323	373	423	473	723	773	873	923	Threshold values in mW
FDD V LTE 5, 26	835	220	275	331	387	442	498	776	832	943	999	
FDD IV LTE 4, 66	1750	213	313	413	513	613	713	1213	1313	1513	1613	
FDD II LTE 2	1900	209	309	409	509	609	709	1209	1309	1509	1609	
LTE 30	2300	199	299	399	499	599	699	1199	1299	1499	1599	
LTE 7, 38, 41	2600	193	293	393	493	593	693	1193	1293	1493	1593	

Since the highest output power for all bands in laptop mode is 199.5mW and the distance to the phantom is >190mm, Laptop position is not required

The highest output power for all bands in tablet mode is 199.5mW and the smaller distance is >70mm. The above power is smaller than all the values of the table for d>70mm, therefore, SAR is not required for the tablet bottom and left edge positions

B.1.3.2 General SAR test reduction

According to FCC OET KDB 447498 D01, testing of other required channels within the operating mode of a frequency band is not required when the reported 1-g or 10-g SAR for the mid-band or highest output power channel is:

- ≤ 0.8 W/kg or 2.0 W/kg, for 1-g or 10-g respectively, when the transmission band is ≤ 100 MHz
- ≤ 0.6 W/kg or 1.5 W/kg, for 1-g or 10-g respectively, when the transmission band is between 100 MHz and 200 MHz
- ≤ 0.4 W/kg or 1.0 W/kg, for 1-g or 10-g respectively, when the transmission band is ≥ 200 MHz

WLAN SAR Test reduction

Transmission Mode	SAR test exclusion/reduction
DSSS	<p>According to FCC OET KDB 248227 D01, SAR is measured for 2.4 GHz 802.11b, SAR test reduction is determined according to the following:</p> <ul style="list-style-type: none"> ▪ When the reported SAR of the highest measured maximum output power channel for the exposure configuration is ≤ 0.8 W/kg, no further SAR testing is required for 802.11b DSSS in that exposure configuration. ▪ When the reported SAR is > 0.8 W/kg, SAR is required for that exposure configuration using the next highest measured output power channel. When any reported SAR is > 1.2 W/kg, SAR is required for the third channel. <p>According to FCC OET KDB 248227 D01, SAR is not required for 2.4 GHz OFDM conditions when the highest reported SAR for DSSS is adjusted by the ratio of OFDM to DSSS specified maximum output power and the adjusted SAR is ≤ 1.2 W/kg.</p>
OFDM	<p>According to FCC OET KDB 248227 D01, 802.11a/g/n/ac modes have the same specified maximum output power, largest channel bandwidth, lowest order modulation and lowest data rate, the lowest order 802.11 mode is selected, i.e., 802.11a is chosen over 802.11n then 802.11ac or 802.11g is chosen over 802.11n.</p> <p>According to FCC OET KDB 248227 D01, an <i>initial test configuration</i> is determined for OFDM and DSSS transmission modes according to the channel bandwidth, modulation and data rate combination(s) with the highest maximum output power specified for production units in each standalone and aggregated frequency band. SAR is measured using the highest measured maximum output power channel. SAR test reduction for subsequent highest output test channels is determined according to reported SAR of the initial test configuration.</p> <p>The <i>initial test configuration</i> for 5 GHz OFDM transmission modes is determined by the 802.11 configuration with the highest maximum output power specified for production units, including tune-up tolerance, in each standalone and aggregated frequency band. SAR for the initial test configuration is measured using the highest maximum output power channel determined by the default power measurement procedures.</p> <p>According to FCC OET KDB 248227 D01, when the reported SAR of the initial test configuration is > 0.8 W/kg, SAR measurement is required for subsequent next highest measured output power channel(s) in the initial test configuration until reported SAR is ≤ 1.2 W/kg or all required channels are tested.</p>

WWAN SAR Test reduction

Transmission Mode	SAR test exclusion/reduction
HSDPA	According to FCC OET KDB 941225 D01, SAR evaluation is not required when the maximum average output power is < ¼ dB higher than the measured on the corresponding channels without HSDPA, using 12.2kbps RMC, and the maximum SAR for 12.2kbps RMC is < 1.2 W/kg.
HSUPA	According to FCC OET KDB 941225 D01, SAR evaluation is not required when the maximum average output power is < ¼ dB higher than the measured on the corresponding channels without HSUPA, using 12.2kbps RMC, and the maximum SAR for 12.2kbps RMC is < 1.2 W/kg.
DC+HSDPA	According to FCC OET KDB 941225 D01, SAR evaluation is not required when the maximum average output power is < ¼ dB higher than the measured on the corresponding channels without DC+HSDPA, using 12.2kbps RMC, and the maximum SAR for 12.2kbps RMC is < 1.2 W/kg.
LTE	<p>According to FCC OET KDB 941225 D05, testing of 100% RB allocation, higher order modulations or lower BW is not required when these conditions are met:</p> <ul style="list-style-type: none"> ○ For QPSK with 100% RB allocation, SAR is not required when the highest maximum output power for 100 % RB allocation is less than the highest maximum output power in 50% and 1 RB allocations and the highest reported SAR for 1 RB and 50% RB allocation are ≤ 0.8 W/kg. ○ For each modulation besides QPSK, SAR is required only when the highest maximum output power for the configuration in the higher order modulation is > ½ dB higher than the same configuration in QPSK or when the reported SAR for the QPSK configuration is > 1.45 W/kg. ○ For lower BW, only measure SAR when the highest maximum output power of a configuration requiring testing in the smaller channel bandwidth is > ½ dB higher than the equivalent channel configurations in the largest channel bandwidth configuration or the reported SAR of a configuration for the largest channel bandwidth is > 1.45 W/kg. <p>For LTE bands that do not support at least three non-overlapping channels in certain channel bandwidths, test the available non-overlapping channels instead. When a device supports overlapping channel assignment in a channel bandwidth configuration, the middle channel of the group of overlapping channels should be selected for testing; therefore, the requirement for H, M, and L channels may not fully apply</p>

B.2 Conducted Power Measurements – Tablet mode

B.2.1 WCDMA/ HSPA/ DC-HSPA

B.2.1.1 WCDMA Band II

Mode	Channel Number	Freq (MHz)	Subset	Average Power Measured (dBm)	Factory Upper Tolerance (dBm)
RMC	9262	1852.4	-	22.58	23.00
	9400	1880	-	22.61	23.00
	9538	1907.6	-	22.35	23.00
HSDPA	9262	1852.4	1	22.58	23.00
			2	22.48	23.00
			3	21.94	23.00
			4	21.72	23.00
	9400	1880	1	22.61	23.00
			2	22.50	23.00
			3	22.05	23.00
			4	21.75	23.00
	9538	1907.6	1	22.45	23.00
			2	22.33	23.00
			3	21.80	23.00
			4	21.55	23.00
HSUPA	9262	1852.4	1	22.60	23.00
			2	22.54	23.00
			3	22.61	23.00
			4	22.50	23.00
			5	22.43	23.00
	9400	1880	1	22.63	23.00
			2	22.63	23.00
			3	22.67	23.00
			4	22.61	23.00
			5	22.45	23.00
	9538	1907.6	1	22.40	23.00
			2	22.43	23.00
			3	22.44	23.00
			4	22.39	23.00
			5	22.23	23.00
DC-HSDPA	9262	1852.4	1	22.60	23.00
			2	22.51	23.00
			3	21.97	23.00
			4	21.75	23.00
	9400	1880	1	22.59	23.00
			2	22.54	23.00
			3	22.08	23.00
			4	21.80	23.00
	9538	1907.6	1	22.42	23.00
			2	22.36	23.00
			3	21.73	23.00
			4	21.54	23.00

B.2.1.2 WCDMA Band IV

Mode	Channel Number	Freq (MHz)	Subset	Average Power Measured (dBm)	Factory Upper Tolerance (dBm)
RMC	1312	1712.4	-	20.43	21.00
	1413	1732.6	-	20.51	21.00
	1513	1752.6	-	20.68	21.00
HSDPA	1312	1712.4	1	20.39	21.00
			2	20.41	21.00
			3	20.45	21.00
			4	20.40	21.00
	1413	1732.6	1	20.50	21.00
			2	20.52	21.00
			3	20.53	21.00
			4	20.57	21.00
	1513	1752.6	1	20.67	21.00
			2	20.76	21.00
			3	20.71	21.00
			4	20.81	21.00
HSUPA	1312	1712.4	1	20.42	21.00
			2	20.35	21.00
			3	20.39	21.00
			4	20.35	21.00
			5	20.40	21.00
	1413	1732.6	1	20.46	21.00
			2	20.42	21.00
			3	20.46	21.00
			4	20.40	21.00
			5	20.54	21.00
	1513	1752.6	1	20.67	21.00
			2	20.71	21.00
			3	20.67	21.00
			4	20.63	21.00
			5	20.69	21.00
DC-HSDPA	1312	1712.4	1	20.41	21.00
			2	20.42	21.00
			3	20.47	21.00
			4	20.43	21.00
	1413	1732.6	1	20.50	21.00
			2	20.53	21.00
			3	20.53	21.00
			4	20.53	21.00
	1513	1752.6	1	20.73	21.00
			2	20.71	21.00
			3	20.68	21.00
			4	20.75	21.00

B.2.1.3 WCDMA Band V

Mode	Channel Number	Freq (MHz)	Subset	Pwr Avg (dBm)	Factory Upper Tolerance (dBm)
RMC	4132	826.4	-	22.97	23.00
	4183	836.6	-	22.58	23.00
	4233	846.6	-	22.75	23.00
HSDPA	4132	826.4	1	22.86	23.00
			2	22.90	23.00
			3	22.39	23.00
			4	22.12	23.00
	4183	836.6	1	22.52	23.00
			2	22.58	23.00
			3	22.63	23.00
			4	22.41	23.00
	4233	846.6	1	22.85	23.00
			2	22.80	23.00
			3	22.38	23.00
			4	22.09	23.00
HSUPA	4132	826.4	1	22.95	23.00
			2	22.94	23.00
			3	22.41	23.00
			4	22.94	23.00
			5	22.91	23.00
	4183	836.6	1	22.66	23.00
			2	22.64	23.00
			3	22.64	23.00
			4	22.61	23.00
			5	22.53	23.00
	4233	846.6	1	22.89	23.00
			2	22.75	23.00
			3	22.82	23.00
			4	22.83	23.00
			5	22.78	23.00
DC- HSDPA	4132	826.4	1	22.88	23.00
			2	22.91	23.00
			3	22.39	23.00
			4	22.14	23.00
	4183	836.6	1	22.51	23.00
			2	22.60	23.00
			3	22.60	23.00
			4	22.35	23.00
	4233	846.6	1	22.81	23.00
			2	22.77	23.00
			3	22.38	23.00
			4	22.08	23.00

B.2.2 LTE

B.2.2.1 LTE Band 2 FDD

Band	BW	Channel #	Freq (MHz)	% RB Allocation	RB Position	QPSK			16 QAM		
						Factory Upper Tolerance (dBm)	M P R	Measured Output Power (dBm)	Factory Upper Tolerance (dBm)	M P R	Measured Output Power (dBm)
LTE2	20 MHz	18700	1860	1RB Low	1 Pos 0	23.00	0	22.47	23.00	1	21.65
				1RB Mid	1 Pos 50	23.00	0	22.31	23.00	1	21.49
				1RB High	1 Pos 99	23.00	0	22.63	23.00	1	21.74
				50% RB Low	50 Pos 0	23.00	1	21.44	23.00	2	20.44
				50% RB Mid	50 Pos 24	23.00	1	21.35	23.00	2	20.42
				50% RB High	50 Pos 50	23.00	1	21.44	23.00	2	20.51
		100% RB	100 Pos 0	23.00	1	21.57	23.00	2	20.56		
		18900	1880	1RB Low	1 Pos 0	23.00	0	22.66	23.00	1	21.88
				1RB Mid	1 Pos 50	23.00	0	22.47	23.00	1	21.84
				1RB High	1 Pos 99	23.00	0	22.50	23.00	1	21.72
				50% RB Low	50 Pos 0	23.00	1	21.50	23.00	2	20.57
				50% RB Mid	50 Pos 24	23.00	1	21.50	23.00	2	20.55
				50% RB High	50 Pos 50	23.00	1	21.39	23.00	2	20.45
		100% RB	100 Pos 0	23.00	1	21.62	23.00	2	20.65		
		19100	1900	1RB Low	1 Pos 0	23.00	0	22.41	23.00	1	21.54
				1RB Mid	1 Pos 50	23.00	0	22.25	23.00	1	21.50
				1RB High	1 Pos 99	23.00	0	22.34	23.00	1	21.55
				50% RB Low	50 Pos 0	23.00	1	21.21	23.00	2	20.26
	50% RB Mid			50 Pos 24	23.00	1	21.20	23.00	2	20.27	
	50% RB High			50 Pos 50	23.00	1	21.32	23.00	2	20.42	
	100% RB	100 Pos 0	23.00	1	21.39	23.00	2	20.48			
	15 MHz	18675	1857.5	1RB Low	1 Pos 0	23.00	0	22.70	23.00	1	21.86
				1RB Mid	1 Pos 38	23.00	0	22.42	23.00	1	21.78
				1RB High	1 Pos 74	23.00	0	22.60	23.00	1	21.72
				50% RB Low	38 Pos 0	23.00	1	21.38	23.00	2	20.47
				50% RB Mid	38 Pos 19	23.00	1	21.32	23.00	2	20.42
				50% RB High	38 Pos 39	23.00	1	21.39	23.00	2	20.45
		100% RB	75 Pos 0	23.00	1	21.36	23.00	2	20.40		
		18900	1880	1RB Low	1 Pos 0	23.00	0	22.54	23.00	1	22.00
				1RB Mid	1 Pos 38	23.00	0	22.41	23.00	1	21.90
				1RB High	1 Pos 74	23.00	0	22.41	23.00	1	22.00
				50% RB Low	38 Pos 0	23.00	1	21.59	23.00	2	20.66
				50% RB Mid	38 Pos 19	23.00	1	21.57	23.00	2	20.65
				50% RB High	38 Pos 39	23.00	1	21.53	23.00	2	20.63
		100% RB	75 Pos 0	23.00	1	21.58	23.00	2	20.61		
		19125	1902.5	1RB Low	1 Pos 0	23.00	0	22.37	23.00	1	21.25
				1RB Mid	1 Pos 38	23.00	0	22.43	23.00	1	21.23
				1RB High	1 Pos 74	23.00	0	22.34	23.00	1	21.29
				50% RB Low	38 Pos 0	23.00	1	21.16	23.00	2	20.23
	50% RB Mid			38 Pos 19	23.00	1	21.32	23.00	2	20.37	
	50% RB High			38 Pos 39	23.00	1	21.35	23.00	2	20.37	
	100% RB	75 Pos 0	23.00	1	21.35	23.00	2	20.45			
	10 MHz	18650	1855	1RB Low	1 Pos 0	23.00	0	22.32	23.00	1	21.93
				1RB Mid	1 Pos 24	23.00	0	22.12	23.00	1	21.85
				1RB High	1 Pos 49	23.00	0	22.10	23.00	1	21.83
				50% RB Low	25 Pos 0	23.00	1	21.50	23.00	2	20.56
				50% RB Mid	25 Pos 12	23.00	1	21.45	23.00	2	20.51
				50% RB High	25 Pos 24	23.00	1	21.42	23.00	2	20.44
100% RB		50 Pos 0	23.00	1	21.46	23.00	2	20.56			
18900		1880	1RB Low	1 Pos 0	23.00	0	22.61	23.00	1	21.86	
			1RB Mid	1 Pos 24	23.00	0	22.57	23.00	1	21.82	
			1RB High	1 Pos 49	23.00	0	22.62	23.00	1	21.82	
			50% RB Low	25 Pos 0	23.00	1	21.66	23.00	2	20.70	
			50% RB Mid	25 Pos 12	23.00	1	21.57	23.00	2	20.65	
			50% RB High	25 Pos 24	23.00	1	21.54	23.00	2	20.63	
100% RB		50 Pos 0	23.00	1	21.55	23.00	2	20.59			
19150		1905	1RB Low	1 Pos 0	23.00	0	22.52	23.00	1	21.26	
			1RB Mid	1 Pos 24	23.00	0	22.57	23.00	1	21.36	
			1RB High	1 Pos 49	23.00	0	22.52	23.00	1	21.27	
			50% RB Low	25 Pos 0	23.00	1	21.33	23.00	2	20.35	
	50% RB Mid		25 Pos 12	23.00	1	21.35	23.00	2	20.32		
	50% RB High		25 Pos 24	23.00	1	21.29	23.00	2	20.34		
100% RB	50 Pos 0	23.00	1	21.36	23.00	2	20.37				
Band	BW					QPSK			16 QAM		

		Channel #	Freq (MHz)	% RB Allocation	RB Position	Factory Upper Tolerance (dBm)	M P R	Measured Output Power (dBm)	Factory Upper Tolerance (dBm)	M P R	Measured Output Power (dBm)
LTE2	5.0 MHz	18625	1852.5	1RB Low	1 Pos 0	23.00	0	22.89	23.00	1	21.57
				1RB Mid	1 Pos 12	23.00	0	22.81	23.00	1	21.50
				1RB High	1 Pos 24	23.00	0	22.80	23.00	1	21.51
				50% RB Low	12 Pos 0	23.00	1	21.49	23.00	2	20.59
				50% RB Mid	12 Pos 6	23.00	1	21.47	23.00	2	20.54
				50% RB High	12 Pos 11	23.00	1	21.47	23.00	2	20.50
		100% RB	25 Pos 0	23.00	1	21.52	23.00	2	20.57		
		1RB Low	1 Pos 0	23.00	0	22.53	23.00	1	21.73		
		1RB Mid	1 Pos 12	23.00	0	22.72	23.00	1	21.68		
		1RB High	1 Pos 24	23.00	0	22.45	23.00	1	21.67		
		50% RB Low	12 Pos 0	23.00	1	21.53	23.00	2	20.59		
		50% RB Mid	12 Pos 6	23.00	1	21.54	23.00	2	20.60		
		50% RB High	12 Pos 11	23.00	1	21.56	23.00	2	20.62		
		100% RB	25 Pos 0	23.00	1	21.56	23.00	2	20.58		
		1RB Low	1 Pos 0	23.00	0	22.42	23.00	1	21.50		
		1RB Mid	1 Pos 12	23.00	0	22.33	23.00	1	21.39		
		1RB High	1 Pos 24	23.00	0	22.36	23.00	1	21.43		
		50% RB Low	12 Pos 0	23.00	1	21.29	23.00	2	20.30		
	50% RB Mid	12 Pos 6	23.00	1	21.21	23.00	2	20.21			
	50% RB High	12 Pos 11	23.00	1	21.20	23.00	2	20.20			
	100% RB	25 Pos 0	23.00	1	21.21	23.00	2	20.23			
	3.0 MHz	18615	1851.5	1RB Low	1 Pos 0	23.00	0	22.66	23.00	1	22.02
				1RB Mid	1 Pos 7	23.00	0	22.61	23.00	1	21.50
				1RB High	1 Pos 14	23.00	0	22.57	23.00	1	22.02
				50% RB Low	8 Pos 0	23.00	1	21.56	23.00	2	20.54
				50% RB Mid	8 Pos 4	23.00	1	21.48	23.00	2	20.47
				50% RB High	8 Pos 7	23.00	1	21.47	23.00	2	20.47
		100% RB	15 Pos 0	23.00	1	21.47	23.00	2	20.45		
		1RB Low	1 Pos 0	23.00	0	22.52	23.00	1	21.61		
		1RB Mid	1 Pos 7	23.00	0	22.58	23.00	1	21.97		
		1RB High	1 Pos 14	23.00	0	22.54	23.00	1	21.93		
		50% RB Low	8 Pos 0	23.00	1	21.56	23.00	2	20.52		
		50% RB Mid	8 Pos 4	23.00	1	21.52	23.00	2	20.51		
		50% RB High	8 Pos 7	23.00	1	21.57	23.00	2	20.58		
		100% RB	15 Pos 0	23.00	1	21.54	23.00	2	20.50		
		1RB Low	1 Pos 0	23.00	0	22.32	23.00	1	21.30		
		1RB Mid	1 Pos 7	23.00	0	22.32	23.00	1	21.33		
		1RB High	1 Pos 14	23.00	0	22.26	23.00	1	21.31		
		50% RB Low	8 Pos 0	23.00	1	21.28	23.00	2	20.21		
	50% RB Mid	8 Pos 4	23.00	1	21.15	23.00	2	20.18			
	50% RB High	8 Pos 7	23.00	1	21.23	23.00	2	20.18			
	100% RB	15 Pos 0	23.00	1	21.19	23.00	2	20.12			
	1.4 MHz	18607	1850.7	1RB Low	1 Pos 0	23.00	0	22.66	23.00	1	21.59
				1RB Mid	1 Pos 2	23.00	0	22.46	23.00	1	21.56
				1RB High	1 Pos 5	23.00	0	22.52	23.00	1	21.60
				50% RB Low	3 Pos 0	23.00	1	21.56	23.00	2	20.54
				50% RB Mid	3 Pos 1	23.00	1	21.56	23.00	2	20.66
				50% RB High	3 Pos 2	23.00	1	21.55	23.00	2	20.50
100% RB		6 Pos 0	23.00	1	21.57	23.00	2	20.43			
1RB Low		1 Pos 0	23.00	0	22.52	23.00	1	21.73			
1RB Mid		1 Pos 2	23.00	0	22.47	23.00	1	21.70			
1RB High		1 Pos 5	23.00	0	22.46	23.00	1	21.74			
50% RB Low		3 Pos 0	23.00	1	21.60	23.00	2	20.76			
50% RB Mid		3 Pos 1	23.00	1	21.53	23.00	2	20.74			
50% RB High		3 Pos 2	23.00	1	21.54	23.00	2	20.73			
100% RB		6 Pos 0	23.00	1	21.56	23.00	2	20.57			
1RB Low		1 Pos 0	23.00	0	22.38	23.00	1	21.45			
1RB Mid		1 Pos 2	23.00	0	22.22	23.00	1	21.41			
1RB High		1 Pos 5	23.00	0	22.29	23.00	1	21.27			
50% RB Low		3 Pos 0	23.00	1	21.26	23.00	2	20.43			
50% RB Mid	3 Pos 1	23.00	1	21.26	23.00	2	20.42				
50% RB High	3 Pos 2	23.00	1	21.24	23.00	2	20.39				
100% RB	6 Pos 0	23.00	1	21.23	23.00	2	20.19				

B.2.2.2 LTE Band 4 FDD

SAR Measurement for LTE Band 4 FDD (Frequency range: 1710 – 1755MHz) is covered by LTE Band 66 FDD (Frequency range: 1710 – 1780MHz) due to overlapping frequency range, same maximum tune-up and same bandwidth.

B.2.2.3 LTE band 5 FDD

SAR Measurement for LTE Band 5 FDD (Frequency range: 824 – 849MHz) is covered by LTE Band 26 FDD (Frequency range: 814 – 849MHz) due to overlapping frequency range, same tune-up and similar bandwidth

B.2.2.4 LTE Band 7 FDD

Band	BW	Channel #	Freq (MHz)	% RB Allocation	RB Position	QPSK			16 QAM			
						Factory Upper Tolerance (dBm)	M P R	Measured Output Power (dBm)	Factory Upper Tolerance (dBm)	M P R	Measured Output Power (dBm)	
LTE 7	20 MHz	20850	2510	1RB Low	1 Pos 0	18.00	0	17.35	18.00	0	17.01	
				1RB Mid	1 Pos 50	18.00	0	17.18	18.00	0	16.95	
				1RB High	1 Pos 99	18.00	0	17.08	18.00	0	16.86	
				50% RB Low	50 Pos 0	18.00	0	17.37	18.00	0	17.39	
				50% RB Mid	50 Pos 24	18.00	0	17.20	18.00	0	17.23	
				50% RB High	50 Pos 50	18.00	0	17.16	18.00	0	17.10	
		100% RB	100 Pos 0	18.00	0	17.29	18.00	0	17.26			
		21100	2535	1RB Low	1 Pos 0	18.00	0	17.06	18.00	0	16.80	
				1RB Mid	1 Pos 50	18.00	0	16.93	18.00	0	16.46	
				1RB High	1 Pos 99	18.00	0	17.10	18.00	0	16.71	
				50% RB Low	50 Pos 0	18.00	0	17.00	18.00	0	16.85	
				50% RB Mid	50 Pos 24	18.00	0	17.07	18.00	0	17.02	
				50% RB High	50 Pos 50	18.00	0	17.08	18.00	0	16.93	
		100% RB	100 Pos 0	18.00	0	17.22	18.00	0	17.31			
		21350	2560	1RB Low	1 Pos 0	18.00	0	16.96	18.00	0	16.92	
				1RB Mid	1 Pos 50	18.00	0	16.92	18.00	0	16.38	
				1RB High	1 Pos 99	18.00	0	17.06	18.00	0	17.01	
				50% RB Low	50 Pos 0	18.00	0	16.97	18.00	0	17.01	
				50% RB Mid	50 Pos 24	18.00	0	17.00	18.00	0	17.03	
				50% RB High	50 Pos 50	18.00	0	17.03	18.00	0	17.14	
		100% RB	100 Pos 0	18.00	0	17.07	18.00	0	17.12			
		15 MHz	20825	2507.5	1RB Low	1 Pos 0	18.00	0	17.33	18.00	0	17.44
					1RB Mid	1 Pos 38	18.00	0	17.33	18.00	0	17.48
					1RB High	1 Pos 74	18.00	0	17.12	18.00	0	17.34
	50% RB Low				38 Pos 0	18.00	0	17.42	18.00	0	17.68	
	50% RB Mid				38 Pos 19	18.00	0	17.37	18.00	0	17.55	
	50% RB High				38 Pos 39	18.00	0	17.27	18.00	0	17.35	
	100% RB		75 Pos 0	18.00	0	17.39	18.00	0	17.43			
	21100		2535	1RB Low	1 Pos 0	18.00	0	17.04	18.00	0	17.32	
				1RB Mid	1 Pos 38	18.00	0	17.05	18.00	0	17.34	
				1RB High	1 Pos 74	18.00	0	17.16	18.00	0	17.27	
				50% RB Low	38 Pos 0	18.00	0	16.98	18.00	0	17.12	
				50% RB Mid	38 Pos 19	18.00	0	17.20	18.00	0	17.26	
				50% RB High	38 Pos 39	18.00	0	17.24	18.00	0	17.28	
	100% RB		75 Pos 0	18.00	0	17.20	18.00	0	17.24			
	21375		2562.5	1RB Low	1 Pos 0	18.00	0	17.04	18.00	0	16.94	
				1RB Mid	1 Pos 38	18.00	0	16.96	18.00	0	16.92	
				1RB High	1 Pos 74	18.00	0	17.00	18.00	0	17.01	
				50% RB Low	38 Pos 0	18.00	0	17.05	18.00	0	16.98	
		50% RB Mid		38 Pos 19	18.00	0	17.04	18.00	0	16.99		
		50% RB High		38 Pos 39	18.00	0	17.02	18.00	0	17.05		
	100% RB	75 Pos 0	18.00	0	17.03	18.00	0	17.13				
	10 MHz	20800	2505	1RB Low	1 Pos 0	18.00	0	17.38	18.00	0	17.52	
				1RB Mid	1 Pos 24	18.00	0	17.35	18.00	0	17.59	
				1RB High	1 Pos 49	18.00	0	17.30	18.00	0	17.61	
				50% RB Low	25 Pos 0	18.00	0	17.43	18.00	0	17.53	
				50% RB Mid	25 Pos 12	18.00	0	17.39	18.00	0	17.49	
				50% RB High	25 Pos 25	18.00	0	17.40	18.00	0	17.46	
		100% RB	50 Pos0	18.00	0	17.47	18.00	0	17.36			
		21100	2535	1RB Low	1 Pos 0	18.00	0	17.03	18.00	0	17.07	
				1RB Mid	1 Pos 24	18.00	0	17.10	18.00	0	16.66	
				1RB High	1 Pos 49	18.00	0	17.16	18.00	0	16.75	
				50% RB Low	25 Pos 0	18.00	0	17.14	18.00	0	17.12	
				50% RB Mid	25 Pos 12	18.00	0	17.16	18.00	0	17.11	
				50% RB High	25 Pos 25	18.00	0	17.16	18.00	0	17.31	
		100% RB	50 Pos0	18.00	0	17.17	18.00	0	17.06			
		21400	2565	1RB Low	1 Pos 0	18.00	0	17.06	18.00	0	17.35	
				1RB Mid	1 Pos 24	18.00	0	17.12	18.00	0	17.20	
				1RB High	1 Pos 49	18.00	0	17.15	18.00	0	17.15	
				50% RB Low	25 Pos 0	18.00	0	17.10	18.00	0	17.14	
				50% RB Mid	25 Pos 12	18.00	0	17.13	18.00	0	17.22	
				50% RB High	25 Pos 25	18.00	0	17.09	18.00	0	17.13	
		100% RB	50 Pos0	18.00	0	17.05	18.00	0	17.14			

Band	BW	Channel #	Freq (MHz)	% RB Allocation	RB Position	QPSK			16 QAM		
						Factory Upper Tolerance (dBm)	M P R	Measured Output Power (dBm)	Factory Upper Tolerance (dBm)	M P R	Measured Output Power (dBm)
LTE 7	5 MHz	20775	2502.5	1RB Low	1 Pos 0	18.00	0	17.38	18.00	0	17.23
				1RB Mid	1 Pos 12	18.00	0	17.33	18.00	0	17.20
				1RB High	1 Pos 24	18.00	0	17.41	18.00	0	17.29
				50% RB Low	12 Pos 0	18.00	0	17.31	18.00	0	17.37
				50% RB Mid	12 Pos 6	18.00	0	17.30	18.00	0	17.34
				50% RB High	12 Pos 11	18.00	0	17.32	18.00	0	17.36
		100% RB	25 Pos 0	18.00	0	17.31	18.00	0	17.39		
		21100	2535	1RB Low	1 Pos 0	18.00	0	17.22	18.00	0	17.30
				1RB Mid	1 Pos 12	18.00	0	16.98	18.00	0	17.26
				1RB High	1 Pos 24	18.00	0	17.08	18.00	0	17.33
				50% RB Low	12 Pos 0	18.00	0	17.09	18.00	0	17.16
				50% RB Mid	12 Pos 6	18.00	0	17.07	18.00	0	17.16
				50% RB High	12 Pos 11	18.00	0	17.05	18.00	0	17.11
		100% RB	25 Pos 0	18.00	0	17.10	18.00	0	17.12		
		21425	2567.5	1RB Low	1 Pos 0	18.00	0	17.13	18.00	0	16.80
				1RB Mid	1 Pos 12	18.00	0	17.21	18.00	0	16.72
				1RB High	1 Pos 24	18.00	0	17.26	18.00	0	16.80
				50% RB Low	12 Pos 0	18.00	0	17.04	18.00	0	16.91
				50% RB Mid	12 Pos 6	18.00	0	17.00	18.00	0	17.09
				50% RB High	12 Pos 11	18.00	0	17.01	18.00	0	17.10
		100% RB	25 Pos 0	18.00	0	17.06	18.00	0	16.90		

B.2.2.5 LTE Band 12 FDD

Band	BW	Channel #	Freq (MHz)	% RB Allocation	RB Position	QPSK			16 QAM			
						Factory Upper Tolerance (dBm)	M P R	Measured Output Power (dBm)	Factory Upper Tolerance (dBm)	M P R	Measured Output Power (dBm)	
LTE 12	10 MHz	23095	707.5	1RB Low	1 Pos 0	23.00	0	22.62	23.00	1	21.99	
				1RB Mid	1 Pos 24	23.00	0	22.61	23.00	1	21.91	
				1RB High	1 Pos 49	23.00	0	22.64	23.00	1	22.12	
				50% RB Low	25 Pos 0	23.00	1	21.53	23.00	2	20.74	
				50% RB Mid	25 Pos 12	23.00	1	21.71	23.00	2	20.86	
				50% RB High	25 Pos 24	23.00	1	21.82	23.00	2	21.04	
	5 MHz	23035	701.5	1RB Low	1 Pos 0	23.00	0	22.71	23.00	1	22.20	
				1RB Mid	1 Pos 12	23.00	0	22.90	23.00	1	22.29	
				1RB High	1 Pos 24	23.00	0	22.67	23.00	1	22.26	
				50% RB Low	12 Pos 0	23.00	1	21.60	23.00	2	20.61	
				50% RB Mid	12 Pos 6	23.00	1	21.36	23.00	2	20.69	
				50% RB High	12 Pos 11	23.00	1	21.62	23.00	2	20.48	
		23095	707.5	100% RB	25 Pos 0	23.00	1	21.62	23.00	2	20.51	
				1RB Low	1 Pos 0	23.00	0	22.66	23.00	1	21.95	
				1RB Mid	1 Pos 12	23.00	0	22.59	23.00	1	21.99	
				1RB High	1 Pos 24	23.00	0	22.73	23.00	1	22.12	
				50% RB Low	12 Pos 0	23.00	1	21.70	23.00	2	20.79	
				50% RB Mid	12 Pos 6	23.00	1	21.68	23.00	2	20.70	
			23155	713.5	50% RB High	12 Pos 11	23.00	1	21.62	23.00	2	20.84
					100% RB	25 Pos 0	23.00	1	21.70	23.00	2	20.82
					1RB Low	1 Pos 0	23.00	0	22.79	23.00	1	22.01
					1RB Mid	1 Pos 12	23.00	0	22.77	23.00	1	21.83
					1RB High	1 Pos 24	23.00	0	22.63	23.00	1	21.90
					50% RB Low	12 Pos 0	23.00	1	21.64	23.00	2	20.60
	3 MHz	23025	700.5	50% RB Mid	12 Pos 6	23.00	1	21.64	23.00	2	20.71	
				50% RB High	12 Pos 11	23.00	1	21.62	23.00	2	20.66	
				100% RB	25 Pos 0	23.00	1	21.67	23.00	2	20.66	
				1RB Low	1 Pos 0	23.00	0	22.39	23.00	1	21.55	
				1RB Mid	1 Pos 7	23.00	0	22.53	23.00	1	21.94	
				1RB High	1 Pos 14	23.00	0	22.50	23.00	1	21.97	
		23095	707.5	50% RB Low	8 Pos 0	23.00	1	21.76	23.00	2	20.65	
				50% RB Mid	8 Pos 4	23.00	1	21.46	23.00	2	20.66	
				50% RB High	8 Pos 7	23.00	1	21.48	23.00	2	20.65	
				100% RB	15 Pos 0	23.00	1	21.64	23.00	2	20.52	
				1RB Low	1 Pos 0	23.00	0	22.46	23.00	1	21.75	
				1RB Mid	1 Pos 7	23.00	0	22.52	23.00	1	21.86	
			23165	714.5	1RB High	1 Pos 14	23.00	0	22.49	23.00	1	21.76
					50% RB Low	8 Pos 0	23.00	1	21.56	23.00	2	20.60
					50% RB Mid	8 Pos 4	23.00	1	21.58	23.00	2	20.61
					50% RB High	8 Pos 7	23.00	1	21.60	23.00	2	20.67
					100% RB	15 Pos 0	23.00	1	21.63	23.00	2	20.55
					1RB Low	1 Pos 0	23.00	0	22.65	23.00	1	21.80
		23165	714.5	1RB Mid	1 Pos 7	23.00	0	22.59	23.00	1	21.71	
				1RB High	1 Pos 14	23.00	0	22.56	23.00	1	21.73	
				50% RB Low	8 Pos 0	23.00	1	21.50	23.00	2	20.63	
				50% RB Mid	8 Pos 4	23.00	1	21.52	23.00	2	20.42	
				50% RB High	8 Pos 7	23.00	1	21.58	23.00	2	20.42	
				100% RB	15 Pos 0	23.00	1	21.38	23.00	2	20.34	

Band	BW	Channel #	Freq (MHz)	% RB Allocation	RB Position	QPSK			16 QAM				
						Factory Upper Tolerance (dBm)	M P R	Measured Output Power (dBm)	Factory Upper Tolerance (dBm)	M P R	Measured Output Power (dBm)		
LTE 12	1.4 MHz	23017	699.7	1RB Low	1 Pos 0	23.00	0	22.43	23.00	1	21.50		
				1RB Mid	1 Pos 2	23.00	0	22.40	23.00	1	21.48		
				1RB High	1 Pos 5	23.00	0	22.61	23.00	1	21.41		
				50% RB Low	3 Pos 0	23.00	1	22.50	23.00	2	21.73		
				50% RB Mid	3 Pos 1	23.00	1	22.51	23.00	2	21.72		
				50% RB High	3 Pos 2	23.00	1	22.49	23.00	2	21.76		
		23095	707.5	100% RB	6 Pos 0	23.00	1	21.66	23.00	2	20.31		
				1RB Low	1 Pos 0	23.00	0	22.55	23.00	1	21.22		
				1RB Mid	1 Pos 2	23.00	0	22.44	23.00	1	21.34		
				1RB High	1 Pos 5	23.00	0	22.54	23.00	1	21.25		
				50% RB Low	3 Pos 0	23.00	1	22.49	23.00	2	21.61		
				50% RB Mid	3 Pos 1	23.00	1	22.50	23.00	2	21.61		
		23173	715.3	50% RB High	3 Pos 2	23.00	1	22.50	23.00	2	21.60		
				100% RB	6 Pos 0	23.00	1	21.53	23.00	2	20.37		
				1RB Low	1 Pos 0	23.00	0	22.70	23.00	1	21.83		
				1RB Mid	1 Pos 2	23.00	0	22.41	23.00	1	21.64		
				1RB High	1 Pos 5	23.00	0	22.69	23.00	1	21.68		
				50% RB Low	3 Pos 0	23.00	1	22.31	23.00	2	21.39		
						50% RB Mid	3 Pos 1	23.00	1	22.41	23.00	2	21.33
						50% RB High	3 Pos 2	23.00	1	22.28	23.00	2	21.34
						100% RB	6 Pos 0	23.00	1	21.37	23.00	2	20.40

B.2.2.6 LTE Band 13 FDD

Band	BW	Channel #	Freq (MHz)	% RB Allocation	RB Position	QPSK			16 QAM		
						Factory Upper Tolerance (dBm)	M P R	Measured Output Power (dBm)	Factory Upper Tolerance (dBm)	M P R	Measured Output Power (dBm)
LTE 13	10 MHz	23230	782	1RB Low	1 Pos 0	23.00	0	22.64	23.00	1	21.94
				1RB Mid	1 Pos 24	23.00	0	22.50	23.00	1	22.14
				1RB High	1 Pos 49	23.00	0	22.46	23.00	1	22.02
				50% RB Low	25 Pos 0	23.00	1	22.00	23.00	2	21.07
				50% RB Mid	25 Pos 12	23.00	1	22.00	23.00	2	20.98
				50% RB High	25 Pos 24	23.00	1	22.00	23.00	2	21.09
				100% RB	50 Pos 0	23.00	1	21.96	23.00	2	21.76
	5.0 MHz	23230	782	1RB Low	1 Pos 0	23.00	0	22.65	23.00	1	21.76
				1RB Mid	1 Pos 12	23.00	0	22.53	23.00	1	22.03
				1RB High	1 Pos 24	23.00	0	22.58	23.00	1	21.89
				50% RB Low	12 Pos 0	23.00	1	21.91	23.00	2	21.00
				50% RB Mid	12 Pos 6	23.00	1	21.73	23.00	2	21.02
				50% RB High	12 Pos 11	23.00	1	21.96	23.00	2	20.85
				100% RB	25 Pos 0	23.00	1	21.89	23.00	2	21.00

B.2.2.7 LTE Band 17 FDD

SAR Measurement for LTE Band 17 FDD (Frequency range: 704 – 716MHz) is covered by LTE Band 12 FDD (Frequency range: 699 – 716MHz) due to overlapping frequency range, same maximum tune-up and same bandwidth.

B.2.2.8 LTE Band 26 FDD

Band	BW	Channel #	Freq (MHz)	% RB Allocation	RB Position	QPSK			16 QAM		
						Factory Upper Tolerance (dBm)	M P R	Measured Output Power (dBm)	Factory Upper Tolerance (dBm)	M P R	Measured Output Power (dBm)
LTE26	15 MHz	26775	821.5	1RB Low	1 Pos 0	23.00	0	22.88	23.00	1	22.02
				1RB Mid	1 Pos 38	23.00	0	22.41	23.00	1	22.03
				1RB High	1 Pos 74	23.00	0	22.95	23.00	1	21.81
				50% RB Low	38 Pos 0	23.00	1	22.06	23.00	2	21.02
				50% RB Mid	38 Pos 19	23.00	1	22.00	23.00	2	21.08
				50% RB High	38 Pos 39	23.00	1	22.01	23.00	2	21.07
		100% RB	75 Pos 0	23.00	1	22.04	23.00	2	21.40		
		26865	831.5	1RB Low	1 Pos 0	23.00	0	22.94	23.00	1	22.03
				1RB Mid	1 Pos 38	23.00	0	22.73	23.00	1	21.98
				1RB High	1 Pos 74	23.00	0	22.60	23.00	1	21.66
				50% RB Low	38 Pos 0	23.00	1	21.97	23.00	2	20.94
				50% RB Mid	38 Pos 19	23.00	1	21.84	23.00	2	20.91
				50% RB High	38 Pos 39	23.00	1	21.72	23.00	2	20.83
		100% RB	75 Pos 0	23.00	1	22.00	23.00	2	20.86		
		26965	841.5	1RB Low	1 Pos 0	23.00	0	22.71	23.00	1	21.53
				1RB Mid	1 Pos 38	23.00	0	22.83	23.00	1	21.60
				1RB High	1 Pos 74	23.00	0	22.88	23.00	1	22.00
				50% RB Low	38 Pos 0	23.00	1	21.72	23.00	2	20.74
	50% RB Mid			38 Pos 19	23.00	1	21.90	23.00	2	20.79	
	50% RB High			38 Pos 39	23.00	1	21.92	23.00	2	21.00	
	100% RB	75 Pos 0	23.00	1	21.99	23.00	2	21.05			
	10 MHz	26750	820	1RB Low	1 Pos 0	23.00	0	22.71	23.00	1	22.34
				1RB Mid	1 Pos 24	23.00	0	22.76	23.00	1	22.37
				1RB High	1 Pos 49	23.00	0	22.83	23.00	1	22.49
				50% RB Low	25 Pos 0	23.00	1	22.02	23.00	2	21.08
				50% RB Mid	25 Pos 12	23.00	1	22.07	23.00	2	21.20
				50% RB High	25 Pos 24	23.00	1	22.08	23.00	2	21.24
		100% RB	50 Pos 0	23.00	1	22.13	23.00	2	21.16		
		26865	831.5	1RB Low	1 Pos 0	23.00	0	22.99	23.00	1	21.80
				1RB Mid	1 Pos 24	23.00	0	22.75	23.00	1	21.61
				1RB High	1 Pos 49	23.00	0	22.75	23.00	1	21.68
				50% RB Low	25 Pos 0	23.00	1	21.79	23.00	2	21.06
				50% RB Mid	25 Pos 12	23.00	1	21.70	23.00	2	20.71
				50% RB High	25 Pos 24	23.00	1	21.78	23.00	2	20.93
		100% RB	50 Pos 0	23.00	1	21.83	23.00	2	20.84		
		26990	844	1RB Low	1 Pos 0	23.00	0	22.67	23.00	1	21.99
				1RB Mid	1 Pos 24	23.00	0	22.89	23.00	1	22.24
				1RB High	1 Pos 49	23.00	0	22.88	23.00	1	22.22
				50% RB Low	25 Pos 0	23.00	1	21.93	23.00	2	20.77
	50% RB Mid			25 Pos 12	23.00	1	21.92	23.00	2	20.91	
	50% RB High			25 Pos 24	23.00	1	21.85	23.00	2	20.99	
	100% RB	50 Pos 0	23.00	1	22.09	23.00	2	21.03			
	5.0 MHz	26715	816.5	1RB Low	1 Pos 0	23.00	0	22.47	23.00	1	22.44
				1RB Mid	1 Pos 12	23.00	0	22.47	23.00	1	21.92
				1RB High	1 Pos 24	23.00	0	22.98	23.00	1	21.94
				50% RB Low	12 Pos 0	23.00	1	21.93	23.00	2	21.02
				50% RB Mid	12 Pos 6	23.00	1	22.07	23.00	2	21.08
				50% RB High	12 Pos 11	23.00	1	21.99	23.00	2	21.07
		100% RB	25 Pos 0	23.00	1	22.03	23.00	2	21.08		
		26865	831.5	1RB Low	1 Pos 0	23.00	0	23.00	23.00	1	21.96
				1RB Mid	1 Pos 12	23.00	0	22.77	23.00	1	21.80
				1RB High	1 Pos 24	23.00	0	22.88	23.00	1	22.24
				50% RB Low	12 Pos 0	23.00	1	21.82	23.00	2	20.94
				50% RB Mid	12 Pos 6	23.00	1	21.65	23.00	2	20.55
50% RB High				12 Pos 11	23.00	1	21.67	23.00	2	20.84	
100% RB		25 Pos 0	23.00	1	21.69	23.00	2	20.83			
27015		846.5	1RB Low	1 Pos 0	23.00	0	22.54	23.00	1	22.02	
			1RB Mid	1 Pos 12	23.00	0	22.88	23.00	1	22.04	
			1RB High	1 Pos 24	23.00	0	22.93	23.00	1	22.07	
			50% RB Low	12 Pos 0	23.00	1	22.01	23.00	2	20.97	
	50% RB Mid		12 Pos 6	23.00	1	21.77	23.00	2	20.98		
	50% RB High		12 Pos 11	23.00	1	21.96	23.00	2	20.85		
100% RB	25 Pos 0	23.00	1	21.85	23.00	2	20.91				

Band	BW	Channel #	Freq (MHz)	% RB Allocation	RB Position	QPSK			16 QAM		
						Factory Upper Tolerance (dBm)	M P R	Measured Output Power (dBm)	Factory Upper Tolerance (dBm)	M P R	Measured Output Power (dBm)
LTE26	3.0 MHz	26705	815.5	1RB Low	1 Pos 0	23.00	0	22.76	23.00	1	22.01
				1RB Mid	1 Pos 7	23.00	0	22.81	23.00	1	21.89
				1RB High	1 Pos 14	23.00	0	22.84	23.00	1	21.94
				50% RB Low	8 Pos 0	23.00	1	21.93	23.00	2	20.82
				50% RB Mid	8 Pos 4	23.00	1	21.83	23.00	2	21.05
				50% RB High	8 Pos 7	23.00	1	21.98	23.00	2	20.85
		100% RB	15 Pos 0	23.00	1	21.89	23.00	2	21.02		
		26865	831.5	1RB Low	1 Pos 0	23.00	0	22.75	23.00	1	21.80
				1RB Mid	1 Pos 7	23.00	0	22.69	23.00	1	21.80
				1RB High	1 Pos 14	23.00	0	22.64	23.00	1	22.03
				50% RB Low	8 Pos 0	23.00	1	21.86	23.00	2	20.70
				50% RB Mid	8 Pos 4	23.00	1	21.67	23.00	2	20.62
				50% RB High	8 Pos 7	23.00	1	21.69	23.00	2	20.63
		100% RB	15 Pos 0	23.00	1	21.71	23.00	2	20.60		
		27025	847.5	1RB Low	1 Pos 0	23.00	0	22.85	23.00	1	21.89
				1RB Mid	1 Pos 7	23.00	0	22.91	23.00	1	21.99
				1RB High	1 Pos 14	23.00	0	22.81	23.00	1	21.98
				50% RB Low	8 Pos 0	23.00	1	21.89	23.00	2	20.78
	50% RB Mid			8 Pos 4	23.00	1	21.95	23.00	2	20.84	
	50% RB High			8 Pos 7	23.00	1	21.94	23.00	2	20.97	
	100% RB	15 Pos 0	23.00	1	21.82	23.00	2	20.75			
	1.4 MHz	26697	814.7	1RB Low	1 Pos 0	23.00	0	22.98	23.00	1	22.00
				1RB Mid	1 Pos 2	23.00	0	22.90	23.00	1	22.01
				1RB High	1 Pos 5	23.00	0	22.88	23.00	1	22.01
				50% RB Low	3 Pos 0	23.00	1	21.91	23.00	2	20.97
				50% RB Mid	3 Pos 1	23.00	1	21.85	23.00	2	20.96
				50% RB High	3 Pos 2	23.00	1	21.84	23.00	2	21.05
		100% RB	6 Pos 0	23.00	1	20.90	23.00	2	19.68		
		26865	831.5	1RB Low	1 Pos 0	23.00	0	22.70	23.00	1	21.74
				1RB Mid	1 Pos 2	23.00	0	22.71	23.00	1	21.87
				1RB High	1 Pos 5	23.00	0	22.76	23.00	1	21.91
				50% RB Low	3 Pos 0	23.00	1	21.76	23.00	2	20.72
				50% RB Mid	3 Pos 1	23.00	1	21.73	23.00	2	20.69
				50% RB High	3 Pos 2	23.00	1	21.68	23.00	2	20.69
		100% RB	6 Pos 0	23.00	1	20.80	23.00	2	19.72		
		27033	848.3	1RB Low	1 Pos 0	23.00	0	22.90	23.00	1	22.00
				1RB Mid	1 Pos 2	23.00	0	22.86	23.00	1	21.97
				1RB High	1 Pos 5	23.00	0	22.92	23.00	1	21.80
				50% RB Low	3 Pos 0	23.00	1	21.70	23.00	2	20.91
	50% RB Mid			3 Pos 1	23.00	1	21.76	23.00	2	20.89	
	50% RB High			3 Pos 2	23.00	1	21.68	23.00	2	20.69	
	100% RB	6 Pos 0	23.00	1	20.70	23.00	2	19.88			

B.2.2.9 LTE Band 30 FDD

Band	BW	Channel #	Freq (MHz)	% RB Allocation	RB Position	QPSK			16 QAM		
						Factory Upper Tolerance (dBm)	M P R	Measured Output Power (dBm)	Factory Upper Tolerance (dBm)	M P R	Measured Output Power (dBm)
LTE30	10 MHz	27710	2310	1RB Low	1 Pos 0	23.00	0	22.43	23.00	1	21.55
				1RB Mid	1 Pos 24	23.00	0	22.32	23.00	1	21.41
				1RB High	1 Pos 49	23.00	0	22.37	23.00	1	21.56
				50% RB Low	25 Pos 0	23.00	1	21.50	23.00	2	20.59
				50% RB Mid	25 Pos 12	23.00	1	21.58	23.00	2	20.62
				50% RB High	25 Pos 24	23.00	1	21.64	23.00	2	20.65
				100% RB	50 Pos 0	23.00	1	21.62	23.00	2	20.59
	5.0 MHz	27710	2310	1RB Low	1 Pos 0	23.00	0	22.35	23.00	1	21.78
				1RB Mid	1 Pos 12	23.00	0	22.33	23.00	1	21.33
				1RB High	1 Pos 24	23.00	0	22.32	23.00	1	21.88
				50% RB Low	12 Pos 0	23.00	1	21.62	23.00	2	20.57
				50% RB Mid	12 Pos 6	23.00	1	21.62	23.00	2	21.63
				50% RB High	12 Pos 11	23.00	1	21.58	23.00	2	20.46
				100% RB	25 Pos 0	23.00	1	20.59	23.00	2	20.49

B.2.2.10 LTE Band 38 TDD

Band	BW	Channel #	Freq (MHz)	% RB Allocation	RB Position	QPSK			16 QAM		
						Factory Upper Tolerance (dBm)	M P R	Measured Output Power (dBm)	Factory Upper Tolerance (dBm)	M P R	Measured Output Power (dBm)
LTE38	20 MHz	37850	2580	1RB Low	1 Pos 0	21.00	0	20.12	21.00	0	20.24
				1RB Mid	1 Pos 50	21.00	0	20.16	21.00	0	20.25
				1RB High	1 Pos 99	21.00	0	20.22	21.00	0	20.34
				50% RB Low	50 Pos 0	21.00	0	20.06	21.00	0	20.16
				50% RB Mid	50 Pos 24	21.00	0	20.09	21.00	0	20.17
				50% RB High	50 Pos 50	21.00	0	20.10	21.00	0	20.20
		100% RB	100 Pos 0	21.00	0	20.08	21.00	0	20.17		
		1RB Low	1 Pos 0	21.00	0	20.18	21.00	0	20.14		
		1RB Mid	1 Pos 50	21.00	0	20.10	21.00	0	20.08		
		1RB High	1 Pos 99	21.00	0	20.07	21.00	0	20.07		
		50% RB Low	50 Pos 0	21.00	0	20.06	21.00	0	20.10		
		50% RB Mid	50 Pos 24	21.00	0	20.01	21.00	0	20.06		
		50% RB High	50 Pos 50	21.00	0	19.99	21.00	0	20.03		
		100% RB	100 Pos 0	21.00	0	20.03	21.00	0	20.04		
		1RB Low	1 Pos 0	21.00	0	20.01	21.00	0	20.25		
		1RB Mid	1 Pos 50	21.00	0	19.88	21.00	0	20.13		
		1RB High	1 Pos 99	21.00	0	19.92	21.00	0	20.17		
		50% RB Low	50 Pos 0	21.00	0	19.95	21.00	0	20.04		
		50% RB Mid	50 Pos 24	21.00	0	19.91	21.00	0	19.96		
		50% RB High	50 Pos 50	21.00	0	19.91	21.00	0	19.96		
		100% RB	100 Pos 0	21.00	0	19.96	21.00	0	19.94		
		1RB Low	1 Pos 0	21.00	0	20.08	21.00	0	20.85		
		1RB Mid	1 Pos 38	21.00	0	20.13	21.00	0	20.85		
		1RB High	1 Pos 74	21.00	0	20.18	21.00	0	20.93		
	50% RB Low	38 Pos 0	21.00	0	20.04	21.00	0	20.20			
	50% RB Mid	38 Pos 19	21.00	0	20.07	21.00	0	20.25			
	50% RB High	38 Pos 39	21.00	0	20.07	21.00	0	20.26			
	100% RB	75 Pos 0	21.00	0	20.02	21.00	0	20.12			
	1RB Low	1 Pos 0	21.00	0	19.99	21.00	0	20.42			
	1RB Mid	1 Pos 38	21.00	0	19.97	21.00	0	20.38			
	1RB High	1 Pos 74	21.00	0	19.89	21.00	0	20.26			
	50% RB Low	38 Pos 0	21.00	0	20.07	21.00	0	20.17			
	50% RB Mid	38 Pos 19	21.00	0	20.06	21.00	0	20.18			
	50% RB High	38 Pos 39	21.00	0	20.01	21.00	0	20.12			
	100% RB	75 Pos 0	21.00	0	20.04	21.00	0	20.03			
	1RB Low	1 Pos 0	21.00	0	19.95	21.00	0	20.76			
	1RB Mid	1 Pos 38	21.00	0	19.86	21.00	0	20.73			
	1RB High	1 Pos 74	21.00	0	19.87	21.00	0	20.70			
	50% RB Low	38 Pos 0	21.00	0	19.92	21.00	0	20.11			
	50% RB Mid	38 Pos 19	21.00	0	19.91	21.00	0	20.09			
	50% RB High	38 Pos 39	21.00	0	19.88	21.00	0	20.08			
	100% RB	75 Pos 0	21.00	0	19.89	21.00	0	20.02			
	1RB Low	1 Pos 0	21.00	0	20.11	21.00	0	20.83			
	1RB Mid	1 Pos 24	21.00	0	20.13	21.00	0	20.84			
	1RB High	1 Pos 49	21.00	0	20.19	21.00	0	20.96			
	50% RB Low	25 Pos 0	21.00	0	20.03	21.00	0	20.21			
	50% RB Mid	25 Pos 12	21.00	0	20.04	21.00	0	20.19			
	50% RB High	25 Pos 24	21.00	0	20.08	21.00	0	20.23			
	100% RB	50 Pos 0	21.00	0	20.02	21.00	0	20.12			
	1RB Low	1 Pos 0	21.00	0	19.98	21.00	0	20.55			
	1RB Mid	1 Pos 24	21.00	0	19.92	21.00	0	20.45			
	1RB High	1 Pos 49	21.00	0	19.98	21.00	0	20.46			
	50% RB Low	25 Pos 0	21.00	0	20.07	21.00	0	20.05			
	50% RB Mid	25 Pos 12	21.00	0	20.07	21.00	0	20.08			
	50% RB High	25 Pos 24	21.00	0	20.05	21.00	0	20.02			
	100% RB	50 Pos 0	21.00	0	20.01	21.00	0	20.07			
	1RB Low	1 Pos 0	21.00	0	19.86	21.00	0	20.71			
	1RB Mid	1 Pos 24	21.00	0	19.81	21.00	0	20.64			
	1RB High	1 Pos 49	21.00	0	19.87	21.00	0	20.71			
	50% RB Low	25 Pos 0	21.00	0	19.93	21.00	0	20.04			
	50% RB Mid	25 Pos 12	21.00	0	19.88	21.00	0	20.02			
	50% RB High	25 Pos 24	21.00	0	19.90	21.00	0	20.04			
	100% RB	50 Pos 0	21.00	0	19.85	21.00	0	19.92			

Band	BW	Channel #	Freq (MHz)	% RB Allocation	RB Position	QPSK			16 QAM		
						Factory Upper Tolerance (dBm)	M P R	Measured Output Power (dBm)	Factory Upper Tolerance (dBm)	M P R	Measured Output Power (dBm)
LTE38	5 MHz	37775	2572.5	1RB Low	1 Pos 0	21.00	0	20.05	21.00	0	19.88
				1RB Mid	1 Pos 12	21.00	0	20.02	21.00	0	19.88
				1RB High	1 Pos 24	21.00	0	20.06	21.00	0	19.94
				50% RB Low	12 Pos 0	21.00	0	19.93	21.00	0	19.87
				50% RB Mid	12 Pos 6	21.00	0	19.91	21.00	0	19.92
				50% RB High	12 Pos 11	21.00	0	19.96	21.00	0	19.88
		100% RB	25 Pos 0	21.00	0	19.97	21.00	0	19.89		
		38000	2595	1RB Low	1 Pos 0	21.00	0	20.13	21.00	0	20.18
				1RB Mid	1 Pos 12	21.00	0	20.09	21.00	0	20.11
				1RB High	1 Pos 24	21.00	0	20.03	21.00	0	20.14
				50% RB Low	12 Pos 0	21.00	0	20.02	21.00	0	19.99
				50% RB Mid	12 Pos 6	21.00	0	19.99	21.00	0	20.02
				50% RB High	12 Pos 11	21.00	0	20.00	21.00	0	19.96
		100% RB	25 Pos 0	21.00	0	20.00	21.00	0	19.97		
		38225	2617.5	1RB Low	1 Pos 0	21.00	0	19.93	21.00	0	19.89
				1RB Mid	1 Pos 12	21.00	0	19.84	21.00	0	19.85
				1RB High	1 Pos 24	21.00	0	19.89	21.00	0	19.90
				50% RB Low	12 Pos 0	21.00	0	19.83	21.00	0	19.86
				50% RB Mid	12 Pos 6	21.00	0	19.80	21.00	0	19.91
				50% RB High	12 Pos 11	21.00	0	19.79	21.00	0	19.85
		100% RB	25 Pos 0	21.00	0	19.81	21.00	0	19.83		

B.2.2.11 LTE Band 41 TDD

Band	BW	Channel #	Freq (MHz)	% RB Allocation	RB Position	QPSK			16 QAM		
						Factory Upper Tolerance (dBm)	M P R	Measured Output Power (dBm)	Factory Upper Tolerance (dBm)	M P R	Measured Output Power (dBm)
LTE41	20 MHz	39750	2506	1RB Low	1 Pos 0	20.50	0	19.71	20.50	0	19.80
				1RB Mid	1 Pos 50	20.50	0	19.75	20.50	0	19.84
				1RB High	1 Pos 99	20.50	0	19.72	20.50	0	19.85
				50% RB Low	50 Pos 0	20.50	0	19.73	20.50	0	19.77
				50% RB Mid	50 Pos 24	20.50	0	19.70	20.50	0	19.74
				50% RB High	50 Pos 50	20.50	0	19.68	20.50	0	19.66
		100% RB	100 Pos 0	20.50	0	19.78	20.50	0	19.80		
		40185	2549.5	1RB Low	1 Pos 0	20.50	0	19.44	20.50	0	19.36
				1RB Mid	1 Pos 50	20.50	0	19.42	20.50	0	19.37
				1RB High	1 Pos 99	20.50	0	19.60	20.50	0	19.54
				50% RB Low	50 Pos 0	20.50	0	19.27	20.50	0	19.32
				50% RB Mid	50 Pos 24	20.50	0	19.23	20.50	0	19.32
				50% RB High	50 Pos 50	20.50	0	19.30	20.50	0	19.35
		100% RB	100 Pos 0	20.50	0	19.25	20.50	0	19.28		
		40620	2593	1RB Low	1 Pos 0	20.50	0	19.46	20.50	0	19.76
				1RB Mid	1 Pos 50	20.50	0	19.39	20.50	0	19.66
				1RB High	1 Pos 99	20.50	0	19.50	20.50	0	19.71
				50% RB Low	50 Pos 0	20.50	0	19.45	20.50	0	19.54
				50% RB Mid	50 Pos 24	20.50	0	19.43	20.50	0	19.52
				50% RB High	50 Pos 50	20.50	0	19.43	20.50	0	19.50
		100% RB	100 Pos 0	20.50	0	19.50	20.50	0	19.50		
		41055	2636.5	1RB Low	1 Pos 0	20.50	0	19.43	20.50	0	19.53
				1RB Mid	1 Pos 50	20.50	0	19.32	20.50	0	19.47
				1RB High	1 Pos 99	20.50	0	19.47	20.50	0	19.62
				50% RB Low	50 Pos 0	20.50	0	19.28	20.50	0	19.26
				50% RB Mid	50 Pos 24	20.50	0	19.24	20.50	0	19.25
				50% RB High	50 Pos 50	20.50	0	19.28	20.50	0	19.29
		100% RB	100 Pos 0	20.50	0	19.32	20.50	0	19.28		
		41490	2680	1RB Low	1 Pos 0	20.50	0	19.28	20.50	0	19.28
				1RB Mid	1 Pos 50	20.50	0	19.17	20.50	0	19.16
				1RB High	1 Pos 99	20.50	0	19.36	20.50	0	19.35
				50% RB Low	50 Pos 0	20.50	0	19.05	20.50	0	19.11
				50% RB Mid	50 Pos 24	20.50	0	18.99	20.50	0	19.07
				50% RB High	50 Pos 50	20.50	0	19.05	20.50	0	19.10
		100% RB	100 Pos 0	20.50	0	19.14	20.50	0	19.28		

Band	BW	Channel #	Freq (MHz)	% RB Allocation	RB Position	QPSK			16 QAM		
						Factory Upper Tolerance (dBm)	M P R	Measured Output Power (dBm)	Factory Upper Tolerance (dBm)	M P R	Measured Output Power (dBm)
LTE41	15 MHz	39750	2506	1RB Low	1 Pos 0	20.50	0	19.79	20.50	0	20.46
				1RB Mid	1 Pos 38	20.50	0	19.82	20.50	0	20.19
				1RB High	1 Pos 74	20.50	0	19.84	20.50	0	20.20
				50% RB Low	38 Pos 0	20.50	0	19.72	20.50	0	19.77
				50% RB Mid	38 Pos 19	20.50	0	19.78	20.50	0	19.83
				50% RB High	38 Pos 39	20.50	0	19.73	20.50	0	19.78
		40185	2549.5	100% RB	75 Pos 0	20.50	0	19.79	20.50	0	19.82
				1RB Low	1 Pos 0	20.50	0	19.28	20.50	0	19.76
				1RB Mid	1 Pos 38	20.50	0	19.28	20.50	0	19.76
				1RB High	1 Pos 74	20.50	0	19.38	20.50	0	19.82
				50% RB Low	38 Pos 0	20.50	0	19.37	20.50	0	19.47
				50% RB Mid	38 Pos 19	20.50	0	19.37	20.50	0	19.48
		40620	2593	50% RB High	38 Pos 39	20.50	0	19.40	20.50	0	19.52
				100% RB	75 Pos 0	20.50	0	19.33	20.50	0	19.34
				1RB Low	1 Pos 0	20.50	0	19.44	20.50	0	20.35
				1RB Mid	1 Pos 38	20.50	0	19.42	20.50	0	20.33
				1RB High	1 Pos 74	20.50	0	19.41	20.50	0	20.23
				50% RB Low	38 Pos 0	20.50	0	19.51	20.50	0	19.58
		41055	2636.5	50% RB Mid	38 Pos 19	20.50	0	19.51	20.50	0	19.58
				50% RB High	38 Pos 39	20.50	0	19.45	20.50	0	19.54
				100% RB	75 Pos 0	20.50	0	19.48	20.50	0	19.56
				1RB Low	1 Pos 0	20.50	0	19.55	20.50	0	20.31
				1RB Mid	1 Pos 38	20.50	0	19.48	20.50	0	20.27
				1RB High	1 Pos 74	20.50	0	19.55	20.50	0	20.29
		41490	2680.0	50% RB Low	38 Pos 0	20.50	0	19.35	20.50	0	19.36
				50% RB Mid	38 Pos 19	20.50	0	19.31	20.50	0	19.35
				50% RB High	38 Pos 39	20.50	0	19.33	20.50	0	19.37
				100% RB	75 Pos 0	20.50	0	19.33	20.50	0	19.31
				1RB Low	1 Pos 0	20.50	0	19.06	20.50	0	19.54
				1RB Mid	1 Pos 38	20.50	0	19.04	20.50	0	19.49
				1RB High	1 Pos 74	20.50	0	19.11	20.50	0	19.54
				50% RB Low	38 Pos 0	20.50	0	19.07	20.50	0	19.18
				50% RB Mid	38 Pos 19	20.50	0	19.05	20.50	0	19.18
				50% RB High	38 Pos 39	20.50	0	19.09	20.50	0	19.21
				100% RB	75 Pos 0	20.50	0	19.14	20.50	0	19.03

Band	BW	Channel #	Freq (MHz)	% RB Allocation	RB Position	QPSK			16 QAM		
						Factory Upper Tolerance (dBm)	M P R	Measured Output Power (dBm)	Factory Upper Tolerance (dBm)	M P R	Measured Output Power (dBm)
LTE41	10 MHz	39750	2506	1RB Low	1 Pos 0	20.50	0	19.88	20.50	0	20.50
				1RB Mid	1 Pos 24	20.50	0	19.90	20.50	0	20.50
				1RB High	1 Pos 49	20.50	0	19.83	20.50	0	20.50
				50% RB Low	25 Pos 0	20.50	0	19.72	20.50	0	19.72
				50% RB Mid	25 Pos 12	20.50	0	19.72	20.50	0	19.73
				50% RB High	25 Pos 24	20.50	0	19.70	20.50	0	19.73
		40185	2549.5	100% RB	50 Pos 0	20.50	0	19.72	20.50	0	19.85
				1RB Low	1 Pos 0	20.50	0	19.29	20.50	0	19.87
				1RB Mid	1 Pos 24	20.50	0	19.24	20.50	0	19.84
				1RB High	1 Pos 49	20.50	0	19.35	20.50	0	19.91
				50% RB Low	25 Pos 0	20.50	0	19.40	20.50	0	19.34
				50% RB Mid	25 Pos 12	20.50	0	19.35	20.50	0	19.31
		40620	2593	50% RB High	25 Pos 24	20.50	0	19.41	20.50	0	19.34
				100% RB	50 Pos 0	20.50	0	19.30	20.50	0	19.40
				1RB Low	1 Pos 0	20.50	0	19.45	20.50	0	20.33
				1RB Mid	1 Pos 24	20.50	0	19.43	20.50	0	20.27
				1RB High	1 Pos 49	20.50	0	19.43	20.50	0	20.28
				50% RB Low	25 Pos 0	20.50	0	19.50	20.50	0	19.54
		41055	2636.5	50% RB Mid	25 Pos 12	20.50	0	19.49	20.50	0	19.53
				100% RB	50 Pos 0	20.50	0	19.51	20.50	0	19.53
				1RB Low	1 Pos 0	20.50	0	19.45	20.50	0	19.57
				1RB Mid	1 Pos 24	20.50	0	19.47	20.50	0	20.24
				1RB High	1 Pos 49	20.50	0	19.47	20.50	0	20.22
				50% RB Low	25 Pos 0	20.50	0	19.56	20.50	0	20.32
		41490	2680	50% RB Mid	25 Pos 12	20.50	0	19.34	20.50	0	19.34
				100% RB	50 Pos 0	20.50	0	19.29	20.50	0	19.31
				1RB Low	1 Pos 0	20.50	0	19.31	20.50	0	19.33
				1RB Mid	1 Pos 24	20.50	0	19.31	20.50	0	19.43
				1RB High	1 Pos 49	20.50	0	19.10	20.50	0	19.72
				50% RB Low	25 Pos 0	20.50	0	19.06	20.50	0	19.69
				50% RB Mid	25 Pos 12	20.50	0	19.10	20.50	0	19.76
				100% RB	50 Pos 0	20.50	0	19.15	20.50	0	19.07
				1RB Low	1 Pos 0	20.50	0	19.88	20.50	0	20.50
				1RB Mid	1 Pos 24	20.50	0	19.90	20.50	0	20.50
				1RB High	1 Pos 49	20.50	0	19.83	20.50	0	20.50

Band	BW	Channel #	Freq (MHz)	% RB Allocation	RB Position	QPSK			16 QAM		
						Factory Upper Tolerance (dBm)	M P R	Measured Output Power (dBm)	Factory Upper Tolerance (dBm)	M P R	Measured Output Power (dBm)
LTE41	5.0 MHz	39750	2506	1RB Low	1 Pos 0	20.50	0	19.75	20.50	0	19.73
				1RB Mid	1 Pos 12	20.50	0	19.73	20.50	0	19.75
				1RB High	1 Pos 24	20.50	0	19.72	20.50	0	19.75
				50% RB Low	12 Pos 0	20.50	0	19.73	20.50	0	19.65
				50% RB Mid	12 Pos 6	20.50	0	19.67	20.50	0	19.71
				50% RB High	12 Pos 11	20.50	0	19.70	20.50	0	19.66
		40185	2549.5	100% RB	25 Pos 0	20.50	0	19.73	20.50	0	19.67
				1RB Low	1 Pos 0	20.50	0	19.42	20.50	0	19.38
				1RB Mid	1 Pos 12	20.50	0	19.32	20.50	0	19.31
				1RB High	1 Pos 24	20.50	0	19.38	20.50	0	19.39
				50% RB Low	12 Pos 0	20.50	0	19.30	20.50	0	19.24
				50% RB Mid	12 Pos 6	20.50	0	19.27	20.50	0	19.26
		40620	2593	50% RB High	12 Pos 11	20.50	0	19.23	20.50	0	19.21
				100% RB	25 Pos 0	20.50	0	19.26	20.50	0	19.22
				1RB Low	1 Pos 0	20.50	0	19.49	20.50	0	19.39
				1RB Mid	1 Pos 12	20.50	0	19.46	20.50	0	19.33
				1RB High	1 Pos 24	20.50	0	19.47	20.50	0	19.40
				50% RB Low	12 Pos 0	20.50	0	19.40	20.50	0	19.38
		41055	2636.5	50% RB Mid	12 Pos 6	20.50	0	19.42	20.50	0	19.49
				50% RB High	12 Pos 11	20.50	0	19.40	20.50	0	19.39
				100% RB	25 Pos 0	20.50	0	19.40	20.50	0	19.39
				1RB Low	1 Pos 0	20.50	0	19.31	20.50	0	19.54
				1RB Mid	1 Pos 12	20.50	0	19.22	20.50	0	19.45
				1RB High	1 Pos 24	20.50	0	19.29	20.50	0	19.51
		41490	2680	50% RB Low	12 Pos 0	20.50	0	19.35	20.50	0	19.19
				50% RB Mid	12 Pos 6	20.50	0	19.25	20.50	0	19.29
				50% RB High	12 Pos 11	20.50	0	19.25	20.50	0	19.10
				100% RB	25 Pos 0	20.50	0	19.28	20.50	0	19.13
				1RB Low	1 Pos 0	20.50	0	19.18	20.50	0	19.19
				1RB Mid	1 Pos 12	20.50	0	19.14	20.50	0	19.12
				1RB High	1 Pos 24	20.50	0	19.17	20.50	0	19.19
				50% RB Low	12 Pos 0	20.50	0	19.02	20.50	0	18.98
				50% RB Mid	12 Pos 6	20.50	0	19.05	20.50	0	19.06
				50% RB High	12 Pos 11	20.50	0	19.03	20.50	0	18.97
				100% RB	25 Pos 0	20.50	0	19.06	20.50	0	18.98

B.2.2.1 LTE Band 66 FDD

Band	BW	Channel #	Freq (MHz)	% RB Allocation	RB Position	QPSK			16 QAM		
						Factory Upper Tolerance (dBm)	M P R	Measured Output Power (dBm)	Factory Upper Tolerance (dBm)	M P R	Measured Output Power (dBm)
LTE66	20 MHz	132072	1720	1RB Low	1 Pos 0	21.00	0	20.07	21.00	0	20.35
				1RB Mid	1 Pos 50	21.00	0	20.19	21.00	0	20.49
				1RB High	1 Pos 99	21.00	0	20.12	21.00	0	20.43
				50% RB Low	50 Pos 0	21.00	0	20.27	21.00	0	20.16
				50% RB Mid	50 Pos 24	21.00	0	20.29	21.00	0	20.17
				50% RB High	50 Pos 50	21.00	0	20.20	21.00	0	20.14
		100% RB	100 Pos 0	21.00	0	20.28	21.00	0	20.33		
		132322	1745	1RB Low	1 Pos 0	21.00	0	20.26	21.00	0	20.07
				1RB Mid	1 Pos 50	21.00	0	20.61	21.00	0	20.74
				1RB High	1 Pos 99	21.00	0	20.40	21.00	0	20.20
				50% RB Low	50 Pos 0	21.00	0	20.46	21.00	0	20.40
				50% RB Mid	50 Pos 24	21.00	0	20.40	21.00	0	20.34
				50% RB High	50 Pos 50	21.00	0	20.44	21.00	0	20.43
		100% RB	100 Pos 0	21.00	0	20.63	21.00	0	20.66		
		132572	1770	1RB Low	1 Pos 0	21.00	0	20.56	21.00	0	20.35
				1RB Mid	1 Pos 50	21.00	0	20.37	21.00	0	20.53
				1RB High	1 Pos 99	21.00	0	20.66	21.00	0	20.46
				50% RB Low	50 Pos 0	21.00	0	20.29	21.00	0	20.34
	50% RB Mid			50 Pos 24	21.00	0	20.21	21.00	0	20.12	
	50% RB High			50 Pos 50	21.00	0	20.22	21.00	0	20.18	
	100% RB	100 Pos 0	21.00	0	20.50	21.00	0	20.40			
	15 MHz	132047	1717.5	1RB Low	1 Pos 0	21.00	0	20.01	21.00	0	20.33
				1RB Mid	1 Pos 38	21.00	0	20.31	21.00	0	20.77
				1RB High	1 Pos 74	21.00	0	20.26	21.00	0	20.75
				50% RB Low	38 Pos 0	21.00	0	20.13	21.00	0	19.92
				50% RB Mid	38 Pos 19	21.00	0	20.21	21.00	0	19.98
				50% RB High	38 Pos 39	21.00	0	20.21	21.00	0	20.06
		100% RB	75 Pos 0	21.00	0	20.32	21.00	0	20.34		
		132422	1755	1RB Low	1 Pos 0	21.00	0	20.38	21.00	0	20.88
				1RB Mid	1 Pos 38	21.00	0	20.43	21.00	0	20.52
				1RB High	1 Pos 74	21.00	0	20.50	21.00	0	20.46
				50% RB Low	38 Pos 0	21.00	0	20.38	21.00	0	20.33
				50% RB Mid	38 Pos 19	21.00	0	20.39	21.00	0	20.34
				50% RB High	38 Pos 39	21.00	0	20.33	21.00	0	20.30
		100% RB	75 Pos 0	21.00	0	20.51	21.00	0	20.49		
		132597	1772.5	1RB Low	1 Pos 0	21.00	0	20.24	21.00	0	19.98
				1RB Mid	1 Pos 38	21.00	0	20.09	21.00	0	20.31
				1RB High	1 Pos 74	21.00	0	20.29	21.00	0	20.63
				50% RB Low	38 Pos 0	21.00	0	20.16	21.00	0	20.08
	50% RB Mid			38 Pos 19	21.00	0	20.28	21.00	0	20.18	
	50% RB High			38 Pos 39	21.00	0	20.33	21.00	0	20.26	
	100% RB	75 Pos 0	21.00	0	20.23	21.00	0	20.36			
	10 MHz	132022	1715	1RB Low	1 Pos 0	21.00	0	19.93	21.00	0	20.34
				1RB Mid	1 Pos 24	21.00	0	19.98	21.00	0	20.40
				1RB High	1 Pos 49	21.00	0	20.07	21.00	0	19.87
				50% RB Low	25 Pos 0	21.00	0	20.01	21.00	0	19.83
				50% RB Mid	25 Pos 12	21.00	0	20.05	21.00	0	19.94
				50% RB High	25 Pos 24	21.00	0	20.13	21.00	0	19.99
		100% RB	50 Pos 0	21.00	0	20.19	21.00	0	20.06		
		132422	1755	1RB Low	1 Pos 0	21.00	0	20.57	21.00	0	20.51
				1RB Mid	1 Pos 24	21.00	0	20.59	21.00	0	20.60
				1RB High	1 Pos 49	21.00	0	20.78	21.00	0	20.55
				50% RB Low	25 Pos 0	21.00	0	20.37	21.00	0	20.40
				50% RB Mid	25 Pos 12	21.00	0	20.27	21.00	0	20.41
				50% RB High	25 Pos 24	21.00	0	20.30	21.00	0	20.27
		100% RB	50 Pos 0	21.00	0	20.50	21.00	0	20.45		
		132622	1775	1RB Low	1 Pos 0	21.00	0	20.08	21.00	0	20.61
				1RB Mid	1 Pos 24	21.00	0	20.39	21.00	0	20.60
				1RB High	1 Pos 49	21.00	0	20.65	21.00	0	20.86
				50% RB Low	25 Pos 0	21.00	0	20.06	21.00	0	20.03
50% RB Mid	25 Pos 12			21.00	0	20.15	21.00	0	20.01		
50% RB High	25 Pos 24			21.00	0	20.22	21.00	0	20.18		
100% RB	50 Pos 0	21.00	0	20.36	21.00	0	20.18				

Band	BW	Channel #	Freq (MHz)	% RB Allocation	RB Position	QPSK			16 QAM		
						Factory Upper Tolerance (dBm)	M P R	Measured Output Power (dBm)	Factory Upper Tolerance (dBm)	M P R	Measured Output Power (dBm)
LTE66	5.0 MHz	131997	1712.5	1RB Low	1 Pos 0	21.00	0	20.33	21.00	0	20.44
				1RB Mid	1 Pos 12	21.00	0	20.33	21.00	0	19.56
				1RB High	1 Pos 24	21.00	0	20.41	21.00	0	20.53
				50% RB Low	12 Pos 0	21.00	0	19.85	21.00	0	19.76
				50% RB Mid	12 Pos 6	21.00	0	20.05	21.00	0	19.92
				50% RB High	12 Pos 11	21.00	0	19.87	21.00	0	19.83
		100% RB	25 Pos 0	21.00	0	19.92	21.00	0	19.86		
		132422	1755	1RB Low	1 Pos 0	21.00	0	20.50	21.00	0	20.58
				1RB Mid	1 Pos 12	21.00	0	20.40	21.00	0	20.55
				1RB High	1 Pos 24	21.00	0	20.54	21.00	0	20.63
				50% RB Low	12 Pos 0	21.00	0	20.21	21.00	0	20.39
				50% RB Mid	12 Pos 6	21.00	0	20.29	21.00	0	20.32
				50% RB High	12 Pos 11	21.00	0	20.11	21.00	0	20.30
		100% RB	25 Pos 0	21.00	0	20.24	21.00	0	20.41		
		132647	1777.5	1RB Low	1 Pos 0	21.00	0	20.03	21.00	0	19.62
				1RB Mid	1 Pos 12	21.00	0	20.26	21.00	0	19.89
				1RB High	1 Pos 24	21.00	0	20.29	21.00	0	19.80
				50% RB Low	12 Pos 0	21.00	0	20.13	21.00	0	19.85
	50% RB Mid			12 Pos 6	21.00	0	20.34	21.00	0	20.23	
	50% RB High			12 Pos 11	21.00	0	20.18	21.00	0	19.91	
	100% RB	25 Pos 0	21.00	0	20.26	21.00	0	20.44			
	3.0 MHz	131987	1711.5	1RB Low	1 Pos 0	21.00	0	20.00	21.00	0	20.63
				1RB Mid	1 Pos 7	21.00	0	19.49	21.00	0	20.67
				1RB High	1 Pos 14	21.00	0	19.50	21.00	0	20.72
				50% RB Low	8 Pos 0	21.00	0	19.88	21.00	0	19.62
				50% RB Mid	8 Pos 4	21.00	0	19.92	21.00	0	19.84
				50% RB High	8 Pos 7	21.00	0	19.93	21.00	0	19.69
		100% RB	15 Pos 0	21.00	0	20.00	21.00	0	19.76		
		132422	1755	1RB Low	1 Pos 0	21.00	0	20.52	21.00	0	20.38
				1RB Mid	1 Pos 7	21.00	0	20.54	21.00	0	20.39
				1RB High	1 Pos 14	21.00	0	20.50	21.00	0	20.37
				50% RB Low	8 Pos 0	21.00	0	20.02	21.00	0	20.21
				50% RB Mid	8 Pos 4	21.00	0	20.03	21.00	0	19.78
				50% RB High	8 Pos 7	21.00	0	20.03	21.00	0	19.82
		100% RB	15 Pos 0	21.00	0	20.37	21.00	0	20.10		
		132657	1778.5	1RB Low	1 Pos 0	21.00	0	20.44	21.00	0	20.28
				1RB Mid	1 Pos 7	21.00	0	20.61	21.00	0	20.91
				1RB High	1 Pos 14	21.00	0	20.61	21.00	0	20.52
				50% RB Low	8 Pos 0	21.00	0	20.13	21.00	0	20.28
	50% RB Mid			8 Pos 4	21.00	0	20.24	21.00	0	20.38	
	50% RB High			8 Pos 7	21.00	0	20.28	21.00	0	19.71	
	100% RB	15 Pos 0	21.00	0	20.25	21.00	0	19.86			
	1.4 MHz	131979	1710	1RB Low	1 Pos 0	21.00	0	19.87	21.00	0	20.17
				1RB Mid	1 Pos 2	21.00	0	19.83	21.00	0	19.57
				1RB High	1 Pos 5	21.00	0	19.85	21.00	0	19.66
				50% RB Low	3 Pos 0	21.00	0	19.92	21.00	0	20.38
				50% RB Mid	3 Pos 1	21.00	0	20.05	21.00	0	19.37
				50% RB High	3 Pos 2	21.00	0	20.07	21.00	0	19.37
		100% RB	6 Pos 0	21.00	0	19.78	21.00	0	19.13		
		132422	1755	1RB Low	1 Pos 0	21.00	0	20.32	21.00	0	20.46
				1RB Mid	1 Pos 2	21.00	0	20.52	21.00	0	20.19
				1RB High	1 Pos 5	21.00	0	20.36	21.00	0	20.24
				50% RB Low	3 Pos 0	21.00	0	20.51	21.00	0	20.33
				50% RB Mid	3 Pos 1	21.00	0	20.53	21.00	0	20.34
				50% RB High	3 Pos 2	21.00	0	20.55	21.00	0	20.38
		100% RB	6 Pos 0	21.00	0	20.31	21.00	0	20.21		
		132665	1779.3	1RB Low	1 Pos 0	21.00	0	20.76	21.00	0	20.23
				1RB Mid	1 Pos 2	21.00	0	20.30	21.00	0	20.23
				1RB High	1 Pos 5	21.00	0	20.72	21.00	0	20.56
				50% RB Low	3 Pos 0	21.00	0	20.25	21.00	0	20.23
50% RB Mid	3 Pos 1			21.00	0	20.43	21.00	0	20.24		
50% RB High	3 Pos 2			21.00	0	20.27	21.00	0	20.23		
100% RB	6 Pos 0	21.00	0	20.17	21.00	0	20.22				

B.3 Tissue Parameters Measurement

Body TSL

Body TSL	Target TSL		Measured TSL		Deviation %		
Freq (MHz)	ϵ' (F/m)	σ (S/m)	ϵ' (F/m)	σ (S/m)	Deviation ϵ'	Deviation σ	Date
750	55.53	0.96	53.44	1.01	-3.8	5.2	2021-09-02
835	55.19	0.98	53.22	1.04	-3.6	6.1	
1750	53.43	1.49	51.38	1.50	-3.8	0.7	
1900	53.30	1.52	51.41	1.60	-3.6	5.3	
2300	52.90	1.81	50.84	1.88	-3.9	3.9	
2600	52.51	2.16	50.53	2.13	-3.8	-1.4	
750	55.53	0.96	52.08	0.96	-6.2	-0.4	2021-09-06
835	55.19	0.98	51.96	0.99	-5.9	1.6	
1750	53.43	1.49	50.94	1.46	-4.7	-2.0	
1900	53.30	1.52	50.84	1.55	-4.6	1.6	
2300	52.90	1.81	50.25	1.86	-5.0	3.2	
2600	52.51	2.16	49.73	2.16	-5.3	-0.4	

See Annex D below for more details.

B.4 System Check Measurements

Body Measurements

Frequency (MHz)	Average	Target SAR (W/Kg)	Measured SAR (W/Kg)	Deviation to target (%)	Limit (%)	Date
750	1g	8.46	8.42	-0.47	±10	2021-09-03
	10g	5.59	5.54	-0.89		
835	1g	9.63	10.48	8.83		2021-09-03
	10g	6.31	6.84	8.40		
1750	1g	36.80	35.60	-4.04		2021-09-03
	10g	19.40	18.86	-3.78		
	1g	36.80	34.80	-6.20		2021-09-07
	10g	19.40	18.34	-6.43		
1900	1g	39.50	41.00	1.74		2021-09-03
	10g	20.70	21.20	0.95		
	1g	39.50	39.20	-2.73		2021-09-07
	10g	20.70	20.20	-3.81		
2300	1g	47.20	46.00	-3.97	2021-09-06	
	10g	22.60	22.00	-5.17		
2600	1g	54.60	53.20	-1.66	2021-09-06	
	10g	24.20	23.60	-2.07		

See Annex C for more details.

B.5 SAR Tablet Test Results

B.5.1 WCDMA

Radio Band Name	BW (MHz)	Distance (mm)	Rate	Channel Number	Freq (MHz)	Position	Scaling Factor (dB)	Measured SAR 1g (W/Kg)	Reported SAR 1g (W/Kg)	Plot #
Band II	5	0	RMC 12.2kbps	9262	1852.4	Top edge	0.42	0.95	1.05	
				9400	1880	Back Face	0.39	0.32	0.35	
						Right Edge	0.39	0.07	0.08	
						Top edge	0.39	0.98	1.08	1
9538	1907.6	Top edge	0.65	0.76	0.88					

Radio Band Name	BW (MHz)	Distance (mm)	Rate	Channel Number	Freq (MHz)	Position	Scaling Factor (dB)	Measured SAR 1g (W/Kg)	Reported SAR 1g (W/Kg)	Plot #
Band IV	5	0	RMC 12.2kbps	1312	1712.4	Top edge	0.57	0.78	0.89	2
				1413	1732.6	Back Face	0.49	0.28	0.31	
						Right Edge	0.49	0.15	0.17	
						Top edge	0.49	0.76	0.85	
1513	1752.6	Top edge	0.32	0.82	0.88					

Radio Band Name	BW (MHz)	Distance (mm)	Rate	Channel Number	Freq (MHz)	Position	Scaling Factor (dB)	Measured SAR 1g (W/Kg)	Reported SAR 1g (W/Kg)	Plot #
Band V	5	0	RMC 12.2kbps	4183	836.6	Back Face	0.42	0.40	0.44	
						Right Edge	0.42	0.13	0.14	
						Top edge	0.42	0.68	0.75	3

B.5.2 LTE

B.5.2.1 LTE Band 2 FDD

Band	Mod.	BW (MHz)	Distance (mm)	Channel Number	Freq (MHz)	Position	% RB Allocation	Scaling Factor (dB)	Measured SAR 1g (W/Kg)	Reported SAR 1g (W/Kg)	Plot #
Band 2	QPSK	20	0	18700	1860	Top edge	1RB Mid	0.69	1.20	1.41	
							50RB Mid	0.65	1.06	1.23	
				18900	1880	Back Face	1RB Mid	0.53	0.35	0.39	
							50RB Mid	0.50	0.31	0.35	
						Right Edge	1RB Mid	0.53	0.08	0.09	
							50RB Mid	0.50	0.08	0.09	
						Top edge	1RB Mid	0.53	1.27	1.43	4
							50RB Mid	0.50	1.14	1.28	
				100RB Mid	0.48	1.18	1.18				
				19100	1900	Top edge	1RB Mid	0.75	1.17	1.39	
50RB Mid	0.80	1.06	1.27								

B.5.2.2 LTE Band 7 FDD

Band	Mod.	BW (MHz)	Distance (mm)	Channel Number	Freq (MHz)	Position	% RB Allocation	Scaling Factor (dB)	Measured SAR 1g (W/Kg)	Reported SAR 1g (W/Kg)	Plot #
Band 7	QPSK	20	0	20850	2510	Top edge	1RB Mid	0.82	0.83	1.00	
							50RB Mid	0.80	0.84	1.01	5
				21100	2535	Back Face	1RB Mid	1.07	0.13	0.17	
							50RB Mid	0.93	0.14	0.17	
						Right Edge	1RB Mid	1.07	0.04	0.05	
							50RB Mid	0.93	0.04	0.05	
						Top edge	1RB Mid	1.07	0.76	0.97	
							50RB Mid	0.93	0.78	0.97	
				100RB Mid	0.78	0.81	0.97				
				21350	2560	Top edge	1RB Mid	1.08	0.72	0.92	
50RB Mid	1.00	0.72	0.91								

B.5.2.3 LTE Band 12 FDD

Band	Mod.	BW (MHz)	Distance (mm)	Channel Number	Freq (MHz)	Position	% RB Allocation	Scaling Factor (dB)	Measured SAR 1g (W/Kg)	Reported SAR 1g (W/Kg)	Plot #
Band 12	QPSK	10	0	23095	707.5	Back Face	1RB Mid	0.39	0.52	0.57	
							50RB Mid	0.29	0.52	0.56	
						Right Edge	1RB Mid	0.39	0.09	0.10	
							50RB Mid	0.29	0.07	0.08	
						Top edge	1RB Mid	0.39	0.67	0.73	6
							50RB Mid	0.29	0.54	0.58	

B.5.2.4 LTE Band 13 FDD

Band	Mod.	BW (MHz)	Distance (mm)	Channel Number	Freq (MHz)	Position	% RB Allocation	Scaling Factor (dB)	Measured SAR 1g (W/Kg)	Reported SAR 1g (W/Kg)	Plot #
Band 13	QPSK	10	0	23230	782	Back Face	1RB Mid	0.50	0.33	0.37	
							50RB Mid	0.00	0.30	0.30	
						Right Edge	1RB Mid	0.50	0.15	0.17	
							50RB Mid	0.00	0.13	0.13	
						Top edge	1RB Mid	0.50	0.52	0.58	7
							50RB Mid	0.00	0.48	0.48	

B.5.2.5 LTE Band 26 FDD

Band	Mod.	BW (MHz)	Distance (mm)	Channel Number	Freq (MHz)	Position	% RB Allocation	Scaling Factor (dB)	Measured SAR 1g (W/Kg)	Reported SAR 1g (W/Kg)	Plot #
Band 26	QPSK	15	0	26765	821.5	Top edge	1RB Mid	0.59	0.65	0.75	8
							50RB Mid	0.00	0.53	0.53	
				26865	831.5	Back Face	1RB Mid	0.27	0.32	0.34	
							50RB Mid	0.43	0.40	0.44	
						Right Edge	1RB Mid	0.27	0.13	0.14	
							50RB Mid	0.43	0.11	0.12	
						Top edge	1RB Mid	0.27	0.56	0.60	
							50RB Mid	0.43	0.66	0.73	
				26965	841.5	Top edge	100RB Mid	0.00	0.55	0.55	
							1RB Mid	0.14	0.70	0.72	
				50RB Mid	0.10	0.58	0.59				

B.5.2.6 LTE Band 30 FDD

Band	Mod.	BW (MHz)	Distance (mm)	Channel Number	Freq (MHz)	Position	% RB Allocation	Scaling Factor (dB)	Measured SAR 1g (W/Kg)	Reported SAR 1g (W/Kg)	Plot #
Band 30	QPSK	10	0	27710	2310	Back Face	1RB Mid	0.68	0.33	0.39	
							50RB Mid	0.42	0.27	0.30	
						Right Edge	1RB Mid	0.68	0.15	0.18	
							50RB Mid	0.42	0.12	0.13	
						Top edge	1RB Mid	0.68	1.15	1.34	9
							50RB Mid	0.42	1.09	1.20	
100RB Mid	0.38	1.10	1.20								

B.5.2.7 LTE Band 38 TDD

Band	Mod.	BW (MHz)	Distance (mm)	Channel Number	Freq (MHz)	Position	% RB Allocation	Scaling Factor (dB)	Measured SAR 1g (W/Kg)	Reported SAR 1g (W/Kg)	Plot #
Band 38	QPSK	20	0	37850	2580	Top edge	1RB Mid	0.84	0.86	1.05	
							50RB Mid	0.91	0.85	1.05	
				38000	2595	Back Face	1RB Mid	0.90	0.19	0.24	
							50RB Mid	0.99	0.20	0.25	
						Right Edge	1RB Mid	0.90	0.05	0.06	
							50RB Mid	0.99	0.05	0.06	
						Top edge	1RB Mid	0.90	0.89	1.10	
							50RB Mid	0.99	0.88	1.10	
				38150	2610	Top edge	100RB Mid	0.97	0.89	1.11	
							1RB Mid	1.12	0.87	1.12	10
50RB Mid	1.09	0.86	1.11								

B.5.2.8 LTE Band 41 TDD

Band	Mod.	BW (MHz)	Distance (mm)	Channel Number	Freq (MHz)	Position	% RB Allocation	Scaling Factor (dB)	Measured SAR 1g (W/Kg)	Reported SAR 1g (W/Kg)	Plot #
Band 41	QPSK	20	0	39750	2506	Top edge	1RB Mid	0.75	0.90	1.07	11
							50RB Mid	0.80	0.89	1.07	
				40185	2549.5	Top edge	1RB Mid	1.27	0.74	0.99	
							50RB Mid	1.08	0.76	0.97	
				40620	2593	Back Face	1RB Mid	1.11	0.17	0.22	
							50RB Mid	1.07	0.17	0.22	
						Right Edge	1RB Mid	1.11	0.04	0.05	
							50RB Mid	1.07	0.04	0.05	
						Top edge	1RB Mid	1.11	0.78	1.00	
							50RB Mid	1.07	0.77	0.99	
				100RB Mid	1.00	0.78	0.98				
				41055	2636.5	Top edge	1RB Mid	1.18	0.69	0.90	
							50RB Mid	1.26	0.68	0.90	
				41490	2680	Top Edge	1RB Mid	1.33	0.53	0.72	
50RB Mid	1.51	0.53	0.75								

B.5.2.9 LTE Band 66 FDD

Band	Mod.	BW (MHz)	Distance (mm)	Channel Number	Freq (MHz)	Position	% RB Allocation	Scaling Factor (dB)	Measured SAR 1g (W/Kg)	Reported SAR 1g (W/Kg)	Plot #
Band 66	QPSK	20	0	132072	1720	Top edge	1RB Mid	0.81	0.71	0.86	12
							50RB Mid	0.71	0.72	0.85	
				132322	1745	Top edge	1RB Mid	0.39	0.71	0.78	
							50RB Mid	0.60	0.73	0.84	
							100RB Mid	0.37	0.78	0.85	
						Back Face	1RB Mid	0.39	0.26	0.28	
				50RB Mid	0.60		0.26	0.30			
				Right Edge	1RB Mid	0.39	0.14	0.16			
					50RB Mid	0.60	0.15	0.17			
				132572	1770	Top edge	1RB Mid	0.63	0.70	0.81	
50RB Mid	0.79	0.71	0.85								

B.5.3 SAR Measurement Variability

According to FCC OET KDB 865664, SAR Measurement variability is assessed when the maximum initial measured SAR is ≥ 0.8 W/kg for a certain band/mode. If the measured SAR value of the initial repeated measurement is < 1.45 W/kg with $< 20\%$ variation, only one repeated measurement is required to confirm that the results are not expected to have substantial variations.

A second repeated measurement is required only if the measured results for the initial repeated measurement are within 10% of the SAR limit or vary by more than 20%.

A third repeated measurement is required only if the original, first or second repeated measurement ≥ 1.5 W/Kg and the ratio of largest to smallest SAR for the original, first and second repeated measurement is > 1.2 .

Band / Mode	Position	Ch #	Freq. (MHz)	Measured SAR 1g (W/kg)	1 st Repeated SAR 1g (W/Kg)	2 nd Repeated SAR 1g (W/Kg)	Highest Ratio
WCDMA IV / RMC 12kbps – 5MHz	Top edge	1513	1752.6	0.82	0.82		1.00
LTE FDD 2 / QPSK – 20MHz	Top edge	18900	1880	1.27	1.27		1.00
LTE FDD 30 / QPSK – 10MHz	Top edge	27710	2310	1.15	1.13		0.98
LTE FDD 41 / QPSK – 20MHz	Top edge	39750	2506	0.90	0.88		0.98

B.5.4 Simultaneous Transmission SAR Evaluation

According to FCC OET KDB 447498 D01, when the sum of 1g SAR for all simultaneously transmitting antennas in an operating mode and exposure condition combination is within the SAR limit, SAR test exclusion applies to that simultaneous transmission configuration.

As commented on section 3 and 6, this report only evaluates SAR for cellular transmission on the module, nevertheless in order to consider all possible simultaneous transmissions on the device for compliance, WLAN SAR values reported on document [1] and [2] are considered separately. Note that for WLAN testing there were two antenna manufacturers included in the same report. For the simultaneous considerations, only WNC results of those reports will be used

[1] 210817-02.TR02 - HSN-I47C, SAR WLAN_AX201NGW, FCC_ISED WNC_HB

All the values stated in the table below are the worst case found for standalone measurement with disregard of the transmission mode or channel where the worst case was found

Antenna	Position	Highest Reported SAR (1g) (W/Kg)			
		WWAN	WLAN 2.4GHz	WLAN 5GHz	Bluetooth
Main WWAN	Back Face	0.57			
	Right Edge	0.18			
	Top Edge	1.43			
Main WLAN	Back Face		0.08	0.29	
	Left Edge		0.03	0.11	
	Top Edge		0.30	0.79	
Aux WLAN	Back Face		0.08	0.30	0.00
	Top Edge		0.19	0.79	0.02

* According to FCC OET KDB 447498 D01, when standalone test exclusion is applied to an antenna that transmits simultaneously with other antennas, the standalone SAR must be estimated to 0.4 W/Kg for 1-g SAR when the test separation is > 50mm in order to determine simultaneous transmission test exclusion.

In case the sum of SAR is larger than the limit, SAR test exclusion is determined by the SAR to peak location separation ratio. According to the last table possible simultaneous transmission combinations are identified for each position from 1 to 5, each combination will be analyzed by antenna pairs. Antenna pairs considered in one configuration won't be performed again in case they are repeated on the next simultaneous configuration:

Position	Simultaneous Tx Antenna Combination				Σ SAR 1g (W/Kg)	Limit (W/kg)
	#	Main WWAN	Main Antenna	Aux Antenna		
Top Edge	1	Cellular	WLAN 5GHz	WLAN 5GHz	3.00	1.6
	2	Cellular	WLAN 5GHz	WLAN 5GHz+ BT	3.02	
	3	Cellular	WLAN 5GHz	BT	2.24	
	4	Cellular	WLAN 2.4GHz	WLAN 2.4GHz	1.92	
	5	Cellular	WLAN 2.4GHz	BT	1.75	
Back Edge	1	Cellular	WLAN 5GHz	WLAN 5GHz	1.16	
	2	Cellular	WLAN 5GHz	WLAN 5GHz+ BT	1.16	
	3	Cellular	WLAN 5GHz	BT	0.86	
	4	Cellular	WLAN 2.4GHz	WLAN 2.4GHz	0.73	
	5	Cellular	WLAN 2.4GHz	BT	0.65	

Position	Ant. Pair case	Antenna	Reported SAR 1g (W/kg)	Σ SAR 1g (W/Kg)	Peak Location (mm) (x,y,z)	SAR to peak location separation ratio	Limit
Top Edge	1a	Main WWAN	1.43	2.22	(-3,109,-176.2)	0.02	0.04
		Main WLAN 5GHz	0.79		(-3.5,-90.5,-177)		
	1b	Main WWAN	1.43	2.21	(-3,109,-176.2)	0.02	
		Aux WLAN 5GHz	0.78		(-3.5,-90.5,-177)		
	1c	Main WLAN 5GHz	0.79	1.57			
		Aux WLAN 5GHz	0.78				
	2a	Main WWAN	1.43	1.45			
		Aux BT	0.02				
	4a	Main WWAN	1.43	1.73	(-3,109,-176.2)	0.01	
		Main WLAN 2.4GHz	0.30		(-3.5,-90.5,-177)		
	4b	Main WWAN	1.43	1.62	(-3,109,-176.2)	0.01	
		Aux WLAN 2.4GHz	0.19		(10.5,64.5,-176.4)		
	4c	Main WLAN 2.4GHz	0.30	0.49			
		Aux WLAN 2.4GHz	0.19				

Considering the results described above and according to the simultaneous transmission evaluation exclusions described in FCC OET KDB 447498 D01, no enlarged zoom scan measurements are required

Annex C. Test System Plots

1. WCDMA FDD II, 12.2kbps RMC, CH9400, Top Edge.....	62
2. WCDMA FDD IV, 12.2kbps RMC, CH1312, Top Edge	63
3. WCDMA FDD V, 12.2kbps RMC, CH4183, Top edge.....	64
4. LTE Band 2, QPSK - 20MHz, CH18900, Top Edge	65
5. LTE Band 7, QPSK - 20MHz, CH20850, Top Edge	66
6. LTE Band 12, QPSK - 10MHz, CH23095, Top Edge	67
7. LTE Band 13, QPSK - 10MHz, CH23230, Top edge.....	68
8. LTE Band 26, QPSK - 15MHz, CH26765, Top Edge	69
9. LTE Band 30, QPSK - 10MHz, CH27710, Top Edge	70
10. LTE Band 38, QPSK - 20MHz, CH38150, Top Edge.....	71
11. LTE Band 41, QPSK - 20MHz, CH39750, Top Edge.....	72
12. LTE Band 66, QPSK - 20MHz, CH132072, Top Edge	73
13. System Check Body Liquid 750MHz	74
14. System Check Body Liquid 835MHz	75
15. System Check Body Liquid 1750MHz – 2021-09-03.....	76
16. System Check Body Liquid 1750MHz – 2021-09-07.....	77
17. System Check Body Liquid 1900MHz – 2021-09-03.....	78
18. System Check Body Liquid 1900MHz - 2021-09-07.....	79
19. System Check Body Liquid 2300MHz	80
20. System Check Body Liquid 2600MHz	81

1. WCDMA FDD II, 12.2kbps RMC, CH9400, Top Edge

Device under Test Properties

Name, Manufacturer	Dimensions [mm]	S/N	DUT Type
HSN-I47C	295.0 x 220.0 x 15.0	0001760970	Convertible PC

Exposure Conditions

Phantom Section, TSL	Position, Test Distance [mm]	Band	Group, UID	Frequency [MHz], Channel Number	Conversion Factor	TSL Conductivity [S/m]	TSL Permittivity
Flat, MSL	EDGE TOP, 0.00	Band 2, UTRA/FDD	WCDMA, 10011-CAB	1880.0, 9400	7.98	1.59	51.4

Hardware Setup

Phantom	TSL, Measured Date	Probe, Calibration Date	DAE, Calibration Date
ELI V8.0 (20deg probe tilt) -	MBBL-600-6000, 2021-Sep-02	EX3DV4 - SN3978, 2021-05-22	DAE4 Sn1429, 2021-05-11

Scan Setup

	Area Scan	Zoom Scan
Grid Extents [mm]	90.0 x 150.0	30.0 x 30.0 x 30.0
Grid Steps [mm]	15.0 x 15.0	6.0 x 6.0 x 1.5
Sensor Surface [mm]	3.0	1.4
Graded Grid	No	Yes
Grading Ratio	n/a	1.5
MAIA	Confirmed by MAIA	Confirmed by MAIA
Surface Detection	VMS + 6p	VMS + 6p
Scan Method	Measured	Measured

Measurement Results

	Area Scan	Zoom Scan
Date	2021-09-03, 14:57	2021-09-03, 15:03
psSAR1g [W/Kg]	0.767	0.984
psSAR10g [W/Kg]	0.442	0.522
Power Drift [dB]	0.02	-0.01
Power Scaling	Disabled	Disabled
Scaling Factor [dB]		
TSL Correction	Positive Only	Positive Only
M2/M1 [%]		83.5
Dist 3dB Peak [mm]		8.4

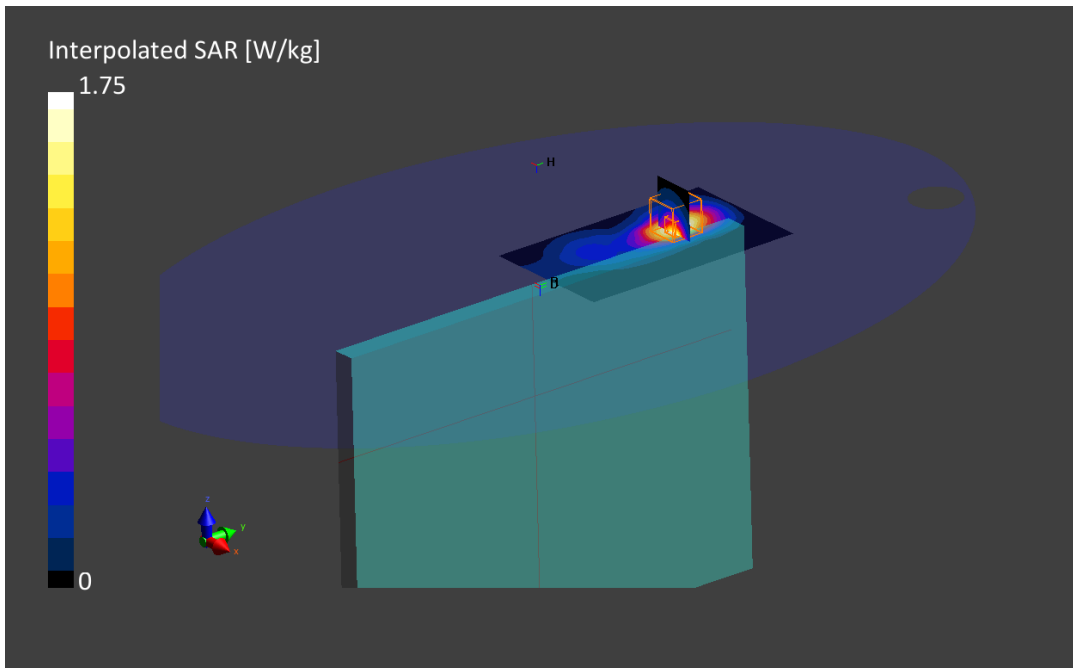

2. WCDMA FDD IV, 12.2kbps RMC, CH1312, Top Edge

Device under Test Properties

Name, Manufacturer	Dimensions [mm]	S/N	DUT Type
HSN-I47C	295.0 x 220.0 x 15.0	0001760970	Convertible PC

Exposure Conditions

Phantom Section, TSL	Position, Test Distance [mm]	Band	Group, UID	Frequency [MHz], Channel Number	Conversion Factor	TSL Conductivity [S/m]	TSL Permittivity
Flat, MSL	EDGE TOP, 0.00	Band 4, UTRA/FDD	WCDMA, 10011-CAB	1712.4, 1312	8.37	1.48	51.4

Hardware Setup

Phantom	TSL, Measured Date	Probe, Calibration Date	DAE, Calibration Date
ELI V8.0 (20deg probe tilt) -	MBBL-600-6000, 2021-Sep-02	EX3DV4 - SN3978, 2021-05-22	DAE4 Sn1429, 2021-05-11

Scan Setup

	Area Scan	Zoom Scan
Grid Extents [mm]	120.0 x 150.0	30.0 x 30.0 x 30.0
Grid Steps [mm]	15.0 x 15.0	6.0 x 6.0 x 1.5
Sensor Surface [mm]	3.0	1.4
Graded Grid	No	Yes
Grading Ratio	n/a	1.5
MAIA	Confirmed by MAIA	Confirmed by MAIA
Surface Detection	VMS + 6p	VMS + 6p
Scan Method	Measured	Measured

Measurement Results

	Area Scan	Zoom Scan
Date	2021-09-03, 15:52	2021-09-03, 15:57
psSAR1g [W/Kg]	0.688	0.778
psSAR10g [W/Kg]	0.397	0.435
Power Drift [dB]	-0.02	-0.02
Power Scaling	Disabled	Disabled
Scaling Factor [dB]		
TSL Correction	Positive Only	Positive Only
M2/M1 [%]		83.9
Dist 3dB Peak [mm]		9.7

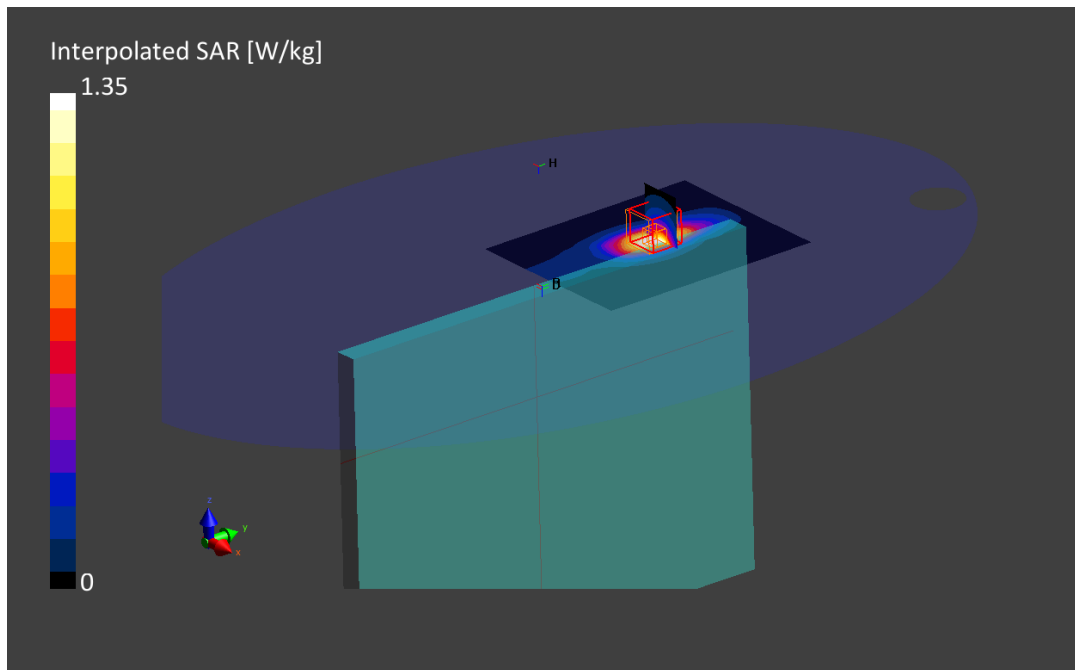

3. WCDMA FDD V, 12.2kbps RMC, CH4183, Top edge

Device under Test Properties

Name, Manufacturer	Dimensions [mm]	S/N	DUT Type
HSN-I47C	295.0 x 220.0 x 15.0	0001760970	Convertible PC

Exposure Conditions

Phantom Section, TSL	Position, Test Distance [mm]	Band	Group, UID	Frequency [MHz], Channel Number	Conversion Factor	TSL Conductivity [S/m]	TSL Permittivity
Flat, MSL	EDGE TOP, 0.00	Band 5, UTRA/FDD	WCDMA, 10011-CAB	836.6, 4183	9.32	1.04	53.2

Hardware Setup

Phantom	TSL, Measured Date	Probe, Calibration Date	DAE, Calibration Date
ELI V8.0 (20deg probe tilt) -	MBBL-600-6000, 2021-Sep-02	EX3DV4 - SN3978, 2021-05-22	DAE4 Sn1429, 2021-05-11

Scan Setup

	Area Scan	Zoom Scan
Grid Extents [mm]	120.0 x 150.0	30.0 x 30.0 x 30.0
Grid Steps [mm]	15.0 x 15.0	6.0 x 6.0 x 1.5
Sensor Surface [mm]	3.0	1.4
Graded Grid	No	Yes
Grading Ratio	n/a	1.5
MAIA	Confirmed by MAIA	Confirmed by MAIA
Surface Detection	VMS + 6p	VMS + 6p
Scan Method	Measured	Measured

Measurement Results

	Area Scan	Zoom Scan
Date	2021-09-03, 12:05	2021-09-03, 12:11
psSAR1g [W/Kg]	0.623	0.683
psSAR10g [W/Kg]	0.403	0.410
Power Drift [dB]	0.01	-0.03
Power Scaling	Disabled	Disabled
Scaling Factor [dB]		
TSL Correction	Positive Only	Positive Only
M2/M1 [%]		83.4
Dist 3dB Peak [mm]		12.0

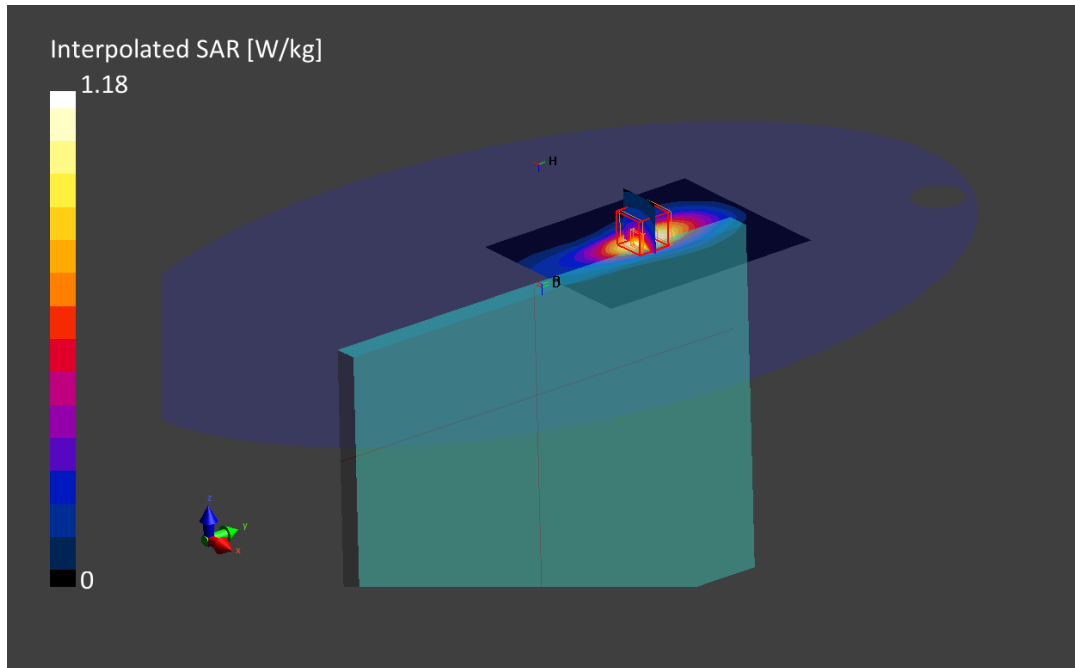

4. LTE Band 2, QPSK - 20MHz, CH18900, Top Edge

Device under Test Properties

Name, Manufacturer	Dimensions [mm]	S/N	DUT Type
HSN-I47C	295.0 x 220.0 x 15.0	0001760970	Convertible PC

Exposure Conditions

Phantom Section, TSL	Position, Test Distance [mm]	Band	Group, UID	Frequency [MHz], Channel Number	Conversion Factor	TSL Conductivity [S/m]	TSL Permittivity
Flat, MSL	EDGE TOP, 0.00	Band 2, E-UTRA/FDD	LTE-FDD, 10169-CAE	1880.0, 18900	7.98	1.53	50.9

Hardware Setup

Phantom	TSL, Measured Date	Probe, Calibration Date	DAE, Calibration Date
ELI V8.0 (20deg probe tilt) -	MBBL-600-6000, 2021-Sep-06	EX3DV4 - SN3978, 2021-05-22	DAE4 Sn1429, 2021-05-11

Scan Setup

	Area Scan	Zoom Scan
Grid Extents [mm]	120.0 x 150.0	30.0 x 30.0 x 30.0
Grid Steps [mm]	15.0 x 15.0	6.0 x 6.0 x 1.5
Sensor Surface [mm]	3.0	1.4
Graded Grid	No	Yes
Grading Ratio	n/a	1.5
MAIA	Confirmed by MAIA	Confirmed by MAIA
Surface Detection	VMS + 6p	VMS + 6p
Scan Method	Measured	Measured

Measurement Results

	Area Scan	Zoom Scan
Date	2021-09-07, 16:52	2021-09-07, 16:58
psSAR1g [W/Kg]	1.16	1.27
psSAR10g [W/Kg]	0.617	0.672
Power Drift [dB]	0.00	-0.01
Power Scaling	Disabled	Disabled
Scaling Factor [dB]		
TSL Correction	Positive Only	Positive Only
M2/M1 [%]		81.9
Dist 3dB Peak [mm]		8.4

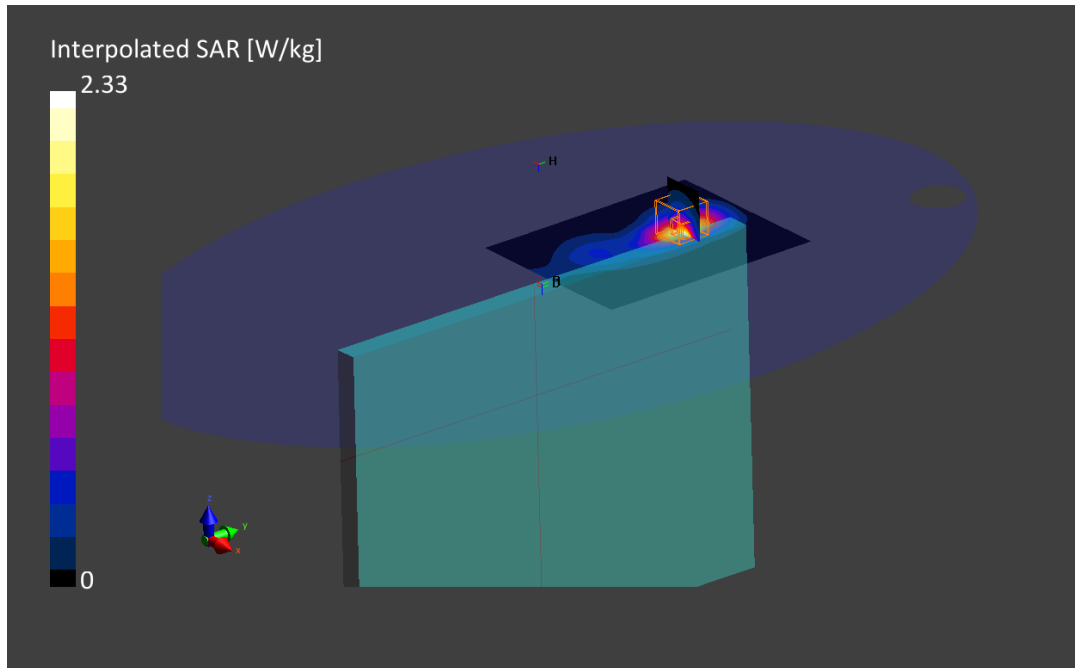

5. LTE Band 7, QPSK - 20MHz, CH20850, Top Edge

Device under Test Properties

Name, Manufacturer	Dimensions [mm]	S/N	DUT Type
HSN-I47C	295.0 x 220.0 x 15.0	0001760970	Convertible PC

Exposure Conditions

Phantom Section, TSL	Position, Test Distance [mm]	Band	Group, UID	Frequency [MHz], Channel Number	Conversion Factor	TSL Conductivity [S/m]	TSL Permittivity
Flat, MSL	EDGE TOP, 0.00	Band 7, E-UTRA/FDD	LTE-FDD, 10297-AAD	2510.0, 20850	7.24	2.05	49.9

Hardware Setup

Phantom	TSL, Measured Date	Probe, Calibration Date	DAE, Calibration Date
ELI V8.0 (20deg probe tilt) -	MABL-600-6000, 2021-Sep-06	EX3DV4 - SN3978, 2021-05-22	DAE4 Sn1429, 2021-05-11

Scan Setup

	Area Scan	Zoom Scan
Grid Extents [mm]	100.0 x 140.0	30.0 x 30.0 x 30.0
Grid Steps [mm]	10.0 x 10.0	5.0 x 5.0 x 1.5
Sensor Surface [mm]	3.0	1.4
Graded Grid	No	Yes
Grading Ratio	n/a	1.5
MAIA	Confirmed by MAIA	Confirmed by MAIA
Surface Detection	VMS + 6p	VMS + 6p
Scan Method	Measured	Measured

Measurement Results

	Area Scan	Zoom Scan
Date	2021-09-06, 18:44	2021-09-06, 18:51
psSAR1g [W/Kg]	0.793	0.840
psSAR10g [W/Kg]	0.341	0.347
Power Drift [dB]	0.02	-0.01
Power Scaling	Disabled	Disabled
Scaling Factor [dB]		
TSL Correction	Positive Only	Positive Only
M2/M1 [%]		81.6
Dist 3dB Peak [mm]		8.0

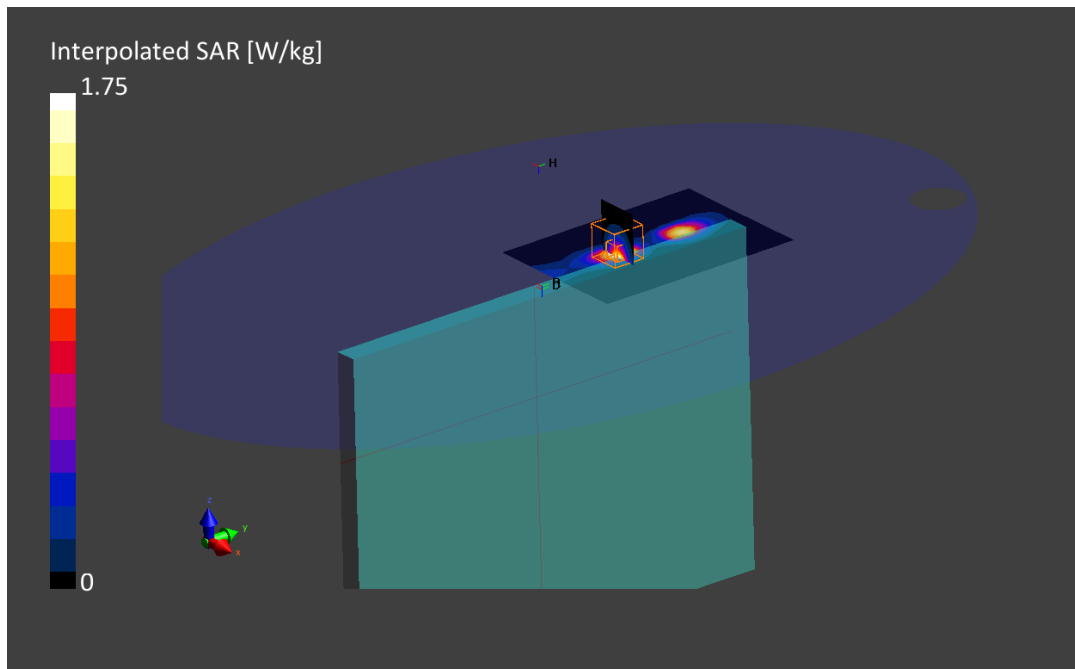

6. LTE Band 12, QPSK - 10MHz, CH23095, Top Edge

Device under Test Properties

Name, Manufacturer	Dimensions [mm]	S/N	DUT Type
HSN-I47C	295.0 x 220.0 x 15.0	0001760970	Convertible PC

Exposure Conditions

Phantom Section, TSL	Position, Test Distance [mm]	Band	Group, UID	Frequency [MHz], Channel Number	Conversion Factor	TSL Conductivity [S/m]	TSL Permittivity
Flat, MSL	EDGE TOP, 0.00	Band 12, E-UTRA/FDD	LTE-FDD, 10175-CAG	707.5, 23095	9.63	0.99	53.5

Hardware Setup

Phantom	TSL, Measured Date	Probe, Calibration Date	DAE, Calibration Date
ELI V8.0 (20deg probe tilt) -	MABL-600-6000, 2021-Sep-02	EX3DV4 - SN3978, 2021-05-22	DAE4 Sn1429, 2021-05-11

Scan Setup

	Area Scan	Zoom Scan
Grid Extents [mm]	120.0 x 150.0	30.0 x 30.0 x 30.0
Grid Steps [mm]	15.0 x 15.0	6.0 x 6.0 x 1.5
Sensor Surface [mm]	3.0	1.4
Graded Grid	No	Yes
Grading Ratio	n/a	1.5
MAIA	Confirmed by MAIA	Confirmed by MAIA
Surface Detection	VMS + 6p	All points
Scan Method	Measured	Measured

Measurement Results

	Area Scan	Zoom Scan
Date	2021-09-03, 09:09	2021-09-03, 09:21
psSAR1g [W/Kg]	0.602	0.674
psSAR10g [W/Kg]	0.386	0.389
Power Drift [dB]	-0.11	0.07
Power Scaling	Disabled	Disabled
Scaling Factor [dB]		
TSL Correction	Positive Only	Positive Only
M2/M1 [%]		83.5
Dist 3dB Peak [mm]		9.6

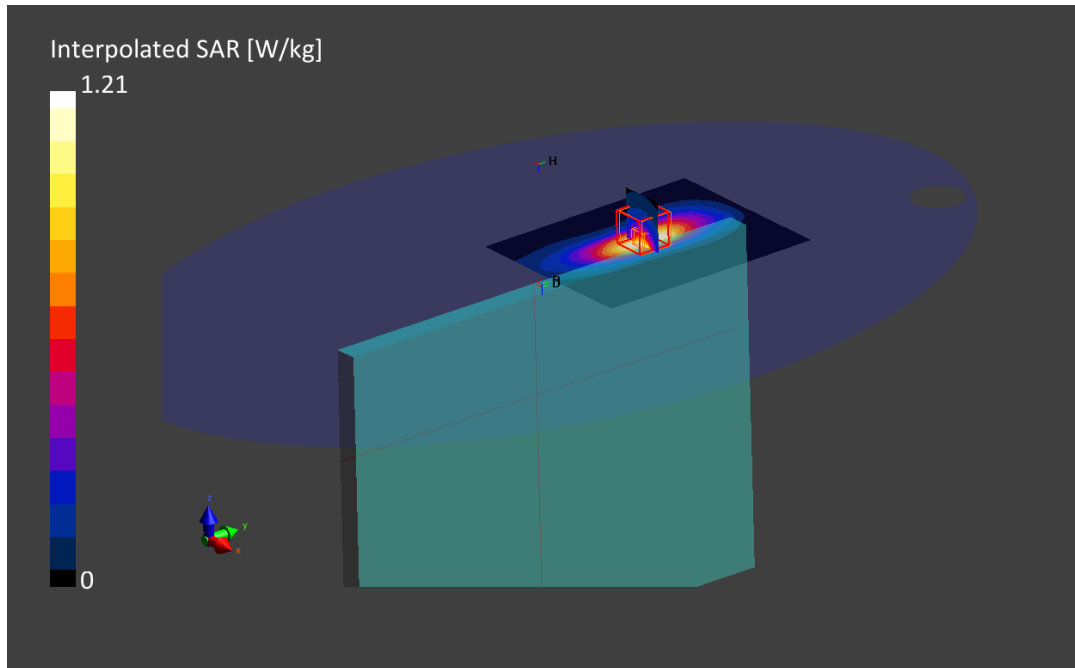

7. LTE Band 13, QPSK - 10MHz, CH23230, Top edge

Device under Test Properties

Name, Manufacturer	Dimensions [mm]	S/N	DUT Type
HSN-I47C	295.0 x 220.0 x 15.0	0001760970	Convertible PC

Exposure Conditions

Phantom Section, TSL	Position, Test Distance [mm]	Band	Group, UID	Frequency [MHz], Channel Number	Conversion Factor	TSL Conductivity [S/m]	TSL Permittivity
Flat, MSL	EDGE TOP, 0.00	Band 13, E-UTRA/FDD	LTE-FDD, 10175-CAG	782.0, 23230	9.63	1.02	53.4

Hardware Setup

Phantom	TSL, Measured Date	Probe, Calibration Date	DAE, Calibration Date
ELI V8.0 (20deg probe tilt) -	MABL-600-6000, 2021-Sep-02	EX3DV4 - SN3978, 2021-05-22	DAE4 Sn1429, 2021-05-11

Scan Setup

	Area Scan	Zoom Scan
Grid Extents [mm]	120.0 x 150.0	30.0 x 30.0 x 30.0
Grid Steps [mm]	15.0 x 15.0	6.0 x 6.0 x 1.5
Sensor Surface [mm]	3.0	1.4
Graded Grid	No	Yes
Grading Ratio	n/a	1.5
MAIA	Confirmed by MAIA	Confirmed by MAIA
Surface Detection	VMS + 6p	All points
Scan Method	Measured	Measured

Measurement Results

	Area Scan	Zoom Scan
Date	2021-09-03, 09:58	2021-09-03, 10:10
psSAR1g [W/Kg]	0.477	0.522
psSAR10g [W/Kg]	0.313	0.316
Power Drift [dB]	0.07	-0.10
Power Scaling	Disabled	Disabled
Scaling Factor [dB]		
TSL Correction	Positive Only	Positive Only
M2/M1 [%]		83.3
Dist 3dB Peak [mm]		10.9

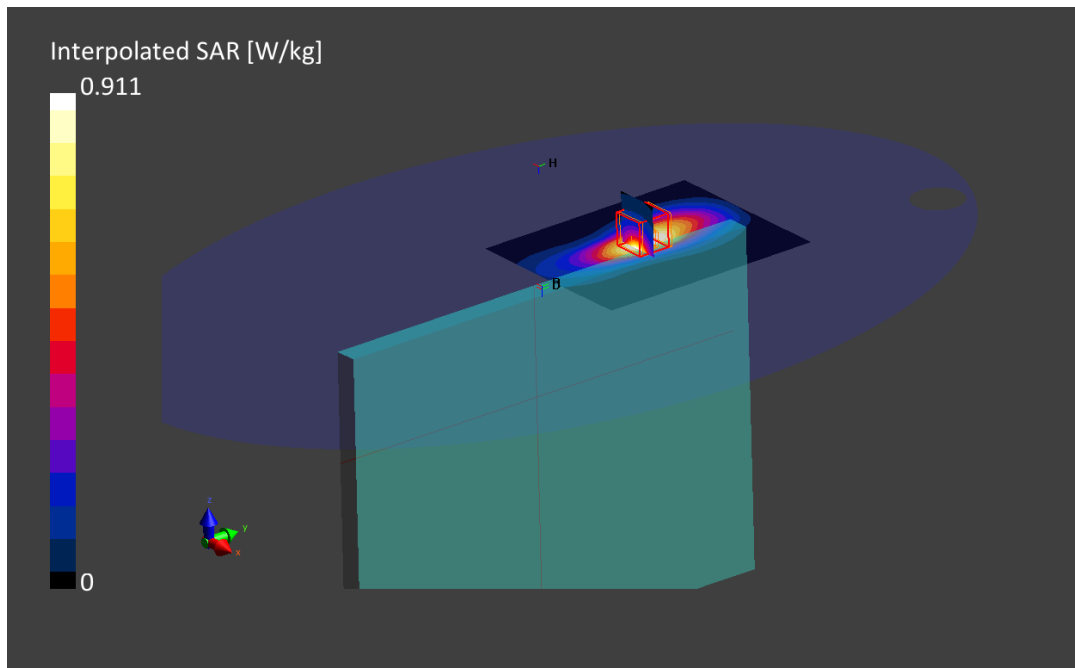

8. LTE Band 26, QPSK - 15MHz, CH26765, Top Edge

Device under Test Properties

Name, Manufacturer	Dimensions [mm]	S/N	DUT Type
HSN-I47C	295.0 x 220.0 x 15.0	0001760970	Convertible PC

Exposure Conditions

Phantom Section, TSL	Position, Test Distance [mm]	Band	Group, UID	Frequency [MHz], Channel Number	Conversion Factor	TSL Conductivity [S/m]	TSL Permittivity
Flat, MSL	EDGE TOP, 0.00	Band 26 E-UTRA/FDD	LTE-FDD, 10181-CAE	821.5, 26765	9.32	1.04	53.3

Hardware Setup

Phantom	TSL, Measured Date	Probe, Calibration Date	DAE, Calibration Date
ELI V8.0 (20deg probe tilt) -	MBBL-600-6000, 2021-Sep-02	EX3DV4 - SN3978, 2021-05-22	DAE4 Sn1429, 2021-05-11

Scan Setup

	Area Scan	Zoom Scan
Grid Extents [mm]	120.0 x 150.0	30.0 x 30.0 x 30.0
Grid Steps [mm]	15.0 x 15.0	6.0 x 6.0 x 1.5
Sensor Surface [mm]	3.0	1.4
Graded Grid	No	Yes
Grading Ratio	n/a	1.5
MAIA	Confirmed by MAIA	Confirmed by MAIA
Surface Detection	VMS + 6p	VMS + 6p
Scan Method	Measured	Measured

Measurement Results

	Area Scan	Zoom Scan
Date	2021-09-03, 14:14	2021-09-03, 14:20
psSAR1g [W/Kg]	0.609	0.647
psSAR10g [W/Kg]	0.394	0.388
Power Drift [dB]	-0.04	-0.03
Power Scaling	Disabled	Disabled
Scaling Factor [dB]		
TSL Correction	Positive Only	Positive Only
M2/M1 [%]		83.3
Dist 3dB Peak [mm]		10.8

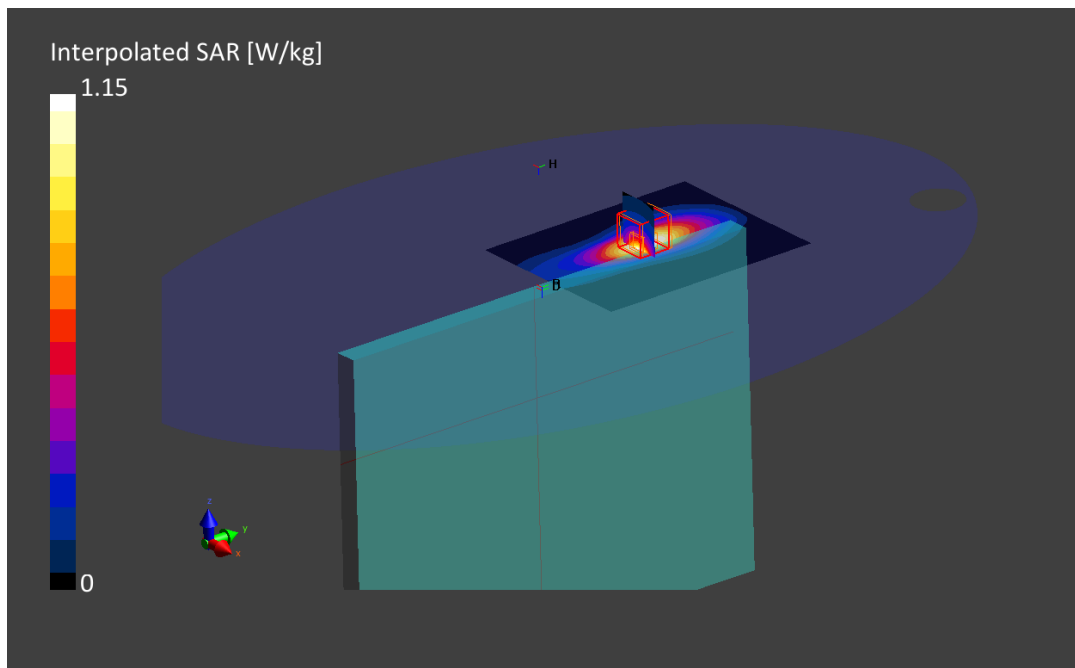

9. LTE Band 30, QPSK - 10MHz, CH27710, Top Edge

Device under Test Properties

Name, Manufacturer	Dimensions [mm]	S/N	DUT Type
HSN-I47C	295.0 x 220.0 x 15.0	0001760970	Convertible PC

Exposure Conditions

Phantom Section, TSL	Position, Test Distance [mm]	Band	Group, UID	Frequency [MHz], Channel Number	Conversion Factor	TSL Conductivity [S/m]	TSL Permittivity
Flat, MSL	EDGE TOP, 0.00	Band 30, E-UTRA/FDD	LTE-FDD, 10175-CAG	2310.0, 27710	7.45	1.87	50.2

Hardware Setup

Phantom	TSL, Measured Date	Probe, Calibration Date	DAE, Calibration Date
ELI V8.0 (20deg probe tilt) -	MABL-600-6000, 2021-Sep-06	EX3DV4 - SN3978, 2021-05-22	DAE4 Sn1429, 2021-05-11

Scan Setup

	Area Scan	Zoom Scan
Grid Extents [mm]	100.0 x 140.0	30.0 x 30.0 x 30.0
Grid Steps [mm]	10.0 x 10.0	5.0 x 5.0 x 1.5
Sensor Surface [mm]	3.0	1.4
Graded Grid	No	Yes
Grading Ratio	n/a	1.5
MAIA	Confirmed by MAIA	Confirmed by MAIA
Surface Detection	VMS + 6p	VMS + 6p
Scan Method	Measured	Measured

Measurement Results

	Area Scan	Zoom Scan
Date	2021-09-06, 19:33	2021-09-06, 19:40
psSAR1g [W/Kg]	1.04	1.15
psSAR10g [W/Kg]	0.484	0.505
Power Drift [dB]	-0.08	0.04
Power Scaling	Disabled	Disabled
Scaling Factor [dB]		
TSL Correction	Positive Only	Positive Only
M2/M1 [%]		79.5
Dist 3dB Peak [mm]		7.3

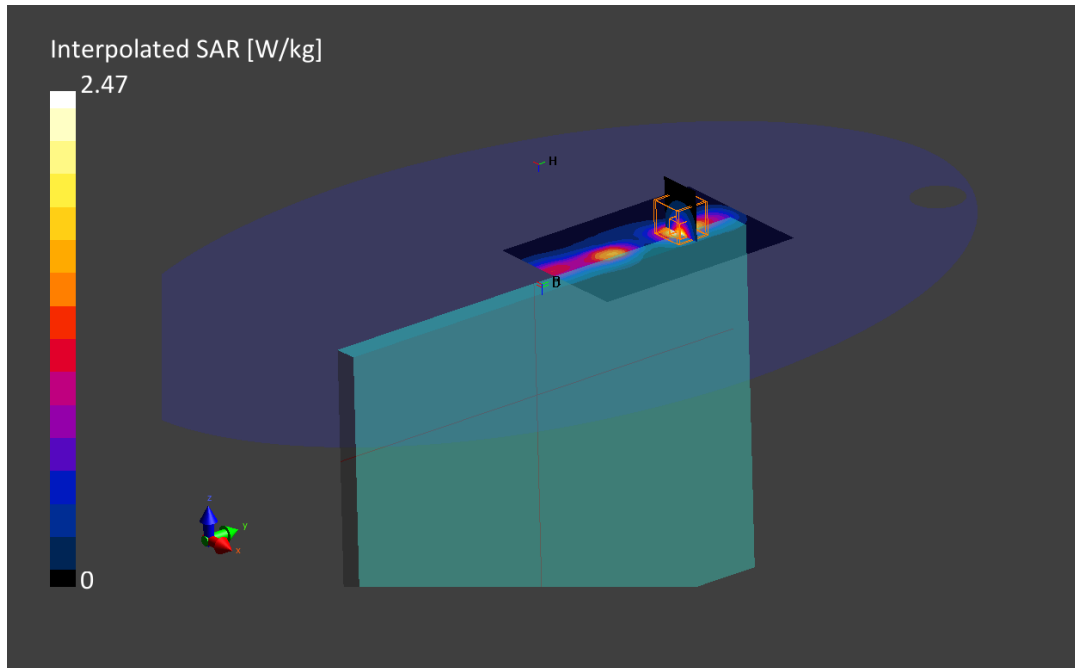

10. LTE Band 38, QPSK - 20MHz, CH38150, Top Edge

Device under Test Properties

Name, Manufacturer	Dimensions [mm]	S/N	DUT Type
HSN-I47C	295.0 x 220.0 x 15.0	0001760970	Convertible PC

Exposure Conditions

Phantom Section, TSL	Position, Test Distance [mm]	Band	Group, UID	Frequency [MHz], Channel Number	Conversion Factor	TSL Conductivity [S/m]	TSL Permittivity
Flat, MSL	EDGE TOP, 0.00	Band 38, E-UTRA/TDD	LTE-TDD, 10435-AAF	2610.0, 38150	7.24	2.17	49.7

Hardware Setup

Phantom	TSL, Measured Date	Probe, Calibration Date	DAE, Calibration Date
ELI V8.0 (20deg probe tilt) -	MABL-600-6000, 2021-Sep-06	EX3DV4 - SN3978, 2021-05-22	DAE4 Sn1429, 2021-05-11

Scan Setup

	Area Scan	Zoom Scan
Grid Extents [mm]	100.0 x 140.0	30.0 x 30.0 x 30.0
Grid Steps [mm]	10.0 x 10.0	5.0 x 5.0 x 1.5
Sensor Surface [mm]	3.0	1.4
Graded Grid	No	Yes
Grading Ratio	n/a	1.5
MAIA	Confirmed by MAIA	Confirmed by MAIA
Surface Detection	VMS + 6p	VMS + 6p
Scan Method	Measured	Measured

Measurement Results

	Area Scan	Zoom Scan
Date	2021-09-06, 12:52	2021-09-06, 12:59
psSAR1g [W/Kg]	0.807	0.867
psSAR10g [W/Kg]	0.341	0.347
Power Drift [dB]	0.02	0.02
Power Scaling	Disabled	Disabled
Scaling Factor [dB]		
TSL Correction	Positive Only	Positive Only
M2/M1 [%]		80.4
Dist 3dB Peak [mm]		7.0

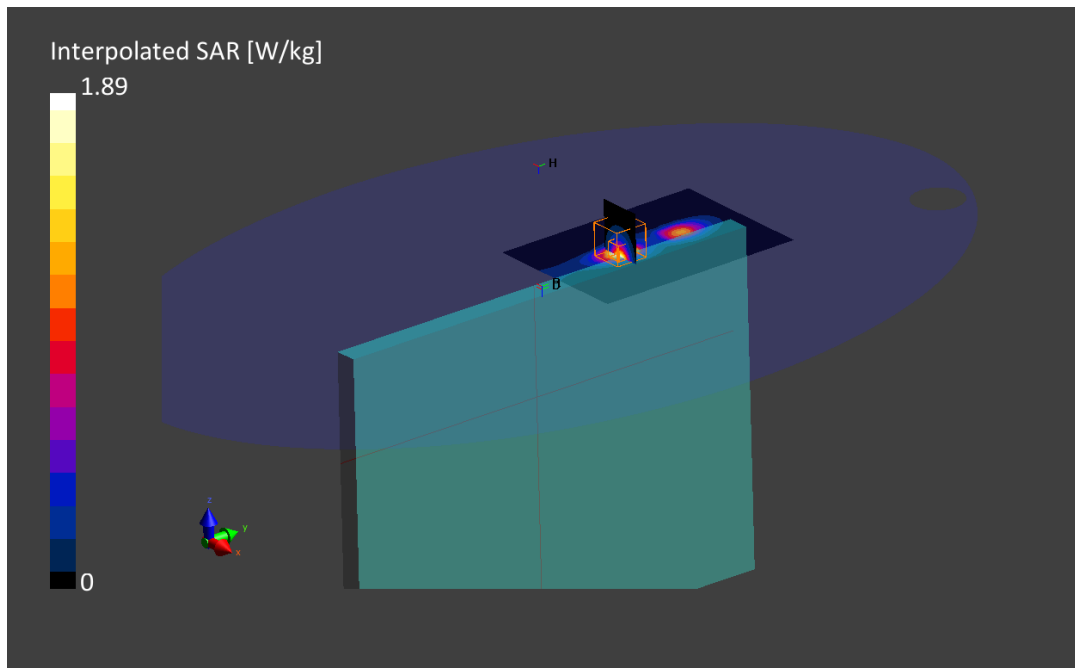

11. LTE Band 41, QPSK - 20MHz, CH39750, Top Edge

Device under Test Properties

Model, Manufacturer	Dimensions [mm]	IMEI	DUT Type
HSN-I47C	295.0 x 220.0 x 15.0	0001760970	Convertible PC

Exposure Conditions

Phantom Section, TSL	Position, Test Distance [mm]	Band	Group, UID	Frequency [MHz], Channel Number	Conversion Factor	TSL Conductivity [S/m]	TSL Permittivity
Flat, MSL	EDGE TOP, 0.00	Band 41, E-UTRA/TDD	LTE-TDD, 10435-AAF	2506.0, 39750	7.24	2.04	49.9

Hardware Setup

Phantom	TSL, Measured Date	Probe, Calibration Date	DAE, Calibration Date
ELI V8.0 (20deg probe tilt) -	MABL-600-6000, 2021-Sep-06	EX3DV4 - SN3978, 2021-05-22	DAE4 Sn1429, 2021-05-11

Scan Setup

	Area Scan	Zoom Scan
Grid Extents [mm]	100.0 x 140.0	30.0 x 30.0 x 30.0
Grid Steps [mm]	10.0 x 10.0	5.0 x 5.0 x 1.5
Sensor Surface [mm]	3.0	1.4
Graded Grid	No	Yes
Grading Ratio	n/a	1.5
MAIA	Confirmed by MAIA	Confirmed by MAIA
Surface Detection	VMS + 6p	VMS + 6p
Scan Method	Measured	Measured

Measurement Results

	Area Scan	Zoom Scan
Date	2021-09-06, 14:35	2021-09-06, 14:42
psSAR1g [W/Kg]	0.842	0.900
psSAR10g [W/Kg]	0.363	0.372
Power Drift [dB]	0.00	0.03
Power Scaling	Disabled	Disabled
Scaling Factor [dB]		
TSL Correction	Positive Only	Positive Only
M2/M1 [%]		81.6
Dist 3dB Peak [mm]		7.6

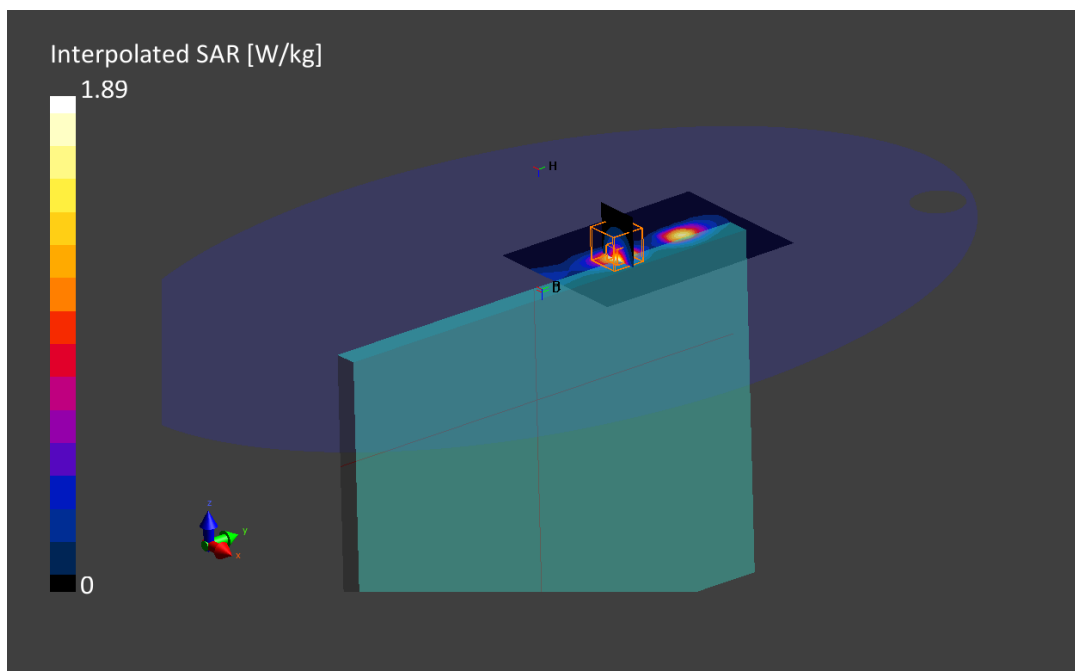

12. LTE Band 66, QPSK - 20MHz, CH132072, Top Edge

Device under Test Properties

Name, Manufacturer	Dimensions [mm]	S/N	DUT Type
HSN-I47C	295.0 x 220.0 x 15.0	0001760970	Convertible PC

Exposure Conditions

Phantom Section, TSL	Position, Test Distance [mm]	Band	Group, UID	Frequency [MHz], Channel Number	Conversion Factor	TSL Conductivity [S/m]	TSL Permittivity
Flat, MSL	EDGE TOP, 0.00	Band 66, E-UTRA/FDD	LTE-FDD, 10169-CAE	1720.0, 132072	8.37	1.44	51.0

Hardware Setup

Phantom	TSL, Measured Date	Probe, Calibration Date	DAE, Calibration Date
ELI V8.0 (20deg probe tilt) -	MABL-600-6000, 2021-Sep-06	EX3DV4 - SN3978, 2021-05-22	DAE4 Sn1429, 2021-05-11

Scan Setup

	Area Scan	Zoom Scan
Grid Extents [mm]	120.0 x 150.0	30.0 x 30.0 x 30.0
Grid Steps [mm]	15.0 x 15.0	6.0 x 6.0 x 1.5
Sensor Surface [mm]	3.0	1.4
Graded Grid	No	Yes
Grading Ratio	n/a	1.5
MAIA	Confirmed by MAIA	Confirmed by MAIA
Surface Detection	VMS + 6p	VMS + 6p
Scan Method	Measured	Measured

Measurement Results

	Area Scan	Zoom Scan
Date	2021-09-07, 12:05	2021-09-07, 12:10
psSAR1g [W/Kg]	0.653	0.714
psSAR10g [W/Kg]	0.370	0.399
Power Drift [dB]	-0.04	0.00
Power Scaling	Disabled	Disabled
Scaling Factor [dB]		
TSL Correction	Positive Only	Positive Only
M2/M1 [%]		83.2
Dist 3dB Peak [mm]		9.6

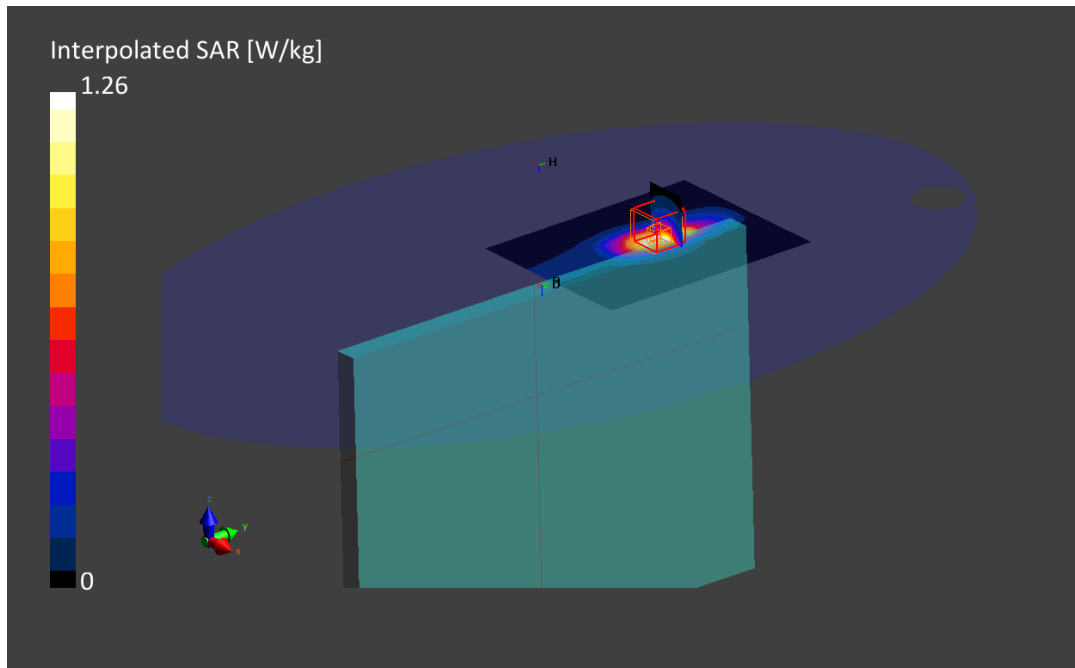

13. System Check Body Liquid 750MHz

Device under Test Properties

Name, Manufacturer	Dimensions [mm]	S/N	DUT Type
Dipole 750MHz, SPEAG	50.0 x 10.0 x 10.0	1136	Validation Dipole

Exposure Conditions

Phantom Section, TSL	Position, Test Distance [mm]	Band	Group, UID	Frequency [MHz], Channel Number	Conversion Factor	TSL Conductivity [S/m]	TSL Permittivity
Flat, MSL	,		0--	750.0, 0	9.63	1.01	53.4

Hardware Setup

Phantom	TSL, Measured Date	Probe, Calibration Date	DAE, Calibration Date
ELI V8.0 (20deg probe tilt) -	MABL-600-6000, 2021-Sep-02	EX3DV4 - SN3978, 2021-05-22	DAE4 Sn1429, 2021-05-11

Scan Setup

	Area Scan	Zoom Scan
Grid Extents [mm]	60.0 x 90.0	30.0 x 30.0 x 30.0
Grid Steps [mm]	15.0 x 15.0	6.0 x 6.0 x 1.5
Sensor Surface [mm]	3.0	1.4
Graded Grid	No	Yes
Grading Ratio	n/a	1.5
MAIA	Confirmed by MAIA	Confirmed by MAIA
Surface Detection	VMS + 6p	VMS + 6p
Scan Method	Measured	Measured

Measurement Results

	Area Scan	Zoom Scan
Date	2021-09-03, 16:44	2021-09-03, 16:48
psSAR1g [W/Kg]	0.409	0.421
psSAR10g [W/Kg]	0.272	0.277
Power Drift [dB]	0.02	0.02
Power Scaling	Disabled	Disabled
Scaling Factor [dB]		
TSL Correction	Positive Only	Positive Only
M2/M1 [%]		87.9
Dist 3dB Peak [mm]		16.3

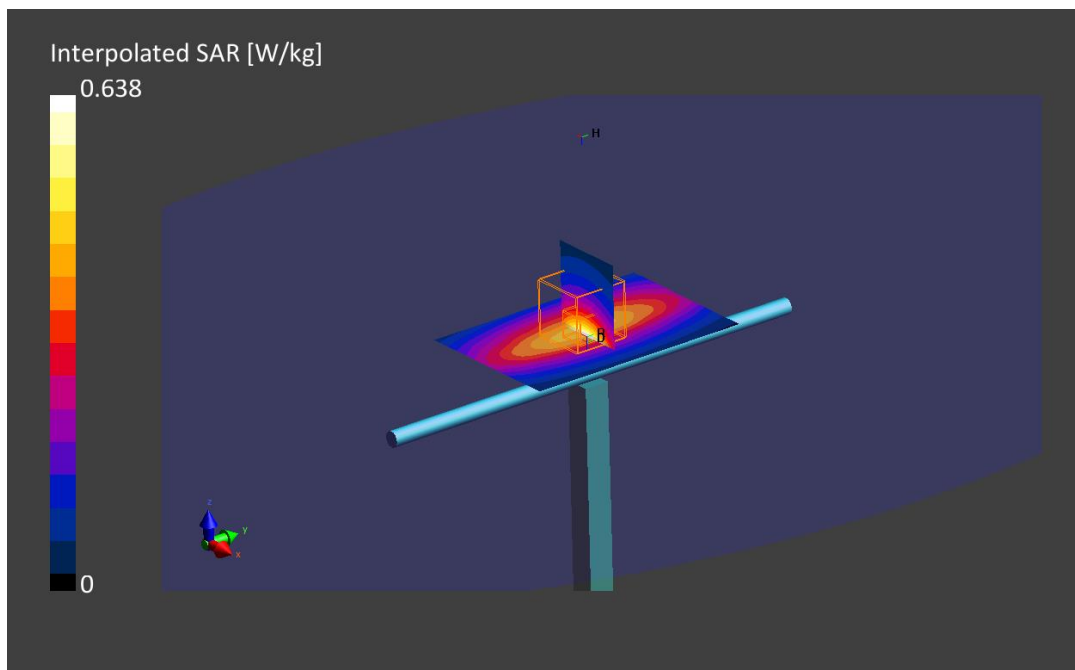

14. System Check Body Liquid 835MHz

Device under Test Properties

Name, Manufacturer	Dimensions [mm]	Serial Number	DUT Type
Dipole 835MHz, SPEAG	50.0 x 10.0 x 10.0	4d192	Validation Dipole

Exposure Conditions

Phantom Section, TSL	Position, Test Distance [mm]	Band	Group, UID	Frequency [MHz], Channel Number	Conversion Factor	TSL Conductivity [S/m]	TSL Permittivity
Flat, MSL	,		, 0--	835.0, 0	9.32	1.04	53.2

Hardware Setup

Phantom	TSL, Measured Date	Probe, Calibration Date	DAE, Calibration Date
ELI V8.0 (20deg probe tilt) -	MBBL-600-6000, 2021-Sep-02	EX3DV4 - SN3978, 2021-05-22	DAE4 Sn1429, 2021-05-11

Scan Setup

	Area Scan	Zoom Scan
Grid Extents [mm]	60.0 x 90.0	30.0 x 30.0 x 30.0
Grid Steps [mm]	15.0 x 15.0	6.0 x 6.0 x 1.5
Sensor Surface [mm]	3.0	1.4
Graded Grid	No	Yes
Grading Ratio	n/a	1.5
MAIA	Confirmed by MAIA	Confirmed by MAIA
Surface Detection	VMS + 6p	VMS + 6p
Scan Method	Measured	Measured

Measurement Results

	Area Scan	Zoom Scan
Date	2021-09-03, 16:54	2021-09-03, 16:58
psSAR1g [W/Kg]	0.512	0.524
psSAR10g [W/Kg]	0.337	0.342
Power Drift [dB]	0.01	-0.03
Power Scaling	Disabled	Disabled
Scaling Factor [dB]		
TSL Correction	Positive Only	Positive Only
M2/M1 [%]		87.4
Dist 3dB Peak [mm]		15.8

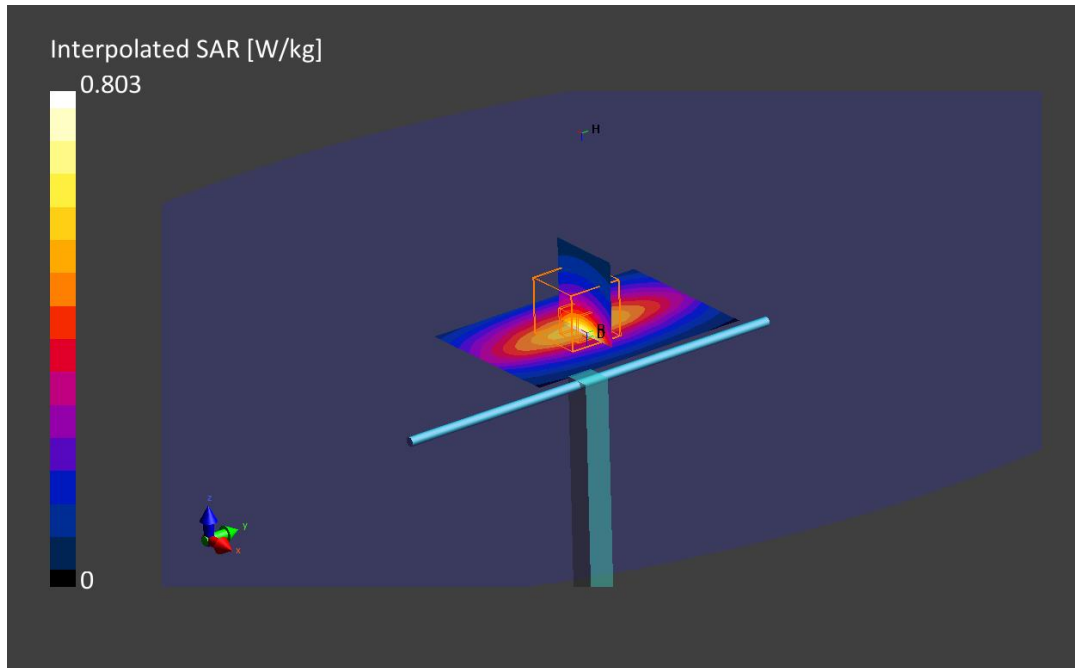

15. System Check Body Liquid 1750MHz – 2021-09-03

Device under Test Properties

Name, Manufacturer	Dimensions [mm]	Serial Number	DUT Type
Dipole 1750MHz, SPEAG	50.0 x 10.0 x 18.0	1133	Validation Dipole

Exposure Conditions

Phantom Section, TSL	Position, Test Distance [mm]	Band	Group, UID	Frequency [MHz], Channel Number	Conversion Factor	TSL Conductivity [S/m]	TSL Permittivity
Flat, MSL	,		, 0--	1750.0, 0	8.37	1.50	51.4

Hardware Setup

Phantom	TSL, Measured Date	Probe, Calibration Date	DAE, Calibration Date
ELI V8.0 (20deg probe tilt) -	MBBL-600-6000, 2021-Sep-02	EX3DV4 - SN3978, 2021-05-21	DAE4ip Sn1658, 2021-08-04

Scan Setup

	Area Scan	Zoom Scan
Grid Extents [mm]	60.0 x 90.0	30.0 x 30.0 x 30.0
Grid Steps [mm]	15.0 x 15.0	6.0 x 6.0 x 1.5
Sensor Surface [mm]	3.0	1.4
Graded Grid	No	Yes
Grading Ratio	n/a	1.5
MAIA	Confirmed by MAIA	Confirmed by MAIA
Surface Detection	VMS + 6p	VMS + 6p
Scan Method	Measured	Measured

Measurement Results

	Area Scan	Zoom Scan
Date	2021-09-03, 17:16	2021-09-03, 17:21
psSAR1g [W/Kg]	1.74	1.78
psSAR10g [W/Kg]	0.910	0.943
Power Drift [dB]	-0.01	-0.02
Power Scaling	Disabled	Disabled
Scaling Factor [dB]		
TSL Correction	Positive Only	Positive Only
M2/M1 [%]		82.8
Dist 3dB Peak [mm]		9.9

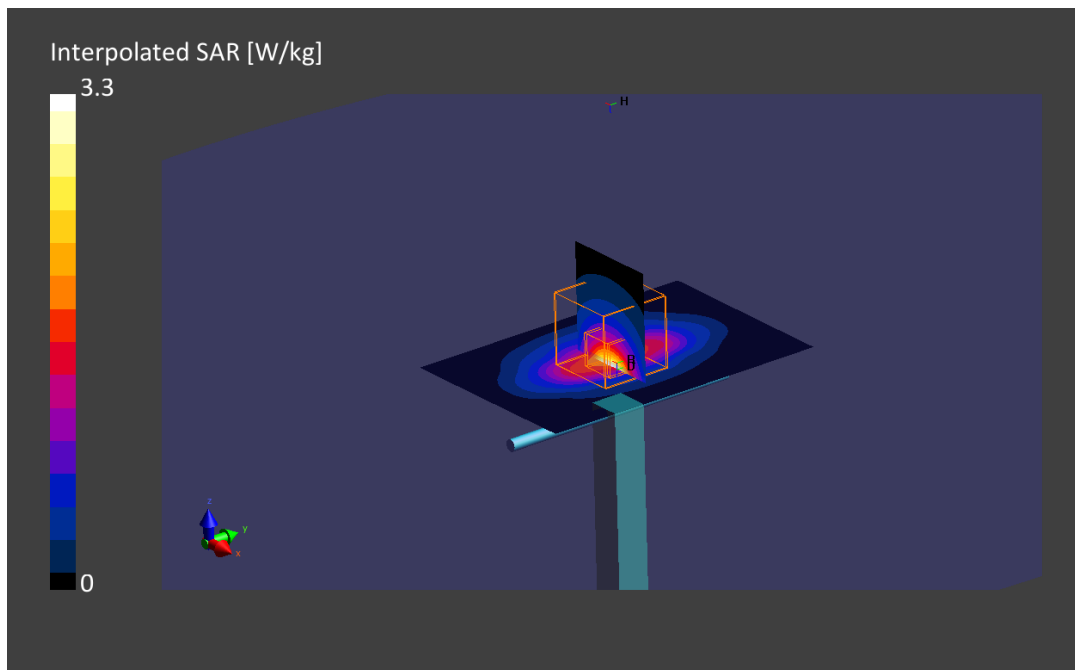

16. System Check Body Liquid 1750MHz – 2021-09-07

Device under Test Properties

Name, Manufacturer	Dimensions [mm]	S/N	DUT Type
Dipole 1750MHz, SPEAG	50.0 x 10.0 x 18.0	1133	Validation Dipole

Exposure Conditions

Phantom Section, TSL	Position, Test Distance [mm]	Band	Group, UID	Frequency [MHz], Channel Number	Conversion Factor	TSL Conductivity [S/m]	TSL Permittivity
Flat, MSL	,		0--	1750.0, 0	8.37	1.46	50.9

Hardware Setup

Phantom	TSL, Measured Date	Probe, Calibration Date	DAE, Calibration Date
ELI V8.0 (20deg probe tilt) -	MBBL-600-6000, 2021-Sep-06	EX3DV4 - SN3978, 2021-05-22	DAE4 Sn1429, 2021-05-11

Scan Setup

	Area Scan	Zoom Scan
Grid Extents [mm]	60.0 x 90.0	30.0 x 30.0 x 30.0
Grid Steps [mm]	15.0 x 15.0	6.0 x 6.0 x 1.5
Sensor Surface [mm]	3.0	1.4
Graded Grid	No	Yes
Grading Ratio	n/a	1.5
MAIA	Confirmed by MAIA	Confirmed by MAIA
Surface Detection	VMS + 6p	VMS + 6p
Scan Method	Measured	Measured

Measurement Results

	Area Scan	Zoom Scan
Date	2021-09-07, 14:45	2021-09-07, 14:49
psSAR1g [W/Kg]	1.60	1.74
psSAR10g [W/Kg]	0.864	0.917
Power Drift [dB]	-0.02	-0.13
Power Scaling	Disabled	Disabled
Scaling Factor [dB]		
TSL Correction	Positive Only	Positive Only
M2/M1 [%]		81.9
Dist 3dB Peak [mm]		9.6

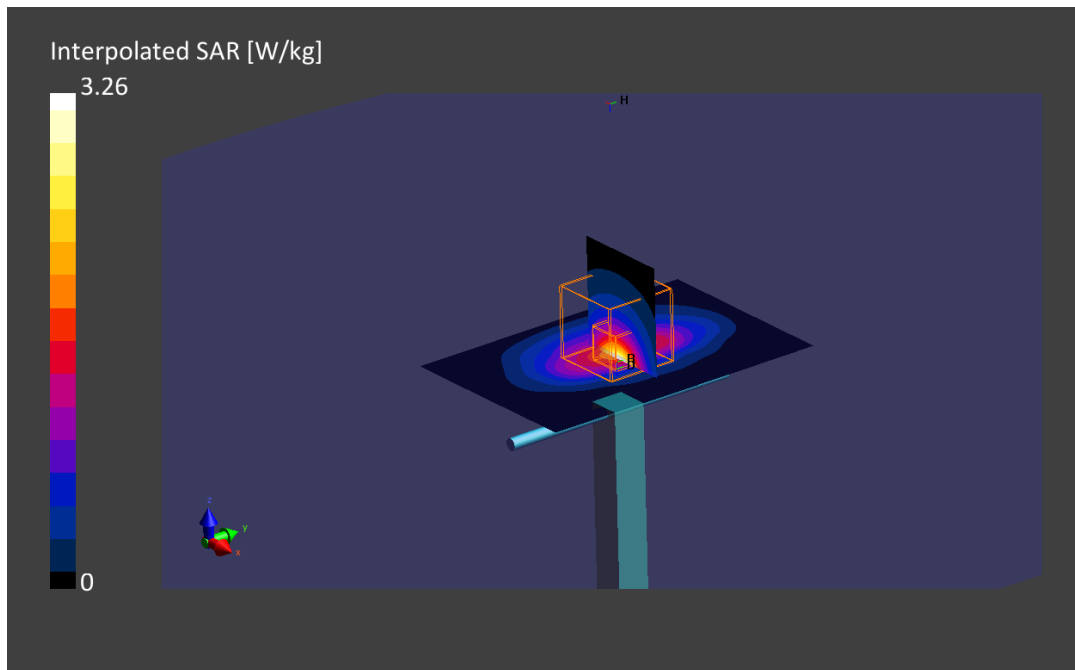

17. System Check Body Liquid 1900MHz – 2021-09-03

Device under Test Properties

Name, Manufacturer	Dimensions [mm]	S/N	DUT Type
Dipole 1900MHz, SPEAG	50.0 x 10.0 x 18.0	5d197	Validation Dipole

Exposure Conditions

Phantom Section, TSL	Position, Test Distance [mm]	Band	Group, UID	Frequency [MHz], Channel Number	Conversion Factor	TSL Conductivity [S/m]	TSL Permittivity
Flat, MSL	,		0--	1900.0, 0	7.98	1.60	51.4

Hardware Setup

Phantom	TSL, Measured Date	Probe, Calibration Date	DAE, Calibration Date
ELI V8.0 (20deg probe tilt) -	MABL-600-6000, 2021-Sep-02	EX3DV4 - SN3978, 2021-05-22	DAE4ip Sn1658, 2021-08-04

Scan Setup

	Area Scan	Zoom Scan
Grid Extents [mm]	60.0 x 90.0	30.0 x 30.0 x 30.0
Grid Steps [mm]	15.0 x 15.0	6.0 x 6.0 x 1.5
Sensor Surface [mm]	3.0	1.4
Graded Grid	No	Yes
Grading Ratio	n/a	1.5
MAIA	Confirmed by MAIA	Confirmed by MAIA
Surface Detection	VMS + 6p	VMS + 6p
Scan Method	Measured	Measured

Measurement Results

	Area Scan	Zoom Scan
Date	2021-09-03, 17:03	2021-09-03, 17:08
psSAR1g [W/Kg]	1.91	2.05
psSAR10g [W/Kg]	0.985	1.06
Power Drift [dB]	-0.04	0.08
Power Scaling	Disabled	Disabled
Scaling Factor [dB]		
TSL Correction	Positive Only	Positive Only
M2/M1 [%]		82.6
Dist 3dB Peak [mm]		9.6

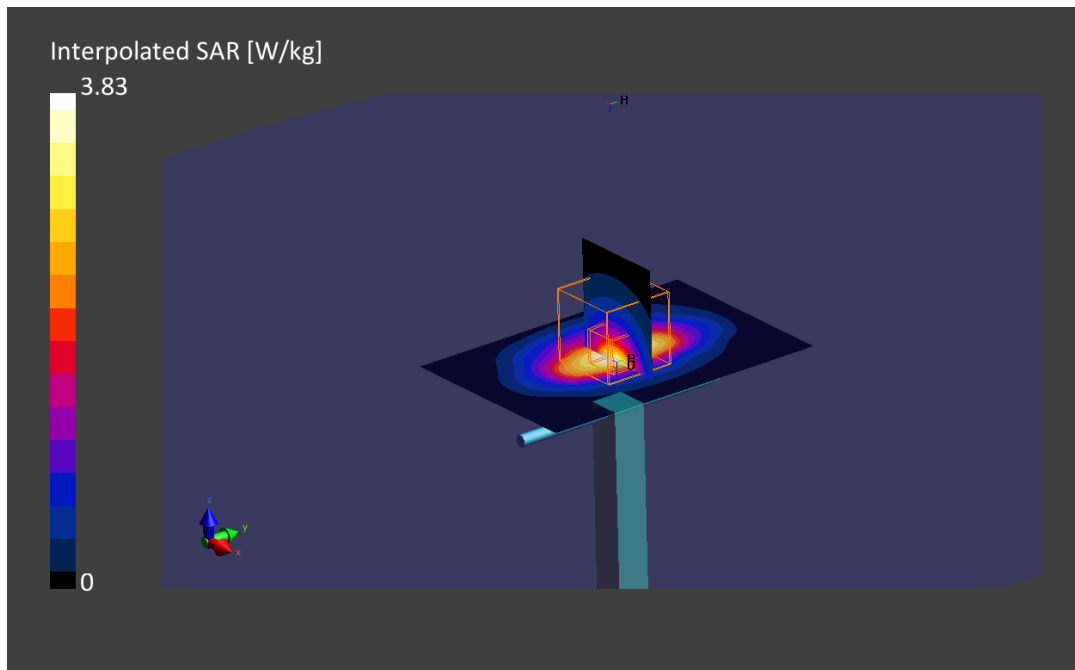

18. System Check Body Liquid 1900MHz - 2021-09-07

Device under Test Properties

Name, Manufacturer	Dimensions [mm]	S/N	DUT Type
Dipole 1900MHz, SPEAG	50.0 x 10.0 x 18.0	5d197	Validation Dipole

Exposure Conditions

Phantom Section, TSL	Position, Test Distance [mm]	Band	Group, UID	Frequency [MHz], Channel Number	Conversion Factor	TSL Conductivity [S/m]	TSL Permittivity
Flat, MSL	,		0--	1900.0, 0	7.98	1.54	50.8

Hardware Setup

Phantom	TSL, Measured Date	Probe, Calibration Date	DAE, Calibration Date
ELI V8.0 (20deg probe tilt) -	MBBL-600-6000, 2021-Sep-06	EX3DV4 - SN3978, 2021-05-22	DAE4 Sn1429, 2021-05-11

Scan Setup

	Area Scan	Zoom Scan
Grid Extents [mm]	60.0 x 90.0	30.0 x 30.0 x 30.0
Grid Steps [mm]	15.0 x 15.0	6.0 x 6.0 x 1.5
Sensor Surface [mm]	3.0	1.4
Graded Grid	No	Yes
Grading Ratio	n/a	1.5
MAIA	Confirmed by MAIA	Confirmed by MAIA
Surface Detection	VMS + 6p	VMS + 6p
Scan Method	Measured	Measured

Measurement Results

	Area Scan	Zoom Scan
Date	2021-09-07, 15:00	2021-09-07, 15:05
psSAR1g [W/Kg]	1.88	1.96
psSAR10g [W/Kg]	0.960	1.01
Power Drift [dB]	0.06	0.01
Power Scaling	Disabled	Disabled
Scaling Factor [dB]		
TSL Correction	Positive Only	Positive Only
M2/M1 [%]		83.2
Dist 3dB Peak [mm]		9.6

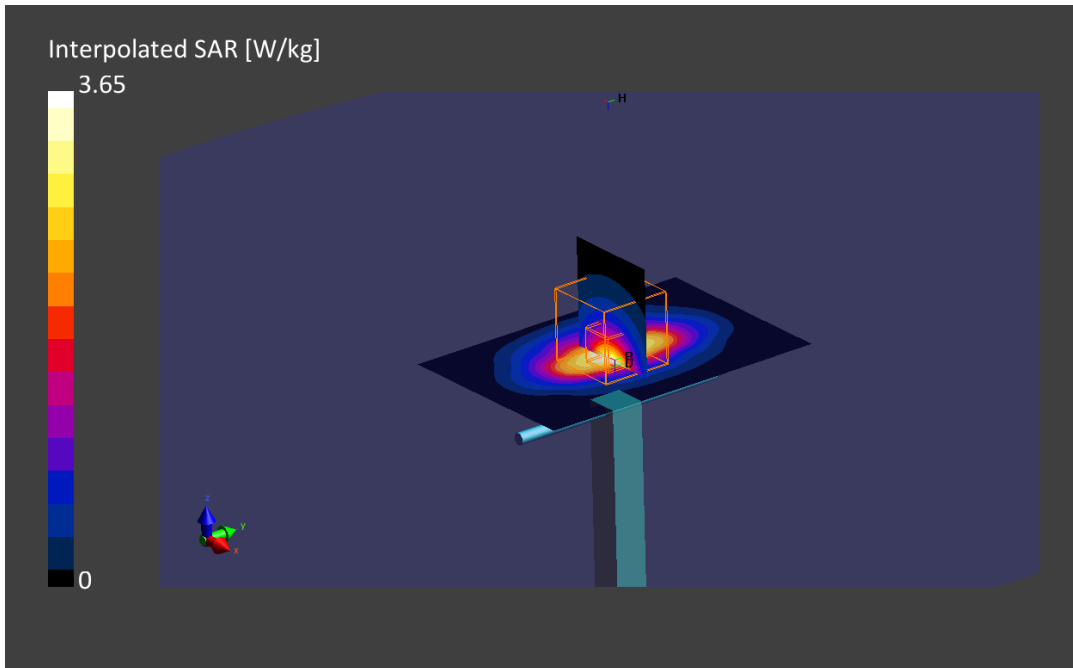

19. System Check Body Liquid 2300MHz

Device under Test Properties

Name, Manufacturer	Dimensions [mm]	Serial Number	DUT Type
D2300MHZ, SPEAG	50.0 x 10.0 x 18.0	1046	Validation Dipole

Exposure Conditions

Phantom Section, TSL	Position, Test Distance [mm]	Band	Group, UID	Frequency [MHz], Channel Number	Conversion Factor	TSL Conductivity [S/m]	TSL Permittivity
Flat, MSL	,		, 0--	2300.0, 0	7.45	1.86	50.2

Hardware Setup

Phantom	TSL, Measured Date	Probe, Calibration Date	DAE, Calibration Date
ELI V8.0 (20deg probe tilt) -	MBBL-600-6000, 2021-Sep-06	EX3DV4 - SN3978, 2021-05-22	DAE4ip Sn1658, 2021-08-04

Scan Setup

	Area Scan	Zoom Scan
Grid Extents [mm]	40.0 x 80.0	30.0 x 30.0 x 30.0
Grid Steps [mm]	10.0 x 10.0	5.0 x 5.0 x 1.5
Sensor Surface [mm]	3.0	1.4
Graded Grid	No	Yes
Grading Ratio	n/a	1.5
MAIA	Confirmed by MAIA	Confirmed by MAIA
Surface Detection	VMS + 6p	VMS + 6p
Scan Method	Measured	Measured

Measurement Results

	Area Scan	Zoom Scan
Date	2021-09-06, 09:46	2021-09-06, 09:52
psSAR1g [W/Kg]	2.26	2.30
psSAR10g [W/Kg]	1.09	1.10
Power Drift [dB]	-0.03	0.00
Power Scaling	Disabled	Disabled
Scaling Factor [dB]		
TSL Correction	Positive Only	Positive Only
M2/M1 [%]		81.2
Dist 3dB Peak [mm]		8.9

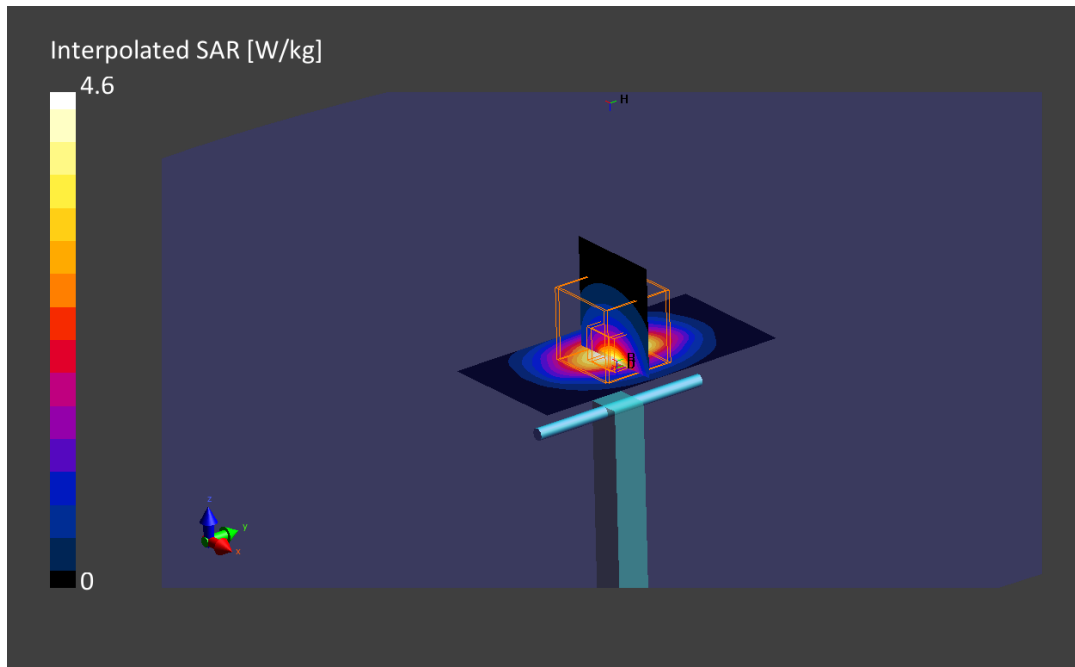

20. System Check Body Liquid 2600MHz

Device under Test Properties

Name, Manufacturer	Dimensions [mm]	Serial Number	DUT Type
D2600MHz, SPEAG	50.0 x 10.0 x 18.0	1100	Validation Dipole

Exposure Conditions

Phantom Section, TSL	Position, Test Distance [mm]	Band	Group, UID	Frequency [MHz], Channel Number	Conversion Factor	TSL Conductivity [S/m]	TSL Permittivity
Flat, MSL	,		, 0--	2600.0, 0	7.24	2.16	49.7

Hardware Setup

Phantom	TSL, Measured Date	Probe, Calibration Date	DAE, Calibration Date
ELI V8.0 (20deg probe tilt) -	MABL-600-6000, 2021-Sep-06	EX3DV4 - SN3978, 2021-05-22	DAE4 Sn1429, 2021-05-11

Scan Setup

	Area Scan	Zoom Scan
Grid Extents [mm]	40.0 x 80.0	30.0 x 30.0 x 30.0
Grid Steps [mm]	10.0 x 10.0	5.0 x 5.0 x 1.5
Sensor Surface [mm]	3.0	1.4
Graded Grid	No	Yes
Grading Ratio	n/a	1.5
MAIA	Confirmed by MAIA	Confirmed by MAIA
Surface Detection	VMS + 6p	VMS + 6p
Scan Method	Measured	Measured

Measurement Results

	Area Scan	Zoom Scan
Date	2021-09-06, 10:08	2021-09-06, 10:15
psSAR1g [W/Kg]	2.49	2.66
psSAR10g [W/Kg]	1.14	1.18
Power Drift [dB]	0.00	-0.06
Power Scaling	Disabled	Disabled
Scaling Factor [dB]		
TSL Correction	Positive Only	Positive Only
M2/M1 [%]		81.2
Dist 3dB Peak [mm]		8.5

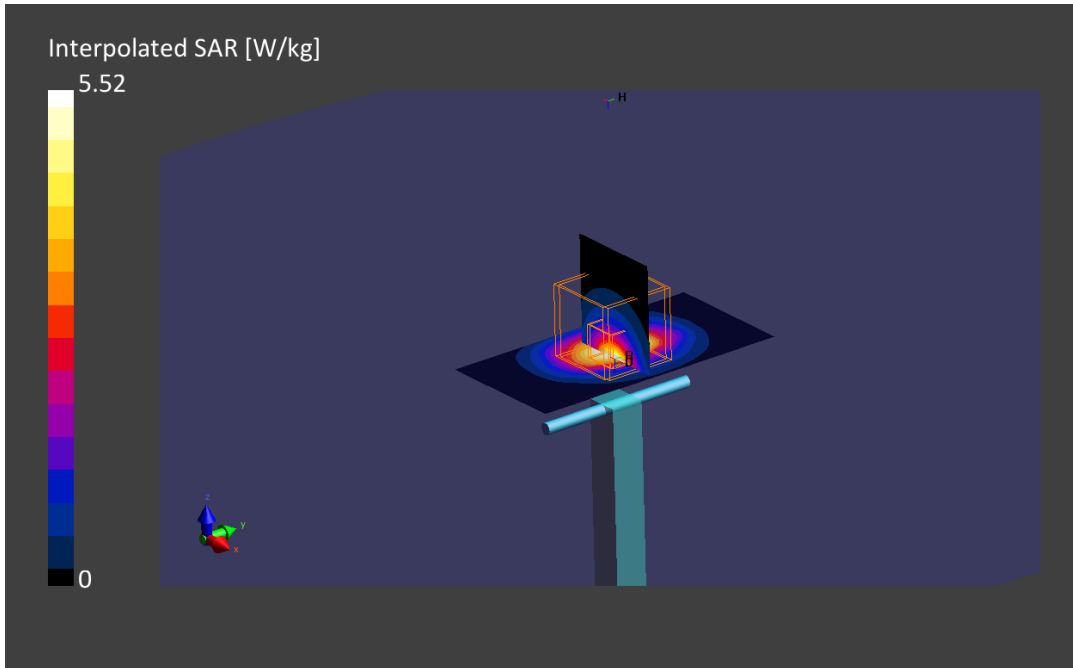

Annex D. TSL Dielectric Parameters

D.1 Body 600MHz-900MHz

Freq. (MHz)	Target		2021-09-02 Measured		2021-09-06 Measured	
	ϵ' (F/m)	σ (S/m)	ϵ'_1 (F/m)	σ_1 (S/m)	ϵ'_2 (F/m)	σ_2 (S/m)
	600	56.12	0.95	53.91	0.96	52.87
610	56.08	0.95	53.87	0.96	52.82	0.92
620	56.04	0.95	53.82	0.96	52.77	0.93
630	56.00	0.95	53.78	0.96	52.71	0.93
640	55.96	0.95	53.74	0.97	52.66	0.93
650	55.92	0.96	53.70	0.97	52.62	0.93
660	55.88	0.96	53.66	0.97	52.57	0.94
670	55.84	0.96	53.63	0.98	52.51	0.94
680	55.80	0.96	53.59	0.98	52.46	0.94
690	55.76	0.96	53.56	0.98	52.41	0.95
700	55.73	0.96	53.53	0.99	52.35	0.95
710	55.69	0.96	53.51	0.99	52.29	0.95
720	55.65	0.96	53.49	1.00	52.24	0.95
730	55.61	0.96	53.47	1.00	52.19	0.95
740	55.57	0.96	53.46	1.00	52.13	0.96
750	55.53	0.96	53.44	1.01	52.08	0.96
760	55.49	0.96	53.42	1.01	52.04	0.96
770	55.45	0.96	53.41	1.01	52.00	0.97
780	55.41	0.97	53.39	1.02	51.97	0.97
790	55.38	0.97	53.37	1.02	51.95	0.97
800	55.34	0.97	53.35	1.03	51.94	0.98
810	55.30	0.97	53.32	1.03	51.93	0.98
820	55.26	0.98	53.29	1.03	51.94	0.98
830	55.23	0.98	53.26	1.04	51.95	0.99
840	55.19	0.98	53.22	1.04	51.96	0.99
850	55.15	0.99	53.19	1.04	51.98	1.00
860	55.12	1.00	53.15	1.05	52.00	1.00
870	55.09	1.01	53.12	1.05	52.02	1.00
880	55.06	1.03	53.08	1.06	52.04	1.01
890	55.03	1.04	53.06	1.06	52.05	1.01
900	55.00	1.05	53.03	1.06	52.06	1.02

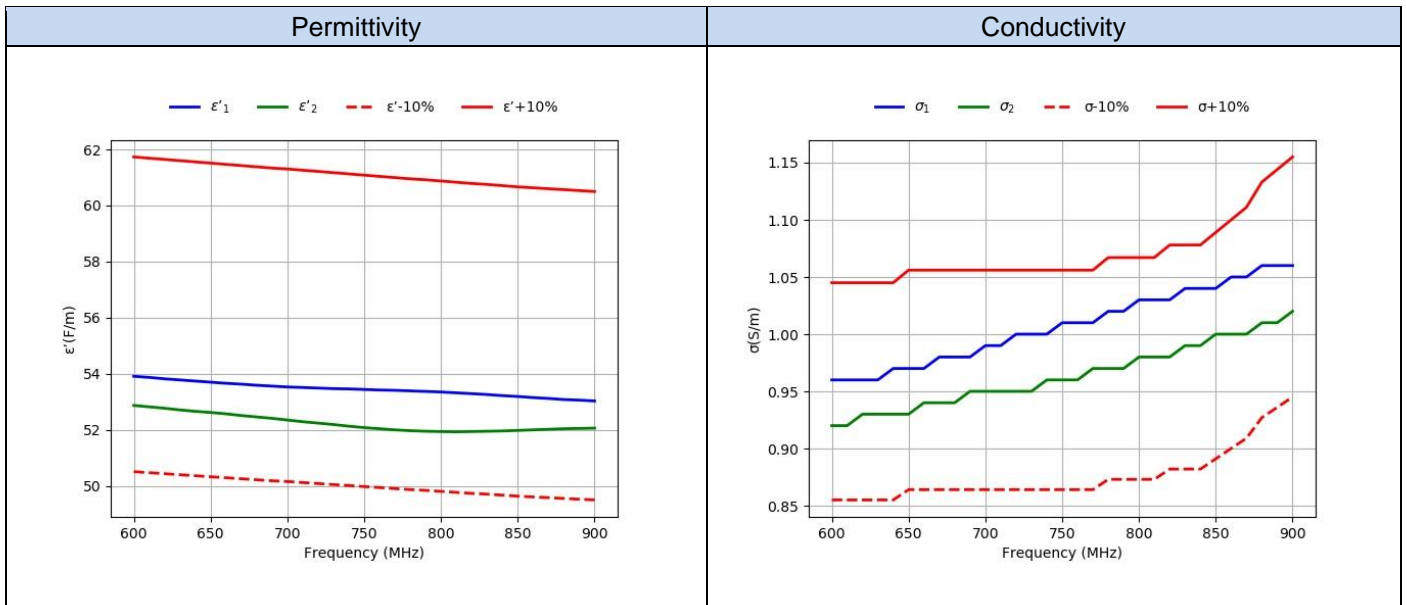

D.2 Body 1700MHz-2000MHz

Freq. (MHz)	Target		2021-09-02 Measured		2021-09-06 Measured	
	ϵ' (F/m)	σ (S/m)	ϵ'_1 (F/m)	σ_1 (S/m)	ϵ'_2 (F/m)	σ_2 (S/m)
	1700	53.56	1.46	51.37	1.47	50.99
1710	53.54	1.46	51.36	1.48	50.97	1.44
1720	53.51	1.47	51.36	1.48	50.95	1.44
1730	53.48	1.48	51.36	1.49	50.94	1.45
1740	53.46	1.48	51.37	1.50	50.94	1.45
1750	53.43	1.49	51.38	1.5	50.94	1.46
1760	53.41	1.49	51.39	1.51	50.94	1.46
1770	53.38	1.50	51.40	1.51	50.94	1.47
1780	53.35	1.51	51.41	1.52	50.95	1.47
1790	53.33	1.51	51.41	1.53	50.96	1.48
1800	53.30	1.52	51.41	1.53	50.96	1.48
1810	53.30	1.52	51.41	1.54	50.96	1.49
1820	53.30	1.52	51.40	1.55	50.96	1.49
1830	53.30	1.52	51.39	1.55	50.95	1.50
1840	53.30	1.52	51.38	1.56	50.94	1.50
1850	53.30	1.52	51.37	1.57	50.93	1.51
1860	53.30	1.52	51.37	1.57	50.91	1.52
1870	53.30	1.52	51.38	1.58	50.90	1.52
1880	53.30	1.52	51.38	1.59	50.88	1.53
1890	53.30	1.52	51.40	1.59	50.86	1.54
1900	53.30	1.52	51.41	1.60	50.84	1.55
1910	53.30	1.52	51.42	1.61	50.83	1.55
1920	53.30	1.52	51.42	1.61	50.81	1.56
1930	53.30	1.52	51.41	1.62	50.80	1.57
1940	53.30	1.52	51.40	1.62	50.78	1.58
1950	53.30	1.52	51.39	1.63	50.76	1.59
1960	53.30	1.52	51.37	1.64	50.73	1.60
1970	53.30	1.52	51.36	1.64	50.71	1.61
1980	53.30	1.52	51.35	1.65	50.70	1.62
1990	53.30	1.52	51.34	1.65	50.68	1.63
2000	53.30	1.52	51.32	1.66	50.68	1.64

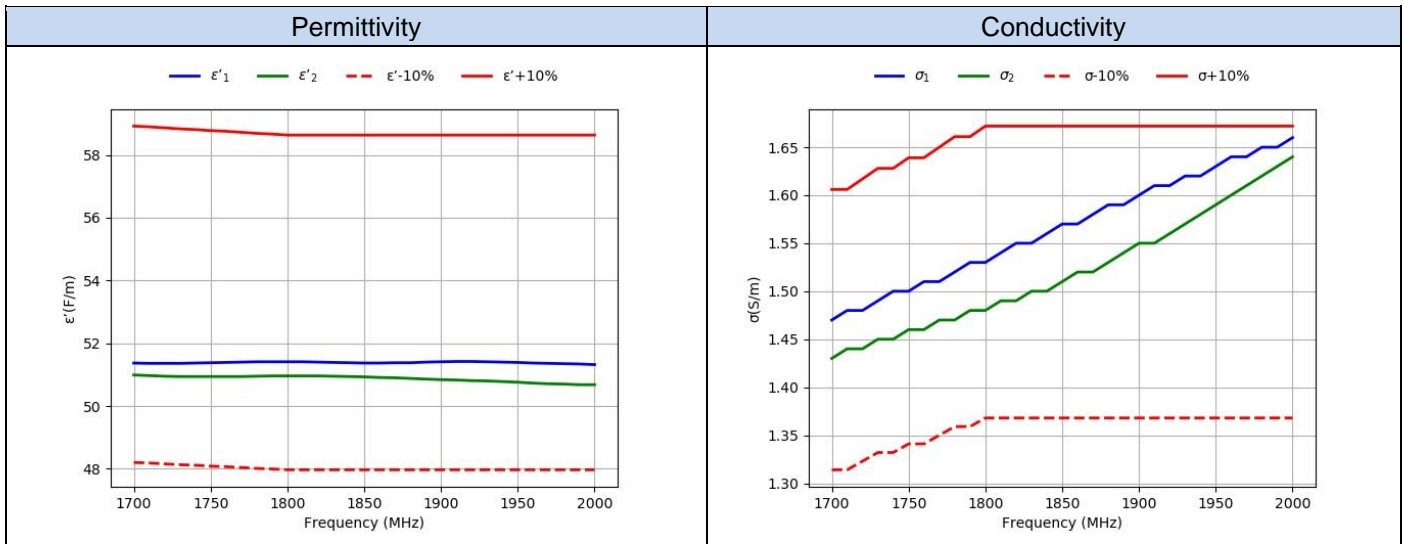

D.3 Body 2300MHz-2700MHz

Freq.(MHz)	Target		2021-09-02		2021-09-06	
			Measured		Measured	
	e' (F/m)	s (S/m)	e'1 (F/m)	s1 (S/m)	e'1 (F/m)	s1 (S/m)
2300	52.90	1.81	50.84	1.88	50.25	1.86
2310	52.89	1.82	50.83	1.89	50.24	1.87
2320	52.87	1.83	50.82	1.90	50.23	1.88
2330	52.86	1.84	50.82	1.90	50.22	1.89
2340	52.85	1.84	50.81	1.91	50.21	1.89
2350	52.83	1.85	50.81	1.92	50.21	1.90
2360	52.82	1.86	50.80	1.93	50.20	1.91
2370	52.81	1.87	50.79	1.93	50.20	1.92
2380	52.79	1.88	50.78	1.94	50.20	1.92
2390	52.78	1.89	50.77	1.95	50.19	1.93
2400	52.77	1.90	50.76	1.96	50.19	1.94
2410	52.75	1.91	50.76	1.97	50.18	1.95
2420	52.74	1.92	50.75	1.97	50.17	1.95
2430	52.73	1.93	50.74	1.98	50.16	1.96
2440	52.71	1.94	50.73	1.99	50.14	1.97
2450	52.70	1.95	50.73	2.00	50.11	1.98
2460	52.69	1.96	50.72	2.01	50.08	1.99
2470	52.67	1.98	50.72	2.02	50.05	2.00
2480	52.66	1.99	50.71	2.03	50.02	2.01
2490	52.65	2.01	50.70	2.03	49.99	2.03
2500	52.64	2.02	50.69	2.04	49.96	2.04
2510	52.62	2.04	50.68	2.05	49.93	2.05
2520	52.61	2.05	50.67	2.06	49.90	2.06
2530	52.60	2.06	50.65	2.07	49.87	2.07
2540	52.59	2.08	50.64	2.08	49.85	2.09
2550	52.57	2.09	50.62	2.09	49.82	2.10
2560	52.56	2.11	50.61	2.09	49.80	2.11
2570	52.55	2.12	50.59	2.10	49.78	2.12
2580	52.53	2.13	50.57	2.11	49.76	2.13
2590	52.52	2.15	50.55	2.12	49.74	2.14
2600	52.51	2.16	50.53	2.13	49.73	2.16
2610	52.50	2.18	50.51	2.14	49.71	2.17
2620	52.48	2.19	50.49	2.15	49.69	2.18
2630	52.47	2.21	50.48	2.16	49.67	2.19
2640	52.46	2.22	50.46	2.17	49.65	2.20
2650	52.45	2.23	50.44	2.18	49.63	2.21
2660	52.43	2.25	50.43	2.19	49.61	2.22
2670	52.42	2.26	50.41	2.19	49.59	2.23
2680	52.41	2.28	50.40	2.20	49.57	2.24
2690	52.39	2.29	50.39	2.21	49.55	2.25
2700	52.38	2.30	50.37	2.22	49.53	2.26

