



TEST REPORT

TAS ALGORITHM COMPLIANCE TEST REPORT

EUT Description	Wireless Module Installed in Convertible PC
Brand Name	HP
Model Name	HSN-I46C
FCC ID	B94HNI46CKLU
Date of Test Start/End	2023-11-29 /2023-12-20
Features	LTE FDD / LTE TDD / WCDMA / ULCA
Description	Platform : HSN-I46C

Applicant	HP Inc.
Address	1501 Page Mill Road, Palo Alto CA 94304, USA
Contact Person	Sam Lin
Telephone/Fax/ Email	+886 2 37896331/sam.lin2@hp.com

Test Report identification	231006-03.TR08
Revision Control	Rev. 01 This test report revision replaces any previous test report revision

The test results relate only to the samples tested.

Reviewed by _____

Adel LOUNES
(Test Lead Engineer)

Intel Corporation S.A.S – WRF Lab
425 rue de Goa – Le Cargo B6 - 06600, Antibes, France
Tel. +33493001400 / Fax +33493001401

TABLE OF CONTENTS

1. General conditions, competences and guarantees	3
2. Environmental Conditions	3
3. Test Samples	3
4. EUT Features	4
5. Remarks and comments	5
6. Document Revision History	5
Annex A. Test Setup Description	6
A.1 MEASUREMENT SYSTEM.....	6
A.2 EQUIPMENTS LIST	7
Annex B. Test Results	8
B.1 SUMMARY OF TEST CASES	8
B.2 BANDS VALIDATION - LTE.....	9
B.3 BANDS VALIDATION - WCDMA	16
B.4 TIME VARYING TEST SEQUENCE - LTE.....	19
B.5 TIME VARYING TEST SEQUENCE - WCDMA	21
B.6 HANDOVER - LTE-LTE.....	23
B.7 HANDOVER - LTE-WCDMA	24

1. General conditions, competences and guarantees

- ✓ Intel WRF Lab only provides testing services and is committed to providing reliable, unbiased test results and interpretations.
- ✓ Intel WRF Lab is liable to the client for the maintenance of the confidentiality of all information related to the item under test and the results of the test.
- ✓ Intel WRF Lab has developed calibration and proficiency programs for its measurement equipment to ensure correlated and reliable results to its customers.
- ✓ This report is only referred to the item that has undergone the test.
- ✓ This report does not imply an approval of the product by the Certification Bodies or competent Authorities.

2. Environmental Conditions

- ✓ At the site where the measurements were performed the following limits were not exceeded during the tests:

Temperature	22.2+/-1.6 C
Humidity	35.7+/-17.4 %

3. Test Samples

Sample	ID	Description	Model	Serial	Note
#1	231006-03.S07	Convertible PC with FM350-GL-16 Module Embeded	HSN-I46C	0003770971	-

4. EUT Features

The herein information is provided by the customer.

Intel WRF Lab declines any responsibility for the accuracy of the stated customer provided information, especially if it has any impact on the correctness of test results presented in this report.

Brand Name	Fibocom
Model Name	FM350-GL-16
Firmware	11600.0000.00.29.22.10 v1.0.0
Prototype / Production	Production
Host Identification	HSN-I46C

Supported radios

WWAN: The module is a data only DUT. The applicable frequency bands and operating modes are identified in the following table.

Mode	Bands	Supported Tx Mode			
		RMC	HSDPA	HSUPA	DC-HSDPA
WCDMA / HSPA+	FDD II (1850.0 – 1910.0 MHz)	✓	✓	✓	✓
	FDD IV (1710.0 – 1755.0 MHz)	✓	✓	✓	✓
	FDD V (824.0 – 849.0 MHz)	✓	✓	✓	✓

FDD/TDD	Bands	Modulations	Bandwidth					
			1.4	3	5	10	15	20
LTE FDD	Band 2 (1850.0 – 1910.0 MHz)	QPSK/16QAM/64QAM/256QAM	✓	✓	✓	✓	✓	✓
	Band 4 (1710.0 – 1755.0 MHz)	QPSK/16QAM/64QAM/256QAM	✓	✓	✓	✓	✓	✓
	Band 5 (824.0 – 849.0 MHz)	QPSK/16QAM/64QAM/256QAM	✓	✓	✓	✓		
	Band 7 (2500.0 – 2570.0 MHz)	QPSK/16QAM/64QAM/256QAM			✓	✓	✓	✓
	Band 12 (699.0 – 716.0 MHz)	QPSK/16QAM/64QAM/256QAM	✓	✓	✓	✓		
	Band 13 (777.0 – 787.0 MHz)	QPSK/16QAM/64QAM/256QAM			✓	✓		
	Band 14 (788.0 – 798.0 MHz)	QPSK/16QAM/64QAM/256QAM			✓	✓		
	Band 17 (704.0 – 716.0 MHz)	QPSK/16QAM/64QAM/256QAM			✓	✓		
	Band 25 (1850.0 – 1915.0 MHz)	QPSK/16QAM/64QAM/256QAM	✓	✓	✓	✓	✓	✓
	Band 26 (814.0 – 849.0 MHz)	QPSK/16QAM/64QAM/256QAM	✓	✓	✓	✓	✓	
	Band 30 (2305.0 – 2315.0 MHz)	QPSK/16QAM/64QAM/256QAM			✓	✓		
LTE TDD	Band 66 (1710.0 – 1780.0 MHz)	QPSK/16QAM/64QAM/256QAM	✓	✓	✓	✓	✓	✓
	Band 71 (663.0 – 698.0 MHz)	QPSK/16QAM/64QAM/256QAM			✓	✓	✓	✓
	Band 38 (2570.0 – 2620.0 MHz)	QPSK/16QAM/64QAM/256QAM			✓	✓	✓	✓
	Band 41 (2496.0 – 2690.0 MHz)	QPSK/16QAM/64QAM/256QAM			✓	✓	✓	✓
	Band 48 (3550.0 – 3700.0 MHz)	QPSK/16QAM/64QAM/256QAM			✓	✓	✓	✓

5. Remarks and comments

1. The test report is a validation of the FCC TAS algorithm

6. Document Revision History

Revision #	Date	Modified by	Revision Details
Rev.00	2023-12-22	Tanguy MATHIEU	First Issue
Rev.01	2024-01-10	Tanguy MATHIEU	Front page information updated upon customer request

Annex A. Test Setup Description

A.1 Measurement System

The conducted power measurement test setup is described in the following and illustrated in Figure 1

- The DUT is a Fibocom M2 FM350-GL-16 Cellular Modem installed inside HP model HSN-I46C Convertible PC.
- The control PC is used to configure the call box to send power control test sequences to the FM350-GL-16
- Uplink signal power is monitored by the spectrum analyzer and recorded by the PC with a time resolution of 25 msec which is substantially less than the power adjustment interval (Avg_SAR_Check_Period) of 0.05 sec used for FM350-GL-16 .
- The values of Avg_SAR_Power are read from the FM350-GL-16 by the PC at each Avg_SAR_Check_Period
- In addition to power results, the time sequence of power control commands and power samples are also recorded by the PC to enable results to be correlated and plotted. Uplink signal from the FM350-GL-16 is fed through a 3 dB power splitter, which delivers an equal amount of signal to the spectrum analyser and the call box. The splitter has high isolation between the spectrum analyser and the call box. Due to different uplink/downlink frequencies and the zero span time-domain measurement used, interference of uplink and downlink signals are avoided.
- Path loss in the power measurement setup from the FM350-GL-16 main antenna port to either the call box or the spectrum analyser is taken into account

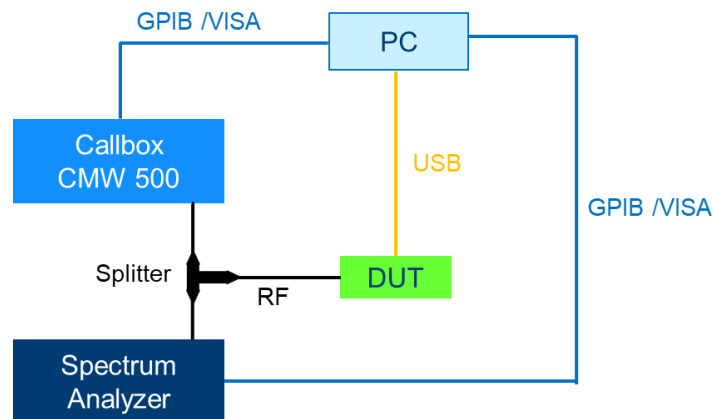

Figure 1 - Test Setup

A.2 Equipments List

The equipments used for the conducted power measurement test setup are listed in Table below.

ID#	Device	Type/Model	Serial #	Manufacturer	Cal. Date	Cal. Due Date
025-005	Communication Tester	CMW500	161493	Rohde & Schwarz	N/A	N/A
265-000	Spectrum Analyzer	FSV30	101318	Rohde & Schwarz	2023-03-29	2025-03-29
455-001	RF Cable	-	-	-	2023-02-23	2024-02-23
455-002	RF Cable	-	-	-	2023-02-23	2024-02-23
455-003	RF Splitter	-	-	-	2023-02-23	2024-02-23

Annex B. Test Results

B.1 Summary of Test Cases

The following table lists the types of TAS algorithm validation tests performed and the corresponding Tables describing the test configurations and validation results.

Validation type	RAT	Configurations	Results	Verdict
Bands Compliance	LTE	Table 1	Section B.2	Pass
Bands Compliance	WCDMA	Table 2	Section B.3	Pass
Time Varying Test Sequence	LTE	Table 3	Section B.4	Pass
Time Varying Test Sequence	WCDMA	Table 4	Section B.5	Pass
Handover	LTE-LTE	Table 5	Section B.6	Pass
Handover	LTE-WCDMA	Table 6	Section B.7	Pass

B.2 Bands Validation - LTE*Table 1 - Test Cases for Bands Compliance of LTE bands*

Case	Band	Max Power DPR OFF [dBm]	Roll Period [s]	Check Period [s]	TAS Upper Threshold [dBm]	TAS Lower Threshold [dBm]	Max Power DPR ON [dBm]
1	5	24.0	100	0.05	20.5	19.5	18.5
2	7	24.0	100	0.05	14.0	13.0	12.0
3	12	24.0	100	0.05	19.5	18.5	17.5
4	13	24.0	100	0.05	19.5	18.5	17.5
5	14	24.0	100	0.05	19.5	18.5	17.5
6	25	24.0	100	0.05	16.5	15.5	14.5
7	26	24.0	100	0.05	20.0	19.0	18.0
8	30	23.0	100	0.05	17.0	16.0	15.0
9	41	24.0	100	0.05	16.0	15.0	14.0
10	48	21.0	100	0.05	15.0	14.0	13.0
11	66	24.0	100	0.05	19.0	18.0	17.0
12	71	24.0	100	0.05	20.0	19.0	18.0

Note: The Average power is calculated using the measured instantaneous power and compared to the UpperThreshold Plus Tune-Up Tolerance. This is applied for all the test cases in this report.

Case #1: LTE Band 5 – Max Power 24 dBm – Roll Period 100 sec – Check Period 0.05 sec		
Avg_SAR_UppThresh [dBm]	Avg_SAR_LowThresh [dBm]	Max_Power_DPR_ON [dBm]
20.5	19.5	18.5

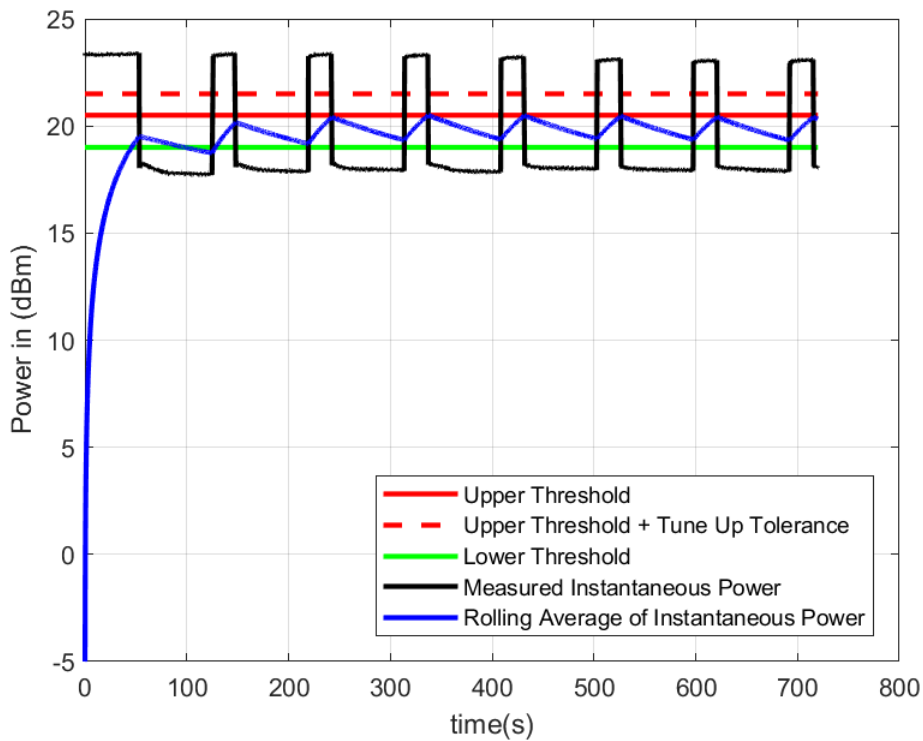

Case #2: LTE Band 7 – Max Power 24 dBm – Roll Period 100 sec – Check Period 0.05 sec		
Avg_SAR_UppThresh [dBm]	Avg_SAR_LowThresh [dBm]	Max_Power_DPR_ON [dBm]
14	13	12

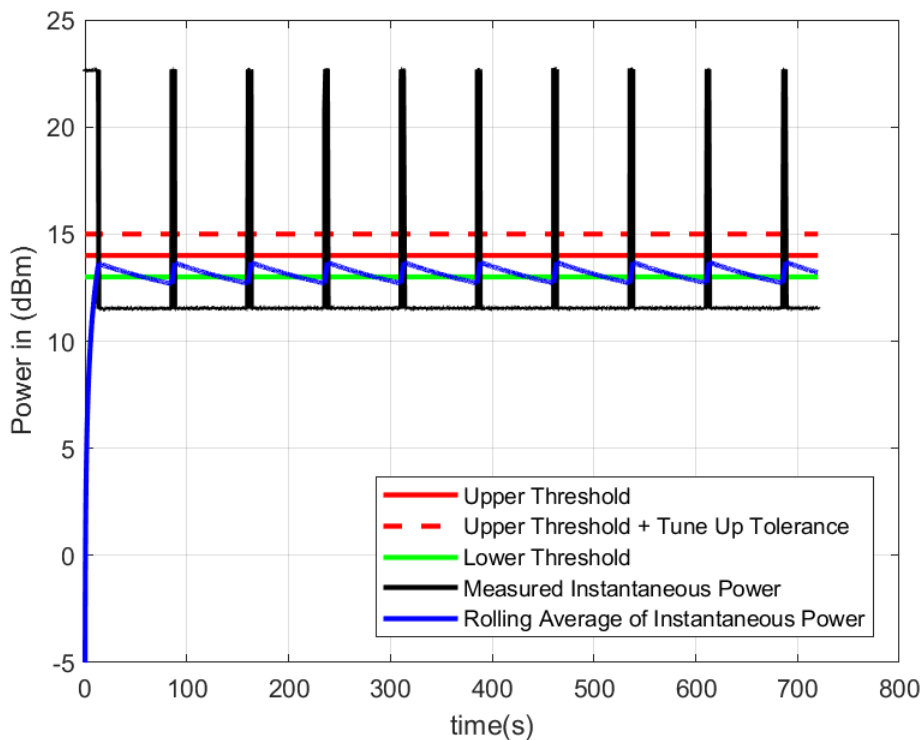

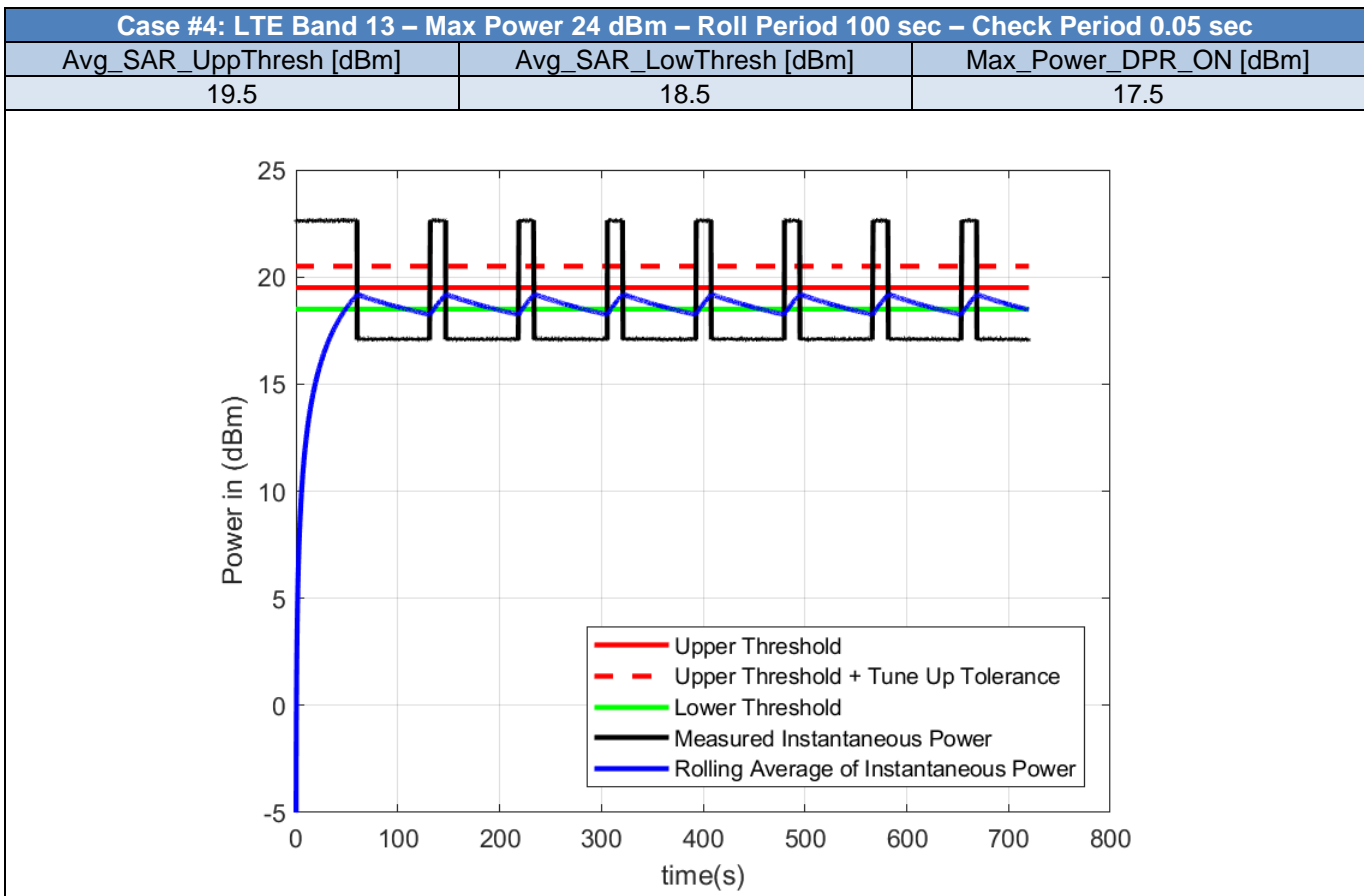
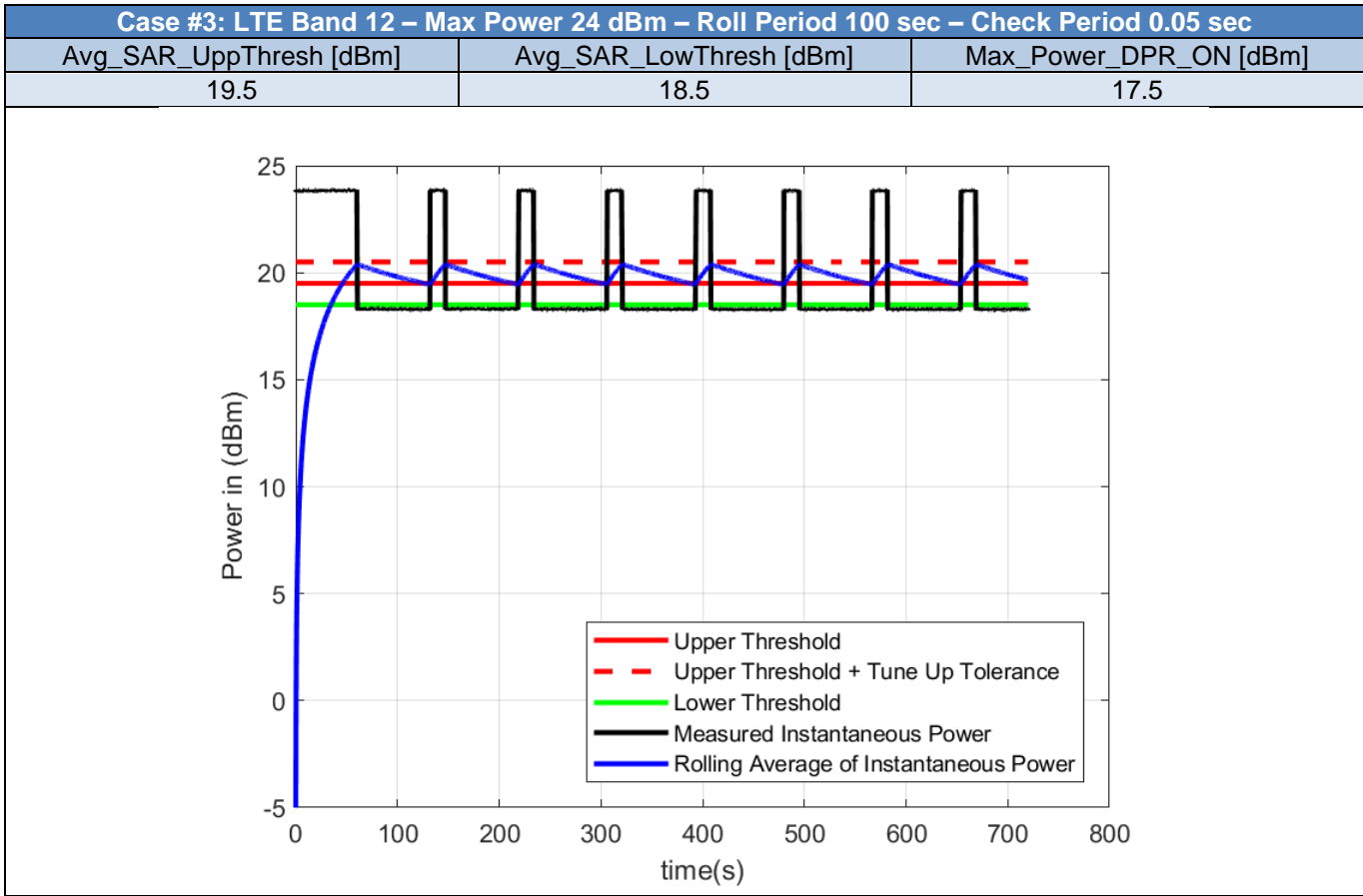

Case #5: LTE Band 14 – Max Power 24 dBm – Roll Period 100 sec – Check Period 0.05 sec		
Avg_SAR_UppThresh [dBm]	Avg_SAR_LowThresh [dBm]	Max_Power_DPR_ON [dBm]
19.5	18.5	17.5

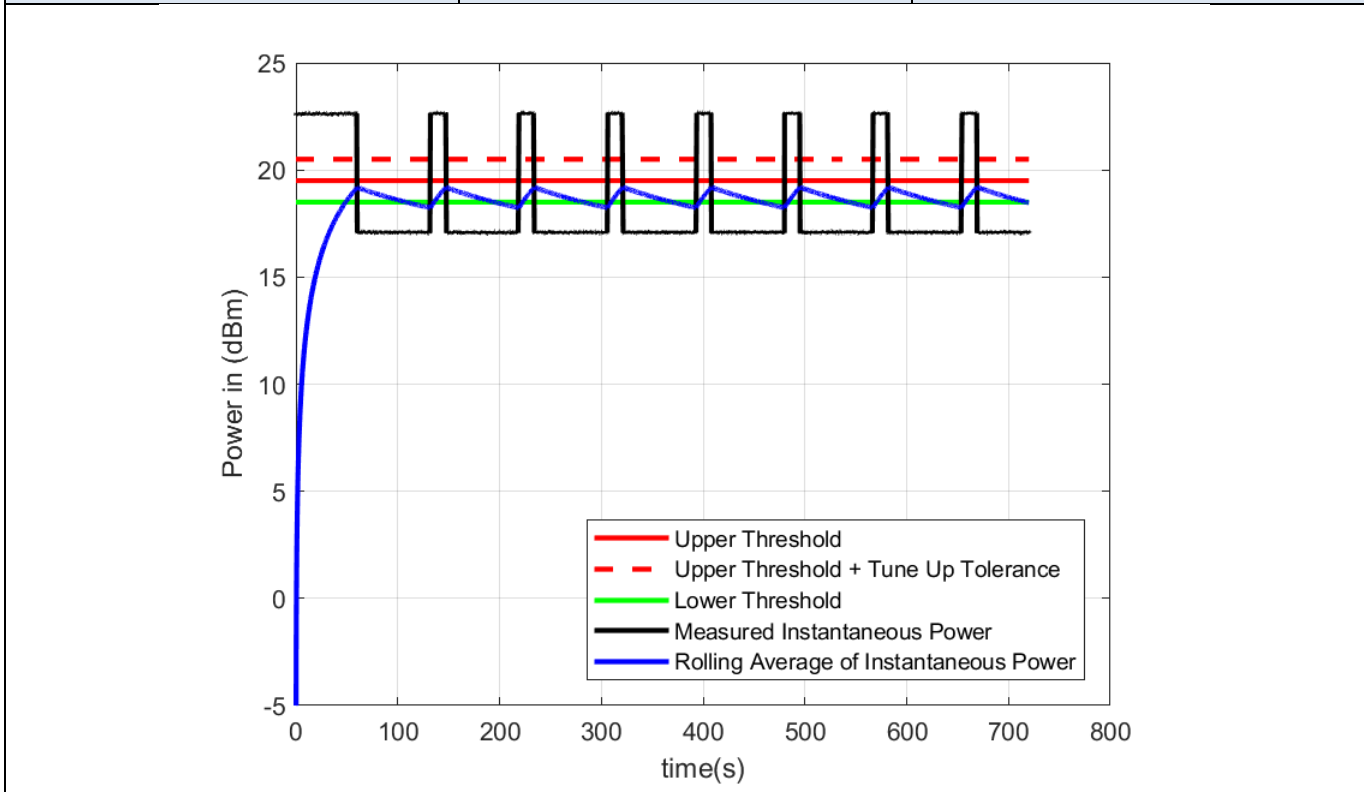

Case #6: LTE Band 25 – Max Power 24 dBm – Roll Period 100 sec – Check Period 0.05 sec		
Avg_SAR_UppThresh [dBm]	Avg_SAR_LowThresh [dBm]	Max_Power_DPR_ON [dBm]
16.5	15.5	14.5

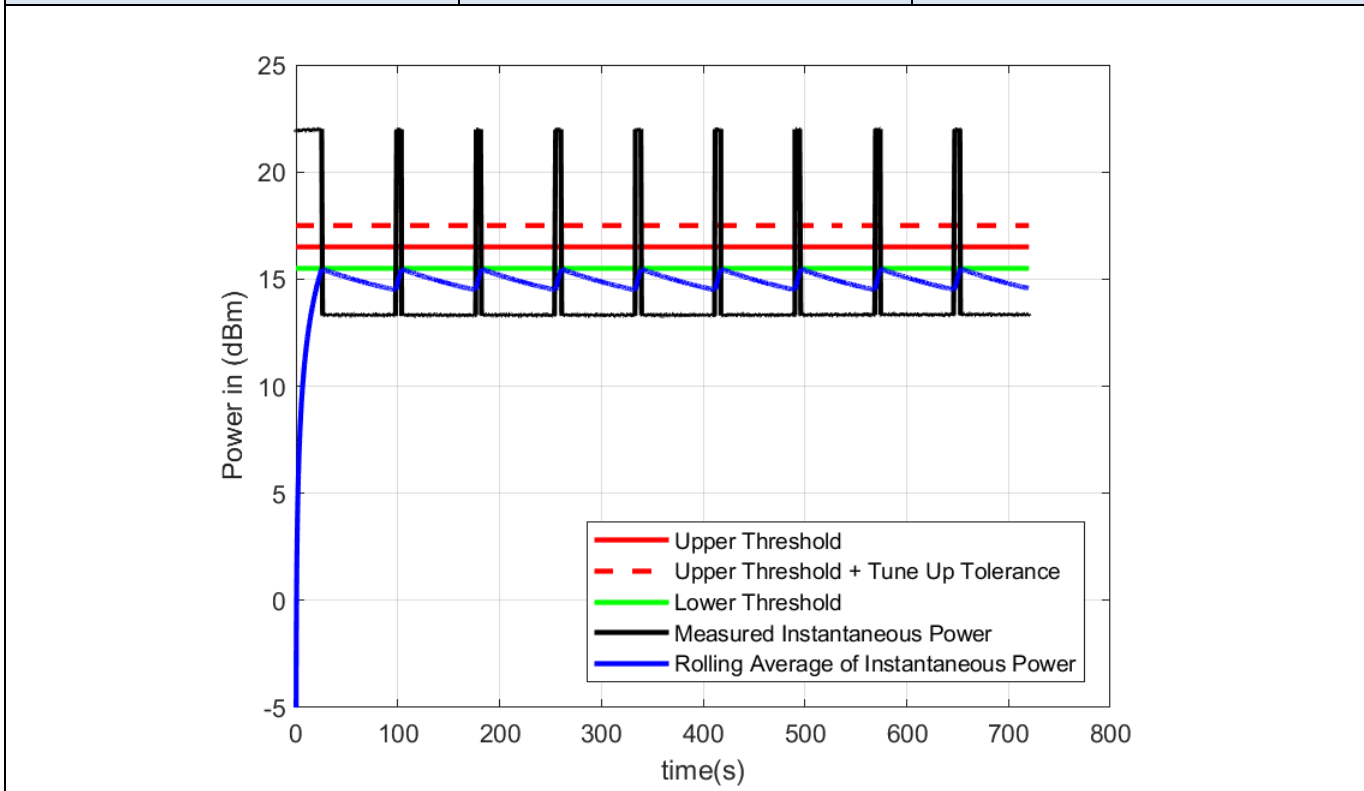

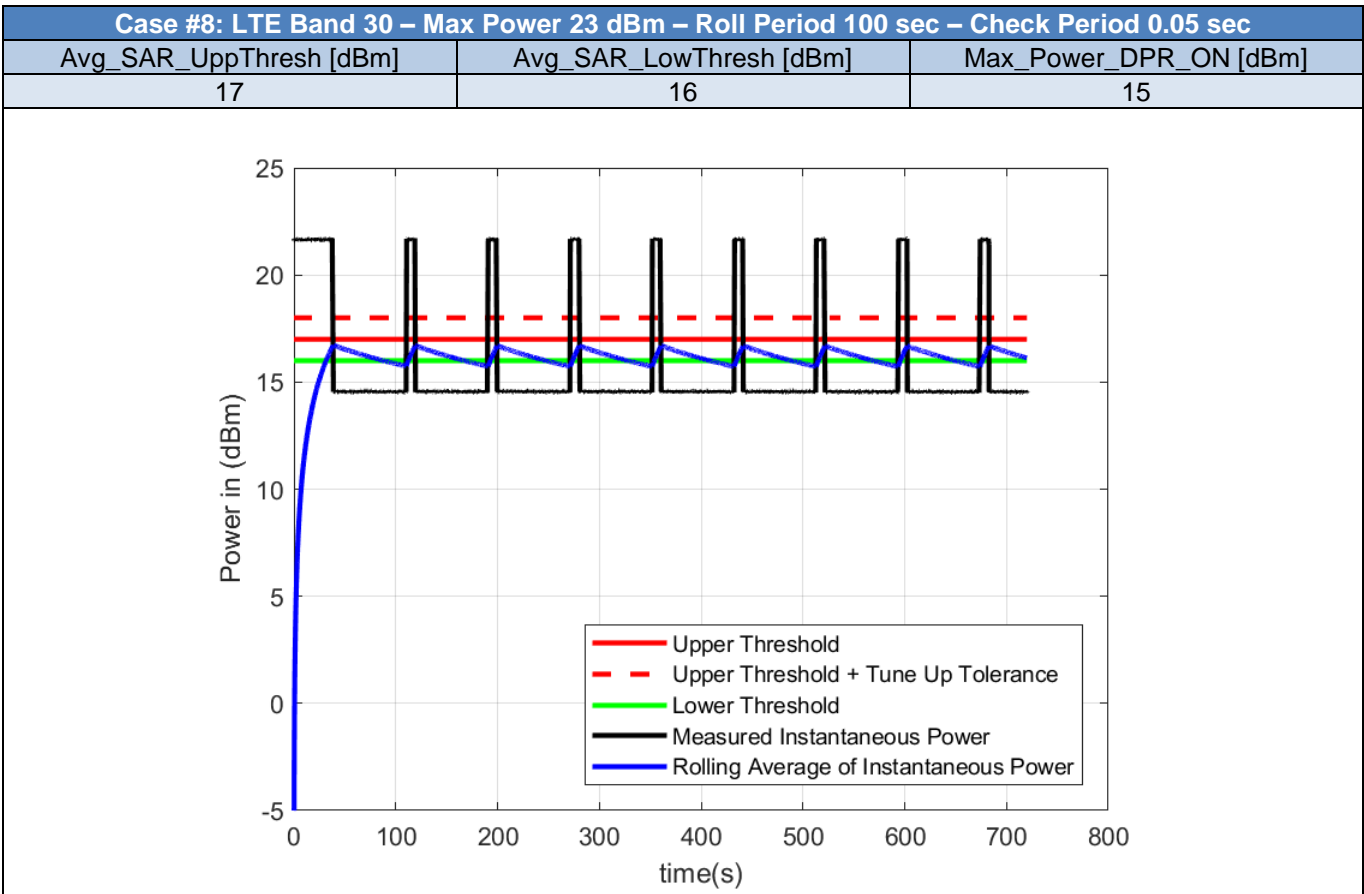
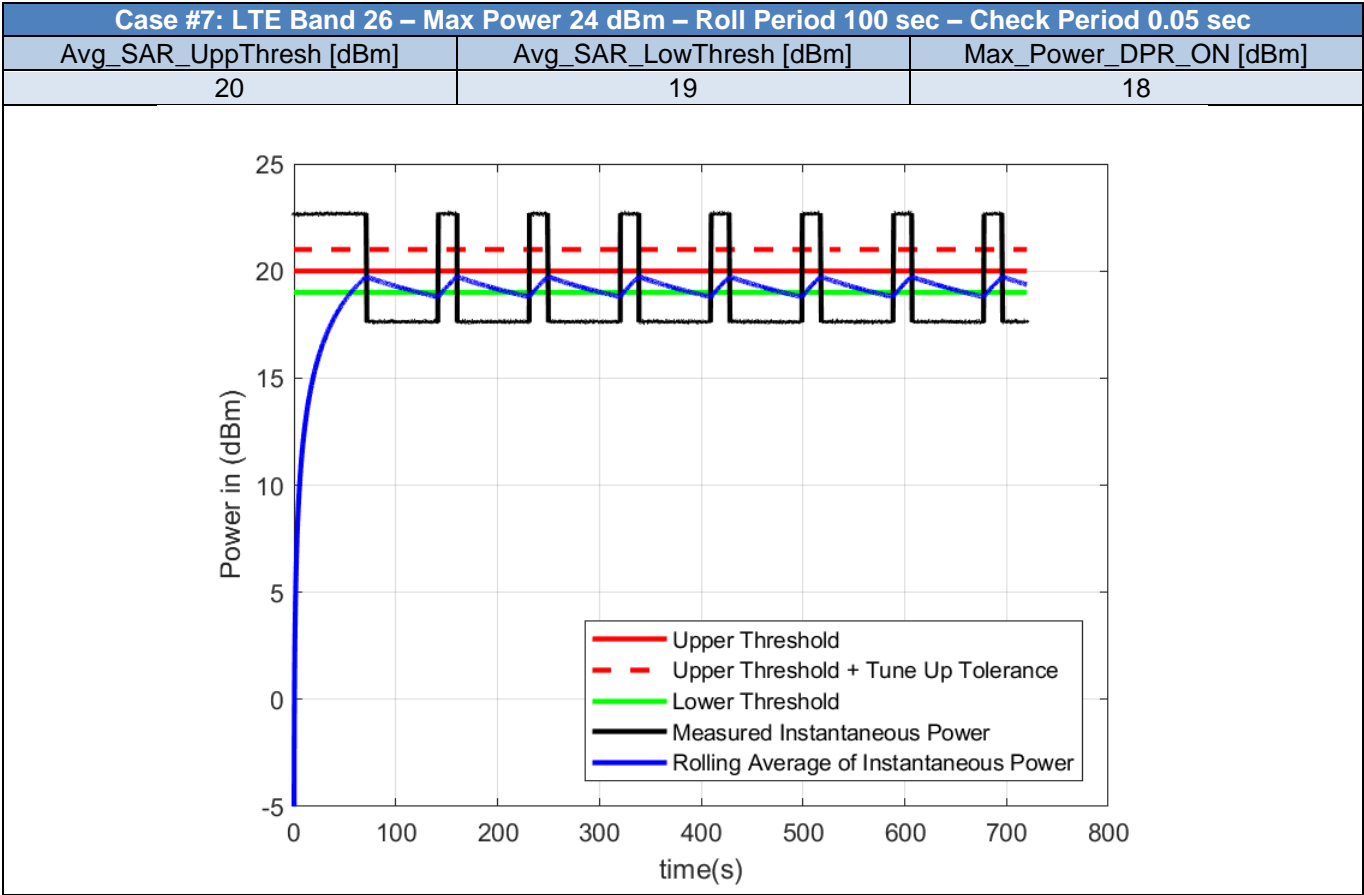

Case #9: LTE Band 41 – Max Power 24 dBm – Roll Period 100 sec – Check Period 0.05 sec		
Avg_SAR_UppThresh [dBm]	Avg_SAR_LowThresh [dBm]	Max_Power_DPR_ON [dBm]
16	15	14

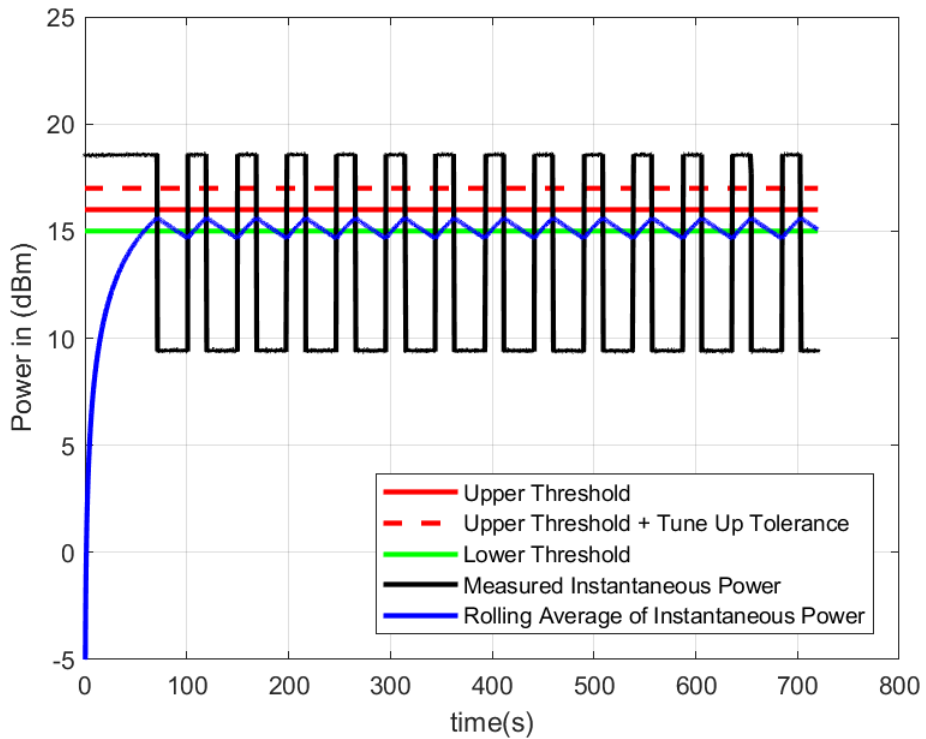

Case #10: LTE Band 48 – Max Power 21 dBm – Roll Period 100 sec – Check Period 0.05 sec		
Avg_SAR_UppThresh [dBm]	Avg_SAR_LowThresh [dBm]	Max_Power_DPR_ON [dBm]
15	14	13

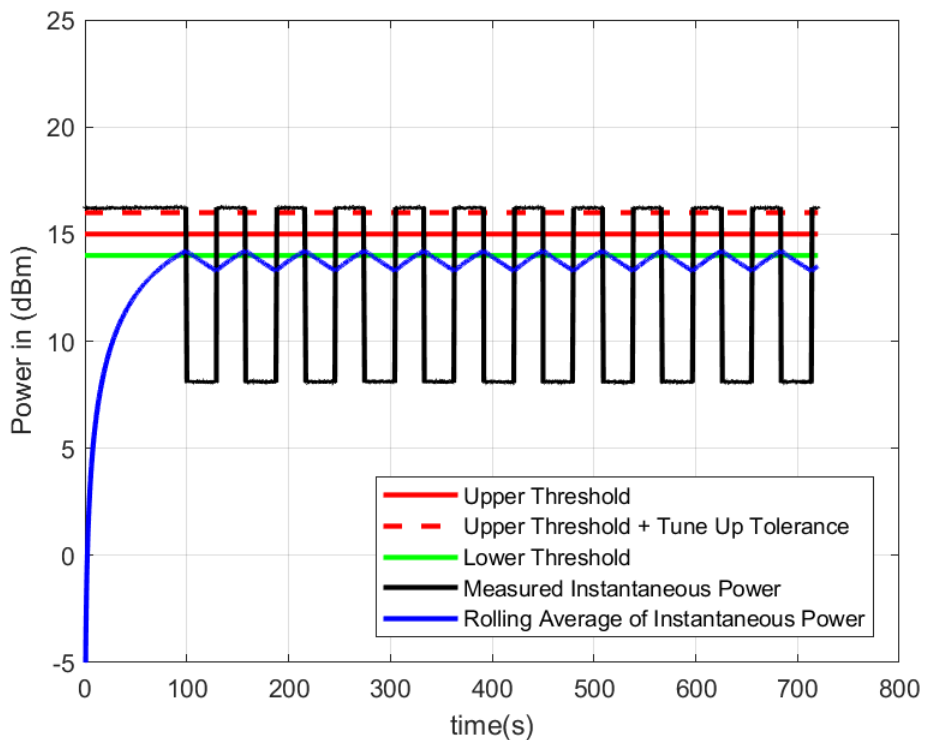

Case #11: LTE Band 66 – Max Power 24 dBm – Roll Period 100 sec – Check Period 0.05 sec		
Avg_SAR_UppThresh [dBm]	Avg_SAR_LowThresh [dBm]	Max_Power_DPR_ON [dBm]
19	18	17

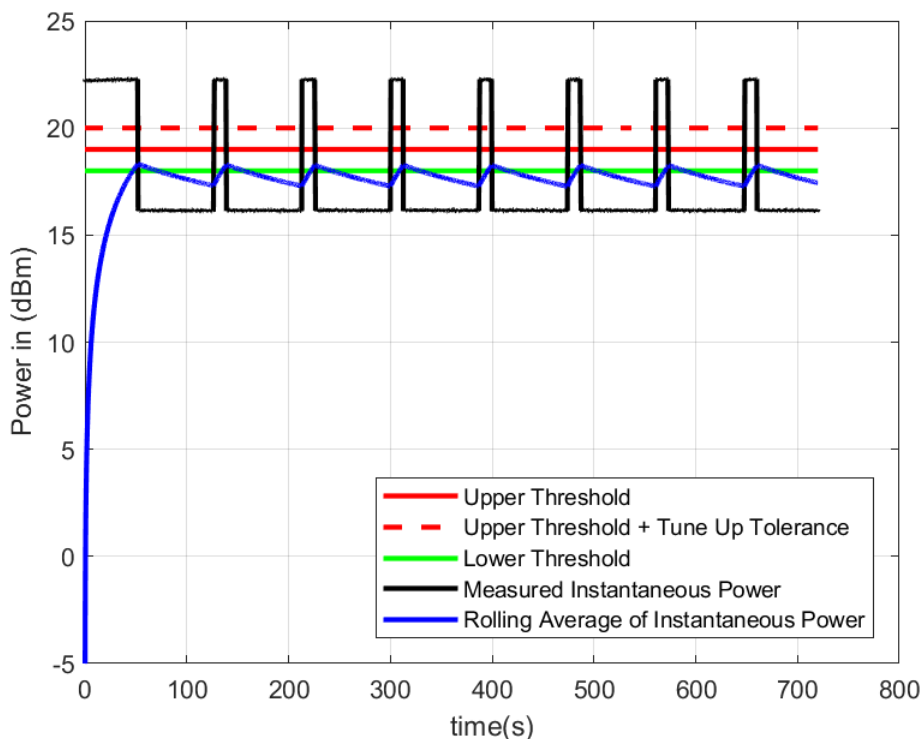

Case #12: LTE Band 71 – Max Power 24 dBm – Roll Period 100 sec – Check Period 0.05 sec		
Avg_SAR_UppThresh [dBm]	Avg_SAR_LowThresh [dBm]	Max_Power_DPR_ON [dBm]
20	19	18

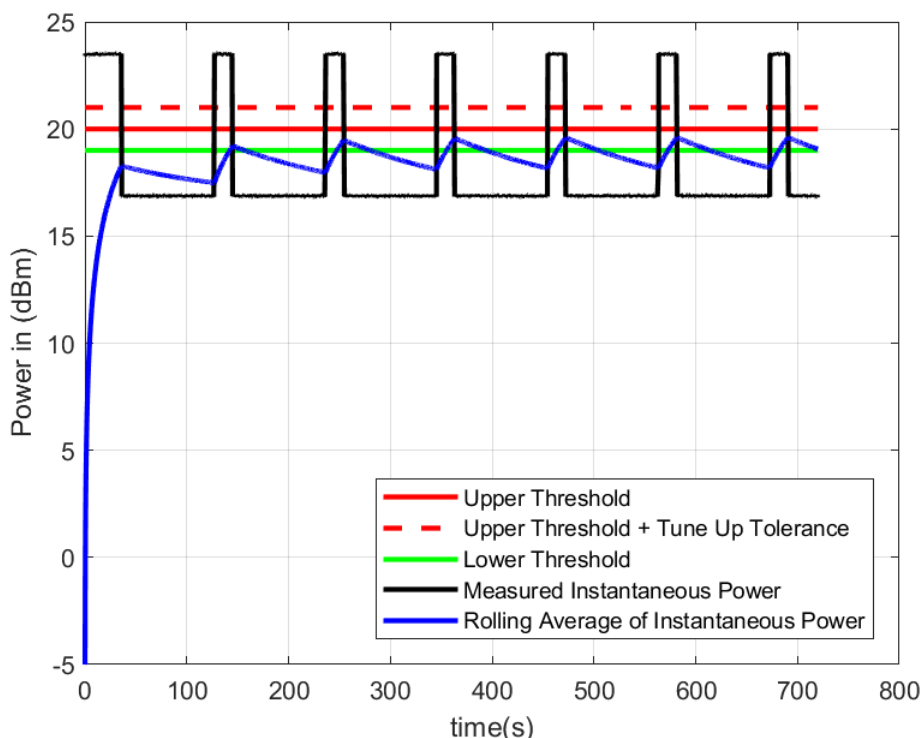

B.3 Bands Validation - WCDMA*Table 2 - Test Cases for Bands Compliance of WCDMA bands*

Case	Band	Max Power DPR OFF [dBm]	Roll Period [s]	Check Period [s]	TAS Upper Threshold [dBm]	TAS Lower Threshold [dBm]	Max Power DPR ON [dBm]
13	2	24.5	100	0.05	16.5	15.5	14.5
14	4	24.5	100	0.05	19.0	18.0	17.0
15	5	24.5	100	0.05	20.5	19.5	18.5

Note: The Average power is calculated using the measured instantaneous power and compared to the UpperThreshold Plus Tune-Up Tolerance. This is applied for all the test cases in this report.

Case #13: WCDMA Band 2 – Max Power 24.5 dBm – Roll Period 100 sec – Check Period 0.05 sec		
Avg_SAR_UppThresh [dBm]	Avg_SAR_LowThresh [dBm]	Max_Power_DPR_ON [dBm]
16.5	15.5	14.5

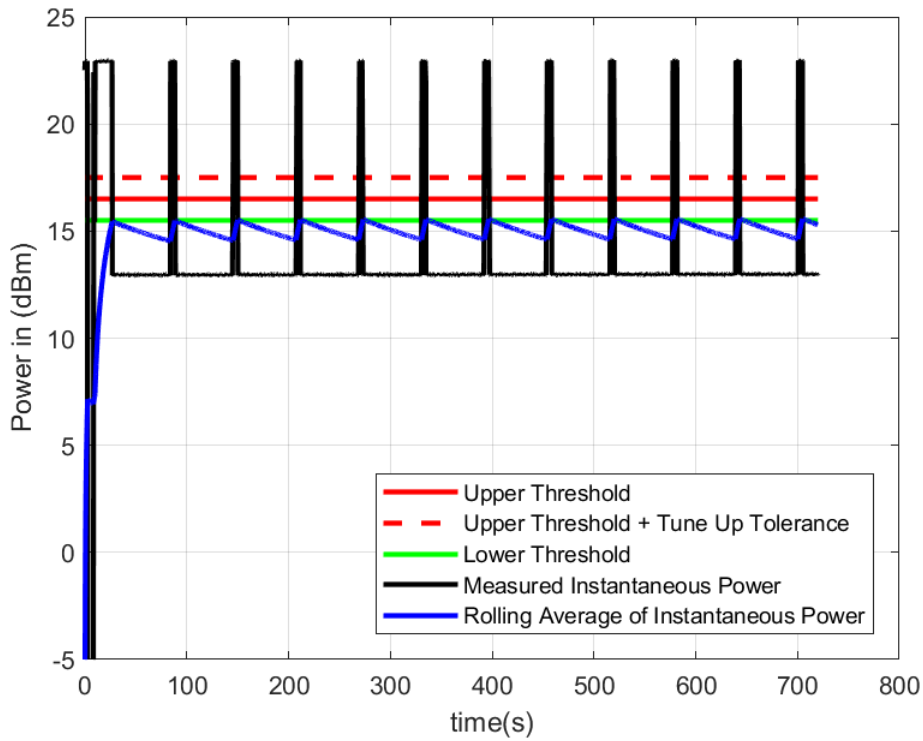

Case #14: WCDMA Band 4 – Max Power 24.5 dBm – Roll Period 100 sec – Check Period 0.05 sec		
Avg_SAR_UppThresh [dBm]	Avg_SAR_LowThresh [dBm]	Max_Power_DPR_ON [dBm]
19	18	17

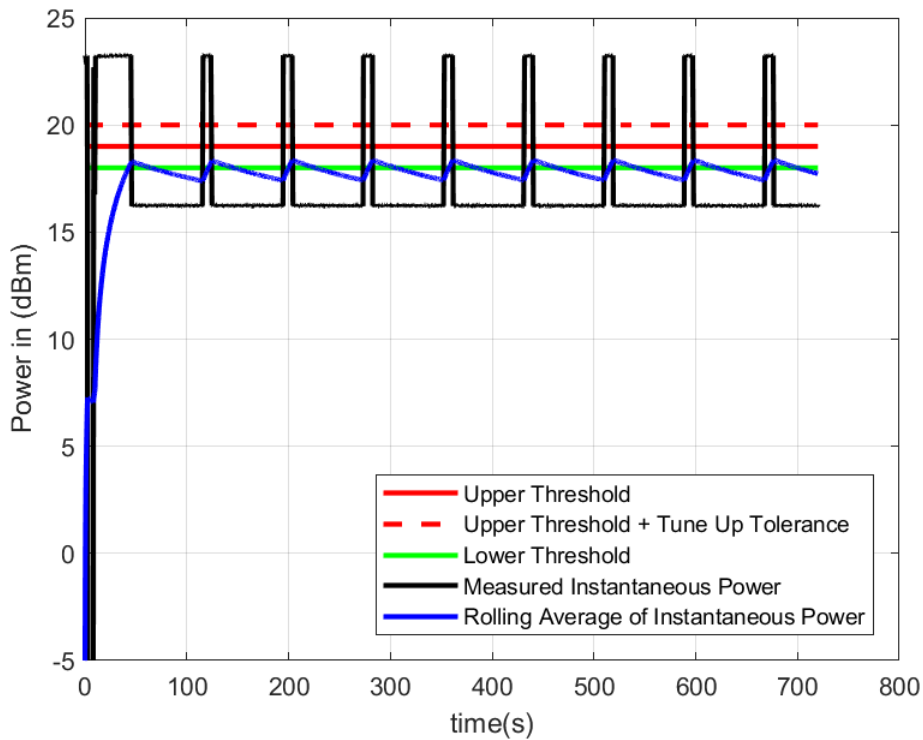

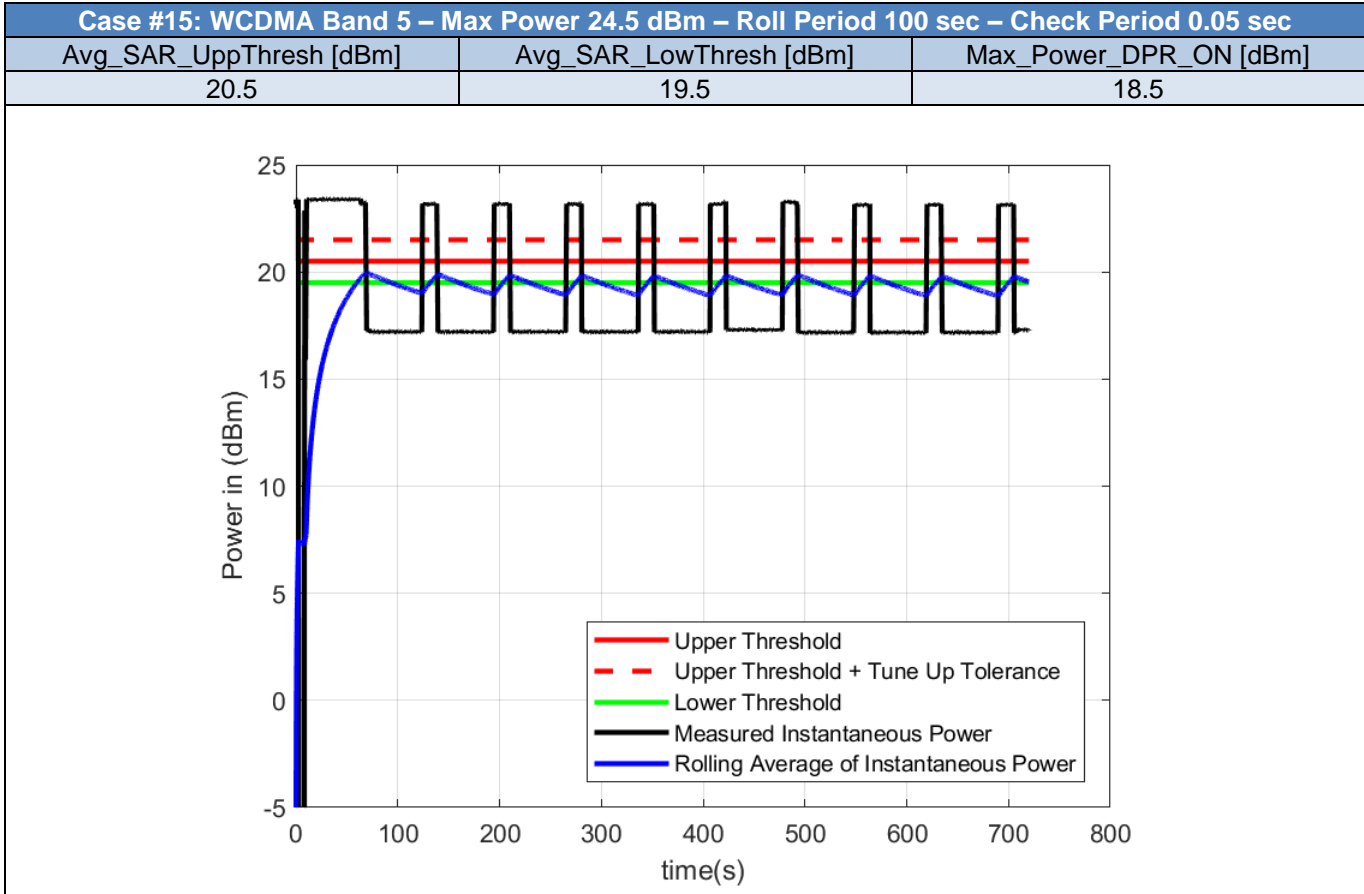

B.4 Time Varying Test Sequence - LTE

Table 3 - Test Cases for Time Varying Test Sequence of LTE bands

Case	RAT	Band	Max_Power_ DPR_OFF	Roll_Period	Check_Perio d	Avg_SAR_Up pThresh	Avg_SAR_Lo wThresh	Max_Power_ DPR_ON
1 & 2	LTE	2	24.0	100	0.05	16.5	15.5	14.5

Note: The Average power is calculated using the measured instantaneous power and compared to the UpperThreshold Plus Tune-Up Tolerance. This is applied for all the test cases in this report.

Case #1: Sequence 1 - LTE Band 2 – Max Power 24 dBm – Roll Period 100 sec – Check Period 0.05 sec

Avg_SAR_UppThresh [dBm]	Avg_SAR_LowThresh [dBm]	Max_Power_DPR_ON [dBm]
16.5	15.5	14.5

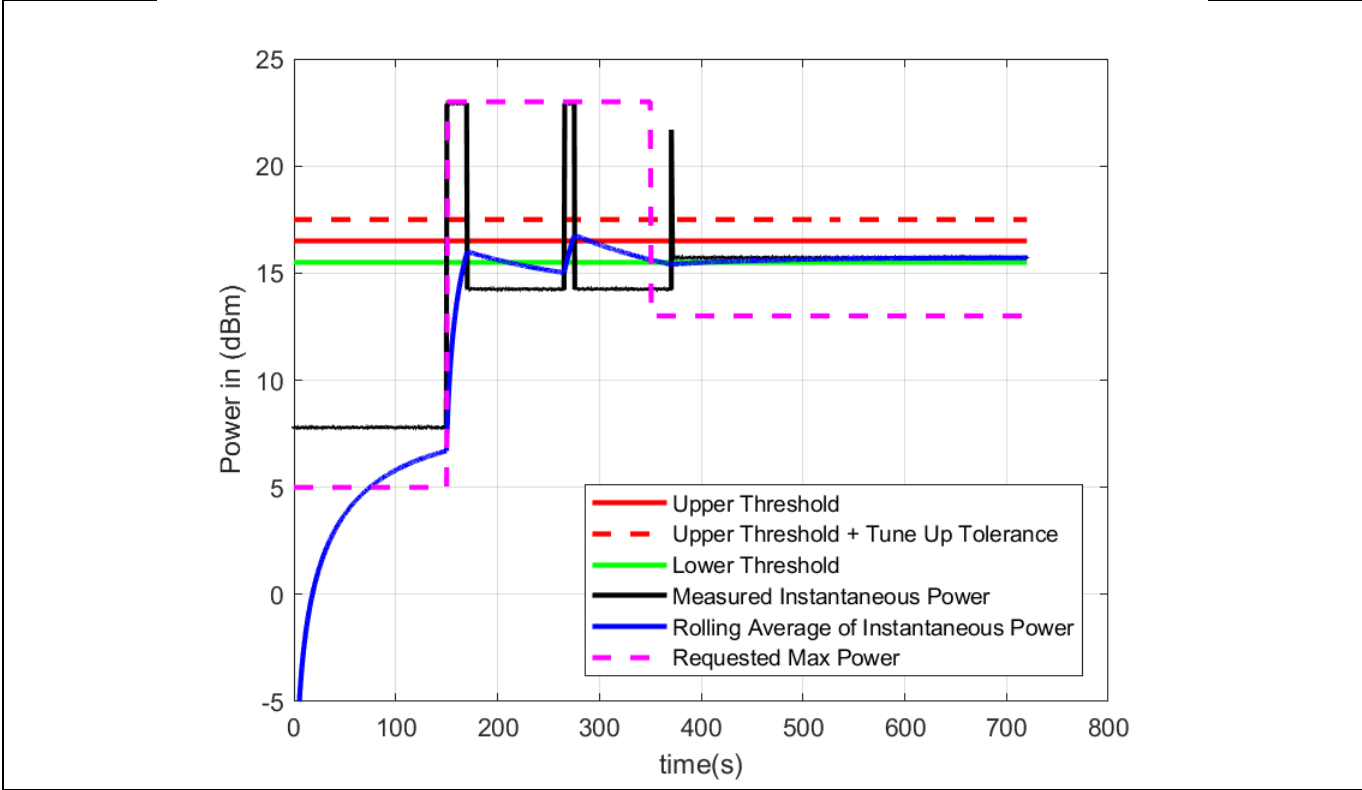

Case #2: Sequence 2 - LTE Band 2 – Max Power 24 dBm – Roll Period 100 sec – Check Period 0.05 sec

Avg_SAR_UppThresh [dBm]	Avg_SAR_LowThresh [dBm]	Max_Power_DPR_ON [dBm]
16.5	15.5	14.5

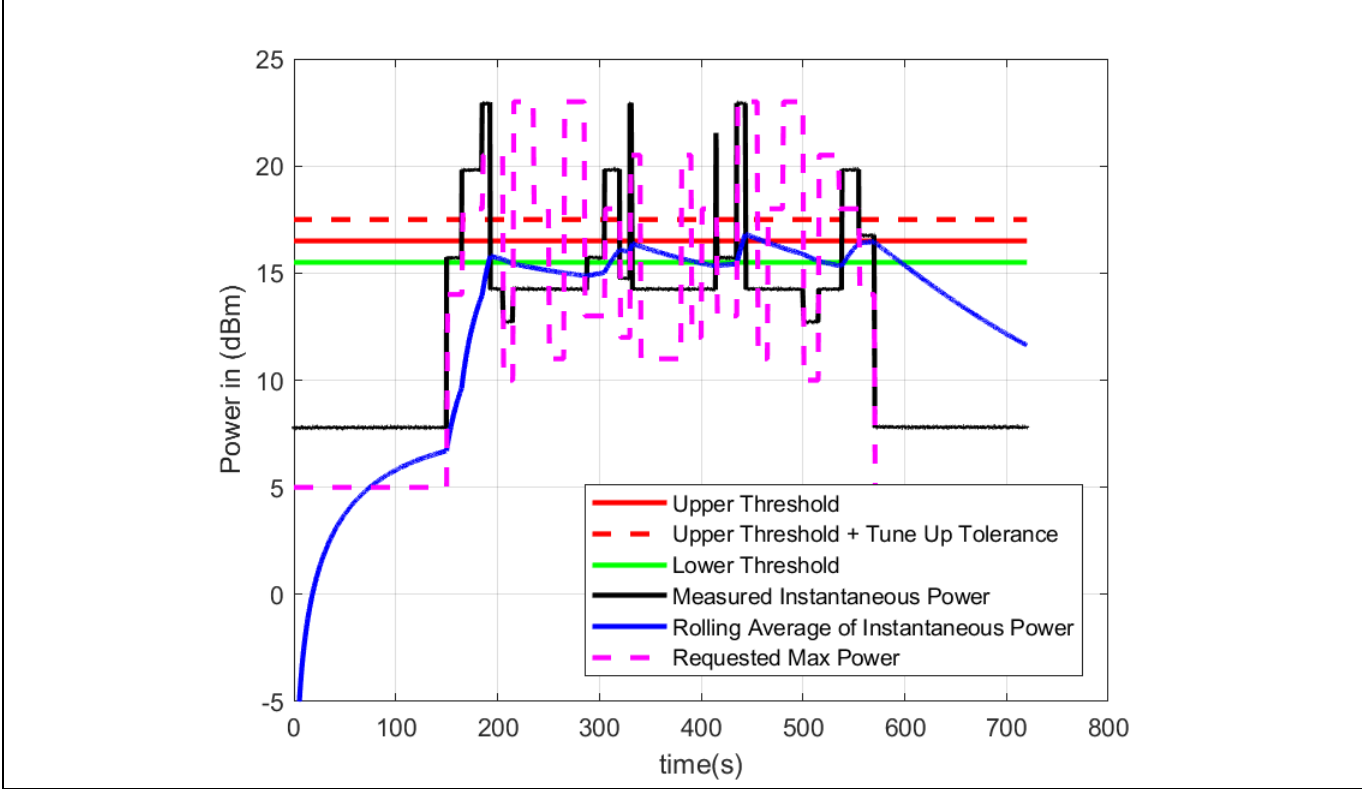

B.5 Time Varying Test Sequence - WCDMA

Table 4 - Test Cases for Time Varying Test Sequence of WCDMA bands

Case	RAT	Band	Max_Power_ DPR_OFF	Roll_Period	Check_Perio d	Avg_SAR_Up pThresh	Avg_SAR_Lo wThresh	Max_Power_ DPR_ON
1 & 2	WCDMA	2	24.5	100	0.05	16.5	15.5	14.5

Note: The Average power is calculated using the measured instantaneous power and compared to the UpperThreshold Plus Tune-Up Tolerance. This is applied for all the test cases in this report.

Case #1 : Seq 1 - WCDMA Band 2 – Max Power 24.5 dBm – Roll Period 100 sec – Check Period 0.05 sec

Avg_SAR_UppThresh [dBm]	Avg_SAR_LowThresh [dBm]	Max_Power_DPR_ON [dBm]
16.5	15.5	14.5

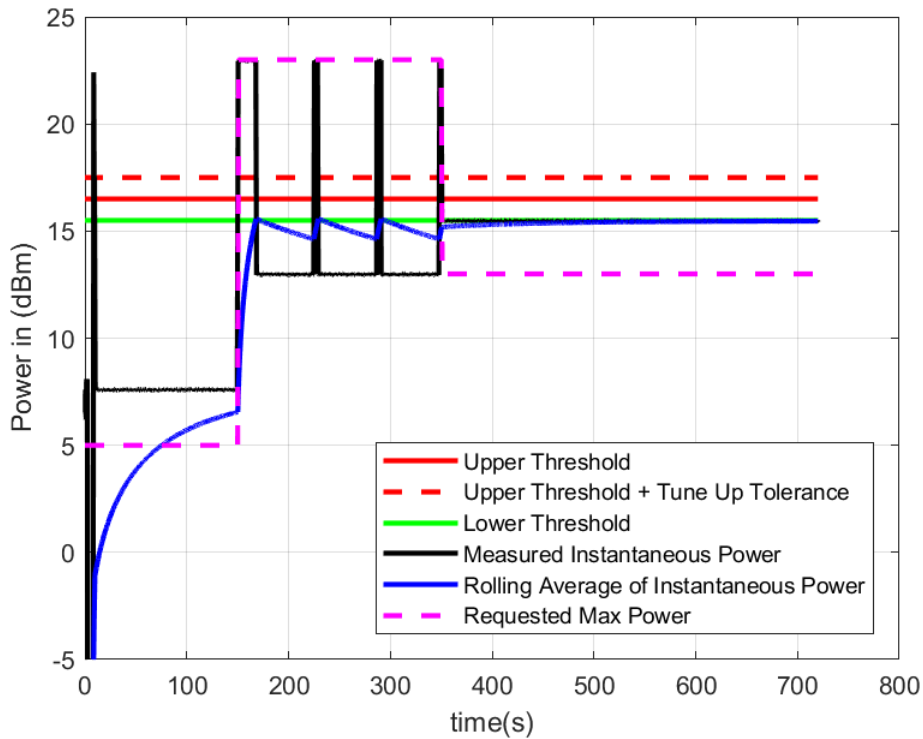

Case #2: Seq 2 - WCDMA Band 2 – Max Power 24.5 dBm – Roll Period 100 sec – Check Period 0.05 sec

Avg_SAR_UppThresh [dBm]	Avg_SAR_LowThresh [dBm]	Max_Power_DPR_ON [dBm]
16.5	15.5	14.5

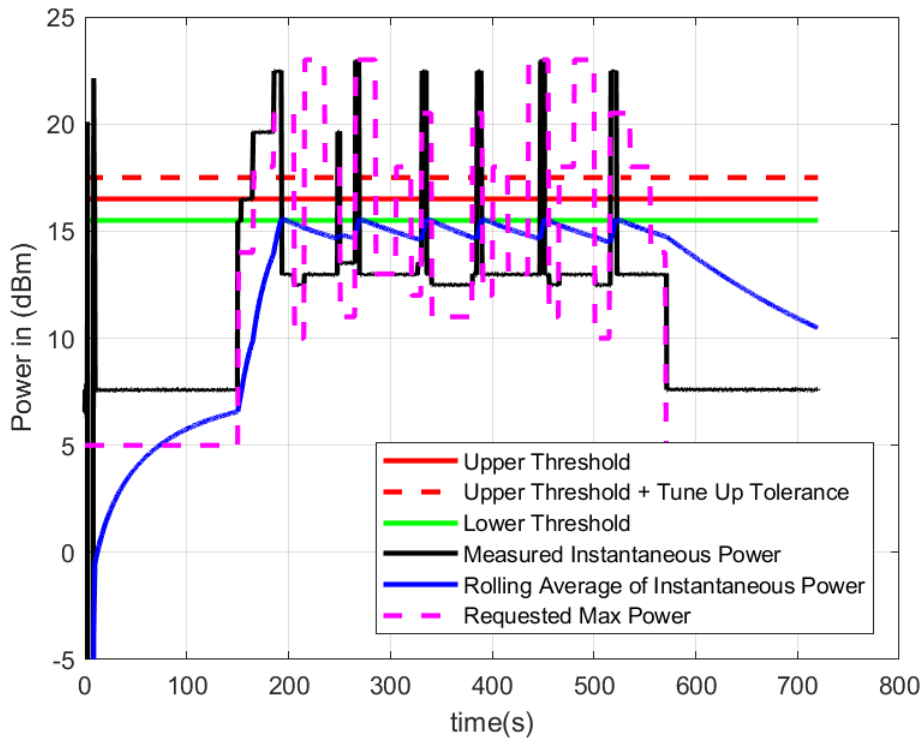

B.6 Handover - LTE-LTE

Table 5 - Test Cases for Handover of LTE-LTE bands

Case	RAT	Band	Max_Power_DPR_OFF_dBm	Roll_Period_s	Check_Period_s	Avg_SAR_UppThresh_dBm	Avg_SAR_LowThresh_dBm	Max_Power_DPR_ON_dBm
1	LTE	2	24.0	100	0.05	16.5	15.5	14.5
	LTE	4	24.0	100	0.05	19.0	18.0	17.0

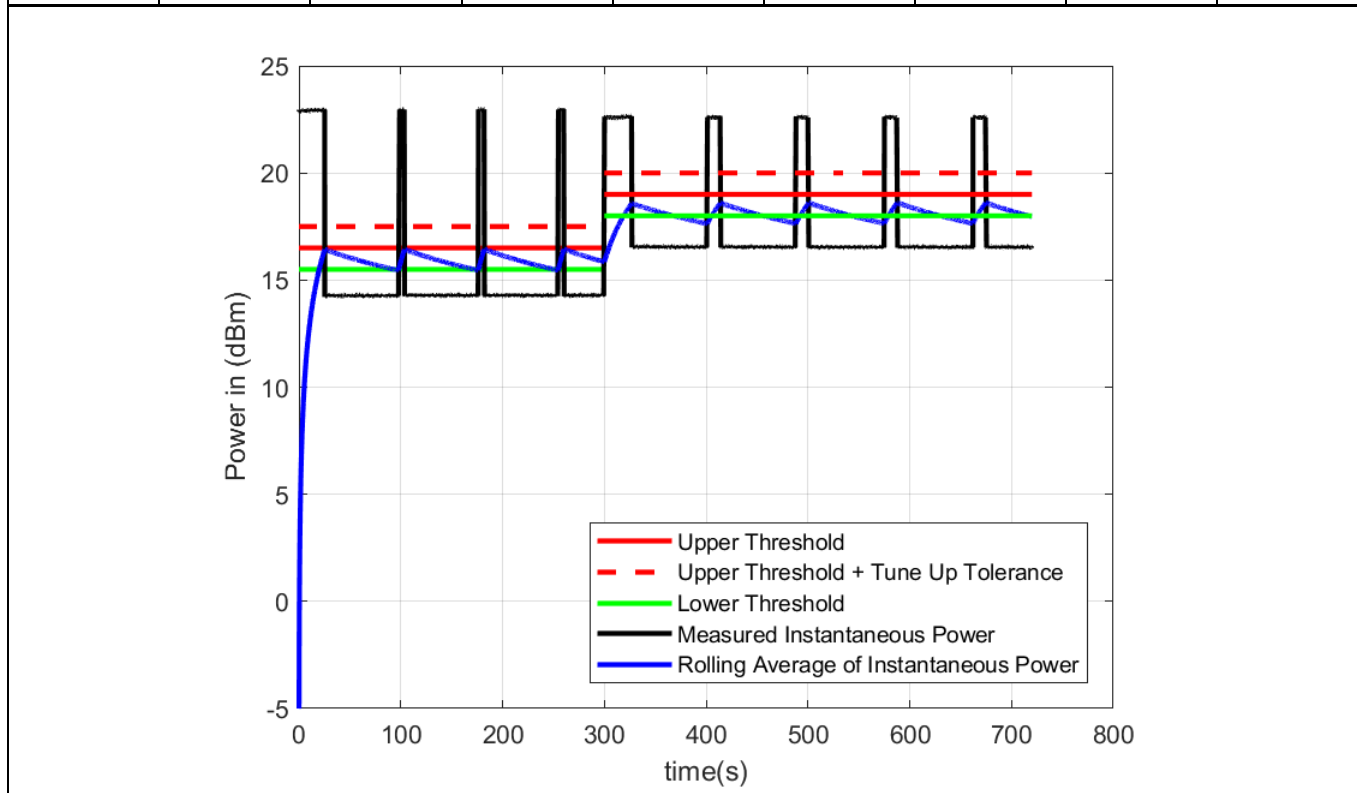

Note: The Average power is calculated using the measured instantaneous power and compared to the UpperThreshold Plus Tune-Up Tolerance. This is applied for all the test cases in this report.

B.7 Handover - LTE-WCDMA

Table 6 - Test Cases for Handover of LTE-WCDMA bands

Case	RAT	Band	Max_Power_DPR_OFF_dBm	Roll_Period_s	Check_Period_s	Avg_SAR_UppThresh_dBm	Avg_SAR_LowThresh_dBm	Max_Power_DPR_ON_dBm
1	LTE	2	24.0	100	0.05	16.5	15.5	14.5
	WCDMA	4	24.5	100	0.05	19.0	18.0	17.0

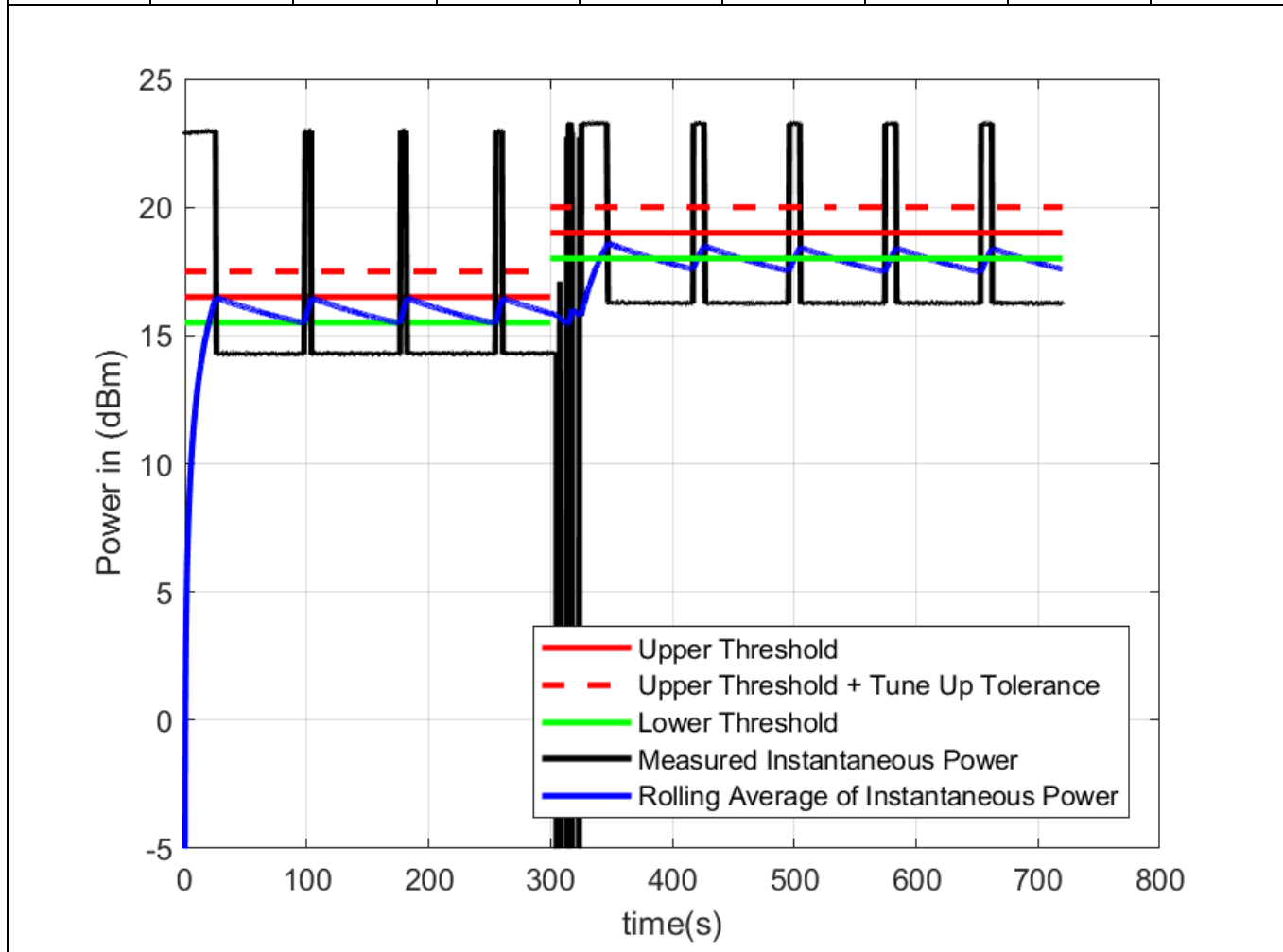

Note: The Average power is calculated using the measured instantaneous power and compared to the UpperThreshold Plus Tune-Up Tolerance. This is applied for all the test cases in this report.

End of the report

This page is left intentionally blank and marks the last page of the test report.