



TEST REPORT

EUT Description	WWAN module installed in Convertible PC
Brand Name	HP
Model Name	HSN-I45C
FCC ID	B94HNI45CKL
Date of Test Start/End	2023-12-08 / 2023-12-19
Features	WWAN (5G, LTE, UMTS), WLAN, BT (see section 6)
Description	Platform: HSN-I45C + Vendor 1 / Vendor 2 antennas

Applicant	HP Inc.
Address (FCC)	1501 Page Mill Road, Palo Alto CA 94304 USA
Contact Person	Sam Lin
Telephone/Fax/ Email	(TEL) +886 2 37896331 / (Email) sam.lin2@hp.com

Reference Standards	FCC 47 CFR Part §2.1093 (see section 0)	
RF Exposure Environment	Portable devices - General population/uncontrolled exposure	
	SAR Result	SAR Limit
Maximum SAR Result & Limit	0.79 W/kg (1g)	1.6 W/kg (1g)
Min. test separation distance	0mm to phantom, 2.2mm to antenna edge	

Test Report identification	231102-01.TR01
Revision Control	Rev. 00 This test report revision replaces any previous test report revision. (see section 9)

The test results relate only to the samples tested.
Reference to accreditation shall be used only by full reproduction of test report.

Issued by

Reviewed by

Adel LOUNES
(Test Lead Engineer)

Zayd OUACHICHA
(Technical Manager)

Intel Corporation S.A.S – WRF Lab
425 rue de Goa – Le Cargo B6 - 06600 Antibes, France
Tel. +33493001400 / Fax +33493001401

Table of Contents

1. Standards, reference documents and applicable test methods	4
2. General conditions, competences and guarantees.	4
3. Preface	4
4. Environmental Conditions	5
5. Test samples	5
6. EUT Features	6
7. Remarks and comments	14
8. Test Verdicts summary	14
9. Document Revision History	14
Annex A. Test & System Description	15
A.1 SAR DEFINITION	15
A.2 SAR MEASUREMENT SYSTEM	16
A.2.1 SAR Measurement Setup	16
A.2.2 E-Field Measurement Probe	17
A.2.3 Flat Phantom	17
A.2.4 Device Positioner	18
A.3 DATA EVALUATION	19
A.4 SYSTEM AND LIQUID CHECK	21
A.4.1 System Check	21
A.4.2 Liquid Check	22
A.5 TEST EQUIPMENT LIST	23
A.5.1 Tissue Simulant Liquid	23
A.6 MEASUREMENT UNCERTAINTY EVALUATION	24
A.7 RF EXPOSURE LIMITS	24
Annex B. Test Results	25
B.1 TEST CONDITIONS	25
B.1.1 Test SAR Test positions relative to the phantom	25
B.1.2 Test signal, Output power and Test Frequencies	26
B.2 CONDUCTED POWER MEASUREMENTS	27
B.2.1 5G NR (FR1)	27
B.2.2 LTE	30
B.3 TISSUE PARAMETERS MEASUREMENT	32
B.4 SYSTEM CHECK MEASUREMENTS	32
B.5 SAR TEST RESULTS	32
B.5.1 5G NR	32
B.5.2 ENDC	33
B.5.3 LTE	33
B.6.1 SAR Measurement Variability	34
B.6.2 Simultaneous Transmission SAR Evaluation	34
Annex C. Test System Plots	37
Annex D. TSL Dielectric Parameters	46
D.1 BODY	46
Annex E. Calibration Certificates	48
Annex F. Photographs	49
F.1 TEST SAMPLE	49



F.2	TEST POSITIONS.....	51
F.3	ANTENNA HOST PLATFORM LOCATION AND ADJACENT EDGE POSITIONS RELATIVE TO THE BODY	52
F.4	PHANTOM LIQUID LEVEL DURING MEASUREMENTS	53

1. Standards, reference documents and applicable test methods

FCC

1. FCC Title 47 CFR Part §2.1093 – Radiofrequency radiation exposure evaluation: portable devices. 2019-10-01 Edition
2. FCC OET KDB 447498 D04 interim v01 General RF Exposure Guidance v01– RF Exposure Procedures and Equipment Authorization Policies for Mobile and Portable Devices.
3. FCC OET KDB 616217 D04 v01r02 – SAR Evaluation Considerations for Laptop, Notebook, Netbook and Tablet Computers.
4. FCC OET KDB 865664 D01 v01r04 – SAR Measurement Requirements for 100 MHz to 6 GHz.
5. FCC OET KDB 865664 D02 v01r02 – RF Exposure Compliance Reporting and Documentation Considerations.
6. FCC OET KDB 941225 D05 v02r05 – SAR Evaluation Considerations for LTE Devices.
7. FCC OET KDB 941225 D01 v03r01 – 3G SAR Measurement Procedures.
8. IEEE Std 1528-2013 – IEEE Recommended Practice Determining the Peak Spatial-Average Specific Absorption Rate (SAR) in the Human Head from Wireless Communication Devices: Measurement Techniques...
9. TCB Workshop Nov 2017 71-RF-Exposure-TCB-Slides-LTE UL/DL Carrier Aggregation SAR
10. TCB workshop November 2019; RF Exposure Policy Updates (5G NR FR1 NSA EN-DC UE SAR Evaluations), the FCC OET KDB 941225 D05 rules apply.

2. General conditions, competences and guarantees.

- ✓ Tests performed under FCC standards identified in section 1 are covered by A2LA accreditation.
- ✓ Intel Corporation SAS Wireless RF Lab (Intel WRF Lab) is an ISO/IEC 17025:2017 laboratory accredited by the American Association for Laboratory Accreditation (A2LA) with the certificate number 3478.01.
- ✓ Intel Corporation SAS Wireless RF Lab (Intel WRF Lab) is an Accredited Test Firm recognized by the FCC, with Designation Number FR0011.
- ✓ Intel WRF Lab only provides testing services and is committed to providing reliable, unbiased test results and interpretations.
- ✓ Intel WRF Lab is liable to the client for the maintenance of the confidentiality of all information related to the item under test and the results of the test.
- ✓ Intel WRF Lab has developed calibration and proficiency programs for its measurement equipment to ensure correlated and reliable results to its customers.
- ✓ This report is only referred to the item that has undergone the test.
- ✓ This report does not imply an approval of the product by the Certification Bodies or competent Authorities.

3. Preface

The HSN-I45C convertible PC includes the Time Averaging SAR (TAS) concept. The TAS algorithm is implemented in the Fibocom M2 FM350-GLcellular modem, which is incorporated in the HSN-I45C cellular module (FCC ID: ZMOFM350GL).

The implementation details and TAS operating characteristics are described in a separated document [1]. The validation of algorithm operations is performed by Intel Corporation according to the range of commonly used accessible control parameters used for typical host products. The validation results are reported in document [2].

The FCC SAR limit is a time averaged exposure metric. At host level, the normally required SAR test procedures are applicable for SAR compliance testing at upper-threshold values of the algorithm, which is the maximum output power level for continuous time-averaging operations TAS algorithm enforces. The reliability of this has been demonstrated by results in the Algorithm Validation Test Report [2].

The model supports simultaneous transmission of WWAN, BT and WLAN. The TAS algorithm is only applied to WWAN cellular module.

The SAR evaluation of WWAN is performed in this report as well as the RF exposure assessment for simultaneous transmission of WWAN, WLAN and BT.

[1] 210317_TAS_Operational_Report_Rev01

[2] 201029-02.TR01_Rev01_Validation Report for 5G Time Averaging Algorithm

4. Environmental Conditions

✓ At the site where the measurements were performed the following limits were not exceeded during the tests:

Temperature	2071°C ± 1°C
Humidity	38.9% ± 5.4%
Liquid Temperature	22.6°C ± 0.9°C

5. Test samples

Sample	Control #	Description	Model	Serial #	Date of receipt	Comment
#01	210916-08.S03	WWAN module installed in Convertible PC	HSN-I45C	0001760BBY	2021-09-23	Antenna Vendor 2
#02	210916-08.S10	WWAN module installed in Convertible PC	HSN-I45C	0001760BBT	2021-09-23	Antenna Vendor 1

6. EUT Features

The herein information is provided by the customer.

Intel WRF Lab declines any responsibility for the accuracy of the stated customer provided information, especially if it has any impact on the correctness of test results presented in this report.

Brand Name	HP
Model Name	HSN-I45C
Prototype / Production	Production
Host Identification	HSN-I45C
Exposure Conditions	Body worn

Supported radios

The applicable frequency bands and operating modes are identified in the following table.

WWAN:

Mode	Bands	Supported Tx Mode			
		WCDMA	HSDPA	HSUPA	DC-HSDPA
WCDMA / HSPA+	FDD II (1850.0 – 1910.0 MHz)	✓	✓	✓	✓
	FDD IV (1710.0 – 1755.0 MHz)	✓	✓	✓	✓
	FDD V (824.0 – 849.0 MHz)	✓	✓	✓	✓

FDD/TDD	Bands	Modulations	Bandwidth					
			1.4	3	5	10	15	20
LTE FDD	Band 2 (1850.0 – 1910.0 MHz)	QPSK/16QAM/64QAM/256QAM	✓	✓	✓	✓	✓	✓
	Band 4 (1710.0 – 1755.0 MHz)	QPSK/16QAM/64QAM/256QAM	✓	✓	✓	✓	✓	✓
	Band 5 (824.0 – 849.0 MHz)	QPSK/16QAM/64QAM/256QAM	✓	✓	✓	✓		
	Band 7 (2500.0 – 2570.0 MHz)	QPSK/16QAM/64QAM/256QAM			✓	✓	✓	✓
	Band 12 (699.0 – 716.0 MHz)	QPSK/16QAM/64QAM/256QAM	✓	✓	✓	✓		
	Band 13 (777.0 – 787.0 MHz)	QPSK/16QAM/64QAM/256QAM			✓	✓		
	Band 14 (788.0 – 798.0 MHz)	QPSK/16QAM/64QAM/256QAM			✓	✓		
	Band 17 (704.0 – 716.0 MHz)	QPSK/16QAM/64QAM/256QAM			✓	✓		
	Band 25 (1850.0 – 1915.0 MHz)	QPSK/16QAM/64QAM/256QAM	✓	✓	✓	✓	✓	✓
	Band 26 (814.0 – 849.0 MHz)	QPSK/16QAM/64QAM/256QAM	✓	✓	✓	✓	✓	
	Band 30 (2305.0 – 2315.0 MHz)	QPSK/16QAM/64QAM/256QAM			✓	✓		
	Band 66 (1710.0 – 1780.0 MHz)	QPSK/16QAM/64QAM/256QAM	✓	✓	✓	✓	✓	✓
Band 71 (663.0 – 698.0 MHz)	QPSK/16QAM/64QAM/256QAM			✓	✓	✓	✓	
LTE TDD	Band 38 (2570.0 – 2620.0 MHz)	QPSK/16QAM/64QAM/256QAM			✓	✓	✓	✓
	Band 41 (2496.0 – 2690.0 MHz)	QPSK/16QAM/64QAM/256QAM			✓	✓	✓	✓
	Band 48 (3550.0 – 3700.0 MHz)	QPSK/16QAM/64QAM/256QAM			✓	✓	✓	✓

Bands	Modulation	SCS (KHz)	Bandwidth													
			5	10	15	20	25	30	40	50	60	70	80	90	100	
N2 FDD (1850.0 – 1910.0 MHz)	PI/2 BPSK QPSK 16QAM 64QAM 256QAM	15 30	✓	✓	✓	✓										
N5 FDD (824.0 – 849.0 MHz)	PV2 BPSK QPSK 16QAM 64QAM 256QAM	15 30 60	✓	✓	✓	✓										
N7 FDD (2500.0 – 2570.0 MHz)	PV2 BPSK QPSK 16QAM 64QAM 256QAM	15 30	✓	✓	✓	✓										
N25 FDD (1850.0 – 1915 MHz)	PV2 BPSK QPSK 16QAM 64QAM 256QAM	15 30	✓	✓	✓	✓										
N30 FDD (2305.0 – 2315.0 MHz)	PV2 BPSK QPSK 16QAM 64QAM 256QAM	15 30	✓	✓												
N38 TDD (2570.0 – 2620.0 MHz)	PV2 BPSK QPSK 16QAM 64QAM 256QAM	15 30 60	✓	✓	✓	✓										
N41 TDD (2496.0 – 2690.0 MHz)	PV2 BPSK QPSK 16QAM 64QAM 256QAM	15 30				✓				✓	✓	✓		✓	✓	✓
N48 TDD (3550.0 – 3700.0 MHz)	PV2 BPSK QPSK 16QAM 64QAM 256QAM	15 30	✓	✓	✓	✓				✓						
N66 FDD (1710.0 – 1780.0 MHz)	PV2 BPSK QPSK 16QAM 64QAM 256QAM	15 30	✓	✓	✓	✓				✓						
N71 FDD (663.0 – 698.0 MHz)	PV2 BPSK QPSK 16QAM 64QAM 256QAM	15 30	✓	✓	✓	✓										
N77 TDD* (3450.0 – 3550.0 MHz) (3700.0 – 3980.0 MHz)	PV2 BPSK QPSK 16QAM 64QAM 256QAM	15 30		✓	✓	✓				✓	✓	✓		✓	✓	✓
N78 TDD** (3700.0 – 3800.0 MHz)	PV2 BPSK QPSK 16QAM 64QAM 256QAM	15 30		✓	✓	✓				✓	✓	✓		✓	✓	✓

*FCC limits 5G NR B77 to 3450-3550MHz & 3700-3980MHz

** FCC limits 5G NR B78 to 3700-3800MHz

UL carrier aggregation LTE (Inter-Band)	UL carrier aggregation LTE (Intra-band)
2A – 5A	5B
2A – 12A	7C
2A – 13A	38C
2A – 14A	41C
2A – 48A	48C
4A – 5A	66B
4A – 12A	66C
4A – 13A	
5A – 7A	
5A – 30A	
5A – 48A	
5A – 66A	
12A – 30A	
12A – 66A	
13A – 48A	
13A – 66A	
14A – 30A	
14A – 66A	
25A – 26A	
48A – 66A	

EN/DC possible combinations	
NR 5G Band	Associated LTE Bands
N2A	5, 12, 13, 14
N5A	2, 7, 30, 66, 48
N66A	5, 12, 13, 48
N41A	2,66,41
N48A	LTE Band 2, 66
N77A	2,5,12,13,14, 30,66, 41
N78A	2, 5, 7, 38

UL carrier aggregation 5G FR1
n2A – n5A
n5A – n66A

WLAN

Mode	UL Freq Range
802.11b/g/n/ax	2.4GHz (2400.0 – 2483.5 MHz)
802.11a/n/ac/ax	5.2GHz (5150.0 – 5250.0 MHz)
	5.3GHz (5250.0 – 5350.0 MHz)
	5.6GHz (5470.0 – 5725.0 MHz)
	5.8GHz (5725.0 – 5850.0 MHz)
	5.9GHz (5850.0 – 5895.0 MHz)
802.11ax	6.0GHz (5925.0 – 7125.0 MHz)
Bluetooth v5.2 & BLE	2.4GHz (2400.0 – 2483.5 MHz)

Antenna Information "information provided by the applicant"

The DUTs have 2 WWAN TX antennas:

Transmitter	Main (Antenna 5)	Aux (Antenna 8)
Manufacturer	Vendor1	Vendor1
Antenna type	PIFA antenna	PIFA antenna
Part number	6036B0313901 (81ELA215.G12)	6036B0313901 (81ELA215.G12)
Transmitter	Main (Antenna 5)	Aux (Antenna 8)
Manufacturer	Vendor2	Vendor2
Antenna type	PIFA antenna	PIFA antenna
Part number	6036B0314601 (00-3302701050)	6036B0314601 (00-3302701050)

See Annex F for more details on antennas location.

WWAN Antenna Mapping

Configuration	Main (Ant 5)	Aux (Ant 8)
WCDMA	LB / MHB	
LTE	LB / MHB	
		UHB
NR 5G SA	(LB / MHB)	
		UHB
LTE ULCA	LB	MHB /UHB
	MHB	UHB
	B41	UHB
NR 5G ENDC	LB	MHB / B41
	B41	N41
	MHB	B41/N41
	B41/N41	UHB
	MHB	UHB
NR 5G ULCA	LB	MHB

- LB: WCDMA FDD V, LTE B5/12/13/14/17/26, 5G NR n5
- MHB: WCDMA FDD II/ FDD IV, LTE B2/4/7/25/30/66/38, 5G NR n2/n7/n25/n30/n38/n66
- UHB: LTE: B41/48; NR 5G: n41/n48/n77/n78

Note: For EN-DC mode the 4G and 5G carriers transmit on separate antennas.
For inter-bands on LTE and NR 5G ULCA the carriers transmit on separate antennas.

Simultaneous Transmission Configurations

- WWAN Main (Ant5) + WWAN Aux (Ant8) + WLAN 2.4GHz Main + BT Aux
- WWAN Main (Ant5) + WWAN Aux (Ant8) + WLAN 2.4GHz Main + WLAN 2.4GHz Aux
- WWAN Main (Ant5) + WWAN Aux (Ant8) + WLAN 5GHz Main + BT Aux
- WWAN Main (Ant5) + WWAN Aux (Ant8) + WLAN 5GHz Main + WLAN 5GHz Aux
- WWAN Main (Ant5) + WWAN Aux (Ant8) + WLAN 5GHz Main + WLAN 5GHz Aux + BT Aux
- WWAN Main (Ant5) + WWAN Aux (Ant8) + WLAN 6GHz Main + BT Aux
- WWAN Main (Ant5) + WWAN Aux (Ant8) + WLAN 6GHz Main + WLAN 6GHz Aux
- WWAN Main (Ant5) + WWAN Aux (Ant8) + WLAN 6GHz Main + WLAN 6GHz Aux + BT Aux

WLAN transmitter is considered in this report just for the simultaneous transmission evaluation with the WWAN module (See section B.5.5)

Additional information

- 5.60-5.65 GHz band (TDWR) is supported by the device
- Band gap is supported by the device
- One power setting is implemented in the DUT:
 - Max power for Notebook mode
- Maximum Power Reduction (MPR) is implemented according to 3GPP, built-in by design on the tune-up power:

Modulation	Channel bandwidth / #RB						MPR (dB)
	1.4 MHz	3.0 MHz	5 MHz	10 MHz	15 MHz	20 MHz	
QPSK	> 5	> 4	> 8	> 12	> 16	> 18	≤ 1
16 QAM	≤ 5	≤ 4	≤ 8	≤ 12	≤ 16	≤ 18	≤ 1
16 QAM	> 5	> 4	> 8	> 12	> 16	> 18	≤ 2
64 QAM	≤ 5	≤ 4	≤ 8	≤ 12	≤ 16	≥ 18	≤ 2
64 QAM	> 5	> 4	> 8	> 12	> 16	> 18	≤ 3
256 QAM	≥ 1						≤ 5

The DUT uses the maximum MPR values described in the above tables.

The maximum power reduction is applicable on the Tune up tolerance.

- According to 3GPP 38-101-1, the UE is allowed to reduce the maximum output power due to higher order modulations and for channel bandwidths that meets both following criteria:
 - Channel bandwidth ≤ 100MHz.
 - Relative channel bandwidth ≤ 4% for TDD bands and ≤ 3% for FDD bands

Maximum power reduction (MPR) for power class 3			
Modulation	MPR (Db)		
	Edge RB allocations	Outer RB allocations	Inner RB allocations
DFT-s-OFDM PI/2 BPSK	≤ 3.5 ¹	≤ 1.2 ¹	≤ 0.2 ¹
	0.5 ²	0.5 ²	0 ²
DFT-s-OFDM QPSK	≤ 1		0
DFT-s-OFDM 16 QAM	≤ 2		≤ 1
DFT-s-OFDM 64 QAM	≤ 2.5		
DFT-s-OFDM 256 QAM	4.5		
CP-OFDM QPSK	≤ 3		≤ 1.5
CP-OFDM 16 QAM	≤ 3		≤ 2
CP-OFDM 64 QAM	≤ 3.5		
CP-OFDM 256 QAM	≤ 6.5		

NOTE 1: Applicable for UE operating in TDD mode with PI/2 BPSK modulation and if the IE [P-Boost-BPSK] is set to 1 and 40% or less slots in radio frame are used for UL transmission for bands n40, n77, n78 and n79.

NOTE 2: Applicable for UE operating in FDD mode, or in TDD mode in bands other than n40, n77, n78 and n79 and if the IE [Pboost-BPSK] is set to 0 and if more than 40% of slots in radio frame are used for UL transmission for bands n40, n77, n78 and n79.

Maximum power reduction (MPR) for power class 2			
Modulation	MPR (dB)		
	Edge RB allocations	Outer RB allocations	Inner RB allocations
DFT-s-OFDM PI/2 BPSK	≤ 3.5	≤ 0.5	0
DFT-s-OFDM QPSK	≤ 3.5	≤ 1	0
DFT-s-OFDM 16 QAM	≤ 3.5	≤ 2	≤ 1
DFT-s-OFDM 64 QAM	≤ 3.5	≤ 2.5	
DFT-s-OFDM 256 QAM	≤ 4.5		
CP-OFDM QPSK	≤ 3.5	≤ 3	≤ 1.5
CP-OFDM 16 QAM	≤ 3.5	≤ 3	≤ 2
CP-OFDM 64 QAM	≤ 3.5		
CP-OFDM 256 QAM	≤ 6.5		

The DUT uses the maximum MPR values described in the above tables.

The maximum power reduction is applicable on the Tune up tolerance.

The following table indicates the power levels and tolerance for each mode:

Maximum Output power specification + Tune up tolerance

Mode	Tx Antenna	Technology	Bands	Class	Nominal (dBm)	Tolerance dB	Lower Tolerance (dBm)	Upper Tolerance (dBm)
Tablet	5	WCDMA/HSPA	FDD II (1850.0 – 1910.0 MHz)	3	16.0	±1	15.0	17.0
	5	WCDMA/HSPA	FDD IV (1710.0 – 1755.0 MHz)	3	16.5	±1	15.5	17.5
	5	WCDMA/HSPA	FDD V (824.0 – 849.0 MHz)	3	20.0	±1	19.0	21.0
	5	LTE	B2 (1850.0 – 1910.0 MHz)	3	16.0	±1	15.0	17.0
	5	LTE	B4 (1710.0 – 1755.0 MHz)	3	16.5	±1	15.5	17.5
	5	LTE	B5 (824.0 – 849.0 MHz)	3	20.0	±1	19.0	21.0
	5	LTE	B7 (2500.0 – 2570.0 MHz)	3	14.5	±1	13.5	15.5
	5	LTE	B12 (699.0 – 716.0 MHz)	3	17.0	±1	16.0	18.0
	5	LTE	B13 (777.0 – 787.0 MHz)	3	18.0	±1	17.0	19.0
	5	LTE	B14 (788.0 – 798.0 MHz)	3	18.0	±1	17.0	19.0
	5	LTE	B17 (704.0 – 716.0 MHz)	3	17.0	±1	16.0	18.0
	5	LTE	B25 (1850.0 – 1915.0 MHz)	3	15.0	±1	14.0	16.0
	5	LTE	B26 (814.0 – 849.0 MHz)	3	19.5	±1	18.5	20.5
	5	LTE	B30 (2305.0 – 2315.0 MHz)	3	13.0	±1	12.0	14.0
	5	LTE	B38 (2570.0 – 2620.0 MHz)	3	16.5	±1	15.5	17.5
	5	LTE	B41 (2496.0 – 2690.0 MHz)	3	13.5	±1	12.5	14.5
	5	LTE	B41 (2496.0 – 2690.0 MHz)	2	13.5	±1	12.5	14.5
	5	LTE	B66 (1710.0 – 1780.0 MHz)	3	16.5	±1	15.5	17.5
	5	LTE	B71 (663.0 – 698.0 MHz)	3	17.0	±1	16.0	18.0
	8	LTE	B2 (1850.0 – 1910.0 MHz)	3	16.5	±1	15.5	17.5
	8	LTE	B4 (1710.0 – 1755.0 MHz)	3	18.0	±1	17.0	19.0
	8	LTE	B7 (2500.0 – 2570.0 MHz)	3	18.0	±1	17.0	19.0
	8	LTE	B25 (1850.0 – 1915.0 MHz)	3	18.5	±1	17.5	19.5
	8	LTE	B30 (2305.0 – 2315.0 MHz)	3	17.5	±1	16.5	18.5
	8	LTE	B41 (2496.0 – 2690.0 MHz)	3	20.0	±1	19.0	21.0
	8	LTE	B41 (2496.0 – 2690.0 MHz)	2	20.0	±1	19.0	21.0
	8	LTE	B48 (3550.0 – 3700.0 MHz)	3	19.0	±1	18.0	20.0
	8	LTE	B66 (1710.0 – 1780.0 MHz)	3	18.0	±1	17.0	19.0
	5	5G NR	N2 (1850.0 – 1910.0 MHz)	3	16.0	±1	15.0	17.0
	5	5G NR	N5 (824.0 – 849.0 MHz)	3	20.0	±1	19.0	21.0
	5	5G NR	N7 (2500.0 – 2570.0 MHz)	3	14.5	±1	13.5	15.5
	5	5G NR	N25 (1850.0 – 1915.0 MHz)	3	16.5	±1	15.5	17.5
	5	5G NR	N30 (2305.0 – 2315.0 MHz)	3	13.5	±1	12.5	14.5
	5	5G NR	N38 (2570.0 – 2620.0 MHz)	3	14.0	±1	13.0	15.0
	5	5G NR	N41 (2496.0 – 2690.0 MHz)	3	13.5	±1	12.5	14.5
	5	5G NR	N41 (2496.0 – 2690.0 MHz)	2	13.5	±1	12.5	14.5
	5	5G NR	N66 (1710.0 – 1780.0 MHz)	3	17.0	±1	16.0	18.0
	5	5G NR	N71 (663.0 – 698.0 MHz)	3	17.0	±1	16.0	18.0
	5	5G NR	N77 (3700.0 – 3980.0 MHz)	3	15.0	±1	14.0	16.0
	5	5G NR	N77 (3700.0 – 3980.0 MHz)	2	15.0	±1	14.0	16.0
	5	5G NR	N78 (3700.0 – 3800.0 MHz)	3	14.0	±1	13.0	15.0
	5	5G NR	N78 (3700.0 – 3800.0 MHz)	3	14.0	±1	13.0	15.0
	8	5G NR	N2 (1850.0 – 1910.0 MHz)	3	17.0	±1	16.0	18.0
	8	5G NR	N38 (2570.0 – 2620.0 MHz)	3	19.0	±1	18.0	20.0
	8	5G NR	N41 (2496.0 – 2690.0 MHz)	3	18.0	±1	17.0	19.0
8	5G NR	N41 (2496.0 – 2690.0 MHz)	2	18.0	±1	17.0	19.0	
8	5G NR	N48 (3550.0 – 3700.0 MHz)	3	18.0	±1	17.0	19.0	
8	5G NR	N66 (1710.0 – 1780.0 MHz)	3	18.0	±1	17.0	19.0	
8	5G NR	N77 (3450.0 – 3550.0 MHz)	3	18.0	±1	17.0	19.0	
8	5G NR	N77 (3700.0 – 3980.0 MHz)	3	16.5	±1	15.5	17.5	
8	5G NR	N77 (3700.0 – 3980.0 MHz)	2	16.5	±1	15.5	17.5	
8	5G NR	N78 (3700.0 – 3800.0 MHz)	3	17.0	±1	16.0	18.0	
8	5G NR	N78 (3700.0 – 3800.0 MHz)	3	17.0	±1	16.0	18.0	
8	5G NR	N66 (1710.0 – 1780.0 MHz)	3	18.0	±1	17.0	19.0	

As mentioned in Section 3, the SAR compliance testing is performed at upper-threshold values of the algorithm, which is the maximum output power level for continuous time-averaging operations TAS algorithm enforces.

Test Report N° 231102-01.TR01

In TAS operation, the control parameters including the upper-threshold value are stored in NVM. They are inaccessible to the normal users and no other interface is available for changing these control parameters.

The table below shows the upper-threshold values used as continuous power for SAR testing as well as the different TAS parameters defined in [1] and [2] to be embedded in the host:

Mode	Tx Antenna	Technology	Bands	Class	Nominal Full Power (dBm)	Upper Threshold (dBm)	Lower Threshold (dBm)	DPR_ON Power (dBm)
Tablet	5	WCDMA/HSPA	FDD II (1850.0 – 1910.0 MHz)	3	23.5	18.0	17.0	16.0
	5	WCDMA/HSPA	FDD IV (1710.0 – 1755.0 MHz)	3	23.5	18.5	17.5	16.5
	5	WCDMA/HSPA	FDD V (824.0 – 849.0 MHz)	3	23.5	22.0	21.0	20.0
	5	LTE	B2 (1850.0 – 1910.0 MHz)	3	23.0	18.0	17.0	16.0
	5	LTE	B4 (1710.0 – 1755.0 MHz)	3	23.0	18.5	17.5	16.5
	5	LTE	B5 (824.0 – 849.0 MHz)	3	23.0	22.0	21.0	20.0
	5	LTE	B7 (2500.0 – 2570.0 MHz)	3	23.0	16.5	15.5	14.5
	5	LTE	B12 (699.0 – 716.0 MHz)	3	23.0	19.0	18.0	17.0
	5	LTE	B13 (777.0 – 787.0 MHz)	3	23.0	20.0	19.0	18.0
	5	LTE	B14 (788.0 – 798.0 MHz)	3	23.0	20.0	19.0	18.0
	5	LTE	B17 (704.0 – 716.0 MHz)	3	23.0	19.0	18.0	17.0
	5	LTE	B25 (1850.0 – 1915.0 MHz)	3	23.0	17.0	16.0	15.0
	5	LTE	B26 (814.0 – 849.0 MHz)	3	23.0	21.5	20.5	19.5
	5	LTE	B30 (2305.0 – 2315.0 MHz)	3	23.0	15.0	14.0	13.0
	5	LTE	B38 (2570.0 – 2620.0 MHz)	3	23.0	18.5	17.5	16.5
	5	LTE	B41 (2496.0 – 2690.0 MHz)	3	23.0	15.5	14.5	13.5
	5	LTE	B41 (2496.0 – 2690.0 MHz)	2	26.0	15.5	14.5	13.5
	5	LTE	B66 (1710.0 – 1780.0 MHz)	3	23.0	18.5	17.5	16.5
	5	LTE	B71 (663.0 – 698.0 MHz)	3	23.0	17.0	16.0	15.0
	8	LTE	B2 (1850.0 – 1910.0 MHz)	3	23.0	18.5	17.5	16.5
	8	LTE	B4 (1710.0 – 1755.0 MHz)	3	23.0	20.0	19.0	18.0
	8	LTE	B7 (2500.0 – 2570.0 MHz)	3	23.0	20.0	19.0	18.0
	8	LTE	B25 (1850.0 – 1915.0 MHz)	3	23.0	20.5	19.5	18.5
	8	LTE	B30 (2305.0 – 2315.0 MHz)	3	23.0	19.5	18.5	17.5
	8	LTE	B41 (2496.0 – 2690.0 MHz)	3	23.0	22.0	21.0	20.0
	8	LTE	B41 (2496.0 – 2690.0 MHz)	2	26.0	22.0	21.0	20.0
	8	LTE	B48 (3550.0 – 3700.0 MHz)	3	21.0	21.0	20.0	19.0
	8	LTE	B66 (1710.0 – 1780.0 MHz)	3	23.0	20.0	19.0	18.0
	5	5G NR	N2 (1850.0 – 1910.0 MHz)	3	23.0	18.0	17.0	16.0
	5	5G NR	N5 (824.0 – 849.0 MHz)	3	23.0	22.0	21.0	20.0
	5	5G NR	N7 (2500.0 – 2570.0 MHz)	3	23.0	16.5	15.5	14.5
	5	5G NR	N25 (1850.0 – 1915.0 MHz)	3	23.0	18.5	17.5	16.5
	5	5G NR	N30 (2305.0 – 2315.0 MHz)	3	23.0	15.5	14.5	13.5
	5	5G NR	N38 (2570.0 – 2620.0 MHz)	3	23.0	16.0	15.0	14.0
	5	5G NR	N41 (2496.0 – 2690.0 MHz)	3	23.0	15.5	14.5	13.5
	5	5G NR	N41 (2496.0 – 2690.0 MHz)	2	23.0	15.5	14.5	13.5
	5	5G NR	N66 (1710.0 – 1780.0 MHz)	3	23.0	19.0	18.0	17.0
	5	5G NR	N71 (663.0 – 698.0 MHz)	3	23.0	17.0	16.0	15.0
	5	5G NR	N77 (3700.0 – 3980.0 MHz)	3	23.0	17.0	16.0	15.0
	5	5G NR	N77 (3700.0 – 3980.0 MHz)	2	23.0	17.0	16.0	15.0
	5	5G NR	N78 (3700.0 – 3800.0 MHz)	3	23.0	16.0	15.0	14.0
	5	5G NR	N78 (3700.0 – 3800.0 MHz)	3	23.0	16.0	15.0	14.0
	8	5G NR	N2 (1850.0 – 1910.0 MHz)	3	23.0	19.0	18.0	17.0
	8	5G NR	N38 (2570.0 – 2620.0 MHz)	3	23.0	21.0	20.0	19.0
	8	5G NR	N41 (2496.0 – 2690.0 MHz)	3	23.0	20.0	19.0	18.0
	8	5G NR	N41 (2496.0 – 2690.0 MHz)	2	26.0	20.0	19.0	18.0
	8	5G NR	N48 (3550.0 – 3700.0 MHz)	3	23.0	18.0	17.0	16.0
	8	5G NR	N66 (1710.0 – 1780.0 MHz)	3	23.0	18.0	17.0	16.0
	8	5G NR	N77 (3450.0 – 3550.0 MHz)	3	23.0	18.0	17.0	16.0
	8	5G NR	N77 (3700.0 – 3980.0 MHz)	3	23.0	18.5	17.5	16.5
8	5G NR	N77 (3700.0 – 3980.0 MHz)	2	26.0	18.5	17.5	16.5	
8	5G NR	N78 (3700.0 – 3800.0 MHz)	3	23.0	19.0	18.0	17.0	
8	5G NR	N78 (3700.0 – 3800.0 MHz)	3	23.0	19.0	18.0	17.0	

7. Remarks and comments

1. Only the plots for the test positions with the highest measured SAR per band/mode are included in Annex C as required per FCC OET KDB 865664 D02, paragraph 2.3.h.
2. Maximum transmission power on modulations 64QAM and 256QAM for LTE and 5G NR, are lower than other modulations QPSK and 16QAM. Therefore, according to spot check evaluation, higher power modulations were chosen to perform all tests shown in the report.
3. The same conducted power measurements were used on both samples since the same WWAN module has been used on the samples under test during SAR measurements.
4. This report only includes the test and results for bands: LTE 71, N48 & N71 & N77 (3450.0 – 3550.0 MHz). For other cellular bands refer to report: 210916-08.TR03 and 210916-08.TR04

8. Test Verdicts summary

The statement of conformity to applicable standards in the table below are based on the measured values, without taking into account the measurement uncertainties.

Mode	Band (UL)	Highest Reported SAR (1g) (W/kg)	Verdict
5G NR FR1 TDD	N48 (3550.0 – 3700.0 MHz)	0.78	P
	N77 (3450.0 – 3550.0 MHz)	0.79	P
5G NR FR1 FDD	NR 71 (663.0 – 698.0 MHz)	0.72	P
LTE FDD	Band 71 (663.0 – 698.0 MHz)	0.76	P

P: Pass NM: Not Measured
F: Fail NA: Not Applicable

According to the FCC OET KDB 690783 D01, this is the summary of the values for the Grant Listing:

Exposure Condition	Highest Reported SAR (1g) (W/kg)			
	Equipment Class			
	PCE	DTS	DSS	U-NII
Body Worn	0.79	0.40	0.40	0.40
Simultaneous Tx	Sum-SAR: 2.75	Sum-SAR: 2.75	Sum-SAR: 2.75	Sum-SAR: 2.75

Considering the results of the performed test according to FCC 47CFR Part 2.1093 and ISED RSS 102, Issue 5 the item under test is IN COMPLIANCE with the requested specifications specified in Section1. Standards, reference documents and applicable test methods

9. Document Revision History

Revision #	Modified by	Revision Details
Rev.00	Y.Haddad	First Issue

Annex A. Test & System Description

A.1 SAR Definition

Specific Absorption rate is defined as the time derivative of the incremental energy (dW) absorbed by (dissipated in) and incremental mass (dm) contained in a volume element (dV) of a given density (ρ).

$$SAR = \frac{d}{dt} \cdot \left(\frac{dW}{dm} \right) = \frac{d}{dt} \cdot \left(\frac{dW}{\rho \cdot dV} \right)$$

SAR is expressed in units of watts per kilogram (W/kg). SAR can be related to the electric field at a point by

$$SAR = \frac{\sigma |E|^2}{\rho}$$

Where:

σ = Conductivity of the tissue (S/m)

ρ = Mass density of the tissue (kg/m³)

E = RMS electric field strength (V/m)

A.2 SAR Measurement System

A.2.1 SAR Measurement Setup

The DASY6 system for performing compliance tests consists of the following items:

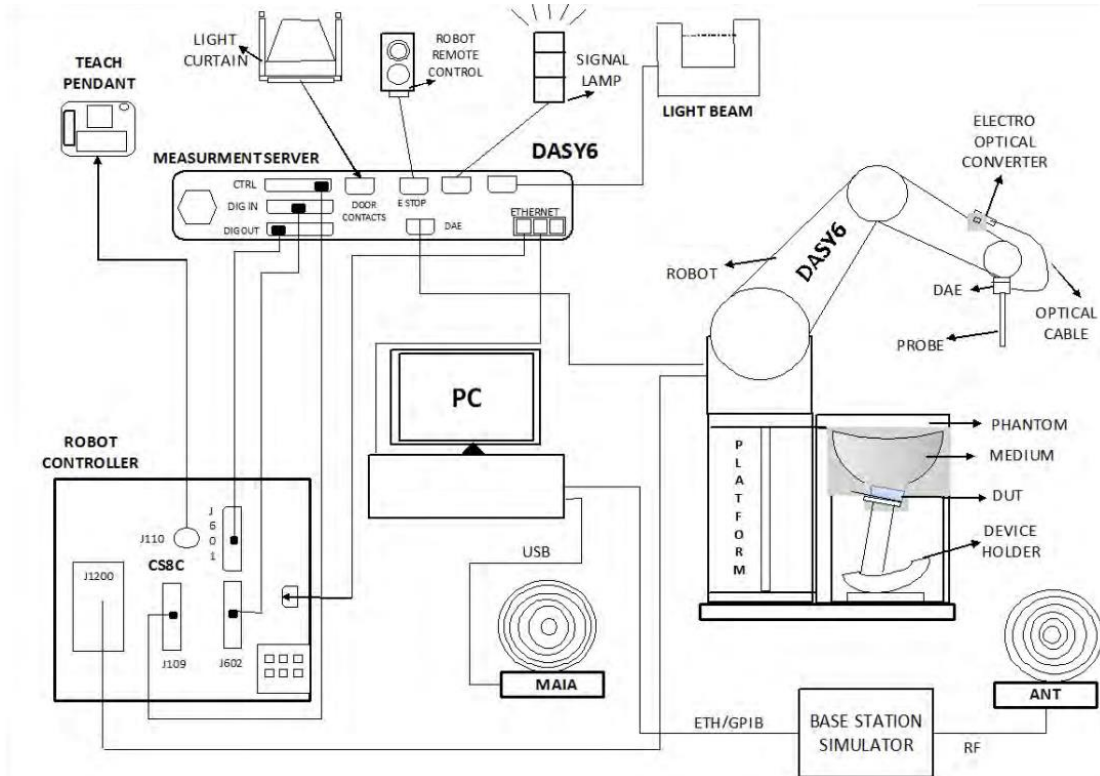

- ✓ A standard high precision 6-axis robot (Stäubli TX/RX family) with controller, teach pendant and software. It includes an arm extension for accommodating the data acquisition electronics (DAE)
- ✓ An isotropic field probe optimized and calibrated for the targeted measurements.
- ✓ A data acquisition electronics (DAE) which performs the signal amplification, signal multiplexing, AD-conversion, offset measurements, mechanical surface detection, collision detection, etc. The signal is optically transmitted to the EOC.
- ✓ The Electro-optical Converter (EOC) performs the conversion from optical to electrical signals for the digital communication to the DAE. The EOC signal is transmitted to the measurement server.
- ✓ The function of the measurement server is to perform the time critical tasks such as signal filtering, control of the robot operation and fast movements interrupts.
- ✓ The Light Beam used is for probe alignment. This improves the (absolute) accuracy of the probe positioning.
- ✓ A computer running Windows professional operating system and the DASY6 software.
- ✓ Remote control and teach pendant as well as additional circuitry for robot safety such as warning lamps, etc.
- ✓ The phantom, the device holder and other accessories according to the targeted measurement.
- ✓ MAIA is a hardware interface (Antenna) used to evaluate the modulation and audio interference characteristics of RF signals.
- ✓ ANT is an ultra-wideband antenna for use with the base station simulators over 698 MHz to 6GHz.
- ✓ The base station simulator is an equipment used for SAR cellular tests in order to emulate the cellular signals characteristics and behavior between a regular base station and the equipment under test.
- ✓ Tissue simulating liquid.
- ✓ System Validation dipoles.
- ✓ Network emulator.

A.2.2 E-Field Measurement Probe

The probe is constructed using three orthogonal dipole sensors arranged on an interlocking, triangular prism core. The probe has built-in shielding against static charges and is contained within a PEEK cylindrical enclosure material at the tip.

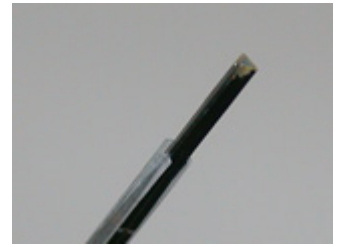

The probe's characteristics are:

Frequency Range	30MHz – 6GHz
Length	337 mm
Probe tip external diameter	2.5 mm
Typical distance between dipoles and the probe tip	1 mm
Axial Isotropy (in human-equivalent liquids)	±0.3 dB
Hemispherical Isotropy (in human-equivalent liquids)	±0.5 dB
Linearity	±0.2 dB
Maximum operating SAR	100 W/kg
Lower SAR detection threshold	0.001 W/kg

A.2.3 Flat Phantom

Phantom for compliance testing of handheld and body-mounted wireless devices in the frequency range of 30 MHz to 6 GHz. ELI is fully compatible with the IEC 62209-2 standard and all known tissue simulating liquids. ELI has been optimized regarding its performance and can be integrated into our standard phantom tables. A cover prevents evaporation of the liquid. Reference markings on the phantom allow installation of the complete setup, including all predefined phantom positions and measurement grids, by teaching three points. The phantom is compatible with all SPEAG dosimetric probes and dipoles.

The phantom's characteristics are:

Material	Vinylester, glass fiber reinforced (VE-GF)
Shell thickness	2 mm ± 0.2 mm
Filling volume	30 Liters approx.
Dimensions	Major axis: 600mm / Minor axis: 400mm

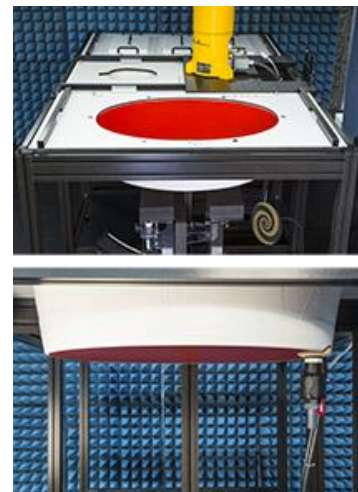

A.2.4 Device Positioner

The SAR in the phantom is approximately inversely proportional to the square of the distance between the source and the liquid surface. For a source at 5 mm distance, a positioning uncertainty of 0.5 mm would produce a SAR uncertainty of 20%. Accurate device positioning is therefore crucial for accurate and repeatable measurements. The positions in which the devices must be measured are defined by the standards.



The DASY device holder is designed to cope with the different positions given in the standard. It has two scales for device rotation (with respect to the body axis) and device inclination (with respect to the line between the ear reference points). The rotation center for both scales is the ear reference point (ERP). Thus the device needs no repositioning when changing the angles.

The DASY device holder is constructed of low-loss POM material having the following dielectric parameters: relative permittivity $\epsilon=3$ and loss tangent $\delta=0.02$. The amount of dielectric material has been reduced in the closest vicinity of the device, since measurements have suggested that the influence of the clamp on the test results could thus be lowered.

A simple but effective and easy-to-use extension for the Mounting Device; facilitates testing of larger devices according to IEC 62209-2 (e.g., laptops, cameras, etc.); lightweight and fits easily on the upper part of the Mounting Device in place of the phone positioner. The extension is fully compatible with the Twin SAM, ELI and other Flat Phantoms.



A.3 Data Evaluation

- **Power Reference measurement**

The robot measures the E field in a specified reference position that can be either the selected section's grid reference point or a user point in this section at 4mm of the inner surface of the phantom, 2mm for frequencies above 3GHz.

- **Area Scan**

Measurement procedures for evaluating SAR from wireless handsets typically start with a coarse measurement grid to determine the approximate location of the local peak SAR values. This is known as the area-scan procedure. The SAR distribution is scanned along the inside surface of one side of the phantom head, at least for an area larger than the projection of the handset and antenna. The distance between the measured points and phantom surface should be less than 8 mm, and should remain constant (with variation less than ± 1 mm) during the entire scan in order to determine the locations of the local peak SAR with sufficient accuracy. The angle between the probe axis and the surface normal line is recommended but not required to be less than 30° . If this angle is larger than 30° and the closest point on the probe-tip housing to the phantom surface is closer than a probe diameter, the boundary effect may become larger and polarization dependent. This additional uncertainty needs to be analyzed and accounted for. To achieve this, modified test procedures and additional uncertainty analyses not described in this recommended practice may be required. The measurement and interpolation point spacing should be chosen such as to allow identification of the local peak locations to within one-half of the linear dimension of a side of the zoom-scan volume. Because a local peak having specific amplitude and steep gradients may produce a lower peak spatial-average SAR compared to peaks with slightly lower amplitude and less steep gradients, it is necessary to evaluate these other peaks as well. However, since the spatial gradients of local SAR peaks are a function of the wavelength inside the tissue-equivalent liquid and the incident magnetic field strength, it is not necessary to evaluate local peaks that are less than 2 dB or more below the global maximum peak. Two-dimensional spline algorithms (Brishoual et al. 2001; Press et al., 1996) are typically used to determine the peaks and gradients within the scanned area. If a peak is found at a distance from the scan border of less than one-half the edge dimension of the desired 1 g or 10 g cube, the measurement area should be enlarged if possible.

- **Zoom Scan**

To evaluate the peak spatial-average SAR values for 1 g or 10 g cubes, fine resolution volume scans, called zoom scans, are performed at the peak SAR locations identified during the area scan. The minimum zoom scan volume size should extend at least 1.5 times the edge dimension of a 1 g cube in all directions from the center of the scan volume, for both 1 g and 10 g peak spatial-average SAR evaluations. Along the phantom curved surfaces, the front face of the volume facing the tissue/liquid interface conforms to the curved boundary, to ensure that all SAR peaks are captured. The back face should be equally distorted to maintain the correct averaging mass. The flatness and orientation of the four side faces are unchanged from that of a cube whose orientation is within $\pm 30^\circ$ of the line normal to the phantom at the center of the cube face next to the phantom surface. The peak local SAR locations that were determined in the area scan (interpolated values) should be used for the centers of the zoom scans. If a scan volume cannot be centered due to proximity of a phantom shape feature, the probe should be tilted to allow scan volume enlargement. If probe tilt is not feasible, the zoom-scan origin may be shifted, but not by more than half of the 1 g or 10 g cube edge dimension.

After the zoom-scan measurement, extrapolations from the closest measured points to the surface, for example along lines parallel to the zoom-scan centerline, and interpolations to a finer resolution between all measured and extrapolated points are performed. Extrapolation algorithm considerations are described in 6.5.3, and 3-D spline methods (Brishoual et al., 2001; Kreyszig, 1983; Press et al., 1996) can be used for interpolation. The peak spatial-average SAR is finally determined by a numerical averaging of the local SAR values in the interpolation grid, using for example a trapezoidal algorithm for the integration (averaging).

In some areas of the phantom, such as the jaw and upper head regions, the angle of the probe with respect to the line normal to the surface may be relatively large, e.g., greater than $\pm 30^\circ$, which could increase the boundary effect error to a larger level. In these cases, during the zoom scan a change in the orientation of the probe, the phantom, or both is recommended but not required for the duration of the zoom scan, so that the angle between the probe axis and the line normal to the surface is within 30° for all measurement points.

- **Power Drift measurement**

The robot re-measures the E-Field in the same reference location measured at the Power Reference. The drift measurement gives the field difference in dB from the first to the last reference reading. This allows a user to monitor the power drift of the device under test that must remain within a maximum variation of $\pm 5\%$.

- **Post-processing**

The procedure for spatial peak SAR evaluation has been implemented according to the IEEE1528 and IEC 62209-1/2 standards. It can be conducted for 1g and 10g.

The software allows evaluations that combine measured data and robot positions, such as:

- ✓ Maximum search
- ✓ Extrapolation
- ✓ Boundary correction
- ✓ Peak search for averaged SAR

Interpolation between the measured points is performed when the resolution of the grid is not fine enough to compute the average SAR over a given mass.

Extrapolation routines are used to obtain SAR values between the lowest measurement points and the inner phantom surface. The extrapolation is determined by the surface detection distance and the probe sensor offset. Several measurements at different distances are necessary for the extrapolation.

A.4 System and Liquid Check

A.4.1 System Check

The system performance check verifies that the system operates within its specifications. System and operator errors can be detected and corrected. It is recommended that the system performance check be performed prior to any usage of the system in order to guarantee reproducible results.

The system performance check uses normal SAR measurements in a simplified setup with a well characterized source. This setup was selected to give a high sensitivity to all parameters that might fail or vary over time. The system check does not intend to replace the calibration of the components, but indicates situations where the system uncertainty is exceeded due to drift or failure.

In the simplified setup for system check, the EUT is replaced by a calibrated dipole and the power source is replaced by a controlled continuous wave generated by a signal generator. The calibrated dipole must be placed beneath the flat phantom section of the phantom at the correct distance.

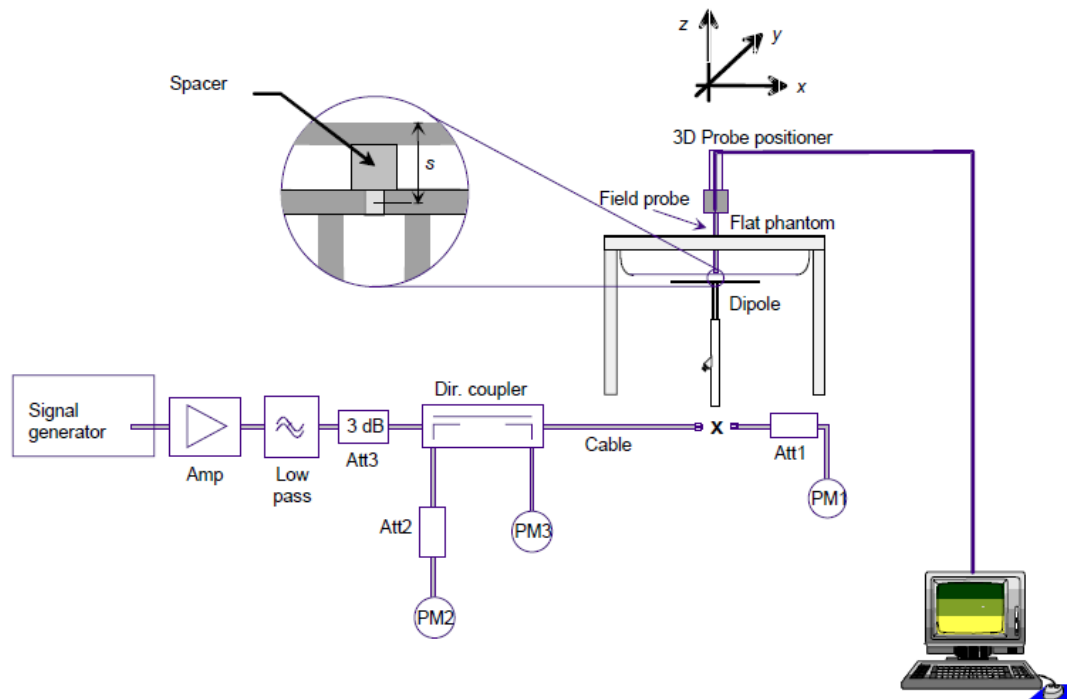

The equipment setup is shown below:

- ✓ Signal Generator
- ✓ Amplifier
- ✓ Directional coupler
- ✓ Power meter
- ✓ Calibrated dipole

First, the power meter PM1 (including attenuator Att1) is connected to the cable to measure the forward power at the location of the connector (x) to the system check source. The signal generator is adjusted for the desired forward power at the connector as read by power meter PM1 after attenuation Att1 and also as coupled through Att2 to PM2. After connecting the cable to the source, the signal generator is readjusted for the same reading at power meter PM2.

SAR results are normalized to a forward power of 1W to compare the values with the calibration reports results as described at IEEE 1528 and IEC 62209 standards.

A.4.2 Liquid Check

The dielectric parameters check is done prior to the use of the tissue simulating liquid. The verification is made by comparing the relative permittivity and conductivity to the values recommended by the applicable standards.

The liquid verification was performed using the following test setup:

- ✓ VNA (Vector Network Analyzer)
- ✓ Open-Short-Load calibration kit
- ✓ RF Cable
- ✓ Open-Ended Coaxial probe
- ✓ DAK software tool
- ✓ SAR Liquid
- ✓ De-ionized water
- ✓ Thermometer

These are the target dielectric properties of the tissue-equivalent liquid material as defined in FCC OET KDB 865664 D01.

Frequency (MHz)	Body SAR	
	ϵ_r (F/m)	σ (S/m)
150	61.9	0.80
300	58.2	0.92
450	56.7	0.94
835	55.2	0.97
900	55.0	1.05
1450	54.0	1.30
1800-2000	53.3	1.52
2450	52.7	1.95
3000	52.0	2.73
5800	48.2	6.00

(ϵ_r = relative permittivity, σ = conductivity and $\rho = 1000$ kg/m³)

The measurement system implement a SAR error compensation algorithm as documented in IEEE Std 1528-2013 (equivalent to draft standard IEEE P1528-2011) to automatically compensate the measured SAR results for deviations between the measured and required tissue dielectric parameters (applied to only scale up the measured SAR, and not downward) so, according to FCC OET KDB 865664 D01, the tolerance for ϵ_r and σ may be relaxed to $\pm 10\%$.

A.5 Test Equipment List

SAR system #3

ID #	Device	Type/Model	Serial Number	Manufacturer	Cal. Date	Cal. Due Date
003-000	6-Axis Robot	TX60 Lspeag	F17/59RCB1/A/01	STAÜBLI	NA	NA
003-001	Robot Controller	CS8C	F17/59RCB1/C/01	STAÜBLI	NA	NA
003-002	Oval Flat Phantom	ELI V5.0	1260	SPEAG	NA	NA
003-003	Light Beam Unit	SE UKS 030 AA	1170	Di-soric	NA	NA
003-004	Measurement Server	DASY6	1547	SPEAG	NA	NA
003-005	Electro Optical Converter	EOC60	1104	SPEAG	NA	NA
004-005	Measurement Software	DASY6 v16.0	9-658E90FA	SPEAG	NA	NA
004-006	Dosimetric E-Field probe	EX3DV4	7604	SPEAG	2023-09-08	2024-09-08
004-014	Data Acquisition Electronics	DAEip	1704	SPEAG	2023-04-18	2024-04-18
003-009	Laptop Holder	N/A	N/A	SPEAG	NA	NA

Shared equipment

ID #	Device	Type/Model	Serial Number	Manufacturer	Cal. Date	Cal. Due Date
123-000	USB Power Sensor	NRP-Z81	102278	R&S	2023-04-18	2025-04-18
124-000	USB Power Sensor	NRP-Z81	102279	R&S	2023-04-18	2025-04-18
077-000	Coupler	CD0.5-8-20-30	1251-002	Amd-group	2023-02-20	2024-02-20
079-001	RF Cable	CBL-0.5M-SMSM+	226527	Mini-Circuits	2023-02-20	2024-02-20
167-001	RF Cable	CBL-2M-SMSM+	233846	Mini-Circuits	2023-02-20	2024-02-20
198-000	0.8-21GHz RF amplifier	TVA-82-213A+	2004003	Mini-Circuits	2023-02-20	2024-02-20
129-000	Signal Generator	SMB100A	178212	R&S	2022-12-19	2024-12-19
496-000	Temp & Humidity Logger	RA32E-TH1-RAS	RA32-FBFD5A	AVTECH	2023-07-25	2024-07-25
099-000	Liquid measurement SW	DAK-3.5 V3.0.2.3	9-2687B491	SPEAG	NA	NA
369-000	Dielectric Probe Kit	DAK-3.5	1309	SPEAG	2023-03-13	2025-03-13
451-000	Vector Reflectometer R140	PLANAR R140	21190006	Copper Mountain	2021-11-09	2023-11-09
339-000	VNA Analyzer ZNB 40	ZNB 40	101740	R&S	2023-05-19	2025-05-19
405-000	System Validation Dipole 3500MHz	D3.5GHzV2	1123	SPEAG	2022-04-05	2024-04-05
404-000	System Validation Dipole 3700MHz	D3.7GHzV2	1093	SPEAG	2022-04-05	2024-04-05
071-000	750 MHz System Validation Dipole	D750V3	1136	SPEAG	2021-01-21	2024-01-21
023-000	5G Network Emulator	CMX500	101444	R&S	2022-08-24	2024-08-24

A.5.1 Tissue Simulant Liquid

TSL	Manufacturer / Model	Freq Range (MHz)	Main Ingredients
Body WideBand	SPEAG MBBL600-6000V6 Batch 220309-01	600-6000	Ethenediol, Sodium petroleum sulfonate, Hexylene Glycol / 2-Methyl-pentane-2.4-diol, Alkoxyated alcohol

A.6 Measurement Uncertainty Evaluation

The system uncertainty evaluation is shown in the table below with a coverage factor of $k = 2$ to indicate a 95% level of confidence:

SPEAG DASY6 Uncertainty Budget								
According to IEC/IEEE 62209-1528 (4 MHz - 6 GHz)								
including IEEE 1528-2013 and IEC 62209-1/2016, IEC 62209-2/2010								
Symbol	Error Description	Uncert. Value	Prob. Dist.	Div.	(ci) 1g	(ci) 10g	Std Unc. (1g)	Std Unc. (10g)
Measurement System Errors								
CF	Probe Calibration	±14.0 %	N	2	1	1	±7.0 %	±7.0 %
CF _{drift}	Probe Calibration Drift	±1.0 %	N	1	1	1	±1.0 %	±1.0 %
LIN	Probe Linearity	±4.7 %	R	√3	1	1	±2.7 %	±2.7 %
BBS	Broadband Signal	±3.0 %	N	2	1	1	±1.5 %	±1.5 %
ISO	Axial Isotropy	±4.7 %	R	√3	0.5	0.5	±1.4 %	±1.4 %
ISO	Hemispherical Isotropy	±9.6 %	R	√3	0.5	0.5	±2.8 %	±2.8 %
DAE	Data Acquisition	±0.3 %	N	1	1	1	±0.3 %	±0.3 %
AMB	RF Ambient	±1.8 %	N	1	1	1	±1.8 %	±1.8 %
Δ _{sys}	Probe Positioning	±0.2 %	N	1	0.33	0.33	±0.1 %	±0.1 %
DAT	Data Processing	±2.3 %	N	1	1	1	±2.3 %	±2.3 %
Phantom and Device Errors								
LIQ(σ)	Conductivity (meas.) _{DAK}	±2.5 %	N	1	0.78	0.71	±2.0 %	±1.8 %
LIQ(Tσ)	Conductivity (temp.) _{BB}	±3.4 %	R	√3	0.78	0.71	±1.5 %	±1.4 %
EPS	Phantom Permittivity	±14.0 %	R	√3	0.25	0.25	±2.0 %	±2.0 %
DAS	Distance DUT - TSL	±2.0 %	N	1	2	2	±4.0 %	±4.0 %
H	Device Holder	±3.6 %	N	1	1	1	±3.6 %	±3.6 %
MOD	DUT Modulation _m	±2.4 %	R	√3	1	1	±1.4 %	±1.4 %
TAS	Time-average SAR	±2.6 %	R	√3	1	1	±1.5 %	±1.5 %
RF _{drift}	DUT drift	±5.0 %	N	1	1	1	±2.9 %	±2.9 %
Correction to the SAR results								
C(ε, σ)	Deviation to Target	±1.9 %	N	1	1	0.84	±1.9 %	±1.6 %
Combined Std. Uncertainty							±11.5 %	±11.4 %
Expanded STD Uncertainty							±23.1 %	±22.9 %

A.7 RF Exposure Limits

SAR assessments have been made in line with the requirements of FCC 47 CFR Part 2.1093 and ISED RSS 102 issue 5 on the limitation of exposure of the general population / uncontrolled exposure for portable devices.

Exposure Type	General Population / Uncontrolled Environment
Peak spatial-average SAR (averaged over any 1 gram of tissue)	1.6 W/kg
Whole body average SAR	0.08 W/kg
Peak spatial-average SAR (extremities) (averaged over any 10 grams of tissue)	4.0 W/kg

Annex B. Test Results

The herein test results were performed by:

Test case measurement	Test Personnel
SAR measurement	Y.Haddad
Conducted measurement	A. A.Gilbert

B.1 Test Conditions

B.1.1 Test SAR Test positions relative to the phantom

The device under test was a HSN-I45C card inside a convertible PC host platform (HP) using a PIFA antenna. The card was operated utilizing proprietary software (RD Tool v1.0.3.2) and each channel was measured using a communication tester to determine the maximum average power.

The device has 2 power setting:

- Notebook mode
- Tablet mode

See section 6 for details about power values for each configuration.

See Annex F.2 for information about the existing configurations.

In the same manner the required test positions analysis is done considering the two possible user configurations and power levels for each one

Notebook mode

The highest tune up power for this mode is 27dBm in LTE41 PC2. Notebook mode can be reduced given the distance of the antenna to the measurement point and the above maximum power. For more details refer to section B.1.3.1

Tablet mode

According to FCC OET KDB 616217 D04, the back surface and edges of the tablet should be tested for SAR compliance with the tablet touching the phantom. The SAR Test Exclusion Threshold in FCC OET KDB 447498 D01 can be applied to determine SAR test exclusion for adjacent edge configurations. (See section 6 for power specifications)

The reduced power values shown on section 6 and the closest distance from the antenna to an adjacent tablet edge is used to determine if SAR testing is required for the adjacent edges, with the adjacent edge positioned against the phantom and the edge containing the antenna positioned perpendicular to the phantom.

Considering the antenna location diagrams in Annex F and the test exclusions described before, the surfaces/edges to be measured for each antenna are:

Tablet	WWAN Man 5	WWAN Aux 8
Position	Top Edge Back Face Right Edge	Top Edge Back Face

Annex F for more information on the tested positions

B.1.2 Test signal, Output power and Test Frequencies

B.1.2.1 TDD consideration

According to KDB 941225 D05 SAR for LTE Devices, for Time-Division Duplex (TDD) systems, SAR must be tested using a fixed periodic duty factor according to the highest transmission duty factor implemented for the device and supported by the defined 3GPP LTE TDD configurations.

LTE TDD Bands support 3GPP TS 36.211 section 4.2 for Type 2 Frame structure and table 2 for uplink-downlink configurations and table 1 for special subframe configurations

Table 1

Special subframe configuration	Normal cyclic prefix in downlink			Extended cyclic prefix in downlink		
	DwPTS	UpPTS		DwPTS	UpPTS	
		Normal cyclic prefix in uplink	Extended cyclic prefix in uplink		Normal cyclic prefix in uplink	Extended cyclic prefix in uplink
0	6592 T _s	(1+X) 2192 T _s	(1+X) 2560 T _s	7680 · T _s	(1+X) 2192 T _s	(1+X) 2560 T _s
1	19760 T _s			20480 T _s		
2	21952 T _s			23040 T _s		
3	24144 T _s			25600 T _s		
4	26336 T _s			7680 T _s		
5	6592 T _s	(2+X) 2192 T _s	(2+X) 2560 T _s	20480 T _s	(2+X) 2192 T _s	(2+X) 2560 T _s
6	19760 T _s			23040 T _s		
7	21952 T _s			12800 T _s		
8	24144 T _s			-		
9	13168 T _s			-		
10	13168 T _s	13150 T _s	12800 T _s	-	-	-

Table 2

Uplink-Downlink Config.	Downlink-to-Uplink Switch-point Periodicity	Subframe Number										Calculated Duty Cycle (%)
		0	1	2	3	4	5	6	7	8	9	
0	5 ms	D	S	U	U	U	D	S	U	U	U	63.3%
1	5 ms	D	S	U	U	D	D	S	U	U	D	43.3%
2	5 ms	D	S	U	D	D	D	S	U	D	D	23.3%
3	10 ms	D	S	U	U	U	D	D	D	D	D	31.7%
4	10 ms	D	S	U	U	D	D	D	D	D	D	21.7%
5	10 ms	D	S	U	D	D	D	D	D	D	D	11.7%
6	5 ms	D	S	U	U	U	D	S	U	U	D	53.3%

Calculated duty cycle = Extended cyclic prefix in uplink * (T_s) * # of S + # of U / period

The configuration used for SAR testing was the number 0 which corresponds to the highest duty cycle (Power Class 3) Frame structure and maximal measured duty cycle for NR 5G FR1 are described in the table 3.

B.1.2.2 5G NR TDD consideration

Table 3

Subframe Number																			
Radio Frame 0																			
SF0	SF1	SF2	SF3	SF4	SF5	SF6	SF7	SF8	SF9	SF0	SF1	SF2	SF3	SF4	SF5	SF6	SF7	SF8	SF9
0	1	2	3	4	5	6	7	8	9	0	1	2	3	4	5	6	7	8	9
D	s	U	U	S	U	S	U	S	U	S	U	S	U	S	U	S	U	S	U
Radio Frame 1-2																			
SF0	SF1	SF2	SF3	SF4	SF5	SF6	SF7	SF8	SF9	SF0	SF1	SF2	SF3	SF4	SF5	SF6	SF7	SF8	SF9
0	1	2	3	4	5	6	7	8	9	0	1	2	3	4	5	6	7	8	9
S	U	S	U	S	U	S	U	S	U	S	U	S	U	S	U	S	U	S	U
Radio Frame 3																			
SF0	SF1	SF2	SF3	SF4	SF5	SF6	SF7	SF8	SF9	SF0	SF1	SF2	SF3	SF4	SF5	SF6	SF7	SF8	SF9
0	1	2	3	4	5	6	7	8	9	0	1	2	3	4	5	6	7	8	9
S	U	S	U	S	U	S	U	S	U	S	U	S	U	S	U	S	U	S	U

“D”: Full DL slot, “s”: partial slot, “S”: partial slot for PUSCH, “U”: full UL slot

B.2 Conducted Power Measurements

B.2.1 5G NR (FR1)

B.2.1.1 5G NR (FR1) Band 48 TDD Antenna 8

Band	BW	Modulation	Mode	RB Allocation	RB Offset	Factory upper tolerance (dBm)	Measured Output Power (dBm)				
							Frequency (MHz) / Channel				
							3570	3625	3680		
NR48	40	DFS-s OFDM	PI/2 BPSK	1RB Mid	0	18.00	638000	641668	645333		
			QPSK	1RB Low	0	18.00		16.57			
				1RB Mid	136	18.00		16.65			
				1RB High	270	18.00		17.38			
				50% RB Low	0	18.00		16.77			
				50% RB Mid	68	18.00		17.04			
				50% RB High	137	18.00		17.26			
				100% RB	0	18.00		17.16			
			16QAM	1RB Mid	0	18.00		17.07			
			64QAM	1RB Mid	0	18.00		16.56			
			256QAM	1RB Mid	0	18.00		16.71			
			CP-OFDM	QPSK	1RB Mid	0	18.00		16.97		
									16.60		
									Frequency (MHz) / Channel		
							3565	3625	3685		
							63766	641668	645666		
	30	DFS-s OFDM	QPSK	1RB Mid	0	18.00		17.01			
				50% RB Mid	0	18.00		17.23			
									Frequency (MHz) / Channel		
									3560	3625	3690
	20	DFS-s OFDM	QPSK	1RB Mid	0	18.00		17.01			
				50% RB Mid	0	18.00		17.23			
									637333	641668	646000
	15	DFS-s OFDM	QPSK	1RB Mid	0	18.00		17.01			
				50% RB Mid	0	18.00		17.23			
									Frequency (MHz) / Channel		
									3557.5	3625	3692.5
	10	DFS-s OFDM	QPSK	1RB Mid	0	18.00		17.04			
50% RB Mid				0	18.00		17.22				
								637166	641668	646166	
						Frequency (MHz) / Channel					
						3555	3625	3695			
						637000	641668	646333			
10	DFS-s OFDM	QPSK	1RB Mid	0	18.00		17.00				
			50% RB Mid	0	18.00		17.24				

B.2.1.1 5G NR (FR1) Band 71 FDD Antenna 5

Band	BW	Modulation	Mode	RB Allocation	RB Offset	Factory upper tolerance (dBm)	Measured Output Power (dBm)			
							Frequency (MHz) / Channel			
							673.0	680.5	688.0	
							134600	136100	137600	
NR71	20	DFS-s OFDM	PI/2 BPSK	1RB Mid	50	17.00		16.10		
			QPSK	1RB Low	0	17.00		16.05		
				1RB Mid	50	17.00		16.30		
				1RB High	99	17.00		16.21		
				50% RB Low	0	17.00		16.23		
				50% RB Mid	25	17.00		16.36		
				50% RB High	49	17.00		16.38		
				100% RB	0	17.00		16.36		
			16QAM	1RB Mid	50	17.00		16.07		
			64QAM	1RB Mid	50	17.00		16.21		
			256QAM	1RB Mid	50	17.00		16.06		
	CP-OFDM	QPSK	1RB Mid	50	17.00		16.16			
								Frequency (MHz) / Channel		
								670.5	680.5	690.5
								134100	136100	138100
	15	DFS-s OFDM	QPSK	1RB Mid	50	17.00		16.11		
				50% RB Mid	25	17.00		16.26		
								Frequency (MHz) / Channel		
								668.0	680.5	693.0
								133600	136100	138600
	10	DFS-s OFDM	QPSK	1RB Mid	50	17.00		16.06		
				50% RB Mid	25	17.00		16.14		
								Frequency (MHz) / Channel		
							665.5	680.5	695.5	
							133100	136100	139100	
5	DFS-s OFDM	QPSK	1RB Mid	50	17.00		16.23			
			50% RB Mid	25	17.00		16.34			

B.2.1.2 5G NR (FR1) Band 77 TDD Antenna 8

Band	BW	Modulation	Mode	RB Allocation	RB Offset	Factory upper tolerance (dBm)	Measured Output Power (dBm)					
							Frequency (MHz) / Channel					
NR77	100	DFS-s OFDM	PI/2 BPSK	1RB Low	0	18.00			3499.98			
			QPSK	1RB Low	0	18.00			16.72			
				1RB Mid	136	18.00			633332			
				1RB High	270	18.00			16.63			
				50% RB Low	0	18.00			17.70			
				50% RB Mid	68	18.00			16.91			
				50% RB High	137	18.00			17.29			
				100% RB	0	18.00			17.75			
			16QAM	1RB Low	0	18.00			17.39			
			64QAM	1RB Low	0	18.00			16.61			
	256QAM	1RB Low	0	18.00			16.85					
	CP-OFDM	QPSK	1RB Low	0	18.00			16.79				
								Frequency (MHz) / Channel				
										3499.98		
										633332		
	90	DFS-s OFDM	QPSK	1RB Low	0	18.00			16.64			
				50% RB Low	0	18.00			17.17			
								Frequency (MHz) / Channel				
										3499.98		
										633332		
	80	DFS-s OFDM	QPSK	1RB Low	0	18.00			16.62			
				50% RB Low	0	18.00			17.26			
								Frequency (MHz) / Channel				
										3499.98		
										633332		
	60	DFS-s OFDM	QPSK	1RB Low	0	18.00			16.71			
				50% RB Low	0	18.00			17.31			
								Frequency (MHz) / Channel				
									3499.98			
									633332			
50	DFS-s OFDM	QPSK	1RB Low	0	18.00			16.88				
			50% RB Low	0	18.00			17.4				
							Frequency (MHz) / Channel					
									3499.98			
									633332			
40	DFS-s OFDM	QPSK	1RB Low	0	18.00			16.73				
			50% RB Low	0	18.00			17.42				
							Frequency (MHz) / Channel					
									3499.98			
									633332			
20	DFS-s OFDM	QPSK	1RB Low	0	18.00			17.29				
			50% RB Low	0	18.00			17.54				

B.2.1.3 5G NR (FR1) UL Carrier Aggregation

For NR ULCA mode, each carrier transmits on separate antennas. Each exposure has been measured separately. For each, the highest standalone SAR conditions are added to derive the Total SAR. Refer to paragraph B.3.4 and B.3.5.

B.2.2 LTE

B.2.2.1 LTE band 71 FDD – Antenna 5

Band	BW	Channel #	Freq (MHz)	% RB Allocation	RB Position	QPSK			16 QAM		
						Factory Upper Tolerance (dBm)	M P R	Measured Output Power (dBm)	Factory Upper Tolerance (dBm)	M P R	Measured Output Power (dBm)
LTE71	20 MHz	133222	673	1RB Low	1 Pos 0	17.00	0	15.96	17.00	1	15.33
				1RB Mid	1 Pos 50	17.00	0	16.05	17.00	1	15.44
				1RB High	1 Pos 99	17.00	0	15.92	17.00	1	15.29
				50% RB Low	50 Pos 0	17.00	1	15.10	17.00	2	14.04
				50% RB Mid	50 Pos 24	17.00	1	15.06	17.00	2	14.06
				50% RB High	50 Pos 50	17.00	1	14.92	17.00	2	13.91
		100% RB	100 Pos 0	17.00	1	15.01	17.00	2	14.02		
		133297	680.5	1RB Low	1 Pos 0	17.00	0	15.88	17.00	1	15.45
				1RB Mid	1 Pos 50	17.00	0	16.13	17.00	1	15.57
				1RB High	1 Pos 99	17.00	0	15.90	17.00	1	15.34
				50% RB Low	50 Pos 0	17.00	1	15.10	17.00	2	14.12
				50% RB Mid	50 Pos 24	17.00	1	15.07	17.00	2	14.10
				50% RB High	50 Pos 50	17.00	1	15.10	17.00	2	14.13
		100% RB	100 Pos 0	17.00	1	15.08	17.00	2	14.09		
		133372	688	1RB Low	1 Pos 0	17.00	0	15.95	17.00	1	15.52
				1RB Mid	1 Pos 50	17.00	0	16.07	17.00	1	15.63
				1RB High	1 Pos 99	17.00	0	16.01	17.00	1	15.47
				50% RB Low	50 Pos 0	17.00	1	15.11	17.00	2	14.16
	50% RB Mid			50 Pos 24	17.00	1	15.13	17.00	2	14.13	
	50% RB High			50 Pos 50	17.00	1	15.06	17.00	2	14.09	
	100% RB	100 Pos 0	17.00	1	15.04	17.00	2	14.07			
	15 MHz	133197	670.5	1RB Low	1 Pos 0	17.00	0	15.97	17.00	1	15.41
				1RB Mid	1 Pos 38	17.00	0	16.11	17.00	1	15.49
				1RB High	1 Pos 74	17.00	0	15.99	17.00	1	15.39
				50% RB Low	38 Pos 0	17.00	1	15.12	17.00	2	14.20
				50% RB Mid	38 Pos 19	17.00	1	15.11	17.00	2	14.17
				50% RB High	38 Pos 39	17.00	1	15.01	17.00	2	14.11
		100% RB	75 Pos 0	17.00	1	15.13	17.00	2	14.14		
		133297	680.5	1RB Low	1 Pos 0	17.00	0	15.91	17.00	1	15.15
				1RB Mid	1 Pos 38	17.00	0	16.03	17.00	1	15.16
				1RB High	1 Pos 74	17.00	0	15.90	17.00	1	15.17
				50% RB Low	38 Pos 0	17.00	1	15.10	17.00	2	14.13
				50% RB Mid	38 Pos 19	17.00	1	15.09	17.00	2	14.14
				50% RB High	38 Pos 39	17.00	1	15.06	17.00	2	14.04
		100% RB	75 Pos 0	17.00	1	15.13	17.00	2	14.12		
		133397	690.5	1RB Low	1 Pos 0	17.00	0	16.07	17.00	1	15.86
				1RB Mid	1 Pos 38	17.00	0	16.11	17.00	1	15.88
				1RB High	1 Pos 74	17.00	0	16.06	17.00	1	15.75
				50% RB Low	38 Pos 0	17.00	1	15.02	17.00	2	14.03
	50% RB Mid			38 Pos 19	17.00	1	15.08	17.00	2	14.08	
	50% RB High			38 Pos 39	17.00	1	15.11	17.00	2	14.12	
	100% RB	75 Pos 0	17.00	1	15.10	17.00	2	14.11			
	10 MHz	133172	668	1RB Low	1 Pos 0	17.00	0	16.03	17.00	1	15.18
				1RB Mid	1 Pos 24	17.00	0	16.15	17.00	1	15.19
				1RB High	1 Pos 49	17.00	0	16.01	17.00	1	15.11
				50% RB Low	25 Pos 0	17.00	1	15.14	17.00	2	14.19
				50% RB Mid	25 Pos 12	17.00	1	15.08	17.00	2	14.23
				50% RB High	25 Pos 24	17.00	1	15.12	17.00	2	14.17
100% RB		50 Pos 0	17.00	1	15.20	17.00	2	14.21			
133297		680.5	1RB Low	1 Pos 0	17.00	0	16.09	17.00	1	15.42	
			1RB Mid	1 Pos 24	17.00	0	16.10	17.00	1	15.50	
			1RB High	1 Pos 49	17.00	0	16.02	17.00	1	15.40	
			50% RB Low	25 Pos 0	17.00	1	15.15	17.00	2	14.19	
			50% RB Mid	25 Pos 12	17.00	1	15.11	17.00	2	14.15	
			50% RB High	25 Pos 24	17.00	1	15.08	17.00	2	14.13	
100% RB		50 Pos 0	17.00	1	15.16	17.00	2	14.03			
133422		693	1RB Low	1 Pos 0	17.00	0	16.01	17.00	1	15.12	
			1RB Mid	1 Pos 24	17.00	0	16.07	17.00	1	15.18	
			1RB High	1 Pos 49	17.00	0	16.03	17.00	1	15.13	
			50% RB Low	25 Pos 0	17.00	1	15.12	17.00	2	14.17	
	50% RB Mid		25 Pos 12	17.00	1	15.09	17.00	2	14.15		
	50% RB High		25 Pos 24	17.00	1	15.06	17.00	2	14.11		
100% RB	50 Pos 0	17.00	1	15.13	17.00	2	14.09				

Band	BW	Channel #	Freq (MHz)	% RB Allocation	RB Position	QPSK			16 QAM		
						Factory Upper Tolerance (dBm)	M P R	Measured Output Power (dBm)	Factory Upper Tolerance (dBm)	M P R	Measured Output Power (dBm)
LTE71	5.0 MHz	133147	665.5	1RB Low	1 Pos 0	17.00	0	16.16	17.00	1	15.18
				1RB Mid	1 Pos 12	17.00	0	16.15	17.00	1	15.28
				1RB High	1 Pos 24	17.00	0	16.11	17.00	1	15.17
				50% RB Low	12 Pos 0	17.00	1	15.05	17.00	2	14.08
				50% RB Mid	12 Pos 6	17.00	1	15.15	17.00	2	14.14
				50% RB High	12 Pos 11	17.00	1	15.08	17.00	2	14.07
		100% RB	25 Pos 0	17.00	1	15.05	17.00	2	14.11		
		133297	680.5	1RB Low	1 Pos 0	17.00	0	16.03	17.00	1	15.64
				1RB Mid	1 Pos 12	17.00	0	16.12	17.00	1	15.68
				1RB High	1 Pos 24	17.00	0	16.09	17.00	1	15.63
				50% RB Low	12 Pos 0	17.00	1	15.10	17.00	2	14.22
				50% RB Mid	12 Pos 6	17.00	1	15.18	17.00	2	14.26
				50% RB High	12 Pos 11	17.00	1	15.12	17.00	2	14.23
		100% RB	25 Pos 0	17.00	1	15.10	17.00	2	14.02		
		133447	695.5	1RB Low	1 Pos 0	17.00	0	16.20	17.00	1	15.16
				1RB Mid	1 Pos 12	17.00	0	16.16	17.00	1	15.30
				1RB High	1 Pos 24	17.00	0	16.10	17.00	1	15.17
				50% RB Low	12 Pos 0	17.00	1	15.13	17.00	2	14.18
				50% RB Mid	12 Pos 6	17.00	1	15.06	17.00	2	14.14
				50% RB High	12 Pos 11	17.00	1	15.10	17.00	2	14.18
		100% RB	25 Pos 0	17.00	1	15.15	17.00	2	14.07		

B.3 Tissue Parameters Measurement

Body TSL

Body TSL	Target TSL		Measured TSL		Deviation %		Date
Freq (MHz)	ϵ' (F/m)	σ (S/m)	ϵ' (F/m)	σ (S/m)	Deviation ϵ'	Deviation σ	
750.0	55.53	0.96	54.60	0.92	1.93	-4.17	2023-12-13
3500	51.32	3.31	50.09	3.10	-2.40	-6.34	2023-12-18
3700	51.05	3.55	49.99	3.32	-2.08	-6.48	2023-12-13
3700	51.05	3.55	49.72	3.33	-2.34	-9.13	2023-12-18

See Annex D for more details.

B.4 System Check Measurements

Body Measurements

Frequency (MHz)	Average	Target SAR (W/kg)	Measured SAR (W/kg)	Forwarded power (mW)	Deviation to target (%)	Limit (%)	Date
3500	1g	63.70	64.20	50.00	0.78	±10	2023-12-18
	10g	23.60	24.00		1.69		
3700	1g	62.10	62.60		0.81		2023-12-18
	10g	22.20	23.20		4.50		
3700	1g	62.10	58.60		-5.64		2023-12-15
	10g	22.20	21.40		-3.60		
750	1g	8.75	8.06		2.40		2023-12-15
	10g	5.72	5.16		-1.05		

See Annex C for more details.

B.5 SAR Test Results

B.5.1 5G NR

B.5.1.1 5G NR 48 (3550 – 3700MHz)

Band	Antenna	Modulation / BW	Channel Number	Freq (MHz)	Position	% RB Allocation	Scaling Factor (dB)	Measured SAR 1g (W/kg)	Reported SAR 1g (W/kg)	Plot #	
NR48	Vendor2	QPSK / 40MHz	641668	3625.00	Back face	1RB Mid	0.62	0.08	0.09		
						50RB Mid	0.74	0.08	0.09		
	1RB Mid					0.62	0.07	0.09			
	50RB Mid					0.74	0.10	0.12			
	Vendor1				Vendor2	Top edge	1RB Mid	0.62	0.68	0.78	
							50RB Mid	0.74	0.54	0.64	
					Vendor1		1RB Mid	0.62	0.68	0.78	1
							50RB Mid	0.74	0.52	0.61	

B.5.1.2 5G NR 71

Band	Antenna	Modulation / BW	Channel Number	Freq (MHz)	Position	% RB Allocation	Scaling Factor (dB)	Measured SAR 1g (W/kg)	Reported SAR 1g (W/kg)	Plot #
NR71	Vendor2	QPSK / 20MHz	136100	680.5	Back face	1RB Mid	0.70	0.08	0.09	
						50RB Mid	0.64	0.09	0.10	
	1RB Mid					0.70	0.06	0.07		
	50RB Mid					0.64	0.06	0.07		
	Vendor1				Top edge	1RB Mid	0.70	0.56	0.66	
						50RB Mid	0.64	0.62	0.72	3
						1RB Mid	0.70	0.39	0.45	
						50RB Mid	0.64	0.39	0.45	
	Vendor2				Right edge	1RB Mid	0.70	0.02	0.03	
						50RB Mid	0.64	0.03	0.04	
						1RB Mid	0.70	0.03	0.04	
						50RB Mid	0.64	0.03	0.03	
Vendor1	Right edge	1RB Mid	0.70	0.03	0.04					
		50RB Mid	0.64	0.03	0.03					
		1RB Mid	0.70	0.03	0.04					
		50RB Mid	0.64	0.03	0.03					

B.5.1.3 5G NR 77 (3450 – 3550MHz)

Band	Antenna	Modulation / BW	Channel Number	Freq (MHz)	Position	% RB Allocation	Scaling Factor (dB)	Measured SAR 1g (W/kg)	Reported SAR 1g (W/kg)	Plot #
NR77	Vendor2	QPSK / 100MHz	633332	3499.98	Back face	1RB Mid	0.30	0.06	0.07	
						50RB Mid	0.25	0.08	0.09	
	1RB Mid					0.30	0.07	0.07		
	50RB Mid					0.25	0.15	0.16		
	Vendor1				Top edge	1RB Mid	0.30	0.48	0.51	
						50RB Mid	0.25	0.49	0.52	
						1RB Mid	0.30	0.74	0.79	2
						50RB Mid	0.25	0.74	0.78	

B.5.2 ENDC

For EN-DC mode, the 4G and 5G carriers transmit on separate antennas. Each exposure has been measured separately. For both LTE and 5G-NR, the highest standalone SAR conditions are added to derive the Total SAR.

B.5.3 LTE**B.5.3.1 LTE Band 71 FDD**

Band	Antenna	Modulation / BW	Channel Number	Freq (MHz)	Position	% RB Allocation	Scaling Factor (dB)	Measured SAR 1g (W/kg)	Reported SAR 1g (W/kg)	Plot #
LTE71	Vendor2	QPSK / 20MHz	136100	680.5	Back face	1RB Mid	0.87	0.01	0.01	
						50RB Mid	0.93	0.09	0.11	
	1RB Mid					0.93	0.06	0.07		
	50RB Mid					0.92	0.06	0.07		
	Vendor1				Top edge	1RB Mid	0.87	0.62	0.76	4
						50RB Mid	0.93	0.53	0.66	
						1RB Mid	0.87	0.42	0.51	
						50RB Mid	0.93	0.41	0.51	
	Vendor2				Right edge	1RB Mid	0.03	0.03	0.03	
						50RB Mid	0.03	0.03	0.03	
						1RB Mid	0.87	0.02	0.03	
						50RB Mid	0.93	0.02	0.03	
Vendor1	Right edge	1RB Mid	0.03	0.03	0.03					
		50RB Mid	0.03	0.03	0.03					
		1RB Mid	0.87	0.02	0.03					
		50RB Mid	0.93	0.02	0.03					

B.6.1 SAR Measurement Variability

According to FCC OET KDB 865664, SAR Measurement variability is assessed when the maximum initial measured SAR is ≥ 0.8 W/kg for a certain band/mode. If the measured SAR value of the initial repeated measurement is < 1.45 W/kg with $< 20\%$ variation, only one repeated measurement is required to confirm that the results are not expected to have substantial variations.

As all measured SAR results are below 0.8W/kg, therefore SAR variability is not required.

B.6.2 Simultaneous Transmission SAR Evaluation

According to FCC OET KDB 447498 D01, when the sum of 1g SAR for all simultaneously transmitting antennas in an operating mode and exposure condition combination is within the SAR limit, SAR test exclusion applies to that simultaneous transmission configuration.

All the values stated in the table below are the worst case found for standalone measurement with disregard of the transmission mode or channel where the worst case was found.

Antenna	Position	Highest Reported SAR (1g) (W/kg)			
		WWAN	WLAN 2.4GHz	WLAN 5GHz	Bluetooth
Main WWAN	Back face	0.11			
Aux WWAN		0.16			
Main WLAN			0.40*	0.40*	
Aux WLAN			0.40*	0.40*	0.40*
Main WWAN	Top edge	0.76			
Aux WWAN		0.79			
Main WLAN			0.40*	0.40*	
Aux WLAN			0.40*	0.40*	0.40*
Main WWAN	Right edge	0.04			
Aux WWAN		0.40*			
Main WLAN			0.40*	0.40*	
Aux WLAN			0.40*	0.40*	0.40*

*According to FCC OET KDB 447498 D01, when standalone test exclusion is applied to an antenna that transmits simultaneously with other antennas, the standalone SAR must be estimated to 0.4 W/Kg for 1-g SAR when the test separation is > 50 mm in order to determine simultaneous transmission test exclusion.

Position	Simultaneous Tx Antenna Combination					Σ SAR 1g (W/Kg)	Limit (W/kg)
	#	WWAN Main Ant5	WWAN Aux Ant8	WLAN Main	WLAN Aux		
Back face	1	Cellular	Cellular	WLAN 5/6GHz	WLAN 5/6GHz	1.07	1.6
	2	Cellular	Cellular	WLAN 5/6GHz	WLAN 5/6GHz+ BT	1.47	
	3	Cellular	Cellular	WLAN 5/6GHz	BT	1.07	
	4	Cellular	Cellular	WLAN 2.4GHz	WLAN 2.4GHz	1.07	
	5	Cellular	Cellular	WLAN 2.4GHz	BT	1.07	
Top edge	1	Cellular	Cellular	WLAN 5/6GHz	WLAN 5/6GHz	2.35	
	2	Cellular	Cellular	WLAN 5/6GHz	WLAN 5/6GHz+ BT	2.75	
	3	Cellular	Cellular	WLAN 5/6GHz	BT	2.35	
	4	Cellular	Cellular	WLAN 2.4GHz	WLAN 2.4GHz	2.35	
	5	Cellular	Cellular	WLAN 2.4GHz	BT	2.35	
Right edge	1	Cellular	Cellular	WLAN 5/6GHz	WLAN 5/6GHz	1.24	
	2	Cellular	Cellular	WLAN 5/6GHz	WLAN 5/6GHz+ BT	1.64	
	3	Cellular	Cellular	WLAN 5/6GHz	BT	1.24	
	4	Cellular	Cellular	WLAN 2.4GHz	WLAN 2.4GHz	1.24	
	5	Cellular	Cellular	WLAN 2.4GHz	BT	1.24	

In case the sum of SAR is larger than the limit, SAR test exclusion is determined by the SAR to peak location separation ratio (SPLSR). According to the last table possible simultaneous transmission combinations are identified for each position from 1 to 5, each combination will be analyzed by antenna pairs. Antenna pairs considered in one configuration won't be performed again in case they are repeated on the next simultaneous configuration:

Position	Ant. Pair case	Antenna	Reported SAR 1g (W/kg)	Σ SAR 1g (W/kg)	Peak Location (mm) (x,y,z)	SAR to peak location separation ratio	Limit
Top edge	1a	WWAN (Main Ant5)	0.76	1.55			0.04
		WWAN (Aux Ant8)	0.79				
	1b	WWAN (Main Ant5)	0.76	1.16			
		Main WLAN 5/6GHz	0.40				
	1c	WWAN (Main Ant5)	0.76	1.16			
		Aux WLAN 5/6GHz	0.40				
	1d	WWAN (Aux Ant8)	0.79	1.19			
		Main WLAN 5/6GHz	0.40				
	1e	WWAN (Aux Ant8)	0.79	1.19			
		Aux WLAN 5/6GHz	0.40				
	1f	Main WLAN 5GHz	0.40	0.80			
		Aux WLAN 5/6GHz	0.40				
	2a	WWAN (Main Ant5)	0.76	1.16			
		Aux WLAN1 BT	0.40				
	2b	WWAN (Aux Ant8)	0.79	1.19			
Aux WLAN1 BT		0.40					
4a	WWAN (Main Ant5)	0.76	1.16				
	Main WLAN 2.4GHz	0.40					
4b	WWAN (Main Ant5)	0.76	1.16				
	Aux WLAN 2.4GHz	0.40					
4c	WWAN (Aux Ant8)	0.79	1.19				
	Main WLAN 2.4GHz	0.40					
4d	WWAN (Aux Ant8)	0.79	1.19				
	Aux WLAN 2.4GHz	0.40					
4e	Main WLAN 2.4GHz	0.40	0.80				
	Aux WLAN1 2.4GHz	0.40					

Position	Ant. Pair case	Antenna	Reported SAR 1g (W/kg)	Σ SAR 1g (W/Kg)	Peak Location (mm) (x,y,z)	SAR to peak location separation ratio	Limit
Right edge	1a	WWAN (Main Ant5)	0.04	0.44			0.04
		WWAN (Aux Ant8)	0.40				
	1b	WWAN (Main Ant5)	0.04	0.44			
		Main WLAN 5/6GHz	0.40				
	1c	WWAN (Main Ant5)	0.04	0.44			
		Aux WLAN 5/6GHz	0.40				
	1d	WWAN (Aux Ant8)	0.40	0.80			
		Main WLAN 5/6GHz	0.40				
	1e	WWAN (Aux Ant8)	0.40	0.80			
		Aux WLAN 5/6GHz	0.40				
	1f	Main WLAN 5GHz	0.40	0.80			
		Aux WLAN 5/6GHz	0.40				
	2a	WWAN (Main Ant5)	0.04	0.44			
		Aux WLAN1 BT	0.40				
	2b	WWAN (Aux Ant8)	0.40	0.80			
		Aux WLAN1 BT	0.40				
	4a	WWAN (Main Ant5)	0.04	0.44			
		Main WLAN 2.4GHz	0.40				
	4b	WWAN (Main Ant5)	0.04	0.44			
		Aux WLAN 2.4GHz	0.40				
4c	WWAN (Aux Ant8)	0.40	0.80				
	Main WLAN 2.4GHz	0.40					
4d	WWAN (Aux Ant8)	0.40	0.80				
	Aux WLAN 2.4GHz	0.40					
4e	Main WLAN 2.4GHz	0.40	0.80				
	Aux WLAN1 2.4GHz	0.40					

Considering the results described above and according to the simultaneous transmission evaluation exclusions described in FCC OET KDB 447498 D01, no SPLSR nor enlarged zoom scan measurements are required.

Annex C. Test System Plots

1. 5G NR FR1 Band 48, QPSK - 40MHz, CH641668, Antenna Vendor1, Top edge.....	38
2. 5G NR FR1 Band 77, QPSK - 100MHz, CH633332, Antenna Vendor1, Top edge.....	39
3. 5G NR FR1 Band 71, QPSK - 20MHz, CH136100, Antenna Vendor2, Top edge.....	40
4. LTE Band 71, QPSK - 20MHz, CH136100, Antenna Vendor2, Top edge.....	41
5. System Check Body Liquid 3500MHz	42
6. System Check Body Liquid 3700MHz – 2023-12-18	43
7. System Check Body Liquid 3700MHz – 2023-12-15	44
8. System Check Body Liquid 750MHz	45

1. 5G NR FR1 Band 48, QPSK - 40MHz, CH641668, Antenna Vendor1, Top edge

Device under Test Properties

Name, Manufacturer	Dimensions [mm]	S/N	DUT Type
HSN-I45C,HP	220.0 x 320.0 x 8.0	0001760BBY	Convertible PC

Exposure Conditions

Phantom Section, TSL	Position, Test Distance [mm]	Band	Group, UID	Frequency [MHz], Channel Number	Conversion Factor	TSL Conductivity [S/m]	TSL Permittivity
Flat, MSL	EDGE TOP, 0.00	Band n48	5G NR FR1 TDD, 10803-AAD	3625.000, 641667	6.62	3.23	50.1

Hardware Setup

Phantom	TSL, Measured Date	Probe, Calibration Date	DAE, Calibration Date
ELI V8.0 (20deg probe tilt)	MBBL-600-6000, 2023-Dec-13	EX3DV4 - SN7604, 2023-09-08	DAE4ip Sn1704, 2023-04-18

Scan Setup

	Area Scan	Zoom Scan
Grid Extents [mm]	100.0 x 100.0	28.0 x 28.0 x 28.0
Grid Steps [mm]	10.0 x 10.0	5.0 x 5.0 x 1.4
Sensor Surface [mm]	3.0	1.4
Graded Grid	Yes	Yes
Grading Ratio	1.5	1.5
MAIA	Confirmed by MAIA	Confirmed by MAIA
Surface Detection	VMS + 6p	VMS + 6p
Scan Method	Measured	Measured

Measurement Results

	Area Scan	Zoom Scan
Date	2023-12-15, 14:53	2023-12-15, 15:00
psSAR1g [W/kg]	0.754	0.680
psSAR10g [W/kg]	0.287	0.257
Power Drift [dB]	-0.21	-0.13
Power Scaling	Disabled	Disabled
Scaling Factor [dB]		
TSL Correction	Positive Only	Positive Only
M2/M1 [%]		69.5
Dist 3dB Peak [mm]		7.7

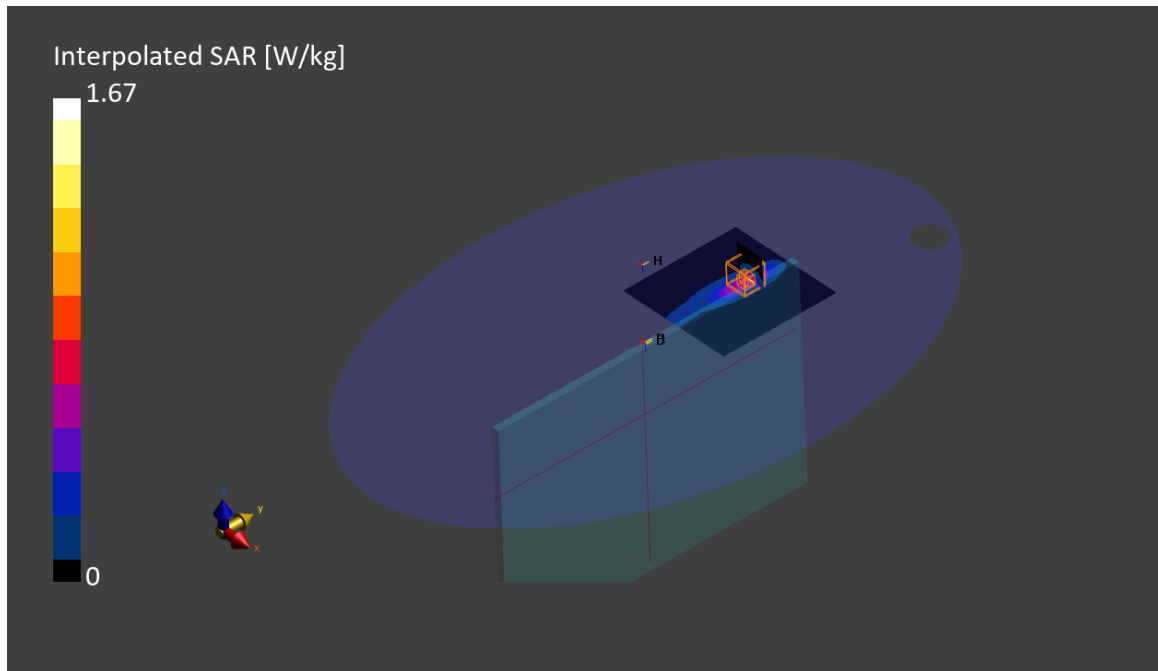

2. 5G NR FR1 Band 77, QPSK - 100MHz, CH633332, Antenna Vendor1, Top edge

Device under Test Properties

Name, Manufacturer	Dimensions [mm]	S/N	DUT Type
HSN-I45C,HP	220.0 x 320.0 x 8.0	0001760BBY	Convertible PC

Exposure Conditions

Phantom Section, TSL	Position, Test Distance [mm]	Band	Group, UID	Frequency [MHz], Channel Number	Conversion Factor	TSL Conductivity [S/m]	TSL Permittivity
Flat, MSL	EDGE TOP, 0.00	Band n77	5G NR FR1 TDD, 10866-AAD	3499.98, 633332	6.37	3.10	50.1

Hardware Setup

Phantom	TSL, Measured Date	Probe, Calibration Date	DAE, Calibration Date
ELI V8.0 (20deg probe tilt)	MBBL-600-6000, 2023-Dec-18	EX3DV4 - SN7604, 2023-09-08	DAE4ip Sn1704, 2023-04-18

Scan Setup

	Area Scan	Zoom Scan
Grid Extents [mm]	100.0 x 100.0	28.0 x 28.0 x 28.0
Grid Steps [mm]	10.0 x 10.0	5.0 x 5.0 x 1.4
Sensor Surface [mm]	3.0	1.4
Graded Grid	Yes	Yes
Grading Ratio	1.5	1.5
MAIA	Confirmed by MAIA	Confirmed by MAIA
Surface Detection	VMS + 6p	VMS + 6p
Scan Method	Measured	Measured

Measurement Results

	Area Scan	Zoom Scan
Date	2023-12-18, 09:43	2023-12-18, 09:51
psSAR1g [W/kg]	0.648	0.735
psSAR10g [W/kg]	0.251	0.268
Power Drift [dB]	-0.00	0.01
Power Scaling	Disabled	Disabled
Scaling Factor [dB]		
TSL Correction	Positive Only	Positive Only
M2/M1 [%]		77.1
Dist 3dB Peak [mm]		7.3

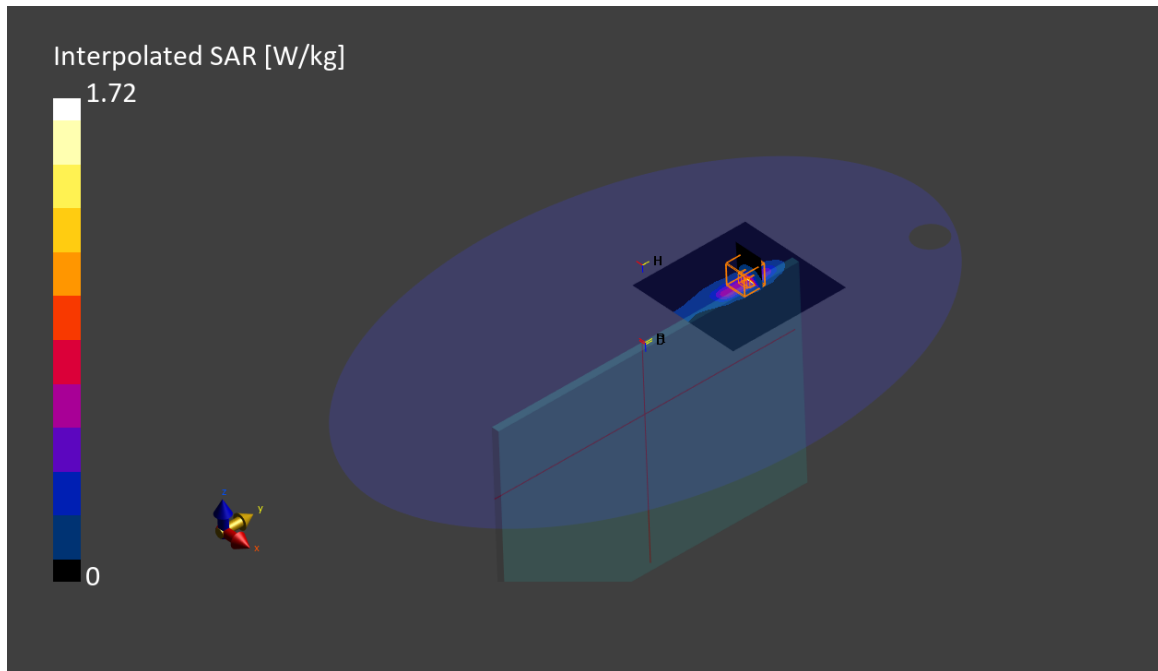

3. 5G NR FR1 Band 71, QPSK - 20MHz, CH136100, Antenna Vendor2, Top edge

Device under Test Properties

Name, Manufacturer	Dimensions [mm]	S/N	DUT Type
HSN-I45C,HP	220.0 x 320.0 x 8.0	0001760BBT	Convertible PC

Exposure Conditions

Phantom Section, TSL	Position, Test Distance [mm]	Band	Group, UID	Frequency [MHz], Channel Number	Conversion Factor	TSL Conductivity [S/m]	TSL Permittivity
Flat, MSL	EDGE TOP, 0.00	Band n71	5G NR FR1 FDD, 10939-AAB	680.500, 136100	11.32	0.896	54.8

Hardware Setup

Phantom	TSL, Measured Date	Probe, Calibration Date	DAE, Calibration Date
ELI V8.0 (20deg probe tilt)	MABL-600-6000, 2023-Dec-13	EX3DV4 - SN7604, 2023-09-08	DAE4ip Sn1704, 2023-04-18

Scan Setup

	Area Scan	Zoom Scan
Grid Extents [mm]	120.0 x 120.0	30.0 x 30.0 x 30.0
Grid Steps [mm]	15.0 x 15.0	6.0 x 6.0 x 1.5
Sensor Surface [mm]	3.0	1.4
Graded Grid	Yes	Yes
Grading Ratio	1.5	1.5
MAIA	Confirmed by MAIA	Confirmed by MAIA
Surface Detection	VMS + 6p	VMS + 6p
Scan Method	Measured	Measured

Measurement Results

	Area Scan	Zoom Scan
Date	2023-12-15, 13:59	2023-12-15, 14:05
psSAR1g [W/kg]	0.571	0.622
psSAR10g [W/kg]	0.335	0.295
Power Drift [dB]	-0.05	0.12
Power Scaling	Disabled	Disabled
Scaling Factor [dB]		
TSL Correction	Positive Only	Positive Only
M2/M1 [%]		68.5
Dist 3dB Peak [mm]		7.2

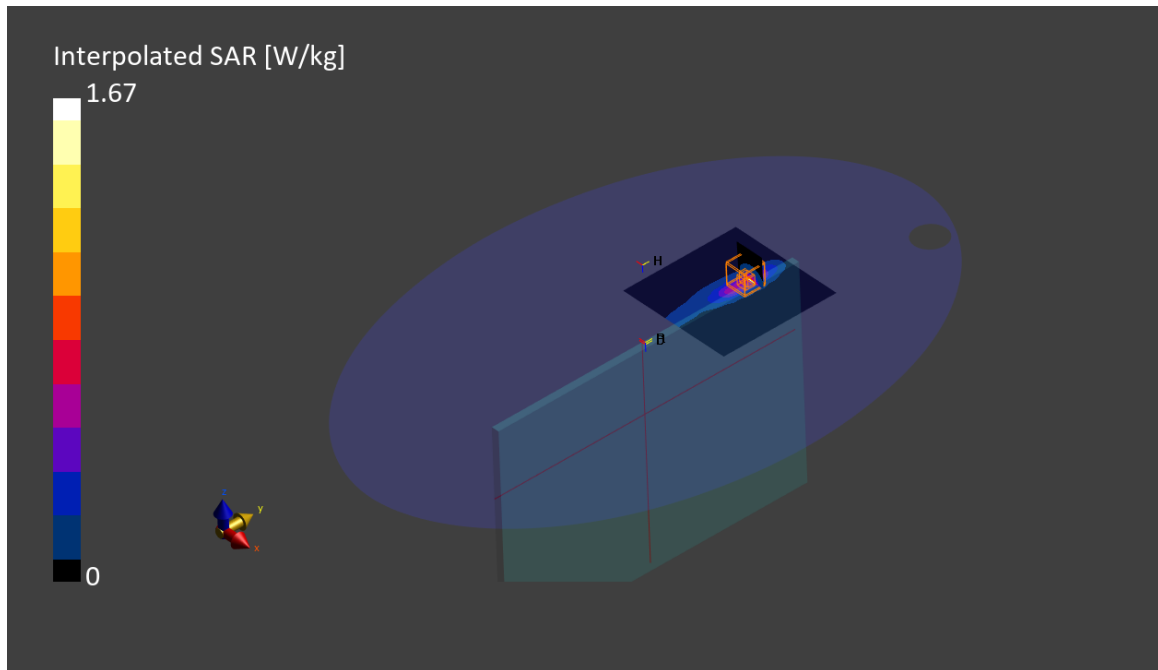

4. LTE Band 71, QPSK - 20MHz, CH136100, Antenna Vendor2, Top edge

Device under Test Properties

Name, Manufacturer	Dimensions [mm]	S/N	DUT Type
HSN-I45C,HP	220.0 x 320.0 x 8.0	0001760BBT	Convertible PC

Exposure Conditions

Phantom Section, TSL	Position, Test Distance [mm]	Band	Group, UID	Frequency [MHz], Channel Number	Conversion Factor	TSL Conductivity [S/m]	TSL Permittivity
Flat, MSL	EDGE TOP, 0.00	Band 71, E-UTRA/FDD	LTE-FDD, 10169-CAE	680.5, 133297	11.32	0.896	54.8

Hardware Setup

Phantom	TSL, Measured Date	Probe, Calibration Date	DAE, Calibration Date
ELI V8.0 (20deg probe tilt)	MABL-600-6000, 2023-Dec-13	EX3DV4 - SN7604, 2023-09-08	DAE4ip Sn1704, 2023-04-18

Scan Setup

	Area Scan	Zoom Scan
Grid Extents [mm]	120.0 x 120.0	30.0 x 30.0 x 30.0
Grid Steps [mm]	15.0 x 15.0	6.0 x 6.0 x 1.5
Sensor Surface [mm]	3.0	1.4
Graded Grid	Yes	Yes
Grading Ratio	1.5	1.5
MAIA	Confirmed by MAIA	Confirmed by MAIA
Surface Detection	VMS + 6p	VMS + 6p
Scan Method	Measured	Measured

Measurement Results

	Area Scan	Zoom Scan
Date	2023-12-15, 11:24	2023-12-15, 11:30
psSAR1g [W/kg]	0.604	0.620
psSAR10g [W/kg]	0.346	0.295
Power Drift [dB]	-0.01	-0.07
Power Scaling	Disabled	Disabled
Scaling Factor [dB]		
TSL Correction	Positive Only	Positive Only
M2/M1 [%]		67.1
Dist 3dB Peak [mm]		7.2

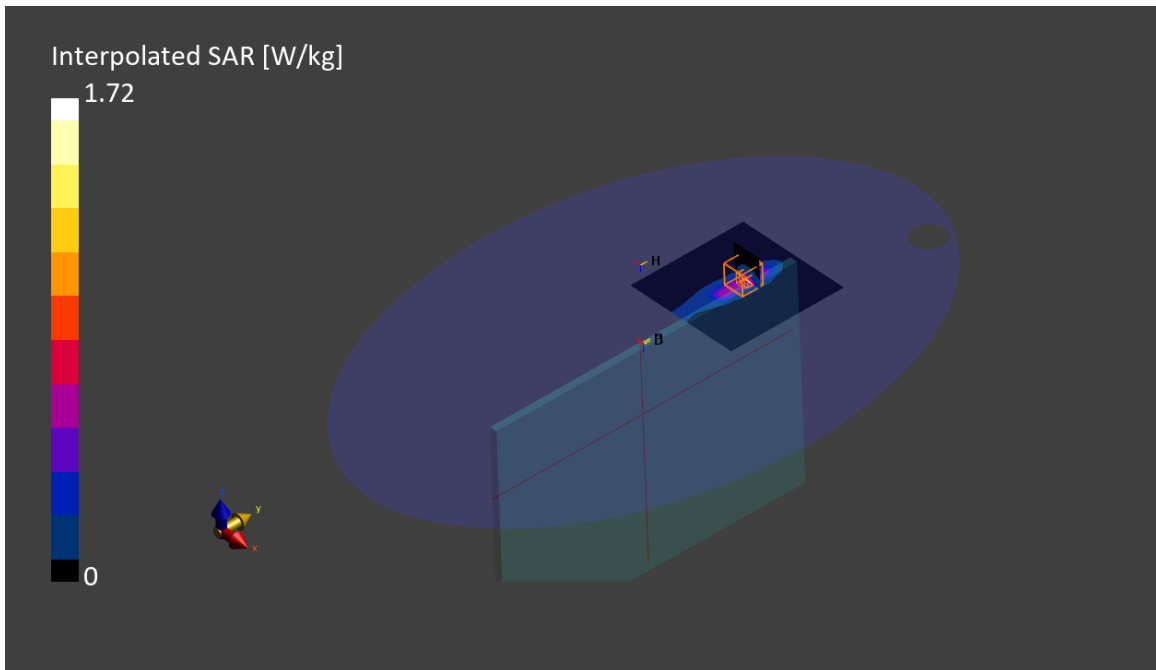

5. System Check Body Liquid 3500MHz

Device under Test Properties

Name, Manufacturer	Dimensions [mm]	Serial Number	DUT Type
Dipole 3500MHz, SPEAG	50.0 x 10.0 x 8.0	1123	Validation Dipole

Exposure Conditions

Phantom Section, TSL	Position, Test Distance [mm]	Band	Group, UID	Frequency [MHz], Channel Number	Conversion Factor	TSL Conductivity [S/m]	TSL Permittivity
Flat, MSL	,		, 0--	3500, 0	6.37	3.10	50.1

Hardware Setup

Phantom	TSL, Measured Date	Probe, Calibration Date	DAE, Calibration Date
ELI V8.0 (20deg probe tilt)	MABL-600-6000, 2023-Dec-18	EX3DV4 - SN7604, 2023-09-08	DAE4ip Sn1704, 2023-04-18

Scan Setup

	Area Scan	Zoom Scan
Grid Extents [mm]	40.0 x 80.0	28.0 x 28.0 x 28.0
Grid Steps [mm]	10.0 x 10.0	5.0 x 5.0 x 1.4
Sensor Surface [mm]	3.0	1.4
Graded Grid	N/A	Yes
Grading Ratio	N/A	1.5
MAIA	Confirmed by MAIA	Confirmed by MAIA
Surface Detection	VMS + 6p	VMS + 6p
Scan Method	Measured	Measured

Measurement Results

	Area Scan	Zoom Scan
Date	2023-12-18, 14:13	2023-12-18, 14:19
psSAR1g [W/kg]	3.39	3.21
psSAR10g [W/kg]	1.27	1.20
Power Drift [dB]	-0.09	-0.21
Power Scaling	Disabled	Disabled
Scaling Factor [dB]		
TSL Correction	Positive Only	Positive Only
M2/M1 [%]		78.1
Dist 3dB Peak [mm]		8.0

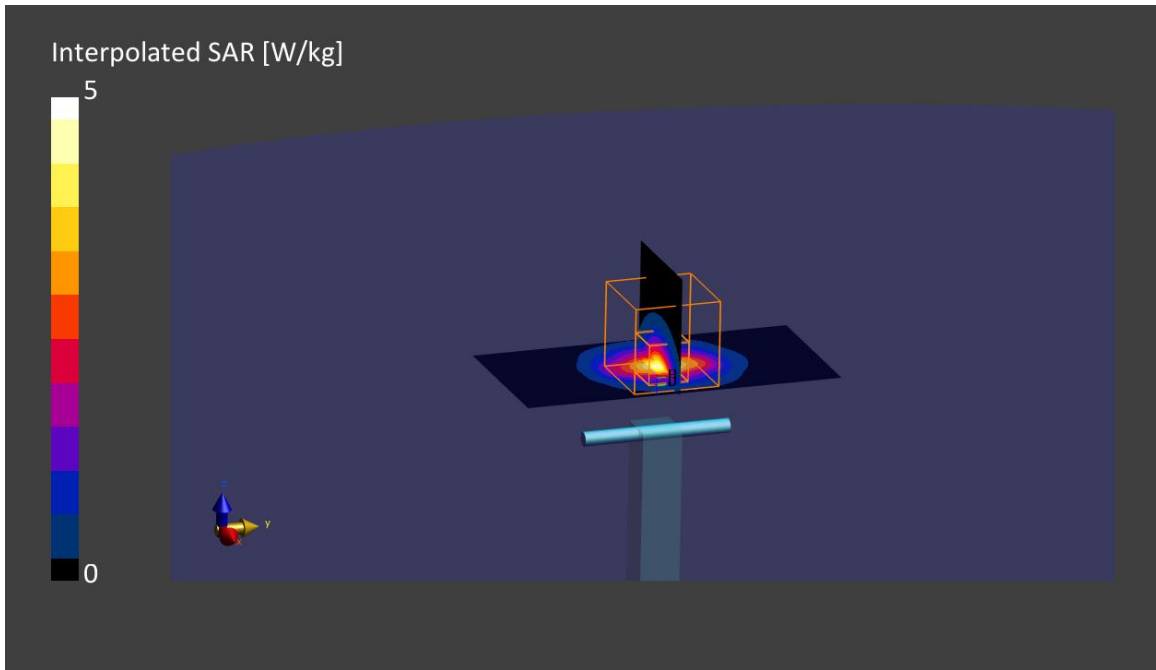

6. System Check Body Liquid 3700MHz – 2023-12-18

Device under Test Properties

Name, Manufacturer	Dimensions [mm]	Serial Number	DUT Type
Dipole 3700MHz, SPEAG	50.0 x 10.0 x 8.0	1093	Validation Dipole

Exposure Conditions

Phantom Section, TSL	Position, Test Distance [mm]	Band	Group, UID	Frequency [MHz], Channel Number	Conversion Factor	TSL Conductivity [S/m]	TSL Permittivity
Flat, MSL	,		, 0--	3700.000, 0	6.62	3.33	49.7

Hardware Setup

Phantom	TSL, Measured Date	Probe, Calibration Date	DAE, Calibration Date
ELI V8.0 (20deg probe tilt)	MABL-600-6000, 2023-Dec-18	EX3DV4 - SN7604, 2023-09-08	DAE4ip Sn1704, 2023-04-18

Scan Setup

	Area Scan	Zoom Scan
Grid Extents [mm]	40.0 x 80.0	28.0 x 28.0 x 28.0
Grid Steps [mm]	10.0 x 10.0	5.0 x 5.0 x 1.4
Sensor Surface [mm]	3.0	1.4
Graded Grid	N/A	Yes
Grading Ratio	N/A	1.5
MAIA	Confirmed by MAIA	Confirmed by MAIA
Surface Detection	VMS + 6p	VMS + 6p
Scan Method	Measured	Measured

Measurement Results

	Area Scan	Zoom Scan
Date	2023-12-18, 14:04	2023-12-18, 14:11
psSAR1g [W/kg]	3.39	3.13
psSAR10g [W/kg]	1.27	1.16
Power Drift [dB]	-0.11	-0.21
Power Scaling	Disabled	Disabled
Scaling Factor [dB]		
TSL Correction	Positive Only	Positive Only
M2/M1 [%]		74.1
Dist 3dB Peak [mm]		8.6

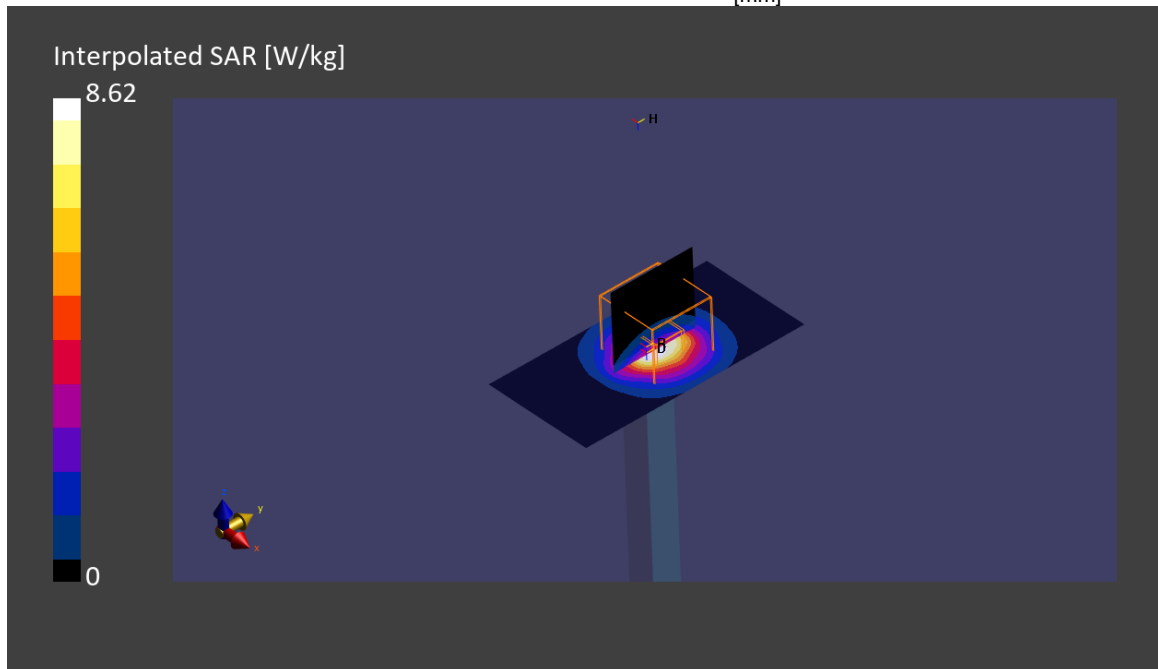

7. System Check Body Liquid 3700MHz – 2023-12-15

Device under Test Properties

Name, Manufacturer	Dimensions [mm]	Serial Number	DUT Type
Dipole 3700MHz, SPEAG	50.0 x 10.0 x 8.0	1093	Validation Dipole

Exposure Conditions

Phantom Section, TSL	Position, Test Distance [mm]	Band	Group, UID	Frequency [MHz], Channel Number	Conversion Factor	TSL Conductivity [S/m]	TSL Permittivity
Flat, MSL	,		, 0--	3700.000, 0	6.62	3.32	50.0

Hardware Setup

Phantom	TSL, Measured Date	Probe, Calibration Date	DAE, Calibration Date
ELI V8.0 (20deg probe tilt)	MBBL-600-6000 , 2023-Dec-13	EX3DV4 - SN7604, 2023-09-08	DAE4ip Sn1704, 2023-04-18

Scan Setup

	Area Scan	Zoom Scan
Grid Extents [mm]	40.0 x 80.0	28.0 x 28.0 x 28.0
Grid Steps [mm]	10.0 x 10.0	5.0 x 5.0 x 1.4
Sensor Surface [mm]	3.0	1.4
Graded Grid	Yes	Yes
Grading Ratio	1.5	1.5
MAIA	Confirmed by MAIA	Confirmed by MAIA
Surface Detection	VMS + 6p	VMS + 6p
Scan Method	Measured	Measured

Measurement Results

	Area Scan	Zoom Scan
Date	2023-12-15, 08:49	2023-12-15, 08:55
psSAR1g [W/kg]	3.33	2.93
psSAR10g [W/kg]	1.26	1.07
Power Drift [dB]	-0.09	-0.11
Power Scaling	Disabled	Disabled
Scaling Factor [dB]		
TSL Correction	Positive Only	Positive Only
M2/M1 [%]		70.2
Dist 3dB Peak [mm]		8.0

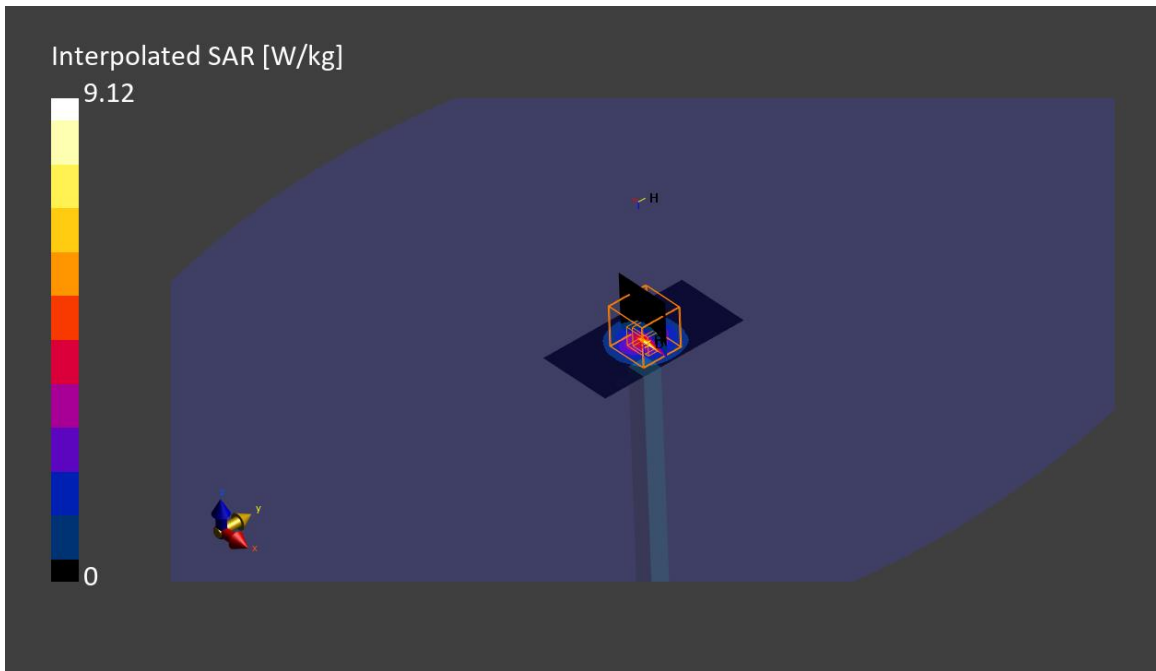

8. System Check Body Liquid 750MHz

Device under Test Properties

Model, Manufacturer	Dimensions [mm]	SN	DUT Type
Dipole 750MHz, SPEAG	50.0 x 10.0 x 8.0	1136	Validation Dipole

Exposure Conditions

Phantom Section, TSL	Position, Test Distance [mm]	Band	Group, UID	Frequency [MHz], Channel Number	Conversion Factor	TSL Conductivity [S/m]	TSL Permittivity
Flat, MSL	,		, 0--	750, 0	11.32	0.920	54.6

Hardware Setup

Phantom	TSL, Measured Date	Probe, Calibration Date	DAE, Calibration Date
ELI V8.0 (20deg probe tilt)	MBBL-600-6000, 2023-Dec-13	EX3DV4 - SN7604, 2023-09-08	DAE4ip Sn1704, 2023-04-18

Scan Setup

	Area Scan	Zoom Scan
Grid Extents [mm]	40.0 x 90.0	30.0 x 30.0 x 30.0
Grid Steps [mm]	10.0 x 15.0	6.0 x 6.0 x 1.5
Sensor Surface [mm]	3.0	1.4
Graded Grid	N/A	Yes
Grading Ratio	N/A	1.5
MAIA	Confirmed by MAIA	Confirmed by MAIA
Surface Detection	VMS + 6p	VMS + 6p
Scan Method	Measured	Measured

Measurement Results

	Area Scan	Zoom Scan
Date	2023-12-15, 08:16	2023-12-15, 08:21
psSAR1g [W/kg]	0.427	0.403
psSAR10g [W/kg]	0.285	0.258
Power Drift [dB]	-0.20	-0.13
Power Scaling	Disabled	Disabled
Scaling Factor		
TSL Correction	Positive Only	Positive Only
M2/M1 [%]		82.8
Dist 3dB Peak [mm]		18.4

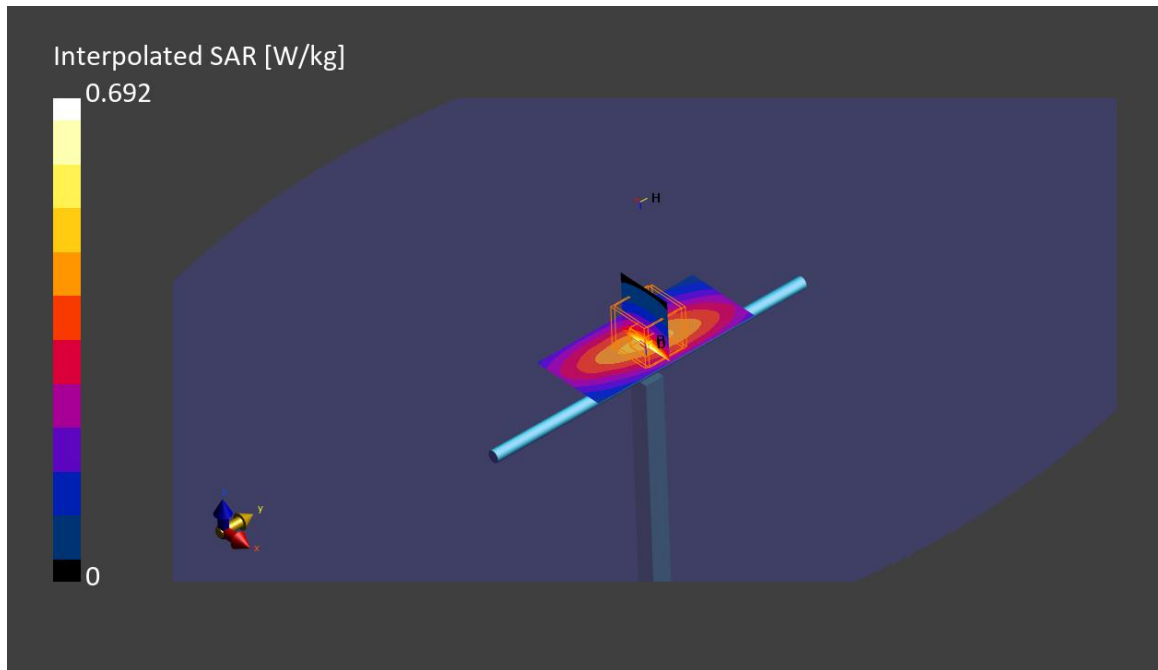

Annex D. TSL Dielectric Parameters

D.1 Body

Freq. (MHz)	Target		2023-12-13 Measured		2023-12-18 Measured	
	ϵ' (F/m)	σ (S/m)	ϵ'_1 (F/m)	ϵ'_2 (F/m)	ϵ'_2 (F/m)	ϵ'_2 (F/m)
	3400.0	51.46	3.2	50.48	2.98	50.27
3450.0	51.39	3.26	50.39	3.03	50.18	3.04
3500.0	51.32	3.31	50.31	3.09	50.09	3.10
3550.0	51.25	3.37	50.23	3.15	49.99	3.16
3600.0	51.19	3.43	50.15	3.20	49.9	3.22
3650.0	51.12	3.49	50.07	3.26	49.81	3.27
3700.0	51.05	3.55	49.99	3.32	49.72	3.33
3750.0	50.98	3.61	49.91	3.38	49.63	3.39
3800.0	50.91	3.66	49.84	3.44	49.54	3.45
3850.0	50.85	3.72	49.76	3.51	49.45	3.51
3900.0	50.78	3.78	49.68	3.57	49.37	3.57
3950.0	50.71	3.84	49.60	3.64	49.28	3.63
4000.0	50.64	3.9	49.52	3.70	49.20	3.70

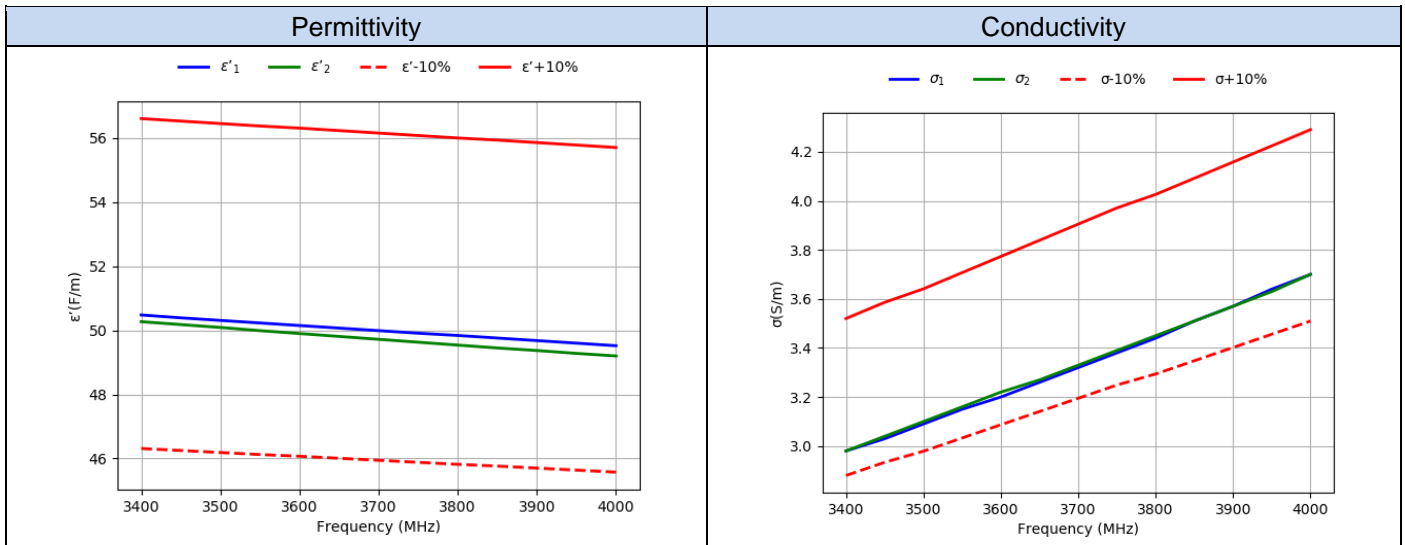

			2023-12-13	
Freq. (MHz)	Target		Measured	
	ϵ' (F/m)	σ (S/m)	ϵ'_1 (F/m)	σ_1 (S/m)
650.0	55.92	0.96	54.85	0.89
700.0	55.73	0.96	54.73	0.90
750.0	55.53	0.96	54.60	0.92

