

TEST REPORT

EUT Description	Convertible PC	
Brand Name	HP	
Model Name	HSN-I45C	
FCC ID	B94HNI45CKL	
Date of Test Start/End	2021-11-23 / 2022-01-20	
Features	WWAN (5G, LTE, UMTS), WLAN, BT (see section 6)	
Description	HP HSN-I45C + WNC antenna	
Applicant	HP Inc.	
Address (FCC)	1501 Page Mill Road, Palo Alto CA 94304 USA	
Contact Person	Cindy Su	
Telephone/Fax/ Email	+886 237895951/cindy.su@hp.com	
Reference Standards	FCC 47 CFR Part §2.1093 (see section 1)	
RF Exposure Environment	Portable devices - General population/uncontrolled exposure	
	SAR Result	SAR Limit
Maximum SAR Result & Limit	1.42 W/kg (1g)	1.6 W/kg (1g)
Min. test separation distance	0mm to phantom, 2.2mm to antenna edge	
Test Report identification	210916-08.TR03	
Revision Control	Rev. 01 This test report revision replaces any previous test report revision (see section 9)	

The test results relate only to the samples tested.
Reference to accreditation shall be used only by full reproduction of test report.

Issued by

Reviewed by

Edgar GARCIA
(SAR Test Engineer)

Ines KHARRAT
(Technical Manager)

Intel Corporation S.A.S – WRF Lab
425 rue de Goa – Le Cargo B6 - 06600 Antibes, France
Tel. +33493001400 / Fax +33493001401

Table of Contents

1. Standards, reference documents and applicable test methods	4
2. General conditions, competences and guarantees	4
3. Preface	5
4. Environmental Conditions	6
5. Test samples	6
6. EUT Features	7
7. Remarks and comments	14
8. Test Verdicts summary	14
9. Document Revision History	15
Annex A. Test & System Description	16
A.1 SAR DEFINITION	16
A.2 SAR MEASUREMENT SYSTEM	17
A.2.1 SAR Measurement Setup	17
A.2.2 E-Field Measurement Probe	18
A.2.3 Flat Phantom	18
A.2.4 Device Positioner	19
A.3 DATA EVALUATION	20
A.4 SYSTEM AND LIQUID CHECK	22
A.4.1 System Check	22
A.4.2 Liquid Check	23
A.5 TEST EQUIPMENT LIST	24
A.5.1 Tissue Simulant Liquid	25
A.6 MEASUREMENT UNCERTAINTY EVALUATION	26
A.7 RF EXPOSURE LIMITS	27
Annex B. Test Results	28
B.1 TEST CONDITIONS	28
B.1.1 Test SAR Test positions relative to the phantom	28
B.1.2 Test signal, Output power and Test Frequencies	29
B.1.3 Evaluation Exclusion and Test Reductions	30
B.2 CONDUCTED POWER MEASUREMENTS – TABLET MODE	35
B.2.1 WCDMA/ HSPA/ DC-HSPA	35
B.2.2 LTE	38
B.2.3 LTE UL Carrier Aggregation	69
B.2.4 5G NR (FR1) Tablet Mode	71
B.3 TISSUE PARAMETERS MEASUREMENT	85
B.4 SYSTEM CHECK MEASUREMENTS	86
B.5 SAR TEST RESULTS	87
B.5.1 WCDMA – Antenna 5	87
B.5.2 LTE	88
B.5.3 5G NR	97
B.5.4 ENDC	102
B.5.6 SAR Measurement Variability	103
B.5.7 Simultaneous Transmission SAR Evaluation	104
Annex C. Test System Plots	109
Annex D. TSL Dielectric Parameters	149
D.1 BODY 600MHZ-900MHZ SAR SYSTEM 2	149

D.2	BODY 1700MHZ-2000MHZ SAR SYSTEM 2	151
D.3	BODY 2300MHZ-2700MHZ SAR SYSTEM 2	153
D.4	BODY 3500MHZ-3900MHZ SAR SYSTEM 2	155
D.5	BODY 600MHZ-900MHZ SAR SYSTEM 4	157
D.6	BODY 1700MHZ-2000MHZ SAR SYSTEM 4	158
D.7	BODY 3500MHZ-3900MHZ SAR SYSTEM 4	160
Annex E.	Calibration Certificates	162
Annex F.	Photographs	164
F.1	TEST SAMPLE	164
F.2	TEST POSITIONS.....	166
F.3	ANTENNA HOST PLATFORM LOCATION AND ADJACENT EDGE POSITIONS RELATIVE TO THE BODY.....	167
F.4	PHANTOM LIQUID LEVEL DURING MEASUREMENTS	168

1. Standards, reference documents and applicable test methods

FCC	<ol style="list-style-type: none"> 1. FCC Title 47 CFR Part §2.1093 – Radiofrequency radiation exposure evaluation: portable devices. 2019-10-01 Edition 2. FCC OET KDB 447498 D01 v06 – RF Exposure Procedures and Equipment Authorization Policies for Mobile and Portable Devices. 3. FCC OET KDB 616217 D04 v01r02 – SAR Evaluation Considerations for Laptop, Notebook, Netbook and Tablet Computers. 4. FCC OET KDB 865664 D01 v01r04 – SAR Measurement Requirements for 100 MHz to 6 GHz. 5. FCC OET KDB 865664 D02 v01r02 – RF Exposure Compliance Reporting and Documentation Considerations. 6. FCC OET KDB 941225 D05 v02r05 – SAR Evaluation Considerations for LTE Devices. 7. FCC OET KDB 941225 D01 v03r01 – 3G SAR Measurement Procedures. 8. IEEE Std 1528-2013 – IEEE Recommended Practice Determining the Peak Spatial-Average Specific Absorption Rate (SAR) in the Human Head from Wireless Communication Devices: Measurement Techniques... 9. TCB workshop November 2017; RF Exposure Procedures (LTE UL/DL Carrier Aggregation SAR) 10. TCB workshop October 2018; RF Exposure Procedures (LTE Inter-Band Uplink Carrier Aggregation –Interim Procedures) 11. TCB workshop November 2019; RF Exposure Policy Updates (5G NR FR1 NSA EN-DC UE SAR Evaluations) 12. TCB workshop November 2019; 5G NR/ EN-DC Compliance Test Configurations
-----	---

2. General conditions, competences and guarantees

- ✓ Tests performed under FCC standards identified in section 1 are covered by A2LA accreditation.
- ✓ Intel Corporation SAS Wireless RF Lab (Intel WRF Lab) is an ISO/IEC 17025:2017 laboratory accredited by the American Association for Laboratory Accreditation (A2LA) with the certificate number 3478.01.
- ✓ Intel Corporation SAS Wireless RF Lab (Intel WRF Lab) is an Accredited Test Firm recognized by the FCC, with Designation Number FR0011.
- ✓ Intel Corporation SAS Wireless RF Lab (Intel WRF Lab) is an ISO/IEC 17025:2017 testing laboratory accredited by the French Committee for Accreditation (Cofrac) with the certificate number 1-6736.
- ✓ Intel Corporation SAS Wireless RF Lab (Intel WRF Lab) is a Registered Test Site listed by ISED, with ISED #1000Y.
- ✓ Intel WRF Lab declines any responsibility with respect to the identified information provided by the customer and that may affect the validity of results.
- ✓ Intel WRF Lab only provides testing services and is committed to providing reliable, unbiased test results and interpretations.
- ✓ Intel WRF Lab is liable to the client for the maintenance of the confidentiality of all information related to the item under test and the results of the test.
- ✓ Intel WRF Lab has developed calibration and proficiency programs for its measurement equipment to ensure correlated and reliable results to its customers.
- ✓ This report is only referred to the item that has undergone the test.
- ✓ This report does not imply an approval of the product by the Certification Bodies or competent Authorities.

3. Preface

The HSN-I45C convertible PC includes the Time Averaging SAR (TAS) concept. The TAS algorithm is implemented in the Fibocom M2 FM350-GL Cellular Modem (FCC ID: ZMOFM350GL).

The implementation details and TAS operating characteristics are described in a separated document [1]. The validation of algorithm operations is performed by Intel Corporation according to the range of commonly used accessible control parameters used for typical host products. The validation results are reported in document [2].

The FCC SAR limit is a time averaged exposure metric. At host level, the normally required SAR test procedures are applicable for SAR compliance testing at upper-threshold values of the algorithm, which is the maximum output power level for continuous time-averaging operations TAS algorithm enforces. The reliability of this has been demonstrated by results in the Algorithm Validation Test Report [2].

The model supports simultaneous transmission of WWAN, BT and WLAN. The TAS algorithm is only applied to WWAN cellular module. The WLAN / BT SAR evaluation is presented in the document [3].

The SAR evaluation of WWAN is performed in this report as well as the RF exposure assessment for simultaneous transmission of WWAN, WLAN and BT.

[1] 210317_TAS_Operational_Report_Rev01

[2] 201029-02.TR01_Rev01_Validation Report for 5G Time Averaging Algorithm

[3] 210916-08.TR01_FCC-IC_WLAN SAR_HP WarPath 14LX_FM350GL

4. Environmental Conditions

- ✓ At the site where the measurements were performed the following limits were not exceeded during the tests:

Temperature	21°C ± 2°C
Humidity	40% ± 20%
Liquid Temperature	21°C ± 2°C

5. Test samples

Sample	Control #	Description	Model	Serial #	Date of receipt	Note
#01	210916-08.S06	Convertible PC	HSN-I45C	0001760BC5	2021-09-23	Used for 5G NR tests
#02	210916-08.S05	Convertible PC	HSN-I45C	0001760BC4	2021-09-23	Used for LTE and WCDMA tests

6. EUT Features

The herein information is provided by the customer.

Intel WRF Lab declines any responsibility for the accuracy of the stated customer provided information, especially if it has any impact on the correctness of test results presented in this report.

Brand Name	HP
Model Name	HSN-I45C
Prototype / Production	Production
Host Identification	HSN-I45C
Exposure Conditions	Body worn

Supported radios									
WWAN:									
Mode	Bands	Supported Tx Mode							
		RMC	HSDPA	HSUPA	DC-HSDPA				
WCDMA	FDD II (1850.0 – 1910.0 MHz)	✓	✓	✓	✓				
	FDD IV (1710.0 – 1755.0 MHz)	✓	✓	✓	✓				
	FDD V (824.0 – 849.0 MHz)	✓	✓	✓	✓				
LTE FDD	Bands	Modulations	Bandwidth						
			1.4	3	5	10	15	20	
LTE FDD	Band 2 (1850.0 – 1910.0 MHz)	QPSK/16QAM/64QAM/256QAM	✓	✓	✓	✓	✓	✓	✓
	Band 4 (1710.0 – 1755.0 MHz)	QPSK/16QAM/64QAM/256QAM	✓	✓	✓	✓	✓	✓	
	Band 5 (824.0 – 849.0 MHz)	QPSK/16QAM/64QAM/256QAM	✓	✓	✓	✓			
	Band 7 (2500.0 – 2570.0 MHz)	QPSK/16QAM/64QAM/256QAM			✓	✓	✓	✓	
	Band 12 (699.0 – 716.0 MHz)	QPSK/16QAM/64QAM/256QAM	✓	✓	✓	✓			
	Band 13 (777.0 – 787.0 MHz)	QPSK/16QAM/64QAM/256QAM			✓	✓			
	Band 14 (788.0 – 798.0 MHz)	QPSK/16QAM/64QAM/256QAM			✓	✓			
	Band 17 (704.0 – 716.0 MHz)	QPSK/16QAM/64QAM/256QAM			✓	✓			
	Band 25 (1850.0 – 1915.0 MHz)	QPSK/16QAM/64QAM/256QAM	✓	✓	✓	✓	✓	✓	
	Band 26 (814.0 – 849.0 MHz)	QPSK/16QAM/64QAM/256QAM	✓	✓	✓	✓	✓		
	Band 30 (2305.0 – 2315.0 MHz)	QPSK/16QAM/64QAM/256QAM			✓	✓			
Band 66 (1710.0 – 1780.0 MHz)	QPSK/16QAM/64QAM/256QAM	✓	✓	✓	✓	✓	✓		
LTE TDD	Band 38 (2570.0 – 2620.0 MHz)	QPSK/16QAM/64QAM/256QAM			✓	✓	✓	✓	
	Band 41 (2496.0 – 2690.0 MHz)	QPSK/16QAM/64QAM/256QAM			✓	✓	✓	✓	
	Band 48 (3550.0 – 3700.0 MHz)	QPSK/16QAM/64QAM/256QAM			✓	✓	✓	✓	

Bands	Modulation	SCS (KHz)	Bandwidth													
			5	10	15	20	25	30	40	50	60	70	80	90	100	
N2 FDD (1850.0 – 1910.0 MHz)	PI/2 BPSK	15	✓													
	QPSK	30		✓	✓	✓										
	16QAM			✓	✓	✓										
	64QAM															
N5 FDD (824.0 – 849.0 MHz)	PV2 BPSK	15	✓													
	QPSK	30		✓	✓	✓										
	16QAM	60														
	64QAM															
N7 FDD (2500.0 – 2570.0 MHz)	PV2 BPSK	15	✓													
	QPSK	30		✓	✓	✓										
	16QAM			✓	✓	✓										
	64QAM															
N25 FDD (1850.0 – 1915 MHz)	PV2 BPSK	15	✓													
	QPSK	30		✓	✓	✓										
	16QAM			✓	✓	✓										
	64QAM															
N30 FDD (2305.0 – 2315.0 MHz)	PV2 BPSK	15	✓													
	QPSK	30		✓												
	16QAM			✓												
	64QAM															
N38 TDD (2570.0 – 2620.0 MHz)	PV2 BPSK	15	✓													
	QPSK	30		✓	✓	✓				✓						
	16QAM	60		✓	✓	✓				✓						
	64QAM			✓	✓	✓				✓						
N41 TDD (2496.0 – 2690.0 MHz)	PV2 BPSK	15														
	QPSK	30				✓				✓	✓	✓		✓	✓	✓
	16QAM					✓				✓	✓	✓		✓	✓	✓
	64QAM					✓				✓	✓	✓		✓	✓	✓
N66 FDD (1710.0 – 1780.0 MHz)	PV2 BPSK	15	✓													
	QPSK	30		✓	✓	✓				✓						
	16QAM			✓	✓	✓				✓						
	64QAM									✓						
N77 TDD* (3700.0 – 3980.0 MHz)	PV2 BPSK	15														
	QPSK	30		✓	✓	✓				✓	✓	✓		✓	✓	✓
	16QAM			✓	✓	✓				✓	✓	✓		✓	✓	✓
	64QAM									✓	✓	✓		✓	✓	✓
N78 TDD** (3700.0 – 3800.0 MHz)	PV2 BPSK	15														
	QPSK	30		✓	✓	✓				✓	✓	✓		✓	✓	✓
	16QAM			✓	✓	✓				✓	✓	✓		✓	✓	✓
	64QAM									✓	✓	✓		✓	✓	✓

*FCC limits 5G NR B77 to 3700-3980MHz

** FCC limits 5G NR B78 to 3700-3800MHz

UL carrier aggregation LTE (Inter-Band)	UL carrier aggregation LTE (Intra-band)
2A – 5A	5B
2A – 12A	7C
2A – 13A	38C
2A – 14A	41C
2A – 48A	48C
4A – 5A	66B
4A – 12A	66C
4A – 13A	
5A – 7A	
5A – 30A	
5A – 48A	
5A – 66A	
12A – 30A	
12A – 66A	
13A – 48A	
13A – 66A	
14A – 30A	
14A – 66A	
25A – 26A	
48A – 66A	

EN/DC possible combinations	
NR 5G Band	Associated LTE Bands
N2A	5, 12, 13, 14
N5A	2, 7, 30, 66, 48
N66A	5, 12, 13, 48
N41A	2,66,41
N77A	2,5,12,13,14, 30,66, 41
N78A	2, 5, 7, 38

UL carrier aggregation 5G FR1
n2A – n5A
n5A – n66A

WLAN

Mode	UL Freq Range
802.11b/g/n/ax	2.4GHz (2400.0 – 2483.5 MHz)
802.11a/n/ac/ax	5.2GHz (5150.0 – 5250.0 MHz) 5.3GHz (5250.0 – 5350.0 MHz) 5.6GHz (5470.0 – 5725.0 MHz) 5.8GHz (5725.0 – 5850.0 MHz) 5.8GHz (5725.0 – 5875.0 MHz)
802.11ax	6.0GHz (5925.0 – 7250.0 MHz)
Bluetooth v5.2 & BLE	2.4GHz (2400.0 – 2483.5 MHz)

Antenna Information & Mapping

Antenna Information “information provided by the applicant”

The DUT has 2 WWAN TX antenna:

Transmitter	Antenna Main 5	Antenna Aux 8
Manufacturer	WNC	WNC
Antenna type	PIFA antenna	PIFA antenna
Part number	6036B0313901 (81ELA215.G12)	6036B0313901 (81ELA215.G12)

See Annex F for more details on antennas location.

WWAN Antenna Mapping

Configuration	Antenna 5	Antenna 8
WCDMA	LB / MHB	
LTE	LB / MHB	
		UHB
NR 5G SA	(LB / MHB)	
		UHB
LTE ULCA	LB	MHB /UHB
	MHB	UHB
	B41	UHB
NR 5G ENDC	LB	MHB / B41
	B41	N41
	MHB	B41/N41
	B41/N41	UHB
	MHB	UHB
NR 5G ULCA	LB	MHB

- LB: WCDMA FDD V, LTE B5/12/13/14/17/26, 5G NR n5
- MHB: WCDMA FDD II/ FDD IV, LTE B2/4/7/25/30/66/38, 5G NR n2/n7/n25/n30/n38/n66
- UHB: LTE: B41/48; NR 5G: n41/n77/n78

Note: For EN-DC mode the 4G and 5G carriers transmit on separate antennas.
For inter-bands on LTE and NR 5G ULCA the carriers transmit on separate antennas.

Simultaneous Transmission Configurations

WWAN Main (Ant5) + WWAN Aux (Ant8) + WLAN 2.4GHz Main + BT Aux
 WWAN Main (Ant5) + WWAN Aux (Ant8) + WLAN 2.4GHz Main + WLAN 2.4GHz Aux
 WWAN Main (Ant5) + WWAN Aux (Ant8) + WLAN 5GHz Main + BT Aux
 WWAN Main (Ant5) + WWAN Aux (Ant8) + WLAN 5GHz Main + WLAN 5GHz Aux
 WWAN Main (Ant5) + WWAN Aux (Ant8) + WLAN 5GHz Main + WLAN 5GHz Aux + BT Aux
 WWAN Main (Ant5) + WWAN Aux (Ant8) + WLAN 6GHz Main + BT Aux
 WWAN Main (Ant5) + WWAN Aux (Ant8) + WLAN 6GHz Main + WLAN 6GHz Aux
 WWAN Main (Ant5) + WWAN Aux (Ant8) + WLAN 6GHz Main + WLAN 6GHz Aux + BT Aux

WLAN transmitter is considered in this report just for the simultaneous transmission evaluation with the WWAN module (See section B.5.7)

Additional information

- 5.60-5.65 GHz band (TDWR) is supported by the device
- Band gap is supported by the device
- Two different power settings are implemented in the DUT:
 - Max power for Notebook mode
 - Reduced power for Tablet mode
- Maximum Power Reduction (MPR) is implemented according to 3GPP, and it is a permanent feature, built-in by design on the tune-up power:

Modulation	Channel bandwidth / #RB						MPR (dB)
	1.4 MHz	3.0 MHz	5 MHz	10 MHz	15 MHz	20 MHz	
QPSK	> 5	> 4	> 8	> 12	> 16	> 18	≤ 1
16 QAM	≤ 5	≤ 4	≤ 8	≤ 12	≤ 16	≤ 18	≤ 1
16 QAM	> 5	> 4	> 8	> 12	> 16	> 18	≤ 2
64 QAM	≤ 5	≤ 4	≤ 8	≤ 12	≤ 16	≥ 18	≤ 2
64 QAM	> 5	> 4	> 8	> 12	> 16	> 18	≤ 3
256 QAM	≥ 1						≤ 5

- According to 3GPP 38-101-1, the UE is allowed to reduce the maximum output power due to higher order modulations and for channel bandwidths that meets both following criteria:
 - Channel bandwidth ≤ 100MHz.
 - Relative channel bandwidth ≤ 4% for TDD bands and ≤ 3% for FDD bands

Modulation	MPR (Db)		
	Edge RB allocations	Outer RB allocations	Inner RB allocations
DFT-s-OFDM PI/2 BPSK	≤ 3.5 ¹	≤ 1.2 ¹	≤ 0.2 ¹
	0.5 ²	0.5 ²	0 ²
DFT-s-OFDM QPSK	≤ 1		0
DFT-s-OFDM 16 QAM	≤ 2		≤ 1
DFT-s-OFDM 64 QAM	≤ 2.5		
DFT-s-OFDM 256 QAM	4.5		
CP-OFDM QPSK	≤ 3	≤ 1.5	
CP-OFDM 16 QAM	≤ 3	≤ 2	
CP-OFDM 64 QAM	≤ 3.5		
CP-OFDM 256 QAM	≤ 6.5		

NOTE 1: Applicable for UE operating in TDD mode with PI/2 BPSK modulation and if the IE [P-Boost-BPSK] is set to 1 and 40% or less slots in radio frame are used for UL transmission for bands n40, n77, n78 and n79.
 NOTE 2: Applicable for UE operating in FDD mode, or in TDD mode in bands other than n40, n77, n78 and n79 and if the IE [Pboost-BPSK] is set to 0 and if more than 40% of slots in radio frame are used for UL transmission for bands n40, n77, n78 and n79.

Modulation	MPR (Db)		
	Edge RB allocations	Outer RB allocations	Inner RB allocations
DFT-s-OFDM PI/2 BPSK	≤ 3.5	≤ 0.5	0
DFT-s-OFDM QPSK	≤ 3.5	≤ 1	0
DFT-s-OFDM 16 QAM	≤ 3.5	≤ 2	≤ 1
DFT-s-OFDM 64 QAM	≤ 3.5	≤ 2.5	
DFT-s-OFDM 256 QAM	≤ 4.5		
CP-OFDM QPSK	≤ 3.5	≤ 3	≤ 1.5
CP-OFDM 16 QAM	≤ 3.5	≤ 3	≤ 2
CP-OFDM 64 QAM	≤ 3.5		
CP-OFDM 256 QAM	≤ 6.5		

The DUT uses the maximum MPR values described in the above tables.

The maximum power reduction is applicable on the Tune up tolerance.

The following table indicates the power levels and tolerance for each mode:

Maximum Output power specification + Tune up tolerance

Mode	Tx Antenna	Technology	Bands	Class	Nominal (dBm)	Tolerance dB	Lower Tolerance (dBm)	Upper Tolerance (dBm)
Tablet	5	WCDMA/HSPA	FDD II (1850.0 – 1910.0 MHz)	3	16.0	±1	15.0	17.0
	5	WCDMA/HSPA	FDD IV (1710.0 – 1755.0 MHz)	3	16.5	±1	15.5	17.5
	5	WCDMA/HSPA	FDD V (824.0 – 849.0 MHz)	3	20.0	±1	19.0	21.0
	5	LTE	B2 (1850.0 – 1910.0 MHz)	3	16.0	±1	15.0	17.0
	5	LTE	B4 (1710.0 – 1755.0 MHz)	3	16.5	±1	15.5	17.5
	5	LTE	B5 (824.0 – 849.0 MHz)	3	20.0	±1	19.0	21.0
	5	LTE	B7 (2500.0 – 2570.0 MHz)	3	14.5	±1	13.5	15.5
	5	LTE	B12 (699.0 – 716.0 MHz)	3	17.0	±1	16.0	18.0
	5	LTE	B13 (777.0 – 787.0 MHz)	3	18.0	±1	17.0	19.0
	5	LTE	B14 (788.0 – 798.0 MHz)	3	18.0	±1	17.0	19.0
	5	LTE	B17 (704.0 – 716.0 MHz)	3	17.0	±1	16.0	18.0
	5	LTE	B25 (1850.0 – 1915.0 MHz)	3	15.0	±1	14.0	16.0
	5	LTE	B26 (814.0 – 849.0 MHz)	3	19.5	±1	18.5	20.5
	5	LTE	B30 (2305.0 – 2315.0 MHz)	3	13.0	±1	12.0	14.0
	5	LTE	B38 (2570.0 – 2620.0 MHz)	3	16.5	±1	15.5	17.5
	5	LTE	B41 (2496.0 – 2690.0 MHz)	3	13.5	±1	12.5	14.5
	5	LTE	B41 (2496.0 – 2690.0 MHz)	2	13.5	±1	12.5	14.5
	5	LTE	B66 (1710.0 – 1780.0 MHz)	3	16.5	±1	15.5	17.5
	8	LTE	B2 (1850.0 – 1910.0 MHz)	3	16.5	±1	15.5	17.5
	8	LTE	B4 (1710.0 – 1755.0 MHz)	3	18.0	±1	17.0	19.0
	8	LTE	B7 (2500.0 – 2570.0 MHz)	3	18.0	±1	17.0	19.0
	8	LTE	B25 (1850.0 – 1915.0 MHz)	3	18.5	±1	17.5	19.5
	8	LTE	B30 (2305.0 – 2315.0 MHz)	3	17.5	±1	16.5	18.5
	8	LTE	B41 (2496.0 – 2690.0 MHz)	3	20.0	±1	19.0	21.0
	8	LTE	B41 (2496.0 – 2690.0 MHz)	2	20.0	±1	19.0	21.0
	8	LTE	B48 (3550.0 – 3700.0 MHz)	3	19.0	±1	18.0	20.0
	8	LTE	B66 (1710.0 – 1780.0 MHz)	3	18.0	±1	17.0	19.0
	5	5G NR	N2 (1850.0 – 1910.0 MHz)	3	16.0	±1	15.0	17.0
	5	5G NR	N5 (824.0 – 849.0 MHz)	3	20.0	±1	19.0	21.0
	5	5G NR	N7 (2500.0 – 2570.0 MHz)	3	14.5	±1	13.5	15.5
	5	5G NR	N25 (1850.0 – 1915.0 MHz)	3	16.5	±1	15.5	17.5
	5	5G NR	N30 (2305.0 – 2315.0 MHz)	3	13.5	±1	12.5	14.5
	5	5G NR	N38 (2570.0 – 2620.0 MHz)	3	14.0	±1	13.0	15.0
	5	5G NR	N41 (2496.0 – 2690.0 MHz)	3	13.5	±1	12.5	14.5
	5	5G NR	N41 (2496.0 – 2690.0 MHz)	2	13.5	±1	12.5	14.5
	5	5G NR	N66 (1710.0 – 1780.0 MHz)	3	17.0	±1	16.0	18.0
	5	5G NR	N77 (3700.0 – 3980.0 MHz)	3	15.0	±1	14.0	16.0
	5	5G NR	N77 (3700.0 – 3980.0 MHz)	2	15.0	±1	14.0	16.0
	5	5G NR	N78 (3700.0 – 3800.0 MHz)	3	14.0	±1	13.0	15.0
	5	5G NR	N78 (3700.0 – 3800.0 MHz)	3	14.0	±1	13.0	15.0
	8	5G NR	N2 (1850.0 – 1910.0 MHz)	3	17.0	±1	16.0	18.0
	8	5G NR	N38 (2570.0 – 2620.0 MHz)	3	19.0	±1	18.0	20.0
8	5G NR	N41 (2496.0 – 2690.0 MHz)	3	18.0	±1	17.0	19.0	
8	5G NR	N41 (2496.0 – 2690.0 MHz)	2	18.0	±1	17.0	19.0	
8	5G NR	N66 (1710.0 – 1780.0 MHz)	3	18.0	±1	17.0	19.0	
8	5G NR	N77 (3700.0 – 3980.0 MHz)	3	16.5	±1	15.5	17.5	
8	5G NR	N77 (3700.0 – 3980.0 MHz)	2	16.5	±1	15.5	17.5	
8	5G NR	N78 (3700.0 – 3800.0 MHz)	3	17.0	±1	16.0	18.0	
8	5G NR	N78 (3700.0 – 3800.0 MHz)	3	17.0	±1	16.0	18.0	

As mentioned in Section 3, the SAR compliance testing is performed at upper-threshold values of the algorithm, which is the maximum output power level for continuous time-averaging operations TAS algorithm enforces.

In TAS operation, the control parameters including the upper-threshold value are stored in NVM. They are inaccessible to the normal users and no other interface is available for changing these control parameters.

The table below shows the upper-threshold values used as continuous power for SAR testing as well as the different TAS parameters defined in [1] and [2] to be embedded in the host:

Mode	Tx Antenna	Technology	Bands	Class	Nominal Full Power (dBm)	Upper Threshold (dBm)	Lower Threshold (dBm)	DPR_ON Power (dBm)
Tablet	5	WCDMA/HSPA	FDD II (1850.0 – 1910.0 MHz)	3	23.5	18.0	17.0	16.0
	5	WCDMA/HSPA	FDD IV (1710.0 – 1755.0 MHz)	3	23.5	18.5	17.5	16.5
	5	WCDMA/HSPA	FDD V (824.0 – 849.0 MHz)	3	23.5	22.0	21.0	20.0
	5	LTE	B2 (1850.0 – 1910.0 MHz)	3	23.0	18.0	17.0	16.0
	5	LTE	B4 (1710.0 – 1755.0 MHz)	3	23.0	18.5	17.5	16.5
	5	LTE	B5 (824.0 – 849.0 MHz)	3	23.0	22.0	21.0	20.0
	5	LTE	B7 (2500.0 – 2570.0 MHz)	3	23.0	16.5	15.5	14.5
	5	LTE	B12 (699.0 – 716.0 MHz)	3	23.0	19.0	18.0	17.0
	5	LTE	B13 (777.0 – 787.0 MHz)	3	23.0	20.0	19.0	18.0
	5	LTE	B14 (788.0 – 798.0 MHz)	3	23.0	20.0	19.0	18.0
	5	LTE	B17 (704.0 – 716.0 MHz)	3	23.0	19.0	18.0	17.0
	5	LTE	B25 (1850.0 – 1915.0 MHz)	3	23.0	17.0	16.0	15.0
	5	LTE	B26 (814.0 – 849.0 MHz)	3	23.0	21.5	20.5	19.5
	5	LTE	B30 (2305.0 – 2315.0 MHz)	3	23.0	15.0	14.0	13.0
	5	LTE	B38 (2570.0 – 2620.0 MHz)	3	23.0	18.5	17.5	16.5
	5	LTE	B41 (2496.0 – 2690.0 MHz)	3	23.0	15.5	14.5	13.5
	5	LTE	B41 (2496.0 – 2690.0 MHz)	2	26.0	15.5	14.5	13.5
	5	LTE	B66 (1710.0 – 1780.0 MHz)	3	23.0	18.5	17.5	16.5
	8	LTE	B2 (1850.0 – 1910.0 MHz)	3	23.0	18.5	17.5	16.5
	8	LTE	B4 (1710.0 – 1755.0 MHz)	3	23.0	20.0	19.0	18.0
	8	LTE	B7 (2500.0 – 2570.0 MHz)	3	23.0	20.0	19.0	18.0
	8	LTE	B25 (1850.0 – 1915.0 MHz)	3	23.0	20.5	19.5	18.5
	8	LTE	B30 (2305.0 – 2315.0 MHz)	3	23.0	19.5	18.5	17.5
	8	LTE	B41 (2496.0 – 2690.0 MHz)	3	23.0	22.0	21.0	20.0
	8	LTE	B41 (2496.0 – 2690.0 MHz)	2	26.0	22.0	21.0	20.0
	8	LTE	B48 (3550.0 – 3700.0 MHz)	3	21.0	21.0	20.0	19.0
	8	LTE	B66 (1710.0 – 1780.0 MHz)	3	23.0	20.0	19.0	18.0
	5	5G NR	N2 (1850.0 – 1910.0 MHz)	3	23.0	18.0	17.0	16.0
	5	5G NR	N5 (824.0 – 849.0 MHz)	3	23.0	22.0	21.0	20.0
	5	5G NR	N7 (2500.0 – 2570.0 MHz)	3	23.0	16.5	15.5	14.5
	5	5G NR	N25 (1850.0 – 1915.0 MHz)	3	23.0	18.5	17.5	16.5
	5	5G NR	N30 (2305.0 – 2315.0 MHz)	3	23.0	15.5	14.5	13.5
	5	5G NR	N38 (2570.0 – 2620.0 MHz)	3	23.0	16.0	15.0	14.0
	5	5G NR	N41 (2496.0 – 2690.0 MHz)	3	23.0	15.5	14.5	13.5
	5	5G NR	N41 (2496.0 – 2690.0 MHz)	2	23.0	15.5	14.5	13.5
	5	5G NR	N66 (1710.0 – 1780.0 MHz)	3	23.0	19.0	18.0	17.0
	5	5G NR	N77 (3700.0 – 3980.0 MHz)	3	23.0	17.0	16.0	15.0
	5	5G NR	N77 (3700.0 – 3980.0 MHz)	2	23.0	17.0	16.0	15.0
	5	5G NR	N78 (3700.0 – 3800.0 MHz)	3	23.0	16.0	15.0	14.0
	5	5G NR	N78 (3700.0 – 3800.0 MHz)	3	23.0	16.0	15.0	14.0
8	5G NR	N2 (1850.0 – 1910.0 MHz)	3	23.0	19.0	18.0	17.0	
8	5G NR	N38 (2570.0 – 2620.0 MHz)	3	23.0	21.0	20.0	19.0	
8	5G NR	N41 (2496.0 – 2690.0 MHz)	3	23.0	20.0	19.0	18.0	
8	5G NR	N41 (2496.0 – 2690.0 MHz)	2	26.0	20.0	19.0	18.0	
8	5G NR	N66 (1710.0 – 1780.0 MHz)	3	23.0	20.0	19.0	18.0	
8	5G NR	N77 (3700.0 – 3980.0 MHz)	3	23.0	18.5	17.5	16.5	
8	5G NR	N77 (3700.0 – 3980.0 MHz)	2	26.0	18.5	17.5	16.5	
8	5G NR	N78 (3700.0 – 3800.0 MHz)	3	23.0	19.0	18.0	17.0	
8	5G NR	N78 (3700.0 – 3800.0 MHz)	3	23.0	19.0	18.0	17.0	

SAR compliance is demonstrated with the *Reported SAR: Reported SAR = measured 1gSAR @ Reported Upper Threshold < FCC SAR limit* where, *Reported Upper Threshold = Upper Threshold (stored in NVM) + Tolerance*

7. Remarks and comments

- Only the plots for the test positions with the highest measured SAR per band/mode are included in Annex C as required per FCC OET KDB 865664 D02, paragraph 2.3.8.

8. Test Verdicts summary

The statement of conformity to applicable standards in the table below are based on the measured values, without taking into account the measurement uncertainties.

Mode	Band (UL)	Highest Reported SAR (1g) (W/kg)	Verdict
WCDMA	FDD II (1850.0 – 1910.0 MHz)	0.63	P
	FDD IV (1710.0 – 1755.0 MHz)	0.69	P
	FDD V (824.0 – 849.0 MHz)	0.91	P
LTE FDD	Band 2 (1850.0 – 1910.0 MHz)	0.68	P
	Band 4 (1710.0 – 1755.0 MHz)	NM	NA
	Band 5 (824.0 – 849.0 MHz)	0.90	P
	Band 7 (2500.0 – 2570.0 MHz)	1.24	P
	Band 12 (699.0 – 716.0 MHz)	0.72	P
	Band 13 (777.0 – 787.0 MHz)	0.71	P
	Band 14 (788.0 – 798.0 MHz)	0.73	P
	Band 17 (704.0 – 716.0 MHz)	NM	NA
	Band 25 (1850.0 – 1915.0 MHz)	1.42	P
	Band 26 (814.0 – 849.0 MHz)	0.86	P
	Band 30 (2305.0 – 2315.0 MHz)	0.99	P
	Band 66 (1710.0 – 1780.0 MHz)	0.83	P
	LTE TDD	Band 38 (2570.0 – 2620.0 MHz)	1.00
Band 41 (2496.0 – 2690.0 MHz)		0.54	P
Band 48 (3550.0 – 3700.0 MHz)		1.37	P
5G NR FR1 FDD	Band 2 (1850.0 – 1910.0 MHz)	0.33	P
	Band 5 (824.0 – 849.0 MHz)	0.55	P
	Band 7 (2500.0 – 2570.0 MHz)	0.58	P
	Band 25 (1850.0 – 1915.0 MHz)	0.51	P
	Band 30 (2305.0 – 2315.0 MHz)	0.90	P
	Band 66 (1710.0 – 1780.0 MHz)	0.83	P
5G NR FR1 TDD	Band 38 (2570.0 – 2620.0 MHz)	0.87	P
	Band 41 (2496.0 – 2690.0 MHz)	1.10	P
	Band 77 (3700.0 – 3980.0 MHz)	0.97	P
	Band 78 (3700.0 – 3800.0 MHz)	0.98	P

P: Pass
 F: Fail
 NM: Not Measured
 NA: Not Applicable

According to the FCC OET KDB 690783 D01, this is the summary of the values for the Grant Listing:

Exposure Condition	Highest Reported SAR (1g) (W/kg)			
	Equipment Class			
	PCE	DTS	DSS	U-NII
Body Worn	1.42	0.66	0.40	0.92
Simultaneous Tx	Sum-SAR: 2.43 SPLSR: 0.03	Sum-SAR: 1.94 SPLSR: 0.03	Sum-SAR: 2.43 SPLSR: 0.02	Sum-SAR: 2.43 SPLSR: 0.03

Considering the results of the performed test according to FCC 47CFR Part 2.1093 and ISED RSS 102, Issue 5 the item under test is IN COMPLIANCE with the requested specifications specified in Section1. Standards, reference documents and applicable test methods

9. Document Revision History

Revision #	Modified by	Revision Details
Rev. 00	A.Lounes, R.Luciani	First Issue
Rev. 01	E. Garcia	Corrected FCC id

Annex A. Test & System Description

A.1 SAR Definition

Specific Absorption rate is defined as the time derivative of the incremental energy (dW) absorbed by (dissipated in) and incremental mass (dm) contained in a volume element (dV) of a given density (ρ).

$$SAR = \frac{d}{dt} \cdot \left(\frac{dW}{dm} \right) = \frac{d}{dt} \cdot \left(\frac{dW}{\rho \cdot dV} \right)$$

SAR is expressed in units of watts per kilogram (W/kg). SAR can be related to the electric field at a point by

$$SAR = \frac{\sigma |E|^2}{\rho}$$

Where:

σ = Conductivity of the tissue (S/m)
 ρ = Mass density of the tissue (kg/m³)
E = RMS electric field strength (V/m)

A.2 SAR Measurement System

A.2.1 SAR Measurement Setup

The DASY6 system for performing compliance tests consists of the following items:

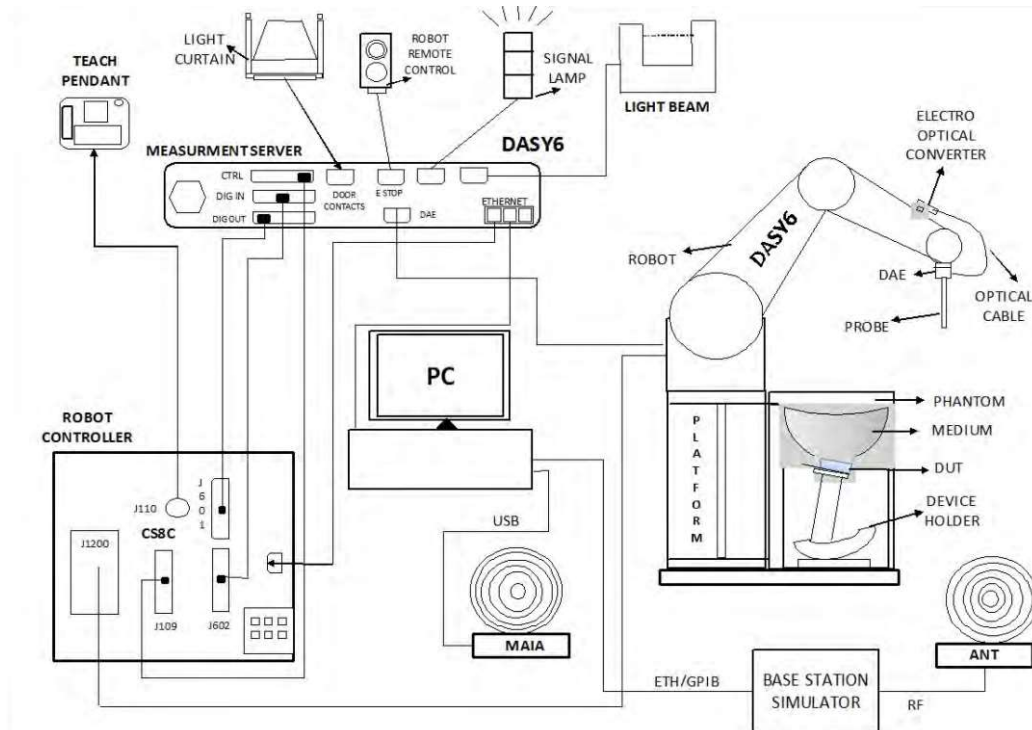

- ✓ A standard high precision 6-axis robot (Stäubli TX/RX family) with controller, teach pendant and software. It includes an arm extension for accommodating the data acquisition electronics (DAE)
- ✓ An isotropic field probe optimized and calibrated for the targeted measurements.
- ✓ A data acquisition electronics (DAE) which performs the signal amplification, signal multiplexing, AD-conversion, offset measurements, mechanical surface detection, collision detection, etc. The unit is battery powered with standard or rechargeable batteries. The signal is optically transmitted to the EOC.
- ✓ The Electro-optical Converter (EOC) performs the conversion from optical to electrical signals for the digital communication to the DAE. The EOC signal is transmitted to the measurement server.
- ✓ The function of the measurement server is to perform the time critical tasks such as signal filtering, control of the robot operation and fast movements interrupts.
- ✓ The Light Beam used is for probe alignment. This improves the (absolute) accuracy of the probe positioning.
- ✓ A computer running Win10 professional operating system and the DASY6 software.
- ✓ Remote control and teach pendant as well as additional circuitry for robot safety such as warning lamps, etc.
- ✓ The phantom, the device holder and other accessories according to the targeted measurement.
- ✓ MAIA is a hardware interface (Antenna) used to evaluate the modulation and audio interference characteristics of RF signals.
- ✓ ANT is an ultra-wideband antenna for use with the base station simulators over 698 MHz to 6GHz.
- ✓ The base station simulator is an equipment used for SAR cellular tests in order to emulate the cellular signals characteristics and behavior between a regular base station and the equipment under test.
- ✓ Tissue simulating liquid.
- ✓ System Validation dipoles.
- ✓ Network emulator.

A.2.2 E-Field Measurement Probe

The probe is constructed using three orthogonal dipole sensors arranged on an interlocking, triangular prism core. The probe has built-in shielding against static charges and is contained within a PEEK cylindrical enclosure material at the tip.



The probe's characteristics are:

Frequency Range	30MHz – 6GHz
Length	337 mm
Probe tip external diameter	2.5 mm
Typical distance between dipoles and the probe tip	1 mm
Axial Isotropy (in human-equivalent liquids)	±0.3 dB
Hemispherical Isotropy (in human-equivalent liquids)	±0.5 dB
Linearity	±0.2 dB
Maximum operating SAR	100 W/kg
Lower SAR detection threshold	0.001 W/kg

A.2.3 Flat Phantom

Phantom for compliance testing of handheld and body-mounted wireless devices in the frequency range of 30 MHz to 6 GHz. ELI is fully compatible with the IEC 62209-2 standard and all known tissue simulating liquids. ELI has been optimized regarding its performance and can be integrated into our standard phantom tables. A cover prevents evaporation of the liquid. Reference markings on the phantom allow installation of the complete setup, including all predefined phantom positions and measurement grids, by teaching three points. The phantom is compatible with all SPEAG dosimetric probes and dipoles.

The phantom's characteristics are:

Material	Vinylester, glass fiber reinforced (VE-GF)
Shell thickness	2 mm ± 0.2 mm
Filling volume	30 Liters approx.
Dimensions	Major axis: 600mm / Minor axis: 400mm

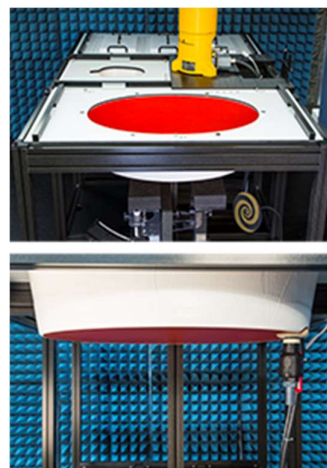

A.2.4 Device Positioner

The SAR in the phantom is approximately inversely proportional to the square of the distance between the source and the liquid surface. For a source at 5 mm distance, a positioning uncertainty of 0.5 mm would produce a SAR uncertainty of 20%. Accurate device positioning is therefore crucial for accurate and repeatable measurements. The positions in which the devices must be measured are defined by the standards.



The DASY device holder is designed to cope with the different positions given in the standard. It has two scales for device rotation (with respect to the body axis) and device inclination (with respect to the line between the ear reference points). The rotation center for both scales is the ear reference point (ERP). Thus the device needs no repositioning when changing the angles.

The DASY device holder is constructed of low-loss POM material having the following dielectric parameters: relative permittivity $\epsilon=3$ and loss tangent $\delta=0.02$. The amount of dielectric material has been reduced in the closest vicinity of the device, since measurements have suggested that the influence of the clamp on the test results could thus be lowered.

A simple but effective and easy-to-use extension for the Mounting Device; facilitates testing of larger devices according to IEC 62209-2 (e.g., laptops, cameras, etc.); lightweight and fits easily on the upper part of the Mounting Device in place of the phone positioner. The extension is fully compatible with the Twin SAM, ELI and other Flat Phantoms.



A.3 Data Evaluation

- **Power Reference measurement**

The robot measures the E field in a specified reference position that can be either the selected section's grid reference point or a user point in this section at 4mm of the inner surface of the phantom, 2mm for frequencies above 3GHz.

- **Area Scan**

Measurement procedures for evaluating SAR from wireless handsets typically start with a coarse measurement grid to determine the approximate location of the local peak SAR values. This is known as the area-scan procedure. The SAR distribution is scanned along the inside surface of one side of the phantom head, at least for an area larger than the projection of the handset and antenna. The distance between the measured points and phantom surface should be less than 8 mm, and should remain constant (with variation less than ± 1 mm) during the entire scan in order to determine the locations of the local peak SAR with sufficient accuracy. The angle between the probe axis and the surface normal line is recommended but not required to be less than 30° . If this angle is larger than 30° and the closest point on the probe-tip housing to the phantom surface is closer than a probe diameter, the boundary effect may become larger and polarization dependent. This additional uncertainty needs to be analyzed and accounted for. To achieve this, modified test procedures and additional uncertainty analyses not described in this recommended practice may be required. The measurement and interpolation point spacing should be chosen such as to allow identification of the local peak locations to within one-half of the linear dimension of a side of the zoom-scan volume. Because a local peak having specific amplitude and steep gradients may produce a lower peak spatial-average SAR compared to peaks with slightly lower amplitude and less steep gradients, it is necessary to evaluate these other peaks as well. However, since the spatial gradients of local SAR peaks are a function of the wavelength inside the tissue-equivalent liquid and the incident magnetic field strength, it is not necessary to evaluate local peaks that are less than 2 dB or more below the global maximum peak. Two-dimensional spline algorithms (Brishoual et al. 2001; Press et al., 1996) are typically used to determine the peaks and gradients within the scanned area. If a peak is found at a distance from the scan border of less than one-half the edge dimension of the desired 1 g or 10 g cube, the measurement area should be enlarged if possible.

- **Zoom Scan**

To evaluate the peak spatial-average SAR values for 1 g or 10 g cubes, fine resolution volume scans, called zoom scans, are performed at the peak SAR locations identified during the area scan. The minimum zoom scan volume size should extend at least 1.5 times the edge dimension of a 1 g cube in all directions from the center of the scan volume, for both 1 g and 10 g peak spatial-average SAR evaluations. Along the phantom curved surfaces, the front face of the volume facing the tissue/liquid interface conforms to the curved boundary, to ensure that all SAR peaks are captured. The back face should be equally distorted to maintain the correct averaging mass. The flatness and orientation of the four side faces are unchanged from that of a cube whose orientation is within $\pm 30^\circ$ of the line normal to the phantom at the center of the cube face next to the phantom surface. The peak local SAR locations that were determined in the area scan (interpolated values) should be used for the centers of the zoom scans. If a scan volume cannot be centered due to proximity of a phantom shape feature, the probe should be tilted to allow scan volume enlargement. If probe tilt is not feasible, the zoom-scan origin may be shifted, but not by more than half of the 1 g or 10 g cube edge dimension.

After the zoom-scan measurement, extrapolations from the closest measured points to the surface, for example along lines parallel to the zoom-scan centerline, and interpolations to a finer resolution between all measured and extrapolated points are performed. Extrapolation algorithm considerations are described in 6.5.3, and 3-D spline methods (Brishoual et al., 2001; Kreyszig, 1983; Press et al., 1996) can be used for interpolation. The peak spatial-average SAR is finally determined by a numerical averaging of the local SAR values in the interpolation grid, using for example a trapezoidal algorithm for the integration (averaging).

In some areas of the phantom, such as the jaw and upper head regions, the angle of the probe with respect to the line normal to the surface may be relatively large, e.g., greater than $\pm 30^\circ$, which could increase the boundary effect error to a larger level. In these cases, during the zoom scan a change in the orientation of the probe, the phantom, or both is recommended but not required for the duration of the zoom scan, so that the angle between the probe axis and the line normal to the surface is within 30° for all measurement points.

- **Power Drift measurement**

The robot re-measures the E-Field in the same reference location measured at the Power Reference. The drift measurement gives the field difference in dB from the first to the last reference reading. This allows a user to monitor the power drift of the device under test that must remain within a maximum variation of $\pm 5\%$.

- **Post-processing**

The procedure for spatial peak SAR evaluation has been implemented according to the IEEE1528 and IEC 62209-1/2 standards. It can be conducted for 1g and 10g.

The software allows evaluations that combine measured data and robot positions, such as:

- ✓ Maximum search
- ✓ Extrapolation
- ✓ Boundary correction
- ✓ Peak search for averaged SAR

Interpolation between the measured points is performed when the resolution of the grid is not fine enough to compute the average SAR over a given mass.

Extrapolation routines are used to obtain SAR values between the lowest measurement points and the inner phantom surface. The extrapolation is determined by the surface detection distance and the probe sensor offset. Several measurements at different distances are necessary for the extrapolation.

A.4 System and Liquid Check

A.4.1 System Check

The system performance check verifies that the system operates within its specifications. System and operator errors can be detected and corrected. It is recommended that the system performance check be performed prior to any usage of the system in order to guarantee reproducible results.

The system performance check uses normal SAR measurements in a simplified setup with a well characterized source. This setup was selected to give a high sensitivity to all parameters that might fail or vary over time. The system check does not intend to replace the calibration of the components, but indicates situations where the system uncertainty is exceeded due to drift or failure.

In the simplified setup for system check, the EUT is replaced by a calibrated dipole and the power source is replaced by a controlled continuous wave generated by a signal generator. The calibrated dipole must be placed beneath the flat phantom section of the phantom at the correct distance.

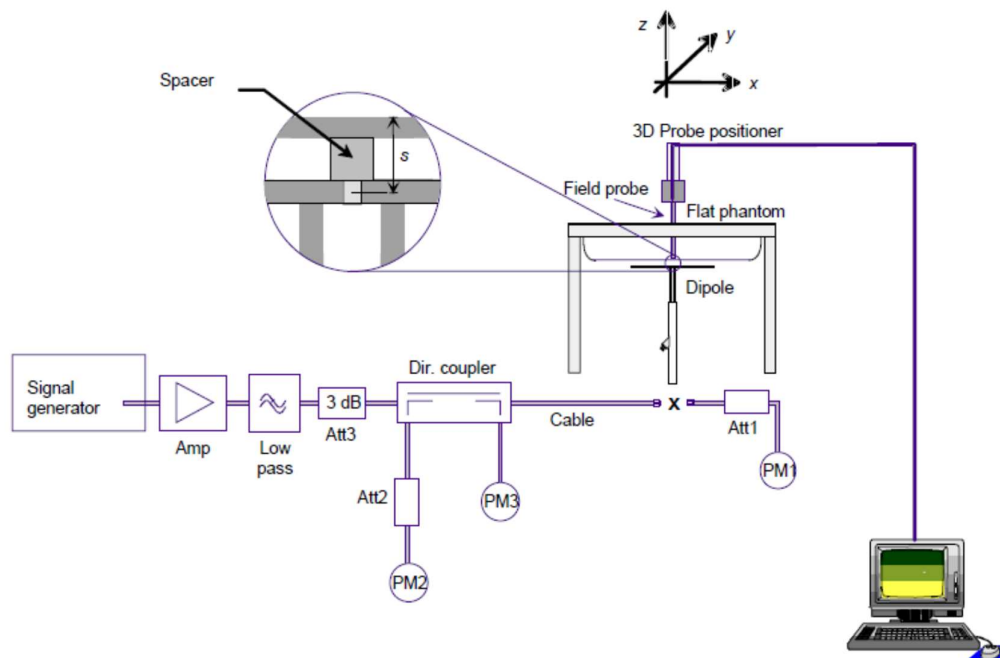

The equipment setup is shown below:

- ✓ Signal Generator
- ✓ Amplifier
- ✓ Directional coupler
- ✓ Power meter
- ✓ Calibrated dipole

First, the power meter PM1 (including attenuator Att1) is connected to the cable to measure the forward power at the location of the connector (x) to the system check source. The signal generator is adjusted for the desired forward power at the connector as read by power meter PM1 after attenuation Att1 and also as coupled through Att2 to PM2. After connecting the cable to the source, the signal generator is readjusted for the same reading at power meter PM2.

SAR results are normalized to a forward power of 1W to compare the values with the calibration reports results as described at IEEE 1528 and IEC 62209 standards.

A.4.2 Liquid Check

The dielectric parameters check is done prior to the use of the tissue simulating liquid. The verification is made by comparing the relative permittivity and conductivity to the values recommended by the applicable standards.

The liquid verification was performed using the following test setup:

- ✓ VNA (Vector Network Analyzer)
- ✓ Open-Short-Load calibration kit
- ✓ RF Cable
- ✓ Open-Ended Coaxial probe
- ✓ DAK software tool
- ✓ SAR Liquid
- ✓ De-ionized water
- ✓ Thermometer

These are the target dielectric properties of the tissue-equivalent liquid material as defined in FCC OET KDB 865664 D01.

Frequency (MHz)	Body SAR	
	ϵ_r (F/m)	σ (S/m)
150	61.9	0.80
300	58.2	0.92
450	56.7	0.94
835	55.2	0.97
900	55.0	1.05
1450	54.0	1.30
1800-2000	53.3	1.52
2450	52.7	1.95
3000	52.0	2.73
5800	48.2	6.00

(ϵ_r = relative permittivity, σ = conductivity and ρ = 1000 kg/m³)

The measurement system implement a SAR error compensation algorithm as documented in IEEE Std 1528-2013 (equivalent to draft standard IEEE P1528-2011) to automatically compensate the measured SAR results for deviations between the measured and required tissue dielectric parameters (applied to only scale up the measured SAR, and not downward) so, according to FCC OET KDB 865664 D01, the tolerance for ϵ_r and σ may be relaxed to $\pm 10\%$.

A.5 Test Equipment List

SAR system #2 (used for LTE tests)

ID #	Device	Type/Model	Serial Number	Manufacturer	Cal. Date	Cal. Due Date
002-000	6-Axis Robot	TX60 Lspeag	F16/55FXA1/A/01	STAÜBLI	NA	NA
002-001	Robot Controller	CS8C	F16/55FXA1/C/01	STAÜBLI	NA	NA
002-002	Measurement Server	DASY6	1489	SPEAG	NA	NA
002-003	Electro Optical Converter	EOC60	1098	SPEAG	NA	NA
002-004	Light Beam Unit	SE UKS 030 AA	N/A	Di-soric	NA	NA
002-005	Oval Flat Phantom	ELI V8.0	2048	SPEAG	NA	NA
002-006	Laptop Holder		N/A	SPEAG	NA	NA
002-007	Measurement Software	DASY6 v6.14	9-5DEE27C2	SPEAG	NA	NA
002-008	Data Acquisition Electronics	DAE4	1429	SPEAG	2021-05-11	2022-05-11
002-009	Dosimetric E-Field probe 750-5800MHz	EX3DV4	3978	SPEAG	2021-05-22	2022-05-22
002-010	MAIA Antenna	MAIA	1249	SPEAG	NA	NA

SAR system #4 (used for 5G Tests)

ID #	Device	Type/Model	Serial Number	Manufacturer	Cal. Date	Cal. Due Date
004-000	6-Axis Robot	TX90XLspeag	F11/5JL2A1/A/01	SPEAG	NA	NA
004-001	Robot Controller	CS8C	F11/5JL2A1/C/01	SPEAG	NA	NA
004-002	Oval Flat Phantom	ELI V8.0	2124	SPEAG	NA	NA
004-003	Measurement Server	SE UMS 028 BB	N/A	SPEAG	NA	NA
004-004	Light Beam Unit	SE UKS 030 AA	1030	SPEAG	NA	NA
004-005	DASY6 Software	DASY6 Software	9-658E90FA	SPEAG	NA	NA
004-006	Dosimetric E-Field probe 750-5800MHz	EX3DV4	7604	SPEAG	2021-08-16	2022-08-16
086-000	Dosimetric E-Field probe 750-5800MHz	EX3DV4	7455	SPEAG	2021-03-20	2022-03-20
004-007	Data Acquisition Electronics	DAE4	1628	SPEAG	2021-08-06	2022-08-06
085-000	Data Acquisition Electronics	DAE4	1517	SPEAG	2021-03-11	2022-03-11
004-008	MAIA Antenna	MAIA	1292	SPEAG	NA	NA
458-000	Automation SW	SARA v2.2	-	Intel	NA	NA

Shared equipment

ID #	Device	Type/Model	Serial Number	Manufacturer	Cal. Date	Cal. Due Date
123-000	USB Power Sensor	NRP-Z81	102278	R&S	2021-04-13	2023-04-13
124-000	USB Power Sensor	NRP-Z81	102279	R&S	2021-04-13	2023-04-13
126-000	Vector Signal Generator	ESG E4438C	MY45092885	Agilent	2021-05-27	2023-05-27
099-000	Liquid measurement SW	DAK-3.5 V3.0.2.3	9-2687B491	SPEAG	n/a	n/a
135-000	Network Emulator	CMW500	152721	R&S	2020-03-26	2022-03-26
023-000	5G Network Emulator	CMX500	101444	R&S	2020-08-24	2022-08-24
069-000	Dielectric Probe Kit	DAK-3.5	1309	SPEAG	2021-03-10	2023-03-10
078-000	RF Cable	ST-18/SMAm/SMAm/48	1158830	Huber & Suhner	2021-08-13	2022-02-13
079-000	RF Cable	ST-18/SMAm/SMAm/48	1158831	Huber & Suhner	2021-08-13	2022-02-13
077-000	Coupler	CD0.5-8-20-30	1251-002	Amd-group	2021-08-13	2022-02-13
384-000	0.1-6GHz RF amplifier	AMT-A0328	1818	Agile Microwave Technology	2021-08-13	2022-02-13
141-000	USB Power Sensor	NRP-Z81	104381	R&S	2020-06-03	2022-06-03
398-000	Thermometer	TESTO 922	33622932/208	TESTO	2021-11-09	2023-11-09
327-000	Temp & Humidity Logger	RA32E-TH1-RAS	RA32-F0DEF9	AVTECH	2021-03-09	2023-03-09
089-000	Vector Reflectometer	PLANAR R140	0190616	Copper Mountain Technologies	2021-09-02	2023-09-02
339-000	Vector Network Analyzer	ZNB40	101740	R&S	2020-07-10	2022-07-10
327-000	Temp & Humidity Logger	RA32E-TH1-RAS	RA32-F0DED9	AVTECH	2021-03-09	2023-03-09
398-000	Thermometer	TESTO 922	33622932/208	Testo	2021-11-09	2023-11-09
114-000	Measurement Software	DASY6 v6.14	9-11F3E9C3	SPEAG	NA	NA
071-000	System Validation Dipole 750MHz	D750V3	1136	SPEAG	2021-01-21	2023-01-21
072-000	System Validation Dipole 835MHz	D835V2	4d192	SPEAG	2021-01-21	2023-01-21
073-000	System Validation Dipole 1750 MHz	D1750V2	1133	SPEAG	2021-01-20	2023-01-20
074-000	System Validation Dipole 1900 MHz	D1900V2	5d197	SPEAG	2021-01-20	2023-01-20
075-000	System Validation Dipole 2300 MHz	D2300V2	1046	SPEAG	2021-01-13	2023-01-13
076-000	System Validation Dipole 2600 MHz	D2600V2	1100	SPEAG	2021-01-13	2023-01-13
404-000	System Validation Dipole 3700MHz	D3700V2	1093	SPEAG	2021-05-11	2023-05-11

A.5.1 Tissue Simulant Liquid

TSL	Manufacturer / Model	Freq Range (MHz)	Main Ingredients	Note
Body WideBand System #2	SPEAG MBBL600-6000V6 Batch 160603-01	600-6000	Ethenediol, Sodium petroleum sulfonate, Hexylene Glycol / 2-Methyl-pentane-2.4-diol, Alkoxyated alcohol	Used for WCDMA and LTE tests
Body WideBand System #4	SPEAG MBBL600-6000V6 Batch 160630-01	600-6000	Ethenediol, Sodium petroleum sulfonate, Hexylene Glycol / 2-Methyl-pentane-2.4-diol, Alkoxyated alcohol	Used for 5G NR tests

A.6 Measurement Uncertainty Evaluation

The system uncertainty evaluation is shown in the table below with a coverage factor of $k = 2$ to indicate a 95% level of confidence:

SPEAG DASY6 Uncertainty Budget According to IEC/IEEE 62209-1528 (4 MHz - 6 GHz) including IEEE 1528-2013 and IEC 62209-1/2016, IEC 62209-2/2010								
Symbol	Error Description	Uncert. Value	Prob. Dist.	Div.	(ci) 1g	(ci) 10g	Std Unc. (1g)	Std Unc. (10g)
Measurement System Errors								
CF	<i>Probe Calibration</i>	±14.0 %	N	2	1	1	±7.0 %	±7.0 %
CF _{drift}	Probe Calibration Drift	±1.0 %	N	1	1	1	±1.0 %	±1.0 %
LIN	Probe Linearity	±4.7 %	R	√3	1	1	±2.7 %	±2.7 %
BBS	Broadband Signal	±3.0 %	N	2	1	1	±1.5 %	±1.5 %
ISO	<i>Axial Isotropy</i>	±4.7 %	R	√3	0.5	0.5	±1.4 %	±1.4 %
ISO	Hemispherical Isotropy	±9.6 %	R	√3	0.5	0.5	±2.8 %	±2.8 %
DAE	Data Acquisition	±0.3 %	N	1	1	1	±0.3 %	±0.3 %
AMB	RF Ambient	±1.8 %	N	1	1	1	±1.8 %	±1.8 %
Δ _{sys}	Probe Positioning	±0.2 %	N	1	0.33	0.33	±0.1 %	±0.1 %
DAT	Data Processing	±2.3 %	N	1	1	1	±2.3 %	±2.3 %
Phantom and Device Errors								
LIQ(σ)	Conductivity (meas.) _{DAK}	±2.5 %	N	1	0.78	0.71	±2.0 %	±1.8 %
LIQ(Tσ)	Conductivity (temp.) _{BB}	±3.4 %	R	√3	0.78	0.71	±1.5 %	±1.4 %
EPS	Phantom Permittivity	±14.0 %	R	√3	0.25	0.25	±2.0 %	±2.0 %
DAS	Distance DUT - TSL	±2.0 %	N	1	2	2	±4.0 %	±4.0 %
H	Device Holder	±3.6 %	N	1	1	1	±3.6 %	±3.6 %
MOD	DUT Modulation _m	±2.4 %	R	√3	1	1	±1.4 %	±1.4 %
TAS	Time-average SAR	±2.6 %	R	√3	1	1	±1.5 %	±1.5 %
RF _{drift}	DUT drift	±5.0 %	N	1	1	1	±2.9 %	±2.9 %
Correction to the SAR results								
C(ε, σ)	Deviation to Target	±1.9 %	N	1	1	0.84	±1.9 %	±1.6 %
Combined Std. Uncertainty							±11.5 %	±11.4 %
Expanded STD Uncertainty							±23.1 %	±22.9 %

A.7 RF Exposure Limits

SAR assessments have been made in line with the requirements of FCC 47 CFR Part 2.1093 and ISED RSS 102 issue 5 on the limitation of exposure of the general population / uncontrolled exposure for portable devices.

Exposure Type	General Population / Uncontrolled Environment
Peak spatial-average SAR (averaged over any 1 gram of tissue)	1.6 W/kg
Whole body average SAR	0.08 W/kg
Peak spatial-average SAR (extremities) (averaged over any 10 grams of tissue)	4.0 W/kg

Annex B. Test Results

The herein test results were performed by:

Test case measurement	Test Personnel
Conducted measurement	F. Heurtematte
SAR measurement	E.Garcia, A.Lounes, R Luciani

B.1 Test Conditions

B.1.1 Test SAR Test positions relative to the phantom

The device under test was convertible PC host platform (HP) HSN-I45C using FM350-GL WWAN module and PIFA antennas. The card was operated utilizing proprietary software (RD Tool v1.0.3.2) and each channel was measured using a communication tester to determine the maximum average power.

The device has 2 power settings:

- Notebook mode
- Tablet mode

See section 6 for details about power values for each configuration

See Annex F.3 for information about the existing configurations

In the same manner the required test positions analysis is done considering the two possible user configurations and power levels for each one

Laptop mode

The highest tune up power for this mode is 27dBm in LTE41 PC2. Notebook mode can be reduced given the distance of the antenna to the measurement point and the above maximum power. For more details refer to section B.1.3.1

Tablet mode

According to FCC OET KDB 616217 D04, the back surface and edges of the tablet should be tested for SAR compliance with the tablet touching the phantom. The SAR Test Exclusion Threshold in FCC OET KDB 447498 D01 can be applied to determine SAR test exclusion for adjacent edge configurations. (See section 6 for power specifications)

The reduced power values shown on section 6 and the closest distance from the antenna to an adjacent tablet edge is used to determine if SAR testing is required for the adjacent edges, with the adjacent edge positioned against the phantom and the edge containing the antenna positioned perpendicular to the phantom.

Considering the antenna location diagrams in Annex F and the test exclusions described before, the surfaces/edges to be measured for each antenna are:

Tablet	WWAN Main	WWAN Aux
Position	<ul style="list-style-type: none"> • Top Edge • Back Face • Right Edge 	<ul style="list-style-type: none"> • Top Edge • Back Face

See B.1.3.1 for a more detailed list of the applied reductions.

See F.2 Test positions section for more information on the tested positions.

B.1.2 Test signal, Output power and Test Frequencies

B.1.2.1 TDD consideration

According to KDB 941225 D05 SAR for LTE Devices, for Time-Division Duplex (TDD) systems, SAR must be tested using a fixed periodic duty factor according to the highest transmission duty factor implemented for the device and supported by the defined 3GPP LTE TDD configurations.

LTE TDD Bands support 3GPP TS 36.211 section 4.2 for Type 2 Frame structure and table 2 for uplink-downlink configurations and table 1 for special subframe configurations

Table 1

Special subframe configuration	Normal cyclic prefix in downlink			Extended cyclic prefix in downlink		
	DwPTS	UpPTS		DwPTS	UpPTS	
		Normal cyclic prefix in uplink	Extended cyclic prefix in uplink		Normal cyclic prefix in uplink	Extended cyclic prefix in uplink
0	6592 T _s	(1+X) 2192 T _s	(1+X) 2560 T _s	7680 · T _s	(1+X) 2192 T _s	(1+X) 2560 T _s
1	19760 T _s			20480 T _s		
2	21952 T _s			23040 T _s		
3	24144 T _s			25600 T _s		
4	26336 T _s			7680 T _s		
5	6592 T _s	(2+X) 2192 T _s	(2+X) 2560 T _s	20480 T _s	(2+X) 2192 T _s	(2+X) 2560 T _s
6	19760 T _s			23040 T _s		
7	21952 T _s			12800 T _s		
8	24144 T _s			-		
9	13168 T _s			-		
10	13168 T _s	13150 T _s	12800 T _s	-	-	-

Table2

Uplink-Downlink Config.	Downlink-to-Uplink Switch-point Periodicity	Subframe Number										Calculated Duty Cycle (%)
		0	1	2	3	4	5	6	7	8	9	
0	5 ms	D	S	U	U	U	D	S	U	U	U	63.3%
1	5 ms	D	S	U	U	D	D	S	U	U	D	43.3%
2	5 ms	D	S	U	D	D	D	S	U	D	D	23.3%
3	10 ms	D	S	U	U	U	D	D	D	D	D	31.7%
4	10 ms	D	S	U	U	D	D	D	D	D	D	21.7%
5	10 ms	D	S	U	D	D	D	D	D	D	D	11.7%
6	5 ms	D	S	U	U	U	D	S	U	U	D	53.3%

Calculated duty cycle = Extended cyclic prefix in uplink * (T_s) * # of S + # of U / period

The configuration used for SAR testing was the number 0 which corresponds to the highest duty cycle (Power Class 3)

Frame structure and maximal measured duty cycle for NR 5G FR1 are described in the table 3.

B.1.2.1 5G NR TDD consideration

Table3

Radio Frame 0																			
SF0	SF1	SF2	SF3	SF4	SF5	SF6	SF7	SF8	SF9	SF0	SF1	SF2	SF3	SF4	SF5	SF6	SF7	SF8	SF9
0	1	2	3	4	5	6	7	8	9	0	1	2	3	4	5	6	7	8	9
D	s	U	U	S	U	S	U	S	U	S	U	S	U	S	U	S	U	S	U
Radio Frame 1-2																			
SF0	SF1	SF2	SF3	SF4	SF5	SF6	SF7	SF8	SF9	SF0	SF1	SF2	SF3	SF4	SF5	SF6	SF7	SF8	SF9
0	1	2	3	4	5	6	7	8	9	0	1	2	3	4	5	6	7	8	9
S	U	S	U	S	U	S	U	S	U	S	U	S	U	S	U	S	U	S	U
Radio Frame 3																			
SF0	SF1	SF2	SF3	SF4	SF5	SF6	SF7	SF8	SF9	SF0	SF1	SF2	SF3	SF4	SF5	SF6	SF7	SF8	SF9
0	1	2	3	4	5	6	7	8	9	0	1	2	3	4	5	6	7	8	9
S	U	S	U	S	U	S	U	S	U	S	U	S	U	S	U	S	U	S	U

“D”: Full DL slot, “s”: partial slot, “S”: partial slot for PUSCH, “U”: full UL slot

B.1.3 Evaluation Exclusion and Test Reductions

B.1.3.1 SAR evaluation exclusion

The SAR Test Exclusion Threshold in FCC OET KDB 447498 D01 v06 can be applied to determine SAR test exclusion for adjacent edge configurations. For 100MHz to 6GHz and test separation distances ≤50mm, the 1-g and 10-g SAR test exclusion thresholds are determined by the following formula:

$$[(\text{max. power of channel, including tune – up tolerance, mW}) / (\text{min. test separation distance, mm})] \cdot \sqrt{f(\text{GHz})} \leq 3.0 \text{ for } 1g \text{ SAR, and } \leq 7.5 \text{ for } 10g \text{ extremity SAR} \quad (1)$$

Where:

- f(GHz) is the RF channel transmit frequency in GHz
- Power and distance are rounded to the nearest mW and mm before calculation
- The result is rounded to one decimal place for comparison
- The values 3.0 and 7.5 are referred to as numeric thresholds

The test exclusions are applicable only when the minimum test separation distance is ≤ 50 mm, and for transmission frequencies between 100 MHz and 6 GHz. When the minimum test separation distance is < 5 mm, a distance of 5 mm is applied to determine SAR test exclusion.

For test separation distances > 50 mm, the 1-g and 10-g SAR test exclusion thresholds are determined using the following formulas:

$$((\text{Power allowed at numeric threshold for } 50 \text{ mm in (1)}) + (\text{test separation distance} - 50 \text{ mm}) \cdot (f_{\text{MHz}}/150))\text{mW,} \quad (2)$$

for 100MHz to 1500MHz

$$((\text{Power allowed at numeric threshold for } 50 \text{ mm in (1)}) + (\text{test separation distance} - 50 \text{ mm}) \cdot 10)\text{mW,} \quad (3)$$

for 1500MHz and ≤ 6GHz

Test Exclusion

Antenna	Band Name	Output power		Back Face	Top Edge	Left Edge	Right Edge	Bottom Edge	Laptop	Back Face	Top Edge	Left Edge	Right Edge	Bottom Edge	Laptop
		dBm	mW												
WWAN Main (Ant 5)	UTRA II	17.0	50.1	<50	<50	>50	<50	>50	>50	c	T	R	T	R	R
	UTRA IV	17.5	56.2	<50	<50	>50	<50	>50	>50	T	T	R	T	R	R
	UTRA V	21.0	125.9	<50	<50	>50	<50	>50	>50	T	T	R	T	R	R
	LTE 2	17.0	50.1	<50	<50	>50	<50	>50	>50	T	T	R	T	R	R
	LTE 4	17.5	56.2	<50	<50	>50	<50	>50	>50	R	R	R	R	R	R
	LTE 5	21.0	125.9	<50	<50	>50	<50	>50	>50	R	R	R	R	R	R
	LTE 7	15.5	35.5	<50	<50	>50	<50	>50	>50	T	T	R	T	R	R
	LTE 12	18.0	63.1	<50	<50	>50	<50	>50	>50	T	T	R	T	R	R
	LTE 13	19.0	79.4	<50	<50	>50	<50	>50	>50	T	T	R	T	R	R
	LTE 14	19.0	79.4	<50	<50	>50	<50	>50	>50	T	T	R	T	R	R
	LTE 17	18.0	63.1	<50	<50	>50	<50	>50	>50	R	R	R	R	R	R
	LTE 25	16.0	39.8	<50	<50	>50	<50	>50	>50	T	T	R	T	R	R
	LTE 26	20.5	112.2	<50	<50	>50	<50	>50	>50	T	T	R	T	R	R
	LTE 30	14.0	25.1	<50	<50	>50	<50	>50	>50	T	T	R	T	R	R
	LTE 38	17.5	56.2	<50	<50	>50	<50	>50	>50	T	T	R	T	R	R
	LTE 41	14.5	28.2	<50	<50	>50	<50	>50	>50	T	T	R	T	R	R
	LTE 48	14.5	28.2	<50	<50	>50	<50	>50	>50	T	T	R	T	R	R
	LTE 66	17.5	56.2	<50	<50	>50	<50	>50	>50	T	T	R	T	R	R
	NR 2	17.0	50.1	<50	<50	>50	<50	>50	>50	R	R	R	R	R	R
	NR 5	21.0	125.9	<50	<50	>50	<50	>50	<50	T	T	R	T	R	R
NR 7	15.5	35.5	<50	<50	>50	<50	>50	<50	T	T	R	T	R	R	
NR 25	17.5	56.2	<50	<50	>50	<50	>50	<50	T	T	R	T	R	R	
NR 30	14.5	28.2	<50	<50	>50	<50	>50	<50	T	T	R	T	R	R	
NR 38	15.0	31.6	<50	<50	>50	<50	>50	<50	T	T	R	T	R	R	
NR 41	14.5	28.2	<50	<50	>50	<50	>50	<50	T	T	R	T	R	R	
NR 66	18.0	63.1	<50	<50	>50	<50	>50	<50	T	T	R	T	R	R	
NR 77	16.0	39.8	<50	<50	>50	<50	>50	<50	T	T	R	T	R	R	
NR 78	15.0	31.6	<50	<50	>50	<50	>50	<50	R	R	R	R	R	R	

T: Tested position

R: Reduced

See Annex F for a more detailed explanation of the separation distance related to the platform.

	Band Name	Output power		Back Face	Top Edge	Left Edge	Right Edge	Bottom Edge	Laptop
		Notebook Tablet							
		dBm	mW						
WWAN Aux (Ant 8)	LTE 2	17.5	56.2	<50	<50	>50	>50	>50	>50
	LTE 4	19.0	79.4	<50	<50	>50	>50	>50	>50
	LTE 7	19.0	79.4	<50	<50	>50	>50	>50	>50
	LTE 25	19.5	89.1	<50	<50	>50	>50	>50	>50
	LTE 30	18.5	70.8	<50	<50	>50	>50	>50	>50
	LTE 41	21.0	125.9	<50	<50	>50	>50	>50	>50
	LTE 48	20.0	100.0	<50	<50	>50	>50	>50	>50
	LTE 66	19.0	79.4	<50	<50	>50	>50	>50	>50
	NR 2	18.0	63.1	<50	<50	>50	>50	>50	>50
	NR 38	20.0	100.0	<50	<50	>50	>50	>50	>50
	NR 41	19.0	79.4	<50	<50	>50	>50	>50	>50
	NR 66	19.0	79.4	<50	<50	>50	>50	>50	>50
	NR 77	17.5	56.2	<50	<50	>50	>50	>50	>50
	NR 78	18.0	63.1	<50	<50	>50	>50	>50	>50

Back Face	Top Edge	Left Edge	Right Edge	Bottom Edge	Laptop
R	R	R	R	R	R
R	R	R	R	R	R
T	T	R	T	R	R
T	T	R	T	R	R
T	T	R	T	R	R
T	T	R	T	R	R
T	T	R	T	R	R
T	T	R	T	R	R
T	T	R	T	R	R
T	T	R	T	R	R
T	T	R	T	R	R
T	T	R	T	R	R
T	T	R	T	R	R

In order to evaluate SAR test exclusion for laptop and tablet user positions in which the separation distance passes the 50mm limit, equations (2) and (3) are used with the corresponding frequencies for each band, the user distances for the two positions and with the power values described on Section 6. The table below shows all cellular bands evaluated in this report grouped by frequency band, separation distances and the corresponding Power threshold in mW for each combination (distance and frequency)

Bands	Freq	Separation distance to the body on mm										
		60	70	80	90	100	110	160	170	190	200	
LTE 12,13, 14 17	750	223	273	323	373	423	473	723	773	873	923	Threshold values in mW
FDD V LTE 5, 26, NR 5	835	220	275	331	387	442	498	776	832	943	999	
FDD IV LTE 4, 66, NR 66	1750	213	313	413	513	613	713	1213	1313	1513	1613	
FDD II LTE 2, 25 NR 2, 25	1900	209	309	409	509	609	709	1209	1309	1509	1609	
LTE 30, NR 30	2300	199	299	399	499	599	699	1199	1299	1499	1599	
LTE 7, 38, 41, NR 7, 38, 41	2600	193	293	393	493	593	693	1193	1293	1493	1593	
LTE 48, NR 77, NR78	3700	180	280	380	480	580	680	1180	1280	1480	1580	

The highest output power for all bands in tablet mode is 125.9mW which is smaller than all the values of the table, SAR is not required for the tablet bottom and left edge positions

The highest output power for all bands in notebook mode is 501.2mW which is smaller than all the values of the table, for distances >160mm. Since the considered distance between the user body and the antenna is minimum 200mm, SAR is not required for the notebook mode position. Refer to annex F3 for antenna position using notebook mode.

B.1.3.2 General SAR test reduction

According to FCC OET KDB 447498 D01, testing of other required channels within the operating mode of a frequency band is not required when the reported 1-g or 10-g SAR for the mid-band or highest output power channel is:

- ≤ 0.8 W/kg or 2.0 W/kg, for 1-g or 10-g respectively, when the transmission band is ≤ 100 MHz
- ≤ 0.6 W/kg or 1.5 W/kg, for 1-g or 10-g respectively, when the transmission band is between 100 MHz and 200 MHz
- ≤ 0.4 W/kg or 1.0 W/kg, for 1-g or 10-g respectively, when the transmission band is ≥ 200 MHz

WLAN SAR Test reduction

Transmission Mode	SAR test exclusion/reduction
DSSS	<p>According to FCC OET KDB 248227 D01, SAR is measured for 2.4 GHz 802.11b, SAR test reduction is determined according to the following:</p> <ul style="list-style-type: none"> ▪ When the reported SAR of the highest measured maximum output power channel for the exposure configuration is ≤ 0.8 W/kg, no further SAR testing is required for 802.11b DSSS in that exposure configuration. ▪ When the reported SAR is > 0.8 W/kg, SAR is required for that exposure configuration using the next highest measured output power channel. When any reported SAR is > 1.2 W/kg, SAR is required for the third channel. <p>According to FCC OET KDB 248227 D01, SAR is not required for 2.4 GHz OFDM conditions when the highest reported SAR for DSSS is adjusted by the ratio of OFDM to DSSS specified maximum output power and the adjusted SAR is ≤ 1.2 W/kg.</p>
OFDM	<p>According to FCC OET KDB 248227 D01, 802.11a/g/n/ac modes have the same specified maximum output power, largest channel bandwidth, lowest order modulation and lowest data rate, the lowest order 802.11 mode is selected; i.e., 802.11a is chosen over 802.11n then 802.11ac or 802.11g is chosen over 802.11n.</p> <p>According to FCC OET KDB 248227 D01, an <i>initial test configuration</i> is determined for OFDM and DSSS transmission modes according to the channel bandwidth, modulation and data rate combination(s) with the highest maximum output power specified for production units in each standalone and aggregated frequency band. SAR is measured using the highest measured maximum output power channel. SAR test reduction for subsequent highest output test channels is determined according to reported SAR of the initial test configuration.</p> <p>The <i>initial test configuration</i> for 5 GHz OFDM transmission modes is determined by the 802.11 configuration with the highest maximum output power specified for production units, including tune-up tolerance, in each standalone and aggregated frequency band. SAR for the initial test configuration is measured using the highest maximum output power channel determined by the default power measurement procedures.</p> <p>According to FCC OET KDB 248227 D01, when the reported SAR of the initial test configuration is > 0.8 W/kg, SAR measurement is required for subsequent next highest measured output power channel(s) in the initial test configuration until reported SAR is ≤ 1.2 W/kg or all required channels are tested.</p>

WWAN SAR Test reduction

Transmission Mode	SAR test exclusion/reduction
HSDPA	According to FCC OET KDB 941225 D01, SAR evaluation is not required when the maximum average output power is < ¼ dB higher than the measured on the corresponding channels without HSDPA, using 12.2kbps RMC, and the maximum SAR for 12.2kbps RMC is < 1.2 W/kg.
HSUPA DC+HSDPA HSPA+	According to FCC OET KDB 941225 D01, SAR evaluation is not required when the maximum average output power is < ¼ dB higher than the measured on the corresponding channels without HSUPA, using 12.2kbps RMC, and the maximum SAR for 12.2kbps RMC is < 1.2 W/kg.
LTE	<p>According to FCC OET KDB 941225 D05, testing of 100% RB allocation, higher order modulations or lower BW is not required when these conditions are met:</p> <ul style="list-style-type: none"> ○ For QPSK with 100% RB allocation, SAR is not required when the highest maximum output power for 100 % RB allocation is less than the highest maximum output power in 50% and 1 RB allocations and the highest reported SAR for 1 RB and 50% RB allocation are ≤ 0.8 W/kg. ○ For each modulation besides QPSK, SAR is required only when the highest maximum output power for the configuration in the higher order modulation is > ½ dB higher than the same configuration in QPSK or when the reported SAR for the QPSK configuration is > 1.45 W/kg. ○ For lower BW, only measure SAR when the highest maximum output power of a configuration requiring testing in the smaller channel bandwidth is > ½ dB higher than the equivalent channel configurations in the largest channel bandwidth configuration or the reported SAR of a configuration for the largest channel bandwidth is > 1.45 W/kg. <p>For LTE bands that do not support at least three non-overlapping channels in certain channel bandwidths, test the available non-overlapping channels instead. When a device supports overlapping channel assignment in a channel bandwidth configuration, the middle channel of the group of overlapping channels should be selected for testing; therefore, the requirement for H, M, and L channels may not fully apply</p> <p>The conducted power for the higher order modulations i.e 64 QAM and 256 QAM has not been measured since the applicable MPR is respectively 2dB and 5dB.</p>
5G NR	According to TCB workshop November 2019; RF Exposure Policy Updates (5G NR FR1 NSA EN-DC UE SAR Evaluations), the FCC OET KDB 941225 D05 rules apply.

B.2 Conducted Power Measurements – Tablet mode

B.2.1 WCDMA/ HSPA/ DC-HSPA

B.2.1.1 WCDMA Band II Antenna 5

Mode	Channel Number	Freq (MHz)	Subset	Average Power Measured (dBm)	Factory Upper Tolerance (dBm)
RMC	9262	1852.4	-	16.91	17.00
	9400	1880	-	16.84	17.00
	9538	1907.6	-	16.74	17.00
HSDPA	9262	1852.4	1	16.88	17.00
			2	16.90	17.00
			3	16.93	17.00
			4	16.89	17.00
	9400	1880	1	16.90	17.00
			2	16.92	17.00
			3	16.92	17.00
			4	16.90	17.00
	9538	1907.6	1	16.78	17.00
			2	16.76	17.00
			3	16.82	17.00
			4	16.80	17.00
HSUPA	9262	1852.4	1	16.39	17.00
			2	NM	17.00
			3	NM	17.00
			4	NM	17.00
			5	15.88	17.00
	9400	1880	1	16.33	17.00
			2	NM	17.00
			3	NM	17.00
			4	NM	17.00
			5	15.75	17.00
	9538	1907.6	1	16.25	17.00
			2	NM	17.00
			3	NM	17.00
			4	NM	17.00
			5	15.62	17.00
DC-HSDPA	9262	1852.4	1	16.88	17.00
			2	16.91	17.00
			3	16.94	17.00
			4	16.93	17.00
	9400	1880	1	16.88	17.00
			2	16.88	17.00
			3	16.91	17.00
			4	16.90	17.00
	9538	1907.6	1	16.79	17.00
			2	16.77	17.00
			3	16.80	17.00
			4	16.77	17.00

According to KDB 941225, SAR measurements are not required for the secondary modes different than RMC as the maximum output power specified for production units in the secondary modes are $\leq 1/4$ dB higher than the primary mode and the highest reported SAR of the primary mode is scaled by the ratio of specified maximum output power of the secondary to primary mode and the adjusted SAR is $\leq 1.2W/Kg$.

NM: Not measured

B.2.1.2 WCDMA Band IV Antenna 5

Mode	Channel Number	Freq (MHz)	Subset	Average Power Measured (dBm)	Factory Upper Tolerance (dBm)
RMC	1312	1712.4	-	17.05	17.50
	1413	1732.6	-	16.99	17.50
	1513	1752.6	-	17.04	17.50
HSDPA	1312	1712.4	1	17.07	17.50
			2	17.05	17.50
			3	17.11	17.50
			4	17.06	17.50
	1413	1732.6	1	16.98	17.50
			2	16.98	17.50
			3	17.03	17.50
			4	17.00	17.50
	1513	1752.6	1	17.01	17.50
			2	17.02	17.50
			3	17.11	17.50
			4	17.05	17.50
HSUPA	1312	1712.4	1	16.54	17.50
			2	NM	17.50
			3	NM	17.50
			4	NM	17.50
			5	16.51	17.50
	1413	1732.6	1	16.50	17.50
			2	NM	17.50
			3	NM	17.50
			4	NM	17.50
			5	16.49	17.50
	1513	1752.6	1	16.53	17.50
			2	NM	17.50
			3	NM	17.50
			4	NM	17.50
			5	16.48	17.50
DC-HSDPA	1312	1712.4	1	17.08	17.50
			2	17.07	17.50
			3	17.13	17.50
			4	17.08	17.50
	1413	1732.6	1	17.01	17.50
			2	16.96	17.50
			3	17.01	17.50
			4	16.97	17.50
	1513	1752.6	1	17.03	17.50
			2	17.03	17.50
			3	17.09	17.50
			4	17.01	17.50

According to KDB 941225, SAR measurements are not required for the secondary modes different than RMC as the maximum output power specified for production units in the secondary modes are $\leq 1/4$ dB higher than the primary mode and the highest reported SAR of the primary mode is scaled by the ratio of specified maximum output power of the secondary to primary mode and the adjusted SAR is $\leq 1.2W/Kg$.

NM: Not measured

B.2.1.3 WCDMA Band V Antenna 5

Mode	Channel Number	Freq (MHz)	Subset	Average Power Measured (dBm)	Factory Upper Tolerance (dBm)
RMC	4132	826.4	-	20.90	21.00
	4183	836.6	-	20.82	21.00
	4233	846.6	-	20.75	21.00
HSDPA	4132	826.4	1	20.87	21.00
			2	20.87	21.00
			3	20.92	21.00
			4	20.88	21.00
	4183	836.6	1	20.82	21.00
			2	20.82	21.00
			3	20.85	21.00
			4	20.83	21.00
	4233	846.6	1	20.75	21.00
			2	20.71	21.00
			3	20.77	21.00
			4	20.75	21.00
HSUPA	4132	826.4	1	20.38	21.00
			2	NM	21.00
			3	NM	21.00
			4	NM	21.00
			5	20.21	21.00
	4183	836.6	1	20.35	21.00
			2	NM	21.00
			3	NM	21.00
			4	NM	21.00
			5	20.17	21.00
	4233	846.6	1	20.10	21.00
			2	NM	21.00
			3	NM	21.00
			4	NM	21.00
			5	20.04	21.00
DC- HSDPA	4132	826.4	1	20.87	21.00
			2	20.87	21.00
			3	20.93	21.00
			4	20.89	21.00
	4183	836.6	1	20.82	21.00
			2	20.82	21.00
			3	20.86	21.00
			4	20.81	21.00
	4233	846.6	1	20.76	21.00
			2	20.74	21.00
			3	20.79	21.00
			4	20.74	21.00

According to KDB 941225, SAR measurements are not required for the secondary modes different than RMC as the maximum output power specified for production units in the secondary modes are $\leq 1/4$ dB higher than the primary mode and the highest reported SAR of the primary mode is scaled by the ratio of specified maximum output power of the secondary to primary mode and the adjusted SAR is $\leq 1.2W/Kg$.

NM: Not measured

B.2.2 LTE

B.2.2.1 LTE Band 2 FDD Antenna 5

Band	BW	Ch #	Freq (MHz)	% RB Allocation	RB Position	MPR		Factory Upper	Factory Upper	Measured Output Power (dBm) Antenna 5	
						QPSK	16QAM	Tolerance (dBm) QPSK	Tolerance (dBm) 16-QAM	QPSK	16-QAM
LTE2	20 MHz	18700	1860	1RB Low	1 Pos 0	0	0	17.00	17.00	16.88	16.05
				1RB Mid	1 Pos 50	0	0	17.00	17.00	16.80	16.00
				1RB High	1 Pos 99	0	0	17.00	17.00	16.91	16.10
				50% RB Low	50 Pos 0	1	2	16.00	15.00	15.70	14.80
				50% RB Mid	50 Pos 24	1	2	16.00	15.00	15.81	14.87
				50% RB High	50 Pos 50	1	2	16.00	15.00	15.76	14.81
		100% RB	100 Pos 0	1	2	16.00	15.00	15.77	14.79		
		1RB Low	1 Pos 0	0	0	17.00	17.00	17.00	15.97		
		1RB Mid	1 Pos 50	0	0	17.00	17.00	16.95	15.88		
		1RB High	1 Pos 99	0	0	17.00	17.00	16.95	16.02		
		50% RB Low	50 Pos 0	1	2	16.00	15.00	15.73	14.84		
		50% RB Mid	50 Pos 24	1	2	16.00	15.00	15.88	14.99		
		50% RB High	50 Pos 50	1	2	16.00	15.00	15.86	14.98		
		100% RB	100 Pos 0	1	2	16.00	15.00	15.84	14.84		
		1RB Low	1 Pos 0	0	0	17.00	17.00	16.82	16.49		
		1RB Mid	1 Pos 50	0	0	17.00	17.00	16.85	16.48		
		1RB High	1 Pos 99	0	0	17.00	17.00	16.80	16.50		
		50% RB Low	50 Pos 0	1	2	16.00	15.00	15.81	14.88		
	50% RB Mid	50 Pos 24	1	2	16.00	15.00	15.88	14.91			
	50% RB High	50 Pos 50	1	2	16.00	15.00	15.79	14.85			
	100% RB	100 Pos 0	1	2	16.00	15.00	15.86	14.88			
	1RB Low	1 Pos 0	0	0	17.00	17.00	16.83	16.46			
	1RB Mid	1 Pos 38	0	0	17.00	17.00	16.79	16.42			
	1RB High	1 Pos 74	0	0	17.00	17.00	16.79	16.46			
	50% RB Low	38 Pos 0	1	2	16.00	15.00	15.84	13.89			
	50% RB Mid	38 Pos 19	1	2	16.00	15.00	15.81	13.92			
	50% RB High	38 Pos 39	1	2	16.00	15.00	15.82	13.84			
	100% RB	75 Pos 0	1	2	16.00	15.00	15.81	14.89			
	1RB Low	1 Pos 0	0	0	17.00	17.00	16.67	16.47			
	1RB Mid	1 Pos 38	0	0	17.00	17.00	16.80	16.42			
	1RB High	1 Pos 74	0	0	17.00	17.00	16.86	16.49			
	50% RB Low	38 Pos 0	1	2	16.00	15.00	15.75	14.88			
	50% RB Mid	38 Pos 19	1	2	16.00	15.00	15.89	14.97			
	50% RB High	38 Pos 39	1	2	16.00	15.00	15.73	14.84			
	100% RB	75 Pos 0	1	2	16.00	15.00	15.81	14.83			
	1RB Low	1 Pos 0	0	0	17.00	17.00	16.99	16.41			
1RB Mid	1 Pos 38	0	0	17.00	17.00	16.69	16.15				
1RB High	1 Pos 74	0	0	17.00	17.00	16.84	16.26				
50% RB Low	38 Pos 0	1	2	16.00	15.00	15.81	14.83				
50% RB Mid	38 Pos 19	1	2	16.00	15.00	15.86	14.90				
50% RB High	38 Pos 39	1	2	16.00	15.00	15.83	14.88				
100% RB	75 Pos 0	1	2	16.00	15.00	15.81	14.86				

Band	BW	Ch #	Freq (MHz)	% RB Allocation	RB Position	MPR		Factory Upper Tolerance (dBm) QPSK	Factory Upper Tolerance (dBm) 16-QAM	Measured Output Power (dBm) Antenna 5	
						QPSK	16QAM			QPSK	16-QAM
						LTE2	10 MHz			18650	1855
				1RB Mid	1 Pos 24	0	0	17.00	17.00	16.85	16.46
				1RB High	1 Pos 49	0	0	17.00	17.00	16.83	16.45
				50% RB Low	25 Pos 0	1	2	16.00	15.00	15.84	13.86
				50% RB Mid	25 Pos 12	1	2	16.00	15.00	15.81	13.97
				50% RB High	25 Pos 24	1	2	16.00	15.00	15.84	13.88
				100% RB	50 Pos 0	1	2	16.00	15.00	15.82	14.95
		18900	1880	1RB Low	1 Pos 0	0	0	17.00	17.00	16.95	16.18
				1RB Mid	1 Pos 24	0	0	17.00	17.00	16.84	16.10
				1RB High	1 Pos 49	0	0	17.00	17.00	17.00	16.24
				50% RB Low	25 Pos 0	1	2	16.00	15.00	15.83	14.89
				50% RB Mid	25 Pos 12	1	2	16.00	15.00	15.81	14.86
				50% RB High	25 Pos 24	1	2	16.00	15.00	15.82	14.88
				100% RB	50 Pos 0	1	2	16.00	15.00	15.84	14.87
		19150	1905	1RB Low	1 Pos 0	0	0	17.00	17.00	16.76	16.00
				1RB Mid	1 Pos 24	0	0	17.00	17.00	16.80	15.93
				1RB High	1 Pos 49	0	0	17.00	17.00	16.74	15.93
				50% RB Low	25 Pos 0	1	2	16.00	15.00	15.73	14.80
				50% RB Mid	25 Pos 12	1	2	16.00	15.00	15.84	14.85
				50% RB High	25 Pos 24	1	2	16.00	15.00	15.79	14.83
				100% RB	50 Pos 0	1	2	16.00	15.00	15.83	14.85
	5.0 MHz	18625	1852.5	1RB Low	1 Pos 0	0	0	17.00	17.00	16.79	15.84
				1RB Mid	1 Pos 50	0	0	17.00	17.00	16.77	15.80
				1RB High	1 Pos 99	0	0	17.00	17.00	16.80	15.81
				50% RB Low	50 Pos 0	0	2	17.00	15.00	16.83	13.86
				50% RB Mid	50 Pos 24	0	2	17.00	15.00	16.85	13.88
				50% RB High	50 Pos 50	0	2	17.00	15.00	16.81	13.92
				100% RB	100 Pos 0	1	2	16.00	15.00	15.81	14.84
		18900	1880	1RB Low	1 Pos 0	0	0	17.00	17.00	17.00	16.13
				1RB Mid	1 Pos 50	0	0	17.00	17.00	16.87	15.94
				1RB High	1 Pos 99	0	0	17.00	17.00	17.00	16.00
				50% RB Low	50 Pos 0	1	2	16.00	15.00	15.87	14.83
				50% RB Mid	50 Pos 24	1	2	16.00	15.00	15.87	14.86
				50% RB High	50 Pos 50	1	2	16.00	15.00	15.93	14.90
				100% RB	100 Pos 0	1	2	16.00	15.00	15.91	14.96
		19175	1907.5	1RB Low	1 Pos 0	0	0	17.00	17.00	17.00	16.32
				1RB Mid	1 Pos 50	0	0	17.00	17.00	16.96	16.24
				1RB High	1 Pos 99	0	0	17.00	17.00	17.00	16.42
				50% RB Low	50 Pos 0	1	2	16.00	15.00	15.84	14.87
				50% RB Mid	50 Pos 24	1	2	16.00	15.00	15.95	14.94
				50% RB High	50 Pos 50	1	2	16.00	15.00	15.74	14.77
				100% RB	100 Pos 0	1	2	16.00	15.00	15.88	14.85

Band	BW	Ch #	Freq (MHz)	% RB Allocation	RB Position	MPR		Factory Upper Tolerance (dBm) QPSK	Factory Upper Tolerance (dBm) 16-QAM	Measured Output Power (dBm) Antenna 5	
						QPSK	16QAM			QPSK	16-QAM
LTE2	3.0 MHz	18615	1851.5	1RB Low	1 Pos 0	0	0	17.00	17.00	16.86	15.85
				1RB Mid	1 Pos 38	0	0	17.00	17.00	16.81	15.83
				1RB High	1 Pos 74	0	0	17.00	17.00	16.83	15.86
				50% RB Low	38 Pos 0	0	2	17.00	15.00	16.86	14.06
				50% RB Mid	38 Pos 19	0	2	17.00	15.00	16.85	14.04
				50% RB High	38 Pos 39	0	2	17.00	15.00	16.84	14.05
				100% RB	75 Pos 0	1	2	16.00	15.00	15.84	14.87
		18900	1880	1RB Low	1 Pos 0	0	0	17.00	17.00	15.88	16.01
				1RB Mid	1 Pos 38	0	0	17.00	17.00	16.89	15.77
				1RB High	1 Pos 74	0	0	17.00	17.00	16.98	15.87
				50% RB Low	38 Pos 0	1	2	16.00	15.00	15.83	14.83
				50% RB Mid	38 Pos 19	1	2	16.00	15.00	15.87	14.88
				50% RB High	38 Pos 39	1	2	16.00	15.00	15.86	14.90
		19185	1908.5	100% RB	75 Pos 0	1	2	16.00	15.00	15.85	14.96
				1RB Low	1 Pos 0	0	0	17.00	17.00	16.86	16.40
				1RB Mid	1 Pos 38	0	0	17.00	17.00	16.90	16.45
				1RB High	1 Pos 74	0	0	17.00	17.00	16.76	16.36
				50% RB Low	38 Pos 0	1	2	16.00	15.00	15.74	14.77
	50% RB Mid			38 Pos 19	1	2	16.00	15.00	15.90	14.91	
	50% RB High			38 Pos 39	1	2	16.00	15.00	15.85	14.83	
	1.4 MHz	18607	1850.7	100% RB	75 Pos 0	1	2	16.00	15.00	15.81	14.80
				1RB Low	1 Pos 0	0	0	17.00	17.00	16.86	16.40
				1RB Mid	1 Pos 38	0	0	17.00	17.00	16.90	16.45
				1RB High	1 Pos 74	0	0	17.00	17.00	16.76	16.36
				50% RB Low	38 Pos 0	1	2	16.00	15.00	15.74	14.77
				50% RB Mid	38 Pos 19	1	2	16.00	15.00	15.90	14.91
				50% RB High	38 Pos 39	1	2	16.00	15.00	15.85	14.83
		18900	1880	1RB Low	1 Pos 0	0	0	17.00	17.00	16.91	15.90
				1RB Mid	1 Pos 24	0	0	17.00	17.00	16.88	15.86
				1RB High	1 Pos 49	0	0	17.00	17.00	16.88	15.87
				50% RB Low	25 Pos 0	0	2	17.00	15.00	16.90	14.14
				50% RB Mid	25 Pos 12	0	2	17.00	15.00	16.88	14.15
				50% RB High	25 Pos 24	0	2	17.00	15.00	16.90	14.17
				100% RB	50 Pos 0	1	2	16.00	15.00	15.87	14.92
		19193	1909.3	1RB Low	1 Pos 0	0	0	17.00	17.00	16.82	16.36
				1RB Mid	1 Pos 24	0	0	17.00	17.00	16.78	16.29
1RB High				1 Pos 49	0	0	17.00	17.00	16.77	16.36	
50% RB Low				25 Pos 0	1	2	16.00	15.00	15.80	15.00	
50% RB Mid	25 Pos 12			1	2	16.00	15.00	15.78	15.00		
50% RB High	25 Pos 24			1	2	16.00	15.00	15.79	15.00		
100% RB	50 Pos 0			1	2	16.00	15.00	15.81	14.91		

B.2.2.2 LTE Band 2 FDD Antenna 8

SAR Measurement for LTE Band 2 FDD (Frequency range: 1850 – 1910MHz) is covered by LTE Band 25 FDD (Frequency range: 1850 – 1915MHz) due to overlapping frequency range, same maximum tune-up and same bandwidth.

B.2.2.3 LTE Band 4 FDD Antenna 5 & Antenna 8

SAR Measurement for LTE Band 4 FDD (Frequency range: 1710 – 1755MHz) is covered by LTE Band 66 FDD (Frequency range: 1710 – 1780MHz) due to overlapping frequency range, same maximum tune-up and same bandwidth.

B.2.2.4 LTE band 5 FDD Antenna 5

.Band	BW	Ch #	Freq (MHz)	% RB Allocation	RB Position	MPR		Factory Upper Tolerance (dBm) QPSK	Factory Upper Tolerance (dBm) 16-QAM	Measured Output Power (dBm) Antenna 5				
						QPSK	16QAM			QPSK	16-QAM			
						LTE5	10 MHz			20525	836.5	1RB Low	1 Pos 0	0
				1RB Mid	1 Pos 24	0	1	21.00	20.00	20.27	19.59			
				1RB High	1 Pos 49	0	1	21.00	20.00	20.25	19.59			
				50% RB Low	25 Pos 0	1	2	20.00	19.00	19.22	18.31			
				50% RB Mid	25 Pos 12	1	2	20.00	19.00	19.31	18.39			
				50% RB High	25 Pos 24	1	2	20.00	19.00	19.24	18.34			
				100% RB	50 Pos 0	1	2	20.00	19.00	19.35	18.33			
	5.0 MHz	20425	826.5	1RB Low	1 Pos 0	0	1	21.00	20.00	20.37	19.20			
							1RB Mid	1 Pos 12	0	1	21.00	20.00	20.46	19.32
							1RB High	1 Pos 24	0	1	21.00	20.00	20.42	19.25
							50% RB Low	12 Pos 0	1	2	20.00	19.00	19.32	18.36
							50% RB Mid	12 Pos 6	1	2	20.00	19.00	19.36	18.37
							50% RB High	12 Pos 11	1	2	20.00	19.00	19.27	18.33
					100% RB	25 Pos 0	1	2	20.00	19.00	19.40	18.41		
			20525	836.5	1RB Low	1 Pos 0	0	1	21.00	20.00	20.45	19.61		
							1RB Mid	1 Pos 12	0	1	21.00	20.00	20.37	19.53
							1RB High	1 Pos 24	0	1	21.00	20.00	20.34	19.49
							50% RB Low	12 Pos 0	1	2	20.00	19.00	19.33	18.37
							50% RB Mid	12 Pos 6	1	2	20.00	19.00	19.34	18.41
							50% RB High	12 Pos 11	1	2	20.00	19.00	19.26	18.30
					100% RB	25 Pos 0	1	2	20.00	19.00	19.43	18.39		
			20625	846.5	1RB Low	1 Pos 0	0	1	21.00	20.00	20.23	19.54		
							1RB Mid	1 Pos 12	0	1	21.00	20.00	20.25	19.55
							1RB High	1 Pos 24	0	1	21.00	20.00	20.34	19.59
							50% RB Low	12 Pos 0	1	2	20.00	19.00	19.20	18.17
						50% RB Mid	12 Pos 6	1	2	20.00	19.00	19.23	18.23	
						50% RB High	12 Pos 11	1	2	20.00	19.00	19.23	18.19	
				100% RB	25 Pos 0	1	2	20.00	19.00	19.31	18.33			
	3.0 MHz	20415	825.5	1RB Low	1 Pos 0	0	1	21.00	20.00	20.19	19.53			
							1RB Mid	1 Pos 7	0	1	21.00	20.00	20.17	19.49
							1RB High	1 Pos 14	0	1	21.00	20.00	20.19	19.48
							50% RB Low	8 Pos 0	1	2	20.00	19.00	19.20	18.22
							50% RB Mid	8 Pos 4	1	2	20.00	19.00	19.19	18.24
							50% RB High	8 Pos 7	1	2	20.00	19.00	19.17	18.22
					100% RB	15 Pos 0	1	2	20.00	19.00	19.18	18.14		
			20525	836.5	1RB Low	1 Pos 0	0	1	21.00	20.00	20.29	19.64		
							1RB Mid	1 Pos 7	0	1	21.00	20.00	20.33	19.64
							1RB High	1 Pos 14	0	1	21.00	20.00	20.34	19.65
							50% RB Low	8 Pos 0	1	2	20.00	19.00	19.33	18.35
							50% RB Mid	8 Pos 4	1	2	20.00	19.00	19.33	18.37
							50% RB High	8 Pos 7	1	2	20.00	19.00	19.33	18.40
					100% RB	15 Pos 0	1	2	20.00	19.00	19.31	18.32		
			20635	847.5	1RB Low	1 Pos 0	0	1	21.00	20.00	20.34	19.61		
							1RB Mid	1 Pos 7	0	1	21.00	20.00	20.37	19.66
							1RB High	1 Pos 14	0	1	21.00	20.00	20.38	19.68
							50% RB Low	8 Pos 0	1	2	20.00	19.00	19.36	18.41
							50% RB Mid	8 Pos 4	1	2	20.00	19.00	19.34	18.42
							50% RB High	8 Pos 7	1	2	20.00	19.00	19.33	18.38
					100% RB	15 Pos 0	1	2	20.00	19.00	19.37	18.34		

Band	BW	Ch #	Freq (MHz)	% RB Allocation	RB Position	MPR		Factory Upper Tolerance (dBm) QPSK	Factory Upper Tolerance (dBm) 16-QAM	Measured Output Power (dBm) Antenna 5	
						QPSK	16QAM			QPSK	16-QAM
								QPSK	16-QAM		
LTE5	1.4 MHz	20407	824.7	1RB Low	1 Pos 0	0	1	21.00	20.00	20.10	19.21
				1RB Mid	1 Pos 24	0	1	21.00	20.00	20.13	19.23
				1RB High	1 Pos 49	0	1	21.00	20.00	20.15	19.23
				50% RB Low	25 Pos 0	0	1	21.00	20.00	20.05	19.36
				50% RB Mid	25 Pos 12	0	1	21.00	20.00	20.05	19.36
				50% RB High	25 Pos 24	0	1	21.00	20.00	20.05	19.36
		100% RB	50 Pos 0	1	2	20.00	19.00	19.17	18.19		
		20525	836.5	1RB Low	1 Pos 0	0	1	21.00	20.00	20.19	19.13
				1RB Mid	1 Pos 12	0	1	21.00	20.00	20.27	19.22
				1RB High	1 Pos 24	0	1	21.00	20.00	20.23	19.18
				50% RB Low	12 Pos 0	0	1	21.00	20.00	20.14	19.33
				50% RB Mid	12 Pos 6	0	1	21.00	20.00	20.18	19.36
				50% RB High	12 Pos 11	0	1	21.00	20.00	20.18	19.39
		100% RB	25 Pos 0	1	2	20.00	19.00	19.17	18.36		
		20643	848.3	1RB Low	1 Pos 0	0	1	21.00	20.00	20.18	19.12
				1RB Mid	1 Pos 12	0	1	21.00	20.00	20.19	19.16
				1RB High	1 Pos 24	0	1	21.00	20.00	20.14	19.10
				50% RB Low	12 Pos 0	0	1	21.00	20.00	20.16	19.39
				50% RB Mid	12 Pos 6	0	1	21.00	20.00	20.18	19.38
				50% RB High	12 Pos 11	0	1	21.00	20.00	20.17	19.40
		100% RB	25 Pos 0	1	2	20.00	19.00	19.21	18.42		

B.2.2.5 LTE Band 7 FDD

Band	BW	Ch #	Freq (MHz)	% RB Allocation	RB Position	MPR		Factory Upper Tolerance	Factory Upper Tolerance	Measured Output Power (dBm) Antenna 5		Factory Upper Tolerance	Factory Upper Tolerance	Measured Output Power (dBm) Antenna 8	
						QPSK	16QAM	(dBm) QPSK	(dBm) 16QAM	QPSK	16-QAM	(dBm) QPSK	(dBm) 16QAM	QPSK	16-QAM
LTE7	20 MHz	20850	2510	1RB Low	1 Pos 0	0	1	15.50	14.50	15.04	14.42	19.00	18.00	18.79	17.81
				1RB Mid	1 Pos 50	0	1	15.50	14.50	15.01	14.23	19.00	18.00	18.80	17.89
				1RB High	1 Pos 99	0	1	15.50	14.50	14.95	14.28	19.00	18.00	18.72	17.75
				50% RB Low	50 Pos 0	1	2	14.50	13.50	13.97	12.96	18.00	17.00	17.81	16.83
				50% RB Mid	50 Pos 24	1	2	14.50	13.50	14.03	13.03	18.00	17.00	17.86	16.87
				50% RB High	50 Pos 50	1	2	14.50	13.50	13.95	12.96	18.00	17.00	17.73	16.73
				100% RB	100 Pos 0	1	2	14.50	13.50	13.92	12.95	18.00	17.00	17.83	16.74
		21100	2535	1RB Low	1 Pos 0	0	1	15.50	14.50	15.02	14.01	19.00	18.00	18.63	17.24
				1RB Mid	1 Pos 50	0	1	15.50	14.50	14.95	13.74	19.00	18.00	18.70	17.27
				1RB High	1 Pos 99	0	1	15.50	14.50	15.00	13.85	19.00	18.00	18.58	17.18
				50% RB Low	50 Pos 0	1	2	14.50	13.50	13.96	12.96	18.00	17.00	17.76	16.77
				50% RB Mid	50 Pos 24	1	2	14.50	13.50	13.94	12.94	18.00	17.00	17.74	16.76
				50% RB High	50 Pos 50	1	2	14.50	13.50	13.80	12.81	18.00	17.00	17.54	16.57
				100% RB	100 Pos 0	1	2	14.50	13.50	13.86	12.87	18.00	17.00	17.73	16.62
	21350	2560	1RB Low	1 Pos 0	0	1	15.50	14.50	14.92	13.87	19.00	18.00	18.65	17.30	
			1RB Mid	1 Pos 50	0	1	15.50	14.50	14.90	13.71	19.00	18.00	18.69	17.37	
			1RB High	1 Pos 99	0	1	15.50	14.50	14.88	13.80	19.00	18.00	18.66	17.32	
			50% RB Low	50 Pos 0	1	2	14.50	13.50	13.85	12.83	18.00	17.00	17.65	16.61	
			50% RB Mid	50 Pos 24	1	2	14.50	13.50	13.91	12.80	18.00	17.00	17.69	16.64	
			50% RB High	50 Pos 50	1	2	14.50	13.50	13.75	12.70	18.00	17.00	17.54	16.49	
			100% RB	100 Pos 0	1	2	14.50	13.50	13.79	12.81	18.00	17.00	17.67	16.56	
	15 MHz	20825	2507.5	1RB Low	1 Pos 0	0	1	15.50	14.50	15.08	14.33	19.00	18.00	18.84	18.03
				1RB Mid	1 Pos 38	0	1	15.50	14.50	14.96	14.31	19.00	18.00	18.71	17.95
				1RB High	1 Pos 74	0	1	15.50	14.50	15.02	14.28	19.00	18.00	18.77	18.06
				50% RB Low	38 Pos 0	1	2	14.50	13.50	14.00	13.02	18.00	17.00	17.80	16.83
				50% RB Mid	38 Pos 19	1	2	14.50	13.50	13.97	12.98	18.00	17.00	17.77	16.78
				50% RB High	38 Pos 39	1	2	14.50	13.50	13.97	12.97	18.00	17.00	17.75	16.79
				100% RB	75 Pos 0	1	2	14.50	13.50	14.01	13.00	18.00	17.00	17.84	16.85
		21100	2535	1RB Low	1 Pos 0	0	1	15.50	14.50	14.99	14.09	19.00	18.00	18.75	17.55
				1RB Mid	1 Pos 38	0	1	15.50	14.50	14.89	14.03	19.00	18.00	18.65	17.47
				1RB High	1 Pos 74	0	1	15.50	14.50	14.87	14.05	19.00	18.00	18.73	17.54
				50% RB Low	38 Pos 0	1	2	14.50	13.50	13.92	12.91	18.00	17.00	17.69	16.70
				50% RB Mid	38 Pos 19	1	2	14.50	13.50	13.90	12.87	18.00	17.00	17.65	16.66
				50% RB High	38 Pos 39	1	2	14.50	13.50	13.80	12.84	18.00	17.00	17.58	16.56
				100% RB	75 Pos 0	1	2	14.50	13.50	13.88	12.88	18.00	17.00	17.71	16.65
	21375	2562.5	1RB Low	1 Pos 0	0	1	15.50	14.50	14.90	14.10	19.00	18.00	18.67	17.69	
			1RB Mid	1 Pos 38	0	1	15.50	14.50	14.83	14.00	19.00	18.00	18.61	17.60	
			1RB High	1 Pos 74	0	1	15.50	14.50	14.84	14.00	19.00	18.00	18.66	17.68	
			50% RB Low	38 Pos 0	1	2	14.50	13.50	13.79	12.83	18.00	17.00	17.61	16.63	
			50% RB Mid	38 Pos 19	1	2	14.50	13.50	13.76	12.81	18.00	17.00	17.62	16.63	
			50% RB High	38 Pos 39	1	2	14.50	13.50	13.80	12.85	18.00	17.00	17.57	16.63	
			100% RB	75 Pos 0	1	2	14.50	13.50	13.80	12.79	18.00	17.00	17.62	16.59	

LTE7	10 MHz	20800	2505	1RB Low	1 Pos 0	0	1	15.50	14.50	15.25	14.50	19.00	18.00	18.90	18.09	
				1RB Mid	1 Pos 24	0	1	15.50	14.50	15.08	14.34	19.00	18.00	18.86	18.04	
				1RB High	1 Pos 49	0	1	15.50	14.50	15.18	14.41	19.00	18.00	18.81	18.02	
				50% RB Low	25 Pos 0	1	2	14.50	13.50	14.01	13.12	18.00	17.00	17.82	16.90	
				50% RB Mid	25 Pos 12	1	2	14.50	13.50	14.02	13.08	18.00	17.00	17.82	16.88	
				50% RB High	25 Pos 24	1	2	14.50	13.50	14.02	13.11	18.00	17.00	17.80	16.85	
		100% RB	50 Pos 0	1	2	14.50	13.50	14.08	12.97	18.00	17.00	17.93	16.82			
		21100	2535	1RB Low	1 Pos 0	0	1	15.50	14.50	15.19	14.11	19.00	18.00	18.73	17.38	
				1RB Mid	1 Pos 24	0	1	15.50	14.50	14.97	13.82	19.00	18.00	18.75	17.38	
				1RB High	1 Pos 49	0	1	15.50	14.50	15.14	14.07	19.00	18.00	18.73	17.37	
				50% RB Low	25 Pos 0	1	2	14.50	13.50	13.91	12.89	18.00	17.00	17.69	16.70	
				50% RB Mid	25 Pos 12	1	2	14.50	13.50	13.90	12.90	18.00	17.00	17.70	16.70	
				50% RB High	25 Pos 24	1	2	14.50	13.50	13.86	12.83	18.00	17.00	17.61	16.60	
		100% RB	50 Pos 0	1	2	14.50	13.50	13.89	12.87	18.00	17.00	17.78	16.67			
		21400	2565	1RB Low	1 Pos 0	0	1	15.50	14.50	15.09	14.32	19.00	18.00	18.69	17.70	
				1RB Mid	1 Pos 24	0	1	15.50	14.50	14.89	14.03	19.00	18.00	18.74	17.68	
				1RB High	1 Pos 49	0	1	15.50	14.50	15.07	14.28	19.00	18.00	18.72	17.65	
				50% RB Low	25 Pos 0	1	2	14.50	13.50	13.82	12.86	18.00	17.00	17.67	16.63	
	50% RB Mid			25 Pos 12	1	2	14.50	13.50	13.83	12.87	18.00	17.00	17.66	16.69		
	50% RB High			25 Pos 24	1	2	14.50	13.50	13.79	12.82	18.00	17.00	17.57	16.58		
	100% RB	50 Pos 0	1	2	14.50	13.50	13.79	12.78	18.00	17.00	17.77	16.62				
	5 MHz	20775	2502.5	1RB Low	1 Pos 0	0	1	15.50	14.50	15.24	14.50	19.00	18.00	18.85	18.24	
				1RB Mid	1 Pos 12	0	1	15.50	14.50	15.06	14.23	19.00	18.00	18.85	18.20	
				1RB High	1 Pos 24	0	1	15.50	14.50	15.21	14.50	19.00	18.00	18.90	18.26	
				50% RB Low	12 Pos 0	1	2	14.50	13.50	14.07	13.04	18.00	17.00	17.83	16.86	
				50% RB Mid	12 Pos 6	1	2	14.50	13.50	14.01	12.99	18.00	17.00	17.80	16.81	
				50% RB High	12 Pos 11	1	2	14.50	13.50	14.03	12.99	18.00	17.00	17.86	16.81	
			100% RB	25 Pos 0	1	2	14.50	13.50	14.07	13.07	18.00	17.00	17.89	16.88		
			21100	2535	1RB Low	1 Pos 0	0	1	15.50	14.50	15.10	14.45	19.00	18.00	18.70	17.84
					1RB Mid	1 Pos 12	0	1	15.50	14.50	14.88	14.16	19.00	18.00	18.69	17.78
					1RB High	1 Pos 24	0	1	15.50	14.50	15.04	14.38	19.00	18.00	18.68	17.80
					50% RB Low	12 Pos 0	1	2	14.50	13.50	13.89	12.97	18.00	17.00	17.76	16.76
					50% RB Mid	12 Pos 6	1	2	14.50	13.50	13.87	12.90	18.00	17.00	17.70	16.73
		50% RB High			12 Pos 11	1	2	14.50	13.50	13.85	12.89	18.00	17.00	17.65	16.67	
		100% RB	25 Pos 0	1	2	14.50	13.50	13.88	12.91	18.00	17.00	17.76	16.68			
		21425	2567.5	1RB Low	1 Pos 0	0	1	15.50	14.50	15.05	14.38	19.00	18.00	18.72	17.73	
				1RB Mid	1 Pos 12	0	1	15.50	14.50	14.84	14.01	19.00	18.00	18.71	17.70	
				1RB High	1 Pos 24	0	1	15.50	14.50	15.09	14.36	19.00	18.00	18.73	17.71	
				50% RB Low	12 Pos 0	1	2	14.50	13.50	13.84	12.82	18.00	17.00	17.66	16.62	
	50% RB Mid			12 Pos 6	1	2	14.50	13.50	13.82	12.75	18.00	17.00	17.65	16.59		
	50% RB High			12 Pos 11	1	2	14.50	13.50	13.81	12.74	18.00	17.00	17.63	16.58		
	100% RB	25 Pos 0	1	2	14.50	13.50	13.84	12.77	18.00	17.00	17.69	16.63				

B.2.2.6 LTE Band 12 FDD

Band	BW	Ch #	Freq (MHz)	% RB Allocation	RB Position	MPR		Factory Upper Tolerance (dBm) QPSK	Factory Upper Tolerance (dBm) 16-QAM	Measured Output Power (dBm) Antenna 5				
						QPSK	16QAM			QPSK	16-QAM			
						LTE12	10 MHz			23095	707.5	1RB Low	1 Pos 0	0
				1RB Mid	1 Pos 24	0	1	18.00	17.00	17.33	16.62			
				1RB High	1 Pos 49	0	1	18.00	17.00	17.31	16.60			
				50% RB Low	25 Pos 0	1	2	17.00	16.00	16.23	15.28			
				50% RB Mid	25 Pos 12	1	2	17.00	16.00	16.28	15.38			
				50% RB High	25 Pos 24	1	2	17.00	16.00	16.30	15.36			
				100% RB	50 Pos 0	1	2	17.00	16.00	16.27	15.28			
	5.0 MHz	23035	701.5	1RB Low	1 Pos 0	0	1	18.00	17.00	17.53	16.72			
							1RB Mid	1 Pos 12	0	1	18.00	17.00	17.44	16.63
							1RB High	1 Pos 24	0	1	18.00	17.00	17.47	16.67
							50% RB Low	12 Pos 0	1	2	17.00	16.00	16.39	15.39
							50% RB Mid	12 Pos 6	1	2	17.00	16.00	16.37	15.36
							50% RB High	12 Pos 11	1	2	17.00	16.00	16.34	15.31
					100% RB	25 Pos 0	1	2	17.00	16.00	16.37	15.42		
			23095	707.5	1RB Low	1 Pos 0	0	1	18.00	17.00	17.39	16.65		
							1RB Mid	1 Pos 12	0	1	18.00	17.00	17.28	16.53
							1RB High	1 Pos 24	0	1	18.00	17.00	17.34	16.62
							50% RB Low	12 Pos 0	1	2	17.00	16.00	16.28	15.29
							50% RB Mid	12 Pos 6	1	2	17.00	16.00	16.29	15.32
							50% RB High	12 Pos 11	1	2	17.00	16.00	16.29	15.34
					100% RB	25 Pos 0	1	2	17.00	16.00	16.29	15.29		
			23155	713.5	1RB Low	1 Pos 0	0	1	18.00	17.00	17.31	16.59		
							1RB Mid	1 Pos 12	0	1	18.00	17.00	17.30	16.46
							1RB High	1 Pos 24	0	1	18.00	17.00	17.38	16.51
							50% RB Low	12 Pos 0	1	2	17.00	16.00	16.32	15.26
						50% RB Mid	12 Pos 6	1	2	17.00	16.00	16.28	15.22	
						50% RB High	12 Pos 11	1	2	17.00	16.00	16.28	15.21	
				100% RB	25 Pos 0	1	2	17.00	16.00	16.28	15.24			
	3.0 MHz	23025	700.5	1RB Low	1 Pos 0	0	1	18.00	17.00	17.40	16.73			
							1RB Mid	1 Pos 7	0	1	18.00	17.00	17.37	16.71
							1RB High	1 Pos 14	0	1	18.00	17.00	17.34	16.67
							50% RB Low	8 Pos 0	1	2	17.00	16.00	16.34	15.38
							50% RB Mid	8 Pos 4	1	2	17.00	16.00	16.32	15.39
							50% RB High	8 Pos 7	1	2	17.00	16.00	16.29	15.33
					100% RB	15 Pos 0	1	2	17.00	16.00	16.34	15.33		
			23095	707.5	1RB Low	1 Pos 0	0	1	18.00	17.00	17.29	16.59		
							1RB Mid	1 Pos 7	0	1	18.00	17.00	17.28	16.61
							1RB High	1 Pos 14	0	1	18.00	17.00	17.25	16.57
							50% RB Low	8 Pos 0	1	2	17.00	16.00	16.24	15.26
							50% RB Mid	8 Pos 4	1	2	17.00	16.00	16.29	15.30
							50% RB High	8 Pos 7	1	2	17.00	16.00	16.26	15.30
					100% RB	15 Pos 0	1	2	17.00	16.00	16.27	15.26		
			23165	714.5	1RB Low	1 Pos 0	0	1	18.00	17.00	17.30	16.58		
							1RB Mid	1 Pos 7	0	1	18.00	17.00	17.28	16.62
							1RB High	1 Pos 14	0	1	18.00	17.00	17.23	16.57
							50% RB Low	8 Pos 0	1	2	17.00	16.00	16.23	15.26
							50% RB Mid	8 Pos 4	1	2	17.00	16.00	16.20	15.23
							50% RB High	8 Pos 7	1	2	17.00	16.00	16.21	15.26
					100% RB	15 Pos 0	1	2	17.00	16.00	16.26	15.24		

Band	BW	Ch #	Freq (MHz)	% RB Allocation	RB Position	MPR		Factory Upper Tolerance (dBm) QPSK	Factory Upper Tolerance (dBm) 16-QAM	Measured Output Power (dBm) Antenna 5	
						QPSK	16QAM			QPSK	16-QAM
								QPSK	16-QAM		
LTE12	1.4 MHz	23017	699.7	1RB Low	1 Pos 0	0	1	18.00	17.00	17.43	16.38
				1RB Mid	1 Pos 24	0	1	18.00	17.00	17.46	16.41
				1RB High	1 Pos 49	0	1	18.00	17.00	17.44	16.37
				50% RB Low	25 Pos 0	0	1	18.00	17.00	17.40	16.55
				50% RB Mid	25 Pos 12	0	1	18.00	17.00	17.41	16.55
				50% RB High	25 Pos 24	0	1	18.00	17.00	17.39	16.56
		100% RB	50 Pos 0	1	2	17.00	16.00	16.36	15.43		
		23095	707.5	1RB Low	1 Pos 0	0	1	18.00	17.00	17.37	16.28
				1RB Mid	1 Pos 12	0	1	18.00	17.00	17.39	16.36
				1RB High	1 Pos 24	0	1	18.00	17.00	17.35	16.29
				50% RB Low	12 Pos 0	0	1	18.00	17.00	17.28	16.48
				50% RB Mid	12 Pos 6	0	1	18.00	17.00	17.30	16.47
				50% RB High	12 Pos 11	0	1	18.00	17.00	17.27	16.44
		100% RB	25 Pos 0	1	2	17.00	16.00	16.30	15.34		
		23173	715.3	1RB Low	1 Pos 0	0	1	18.00	17.00	17.29	16.23
				1RB Mid	1 Pos 12	0	1	18.00	17.00	17.28	16.24
				1RB High	1 Pos 24	0	1	18.00	17.00	17.27	16.21
				50% RB Low	12 Pos 0	0	1	18.00	17.00	17.23	16.39
				50% RB Mid	12 Pos 6	0	1	18.00	17.00	17.25	16.42
				50% RB High	12 Pos 11	0	1	18.00	17.00	17.27	16.43
		100% RB	25 Pos 0	1	2	17.00	16.00	16.24	15.35		

B.2.2.7 LTE Band 13 FDD

Band	BW	Ch #	Freq (MHz)	% RB Allocation	RB Position	MPR		Factory Upper Tolerance (dBm) QPSK	Factory Upper Tolerance (dBm) 16-QAM	Measured Output Power (dBm) Antenna 5	
						QPSK	16QAM			QPSK	16-QAM
LTE13	10 MHz	23230	782	1RB Low	1 Pos 0	0	1	19.00	18.00	18.41	17.59
				1RB Mid	1 Pos 24	0	1	19.00	18.00	18.38	17.61
				1RB High	1 Pos 49	0	1	19.00	18.00	18.33	17.59
				50% RB Low	25 Pos 0	1	2	18.00	17.00	17.17	16.27
				50% RB Mid	25 Pos 12	1	2	18.00	17.00	17.28	16.37
				50% RB High	25 Pos 24	1	2	18.00	17.00	17.23	16.30
				100% RB	50 Pos 0	1	2	18.00	17.00	17.21	16.19
	5.0 MHz	23230	782	1RB Low	1 Pos 0	0	1	19.00	18.00	18.31	17.54
				1RB Mid	1 Pos 12	0	1	19.00	18.00	18.28	17.55
				1RB High	1 Pos 24	0	1	19.00	18.00	18.27	17.52
				50% RB Low	12 Pos 0	1	2	18.00	17.00	17.25	16.28
				50% RB Mid	12 Pos 6	1	2	18.00	17.00	17.22	16.26
				50% RB High	12 Pos 11	1	2	18.00	17.00	17.28	16.33
				100% RB	25 Pos 0	1	2	18.00	17.00	17.28	16.29

B.2.2.8 LTE Band 14 FDD

Band	BW	Ch #	Freq (MHz)	% RB Allocation	RB Position	MPR		Factory Upper Tolerance (dBm) QPSK	Factory Upper Tolerance (dBm) 16-QAM	Measured Output Power (dBm) Antenna 5	
						QPSK	16QAM			QPSK	16-QAM
						LTE14	10 MHz			23330	793
				1RB Mid	1 Pos 24	0	1	19.00	18.00	18.31	17.59
				1RB High	1 Pos 49	0	1	19.00	18.00	18.26	17.50
				50% RB Low	25 Pos 0	1	2	18.00	17.00	17.17	16.25
				50% RB Mid	25 Pos 12	1	2	18.00	17.00	17.26	16.32
				50% RB High	25 Pos 24	1	2	18.00	17.00	17.19	16.24
				100% RB	50 Pos 0	1	2	18.00	17.00	17.21	16.20
	5.0 MHz	23330	793	1RB Low	1 Pos 0	0	1	19.00	18.00	18.39	17.52
				1RB Mid	1 Pos 12	0	1	19.00	18.00	18.30	17.44
				1RB High	1 Pos 24	0	1	19.00	18.00	18.37	17.55
				50% RB Low	12 Pos 0	1	2	18.00	17.00	17.18	16.17
				50% RB Mid	12 Pos 6	1	2	18.00	17.00	17.19	16.19
				50% RB High	12 Pos 11	1	2	18.00	17.00	17.23	16.21
				100% RB	25 Pos 0	1	2	18.00	17.00	17.25	16.26

B.2.2.9 LTE Band 17 FDD

SAR Measurement for LTE Band 17 FDD (Frequency range: 704 – 716MHz) is covered by LTE Band 12 FDD (Frequency range: 699 – 716MHz) due to overlapping frequency range, same maximum tune-up and same bandwidth.

B.2.2.10 LTE Band 25 FDD

Band	BW	Ch #	Freq (MHz)	% RB Allocation	RB Position	MPR		Factory Upper Tolerance (dBm) QPSK	Factory Upper Tolerance (dBm) 16-QAM	Measured Output Power (dBm) Antenna 5		Factory Upper Tolerance (dBm) QPSK	Factory Upper Tolerance (dBm) 16-QAM	Measured Output Power (dBm) Antenna 8			
						QPSK	16QAM			QPSK	16-QAM			QPSK	16-QAM		
LTE25	20 MHz	26140	1860.0	1RB Low	1 Pos 0	0	1	16.00	15.00	15.14	14.02	19.50	18.50	18.73	17.98		
				1RB Mid	1 Pos 50	0	1	16.00	15.00	15.05	13.92	19.50	18.50	18.77	18.02		
				1RB High	1 Pos 99	0	1	16.00	15.00	15.03	13.94	19.50	18.50	18.81	18.05		
				50% RB Low	50 Pos 0	1	2	15.00	14.00	13.94	12.96	18.50	17.50	17.80	16.77		
				50% RB Mid	50 Pos 24	1	2	15.00	14.00	14.14	13.19	18.50	17.50	17.81	16.80		
				50% RB High	50 Pos 50	1	2	15.00	14.00	14.05	13.05	18.50	17.50	17.72	16.67		
				100% RB	100 Pos 0	1	2	15.00	14.00	13.93	12.96	18.50	17.50	17.81	16.72		
		26365	1882.5	1RB Low	1 Pos 0	0	1	16.00	15.00	15.14	14.34	19.50	18.50	18.88	17.70		
				1RB Mid	1 Pos 50	0	1	16.00	15.00	15.08	14.25	19.50	18.50	18.88	17.68		
				1RB High	1 Pos 99	0	1	16.00	15.00	15.14	14.36	19.50	18.50	18.83	17.60		
				50% RB Low	50 Pos 0	1	2	15.00	14.00	14.08	13.07	18.50	17.50	17.80	16.77		
				50% RB Mid	50 Pos 24	1	2	15.00	14.00	14.12	13.14	18.50	17.50	17.93	16.94		
				50% RB High	50 Pos 50	1	2	15.00	14.00	13.97	12.98	18.50	17.50	17.80	16.82		
				100% RB	100 Pos 0	1	2	15.00	14.00	14.08	13.03	18.50	17.50	17.97	16.73		
		26590	1905.0	1RB Low	1 Pos 0	0	1	16.00	15.00	15.11	13.98	19.50	18.50	18.88	17.71		
				1RB Mid	1 Pos 50	0	1	16.00	15.00	15.14	14.00	19.50	18.50	18.96	17.79		
				1RB High	1 Pos 99	0	1	16.00	15.00	15.28	14.05	19.50	18.50	19.02	17.81		
				50% RB Low	50 Pos 0	1	2	15.00	14.00	14.03	13.00	18.50	17.50	17.86	16.80		
				50% RB Mid	50 Pos 24	1	2	15.00	14.00	14.16	13.11	18.50	17.50	17.94	16.88		
				50% RB High	50 Pos 50	1	2	15.00	14.00	14.02	12.96	18.50	17.50	17.87	16.76		
				100% RB	100 Pos 0	1	2	15.00	14.00	14.03	13.01	18.50	17.50	17.87	16.83		
		15 MHz	26115	1857.5	1RB Low	1 Pos 0	0	1	16.00	15.00	15.20	14.18	19.50	18.50	18.72	18.03	
					1RB Mid	1 Pos 38	0	1	16.00	15.00	15.07	14.02	19.50	18.50	18.68	18.05	
					1RB High	1 Pos 74	0	1	16.00	15.00	15.17	14.16	19.50	18.50	18.76	18.13	
	50% RB Low				38 Pos 0	1	2	15.00	14.00	14.02	13.00	18.50	17.50	17.72	16.71		
	50% RB Mid				38 Pos 19	1	2	15.00	14.00	14.09	13.08	18.50	17.50	17.76	16.77		
	50% RB High				38 Pos 39	1	2	15.00	14.00	14.02	12.98	18.50	17.50	17.71	16.66		
	100% RB				75 Pos 0	1	2	15.00	14.00	14.02	13.04	18.50	17.50	17.76	16.76		
	26365				1882.5	1RB Low	1 Pos 0	0	1	16.00	15.00	15.06	14.35	19.50	18.50	18.88	17.96
						1RB Mid	1 Pos 38	0	1	16.00	15.00	14.98	14.32	19.50	18.50	18.80	17.85
						1RB High	1 Pos 74	0	1	16.00	15.00	15.09	14.43	19.50	18.50	18.89	17.92
						50% RB Low	38 Pos 0	1	2	15.00	14.00	14.03	13.06	18.50	17.50	17.78	16.74
						50% RB Mid	38 Pos 19	1	2	15.00	14.00	14.09	13.07	18.50	17.50	17.86	16.81
			50% RB High	38 Pos 39		1	2	15.00	14.00	14.00	12.96	18.50	17.50	17.76	16.69		
	26615		1907.5	100% RB	75 Pos 0	1	2	15.00	14.00	14.04	13.03	18.50	17.50	17.85	16.80		
				1RB Low	1 Pos 0	0	1	16.00	15.00	15.08	14.23	19.50	18.50	18.83	18.01		
				1RB Mid	1 Pos 38	0	1	16.00	15.00	15.07	14.30	19.50	18.50	18.90	18.09		
				1RB High	1 Pos 74	0	1	16.00	15.00	15.07	14.17	19.50	18.50	18.89	18.04		
				50% RB Low	38 Pos 0	1	2	15.00	14.00	14.05	13.11	18.50	17.50	17.83	16.86		
				50% RB Mid	38 Pos 19	1	2	15.00	14.00	14.12	13.18	18.50	17.50	17.92	16.93		
	50% RB High		38 Pos 39	1	2	15.00	14.00	14.09	13.10	18.50	17.50	17.93	16.90				
	100% RB		75 Pos 0	1	2	15.00	14.00	14.09	13.09	18.50	17.50	17.91	16.84				

Band	BW	Ch #	Freq (MHz)	% RB Allocation	RB Position	MPR		Factory Upper Tolerance	Factory Upper Tolerance	Measured Output Power (dBm) Antenna 5		Factory Upper Tolerance	Factory Upper Tolerance	Measured Output Power (dBm) Antenna 8	
						QPSK	16QAM	(dBm) QPSK	(dBm) 16-QAM	QPSK	16-QAM	(dBm) QPSK	(dBm) 16-QAM	QPSK	16-QAM
LTE25	10 MHz	26090	1855.0	1RB Low	1 Pos 0	0	1	16.00	15.00	15.25	14.18	19.50	18.50	18.77	18.04
				1RB Mid	1 Pos 24	0	1	16.00	15.00	15.20	14.08	19.50	18.50	18.78	18.06
				1RB High	1 Pos 49	0	1	16.00	15.00	15.14	14.12	19.50	18.50	18.75	18.04
				50% RB Low	25 Pos 0	1	2	15.00	14.00	14.03	13.02	18.50	17.50	17.71	16.77
				50% RB Mid	25 Pos 12	1	2	15.00	14.00	14.13	13.15	18.50	17.50	17.77	16.87
				50% RB High	25 Pos 24	1	2	15.00	14.00	14.08	13.10	18.50	17.50	17.71	16.74
		100% RB	50 Pos 0	1	2	15.00	14.00	14.08	13.06	18.50	17.50	17.83	16.69		
		1RB Low	1 Pos 0	0	1	16.00	15.00	15.10	14.43	19.50	18.50	18.96	17.79		
		1RB Mid	1 Pos 24	0	1	16.00	15.00	15.13	14.40	19.50	18.50	18.95	17.76		
		1RB High	1 Pos 49	0	1	16.00	15.00	15.14	14.45	19.50	18.50	18.91	17.74		
		50% RB Low	25 Pos 0	1	2	15.00	14.00	14.01	13.07	18.50	17.50	17.78	16.78		
		50% RB Mid	25 Pos 12	1	2	15.00	14.00	14.12	13.19	18.50	17.50	17.87	16.91		
		50% RB High	25 Pos 24	1	2	15.00	14.00	13.99	13.06	18.50	17.50	17.81	16.84		
		100% RB	50 Pos 0	1	2	15.00	14.00	14.03	12.98	18.5	17.50	17.93	16.81		
		1RB Low	1 Pos 0	0	1	16.00	15.00	15.17	14.26	19.50	18.50	18.92	18.03		
		1RB Mid	1 Pos 24	0	1	16.00	15.00	15.17	14.24	19.50	18.50	18.95	18.05		
		1RB High	1 Pos 49	0	1	16.00	15.00	15.23	14.38	19.50	18.50	18.99	18.12		
		50% RB Low	25 Pos 0	1	2	15.00	14.00	14.12	13.17	18.50	17.50	17.91	16.92		
		50% RB Mid	25 Pos 12	1	2	15.00	14.00	14.16	13.20	18.50	17.50	17.91	16.95		
		50% RB High	25 Pos 24	1	2	15.00	14.00	14.04	13.07	18.50	17.50	17.89	16.78		
		100% RB	50 Pos 0	1	2	15.00	14.00	14.12	13.08	18.50	17.50	17.99	16.83		
		1RB Low	1 Pos 0	0	1	16.00	15.00	15.21	14.48	19.50	18.50	18.84	18.13		
		1RB Mid	1 Pos 50	0	1	16.00	15.00	15.09	14.29	19.50	18.50	18.83	18.12		
		1RB High	1 Pos 99	0	1	16.00	15.00	15.19	14.37	19.50	18.50	18.87	18.12		
	50% RB Low	50 Pos 0	1	2	15.00	14.00	14.09	13.12	18.50	17.50	17.72	16.74			
	50% RB Mid	50 Pos 24	1	2	15.00	14.00	14.08	13.14	18.50	17.50	17.81	16.74			
	50% RB High	50 Pos 50	1	2	15.00	14.00	14.07	13.11	18.50	17.50	17.82	16.76			
	100% RB	100 Pos 0	1	2	15.00	14.00	14.13	13.15	18.50	17.50	17.87	16.82			
	1RB Low	1 Pos 0	0	1	16.00	15.00	15.26	14.46	19.50	18.50	18.85	18.15			
	1RB Mid	1 Pos 50	0	1	16.00	15.00	15.20	14.35	19.50	18.50	18.82	18.07			
	1RB High	1 Pos 99	0	1	16.00	15.00	15.24	14.42	19.50	18.50	18.85	18.12			
	50% RB Low	50 Pos 0	1	2	15.00	14.00	14.06	13.04	18.50	17.50	17.84	16.81			
	50% RB Mid	50 Pos 24	1	2	15.00	14.00	14.09	13.06	18.50	17.50	17.83	16.89			
	50% RB High	50 Pos 50	1	2	15.00	14.00	14.15	13.12	18.50	17.50	17.79	16.82			
	100% RB	100 Pos 0	1	2	15.00	14.00	14.11	13.11	18.50	17.50	17.90	16.86			
	1RB Low	1 Pos 0	0	1	16.00	15.00	15.28	14.45	19.50	18.50	18.97	18.18			
	1RB Mid	1 Pos 50	0	1	16.00	15.00	15.16	14.37	19.50	18.50	18.97	18.17			
	1RB High	1 Pos 99	0	1	16.00	15.00	15.39	14.49	19.50	18.50	19.04	18.24			
	50% RB Low	50 Pos 0	1	2	15.00	14.00	14.28	13.23	18.50	17.50	18.00	16.97			
	50% RB Mid	50 Pos 24	1	2	15.00	14.00	14.22	13.14	18.50	17.50	17.96	16.91			
	50% RB High	50 Pos 50	1	2	15.00	14.00	14.21	13.12	18.50	17.50	17.95	16.87			
	100% RB	100 Pos 0	1	2	15.00	14.00	14.20	13.19	18.50	17.50	17.98	16.95			

Band	BW	Ch #	Freq (MHz)	% RB Allocation	RB Position	MPR		Factory Upper Tolerance	Factory Upper Tolerance	Measured Output Power (dBm) Antenna 5		Factory Upper Tolerance	Factory Upper Tolerance	Measured Output Power (dBm) Antenna 8	
						QPSK	16QAM	(dBm) QPSK	(dBm) 16-QAM	QPSK	16-QAM	(dBm) QPSK	(dBm) 16-QAM	QPSK	16-QAM
LTE25	3 MHz	26055	1851.5	1RB Low	1 Pos 0	0	1	16.00	15.00	15.12	14.43	19.50	18.50	18.76	18.04
				1RB Mid	1 Pos 38	0	1	16.00	15.00	15.15	14.39	19.50	18.50	18.72	18.04
				1RB High	1 Pos 74	0	1	16.00	15.00	15.09	14.37	19.50	18.50	18.72	18.09
				50% RB Low	38 Pos 0	1	2	15.00	14.00	14.06	13.10	18.50	17.50	17.71	16.77
				50% RB Mid	38 Pos 19	1	2	15.00	14.00	14.01	13.07	18.50	17.50	17.73	16.78
				50% RB High	38 Pos 39	1	2	15.00	14.00	14.01	13.05	18.50	17.50	17.73	16.77
		100% RB	75 Pos 0	1	2	15.00	14.00	14.05	13.04	18.50	17.50	17.72	16.72		
		1RB Low	1 Pos 0	0	1	16.00	15.00	15.09	14.38	19.50	18.50	18.81	18.10		
		1RB Mid	1 Pos 38	0	1	16.00	15.00	15.06	14.38	19.50	18.50	18.79	18.10		
		1RB High	1 Pos 74	0	1	16.00	15.00	15.09	14.42	19.50	18.50	18.75	18.11		
		50% RB Low	38 Pos 0	1	2	15.00	14.00	14.05	13.07	18.50	17.50	17.81	16.71		
		50% RB Mid	38 Pos 19	1	2	15.00	14.00	14.06	13.09	18.50	17.50	17.78	16.71		
		50% RB High	38 Pos 39	1	2	15.00	14.00	14.07	13.08	18.50	17.50	17.76	16.71		
		100% RB	75 Pos 0	1	2	15.00	14.00	14.07	13.06	18.50	17.50	17.79	16.70		
		1RB Low	1 Pos 0	0	1	16.00	15.00	15.20	14.48	19.50	18.50	18.92	18.23		
		1RB Mid	1 Pos 38	0	1	16.00	15.00	15.13	14.43	19.50	18.50	18.89	18.22		
		1RB High	1 Pos 74	0	1	16.00	15.00	15.14	14.49	19.50	18.50	18.91	18.24		
		50% RB Low	38 Pos 0	1	2	15.00	14.00	14.16	13.18	18.50	17.50	17.92	16.93		
		50% RB Mid	38 Pos 19	1	2	15.00	14.00	14.18	13.24	18.50	17.50	17.91	16.96		
		50% RB High	38 Pos 39	1	2	15.00	14.00	14.16	13.19	18.50	17.50	17.91	16.94		
	100% RB	75 Pos 0	1	2	15.00	14.00	14.20	13.15	18.50	17.50	17.94	16.90			
	1RB Low	1 Pos 0	0	1	16.00	15.00	15.14	14.09	19.50	18.50	18.85	17.81			
	1RB Mid	1 Pos 24	0	1	16.00	15.00	15.17	14.12	19.50	18.50	18.89	17.86			
	1RB High	1 Pos 49	0	1	16.00	15.00	15.10	14.09	19.50	18.50	18.87	17.80			
	50% RB Low	25 Pos 0	0	1	16.00	15.00	15.05	14.24	18.50	17.50	18.78	17.94			
	50% RB Mid	25 Pos 12	0	1	16.00	15.00	15.04	14.23	18.50	17.50	18.79	17.90			
	50% RB High	25 Pos 24	0	1	16.00	15.00	15.06	14.23	18.50	17.50	18.76	17.95			
	100% RB	50 Pos 0	1	2	15.00	14.00	14.10	13.10	18.50	17.50	17.75	16.80			
	1RB Low	1 Pos 0	0	1	16.00	15.00	15.06	13.99	19.50	18.50	18.88	17.83			
	1RB Mid	1 Pos 24	0	1	16.00	15.00	15.09	14.04	19.50	18.50	18.91	17.89			
	1RB High	1 Pos 49	0	1	16.00	15.00	15.05	14.01	19.50	18.50	18.88	17.79			
	50% RB Low	25 Pos 0	0	1	16.00	15.00	15.04	14.25	18.50	17.50	18.81	17.96			
	50% RB Mid	25 Pos 12	0	1	16.00	15.00	15.02	14.24	18.50	17.50	18.82	17.98			
	50% RB High	25 Pos 24	0	1	16.00	15.00	14.99	14.23	18.50	17.50	18.77	17.95			
	100% RB	50 Pos 0	1	2	15.00	14.00	14.06	13.14	18.50	17.50	17.81	16.88			
	1RB Low	1 Pos 0	0	1	16.00	15.00	15.19	14.14	19.50	18.50	19.02	17.97			
	1RB Mid	1 Pos 24	0	1	16.00	15.00	15.20	14.20	19.50	18.50	19.06	18.04			
	1RB High	1 Pos 49	0	1	16.00	15.00	15.18	14.13	19.50	18.50	19.02	17.97			
	50% RB Low	25 Pos 0	0	1	16.00	15.00	15.12	14.34	18.50	17.50	18.96	18.12			
	50% RB Mid	25 Pos 12	0	1	16.00	15.00	15.12	14.33	18.50	17.50	18.98	18.11			
50% RB High	25 Pos 24	0	1	16.00	15.00	15.12	14.36	18.50	17.50	18.98	18.15				
100% RB	50 Pos 0	1	2	15.00	14.00	14.17	13.24	18.50	17.50	17.94	17.02				

B.2.2.11 LTE Band 26 FDD

Band	BW	Ch#	Freq (MHz)	% RB Allocation	RB Position	MPR		Factory Upper Tolerance (dBm) QPSK	Factory Upper Tolerance (dBm) 16-QAM	Measured Output Power (dBm) Antenna 5			
						QPSK	16QAM			QPSK	16-QAM		
								QPSK	16-QAM				
LTE26	15 MHz	26775	821.5	1RB Low	1 Pos 0	0	1	20.50	19.50	19.28	18.57		
				1RB Mid	1 Pos 38	0	1	20.50	19.50	19.24	18.56		
				1RB High	1 Pos 74	0	1	20.50	19.50	19.31	18.60		
				50% RB Low	38 Pos 0	1	2	19.50	18.50	18.30	17.29		
				50% RB Mid	38 Pos 19	1	2	19.50	18.50	18.33	17.29		
				50% RB High	38 Pos 39	1	2	19.50	18.50	18.32	17.29		
				100% RB	75 Pos 0	1	2	19.50	18.50	18.36	17.29		
		26865	831.5	1RB Low	1 Pos 0	0	1	20.50	19.50	19.33	18.41		
				1RB Mid	1 Pos 38	0	1	20.50	19.50	19.30	18.36		
				1RB High	1 Pos 74	0	1	20.50	19.50	19.40	18.43		
				50% RB Low	38 Pos 0	1	2	19.50	18.50	18.33	17.26		
				50% RB Mid	38 Pos 19	1	2	19.50	18.50	18.31	17.27		
				50% RB High	38 Pos 39	1	2	19.50	18.50	18.25	17.22		
				100% RB	75 Pos 0	1	2	19.50	18.50	18.34	17.30		
		26965	841.5	1RB Low	1 Pos 0	0	1	20.50	19.50	19.29	18.50		
				1RB Mid	1 Pos 38	0	1	20.50	19.50	19.21	18.38		
				1RB High	1 Pos 74	0	1	20.50	19.50	19.30	18.48		
				50% RB Low	38 Pos 0	1	2	19.50	18.50	18.37	17.38		
				50% RB Mid	38 Pos 19	1	2	19.50	18.50	18.29	17.32		
				50% RB High	38 Pos 39	1	2	19.50	18.50	18.22	17.27		
				100% RB	75 Pos 0	1	2	19.50	18.50	18.35	17.30		
		10 MHz	26750	820	1RB Low	1 Pos 0	0	1	20.50	19.50	19.33	18.59	
					1RB Mid	1 Pos 24	0	1	20.50	19.50	19.34	18.61	
					1RB High	1 Pos 49	0	1	20.50	19.50	19.33	18.61	
	50% RB Low				25 Pos 0	1	2	19.50	18.50	18.28	17.33		
	50% RB Mid				25 Pos 12	1	2	19.50	18.50	18.34	17.41		
	50% RB High				25 Pos 24	1	2	19.50	18.50	18.27	17.31		
	100% RB				50 Pos 0	1	2	19.50	18.50	18.37	17.27		
	26865				831.5	1RB Low	1 Pos 0	0	1	20.50	19.50	19.42	18.26
						1RB Mid	1 Pos 24	0	1	20.50	19.50	19.47	18.29
						1RB High	1 Pos 49	0	1	20.50	19.50	19.41	18.25
						50% RB Low	25 Pos 0	1	2	19.50	18.50	18.34	17.31
						50% RB Mid	25 Pos 12	1	2	19.50	18.50	18.36	17.35
			50% RB High	25 Pos 24		1	2	19.50	18.50	18.18	17.21		
	26990		844	1RB Low	1 Pos 0	0	1	20.50	19.50	19.37	18.52		
				1RB Mid	1 Pos 24	0	1	20.50	19.50	19.36	18.52		
				1RB High	1 Pos 49	0	1	20.50	19.50	19.29	18.46		
				50% RB Low	25 Pos 0	1	2	19.50	18.50	18.36	17.35		
				50% RB Mid	25 Pos 12	1	2	19.50	18.50	18.34	17.35		
				50% RB High	25 Pos 24	1	2	19.50	18.50	18.23	17.19		
	100% RB		50 Pos 0	1	2	19.50	18.50	18.28	17.25				

Band	BW	Ch#	Freq (MHz)	% RB Allocation	RB Position	MPR		Factory Upper Tolerance (dBm) QPSK	Factory Upper Tolerance (dBm) 16-QAM	Measured Output Power (dBm) Antenna 5	
						QPSK	16QAM			QPSK	16-QAM
								QPSK	16-QAM		
LTE26	5.0 MHz	26715	816.5	1RB Low	1 Pos 0	0	1	20.50	19.50	19.33	18.61
				1RB Mid	1 Pos 12	0	1	20.50	19.50	19.31	18.57
				1RB High	1 Pos 24	0	1	20.50	19.50	19.34	18.62
				50% RB Low	12 Pos 0	1	2	19.50	18.50	18.35	17.26
				50% RB Mid	12 Pos 6	1	2	19.50	18.50	18.31	17.22
				50% RB High	12 Pos 11	1	2	19.50	18.50	18.26	17.21
		100% RB	25 Pos 0	1	2	19.50	18.50	18.33	17.33		
		26865	831.5	1RB Low	1 Pos 0	0	1	20.50	19.50	19.35	18.60
				1RB Mid	1 Pos 12	0	1	20.50	19.50	19.34	18.61
				1RB High	1 Pos 24	0	1	20.50	19.50	19.31	18.62
				50% RB Low	12 Pos 0	1	2	19.50	18.50	18.36	17.35
				50% RB Mid	12 Pos 6	1	2	19.50	18.50	18.36	17.34
				50% RB High	12 Pos 11	1	2	19.50	18.50	18.34	17.32
		100% RB	25 Pos 0	1	2	19.50	18.50	18.36	17.33		
		27015	846.5	1RB Low	1 Pos 0	0	1	20.50	19.50	19.31	18.54
				1RB Mid	1 Pos 12	0	1	20.50	19.50	19.29	18.50
				1RB High	1 Pos 24	0	1	20.50	19.50	19.36	18.55
				50% RB Low	12 Pos 0	1	2	19.50	18.50	18.35	17.28
	50% RB Mid			12 Pos 6	1	2	19.50	18.50	18.30	17.22	
	50% RB High			12 Pos 11	1	2	19.50	18.50	18.27	17.17	
	100% RB	25 Pos 0	1	2	19.50	18.50	18.35	17.24			
	3.0 MHz	26705	815.5	1RB Low	1 Pos 0	0	1	20.50	19.50	19.24	18.56
				1RB Mid	1 Pos 38	0	1	20.50	19.50	19.26	18.58
				1RB High	1 Pos 74	0	1	20.50	19.50	19.18	18.56
				50% RB Low	38 Pos 0	1	2	19.50	18.50	18.25	17.23
				50% RB Mid	38 Pos 19	1	2	19.50	18.50	18.24	17.23
				50% RB High	38 Pos 39	1	2	19.50	18.50	18.25	17.26
		100% RB	75 Pos 0	1	2	19.50	18.50	18.28	17.21		
		26865	831.5	1RB Low	1 Pos 0	0	1	20.50	19.50	19.33	18.66
				1RB Mid	1 Pos 38	0	1	20.50	19.50	19.32	18.63
				1RB High	1 Pos 74	0	1	20.50	19.50	19.27	18.64
				50% RB Low	38 Pos 0	1	2	19.50	18.50	18.32	17.32
				50% RB Mid	38 Pos 19	1	2	19.50	18.50	18.32	17.32
				50% RB High	38 Pos 39	1	2	19.50	18.50	18.32	17.30
		100% RB	75 Pos 0	1	2	19.50	18.50	18.35	17.30		
		27025	847.5	1RB Low	1 Pos 0	0	1	20.50	19.50	19.27	18.59
				1RB Mid	1 Pos 38	0	1	20.50	19.50	19.26	18.57
				1RB High	1 Pos 74	0	1	20.50	19.50	19.27	18.58
				50% RB Low	38 Pos 0	1	2	19.50	18.50	18.29	17.28
	50% RB Mid			38 Pos 19	1	2	19.50	18.50	18.27	17.29	
	50% RB High			38 Pos 39	1	2	19.50	18.50	18.25	17.24	
	100% RB	75 Pos 0	1	2	19.50	18.50	18.28	17.22			

Band	BW	Ch#	Freq (MHz)	% RB Allocation	RB Position	MPR		Factory Upper Tolerance (dBm) QPSK	Factory Upper Tolerance (dBm) 16-QAM	Measured Output Power (dBm) Antenna 5			
						QPSK	16QAM			QPSK	16-QAM		
								QPSK	16-QAM				
Band 26	1.4 MHz	26697	814.7	1RB Low	1 Pos 0	0	1	20.50	19.50	19.29	18.22		
				1RB Mid	1 Pos 24	0	1	20.50	19.50	19.34	18.25		
				1RB High	1 Pos 49	0	1	20.50	19.50	19.25	18.20		
				50% RB Low	25 Pos 0	0	1	20.50	19.50	19.24	18.43		
				50% RB Mid	25 Pos 12	0	1	20.50	19.50	19.23	18.41		
				50% RB High	25 Pos 24	0	1	20.50	19.50	19.24	18.43		
		26865	831.5	100% RB	50 Pos 0	1	2	19.50	18.50	18.23	17.30		
				1RB Low	1 Pos 0	0	1	20.50	19.50	19.28	18.31		
				1RB Mid	1 Pos 24	0	1	20.50	19.50	19.28	18.35		
				1RB High	1 Pos 49	0	1	20.50	19.50	19.24	18.29		
				50% RB Low	25 Pos 0	0	1	20.50	19.50	19.29	18.46		
				50% RB Mid	25 Pos 12	0	1	20.50	19.50	19.30	18.46		
		27033	848.3	50% RB High	25 Pos 24	0	1	20.50	19.50	19.31	18.46		
				100% RB	50 Pos 0	1	2	19.50	18.50	18.28	17.33		
				1RB Low	1 Pos 0	0	1	20.50	19.50	19.14	18.18		
				1RB Mid	1 Pos 24	0	1	20.50	19.50	19.12	18.22		
				1RB High	1 Pos 49	0	1	20.50	19.50	19.10	18.16		
				50% RB Low	25 Pos 0	0	1	20.50	19.50	19.12	18.41		
						50% RB Mid	25 Pos 12	0	1	20.50	19.50	19.10	18.42
						50% RB High	25 Pos 24	0	1	20.50	19.50	19.09	18.43
						100% RB	50 Pos 0	1	2	19.50	18.50	18.22	17.34

B.2.2.12 LTE Band 30 FDD

Band	BW	Ch #	Freq (MHz)	% RB Allocation	RB Position	MPR		Factory Upper Tolerance (dBm) QPSK	Factory Upper Tolerance (dBm) 16-QAM	Measured Output Power (dBm) Antenna 5		Factory Upper Tolerance (dBm) QPSK	Factory Upper Tolerance (dBm) 16-QAM	Measured Output Power (dBm) Antenna 8	
						QPSK	16QAM			QPSK	16-QAM			QPSK	16-QAM
LTE30	10 MHz	27710	2310	1RB Low	1 Pos 0	0	1	14.00	13.00	12.83	12.17	18.50	17.50	17.79	16.54
				1RB Mid	1 Pos 50	0	1	14.00	13.00	12.82	12.08	18.50	17.50	17.73	16.58
				1RB High	1 Pos 99	0	1	14.00	13.00	12.86	12.17	18.50	17.50	17.77	16.53
				50% RB Low	50 Pos 0	1	2	13.00	12.00	11.69	10.78	17.50	19.00	16.64	15.60
				50% RB Mid	50 Pos 24	1	2	13.00	12.00	11.84	10.90	17.50	19.00	16.67	15.72
				50% RB High	50 Pos 50	1	2	13.00	12.00	11.62	10.70	17.50	19.00	16.49	15.50
				100% RB	100 Pos 0	1	2	13.00	12.00	11.72	10.69	17.50	19.00	16.78	15.61
	5.0 MHz	27710	2310	1RB Low	1 Pos 0	0	1	14.00	13.00	13.03	12.29	18.50	17.50	17.77	17.05
				1RB Mid	1 Pos 38	0	1	14.00	13.00	12.89	12.13	18.50	17.50	17.72	17.00
				1RB High	1 Pos 74	0	1	14.00	13.00	13.04	12.28	18.50	17.50	17.75	17.03
				50% RB Low	38 Pos 0	1	2	13.00	12.00	11.89	10.87	17.50	16.50	16.71	15.70
				50% RB Mid	38 Pos 19	1	2	13.00	12.00	11.88	10.86	17.50	16.50	16.69	15.67
				50% RB High	38 Pos 39	1	2	13.00	12.00	11.83	10.80	17.50	16.50	16.63	15.59
				100% RB	75 Pos 0	1	2	13.00	12.00	11.92	10.93	17.50	16.50	16.78	15.75

B.2.2.13 LTE Band 38 TDD

Band	BW	Ch #	Freq (MHz)	% RB Allocation	RB Position	MPR		Factory Upper Tolerance (dBm) QPSK	Factory Upper Tolerance (dBm) 16-QAM	Measured Output Power (dBm) Antenna 5		
						QPSK	16QAM			QPSK	16-QAM	
LTE38	20 MHz	37850	2580	1RB Low	1 Pos 0	0	1	17.50	16.50	17.42	16.14	
				1RB Mid	1 Pos 50	0	1	17.50	16.50	17.43	16.13	
				1RB High	1 Pos 99	0	1	17.50	16.50	17.41	16.10	
				50% RB Low	50 Pos 0	1	2	16.50	15.50	16.39	15.42	
				50% RB Mid	50 Pos 24	1	2	16.50	15.50	16.43	15.44	
				50% RB High	50 Pos 50	1	2	16.50	15.50	16.33	15.37	
		100% RB	100 Pos 0	1	2	16.50	15.50	16.35	15.32			
		38000	2595	1RB Low	1 Pos 0	0	1	17.50	16.50	17.43	16.62	
				1RB Mid	1 Pos 50	0	1	17.50	16.50	17.46	16.66	
				1RB High	1 Pos 99	0	1	17.50	16.50	17.38	16.55	
				50% RB Low	50 Pos 0	1	2	16.50	15.50	16.49	15.47	
				50% RB Mid	50 Pos 24	1	2	16.50	15.50	16.51	15.50	
				50% RB High	50 Pos 50	1	2	16.50	15.50	16.33	15.32	
		100% RB	100 Pos 0	1	2	16.50	15.50	16.42	15.41			
		38150	2610	1RB Low	1 Pos 0	0	1	17.50	16.50	17.39	16.34	
				1RB Mid	1 Pos 50	0	1	17.50	16.50	17.42	16.35	
				1RB High	1 Pos 99	0	1	17.50	16.50	17.40	16.34	
				50% RB Low	50 Pos 0	1	2	16.50	15.50	16.38	15.32	
				50% RB Mid	50 Pos 24	1	2	16.50	15.50	16.40	15.37	
				50% RB High	50 Pos 50	1	2	16.50	15.50	16.35	15.30	
		100% RB	100 Pos 0	1	2	16.50	15.50	16.34	15.34			
		15 MHz	37825	2577.5	1RB Low	1 Pos 0	0	1	17.50	16.50	17.49	16.48
					1RB Mid	1 Pos 38	0	1	17.50	16.50	17.38	16.39
					1RB High	1 Pos 74	0	1	17.50	16.50	17.49	16.44
	50% RB Low				38 Pos 0	1	2	16.50	15.50	16.42	15.40	
	50% RB Mid				38 Pos 19	1	2	16.50	15.50	16.40	15.39	
	50% RB High				38 Pos 39	1	2	16.50	15.50	16.36	15.35	
	100% RB			75 Pos 0	1	2	16.50	15.50	16.38	15.36		
	38000			2595	1RB Low	1 Pos 0	0	1	17.50	16.50	17.42	16.77
					1RB Mid	1 Pos 38	0	1	17.50	16.50	17.32	16.69
					1RB High	1 Pos 74	0	1	17.50	16.50	17.45	16.79
					50% RB Low	38 Pos 0	1	2	16.50	15.50	16.47	15.45
					50% RB Mid	38 Pos 19	1	2	16.50	15.50	16.48	15.46
			50% RB High		38 Pos 39	1	2	16.50	15.50	16.40	15.39	
	100% RB		75 Pos 0	1	2	16.50	15.50	16.46	15.44			
	38175		2612.5	1RB Low	1 Pos 0	0	1	17.50	16.50	17.38	16.44	
				1RB Mid	1 Pos 38	0	1	17.50	16.50	17.36	16.45	
				1RB High	1 Pos 74	0	1	17.50	16.50	17.32	16.34	
				50% RB Low	38 Pos 0	1	2	16.50	15.50	16.36	15.40	
				50% RB Mid	38 Pos 19	1	2	16.50	15.50	16.35	15.38	
				50% RB High	38 Pos 39	1	2	16.50	15.50	16.35	15.41	
	100% RB		75 Pos 0	1	2	16.50	15.50	16.38	15.34			

Band	BW	Ch #	Freq (MHz)	% RB Allocation	RB Position	MPR		Factory Upper	Factory Upper	Measured Output Power (dBm) Antenna 5	
						QPSK	16QAM	Tolerance (dBm) QPSK	Tolerance (dBm) 16-QAM	QPSK	16-QAM
LTE38	10 MHz	37800	2575	1RB Low	1 Pos 0	0	1	17.50	16.50	17.49	16.43
				1RB Mid	1 Pos 24	0	1	17.50	16.50	17.47	16.40
				1RB High	1 Pos 49	0	1	17.50	16.50	17.47	16.39
				50% RB Low	25 Pos 0	1	2	16.50	15.50	16.42	15.41
				50% RB Mid	25 Pos 12	1	2	16.50	15.50	16.41	15.41
				50% RB High	25 Pos 24	1	2	16.50	15.50	16.35	15.34
		100% RB	50 Pos 0	1	2	16.50	15.50	16.39	15.35		
		1RB Low	1 Pos 0	0	1	17.50	16.50	17.50	16.91		
		1RB Mid	1 Pos 24	0	1	17.50	16.50	17.49	16.83		
		1RB High	1 Pos 49	0	1	17.50	16.50	17.50	16.87		
		50% RB Low	25 Pos 0	1	2	16.50	15.50	16.47	15.54		
		50% RB Mid	25 Pos 12	1	2	16.50	15.50	16.51	15.56		
		50% RB High	25 Pos 24	1	2	16.50	15.50	16.42	15.50		
		100% RB	50 Pos 0	1	2	16.50	15.50	16.49	15.46		
		1RB Low	1 Pos 0	0	1	17.50	16.50	17.47	16.46		
		1RB Mid	1 Pos 24	0	1	17.50	16.50	17.43	16.39		
		1RB High	1 Pos 49	0	1	17.50	16.50	17.46	16.46		
		50% RB Low	25 Pos 0	1	2	16.50	15.50	16.32	15.38		
		50% RB Mid	25 Pos 12	1	2	16.50	15.50	16.37	15.42		
		50% RB High	25 Pos 24	1	2	16.50	15.50	16.40	15.42		
		100% RB	50 Pos 0	1	2	16.50	15.50	16.39	15.35		
		1RB Low	1 Pos 0	0	1	17.50	16.50	17.50	16.85		
		1RB Mid	1 Pos 50	0	1	17.50	16.50	17.47	16.70		
		1RB High	1 Pos 99	0	1	17.50	16.50	17.50	16.86		
	50% RB Low	50 Pos 0	1	2	16.50	15.50	16.50	15.58			
	50% RB Mid	50 Pos 24	1	2	16.50	15.50	16.48	15.51			
	50% RB High	50 Pos 50	1	2	16.50	15.50	16.45	15.50			
	100% RB	100 Pos 0	1	2	16.50	15.50	16.50	15.52			
	1RB Low	1 Pos 0	0	1	17.50	16.50	17.50	16.71			
	1RB Mid	1 Pos 50	0	1	17.50	16.50	17.46	16.59			
	1RB High	1 Pos 99	0	1	17.50	16.50	17.50	16.67			
	50% RB Low	50 Pos 0	1	2	16.50	15.50	16.46	15.40			
	50% RB Mid	50 Pos 24	1	2	16.50	15.50	16.44	15.38			
	50% RB High	50 Pos 50	1	2	16.50	15.50	16.44	15.37			
	100% RB	100 Pos 0	1	2	16.50	15.50	16.47	15.41			
	1RB Low	1 Pos 0	0	1	17.50	16.50	17.48	16.84			
	1RB Mid	1 Pos 50	0	1	17.50	16.50	17.49	16.78			
	1RB High	1 Pos 99	0	1	17.50	16.50	17.50	16.87			
	50% RB Low	50 Pos 0	1	2	16.50	15.50	16.43	15.38			
	50% RB Mid	50 Pos 24	1	2	16.50	15.50	16.42	15.38			
	50% RB High	50 Pos 50	1	2	16.50	15.50	16.42	15.36			
	100% RB	75 Pos 0	1	2	16.50	15.50	16.45	15.43			

B.2.2.14 LTE Band 41 TDD

Band	BW	Ch #	Freq (MHz)	% RB Allocation	RB Position	MPR		Factory Upper Tolerance (dBm) QPSK	Factory Upper Tolerance (dBm) 16-QAM	Measured Output Power (dBm) Antenna 5		Factory Upper Tolerance (dBm) QPSK	Factory Upper Tolerance (dBm) 16-QAM	Measured Output Power (dBm) Antenna 8	
						QPSK	16QAM			QPSK	16-QAM			QPSK	16-QAM
LTE41	20 MHz	39750	2506	1RB Low	1 Pos 0	0	1	14.50	13.50	14.20	13.42	21.00	20.00	20.23	19.39
				1RB Mid	1 Pos 50	0	1	14.50	13.50	13.69	12.90	21.00	20.00	20.25	19.40
				1RB High	1 Pos 99	0	1	14.50	13.50	13.17	12.37	21.00	20.00	20.04	19.18
				50% RB Low	50 Pos 0	1	2	13.50	12.50	12.90	11.90	20.00	19.00	19.19	18.20
				50% RB Mid	50 Pos 24	1	2	13.50	12.50	12.70	11.72	20.00	19.00	19.23	18.19
				50% RB High	50 Pos 50	1	2	13.50	12.50	12.38	11.42	20.00	19.00	19.06	18.01
				100% RB	100 Pos 0	1	2	13.50	12.50	12.65	11.66	20.00	19.00	19.14	18.15
		40185	2549.5	1RB Low	1 Pos 0	0	1	14.50	13.50	12.79	11.52	21.00	20.00	19.97	18.69
				1RB Mid	1 Pos 50	0	1	14.50	13.50	12.85	11.50	21.00	20.00	20.03	18.66
				1RB High	1 Pos 99	0	1	14.50	13.50	12.96	11.61	21.00	20.00	20.04	18.73
				50% RB Low	50 Pos 0	1	2	13.50	12.50	11.86	10.91	20.00	19.00	19.02	18.11
				50% RB Mid	50 Pos 24	1	2	13.50	12.50	11.90	10.96	20.00	19.00	19.08	18.15
				50% RB High	50 Pos 50	1	2	13.50	12.50	11.78	10.86	20.00	19.00	18.91	17.97
				100% RB	100 Pos 0	1	2	13.50	12.50	11.86	10.89	20.00	19.00	19.00	18.06
		40620	2593	1RB Low	1 Pos 0	0	1	14.50	13.50	13.43	12.41	21.00	20.00	20.38	19.38
				1RB Mid	1 Pos 50	0	1	14.50	13.50	13.51	12.49	21.00	20.00	20.43	19.37
				1RB High	1 Pos 99	0	1	14.50	13.50	13.52	12.54	21.00	20.00	20.20	19.18
				50% RB Low	50 Pos 0	1	2	13.50	12.50	12.46	11.43	20.00	19.00	19.43	18.42
				50% RB Mid	50 Pos 24	1	2	13.50	12.50	12.46	11.43	20.00	19.00	19.43	18.36
				50% RB High	50 Pos 50	1	2	13.50	12.50	12.46	11.43	20.00	19.00	19.32	18.18
				100% RB	100 Pos 0	1	2	13.50	12.50	12.48	11.46	20.00	19.00	19.37	18.34
		41055	2636.5	1RB Low	1 Pos 0	0	1	14.50	13.50	13.97	13.24	21.00	20.00	20.30	19.46
				1RB Mid	1 Pos 38	0	1	14.50	13.50	14.04	13.23	21.00	20.00	20.29	19.49
				1RB High	1 Pos 74	0	1	14.50	13.50	14.16	13.38	21.00	20.00	20.15	19.31
				50% RB Low	38 Pos 0	1	2	13.50	12.50	13.02	12.07	20.00	19.00	19.37	18.32
				50% RB Mid	38 Pos 19	1	2	13.50	12.50	13.09	12.13	20.00	19.00	19.29	18.28
				50% RB High	38 Pos 39	1	2	13.50	12.50	13.03	12.06	20.00	19.00	19.14	18.19
				100% RB	75 Pos 0	1	2	13.50	12.50	13.02	12.07	20.00	19.00	19.26	18.26
		41490	2680	1RB Low	1 Pos 0	0	1	14.50	13.50	13.90	12.56	21.00	20.00	20.35	19.05
				1RB Mid	1 Pos 38	0	1	14.50	13.50	13.60	12.27	21.00	20.00	20.27	18.95
				1RB High	1 Pos 74	0	1	14.50	13.50	13.49	12.19	21.00	20.00	20.11	18.81
				50% RB Low	38 Pos 0	1	2	13.50	12.50	12.63	11.74	20.00	19.00	19.35	18.45
50% RB Mid	38 Pos 19			1	2	13.50	12.50	12.62	11.66	20.00	19.00	19.38	18.36		
50% RB High	38 Pos 39			1	2	13.50	12.50	12.52	11.49	20.00	19.00	19.22	18.28		
100% RB	75 Pos 0			1	2	13.50	12.50	12.57	11.59	20.00	19.00	19.28	18.29		

Band	BW	Ch #	Freq (MHz)	% RB Allocation	RB Position	MPR		Factory Upper Tolerance	Factory Upper Tolerance	Measured Output Power (dBm) Antenna 5		Factory Upper Tolerance	Factory Upper Tolerance	Measured Output Power (dBm) Antenna 8			
						QPSK	16QAM	(dBm) QPSK	(dBm) 16-QAM	QPSK	16-QAM	(dBm) QPSK	(dBm) 16-QAM	QPSK	16-QAM		
LTE41	15 MHz	39750	2506	1RB Low	1 Pos 0	0	1	14.50	13.50	14.02	13.39	21.00	20.00	20.22	19.53		
				1RB Mid	1 Pos 50	0	1	14.50	13.50	13.20	12.56	21.00	20.00	20.01	19.36		
				1RB High	1 Pos 99	0	1	14.50	13.50	13.67	13.03	21.00	20.00	20.17	19.52		
				50% RB Low	50 Pos 0	1	2	13.50	12.50	12.81	11.87	20.00	19.00	19.21	18.25		
				50% RB Mid	50 Pos 24	1	2	13.50	12.50	12.66	11.70	20.00	19.00	19.14	18.20		
				50% RB High	50 Pos 50	1	2	13.50	12.50	12.41	11.41	20.00	19.00	19.00	18.00		
		40185	2549.5	2593	2593	100% RB	100 Pos 0	1	2	13.50	12.50	12.67	11.67	20.00	19.00	19.19	18.16
						1RB Low	1 Pos 0	0	1	14.50	13.50	12.88	11.91	21.00	20.00	20.10	19.15
						1RB Mid	1 Pos 50	0	1	14.50	13.50	12.90	11.93	21.00	20.00	20.01	19.04
						1RB High	1 Pos 99	0	1	14.50	13.50	12.83	11.86	21.00	20.00	19.97	19.01
						50% RB Low	50 Pos 0	1	2	13.50	12.50	11.84	10.85	20.00	19.00	19.02	17.96
						50% RB Mid	50 Pos 24	1	2	13.50	12.50	11.80	10.82	20.00	19.00	19.04	17.98
		40620	2593	2593	2593	50% RB High	50 Pos 50	1	2	13.50	12.50	11.79	10.82	20.00	19.00	18.94	17.92
						100% RB	100 Pos 0	1	2	13.50	12.50	11.84	10.86	20.00	19.00	19.05	17.99
						1RB Low	1 Pos 0	0	1	14.50	13.50	13.42	12.49	21.00	20.00	20.38	19.47
						1RB Mid	1 Pos 50	0	1	14.50	13.50	13.51	12.57	21.00	20.00	20.26	19.28
						1RB High	1 Pos 99	0	1	14.50	13.50	13.51	12.58	21.00	20.00	20.37	19.40
						50% RB Low	50 Pos 0	1	2	13.50	12.50	12.39	11.44	20.00	19.00	19.35	18.42
		41055	2636.5	2680	2680	50% RB Mid	50 Pos 24	1	2	13.50	12.50	12.40	11.45	20.00	19.00	19.37	18.36
						50% RB High	50 Pos 50	1	2	13.50	12.50	12.40	11.47	20.00	19.00	19.23	18.24
						100% RB	100 Pos 0	1	2	13.50	12.50	12.45	11.46	20.00	19.00	19.36	18.34
						1RB Low	1 Pos 0	0	1	14.50	13.50	14.00	13.40	21.00	20.00	20.27	19.66
						1RB Mid	1 Pos 38	0	1	14.50	13.50	14.11	13.49	21.00	20.00	20.20	19.57
						1RB High	1 Pos 74	0	1	14.50	13.50	14.00	13.35	21.00	20.00	20.25	19.58
		41490	2680	2680	2680	50% RB Low	38 Pos 0	1	2	13.50	12.50	13.01	12.03	20.00	19.00	19.26	18.30
						50% RB Mid	38 Pos 19	1	2	13.50	12.50	13.07	12.06	20.00	19.00	19.26	18.23
						50% RB High	38 Pos 39	1	2	13.50	12.50	13.04	12.10	20.00	19.00	19.16	18.17
						100% RB	75 Pos 0	1	2	13.50	12.50	13.07	12.04	20.00	19.00	19.23	18.31
						1RB Low	1 Pos 0	0	1	14.50	13.50	13.75	12.87	21.00	20.00	20.47	19.44
						1RB Mid	1 Pos 38	0	1	14.50	13.50	13.47	12.56	21.00	20.00	20.28	19.22
		41490	2680	2680	2680	1RB High	1 Pos 74	0	1	14.50	13.50	13.59	12.60	21.00	20.00	20.31	19.33
						50% RB Low	38 Pos 0	1	2	13.50	12.50	12.68	11.63	20.00	19.00	19.28	18.37
						50% RB Mid	38 Pos 19	1	2	13.50	12.50	12.55	11.54	20.00	19.00	19.31	18.24
						50% RB High	38 Pos 39	1	2	13.50	12.50	12.53	11.48	20.00	19.00	19.24	18.23
		41490	2680	2680	2680	100% RB	75 Pos 0	1	2	13.50	12.50	12.61	11.61	20.00	19.00	19.28	18.32

Band	BW	Ch #	Freq (MHz)	% RB Allocation	RB Position	MPR		Factory Upper Tolerance	Factory Upper Tolerance	Measured Output Power (dBm) Antenna 5		Factory Upper Tolerance	Factory Upper Tolerance	Measured Output Power (dBm) Antenna 8	
						QPSK	16QAM	(dBm) QPSK	(dBm) 16-QAM	QPSK	16-QAM	(dBm) QPSK	(dBm) 16-QAM	QPSK	16-QAM
LTE41	10 MHz	39750	2506	1RB Low	1 Pos 0	0	1	14.50	13.50	13.96	13.30	21.00	20.00	20.27	19.58
				1RB Mid	1 Pos 50	0	1	14.50	13.50	13.72	13.04	21.00	20.00	20.26	19.54
				1RB High	1 Pos 99	0	1	14.50	13.50	13.42	12.76	21.00	20.00	20.12	19.46
				50% RB Low	50 Pos 0	1	2	13.50	12.50	12.77	11.87	20.00	19.00	19.22	18.29
				50% RB Mid	50 Pos 24	1	2	13.50	12.50	12.69	11.82	20.00	19.00	19.24	18.32
				50% RB High	50 Pos 50	1	2	13.50	12.50	12.56	11.63	20.00	19.00	19.09	18.24
		100% RB	100 Pos 0	1	2	13.50	12.50	12.71	11.67	20.00	19.00	19.21	18.19		
		40185	2549.5	1RB Low	1 Pos 0	0	1	14.50	13.50	12.92	11.84	21.00	20.00	20.11	19.00
				1RB Mid	1 Pos 50	0	1	14.50	13.50	12.88	11.76	21.00	20.00	20.02	18.93
				1RB High	1 Pos 99	0	1	14.50	13.50	13.00	11.89	21.00	20.00	20.11	19.01
				50% RB Low	50 Pos 0	1	2	13.50	12.50	11.83	10.88	20.00	19.00	19.00	18.00
				50% RB Mid	50 Pos 24	1	2	13.50	12.50	11.83	10.84	20.00	19.00	19.01	17.98
				50% RB High	50 Pos 50	1	2	13.50	12.50	11.77	10.83	20.00	19.00	18.92	17.98
		100% RB	100 Pos 0	1	2	13.50	12.50	11.85	10.90	20.00	19.00	19.04	17.99		
		40620	2593	1RB Low	1 Pos 0	0	1	14.50	13.50	13.53	12.57	21.00	20.00	20.49	19.52
				1RB Mid	1 Pos 50	0	1	14.50	13.50	13.53	12.62	21.00	20.00	20.44	19.43
				1RB High	1 Pos 99	0	1	14.50	13.50	13.57	12.60	21.00	20.00	20.32	19.37
				50% RB Low	50 Pos 0	1	2	13.50	12.50	12.46	11.50	20.00	19.00	19.39	18.40
				50% RB Mid	50 Pos 24	1	2	13.50	12.50	12.45	11.51	20.00	19.00	19.37	18.45
				50% RB High	50 Pos 50	1	2	13.50	12.50	12.41	11.46	20.00	19.00	19.25	18.29
		100% RB	100 Pos 0	1	2	13.50	12.50	12.44	11.44	20.00	19.00	19.33	18.33		
		41055	2636.5	1RB Low	1 Pos 0	0	1	14.50	13.50	14.11	12.43	21.00	20.00	20.37	19.70
				1RB Mid	1 Pos 38	0	1	14.50	13.50	14.10	13.43	21.00	20.00	20.32	19.64
				1RB High	1 Pos 74	0	1	14.50	13.50	14.21	12.50	21.00	20.00	20.26	19.59
				50% RB Low	38 Pos 0	1	2	13.50	12.50	13.02	12.11	20.00	19.00	19.32	18.37
				50% RB Mid	38 Pos 19	1	2	13.50	12.50	13.08	12.19	20.00	19.00	19.29	18.32
				50% RB High	38 Pos 39	1	2	13.50	12.50	13.01	12.17	20.00	19.00	19.18	18.28
		100% RB	75 Pos 0	1	2	13.50	12.50	13.07	12.09	20.00	19.00	19.25	18.23		
		41490	2680	1RB Low	1 Pos 0	0	1	14.50	13.50	13.84	12.73	21.00	20.00	20.39	19.32
				1RB Mid	1 Pos 38	0	1	14.50	13.50	13.59	12.49	21.00	20.00	20.26	19.20
1RB High	1 Pos 74			0	1	14.50	13.50	13.64	12.59	21.00	20.00	20.25	19.20		
50% RB Low	38 Pos 0			1	2	13.50	12.50	12.58	11.65	20.00	19.00	19.29	18.35		
50% RB Mid	38 Pos 19			1	2	13.50	12.50	12.60	11.61	20.00	19.00	19.37	18.30		
50% RB High	38 Pos 39			1	2	13.50	12.50	12.51	11.50	20.00	19.00	19.25	18.21		
100% RB	75 Pos 0	1	2	13.50	12.50	12.61	11.60	20.00	19.00	19.27	18.31				

Band	BW	Ch #	Freq (MHz)	% RB Allocation	RB Position	MPR		Factory Upper Tolerance (dBm) QPSK	Factory Upper Tolerance (dBm) 16-QAM	Measured Output Power (dBm) Antenna 5		Factory Upper Tolerance (dBm) QPSK	Factory Upper Tolerance (dBm) 16-QAM	Measured Output Power (dBm) Antenna 8			
						QPSK	16QAM	QPSK	16-QAM	QPSK	16-QAM	QPSK	16-QAM				
LTE41	5 MHz	39750	2506	1RB Low	1 Pos 0	0	1	14.50	13.50	13.84	13.26	21.00	20.00	20.35	19.53		
				1RB Mid	1 Pos 50	0	1	14.50	13.50	13.71	13.07	21.00	20.00	20.30	19.42		
				1RB High	1 Pos 99	0	1	14.50	13.50	13.54	12.93	21.00	20.00	20.22	19.43		
				50% RB Low	50 Pos 0	1	2	13.50	12.50	12.74	11.73	20.00	19.00	19.33	18.20		
				50% RB Mid	50 Pos 24	1	2	13.50	12.50	12.67	11.68	20.00	19.00	19.27	18.22		
				50% RB High	50 Pos 50	1	2	13.50	12.50	12.62	11.58	20.00	19.00	19.26	18.19		
		40185	2549.5	100% RB	100 Pos 0	1	2	13.50	12.50	12.68	11.71	20.00	19.00	19.25	18.22		
				1RB Low	1 Pos 0	0	1	14.50	13.50	12.90	12.21	21.00	20.00	20.04	19.43		
				1RB Mid	1 Pos 50	0	1	14.50	13.50	12.76	12.05	21.00	20.00	20.03	19.37		
				1RB High	1 Pos 99	0	1	14.50	13.50	12.87	12.16	21.00	20.00	20.09	19.47		
				50% RB Low	50 Pos 0	1	2	13.50	12.50	11.85	10.86	20.00	19.00	19.03	17.97		
				50% RB Mid	50 Pos 24	1	2	13.50	12.50	11.78	10.84	20.00	19.00	19.02	17.94		
		40620	2593	50% RB High	50 Pos 50	1	2	13.50	12.50	11.76	10.84	20.00	19.00	19.03	17.95		
				100% RB	100 Pos 0	1	2	13.50	12.50	11.80	10.86	20.00	19.00	19.08	18.05		
				1RB Low	1 Pos 0	0	1	14.50	13.50	13.56	12.80	21.00	20.00	20.44	19.72		
				1RB Mid	1 Pos 50	0	1	14.50	13.50	13.53	12.73	21.00	20.00	20.38	19.63		
				1RB High	1 Pos 99	0	1	14.50	13.50	13.56	12.78	21.00	20.00	20.35	19.62		
				50% RB Low	50 Pos 0	1	2	13.50	12.50	12.44	11.43	20.00	19.00	19.39	18.46		
		41055	2636.5	50% RB Mid	50 Pos 24	1	2	13.50	12.50	12.43	11.41	20.00	19.00	19.34	18.43		
				50% RB High	50 Pos 50	1	2	13.50	12.50	12.43	11.41	20.00	19.00	19.36	18.41		
				100% RB	100 Pos 0	1	2	13.50	12.50	12.46	11.45	20.00	19.00	19.38	18.43		
				1RB Low	1 Pos 0	0	1	14.50	13.50	14.20	13.44	21.00	20.00	20.41	19.56		
				1RB Mid	1 Pos 38	0	1	14.50	13.50	14.10	13.37	21.00	20.00	20.34	19.50		
				1RB High	1 Pos 74	0	1	14.50	13.50	14.24	13.47	21.00	20.00	20.34	19.46		
		41490	2680	50% RB Low	38 Pos 0	1	2	13.50	12.50	13.04	12.05	20.00	19.00	19.29	18.24		
				50% RB Mid	38 Pos 19	1	2	13.50	12.50	13.05	12.03	20.00	19.00	19.31	18.27		
				50% RB High	38 Pos 39	1	2	13.50	12.50	13.09	12.06	20.00	19.00	19.25	18.21		
				100% RB	75 Pos 0	1	2	13.50	12.50	13.07	12.13	20.00	19.00	19.31	18.30		
				1RB Low	1 Pos 0	0	1	14.50	13.50	13.73	13.05	21.00	20.00	20.34	19.68		
				1RB Mid	1 Pos 38	0	1	14.50	13.50	13.53	12.84	21.00	20.00	20.36	19.67		
						1RB High	1 Pos 74	0	1	14.50	13.50	13.64	12.96	21.00	20.00	20.34	19.64
						50% RB Low	38 Pos 0	1	2	13.50	12.50	12.65	11.68	20.00	19.00	19.30	18.32
						50% RB Mid	38 Pos 19	1	2	13.50	12.50	12.59	11.62	20.00	19.00	19.25	18.32
						50% RB High	38 Pos 39	1	2	13.50	12.50	12.59	11.57	20.00	19.00	19.23	18.28
						100% RB	75 Pos 0	1	2	13.50	12.50	12.60	11.59	20.00	19.00	19.35	18.39

B.2.2.15 LTE Band 48 TDD

Band	BW	Ch #	Freq (MHz)	% RB Allocation	RB Position	MPR		Factory Upper Tolerance (dBm) QPSK	Factory Upper Tolerance (dBm) 16-QAM	Measured Output Power (dBm) Antenna 8	
						QPSK	16QAM			QPSK	16-QAM
LTE48	20 MHz	55340	3560	1RB Low	1 Pos 0	0	1	20.00	19.00	19.10	18.49
				1RB Mid	1 Pos 50	0	1	20.00	19.00	19.22	18.57
				1RB High	1 Pos 99	0	1	20.00	19.00	19.18	18.57
				50% RB Low	50 Pos 0	1	2	19.00	18.00	18.22	17.24
				50% RB Mid	50 Pos 24	1	2	19.00	18.00	18.24	17.23
				50% RB High	50 Pos 50	1	2	19.00	18.00	18.16	17.18
		100% RB	100 Pos 0	1	2	19.00	18.00	18.21	17.23		
		1RB Low	1 Pos 0	0	1	20.00	19.00	19.32	18.36		
		1RB Mid	1 Pos 50	0	1	20.00	19.00	19.45	18.52		
		1RB High	1 Pos 99	0	1	20.00	19.00	19.43	18.53		
		50% RB Low	50 Pos 0	1	2	19.00	18.00	18.49	17.52		
		50% RB Mid	50 Pos 24	1	2	19.00	18.00	18.51	17.51		
		50% RB High	50 Pos 50	1	2	19.00	18.00	18.49	17.47		
		100% RB	100 Pos 0	1	2	19.00	18.00	18.50	17.52		
		1RB Low	1 Pos 0	0	1	20.00	19.00	19.20	18.50		
		1RB Mid	1 Pos 50	0	1	20.00	19.00	19.26	18.54		
		1RB High	1 Pos 99	0	1	20.00	19.00	19.27	18.53		
		50% RB Low	50 Pos 0	1	2	19.00	18.00	18.32	17.31		
	50% RB Mid	50 Pos 24	1	2	19.00	18.00	18.31	17.29			
	50% RB High	50 Pos 50	1	2	19.00	18.00	18.22	17.23			
	100% RB	100 Pos 0	1	2	19.00	18.00	18.31	17.26			
	1RB Low	1 Pos 0	0	1	20.00	19.00	19.14	18.38			
	1RB Mid	1 Pos 38	0	1	20.00	19.00	19.24	18.48			
	1RB High	1 Pos 74	0	1	20.00	19.00	19.22	18.44			
	50% RB Low	38 Pos 0	1	2	19.00	18.00	18.16	17.15			
	50% RB Mid	38 Pos 19	1	2	19.00	18.00	18.16	17.15			
	50% RB High	38 Pos 39	1	2	19.00	18.00	18.15	17.14			
	100% RB	75 Pos 0	1	2	19.00	18.00	18.19	17.17			
	1RB Low	1 Pos 0	0	1	20.00	19.00	19.47	18.65			
	1RB Mid	1 Pos 38	0	1	20.00	19.00	19.60	18.81			
	1RB High	1 Pos 74	0	1	20.00	19.00	19.55	18.80			
	50% RB Low	38 Pos 0	1	2	19.00	18.00	18.48	17.55			
	50% RB Mid	38 Pos 19	1	2	19.00	18.00	18.48	17.55			
	50% RB High	38 Pos 39	1	2	19.00	18.00	18.48	17.56			
	100% RB	75 Pos 0	1	2	19.00	18.00	18.49	17.52			
	1RB Low	1 Pos 0	0	1	20.00	19.00	19.19	18.74			
	1RB Mid	1 Pos 38	0	1	20.00	19.00	19.22	18.82			
	1RB High	1 Pos 74	0	1	20.00	19.00	19.15	18.83			
	50% RB Low	38 Pos 0	1	2	19.00	18.00	18.25	17.25			
	50% RB Mid	38 Pos 19	1	2	19.00	18.00	18.25	17.27			
	50% RB High	38 Pos 39	1	2	19.00	18.00	18.24	17.28			
	100% RB	75 Pos 0	1	2	19.00	18.00	18.25	17.22			

Band	BW	Ch #	Freq (MHz)	% RB Allocation	RB Position	MPR		Factory Upper Tolerance (dBm) QPSK	Factory Upper Tolerance (dBm) 16-QAM	Measured Output Power (dBm) Antenna 8	
						QPSK	16QAM			QPSK	16-QAM
LTE48	10 MHz	55290	3555	1RB Low	1 Pos 0	0	1	20.00	19.00	19.18	18.05
				1RB Mid	1 Pos 24	0	1	20.00	19.00	19.22	18.06
				1RB High	1 Pos 49	0	1	20.00	19.00	19.22	18.09
				50% RB Low	25 Pos 0	1	2	19.00	18.00	18.18	17.18
				50% RB Mid	25 Pos 12	1	2	19.00	18.00	18.21	17.19
				50% RB High	25 Pos 24	1	2	19.00	18.00	18.19	17.17
		100% RB	50 Pos 0	1	2	19.00	18.00	18.25	17.26		
		1RB Low	1 Pos 0	0	1	20.00	19.00	19.50	18.73		
		1RB Mid	1 Pos 24	0	1	20.00	19.00	19.54	18.78		
		1RB High	1 Pos 49	0	1	20.00	19.00	19.58	18.83		
		50% RB Low	25 Pos 0	1	2	19.00	18.00	18.49	17.5		
		50% RB Mid	25 Pos 12	1	2	19.00	18.00	18.51	17.48		
		50% RB High	25 Pos 24	1	2	19.00	18.00	18.50	17.50		
		100% RB	50 Pos 0	1	2	19.00	18.00	18.58	17.59		
		1RB Low	1 Pos 0	0	1	20.00	19.00	19.23	18.84		
		1RB Mid	1 Pos 24	0	1	20.00	19.00	19.31	18.86		
		1RB High	1 Pos 49	0	1	20.00	19.00	19.28	18.87		
		50% RB Low	25 Pos 0	1	2	19.00	18.00	18.28	17.34		
		50% RB Mid	25 Pos 12	1	2	19.00	18.00	18.30	17.35		
		50% RB High	25 Pos 24	1	2	19.00	18.00	18.25	17.31		
		100% RB	50 Pos 0	1	2	19.00	18.00	18.36	17.35		
		1RB Low	1 Pos 0	0	1	20.00	19.00	19.16	18.52		
		1RB Mid	1 Pos 50	0	1	20.00	19.00	19.19	18.51		
		1RB High	1 Pos 99	0	1	20.00	19.00	19.18	18.56		
	50% RB Low	50 Pos 0	1	2	19.00	18.00	18.15	17.18			
	50% RB Mid	50 Pos 24	1	2	19.00	18.00	18.16	17.15			
	50% RB High	50 Pos 50	1	2	19.00	18.00	18.13	17.15			
	100% RB	100 Pos 0	1	2	19.00	18.00	18.21	17.16			
	1RB Low	1 Pos 0	0	1	20.00	19.00	19.48	18.80			
	1RB Mid	1 Pos 50	0	1	20.00	19.00	19.55	18.87			
	1RB High	1 Pos 99	0	1	20.00	19.00	19.59	18.90			
	50% RB Low	50 Pos 0	1	2	19.00	18.00	18.45	17.42			
	50% RB Mid	50 Pos 24	1	2	19.00	18.00	18.44	17.39			
	50% RB High	50 Pos 50	1	2	19.00	18.00	18.43	17.40			
	100% RB	100 Pos 0	1	2	19.00	18.00	18.47	17.55			
	1RB Low	1 Pos 0	0	1	20.00	19.00	19.38	18.94			
	1RB Mid	1 Pos 50	0	1	20.00	19.00	19.33	18.94			
	1RB High	1 Pos 99	0	1	20.00	19.00	19.35	18.97			
	50% RB Low	50 Pos 0	1	2	19.00	18.00	18.28	17.29			
	50% RB Mid	50 Pos 24	1	2	19.00	18.00	18.27	17.28			
	50% RB High	50 Pos 50	1	2	19.00	18.00	18.26	17.28			
	100% RB	75 Pos 0	1	2	19.00	18.00	18.31	17.30			

B.2.2.16 LTE Band 66 FDD

Band	BW	Ch #	Freq (MHz)	% RB Allocation	RB Position	MPR		Factory Upper	Factory Upper	Measured Output Power (dBm)		Factory Upper	Factory Upper	Measured Output Power (dBm)	
						QPSK	16QAM	Tolerance	Tolerance	Antenna 5		Tolerance	Tolerance	Antenna 8	
								(dBm)	(dBm)	QPSK	16-QAM	(dBm)	(dBm)	QPSK	16-QAM
LTE66	20 MHz	132072	1720	1RB Low	1 Pos 0	0	1	17.50	16.50	16.78	16.05	19.00	18.00	18.53	17.70
				1RB Mid	1 Pos 50	0	1	17.50	16.50	16.75	15.95	19.00	18.00	18.56	17.76
				1RB High	1 Pos 99	0	1	17.50	16.50	16.67	15.88	19.00	18.00	18.44	17.61
				50% RB Low	50 Pos 0	1	2	16.50	15.50	15.85	14.74	18.00	17.00	17.53	16.53
				50% RB Mid	50 Pos 24	1	2	16.50	15.50	15.78	14.77	18.00	17.00	17.56	16.47
				50% RB High	50 Pos 50	1	2	16.50	15.50	15.51	14.60	18.00	17.00	17.46	16.39
		100% RB	100 Pos 0	1	2	16.50	15.50	15.65	14.69	18.00	17.00	17.57	16.43		
		1RB Low	1 Pos 0	0	1	17.50	16.50	16.89	15.67	19.00	18.00	18.38	17.22		
		1RB Mid	1 Pos 50	0	1	17.50	16.50	16.68	15.42	19.00	18.00	18.41	17.23		
		1RB High	1 Pos 99	0	1	17.50	16.50	16.77	15.63	19.00	18.00	18.40	17.23		
		50% RB Low	50 Pos 0	1	2	16.50	15.50	15.72	14.71	18.00	17.00	17.54	16.57		
		50% RB Mid	50 Pos 24	1	2	16.50	15.50	15.72	14.76	18.00	17.00	17.52	16.50		
		50% RB High	50 Pos 50	1	2	16.50	15.50	15.58	14.60	18.00	17.00	17.37	16.33		
		100% RB	100 Pos 0	1	2	16.50	15.50	15.63	14.64	18.00	17.00	17.52	16.44		
		1RB Low	1 Pos 0	0	1	17.50	16.50	16.88	15.71	19.00	18.00	18.49	17.34		
		1RB Mid	1 Pos 50	0	1	17.50	16.50	16.81	15.63	19.00	18.00	18.54	17.37		
		1RB High	1 Pos 99	0	1	17.50	16.50	16.89	15.75	19.00	18.00	18.48	17.36		
		50% RB Low	50 Pos 0	1	2	16.50	15.50	15.76	14.79	18.00	17.00	17.42	16.33		
	50% RB Mid	50 Pos 24	1	2	16.50	15.50	15.85	14.76	18.00	17.00	17.55	16.47			
	50% RB High	50 Pos 50	1	2	16.50	15.50	15.69	14.68	18.00	17.00	17.33	16.25			
	100% RB	100 Pos 0	1	2	16.50	15.50	15.72	14.79	18.00	17.00	17.50	16.35			
	1RB Low	1 Pos 0	0	1	17.50	16.50	16.72	16.03	19.00	18.00	18.52	17.80			
	1RB Mid	1 Pos 38	0	1	17.50	16.50	16.50	15.82	19.00	18.00	18.33	17.65			
	1RB High	1 Pos 74	0	1	17.50	16.50	16.73	16.05	19.00	18.00	18.50	17.81			
	50% RB Low	38 Pos 0	1	2	16.50	15.50	15.73	14.78	18.00	17.00	17.52	16.50			
	50% RB Mid	38 Pos 19	1	2	16.50	15.50	15.71	14.68	18.00	17.00	17.46	16.46			
	50% RB High	38 Pos 39	1	2	16.50	15.50	15.68	14.69	18.00	17.00	17.42	16.42			
	100% RB	75 Pos 0	1	2	16.50	15.50	15.59	14.74	18.00	17.00	17.50	16.46			
	1RB Low	1 Pos 0	0	1	17.50	16.50	16.68	15.79	19.00	18.00	18.44	17.49			
	1RB Mid	1 Pos 38	0	1	17.50	16.50	16.65	15.75	19.00	18.00	18.41	17.45			
	1RB High	1 Pos 74	0	1	17.50	16.50	16.67	15.83	19.00	18.00	18.42	17.51			
	50% RB Low	38 Pos 0	1	2	16.50	15.50	15.66	14.66	18.00	17.00	17.42	16.44			
	50% RB Mid	38 Pos 19	1	2	16.50	15.50	15.67	14.68	18.00	17.00	17.39	16.39			
	50% RB High	38 Pos 39	1	2	16.50	15.50	15.61	14.63	18.00	17.00	17.31	16.34			
	100% RB	75 Pos 0	1	2	16.50	15.50	15.69	14.69	18.00	17.00	17.48	16.44			
	1RB Low	1 Pos 0	0	1	17.50	16.50	16.74	15.96	19.00	18.00	18.44	17.61			
1RB Mid	1 Pos 38	0	1	17.50	16.50	16.74	15.93	19.00	18.00	18.41	17.60				
1RB High	1 Pos 74	0	1	17.50	16.50	16.77	15.94	19.00	18.00	18.48	17.63				
50% RB Low	38 Pos 0	1	2	16.50	15.50	15.66	14.80	18.00	17.00	17.40	16.43				
50% RB Mid	38 Pos 19	1	2	16.50	15.50	15.74	14.78	18.00	17.00	17.43	16.49				
50% RB High	38 Pos 39	1	2	16.50	15.50	15.75	14.80	18.00	17.00	17.41	16.41				
100% RB	75 Pos 0	1	2	16.50	15.50	15.71	14.72	18.00	17.00	17.42	16.35				

Band	BW	Ch #	Freq (MHz)	% RB Allocation	RB Position	MPR		Factory Upper	Factory Upper	Measured Output Power (dBm) Antenna 5		Factory Upper	Factory Upper	Measured Output Power (dBm) Antenna 8	
						QPSK	16QAM	(dBm) QPSK	(dBm) 16-QAM	QPSK	16-QAM	(dBm) QPSK	(dBm) 16-QAM	QPSK	16-QAM
LTE66	10 MHz	132022	1715	1RB Low	1 Pos 0	0	1	17.50	16.50	16.76	16.18	19.00	18.00	18.59	17.86
				1RB Mid	1 Pos 24	0	1	17.50	16.50	16.74	16.06	19.00	18.00	18.53	17.77
				1RB High	1 Pos 49	0	1	17.50	16.50	16.77	16.10	19.00	18.00	18.52	17.80
				50% RB Low	25 Pos 0	1	2	16.50	15.50	15.67	14.77	18.00	17.00	17.51	16.56
				50% RB Mid	25 Pos 12	1	2	16.50	15.50	15.71	14.84	18.00	17.00	17.50	16.63
				50% RB High	25 Pos 24	1	2	16.50	15.50	15.73	14.80	18.00	17.00	17.44	16.48
		100% RB	50 Pos 0	1	2	16.50	15.50	15.73	14.70	18.00	17.00	17.63	16.45		
		1RB Low	1 Pos 0	0	1	17.50	16.50	16.87	15.60	19.00	18.00	18.50	17.38		
		1RB Mid	1 Pos 24	0	1	17.50	16.50	16.70	15.52	19.00	18.00	18.48	17.31		
		1RB High	1 Pos 49	0	1	17.50	16.50	16.88	15.74	19.00	18.00	18.51	17.36		
		50% RB Low	25 Pos 0	1	2	16.50	15.50	15.64	14.66	18.00	17.00	17.44	16.45		
		50% RB Mid	25 Pos 12	1	2	16.50	15.50	15.67	14.70	18.00	17.00	17.40	16.40		
		50% RB High	25 Pos 24	1	2	16.50	15.50	15.55	14.59	18.00	17.00	17.34	16.24		
		100% RB	50 Pos 0	1	2	16.50	15.50	15.66	14.67	18.00	17.00	17.52	16.39		
		1RB Low	1 Pos 0	0	1	17.50	16.50	16.79	15.95	19.00	18.00	18.50	17.65		
		1RB Mid	1 Pos 24	0	1	17.50	16.50	16.79	15.91	19.00	18.00	18.50	17.64		
		1RB High	1 Pos 49	0	1	17.50	16.50	16.86	16.03	19.00	18.00	18.49	17.66		
		50% RB Low	25 Pos 0	1	2	16.50	15.50	15.67	14.73	18.00	17.00	17.40	16.46		
		50% RB Mid	25 Pos 12	1	2	16.50	15.50	15.72	14.79	18.00	17.00	17.47	16.49		
		50% RB High	25 Pos 24	1	2	16.50	15.50	15.70	14.72	18.00	17.00	17.34	16.35		
		100% RB	50 Pos 0	1	2	16.50	15.50	15.75	14.69	18.00	17.00	17.58	16.37		
		1RB Low	1 Pos 0	0	1	17.50	16.50	17.03	16.24	19.00	18.00	18.60	17.84		
		1RB Mid	1 Pos 50	0	1	17.50	16.50	16.79	16.09	19.00	18.00	18.54	17.74		
		1RB High	1 Pos 99	0	1	17.50	16.50	16.91	16.23	19.00	18.00	18.55	17.78		
	50% RB Low	50 Pos 0	1	2	16.50	15.50	15.81	14.81	18.00	17.00	17.54	16.52			
	50% RB Mid	50 Pos 24	1	2	16.50	15.50	15.75	14.77	18.00	17.00	17.47	16.49			
	50% RB High	50 Pos 50	1	2	16.50	15.50	15.80	14.75	18.00	17.00	17.47	16.45			
	100% RB	100 Pos 0	1	2	16.50	15.50	15.81	14.82	18.00	17.00	17.60	16.55			
	1RB Low	1 Pos 0	0	1	17.50	16.50	16.76	16.00	19.00	18.00	18.43	17.73			
	1RB Mid	1 Pos 50	0	1	17.50	16.50	16.67	15.98	19.00	18.00	18.38	17.65			
	1RB High	1 Pos 99	0	1	17.50	16.50	16.82	16.07	19.00	18.00	18.48	17.75			
	50% RB Low	50 Pos 0	1	2	16.50	15.50	15.71	14.74	18.00	17.00	17.46	16.47			
	50% RB Mid	50 Pos 24	1	2	16.50	15.50	15.62	14.69	18.00	17.00	17.40	16.39			
	50% RB High	50 Pos 50	1	2	16.50	15.50	15.62	14.64	18.00	17.00	17.35	16.35			
	100% RB	100 Pos 0	1	2	16.50	15.50	15.65	14.71	18.00	17.00	17.52	16.46			
	1RB Low	1 Pos 0	0	1	17.50	16.50	16.85	15.91	19.00	18.00	18.53	17.72			
	1RB Mid	1 Pos 50	0	1	17.50	16.50	16.74	16.00	19.00	18.00	18.51	17.70			
	1RB High	1 Pos 99	0	1	17.50	16.50	16.78	15.99	19.00	18.00	18.59	17.75			
	50% RB Low	50 Pos 0	1	2	16.50	15.50	15.78	14.75	18.00	17.00	17.53	16.46			
	50% RB Mid	50 Pos 24	1	2	16.50	15.50	15.76	14.74	18.00	17.00	17.50	16.40			
	50% RB High	50 Pos 50	1	2	16.50	15.50	15.76	14.73	18.00	17.00	17.42	16.35			
	100% RB	100 Pos 0	1	2	16.50	15.50	15.76	14.72	18.00	17.00	17.54	16.43			

Band	BW	Ch #	Freq (MHz)	% RB Allocation	RB Position	MPR		Factory Upper	Factory Upper	Measured Output Power (dBm)		Factory Upper	Factory Upper	Measured Output Power (dBm)	
						QPSK	16QAM	Tolerance (dBm)	Tolerance (dBm)	Antenna 5		Tolerance (dBm)	Tolerance (dBm)	Antenna 8	
								QPSK	16-QAM	QPSK	16-QAM	QPSK	16-QAM	QPSK	16-QAM
LTE66	3.0 MHz	131987	1711.5	1RB Low	1 Pos 0	0	1	17.50	16.50	16.76	16.10	19.00	18.00	18.52	17.80
				1RB Mid	1 Pos 38	0	1	17.50	16.50	16.71	16.04	19.00	18.00	18.49	17.81
				1RB High	1 Pos 74	0	1	17.50	16.50	16.68	16.05	19.00	18.00	18.45	17.76
				50% RB Low	38 Pos 0	1	2	16.50	15.50	15.77	14.82	18.00	17.00	17.49	16.51
				50% RB Mid	38 Pos 19	1	2	16.50	15.50	15.76	14.83	18.00	17.00	17.51	16.52
				50% RB High	38 Pos 39	1	2	16.50	15.50	15.73	14.78	18.00	17.00	17.43	16.47
		100% RB	75 Pos 0	1	2	16.50	15.50	15.79	14.76	18.00	17.00	17.52	16.40		
		1RB Low	1 Pos 0	0	1	17.50	16.50	16.62	15.95	19.00	18.00	18.38	17.68		
		1RB Mid	1 Pos 38	0	1	17.50	16.50	16.60	15.93	19.00	18.00	18.36	17.69		
		1RB High	1 Pos 74	0	1	17.50	16.50	16.58	15.99	19.00	18.00	18.32	17.66		
		50% RB Low	38 Pos 0	0	1	17.50	16.50	15.63	14.69	18.00	17.00	17.37	16.41		
		50% RB Mid	38 Pos 19	0	1	17.50	16.50	15.62	14.68	18.00	17.00	17.34	16.40		
		50% RB High	38 Pos 39	0	1	17.50	16.50	15.62	14.69	18.00	17.00	17.33	16.37		
		100% RB	75 Pos 0	1	2	16.50	15.50	15.63	14.60	18.00	17.00	17.37	16.30		
		1RB Low	1 Pos 0	0	1	17.50	16.50	16.77	16.13	19.00	18.00	18.45	17.75		
		1RB Mid	1 Pos 38	0	1	17.50	16.50	16.63	16.05	19.00	18.00	18.45	17.77		
		1RB High	1 Pos 74	0	1	17.50	16.50	16.71	16.03	19.00	18.00	18.43	17.72		
		50% RB Low	38 Pos 0	1	2	16.50	15.50	15.71	14.80	18.00	17.00	17.48	16.52		
		50% RB Mid	38 Pos 19	1	2	16.50	15.50	15.74	14.79	18.00	17.00	17.46	16.49		
		50% RB High	38 Pos 39	1	2	16.50	15.50	15.74	14.77	18.00	17.00	17.43	16.49		
		100% RB	75 Pos 0	1	2	16.50	15.50	15.75	14.72	18.00	17.00	17.46	16.38		
		1RB Low	1 Pos 0	0	1	17.50	16.50	16.88	15.87	19.00	18.00	18.60	17.58		
		1RB Mid	1 Pos 24	0	1	17.50	16.50	16.93	15.94	19.00	18.00	18.64	17.63		
		1RB High	1 Pos 49	0	1	17.50	16.50	16.91	15.88	19.00	18.00	18.59	17.58		
	50% RB Low	25 Pos 0	0	1	17.50	16.50	16.80	15.92	18.00	17.00	18.53	17.68			
	50% RB Mid	25 Pos 12	0	1	17.50	16.50	16.80	15.95	18.00	17.00	18.54	17.65			
	50% RB High	25 Pos 24	0	1	17.50	16.50	16.80	15.98	18.00	17.00	18.51	17.70			
	100% RB	50 Pos 0	1	2	16.50	15.50	15.75	14.82	18.00	17.00	17.50	16.54			
	1RB Low	1 Pos 0	0	1	17.50	16.50	16.70	15.71	19.00	18.00	18.47	17.46			
	1RB Mid	1 Pos 24	0	1	17.50	16.50	16.76	15.77	19.00	18.00	18.51	17.54			
	1RB High	1 Pos 49	0	1	17.50	16.50	16.69	15.69	19.00	18.00	18.50	17.46			
	50% RB Low	25 Pos 0	0	1	17.50	16.50	16.63	15.86	18.00	17.00	18.41	17.53			
	50% RB Mid	25 Pos 12	0	1	17.50	16.50	16.64	15.76	18.00	17.00	18.40	17.55			
	50% RB High	25 Pos 24	0	1	17.50	16.50	16.61	15.77	18.00	17.00	18.40	17.54			
	100% RB	50 Pos 0	1	2	16.50	15.50	15.63	14.68	18.00	17.00	17.36	16.39			
	1RB Low	1 Pos 0	0	1	17.50	16.50	16.86	15.80	19.00	18.00	18.53	17.53			
	1RB Mid	1 Pos 24	0	1	17.50	16.50	16.85	15.92	19.00	18.00	18.57	17.57			
	1RB High	1 Pos 49	0	1	17.50	16.50	16.80	15.82	19.00	18.00	18.53	17.56			
	50% RB Low	25 Pos 0	0	1	17.50	16.50	16.72	15.91	18.00	17.00	18.48	17.61			
	50% RB Mid	25 Pos 12	0	1	17.50	16.50	16.77	15.88	18.00	17.00	18.48	17.61			
	50% RB High	25 Pos 24	0	1	17.50	16.50	16.75	15.90	18.00	17.00	18.48	17.64			
	100% RB	50 Pos 0	1	2	16.50	15.50	15.74	14.80	18.00	17.00	17.44	16.51			

B.2.3 LTE UL Carrier Aggregation

B.2.3.1 Inter-Band

For LTE ULCA mode, each carrier transmits on separate antennas. Each exposure has been measured separately. For each, the highest standalone SAR conditions are added to derive the Total SAR. Refer to paragraph B.5.7.

B.2.3.2 Intra-Band Contiguous

UL CA shall be tested based on the worst-case SAR configuration determined from non-CA SAR testing result. The UL CA mode power measurements represent the total power across both carriers.

According to November 2017 TCB workshop, the following needs to be performed: The maximum measured output power, RB allocation, CC offsets, CC channel BWs, MPR, modulation and other relevant information for all UL CA SAR configurations are required in SAR reports to support the test setup and results, including explanations, call box configurations and certain testing restriction

1) When the maximum output for UL CA is \leq standalone LTE mode

- The primary carrier is configured according to the highest standalone SAR configuration tested
- The secondary carrier and subsequent CCs are configured according to procedures used for power measurement and parameters similar to that used for the PCC

2) When the Reported SAR for UL CA configuration, is > 1.2 W/kg, UL CA SAR is also required for all the other test channels

LTE CA 5B:

Band	Antenna	Mode	Modulation / BW	PCC			SCC			Pwr Avg (dBm)	Factory Upper Tolerance (dBm)
				Ch	Freq (MHz)	RB Allocation	Ch	Freq (MHz)	RB Allocation		
LTE 5	5	Tablet	QPSK / 10MHz	26775	822.5	1RB High	20476	831.6	1RB Low	20.73	21.00

LTE CA 7C:

Band	Antenna	Mode	Modulation / BW	PCC			SCC			Pwr Avg (dBm)	Factory Upper Tolerance (dBm)
				Ch	Freq (MHz)	RB Allocation	Ch	Freq (MHz)	RB Allocation		
LTE 7	5	Tablet	QPSK / 20MHz	20850	2510	1RB High	21100	2535	1RB Low	15.42	15.50
	8			20850	2510	1RB High	21100	2535	1RB Low	18.12	19.00

LTE CA 38C:

Band	Antenna	Modulation / BW	PCC			SCC			Pwr Avg (dBm)	Factory Upper Tolerance (dBm)
			Ch	Freq (MHz)	RB Allocation	Ch	Freq (MHz)	RB Allocation		
LTE 38C	Main 5	QPSK / 20MHz	37901	2585.1	1RB High	38099	2604.9	1RB Low	17.24	17.50

LTE CA 41C:

Band	Antenna	Mode	Modulation / BW	PCC			SCC			Pwr Avg (dBm)	Factory Upper Tolerance (dBm)
				Ch	Freq (MHz)	RB Allocation	Ch	Freq (MHz)	RB Allocation		
LTE 41	Ant8	Tablet	QPSK / 20MHz	40185	2549.5	1RB High	40620	2593	1RB Low	20.61	21.00

LTE CA 48C:

Band	Antenna	Mode	Modulation / BW	PCC			SCC			Pwr Avg (dBm)	Factory Upper Tolerance (dBm)
				Ch	Freq (MHz)	RB Allocation	Ch	Freq (MHz)	RB Allocation		
LTE 48	Ant8	Tablet	QPSK / 20MHz	55891	3615.1	1RB High	56089	3634.9	1RB Low	19.94	20.00

LTE CA 66B, 66C:

Band	Antenna	Mode	Modulation / BW	PCC			SCC			Pwr Avg (dBm)	Factory Upper Tolerance (dBm)
				Ch	Freq (MHz)	RB Allocation	Ch	Freq (MHz)	RB Allocation		
LTE 66 66B	Ant5	Tablet	QPSK / 10MHz	132022	1715.0	1RB High	132122	1725	1RB Low	17.19	17.50
	Ant8			132022	1715.0	1RB High	132122	1725	1RB Low	18.03	19.00
LTE 66 66C	Ant5		QPSK / 20MHz	132072	1720.0	1RB High	132322	1745	1RB Low	17.39	17.50
	Ant8			132072	1720.0	1RB High	132322	1745	1RB Low	18.98	19.00

B.2.3.1 Inter-Band Contiguous and ENDC

For LTE ULCA mode, each carrier transmits on separate antennas. Each exposure has been measured separately. For each, the highest standalone SAR conditions are added to derive the Total SAR. The factory upper tolerance (dBm) related to the worst-case SAR results obtained in standalone mode have been reduced by 3dB for both LTE carrier aggregation inter-band and 5G ENDC.

Band	Antenna	BW	Channel #	Freq (MHz)	% RB Allocation	RB Position	QPSK		
							Factory Upper Tolerance (dBm)	MPR	Measured Output Power (dBm)
LTE 2A	5	20 MHz	18900	1880	1RB Mid	1 Pos 49	14.00	0	13.95
LTE 5A	5	10 MHz	20525	836.5	1RB Mid	1 Pos 24	18.00	0	17.27
LTE 7A	8	20 MHz	21100	2535	1RB Mid	1 Pos 49	16.00	0	15.55
LTE 12A	5	10 MHz	23095	707.5	1RB Mid	1 Pos 24	15.00	0	14.44
LTE 13A	5	10 MHz	23230	782	1RB Mid	1 Pos 24	16.00	0	15.38
LTE 14A	5	10 MHz	23330	793	1RB Mid	1 Pos 24	16.00	0	15.31
LTE 25A	5	20 MHz	26365	1882.5	1RB Mid	1 Pos 49	13.00	0	12.08
LTE 25A	8	20 MHz	26365	1882.5	1RB Mid	1 Pos 49	16.50	0	15.40
LTE 26A	5	15 MHz	26865	831.5	1RB Mid	1 Pos 38	17.50	0	16.30
LTE 30A	8	10 MHz	27710	2310	1RB Mid	1 Pos 24	11.00	0	9.82
LTE 41	5	20 MHz	40620	2593	1RB Mid	1 Pos 49	11.50	0	9.85
LTE 41	8	20 MHz	40620	2593	1RB Mid	1 Pos 49	18.00	0	17.03
LTE 48A	8	20 MHz	55990	3625	1RB Mid	1 Pos 49	17.00	0	16.45
LTE 66A	5	20 MHz	132322	1745	1RB Mid	1 Pos 49	14.50	0	13.68
LTE 66A	8	20 MHz	132322	1745	1RB Mid	1 Pos 49	16.00	0	14.64

B.2.4 5G NR (FR1) Tablet Mode

B.2.4.1 5G NR (FR1) Band 2 FDD Antenna 5

SAR Measurement for NR Band 2 FDD (Frequency range: 1850 – 1910MHz) is covered by NR Band 25 FDD (Frequency range: 1850 – 1915MHz) due to overlapping frequency range, same maximum tune-up and same bandwidth.

B.2.4.2 5G NR (FR1) Band 2 FDD Antenna 8

Band	BW (MHz)	Modulation	Mode	RB Allocation	RB Offset	*Factory upper tolerance (dBm)	Measured Output Power (dBm) Antenna 8							
							Frequency (MHz) / Channel							
							1860	1880	1900					
							372000	376000	396000					
NR2	20	DFS-s OFDM	PI/2 BPSK	1RB Low	0	18.00		16.66						
			QPSK	1RB Low	0	18.00		16.65						
				1RB Mid	50	18.00		16.88						
				1RB High	99	18.00		16.96						
				50% RB Low	0	18.00		16.52						
				50% RB Mid	25	18.00		16.86						
				50% RB High	49	18.00		17.05						
				100% RB	0	18.00		16.77						
			16QAM	1RB Low	0	18.00		16.75						
			64QAM	1RB Low	0	18.00		16.73						
			256QAM	1RB Low	0	18.00		16.50						
			CP-OFDM	QPSK	1RB Low	0		18.00		16.60				
										Frequency (MHz) / Channel				
										1857.5	1880	1880		
								371500	376000	380500				
	15	DFS-s OFDM	QPSK	1RB Low	0	18.00	16.66							
				50% RB Low	0	18.00	16.60							
											Frequency (MHz) / Channel			
											1855	1880	1905	
								371000	376000	381000				
	10	DFS-s OFDM	QPSK	1RB Low	0	18.00	16.62							
				50% RB Low	0	18.00	16.54							
								Frequency (MHz) / Channel						
								1852.5	1880	1907.5				
								370500	376000	381500				
	5	DFS-s OFDM	QPSK	1RB Low	0	18.00	16.80							
				50% RB Low	0	18.00	16.74							

*For all 5G NR testing, the factory upper tolerance includes MPR feature

B.2.4.3 5G NR (FR1) Band 5 FDD Antenna 5

Band	BW (MHz)	Modulation	Mode	RB Allocation	RB Offset	Factory upper tolerance (dBm)	Measured Output Power (dBm) Antenna 5			
							Frequency (MHz) / Channel			
							834	836.5	839	
							166800	167300	167800	
NR5	20	DFS-s OFDM	PI/2 BPSK	1RB Low	0	21.00		20.49		
			QPSK	1RB Low	0	21.00		20.50		
				1RB Mid	50	21.00		20.72		
				1RB High	99	21.00		20.87		
				50% RB Low	0	21.00		20.64		
				50% RB Mid	25	21.00		20.80		
				50% RB High	49	21.00		20.88		
				100% RB	0	21.00		20.76		
			16QAM	1RB Low	0	21.00		20.90		
			64QAM	1RB Low	0	21.00		20.62		
	256QAM	1RB Low	0	21.00		20.59				
	CP-OFDM	QPSK	1RB Low	0	21.00		20.48			
								Frequency (MHz) / Channel		
								831.5	836.5	841.5
								166300	167300	168300
	15	DFS-s OFDM	QPSK	1RB Low	0	21.00		20.62		
				50% RB Low	0	21.00		20.69		
								Frequency (MHz) / Channel		
								829	836.5	844
								165800	167300	168800
	10	DFS-s OFDM	QPSK	1RB Low	0	21.00		20.55		
				50% RB Low	0	21.00		20.56		
								Frequency (MHz) / Channel		
							826.5	836.5	846.5	
							165300	167300	169300	
5	DFS-s OFDM	QPSK	1RB Low	0	21.00		20.66			
			50% RB Low	0	21.00		20.72			

B.2.4.4 5G NR (FR1) Band 7 FDD Antenna 5

Band	BW (MHz)	Modulation	Mode	RB Allocation	RB Offset	Factory upper tolerance (dBm)	Measured Output Power (dBm) Antenna 5			
							Frequency (MHz) / Channel			
							2510	2535	2560	
							502000	507000	512000	
NR7	20	DFS-s OFDM	PI/2 BPSK	1RB Low	0	15.50		15.10		
			QPSK	1RB Low	0	15.50		15.13		
				1RB Mid	50	15.50		15.02		
				1RB High	99	15.50		15.03		
				50% RB Low	0	15.50		15.08		
				50% RB Mid	25	15.50		15.08		
				50% RB High	49	15.50		15.09		
				100% RB	0	15.50		15.11		
			16QAM	1RB Low	0	15.50		15.50		
			64QAM	1RB Low	0	15.50		15.35		
	256QAM	1RB Low	0	15.50		15.24				
	CP-OFDM	QPSK	1RB Low	0	15.50		15.20			
								Frequency (MHz) / Channel		
								2507.5	2535	2562.5
								501500	507000	512500
	15	DFS-s OFDM	QPSK	1RB Low	0	15.50		15.12		
				50% RB Low	0	15.50		15.09		
								Frequency (MHz) / Channel		
								2505	2535	2565
								501000	507000	513000
	10	DFS-s OFDM	QPSK	1RB Low	0	15.50		15.03		
				50% RB Low	0	15.50		14.93		
								Frequency (MHz) / Channel		
								2502.5	2535	2567.5
								500500	507000	513500
	5	DFS-s OFDM	QPSK	1RB Low	0	15.50		15.09		
				50% RB Low	0	15.50		15.09		

B.2.4.5 5G NR (FR1) Band 25 FDD Antenna 5

Band	BW (MHz)	Modulation	Mode	RB Allocation	RB Offset	Factory upper tolerance (dBm)	Measured Output Power (dBm) Antenna 5			
							Frequency (MHz) / Channel			
							1860	1882.5	1905	
							372000	376500	381000	
NR25	20	DFS-s OFDM	PI/2 BPSK	1RB Low	0	17.50		16.73		
			QPSK	1RB Low	0	17.50		16.74		
				1RB Mid	50	17.50		17.04		
				1RB High	99	17.50		16.89		
				50% RB Low	0	17.50		16.59		
				50% RB Mid	25	17.50		16.86		
				50% RB High	49	17.50		16.94		
				100% RB	0	17.50		16.73		
			16QAM	1RB Low	0	17.50		17.08		
			64QAM	1RB Low	0	17.50		16.88		
	256QAM	1RB Low	0	17.50		16.80				
	CP-OFDM	QPSK	1RB Low	0	17.50		16.77			
								Frequency (MHz) / Channel		
								1857.5	1882.5	1907.5
								371500	376500	381500
	15	DFS-s OFDM	QPSK	1RB Low	0	17.50		16.83		
				50% RB Low	0	17.50		16.71		
								Frequency (MHz) / Channel		
								1855	1882.5	1910
								371000	376500	382000
	10	DFS-s OFDM	QPSK	1RB Low	0	17.50		16.82		
				50% RB Low	0	17.50		16.64		
								Frequency (MHz) / Channel		
								1852.5	1882.5	1912.5
								370500	376500	382500
	5	DFS-s OFDM	QPSK	1RB Low	0	17.50		16.96		
				50% RB Low	0	17.50		16.81		

B.2.4.6 5G NR (FR1) Band 30 FDD Antenna 5

Band	BW (MHz)	Modulation	Mode	RB Allocation	RB Offset	Factory upper tolerance (dBm)	Measured Output Power (dBm) Antenna 5				
							Frequency (MHz) / Channel				
NR30	10	DFS-s OFDM	PI/2 BPSK	1RB Low	0	14.50		2310			
			QPSK	1RB Low	0	14.50		46200			
				1RB Mid	25	14.50		13.37			
				1RB High	49	14.50		13.30			
				50% RB Low	0	14.50		13.29			
				50% RB Mid	12	14.50		13.31			
				50% RB High	25	14.50		13.19			
				100% RB	0	14.50		13.24			
			16QAM	1RB Low	0	14.50		13.08			
			64QAM	1RB Low	0	14.50		13.12			
			256QAM	1RB Low	0	14.50		13.78			
			CP-OFDM	QPSK	1RB Low	0		14.50		13.52	
	5	DFS-s OFDM	QPSK					Frequency (MHz) / Channel			
								2310			
								46200			
				1RB Low	0	14.50	13.43				
				50% RB Low	0	14.50	13.42				

B.2.4.7 5G NR (FR1) Band 38 TDD Antenna Main 5

Band	BW	Modulation	Mode	RB Allocation	RB Offset	Factory upper tolerance (dBm)	Measured Output Power (dBm)			
							Frequency (MHz) / Channel			
							2590	2595	2600	
							518000	519000	520000	
NR38	40	DFS-s OFDM	PI/2 BPSK	1RB Low	0	15.00		14.56		
			QPSK	1RB Low	0	15.00		14.62		
				1RB Mid	136	15.00		14.87		
				1RB High	270	15.00		14.74		
				50% RB Low	0	15.00		14.88		
				50% RB Mid	68	15.00		14.91		
				50% RB High	137	15.00		14.88		
				100% RB	0	15.00		14.91		
			16QAM	1RB Low	0	15.00		14.76		
			64QAM	1RB Low	0	15.00		14.67		
			256QAM	1RB Low	0	15.00		14.63		
	CP-OFDM	QPSK	1RB Low	0	15.00		14.73			
								Frequency (MHz) / Channel		
								2590	2595	2600
								518000	519000	520000
	20	DFS-s OFDM	QPSK	1RB Low	0	15.00		14.69		
				50% RB Low	0	15.00		14.93		
								Frequency (MHz) / Channel		
								2577.5	2595	2612.5
								515500	519000	522500
	15	DFS-s OFDM	QPSK	1RB Low	0	15.00		14.73		
				50% RB Low	0	15.00		14.89		
								Frequency (MHz) / Channel		
								2575	2595	2615
							515000	519000	523000	
10	DFS-s OFDM	QPSK	1RB Low	0	15.00		14.79			
			50% RB Low	0	15.00		14.91			
							Frequency (MHz) / Channel			
							2572.5	2595	2617.5	
							514500	519000	523500	
5	DFS-s OFDM	QPSK	1RB Low	0	15.00		13.78			
			50% RB Low	0	15.00		14.77			

B.2.4.8 5G NR (FR1) Band 38 FDD Antenna Aux 8

Band	BW	Modulation	Mode	RB Allocation	RB Offset	Factory upper tolerance (dBm)	Measured Output Power (dBm)						
							Frequency (MHz) / Channel						
							2590	2595	2600				
NR38	40	DFS-s OFDM	PI/2 BPSK	1RB Low	0	20.00	518000	519000	520000				
			QPSK	1RB Low	0	20.00				19.13			
				1RB Mid	136	20.00				19.17			
				1RB High	270	20.00				19.49			
				50% RB Low	0	20.00				19.53			
				50% RB Mid	68	20.00				19.52			
				50% RB High	137	20.00				19.61			
				100% RB	0	20.00				19.69			
			16QAM	1RB Low	0	20.00				19.64			
			64QAM	1RB Low	0	20.00				19.48			
			256QAM	1RB Low	0	20.00				19.37			
	CP-OFDM	QPSK	1RB Low	0	20.00	19.10							
	20	DFS-s OFDM	QPSK					Frequency (MHz) / Channel					
								2590	2595	2600			
								518000	519000	560000			
								518000	519000	560000			
											1RB Low	0	20.00
								50% RB Low	0	20.00	19.32		
								Frequency (MHz) / Channel					
								2577.5	2595	2612.5			
								515500	519000	522500			
				15	DFS-s OFDM	QPSK					518000	519000	560000
				50% RB Low	0	20.00	19.33						
				Frequency (MHz) / Channel									
				2575	2595	2615							
				515000	519000	523000							
10	DFS-s OFDM	QPSK					518000	519000	560000				
										1RB Low	0	20.00	
				50% RB Low	0	20.00	19.38						
				Frequency (MHz) / Channel									
				2572.5	2595	2617.5							
				514500	519000	523500							
5	DFS-s OFDM	QPSK					518000	519000	560000				
										1RB Low	0	20.00	
				50% RB Low	0	20.00	18.34						
				Frequency (MHz) / Channel									
				2572.5	2595	2617.5							
				514500	519000	523500							
				Frequency (MHz) / Channel									
				2572.5	2595	2617.5							
				514500	519000	523500							

B.2.4.9 5G NR (FR1) Band 41 TDD Antenna 5

Band	BW (MHz)	Modulation	Mode	RB Allocation	RB Offset	Factory upper tolerance (dBm)	Measured Output Power (dBm) Antenna 5					
							Frequency (MHz) / Channel					
							2546	2569.5	2593	2616.5	2640	
NR41	100	DFS-s OFDM	PI/2 BPSK	1RB Low	0	14.50			13.47			
			QPSK	1RB Low	0	14.50			13.47			
				1RB Mid	136	14.50			13.98			
				1RB High	270	14.50			14.50			
				50% RB Low	0	14.50			14.03			
				50% RB Mid	68	14.50			14.42			
				50% RB High	137	14.50			14.49			
				100% RB	0	14.50			14.23			
			16QAM	1RB Low	0	14.50			13.92			
			64QAM	1RB Low	0	14.50			13.64			
	256QAM	1RB Low	0	14.50			13.61					
	CP-OFDM	QPSK	1RB Low	0	14.50			13.48				
								Frequency (MHz) / Channel				
								2541	2567	2593	2619	2645
								508200	513400	518600	523800	529000
	90	DFS-s OFDM	QPSK	1RB Low	0	14.50			13.44			
				50% RB Low	0	14.50			13.93			
								Frequency (MHz) / Channel				
								2536	2564.5	2593	2621.5	2650
								507200	512900	518600	524300	530000
80	DFS-s OFDM	QPSK	1RB Low	0	14.50			13.50				
			50% RB Low	0	14.50			13.97				
							Frequency (MHz) / Channel					
							2526	2559.5	2593	2626.5	2660	
							505200	511900	518600	525300	532000	
60	DFS-s OFDM	QPSK	1RB Low	0	14.50			13.87				
			50% RB Low	0	14.50			13.91				
							Frequency (MHz) / Channel					
							2521	2557	2593	2629	2665	
							504200	511400	518600	525800	5330000	
50	DFS-s OFDM	QPSK	1RB Low	0	14.50			13.92				
			50% RB Low	0	14.50			13.95				
							Frequency (MHz) / Channel					
							2516	2554.5	2593	2631.5	2670	
							503200	510900	518600	526300	534000	
40	DFS-s OFDM	QPSK	1RB Low	0	14.50			13.71				
			50% RB Low	0	14.50			13.93				
							Frequency (MHz) / Channel					
							2506	2549.5	2593	2636.5	2680	
							501200	509900	518600	527300	536000	
20	DFS-s OFDM	QPSK	1RB Low	0	14.50			13.90				
			50% RB Low	0	14.50			13.88				

B.2.4.10 5G NR (FR1) Band 41 TDD Antenna 8

Band	BW	Modulation	Mode	RB Allocation	RB Offset	Factory upper tolerance (dBm)	Measured Output Power (dBm) Antenna 8					
							Frequency (MHz) / Channel					
							2546	2569.5	2593	2616.5	2640	
NR41	100	DFS-s OFDM	PI/2 BPSK	1RB Low	0	19.00	509200	513900	518600	523300	528000	
			QPSK	1RB Low	0	19.00				17.71		
				1RB Mid	136	19.00				17.72		
				1RB High	270	19.00				18.05		
				50% RB Low	0	19.00				17.50		
				50% RB Mid	68	19.00				18.40		
				50% RB High	137	19.00				18.41		
				100% RB	0	19.00				18.30		
			16QAM	1RB Low	0	19.00				18.21		
			64QAM	1RB Low	0	19.00				17.91		
256QAM	1RB Low	0	19.00				17.84					
		CP-OFDM	QPSK	1RB Low	0	19.00				17.67		
										17.69		
							Frequency (MHz) / Channel					
							2541	2567	2593	2619	2645	
							508200	513400	518600	523800	529000	
90	DFS-s OFDM	QPSK	1RB Low	0	19.00					17.87		
			50% RB Low	0	19.00					18.26		
							Frequency (MHz) / Channel					
							2536	2564.5	2593	2621.5	2650	
							507200	512900	518600	524300	530000	
80	DFS-s OFDM	QPSK	1RB Low	0	19.00					17.99		
			50% RB Low	0	19.00					18.25		
							Frequency (MHz) / Channel					
							2526	2559.5	2593	2626.5	2660	
							505200	511900	518600	525300	532000	
60	DFS-s OFDM	QPSK	1RB Low	0	19.00					18.26		
			50% RB Low	0	19.00					18.53		
							Frequency (MHz) / Channel					
							2521	2557	2593	2629	2665	
							504200	511400	518600	525800	5330000	
50	DFS-s OFDM	QPSK	1RB Low	0	19.00					18.18		
			50% RB Low	0	19.00					18.47		
							Frequency (MHz) / Channel					
							2516	2554.5	2593	2631.5	2670	
							503200	510900	518600	526300	534000	
40	DFS-s OFDM	QPSK	1RB Low	0	19.00					17.84		
			50% RB Low	0	19.00					18.33		
							Frequency (MHz) / Channel					
							2506	2549.5	2593	2636.5	2680	
							501200	509900	518600	527300	536000	
20	DFS-s OFDM	QPSK	1RB Low	0	19.00					18.15		
			50% RB Low	0	19.00					18.27		

B.2.4.11 5G NR (FR1) Band 66 FDD Antenna 5

Band	BW	Modulation	Mode	RB Allocation	RB Offset	Factory upper tolerance (dBm)	Measured Output Power (dBm) Antenna 5							
							Frequency (MHz) / Channel							
							1730	1745	1760					
							346000	349000	352000					
NR66	40	DFS-s OFDM	PI/2 BPSK	1RB Low	0	18.00		17.46						
			QPSK	1RB Low	0	18.00		17.39						
				1RB Mid	136	18.00		18.00						
				1RB High	270	18.00		17.76						
				50% RB Low	0	18.00		17.66						
				50% RB Mid	68	18.00		18.00						
				50% RB High	137	18.00		17.85						
				100% RB	0	18.00		17.72						
				16QAM	1RB Low	0		18.00		17.58				
			64QAM	1RB Low	0	18.00		17.53						
			256QAM	1RB Low	0	18.00		17.62						
			CP-OFDM	QPSK	1RB Low	0		18.00		17.43				
										Frequency (MHz) / Channel				
										1725	1745	1765		
								345000	349000	353000				
	30	DFS-s OFDM	QPSK	1RB Low	0	18.00		17.56						
				50% RB Low	0	18.00		17.83						
								Frequency (MHz) / Channel						
								1720	1745	1770				
								344000	349000	354000				
	20	DFS-s OFDM	QPSK	1RB Low	0	18.00		17.77						
				50% RB Low	0	18.00		17.88						
								Frequency (MHz) / Channel						
								1717.5	1745	1772.5				
								343500	349000	354500				
	15	DFS-s OFDM	QPSK	1RB Low	0	18.00		17.85						
50% RB Low				0	18.00	17.96								
							Frequency (MHz) / Channel							
							1715	1745	1775					
							343000	349000	355000					
10	DFS-s OFDM	QPSK	1RB Low	0	18.00		17.86							
			50% RB Low	0	18.00		17.86							
							Frequency (MHz) / Channel							
							1712.5	1745	1745					
							342500	349000	355500					
5	DFS-s OFDM	QPSK	1RB Low	0	18.00		18.00							
			50% RB Low	0	18.00		18.00							

B.2.4.12 5G NR (FR1) Band 66 FDD Antenna 8

Band	BW	Modulation	Mode	RB Allocation	RB Offset	Factory upper tolerance (dBm)	Measured Output Power (dBm) Antenna 8			
							Frequency (MHz) / Channel			
							1730	1745	1760	
							346000	349000	352000	
NR66	40	DFS-s OFDM	PI/2 BPSK	1RB Low	0	19.00		17.92		
			QPSK	1RB Low	0	19.00		17.96		
				1RB Mid	136	19.00		18.58		
				1RB High	270	19.00		18.02		
				50% RB Low	0	19.00		18.24		
				50% RB Mid	68	19.00		18.46		
				50% RB High	137	19.00		18.23		
				100% RB	0	19.00		18.22		
			16QAM	1RB Low	0	19.00		17.92		
			64QAM	1RB Low	0	19.00		18.08		
	256QAM	1RB Low	0	19.00	17.79					
	CP-OFDM	QPSK	1RB Low	0	19.00	17.87				
								Frequency (MHz) / Channel		
								1725	1745	1765
								345000	349000	353000
	30	DFS-s OFDM	QPSK	1RB Low	0	19.00		18.21		
				50% RB Low	0	19.00		18.23		
								Frequency (MHz) / Channel		
								1720	1745	1770
							344000	349000	354000	
20	DFS-s OFDM	QPSK	1RB Low	0	19.00		18.37			
			50% RB Low	0	19.00		18.43			
							Frequency (MHz) / Channel			
							1717.5	1745	1772.5	
							343500	349000	354500	
15	DFS-s OFDM	QPSK	1RB Low	0	19.00		18.49			
			50% RB Low	0	19.00		18.49			
							Frequency (MHz) / Channel			
							1715	1745	1775	
							343000	349000	355000	
10	DFS-s OFDM	QPSK	1RB Low	0	19.00		18.40			
			50% RB Low	0	19.00		18.36			
							Frequency (MHz) / Channel			
							1712.5	1745	1745	
							342500	349000	355500	
5	DFS-s OFDM	QPSK	1RB Low	0	19.00		18.49			
			50% RB Low	0	19.00		18.51			

B.2.4.13 5G NR (FR1) Band 77 TDD Antenna 5

Band	BW	Modulation	Mode	RB Allocation	RB Offset	Factory upper tolerance (dBm)	Measured Output Power (dBm) Antenna 5				
							Frequency (MHz) / Channel				
							3840	3795	3750	3885	3930
NR77	100	DFS-s OFDM	PI/2 BPSK	1RB Low	0	16.00			14.31		
			QPSK	1RB Low	0	16.00			14.33		
				1RB Mid	136	16.00			14.47		
				1RB High	270	16.00			14.32		
				50% RB Low	0	16.00			14.67		
				50% RB Mid	68	16.00			14.75		
				50% RB High	137	16.00			14.79		
				100% RB	0	16.00			14.68		
			16QAM	1RB Low	0	16.00			14.60		
		64QAM	1RB Low	0	16.00			14.31			
		256QAM	1RB Low	0	16.00			14.29			
		CP-OFDM	QPSK	1RB Low	0	16.00			14.25		
							Frequency (MHz) / Channel				
							3840	3795	3750	3885	3930
							656600	653000	650000	659000	662000
90	DFS-s OFDM	QPSK	1RB Low	0	16.00			14.50			
			50% RB Low	0	16.00			14.77			
							Frequency (MHz) / Channel				
							3840	3795	3750	3885	3930
							656600	653000	650000	659000	662000
80	DFS-s OFDM	QPSK	1RB Low	0	16.00			14.63			
			50% RB Low	0	16.00			14.80			
							Frequency (MHz) / Channel				
							3840	3795	3750	3885	3930
							656600	653000	650000	659000	662000
60	DFS-s OFDM	QPSK	1RB Low	0	16.00			14.85			
			50% RB Low	0	16.00			14.72			
							Frequency (MHz) / Channel				
							3840	3795	3750	3885	3930
							656600	653000	650000	659000	662000
50	DFS-s OFDM	QPSK	1RB Low	0	16.00			14.75			
			50% RB Low	0	16.00			14.70			
							Frequency (MHz) / Channel				
							3840	3795	3750	3885	3930
							656600	653000	650000	659000	662000
40	DFS-s OFDM	QPSK	1RB Low	0	16.00			14.29			
			50% RB Low	0	16.00			14.66			
							Frequency (MHz) / Channel				
							3840	3795	3750	3885	3930
							656600	653000	650000	659000	662000
20	DFS-s OFDM	QPSK	1RB Low	0	16.00			14.40			
			50% RB Low	0	16.00			14.58			

B.2.4.14 5G NR (FR1) Band 77 TDD Antenna 8

Band	BW	Modulation	Mode	RB Allocation	RB Offset	Factory upper tolerance (dBm)	Measured Output Power (dBm) Antenna 8					
							Frequency (MHz) / Channel					
							3840	3795	3750	3885	3930	
NR77	100	DFS-s OFDM	PI/2 BPSK	1RB Low	0	17.50			16.16			
			QPSK	1RB Low	0	17.50			16.18			
				1RB Mid	136	17.50			16.32			
				1RB High	270	17.50			16.17			
				50% RB Low	0	17.50			16.55			
				50% RB Mid	68	17.50			16.66			
				50% RB High	137	17.50			16.73			
				100% RB	0	17.50			16.55			
			16QAM	1RB Low	0	17.50			16.21			
			64QAM	1RB Low	0	17.50			16.07			
	256QAM	1RB Low	0	17.50			16.08					
	CP-OFDM	QPSK	1RB Low	0	17.50			16.16				
								Frequency (MHz) / Channel				
								3840	3795	3750	3885	3930
								656600	653000	650000	659000	662000
	90	DFS-s OFDM	QPSK	1RB Low	0	17.50			16.28			
				50% RB Low	0	17.50			16.57			
								Frequency (MHz) / Channel				
								3840	3795	3750	3885	3930
								656600	653000	650000	659000	662000
80	DFS-s OFDM	QPSK	1RB Low	0	17.50			16.34				
			50% RB Low	0	17.50			16.61				
							Frequency (MHz) / Channel					
							3840	3795	3750	3885	3930	
							656600	653000	650000	659000	662000	
60	DFS-s OFDM	QPSK	1RB Low	0	17.50			16.61				
			50% RB Low	0	17.50			16.52				
							Frequency (MHz) / Channel					
							3840	3795	3750	3885	3930	
							656600	653000	650000	659000	662000	
50	DFS-s OFDM	QPSK	1RB Low	0	17.50			16.53				
			50% RB Low	0	17.50			16.51				
							Frequency (MHz) / Channel					
							3840	3795	3750	3885	3930	
							656600	653000	650000	659000	662000	
40	DFS-s OFDM	QPSK	1RB Low	0	17.50			16.24				
			50% RB Low	0	17.50			16.41				
							Frequency (MHz) / Channel					
							3840	3795	3750	3885	3930	
							656600	653000	650000	659000	662000	
20	DFS-s OFDM	QPSK	1RB Low	0	17.50			16.38				
			50% RB Low	0	17.50			16.50				

B.2.4.15 5G NR (FR1) Band 78 TDD

SAR Measurement for NR Band 78 TDD (Frequency range: 3700 – 3800MHz) is covered by NR Band 78 TDD (Frequency range: 3700 – 3980MHz) due to overlapping frequency range, same maximum tune-up and same bandwidth.

B.2.4.16 5G NR (FR1) Band 78 TDD Antenna Aux 8

Band	BW	Modulation	Mode	RB Allocation	RB Offset	Factory upper tolerance (dBm)	Measured Output Power (dBm) Antenna 8					
							Frequency (MHz) / Channel					
							3840	3795	3750	3885	3930	
							656600	653000	650000	659000	662000	
NR78	100	DFS-s OFDM	PI/2 BPSK	1RB Low	0	18.00			17.10			
			QPSK	1RB Low	0	18.00			17.17			
				1RB Mid	136	18.00			17.58			
				1RB High	270	18.00			17.30			
				50% RB Low	0	18.00			17.57			
				50% RB Mid	68	18.00			17.72			
				50% RB High	137	18.00			17.66			
				100% RB	0	18.00			17.51			
			16QAM	1RB Low	0	18.00			17.13			
			64QAM	1RB Low	0	18.00			17.03			
	256QAM	1RB Low	0	18.00			16.96					
	CP-OFDM	QPSK	1RB Low	0	18.00			17.19				
								Frequency (MHz) / Channel				
								3840	3795	3750	3885	3930
								656600	653000	650000	659000	662000
	NR78	90	DFS-s OFDM	QPSK	1RB Low	0	18.00			17.17		
					50% RB Low	0	18.00			17.52		
									Frequency (MHz) / Channel			
							3840	3795	3750	3885	3930	
							656600	653000	650000	659000	662000	
80		DFS-s OFDM	QPSK	1RB Low	0	18.00			17.22			
				50% RB Low	0	18.00			17.58			
							Frequency (MHz) / Channel					
							3840	3795	3750	3885	3930	
							656600	653000	650000	659000	662000	
60		DFS-s OFDM	QPSK	1RB Low	0	18.00			17.27			
				50% RB Low	0	18.00			17.60			
							Frequency (MHz) / Channel					
							3840	3795	3750	3885	3930	
							656600	653000	650000	659000	662000	
50	DFS-s OFDM	QPSK	1RB Low	0	18.00			17.29				
			50% RB Low	0	18.00			17.64				
							Frequency (MHz) / Channel					
							3840	3795	3750	3885	3930	
							656600	653000	650000	659000	662000	
40	DFS-s OFDM	QPSK	1RB Low	0	18.00			17.08				
			50% RB Low	0	18.00			17.63				
							Frequency (MHz) / Channel					
							3840	3795	3750	3885	3930	
							656600	653000	650000	659000	662000	
20	DFS-s OFDM	QPSK	1RB Low	0	18.00			17.53				
			50% RB Low	0	18.00			17.81				

B.2.4.17 5G NR (FR1) UL Carrier Aggregation

For NR ULCA mode, each carrier transmits on separate antennas. Each exposure has been measured separately. For each, the highest standalone SAR conditions are added to derive the Total SAR. Refer to paragraph B.5.7.

B.3 Tissue Parameters Measurement

Body TSL

System #2

Body TSL	Target TSL		Measured TSL		Deviation %		
Freq (MHz)	ϵ' (F/m)	σ (S/m)	ϵ' (F/m)	σ (S/m)	Deviation ϵ'	Deviation σ	Date
750.0	53.46	0.96	52.06	0.95	-6.25	-1.04	2021-12-13
835.0	53.26	0.98	50.7	1.42	-5.11	-4.7	2021-12-13
1750.0	53.43	1.49	50.48	1.52	-5.29	0.0	2021-12-13
1900.0	53.30	1.52	49.97	1.84	-5.54	1.66	2021-12-13
2300.0	52.90	1.81	49.57	2.11	-5.6	-2.31	2021-12-13
2600.0	52.51	2.16	47.65	3.31	-6.53	-8.31	2021-12-13
3700.0	51.05	3.55	47.65	3.31	-6.53	-8.31	2021-12-13

System #4

Body TSL	Target TSL		Measured TSL		Deviation %		
Freq (MHz)	ϵ' (F/m)	σ (S/m)	ϵ' (F/m)	σ (S/m)	Deviation ϵ'	Deviation σ	Date
750.0	55.53	0.96	55.90	0.93	0.66	-3.12	2021-12-09
835.0	55.19	0.98	55.70	0.97	0.92	-1.02	2021-12-09
1750.0	53.43	1.49	51.67	1.55	-3.29	4.03	2022-01-17
1900.0	53.30	1.52	53.62	1.54	0.6	1.32	2021-12-09
2300.0	52.90	1.81	53.14	1.85	0.45	2.21	2021-12-09
2600.0	52.51	2.16	52.52	2.09	0.02	-3.24	2021-12-13
3700.0	51.05	3.55	50.36	3.3	-1.35	-7.04	2021-12-09

See *Annex D* below for more details.

B.4 System Check Measurements

Body Measurements

Frequency (MHz)	Average	Target SAR (W/Kg)	Measured SAR (W/Kg)	Deviation to target (%)	Limit (%)	Date
750	1g	8.75	8.42	-3.77	±10	2021-12-13
	10g	5.72	5.52	-3.50		
835	1g	9.65	10.00	3.63		2021-12-13
	10g	6.32	6.54	3.48		2021-12-10
	1g	9.65	9.56	-0.93		
	10g	6.32	6.16	-2.53		
1750	1g	37.10	33.40	-9.97		2021-12-13
	10g	19.60	17.90	8.67		2021-12-10
	1g	37.10	34.40	-7.28		
	10g	19.60	18.36	-6.33		2022-01-18
	1g	37.10	36.40	-1.89		
	10g	19.60	19.36	-1.22		
1900	1g	40.30	39.60	-1.74		2021-12-13
	10g	21.00	20.60	-1.90		2021-12-10
	1g	40.30	39.60	-1.74		
	10g	21.00	20.40	-2.86		
2300	1g	47.90	44.80	-6.47		2021-12-13
	10g	23.20	21.40	-7.76		2021-12-10
	1g	47.90	46.00	-3.97		
	10g	23.20	21.80	-6.03		
2600	1g	54.10	50.40	-6.84	2021-12-15	
	10g	24.10	22.80	-5.39	2021-12-13	
	1g	54.10	50.40	-6.84		
	10g	24.10	22.40	-7.05		
3700	1g	62.10	62.40	-2.04	2021-12-13	
	10g	22.20	23.20	-1.69		
	1g	62.10	60.80	-2.09	2021-12-10	
	10g	22.20	22.60	1.80		

See Annex C for more details.

B.5 SAR Test Results

B.5.1 WCDMA – Antenna 5

Rate - BW	Radio Band Name	Channel Number	Freq (MHz)	Test position mode	Position	Scaling Factor (dB)	Measured SAR 1g (W/Kg)	Reported SAR 1g (W/Kg)	Plot #
RMC 12.2kbps - 5Mhz	Band 2	9400	1880	Tablet	Back Face	0.16	0.03	0.03	
					Right edge	0.16	0.07	0.07	
					Top edge	0.16	0.60	0.63	1
	Band 4	1413	1732.6	Tablet	Back Face	0.51	0.06	0.07	
					Right edge	0.51	0.13	0.15	
					Top edge	0.51	0.61	0.69	2
	Band 5	4132	826.4	Tablet	Top edge	0.10	0.89	0.91	3
					Back Face	0.18	0.11	0.11	
		4183	836.6	Tablet	Right edge	0.18	0.03	0.03	
					Top edge	0.18	0.80	0.84	
4233	846.6	Tablet	Top edge	0.25	0.74	0.79			

B.5.2 LTE

B.5.2.1 LTE Band 2 FDD

Band	Ant	BW (MHz)	Mod.	Channel Number	Freq (MHz)	Position	% RB Allocation	Scaling Factor (dB)	Measured SAR 1g (W/Kg)	Reported SAR 1g (W/Kg)	Plot #
Band 2	Main /5	10	QPSK	18900	1880.0	Back Face	1RB Mid	0.05	0.04	0.04	
							50RB Mid	0.12	0.03	0.03	
						Right Edge	1RB Mid	0.05	0.07	0.07	
							50RB Mid	0.12	0.05	0.05	
						Top edge	1RB Mid	0.05	0.67	0.68	4
							50RB Mid	0.12	0.53	0.54	

LTE Band 2 for UL CA 2A Inter-band and ENDC

Band	Ant	BW (MHz)	Mod.	Channel Number	Freq (MHz)	Position	% RB Allocation	Scaling Factor (dB)	Measured SAR 1g (W/Kg)	Reported SAR 1g (W/Kg)
Band 5	Main/5	10	QPSK	20525	1880.0	Top edge	1RB Mid	0.05	0.17	0.17

B.5.2.2 LTE Band 5 FDD

Band	Ant	BW (MHz)	Mod.	Channel Number	Freq (MHz)	Position	% RB Allocation	Scaling Factor (dB)	Measured SAR 1g (W/Kg)	Reported SAR 1g (W/Kg)	Plot #
Band 5	Main /5	10	QPSK	20525	836.6	Back Face	1RB Mid	0.54	0.12	0.13	
							50RB Mid	0.64	0.08	0.10	
						Right Edge	1RB Mid	0.54	0.06	0.07	
							50RB Mid	0.64	0.05	0.05	
						Top edge	1RB Mid	0.54	0.79	0.90	5
							50RB Mid	0.64	0.61	0.71	
100RB Mid	0.60	0.64	0.73								

UL CA 5B

UL CA shall be tested based on the worst-case SAR configuration determined from non-CA SAR testing result. The channel BW, channel number, RB allocation, etc. would be selected to allow contiguous CA of PCC and SCC. Uplink output power for UL CA is the total power measured across the PCC and SCC.

Standalone testing in LTE Band5 is not required since Back Face is covered by LTE Band26. Top Edge position with low channel is chosen as the configuration that gives the highest SAR, thus, the same is used for UL CA testing

Band	Antenna	Modulation / BW	PCC			SCC			Position	Scaling Factor (dB)	Measured SAR 1g (W/Kg)	Reported SAR 1g (W/Kg)
			Ch	Freq (MHz)	RB Allocation	Ch	Freq (MHz)	RB Allocation				
LTE 5	Ant5	QPSK / 10MHz	26775	822.5	1RB High	20476	831.6	1RB Low	Top Edge	0.27	0.66	0.70

PCC RB allocation settings for UL CA have been adjusted based on the worst-case power

LTE Band 5 for UL CA 5A Inter-band and ENDC

Band	Ant	BW (MHz)	Mod.	Channel Number	Freq (MHz)	Position	% RB Allocation	Scaling Factor (dB)	Measured SAR 1g (W/Kg)	Reported SAR 1g (W/Kg)
Band 5	Main 5	10	QPSK	20525	836.6	Top edge	1RB Mid	0.54	0.38	0.44

B.5.2.3 LTE Band 7 FDD

Band	Ant	BW (MHz)	Mod.	Channel Number	Freq (MHz)	Position	% RB Allocation	Scaling Factor (dB)	Measured SAR 1g (W/kg)	Reported SAR 1g (W/kg)	Plot #
Band 7	Main 5	20	QPSK	20850	2510.0	Top edge	1RB Mid	0.49	0.88	0.98	
							50RB Mid	0.47	0.69	0.78	
				21100	2535.0	Back Face	1RB Mid	0.55	0.28	0.32	
							50RB Mid	0.56	0.23	0.26	
						Right Edge	1RB Mid	0.55	0.14	0.16	
							50RB Mid	0.56	0.11	0.12	
				Top edge	1RB Mid	0.55	0.88	1.00			
					50RB Mid	0.56	0.70	0.80			
	21350	2560.0	Top edge	1RB Mid	0.60	0.83	0.96				
				50RB Mid	0.59	0.70	0.80				
	Aux 8	20	QPSK	20850	2510.0	Top edge	1RB Mid	0.20	1.18	1.24	6
							50RB Mid	0.14	0.90	0.93	
				21100	2535.0	Back Face	1RB Mid	0.30	0.30	0.09	
							50RB Mid	0.26	0.26	0.07	
						Top edge	1RB Mid	0.30	1.10	1.18	
							50RB Mid	0.26	0.85	0.90	
100RB Mid				0.27	0.82	0.87					
				21350	2560.0	Top edge	1RB Mid	0.31	0.98	1.05	
50RB Mid	0.31	0.76	0.81								

UL CA 7C

UL CA shall be tested based on the worst-case SAR configuration determined from non-CA SAR testing result. The channel BW, channel number, RB allocation, etc. would be selected to allow contiguous CA of PCC and SCC. Uplink output power for UL CA is the total power measured across the PCC and SCC.

From the above table on standalone testing on LTE Band7, Top Edge position with low channel is chosen as the configuration that gives the highest SAR, thus, the same is used for UL CA testing

Band	Antenna	Modulation / BW	PCC			SCC			Position	Scaling Factor (dB)	Measured SAR 1g (W/Kg)	Reported SAR 1g (W/Kg)
			Ch	Freq (MHz)	RB Allocation	Ch	Freq (MHz)	RB Allocation				
LTE 7	Ant5	QPSK / 20MHz	20850	2510	1RB High	21100	2535	1RB Low	Top Edge	0.08	0.24	0.25
	Ant8		20850	2510	1RB High	21100	2535	1RB Low		0.88	0.13	0.15

PCC RB allocation settings for UL CA has been adjusted based on the worst-case power

LTE Band 7 for UL CA 7A Inter-band and ENDC

Band	Ant	BW (MHz)	Mod.	Channel Number	Freq (MHz)	Position	% RB Allocation	Scaling Factor (dB)	Measured SAR 1g (W/Kg)	Reported SAR 1g (W/Kg)
Band 7	Aux 8	20	QPSK	20525	2535.0	Top edge	1RB Mid	0.30	0.78	0.83

B.5.2.4 LTE Band 12 FDD

Band	Ant	BW (MHz)	Mod.	Channel Number	Freq (MHz)	Position	% RB Allocation	Scaling Factor (dB)	Measured SAR 1g (W/kg)	Reported SAR 1g (W/kg)	Plot #
Band 12	Main 5	10	QPSK	23095	707.5	Back Face	1RB Mid	0.67	0.06	0.07	
							50RB Mid	0.72	0.05	0.06	
						Right Edge	1RB Mid	0.67	0.02	0.02	
							50RB Mid	0.72	0.01	0.02	
						Top edge	1RB Mid	0.67	0.62	0.72	7
							50RB Mid	0.72	0.47	0.56	

LTE Band 12 for UL CA 12A Inter-band and ENDC

Band	Ant	BW (MHz)	Mod.	Channel Number	Freq (MHz)	Position	% RB Allocation	Scaling Factor (dB)	Measured SAR 1g (W/Kg)	Reported SAR 1g (W/Kg)
Band 12A	Main 5	10	QPSK	23095	707.5	Top edge	1RB Mid	0.67	0.22	0.25

B.5.2.5 LTE Band 13 FDD

Band	Ant	BW (MHz)	Mod.	Channel Number	Freq (MHz)	Position	% RB Allocation	Scaling Factor (dB)	Measured SAR 1g (W/kg)	Reported SAR 1g (W/kg)	Plot #
Band 13	Main 5	10	QPSK	23230	782	Back Face	1RB Mid	0.62	0.10	0.12	
							50RB Mid	0.72	0.08	0.10	
						Right Edge	1RB Mid	0.62	0.05	0.05	
							50RB Mid	0.72	0.04	0.04	
						Top edge	1RB Mid	0.62	0.62	0.71	8
							50RB Mid	0.72	0.48	0.56	

LTE Band 13 for UL CA 13A Inter-band and ENDC

Band	Ant	BW (MHz)	Mod.	Channel Number	Freq (MHz)	Position	% RB Allocation	Scaling Factor (dB)	Measured SAR 1g (W/Kg)	Reported SAR 1g (W/Kg)
Band 13A	Main 5	10	QPSK	23230	782	Top edge	1RB Mid	0.62	0.29	0.34

B.5.2.6 LTE Band 14 FDD

Band	Ant	BW (MHz)	Mod.	Channel Number	Freq (MHz)	Position	% RB Allocation	Scaling Factor (dB)	Measured SAR 1g (W/kg)	Reported SAR 1g (W/kg)	Plot #
Band 14	Main 5	10	QPSK	23330	793	Back Face	1RB Mid	0.69	0.10	0.11	
							50RB Mid	0.74	0.08	0.09	
						Right Edge	1RB Mid	0.69	0.05	0.06	
							50RB Mid	0.74	0.04	0.05	
						Top edge	1RB Mid	0.69	0.62	0.73	9
							50RB Mid	0.74	0.49	0.58	

LTE Band 14 for UL CA 14A Inter-band and ENDC

Band	Ant	BW (MHz)	Mod.	Channel Number	Freq (MHz)	Position	% RB Allocation	Scaling Factor (dB)	Measured SAR 1g (W/Kg)	Reported SAR 1g (W/Kg)
Band 14A	Main 5	10	QPSK	23330	793	Top edge	1RB Mid	0.69	0.28	0.32

B.5.2.7 LTE Band 25 FDD

Band	Ant	BW (MHz)	Mod.	Channel Number	Freq (MHz)	Position	% RB Allocation	Scaling Factor (dB)	Measured SAR 1g (W/kg)	Reported SAR 1g (W/kg)	Plot #
Band 25	Main 5	20	QPSK	26365	1882.5	Back Face	1RB Mid	0.95	0.03	0.03	
							50RB Mid	0.86	0.02	0.03	
						Right Edge	1RB Mid	0.95	0.04	0.05	
							50RB Mid	0.86	0.03	0.04	
						Top edge	1RB Mid	0.95	0.43	0.54	
							50RB Mid	0.86	0.37	0.46	
	Aux 8	20	QPSK	26140	1860	Top edge	1RB Mid	0.73	0.97	1.15	
							50RB Mid	0.69	0.82	0.96	
				26365	1882.5	Back Face	1RB Mid	0.62	0.44	0.51	
							50RB Mid	0.57	0.03	0.04	
				26365	1882.5	Top edge	1RB Mid	0.62	1.14	1.31	
							50RB Mid	0.57	0.93	1.06	
							100RB Mid	0.53	0.86	0.97	
				26590	1905	Top Edge	1RB Mid	0.54	1.25	1.42	10
50RB Mid	0.56	0.96	1.09								

LTE Band 25 for UL CA 25A Inter-band and ENDC

Band	Ant	BW (MHz)	Mod.	Channel Number	Freq (MHz)	Position	% RB Allocation	Scaling Factor (dB)	Measured SAR 1g (W/Kg)	Reported SAR 1g (W/Kg)
Band 25A	Main 5	20	QPSK	26590	1905	Top edge	1RB Mid	0.95	0.29	0.36
	Aux 8	20	QPSK	26590	1905	Top edge	1RB Mid	0.54	0.47	0.53

B.5.2.8 LTE Band 26 FDD

Band	Ant	BW (MHz)	Mod.	Channel Number	Freq (MHz)	Position	% RB Allocation	Scaling Factor (dB)	Measured SAR 1g (W/kg)	Reported SAR 1g (W/kg)	Plot #
Band 26	Main 5	15	QPSK	26775	821.5	Top edge	1RB Mid	1.19	0.66	0.86	11
							50RB Mid	1.17	0.60	0.79	
				26865	831.5	Back Face	1RB Mid	1.20	0.08	0.11	
							50RB Mid	1.17	0.07	0.09	
						Right Edge	1RB Mid	1.20	0.05	0.06	
							50RB Mid	1.17	0.04	0.05	
				26965	841.5	Top edge	1RB Mid	1.10	0.64	0.83	
							50RB Mid	1.19	0.51	0.67	
							100RB Mid	1.16	0.50	0.66	
				26965	841.5	Top edge	1RB Mid	1.20	0.59	0.78	
							50RB Mid	1.21	0.48	0.63	

LTE Band 26 for UL CA 26A Inter-band and ENDC

Band	Ant	BW (MHz)	Mod.	Channel Number	Freq (MHz)	Position	% RB Allocation	Scaling Factor (dB)	Measured SAR 1g (W/Kg)	Reported SAR 1g (W/Kg)
Band 26A	Main 5	20	QPSK	26775	821.5	Top edge	1RB Mid	1.19	0.27	0.36

B.5.2.9 LTE Band 30 FDD

Band	Ant	BW (MHz)	Mod.	Channel Number	Freq (MHz)	Position	% RB Allocation	Scaling Factor (dB)	Measured SAR 1g (W/kg)	Reported SAR 1g (W/kg)	Plot #
Band 30	Main 5	10	QPSK	27710	2310	Back Face	1RB Mid	0.55	0.05	0.05	
							50RB Mid	0.56	0.04	0.04	
						Right Edge	1RB Mid	0.55	0.07	0.08	
							50RB Mid	0.56	0.05	0.06	
						Top edge	1RB Mid	0.55	0.27	0.31	
							50RB Mid	0.56	0.21	0.24	
	Aux 8	10	QPSK	27710	2310	Back Face	1RB Mid	0.77	0.12	0.14	
							50RB Mid	0.83	0.09	0.11	
						Top edge	1RB Mid	0.77	0.83	0.99	12
							50RB Mid	0.83	0.65	0.78	
100RB Mid	0.72	0.66	0.78								

LTE Band 30 for UL CA 30A Inter-band and ENDC

Band	Ant	BW (MHz)	Mod.	Channel Number	Freq (MHz)	Position	% RB Allocation	Scaling Factor (dB)	Measured SAR 1g (W/Kg)	Reported SAR 1g (W/Kg)
Band 30A	Aux 8	10	QPSK	27710	2310	Top edge	1RB Mid	0.77	0.14	0.17

B.5.2.10 LTE Band 38 TDD

Band	Ant	BW (MHz)	Mod.	Channel Number	Freq (MHz)	Position	% RB Allocation	Scaling Factor (dB)	Measured SAR 1g (W/kg)	Reported SAR 1g (W/kg)	Plot #
Band 38	Main 5	20	QPSK	37850	2580	Top edge	1RB Mid	0.08	0.96	0.97	
							50RB Mid	0.07	0.76	0.77	
				38000	2595	Back Face	1RB Mid	0.04	0.08	0.08	
							50RB Mid	0.00	0.06	0.06	
						Right Edge	1RB Mid	0.04	0.06	0.06	
							50RB Mid	0.00	0.05	0.05	
				38150	2610	Top edge	1RB Mid	0.04	0.75	0.76	
							50RB Mid	0.00	0.76	0.76	
							100RB Mid	0.08	0.74	0.76	
				38150	2610	Top edge	1RB Mid	0.08	0.98	1.00	13
							50RB Mid	0.10	0.78	0.80	

UL CA 38C

UL CA shall be tested based on the worst-case SAR configuration determined from non-CA SAR testing result. The channel BW, channel number, RB allocation, etc. would be selected to allow contiguous CA of PCC and SCC. Uplink output power for UL CA is the total power measured across the PCC and SCC.

From the above table on standalone testing on LTE Band38, Top Edge position was chosen as the configuration that give the highest SAR, thus, the same is used for UL CA testing

Band	Antenna	Modulation / BW	PCC			SCC			Position	Scaling Factor (dB)	Measured SAR 1g (W/Kg)	Reported SAR 1g (W/Kg)
			Ch	Freq (MHz)	RB Allocation	Ch	Freq (MHz)	RB Allocation				
LTE 38	Main 5	QPSK / 20MHz	37901	2585.1	1RB High	38099	2604.9	1RB Low	Top Edge	0.76	0.41	0.48

PCC RB allocation settings for UL CA have been adjusted based on the worst-case power

B.5.2.11 LTE Band 41 TDD

Band	Ant	BW (MHz)	Mod.	Channel Number	Freq (MHz)	Position	% RB Allocation	Scaling Factor (dB)	Measured SAR 1g (W/kg)	Reported SAR 1g (W/kg)	Plot #
Band 41	Main 5	20	QPSK	40620	2593	Back Face	1RB Mid	0.99	0.02	0.02	
							50RB Mid	1.04	0.04	0.05	
						Right Edge	1RB Mid	0.99	0.05	0.07	
							50RB Mid	1.04	0.04	0.05	
	Top edge	1RB Mid	0.99	0.25	0.31						
		50RB Mid	1.04	0.19	0.25						
	Aux 8	20	QPSK	40620	2593	Back Face	1RB Mid	0.46	0.04	0.05	
							50RB Mid	0.53	0.04	0.04	
Top edge						1RB Mid	0.46	0.48	0.54	14	
						50RB Mid	0.53	0.39	0.44		

UL CA 41C

UL CA shall be tested based on the worst-case SAR configuration determined from non-CA SAR testing result. The channel BW, channel number, RB allocation, etc. would be selected to allow contiguous CA of PCC and SCC. Uplink output power for UL CA is the total power measured across the PCC and SCC.

From the above table on standalone testing on LTE Band41, Top Edge position on antenna8 was chosen as the configurations that give the highest SAR, thus, the same is used for UL CA testing

Band	Antenna	Modulation / BW	PCC			SCC			Position	Scaling Factor (dB)	Measured SAR 1g (W/Kg)	Reported SAR 1g (W/Kg)
			Ch	Freq (MHz)	RB Allocation	Ch	Freq (MHz)	RB Allocation				
LTE 41	Ant8	QPSK / 20MHz	40185	2549.5	1RB High	40620	2593	1RB Low	Top Edge	0.39	0.05	0.05

PCC RB allocation settings for UL CA has been adjusted based on the worst-case power

LTE Band 41 for UL CA 41A Inter-band and ENDC

Band	Ant	BW (MHz)	Mod.	Channel Number	Freq (MHz)	Position	% RB Allocation	Scaling Factor (dB)	Measured SAR 1g (W/Kg)	Reported SAR 1g (W/Kg)
Band 41	Aux 8	20	QPSK	40620	2593	Top edge	1RB Mid	0.46	0.12	0.14

B.5.2.12 LTE Band 48 TDD

Band	Ant	BW (MHz)	Mod.	Channel Number	Freq (MHz)	Position	% RB Allocation	Scaling Factor (dB)	Measured SAR 1g (W/kg)	Reported SAR 1g (W/kg)	Plot #
Band 48	Aux 8	20	QPSK	55340	3560	Top edge	1RB Mid	0.78	0.86	1.03	
							50RB Mid	0.76	0.68	0.81	
				55990	3625	Back Face	1RB Mid	0.55	0.02	0.03	
							50RB Mid	0.49	0.02	0.02	
						Top edge	1RB Mid	0.55	1.21	1.37	15
							50RB Mid	0.49	0.89	1.00	
							100RB Mid	0.50	0.89	1.00	
							56640	3690	Top edge	1RB Mid	0.74
				50RB Mid	0.69	0.79	0.92				

UL CA 48C

UL CA shall be tested based on the worst-case SAR configuration determined from non-CA SAR testing result. The channel BW, channel number, RB allocation, etc. would be selected to allow contiguous CA of PCC and SCC. Uplink output power for UL CA is the total power measured across the PCC and SCC.

From the above table on standalone testing on LTE Band48, Top Edge position on antenna 8 was chosen as the configurations that give the highest SAR, thus, the same is used for UL CA testing

Band	Antenna	Modulation / BW	PCC			SCC			Position	Scaling Factor (dB)	Measured SAR 1g (W/kg)	Reported SAR 1g (W/kg)
			Ch	Freq (MHz)	RB Allocation	Ch	Freq (MHz)	RB Allocation				
LTE 48C	Aux 8	QPSK / 20MHz	55891	3615.1	1RB High	56089	3634.9	1RB Low	Top Edge	0.06	0.13	0.13

PCC RB allocation settings for UL CA have been adjusted based on the worst-case power

LTE Band 48 for UL CA 48 Inter-band and ENDC

Band	Ant	BW (MHz)	Mod.	Channel Number	Freq (MHz)	Position	% RB Allocation	Scaling Factor (dB)	Measured SAR 1g (W/Kg)	Reported SAR 1g (W/Kg)
Band 48	Aux 8	20	QPSK	55990	3625	Top edge	1RB Mid	0.55	0.25	0.28

B.5.2.13 LTE Band 66 FDD

Band	Ant	BW (MHz)	Mod.	Channel Number	Freq (MHz)	Position	% RB Allocation	Scaling Factor (dB)	Measured SAR 1g (W/kg)	Reported SAR 1g (W/kg)	Plot #
Band 66	Main 5	20	QPSK	132322	1745	Back Face	1RB Mid	0.82	0.13	0.16	
							50RB Mid	0.78	0.11	0.13	
						Right Edge	1RB Mid	0.82	0.18	0.22	
							50RB Mid	0.78	0.14	0.17	
						Top edge	1RB Mid	0.82	0.66	0.79	
							50RB Mid	0.78	0.52	0.63	
	Aux 8	20	QPSK	132072	1720	Top edge	1RB Mid	0.44	0.75	0.83	16
							50RB Mid	0.44	0.58	0.64	
				132322	1745	Back Face	1RB Mid	0.59	0.13	0.15	
							50RB Mid	0.48	0.10	0.12	
				Top edge	1RB Mid	0.59	0.72	0.82			
					50RB Mid	0.48	0.54	0.60			
				132572	1770	Top edge	100RB Mid	0.48	0.53	0.59	
							1RB Mid	0.46	0.74	0.82	
50RB Mid	0.45	0.56	0.62								

UL CA 66B, 66C

UL CA shall be tested based on the worst-case SAR configuration determined from non-CA SAR testing result. The channel BW, channel number, RB allocation, etc. would be selected to allow contiguous CA of PCC and SCC. Uplink output power for UL CA is the total power measured across the PCC and SCC.

From the above table on standalone testing on LTE Band66, Top Edge position in the low channel was chosen as the configurations that gives the highest SAR, thus, the same is used for UL CA testing for the 66C mode. Since the 10MHz was not tested in standalone, due to KDB 941225 reduction list, the initial configuration for the 66B mode was taken from the worst-case scenario of the 20MHz

Band	Antenna	Modulation / BW	PCC			SCC			Position	Scaling Factor (dB)	Measured SAR 1g (W/Kg)	Reported SAR 1g (W/Kg)
			Ch	Freq (MHz)	RB Allocation	Ch	Freq (MHz)	RB Allocation				
LTE 66 66B	Main5	QPSK / 10MHz	132022	1715.0	1RB High	132122	1725	1RB Low	Top Edge	0.81	0.53	0.64
	Aux 8		132022	1715.0	1RB High	132122	1725	1RB Low		0.97	0.52	0.64
LTE 66 66C	Ant5	QPSK / 20MHz	132072	1720.0	1RB High	132322	1745	1RB Low		0.61	0.10	0.12
	Aux 8		132072	1720.0	1RB High	132322	1745	1RB Low		0.02	0.10	0.10

PCC RB allocation settings for UL CA has been adjusted based on the worst-case power

LTE Band 66 for UL CA 66A Inter-band and ENDC

Band	Ant	BW (MHz)	Mod.	Channel Number	Freq (MHz)	Position	% RB Allocation	Scaling Factor (dB)	Measured SAR 1g (W/Kg)	Reported SAR 1g (W/Kg)
Band 66A	Aux 8	20	QPSK	132072	1720	Top edge	1RB Mid	0.59	0.35	0.40

B.5.3 5G NR

B.5.3.1 5G NR 2

NR Band 2 for ENDC

Band	Ant	BW (MHz)	Mod.	Channel Number	Freq (MHz)	Position	% RB Allocation	Scaling Factor (dB)	Measured SAR 1g (W/Kg)	Reported SAR 1g (W/Kg)
Band 2	Aux 8	20	QPSK	376000	1880	Top edge	1RB Mid	1.12	0.26	0.33

B.5.3.2 5G NR 5

Band	Antenna	Modulation / BW	Channel Number	Freq (MHz)	Test position mode	Position	% RB Allocation	Scaling Factor (dB)	Measured SAR 1g (W/Kg)	Reported SAR 1g (W/Kg)	Plot #
NR5	Main 5	QPSK / 20MHz	167300	836.5	Tablet	Back Face	1RB Mid	0.28	0.09	0.10	
							50RB Mid	0.20	0.09	0.10	
						Right edge	1RB Mid	0.28	0.08	0.08	
							50RB Mid	0.20	0.08	0.08	
						Top edge	1RB Mid	0.28	0.51	0.55	
							50RB Mid	0.20	0.53	0.55	17

B.5.3.3 5G NR 7

Band	Antenna	Modulation / BW	Channel Number	Freq (MHz)	Test position mode	Position	% RB Allocation	Scaling Factor (dB)	Measured SAR 1g (W/Kg)	Reported SAR 1g (W/Kg)	Plot #
NR7	Main 5	QPSK / 20MHz	507000	2535.0	Tablet	Back Face	1RB Mid	0.48	0.05	0.06	
							50RB Mid	0.42	0.05	0.06	
						Right edge	1RB Mid	0.48	0.06	0.07	
							50RB Mid	0.42	0.06	0.07	
						Top edge	1RB Mid	0.48	0.52	0.58	
							50RB Mid	0.42	0.53	0.58	18

B.5.3.4 5G NR 25

Band	Antenna	Modulation / BW	Channel Number	Freq (MHz)	Test position mode	Position	% RB Allocation	Scaling Factor (dB)	Measured SAR 1g (W/Kg)	Reported SAR 1g (W/Kg)	Plot #
NR25	Main 5	QPSK / 20MHz	376500	1882.5	Tablet	Back Face	1RB Mid	0.46	0.03	0.03	
							50RB Mid	0.64	0.03	0.03	
						Right edge	1RB Mid	0.46	0.09	0.10	
							50RB Mid	0.64	0.09	0.10	
						Top edge	1RB Mid	0.46	0.45	0.50	
							50RB Mid	0.64	0.44	0.51	19

B.5.3.5 5G NR 30

Band	Antenna	Modulation / BW	Channel Number	Freq (MHz)	Test position mode	Position	% RB Allocation	Scaling Factor (dB)	Measured SAR 1g (W/Kg)	Reported SAR 1g (W/Kg)	Plot #
NR30	Main 5	QPSK / 10MHz	462000	2310.0	Tablet	Back Face	1RB Mid	1.21	0.04	0.06	
							50RB Mid	1.26	0.04	0.06	
						Right edge	1RB Mid	1.21	0.07	0.10	
							50RB Mid	1.26	0.07	0.10	
						Top edge	1RB Mid	1.21	0.66	0.87	
							50RB Mid	1.26	0.68	0.90	20
	100RB Low	1.38	0.66	0.90							

B.5.3.6 5G NR 38

Band	Antenna	Modulation / BW	Channel Number	Freq (MHz)	Test position mode	Position	% RB Allocation	Scaling Factor (dB)	Measured SAR 1g (W/Kg)	Reported SAR 1g (W/Kg)	Plot #
NR38	Main 5	QPSK / 40MHz	38000	2595	Tablet	Back Face	1RB Mid	0.13	0.03	0.03	
							50RB Mid	0.09	0.06	0.06	
						Right edge	1RB Mid	0.13	0.07	0.08	
							50RB Mid	0.09	0.08	0.08	
	Top edge	1RB Mid	0.13	0.63	0.65						
		50RB Mid	0.09	0.64	0.65						
	Aux 8	QPSK / 40MHz	38000	2595	Tablet	Back Face	1RB Mid	0.51	0.07	0.08	
							50RB Mid	0.39	0.07	0.07	
Top edge						1RB Mid	0.51	0.78	0.87		
						50RB Mid	0.39	0.79	0.87	21	
	100RB Low	0.36	0.75	0.82							

B.5.3.7 5G NR 41

Band	Antenna	Modulation / BW	Channel Number	Freq (MHz)	Test position mode	Position	% RB Allocation	Scaling Factor (dB)	Measured SAR 1g (W/Kg)	Reported SAR 1g (W/Kg)	Plot #
NR41	Main 5	QPSK / 100MHz	518601	2593	Tablet	Back Face	1RB Mid	0.52	0.07	0.07	
							50RB Mid	0.08	0.07	0.07	
						Right edge	1RB Mid	0.52	0.06	0.07	
							50RB Mid	0.08	0.06	0.06	
						Top edge	1RB Mid	0.52	0.97	1.10	22
							50RB Mid	0.08	0.92	0.94	
	Aux 8	QPSK / 100MHz	518601	2593	Tablet	Back Face	1RB Mid	0.95	0.04	0.05	
							50RB Mid	0.59	0.04	0.05	
						Top edge	1RB Mid	0.95	0.29	0.36	
							50RB Mid	0.59	0.30	0.34	

NR Band 41 for ENDC

Band	Ant	BW (MHz)	Mod.	Channel Number	Freq (MHz)	Position	% RB Allocation	Scaling Factor (dB)	Measured SAR 1g (W/Kg)	Reported SAR 1g (W/Kg)
Band 41	Aux 8	100	QPSK	518600	2593	Top edge	1RB Mid	0.95	0.16	0.19
	Main 5							0.52	0.39	0.44

B.5.3.8 5G NR 66

Band	Antenna	Modulation / BW	Channel Number	Freq (MHz)	Test position mode	Position	% RB Allocation	Scaling Factor (dB)	Measured SAR 1g (W/Kg)	Reported SAR 1g (W/Kg)	Plot #
NR66	Main 5	QPSK / 40MHz	349000	1745.0	Tablet	Back Face	1RB Mid	0.00	0.09	0.09	
							50RB Mid	0.00	0.09	0.09	
						Right edge	1RB Mid	0.00	0.21	0.21	
							50RB Mid	0.00	0.20	0.20	
						Top edge	1RB Mid	0.00	0.83	0.83	23
							50RB Mid	0.00	0.82	0.82	
	Aux 8	QPSK / 40MHz	349000	1745.0	Tablet	Back Face	1RB Mid	0.42	0.10	0.11	
							50RB Mid	0.54	0.10	0.11	
						Top edge	1RB Mid	0.42	0.56	0.61	
							50RB Mid	0.54	0.55	0.63	

NR Band 66 for ENDC

Band	Ant	BW (MHz)	Mod.	Channel Number	Freq (MHz)	Position	% RB Allocation	Scaling Factor (dB)	Measured SAR 1g (W/Kg)	Reported SAR 1g (W/Kg)
Band 66	Aux 8	40	QPSK	349000	1745	Top edge	1RB Mid	0.42	0.53	0.58

B.5.3.9 5G NR 77

Band	Antenna	Modulation / BW	Channel Number	Freq (MHz)	Test position mode	Position	% RB Allocation	Scaling Factor (dB)	Measured SAR 1g (W/Kg)	Reported SAR 1g (W/Kg)	Plot #
NR77	Main 5	QPSK / 100MHz	650000	3750.0	Tablet	Back Face	1RB Mid	1.53	0.09	0.12	
							50RB Mid	1.25	0.07	0.09	
						Right edge	1RB Mid	1.53	0.05	0.07	
							50RB Mid	1.25	0.05	0.07	
	Top edge	1RB Mid	1.53	0.49	0.70						
		50RB Mid	1.25	0.51	0.67						
	Aux 8	QPSK / 100MHz	650000	3750.0	Tablet	Back Face	1RB Mid	1.18	0.08	0.10	
							50RB Mid	0.84	0.08	0.09	
Top edge						1RB Mid	1.18	0.74	0.97	24	
						50RB Mid	0.84	0.77	0.94		
100RB Low	0.95	0.75	0.93								

NR Band 77 for ENDC

Band	Ant	BW (MHz)	Mod.	Channel Number	Freq (MHz)	Position	% RB Allocation	Scaling Factor (dB)	Measured SAR 1g (W/Kg)	Reported SAR 1g (W/Kg)
Band 77	Aux 8	100	QPSK	656000	3750	Top edge	1RB Mid	1.18	0.35	0.46
	Main 5							1.53	0.20	0.29

B.5.3.10 5G NR 78

Band	Antenna	Modulation / BW	Channel Number	Freq (MHz)	Test position mode	Position	% RB Allocation	Scaling Factor (dB)	Measured SAR 1g (W/Kg)	Reported SAR 1g (W/Kg)	Plot #
NR78	Aux 8	QPSK / 100MHz	650000	3750.0	Tablet	Back Face	1RB Mid	0.42	0.08	0.09	
							50RB Mid	0.28	0.09	0.09	
						Top edge	1RB Mid	0.42	0.84	0.92	
							50RB Mid	0.28	0.89	0.94	
							100RB Low	0.49	0.87	0.98	25

NR Band 78 for ENDC

Band	Ant	BW (MHz)	Mod.	Channel Number	Freq (MHz)	Position	% RB Allocation	Scaling Factor (dB)	Measured SAR 1g (W/Kg)	Reported SAR 1g (W/Kg)
Band 78	Aux 8	100	QPSK	656000	3750	Top edge	1RB Mid	0.42	0.42	0.46

B.5.4 ENDC

For EN-DC mode, the 4G and 5G carriers transmit on separate antennas. Each exposure has been measured separately. For both LTE and 5G-NR, the highest standalone SAR conditions are added to derive the Total SAR. Refer to paragraph B.5.7

B.5.6 SAR Measurement Variability

According to FCC OET KDB 865664, SAR Measurement variability is assessed when the maximum initial measured SAR is ≥ 0.8 W/kg for a certain band/mode. If the measured SAR value of the initial repeated measurement is < 1.45 W/kg with $< 20\%$ variation, only one repeated measurement is required to confirm that the results are not expected to have substantial variations.

A second repeated measurement is required only if the measured results for the initial repeated measurement are within 10% of the SAR limit or vary by more than 20%.

A third repeated measurement is required only if the original, first or second repeated measurement ≥ 1.5 W/Kg and the ratio of largest to smallest SAR for the original, first and second repeated measurement is > 1.2 .

Band / Mode	Position	Ch #	Freq. (MHz)	Measured SAR 1g (W/kg)	1 st Repeated SAR 1g (W/Kg)	2 nd Repeated SAR 1g (W/Kg)	Highest Ratio
WCDMA V	Top Edge	4132	826.4	0.87	0.89		1.02
LTE 7	Top Edge	20850	2510.0	1.13	1.18		1.04
LTE 25	Top Edge	19150	1905.0	1.16	1.25		1.07
LTE 30	Top Edge	27710	2310.0	0.83	0.82		1.01
LTE 48	Top Edge	55990	3625.0	1.12	1.21		1.08
NR 66	Top Edge	349000	1745.0	0.83	0.83		1.00
NR 78	Top Edge	650000	3750.0	0.89	0.84		1.06

B.5.7 Simultaneous Transmission SAR Evaluation

According to FCC OET KDB 447498 D01, when the sum of 1g SAR for all simultaneously transmitting antennas in an operating mode and exposure condition combination is within the SAR limit, SAR test exclusion applies to that simultaneous transmission configuration.

As commented on sections 3 and 5, this report only evaluates SAR for cellular transmission on the module, nevertheless in order to consider all possible simultaneous transmissions on the device for compliance, WLAN SAR values reported on document [3] mentioned on section 3 are considered.

All the values stated in the table below are the worst case found for standalone measurement with disregard of the transmission mode or channel where the worst case was found

Antenna	Position	Highest Reported SAR (1g) (W/Kg)				
		WWAN		WLAN 2.4GHz	WLAN 5GHz	Bluetooth
Main WWAN	Top Edge	1.04**	0.44***			
	Back Face	0.32				
	Right Edge	0.22				
	Left Edge	0.40*				
Aux WWAN	Top Edge	1.42**	0.58***			
	Back Face	0.51				
	Right Edge	0.40*				
	Left Edge	0.40*				
Main WLAN	Top Edge			0.66	0.92	
	Back Face			0.06	0.31	
	Right Edge			0.40*	0.40*	
	Left Edge			0.21	0.26	
Aux WLAN	Top Edge			0.26	0.44	0.05
	Back Face			0.06	0.23	0.05
	Right Edge			0.40*	0.40*	0.40*
	Left Edge			0.40*	0.40*	0.40*

*According to FCC OET KDB 447498 D01, when standalone test exclusion is applied to an antenna that transmits simultaneously with other antennas, the standalone SAR must be estimated to 0.4 W/Kg for 1-g SAR when the test separation is > 50mm in order to determine simultaneous transmission test exclusion.

**Highest stand alone values.

***Highest ENDC/ULCA values.

Position	Simultaneous Tx Antenna Combination					Σ SAR 1g (W/Kg)	Limit (W/kg)
	#	Cellular - WWAN		Main WLAN	Aux WLAN		
		Ant 05	Ant 08				
Top Edge	1	Cellular	Cellular	WLAN 5/6GHz	WLAN 5/6GHz	2.38	1.6
	2	Cellular	Cellular	WLAN 5/6GHz	WLAN 5/6GHz+ BT	2.43	
	3	Cellular	Cellular	WLAN 5/6GHz	BT	1.99	
	4	Cellular	Cellular	WLAN 2.4GHz	WLAN 2.4GHz	1.94	
	5	Cellular	Cellular	WLAN 2.4GHz	BT	1.73	
Back Face	1	Cellular	Cellular	WLAN 5/6GHz	WLAN 5/6GHz	1.37	
	2	Cellular	Cellular	WLAN 5/6GHz	WLAN 5/6GHz+ BT	1.42	
	3	Cellular	Cellular	WLAN 5/6GHz	BT	1.19	
	4	Cellular	Cellular	WLAN 2.4GHz	WLAN 2.4GHz	0.95	
	5	Cellular	Cellular	WLAN 2.4GHz	BT	0.94	
Right Edge	1	Cellular	Cellular	WLAN 5/6GHz	WLAN 5/6GHz	1.42	
	2	Cellular	Cellular	WLAN 5/6GHz	WLAN 5/6GHz+ BT	1.82	
	3	Cellular	Cellular	WLAN 5/6GHz	BT	1.42	
	4	Cellular	Cellular	WLAN 2.4GHz	WLAN 2.4GHz	1.42	
	5	Cellular	Cellular	WLAN 2.4GHz	BT	1.42	
Left Edge	1	Cellular	Cellular	WLAN 5/6GHz	WLAN 5/6GHz	1.46	
	2	Cellular	Cellular	WLAN 5/6GHz	WLAN 5/6GHz+ BT	1.86	
	3	Cellular	Cellular	WLAN 5/6GHz	BT	1.46	
	4	Cellular	Cellular	WLAN 2.4GHz	WLAN 2.4GHz	1.41	
	5	Cellular	Cellular	WLAN 2.4GHz	BT	1.41	

In case the sum of SAR is larger than the limit, SAR test exclusion is determined by the SAR to peak location separation ratio. According to the last table possible simultaneous transmission combinations are identified for each position from 1 to 5, each combination will be analyzed by antenna pairs. Antenna pairs considered in one configuration won't be performed again in case they are repeated on the next simultaneous configuration:

Position	Ant. Pair case	Antenna	Reported SAR 1g (W/kg)	Σ SAR 1g (W/Kg)	Peak Location (mm) (x,y,z)	SAR to peak location separation ratio	Limit
Top Edge	1a	WWAN (Main 5)	0.44	1.02			0.04
		WWAN (Aux 8)	0.58				
	1b	WWAN (Main 5)	1.04	1.96	(-0.5; 81.0; -177.0)	0.01	
		Main WLAN 5/6GHz	0.92		(2.6; -128.1; -177.0)		
	1c	WWAN (Main 5)	1.04	1.48			
		Aux WLAN 5/6GHz	0.44				
	1d	WWAN (Aux 8)	1.42	2.34	(-9.0; 37.0; -177.0)	0.02	
		Main WLAN 5/6GHz	0.92		(2.6; -128.1; -177.0)		
	1e	WWAN (Aux 8)	1.42	1.86	(-9.0; 37.0; -177.0)	0.03	
		Aux WLAN 5/6GHz	0.44		(2.6; -42.8; -177.0)		
	1f	Main WLAN 5/6GHz	0.92	1.36			
		Aux WLAN 5/6GHz	0.44				
	2a	WWAN (Main 5)	1.04	1.09			
		Aux WLAN1 BT	0.05				
	2b	WWAN (Aux 8)	1.42	1.47			
		Aux WLAN1 BT	0.05				
	4a	WWAN (Main 5)	1.04	1.70	(-0.5; 81.0; -177.0)	0.01	
		Main WLAN 2.4GHz	0.66		(1.8; -131.3; -177.0)		
	4b	WWAN (Main 5)	1.04	1.30			
		Aux WLAN 2.4GHz	0.26				
4c	WWAN (Aux 8)	1.42	2.08	(-9.0; 37.0; -177.0)	0.02		
	Main WLAN 2.4GHz	0.66		(1.8; -131.3; -177.0)			
4d	WWAN (Aux 8)	1.42	1.68	(-9.0; 37.0; -177.0)	0.02		
	Aux WLAN 2.4GHz	0.26		(2.5; -85.0; -177.0)			
4e	Main WLAN 2.4GHz	0.66	0.92				
	Aux WLAN1 2.4GHz	0.26					

Position	Ant. Pair case	Antenna	Reported SAR 1g (W/kg)	Σ SAR 1g (W/Kg)	Peak Location (mm) (x,y,z)	SAR to peak location separation ratio	Limit
Right Edge	1a	WWAN (Main 5)	0.22	0.62			0.04
		WWAN (Aux 8)	0.40				
	1b	WWAN (Main 5)	0.22	0.62			
		Main WLAN 5/6GHz	0.40				
	1c	WWAN (Main 5)	0.22	0.62			
		Aux WLAN 5/6GHz	0.40				
	1d	WWAN (Aux 8)	0.40	0.80			
		Main WLAN 5/6GHz	0.40				
	1e	WWAN (Aux 8)	0.40	0.80			
		Aux WLAN 5/6GHz	0.40				
	1f	Main WLAN 5/6GHz	0.40	0.80			
		Aux WLAN 5/6GHz	0.40				
	2a	WWAN (Main 5)	0.22	0.62			
		Aux WLAN1 BT	0.40				
	2b	WWAN (Aux 8)	0.40	0.80			
		Aux WLAN1 BT	0.40				
	4a	WWAN (Main 5)	0.22	0.62			
		Main WLAN 2.4GHz	0.40				
	4b	WWAN (Main 5)	0.22	0.62			
		Aux WLAN 2.4GHz	0.40				
4c	WWAN (Aux 8)	0.40	0.80				
	Main WLAN 2.4GHz	0.40					
4d	WWAN (Aux 8)	0.40	0.80				
	Aux WLAN 2.4GHz	0.40					
4e	Main WLAN 2.4GHz	0.40	0.80				
	Aux WLAN1 2.4GHz	0.40					

Position	Ant. Pair case	Antenna	Reported SAR 1g (W/kg)	Σ SAR 1g (W/Kg)	Peak Location (mm) (x,y,z)	SAR to peak location separation ratio	Limit
Left Edge	1a	WWAN (Main 5)	0.40	0.80			0.04
		WWAN (Aux 8)	0.40				
	1b	WWAN (Main 5)	0.40	0.66			
		Main WLAN 5/6GHz	0.26				
	1c	WWAN (Main 5)	0.40	0.80			
		Aux WLAN 5/6GHz	0.40				
	1d	WWAN (Aux 8)	0.40	0.66			
		Main WLAN 5/6GHz	0.26				
	1e	WWAN (Aux 8)	0.40	0.80			
		Aux WLAN 5/6GHz	0.40				
	1f	Main WLAN 5/6GHz	0.26	0.66			
		Aux WLAN 5/6GHz	0.40				
	2a	WWAN (Main 5)	0.40	0.80			
		Aux WLAN1 BT	0.40				
	2b	WWAN (Aux 8)	0.40	0.80			
		Aux WLAN1 BT	0.40				
	4a	WWAN (Main 5)	0.40	0.61			
		Main WLAN 2.4GHz	0.21				
	4b	WWAN (Main 5)	0.40	0.80			
		Aux WLAN 2.4GHz	0.40				
4c	WWAN (Aux 8)	0.40	0.61				
	Main WLAN 2.4GHz	0.21					
4d	WWAN (Aux 8)	0.40	0.80				
	Aux WLAN 2.4GHz	0.40					
4e	Main WLAN 2.4GHz	0.21	0.61				
	Aux WLAN1 2.4GHz	0.40					

Annex C. Test System Plots

1. WCDMA FDD II, 12.2kbps RMC, CH9400, Top Edge.....	110
2. WCDMA FDD IV, 12.2kbps RMC, CH1762, Top Edge	111
3. WCDMA FDD V, 12.2kbps RMC, CH4132, Top edge.....	112
4. LTE Band 2, QPSK - 10MHz, CH18900, Top Edge	113
5. LTE Band 5, QPSK - 20MHz, CH20525, Top Edge	114
6. LTE Band 7, QPSK - 20MHz, CH20850, Top Edge	115
7. LTE Band 12, QPSK - 10MHz, CH23095, Top Edge	116
8. LTE Band 13, QPSK - 10MHz, CH23230, Top edge.....	117
9. LTE Band 14, QPSK - 10MHz, CH23330, Top edge.....	118
10. LTE Band 25, QPSK - 20MHz, CH26590, Top Edge.....	119
11. LTE Band 26, QPSK - 15MHz, CH26775, Top Edge.....	120
12. LTE Band 30, QPSK - 10MHz, CH27710, Top Edge.....	121
13. LTE Band 38, QPSK - 20MHz, CH38150, Top Edge.....	122
14. LTE Band 41, QPSK - 20MHz, CH40620, Top Edge.....	123
15. LTE Band 48, QPSK - 20MHz, CH55990, Top Edge.....	124
16. LTE Band 66, QPSK - 20MHz, CH132072, Top Edge.....	125
17. 5G NR FR1 Band 5, QPSK - 20MHz, CH167300, Top Edge.....	126
18. 5G NR FR1 Band 7, QPSK - 20MHz, CH507000, Top Edge.....	127
19. 5G NR FR1 Band 25, QPSK - 20MHz, CH376500, Top Edge.....	128
20. 5G NR FR1 Band 30, QPSK - 10MHz, CH462000, Top Edge.....	129
21. 5G NR FR1 Band 38, QPSK - 40MHz, CH519000, Top Edge.....	130
22. 5G NR FR1 Band 41, QPSK - 100MHz, CH518601-Top Edge.....	131
23. 5G NR FR1 Band 66, QPSK - 100MHz, CH349000-Top Edge.....	132
24. 5G NR FR1 Band 77, QPSK - 100MHz, CH650000-Top Edge.....	133
25. 5G NR FR1 Band 78, QPSK - 100MHz, 650000-Top Edge.....	134
26. System Check Body Liquid 750MHz – 2021-12-13.....	135
27. System Check Body Liquid 835MHz – 2021-12-13.....	136
28. System Check Body Liquid 835MHz – 2021-12-10.....	137
30. System Check Body Liquid 1750MHz – 2022-01-18	139
31. System Check Body Liquid 1750MHz – 2021-12-13	140
32. System Check Body Liquid 1900MHz – 2021-12-13	141
33. System Check Body Liquid 1900MHz – 2021-12-10	142
34. System Check Body Liquid 2300MHz – 2021-12-13	143
35. System Check Body Liquid 2300MHz – 2021-12-10	144
36. System Check Body Liquid 2600MHz – 2021-12-15	145
37. System Check Body Liquid 2600MHz – 2021-12-13	146
38. System Check Body Liquid 3700MHz – 2021-12-13	147
39. System Check Body Liquid 3700MHz – 2021-12-10	148

1. WCDMA FDD II, 12.2kbps RMC, CH9400, Top Edge

Device under Test Properties

Name, Manufacturer	Dimensions [mm]	S/N	DUT Type
HSN-I45C	215.0 x 300.0 x 17.0	0001760BC4	Convertible PC

Exposure Conditions

Phantom Section, TSL	Position, Test Distance [mm]	Band	Group, UID	Frequency [MHz], Channel Number	Conversion Factor	TSL Conductivity [S/m]	TSL Permittivity
Flat MSL	EDGE TOP 0.00	Band2, UTRA/FDD	WCDMA10011CAB	1880.0 9400	7.98	1.51	50.5

Hardware Setup

Phantom	TSL, Measured Date	Probe, Calibration Date	DAE, Calibration Date
ELI V8.0 (20deg probe tilt) - xxxx	MBBL-600-6000 , 2021-Dec-13	EX3DV4 - SN3978, 2021-05-21	DAE4 Sn1429, 2021-05-11

Scan Setup

	Area Scan	Zoom Scan
Grid Extents [mm]	60.0 x 330.0	30.0 x 30.0 x 30.0
Grid Steps [mm]	15.0 x 15.0	5.4 x 5.4 x 1.5
Sensor Surface [mm]	3.0	1.4
Graded Grid	Yes	Yes
Grading Ratio	1.5	1.5
MAIA	Confirmed by MAIA	Confirmed by MAIA
Surface Detection	Yes	Yes
Scan Method	Measured	Measured

Measurement Results

	Area Scan	Zoom Scan
Date	2021-12-13, 18:49	2021-12-13, 19:03
SAR1g [W/Kg]	0.564	0.602
SAR10g [W/Kg]	0.262	0.262
Power Drift [dB]	-0.01	-0.05
Power Scaling	Disabled	Disabled
Scaling Factor [dB]		
TSL Correction	Positive Only	Positive Only

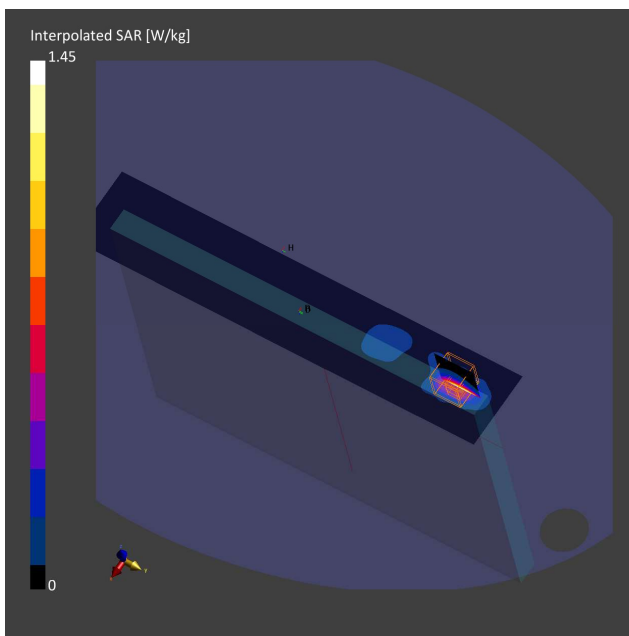

2. WCDMA FDD IV, 12.2kbps RMC, CH1762, Top Edge

Device under Test Properties

Name, Manufacturer	Dimensions [mm]	S/N	DUT Type
HSN-I45C	215.0 x 300.0 x 17.0	0001760BC4	Convertible PC

Exposure Conditions

Phantom Section, TSL	Position, Test Distance [mm]	Band	Group, UID	Frequency [MHz], Channel Number	Conversion Factor	TSL Conductivity [S/m]	TSL Permittivity
Flat MSL	EDGE TOP 0.00	Band 4, UTRA/FDD	WCDMA10011CAB	1732.5 1762	8.37	1.41	50.7

Hardware Setup

Phantom	TSL, Measured Date	Probe, Calibration Date	DAE, Calibration Date
ELI V8.0 (20deg probe tilt) - xxxx	MBBL-600-6000 , 2021-Dec-13	EX3DV4 - SN3978, 2021-05-21	DAE4 Sn1429, 2021-05-11

Scan Setup

	Area Scan	Zoom Scan
Grid Extents [mm]	60.0 x 330.0	30.0 x 30.0 x 30.0
Grid Steps [mm]	15.0 x 15.0	5.0 x 5.0 x 1.4
Sensor Surface [mm]	3.0	1.4
Graded Grid	Yes	Yes
Grading Ratio	1.5	1.4
MAIA	Confirmed by MAIA	Confirmed by MAIA
Surface Detection	Yes	Yes
Scan Method	Measured	Measured

Measurement Results

	Area Scan	Zoom Scan
Date	2021-12-13, 16:24	2021-12-13, 16:39
SAR1g [W/Kg]	0.506	0.612
SAR10g [W/Kg]	0.253	0.283
Power Drift [dB]	0.00	-0.07
Power Scaling	Disabled	Disabled
Scaling Factor [dB]		
TSL Correction	Positive Only	Positive Only

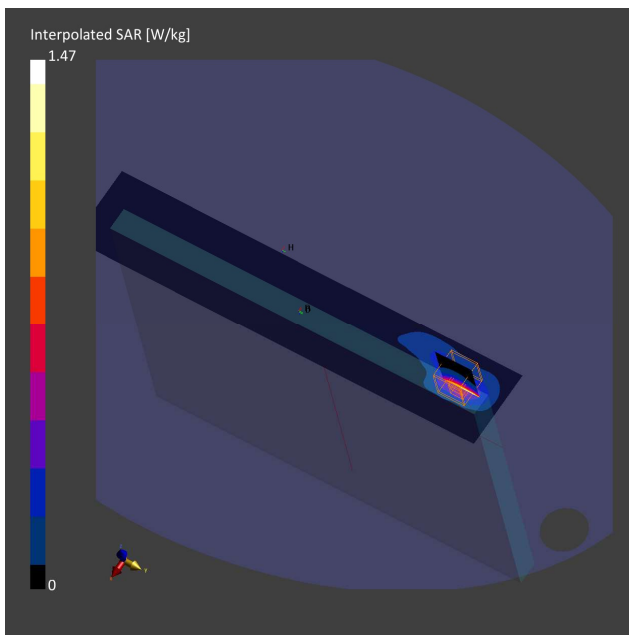

3. WCDMA FDD V, 12.2kbps RMC, CH4132, Top edge

Device under Test Properties

Name, Manufacturer	Dimensions [mm]	S/N	DUT Type
HSN-I45C	215.0 x 300.0 x 17.0	0001760BC4	Convertible PC

Exposure Conditions

Phantom Section, TSL	Position, Test Distance [mm]	Band	Group, UID	Frequency [MHz], Channel Number	Conversion Factor	TSL Conductivity [S/m]	TSL Permittivity
Flat MSL	EDGE TOP 0.00	Band 5, UTRA/FDD	WCDMA10011CAB	826.4 4132	9.32	0.97	51.9

Hardware Setup

Phantom	TSL, Measured Date	Probe, Calibration Date	DAE, Calibration Date
ELI V8.0 (20deg probe tilt) - xxxx	MBBL-600-6000 , 2021-Dec-13	EX3DV4 - SN3978, 2021-05-21	DAE4 Sn1429, 2021-05-11

Scan Setup

	Area Scan	Zoom Scan
Grid Extents [mm]	60.0 x 330.0	30.0 x 30.0 x 30.0
Grid Steps [mm]	15.0 x 15.0	6.0 x 6.0 x 1.5
Sensor Surface [mm]	3.0	1.4
Graded Grid	No	Yes
Grading Ratio	n/a	1.5
MAIA	Confirmed by MAIA	Confirmed by MAIA
Surface Detection	Yes	Yes
Scan Method	Measured	Measured

Measurement Results

	Area Scan	Zoom Scan
Date	2021-12-13, 21:41	2021-12-13, 21:53
SAR1g [W/Kg]	0.894	0.885
SAR10g [W/Kg]	0.530	0.471
Power Drift [dB]	-0.03	-0.04
Power Scaling	Disabled	Disabled
Scaling Factor [dB]		
TSL Correction	Positive Only	Positive Only

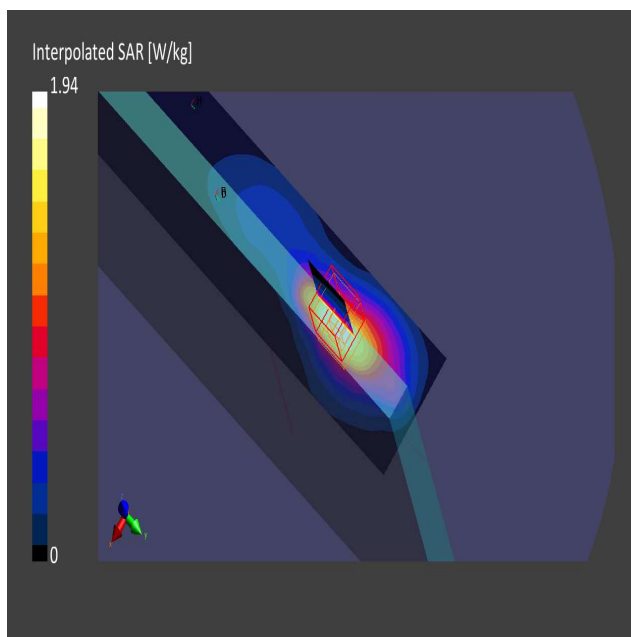

4. LTE Band 2, QPSK - 10MHz, CH18900, Top Edge

Device under Test Properties

Name, Manufacturer	Dimensions [mm]	WLAN / BT MAC	DUT Type
,	215.0 x 300.0 x 17.0	PLEASE MODIFY !!!	Laptop

Exposure Conditions

Phantom Section, TSL	Position, Test Distance [mm]	Band	Group, UID	Frequency [MHz], Channel Number	Conversion Factor	TSL Conductivity [S/m]	TSL Permittivity
Flat MSL	EDGE TOP 0.00	Band 2, E-UTRA/FDD	LTE-FDD10169CAE	1880.0 18900	7.98	1.51	50.5

Hardware Setup

Phantom	TSL, Measured Date	Probe, Calibration Date	DAE, Calibration Date
ELI V8.0 (20deg probe tilt) - xxxx	MBBL-600-6000 , 2021-Dec-13	EX3DV4 - SN3978, 2021-05-21	DAE4 Sn1429, 2021-05-11

Scan Setup

	Area Scan	Zoom Scan
Grid Extents [mm]	60.0 x 330.0	30.0 x 30.0 x 30.0
Grid Steps [mm]	15.0 x 15.0	4.9 x 4.9 x 1.4
Sensor Surface [mm]	3.0	1.4
Graded Grid	Yes	Yes
Grading Ratio	1.5	1.4
MAIA	Confirmed by MAIA	Confirmed by MAIA
Surface Detection	Yes	Yes
Scan Method	Measured	Measured

Measurement Results

	Area Scan	Zoom Scan
Date	2021-12-14, 08:02	2021-12-14, 08:20
SAR1g [W/Kg]	0.376	0.669
SAR10g [W/Kg]	0.208	0.285
Power Drift [dB]	-0.05	0.02
Power Scaling	Disabled	Disabled
Scaling Factor [dB]		
TSL Correction	Positive Only	Positive Only

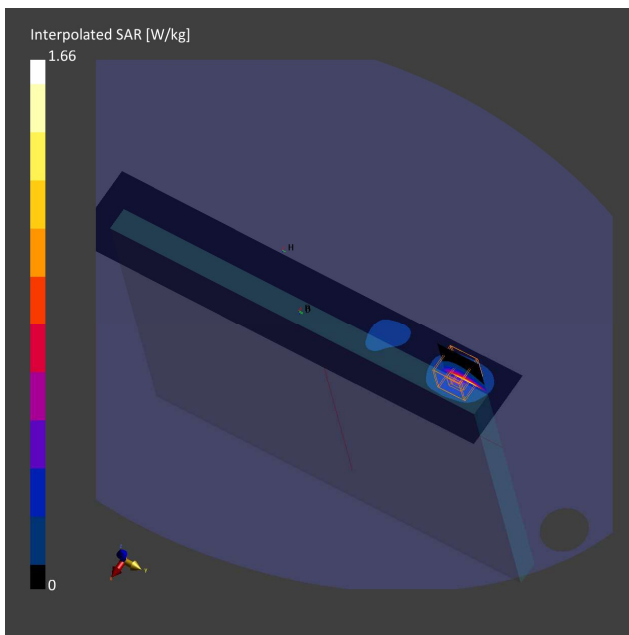

5. LTE Band 5, QPSK - 20MHz, CH20525, Top Edge

Device under Test Properties

Name, Manufacturer	Dimensions [mm]	WLAN / BT MAC	DUT Type
,	215.0 x 300.0 x 17.0	PLEASE MODIFY !!!	Laptop

Exposure Conditions

Phantom Section, TSL	Position, Test Distance [mm]	Band	Group, UID	Frequency [MHz], Channel Number	Conversion Factor	TSL Conductivity [S/m]	TSL Permittivity
Flat MSL	EDGE TOP 0.00	Band 5, E-UTRA/FDD	LTE-FDD10175CAG	836.5 20525	9.32	0.978	51.9

Hardware Setup

Phantom	TSL, Measured Date	Probe, Calibration Date	DAE, Calibration Date
ELI V8.0 (20deg probe tilt) - xxxx	MBBL-600-6000 , 2021-Dec-13	EX3DV4 - SN3978, 2021-05-21	DAE4 Sn1429, 2021-05-11

Scan Setup

	Area Scan	Zoom Scan
Grid Extents [mm]	60.0 x 330.0	30.0 x 30.0 x 30.0
Grid Steps [mm]	15.0 x 15.0	6.0 x 6.0 x 1.5
Sensor Surface [mm]	3.0	1.4
Graded Grid	Yes	Yes
Grading Ratio	1.5	1.5
MAIA	Confirmed by MAIA	Confirmed by MAIA
Surface Detection	Yes	Yes
Scan Method	Measured	Measured

Measurement Results

	Area Scan	Zoom Scan
Date	2021-12-13, 22:47	2021-12-13, 22:59
SAR1g [W/Kg]	0.743	0.792
SAR10g [W/Kg]	0.456	0.427
Power Drift [dB]	-0.08	-0.01
Power Scaling	Disabled	Disabled
Scaling Factor [dB]		
TSL Correction	Positive Only	Positive Only

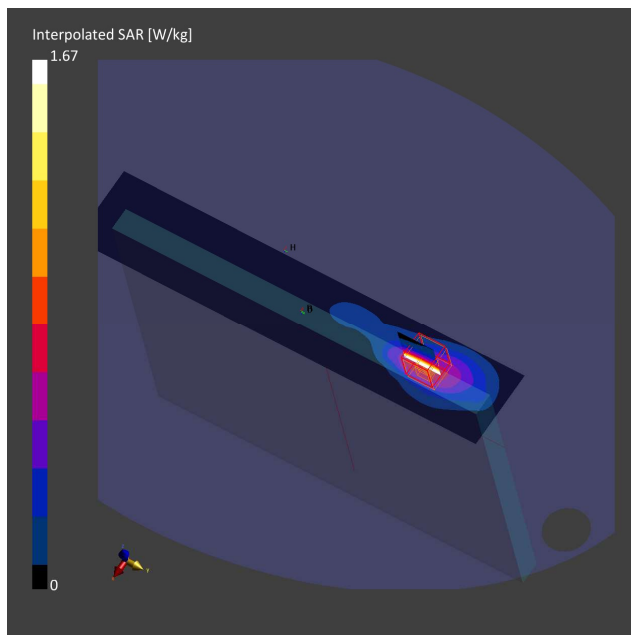

6. LTE Band 7, QPSK - 20MHz, CH20850, Top Edge

Device under Test Properties

Name, Manufacturer	Dimensions [mm]	S/N	DUT Type
HSN-I45C	215.0 x 300.0 x 17.0	0001760BC4	Convertible PC

Exposure Conditions

Phantom Section, TSL	Position, Test Distance [mm]	Band	Group, UID	Frequency [MHz], Channel Number	Conversion Factor	TSL Conductivity [S/m]	TSL Permittivity
Flat MSL	EDGE TOP 0.00	Band 7, E-UTRA/FDD	LTE-FDD10169CAE	2510.0 20850	7.24	2.03	49.7

Hardware Setup

Phantom	TSL, Measured Date	Probe, Calibration Date	DAE, Calibration Date
ELI V8.0 (20deg probe tilt) - xxxx	MBBL-600-6000 , 2021-Dec-13	EX3DV4 - SN3978, 2021-05-21	DAE4 Sn1429, 2021-05-11

Scan Setup

	Area Scan	Zoom Scan
Grid Extents [mm]	60.0 x 340.0	30.0 x 30.0 x 30.0
Grid Steps [mm]	10.0 x 10.0	4.0 x 4.0 x 1.4
Sensor Surface [mm]	3.0	1.4
Graded Grid	No	Yes
Grading Ratio	n/a	1.4
MAIA	Confirmed by MAIA	Confirmed by MAIA
Surface Detection	Yes	Yes
Scan Method	Measured	Measured

Measurement Results

	Area Scan	Zoom Scan
Date	2021-12-14, 17:48	2021-12-14, 18:00
SAR1g [W/Kg]	1.11	1.18
SAR10g [W/Kg]	0.466	0.458
Power Drift [dB]	0.07	0.02
Power Scaling	Disabled	Disabled
Scaling Factor [dB]		
TSL Correction	Positive Only	Positive Only

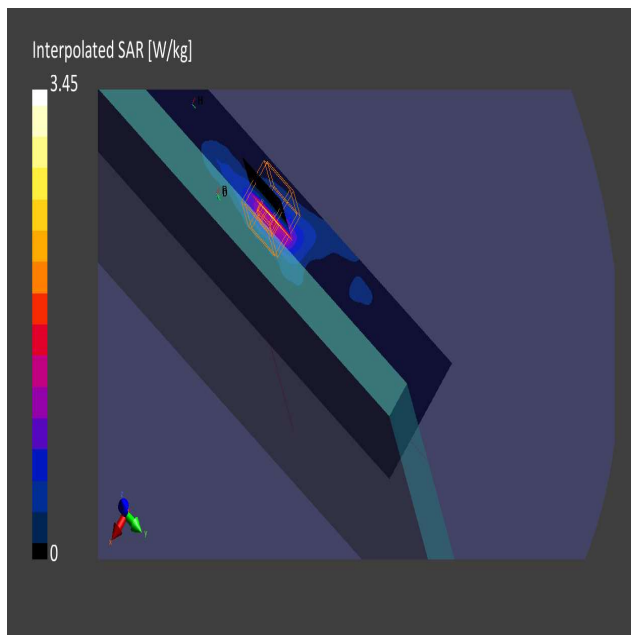

7. LTE Band 12, QPSK - 10MHz, CH23095, Top Edge

Device under Test Properties

Name, Manufacturer	Dimensions [mm]	S/N	DUT Type
HSN-I45C	215.0 x 300.0 x 17.0	0001760BC4	Convertible PC

Exposure Conditions

Phantom Section, TSL	Position, Test Distance [mm]	Band	Group, UID	Frequency [MHz], Channel Number	Conversion Factor	TSL Conductivity [S/m]	TSL Permittivity
Flat MSL	EDGE TOP 0.00	Band 12, E-UTRA/FDD	LTE-FDD10175CAG	707.5 23095	9.63	0.93	52.1

Hardware Setup

Phantom	TSL, Measured Date	Probe, Calibration Date	DAE, Calibration Date
ELI V8.0 (20deg probe tilt) - xxxx	MBBL-600-6000 , 2021-Dec-13	EX3DV4 - SN3978, 2021-05-21	DAE4 Sn1429, 2021-05-11

Scan Setup

	Area Scan	Zoom Scan
Grid Extents [mm]	60.0 x 330.0	30.0 x 30.0 x 30.0
Grid Steps [mm]	15.0 x 15.0	6.0 x 6.0 x 1.5
Sensor Surface [mm]	3.0	1.4
Graded Grid	No	Yes
Grading Ratio	n/a	1.5
MAIA	Confirmed by MAIA	Confirmed by MAIA
Surface Detection	Yes	Yes
Scan Method	Measured	Measured

Measurement Results

	Area Scan	Zoom Scan
Date	2021-12-14, 00:25	2021-12-14, 00:37
SAR1g [W/Kg]	0.531	0.615
SAR10g [W/Kg]	0.321	0.307
Power Drift [dB]	0.01	-0.06
Power Scaling	Disabled	Disabled
Scaling Factor		
TSL Correction	Positive Only	Positive Only

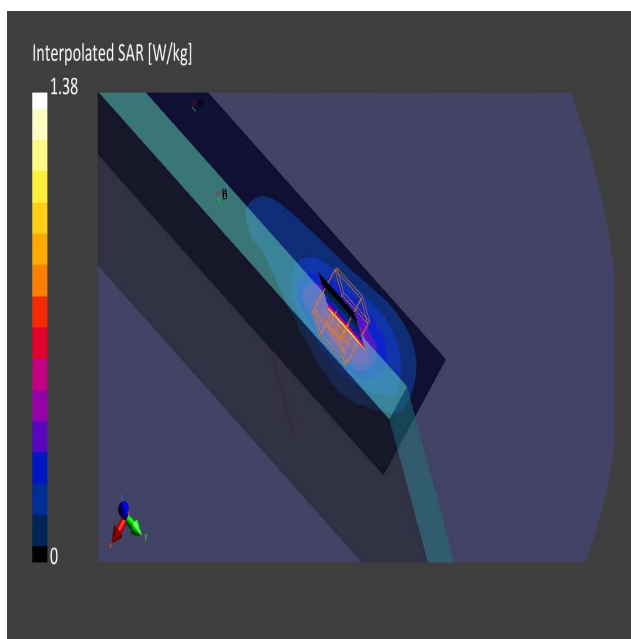

8. LTE Band 13, QPSK - 10MHz, CH23230, Top edge

Device under Test Properties

Name, Manufacturer	Dimensions [mm]	S/N	DUT Type
HSN-I45C	215.0 x 300.0 x 17.0	0001760BC4	Convertible PC

Exposure Conditions

Phantom Section, TSL	Position, Test Distance [mm]	Band	Group, UID	Frequency [MHz], Channel Number	Conversion Factor	TSL Conductivity [S/m]	TSL Permittivity
Flat MSL	EDGE TOP 0.00	Band 13, E-UTRA/FDD	LTE-FDD10175CAG	782.0 23230	9.63	0.96	52.0

Hardware Setup

Phantom	TSL, Measured Date	Probe, Calibration Date	DAE, Calibration Date
ELI V8.0 (20deg probe tilt) - xxxx	MBBL-600-6000 , 2021-Dec-13	EX3DV4 - SN3978, 2021-05-21	DAE4 Sn1429, 2021-05-11

Scan Setup

	Area Scan	Zoom Scan
Grid Extents [mm]	60.0 x 330.0	30.0 x 30.0 x 30.0
Grid Steps [mm]	15.0 x 15.0	6.0 x 6.0 x 1.5
Sensor Surface [mm]	3.0	1.4
Graded Grid	No	Yes
Grading Ratio	n/a	1.5
MAIA	Confirmed by MAIA	Confirmed by MAIA
Surface Detection	Yes	Yes
Scan Method	Measured	Measured

Measurement Results

	Area Scan	Zoom Scan
Date	2021-12-14, 01:14	2021-12-14, 01:19
SAR1g [W/Kg]	0.516	0.618
SAR10g [W/Kg]	0.323	0.319
Power Drift [dB]	-0.01	-0.05
Power Scaling	Disabled	Disabled
Scaling Factor		
TSL Correction	Positive Only	Positive Only

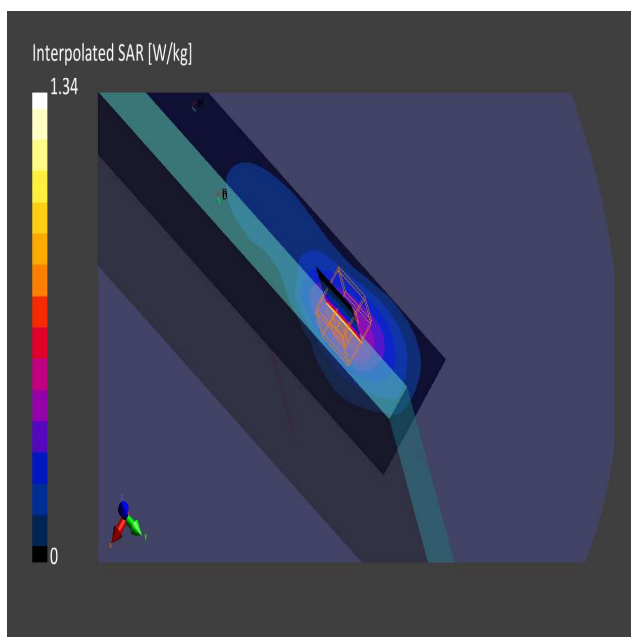

9. LTE Band 14, QPSK - 10MHz, CH23330, Top edge

Device under Test Properties

Name, Manufacturer	Dimensions [mm]	S/N	DUT Type
HSN-I45C	215.0 x 300.0 x 17.0	0001760BC4	Convertible PC

Exposure Conditions

Phantom Section, TSL	Position, Test Distance [mm]	Band	Group, UID	Frequency [MHz], Channel Number	Conversion Factor	TSL Conductivity [S/m]	TSL Permittivity
Flat MSL	EDGE TOP 0.00	Band 14, E-UTRA/FDD	LTE-FDD10175CAG	793.0 23330	9.63	0.96	52.0

Hardware Setup

Phantom	TSL, Measured Date	Probe, Calibration Date	DAE, Calibration Date
ELI V8.0 (20deg probe tilt) - xxxx	MBBL-600-6000 , 2021-Dec-13	EX3DV4 - SN3978, 2021-05-21	DAE4 Sn1429, 2021-05-11

Scan Setup

	Area Scan	Zoom Scan
Grid Extents [mm]	60.0 x 330.0	30.0 x 30.0 x 30.0
Grid Steps [mm]	15.0 x 15.0	6.0 x 6.0 x 1.5
Sensor Surface [mm]	3.0	1.4
Graded Grid	No	Yes
Grading Ratio	n/a	1.5
MAIA	Confirmed by MAIA	Confirmed by MAIA
Surface Detection	Yes	Yes
Scan Method	Measured	Measured

Measurement Results

	Area Scan	Zoom Scan
Date	2021-12-14, 01:43	2021-12-14, 01:55
SAR1g [W/Kg]	0.520	0.622
SAR10g [W/Kg]	0.329	0.325
Power Drift [dB]	-0.02	-0.01
Power Scaling	Disabled	Disabled
Scaling Factor		
TSL Correction	Positive Only	Positive Only

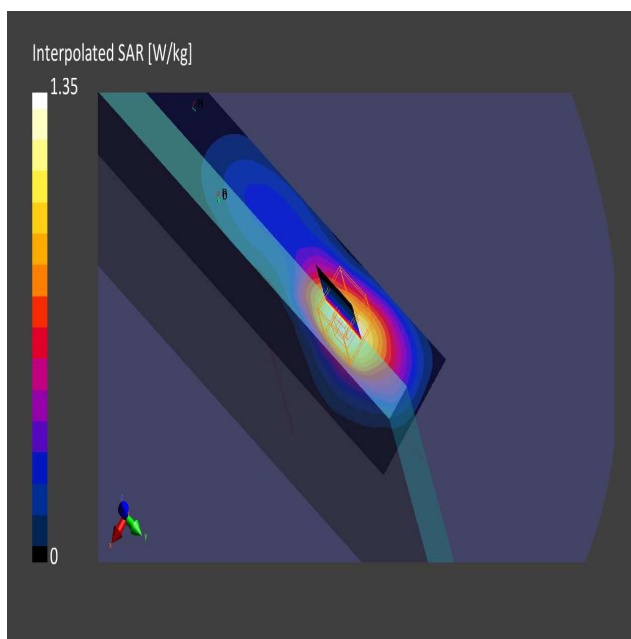

10. LTE Band 25, QPSK - 20MHz, CH26590, Top Edge

Device under Test Properties

Name, Manufacturer	Dimensions [mm]	S/N	DUT Type
HSN-I45C	215.0 x 300.0 x 17.0	0001760BC4	Convertible PC

Exposure Conditions

Phantom Section, TSL	Position, Test Distance [mm]	Band	Group, UID	Frequency [MHz], Channel Number	Conversion Factor	TSL Conductivity [S/m]	TSL Permittivity
Flat MSL	EDGE TOP 0.00	Band 25, E-UTRA/FDD	LTE-FDD10169CAE	1905.0 26590	7.98	1.53	50.5

Hardware Setup

Phantom	TSL, Measured Date	Probe, Calibration Date	DAE, Calibration Date
ELI V8.0 (20deg probe tilt) - xxxx	MBBL-600-6000 , 2021-Dec-13	EX3DV4 - SN3978, 2021-05-21	DAE4 Sn1429, 2021-05-11

Scan Setup

	Area Scan	Zoom Scan
Grid Extents [mm]	60.0 x 330.0	30.0 x 30.0 x 30.0
Grid Steps [mm]	15.0 x 15.0	4.9 x 4.9 x 1.4
Sensor Surface [mm]	3.0	1.4
Graded Grid	No	Yes
Grading Ratio	n/a	1.4
MAIA	Confirmed by MAIA	Confirmed by MAIA
Surface Detection	Yes	Yes
Scan Method	Measured	Measured

Measurement Results

	Area Scan	Zoom Scan
Date	2021-12-14, 09:59	2021-12-14, 10:09
SAR1g [W/Kg]	0.786	1.25
SAR10g [W/Kg]	0.442	0.549
Power Drift [dB]	-0.01	0.03
Power Scaling	Disabled	Disabled
Scaling Factor		
TSL Correction	Positive Only	Positive Only

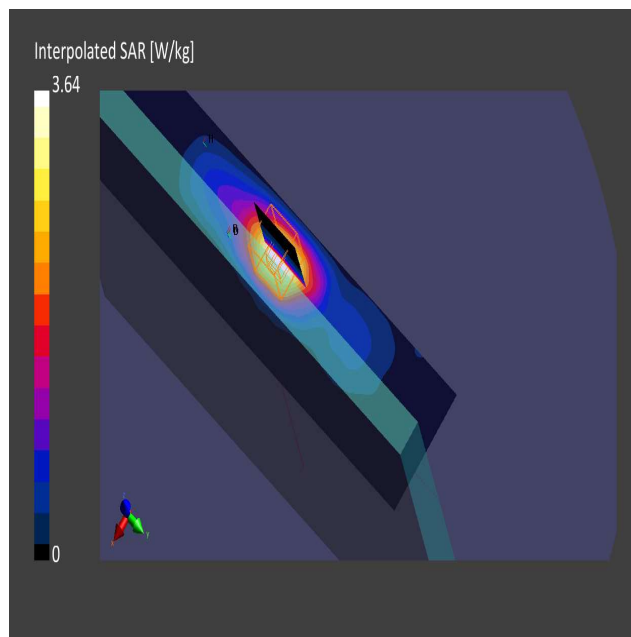

11. LTE Band 26, QPSK - 15MHz, CH26775, Top Edge

Device under Test Properties

Name, Manufacturer	Dimensions [mm]	S/N	DUT Type
HSN-I45C	215.0 x 300.0 x 17.0	0001760BC4	Convertible PC

Exposure Conditions

Phantom Section, TSL	Position, Test Distance [mm]	Band	Group, UID	Frequency [MHz], Channel Number	Conversion Factor	TSL Conductivity [S/m]	TSL Permittivity
Flat MSL	EDGE TOP 0.00	Band 26 E-UTRA/FDD	LTE-FDD10181CAE	821.5 26765	9.32	0.97	51.9

Hardware Setup

Phantom	TSL, Measured Date	Probe, Calibration Date	DAE, Calibration Date
ELI V8.0 (20deg probe tilt) - xxxx	MBBL-600-6000 , 2021-Dec-13	EX3DV4 - SN3978, 2021-05-21	DAE4 Sn1429, 2021-05-11

Scan Setup

	Area Scan	Zoom Scan
Grid Extents [mm]	60.0 x 330.0	30.0 x 30.0 x 30.0
Grid Steps [mm]	15.0 x 15.0	6.0 x 6.0 x 1.5
Sensor Surface [mm]	3.0	1.4
Graded Grid	No	Yes
Grading Ratio	n/a	1.5
MAIA	Confirmed by MAIA	Confirmed by MAIA
Surface Detection	Yes	Yes
Scan Method	Measured	Measured

Measurement Results

	Area Scan	Zoom Scan
Date	2021-12-13, 22:06	2021-12-13, 22:17
SAR1g [W/Kg]	0.653	0.655
SAR10g [W/Kg]	0.389	0.350
Power Drift [dB]	-0.00	-0.02
Power Scaling	Disabled	Disabled
Scaling Factor [dB]		
TSL Correction	Positive Only	Positive Only

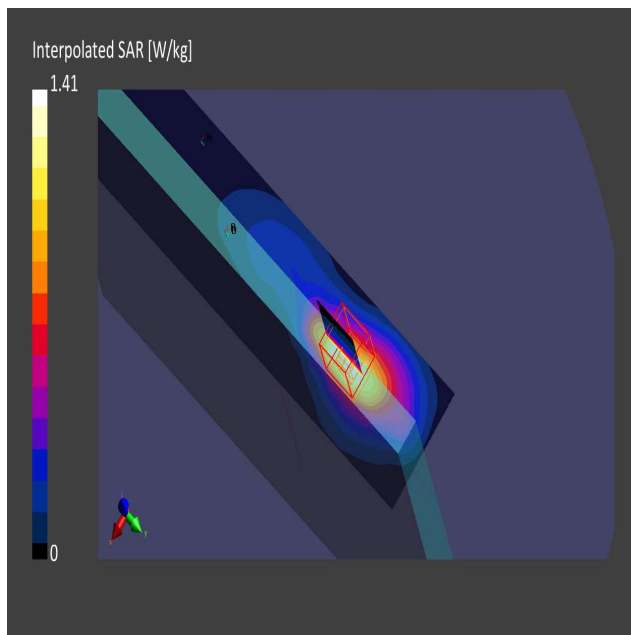

12. LTE Band 30, QPSK - 10MHz, CH27710, Top Edge

Device under Test Properties

Name, Manufacturer	Dimensions [mm]	S/N	DUT Type
HSN-I45C	215.0 x 300.0 x 17.0	0001760BC4	Convertible PC

Exposure Conditions

Phantom Section, TSL	Position, Test Distance [mm]	Band	Group, UID	Frequency [MHz], Channel Number	Conversion Factor	TSL Conductivity [S/m]	TSL Permittivity
Flat MSL	EDGE TOP 0.00	Band 30, E-UTRA/FDD	LTE-FDD10175CAG	2310.0 27710	7.45	1.84	50.0

Hardware Setup

Phantom	TSL, Measured Date	Probe, Calibration Date	DAE, Calibration Date
ELI V8.0 (20deg probe tilt) - xxxx	MBBL-600-6000 , 2021-Dec-13	EX3DV4 - SN3978, 2021-05-21	DAE4 Sn1429, 2021-05-11

Scan Setup

	Area Scan	Zoom Scan
Grid Extents [mm]	60.0 x 340.0	30.0 x 30.0 x 30.0
Grid Steps [mm]	10.0 x 10.0	5.0 x 5.0 x 1.5
Sensor Surface [mm]	3.0	1.4
Graded Grid	No	Yes
Grading Ratio	n/a	1.5
MAIA	Confirmed by MAIA	Confirmed by MAIA
Surface Detection	Yes	Yes
Scan Method	Measured	Measured

Measurement Results

	Area Scan	Zoom Scan
Date	2021-12-13, 10:15	2021-12-13, 10:22
SAR1g [W/Kg]	0.706	0.828
SAR10g [W/Kg]	0.328	0.331
Power Drift [dB]	0.03	-0.00
Power Scaling	Disabled	Disabled
Scaling Factor		
TSL Correction	Positive Only	Positive Only

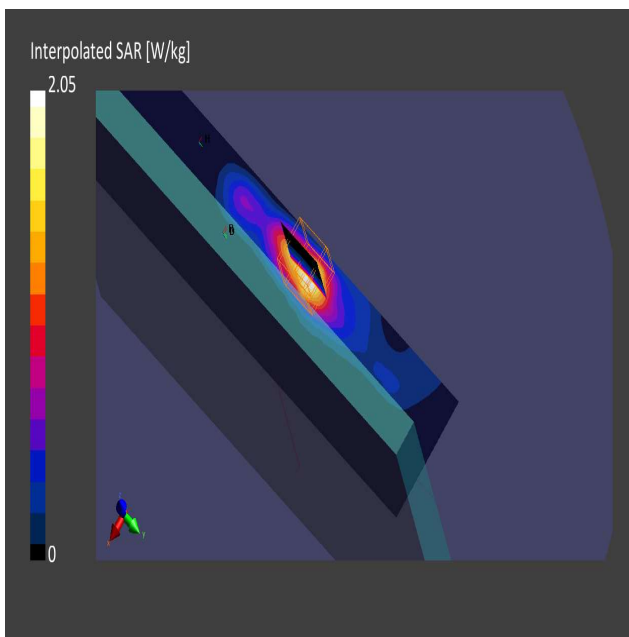

13. LTE Band 38, QPSK - 20MHz, CH38150, Top Edge

Device under Test Properties

Name, Manufacturer	Dimensions [mm]	S/N	DUT Type
HSN-I45C	215.0 x 300.0 x 17.0	0001760BC4	Convertible PC

Exposure Conditions

Phantom Section, TSL	Position, Test Distance [mm]	Band	Group, UID	Frequency [MHz], Channel Number	Conversion Factor	TSL Conductivity [S/m]	TSL Permittivity
Flat, MSL	EDGE TOP, 0.00	Band 38, E-UTRA/TDD	LTE-TDD, 10435-AAF	2610.0, 38150	7.24	2.12	49.6

Hardware Setup

Phantom	TSL, Measured Date	Probe, Calibration Date	DAE, Calibration Date
ELI V8.0 (20deg probe tilt)	MABL-600-6000, 2021-Dec-13	EX3DV4 - SN3978, 2021-05-21	DAE4 Sn1429, 2021-05-11

Scan Setup

	Area Scan	Zoom Scan
Grid Extents [mm]	60.0 x 340.0	30.0 x 30.0 x 30.0
Grid Steps [mm]	10.0 x 10.0	4.5 x 4.5 x 1.5
Sensor Surface [mm]	3.0	1.4
Graded Grid	Yes	Yes
Grading Ratio	1.5	1.5
MAIA	Confirmed by MAIA	Confirmed by MAIA
Surface Detection	Yes	Yes
Scan Method	Measured	Measured

Measurement Results

	Area Scan	Zoom Scan
Date	2021-12-14, 20:35	2021-12-14, 20:43
psSAR1g [W/kg]	0.905	0.977
psSAR10g [W/kg]	0.322	0.336
Power Drift [dB]	0.01	0.02
Power Scaling	Disabled	Disabled
Scaling Factor [dB]		
TSL Correction	Positive Only	Positive Only
M2/M1 [%]		75.6
Dist3dBPeak[mm]		5.4

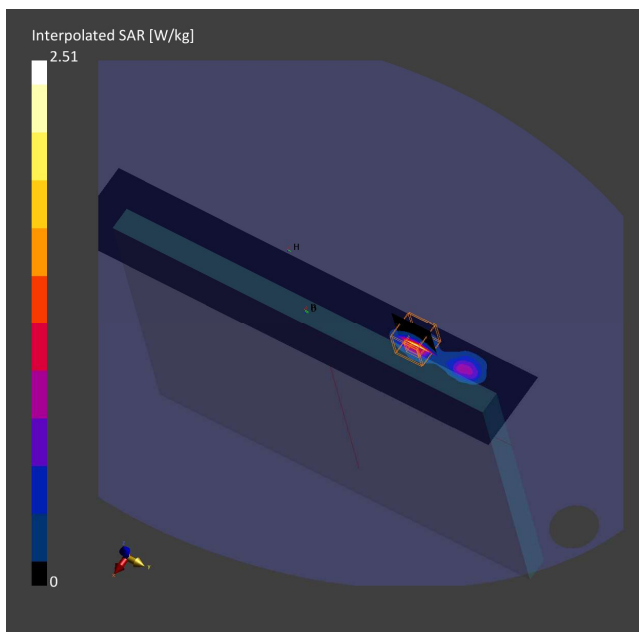

14. LTE Band 41, QPSK - 20MHz, CH40620, Top Edge

Device under Test Properties

Name, Manufacturer	Dimensions [mm]	S/N	DUT Type
HSN-I45C	215.0 x 300.0 x 17.0	0001760BC4	Convertible PC

Exposure Conditions

Phantom Section, TSL	Position, Test Distance [mm]	Band	Group, UID	Frequency [MHz], Channel Number	Conversion Factor	TSL Conductivity [S/m]	TSL Permittivity
Flat MSL	EDGE TOP 0.00	Band 41, E-UTRA/TDD	LTE-TDD10172CAG	2593.0 40620	7.24	2.11	49.6

Hardware Setup

Phantom	TSL, Measured Date	Probe, Calibration Date	DAE, Calibration Date
ELI V8.0 (20deg probe tilt) - xxxx	MBBL-600-6000 , 2021-Dec-13	EX3DV4 - SN3978, 2021-05-21	DAE4 Sn1429, 2021-05-11

Scan Setup

	Area Scan	Zoom Scan
Grid Extents [mm]	60.0 x 340.0	30.0 x 30.0 x 30.0
Grid Steps [mm]	10.0 x 10.0	4.5 x 4.5 x 1.5
Sensor Surface [mm]	3.0	1.4
Graded Grid	No	Yes
Grading Ratio	n/a	1.5
MAIA	Confirmed by MAIA	Confirmed by MAIA
Surface Detection	Yes	Yes
Scan Method	Measured	Measured

Measurement Results

	Area Scan	Zoom Scan
Date	2021-12-14, 11:25	2021-12-14, 11:33
SAR1g [W/Kg]	0.486	0.484
SAR10g [W/Kg]	0.197	0.191
Power Drift [dB]	0.04	0.02
Power Scaling	Disabled	Disabled
Scaling Factor		
TSL Correction	Positive Only	Positive Only

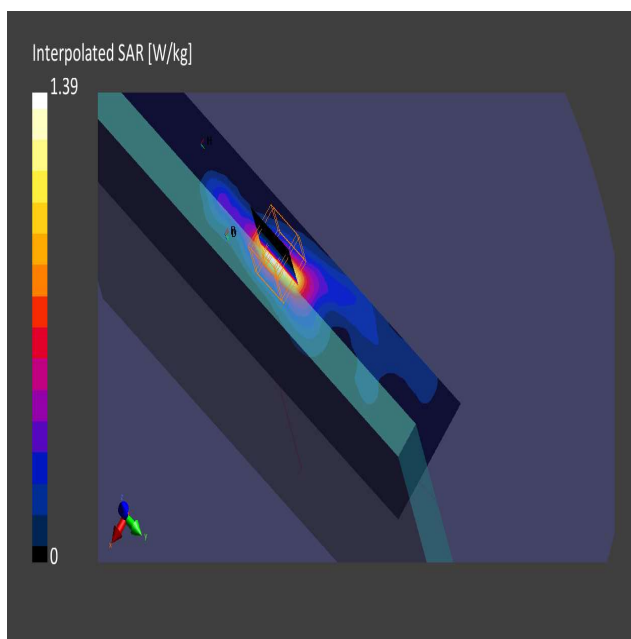

15. LTE Band 48, QPSK - 20MHz, CH55990, Top Edge

Device under Test Properties

Name, Manufacturer	Dimensions [mm]	S/N	DUT Type
HSN-I45C	215.0 x 300.0 x 17.0	0001760BC4	Convertible PC

Exposure Conditions

Phantom Section, TSL	Position, Test Distance [mm]	Band	Group, UID	Frequency [MHz], Channel Number	Conversion Factor	TSL Conductivity [S/m]	TSL Permittivity
Flat, MSL	EDGE TOP, 0.00	Band 48, E-UTRA/TDD	LTE-TDD, 10435-AAF	3625.0, 55990	6.07	3.20	47.9

Hardware Setup

Phantom	TSL, Measured Date	Probe, Calibration Date	DAE, Calibration Date
ELI V8.0 (20deg probe tilt)	MABL-600-6000 , 2021-Dec-13	EX3DV4 - SN3978, 2021-05-21	DAE4 Sn1429, 2021-05-11

Scan Setup

	Area Scan	Zoom Scan
Grid Extents [mm]	60.0 x 340.0	28.0 x 28.0 x 28.0
Grid Steps [mm]	10.0 x 10.0	4.9 x 4.9 x 1.4
Sensor Surface [mm]	3.0	1.4
Graded Grid	No	Yes
Grading Ratio	n/a	1.5
MAIA	Confirmed by MAIA	Confirmed by MAIA
Surface Detection	Yes	Yes
Scan Method	Measured	Measured

Measurement Results

	Area Scan	Zoom Scan
Date	2021-12-13, 13:37	2021-12-13, 13:50
psSAR1g [W/Kg]	1.18	1.21
psSAR10g [W/Kg]	0.407	0.396
Power Drift [dB]	0.07	0.03
Power Scaling	Disabled	Disabled
Scaling Factor [dB]		
TSL Correction	Positive Only	Positive Only

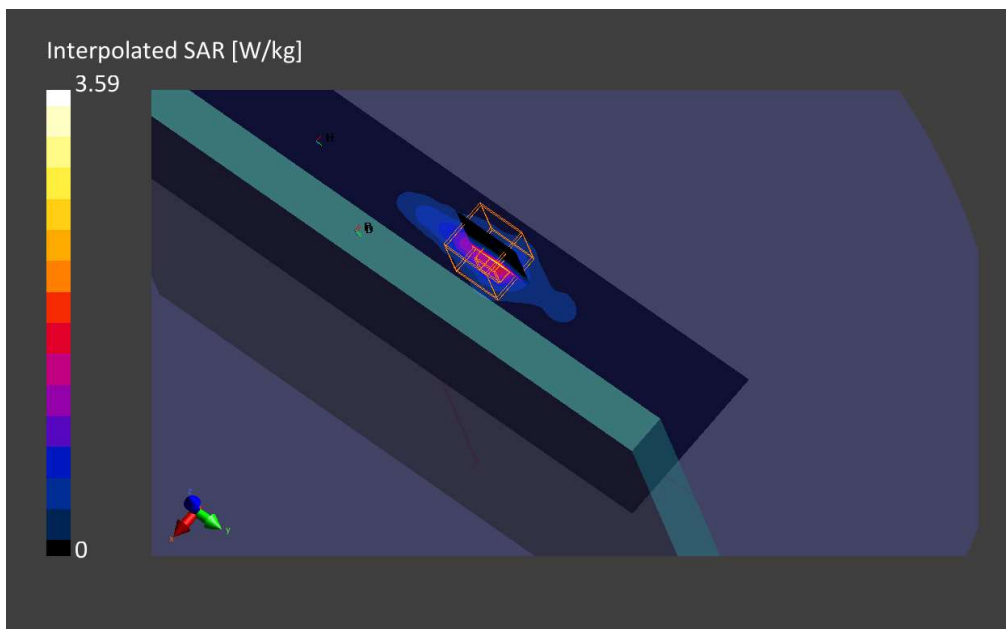

16.LTE Band 66, QPSK - 20MHz, CH132072, Top Edge

Device under Test Properties

Name, Manufacturer	Dimensions [mm]	S/N	DUT Type
HSN-I45C	215.0 x 300.0 x 17.0	0001760BC4	Convertible PC

Exposure Conditions

Phantom Section, TSL	Position, Test Distance [mm]	Band	Group, UID	Frequency [MHz], Channel Number	Conversion Factor	TSL Conductivity [S/m]	TSL Permittivity
Flat MSL	EDGE TOP 0.00	Band 66, E-UTRA/FDD	LTE-FDD10169CAE	1720.0 132072	8.37	1.40	50.7

Hardware Setup

Phantom	TSL, Measured Date	Probe, Calibration Date	DAE, Calibration Date
ELI V8.0 (20deg probe tilt) - xxxx	MBBL-600-6000 , 2021-Dec-13	EX3DV4 - SN3978, 2021-05-21	DAE4 Sn1429, 2021-05-11

Scan Setup

	Area Scan	Zoom Scan
Grid Extents [mm]	60.0 x 330.0	30.0 x 30.0 x 30.0
Grid Steps [mm]	15.0 x 15.0	4.9 x 4.9 x 1.4
Sensor Surface [mm]	3.0	1.4
Graded Grid	No	Yes
Grading Ratio	n/a	1.4
MAIA	Confirmed by MAIA	Confirmed by MAIA
Surface Detection	Yes	Yes
Scan Method	Measured	Measured

Measurement Results

	Area Scan	Zoom Scan
Date	2021-12-13, 15:38	2021-12-13, 15:56
SAR1g [W/Kg]	0.621	0.750
SAR10g [W/Kg]	0.328	0.338
Power Drift [dB]	0.02	-0.08
Power Scaling	Disabled	Disabled
Scaling Factor		
TSL Correction	Positive Only	Positive Only

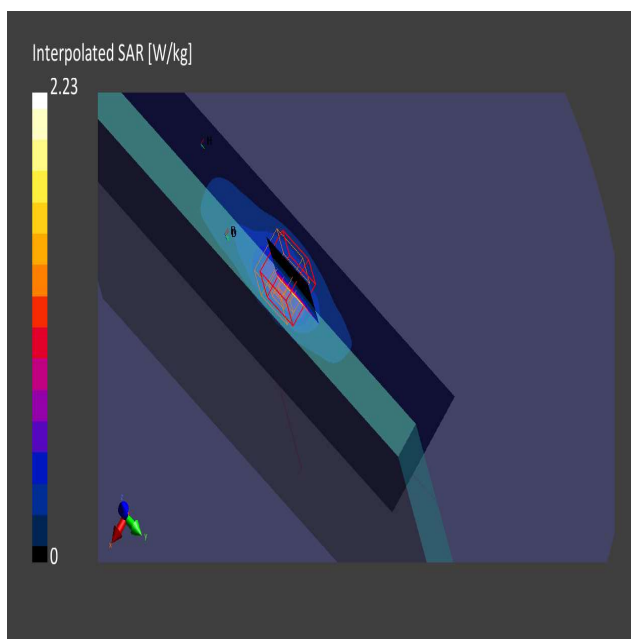

17. 5G NR FR1 Band 5, QPSK - 20MHz, CH167300, Top Edge

Device under Test Properties

Model, Manufacturer	Dimensions [mm]	IMEI	DUT Type
HSN-I45C, HP	210.0 x 300.0 x 20.0	0001760BC5	Convertible PC

Exposure Conditions

Phantom Section, TSL	Position, Test Distance [mm]	Band	Group, UID	Frequency [MHz], Channel Number	Conversion Factor	TSL Conductivity [S/m]	TSL Permittivity
Flat, MSL	EDGE TOP, 0.00	Band n5	5G NR FR1 FDD, 10939-AAB	836.5, 167300	10.82	0.970	55.7

Hardware Setup

Phantom	TSL, Measured Date	Probe, Calibration Date	DAE, Calibration Date
ELI V8.0 (20deg probe tilt) - 2124	MBBL-600-6000, 2021-Dec-09	EX3DV4 - SN7604, 2021-08-16	DAE4ip Sn1658, 2021-08-04

Scan Setup

	Area Scan	Zoom Scan
Grid Extents [mm]	80.0 x 160.0	30.0 x 30.0 x 30.0
Grid Steps [mm]	10.0 x 10.0	6.0 x 6.0 x 1.5
Sensor Surface [mm]	3.0	1.4
Graded Grid	Yes	Yes
Grading Ratio	1.5	1.5
MAIA	Confirmed by MAIA	Confirmed by MAIA
Surface Detection	VMS + 6p	VMS + 6p
Scan Method	Measured	Measured

Measurement Results

	Area Scan	Zoom Scan
Date	2021-12-10, 23:29	2021-12-10, 23:37
psSAR1g [W/kg]	0.521	0.527
psSAR10g [W/kg]	0.308	0.272
Power Drift [dB]	0.01	0.01
Power Scaling	Disabled	Disabled
Scaling Factor [dB]		
TSL Correction	Positive Only	Positive Only
M2/M1 [%]		73.8
Dist 3dB Peak [mm]		8.4

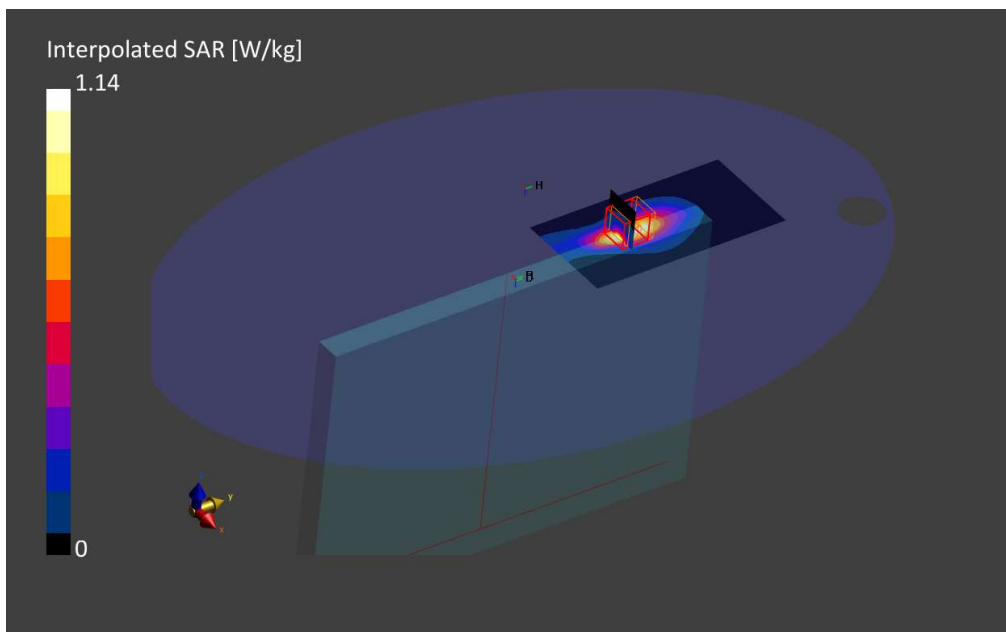

18. 5G NR FR1 Band 7, QPSK - 20MHz, CH507000, Top Edge

Model, Manufacturer	Dimensions [mm]	IMEI	DUT Type
HSN-I45C, HP	210.0 x 300.0 x 20.0	0001760BC5	Convertible PC

Exposure Conditions

Phantom Section, TSL	Position, Test Distance [mm]	Band	Group, UID	Frequency [MHz], Channel Number	Conversion Factor	TSL Conductivity [S/m]	TSL Permittivity
Flat, MSL	EDGE TOP, 0.00	Band n7	5G NR FR1 FDD, 10939-AAB	2535.0, 507000	8.1	2.11	52.7

Hardware Setup

Phantom	TSL, Measured Date	Probe, Calibration Date	DAE, Calibration Date
ELI V8.0 (20deg probe tilt) - 2124	MBBL-600-6000, 2021-Dec-09	EX3DV4 - SN7604, 2021-08-16	DAE4ip Sn1658, 2021-08-04

Scan Setup

	Area Scan	Zoom Scan
Grid Extents [mm]	80.0 x 160.0	30.0 x 30.0 x 30.0
Grid Steps [mm]	10.0 x 10.0	4.9 x 4.9 x 1.5
Sensor Surface [mm]	3.0	1.4
Graded Grid	Yes	Yes
Grading Ratio	1.5	1.5
MAIA	Confirmed by MAIA	Confirmed by MAIA
Surface Detection	VMS + 6p	VMS + 6p
Scan Method	Measured	Measured

Measurement Results

	Area Scan	Zoom Scan
Date	2021-12-10, 09:46	2021-12-10, 10:09
psSAR1g [W/kg]	0.440	0.527
psSAR10g [W/kg]	0.166	0.184
Power Drift [dB]	0.05	-0.04
Power Scaling	Disabled	Disabled
Scaling Factor [dB]		
TSL Correction	Positive Only	Positive Only
M2/M1 [%]		74.3
Dist 3dB Peak [mm]		5.9

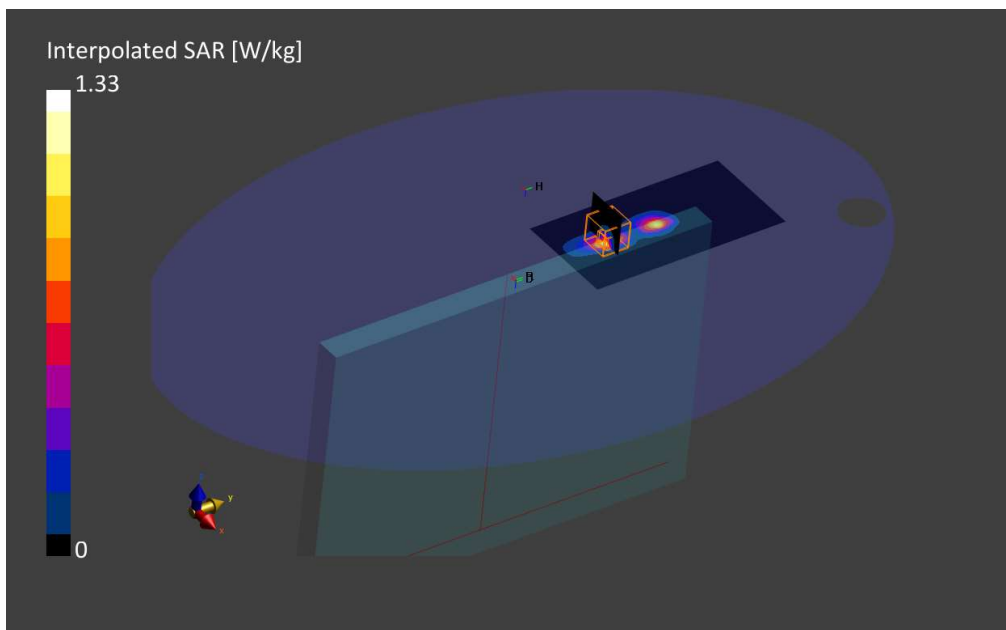

19. 5G NR FR1 Band 25, QPSK - 20MHz, CH376500, Top Edge

Name, Manufacturer	Dimensions [mm]	WLAN / BT MAC	DUT Type
HSN-I45C, HP	210.0 x 300.0 x 20.0	0001760BC5	Convertible PC

Exposure Conditions

Phantom Section, TSL	Position, Test Distance [mm]	Band	Group, UID	Frequency [MHz], Channel Number	Conversion Factor	TSL Conductivity [S/m]	TSL Permittivity
Flat MSL	EDGE TOP 0.00	Band n25	5G NR FR1 FDD10939AAB	1882.5 376500	8.62	1.52	53.7

Hardware Setup

Phantom	TSL, Measured Date	Probe, Calibration Date	DAE, Calibration Date
ELI V8.0 (20deg probe tilt) - 2124	MBBL-600-6000 , 2021-Dec-09	EX3DV4 - SN7604, 2021-08-16	DAE4ip Sn1658, 2021-08-04

Scan Setup

	Area Scan	Zoom Scan
Grid Extents [mm]	80.0 x 160.0	30.0 x 30.0 x 30.0
Grid Steps [mm]	10.0 x 10.0	5.3 x 5.3 x 1.4
Sensor Surface [mm]	3.0	1.4
Graded Grid	Yes	Yes
Grading Ratio	1.5	1.4
MAIA	Confirmed by MAIA	Confirmed by MAIA
Surface Detection	Yes	Yes
Scan Method	Measured	Measured

Measurement Results

	Area Scan	Zoom Scan
Date	2021-12-10, 14:11	2021-12-10, 14:22
SAR1g [W/Kg]	0.386	0.439
SAR10g [W/Kg]	0.180	0.194
Power Drift [dB]	0.00	0.02
Power Scaling	Disabled	Disabled
Scaling Factor [dB]		
TSL Correction	Positive Only	Positive Only

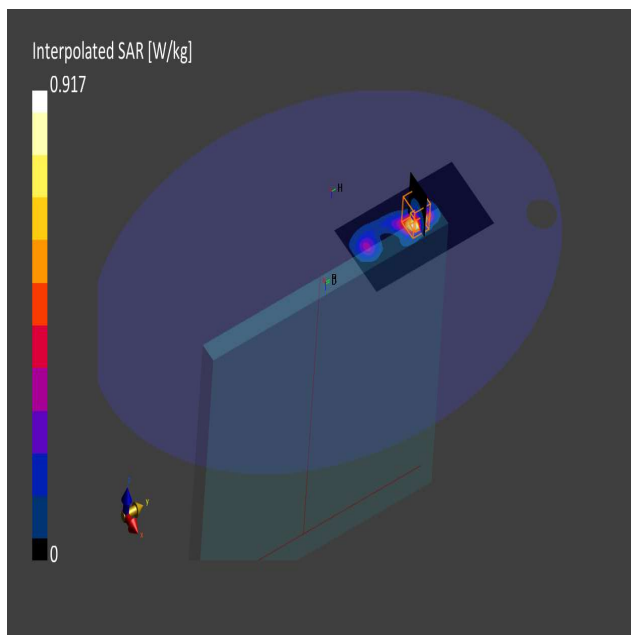

20. 5G NR FR1 Band 30, QPSK - 10MHz, CH462000, Top Edge

Name, Manufacturer	Dimensions [mm]	WLAN / BT MAC	DUT Type
HSN-I45C, HP	210.0 x 300.0 x 20.0	0001760BC5	Convertible PC

Exposure Conditions

Phantom Section, TSL	Position, Test Distance [mm]	Band	Group, UID	Frequency [MHz], Channel Number	Conversion Factor	TSL Conductivity [S/m]	TSL Permittivity
Flat MSL	EDGE TOP 0.00	Band n30	5G NR FR1 FDD10937AAB	2310.0 462000	8.33	1.86	53.1

Hardware Setup

Phantom	TSL, Measured Date	Probe, Calibration Date	DAE, Calibration Date
ELI V8.0 (20deg probe tilt) - 2124	MBBL-600-6000 , 2021-Dec-09	EX3DV4 - SN7604, 2021-08-16	DAE4ip Sn1658, 2021-08-04

Scan Setup

	Area Scan	Zoom Scan
Grid Extents [mm]	80.0 x 160.0	30.0 x 30.0 x 30.0
Grid Steps [mm]	10.0 x 10.0	4.9 x 4.9 x 1.5
Sensor Surface [mm]	3.0	1.4
Graded Grid	Yes	Yes
Grading Ratio	1.5	1.5
MAIA	Confirmed by MAIA	Confirmed by MAIA
Surface Detection	Yes	Yes
Scan Method	Measured	Measured

Measurement Results

	Area Scan	Zoom Scan
Date	2021-12-10, 19:00	2021-12-10, 19:22
SAR1g [W/Kg]	0.586	0.612
SAR10g [W/Kg]	0.220	0.235
Power Drift [dB]	0.00	-0.02
Power Scaling	Disabled	Disabled
Scaling Factor [dB]		
TSL Correction	Positive Only	Positive Only

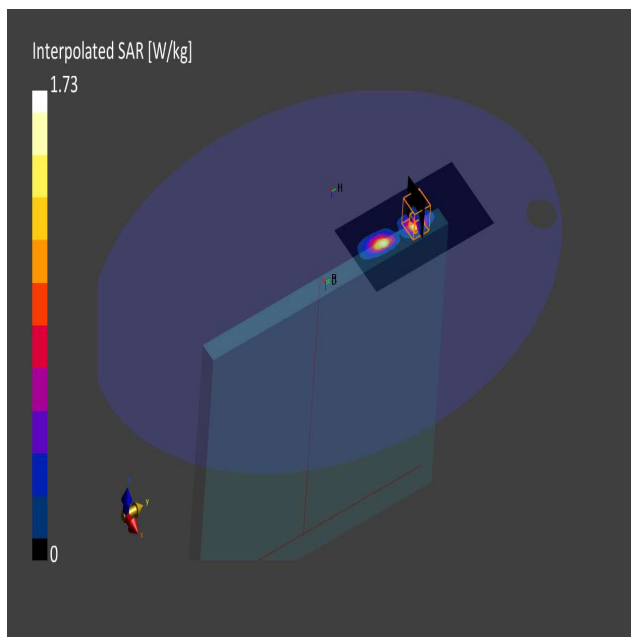

21. 5G NR FR1 Band 38, QPSK - 40MHz, CH519000, Top Edge

Name, Manufacturer	Dimensions [mm]	WLAN / BT MAC	DUT Type
HSN-I45C, HP	210.0 x 300.0 x 20.0	0001760BC5	Convertible PC

Exposure Conditions

Phantom Section, TSL	Position, Test Distance [mm]	Band	Group, UID	Frequency [MHz], Channel Number	Conversion Factor	TSL Conductivity [S/m]	TSL Permittivity
Flat MSL	EDGE TOP 0.00	Band n38	5G NR FR1 TDD10913AAB	2595.0 519000	8.1	2.08	52.5

Hardware Setup

Phantom	TSL, Measured Date	Probe, Calibration Date	DAE, Calibration Date
ELI V8.0 (20deg probe tilt) - 2124	MBBL-600-6000 , 2021-Dec-13	EX3DV4 - SN7604, 2021-08-16	DAE4ip Sn1658, 2021-08-04

Scan Setup

	Area Scan	Zoom Scan
Grid Extents [mm]	80.0 x 160.0	30.0 x 30.0 x 30.0
Grid Steps [mm]	10.0 x 10.0	5.0 x 5.0 x 1.5
Sensor Surface [mm]	3.0	1.4
Graded Grid	Yes	Yes
Grading Ratio	1.5	1.5
MAIA	Confirmed by MAIA	Confirmed by MAIA
Surface Detection	Yes	Yes
Scan Method	Measured	Measured

Measurement Results

	Area Scan	Zoom Scan
Date	2021-12-13, 10:57	2021-12-13, 11:19
SAR1g [W/Kg]	0.744	0.794
SAR10g [W/Kg]	0.258	0.281
Power Drift [dB]	0.02	0.00
Power Scaling	Disabled	Disabled
Scaling Factor		
[dB]		
TSL Correction	Positive Only	Positive Only

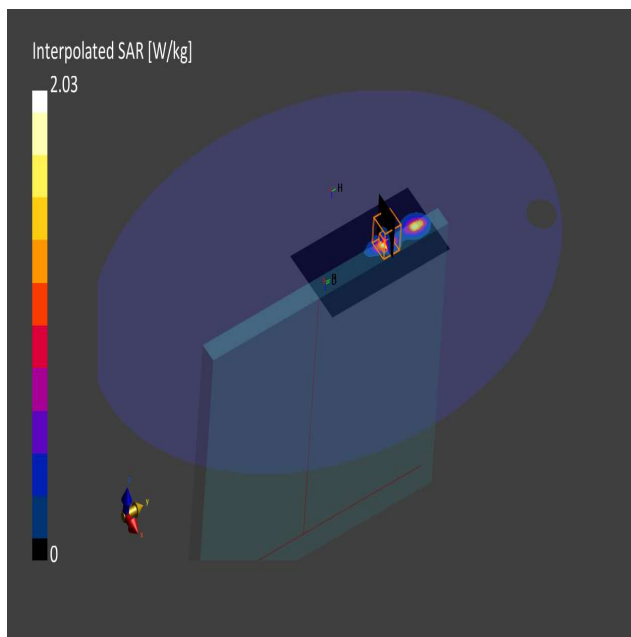

22. 5G NR FR1 Band 41, QPSK - 100MHz, CH518601-Top Edge

Name, Manufacturer	Dimensions [mm]	WLAN / BT MAC	DUT Type
HSN-I45C, HP	210.0 x 300.0 x 20.0	0001760BC5	Convertible PC

Exposure Conditions

Phantom Section, TSL	Position, Test Distance [mm]	Band	Group, UID	Frequency [MHz], Channel Number	Conversion Factor	TSL Conductivity [S/m]	TSL Permittivity
Flat MSL	EDGE TOP 0.00	Band n41	5G NR FR1 TDD10973AAA	2593.0 518598	8.1	2.08	52.5

Hardware Setup

Phantom	TSL, Measured Date	Probe, Calibration Date	DAE, Calibration Date
ELI V8.0 (20deg probe tilt) - 2124	MBBL-600-6000 , 2021-Dec-13	EX3DV4 - SN7604, 2021-08-16	DAE4ip Sn1658, 2021-08-04

Scan Setup

	Area Scan	Zoom Scan
Grid Extents [mm]	80.0 x 160.0	30.0 x 30.0 x 30.0
Grid Steps [mm]	10.0 x 10.0	5.0 x 5.0 x 1.5
Sensor Surface [mm]	3.0	1.4
Graded Grid	Yes	Yes
Grading Ratio	1.5	1.5
MAIA	Confirmed by MAIA	Confirmed by MAIA
Surface Detection	Yes	Yes
Scan Method	Measured	Measured

Measurement Results

	Area Scan	Zoom Scan
Date	2021-12-13, 13:42	2021-12-13, 14:04
SAR1g [W/Kg]	0.896	0.972
SAR10g [W/Kg]	0.312	0.343
Power Drift [dB]	-0.03	-0.01
Power Scaling	Disabled	Disabled
Scaling Factor [dB]		
TSL Correction	Positive Only	Positive Only

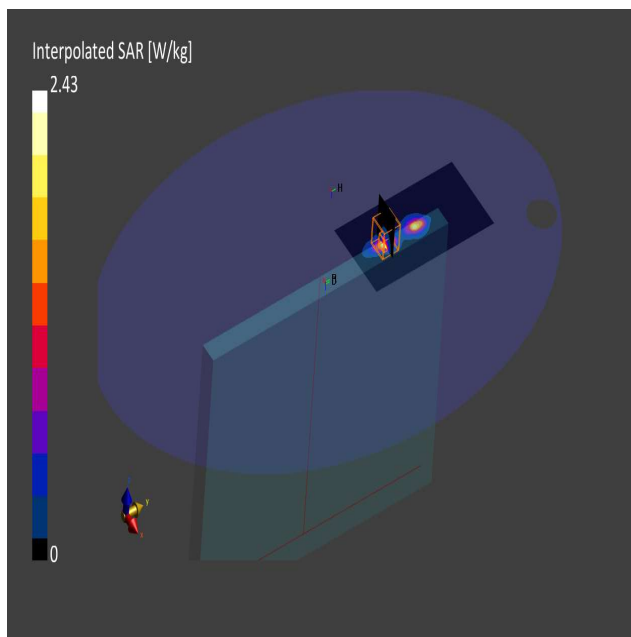

23. 5G NR FR1 Band 66, QPSK - 100MHz, CH349000-Top Edge

Name, Manufacturer	Dimensions [mm]	WLAN / BT MAC	DUT Type
HSN-I45C, HP	210.0 x 300.0 x 20.0	0001760BC5	Convertible PC

Exposure Conditions

Phantom Section, TSL	Position, Test Distance [mm]	Band	Group, UID	Frequency [MHz], Channel Number	Conversion Factor	TSL Conductivity [S/m]	TSL Permittivity
Flat MSL	EDGE TOP 0.00	Band n66	5G NR FR1 FDD10950AAB	1745.0 349000	9.02	1.55	51.7

Hardware Setup

Phantom	TSL, Measured Date	Probe, Calibration Date	DAE, Calibration Date
ELI V8.0 (20deg probe tilt) - 2124	MBBL-600-6000 , 2022-Jan-17	EX3DV4 - SN7604, 2021-08-16	DAE4ip Sn1658, 2021-08-04

Scan Setup

	Area Scan	Zoom Scan
Grid Extents [mm]	80.0 x 160.0	30.0 x 30.0 x 30.0
Grid Steps [mm]	10.0 x 10.0	4.9 x 4.9 x 1.4
Sensor Surface [mm]	3.0	1.4
Graded Grid	Yes	Yes
Grading Ratio	1.5	1.4
MAIA	Confirmed by MAIA	Confirmed by MAIA
Surface Detection	Yes	Yes
Scan Method	Measured	Measured

Measurement Results

	Area Scan	Zoom Scan
Date	2022-01-18, 10:42	2022-01-20, 11:02
SAR1g [W/Kg]	0.766	0.825
SAR10g [W/Kg]	0.362	0.384
Power Drift [dB]	-0.15	0.00
Power Scaling	Disabled	Disabled
Scaling Factor		
[dB]		
TSL Correction	Positive Only	Positive Only

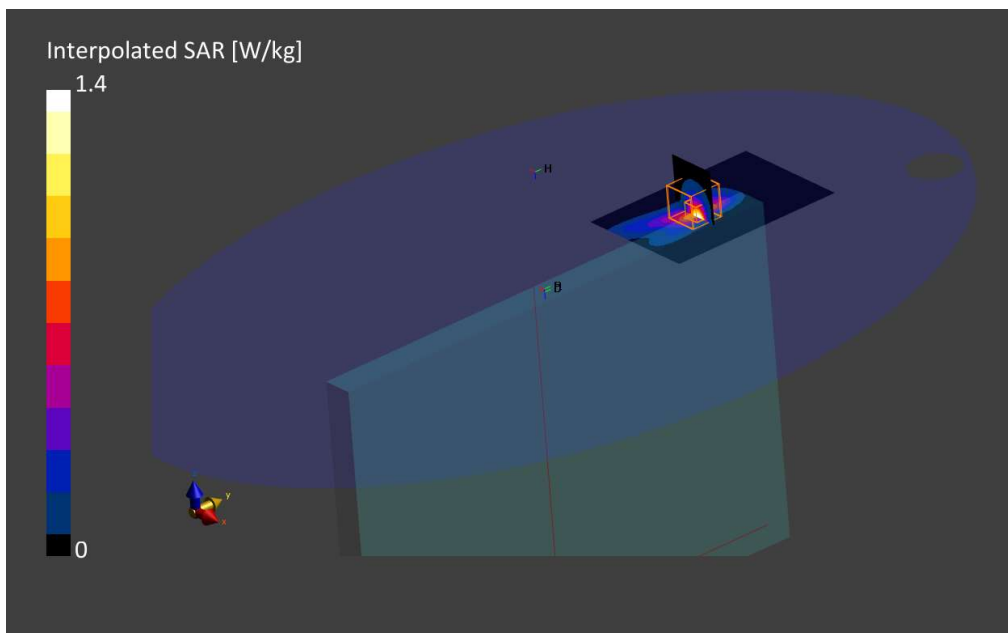

24. 5G NR FR1 Band 77, QPSK - 100MHz, CH650000-Top Edge

Name, Manufacturer	Dimensions [mm]	WLAN / BT MAC	DUT Type
HSN-I45C, HP	210.0 x 300.0 x 20.0	0001760BC5	Convertible PC

Exposure Conditions

Phantom Section, TSL	Position, Test Distance [mm]	Band	Group, UID	Frequency [MHz], Channel Number	Conversion Factor	TSL Conductivity [S/m]	TSL Permittivity
Flat MSL	EDGE TOP 0.00	Band n77	5G NR FR1 TDD10973AAA	3750.0 650000	6.13	3.36	50.3

Hardware Setup

Phantom	TSL, Measured Date	Probe, Calibration Date	DAE, Calibration Date
ELI V8.0 (20deg probe tilt) - 2124	MBBL-600-6000 , 2022-Jan-09	EX3DV4 - SN7455, 2021-03-19	DAE4 Sn1628, 2021-08-06

Scan Setup

	Area Scan	Zoom Scan
Grid Extents [mm]	80.0 x 120.0	28.0 x 28.0 x 28.0
Grid Steps [mm]	10.0 x 10.0	4.9 x 4.9 x 1.4
Sensor Surface [mm]	3.0	1.4
Graded Grid	Yes	Yes
Grading Ratio	1.5	1.5
MAIA	Confirmed by MAIA	Confirmed by MAIA
Surface Detection	Yes	Yes
Scan Method	Measured	Measured

Measurement Results

	Area Scan	Zoom Scan
Date	2022-01-10, 15:15	2022-01-10, 15:26
SAR1g [W/Kg]	0.694	0.739
SAR10g [W/Kg]	0.224	0.236
Power Drift [dB]	0.11	0.03
Power Scaling	Disabled	Disabled
Scaling Factor [dB]		
TSL Correction	Positive Only	Positive Only

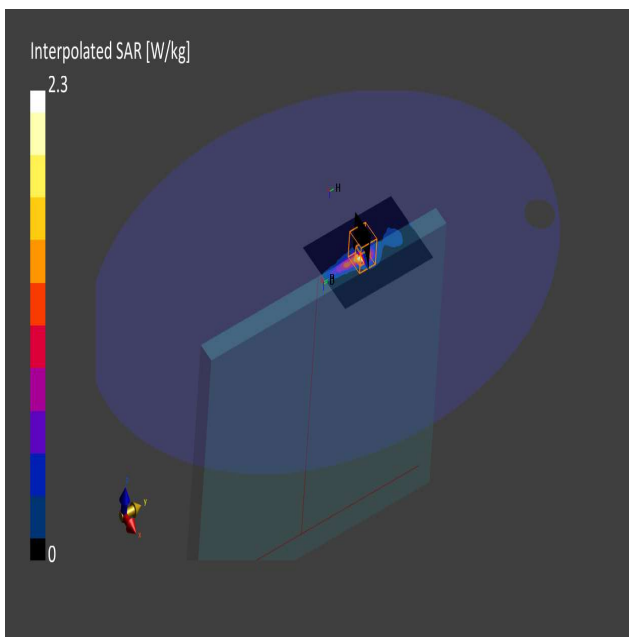

25. 5G NR FR1 Band 78, QPSK - 100MHz, 650000-Top Edge

Name, Manufacturer	Dimensions [mm]	WLAN / BT MAC	DUT Type
HSN-I45C, HP	210.0 x 300.0 x 20.0	0001760BC5	Convertible PC

Exposure Conditions

Phantom Section, TSL	Position, Test Distance [mm]	Band	Group, UID	Frequency [MHz], Channel Number	Conversion Factor	TSL Conductivity [S/m]	TSL Permittivity
Flat MSL	EDGE TOP 0.00	Band n78	5G NR FR1 TDD10868AAD	3750.0 650000	6.13	3.36	50.3

Hardware Setup

Phantom	TSL, Measured Date	Probe, Calibration Date	DAE, Calibration Date
ELI V8.0 (20deg probe tilt) - 2124	MBBL-600-6000 , 2022-Jan-09	EX3DV4 - SN7455, 2021-03-19	DAE4 Sn1628, 2021-08-06

Scan Setup

	Area Scan	Zoom Scan
Grid Extents [mm]	80.0 x 120.0	28.0 x 28.0 x 28.0
Grid Steps [mm]	10.0 x 10.0	4.5 x 4.5 x 1.4
Sensor Surface [mm]	3.0	1.4
Graded Grid	Yes	Yes
Grading Ratio	1.5	1.5
MAIA	Confirmed by MAIA	Confirmed by MAIA
Surface Detection	Yes	Yes
Scan Method	Measured	Measured

Measurement Results

	Area Scan	Zoom Scan
Date	2022-01-10, 14:40	2022-01-10, 15:01
SAR1g [W/Kg]	0.818	0.873
SAR10g [W/Kg]	0.268	0.290
Power Drift [dB]	0.05	0.00
Power Scaling	Disabled	Disabled
Scaling Factor		
[dB]		
TSL Correction	Positive Only	Positive Only

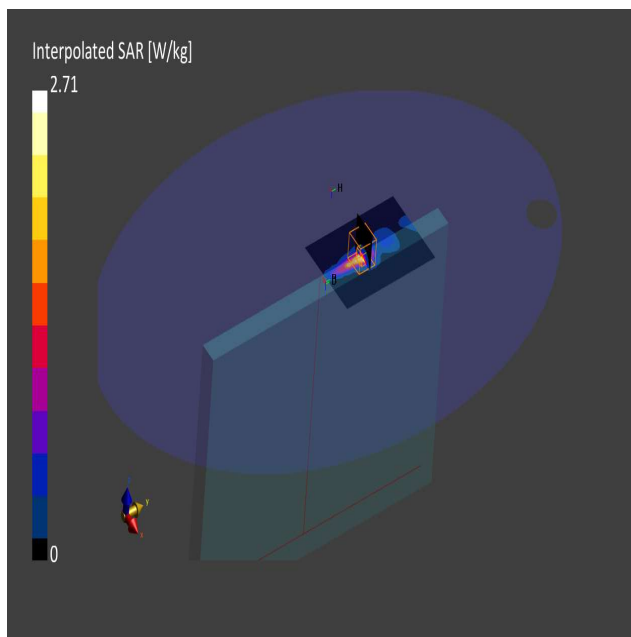

26. System Check Body Liquid 750MHz – 2021-12-13

Device under Test Properties

Name, Manufacturer	Dimensions [mm]	S/N	DUT Type
Dipole 750MHz, SPEAG	50.0 x 10.0 x 8.0	1136	Validation Dipole

Exposure Conditions

Phantom Section, TSL	Position, Test Distance [mm]	Band	Group, UID	Frequency [MHz], Channel Number	Conversion Factor	TSL Conductivity [S/m]	TSL Permittivity
Flat MSL				750.0	9.63	0.95	52.1

Hardware Setup

Phantom	TSL, Measured Date	Probe, Calibration Date	DAE, Calibration Date
ELI V8.0 (20deg probe tilt) - xxxx	MBBL-600-6000 , 2021-Dec-13	EX3DV4 - SN3978, 2021-05-21	DAE4 Sn1429, 2021-05-11

Scan Setup

	Area Scan	Zoom Scan
Grid Extents [mm]	60.0 x 90.0	30.0 x 30.0 x 30.0
Grid Steps [mm]	15.0 x 15.0	6.0 x 6.0 x 1.5
Sensor Surface [mm]	3.0	1.4
Graded Grid	No	Yes
Grading Ratio	n/a	1.5
MAIA	Confirmed by MAIA	Confirmed by MAIA
Surface Detection	Yes	Yes
Scan Method	Measured	Measured

Measurement Results

	Area Scan	Zoom Scan
Date	2021-12-13, 16:50	2021-12-13, 16:55
psSAR1g [W/Kg]	0.401	0.421
psSAR10g [W/Kg]	0.266	0.276
Power Drift [dB]	-0.07	-0.05
Power Scaling	Disabled	Disabled
Scaling Factor		
TSL Correction	Positive Only	Positive Only

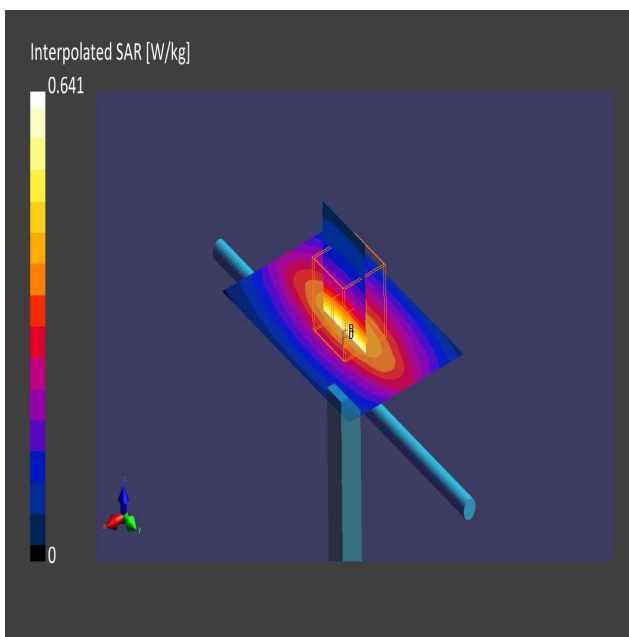

27. System Check Body Liquid 835MHz – 2021-12-13

Device under Test Properties

Name, Manufacturer	Dimensions [mm]	Serial Number	DUT Type
Dipole 835MHz, SPEAG	50.0 x 10.0 x 10.0	4d192	Validation Dipole

Exposure Conditions

Phantom Section, TSL	Position, Test Distance [mm]	Band	Group, UID	Frequency [MHz], Channel Number	Conversion Factor	TSL Conductivity [S/m]	TSL Permittivity
Flat MSL				835.0	9.32	0.98	51.9

Hardware Setup

Phantom	TSL, Measured Date	Probe, Calibration Date	DAE, Calibration Date
ELI V8.0 (20deg probe tilt) - xxxx	MBBL-600-6000 , 2021-Dec-13	EX3DV4 - SN3978, 2021-05-21	DAE4 Sn1429, 2021-05-11

Scan Setup

	Area Scan	Zoom Scan
Grid Extents [mm]	60.0 x 90.0	30.0 x 30.0 x 30.0
Grid Steps [mm]	15.0 x 15.0	6.0 x 6.0 x 1.5
Sensor Surface [mm]	3.0	1.4
Graded Grid	No	Yes
Grading Ratio	n/a	1.5
MAIA	Confirmed by MAIA	Confirmed by MAIA
Surface Detection	Yes	Yes
Scan Method	Measured	Measured

Measurement Results

	Area Scan	Zoom Scan
Date	2021-12-13, 17:05	2021-12-13, 17:12
psSAR1g [W/Kg]	0.481	0.500
psSAR10g [W/Kg]	0.314	0.327
Power Drift [dB]	-0.04	0.07
Power Scaling	Disabled	Disabled
Scaling Factor		
TSL Correction	Positive Only	Positive Only

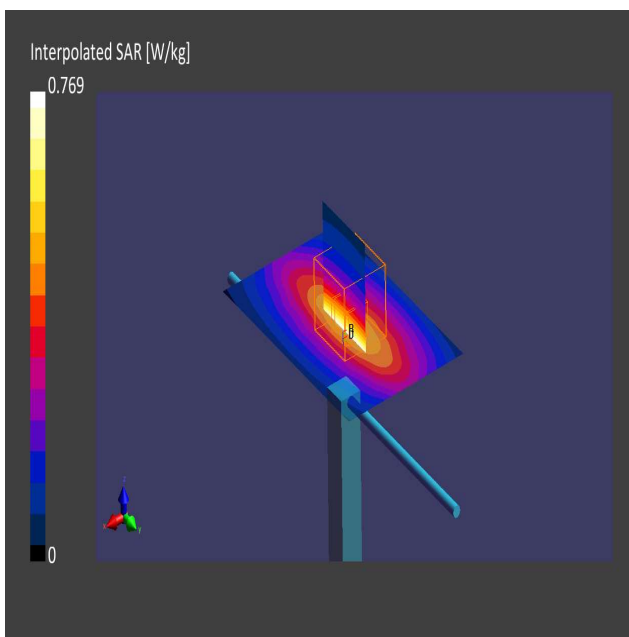

28. System Check Body Liquid 835MHz – 2021-12-10

Name, Manufacturer	Dimensions [mm]	Serial Number	DUT Type
Dipole 835MHz, SPEAG	50.0 x 10.0 x 10.0	4d192	Validation Dipole

Exposure Conditions

Phantom Section, TSL	Position, Test Distance [mm]	Band	Group, UID	Frequency [MHz], Channel Number	Conversion Factor	TSL Conductivity [S/m]	TSL Permittivity
Flat MSL			,	835.0	10.82	0.971	55.7

Hardware Setup

Phantom	TSL, Measured Date	Probe, Calibration Date	DAE, Calibration Date
ELI V8.0 (20deg probe tilt) - 2124	MBBL-600-6000 , 2021-Dec-09	EX3DV4 - SN7604, 2021-08-16	DAE4 Sn1628, 2021-08-06

Scan Setup

	Area Scan	Zoom Scan
Grid Extents [mm]	40.0 x 90.0	30.0 x 30.0 x 30.0
Grid Steps [mm]	10.0 x 15.0	6.0 x 6.0 x 1.5
Sensor Surface [mm]	3.0	1.4
Graded Grid	Yes	Yes
Grading Ratio	1.5	1.5
MAIA	Confirmed by MAIA	Confirmed by MAIA
Surface Detection	Yes	Yes
Scan Method	Measured	Measured

Measurement Results

	Area Scan	Zoom Scan
Date	2021-12-10, 17:08	2021-12-10, 17:14
psSAR1g [W/Kg]	0.502	0.476
psSAR10g [W/Kg]	0.330	0.307
Power Drift [dB]	-0.20	-0.07
Power Scaling	Disabled	Disabled
Scaling Factor [dB]		
TSL Correction	Positive Only	Positive Only

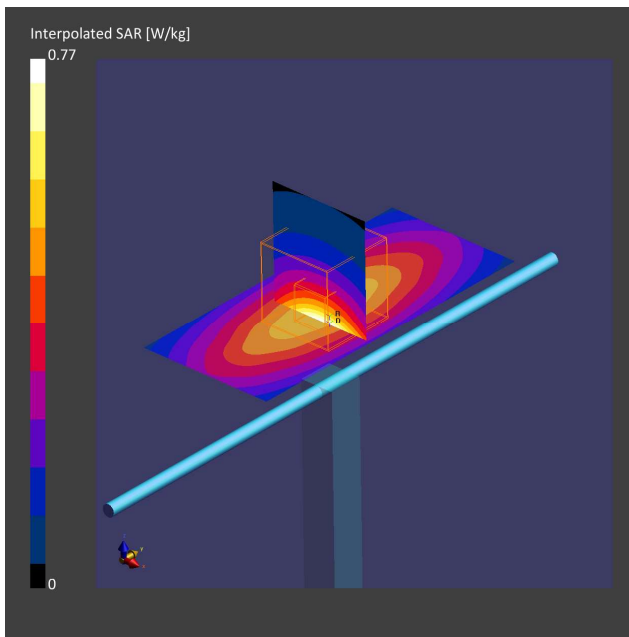

29. System Check Body Liquid 1750MHz – 2021-12-13

Device under Test Properties

Name, Manufacturer	Dimensions [mm]	Serial Number	DUT Type
Dipole 1750MHz, SPEAG	50.0 x 10.0 x 8.0	1133	Validation Dipole

Exposure Conditions

Phantom Section, TSL	Position, Test Distance [mm]	Band	Group, UID	Frequency [MHz], Channel Number	Conversion Factor	TSL Conductivity [S/m]	TSL Permittivity
Flat MSL			,	1750.0	8.37	1.42	50.7

Hardware Setup

Phantom	TSL, Measured Date	Probe, Calibration Date	DAE, Calibration Date
ELI V8.0 (20deg probe tilt) - xxxx	MABL-600-6000 , 2021-Dec-13	EX3DV4 - SN3978, 2021-05-21	DAE4 Sn1429, 2021-05-11

Scan Setup

	Area Scan	Zoom Scan
Grid Extents [mm]	60.0 x 90.0	30.0 x 30.0 x 30.0
Grid Steps [mm]	15.0 x 15.0	6.0 x 6.0 x 1.5
Sensor Surface [mm]	3.0	1.4
Graded Grid	No	Yes
Grading Ratio	n/a	1.5
MAIA	Confirmed by MAIA	Confirmed by MAIA
Surface Detection	Yes	Yes
Scan Method	Measured	Measured

Measurement Results

	Area Scan	Zoom Scan
Date	2021-12-13, 18:04	2021-12-13, 18:12
psSAR1g [W/Kg]	1.56	1.67
psSAR10g [W/Kg]	0.827	0.895
Power Drift [dB]	0.03	-0.08
Power Scaling	Disabled	Disabled
Scaling Factor [dB]		
TSL Correction	Positive Only	Positive Only

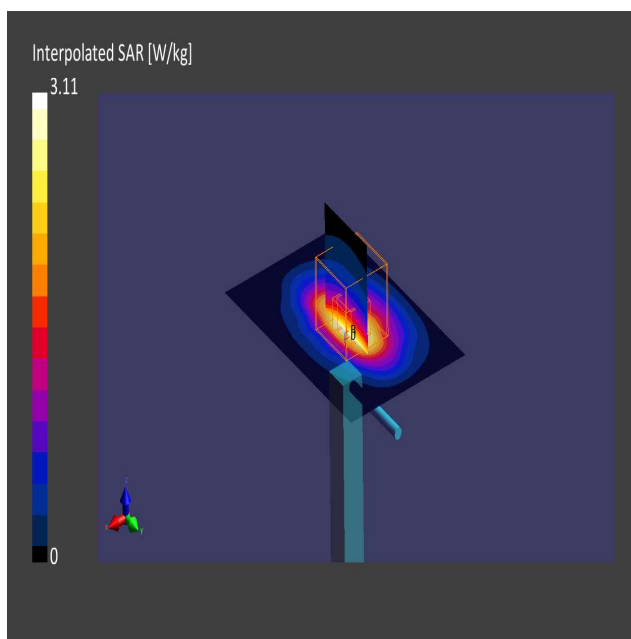

30. System Check Body Liquid 1750MHz – 2022-01-18

Name, Manufacturer	Dimensions [mm]	Serial Number	DUT Type
Dipole 1750MHz, SPEAG	50.0 x 10.0 x 8.0	1133	Validation Dipole

Exposure Conditions

Phantom Section, TSL	Position, Test Distance [mm]	Band	Group, UID	Frequency [MHz], Channel Number	Conversion Factor	TSL Conductivity [S/m]	TSL Permittivity
Flat MSL			,	1750.0	9.02	1.55	51.7

Hardware Setup

Phantom	TSL, Measured Date	Probe, Calibration Date	DAE, Calibration Date
ELI V8.0 (20deg probe tilt) - 2124	MBBL-600-6000 , 2022-Jan-17	EX3DV4 - SN7604, 2021-08-16	DAE4 Sn1628, 2021-08-06

Scan Setup

	Area Scan	Zoom Scan
Grid Extents [mm]	40.0 x 90.0	30.0 x 30.0 x 30.0
Grid Steps [mm]	10.0 x 15.0	6.0 x 6.0 x 1.5
Sensor Surface [mm]	3.0	1.4
Graded Grid	Yes	Yes
Grading Ratio	1.5	1.5
MAIA	Confirmed by MAIA	Confirmed by MAIA
Surface Detection	Yes	Yes
Scan Method	Measured	Measured

Measurement Results

	Area Scan	Zoom Scan
Date	2022-01-18, 17:08	2022-01-18, 17:14
psSAR1g [W/Kg]	1.82	1.82
psSAR10g [W/Kg]	0.961	0.968
Power Drift [dB]	-0.04	-0.04
Power Scaling	Disabled	Disabled
Scaling Factor [dB]		
TSL Correction	Positive Only	Positive Only

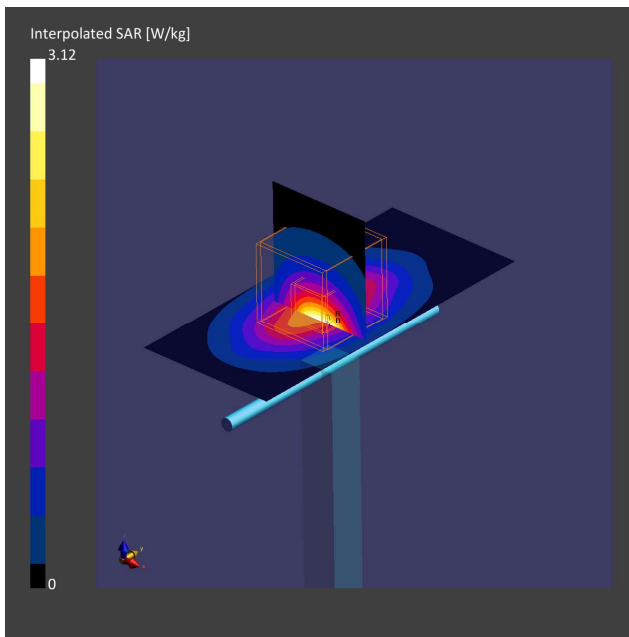

31. System Check Body Liquid 1750MHz – 2021-12-13

Device under Test Properties

Name, Manufacturer	Dimensions [mm]	Serial Number	DUT Type
Dipole 1750MHz, SPEAG	50.0 x 10.0 x 8.0	1133	Validation Dipole

Exposure Conditions

Phantom Section, TSL	Position, Test Distance [mm]	Band	Group, UID	Frequency [MHz], Channel Number	Conversion Factor	TSL Conductivity [S/m]	TSL Permittivity
Flat MSL			,	1750.0	8.37	1.42	50.7

Hardware Setup

Phantom	TSL, Measured Date	Probe, Calibration Date	DAE, Calibration Date
ELI V8.0 (20deg probe tilt) - xxxx	MBBL-600-6000 , 2021-Dec-13	EX3DV4 - SN3978, 2021-05-21	DAE4 Sn1429, 2021-05-11

Scan Setup

	Area Scan	Zoom Scan
Grid Extents [mm]	60.0 x 90.0	30.0 x 30.0 x 30.0
Grid Steps [mm]	15.0 x 15.0	6.0 x 6.0 x 1.5
Sensor Surface [mm]	3.0	1.4
Graded Grid	Yes	Yes
Grading Ratio	1.5	1.5
MAIA	Confirmed by MAIA	Confirmed by MAIA
Surface Detection	Yes	Yes
Scan Method	Measured	Measured

Measurement Results

	Area Scan	Zoom Scan
Date	2021-12-13, 18:04	2021-12-13, 18:12
psSAR1g [W/Kg]	1.56	1.67
psSAR10g [W/Kg]	0.827	0.895
Power Drift [dB]	0.03	-0.08
Power Scaling	Disabled	Disabled
Scaling Factor [dB]		
TSL Correction	Positive Only	Positive Only

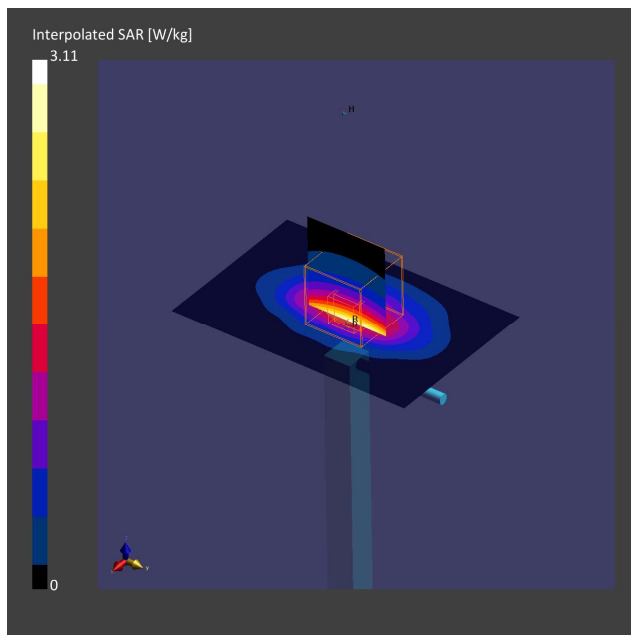

32. System Check Body Liquid 1900MHz – 2021-12-13

Device under Test Properties

Name, Manufacturer	Dimensions [mm]	S/N	DUT Type
Dipole 1900MHz, SPEAG	50.0 x 10.0 x 15.0	5d197	Validation Dipole

Exposure Conditions

Phantom Section, TSL	Position, Test Distance [mm]	Band	Group, UID	Frequency [MHz], Channel Number	Conversion Factor	TSL Conductivity [S/m]	TSL Permittivity
Flat MSL			,	1900.0	7.98	1.52	50.5

Hardware Setup

Phantom	TSL, Measured Date	Probe, Calibration Date	DAE, Calibration Date
ELI V8.0 (20deg probe tilt) - xxxx	MBBL-600-6000 , 2021-Dec-13	EX3DV4 - SN3978, 2021-05-21	DAE4 Sn1429, 2021-05-11

Scan Setup

	Area Scan	Zoom Scan
Grid Extents [mm]	60.0 x 90.0	30.0 x 30.0 x 30.0
Grid Steps [mm]	15.0 x 15.0	6.0 x 6.0 x 1.5
Sensor Surface [mm]	3.0	1.4
Graded Grid	No	Yes
Grading Ratio	n/a	1.5
MAIA	Confirmed by MAIA	Confirmed by MAIA
Surface Detection	Yes	Yes
Scan Method	Measured	Measured

Measurement Results

	Area Scan	Zoom Scan
Date	2021-12-13, 17:27	2021-12-13, 17:32
psSAR1g [W/Kg]	1.87	1.98
psSAR10g [W/Kg]	0.955	1.03
Power Drift [dB]	-0.01	-0.12
Power Scaling	Disabled	Disabled
Scaling Factor [dB]		
TSL Correction	Positive Only	Positive Only

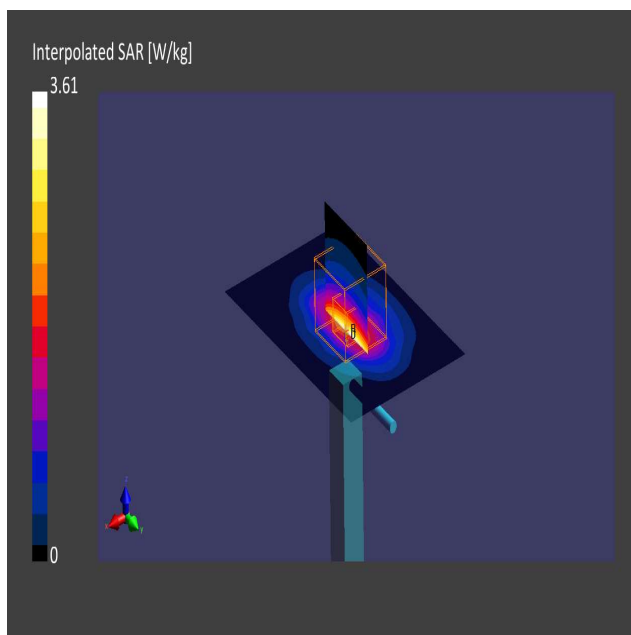

33. System Check Body Liquid 1900MHz – 2021-12-10

Name, Manufacturer	Dimensions [mm]	Serial Number	DUT Type
Dipole 1900MHz, SPEAG	50.0 x 10.0 x 15.0	5d197	Validation Dipole

Exposure Conditions

Phantom Section, TSL	Position, Test Distance [mm]	Band	Group, UID	Frequency [MHz], Channel Number	Conversion Factor	TSL Conductivity [S/m]	TSL Permittivity
Flat MSL			,	1900.0	8.62	1.54	53.6

Hardware Setup

Phantom	TSL, Measured Date	Probe, Calibration Date	DAE, Calibration Date
ELI V8.0 (20deg probe tilt) - 2124	MBBL-600-6000 , 2021-Dec-09	EX3DV4 - SN7604, 2021-08-16	DAE4 Sn1628, 2021-08-06

Scan Setup

	Area Scan	Zoom Scan
Grid Extents [mm]	40.0 x 90.0	30.0 x 30.0 x 30.0
Grid Steps [mm]	10.0 x 15.0	6.0 x 6.0 x 1.5
Sensor Surface [mm]	3.0	1.4
Graded Grid	Yes	Yes
Grading Ratio	1.5	1.5
MAIA	Confirmed by MAIA	Confirmed by MAIA
Surface Detection	Yes	Yes
Scan Method	Measured	Measured

Measurement Results

	Area Scan	Zoom Scan
Date	2021-12-10, 17:20	2021-12-10, 17:26
psSAR1g [W/Kg]	1.94	1.93
psSAR10g [W/Kg]	0.992	0.997
Power Drift [dB]	-0.01	-0.01
Power Scaling	Disabled	Disabled
Scaling Factor [dB]		
TSL Correction	Positive Only	Positive Only

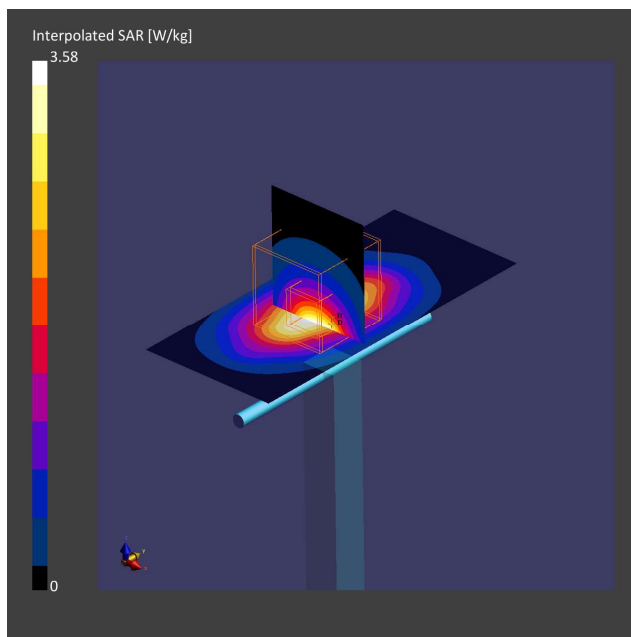

34. System Check Body Liquid 2300MHz – 2021-12-13

Device under Test Properties

Name, Manufacturer	Dimensions [mm]	Serial Number	DUT Type
D2300MHZ, SPEAG	50.0 x 10.0 x 8.0	1046	Validation Dipole

Exposure Conditions

Phantom Section, TSL	Position, Test Distance [mm]	Band	Group, UID	Frequency [MHz], Channel Number	Conversion Factor	TSL Conductivity [S/m]	TSL Permittivity
Flat MSL			,	2300.0	7.45	1.84	50.0

Hardware Setup

Phantom	TSL, Measured Date	Probe, Calibration Date	DAE, Calibration Date
ELI V8.0 (20deg probe tilt) - xxxx	MBBL-600-6000 , 2021-Dec-13	EX3DV4 - SN3978, 2021-05-21	DAE4 Sn1429, 2021-05-11

Scan Setup

	Area Scan	Zoom Scan
Grid Extents [mm]	40.0 x 80.0	30.0 x 30.0 x 30.0
Grid Steps [mm]	10.0 x 10.0	5.0 x 5.0 x 1.5
Sensor Surface [mm]	3.0	1.4
Graded Grid	No	Yes
Grading Ratio	n/a	1.5
MAIA	Confirmed by MAIA	Confirmed by MAIA
Surface Detection	Yes	Yes
Scan Method	Measured	Measured

Measurement Results

	Area Scan	Zoom Scan
Date	2021-12-13, 17:16	2021-12-13, 17:23
psSAR1g [W/Kg]	2.13	2.24
psSAR10g [W/Kg]	1.02	1.07
Power Drift [dB]	0.00	-0.00
Power Scaling	Disabled	Disabled
Scaling Factor		
TSL Correction	Positive Only	Positive Only

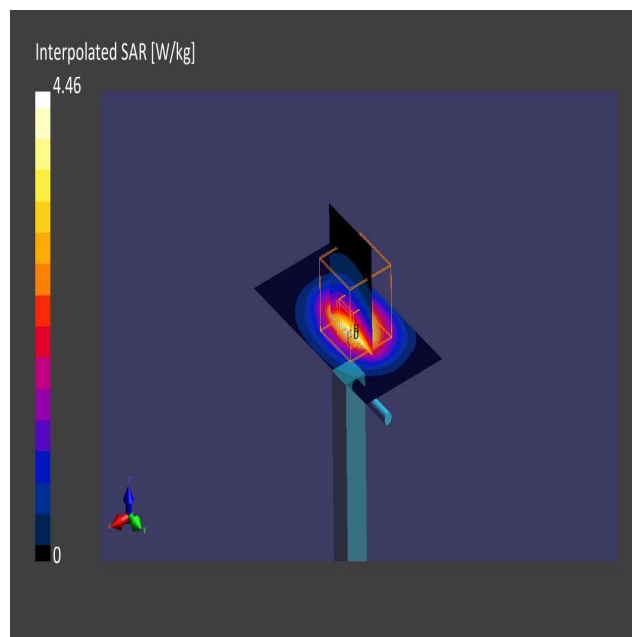

35. System Check Body Liquid 2300MHz – 2021-12-10

Name, Manufacturer	Dimensions [mm]	Serial Number	DUT Type
D2300MHZ, SPEAG	50.0 x 10.0 x 8.0	1046	Validation Dipole

Exposure Conditions

Phantom Section, TSL	Position, Test Distance [mm]	Band	Group, UID	Frequency [MHz], Channel Number	Conversion Factor	TSL Conductivity [S/m]	TSL Permittivity
Flat MSL			,	2300.0	8.33	1.85	53.1

Hardware Setup

Phantom	TSL, Measured Date	Probe, Calibration Date	DAE, Calibration Date
ELI V8.0 (20deg probe tilt) - 2124	MBBL-600-6000 , 2021-Dec-09	EX3DV4 - SN7604, 2021-08-16	DAE4 Sn1628, 2021-08-06

Scan Setup

	Area Scan	Zoom Scan
Grid Extents [mm]	40.0 x 80.0	30.0 x 30.0 x 30.0
Grid Steps [mm]	10.0 x 10.0	5.0 x 5.0 x 1.5
Sensor Surface [mm]	3.0	1.4
Graded Grid	Yes	Yes
Grading Ratio	1.5	1.5
MAIA	Confirmed by MAIA	Confirmed by MAIA
Surface Detection	Yes	Yes
Scan Method	Measured	Measured

Measurement Results

	Area Scan	Zoom Scan
Date	2021-12-10, 17:33	2021-12-10, 17:41
psSAR1g [W/Kg]	2.28	2.26
psSAR10g [W/Kg]	1.07	1.07
Power Drift [dB]	-0.03	-0.02
Power Scaling	Disabled	Disabled
Scaling Factor [dB]		
TSL Correction	Positive Only	Positive Only

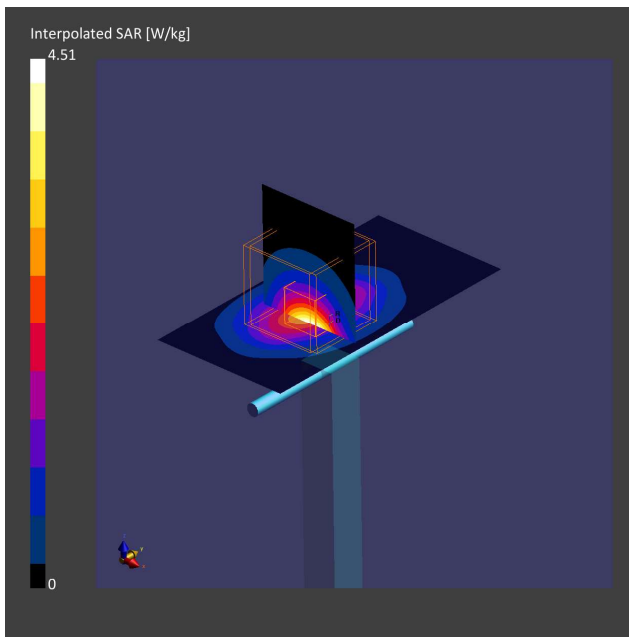

36. System Check Body Liquid 2600MHz – 2021-12-15

Device under Test Properties

Name, Manufacturer	Dimensions [mm]	Serial Number	DUT Type
D2600MHz, SPEAG	50.0 x 10.0 x 8.0	1100	Validation Dipole

Exposure Conditions

Phantom Section, TSL	Position, Test Distance [mm]	Band	Group, UID	Frequency [MHz], Channel Number	Conversion Factor	TSL Conductivity [S/m]	TSL Permittivity
Flat MSL			,	2600.0	7.24	2.11	49.6

Hardware Setup

Phantom	TSL, Measured Date	Probe, Calibration Date	DAE, Calibration Date
ELI V8.0 (20deg probe tilt) - xxxx	MBBL-600-6000 , 2021-Dec-13	EX3DV4 - SN3978, 2021-05-21	DAE4 Sn1429, 2021-05-11

Scan Setup

	Area Scan	Zoom Scan
Grid Extents [mm]	40.0 x 80.0	30.0 x 30.0 x 30.0
Grid Steps [mm]	10.0 x 10.0	5.0 x 5.0 x 1.5
Sensor Surface [mm]	3.0	1.4
Graded Grid	No	Yes
Grading Ratio	n/a	1.5
MAIA	Confirmed by MAIA	Confirmed by MAIA
Surface Detection	Yes	Yes
Scan Method	Measured	Measured

Measurement Results

	Area Scan	Zoom Scan
Date	2021-12-15, 18:32	2021-12-15, 18:38
psSAR1g [W/Kg]	2.47	2.52
psSAR10g [W/Kg]	1.14	1.14
Power Drift [dB]	0.09	-0.01
Power Scaling	Disabled	Disabled
Scaling Factor		
TSL Correction	Positive Only	Positive Only

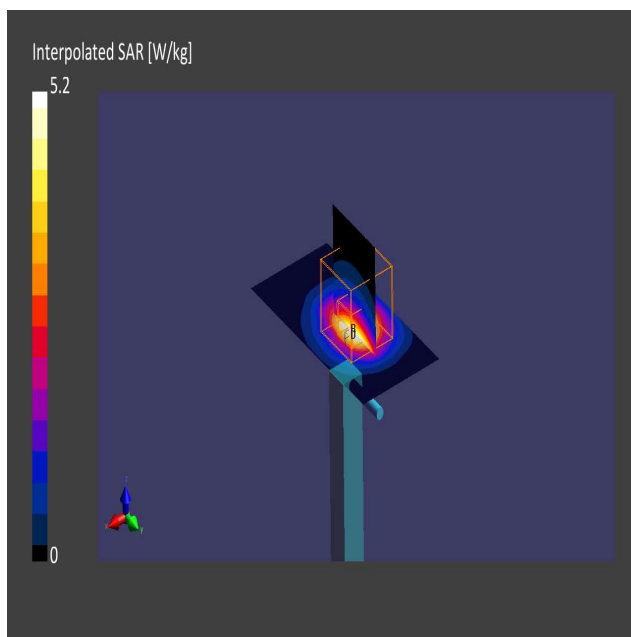

37. System Check Body Liquid 2600MHz – 2021-12-13

Name, Manufacturer	Dimensions [mm]	Serial Number	DUT Type
D2600MHz, SPEAG	50.0 x 10.0 x 8.0	1100	Validation Dipole

Exposure Conditions

Phantom Section, TSL	Position, Test Distance [mm]	Band	Group, UID	Frequency [MHz], Channel Number	Conversion Factor	TSL Conductivity [S/m]	TSL Permittivity
Flat MSL			,	2600.0	8.1	2.09	52.5

Hardware Setup

Phantom	TSL, Measured Date	Probe, Calibration Date	DAE, Calibration Date
ELI V8.0 (20deg probe tilt) - 2124	MBBL-600-6000 , 2021-Dec-13	EX3DV4 - SN7604, 2021-08-16	DAE4ip Sn1658, 2021-08-04

Scan Setup

	Area Scan	Zoom Scan
Grid Extents [mm]	40.0 x 80.0	30.0 x 30.0 x 30.0
Grid Steps [mm]	10.0 x 10.0	5.0 x 5.0 x 1.5
Sensor Surface [mm]	3.0	1.4
Graded Grid	Yes	Yes
Grading Ratio	1.5	1.5
MAIA	Confirmed by MAIA	Confirmed by MAIA
Surface Detection	Yes	Yes
Scan Method	Measured	Measured

Measurement Results

	Area Scan	Zoom Scan
Date	2021-12-13, 16:38	2021-12-13, 16:46
psSAR1g [W/Kg]	2.61	2.52
psSAR10g [W/Kg]	1.15	1.12
Power Drift [dB]	-0.03	-0.11
Power Scaling	Disabled	Disabled
Scaling Factor [dB]		
TSL Correction	Positive Only	Positive Only

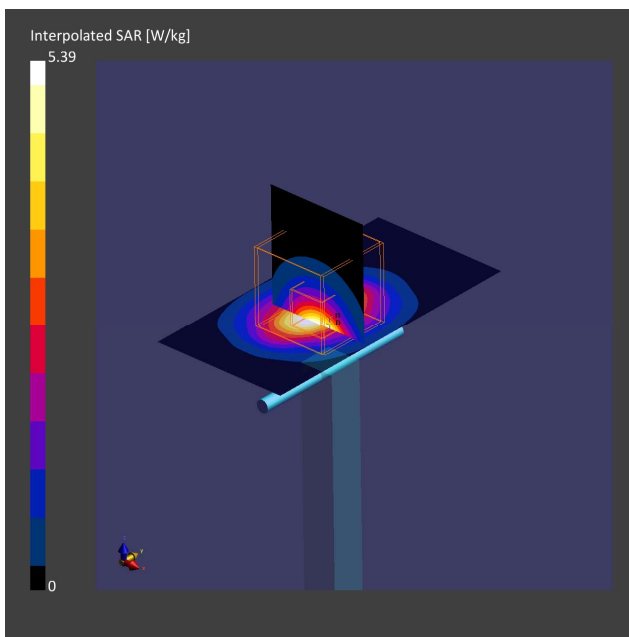

38. System Check Body Liquid 3700MHz – 2021-12-13

Device under Test Properties

Name, Manufacturer	Dimensions [mm]	Serial Number	DUT Type
D3700MHz, SPEAG	50.0 x 10.0 x 17.0	1093	Validation Dipole

Exposure Conditions

Phantom Section, TSL	Position, Test Distance [mm]	Band	Group, UID	Frequency [MHz], Channel Number	Conversion Factor	TSL Conductivity [S/m]	TSL Permittivity
Flat MSL			,	3700.0	6.07	3.25	47.7

Hardware Setup

Phantom	TSL, Measured Date	Probe, Calibration Date	DAE, Calibration Date
ELI V8.0 (20deg probe tilt) -	MBBL-600-6000 , 2021-Dec-13	EX3DV4 - SN3978, 2021-05-21	DAE4 Sn1429, 2021-05-11

Scan Setup

	Area Scan	Zoom Scan
Grid Extents [mm]	40.0 x 80.0	28.0 x 28.0 x 28.0
Grid Steps [mm]	10.0 x 10.0	5.0 x 5.0 x 1.4
Sensor Surface [mm]	3.0	1.4
Graded Grid	No	Yes
Grading Ratio	n/a	1.5
MAIA	Confirmed by MAIA	Confirmed by MAIA
Surface Detection	Yes	Yes
Scan Method	Measured	Measured

Measurement Results

	Area Scan	Zoom Scan
Date	2021-12-13, 17:40	2021-12-13, 17:50
psSAR1g [W/Kg]	3.04	3.12
psSAR10g [W/Kg]	1.12	1.16
Power Drift [dB]	0.01	-0.01
Power Scaling	Disabled	Disabled
Scaling Factor [dB]		
TSL Correction	Positive Only	Positive Only

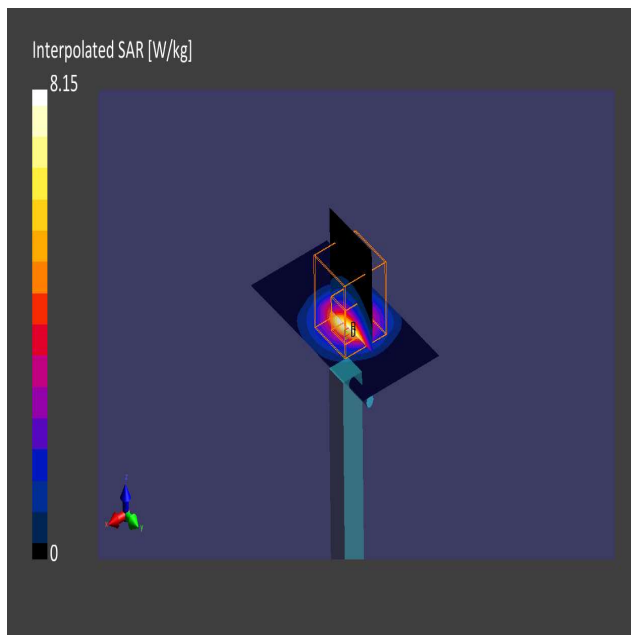

39. System Check Body Liquid 3700MHz – 2021-12-10

Name, Manufacturer	Dimensions [mm]	Serial Number	DUT Type
D3700MHz, SPEAG	50.0 x 10.0 x 17.0	1093	Validation Dipole

Exposure Conditions

Phantom Section, TSL	Position, Test Distance [mm]	Band	Group, UID	Frequency [MHz], Channel Number	Conversion Factor	TSL Conductivity [S/m]	TSL Permittivity
Flat MSL			,	3700.0	6.13	3.30	50.4

Hardware Setup

Phantom	TSL, Measured Date	Probe, Calibration Date	DAE, Calibration Date
ELI V8.0 (20deg probe tilt) - 2124	MBBL-600-6000 , 2021-Dec-10	EX3DV4 - SN7455, 2021-03-19	DAE4 Sn1628, 2021-08-06

Scan Setup

	Area Scan	Zoom Scan
Grid Extents [mm]	40.0 x 80.0	28.0 x 28.0 x 28.0
Grid Steps [mm]	10.0 x 10.0	5.0 x 5.0 x 1.4
Sensor Surface [mm]	3.0	1.4
Graded Grid	Yes	Yes
Grading Ratio	1.5	1.5
MAIA	Confirmed by MAIA	Confirmed by MAIA
Surface Detection	Yes	Yes
Scan Method	Measured	Measured

Measurement Results

	Area Scan	Zoom Scan
Date	2022-01-10, 17:38	2022-01-10, 17:46
psSAR1g [W/Kg]	2.92	3.04
psSAR10g [W/Kg]	1.09	1.13
Power Drift [dB]	-0.05	0.01
Power Scaling	Disabled	Disabled
Scaling Factor [dB]		
TSL Correction	Positive Only	Positive Only

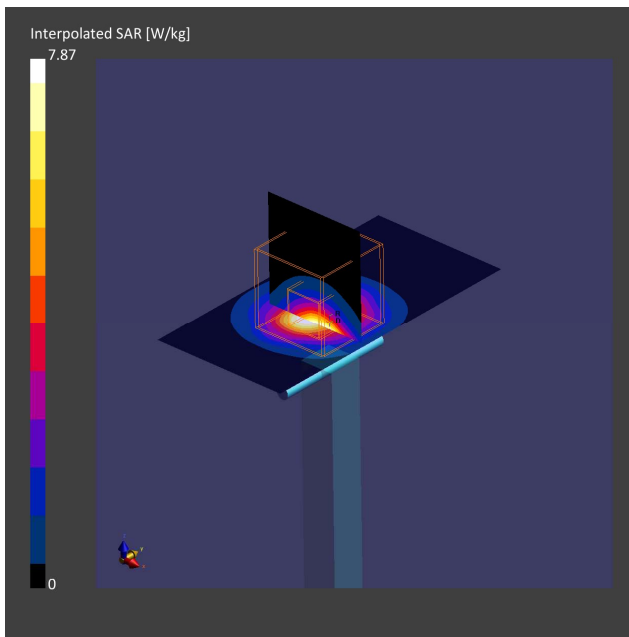

Annex D. TSL Dielectric Parameters

D.1 Body 600MHz-900MHz SAR System 2

			2021-12-13	
Freq. (MHz)	Target		Measured	
	ϵ' (F/m)	σ (S/m)	$\epsilon'1$ (F/m)	$\sigma1$ (S/m)
600	54.02	0.95	52.35	0.9
610	53.97	0.95	52.33	0.9
620	53.93	0.95	52.31	0.91
630	53.89	0.95	52.29	0.91
640	53.85	0.95	52.27	0.91
650	53.81	0.96	52.25	0.92
660	53.77	0.96	52.23	0.92
670	53.73	0.96	52.22	0.92
680	53.69	0.96	52.2	0.93
690	53.66	0.96	52.18	0.93
700	53.62	0.96	52.16	0.93
710	53.59	0.96	52.14	0.94
720	53.55	0.96	52.12	0.94
730	53.52	0.96	52.1	0.94
740	53.49	0.96	52.08	0.95
750	53.46	0.96	52.06	0.95
760	53.43	0.96	52.05	0.95
770	53.4	0.96	52.03	0.96
780	53.38	0.97	52.01	0.96
790	53.35	0.97	52.0	0.96
800	53.33	0.97	51.98	0.97
810	53.31	0.97	51.97	0.97
820	53.29	0.98	51.95	0.97
830	53.27	0.98	51.93	0.98
840	53.25	0.98	51.92	0.98
850	53.23	0.99	51.9	0.98
860	53.21	1.00	51.89	0.99
870	53.2	1.01	51.87	0.99
880	53.18	1.03	51.86	0.99
890	53.17	1.04	51.84	1.0
900	53.16	1.05	51.83	1.0

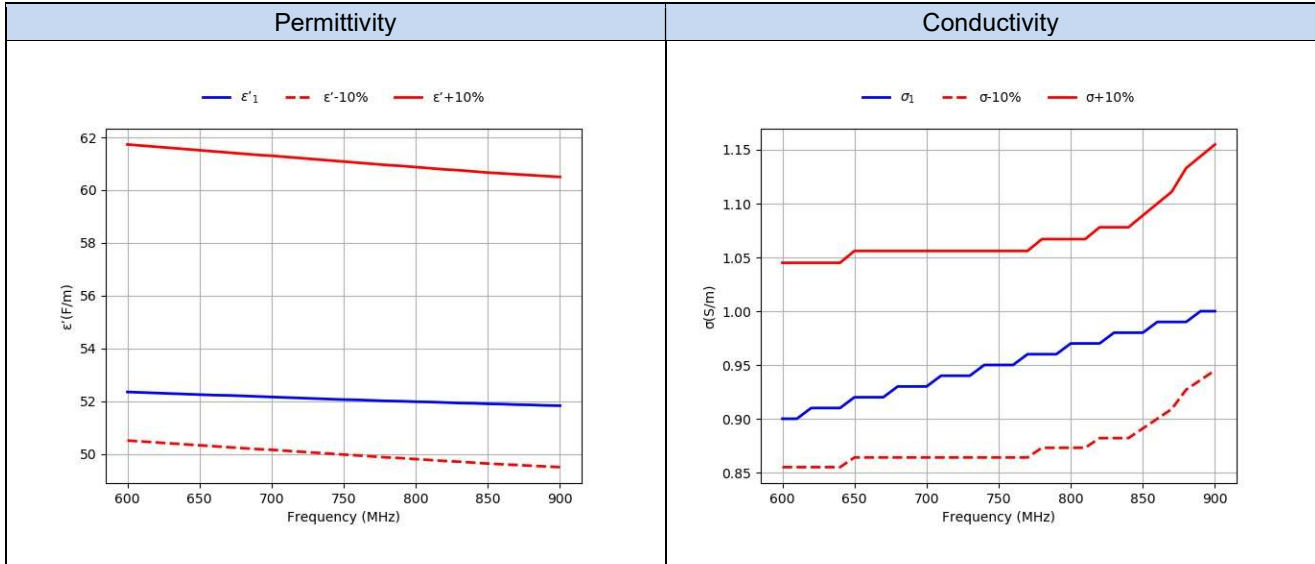

D.2 Body 1700MHz-2000MHz SAR System 2

			2021-12-13	
Freq. (MHz)	Target		Measured	
	ϵ' (F/m)	σ (S/m)	ϵ'_1 (F/m)	σ_1 (S/m)
1700	53.56	1.46	50.77	1.39
1710	53.54	1.46	50.76	1.39
1720	53.51	1.47	50.74	1.4
1730	53.48	1.48	50.73	1.41
1740	53.46	1.48	50.71	1.41
1750	53.43	1.49	50.7	1.42
1760	53.41	1.49	50.69	1.43
1770	53.38	1.5	50.67	1.43
1780	53.35	1.51	50.66	1.44
1790	53.33	1.51	50.65	1.45
1800	53.3	1.52	50.63	1.45
1810	53.3	1.52	50.62	1.46
1820	53.3	1.52	50.61	1.47
1830	53.3	1.52	50.59	1.47
1840	53.3	1.52	50.58	1.48
1850	53.3	1.52	50.56	1.49
1860	53.3	1.52	50.55	1.49
1870	53.3	1.52	50.53	1.5
1880	53.3	1.52	50.52	1.51
1890	53.3	1.52	50.5	1.51
1900	53.3	1.52	50.48	1.52
1910	53.3	1.52	50.47	1.53
1920	53.3	1.52	50.46	1.54
1930	53.3	1.52	50.44	1.54
1940	53.3	1.52	50.43	1.55
1950	53.3	1.52	50.42	1.56
1960	53.3	1.52	50.4	1.56
1970	53.3	1.52	50.39	1.57
1980	53.3	1.52	50.37	1.58
1990	53.3	1.52	50.36	1.59
2000	53.3	1.52	50.35	1.59

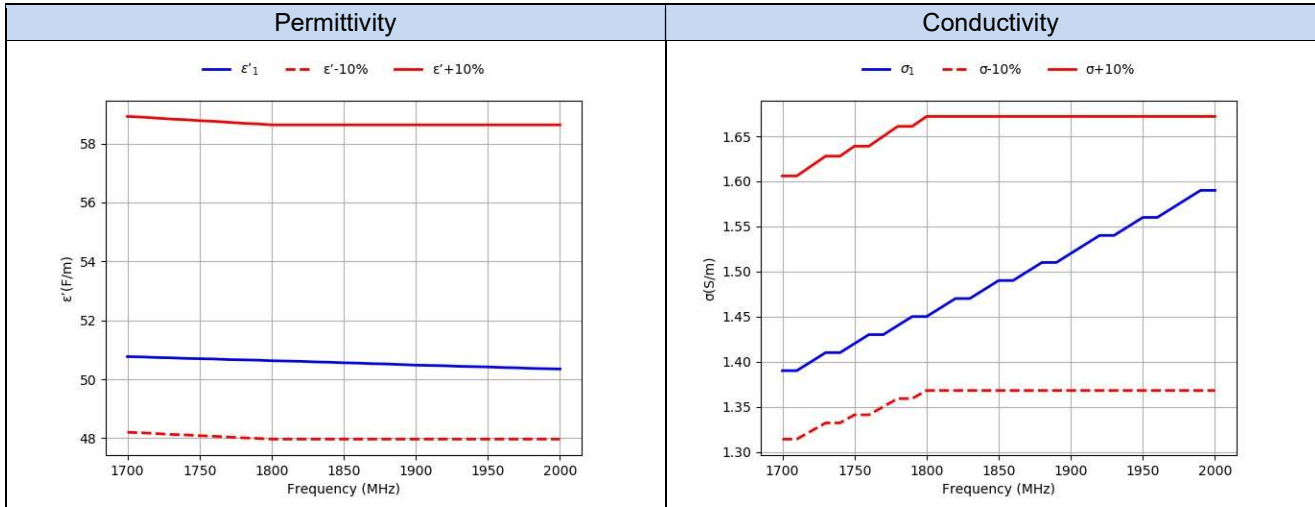

D.3 Body 2300MHz-2700MHz SAR System 2

			2021-12-13	
			Measured	
Target				
Freq.(MHz)	ϵ' (F/m)	σ (S/m)	$\epsilon'1$ (F/m)	$\sigma1$ (S/m)
2300.0	52.9	1.81	49.97	1.84
2310.0	52.89	1.82	49.95	1.84
2320.0	52.87	1.83	49.94	1.85
2330.0	52.86	1.84	49.93	1.86
2340.0	52.85	1.84	49.92	1.87
2350.0	52.83	1.85	49.9	1.88
2360.0	52.82	1.86	49.89	1.89
2370.0	52.81	1.87	49.88	1.9
2380.0	52.79	1.88	49.86	1.91
2390.0	52.78	1.89	49.85	1.92
2400.0	52.77	1.9	49.83	1.92
2410.0	52.75	1.91	49.82	1.93
2420.0	52.74	1.92	49.8	1.94
2430.0	52.73	1.93	49.79	1.95
2440.0	52.71	1.94	49.78	1.96
2450.0	52.7	1.95	49.76	1.97
2460.0	52.69	1.96	49.75	1.98
2470.0	52.67	1.98	49.74	1.99
2480.0	52.66	1.99	49.73	2.0
2490.0	52.65	2.01	49.71	2.01
2500.0	52.64	2.02	49.7	2.02
2510.0	52.62	2.04	49.69	2.03
2520.0	52.61	2.05	49.68	2.04
2530.0	52.6	2.06	49.66	2.05
2540.0	52.59	2.08	49.65	2.06
2550.0	52.57	2.09	49.64	2.06
2560.0	52.56	2.11	49.63	2.07
2570.0	52.55	2.12	49.61	2.08
2580.0	52.53	2.13	49.6	2.09
2590.0	52.52	2.15	49.59	2.1
2600.0	52.51	2.16	49.57	2.11
2610.0	52.5	2.18	49.56	2.12
2620.0	52.48	2.19	49.54	2.13
2630.0	52.47	2.21	49.53	2.14
2640.0	52.46	2.22	49.52	2.15
2650.0	52.45	2.23	49.5	2.16
2660.0	52.43	2.25	49.49	2.17
2670.0	52.42	2.26	49.47	2.18
2680.0	52.41	2.28	49.46	2.19
2690.0	52.39	2.29	49.45	2.2
2700.0	52.38	2.3	49.43	2.21

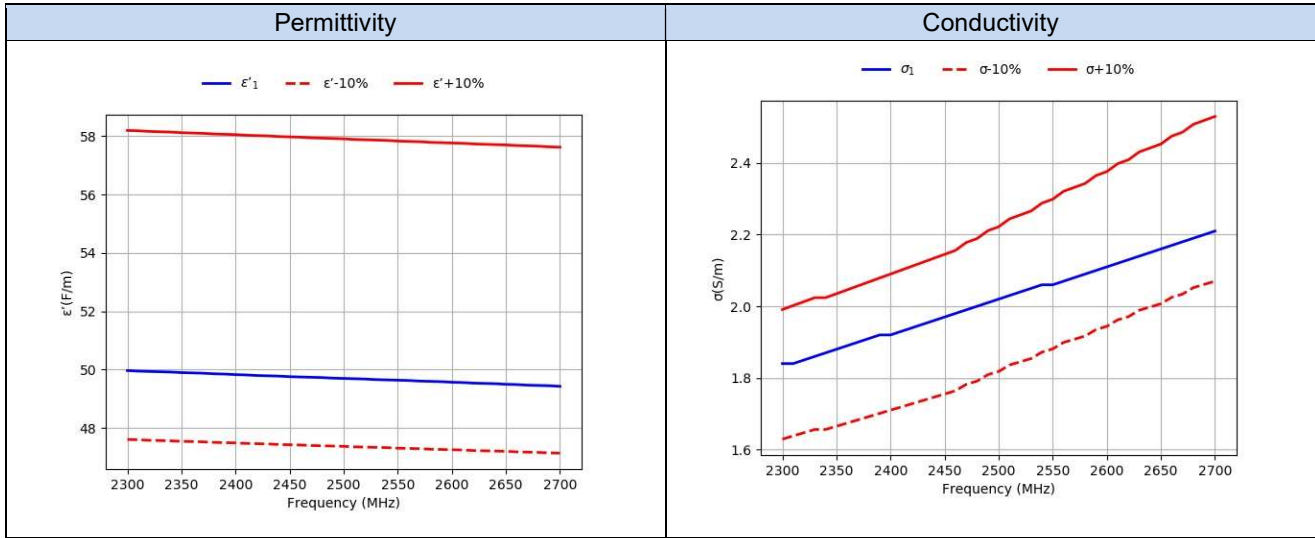

D.4 Body 3500MHz-3900MHz SAR System 2

Freq. (MHz)			2021-12-13	
	Target		Measured	
	ϵ' (F/m)	σ (S/m)	ϵ'_1 (F/m)	σ_1 (S/m)
3550.0	51.25	3.37	47.98	3.08
3560.0	51.24	3.38	47.96	3.09
3570.0	51.23	3.4	47.95	3.1
3580.0	51.21	3.41	47.93	3.12
3590.0	51.2	3.42	47.91	3.13
3600.0	51.19	3.43	47.9	3.14
3610.0	51.17	3.44	47.88	3.15
3620.0	51.16	3.45	47.87	3.16
3630.0	51.15	3.47	47.85	3.17
3640.0	51.13	3.48	47.84	3.18
3650.0	51.12	3.49	47.82	3.19
3660.0	51.1	3.5	47.8	3.21
3670.0	51.09	3.51	47.79	3.22
3680.0	51.08	3.52	47.77	3.23
3690.0	51.06	3.54	47.76	3.24
3700.0	51.05	3.55	47.74	3.25
3710.0	51.04	3.56	47.72	3.26
3720.0	51.02	3.57	47.71	3.27
3730.0	51.01	3.58	47.69	3.28
3740.0	51.0	3.59	47.67	3.3
3750.0	50.98	3.61	47.65	3.31
3760.0	50.97	3.62	47.64	3.32
3770.0	50.95	3.63	47.62	3.33
3780.0	50.94	3.64	47.6	3.34
3790.0	50.93	3.65	47.58	3.36
3800.0	50.91	3.66	47.57	3.37
3810.0	50.9	3.68	47.55	3.38
3820.0	50.89	3.69	47.53	3.39
3830.0	50.87	3.7	47.52	3.41
3840.0	50.86	3.71	47.5	3.42
3850.0	50.85	3.72	47.48	3.43
3860.0	50.83	3.73	47.47	3.45
3870.0	50.82	3.75	47.45	3.46
3880.0	50.81	3.76	47.44	3.47
3890.0	50.79	3.77	47.42	3.49
3900.0	50.78	3.78	47.4	3.5

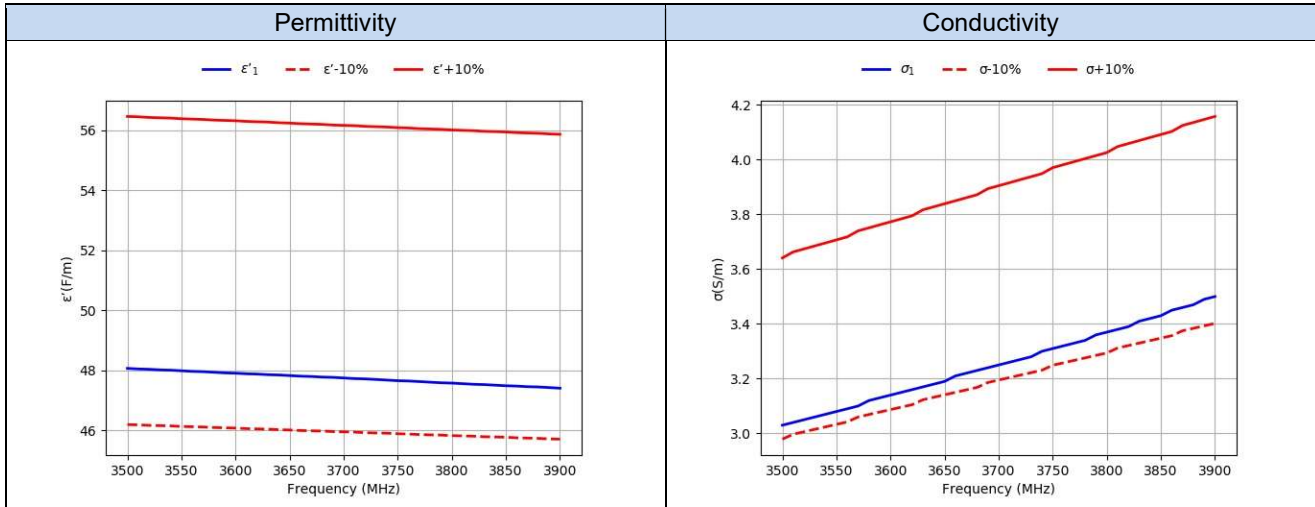

D.5 Body 600MHz-900MHz SAR System 4

Freq. (MHz)	Target		2021-12-09 Measured	
	ϵ' (F/m)	σ (S/m)	$\epsilon'1$ (F/m)	$\sigma1$ (S/m)
	600	56.12	0.95	56.29
610	56.08	0.95	56.26	0.87
620	56.04	0.95	56.23	0.87
630	56.00	0.95	56.19	0.88
640	55.96	0.95	56.16	0.88
650	55.92	0.96	56.13	0.88
660	55.88	0.96	56.10	0.89
670	55.84	0.96	56.08	0.89
680	55.80	0.96	56.05	0.9
690	55.76	0.96	56.02	0.9
700	55.73	0.96	56.00	0.9
710	55.69	0.96	55.97	0.91
720	55.65	0.96	55.95	0.91
730	55.61	0.96	55.94	0.92
740	55.57	0.96	55.92	0.92
750	55.53	0.96	55.90	0.93
760	55.49	0.96	55.88	0.93
770	55.45	0.96	55.86	0.93
780	55.41	0.97	55.85	0.94
790	55.38	0.97	55.83	0.94
800	55.34	0.97	55.80	0.95
810	55.30	0.97	55.78	0.95
820	55.26	0.98	55.75	0.96
830	55.23	0.98	55.73	0.96
840	55.19	0.98	55.70	0.97
850	55.15	0.99	55.68	0.97
860	55.12	1.00	55.65	0.97
870	55.09	1.01	55.63	0.98
880	55.06	1.03	55.61	0.98
890	55.03	1.04	55.58	0.99
900	55.00	1.05	55.56	0.99

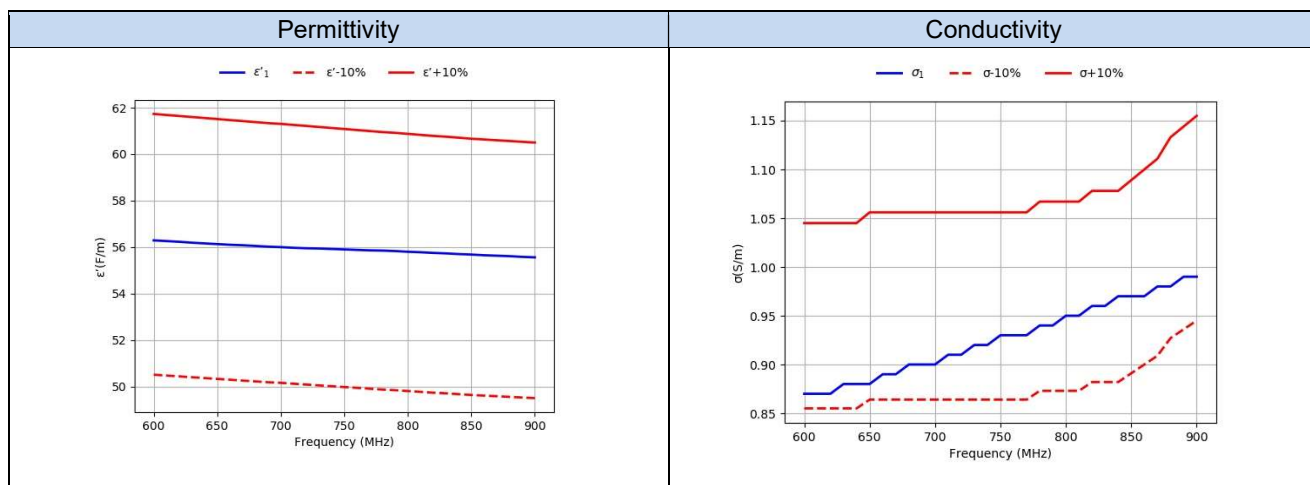

D.6 Body 1700MHz-2000MHz SAR System 4

Freq. (MHz)	Target		2021-12-09		2022-01-17	
			Measured			
	ϵ' (F/m)	σ (S/m)	ϵ'_1 (F/m)	σ_1 (S/m)	ϵ'_2 (F/m)	σ_2 (S/m)
1700	53.56	1.46	54.04	1.42	51.49	1.49
1710	53.54	1.46	54.05	1.42	51.49	1.5
1720	53.51	1.47	54.05	1.43	51.5	1.51
1730	53.48	1.48	54.05	1.44	51.54	1.52
1740	53.46	1.48	54.05	1.45	51.6	1.54
1750	53.43	1.49	54.04	1.45	51.67	1.55
1760	53.41	1.49	54.03	1.46	51.76	1.55
1770	53.38	1.5	54.02	1.47	51.84	1.56
1780	53.35	1.51	54.0	1.47	51.93	1.57
1790	53.33	1.51	53.98	1.48	51.99	1.57
1800	53.3	1.52	53.96	1.48	52.03	1.57
1810	53.3	1.52	53.93	1.49	52.04	1.57
1820	53.3	1.52	53.89	1.49	52.02	1.57
1830	53.3	1.52	53.86	1.5	51.96	1.57
1840	53.3	1.52	53.83	1.5	51.88	1.57
1850	53.3	1.52	53.79	1.51	51.77	1.57
1860	53.3	1.52	53.75	1.51	51.64	1.58
1870	53.3	1.52	53.72	1.52	51.52	1.58
1880	53.3	1.52	53.68	1.52	51.41	1.59
1890	53.3	1.52	53.65	1.53	51.31	1.6
1900	53.3	1.52	53.62	1.54	51.23	1.61
1910	53.3	1.52	53.58	1.54	51.18	1.62
1920	53.3	1.52	53.55	1.55	51.15	1.63
1930	53.3	1.52	53.52	1.55	51.12	1.64
1940	53.3	1.52	53.49	1.56	51.11	1.64
1950	53.3	1.52	53.46	1.57	51.1	1.65
1960	53.3	1.52	53.43	1.58	51.09	1.66
1970	53.3	1.52	53.4	1.59	51.08	1.66
1980	53.3	1.52	53.37	1.59	51.08	1.66
1990	53.3	1.52	53.35	1.6	51.07	1.66
2000	53.3	1.52	53.33	1.61	51.07	1.66

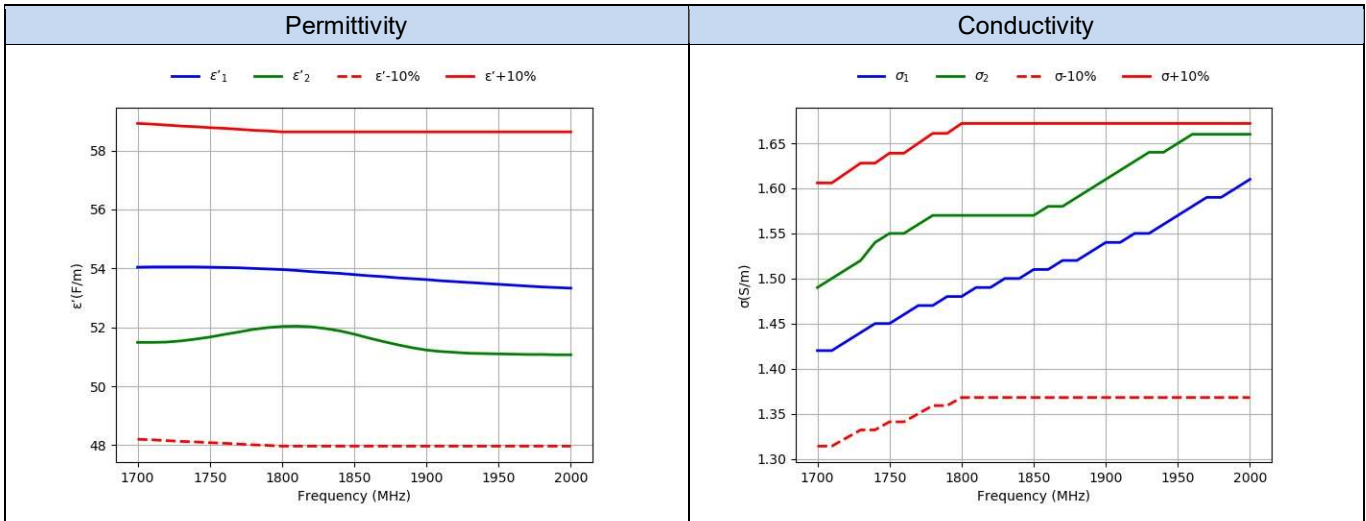

D.7 Body 3500MHz-3900MHz SAR System 4

Freq. (MHz)	Target		2021-12-09 Measured	
	ϵ' (F/m)	σ (S/m)	ϵ'_1 (F/m)	σ_1 (S/m)
	3500	51.32	3.31	50.69
3510	51.31	3.33	50.68	3.06
3520	51.29	3.34	50.66	3.08
3530	51.28	3.35	50.65	3.09
3540	51.27	3.36	50.63	3.10
3550	51.25	3.37	50.62	3.11
3560	51.24	3.38	50.60	3.12
3570	51.23	3.40	50.59	3.13
3580	51.21	3.41	50.57	3.15
3590	51.20	3.42	50.55	3.16
3600	51.19	3.43	50.53	3.17
3610	51.17	3.44	50.51	3.18
3620	51.16	3.45	50.49	3.19
3630	51.15	3.47	50.48	3.21
3640	51.13	3.48	50.46	3.22
3650	51.12	3.49	50.44	3.23
3660	51.10	3.50	50.42	3.24
3670	51.09	3.51	50.40	3.26
3680	51.08	3.52	50.39	3.27
3690	51.06	3.54	50.37	3.28
3700	51.05	3.55	50.36	3.30
3710	51.04	3.56	50.34	3.31
3720	51.02	3.57	50.33	3.32
3730	51.01	3.58	50.31	3.34
3740	51.00	3.59	50.30	3.35
3750	50.98	3.61	50.29	3.36
3760	50.97	3.62	50.27	3.37
3770	50.95	3.63	50.26	3.38
3780	50.94	3.64	50.25	3.40
3790	50.93	3.65	50.23	3.41
3800	50.91	3.66	50.22	3.42
3810	50.90	3.68	50.20	3.43
3820	50.89	3.69	50.19	3.44
3830	50.87	3.70	50.18	3.45
3840	50.86	3.71	50.16	3.46
3850	50.85	3.72	50.15	3.47
3860	50.83	3.73	50.14	3.48
3870	50.82	3.75	50.12	3.49
3880	50.81	3.76	50.10	3.50
3890	50.79	3.77	50.09	3.51
3900	50.78	3.78	50.07	3.52

