



# FCC RF Test Report

**APPLICANT** : Fibocom Wireless Inc.  
**EQUIPMENT** : 5G Module  
**BRAND NAME** : Fibocom  
**MODEL NAME** : FM350-GL  
**FCC ID** : ZMOFM350GL  
**STANDARD** : 47 CFR Part 2, 96  
**CLASSIFICATION** : Citizens Band End User Devices (CBE)  
**EQUIPMENT TYPE** : End User Equipment

The product was received on May 18, 2020 and completely tested on Mar. 22, 2021. We, Sporton International (ShenZhen) Inc., would like to declare that the tested sample has been evaluated in accordance with the procedures given in ANSI C63.26 and shown compliance with the applicable technical standards.

The test results in this report apply exclusively to the tested model / sample. Without written approval of Sporton International (ShenZhen) Inc., the test report shall not be reproduced except in full.

Reviewed by: Derreck Chen / Supervisor

Approved by: Eric Shih / Manager



**Sporton International (ShenZhen) Inc.**

1/F, 2/F, Bldg 5, Shiling Industrial Zone, Xinwei Village, Xili, Nanshan, Shenzhen, 518055  
People's Republic of China



# Table of Contents

History of this test report..... 3

Summary of Test Result..... 4

**1 General Description ..... 5**

    1.1 Applicant..... 5

    1.2 Manufacturer ..... 5

    1.3 Feature of Equipment Under Test..... 5

    1.4 Maximum Conducted Power, Frequency Tolerance, and Emission Designator..... 6

    1.5 Testing Site..... 7

    1.6 Test Software ..... 7

    1.7 Applied Standards ..... 8

**2 Test Configuration of Equipment Under Test ..... 9**

    2.1 Test Mode..... 9

    2.2 Connection Diagram of Test System ..... 10

    2.3 Support Unit used in test configuration ..... 11

    2.4 Measurement Results Explanation Example ..... 11

    2.5 Frequency List of Low/Middle/High Channels..... 11

**3 Conducted Test Items..... 13**

    3.1 Measuring Instruments..... 13

    3.2 Conducted Output Power ..... 14

    3.3 EIRP and PSD..... 15

    3.4 Occupied Bandwidth ..... 16

    3.5 Conducted Band Edge ..... 17

    3.6 Conducted Spurious Emission ..... 18

    3.7 Frequency Stability..... 19

**4 Radiated Test Items ..... 20**

    4.1 Measuring Instruments..... 20

    4.2 Test Setup ..... 20

    4.3 Test Result of Radiated Test..... 20

    4.4 Radiated Spurious Emission ..... 21

**5 List of Measuring Equipment..... 22**

**6 Uncertainty of Evaluation..... 23**

**Appendix A. Test Results of Conducted Test**

**Appendix B. Test Results of EIRP and Radiated Test**

**Appendix C. Test Setup Photographs**



## History of this test report

Report No.	Version	Description	Issued Date
FG051802F	01	Initial issue of report	Apr. 02, 2021



### Summary of Test Result

Report Clause	Ref Std. Clause	Test Items	Result (PASS/FAIL)	Remark
3.2	§2.1046	Conducted Output Power	Reporting only	-
-	§96.41	Peak-to-Average Ratio	Not Required	Not applicable for End User Devices
3.3	§96.41	Maximum E.I.R.P	Pass	-
		Maximum Power Spectral Density	Not Required	Not applicable for End User Devices
3.4	§2.1049 §96.41	Occupied Bandwidth	Reporting only	-
3.5	§2.1051 §96.41	Conducted Band Edge Measurement Adjacent Channel Leakage Ratio	Pass	-
3.6	§2.1051 §96.41	Conducted Spurious Emission	Pass	
3.7	§2.1055	Frequency Stability for Temperature & Voltage	Pass	-
4.4	§2.1051 §96.41	Radiated Spurious Emission	Pass	Under limit 8.45 dB at 14424.400 MHz

**Declaration of Conformity:**

The test results with all measurement uncertainty excluded are presented in accordance with the regulation limits or requirements declared by manufacturers.

**Comments and Explanations:**

The declared of product specification for EUT presented in the report are provided by the manufacturer, and the manufacturer takes all the responsibilities for the accuracy of product specification.



# 1 General Description

## 1.1 Applicant

**Fibocom Wireless Inc.**

1101, Tower A, Building 6, Shenzhen International Innovation Valley, Dashi 1st Rd, Nanshan, Shenzhen, China

## 1.2 Manufacturer

**Fibocom Wireless Inc.**

1101, Tower A, Building 6, Shenzhen International Innovation Valley, Dashi 1st Rd, Nanshan, Shenzhen, China

## 1.3 Feature of Equipment Under Test

Product Feature	
Equipment	5G Module
Brand Name	Fibocom
Model Name	FM350-GL
FCC ID	ZMOFM350GL
Tx Frequency	LTE Band 48: 3550 MHz ~ 3700 MHz
Rx Frequency	LTE Band 48: 3550 MHz ~ 3700 MHz
Bandwidth	5MHz / 10MHz / 15MHz / 20MHz
Maximum Output Power to Antenna	LTE Band 48: 21.32 dBm LTE Band 48_CA: 21.60 dBm
Antenna Gain	LTE Band 48 : 1.0 dBi
Type of Modulation	QPSK / 16QAM / 64QAM / 256QAM
IMEI Code	Conducted: 862146050034535 Radiation: 882146050002276
HW Version	V1.0.6
SW Version	81600.0000.00.09.03.03
EUT Stage	Identical Prototype

**Remark:**

The above EUT's information was declared by manufacturer. Please refer to the specifications or user's manual for more detailed description.



### 1.4 Maximum Conducted Power, Frequency Tolerance, and Emission Designator

LTE Band 48		QPSK			16QAM		
BW (MHz)	Frequency Range (MHz)	Emission Designator (99%OBW)	Frequency Tolerance (ppm)	Maximum Conducted power (W)	Emission Designator (99%OBW)	Frequency Tolerance (ppm)	Maximum Conducted power (W)
5	3552.5~3697.5	4M51G7D	-	0.1321	4M51W7D	-	0.1321
10	3555~3695	9M03G7D	0.0004	0.1303	9M07W7D	-	0.1312
15	3557.5~3692.5	13M4G7D	-	0.1312	13M5W7D	-	0.1318
20	3560~3690	17M9G7D	-	0.1355	17M9W7D	-	0.1327
LTE Band 48		64QAM					
BW (MHz)	Frequency Range (MHz)	Emission Designator (99%OBW)	Frequency Tolerance (ppm)	Maximum Conducted power (W)			
5	3552.5~3697.5	4M51W7D	-	0.1321			
10	3555~3695	9M03W7D	-	0.1321			
15	3557.5~3692.5	13M5W7D	-	0.1318			
20	3560~3690	17M9W7D	-	0.1321			

LTE Band 48 CA		QPSK			16QAM		
BW (MHz) Frequency (MHz)	Emission Designator (99%OBW)	Frequency Tolerance (ppm)	Maximum Conducted power (W)	Emission Designator (99%OBW)	Frequency Tolerance (ppm)	Maximum Conducted power (W)	
5MHz+20MHz	23M4G7D	-	0.1413	23M4W7D	-	0.1426	
10MHz+20MHz	28M0G7D	-	0.1406	28M0W7D	-	0.1419	
15MHz+20MHz	33M2G7D	-	0.1435	32M8W7D	-	0.1409	
20MHz+5MHz	23M3G7D	-	0.1422	23M3W7D	-	0.1416	
20MHz+10MHz	28M1G7D	-	0.1416	28M1W7D	-	0.1432	
20MHz+15MHz	33M1G7D	-	0.1429	32M9W7D	-	0.1445	
20MHz+20MHz	37M7G7D	-	0.1413	37M9W7D	-	0.1435	
LTE Band 48C		64QAM					
BW (MHz) Frequency (MHz)	Emission Designator (99%OBW)	Frequency Tolerance (ppm)	Maximum Conducted power (W)				
5MHz+20MHz	23M3W7D	-	0.1429				
10MHz+20MHz	28M1W7D	-	0.1400				
15MHz+20MHz	32M9W7D	-	0.1426				
20MHz+5MHz	23M3W7D	-	0.1422				
20MHz+10MHz	28M2W7D	-	0.1426				



20MHz+15MHz	32M8W7D	-	0.1432
20MHz+20MHz	37M8W7D	-	0.1419

### 1.5 Testing Site

Sporton International (Shenzhen) Inc. is accredited to ISO/IEC 17025:2017 by American Association for Laboratory Accreditation with Certificate Number 5145.01.

<b>Test Firm</b>	Sporton International (Shenzhen) Inc.		
<b>Test Site Location</b>	1/F, 2/F, Bldg 5, Shiling Industrial Zone, Xinwei Village, Xili, Nanshan, Shenzhen, 518055 People's Republic of China TEL: +86-755-86379589 FAX: +86-755-86379595		
<b>Test Site No.</b>	<b>Sporton Site No.</b>	<b>FCC Designation No.</b>	<b>FCC Test Firm Registration No.</b>
	TH01-SZ	CN1256	421272

<b>Test Firm</b>	Sporton International (Shenzhen) Inc.		
<b>Test Site Location</b>	101, 1st Floor, Block B, Building 1, No. 2, Tengfeng 4th Road, Fenghuang Community, Fuyong Street, Baoan District, Shenzhen City Guangdong Province China 518103 TEL: +86-755-33202398		
<b>Test Site No.</b>	<b>Sporton Site No.</b>	<b>FCC Designation No.</b>	<b>FCC Test Firm Registration No.</b>
	03CH03-SZ	CN1256	421272

### 1.6 Test Software

Item	Site	Manufacturer	Name	Version
1.	03CH03-SZ	AUDIX	E3	6.2009-8-24



## **1.7 Applied Standards**

According to the specifications of the manufacturer, the EUT must comply with the requirements of the following standards:

- ♦ ANSI C63.26-2015
- ♦ ANSI / TIA-603-E
- ♦ 47 CFR Part 2, 96
- ♦ FCC KDB 971168 D01 Power Meas. License Digital Systems v03r01
- ♦ FCC KDB 940660 D01 Part 96 CBRS v03
- ♦ FCC KDB 412172 D01 Determining ERP and EIRP v01r01

### **Remark:**

1. All test items were verified and recorded according to the standards and without any deviation during the test.
2. This EUT has also been tested and complied with the requirements of FCC Part 15, Subpart B, recorded in a separate test report.





## 2 Test Configuration of Equipment Under Test

### 2.1 Test Mode

Antenna port conducted and radiated test items listed below are performed according to KDB 971168 D01 Power Meas. License Digital Systems v03r01 with maximum output power.

For radiated measurement, pre-scanned in three orthogonal panels, X, Y, Z. The worst cases (X plane) were recorded in this report.

Test Items	Band	Bandwidth (MHz)						Modulation				RB #			Test Channel			
		1.4	3	5	10	15	20	QPSK	16QAM	64QAM	256QAM	1	Half	Full	L	M	H	
Max. Output Power	48	-	-	v	v	v	v	v	v	v	v	v	v	v	v	v	v	
26dB and 99% Bandwidth	48	-	-	v	v	v	v	v	v	v				v	v	v	v	
Conducted Band Edge	48	-	-	v	v	v	v	v	v	v			v	v	v	v	v	
Conducted Spurious Emission	48	-	-	v	v	v	v	v	v	v			v	v	v	v	v	
E.R.P / E.I.R.P	48	-	-	v	v	v	v	v	v	v			v			v	v	v
Frequency Stability	48	-	-		v			v	v	v			v				v	
Radiated Spurious Emission	48	Worst Case												v	v	v		
Remark	<ol style="list-style-type: none"> <li>The mark "v" means that this configuration is chosen for testing</li> <li>The mark "-" means that this bandwidth is not supported.</li> <li>The device is investigated from 30MHz to 10 times of fundamental signal for radiated spurious emission test under different RB size/offset and modulations in exploratory test. Subsequently, only the worst case emissions are reported.</li> <li>For modulation of 256QAM, the maximum power of 256QAM is lower than other modulation (QPSK/16QAM/64QAM), therefore, according to engineering evaluation, we choose higher power (QPSK/16QAM/64QAM) to perform all tests and show in the report.</li> </ol>																	

Test Items	Band	Bandwidth (MHz)							Modulation				RB #			Test Channel		
		20+20	20+15	15+20	20+10	10+20	20+5	5+20	QPSK	16QAM	64QAM	256QAM	1	Half	Full	L	M	H
Max. Output Power	48C	v	v	v	v	v	v	v	v	v	v	v	v		v	v	v	v
26dB and 99% Bandwidth	48C	v	v	v	v	v	v	v	v	v	v		v				v	v
Conducted Band Edge	48C	v	v	v	v	v	v	v	v	v	v		v			v	v	v
Conducted Spurious Emission	48C	v	v	v	v	v	v	v	v	v	v		v		v	v	v	v
E.R.P / E.I.R.P	48C	v	v	v	v	v	v	v	v	v	v		v			v	v	v
Radiated Spurious Emission	48C	Worst Case															v	
Note	<ol style="list-style-type: none"> <li>The mark "v" means that this configuration is chosen for testing</li> <li>The mark "-" means that this bandwidth is not supported.</li> <li>The device is investigated from 30MHz to 10 times of fundamental signal for radiated spurious emission test under different RB size/offset and modulations in exploratory test. Subsequently, only the worst case emissions are reported.</li> <li>For modulation of 256QAM, the maximum power of 256QAM is lower than other modulation (QPSK/16QAM/64QAM), therefore, according to engineering evaluation, we choose higher power (QPSK/16QAM/64QAM) to perform all tests and show in the report.</li> </ol>																	

## 2.2 Connection Diagram of Test System

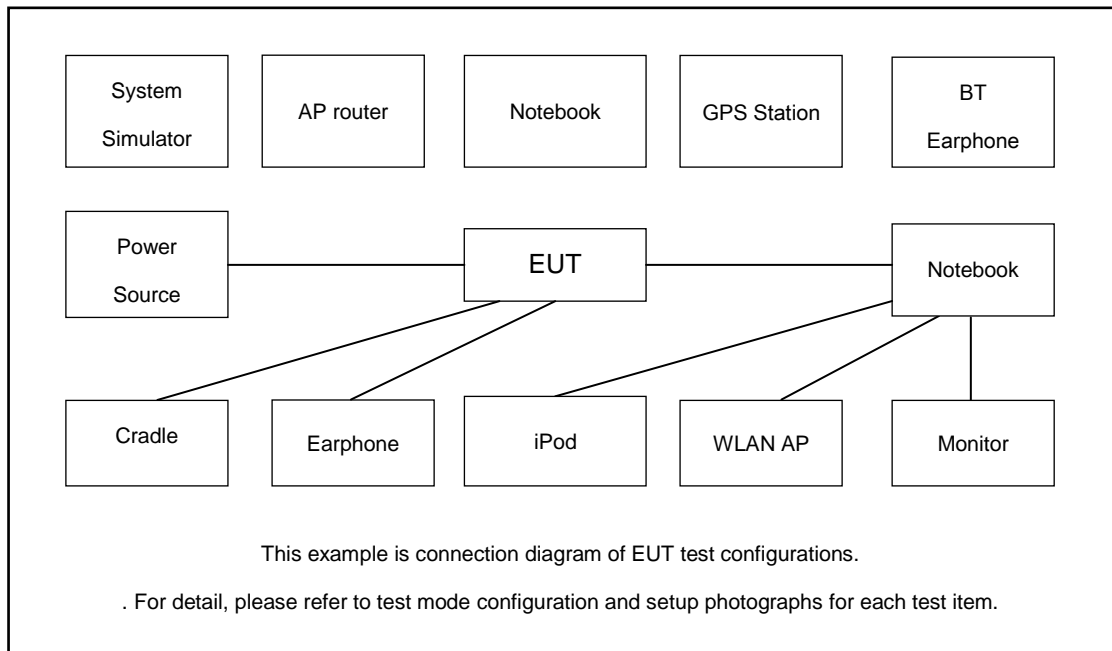

### 2.3 Support Unit used in test configuration

Item	Equipment	Trade Name	Model No.	FCC ID	Data Cable	Power Cord
1.	Power Supply	GWINSTEK	PSS-2002	N/A	N/A	Unshielded, 1.8 m
2.	LTE Base Station	Anritsu	MT8820C	N/A	N/A	Unshielded, 1.8 m
3.	Test jig	N/A	N/A	N/A	N/A	N/A

### 2.4 Measurement Results Explanation Example

For all conducted test items:

The offset level is set in the spectrum analyzer to compensate the RF cable loss and attenuator factor between EUT conducted output port and spectrum analyzer. With the offset compensation, the spectrum analyzer reading level is exactly the EUT RF output level.

The spectrum analyzer offset is derived from RF cable loss and attenuator factor.

$$\text{Offset} = \text{RF cable loss} + \text{attenuator factor}.$$

Following shows an offset computation example with cable loss 9.5 dB and 10dB attenuator.

Example :

$$\begin{aligned} \text{Offset(dB)} &= \text{RF cable loss(dB)} + \text{attenuator factor(dB)}. \\ &= 9.5 + 10 = 19.5 \text{ (dB)} \end{aligned}$$

### 2.5 Frequency List of Low/Middle/High Channels

LTE Band 48 Channel and Frequency List				
BW [MHz]	Channel/Frequency(MHz)	Lowest	Middle	Highest
20	Channel	55340	55990	56640
	Frequency	3560.0	3625.0	3690.0
15	Channel	55315	55990	56665
	Frequency	3557.5	3625.0	3692.5
10	Channel	55290	55990	56690
	Frequency	3555.0	3625.0	3695.0
5	Channel	55265	55990	56715
	Frequency	3552.5	3625.0	3697.5



LTE Band 48C_CA Channel and Frequency List					
BW [MHz]	Channel/Frequency(MHz)		Lowest	Middle	Highest
5 + 20	PCC	Channel	55273	55898	56523
		Frequency	3553.3	3615.8	3678.3
	SCC	Channel	55390	56015	56640
		Frequency	3565	3627.5	3690
20 + 5	PCC	Channel	55340	55965	56590
		Frequency	3560	3622.5	3685
	SCC	Channel	55457	56082	56707
		Frequency	3571.7	3634.2	3696.7
10 + 20	PCC	Channel	55295	55896	56496
		Frequency	3555.5	3615.6	3675.6
	SCC	Channel	55439	56040	56640
		Frequency	3569.9	3630	3690
20 + 10	PCC	Channel	55340	55941	56541
		Frequency	3560	3620.1	3680.1
	SCC	Channel	55484	56085	56685
		Frequency	3574.4	3634.5	3694.5
15 + 20	PCC	Channel	55318	55893	56469
		Frequency	3557.8	3615.3	3672.9
	SCC	Channel	55489	56064	56640
		Frequency	3574.9	3632.4	3690
20 + 15	PCC	Channel	55340	55916	56491
		Frequency	3560	3617.6	3675.1
	SCC	Channel	55511	56087	56662
		Frequency	3577.1	3634.7	3692.2
20 + 20	PCC	Channel	55340	55891	56442
		Frequency	3560	3615.1	3670.2
	SCC	Channel	55538	56089	56640
		Frequency	3579.8	3634.9	3690

### 3 Conducted Test Items

#### 3.1 Measuring Instruments

See list of measuring instruments of this test report.

##### 3.1.1 Test Setup

##### 3.1.2 Conducted Output Power



##### 3.1.3 Occupied Bandwidth, Conducted Band-Edge and Conducted Spurious Emission

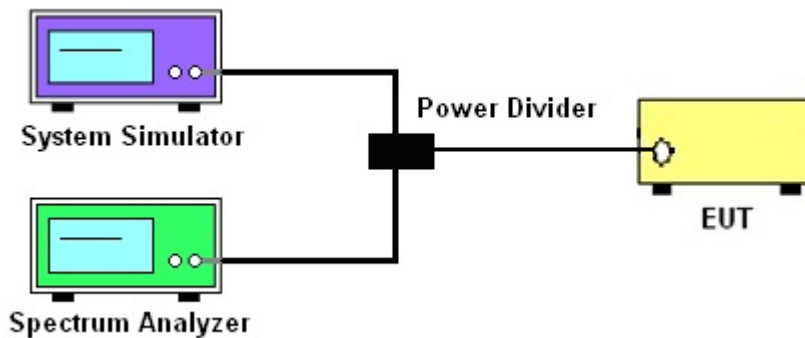

##### 3.1.4 Frequency Stability

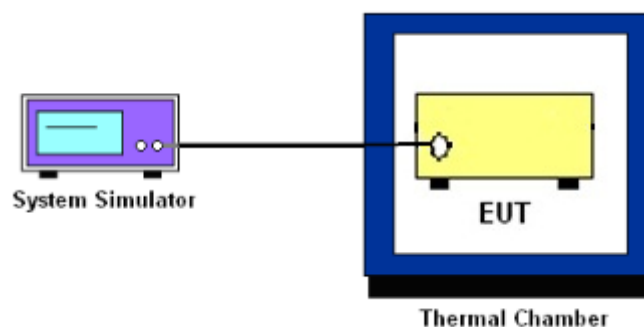

##### 3.1.5 Test Result of Conducted Test

Please refer to Appendix A.



## 3.2 Conducted Output Power

### 3.2.1 Description of the Conducted Output Power Measurement

A system simulator was used to establish communication with the EUT. Its parameters were set to force the EUT transmitting at maximum output power. The measured power in the radio frequency on the transmitter output terminals shall be reported.

### 3.2.2 Test Procedures

1. The transmitter output port was connected to the system simulator.
2. Set EUT at maximum power through the system simulator.
3. Select lowest, middle, and highest channels for each band and different modulation.
4. Measure and record the power level from the system simulator.

### 3.3 EIRP and PSD

#### 3.3.1 Description of the EIRP and PSD Measurement

EIRP and PSD limits for CBRS equipment as below table:

Device		Maximum EIRP (dBm/10 MHz)	Maximum PSD (dBm/MHz)
Applied	End User Device	23	n/a
<input type="checkbox"/>	Category A CBSD	30	20
<input type="checkbox"/>	Category B CBSD	47	37

**Remark:**

1. The worst case EIRP shown in this section is found with LTE operating only using 1RB. As such, the EIRP/10MHz and full channel EIRP values will be identical since 1RB is fully contained within all available channel bandwidths for LTE Band 48 (i.e. 5, 10, 15, 20MHz)

#### 3.3.2 Test Procedures for EIRP

1. Establishing a communications link with the call box (Base station) to measure the Maximum conducted power, the parameters were set to force the EUT transmitting at maximum output power level. Use the average power measurement function to measure total channel power of each channel bandwidth (per ANSI C63.26-2015 Section 5.2.1)
2. Determining ERP and/or EIRP from conducted RF output power measurements (Per ANSI C63.26-2015 Section 5.2.5.5)
 

$EIRP = P_T + G_T - L_C$ ,  $ERP = EIRP - 2.15$ , where  
 $P_T$  = transmitter output power in dBm  
 $G_T$  = gain of the transmitting antenna in dBi  
 $L_C$  = signal attenuation in the connecting cable between the transmitter and antenna in dB



### 3.4 Occupied Bandwidth

#### 3.4.1 Description of Occupied Bandwidth Measurement

The occupied bandwidth is the width of a frequency band such that, below the lower and above the upper frequency limits, the mean powers emitted are each equal to a specified percentage 0.5% of the total mean transmitted power.

The 26 dB emission bandwidth is defined as the frequency range between two points, one above and one below the carrier frequency, at which the spectral density of the emission is attenuated 26 dB below the maximum in-band spectral density of the modulated signal. Spectral density (power per unit bandwidth) is to be measured with a detector of resolution bandwidth equal to approximately 1.0% of the emission bandwidth.

#### 3.4.2 Test Procedures

The testing follows ANSI C63.26-2015 Section 5.4.3 (26dB) and Section 5.4.4 (99OB)

1. The EUT was connected to spectrum analyzer and system simulator via a power divider.
2. The spectrum analyzer center frequency is set to the nominal EUT channel center frequency. The span range for the spectrum analyzer shall be between two and five times the anticipated OBW.
3. The nominal resolution bandwidth (RBW) shall be in the range of 1 to 5 % of the anticipated OBW, and the VBW shall be at least 3 times the RBW.
4. Set the detection mode to peak, and the trace mode to max hold.
5. Determine the reference value: Set the EUT to transmit a modulated signal. Allow the trace to stabilize. Set the spectrum analyzer marker to the highest level of the displayed trace.  
(this is the reference value)
6. Determine the “-26 dB down amplitude” as equal to (Reference Value – X).
7. Place two markers, one at the lowest and the other at the highest frequency of the envelope of the spectral display such that each marker is at or slightly below the “-X dB down amplitude” determined in step 6. If a marker is below this “-X dB down amplitude” value it shall be placed as close as possible to this value. The OBW is the positive frequency difference between the two markers.
8. Use the 99 % power bandwidth function of the spectrum analyzer and report the measured bandwidth.





### 3.5 Conducted Band Edge

#### 3.5.1 Description of Conducted Band Edge Measurement

Part 96.41 (e) (1) (i)

For CBSD the emission limits outside the fundamental are as follows:

Within 0 MHz to 10 MHz above and below the assigned channel  $\leq -13$  dBm/MHz

Greater than 10 MHz above and below the assigned channel  $\leq -25$  dBm/MHz

Part 96.41 (e) (1) (ii)

For End User Devices the emission limits outside the fundamental are as follows:

Within 0 MHz to B MHz above and below the assigned channel  $\leq -13$  dBm/MHz

Greater than B MHz above and below the assigned channel  $\leq -25$  dBm/MHz

where B is the bandwidth in megahertz of the assigned channel or multiple contiguous channels of the End User Device.

Notwithstanding the emission limits in this paragraph, the Adjacent Channel Leakage Ratio for End User Devices shall be at least 30 dB.

Part 96.41 (e) (2)

For CBSDs and End User Devices, the conducted power of emissions below 3540 MHz or above 3710 MHz shall not exceed  $-25$  dBm/MHz, and the conducted power of emissions below 3530 MHz or above 3720 MHz shall not exceed  $-40$ dBm/MHz

#### 3.5.2 Test Procedures

The testing follows FCC KDB 971168 D01 v03r01 Section 6.1.

1. The EUT was connected to spectrum analyzer and system simulator via a power divider.
2. The band edges of low and high channels for the highest RF powers were measured.
3. Set RBW  $\geq 1\%$  EBW in the 1MHz band immediately outside and adjacent to the band edge.
4. Beyond the 1 MHz band from the band edge, RBW=1MHz was used
5. Offset has included the duty factor for LTE Band 48. Duty factor  $=10 \log (1/x)$ , where x is the measured duty cycle.
6. Set spectrum analyzer with RMS detector.
7. The RF fundamental frequency should be excluded against the limit line in the operating frequency band.



## 3.6 Conducted Spurious Emission

### 3.6.1 Description of Conducted Spurious Emission Measurement

96.41 (e)(2)

The conducted power of any emissions below 3530 MHz or above 3720 MHz shall not exceed -40dBm/MHz.

### 3.6.2 Test Procedures

The testing follows FCC KDB 971168 D01 v03r01 Section 6.1.

1. The EUT was connected to spectrum analyzer and system simulator via a power divider.
2. The RF output of EUT was connected to the spectrum analyzer by RF cable and attenuator. The path loss was compensated to the results for each measurement.
3. The middle channel for the highest RF power within the transmitting frequency was measured.
4. The conducted spurious emission for the whole frequency range was taken.
5. Make the measurement with the spectrum analyzer's RBW = 1MHz, VBW = 3MHz.
6. Set spectrum analyzer with RMS detector.
7. Taking the record of maximum spurious emission.
8. The RF fundamental frequency should be excluded against the limit line in the operating frequency band.
9. The limit line is -40dBm/MHz.

## 3.7 Frequency Stability

### 3.7.1 Description of Frequency Stability Measurement

The frequency stability shall be measured by variation of ambient temperature and variation of primary supply voltage to ensure that the fundamental emission stays within the authorized frequency block. The frequency stability of the transmitter shall be maintained within  $\pm 0.00025\%$  ( $\pm 2.5\text{ppm}$ ) of the center frequency

### 3.7.2 Test Procedures for Temperature Variation

The testing follows FCC KDB 971168 D01 v03r01 Section 9.0.

1. The EUT was set up in the thermal chamber and connected with the system simulator.
2. With power OFF, the temperature was decreased to  $-30^{\circ}\text{C}$  and the EUT was stabilized before testing. Power was applied and the maximum change in frequency was recorded within one minute.
3. With power OFF, the temperature was raised in  $10^{\circ}\text{C}$  step up to  $50^{\circ}\text{C}$ . The EUT was stabilized at each step for at least half an hour. Power was applied and the maximum frequency change was recorded within one minute.

### 3.7.3 Test Procedures for Voltage Variation

The testing follows FCC KDB 971168 D01 v03r01 Section 9.0.

1. The EUT was placed in a temperature chamber at  $25\pm 5^{\circ}\text{C}$  and connected with the system simulator.
2. The power supply voltage to the EUT was varied from 85% to 115% of the nominal value measured at the input to the EUT.
3. The variation in frequency was measured for the worst case.

## 4 Radiated Test Items

### 4.1 Measuring Instruments

See list of measuring instruments of this test report.

### 4.2 Test Setup

For radiated emissions from 30MHz to 1GHz

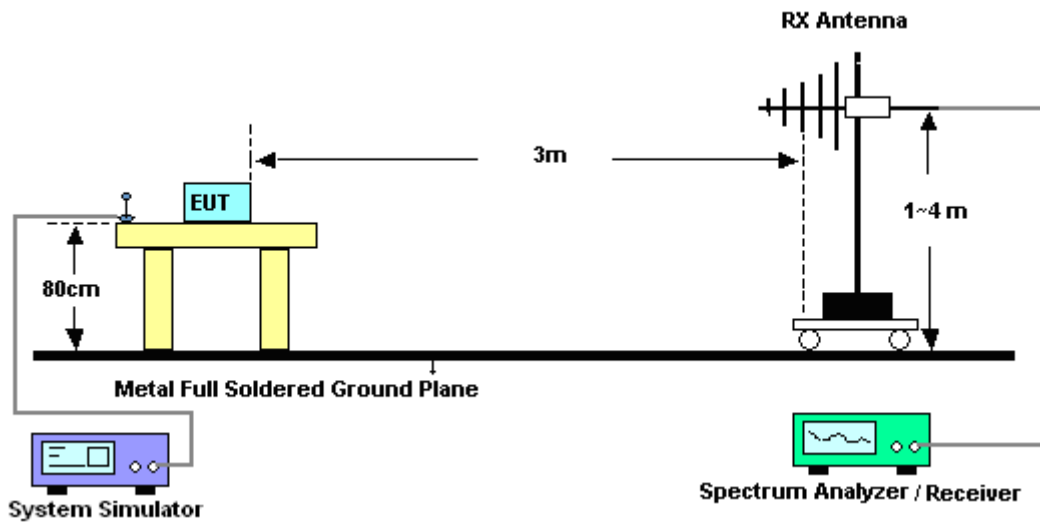

For radiated emissions above 1GHz

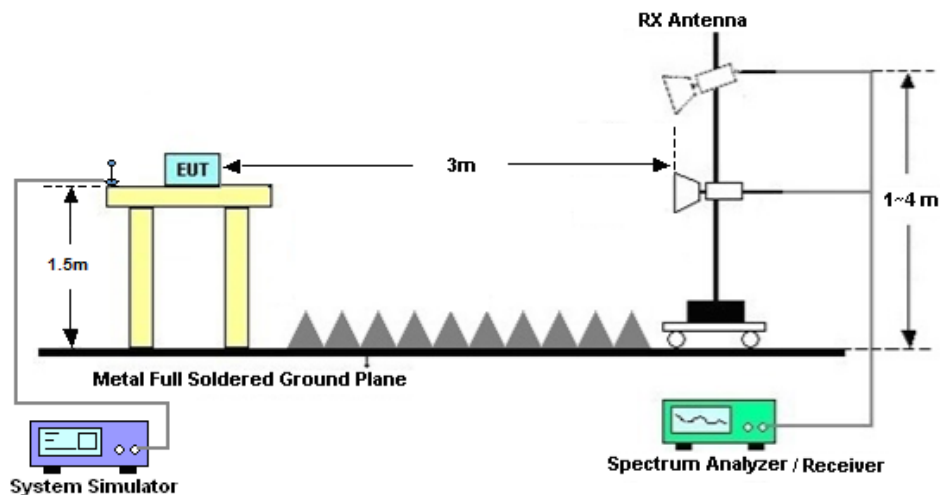

### 4.3 Test Result of Radiated Test

Please refer to Appendix B.



## 4.4 Radiated Spurious Emission

### 4.4.1 Description of Radiated Spurious Emission Measurement

The radiated spurious emission was measured by substitution method according to ANSI / TIA-603-E. The power of any emission outside of the authorized operating frequency ranges must be attenuated below the transmitter power (P) by a factor of at least -40dBm / MHz. The spectrum is scanned from 30 MHz up to a frequency including its 10th harmonic.

### 4.4.2 Test Procedures

1. The EUT was placed on a turntable with 0.8 meter height for frequency below 1GHz and 1.5 meter height for frequency above 1GHz respectively above ground.
2. The EUT was set 3 meters from the receiving antenna mounted on the antenna tower.
3. The table was rotated 360 degrees to determine the position of the highest spurious emission.
4. The height of the receiving antenna is varied between 1m to 4m to search the maximum spurious emission for both horizontal and vertical polarizations.
5. During the measurement, the system simulator parameters were set to force the EUT transmitting at maximum output power.
6. Make the measurement with the spectrum analyzer's RBW = 1MHz, VBW = 3MHz, taking the record of maximum spurious emission.
7. A horn antenna was substituted in place of the EUT and was driven by a signal generator. Tune the output power of signal generator to the same emission level with EUT maximum spurious emission.  
$$\text{EIRP (dBm)} = \text{S.G. Power} - \text{Tx Cable Loss} + \text{Tx Antenna Gain}$$
$$\text{ERP (dBm)} = \text{EIRP} - 2.15$$
8. The RF fundamental frequency should be excluded against the limit line in the operating frequency band.  
The limit line is -40dBm/MHz



## 5 List of Measuring Equipment

Instrument	Manufacturer	Model No.	Serial No.	Characteristics	Calibration Date	Test Date	Due Date	Remark
Spectrum Analyzer	R&S	FSV40	101078	10Hz~40GHz	Apr. 17, 2020	Dec. 19, 2020~Mar. 22, 2021	Apr. 16, 2021	Conducted (TH01-SZ)
Thermal Chamber	Ten Billion Hongzhangroup	LP-150U	H2014081803	-40~+150°C	Jul. 22, 2020	Dec. 19, 2020~Mar. 22, 2021	Jul. 21, 2021	Conducted (TH01-SZ)
EMI Test Receiver&SA	KEYSIGHT	N9038A	MY54450083	20Hz~8.4GHz	Apr. 17, 2020	Jan. 19, 2021	Apr. 16, 2021	Radiation (03CH03-SZ)
EXA Spectrum Analyzer	KEYSIGHT	N9010A	MY55150246	10Hz~44GHz;	Apr. 17, 2020	Jan. 19, 2021	Apr. 16, 2021	Radiation (03CH03-SZ)
Bilog Antenna	TeseQ	CBL6112D	35408	30MHz-2GHz	Jun. 22, 2020	Jan. 19, 2021	Jun. 21, 2021	Radiation (03CH03-SZ)
Double Ridge Horn Antenna	SCHWARZBECK	BBHA9120D	9120D-1355	1GHz~18GHz	Apr. 30, 2020	Jan. 19, 2021	Apr. 29, 2021	Radiation (03CH03-SZ)
Amplifier	Burgeon	BPA-530	102210	0.01Hz ~3000MHz	Oct. 17, 2019	Jan. 19, 2021	Oct. 16, 2021	Radiation (03CH03-SZ)
HF Amplifier	MITEQ	TTA1840-35-HG	1871923	18GHz~40GHz	Jul. 21, 2020	Jan. 19, 2021	Jul. 20, 2021	Radiation (03CH03-SZ)
SHF-EHF Horn	com-power	AH-840	101071	18Ghz-40GHz	Apr. 23, 2020	Jan. 19, 2021	Apr. 22, 2021	Radiation (03CH03-SZ)
Amplifier	Agilent Technologies	83017A	MY39501302	500MHz~26.5GHz	Dec. 25, 2020	Jan. 19, 2021	Dec. 24, 2021	Radiation (03CH03-SZ)
AC Power Source	Chroma	61601	616010001985	N/A	NCR	Jan. 19, 2021	NCR	Radiation (03CH03-SZ)
Turn Table	EM	EM1000	N/A	0~360 degree	NCR	Jan. 19, 2021	NCR	Radiation (03CH03-SZ)
Antenna Mast	EM	EM1000	N/A	1 m~4 m	NCR	Jan. 19, 2021	NCR	Radiation (03CH03-SZ)

NCR: No Calibration Required.



## 6 Uncertainty of Evaluation

### Uncertainty of Radiated Emission Measurement (30 MHz ~ 1000 MHz)

Measuring Uncertainty for a Level of Confidence of 95% ( $U = 2Uc(y)$ )	3.0dB
---	-------

### Uncertainty of Radiated Emission Measurement (1 GHz ~ 18 GHz)

Measuring Uncertainty for a Level of Confidence of 95% ( $U = 2Uc(y)$ )	3.6dB
---	-------

### Uncertainty of Radiated Emission Measurement (18 GHz ~ 40 GHz)

Measuring Uncertainty for a Level of Confidence of 95% ( $U = 2Uc(y)$ )	3.8dB
---	-------



# Appendix A. Test Results of Conducted Test

## Conducted Output Power(Average power)

### LTE Band 48:

BW [MHz]	Modulation	RB Size	RB Offset	Power Low Ch. / Freq.	Power Middle Ch. / Freq.	Power High Ch. / Freq.
Channel				55340	55990	56640
Frequency (MHz)				3560	3625	3690
20	QPSK	1	0	21.08	21.10	20.92
20	QPSK	1	49	21.21	21.32	21.24
20	QPSK	1	99	21.05	21.02	21.12
20	QPSK	50	0	21.20	21.18	21.07
20	QPSK	50	24	21.21	21.21	21.16
20	QPSK	50	50	21.20	21.19	21.14
20	QPSK	100	0	21.12	21.17	21.16
20	16QAM	1	0	21.11	21.14	20.99
20	16QAM	1	49	21.20	21.19	21.18
20	16QAM	1	99	21.11	21.07	21.19
20	16QAM	50	0	21.21	21.22	21.19
20	16QAM	50	24	21.18	21.23	21.16
20	16QAM	50	50	21.19	21.21	21.19
20	16QAM	100	0	21.16	21.13	21.20
20	64QAM	1	0	21.00	21.04	20.90
20	64QAM	1	49	21.10	21.09	21.07
20	64QAM	1	99	21.00	21.10	21.10
20	64QAM	50	0	21.20	21.18	21.15
20	64QAM	50	24	21.18	21.21	21.18
20	64QAM	50	50	21.20	21.20	21.20
20	64QAM	100	0	21.10	21.14	21.16
Channel				55315	55990	56665
Frequency (MHz)				3557.5	3625	3692.5
15	QPSK	1	0	21.03	20.99	21.02
15	QPSK	1	37	21.17	21.08	21.15
15	QPSK	1	74	21.09	21.09	21.10
15	QPSK	36	0	21.12	21.06	21.10
15	QPSK	36	20	21.14	21.10	21.15
15	QPSK	36	39	21.14	21.09	21.18
15	QPSK	75	0	21.14	21.11	21.16
15	16QAM	1	0	21.09	21.06	21.10
15	16QAM	1	37	21.20	21.13	21.17
15	16QAM	1	74	21.16	21.13	21.19
15	16QAM	36	0	21.11	21.03	21.05
15	16QAM	36	20	21.09	21.06	21.06
15	16QAM	36	39	21.09	21.04	21.11
15	16QAM	75	0	21.13	21.12	21.13
15	64QAM	1	0	21.02	21.04	21.02





15	64QAM	1	37	21.14	21.08	21.17
15	64QAM	1	74	21.11	21.10	21.10
15	64QAM	36	0	21.18	21.04	21.11
15	64QAM	36	20	21.10	21.09	21.17
15	64QAM	36	39	21.18	21.12	21.20
15	64QAM	75	0	21.18	21.12	21.13
Channel				55290	55990	56690
Frequency (MHz)				3555	3625	3695
10	QPSK	1	0	21.00	20.98	21.05
10	QPSK	1	25	21.11	21.02	21.10
10	QPSK	1	49	21.08	21.06	21.10
10	QPSK	25	0	21.10	21.03	21.14
10	QPSK	25	12	21.10	21.00	21.13
10	QPSK	25	25	21.12	21.03	21.12
10	QPSK	50	0	21.14	21.06	21.15
10	16QAM	1	0	21.06	20.98	21.14
10	16QAM	1	25	21.15	21.10	21.15
10	16QAM	1	49	21.16	21.11	21.17
10	16QAM	25	0	21.15	21.08	21.14
10	16QAM	25	12	21.16	21.09	21.18
10	16QAM	25	25	21.17	21.07	21.15
10	16QAM	50	0	21.15	21.07	21.16
10	64QAM	1	0	20.98	20.97	21.05
10	64QAM	1	25	21.09	21.00	21.07
10	64QAM	1	49	21.09	21.06	21.06
10	64QAM	25	0	21.17	21.08	21.17
10	64QAM	25	12	21.17	21.13	21.21
10	64QAM	25	25	21.19	21.12	21.20
10	64QAM	50	0	21.14	21.06	21.13
Channel				55265	55990	56715
Frequency (MHz)				3552.5	3625	3697.5
5	QPSK	1	0	21.11	21.12	21.17
5	QPSK	1	12	21.17	21.13	21.20
5	QPSK	1	24	21.15	21.09	21.21
5	QPSK	12	0	21.14	21.13	21.21
5	QPSK	12	7	21.15	21.09	21.19
5	QPSK	12	13	21.14	21.12	21.21
5	QPSK	25	0	21.14	21.13	21.18
5	16QAM	1	0	21.16	21.12	21.21
5	16QAM	1	12	21.20	21.16	21.18
5	16QAM	1	24	21.21	21.12	21.16
5	16QAM	12	0	21.09	21.04	21.15
5	16QAM	12	7	20.92	21.02	21.11
5	16QAM	12	13	21.04	21.02	21.10
5	16QAM	25	0	21.19	21.16	21.18
5	64QAM	1	0	21.08	21.09	21.14
5	64QAM	1	12	21.10	21.07	21.15
5	64QAM	1	24	21.12	21.06	21.13
5	64QAM	12	0	21.12	21.11	21.18
5	64QAM	12	7	21.10	21.06	21.12



---

5	64QAM	12	13	21.14	21.04	21.16
5	64QAM	25	0	21.18	21.15	21.21



CA_48C									
Combination 20MHz+20MHz (100RB+100RB)									
PCC Channel	SCC Channel	Modulation	PCC		SCC		Total RB Size	Target MPR Level (dB)	Measured Power (dBm)
			RB Size	RB offset	RB Size	RB offset			
55340	55538	QPSK	100	0	100	0	200	≤2	21.5
			1	0	1	99	2	≤8.5	20.79
			1	99	1	0	2	≤0	21.48
		16QAM	100	0	100	0	200	≤3	21.57
			1	0	1	99	2	≤8.5	20.8
			1	99	1	0	2	≤1	21.49
		64QAM	100	0	100	0	200	≤3	21.52
			1	0	1	99	2	≤8.5	20.74
			1	99	1	0	2	≤3	21.45
55891	56089	QPSK	100	0	100	0	200	≤2	21.35
			1	0	1	99	2	≤8.5	20.68
			1	99	1	0	2	≤0	21.27
		16QAM	100	0	100	0	200	≤3	21.42
			1	0	1	99	2	≤8.5	20.69
			1	99	1	0	2	≤1	21.29
		64QAM	100	0	100	0	200	≤3	21.37
			1	0	1	99	2	≤8.5	20.64
			1	99	1	0	2	≤3	21.25
56442	56640	QPSK	100	0	100	0	200	≤2	21.37
			1	0	1	99	2	≤8.5	20.71
			1	99	1	0	2	≤0	21.3
		16QAM	100	0	100	0	200	≤3	21.42
			1	0	1	99	2	≤8.5	20.76
			1	99	1	0	2	≤1	21.34
		64QAM	100	0	100	0	200	≤3	21.39
			1	0	1	99	2	≤8.5	20.69
			1	99	1	0	2	≤3	21.29



CA_48C									
Combination 20MHz+15MHz (100RB+75RB)									
PCC Channel	SCC Channel	Modulation	PCC		SCC		Total RB Size	Target MPR Level (dB)	Measured Power (dBm)
			RB Size	RB offset	RB Size	RB offset			
55340	55511	QPSK	100	0	75	0	175	≤2	21.52
			1	0	1	74	2	≤8.5	21.02
			1	99	1	0	2	≤0	21.55
		16QAM	100	0	75	0	175	≤3	21.60
			1	0	1	74	2	≤8.5	21.01
			1	99	1	0	2	≤1	21.57
		64QAM	100	0	75	0	175	≤3	21.56
			1	0	1	74	2	≤8.5	21.00
			1	99	1	0	2	≤3	21.54
55916	56087	QPSK	100	0	75	0	175	≤2	21.37
			1	0	1	74	2	≤8.5	20.88
			1	99	1	0	2	≤0	21.31
		16QAM	100	0	75	0	175	≤3	21.44
			1	0	1	74	2	≤8.5	20.90
			1	99	1	0	2	≤1	21.36
		64QAM	100	0	75	0	175	≤3	21.42
			1	0	1	74	2	≤8.5	20.88
			1	99	1	0	2	≤3	21.31
56491	56662	QPSK	100	0	75	0	175	≤2	21.42
			1	0	1	74	2	≤8.5	20.96
			1	99	1	0	2	≤0	21.38
		16QAM	100	0	75	0	175	≤3	21.47
			1	0	1	74	2	≤8.5	20.97
			1	99	1	0	2	≤1	21.42
		64QAM	100	0	75	0	175	≤3	21.46
			1	0	1	74	2	≤8.5	20.91
			1	99	1	0	2	≤3	21.37



Combination 15MHz+20MHz (75RB+100RB)									
PCC Channel	SCC Channel	Modulation	PCC		SCC		Total RB Size	Target MPR Level (dB)	Measured Power (dBm)
			RB Size	RB offset	RB Size	RB offset			
55318	55489	QPSK	75	0	100	0	175	≤2	21.50
			1	0	1	99	2	≤8.5	21.00
			1	74	1	0	2	≤0	21.57
		16QAM	75	0	100	0	175	≤3	21.44
			1	0	1	99	2	≤8.5	20.84
			1	74	1	0	2	≤1	21.49
		64QAM	75	0	100	0	175	≤3	21.54
			1	0	1	99	2	≤8.5	20.88
			1	74	1	0	2	≤3	21.40
55893	56064	QPSK	75	0	100	0	175	≤2	21.21
			1	0	1	99	2	≤8.5	20.70
			1	74	1	0	2	≤0	21.25
		16QAM	75	0	100	0	175	≤3	21.37
			1	0	1	99	2	≤8.5	20.76
			1	74	1	0	2	≤1	21.26
		64QAM	75	0	100	0	175	≤3	21.26
			1	0	1	99	2	≤8.5	20.74
			1	74	1	0	2	≤3	21.27
56469	56640	QPSK	75	0	100	0	175	≤2	21.22
			1	0	1	99	2	≤8.5	20.78
			1	74	1	0	2	≤0	21.29
		16QAM	75	0	100	0	175	≤3	21.36
			1	0	1	99	2	≤8.5	20.89
			1	74	1	0	2	≤1	21.36
		64QAM	75	0	100	0	175	≤3	21.35
			1	0	1	99	2	≤8.5	20.72
			1	74	1	0	2	≤3	21.25



Combination 20MHz+10MHz (100RB+50RB)									
PCC Channel	SCC Channel	Modulation	PCC		SCC		Total RB Size	Target MPR Level (dB)	Measured Power (dBm)
			RB Size	RB offset	RB Size	RB offset			
55340	55484	QPSK	100	0	50	0	150	≤2	21.51
			1	0	1	49	2	≤8.5	21.00
			1	99	1	0	2	≤0	21.43
		16QAM	100	0	50	0	150	≤3	21.55
			1	0	1	49	2	≤8.5	20.82
			1	99	1	0	2	≤1	21.56
		64QAM	100	0	50	0	150	≤3	21.37
			1	0	1	49	2	≤8.5	20.95
			1	99	1	0	2	≤3	21.54
55941	56085	QPSK	100	0	50	0	150	≤2	21.29
			1	0	1	49	2	≤8.5	20.74
			1	99	1	0	2	≤0	21.25
		16QAM	100	0	50	0	150	≤3	21.27
			1	0	1	49	2	≤8.5	20.89
			1	99	1	0	2	≤1	21.24
		64QAM	100	0	50	0	150	≤3	21.28
			1	0	1	49	2	≤8.5	20.73
			1	99	1	0	2	≤3	21.31
56541	56685	QPSK	100	0	50	0	150	≤2	21.41
			1	0	1	49	2	≤8.5	20.81
			1	99	1	0	2	≤0	21.35
		16QAM	100	0	50	0	150	≤3	21.37
			1	0	1	49	2	≤8.5	20.97
			1	99	1	0	2	≤1	21.42
		64QAM	100	0	50	0	150	≤3	21.34
			1	0	1	49	2	≤8.5	20.77
			1	99	1	0	2	≤3	21.17



Combination 10MHz+20MHz (50RB+100RB)									
PCC Channel	SCC Channel	Modulation	PCC		SCC		Total RB Size	Target MPR Level (dB)	Measured Power (dBm)
			RB Size	RB offset	RB Size	RB offset			
55295	55439	QPSK	50	0	100	0	150	≤2	21.48
			1	0	1	99	2	≤8.5	21.00
			1	49	1	0	2	≤0	21.39
		16QAM	50	0	100	0	150	≤3	21.52
			1	0	1	99	2	≤8.5	20.86
			1	49	1	0	2	≤1	21.50
		64QAM	50	0	100	0	150	≤3	21.45
			1	0	1	99	2	≤8.5	20.90
			1	49	1	0	2	≤3	21.46
55896	56040	QPSK	50	0	100	0	150	≤2	21.22
			1	0	1	99	2	≤8.5	20.75
			1	49	1	0	2	≤0	21.22
		16QAM	50	0	100	0	150	≤3	21.28
			1	0	1	99	2	≤8.5	20.90
			1	49	1	0	2	≤1	21.36
		64QAM	50	0	100	0	150	≤3	21.30
			1	0	1	99	2	≤8.5	20.80
			1	49	1	0	2	≤3	21.22
56496	56640	QPSK	50	0	100	0	150	≤2	21.36
			1	0	1	99	2	≤8.5	20.79
			1	49	1	0	2	≤0	21.22
		16QAM	50	0	100	0	150	≤3	21.46
			1	0	1	99	2	≤8.5	20.89
			1	49	1	0	2	≤1	21.36
		64QAM	50	0	100	0	150	≤3	21.44
			1	0	1	99	2	≤8.5	20.84
			1	49	1	0	2	≤3	21.36



Combination 20MHz+5MHz (100RB+25RB)									
PCC Channel	SCC Channel	Modulation	PCC		SCC		Total RB Size	Target MPR Level (dB)	Measured Power (dBm)
			RB Size	RB offset	RB Size	RB offset			
55340	55457	QPSK	100	0	25	0	125	≤2	21.53
			1	0	1	24	2	≤8.5	21.09
			1	99	1	0	2	≤0	21.38
		16QAM	100	0	25	0	125	≤3	21.51
			1	0	1	24	2	≤8.5	20.93
			1	99	1	0	2	≤1	21.45
		64QAM	100	0	25	0	125	≤3	21.51
			1	0	1	24	2	≤8.5	20.80
			1	99	1	0	2	≤3	21.53
55965	56082	QPSK	100	0	25	0	125	≤2	21.33
			1	0	1	24	2	≤8.5	20.70
			1	99	1	0	2	≤0	21.14
		16QAM	100	0	25	0	125	≤3	21.37
			1	0	1	24	2	≤8.5	20.75
			1	99	1	0	2	≤1	21.16
		64QAM	100	0	25	0	125	≤3	21.38
			1	0	1	24	2	≤8.5	20.71
			1	99	1	0	2	≤3	21.25
56590	56707	QPSK	100	0	25	0	125	≤2	21.34
			1	0	1	24	2	≤8.5	20.82
			1	99	1	0	2	≤0	21.31
		16QAM	100	0	25	0	125	≤3	21.34
			1	0	1	24	2	≤8.5	20.78
			1	99	1	0	2	≤1	21.30
		64QAM	100	0	25	0	125	≤3	21.39
			1	0	1	24	2	≤8.5	20.71
			1	99	1	0	2	≤3	21.24





Combination 5MHz+20MHz (25RB+100RB)									
PCC Channel	SCC Channel	Modulation	PCC		SCC		Total RB Size	Target MPR Level (dB)	Measured Power (dBm)
			RB Size	RB offset	RB Size	RB offset			
55273	55390	QPSK	25	0	100	0	125	≤2	21.50
			1	0	1	99	2	≤8.5	21.11
			1	24	1	0	2	≤0	21.32
		16QAM	25	0	100	0	125	≤3	21.54
			1	0	1	99	2	≤8.5	20.95
			1	24	1	0	2	≤1	21.45
		64QAM	25	0	100	0	125	≤3	21.55
			1	0	1	99	2	≤8.5	20.84
			1	24	1	0	2	≤3	21.46
55898	56015	QPSK	25	0	100	0	125	≤2	21.27
			1	0	1	99	2	≤8.5	20.72
			1	24	1	0	2	≤0	21.31
		16QAM	25	0	100	0	125	≤3	21.35
			1	0	1	99	2	≤8.5	20.83
			1	24	1	0	2	≤1	21.16
		64QAM	25	0	100	0	125	≤3	21.24
			1	0	1	99	2	≤8.5	20.76
			1	24	1	0	2	≤3	21.16
56523	56640	QPSK	25	0	100	0	125	≤2	21.23
			1	0	1	99	2	≤8.5	20.77
			1	24	1	0	2	≤0	21.36
		16QAM	25	0	100	0	125	≤3	21.42
			1	0	1	99	2	≤8.5	20.95
			1	24	1	0	2	≤1	21.39
		64QAM	25	0	100	0	125	≤3	21.32
			1	0	1	99	2	≤8.5	20.79
			1	24	1	0	2	≤3	21.18



**EIRP**

The worst case EIRP shown in this section is found with LTE operating only using 1RB. As such, the EIRP/10MHz and full channel EIRP values will be identical since 1RB is fully contained within all available channel bandwidths for LTE Band 48 (i.e. 5, 10, 15, 20MHz)

LTE Band 48 (GT - LC = 1.0 dB) QPSK									
Bandwidth	5M			10M			15M		
Channel	(Low)	(Mid)	(High)	(Low)	(Mid)	(High)	(Low)	(Mid)	(High)
Conducted Power (dBm/10MHz)	21.15	21.09	21.21	21.14	21.06	21.15	21.14	21.09	21.18
Conducted Power (Watts/10MHz)	0.1303	0.1285	0.1321	0.1300	0.1276	0.1303	0.1300	0.1285	0.1312
EIRP (dBm/10MHz)	22.15	22.09	22.21	22.14	22.06	22.15	22.14	22.09	22.18
EIRP (Watts/10MHz)	0.1641	0.1618	0.1663	0.1637	0.1607	0.1641	0.1637	0.1618	0.1652

LTE Band 48 (GT - LC = 1.0 dB) QPSK			
Bandwidth	20M		
Channel	(Low)	(Mid)	(High)
Conducted Power (dBm/10MHz)	21.21	21.32	21.24
Conducted Power (Watts/10MHz)	0.1321	0.1355	0.1330
EIRP (dBm/10MHz)	22.21	22.32	22.24
EIRP (Watts/10MHz)	0.1663	0.1706	0.1675



LTE Band 48 (GT - LC = 1.0 dB) 16QAM									
Bandwidth	5M			10M			15M		
Channel	(Low)	(Mid)	(High)	(Low)	(Mid)	(High)	(Low)	(Mid)	(High)
Conducted Power (dBm/10MHz)	21.21	21.12	21.16	21.16	21.09	21.18	21.20	21.13	21.17
Conducted Power (Watts/10MHz)	0.1321	0.1294	0.1306	0.1306	0.1285	0.1312	0.1318	0.1297	0.1309
EIRP (dBm/10MHz)	22.21	22.12	22.16	22.16	22.09	22.18	22.20	22.13	22.17
EIRP (Watts/10MHz)	0.1663	0.1629	0.1644	0.1644	0.1618	0.1652	0.1660	0.1633	0.1648

LTE Band 48 (GT - LC = 1.0 dB) 16QAM			
Bandwidth	20M		
Channel	(Low)	(Mid)	(High)
Conducted Power (dBm/10MHz)	21.18	21.23	21.16
Conducted Power (Watts/10MHz)	0.1312	0.1327	0.1306
EIRP (dBm/10MHz)	22.18	22.23	22.16
EIRP (Watts/10MHz)	0.1652	0.1671	0.1644



LTE Band 48 (GT - LC = 1.0 dB) 64QAM									
Bandwidth	5M			10M			15M		
Channel	(Low)	(Mid)	(High)	(Low)	(Mid)	(High)	(Low)	(Mid)	(High)
Conducted Power (dBm/10MHz)	21.18	21.15	21.21	21.17	21.13	21.21	21.18	21.12	21.20
Conducted Power (Watts/10MHz)	0.1312	0.1303	0.1321	0.1309	0.1297	0.1321	0.1312	0.1294	0.1318
EIRP (dBm/10MHz)	22.18	22.15	22.21	22.17	22.13	22.21	22.18	22.12	22.20
EIRP (Watts/10MHz)	0.1652	0.1641	0.1663	0.1648	0.1633	0.1663	0.1652	0.1629	0.1660

LTE Band 48 (GT - LC = 1.0 dB) 64QAM			
Bandwidth	20M		
Channel	(Low)	(Mid)	(High)
Conducted Power (dBm/10MHz)	21.18	21.21	21.18
Conducted Power (Watts/10MHz)	0.1312	0.1321	0.1312
EIRP (dBm/10MHz)	22.18	22.21	22.18
EIRP (Watts/10MHz)	0.1652	0.1663	0.1652



LTE Band 48 CA (GT - LC = 1.0 dB) QPSK									
Bandwidth	5MHz+20MHz			10MHz+20MHz			15MHz+20MHz		
Channel PCC	55273	55898	56523	55295	55896	56496	55318	55893	56469
	(Low)	(Mid)	(High)	(Low)	(Mid)	(High)	(Low)	(Mid)	(High)
Channel SCC	55390	56015	56640	55439	56040	56640	55489	56064	56640
	(Low)	(Mid)	(High)	(Low)	(Mid)	(High)	(Low)	(Mid)	(High)
Conducted Power (dBm)	21.50	21.31	21.36	21.48	21.22	21.36	21.57	21.25	21.29
Conducted Power (Watts)	0.1413	0.1352	0.1368	0.1406	0.1324	0.1368	0.1435	0.1334	0.1346
EIRP(dBm)	22.50	22.31	22.36	22.48	22.22	22.36	22.57	22.25	22.29
EIRP(Watts)	0.1778	0.1702	0.1722	0.1770	0.1667	0.1722	0.1807	0.1679	0.1694

LTE Band 48 CA (GT - LC = 1.0 dB) QPSK						
Bandwidth	20MHz+5MHz			20MHz+10MHz		
Channel PCC	55340	55965	56590	55340	55941	56541
	(Low)	(Mid)	(High)	(Low)	(Mid)	(High)
Channel SCC	55457	56082	56707	55484	56085	56685
	(Low)	(Mid)	(High)	(Low)	(Mid)	(High)
Conducted Power (dBm)	21.53	21.33	21.34	21.51	21.29	21.41
Conducted Power (Watts)	0.1422	0.1358	0.1361	0.1416	0.1346	0.1384
EIRP(dBm)	22.53	22.33	22.34	22.51	22.29	22.41
EIRP(Watts)	0.1791	0.1710	0.1714	0.1782	0.1694	0.1742



LTE Band 48 CA (GT - LC = 1.0 dB) QPSK						
Bandwidth	20MHz+15MHz			20MHz+20MHz		
Channel PCC	55340	55916	56491	55340	55891	56442
	(Low)	(Mid)	(High)	(Low)	(Mid)	(High)
Channel SCC	55511	56087	56662	55538	56089	56640
	(Low)	(Mid)	(High)	(Low)	(Mid)	(High)
Conducted Power (dBm)	21.55	21.37	21.42	21.50	21.35	21.37
Conducted Power (Watts)	0.1429	0.1371	0.1387	0.1413	0.1365	0.1371
EIRP(dBm)	22.55	22.37	22.42	22.50	22.35	22.37
EIRP(Watts)	0.1799	0.1726	0.1746	0.1778	0.1718	0.1726



LTE Band 48 CA (GT - LC = 1.0 dB) 16QAM									
Bandwidth	5MHz+20MHz			10MHz+20MHz			15MHz+20MHz		
Channel PCC	55273	55898	56523	55295	55896	56496	55318	55893	56469
	(Low)	(Mid)	(High)	(Low)	(Mid)	(High)	(Low)	(Mid)	(High)
Channel SCC	55390	56015	56640	55439	56040	56640	55489	56064	56640
	(Low)	(Mid)	(High)	(Low)	(Mid)	(High)	(Low)	(Mid)	(High)
Conducted Power (dBm)	21.54	21.35	21.42	21.52	21.36	21.46	21.49	21.37	21.36
Conducted Power (Watts)	0.1426	0.1365	0.1387	0.1419	0.1368	0.1400	0.1409	0.1371	0.1368
EIRP(dBm)	22.54	22.35	22.42	22.52	22.36	22.46	22.49	22.37	22.36
EIRP(Watts)	0.1795	0.1718	0.1746	0.1786	0.1722	0.1762	0.1774	0.1726	0.1722

LTE Band 48 CA (GT - LC = 1.0 dB) 16QAM						
Bandwidth	20MHz+5MHz			20MHz+10MHz		
Channel PCC	55340	55965	56590	55340	55941	56541
	(Low)	(Mid)	(High)	(Low)	(Mid)	(High)
Channel SCC	55457	56082	56707	55484	56085	56685
	(Low)	(Mid)	(High)	(Low)	(Mid)	(High)
Conducted Power (dBm)	21.51	21.37	21.34	21.56	21.27	21.42
Conducted Power (Watts)	0.1416	0.1371	0.1361	0.1432	0.1340	0.1387
EIRP(dBm)	22.51	22.37	22.34	22.56	22.27	22.42
EIRP(Watts)	0.1782	0.1726	0.1714	0.1803	0.1687	0.1746



LTE Band 48 CA (GT - LC = 1.0 dB) 16QAM						
Bandwidth	20MHz+15MHz			20MHz+20MHz		
Channel PCC	55340	55916	56491	55340	55891	56442
	(Low)	(Mid)	(High)	(Low)	(Mid)	(High)
Channel SCC	55511	56087	56662	55538	56089	56640
	(Low)	(Mid)	(High)	(Low)	(Mid)	(High)
Conducted Power (dBm)	21.60	21.44	21.47	21.57	21.42	21.42
Conducted Power (Watts)	0.1445	0.1393	0.1403	0.1435	0.1387	0.1387
EIRP(dBm)	22.60	22.44	22.47	22.57	22.42	22.42
EIRP(Watts)	0.1820	0.1754	0.1766	0.1807	0.1746	0.1746





LTE Band 48 CA (GT - LC = 1.0 dB) 64QAM									
Bandwidth	5MHz+20MHz			10MHz+20MHz			15MHz+20MHz		
Channel PCC	55273	55898	56523	55295	55896	56496	55318	55893	56469
	(Low)	(Mid)	(High)	(Low)	(Mid)	(High)	(Low)	(Mid)	(High)
Channel SCC	55390	56015	56640	55439	56040	56640	55489	56064	56640
	(Low)	(Mid)	(High)	(Low)	(Mid)	(High)	(Low)	(Mid)	(High)
Conducted Power (dBm)	21.55	21.24	21.32	21.46	21.30	21.44	21.54	21.27	21.35
Conducted Power (Watts)	0.1429	0.1330	0.1355	0.1400	0.1349	0.1393	0.1426	0.1340	0.1365
EIRP(dBm)	22.55	22.24	22.32	22.46	22.30	22.44	22.54	22.27	22.35
EIRP(Watts)	0.1799	0.1675	0.1706	0.1762	0.1698	0.1754	0.1795	0.1687	0.1718

LTE Band 48 CA (GT - LC = 1.0 dB) 64QAM						
Bandwidth	20MHz+5MHz			20MHz+10MHz		
Channel PCC	55340	55965	56590	55340	55941	56541
	(Low)	(Mid)	(High)	(Low)	(Mid)	(High)
Channel SCC	55457	56082	56707	55484	56085	56685
	(Low)	(Mid)	(High)	(Low)	(Mid)	(High)
Conducted Power (dBm)	21.53	21.38	21.39	21.54	21.31	21.34
Conducted Power (Watts)	0.1422	0.1374	0.1377	0.1426	0.1352	0.1361
EIRP(dBm)	22.53	22.38	22.39	22.54	22.31	22.34
EIRP(Watts)	0.1791	0.1730	0.1734	0.1795	0.1702	0.1714



LTE Band 48 CA (GT - LC = 1.0 dB) 64QAM						
Bandwidth	20MHz+15MHz			20MHz+20MHz		
Channel PCC	55340	55916	56491	55340	55891	56442
	(Low)	(Mid)	(High)	(Low)	(Mid)	(High)
Channel SCC	55511	56087	56662	55538	56089	56640
	(Low)	(Mid)	(High)	(Low)	(Mid)	(High)
Conducted Power (dBm)	21.56	21.42	21.46	21.52	21.37	21.39
Conducted Power (Watts)	0.1432	0.1387	0.1400	0.1419	0.1371	0.1377
EIRP(dBm)	22.56	22.42	22.46	22.52	22.37	22.39
EIRP(Watts)	0.1803	0.1746	0.1762	0.1786	0.1726	0.1734



# LTE Band 48

## ACLR

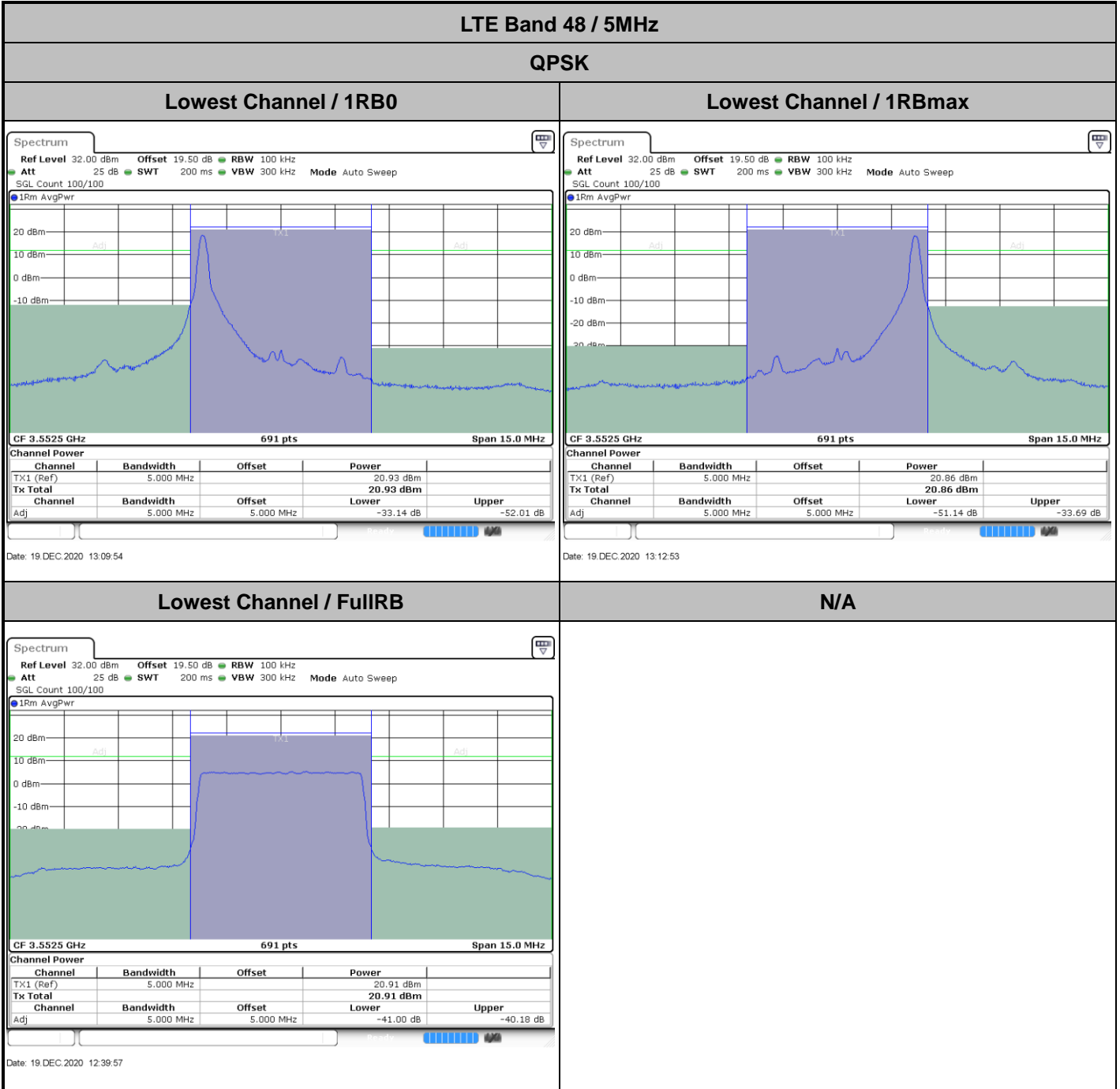



LTE Band 48 / 5MHz

QPSK

Middle Channel / 1RB0

Middle Channel / 1RBmax

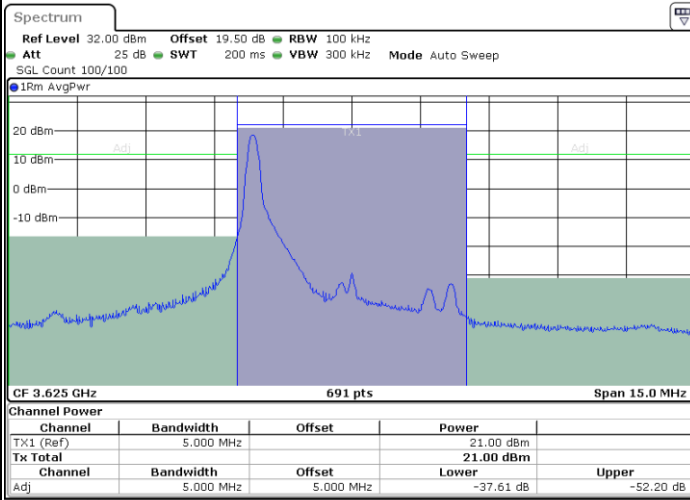

Date: 18.MAR.2021 23:32:17

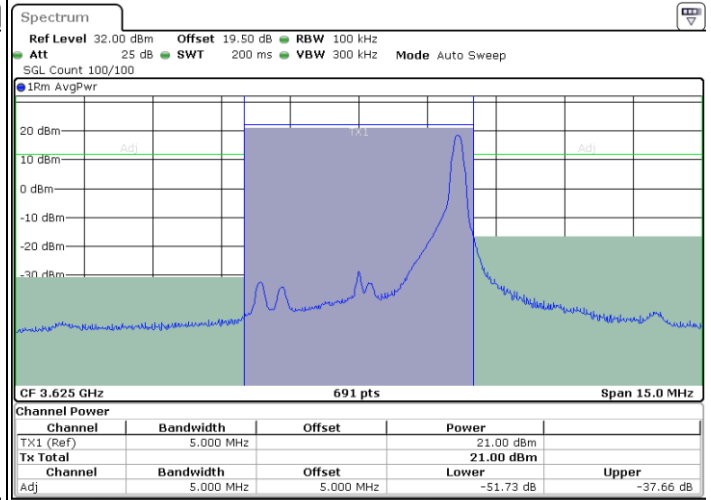

Date: 18.MAR.2021 23:33:46

Middle Channel / FullIRB

N/A

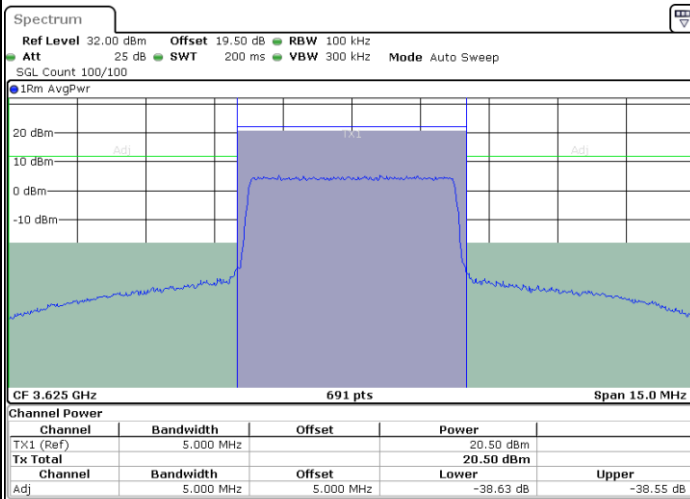

Date: 19.DEC.2020 14:07:59



LTE Band 48 / 5MHz

QPSK

Highest Channel / 1RB0

Highest Channel / 1RBmax

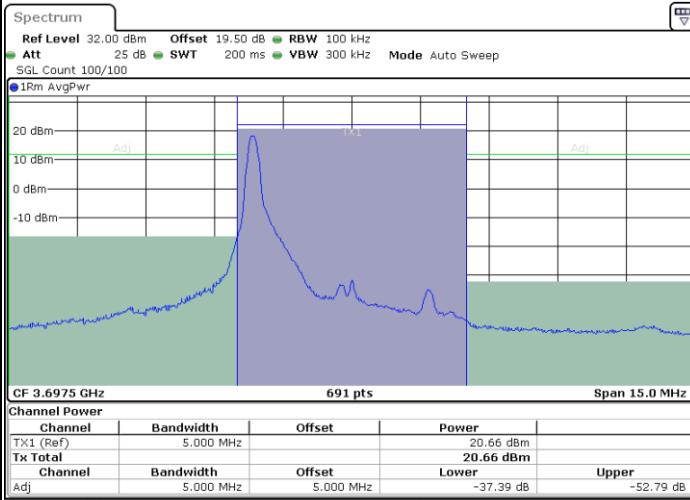

Date: 19 DEC 2020 14:24:08

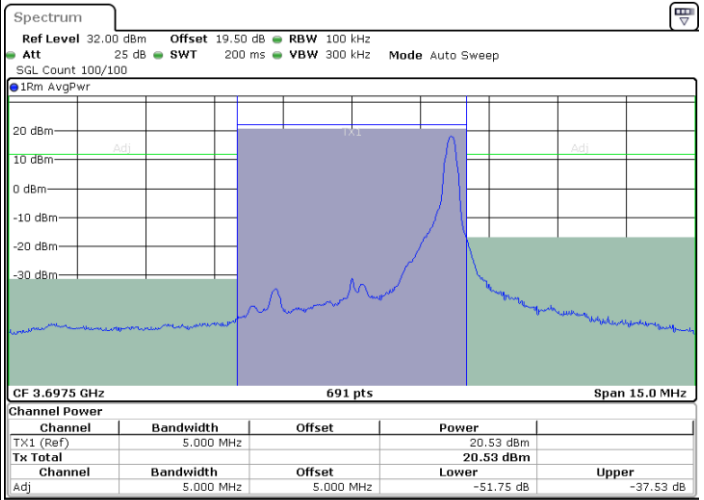

Date: 19 DEC 2020 14:26:55

Highest Channel / FullIRB

N/A

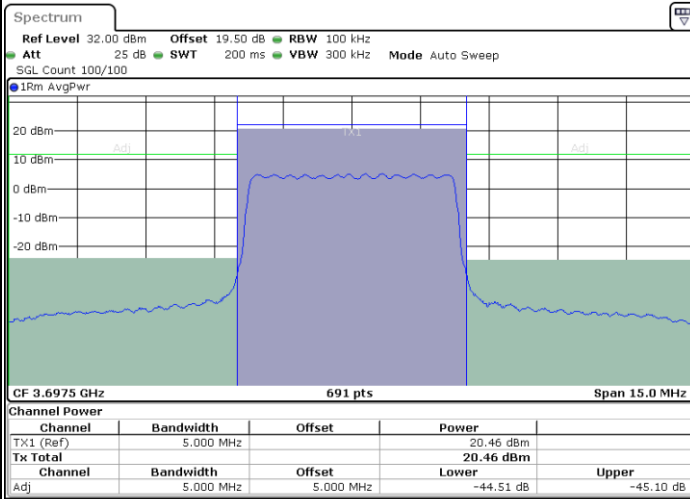

Date: 19 DEC 2020 14:10:46



LTE Band 48 / 10MHz

QPSK

Lowest Channel / 1RB0

Lowest Channel / 1RBmax

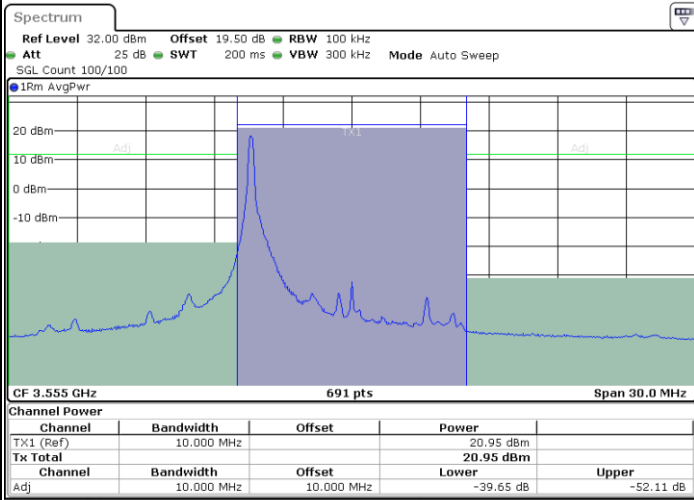

Date: 19 DEC 2020 15:06:02

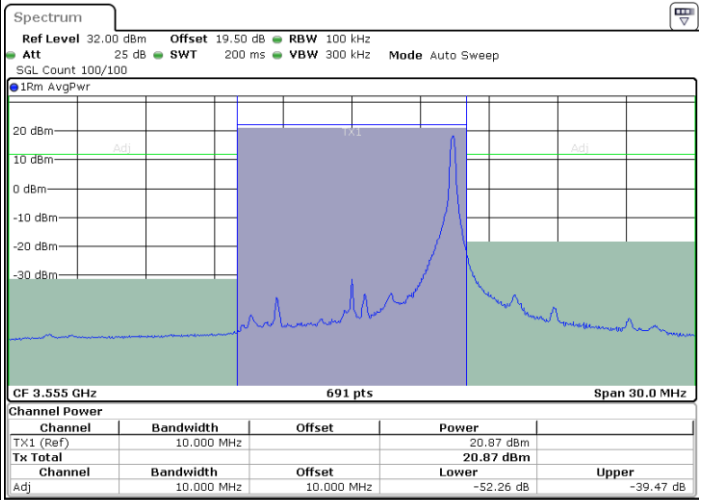

Date: 19 DEC 2020 15:08:46

Lowest Channel / FullIRB

N/A

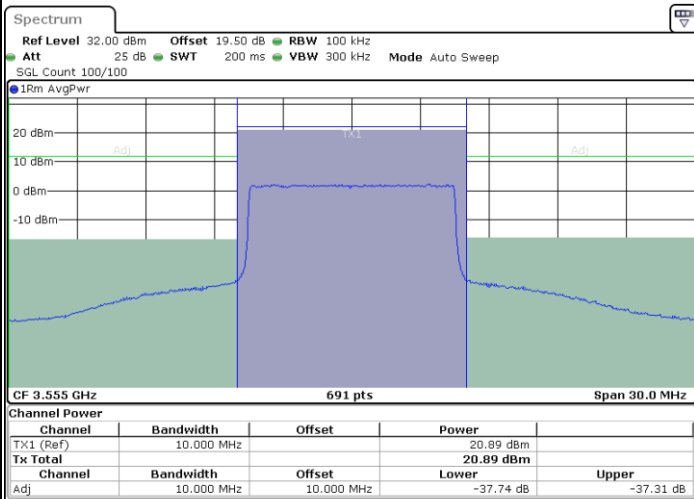

Date: 19 DEC 2020 14:39:14



**LTE Band 48 / 10MHz**

**QPSK**

**MiddleChannel / 1RB0**

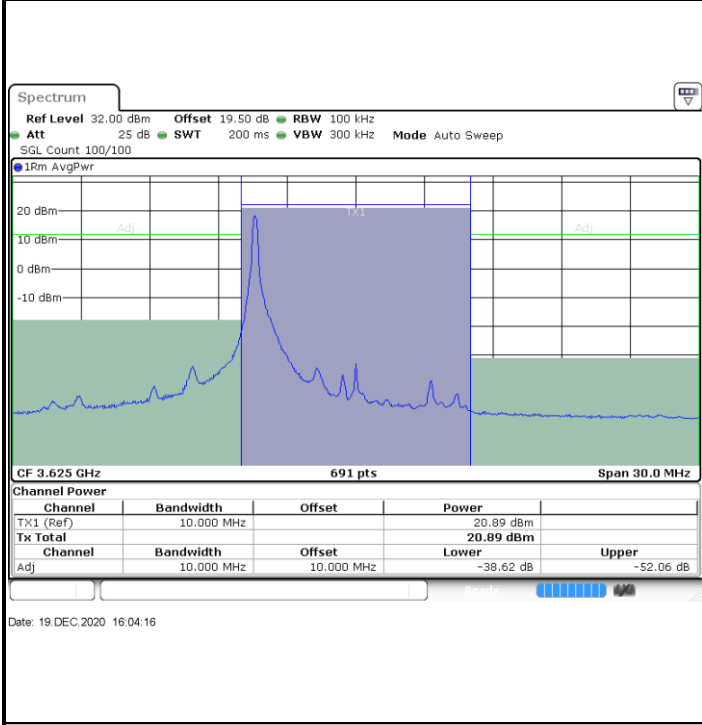

**Middle Channel / 1RBmax**

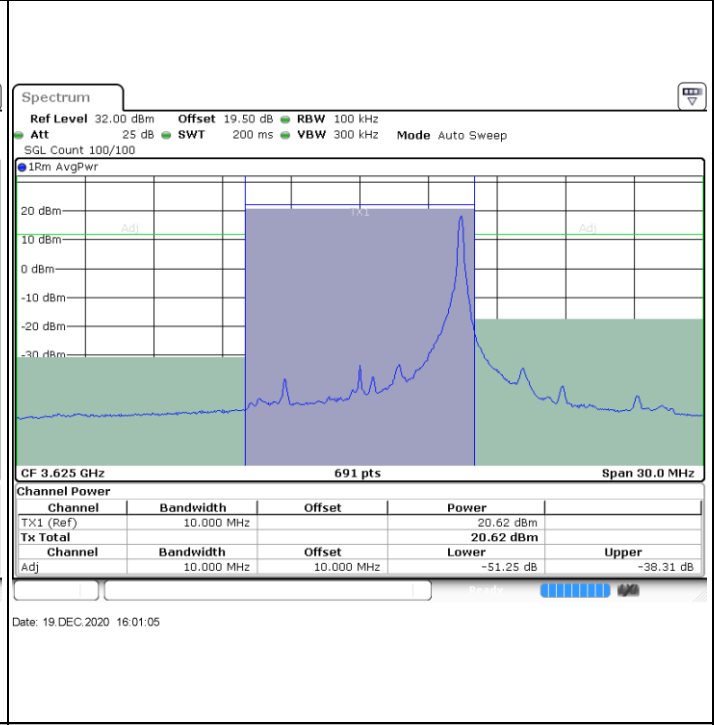

**Middle Channel / FullIRB**

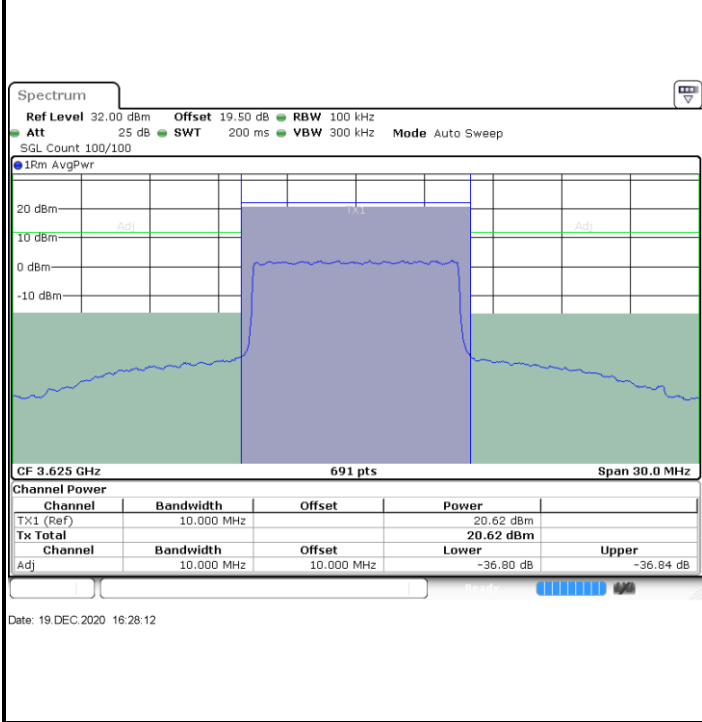

**N/A**



LTE Band 48 / 10MHz

QPSK

Highest Channel / 1RB0

Highest Channel / 1RBmax

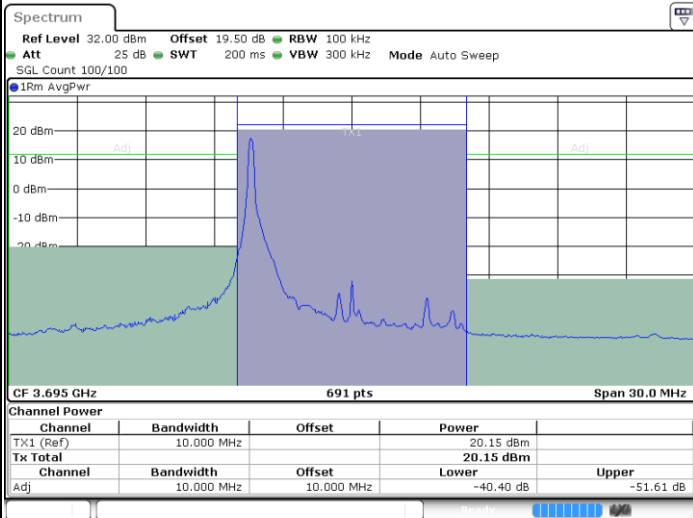

Date: 19 DEC 2020 16:47:45

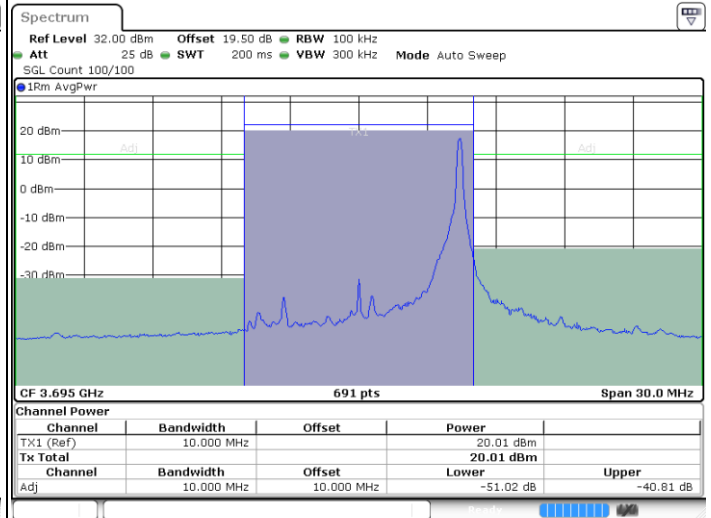

Date: 19 DEC 2020 16:51:33

Highest Channel / FullIRB

N/A

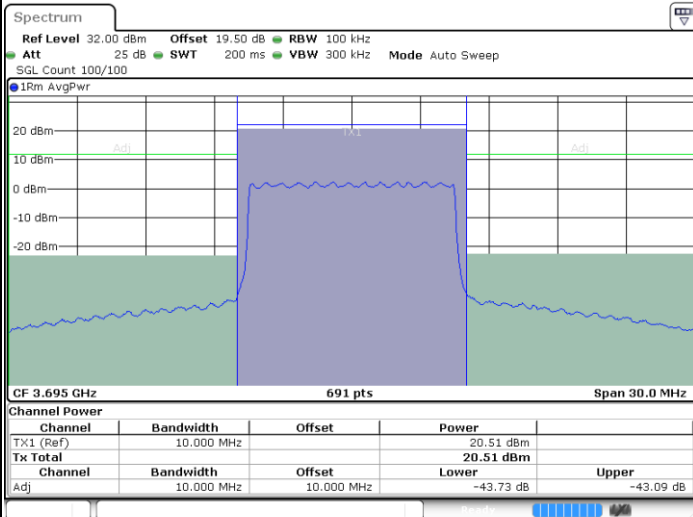

Date: 19 DEC 2020 16:33:14





LTE Band 48 / 15MHz

QPSK

Lowest Channel / 1RB0

Lowest Channel / 1RBmax

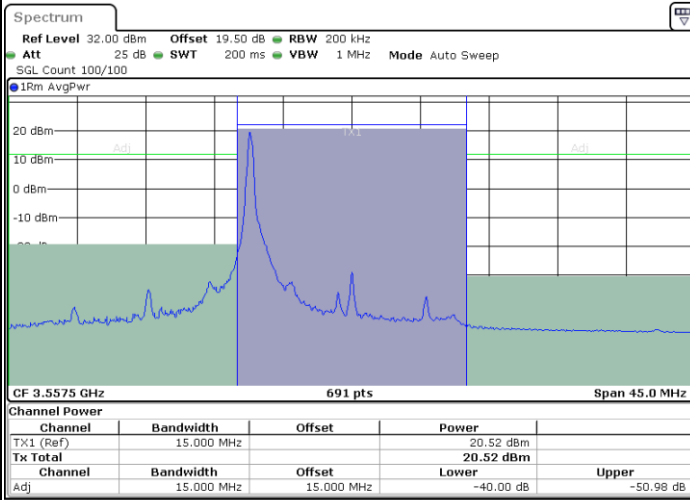

Date: 26.DEC.2020 21:55:12

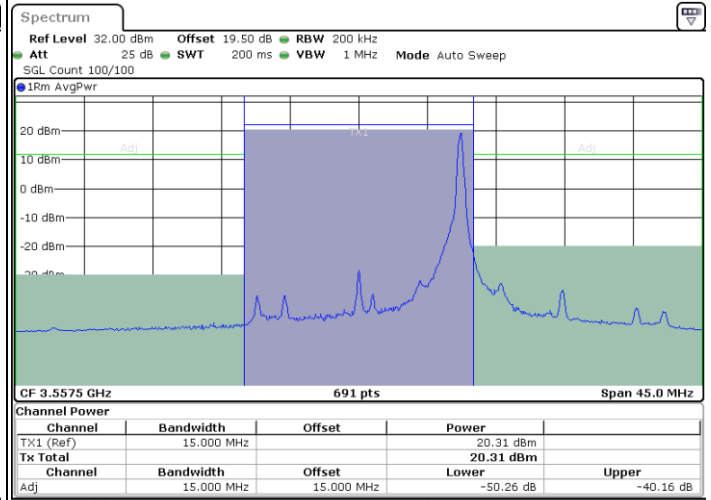

Date: 26.DEC.2020 21:56:51

Lowest Channel / FullIRB

N/A

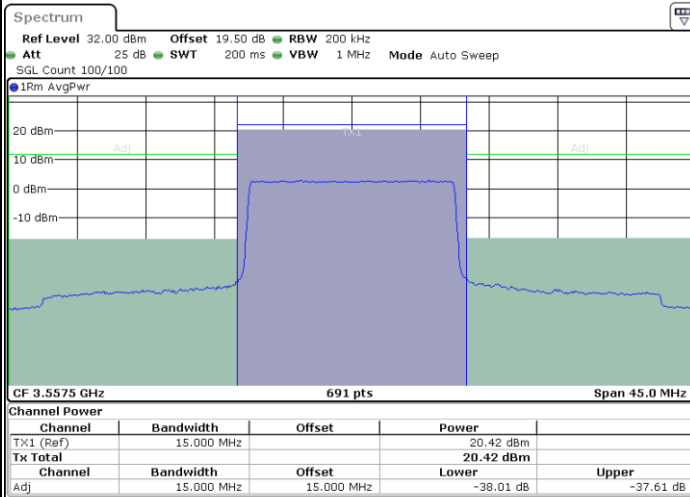

Date: 26.DEC.2020 21:23:53



**LTE Band 48 / 15MHz**

**QPSK**

**Middle Channel / 1RB0**

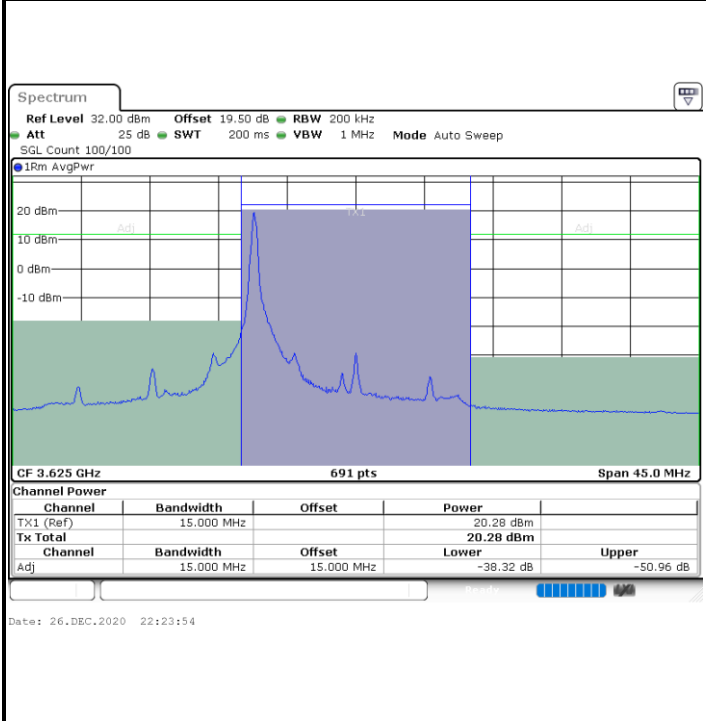

**Middle Channel / 1RBmax**

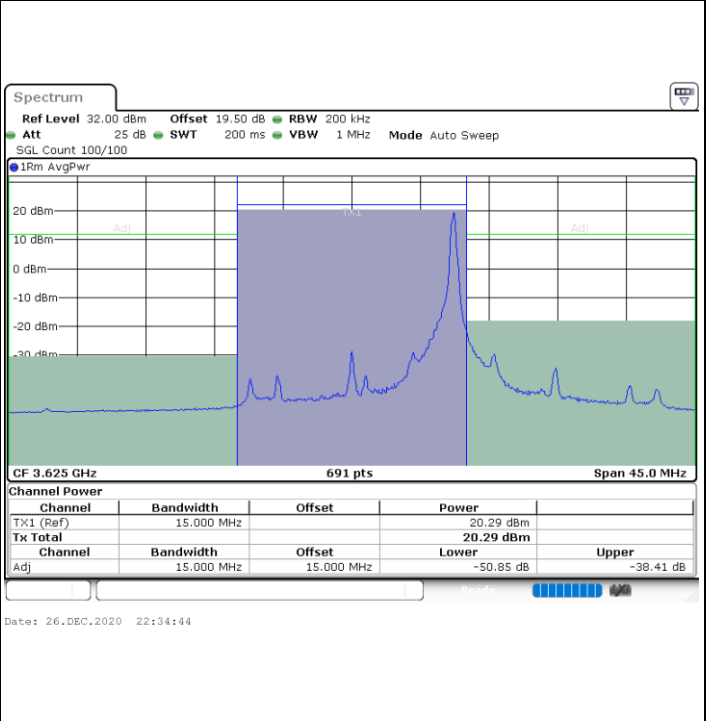

**Middle Channel / FullRB**

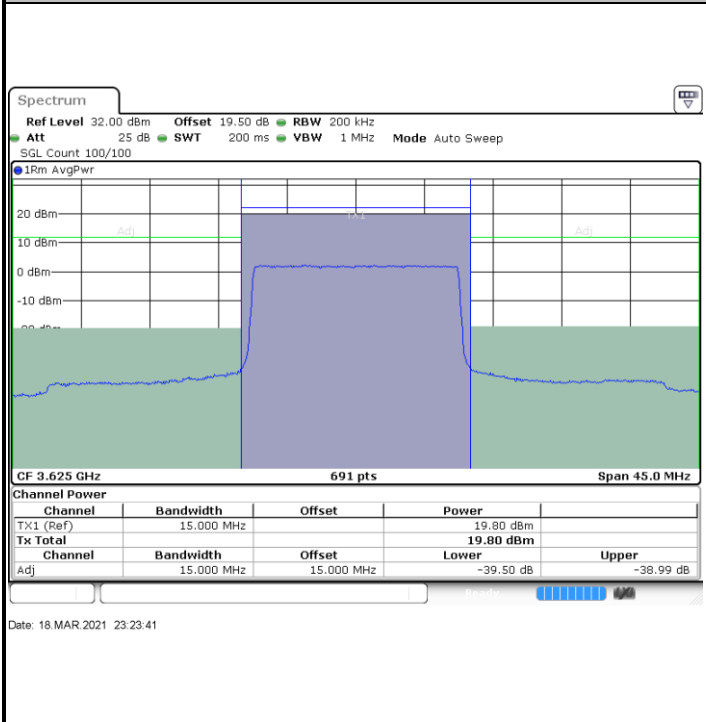

**N/A**



LTE Band 48 / 15MHz

QPSK

Highest Channel / 1RB0

Highest Channel / 1RBmax

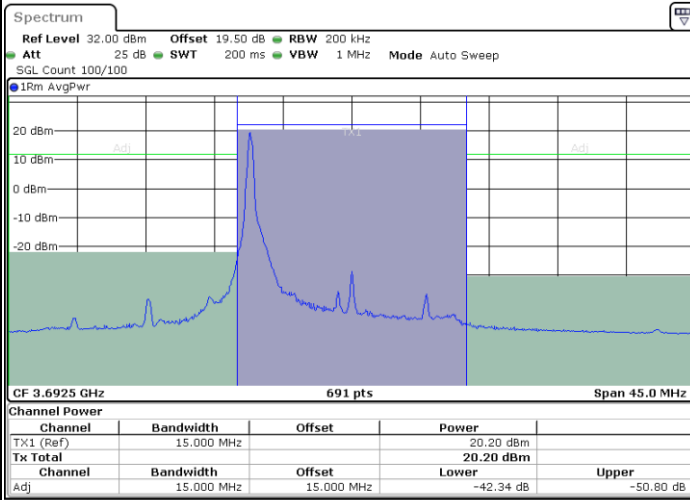

Date: 27.DEC.2020 00:09:21

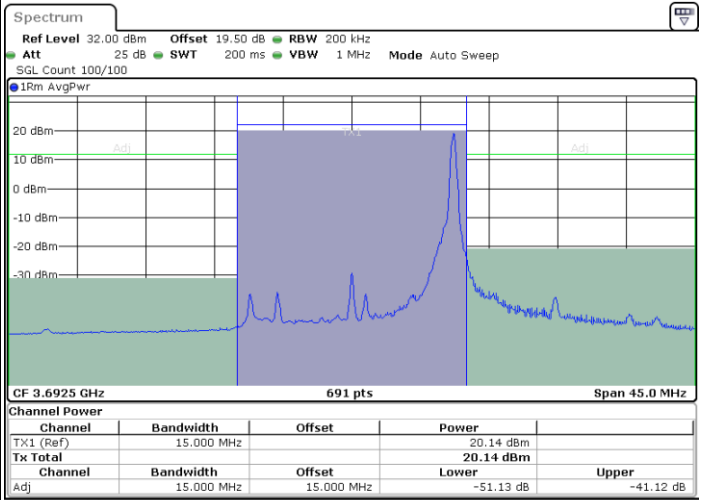

Date: 27.DEC.2020 00:24:03

Highest Channel / FullIRB

N/A

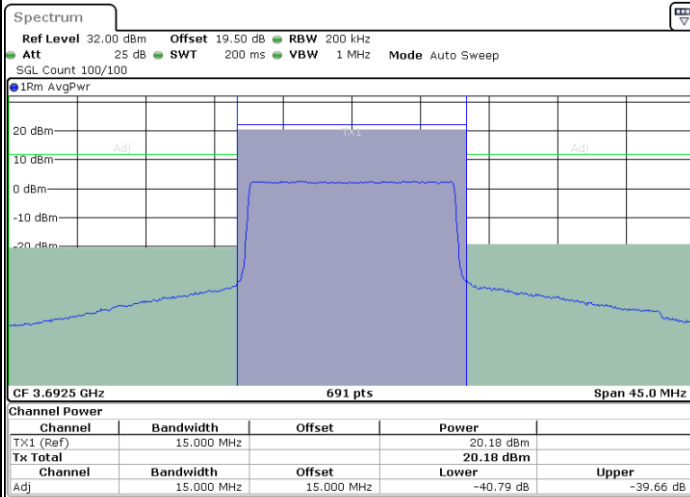

Date: 26.DEC.2020 23:36:36



LTE Band 48 / 20MHz

QPSK

Lowest Channel / 1RB0

Lowest Channel / 1RBmax

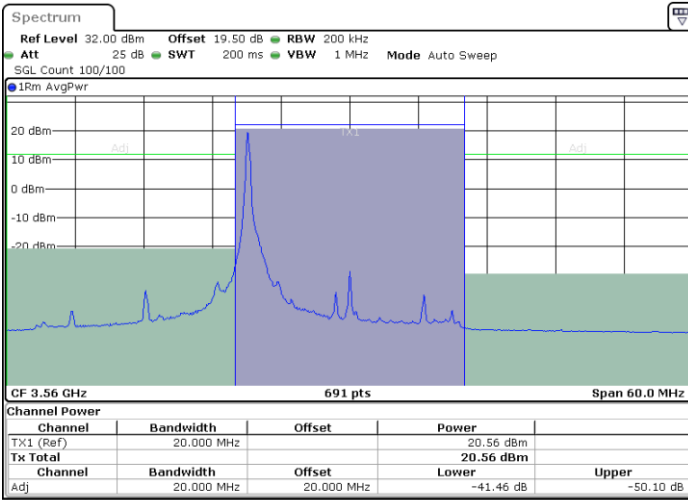

Date: 27.DEC.2020 02:46:54

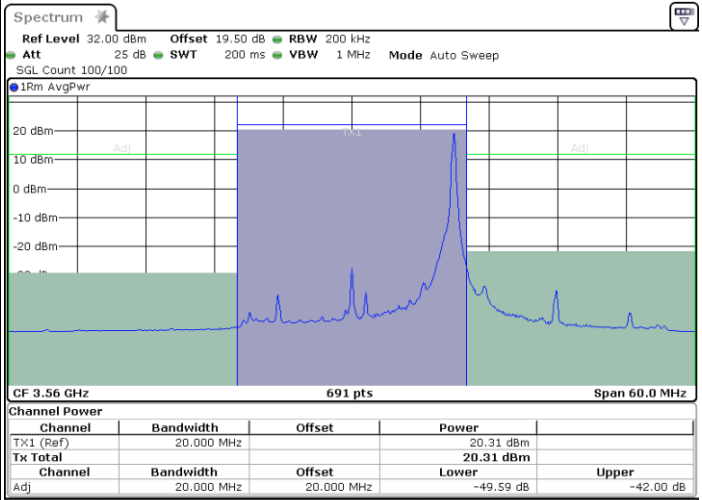

Date: 27.DEC.2020 02:40:14

Lowest Channel / FullIRB

N/A

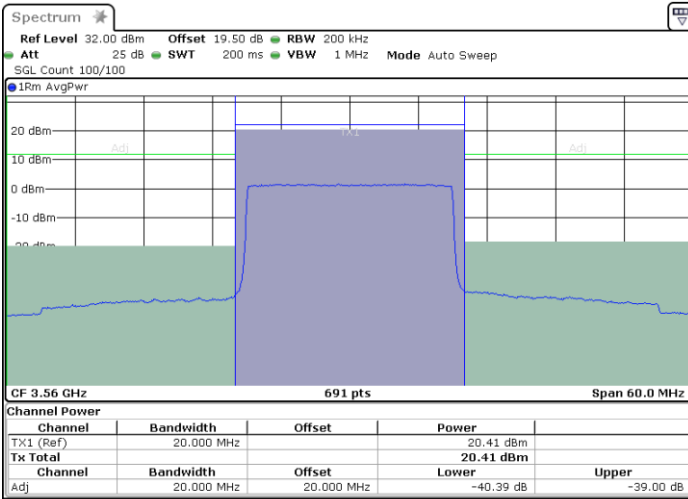

Date: 27.DEC.2020 02:41:27



**LTE Band 48 / 20MHz**

**QPSK**

**Middle Channel / 1RB0**

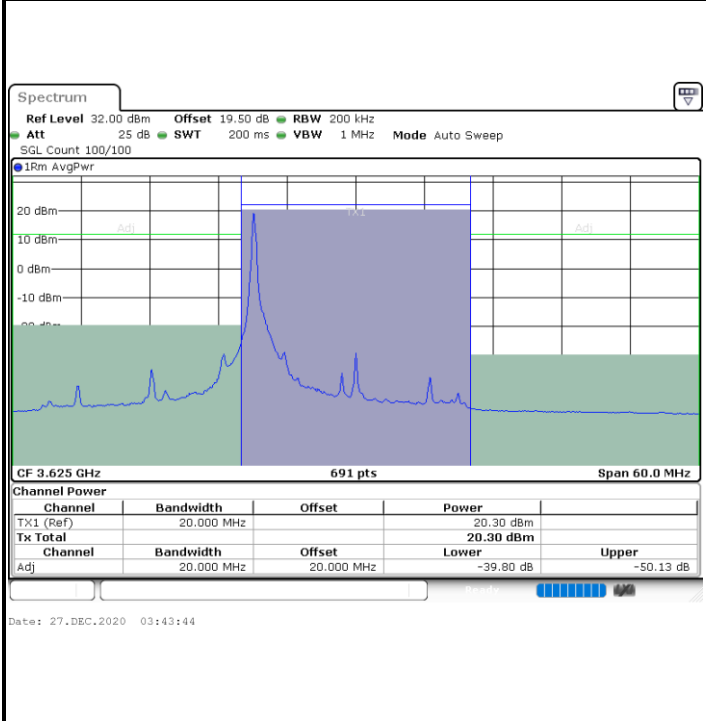

**Middle Channel / 1RBmax**

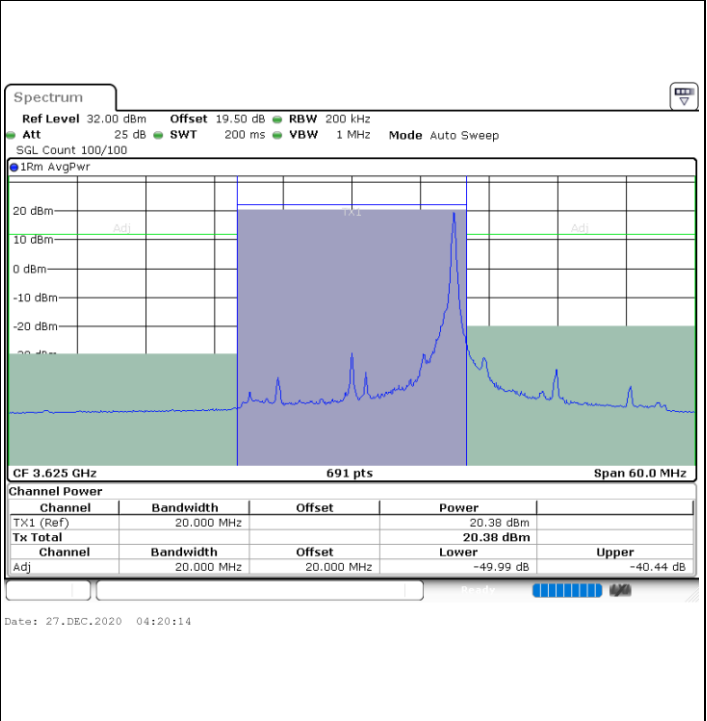

**Middle Channel / FullIRB**

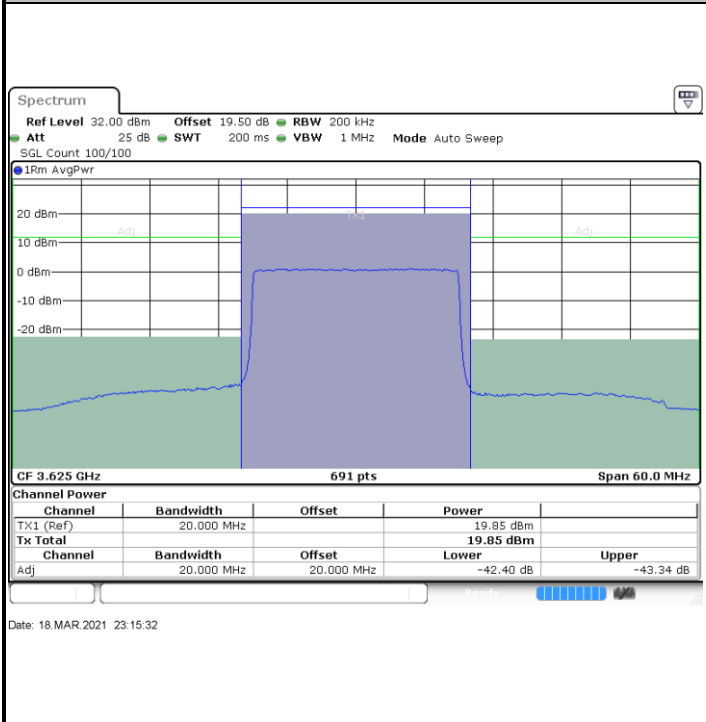

**N/A**



**LTE Band 48 / 20MHz**

**QPSK**

**Highest Channel / 1RB0**

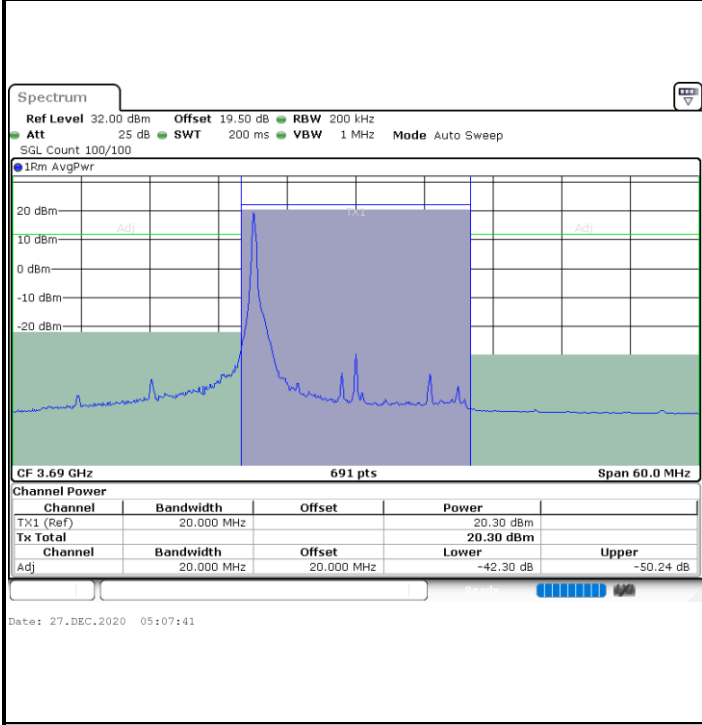

**Highest Channel / 1RBmax**

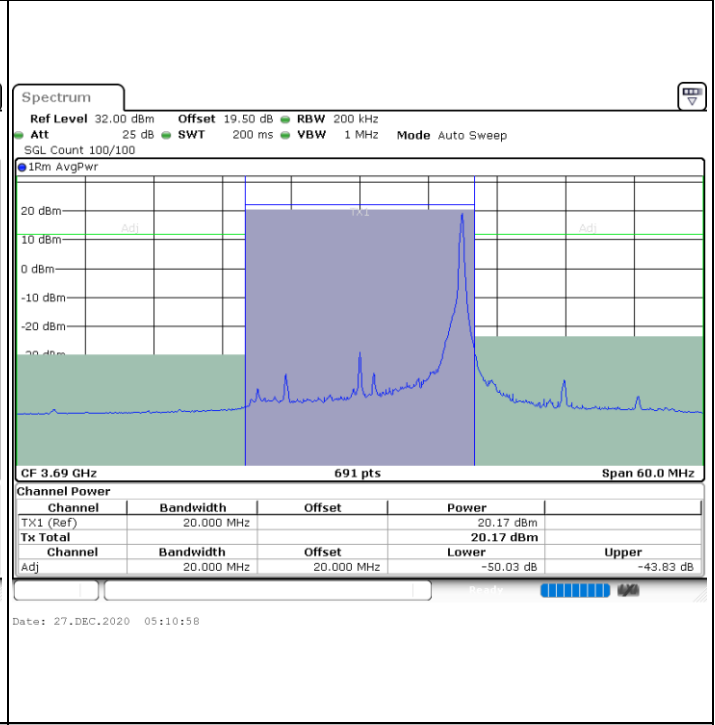

**Highest Channel / FullIRB**

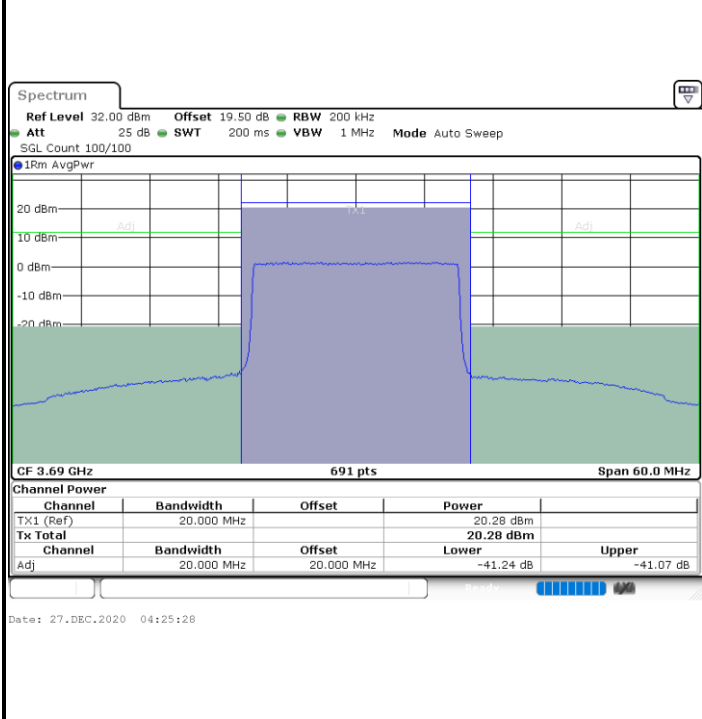

**N/A**



LTE Band 48 / 5MHz

16QAM

Lowest Channel / 1RB0

Lowest Channel / 1RBmax

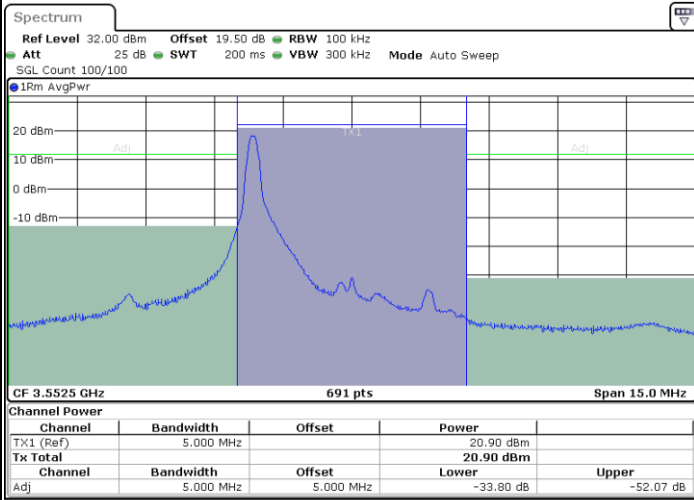

Date: 19 DEC 2020 13:07:29

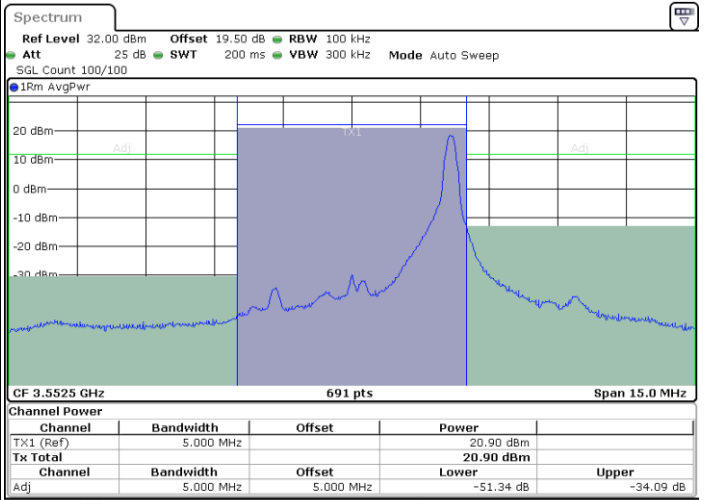

Date: 19 DEC 2020 13:15:59

Lowest Channel / FullIRB

N/A

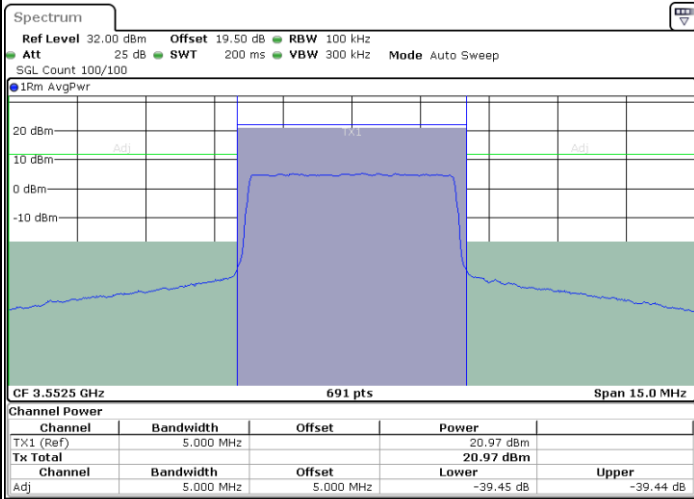

Date: 19 DEC 2020 12:55:08



LTE Band 48 / 5MHz

16QAM

Middle Channel / 1RB0

Middle Channel / 1RBmax

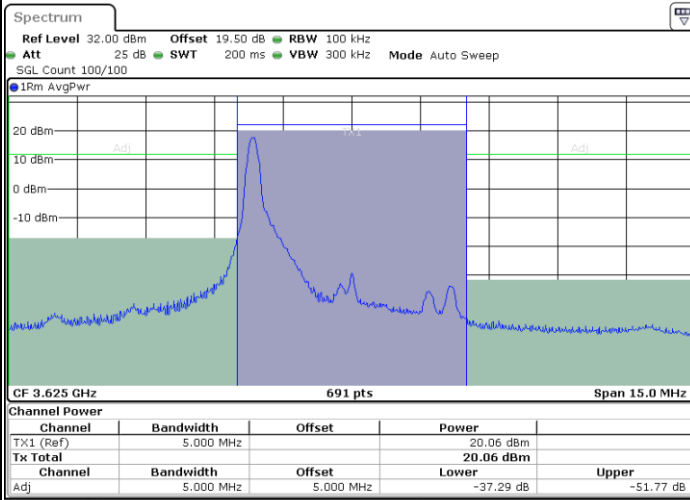

Date: 18.MAR.2021 23:31:33

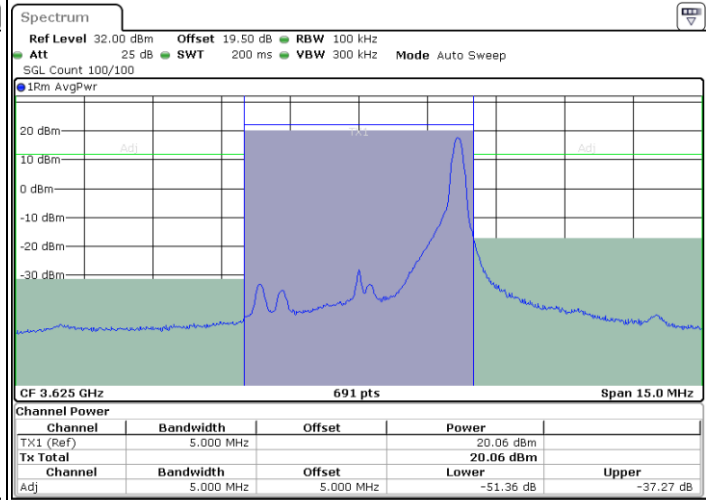

Date: 18.MAR.2021 23:32:57

Middle Channel / FullIRB

N/A

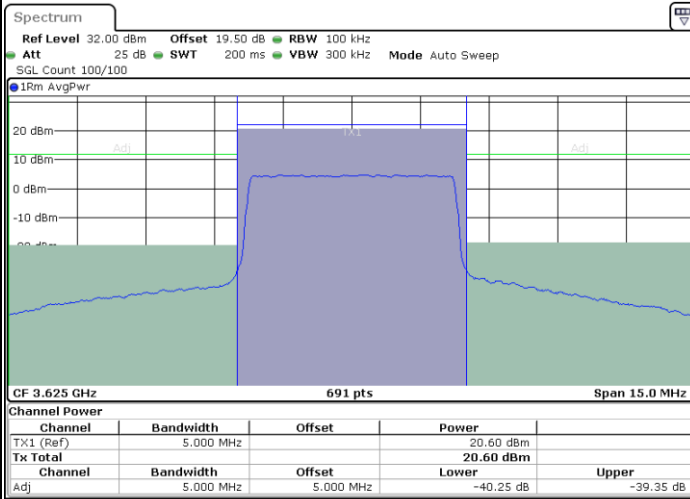

Date: 19.DEC.2020 14:05:11





LTE Band 48 / 5MHz

16QAM

Highest Channel / 1RB0

Highest Channel / 1RBmax

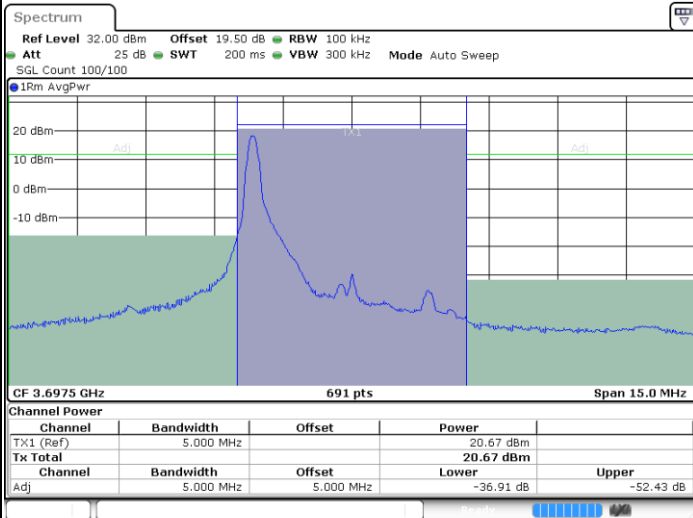

Date: 19 DEC 2020 14:21:36

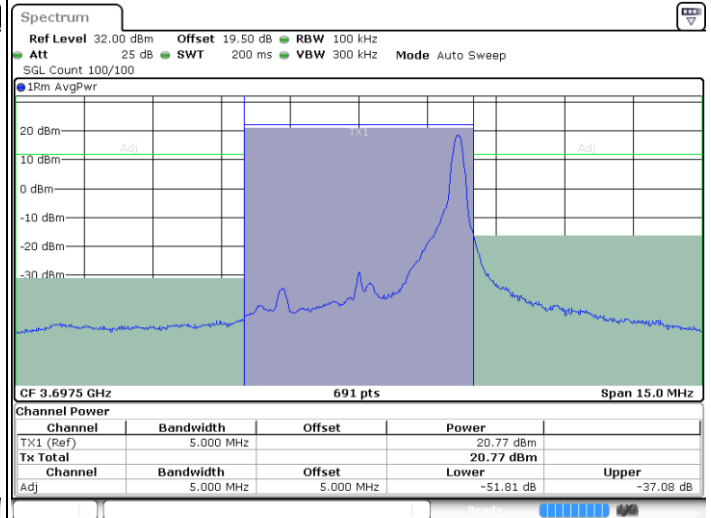

Date: 19 DEC 2020 14:29:32

Highest Channel / FullIRB

N/A

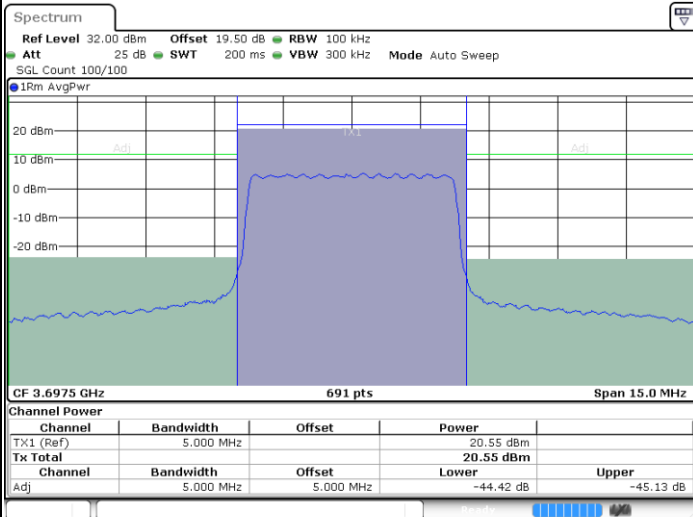

Date: 19 DEC 2020 14:13:43



LTE Band 48 / 10MHz

16QAM

Lowest Channel / 1RB0

Lowest Channel / 1RBmax

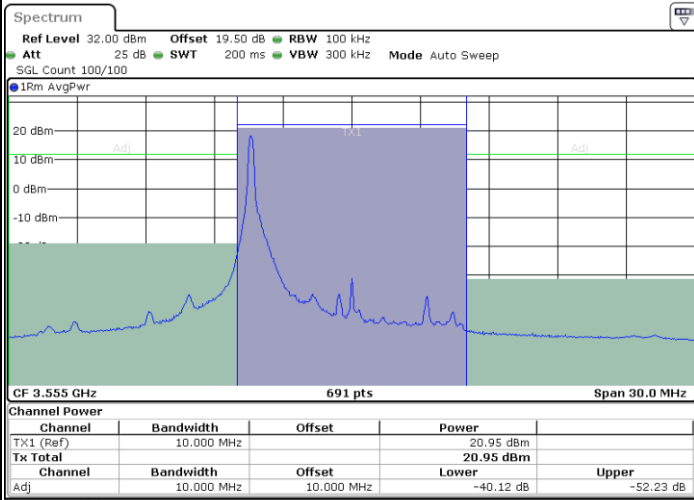

Date: 19 DEC 2020 15:03:50

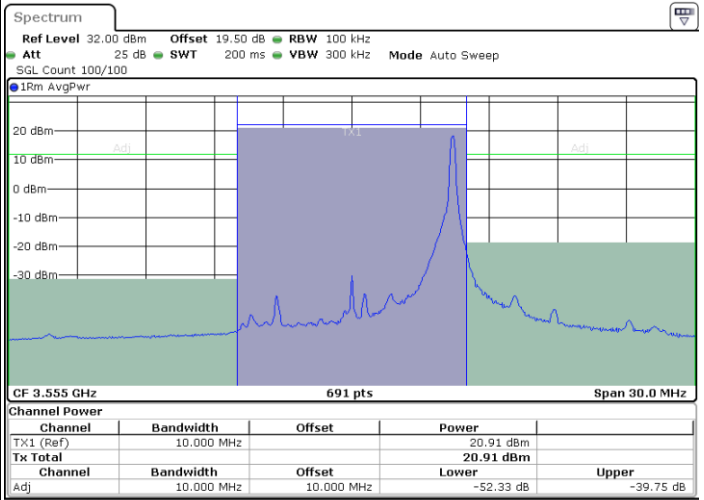

Date: 19 DEC 2020 15:11:17

Lowest Channel / FullIRB

N/A

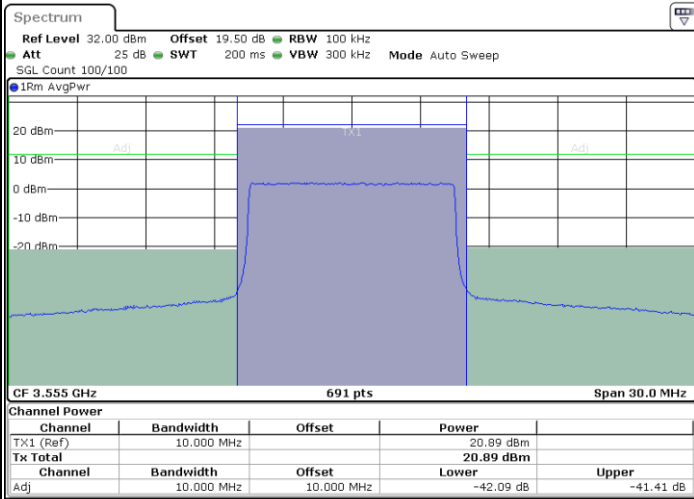

Date: 19 DEC 2020 14:43:23



LTE Band 48 / 10MHz

16QAM

MiddleChannel / 1RB0

Middle Channel / 1RBmax

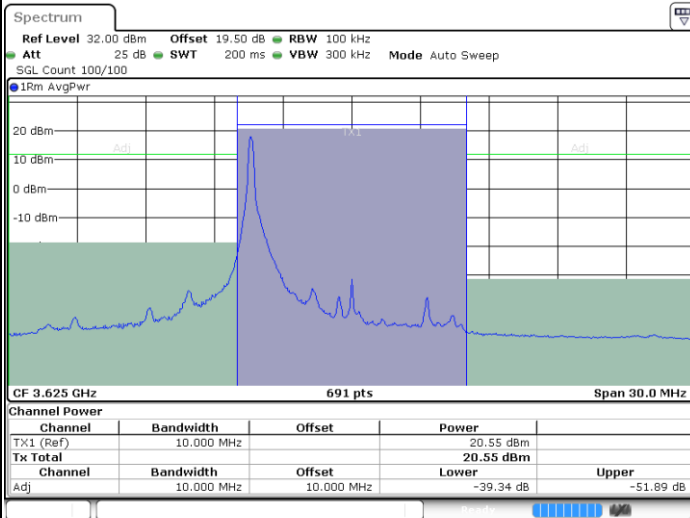

Date: 19 DEC 2020 16:07:13

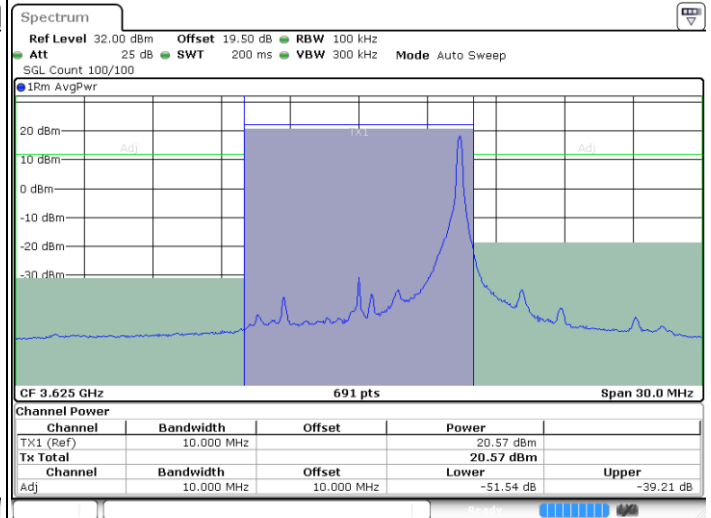

Date: 19 DEC 2020 15:39:01

Middle Channel / FullIRB

N/A

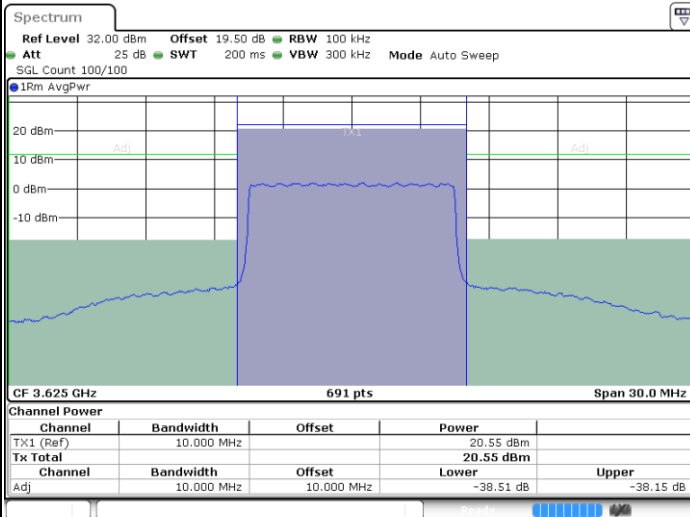

Date: 19 DEC 2020 16:17:47



LTE Band 48 / 10MHz

16QAM

Highest Channel / 1RB0

Highest Channel / 1RBmax

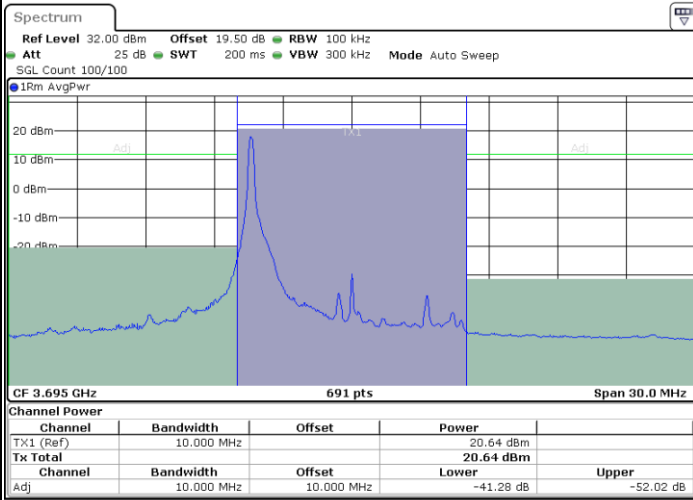

Date: 19 DEC 2020 16:44:38

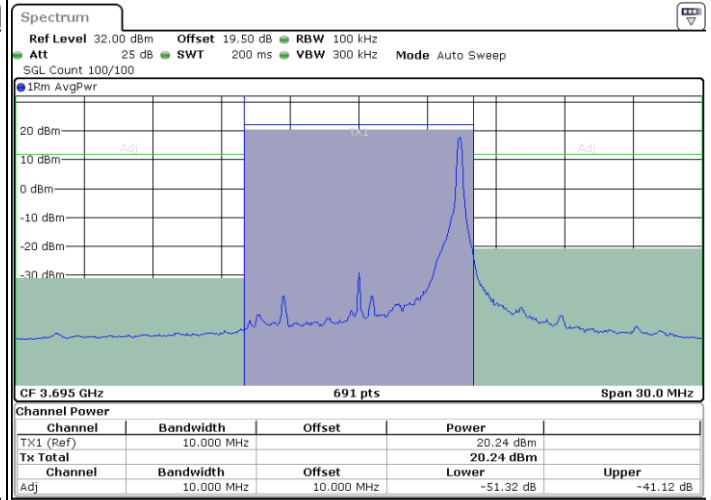

Date: 19 DEC 2020 16:54:23

Highest Channel / FullIRB

N/A

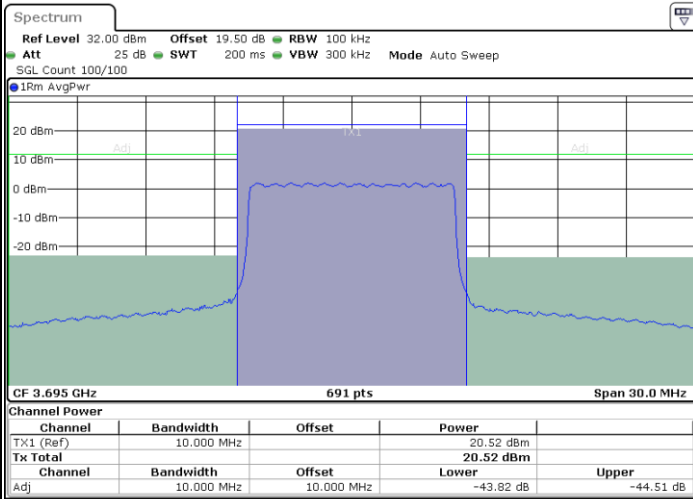

Date: 19 DEC 2020 16:36:06



**LTE Band 48 / 15MHz**

**16QAM**

**Lowest Channel / 1RB0**

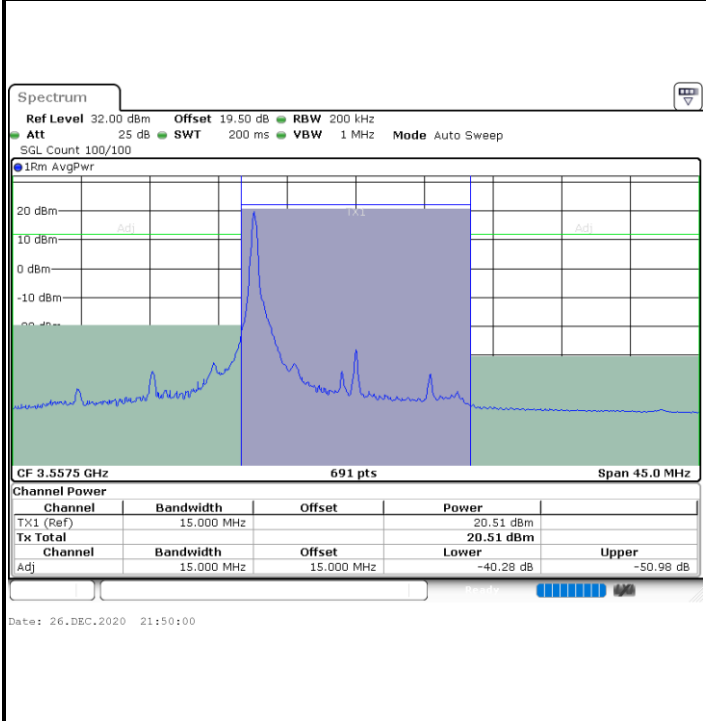

**Lowest Channel / 1RBmax**

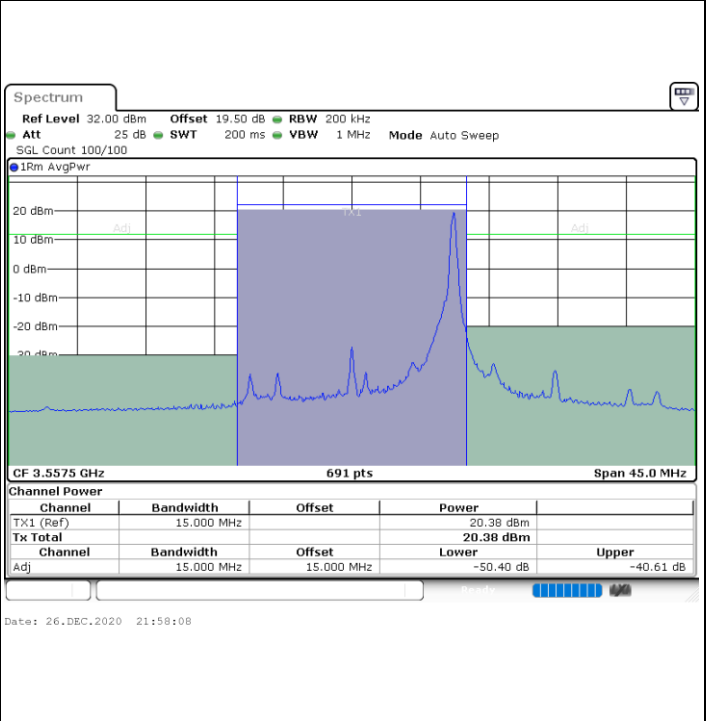

**Lowest Channel / FullIRB**

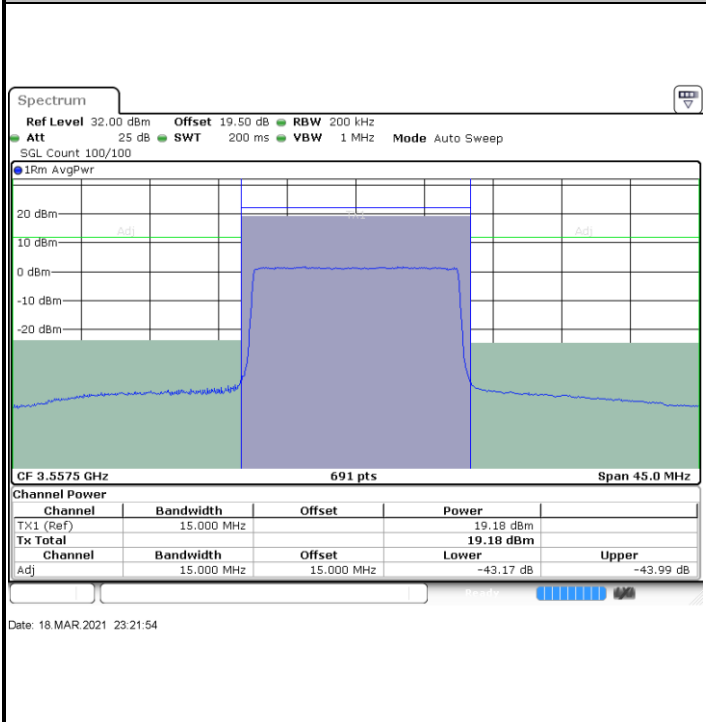

**N/A**



**LTE Band 48 / 15MHz**

**16QAM**

**Middle Channel / 1RB0**

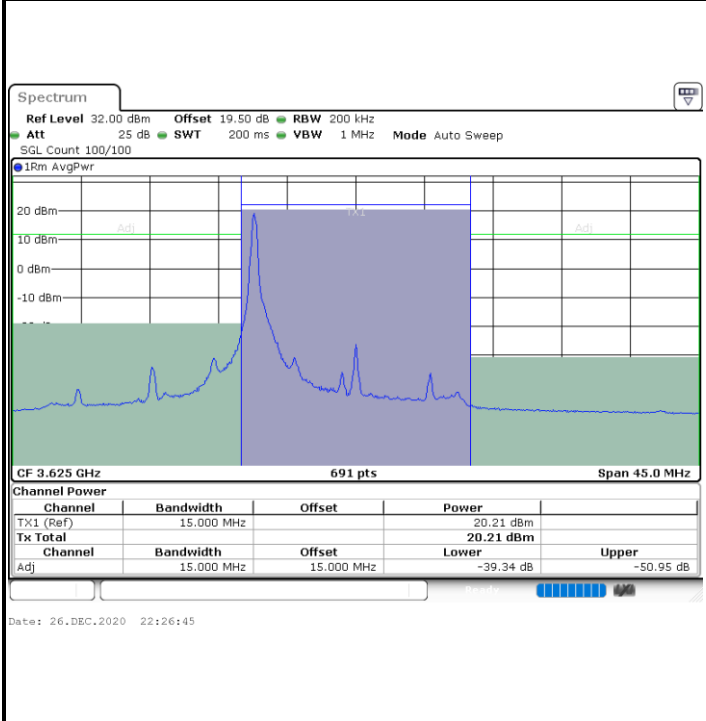

**Middle Channel / 1RBmax**

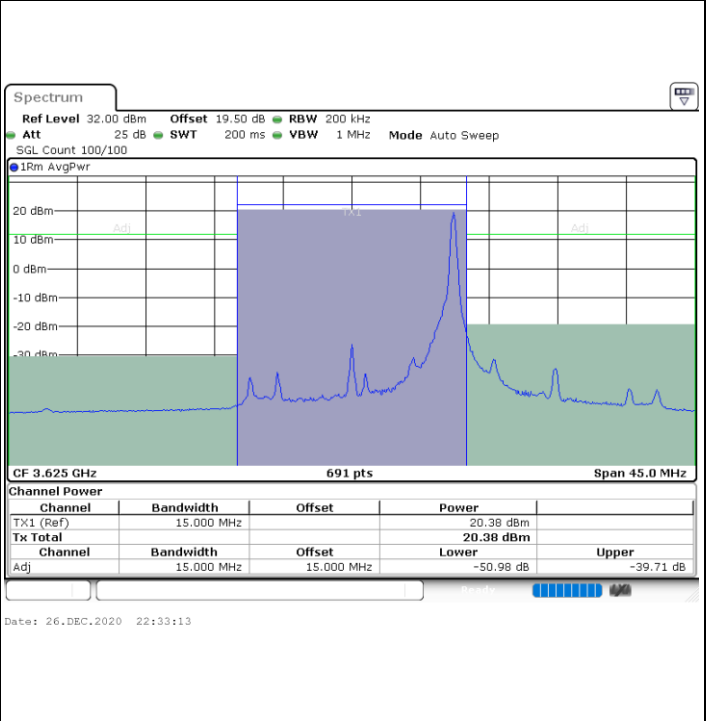

**Middle Channel / FullRB**

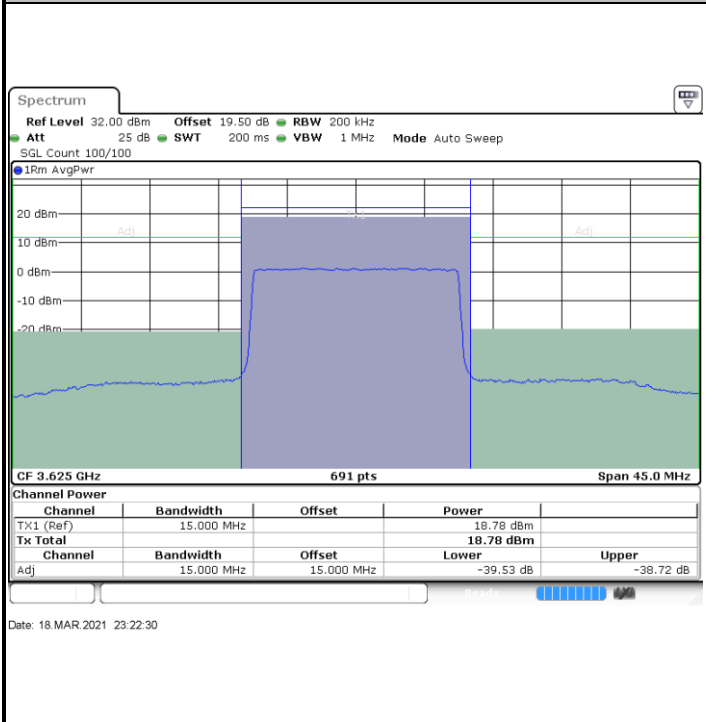

**N/A**



LTE Band 48 / 15MHz

16QAM

Highest Channel / 1RB0

Highest Channel / 1RBmax

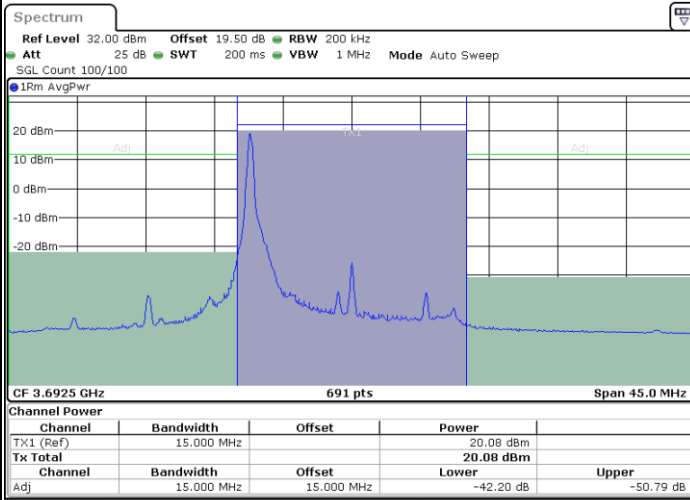

Date: 27.DEC.2020 00:12:55

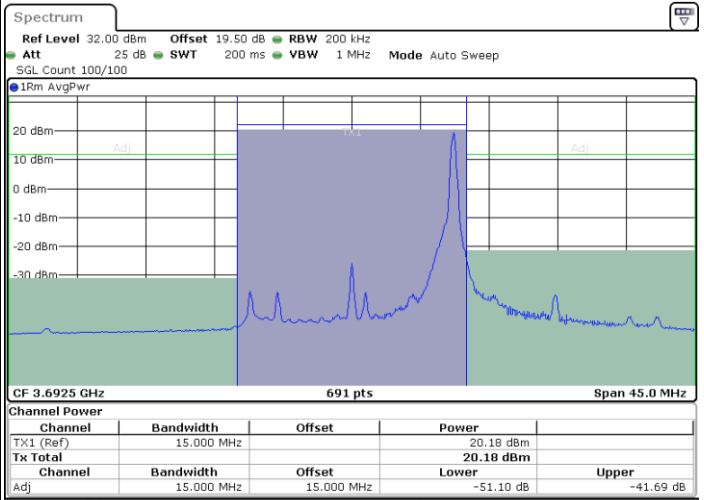

Date: 27.DEC.2020 00:22:05

Highest Channel / FullIRB

N/A

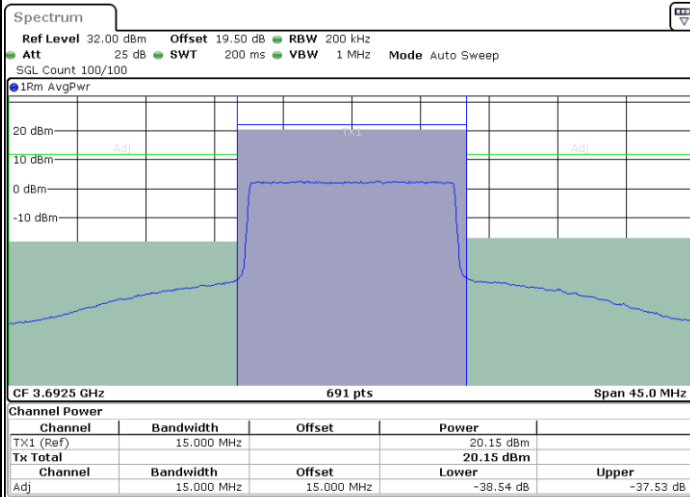

Date: 26.DEC.2020 22:53:10



LTE Band 48 / 20MHz

16QAM

Lowest Channel / 1RB0

Lowest Channel / 1RBmax

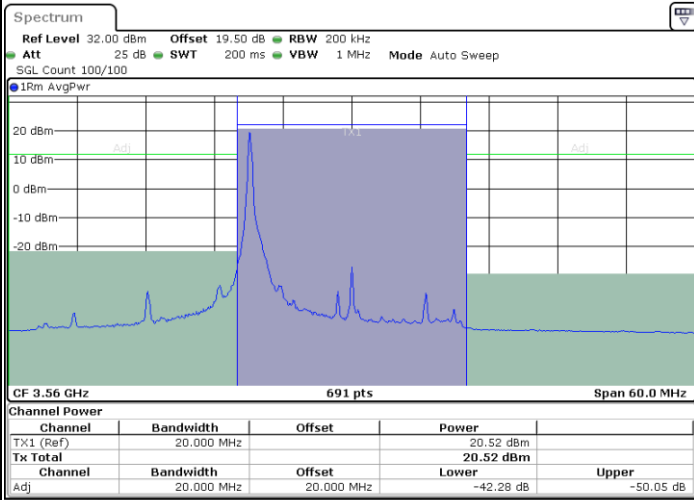

Date: 27.DEC.2020 02:45:21

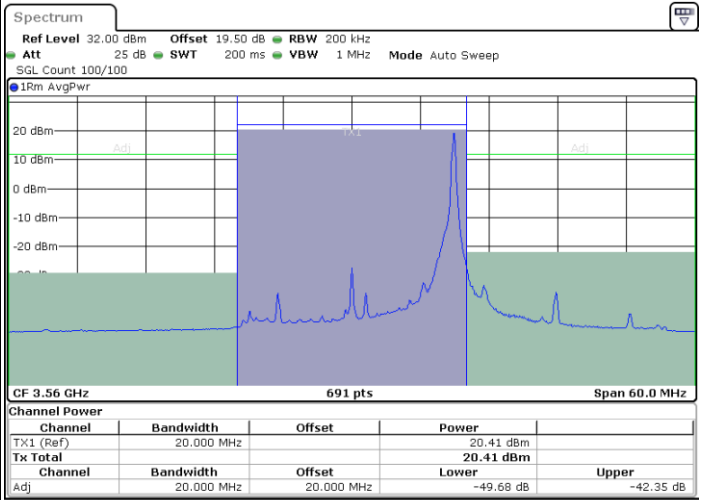

Date: 27.DEC.2020 02:50:31

Lowest Channel / FullIRB

N/A

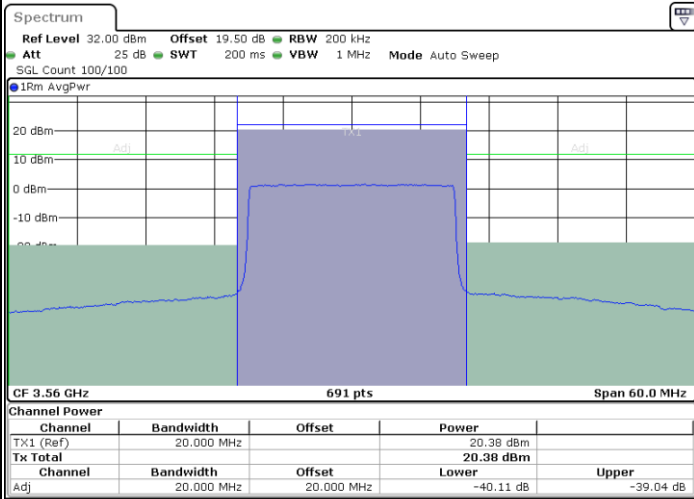

Date: 27.DEC.2020 02:42:09





LTE Band 48 / 20MHz

16QAM

Middle Channel / 1RB0

Middle Channel / 1RBmax

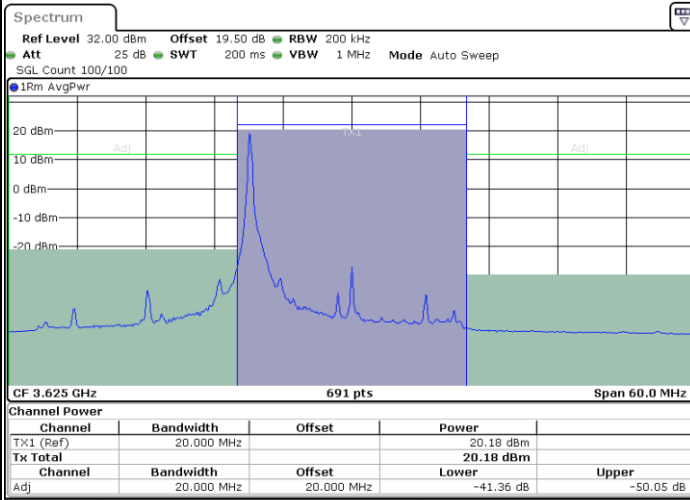

Date: 27.DEC.2020 03:48:00

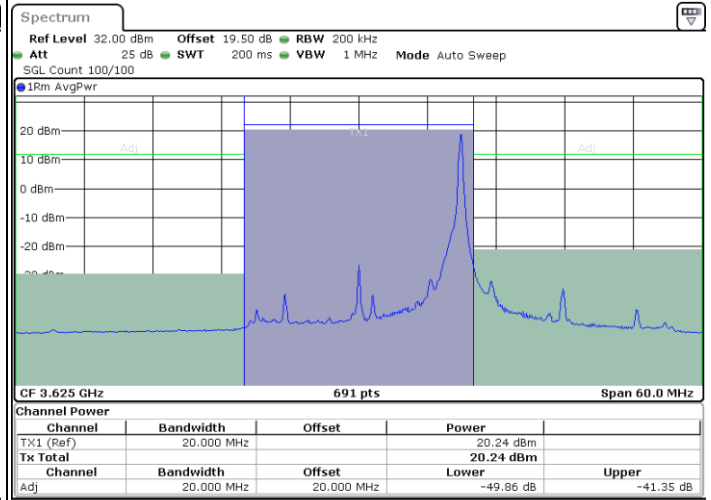

Date: 27.DEC.2020 04:14:38

Middle Channel / FullRB

N/A

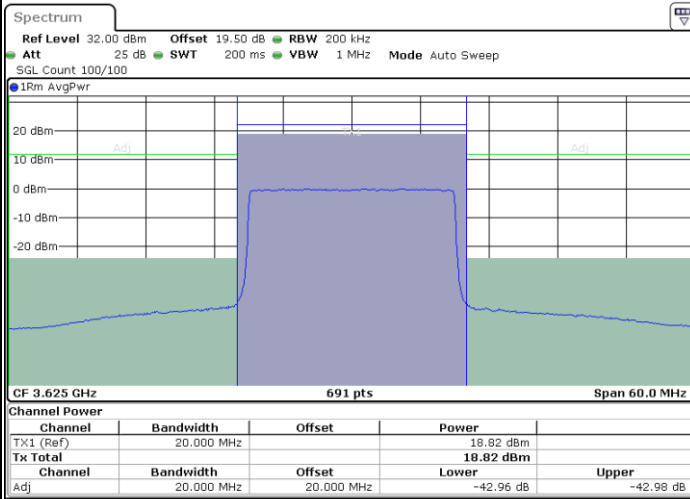

Date: 18.MAR.2021 23:14:11



LTE Band 48 / 20MHz

16QAM

Highest Channel / 1RB0

Highest Channel / 1RBmax

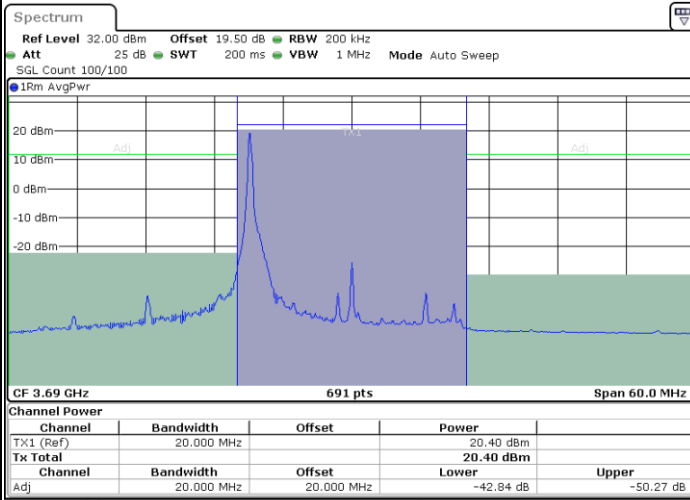

Date: 27.DEC.2020 05:04:13

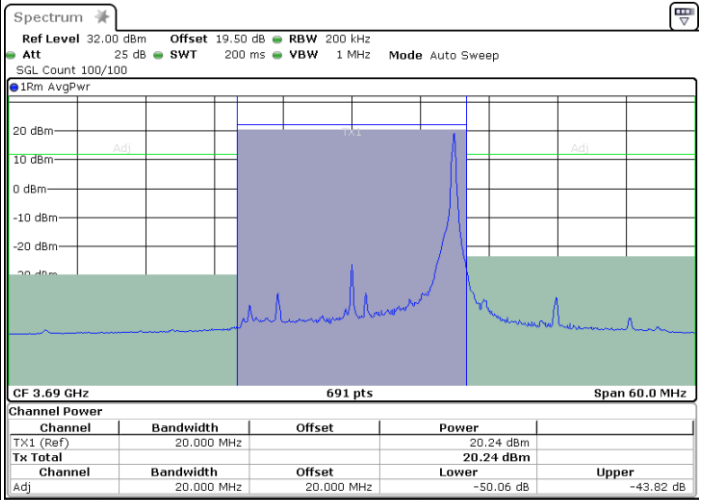

Date: 27.DEC.2020 05:14:39

Highest Channel / FullIRB

N/A

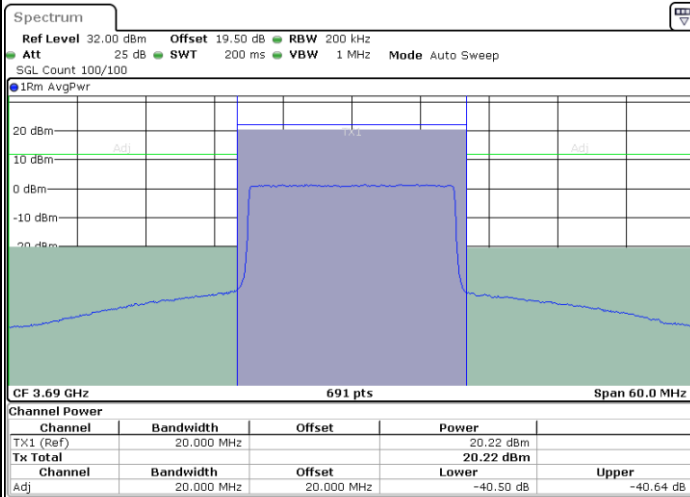

Date: 27.DEC.2020 04:43:59



LTE Band 48 / 5MHz

64QAM

Lowest Channel / 1RB0

Lowest Channel / 1RBmax

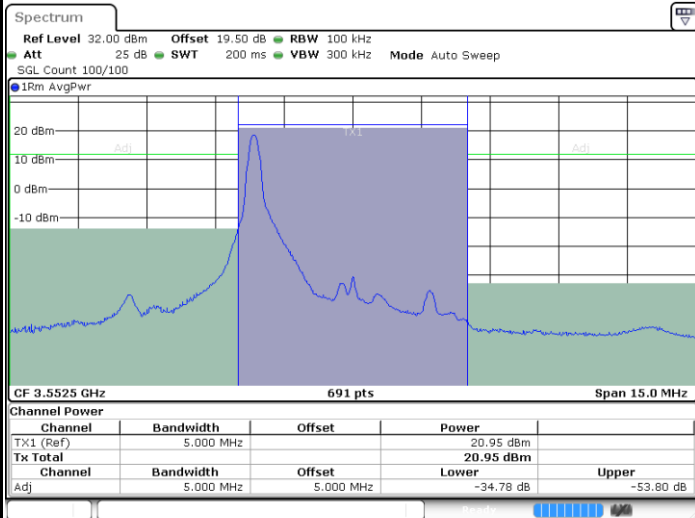

Date: 19 DEC 2020 13:03:17

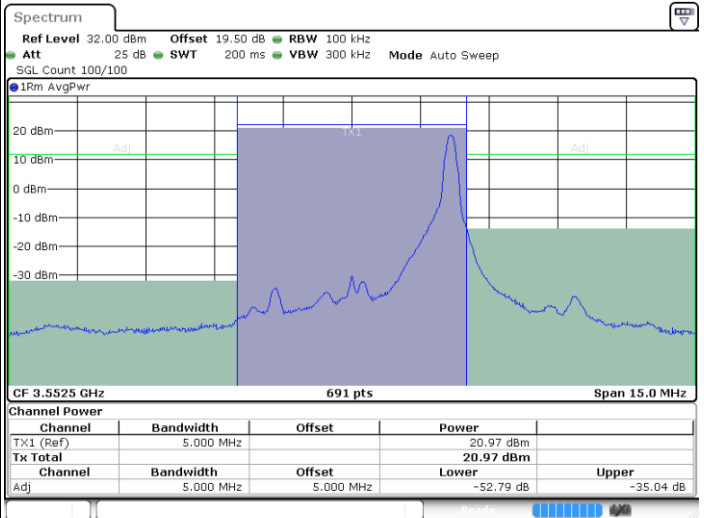

Date: 19 DEC 2020 13:19:16

Lowest Channel / FullIRB

N/A

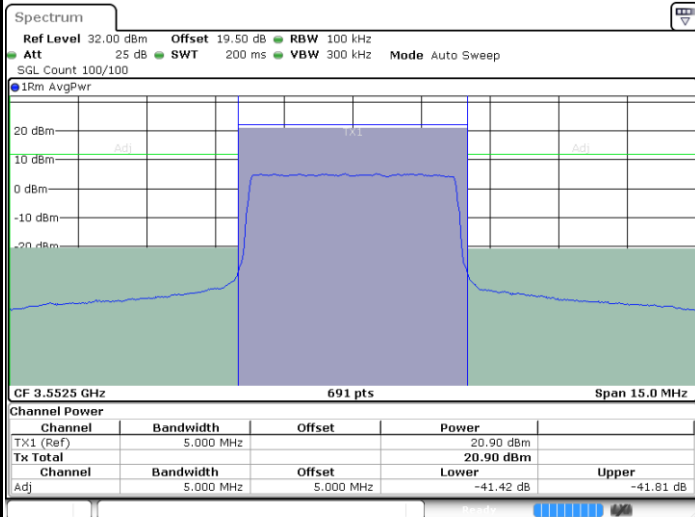

Date: 19 DEC 2020 12:57:39



LTE Band 48 / 5MHz

64QAM

Middle Channel / 1RB0

Middle Channel / 1RBmax

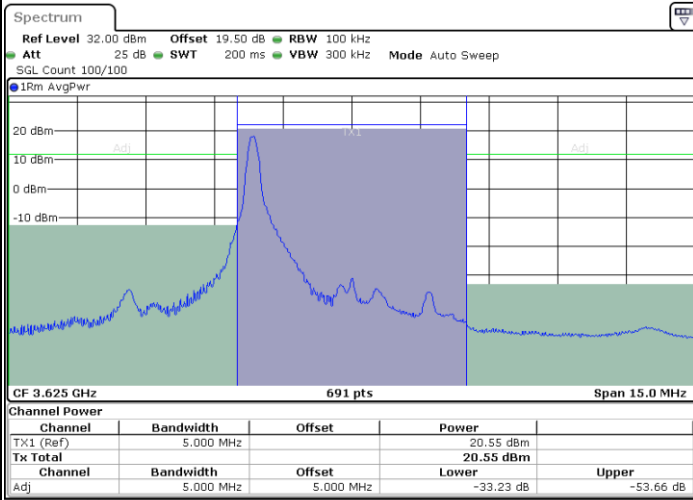

Date: 19 DEC 2020 13:58:11

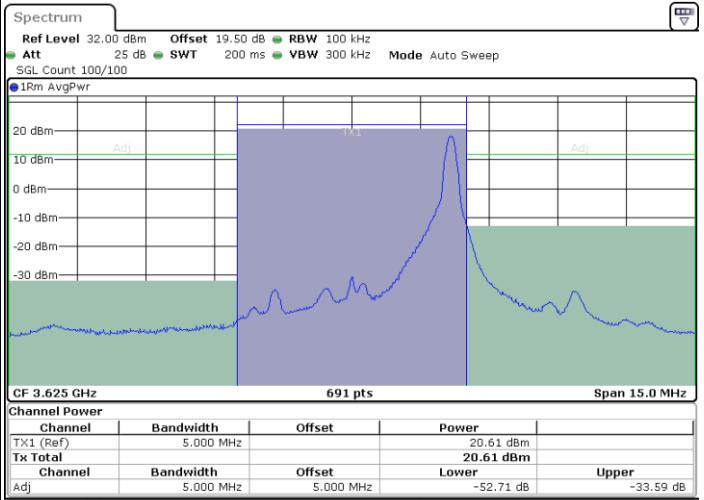

Date: 19 DEC 2020 13:23:05

Middle Channel / FullRB

N/A

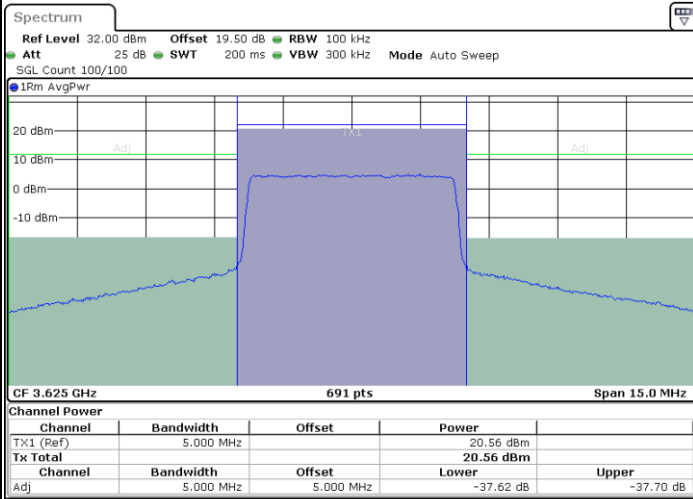

Date: 19 DEC 2020 14:02:20



LTE Band 48 / 5MHz

64QAM

Highest Channel / 1RB0

Highest Channel / 1RBmax

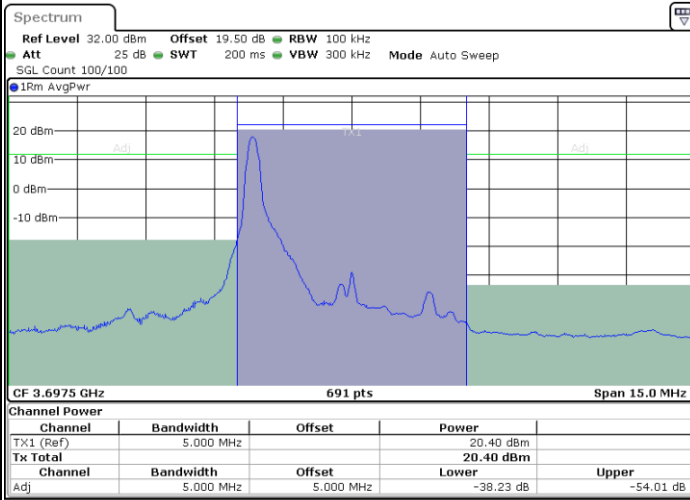

Date: 19 DEC 2020 14:18:52

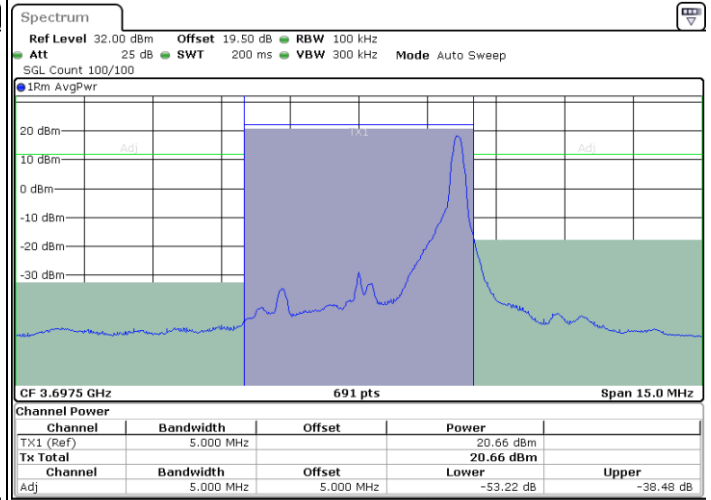

Date: 19 DEC 2020 14:32:02

Highest Channel / FullIRB

N/A

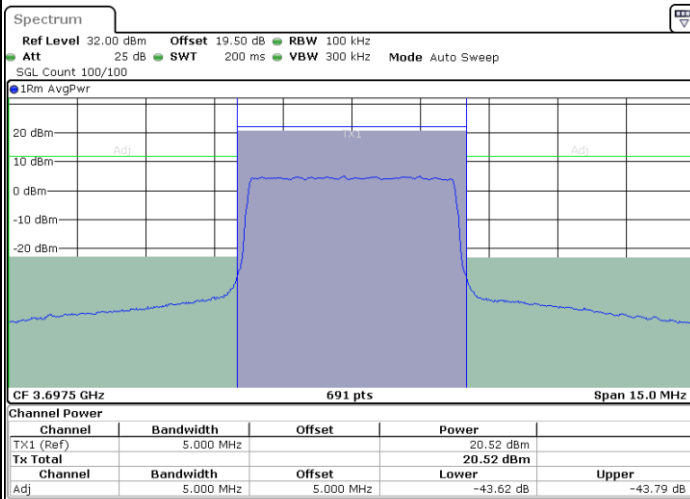

Date: 19 DEC 2020 14:16:13



LTE Band 48 / 10MHz

64QAM

Lowest Channel / 1RB0

Lowest Channel / 1RBmax

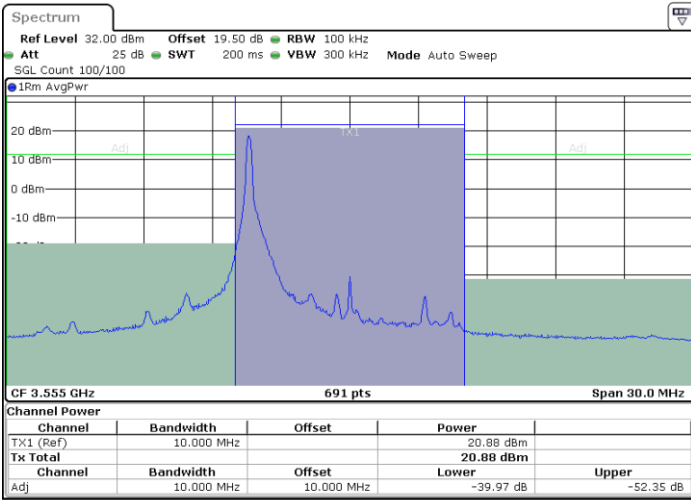

Date: 19 DEC.2020 15:01:16

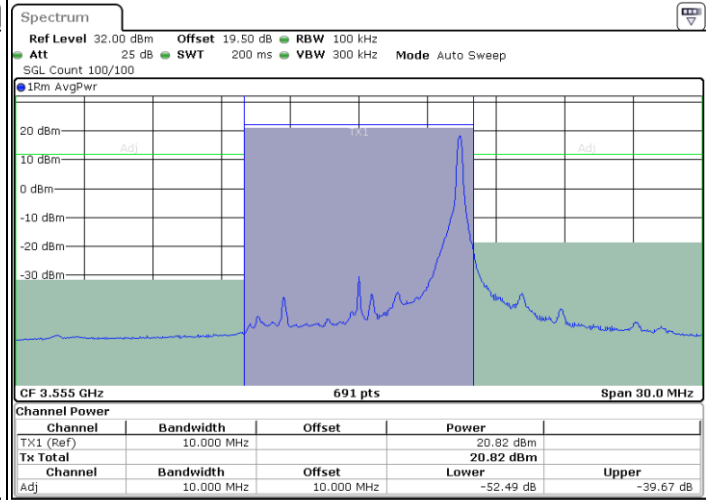

Date: 19 DEC.2020 15:19:30

Lowest Channel / FullIRB

N/A

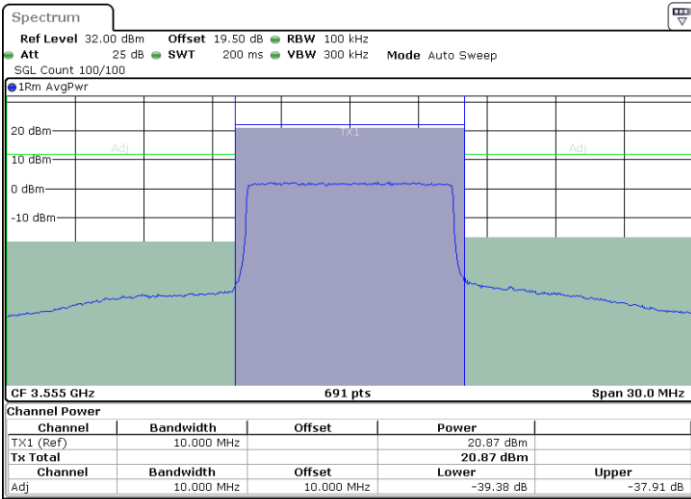

Date: 19 DEC.2020 14:46:02



**LTE Band 48 / 10MHz**

**64QAM**

**MiddleChannel / 1RB0**

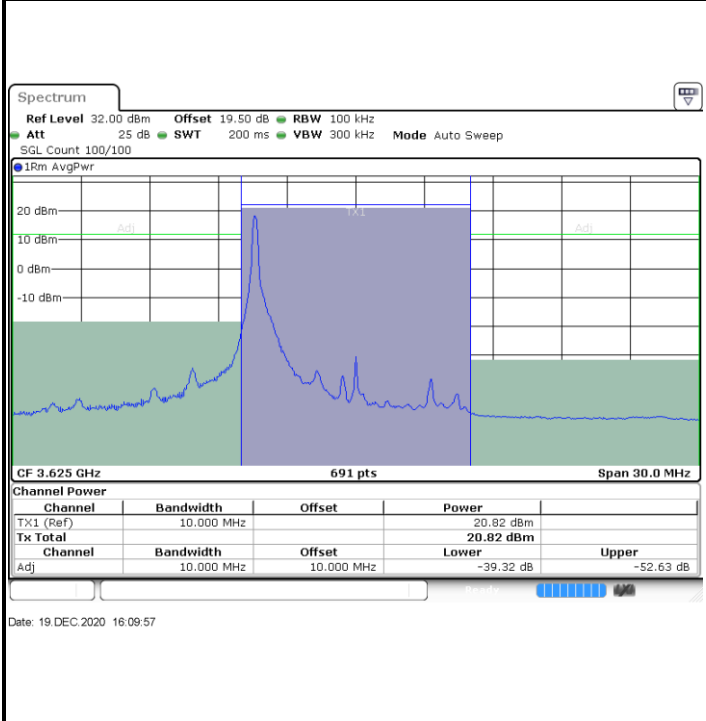

**Middle Channel / 1RBmax**

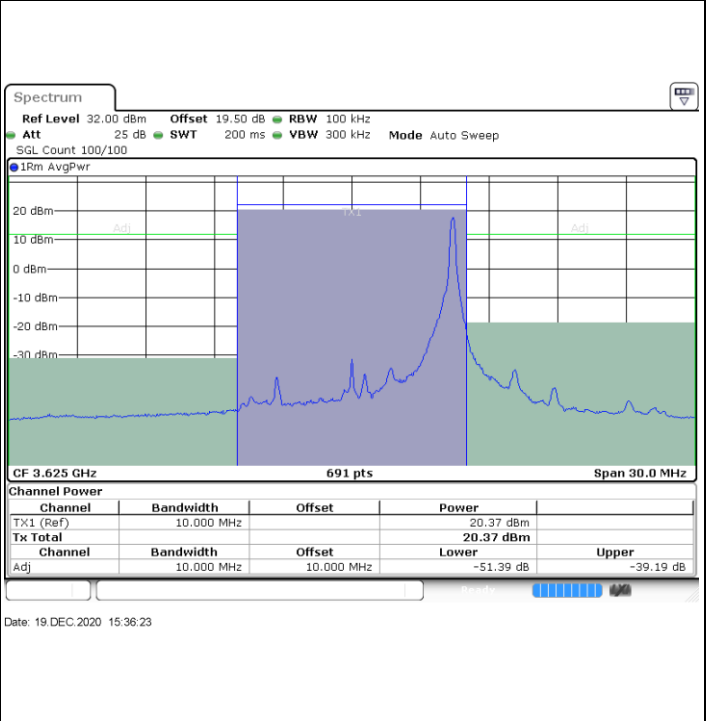

**Middle Channel / FullIRB**

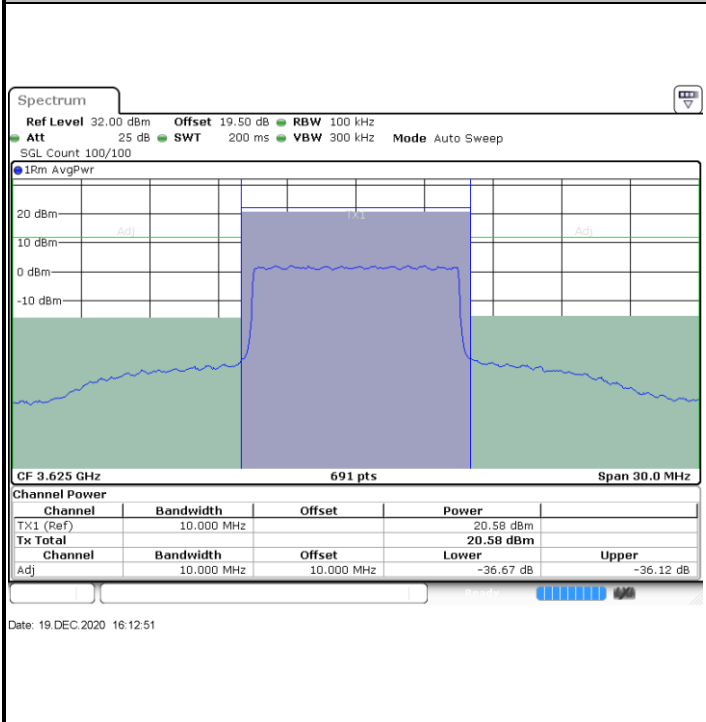

**N/A**



**LTE Band 48 / 10MHz**

**64QAM**

**Highest Channel / 1RB0**

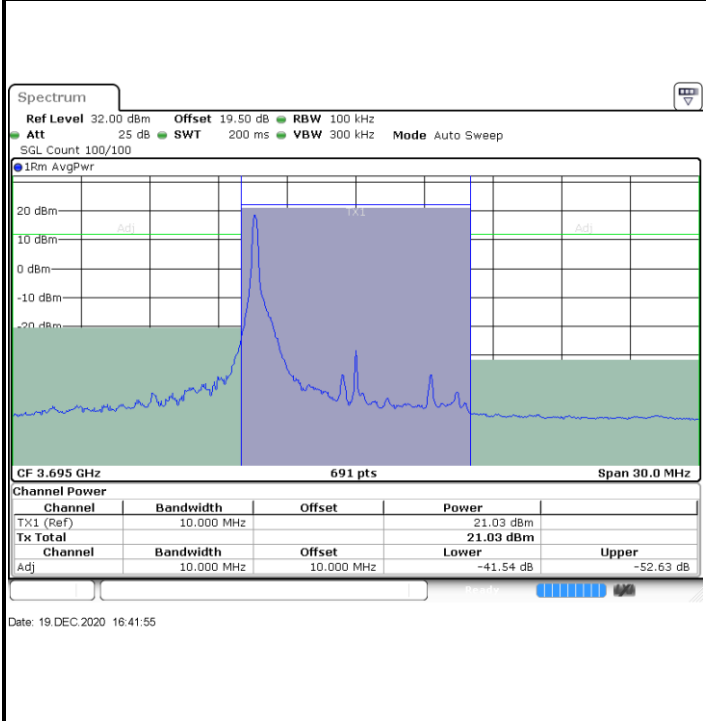

**Highest Channel / 1RBmax**

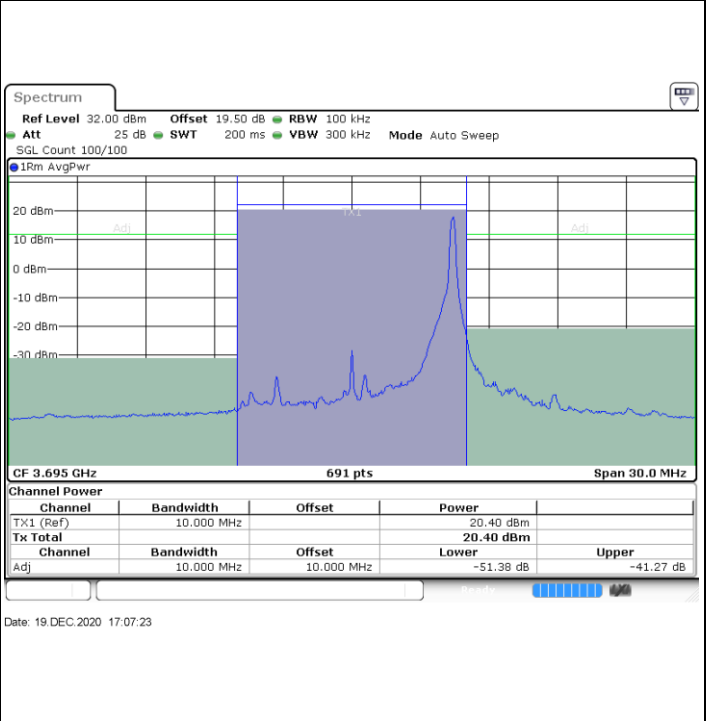

**Highest Channel / FullIRB**

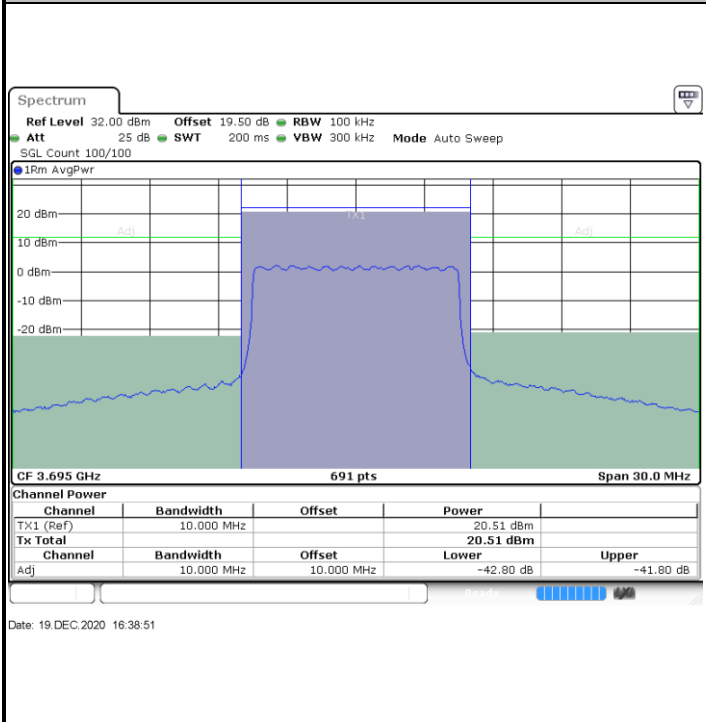

**N/A**





LTE Band 48 / 15MHz

64QAM

Lowest Channel / 1RB0

Lowest Channel / 1RBmax

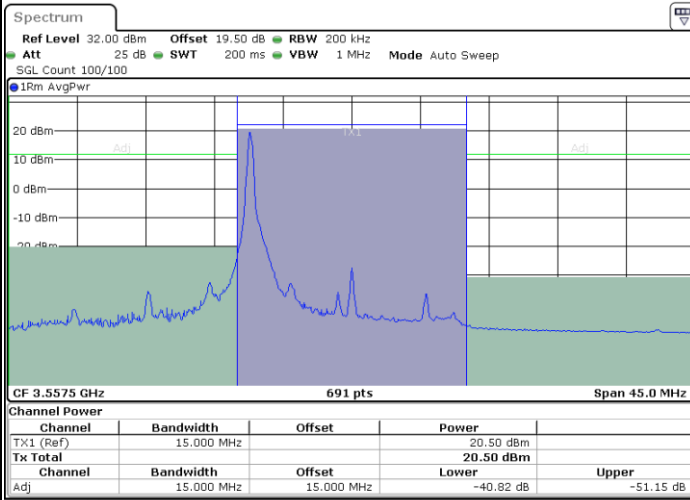

Date: 26.DEC.2020 21:43:33

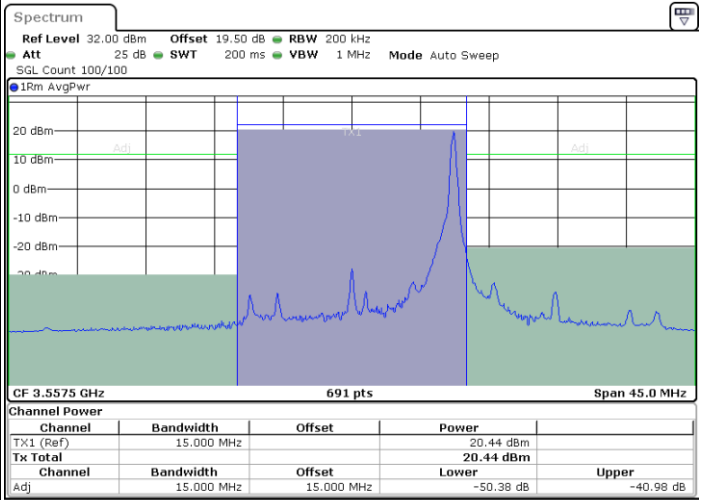

Date: 26.DEC.2020 21:58:53

Lowest Channel / FullIRB

N/A

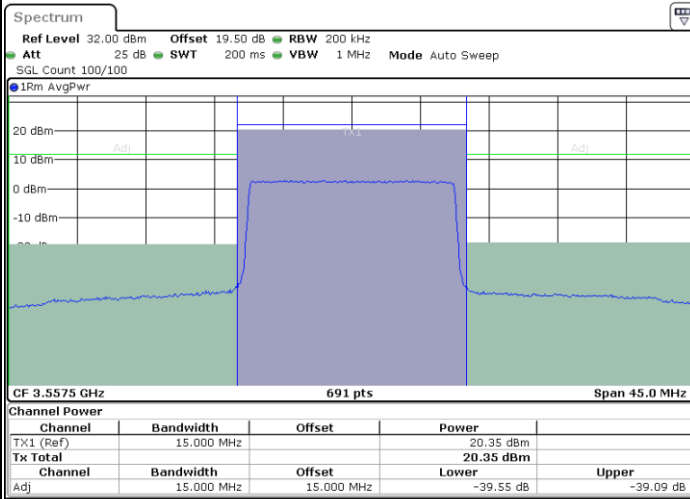

Date: 26.DEC.2020 21:40:54



LTE Band 48 / 15MHz

64QAM

Middle Channel / 1RB0

Middle Channel / 1RBmax

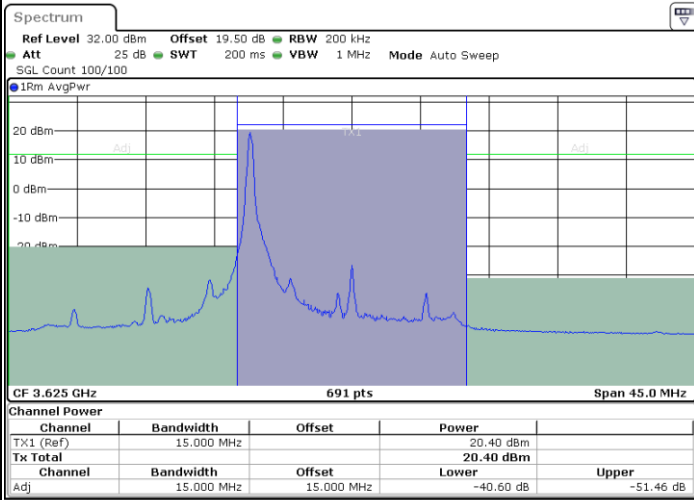

Date: 26. DEC. 2020 22:31:05

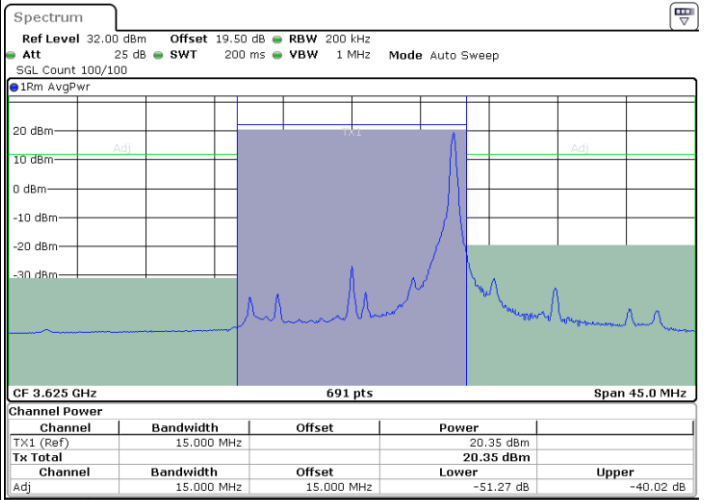

Date: 26. DEC. 2020 22:32:21

Middle Channel / FullRB

N/A

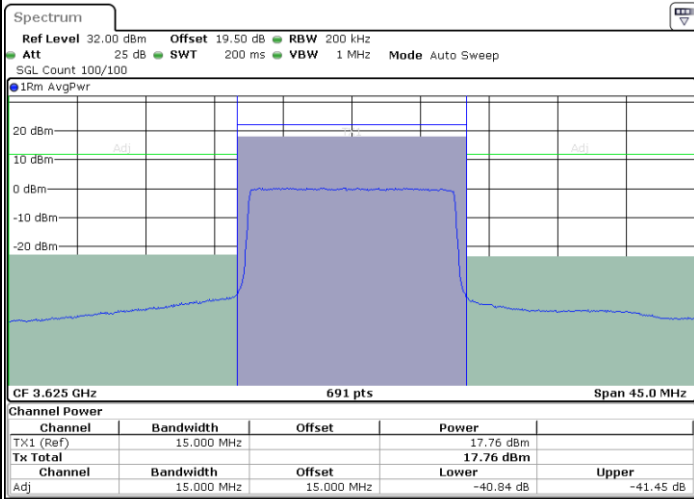

Date: 18. MAR 2021 23:23:07



LTE Band 48 / 15MHz

64QAM

Highest Channel / 1RB0

Highest Channel / 1RBmax

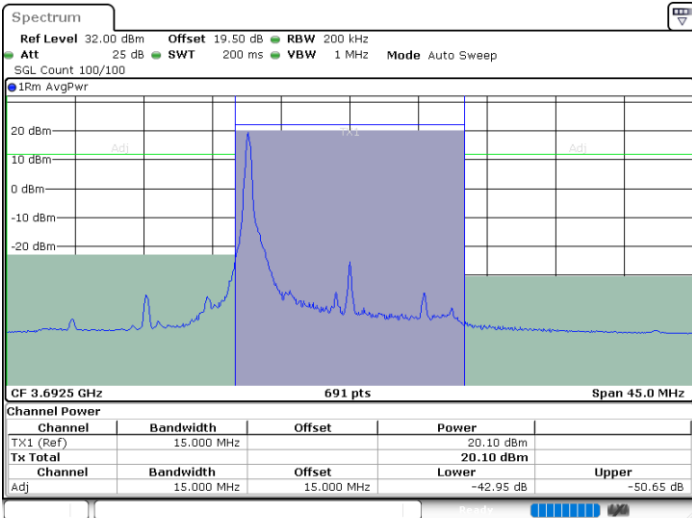

Date: 27.DEC.2020 00:17:06

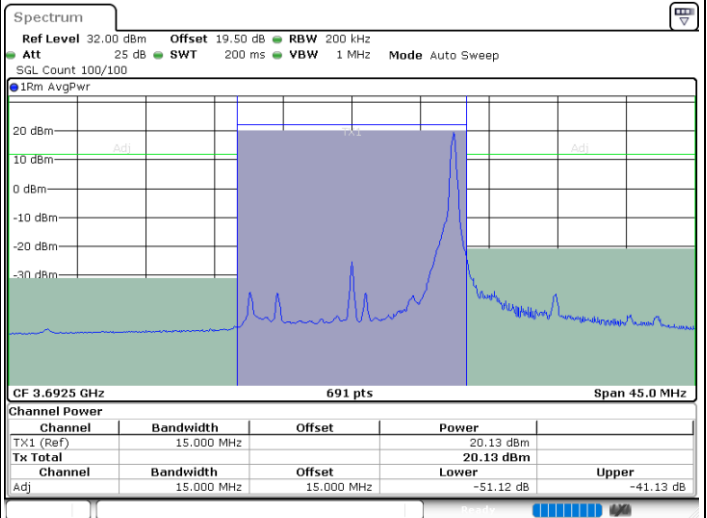

Date: 27.DEC.2020 00:19:51

Highest Channel / FullIRB

N/A

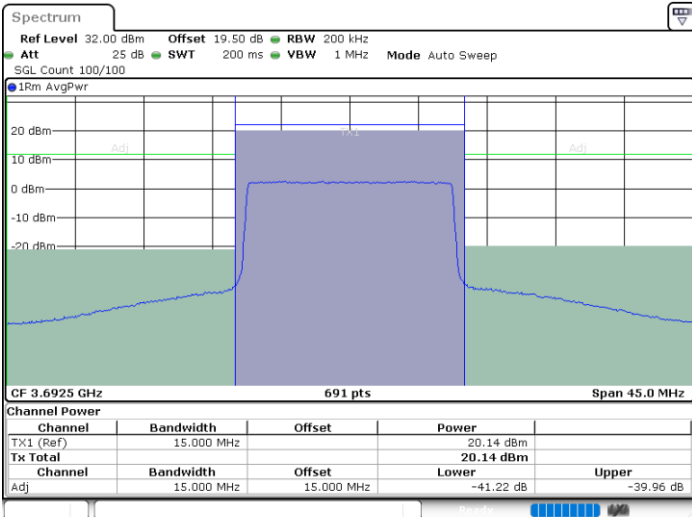

Date: 26.DEC.2020 22:45:40