

FCC Test Report

(PART 24)

Report No.: RF170106C02-1

FCC ID: ZMOL850GL

Test Model: L850-GL

Received Date: Jan. 06, 2017

Test Date: Jan. 10, 2017 ~ Feb. 02, 2017

Issued Date: Feb. 21, 2017

Applicant: Fibocom Wireless Inc.

Address: 5/F, Tower A, Technology Building II, 1057 Nanhai Blvd, Nanshan,
Shenzhen, China

Issued By: Bureau Veritas Consumer Products Services (H.K.) Ltd., Taoyuan Branch

Lab Address: No. 47-2, 14th Ling, Chia Pau Vil., Lin Kou Dist., New Taipei City, Taiwan
(R.O.C)

Test Location: No. 19, Hwa Ya 2nd Rd, Wen Hwa Tsuen, Kwei Shan Hsiang, Taoyuan
Hsien 333, Taiwan, R.O.C.



This report is for your exclusive use. Any copying or replication of this report to or for any other person or entity, or use of our name or trademark, is permitted only with our prior written permission. This report sets forth our findings solely with respect to the test samples identified herein. The results set forth in this report are not indicative or representative of the quality or characteristics of the lot from which a test sample was taken or any similar or identical product unless specifically and expressly noted. Our report includes all of the tests requested by you and the results thereof based upon the information that you provided to us. You have 60 days from date of issuance of this report to notify us of any material error or omission caused by our negligence, provided, however, that such notice shall be in writing and shall specifically address the issue you wish to raise. A failure to raise such issue within the prescribed time shall constitute your unqualified acceptance of the completeness of this report, the tests conducted and the correctness of the report contents. Unless specific mention, the uncertainty of measurement has been explicitly taken into account to declare the compliance or non-compliance to the specification. The report must not be used by the client to claim product certification, approval, or endorsement by TAF or any government agencies.

Table of Contents

| | |
|---|-----------|
| Release Control Record | 3 |
| 1 Certificate of Conformity | 4 |
| 2 Summary of Test Results | 5 |
| 2.1 Measurement Uncertainty | 5 |
| 2.2 Test Site And Instruments | 6 |
| 3 General Information | 8 |
| 3.1 General Description of EUT | 8 |
| 3.2 Configuration of System under Test | 9 |
| 3.2.1 Description of Support Units | 9 |
| 3.3 Test Mode Applicability and Tested Channel Detail | 9 |
| 3.4 EUT Operating Conditions | 11 |
| 3.5 General Description of Applied Standards | 11 |
| 4 Test Types and Results | 12 |
| 4.1 Output Power Measurement | 12 |
| 4.1.1 Limits of Output Power Measurement | 12 |
| 4.1.2 Test Procedures | 12 |
| 4.1.3 Test Setup | 13 |
| 4.1.4 Test Results | 14 |
| 4.2 Frequency Stability Measurement | 20 |
| 4.2.1 Limits of Frequency Stability Measurement | 20 |
| 4.2.2 Test Procedure | 20 |
| 4.2.3 Test Setup | 20 |
| 4.2.4 Test Results | 21 |
| 4.3 Occupied Bandwidth Measurement | 28 |
| 4.3.1 Test Procedure | 28 |
| 4.3.2 Test Setup | 28 |
| 4.3.3 Test Result | 29 |
| 4.4 Band Edge Measurement | 33 |
| 4.4.1 Limits of Band Edge Measurement | 33 |
| 4.4.2 Test Setup | 33 |
| 4.4.3 Test Procedures | 33 |
| 4.4.4 Test Results | 34 |
| 4.5 Peak to Average Ratio | 40 |
| 4.5.1 Limits of Peak to Average Ratio Measurement | 40 |
| 4.5.2 Test Setup | 40 |
| 4.5.3 Test Procedures | 40 |
| 4.5.4 Test Results | 41 |
| 4.6 Conducted Spurious Emissions | 45 |
| 4.6.1 Limits of Conducted Spurious Emissions Measurement | 45 |
| 4.6.2 Test Setup | 45 |
| 4.6.3 Test Procedure | 45 |
| 4.6.4 Test Results | 46 |
| 4.7 Radiated Emission Measurement | 53 |
| 4.7.1 Limits of Radiated Emission Measurement | 53 |
| 4.7.2 Test Procedure | 53 |
| 4.7.3 Deviation from Test Standard | 53 |
| 4.7.4 Test Setup | 53 |
| 4.7.5 Test Results | 54 |
| 5 Pictures of Test Arrangements | 66 |
| Appendix – Information on the Testing Laboratories | 67 |

Release Control Record

| Issue No. | Description | Date Issued |
|---------------|------------------|---------------|
| RF170106C02-1 | Original Release | Feb. 21, 2017 |

1 Certificate of Conformity

Product: LTE module

Brand: Fibocom

Test Model: L850-GL

Sample Status: Identical Prototype

Applicant: Fibocom Wireless Inc.

Test Date: Jan. 10, 2017 ~ Feb. 02, 2017

Standards: FCC Part 24, Subpart E

The above equipment has been tested by **Bureau Veritas Consumer Products Services (H.K.) Ltd., Taoyuan Branch**, and found compliance with the requirement of the above standards. The test record, data evaluation & Equipment Under Test (EUT) configurations represented herein are true and accurate accounts of the measurements of the sample's EMC characteristics under the conditions specified in this report.

Prepared by :  , **Date:** Feb. 21, 2017
Gina Liu / Specialist

Approved by :  , **Date:** Feb. 21, 2017
David Huang / Project Engineer

2 Summary of Test Results

| Applied Standard: FCC Part 24 & Part 2 | | | |
|--|------------------------------------|--------|--|
| FCC Clause | Test Item | Result | Remarks |
| 2.1046 24.232 | Effective Isotropic Radiated Power | Pass | Meet the requirement of limit. |
| 2.1046 24.232(d) | Peak to Average Ratio | Pass | Meet the requirement of limit. |
| 2.1055 24.235 | Frequency Stability | Pass | Meet the requirement of limit. |
| 2.1049 24.238(b) | Occupied Bandwidth | Pass | Meet the requirement of limit. |
| 24.238(b) | Band Edge Measurements | Pass | Meet the requirement of limit. |
| 2.1051 24.238 | Conducted Spurious Emissions | Pass | Meet the requirement of limit. |
| 2.1053 24.238 | Radiated Spurious Emissions | Pass | Meet the requirement of limit. Minimum passing margin is -33.43 dB at 222.06 MHz. |

2.1 Measurement Uncertainty

Where relevant, the following measurement uncertainty levels have been estimated for tests performed on the EUT as specified in CISPR 16-4-2:

| Measurement | Frequency | Expanded Uncertainty (k=2) (±) |
|------------------------------------|--------------------|--------------------------------|
| Conducted Emissions at mains ports | 150 kHz ~ 30 MHz | 2.44 dB |
| Radiated Emissions up to 1 GHz | 30 MHz ~ 200 MHz | 2.93 dB |
| | 200 MHz ~ 1000 MHz | 2.95 dB |
| Radiated Emissions above 1 GHz | 1 GHz ~ 18 GHz | 2.26 dB |
| | 18 GHz ~ 40 GHz | 1.94 dB |

2.2 Test Site And Instruments

| Description & Manufacturer | Model No. | Serial No. | Date of Calibration | Due Date of Calibration |
|--|----------------------|---------------------|---------------------|-------------------------|
| Test Receiver Agilent Technologies | N9038A | MY52260177 | Jun. 21, 2016 | Jun. 20, 2017 |
| Spectrum Analyzer Agilent | N9010A | MY52220314 | Dec. 16, 2016 | Dec. 15, 2017 |
| Spectrum Analyzer ROHDE & SCHWARZ | FSU43 | 101261 | Dec. 13, 2016 | Dec. 12, 2017 |
| BILOG Antenna SCHWARZBECK | VULB9168 | 9168-472 | Dec. 26, 2016 | Dec. 27, 2017 |
| HORN Antenna SCHWARZBECK | BBHA 9120 D | 9120D-969 | Dec. 12, 2016 | Dec. 13, 2017 |
| Double Ridge Guide Horn Antenna EMCO | 3115 | 5619 | Dec. 26, 2016 | Dec. 27, 2017 |
| BILOG Antenna SCHWARZBECK | VULB 9168 | 9168-153 | Dec. 12, 2016 | Dec. 13, 2017 |
| Agilent Communications Tester-Wireless | 8960 Series 10 | MY53201073 | Jul. 03, 2015 | Jul. 02, 2017 |
| Preamplifier EMCI | EMC 012645 | 980115 | Oct. 21, 2016 | Oct. 20, 2017 |
| Preamplifier EMCI | EMC 184045 | 980116 | Oct. 21, 2016 | Oct. 20, 2017 |
| Preamplifier EMCI | EMC 330H | 980112 | Oct. 21, 2016 | Oct. 20, 2017 |
| Power Meter Anritsu | ML2495A | 1232002 | Sep. 08, 2016 | Sep. 07, 2017 |
| Power Sensor Anritsu | MA2411B | 1207325 | Sep. 08, 2016 | Sep. 07, 2017 |
| RF signal cable HUBER+SUHNNER | SUCOFLEX 104 | 309219/4 2950114 | Oct. 21, 2016 | Oct. 20, 2017 |
| RF signal cable HUBER+SUHNNER | SUCOFLEX 104 | 250130/4 | Oct. 21, 2016 | Oct. 20, 2017 |
| RF Coaxial Cable Worken | 8D-FB | Cable-Ch10-01 | Oct. 21, 2016 | Oct. 20, 2017 |
| Software BV ADT | E3 6.120103 | NA | NA | NA |
| Antenna Tower MF | MFA-440H | NA | NA | NA |
| Turn Table MF | MFT-201SS | NA | NA | NA |
| Antenna Tower & Turn Table Controller MF | MF-7802 | NA | NA | NA |
| Radio Communication Analyzer | MT8820C | 6201300640 | Aug. 10, 2015 | Aug. 09, 2017 |
| Temperature & Humidity Chamber | GTH-120-40-CP-A R | MAA1306-019 | Sep. 02, 2016 | Sep. 01, 2017 |
| DC Power Supply Topward | 33010D | 807748 | Oct. 25, 2016 | Oct. 24, 2018 |
| Digital Multimeter Fluke | 87-III | 70360742 | Jul. 01, 2016 | Jun. 30, 2017 |

- Note:
1. The calibration interval of the above test instruments is 12 / 24 months and the calibrations are traceable to NML/ROC and NIST/USA.
 2. The test was performed in HwaYa Chamber 10.
 3. The horn antenna and preamplifier (model: EMC 184045) are used only for the measurement of emission frequency above 1 GHz if tested.
 4. The FCC Site Registration No. is 690701.
 5. The IC Site Registration No. is IC7450F-10.

3 General Information

3.1 General Description of EUT

| | | |
|----------------------------|---|---------------------|
| Product | LTE module | |
| Brand | Fibocom | |
| Test Model | L850-GL | |
| Status of EUT | Identical Prototype | |
| Power Supply Rating | 3.3 Vdc (from Host Equipment) | |
| Modulation Type | WCDMA | BPSK |
| | LTE | QPSK, 16QAM |
| Frequency Range | WCDMA | 1852.4 ~ 1907.6 MHz |
| | LTE Band 2 (Channel Bandwidth: 1.4 MHz) | 1850.7 ~ 1909.3 MHz |
| | LTE Band 2 (Channel Bandwidth: 3 MHz) | 1851.5 ~ 1908.5 MHz |
| | LTE Band 2 (Channel Bandwidth: 5 MHz) | 1852.5 ~ 1907.5 MHz |
| | LTE Band 2 (Channel Bandwidth: 10 MHz) | 1855.0 ~ 1905.0 MHz |
| | LTE Band 2 (Channel Bandwidth: 15 MHz) | 1857.5 ~ 1902.5 MHz |
| | LTE Band 2 (Channel Bandwidth: 20 MHz) | 1860.0 ~ 1900.0 MHz |
| Max. EIRP Power | WCDMA | 428.84 mW |
| | LTE Band 2 (Channel Bandwidth: 1.4 MHz) | 209.07 mW |
| | LTE Band 2 (Channel Bandwidth: 3 MHz) | 215.43 mW |
| | LTE Band 2 (Channel Bandwidth: 5 MHz) | 220.44 mW |
| | LTE Band 2 (Channel Bandwidth: 10 MHz) | 226.62 mW |
| | LTE Band 2 (Channel Bandwidth: 15 MHz) | 231.37 mW |
| | LTE Band 2 (Channel Bandwidth: 20 MHz) | 235.67 mW |
| Emission Designator | WCDMA | 4M14F9W |
| | LTE Band 2 (Channel Bandwidth: 1.4 MHz) | 1M09W7D |
| | LTE Band 2 (Channel Bandwidth: 3 MHz) | 2M70W7D |
| | LTE Band 2 (Channel Bandwidth: 5 MHz) | 4M50G7D |
| | LTE Band 2 (Channel Bandwidth: 10 MHz) | 9M90W7D |
| | LTE Band 2 (Channel Bandwidth: 15 MHz) | 13M4G7D |
| | LTE Band 2 (Channel Bandwidth: 20 MHz) | 18M0G7D |
| Antenna Type | External Antenna | |
| Accessory Device | Refer to Note as below | |
| Data Cable Supplied | Refer to Note as below | |

Note:

1. The above EUT information is declared by manufacturer and for more detailed features description, please refer to the manufacturer's specifications or user's manual.

3.2 Configuration of System under Test

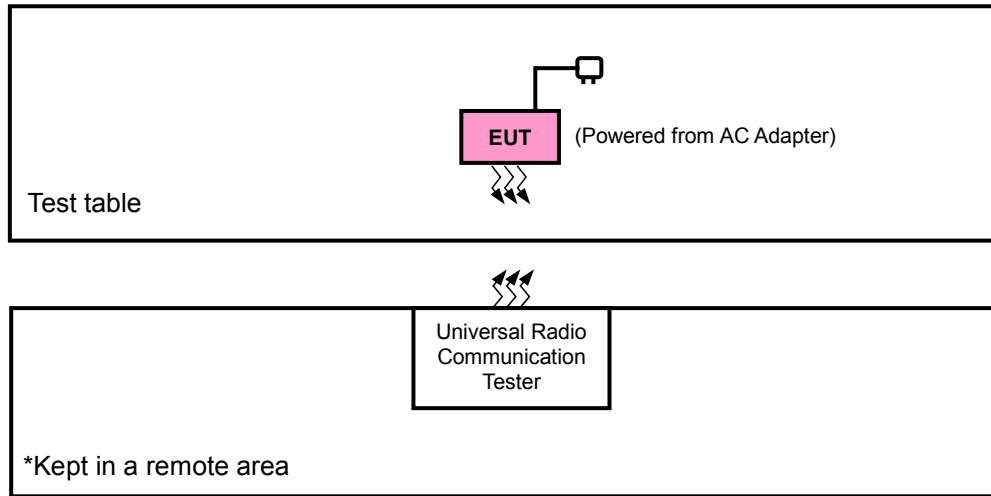

3.2.1 Description of Support Units

The EUT has been tested as an independent unit together with other necessary accessories or support units.

3.3 Test Mode Applicability and Tested Channel Detail

Pre-Scan has been conducted to determine the worst-case mode from all possible combinations between available modulations, data rates, XYZ axis, and antenna ports.

The worst case was found when positioned as the table below. Following channel(s) was (were) selected for the final test as listed below:

| Band | EIRP | Radiated Emission |
|------------|---------|-------------------|
| WCDMA | Z-plane | Z-axis |
| LTE Band 2 | Z-plane | Z-axis |

WCDMA

| EUT Configure Mode | Test Item | Available Channel | Tested Channel | Mode |
|--------------------|-----------------------|-------------------|------------------|-------|
| - | EIRP | 9262 to 9538 | 9262, 9400, 9538 | WCDMA |
| - | Frequency Stability | 9262 to 9538 | 9262, 9538 | WCDMA |
| - | Occupied Bandwidth | 9262 to 9538 | 9262, 9400, 9538 | WCDMA |
| - | Band Edge | 9262 to 9538 | 9262, 9538 | WCDMA |
| - | Peak to Average Ratio | 9262 to 9538 | 9262, 9400, 9538 | WCDMA |
| - | Condcudeted Emission | 9262 to 9538 | 9262, 9400, 9538 | WCDMA |
| - | Radiated Emission | 9262 to 9538 | 9262, 9400, 9538 | WCDMA |

LTE Band 2

| EUT Configure Mode | Test Item | Available Channel | Tested Channel | Channel Bandwidth | Modulation | Mode |
|--------------------|-----------------------|-------------------|---------------------|-------------------|-------------|---|
| - | EIRP | 18607 to 19193 | 18607, 18900, 19193 | 1.4 MHz | QPSK, 16QAM | 1 RB / 0 RB Offset |
| | | 18615 to 19185 | 18615, 18900, 19185 | 3 MHz | QPSK, 16QAM | 1 RB / 0 RB Offset |
| | | 18625 to 19175 | 18625, 18900, 19175 | 5 MHz | QPSK, 16QAM | 1 RB / 0 RB Offset |
| | | 18650 to 19150 | 18650, 18900, 19150 | 10 MHz | QPSK, 16QAM | 1 RB / 0 RB Offset |
| | | 18675 to 19125 | 18675, 18900, 19125 | 15 MHz | QPSK, 16QAM | 1 RB / 0 RB Offset |
| | | 18700 to 19100 | 18700, 18900, 19100 | 20 MHz | QPSK, 16QAM | 1 RB / 0 RB Offset |
| - | Frequency Stability | 18607 to 19193 | 18607, 19193 | 1.4 MHz | QPSK | 1 RB / 0 RB Offset |
| | | 18615 to 19185 | 18615, 19185 | 3 MHz | QPSK | 1 RB / 0 RB Offset |
| | | 18625 to 19175 | 18625, 19175 | 5 MHz | QPSK | 1 RB / 0 RB Offset |
| | | 18650 to 19150 | 18650, 19150 | 10 MHz | QPSK | 1 RB / 0 RB Offset |
| | | 18675 to 19125 | 18675, 19125 | 15 MHz | QPSK | 1 RB / 0 RB Offset |
| | | 18700 to 19100 | 18700, 19100 | 20 MHz | QPSK | 1 RB / 0 RB Offset |
| - | Occupied Bandwidth | 18607 to 19193 | 18607, 18900, 19193 | 1.4 MHz | QPSK, 16QAM | 6 RB / 0 RB Offset |
| | | 18615 to 19185 | 18615, 18900, 19185 | 3 MHz | QPSK, 16QAM | 15 RB / 0 RB Offset |
| | | 18625 to 19175 | 18625, 18900, 19175 | 5 MHz | QPSK, 16QAM | 25 RB / 0 RB Offset |
| | | 18650 to 19150 | 18650, 18900, 19150 | 10 MHz | QPSK, 16QAM | 50 RB / 0 RB Offset |
| | | 18675 to 19125 | 18675, 18900, 19125 | 15 MHz | QPSK, 16QAM | 75 RB / 0 RB Offset |
| | | 18700 to 19100 | 18700, 18900, 19100 | 20 MHz | QPSK, 16QAM | 100 RB / 0 RB Offset |
| - | Peak to Average Ratio | 18607 to 19193 | 18607, 18900, 19193 | 1.4 MHz | QPSK, 16QAM | 1 RB / 0 RB Offset |
| | | 18615 to 19185 | 18615, 18900, 19185 | 3 MHz | QPSK, 16QAM | 1 RB / 0 RB Offset |
| | | 18625 to 19175 | 18625, 18900, 19175 | 5 MHz | QPSK, 16QAM | 1 RB / 0 RB Offset |
| | | 18650 to 19150 | 18650, 18900, 19150 | 10 MHz | QPSK, 16QAM | 1 RB / 0 RB Offset |
| | | 18675 to 19125 | 18675, 18900, 19125 | 15 MHz | QPSK, 16QAM | 1 RB / 0 RB Offset |
| | | 18700 to 19100 | 18700, 18900, 19100 | 20 MHz | QPSK, 16QAM | 1 RB / 0 RB Offset |
| - | Band Edge | 18607 to 19193 | 18607 | 1.4 MHz | QPSK | 1 RB / 0 RB Offset 6 RB / 0 RB Offset |
| | | | 19193 | 1.4 MHz | QPSK | 1 RB / 5 RB Offset 6 RB / 0 RB Offset |
| | | 18615 to 19185 | 18615 | 3 MHz | QPSK | 1 RB / 0 RB Offset 15 RB / 0 RB Offset |
| | | | 19185 | 3 MHz | QPSK | 1 RB / 14 RB Offset 15 RB / 0 RB Offset |
| | | 18625 to 19175 | 18625 | 5 MHz | QPSK | 1 RB / 0 RB Offset 25 RB / 0 RB Offset |
| | | | 19175 | 5 MHz | QPSK | 1 RB / 24 RB Offset 25 RB / 0 RB Offset |
| | | 18650 to 19150 | 18650 | 10 MHz | QPSK | 1 RB / 0 RB Offset 50 RB / 0 RB Offset |
| | | | 19150 | 10 MHz | QPSK | 1 RB / 49 RB Offset 50 RB / 0 RB Offset |
| | | 18675 to 19125 | 18675 | 15 MHz | QPSK | 1 RB / 0 RB Offset 75 RB / 0 RB Offset |
| | | | 19125 | 15 MHz | QPSK | 1 RB / 74 RB Offset 75 RB / 0 RB Offset |
| | | 18700 to 19100 | 18700 | 20 MHz | QPSK | 1 RB / 0 RB Offset 100 RB / 0 RB Offset |
| | | | 19100 | 20 MHz | QPSK | 1 RB / 99 RB Offset 100 RB / 0 RB Offset |

| EUT Configure Mode | Test Item | Available Channel | Tested Channel | Channel Bandwidth | Modulation | Mode |
|--------------------|--------------------|-------------------|---------------------|-------------------|------------|--------------------|
| - | Conducted Emission | 18607 to 19193 | 18607, 18900, 19193 | 1.4 MHz | QPSK | 1 RB / 0 RB Offset |
| | | 18615 to 19185 | 18615, 18900, 19185 | 3 MHz | QPSK | 1 RB / 0 RB Offset |
| | | 18625 to 19175 | 18625, 18900, 19175 | 5 MHz | QPSK | 1 RB / 0 RB Offset |
| | | 18650 to 19150 | 18650, 18900, 19150 | 10 MHz | QPSK | 1 RB / 0 RB Offset |
| | | 18675 to 19125 | 18675, 18900, 19125 | 15 MHz | QPSK | 1 RB / 0 RB Offset |
| | | 18700 to 19100 | 18700, 18900, 19100 | 20 MHz | QPSK | 1 RB / 0 RB Offset |
| - | Radiated Emission | 18700 to 19100 | 18700, 18900, 19100 | 20 MHz | QPSK | 1 RB / 0 RB Offset |

Note: This device was tested under all bandwidths, RB configurations and modulations. The worst case was found in QPSK modulation.

Test Condition:

| Test Item | Environmental Conditions | Input Power | Tested By |
|-----------------------|--------------------------|----------------|-------------|
| EIRP | 26 deg. C, 58 % RH | 3.3 Vdc | Gavin Wu |
| Frequency Stability | 26 deg. C, 58 % RH | 3.3 Vdc | Carlos Chen |
| Occupied Bandwidth | 26 deg. C, 58 % RH | 3.3 Vdc | Carlos Chen |
| Band Edge | 26 deg. C, 58 % RH | 3.3 Vdc | Carlos Chen |
| Peak to Average Ratio | 26 deg. C, 58 % RH | 3.3 Vdc | Carlos Chen |
| Condcudeted Emission | 26 deg. C, 58 % RH | 3.3 Vdc | Carlos Chen |
| Radiated Emission | 25 deg. C, 65 % RH | 120 Vac, 60 Hz | Gavin Wu |

3.4 EUT Operating Conditions

The EUT makes a call to the communication simulator. The communication simulator station system controlled a EUT to export maximum output power under transmission mode and specific channel frequency

3.5 General Description of Applied Standards

The EUT is a RF Product. According to the specifications of the manufacturer, it must comply with the requirements of the following standards:

FCC 47 CFR Part 2

FCC 47 CFR Part 24

KDB 971168 D01 Power Meas License Digital Systems v02r02

ANSI/TIA/EIA-603-D 2010

NOTE: All test items have been performed and recorded as per the above standards.

4 Test Types and Results

4.1 Output Power Measurement

4.1.1 Limits of Output Power Measurement

Mobile / Portable station are limited to 2 watts e.i.r.p.

4.1.2 Test Procedures

EIRP / ERP Measurement:

- a. All measurements were done at low, middle and high operational frequency range. RBW and VBW is 1 MHz for GSM, GPRS & EDGE, 5 MHz for WCDMA and CDMA, and 10 MHz for LTE mode.
- b. Substitution method is used for E.I.R.P measurement. In the semi-anechoic chamber, EUT placed on the 0.8 m height of Turn Table, rotated the table around 360 degrees to search the maximum radiation power and receiver antenna shall be rotated vertical and horizontal polarization and moved height from 1m to 4m to find the maximum polar radiated power. The "Read Value" is the spectrum reading the maximum power value.
- c. The substitution horn antenna is substituted for EUT at the same position and signals generator export the CW signal to the substitution antenna via a tx cable. Rotated the Turn Table and moved receiving antenna to find the maximum radiation power. Adjust output power level of S.G to get a Value of spectrum reading equal to "Read Value" of step b. Record the power level of S.G.
- d. $EIRP = \text{Output power level of S.G} - \text{TX cable loss} + \text{Antenna gain of substitution horn}$. E.R.P power can be calculated form E.I.R.P power by subtracting the gain of dipole, $E.R.P \text{ power} = E.I.P.R \text{ power} - 2.15 \text{ dBi}$.

Conducted Power Measurement:

The EUT was set up for the maximum power with GSM, GPRS, EDGE, WCDMA, CDMA, and LTE link data modulation and link up with simulator. Set the EUT to transmit under low, middle and high channel and record the power level shown on simulator.

4.1.3 Test Setup

EIRP / ERP Measurement:

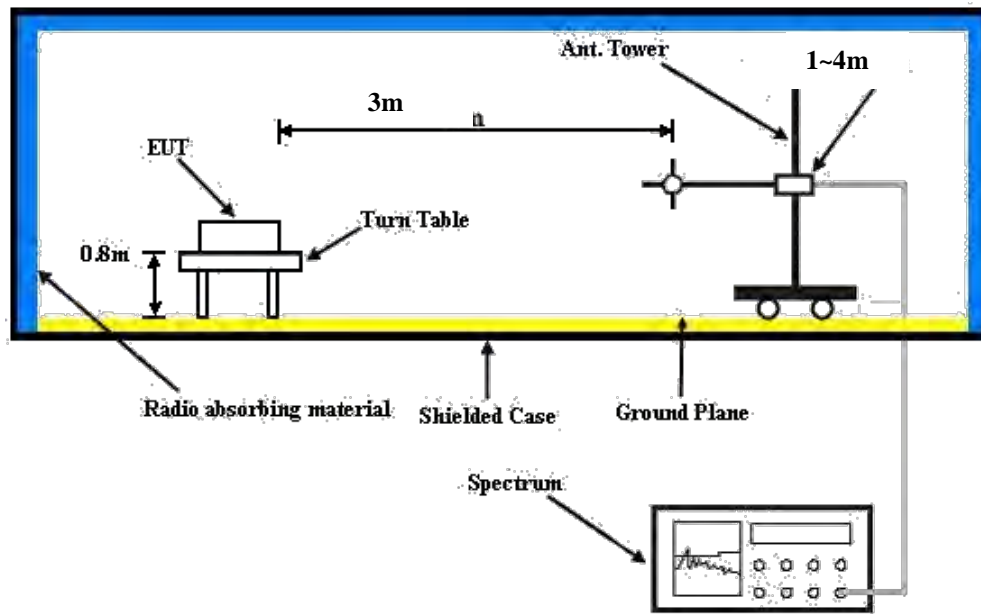

For the actual test configuration, please refer to the attached file (Test Setup Photo).

Conducted Power Measurement:

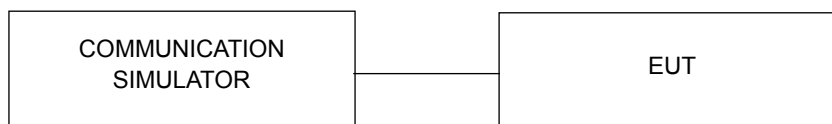

4.1.4 Test Results

Conducted Output Power (dBm)

| Band | WCDMA II | | |
|-----------------|----------|--------|--------|
| | Channel | 9262 | 9400 |
| Frequency (MHz) | 1852.4 | 1880.0 | 1907.6 |
| RMC 12.2K | 23.39 | 23.51 | 23.62 |
| HSDPA Subtest-1 | 21.26 | 22.05 | 22.14 |
| HSDPA Subtest-2 | 21.08 | 22.28 | 21.99 |
| HSDPA Subtest-3 | 21.21 | 22.06 | 22.13 |
| HSDPA Subtest-4 | 21.01 | 22.30 | 22.13 |
| HSUPA Subtest-1 | 20.41 | 20.52 | 20.19 |
| HSUPA Subtest-2 | 18.98 | 19.18 | 19.04 |
| HSUPA Subtest-3 | 19.93 | 19.74 | 19.94 |
| HSUPA Subtest-4 | 19.30 | 19.48 | 19.22 |
| HSUPA Subtest-5 | 20.31 | 20.42 | 20.22 |

| Band / BW | RB Size | RB Offset | QPSK | | | 3GPP MPR (dB) | 16QAM | | | 3GPP MPR (dB) |
|-----------|---------|-----------|--------------|--------------|---------------|---------------|--------------|--------------|---------------|---------------|
| | | | Low Ch 18607 | Mid Ch 18900 | High Ch 19193 | | Low Ch 18607 | Mid Ch 18900 | High Ch 19193 | |
| | | | 1850.7 MHz | 1880.0 MHz | 1909.3 MHz | | 1850.7 MHz | 1880.0 MHz | 1909.3 MHz | |
| 2 / 1.4M | 1 | 0 | 22.28 | 22.34 | 22.30 | 0 | 21.22 | 21.31 | 21.29 | 1 |
| | 1 | 2 | 22.16 | 22.22 | 22.17 | 0 | 21.10 | 21.10 | 21.10 | 1 |
| | 1 | 5 | 21.91 | 22.09 | 22.01 | 0 | 20.88 | 20.92 | 20.96 | 1 |
| | 3 | 0 | 21.31 | 21.38 | 21.34 | 0 | 20.28 | 20.31 | 20.29 | 1 |
| | 3 | 1 | 21.13 | 21.22 | 21.15 | 0 | 20.02 | 20.21 | 20.22 | 1 |
| | 3 | 3 | 21.03 | 21.04 | 21.13 | 0 | 19.89 | 20.03 | 19.91 | 1 |
| | 6 | 0 | 21.13 | 21.13 | 21.28 | 1 | 20.00 | 20.12 | 20.06 | 2 |

| Band / BW | RB Size | RB Offset | QPSK | | | 3GPP MPR (dB) | 16QAM | | | 3GPP MPR (dB) |
|-----------|---------|-----------|--------------|--------------|---------------|---------------|--------------|--------------|---------------|---------------|
| | | | Low Ch 18615 | Mid Ch 18900 | High Ch 19185 | | Low Ch 18615 | Mid Ch 18900 | High Ch 19185 | |
| | | | 1851.5 MHz | 1880.0 MHz | 1908.5 MHz | | 1851.5 MHz | 1880.0 MHz | 1908.5 MHz | |
| 2 / 3M | 1 | 0 | 22.32 | 22.37 | 22.44 | 0 | 21.25 | 21.33 | 21.37 | 1 |
| | 1 | 7 | 22.17 | 22.25 | 22.30 | 0 | 21.19 | 21.15 | 21.27 | 1 |
| | 1 | 14 | 21.96 | 21.99 | 22.09 | 0 | 20.95 | 20.94 | 21.19 | 1 |
| | 8 | 0 | 21.39 | 21.41 | 21.45 | 1 | 20.37 | 20.23 | 20.33 | 2 |
| | 8 | 3 | 21.24 | 21.29 | 21.30 | 1 | 20.22 | 20.22 | 20.31 | 2 |
| | 8 | 7 | 21.11 | 21.14 | 21.09 | 1 | 20.07 | 20.11 | 20.14 | 2 |
| | 15 | 0 | 21.17 | 21.35 | 21.28 | 1 | 20.16 | 20.11 | 20.26 | 2 |

| Band / BW | RB Size | RB Offset | QPSK | | | 3GPP MPR (dB) | 16QAM | | | 3GPP MPR (dB) |
|-----------|---------|-----------|--------------|--------------|---------------|---------------|--------------|--------------|---------------|---------------|
| | | | Low Ch 18625 | Mid Ch 18900 | High Ch 19175 | | Low Ch 18625 | Mid Ch 18900 | High Ch 19175 | |
| | | | 1852.5 MHz | 1880.0 MHz | 1907.5 MHz | | 1852.5 MHz | 1880.0 MHz | 1907.5 MHz | |
| 2 / 5M | 1 | 0 | 22.42 | 22.46 | 22.50 | 0 | 21.41 | 21.43 | 21.47 | 1 |
| | 1 | 12 | 22.32 | 22.33 | 22.37 | 0 | 21.27 | 21.23 | 21.36 | 1 |
| | 1 | 24 | 22.21 | 22.09 | 22.12 | 0 | 21.09 | 21.05 | 21.22 | 1 |
| | 12 | 0 | 21.44 | 21.47 | 21.55 | 1 | 20.23 | 20.43 | 20.40 | 2 |
| | 12 | 6 | 21.30 | 21.31 | 21.46 | 1 | 20.25 | 20.34 | 20.31 | 2 |
| | 12 | 13 | 21.12 | 21.17 | 21.27 | 1 | 20.07 | 20.06 | 20.31 | 2 |
| | 25 | 0 | 21.22 | 21.36 | 21.32 | 1 | 20.33 | 20.36 | 20.32 | 2 |

| Band / BW | RB Size | RB Offset | QPSK | | | 3GPP MPR (dB) | 16QAM | | | 3GPP MPR (dB) |
|-----------|---------|-----------|--------------|--------------|---------------|---------------|--------------|--------------|---------------|---------------|
| | | | Low Ch 18650 | Mid Ch 18900 | High Ch 19150 | | Low Ch 18650 | Mid Ch 18900 | High Ch 19150 | |
| | | | 1855.0 MHz | 1880.0 MHz | 1905.0 MHz | | 1855.0 MHz | 1880.0 MHz | 1905.0 MHz | |
| 2 / 10M | 1 | 0 | 22.50 | 22.56 | 22.60 | 0 | 21.41 | 21.55 | 21.56 | 1 |
| | 1 | 24 | 22.37 | 22.41 | 22.48 | 0 | 21.37 | 21.37 | 21.48 | 1 |
| | 1 | 49 | 22.18 | 22.26 | 22.39 | 0 | 21.10 | 21.17 | 21.22 | 1 |
| | 25 | 0 | 21.48 | 21.55 | 21.59 | 1 | 20.39 | 20.38 | 20.47 | 2 |
| | 25 | 12 | 21.39 | 21.39 | 21.47 | 1 | 20.30 | 20.35 | 20.45 | 2 |
| | 25 | 25 | 21.20 | 21.30 | 21.23 | 1 | 20.20 | 20.16 | 20.22 | 2 |
| | 50 | 0 | 21.32 | 21.46 | 21.40 | 1 | 20.46 | 20.36 | 20.49 | 2 |

| Band / BW | RB Size | RB Offset | QPSK | | | 3GPP MPR (dB) | 16QAM | | | 3GPP MPR (dB) |
|-----------|---------|-----------|--------------|--------------|---------------|---------------|--------------|--------------|---------------|---------------|
| | | | Low Ch 18675 | Mid Ch 18900 | High Ch 19125 | | Low Ch 18675 | Mid Ch 18900 | High Ch 19125 | |
| | | | 1857.5 MHz | 1880.0 MHz | 1902.5 MHz | | 1857.5 MHz | 1880.0 MHz | 1902.5 MHz | |
| 2 / 15M | 1 | 0 | 22.55 | 22.65 | 22.68 | 0 | 21.48 | 21.60 | 21.64 | 1 |
| | 1 | 37 | 22.44 | 22.49 | 22.52 | 0 | 21.38 | 21.48 | 21.54 | 1 |
| | 1 | 74 | 22.26 | 22.38 | 22.47 | 0 | 21.28 | 21.31 | 21.39 | 1 |
| | 36 | 0 | 21.54 | 21.59 | 21.67 | 1 | 20.42 | 20.45 | 20.45 | 2 |
| | 36 | 19 | 21.43 | 21.46 | 21.52 | 1 | 20.38 | 20.35 | 20.54 | 2 |
| | 36 | 39 | 21.28 | 21.25 | 21.39 | 1 | 20.27 | 20.20 | 20.35 | 2 |
| | 75 | 0 | 21.54 | 21.47 | 21.58 | 1 | 20.46 | 20.42 | 20.52 | 2 |

| Band / BW | RB Size | RB Offset | QPSK | | | 3GPP MPR (dB) | 16QAM | | | 3GPP MPR (dB) |
|-----------|---------|-----------|--------------|--------------|---------------|---------------|--------------|--------------|---------------|---------------|
| | | | Low Ch 18700 | Mid Ch 18900 | High Ch 19100 | | Low Ch 18700 | Mid Ch 18900 | High Ch 19100 | |
| | | | 1860.0 MHz | 1880.0 MHz | 1900.0 MHz | | 1860.0 MHz | 1880.0 MHz | 1900.0 MHz | |
| 2 / 20M | 1 | 0 | 22.57 | 22.68 | 22.75 | 0 | 21.53 | 21.66 | 21.68 | 1 |
| | 1 | 50 | 22.42 | 22.55 | 22.61 | 0 | 21.37 | 21.52 | 21.58 | 1 |
| | 1 | 99 | 22.21 | 22.36 | 22.42 | 0 | 21.19 | 21.41 | 21.53 | 1 |
| | 50 | 0 | 21.58 | 21.64 | 21.74 | 1 | 20.41 | 20.53 | 20.57 | 2 |
| | 50 | 25 | 21.47 | 21.52 | 21.58 | 1 | 20.40 | 20.52 | 20.61 | 2 |
| | 50 | 50 | 21.32 | 21.26 | 21.44 | 1 | 20.25 | 20.33 | 20.28 | 2 |
| | 100 | 0 | 21.49 | 21.50 | 21.62 | 1 | 20.36 | 20.53 | 20.64 | 2 |

EIRP Power (dBm)

| WCDMA | | | | | | | |
|-------|---------|-----------------|-----------|------------------------|------------|-----------|--------------------|
| Plane | Channel | Frequency (MHz) | LVL (dBm) | Correction Factor (dB) | EIRP (dBm) | EIRP (mW) | Polarization (H/V) |
| Z | 9262 | 1852.4 | -29.48 | 36.57 | 7.09 | 5.12 | H |
| | 9400 | 1880.0 | -29.88 | 37.22 | 7.34 | 5.43 | |
| | 9538 | 1907.6 | -30.06 | 37.18 | 7.12 | 5.15 | |
| | 9262 | 1852.4 | -11.56 | 37.65 | 26.09 | 406.54 | V |
| | 9400 | 1880.0 | -11.26 | 37.58 | 26.32 | 428.84 | |
| | 9538 | 1907.6 | -11.35 | 37.48 | 26.13 | 410.20 | |

| LTE Band 2 | | | | | | | |
|------------------------------------|---------|-----------------|-----------|------------------------|------------|-----------|--------------------|
| Channel Bandwidth: 1.4 MHz / QPSK | | | | | | | |
| Plane | Channel | Frequency (MHz) | LVL (dBm) | Correction Factor (dB) | EIRP (dBm) | EIRP (mW) | Polarization (H/V) |
| Z | 18607 | 1850.7 | -25.59 | 36.57 | 10.98 | 12.54 | H |
| | 18900 | 1880.0 | -26.17 | 37.22 | 11.05 | 12.75 | |
| | 19193 | 1909.3 | -26.23 | 37.18 | 10.95 | 12.45 | |
| | 18607 | 1850.7 | -14.53 | 37.65 | 23.12 | 205.16 | V |
| | 18900 | 1880.0 | -14.38 | 37.58 | 23.20 | 209.07 | |
| | 19193 | 1909.3 | -14.31 | 37.48 | 23.17 | 207.49 | |
| Channel Bandwidth: 1.4 MHz / 16QAM | | | | | | | |
| Z | 18607 | 1850.7 | -25.82 | 36.57 | 10.75 | 11.89 | H |
| | 18900 | 1880.0 | -26.43 | 37.22 | 10.79 | 12.01 | |
| | 19193 | 1909.3 | -26.51 | 37.18 | 10.67 | 11.67 | |
| | 18607 | 1850.7 | -15.11 | 37.65 | 22.54 | 179.51 | V |
| | 18900 | 1880.0 | -14.95 | 37.58 | 22.63 | 183.36 | |
| | 19193 | 1909.3 | -14.92 | 37.48 | 22.56 | 180.30 | |

| LTE Band 2 | | | | | | | |
|----------------------------------|---------|-----------------|-----------|------------------------|------------|-----------|--------------------|
| Channel Bandwidth: 3 MHz / QPSK | | | | | | | |
| Plane | Channel | Frequency (MHz) | LVL (dBm) | Correction Factor (dB) | EIRP (dBm) | EIRP (mW) | Polarization (H/V) |
| Z | 18615 | 1851.5 | -25.41 | 36.57 | 11.16 | 13.07 | H |
| | 18900 | 1880.0 | -26.02 | 37.22 | 11.20 | 13.19 | |
| | 19185 | 1908.5 | -26.11 | 37.18 | 11.07 | 12.80 | |
| | 18615 | 1851.5 | -14.36 | 37.65 | 23.29 | 213.35 | V |
| | 18900 | 1880.0 | -14.25 | 37.58 | 23.33 | 215.43 | |
| | 19185 | 1908.5 | -14.22 | 37.48 | 23.26 | 211.84 | |
| Channel Bandwidth: 3 MHz / 16QAM | | | | | | | |
| Z | 18615 | 1851.5 | -25.74 | 36.57 | 10.83 | 12.11 | H |
| | 18900 | 1880.0 | -26.35 | 37.22 | 10.87 | 12.23 | |
| | 19185 | 1908.5 | -26.43 | 37.18 | 10.75 | 11.89 | |
| | 18615 | 1851.5 | -15.02 | 37.65 | 22.63 | 183.27 | V |
| | 18900 | 1880.0 | -14.83 | 37.58 | 22.75 | 188.50 | |
| | 19185 | 1908.5 | -14.83 | 37.48 | 22.65 | 184.08 | |

| LTE Band 2 | | | | | | | |
|----------------------------------|---------|-----------------|-----------|------------------------|------------|-----------|--------------------|
| Channel Bandwidth: 5 MHz / QPSK | | | | | | | |
| Plane | Channel | Frequency (MHz) | LVL (dBm) | Correction Factor (dB) | EIRP (dBm) | EIRP (mW) | Polarization (H/V) |
| Z | 18625 | 1852.5 | -25.22 | 36.57 | 11.35 | 13.65 | H |
| | 18900 | 1880.0 | -25.82 | 37.22 | 11.40 | 13.82 | |
| | 19175 | 1907.5 | -25.80 | 37.18 | 11.38 | 13.75 | |
| | 18625 | 1852.5 | -14.28 | 37.65 | 23.37 | 217.32 | V |
| | 18900 | 1880.0 | -14.15 | 37.58 | 23.43 | 220.44 | |
| | 19175 | 1907.5 | -14.12 | 37.48 | 23.36 | 216.77 | |
| Channel Bandwidth: 5 MHz / 16QAM | | | | | | | |
| Z | 18625 | 1852.5 | -25.65 | 36.57 | 10.92 | 12.37 | H |
| | 18900 | 1880.0 | -26.23 | 37.22 | 10.99 | 12.57 | |
| | 19175 | 1907.5 | -26.31 | 37.18 | 10.87 | 12.22 | |
| | 18625 | 1852.5 | -14.94 | 37.65 | 22.71 | 186.68 | V |
| | 18900 | 1880.0 | -14.78 | 37.58 | 22.80 | 190.68 | |
| | 19175 | 1907.5 | -14.71 | 37.48 | 22.77 | 189.23 | |

| LTE Band 2 | | | | | | | |
|-----------------------------------|---------|-----------------|-----------|------------------------|------------|-----------|--------------------|
| Channel Bandwidth: 10 MHz / QPSK | | | | | | | |
| Plane | Channel | Frequency (MHz) | LVL (dBm) | Correction Factor (dB) | EIRP (dBm) | EIRP (mW) | Polarization (H/V) |
| Z | 18650 | 1855.0 | -25.16 | 36.57 | 11.41 | 13.84 | H |
| | 18900 | 1880.0 | -25.76 | 37.22 | 11.46 | 14.01 | |
| | 19150 | 1905.0 | -25.76 | 37.18 | 11.42 | 13.87 | |
| | 18650 | 1855.0 | -14.22 | 37.65 | 23.43 | 220.34 | V |
| | 18900 | 1880.0 | -14.03 | 37.58 | 23.55 | 226.62 | |
| | 19150 | 1905.0 | -14.01 | 37.48 | 23.47 | 222.33 | |
| Channel Bandwidth: 10 MHz / 16QAM | | | | | | | |
| Z | 18650 | 1855.0 | -25.59 | 36.57 | 10.98 | 12.54 | H |
| | 18900 | 1880.0 | -26.19 | 37.22 | 11.03 | 12.69 | |
| | 19150 | 1905.0 | -26.24 | 37.18 | 10.94 | 12.42 | |
| | 18650 | 1855.0 | -14.82 | 37.65 | 22.83 | 191.91 | V |
| | 18900 | 1880.0 | -14.67 | 37.58 | 22.91 | 195.57 | |
| | 19150 | 1905.0 | -14.62 | 37.48 | 22.86 | 193.20 | |

| LTE Band 2 | | | | | | | |
|-----------------------------------|---------|-----------------|-----------|------------------------|------------|-----------|--------------------|
| Channel Bandwidth: 15 MHz / QPSK | | | | | | | |
| Plane | Channel | Frequency (MHz) | LVL (dBm) | Correction Factor (dB) | EIRP (dBm) | EIRP (mW) | Polarization (H/V) |
| Z | 18675 | 1857.5 | -25.05 | 36.57 | 11.52 | 14.20 | H |
| | 18900 | 1880.0 | -25.64 | 37.22 | 11.58 | 14.40 | |
| | 19125 | 1902.5 | -25.62 | 37.18 | 11.56 | 14.33 | |
| | 18675 | 1857.5 | -14.13 | 37.65 | 23.52 | 224.96 | V |
| | 18900 | 1880.0 | -13.94 | 37.58 | 23.64 | 231.37 | |
| | 19125 | 1902.5 | -13.89 | 37.48 | 23.59 | 228.56 | |
| Channel Bandwidth: 15 MHz / 16QAM | | | | | | | |
| Z | 18675 | 1857.5 | -25.50 | 36.57 | 11.07 | 12.80 | H |
| | 18900 | 1880.0 | -26.11 | 37.22 | 11.11 | 12.92 | |
| | 19125 | 1902.5 | -26.16 | 37.18 | 11.02 | 12.65 | |
| | 18675 | 1857.5 | -14.70 | 37.65 | 22.95 | 197.29 | V |
| | 18900 | 1880.0 | -14.52 | 37.58 | 23.06 | 202.44 | |
| | 19125 | 1902.5 | -14.51 | 37.48 | 22.97 | 198.15 | |

| LTE Band 2 | | | | | | | |
|-----------------------------------|---------|-----------------|-----------|------------------------|------------|-----------|--------------------|
| Channel Bandwidth: 20 MHz / QPSK | | | | | | | |
| Plane | Channel | Frequency (MHz) | LVL (dBm) | Correction Factor (dB) | EIRP (dBm) | EIRP (mW) | Polarization (H/V) |
| Z | 18700 | 1860.0 | -24.96 | 36.57 | 11.61 | 14.49 | H |
| | 18900 | 1880.0 | -25.57 | 37.22 | 11.65 | 14.64 | |
| | 19100 | 1900.0 | -25.55 | 37.18 | 11.63 | 14.56 | |
| | 18700 | 1860.0 | -14.05 | 37.65 | 23.60 | 229.14 | V |
| | 18900 | 1880.0 | -13.86 | 37.58 | 23.72 | 235.67 | |
| | 19100 | 1900.0 | -13.79 | 37.48 | 23.69 | 233.88 | |
| Channel Bandwidth: 20 MHz / 16QAM | | | | | | | |
| Z | 18700 | 1860.0 | -25.43 | 36.57 | 11.14 | 13.01 | H |
| | 18900 | 1880.0 | -26.04 | 37.22 | 11.18 | 13.13 | |
| | 19100 | 1900.0 | -26.05 | 37.18 | 11.13 | 12.98 | |
| | 18700 | 1860.0 | -14.59 | 37.65 | 23.06 | 202.35 | V |
| | 18900 | 1880.0 | -14.40 | 37.58 | 23.18 | 208.11 | |
| | 19100 | 1900.0 | -14.43 | 37.48 | 23.05 | 201.84 | |

4.2 Frequency Stability Measurement

4.2.1 Limits of Frequency Stability Measurement

The frequency stability shall be sufficient to ensure that the fundamental emission stays within the authorized frequency block.

4.2.2 Test Procedure

- Device is placed at the oven room. The oven room could control the temperatures and humidity. Power warm up is at least 15 min and power applied should perform before recording frequency error.
- EUT is connected the external power supply to control the DC input power. The test voltage range is from minimum to maximum working voltage. Each step shall be record the frequency error rate.
- The temperature range step is 10 degrees in this test items. All temperature levels shall be hold the ± 0.5 °C during the measurement testing. The each temperature step shall be at least 0.5 hours, consider the EUT could be test under the stability condition.

NOTE: The frequency error was recorded frequency error from the communication simulator.

4.2.3 Test Setup

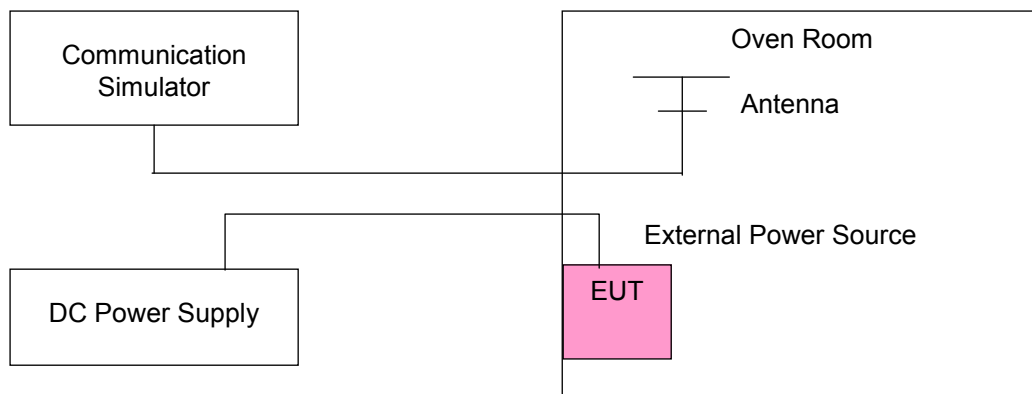

4.2.4 Test Results

Frequency Error vs. Voltage

| Voltage (Volts) | WCDMA | | | | Limit (ppm) |
|-----------------|-----------------|-----------------------|-----------------|-----------------------|-------------|
| | Low Channel | | High Channel | | |
| | Frequency (MHz) | Frequency Error (ppm) | Frequency (MHz) | Frequency Error (ppm) | |
| 3.3 | 1852.400003 | 0.002 | 1907.600002 | 0.001 | 2.5 |
| 3.14 | 1852.400001 | 0.001 | 1907.600002 | 0.001 | 2.5 |
| 4.4 | 1852.400003 | 0.002 | 1907.600002 | 0.001 | 2.5 |

Note: The applicant defined the normal working voltage of the battery is from 3.14 Vdc to 4.4 Vdc.

Frequency Error vs. Temperature

| Temp. (°C) | WCDMA | | | | Limit (ppm) |
|------------|-----------------|-----------------------|-----------------|-----------------------|-------------|
| | Low Channel | | High Channel | | |
| | Frequency (MHz) | Frequency Error (ppm) | Frequency (MHz) | Frequency Error (ppm) | |
| -20 | 1852.400002 | 0.001 | 1907.600002 | 0.001 | 2.5 |
| -10 | 1852.400002 | 0.001 | 1907.600001 | 0.001 | 2.5 |
| 0 | 1852.400002 | 0.001 | 1907.600003 | 0.001 | 2.5 |
| 10 | 1852.400003 | 0.002 | 1907.600003 | 0.002 | 2.5 |
| 20 | 1852.399997 | -0.002 | 1907.599999 | -0.001 | 2.5 |
| 30 | 1852.399997 | -0.001 | 1907.599996 | -0.002 | 2.5 |
| 40 | 1852.399998 | -0.001 | 1907.599998 | -0.001 | 2.5 |
| 50 | 1852.399999 | -0.001 | 1907.599998 | -0.001 | 2.5 |
| 55 | 1852.399997 | -0.002 | 1907.599997 | -0.002 | 2.5 |

Frequency Error vs. Voltage

| Voltage (Volts) | LTE Band 2 | | | | Limit (ppm) |
|--------------------|----------------------------|-----------------------|-----------------|-----------------------|-------------|
| | Channel Bandwidth: 1.4 MHz | | | | |
| | Low Channel | | High Channel | | |
| | Frequency (MHz) | Frequency Error (ppm) | Frequency (MHz) | Frequency Error (ppm) | |
| 3.3 | 1850.700003 | 0.002 | 1909.300004 | 0.002 | 2.5 |
| 3.14 | 1850.700003 | 0.002 | 1909.300003 | 0.001 | 2.5 |
| 4.4 | 1850.700002 | 0.001 | 1909.300002 | 0.001 | 2.5 |

Note: The applicant defined the normal working voltage of the battery is from 3.14 Vdc to 4.4 Vdc.

Frequency Error vs. Temperature

| Temp. (°C) | LTE Band 2 | | | | Limit (ppm) |
|------------|----------------------------|-----------------------|-----------------|-----------------------|-------------|
| | Channel Bandwidth: 1.4 MHz | | | | |
| | Low Channel | | High Channel | | |
| | Frequency (MHz) | Frequency Error (ppm) | Frequency (MHz) | Frequency Error (ppm) | |
| -20 | 1850.700001 | 0.001 | 1909.300004 | 0.002 | 2.5 |
| -10 | 1850.700003 | 0.002 | 1909.300003 | 0.001 | 2.5 |
| 0 | 1850.700002 | 0.001 | 1909.300002 | 0.001 | 2.5 |
| 10 | 1850.700004 | 0.002 | 1909.300002 | 0.001 | 2.5 |
| 20 | 1850.699996 | -0.002 | 1909.299998 | -0.001 | 2.5 |
| 30 | 1850.699998 | -0.001 | 1909.299997 | -0.002 | 2.5 |
| 40 | 1850.699997 | -0.002 | 1909.299997 | -0.001 | 2.5 |
| 50 | 1850.699997 | -0.002 | 1909.299998 | -0.001 | 2.5 |
| 55 | 1850.699997 | -0.002 | 1909.299999 | -0.001 | 2.5 |

Frequency Error vs. Voltage

| Voltage (Volts) | LTE Band 2 | | | | Limit (ppm) |
|--------------------|--------------------------|-----------------------|-----------------|-----------------------|-------------|
| | Channel Bandwidth: 3 MHz | | | | |
| | Low Channel | | High Channel | | |
| | Frequency (MHz) | Frequency Error (ppm) | Frequency (MHz) | Frequency Error (ppm) | |
| 3.3 | 1851.500001 | 0.001 | 1907.500002 | 0.001 | 2.5 |
| 3.14 | 1851.500003 | 0.001 | 1907.500001 | 0.001 | 2.5 |
| 4.4 | 1851.500004 | 0.002 | 1907.500001 | 0.001 | 2.5 |

Note: The applicant defined the normal working voltage of the battery is from 3.14 Vdc to 4.4 Vdc.

Frequency Error vs. Temperature

| Temp. (°C) | LTE Band 2 | | | | Limit (ppm) |
|------------|--------------------------|-----------------------|-----------------|-----------------------|-------------|
| | Channel Bandwidth: 3 MHz | | | | |
| | Low Channel | | High Channel | | |
| | Frequency (MHz) | Frequency Error (ppm) | Frequency (MHz) | Frequency Error (ppm) | |
| -20 | 1851.500003 | 0.002 | 1907.500001 | 0.001 | 2.5 |
| -10 | 1851.500002 | 0.001 | 1907.500002 | 0.001 | 2.5 |
| 0 | 1851.500002 | 0.001 | 1907.500001 | 0.001 | 2.5 |
| 10 | 1851.500003 | 0.002 | 1907.500001 | 0.001 | 2.5 |
| 20 | 1851.499998 | -0.001 | 1907.499998 | -0.001 | 2.5 |
| 30 | 1851.499998 | -0.001 | 1907.499999 | -0.001 | 2.5 |
| 40 | 1851.499996 | -0.002 | 1907.499997 | -0.002 | 2.5 |
| 50 | 1851.499998 | -0.001 | 1907.499998 | -0.001 | 2.5 |
| 55 | 1851.499997 | -0.002 | 1907.499997 | -0.002 | 2.5 |

Frequency Error vs. Voltage

| Voltage (Volts) | LTE Band 2 | | | | Limit (ppm) |
|-----------------|--------------------------|-----------------------|-----------------|-----------------------|-------------|
| | Channel Bandwidth: 5 MHz | | | | |
| | Low Channel | | High Channel | | |
| | Frequency (MHz) | Frequency Error (ppm) | Frequency (MHz) | Frequency Error (ppm) | |
| 3.3 | 1852.500002 | 0.001 | 1907.500004 | 0.002 | 2.5 |
| 3.14 | 1852.500003 | 0.002 | 1907.500002 | 0.001 | 2.5 |
| 4.4 | 1852.500001 | 0.001 | 1907.500002 | 0.001 | 2.5 |

Note: The applicant defined the normal working voltage of the battery is from 3.14 Vdc to 4.4 Vdc.

Frequency Error vs. Temperature

| Temp. (°C) | LTE Band 2 | | | | Limit (ppm) |
|------------|--------------------------|-----------------------|-----------------|-----------------------|-------------|
| | Channel Bandwidth: 5 MHz | | | | |
| | Low Channel | | High Channel | | |
| | Frequency (MHz) | Frequency Error (ppm) | Frequency (MHz) | Frequency Error (ppm) | |
| -20 | 1852.500001 | 0.001 | 1907.500002 | 0.001 | 2.5 |
| -10 | 1852.500003 | 0.002 | 1907.500003 | 0.001 | 2.5 |
| 0 | 1852.500001 | 0.001 | 1907.500004 | 0.002 | 2.5 |
| 10 | 1852.500003 | 0.001 | 1907.500004 | 0.002 | 2.5 |
| 20 | 1852.499998 | -0.001 | 1907.499996 | -0.002 | 2.5 |
| 30 | 1852.499999 | -0.001 | 1907.499999 | -0.001 | 2.5 |
| 40 | 1852.499997 | -0.002 | 1907.499998 | -0.001 | 2.5 |
| 50 | 1852.499999 | -0.001 | 1907.499996 | -0.002 | 2.5 |
| 55 | 1852.499999 | -0.001 | 1907.499996 | -0.002 | 2.5 |

Frequency Error vs. Voltage

| Voltage (Volts) | LTE Band 2 | | | | Limit (ppm) |
|--------------------|---------------------------|-----------------------|-----------------|-----------------------|-------------|
| | Channel Bandwidth: 10 MHz | | | | |
| | Low Channel | | High Channel | | |
| | Frequency (MHz) | Frequency Error (ppm) | Frequency (MHz) | Frequency Error (ppm) | |
| 3.3 | 1855.000002 | 0.001 | 1905.000002 | 0.001 | 2.5 |
| 3.14 | 1855.000001 | 0.001 | 1905.000002 | 0.001 | 2.5 |
| 4.4 | 1855.000001 | 0.001 | 1905.000002 | 0.001 | 2.5 |

Note: The applicant defined the normal working voltage of the battery is from 3.14 Vdc to 4.4 Vdc.

Frequency Error vs. Temperature

| Temp. (°C) | LTE Band 2 | | | | Limit (ppm) |
|------------|---------------------------|-----------------------|-----------------|-----------------------|-------------|
| | Channel Bandwidth: 10 MHz | | | | |
| | Low Channel | | High Channel | | |
| | Frequency (MHz) | Frequency Error (ppm) | Frequency (MHz) | Frequency Error (ppm) | |
| -20 | 1855.000004 | 0.002 | 1905.000004 | 0.002 | 2.5 |
| -10 | 1855.000003 | 0.001 | 1905.000001 | 0.001 | 2.5 |
| 0 | 1855.000001 | 0.001 | 1905.000002 | 0.001 | 2.5 |
| 10 | 1855.000003 | 0.002 | 1905.000004 | 0.002 | 2.5 |
| 20 | 1854.999997 | -0.002 | 1904.999998 | -0.001 | 2.5 |
| 30 | 1854.999998 | -0.001 | 1904.999996 | -0.002 | 2.5 |
| 40 | 1854.999999 | -0.001 | 1904.999998 | -0.001 | 2.5 |
| 50 | 1854.999999 | -0.001 | 1904.999997 | -0.002 | 2.5 |
| 55 | 1854.999997 | -0.001 | 1904.999999 | -0.001 | 2.5 |

Frequency Error vs. Voltage

| Voltage (Volts) | LTE Band 2 | | | | Limit (ppm) |
|-----------------|---------------------------|-----------------------|-----------------|-----------------------|-------------|
| | Channel Bandwidth: 15 MHz | | | | |
| | Low Channel | | High Channel | | |
| | Frequency (MHz) | Frequency Error (ppm) | Frequency (MHz) | Frequency Error (ppm) | |
| 3.3 | 1857.500004 | 0.002 | 1902.500002 | 0.001 | 2.5 |
| 3.14 | 1857.500003 | 0.002 | 1902.500002 | 0.001 | 2.5 |
| 4.4 | 1857.500001 | 0.001 | 1902.500004 | 0.002 | 2.5 |

Note: The applicant defined the normal working voltage of the battery is from 3.14 Vdc to 4.4 Vdc.

Frequency Error vs. Temperature

| Temp. (°C) | LTE Band 2 | | | | Limit (ppm) |
|------------|---------------------------|-----------------------|-----------------|-----------------------|-------------|
| | Channel Bandwidth: 15 MHz | | | | |
| | Low Channel | | High Channel | | |
| | Frequency (MHz) | Frequency Error (ppm) | Frequency (MHz) | Frequency Error (ppm) | |
| -20 | 1857.500002 | 0.001 | 1902.500002 | 0.001 | 2.5 |
| -10 | 1857.500004 | 0.002 | 1902.500003 | 0.002 | 2.5 |
| 0 | 1857.500004 | 0.002 | 1902.500001 | 0.001 | 2.5 |
| 10 | 1857.500002 | 0.001 | 1902.500003 | 0.002 | 2.5 |
| 20 | 1857.499996 | -0.002 | 1902.499996 | -0.002 | 2.5 |
| 30 | 1857.499998 | -0.001 | 1902.499999 | -0.001 | 2.5 |
| 40 | 1857.499997 | -0.002 | 1902.499997 | -0.002 | 2.5 |
| 50 | 1857.499998 | -0.001 | 1902.499997 | -0.001 | 2.5 |
| 55 | 1857.499999 | -0.001 | 1902.499997 | -0.002 | 2.5 |

Frequency Error vs. Voltage

| Voltage (Volts) | LTE Band 2 | | | | Limit (ppm) |
|-----------------|---------------------------|-----------------------|-----------------|-----------------------|-------------|
| | Channel Bandwidth: 20 MHz | | | | |
| | Low Channel | | High Channel | | |
| | Frequency (MHz) | Frequency Error (ppm) | Frequency (MHz) | Frequency Error (ppm) | |
| 3.3 | 1860.000004 | 0.002 | 1900.000001 | 0.001 | 2.5 |
| 3.14 | 1860.000003 | 0.002 | 1900.000003 | 0.002 | 2.5 |
| 4.4 | 1860.000003 | 0.002 | 1900.000003 | 0.001 | 2.5 |

Note: The applicant defined the normal working voltage of the battery is from 3.14 Vdc to 4.4 Vdc.

Frequency Error vs. Temperature

| Temp. (°C) | LTE Band 2 | | | | Limit (ppm) |
|------------|---------------------------|-----------------------|-----------------|-----------------------|-------------|
| | Channel Bandwidth: 20 MHz | | | | |
| | Low Channel | | High Channel | | |
| | Frequency (MHz) | Frequency Error (ppm) | Frequency (MHz) | Frequency Error (ppm) | |
| -20 | 1860.000003 | 0.002 | 1900.000003 | 0.002 | 2.5 |
| -10 | 1860.000003 | 0.001 | 1900.000003 | 0.002 | 2.5 |
| 0 | 1860.000004 | 0.002 | 1900.000001 | 0.001 | 2.5 |
| 10 | 1860.000003 | 0.002 | 1900.000003 | 0.002 | 2.5 |
| 20 | 1859.999998 | -0.001 | 1899.999996 | -0.002 | 2.5 |
| 30 | 1859.999996 | -0.002 | 1899.999997 | -0.002 | 2.5 |
| 40 | 1859.999999 | -0.001 | 1899.999999 | -0.001 | 2.5 |
| 50 | 1859.999999 | -0.001 | 1899.999997 | -0.002 | 2.5 |
| 55 | 1859.999996 | -0.002 | 1899.999998 | -0.001 | 2.5 |

4.3 Occupied Bandwidth Measurement

4.3.1 Test Procedure

The EUT makes a call to the communication simulator. All measurements were done at low, middle and high operational frequency range. The communication simulator station system controlled a EUT to export maximum output power under transmission mode and specific channel frequency. Use OBW measurement function of Spectrum analyzer to measure 99 % occupied bandwidth.

4.3.2 Test Setup

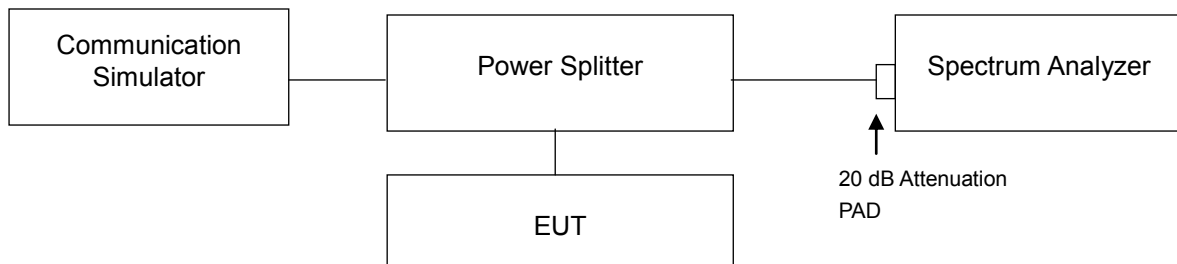

4.3.3 Test Result

| Channel | Frequency (MHz) | 99 % Occupied Bandwidth (MHz) |
|---------|-----------------|-------------------------------|
| | | WCDMA |
| 9262 | 1852.4 | 4.09 |
| 9400 | 1880.0 | 4.09 |
| 9538 | 1907.6 | 4.14 |

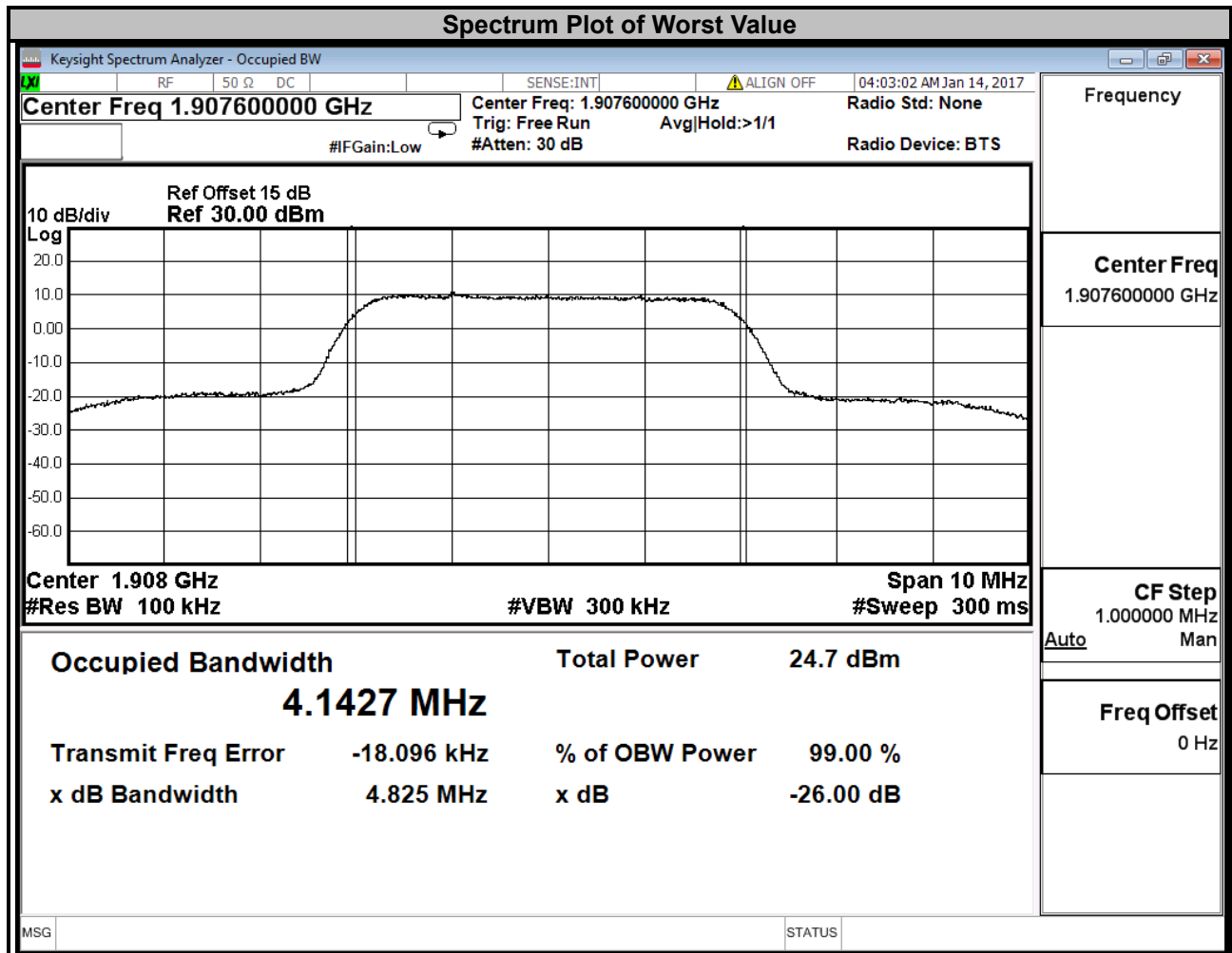

LTE Band 2

| Channel Bandwidth: 1.4 MHz | | | | Channel Bandwidth: 3 MHz | | | |
|----------------------------|-----------------|-------------------------------|-------|--------------------------|-----------------|-------------------------------|-------|
| Channel | Frequency (MHz) | 99 % Occupied Bandwidth (MHz) | | Channel | Frequency (MHz) | 99 % Occupied Bandwidth (MHz) | |
| | | QPSK | 16QAM | | | QPSK | 16QAM |
| 18607 | 1850.7 | 1.09 | 1.10 | 18615 | 1851.5 | 2.70 | 2.70 |
| 18900 | 1880.0 | 1.09 | 1.10 | 18900 | 1880.0 | 2.70 | 2.70 |
| 19193 | 1909.3 | 1.10 | 1.10 | 19185 | 1908.5 | 2.70 | 2.70 |

Spectrum Plot of Worst Value

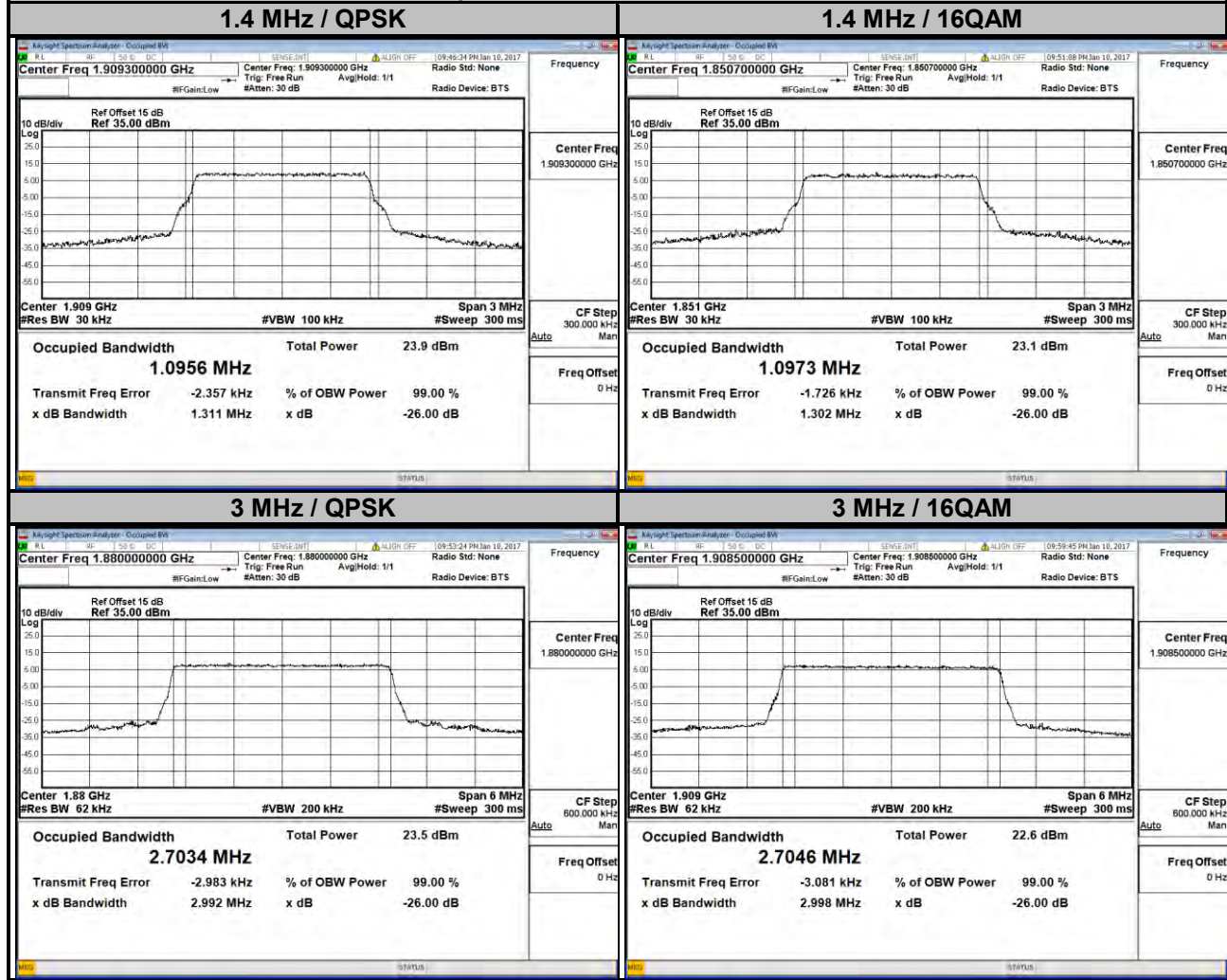

LTE Band 2

| Channel Bandwidth: 5 MHz | | | | Channel Bandwidth: 10 MHz | | | |
|--------------------------|-----------------|-------------------------------|-------|---------------------------|-----------------|-------------------------------|-------|
| Channel | Frequency (MHz) | 99 % Occupied Bandwidth (MHz) | | Channel | Frequency (MHz) | 99 % Occupied Bandwidth (MHz) | |
| | | QPSK | 16QAM | | | QPSK | 16QAM |
| 18625 | 1852.5 | 4.50 | 4.50 | 18650 | 1855.0 | 9.00 | 9.00 |
| 18900 | 1880.0 | 4.50 | 4.50 | 18900 | 1880.0 | 8.98 | 8.99 |
| 19175 | 1907.5 | 4.50 | 4.50 | 19150 | 1905.0 | 8.97 | 8.97 |

Spectrum Plot of Worst Value

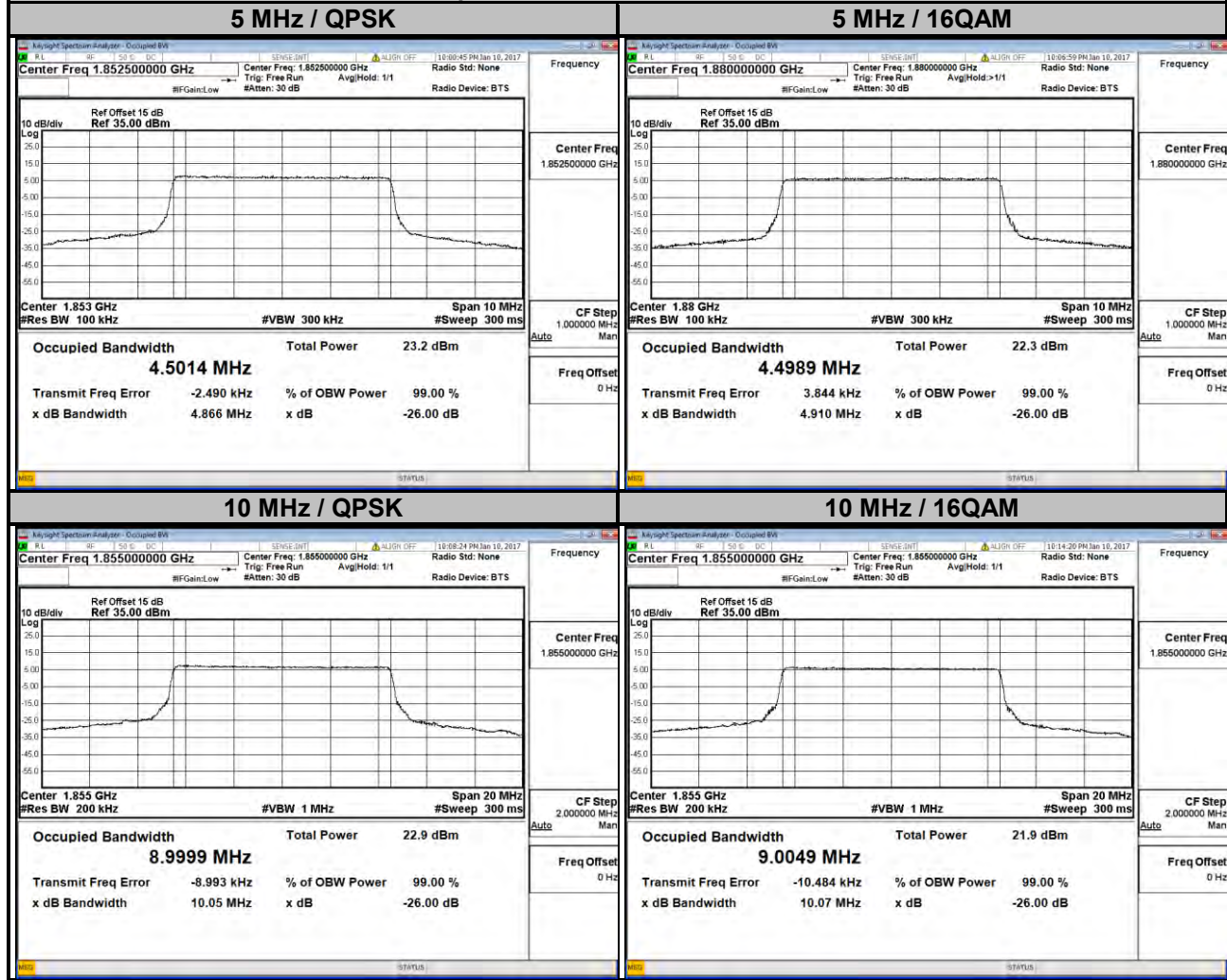

LTE Band 2

Channel Bandwidth: 15 MHz

Channel Bandwidth: 20 MHz

| Channel | Frequency (MHz) | 99 % Occupied Bandwidth (MHz) | | Channel | Frequency (MHz) | 99 % Occupied Bandwidth (MHz) | |
|---------|-----------------|-------------------------------|-------|---------|-----------------|-------------------------------|-------|
| | | QPSK | 16QAM | | | QPSK | 16QAM |
| 18675 | 1857.5 | 13.50 | 13.49 | 18700 | 1860.0 | 18.03 | 18.02 |
| 18900 | 1880.0 | 13.45 | 13.44 | 18900 | 1880.0 | 17.93 | 17.92 |
| 19125 | 1902.5 | 13.45 | 13.44 | 19100 | 1900.0 | 17.99 | 17.97 |

Spectrum Plot of Worst Value

15 MHz / QPSK

15 MHz / 16QAM

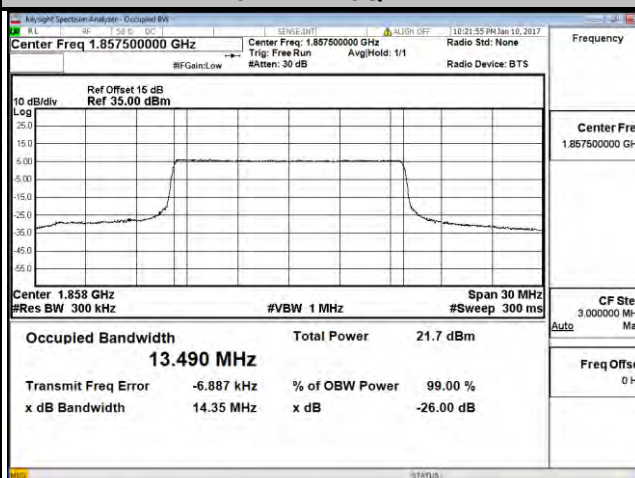
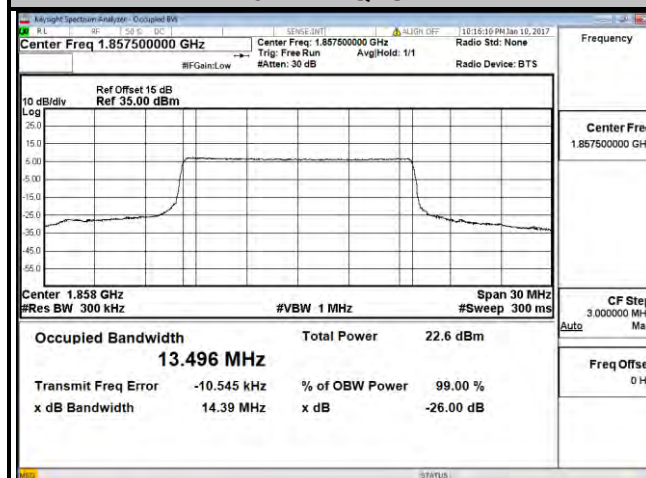

20 MHz / QPSK

20 MHz / 16QAM

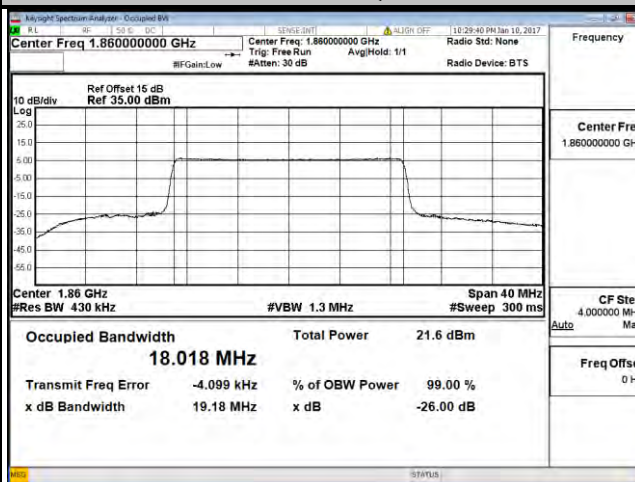
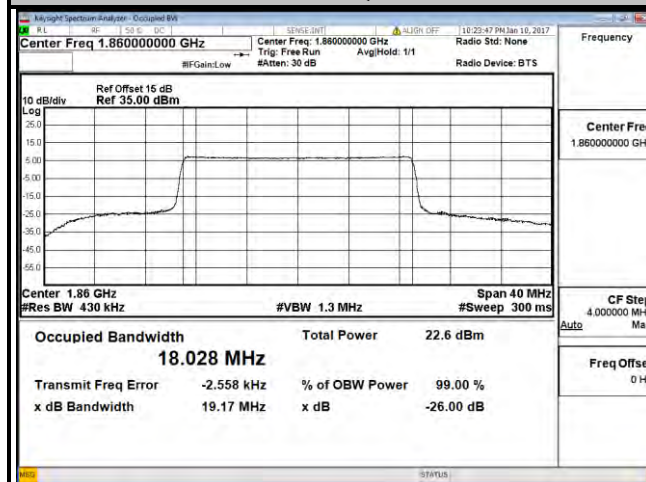

4.4 Band Edge Measurement

4.4.1 Limits of Band Edge Measurement

Power of any emission outside of the authorized operating frequency ranges must be attenuated below the transmitting power (P) by a factor of at least $43 + 10 \log(P)$ dB. In the 1 MHz bands immediately outside and adjacent to the frequency block a resolution bandwidth of at least one percent of the emission bandwidth of the fundamental emission of the transmitter may be employed.

4.4.2 Test Setup

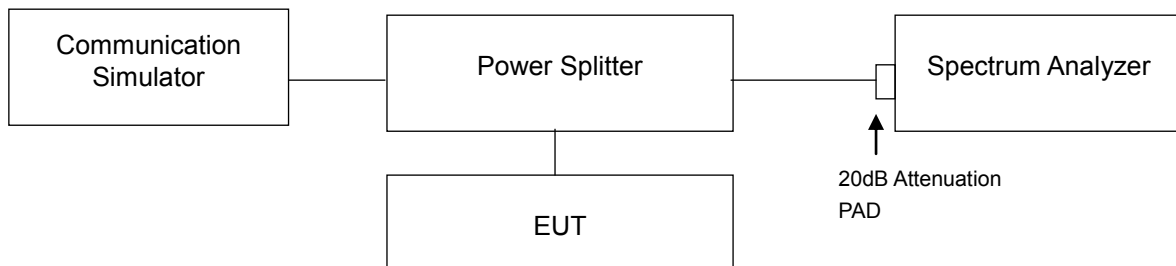

4.4.3 Test Procedures

- All measurements were done at low and high operational frequency range.
- The center frequency of spectrum is the band edge frequency and span is 5 MHz. RB of the spectrum is 100 kHz and VB of the spectrum is 300 kHz (WCDMA).
- The center frequency of spectrum is the band edge frequency and span is 1 MHz. RB of the spectrum is 13 kHz and VB of the spectrum is 51 kHz (LTE Bandwidth 1.4 MHz).
- The center frequency of spectrum is the band edge frequency and span is 1 MHz. RB of the spectrum is 30 kHz and VB of the spectrum is 100 kHz (LTE Bandwidth 3 MHz).
- The center frequency of spectrum is the band edge frequency and span is 1 MHz. RB of the spectrum is 100 kHz and VB of the spectrum is 300 kHz (LTE Bandwidth 5 MHz/10 MHz).
- The center frequency of spectrum is the band edge frequency and span is 1 MHz. RB of the spectrum is 150 kHz and VB of the spectrum is 470 kHz (LTE Bandwidth 15 MHz).
- The center frequency of spectrum is the band edge frequency and span is 1 MHz. RB of the spectrum is 180 kHz and VB of the spectrum is 560 kHz (LTE Bandwidth 20 MHz).
- Record the max trace plot into the test report.

4.4.4 Test Results

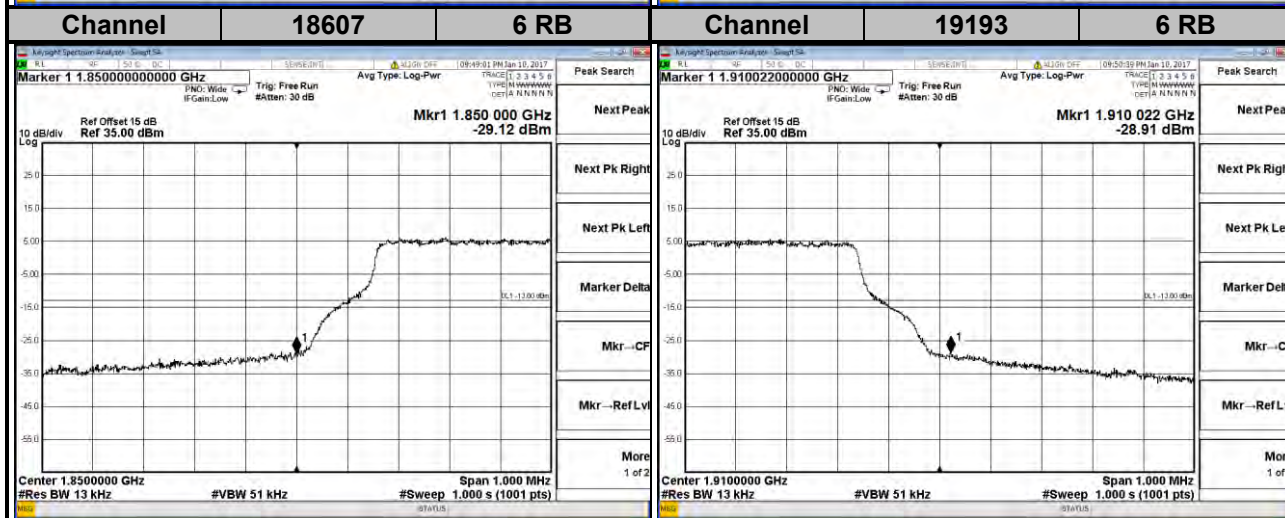
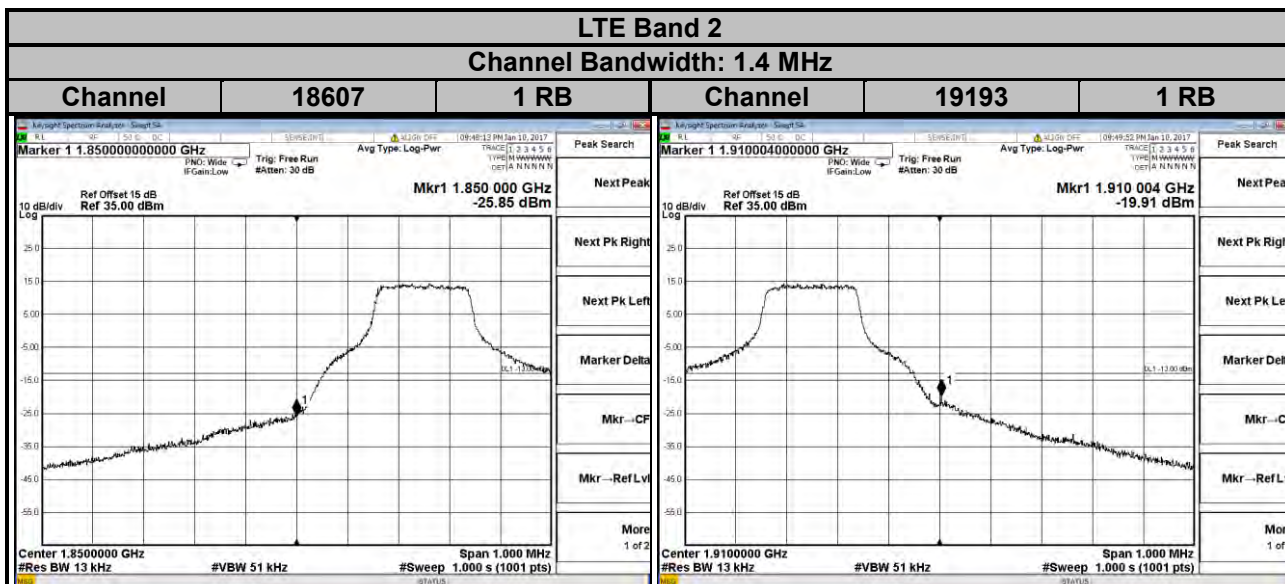
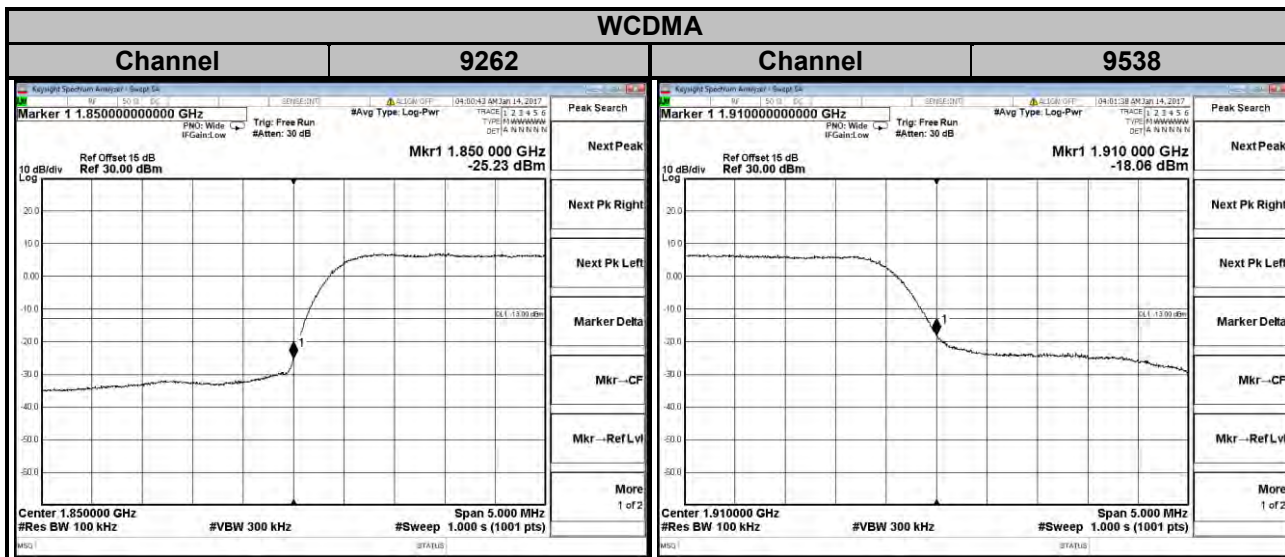

LTE Band 2
Channel Bandwidth: 3 MHz

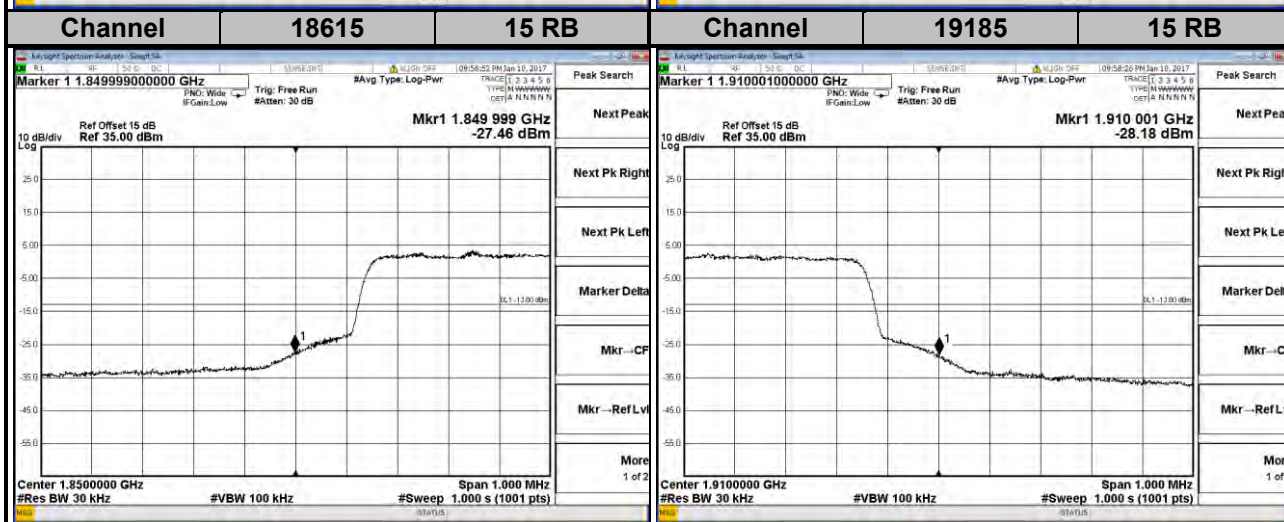
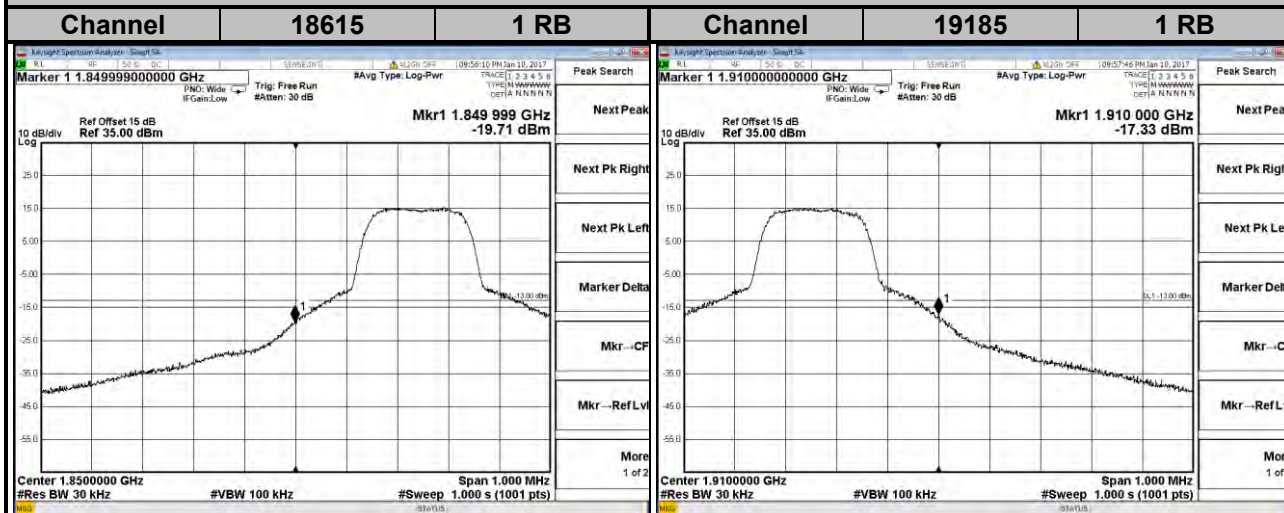

LTE Band 2
Channel Bandwidth: 5 MHz

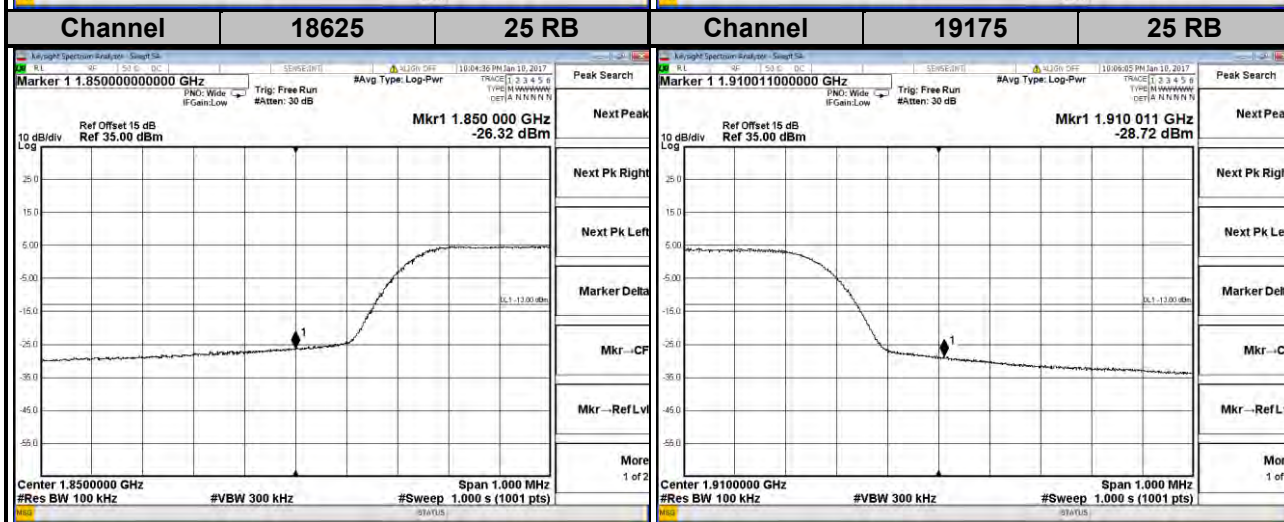
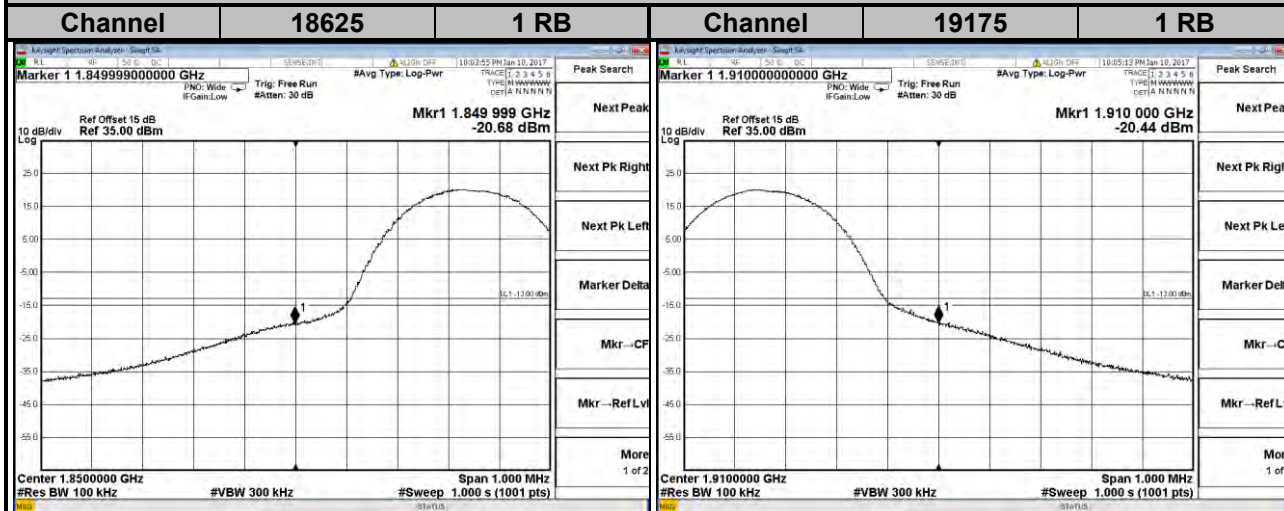

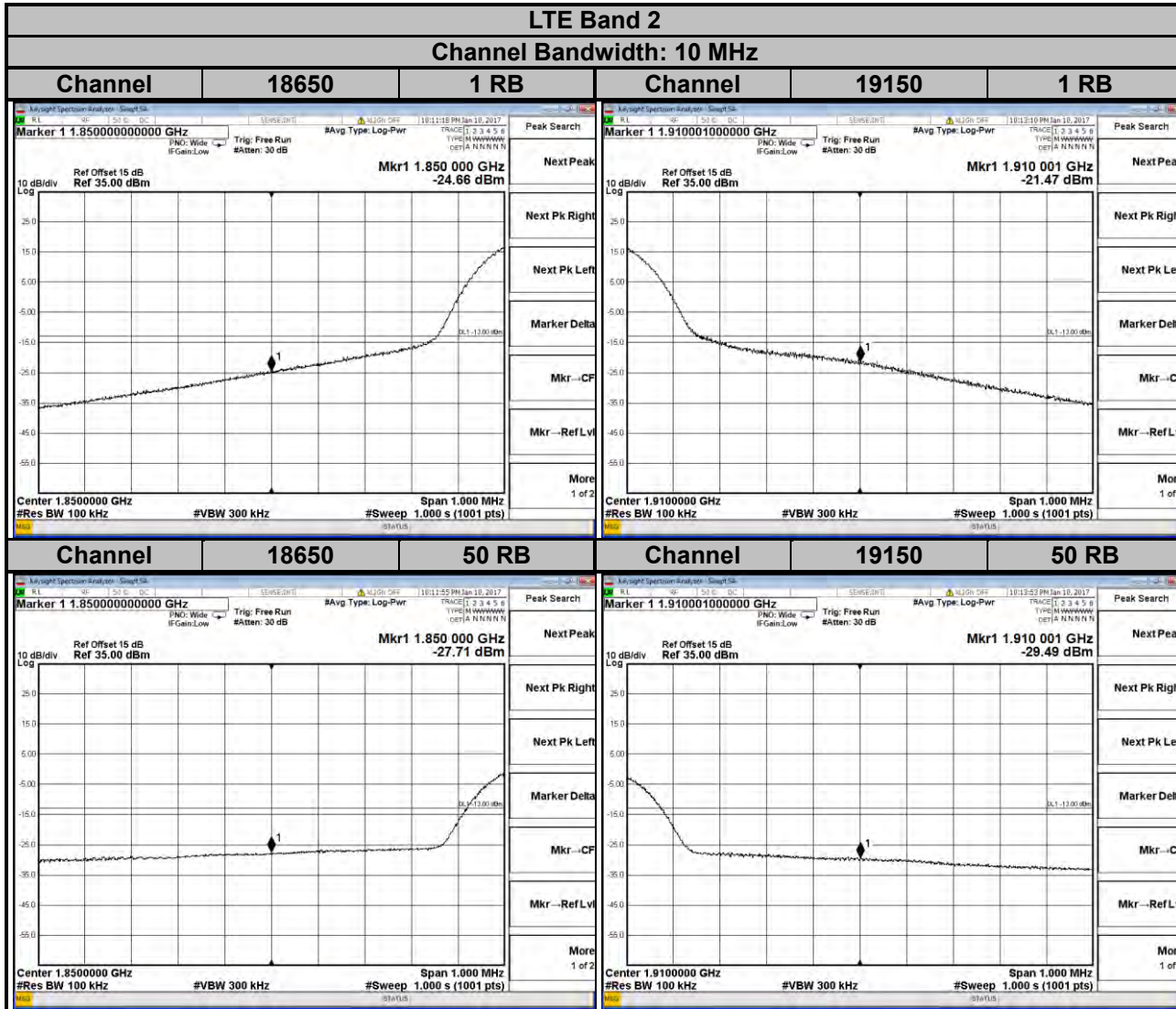

LTE Band 2
Channel Bandwidth: 15 MHz

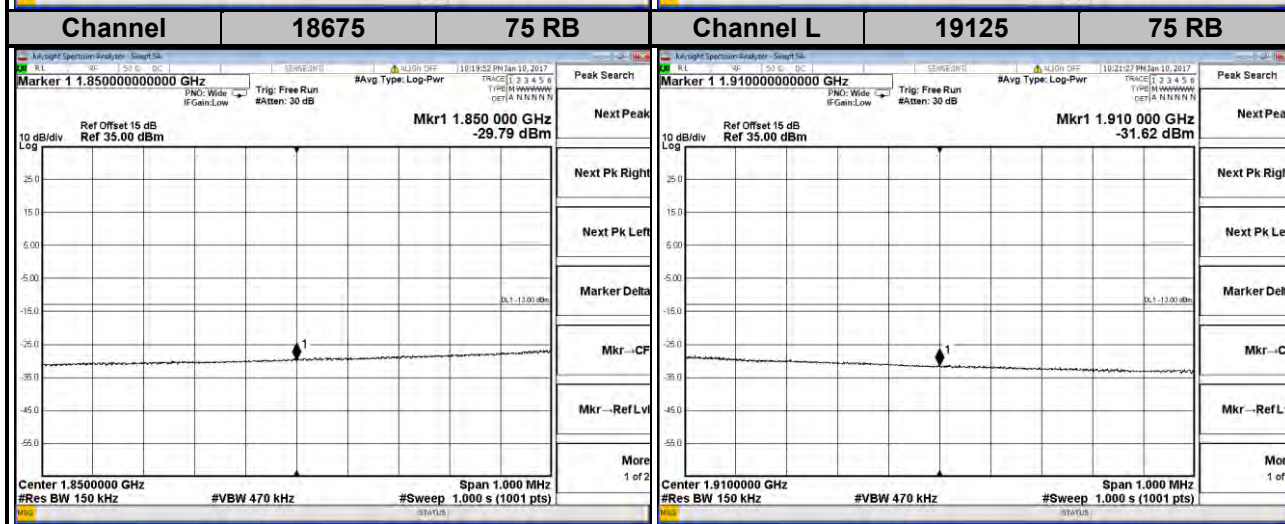
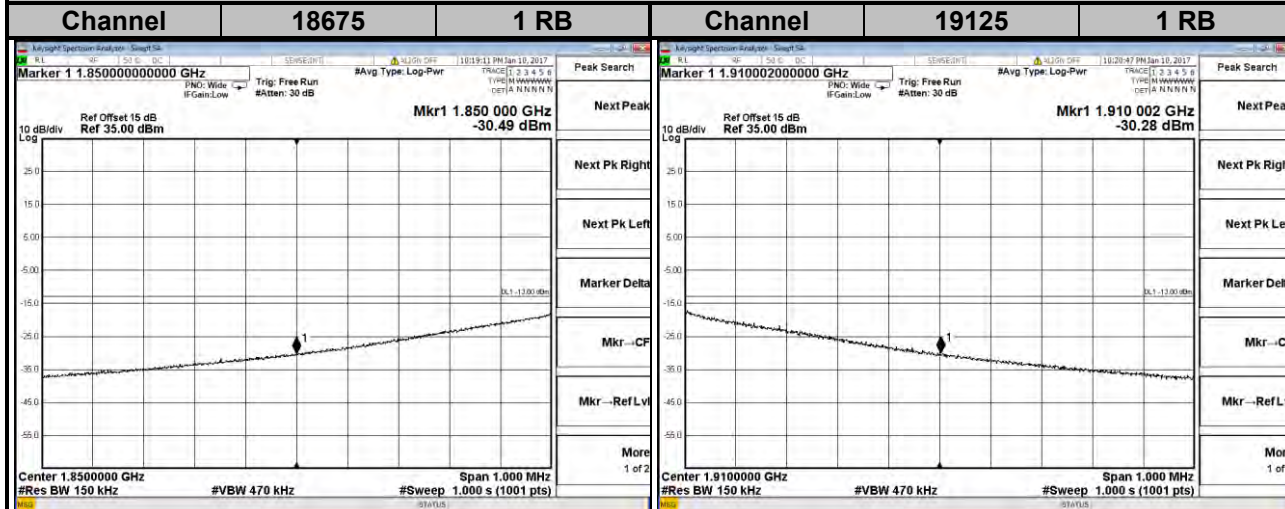

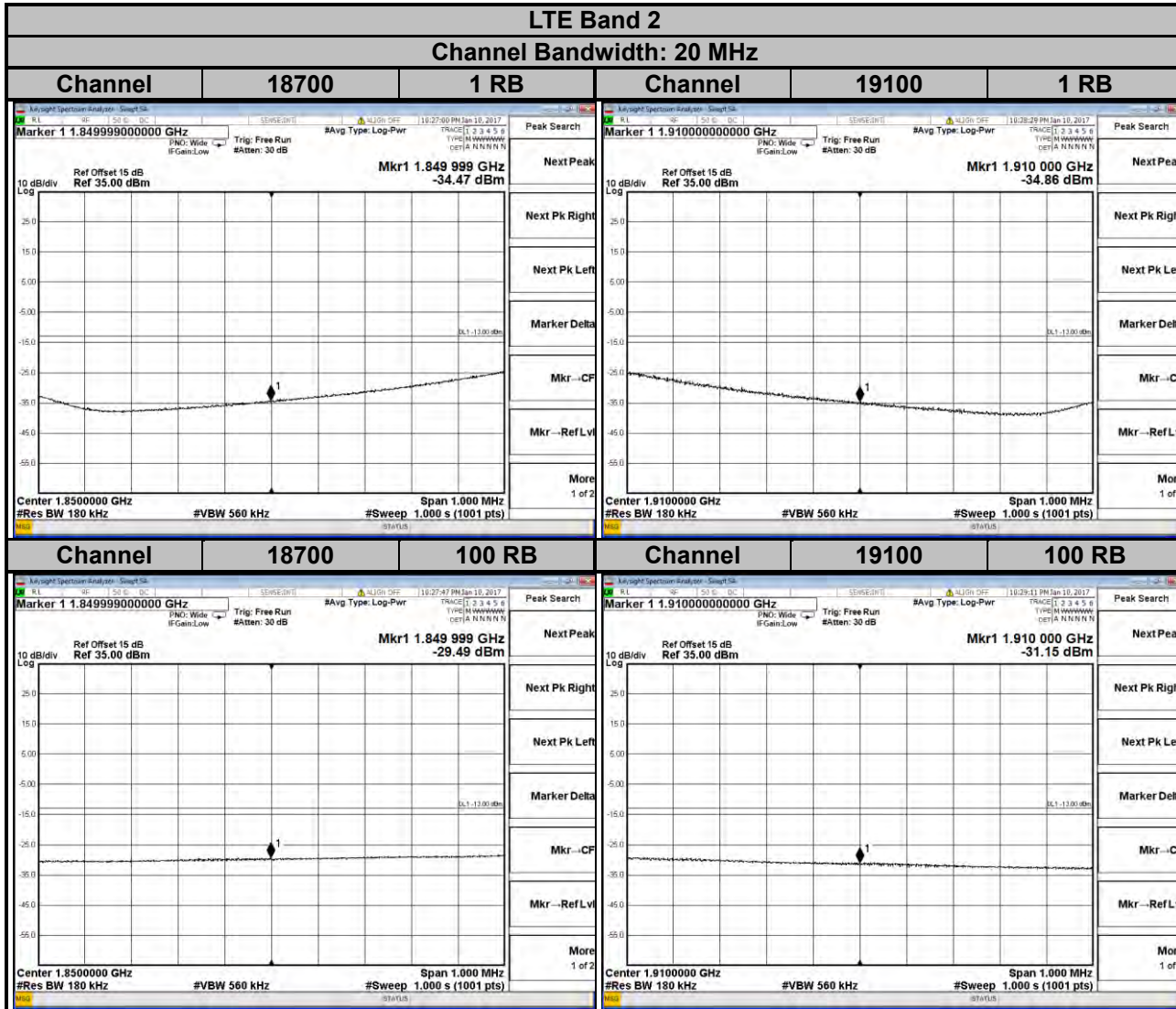

4.5 Peak to Average Ratio

4.5.1 Limits of Peak to Average Ratio Measurement

In measuring transmissions in this band using an average power technique, the peak to-average ratio (PAR) of the transmission may not exceed 13 dB.

4.5.2 Test Setup

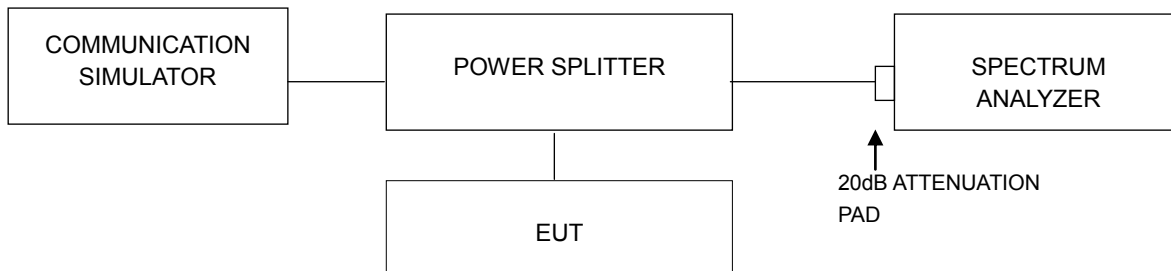

4.5.3 Test Procedures

1. Set resolution/measurement bandwidth \geq signal's occupied bandwidth;
2. Set the number of counts to a value that stabilizes the measured CCDF curve;
3. Record the maximum PAPR level associated with a probability of 0.1 %.

4.5.4 Test Results

| Channel | Frequency (MHz) | Peak to Average Ratio (dB) |
|---------|-----------------|----------------------------|
| | | WCDMA |
| 9262 | 1852.4 | 3.06 |
| 9400 | 1880.0 | 3.08 |
| 9538 | 1907.6 | 2.26 |

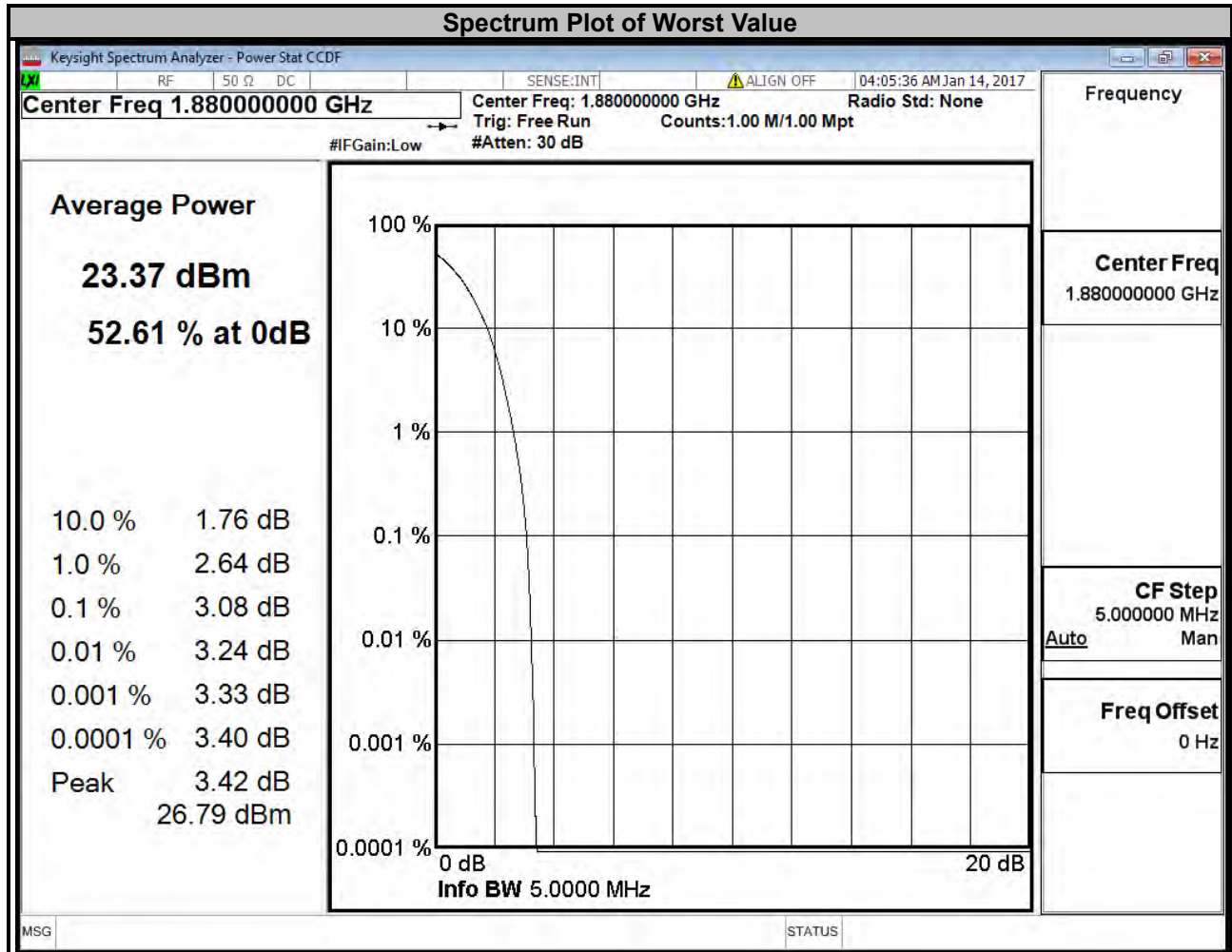

LTE Band 2

| Channel Bandwidth: 1.4 MHz | | | | Channel Bandwidth: 3 MHz | | | |
|----------------------------|-----------------|----------------------------|-------|--------------------------|-----------------|----------------------------|-------|
| Channel | Frequency (MHz) | Peak to Average Ratio (dB) | | Channel | Frequency (MHz) | Peak to Average Ratio (dB) | |
| | | QPSK | 16QAM | | | QPSK | 16QAM |
| 18607 | 1850.7 | 5.43 | 5.09 | 18615 | 1851.5 | 5.51 | 5.06 |
| 18900 | 1880.0 | 5.97 | 5.84 | 18900 | 1880.0 | 6.09 | 5.92 |
| 19193 | 1909.3 | 4.63 | 5.23 | 19185 | 1908.5 | 5.11 | 5.77 |

Spectrum Plot of Worst Value

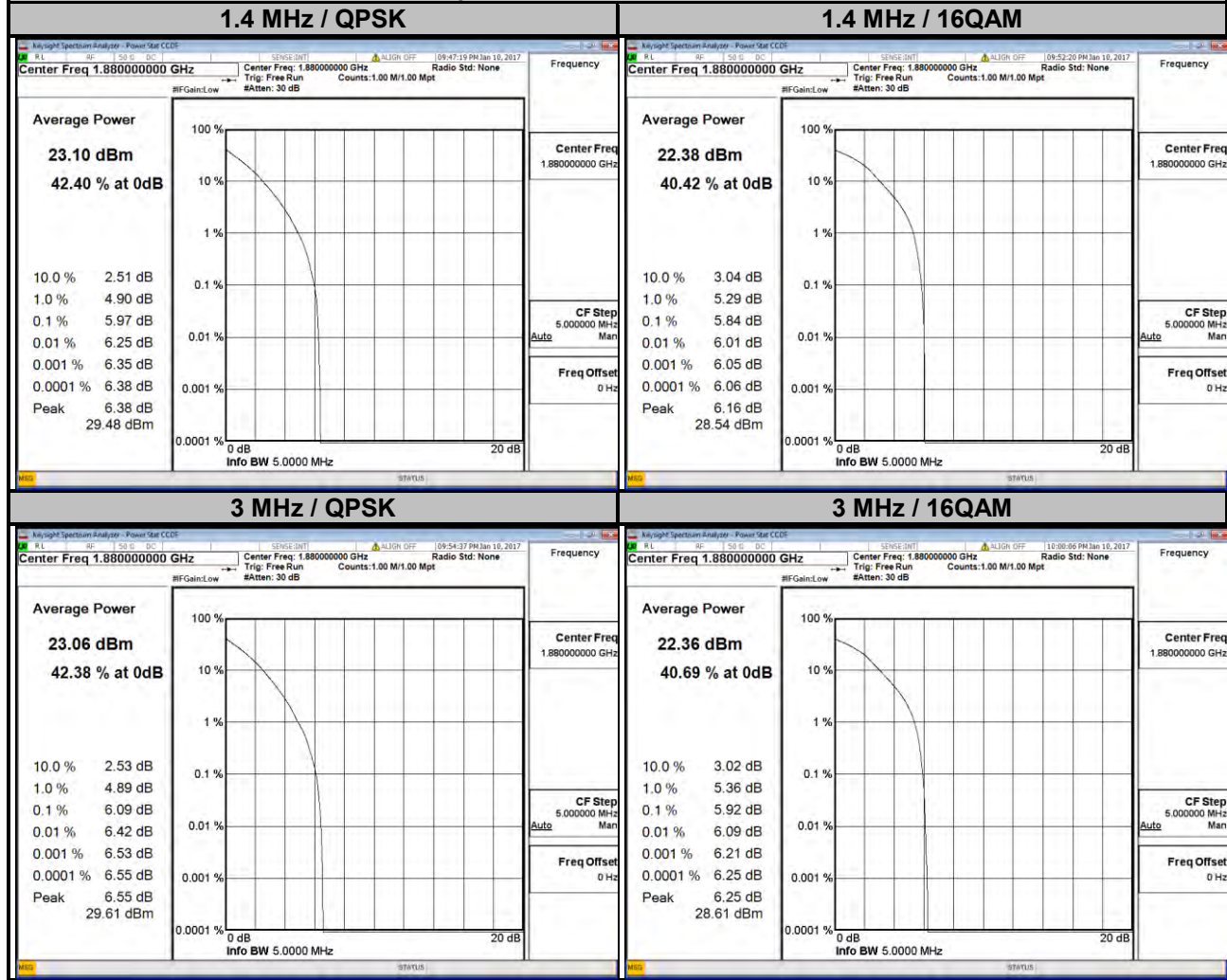

LTE Band 2

| Channel Bandwidth: 5 MHz | | | | Channel Bandwidth: 10 MHz | | | |
|--------------------------|-----------------|----------------------------|-------|---------------------------|-----------------|----------------------------|-------|
| Channel | Frequency (MHz) | Peak to Average Ratio (dB) | | Channel | Frequency (MHz) | Peak to Average Ratio (dB) | |
| | | QPSK | 16QAM | | | QPSK | 16QAM |
| 18625 | 1852.5 | 5.46 | 5.09 | 18650 | 1855.0 | 5.53 | 5.10 |
| 18900 | 1880.0 | 6.06 | 5.95 | 18900 | 1880.0 | 6.11 | 6.05 |
| 19175 | 1907.5 | 5.76 | 6.48 | 19150 | 1905.0 | 6.52 | 7.14 |

Spectrum Plot of Worst Value

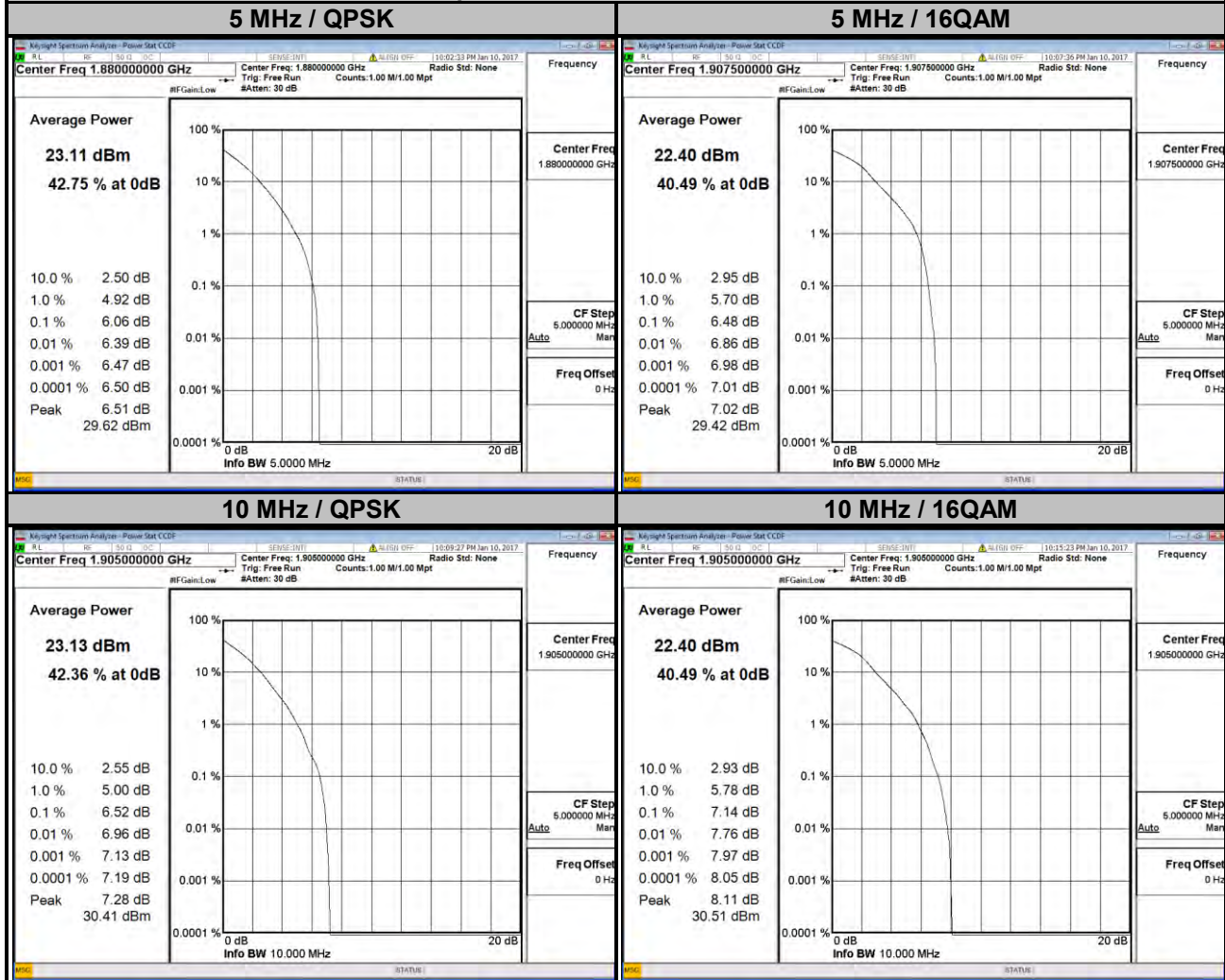

LTE Band 2

| Channel Bandwidth: 15 MHz | | | | Channel Bandwidth: 20 MHz | | | |
|---------------------------|-----------------|----------------------------|-------|---------------------------|-----------------|----------------------------|-------|
| Channel | Frequency (MHz) | Peak to Average Ratio (dB) | | Channel | Frequency (MHz) | Peak to Average Ratio (dB) | |
| | | QPSK | 16QAM | | | QPSK | 16QAM |
| 18675 | 1857.5 | 5.62 | 5.21 | 18700 | 1860.0 | 5.75 | 5.33 |
| 18900 | 1880.0 | 6.15 | 6.17 | 18900 | 1880.0 | 6.33 | 6.29 |
| 19125 | 1902.5 | 6.42 | 7.33 | 19100 | 1900.0 | 6.46 | 6.92 |

Spectrum Plot of Worst Value

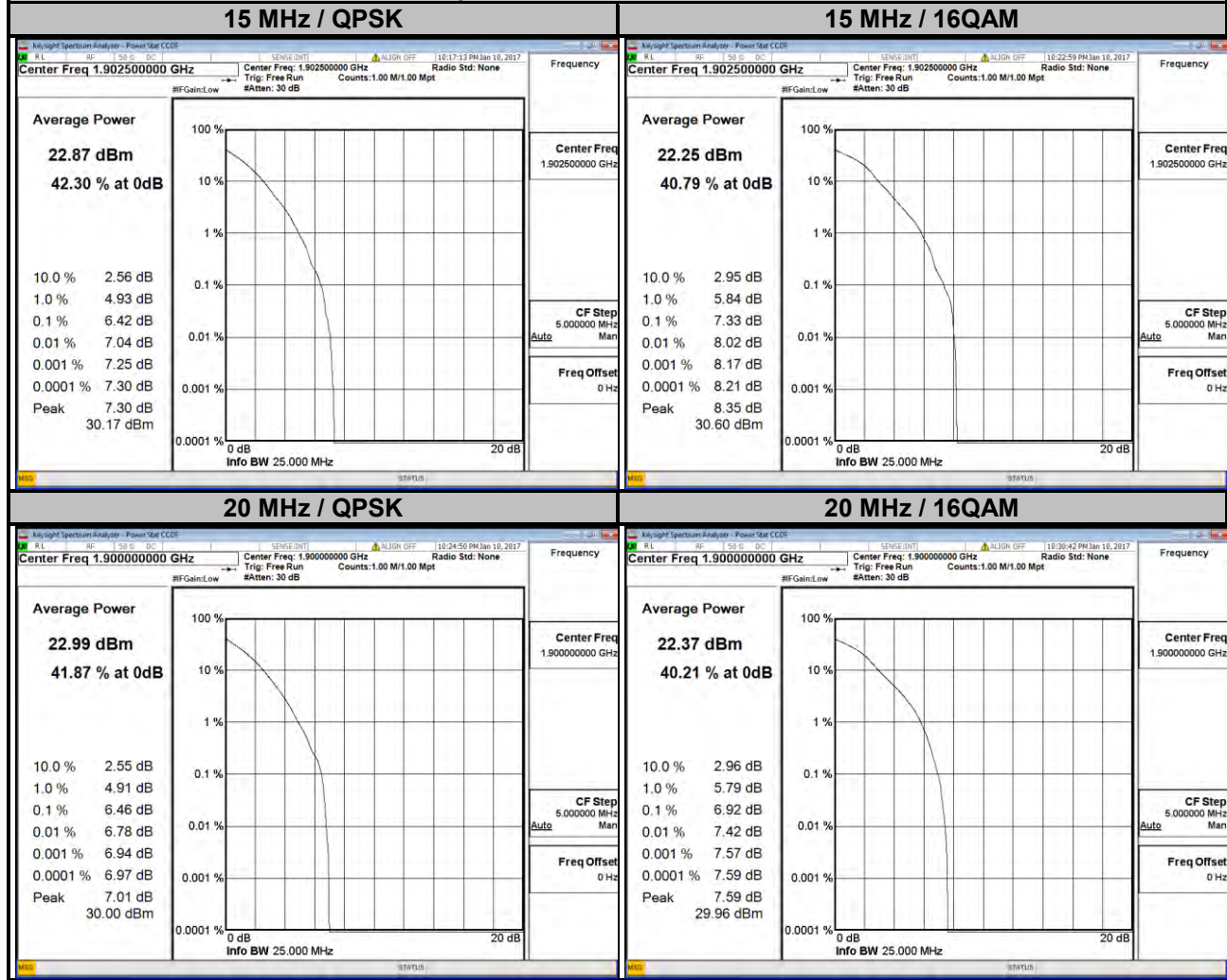

4.6 Conducted Spurious Emissions

4.6.1 Limits of Conducted Spurious Emissions Measurement

The power of any emission outside of the authorized operating frequency ranges must be attenuated below the transmitting power (P) by a factor of at least $43 + 10 \log(P)$ dB. The emission limit equal to -13 dBm.

4.6.2 Test Setup

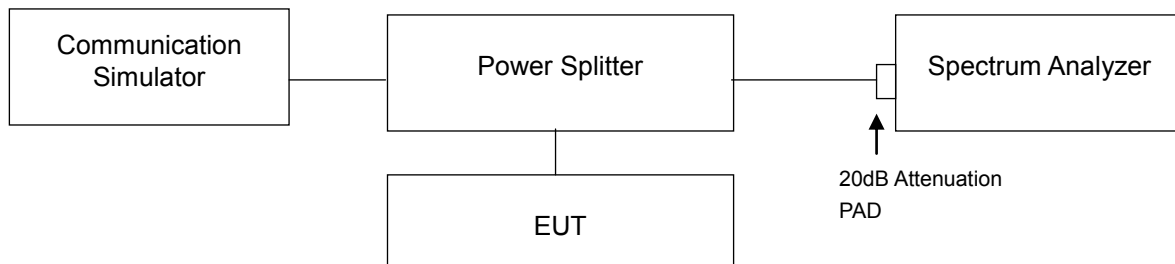

4.6.3 Test Procedure

- The EUT makes a phone call to the communication simulator. All measurements were done at low, middle and high operational frequency range.
- Measuring frequency range is from 9 kHz to 9 GHz. 20 dB attenuation pad is connected with spectrum. RBW=1 MHz and VBW=3 MHz is used for conducted emission measurement.

4.6.4 Test Results

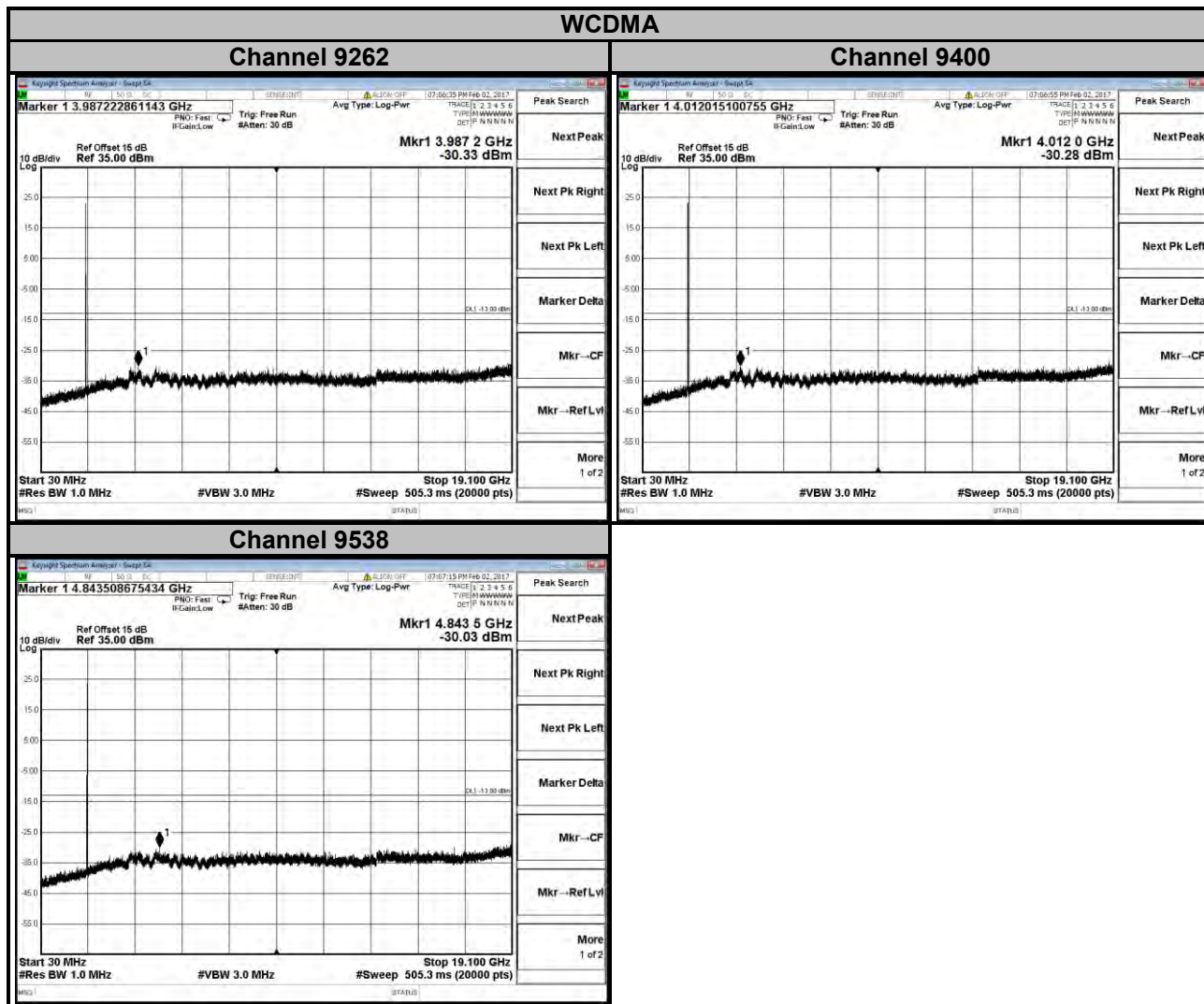

LTE Band 2

Channel Bandwidth: 1.4 MHz

Channel 18607

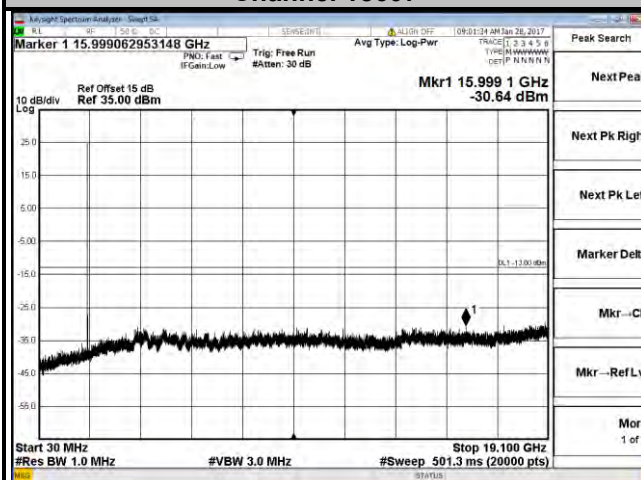

Channel 18900

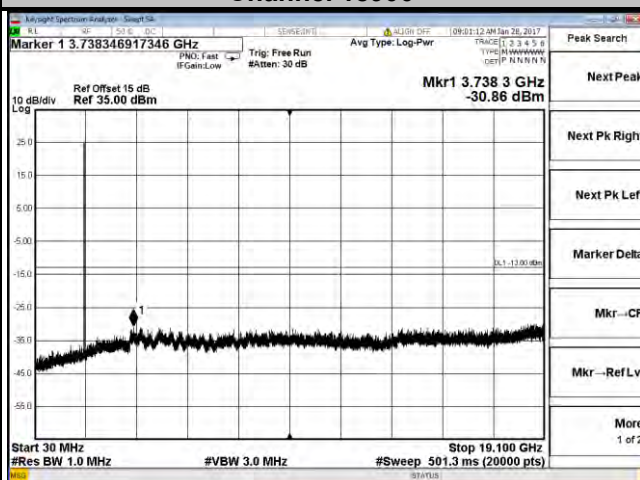

Channel 19193

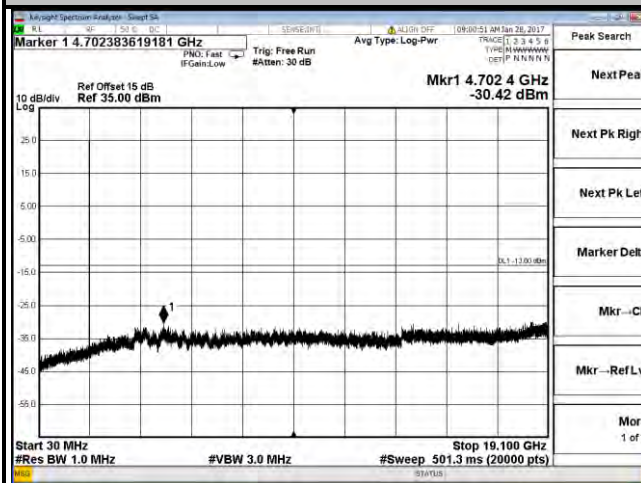

LTE Band 2

Channel Bandwidth: 3 MHz

Channel 18615

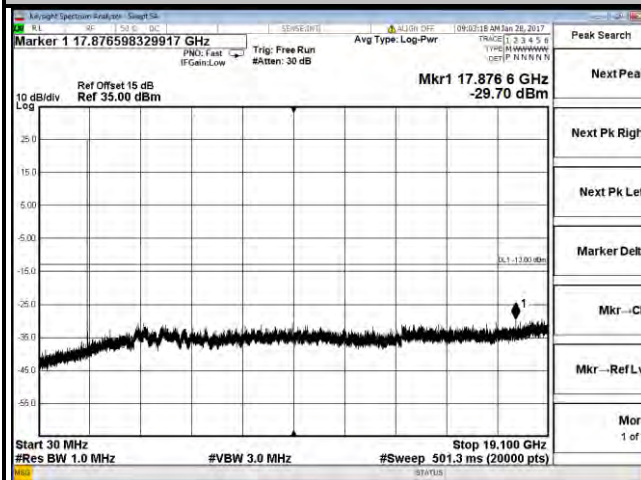

Channel 18900

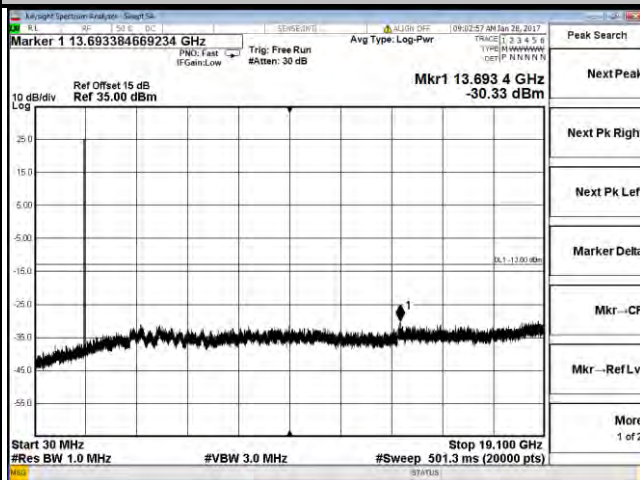

Channel 19185

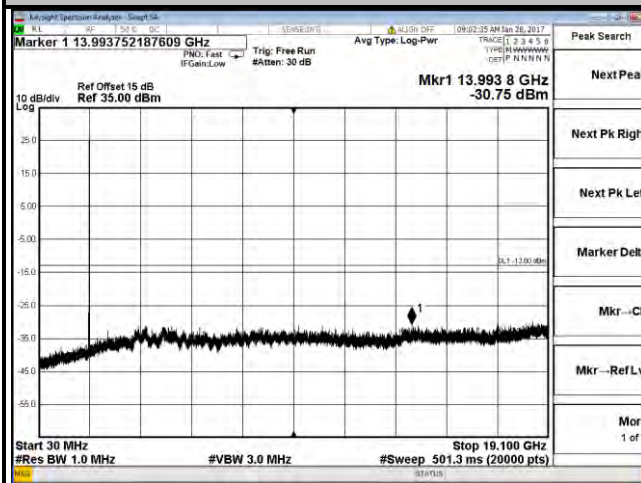

LTE Band 2

Channel Bandwidth: 5 MHz

Channel 18625

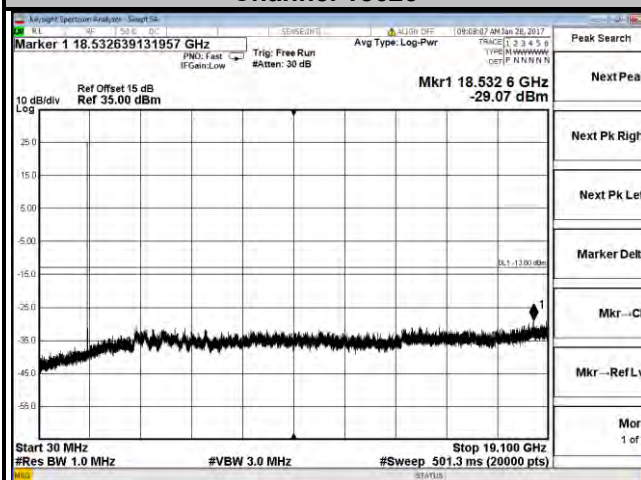

Channel 18900

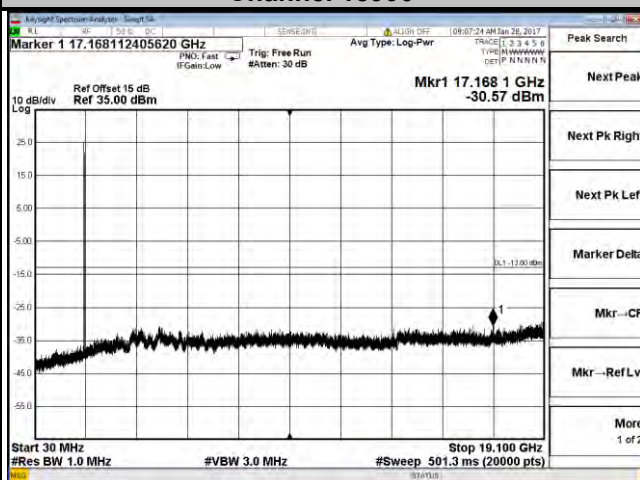

Channel 19175

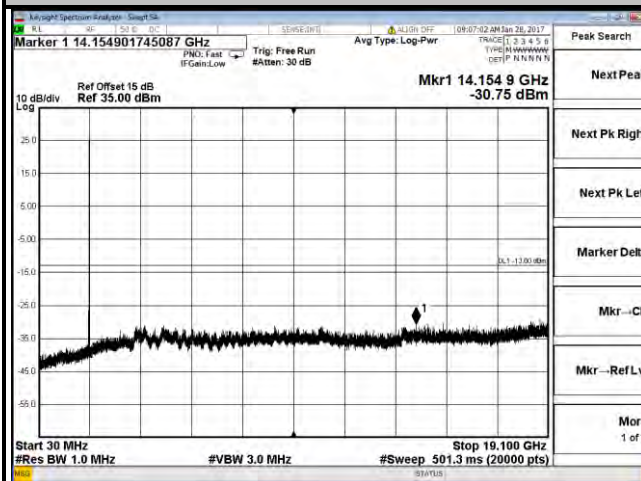

LTE Band 2

Channel Bandwidth: 10 MHz

Channel 18650

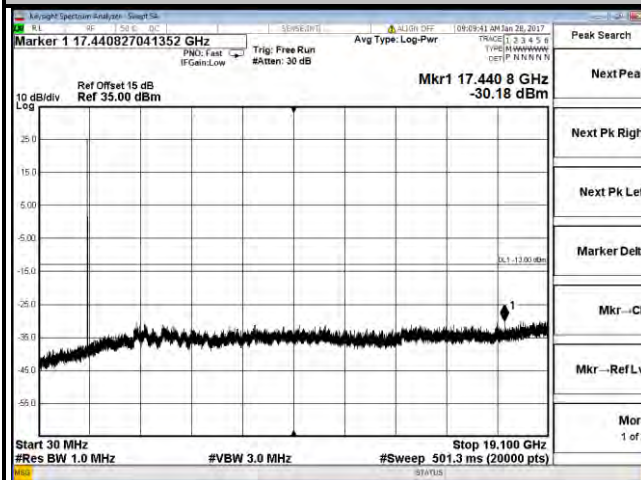

Channel 18900

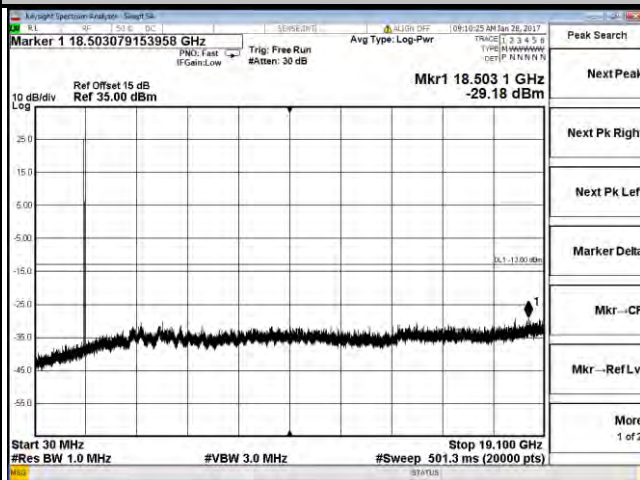

Channel 19150

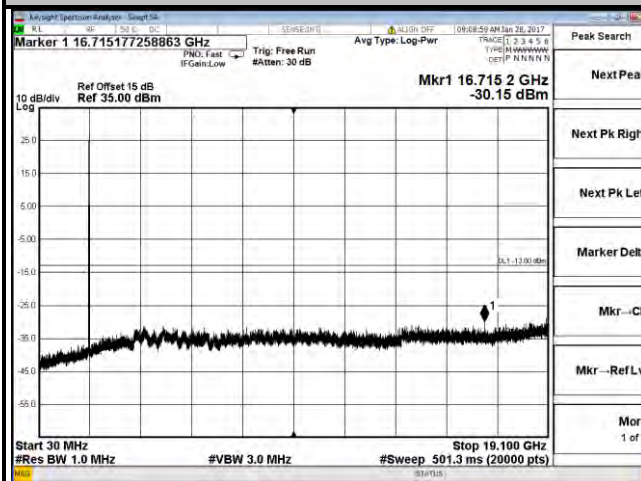

LTE Band 2

Channel Bandwidth: 15 MHz

Channel 18675

Channel 18900

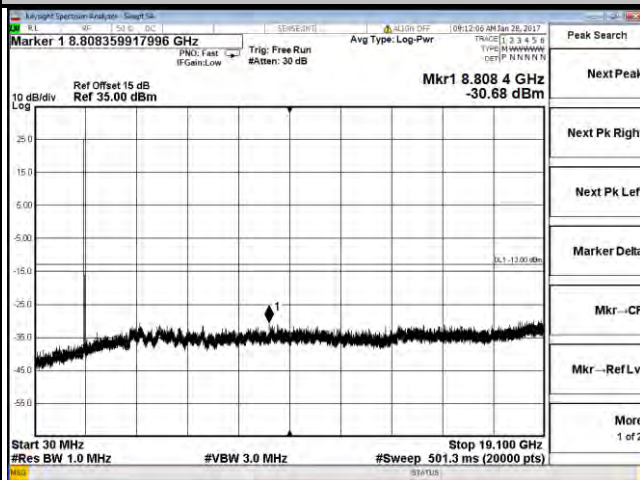
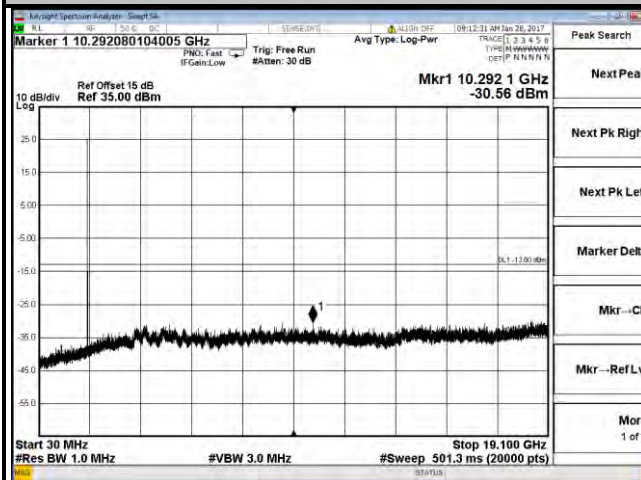

Channel 19125

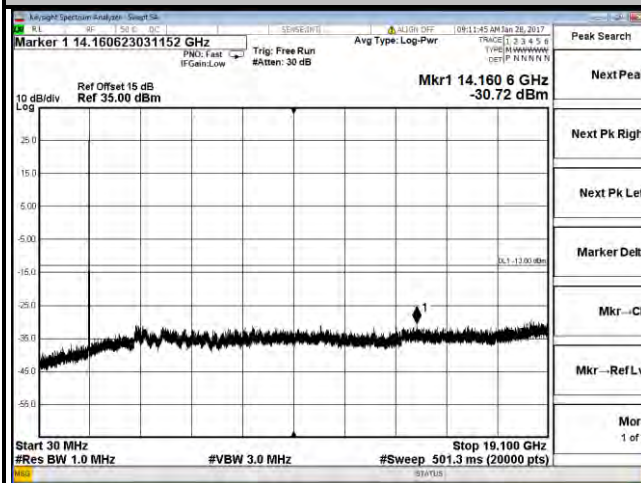

LTE Band 2

Channel Bandwidth: 20 MHz

Channel 18700

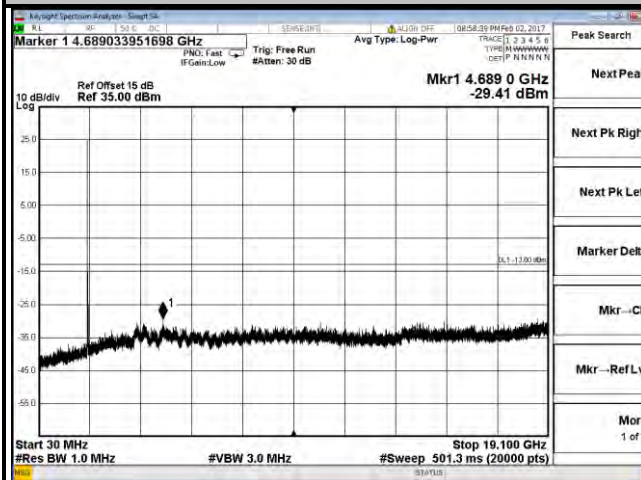

Channel 18900

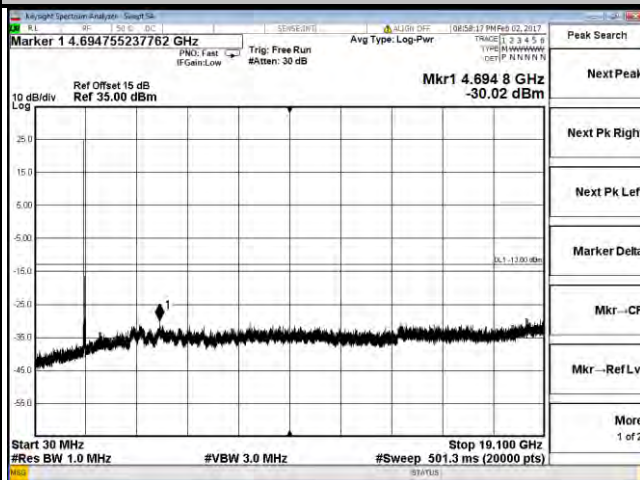

Channel 19100

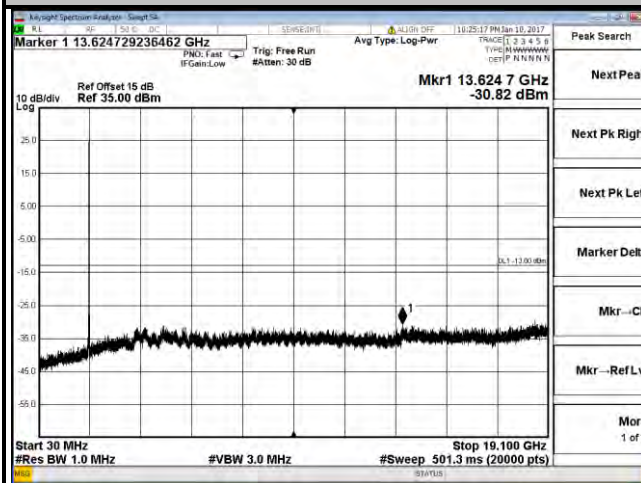

4.7 Radiated Emission Measurement

4.7.1 Limits of Radiated Emission Measurement

The power of any emission outside of the authorized operating frequency ranges must be attenuated below the transmitting power (P) by a factor of at least $43 + 10 \log(P)$ dB. The emission limit is equal to -13 dBm.

4.7.2 Test Procedure

- Substitution method is used for E.I.R.P measurement. In the semi-anechoic chamber, EUT placed on the 0.8 m height of Turn Table, rotated the table around 360 degrees to search the maximum radiation power and receiver antenna shall be rotated vertical and horizontal polarization and moved height from 1 m to 4 m to find the maximum polar radiated power. The "Read Value" is the spectrum reading the maximum power value.
- The substitution horn antenna is substituted for EUT at the same position and signals generator export the CW signal to the substitution antenna via a TX cable. Rotated the Turn Table and moved receiving antenna to find the maximum radiation power. Adjust output power level of S.G to get a Value of spectrum reading equal to "Read Value" of step a. Record the power level of S.G.
- $EIRP = \text{Output power level of S.G} - \text{TX cable loss} + \text{Antenna gain of substitution horn}$.
- E.R.P power can be calculated form E.I.R.P power by subtracting the gain of dipole, $E.R.P \text{ power} = E.I.P.R \text{ power} - 2.15 \text{ dBi}$.

NOTE: The resolution bandwidth and video bandwidth of test receiver/spectrum analyzer is 1 MHz/3 MHz.

4.7.3 Deviation from Test Standard

No deviation.

4.7.4 Test Setup

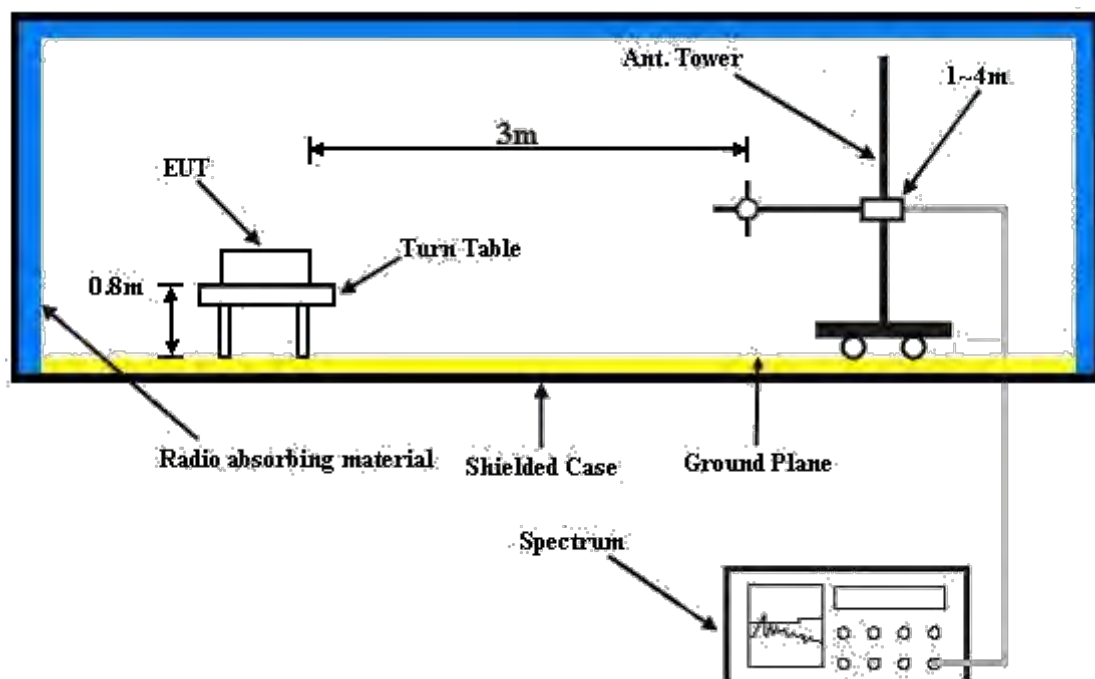

For the actual test configuration, please refer to the attached file (Test Setup Photo).

4.7.5 Test Results

WCDMA:

Low Channel



Bureau Veritas Consumer Products Services Ltd., Taoyuan Branch

A D T

Data: 5

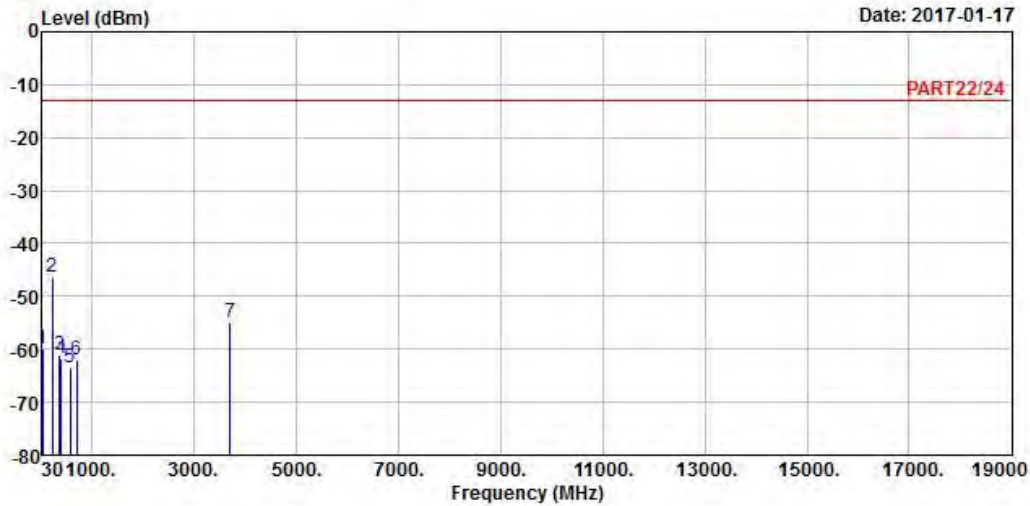

Site : 966 Chamber 5
 Condition: PART22/24 HORIZONTAL
 Remak : WCDMA Band II_L-CH Link
 Tested by: Gavin Wu

| | Freq | Level | Read Level | Limit Line | Over Limit | Factor | Remark |
|------|---------|--------|------------|------------|------------|--------|--------|
| | MHz | dBm | dBm | dBm | dB | dB | |
| 1 | 40.67 | -59.83 | -59.95 | -13.00 | -46.83 | 0.12 | Peak |
| 2 pp | 222.06 | -46.43 | -39.31 | -13.00 | -33.43 | -7.12 | Peak |
| 3 | 364.65 | -61.10 | -54.95 | -13.00 | -48.10 | -6.15 | Peak |
| 4 | 401.51 | -61.81 | -55.88 | -13.00 | -48.81 | -5.93 | Peak |
| 5 | 567.38 | -63.40 | -61.28 | -13.00 | -50.40 | -2.12 | Peak |
| 6 | 709.00 | -62.10 | -62.17 | -13.00 | -49.10 | 0.07 | Peak |
| 7 | 3704.80 | -55.05 | -46.88 | -13.00 | -42.05 | -8.17 | Peak |



A D T

Data: 6

Date: 2017-01-17

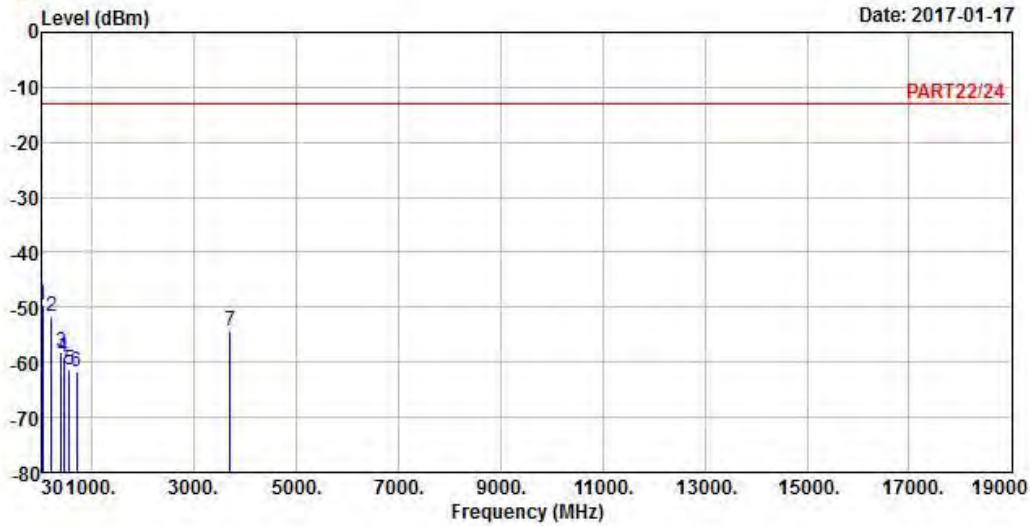

Site : 966 Chamber 5
 Condition: PART22/24 VERTICAL
 Remak : WCDMA Band II_L-CH Link
 Tested by: Gavin Wu

| | Freq | Level | Read Level | Limit Line | Over Limit | Factor | Remark |
|------|---------|--------|------------|------------|------------|--------|--------|
| | MHz | dBm | dBm | dBm | dB | dB | |
| 1 pp | 41.64 | -49.66 | -49.25 | -13.00 | -36.66 | -0.41 | Peak |
| 2 | 207.51 | -51.67 | -43.96 | -13.00 | -38.67 | -7.71 | Peak |
| 3 | 400.54 | -58.28 | -52.34 | -13.00 | -45.28 | -5.94 | Peak |
| 4 | 453.89 | -59.13 | -53.65 | -13.00 | -46.13 | -5.48 | Peak |
| 5 | 554.77 | -61.42 | -58.77 | -13.00 | -48.42 | -2.65 | Peak |
| 6 | 701.24 | -61.59 | -61.51 | -13.00 | -48.59 | -0.08 | Peak |
| 7 | 3704.80 | -54.33 | -46.16 | -13.00 | -41.33 | -8.17 | Peak |

Middle Channel



Bureau Veritas Consumer Products Services Ltd., Taoyuan Branch

A D T

Data: 3

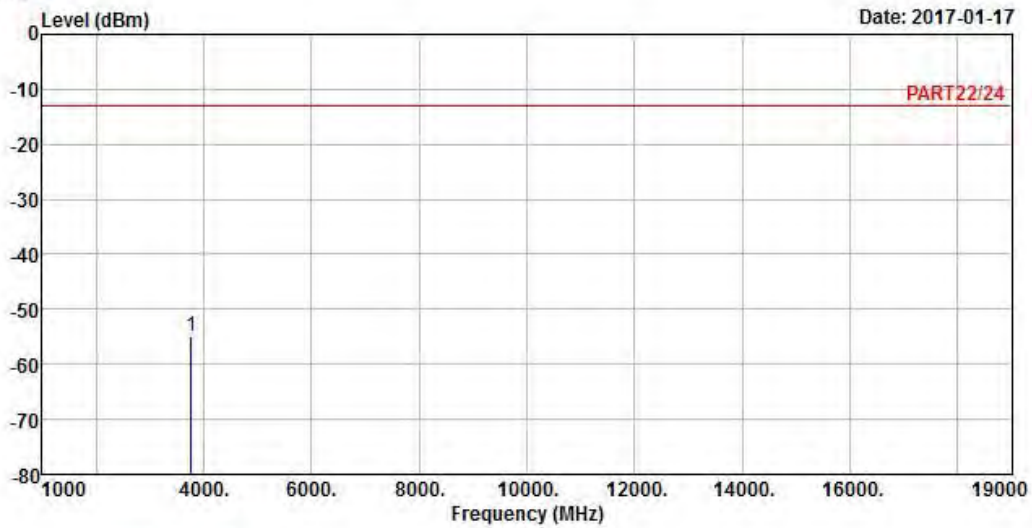

Site : 966 Chamber 5
 Condition: PART22/24 HORIZONTAL
 Remak : WCDMA Band II_M-CH Link
 Tested by: Gavin Wu

| Freq | Level | Read Level | Limit | Over | Factor | Remark |
|--------------|--------|------------|--------|--------|--------|--------|
| MHz | dBm | dBm | dBm | dB | dB | |
| 1 pp 3760.00 | -54.91 | -46.85 | -13.00 | -41.91 | -8.06 | Peak |



Bureau Veritas Consumer Products Services Ltd., Taoyuan Branch

A D T

Data: 4

Date: 2017-01-17

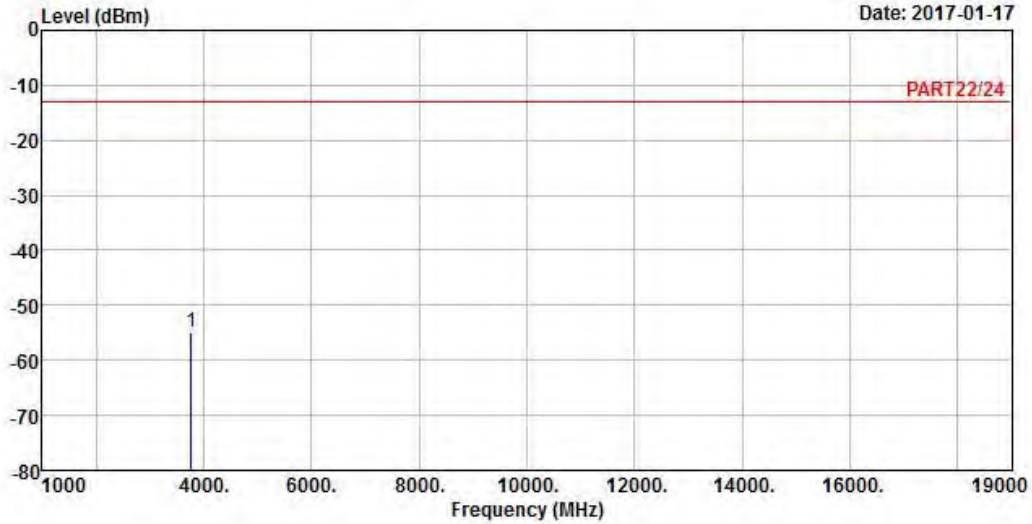

Site : 966 Chamber 5
 Condition: PART22/24 VERTICAL
 Remak : WCDMA Band II_M-CH Link
 Tested by: Gavin Wu

| Freq | Level | Read Level | Limit Line | Over Limit | Factor | Remark |
|--------------|--------|------------|------------|------------|--------|--------|
| MHz | dBm | dBm | dBm | dB | dB | |
| 1 pp 3760.00 | -54.90 | -46.84 | -13.00 | -41.90 | -8.06 | Peak |

High Channel



Bureau Veritas Consumer Products Services Ltd., Taoyuan Branch

A D T

Data: 5

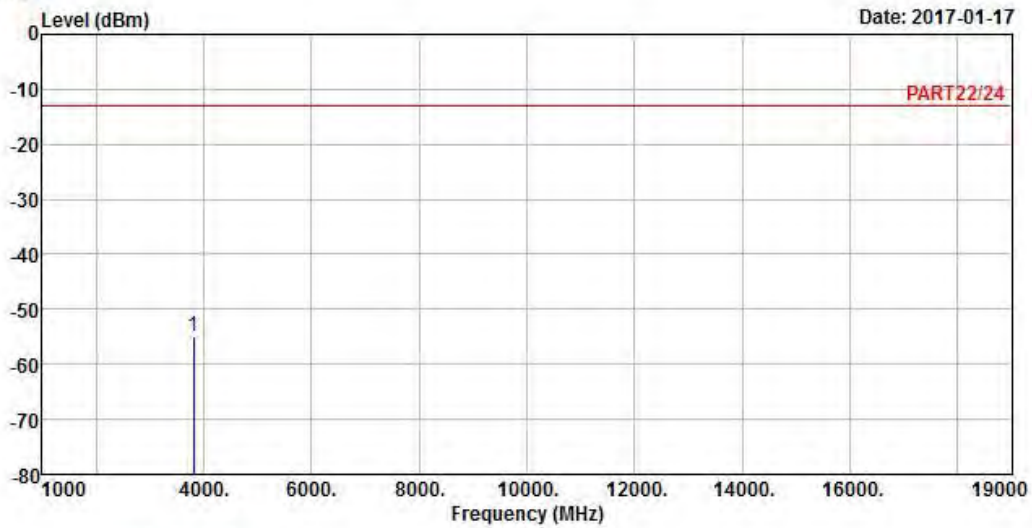

Site : 966 Chamber 5
 Condition: PART22/24 HORIZONTAL
 Remak : WCDMA Band II_H-CH Link
 Tested by: Gavin Wu

| Freq | Level | Read Level | Limit | Over | Factor | Remark |
|--------------|--------|------------|--------|--------|--------|--------|
| MHz | dBm | dBm | dBm | dB | dB | |
| 1 pp 3815.20 | -54.84 | -47.06 | -13.00 | -41.84 | -7.78 | Peak |



Bureau Veritas Consumer Products Services Ltd., Taoyuan Branch

A D T

Data: 6

Date: 2017-01-17

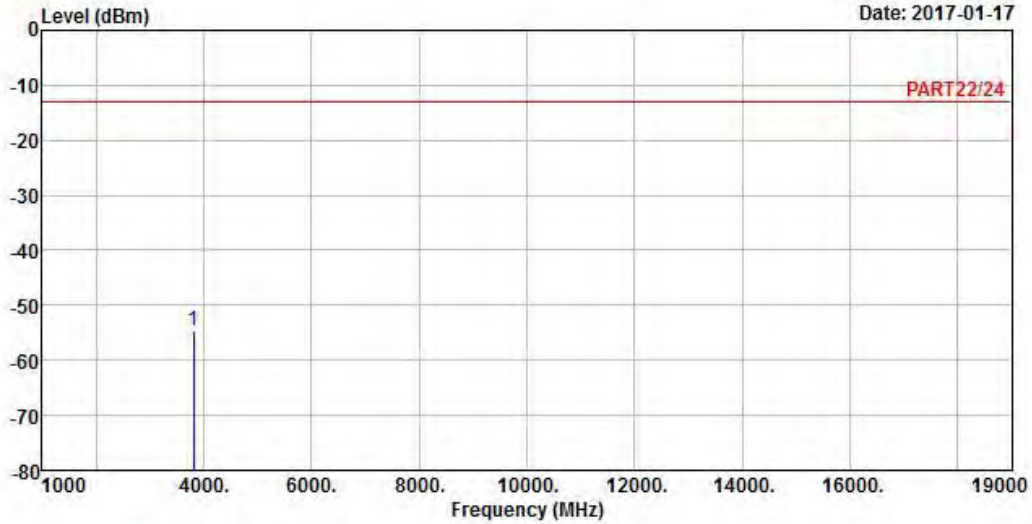

Site : 966 Chamber 5
 Condition: PART22/24 VERTICAL
 Remak : WCDMA Band II_H-CH Link
 Tested by: Gavin Wu

| Freq | Level | Read Level | Limit Line | Over Limit | Factor | Remark |
|--------------|--------|------------|------------|------------|--------|--------|
| MHz | dBm | dBm | dBm | dB | dB | |
| 1 pp 3815.20 | -54.69 | -46.91 | -13.00 | -41.69 | -7.78 | Peak |

LTE Band 2
Channel Bandwidth: 20 MHz / QPSK
Low Channel



Bureau Veritas Consumer Products Services Ltd., Taoyuan Branch

A D T

Data: 3

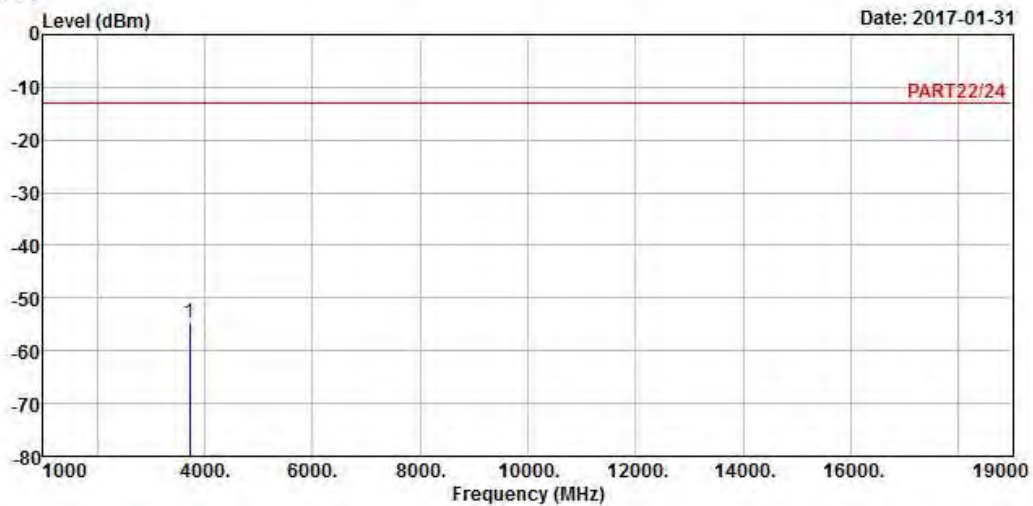

Site : 966 Chamber 5
Condition: PART22/24 HORIZONTAL
Remak : LTE Band II_QPSK_20M_L-CH Link
Tested by: Geetaz Yang

| Freq | Level | Read Level | Limit Line | Over Limit | Factor | Remark |
|--------------|--------|------------|------------|------------|--------|--------|
| MHz | dBm | dBm | dBm | dB | dB | |
| 1 pp 3720.00 | -54.53 | -46.40 | -13.00 | -41.53 | -8.13 | Peak |



Bureau Veritas Consumer Products Services Ltd., Taoyuan Branch

A D T

Data: 3

Date: 2017-01-31

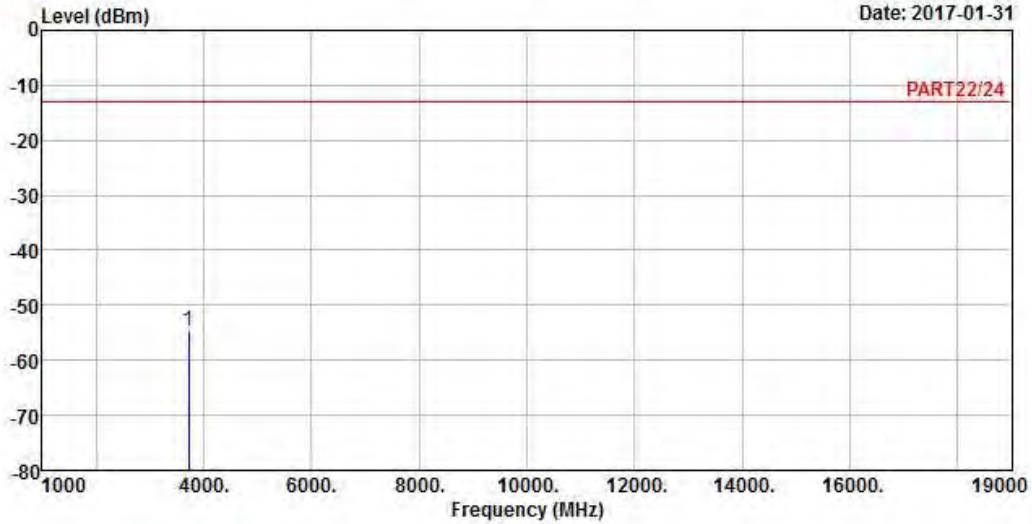

Site : 966 Chamber 5
 Condition: PART22/24 HORIZONTAL
 Remak : LTE Band II_QPSK_20M_L-CH Link
 Tested by: Geetaz Yang

| Freq | Level | Read Level | Limit Line | Over Limit | Factor | Remark |
|--------------|--------|------------|------------|------------|--------|--------|
| MHz | dBm | dBm | dBm | dB | dB | |
| 1 pp 3720.00 | -54.53 | -46.40 | -13.00 | -41.53 | -8.13 | Peak |

Middle Channel



Bureau Veritas Consumer Products Services Ltd., Taoyuan Branch

A D T

Data: 5

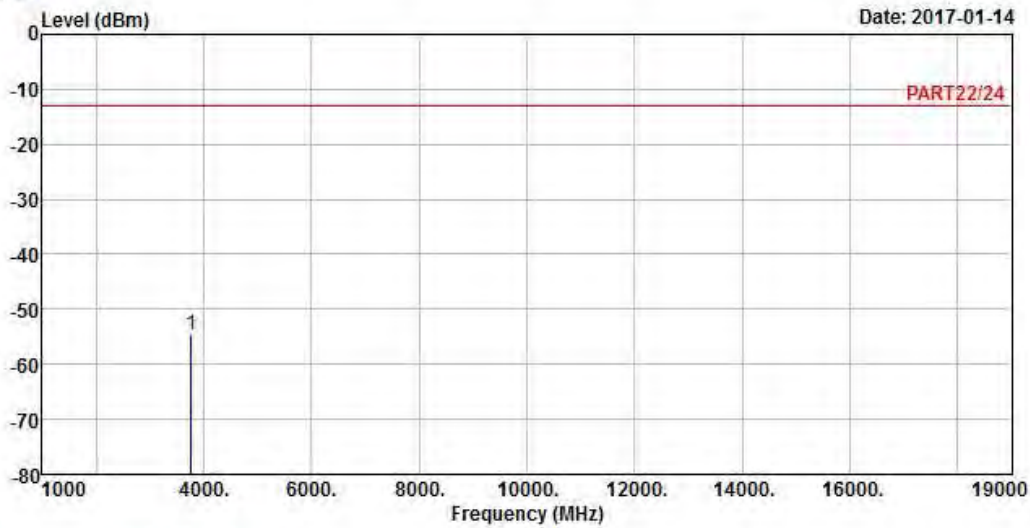

Site : 966 Chamber 5
 Condition: PART22/24 HORIZONTAL
 Remak : LTE Band II_QPSK_20M_M-CH Link
 Tested by: Geetaz Yang

| | Read | Limit | Over | | | |
|--------------|--------|--------|--------|--------|--------|--------|
| Freq | Level | Level | Line | Limit | Factor | Remark |
| MHz | dBm | dBm | dBm | dB | dB | |
| 1 pp 3760.00 | -54.61 | -46.55 | -13.00 | -41.61 | -8.06 | Peak |



Bureau Veritas Consumer Products Services Ltd., Taoyuan Branch

A D T

Data: 6

Date: 2017-01-14

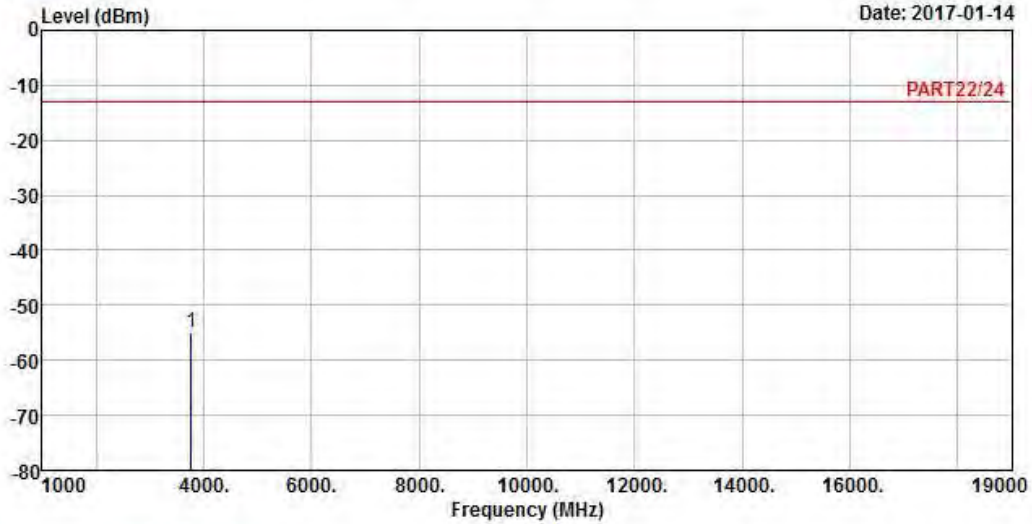

Site : 966 Chamber 5
 Condition: PART22/24 VERTICAL
 Remak : LTE Band II_QPSK_20M_M-CH Link
 Tested by: Geetaz Yang

| Freq | Level | Read Level | Limit Line | Over Limit | Factor | Remark |
|--------------|--------|------------|------------|------------|--------|--------|
| MHz | dBm | dBm | dBm | dB | dB | |
| 1 pp 3760.00 | -54.96 | -46.90 | -13.00 | -41.96 | -8.06 | Peak |

High Channel



Bureau Veritas Consumer Products Services Ltd., Taoyuan Branch

A D T

Data: 5

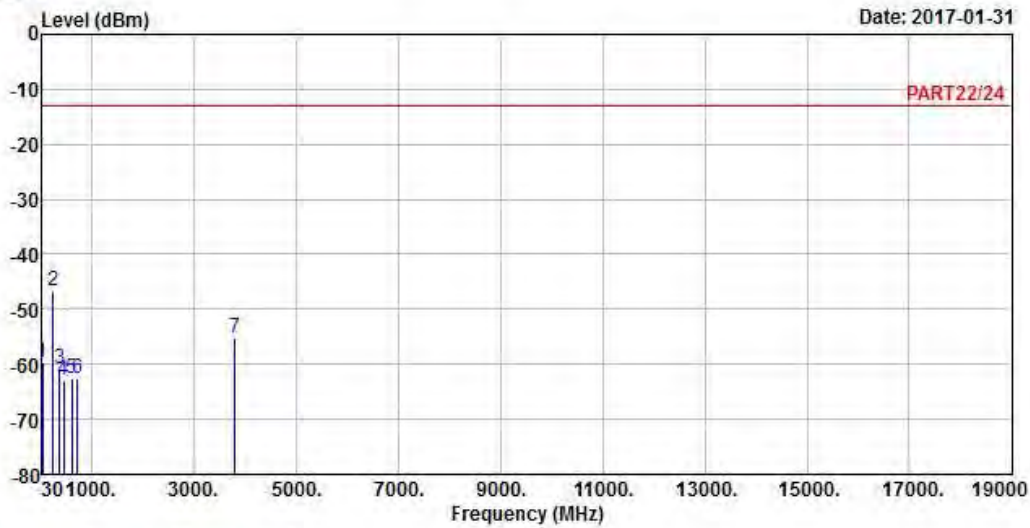

Site : 966 Chamber 5
 Condition: PART22/24 HORIZONTAL
 Remak : LTE Band II_QPSK_20M_H-CH Link
 Tested by: Geetaz Yang

| | Freq | Level | Read Level | Limit | Over | Factor | Remark |
|---|---------|--------|------------|--------|--------|--------|--------|
| | MHz | dBm | dBm | dBm | dB | dB | |
| 1 | 41.64 | -59.62 | -59.21 | -13.00 | -46.62 | -0.41 | Peak |
| 2 | 236.61 | -46.52 | -39.98 | -13.00 | -33.52 | -6.54 | Peak |
| 3 | 366.59 | -60.92 | -54.78 | -13.00 | -47.92 | -6.14 | Peak |
| 4 | 446.13 | -62.74 | -57.16 | -13.00 | -49.74 | -5.58 | Peak |
| 5 | 606.18 | -62.48 | -61.71 | -13.00 | -49.48 | -0.77 | Peak |
| 6 | 724.52 | -62.56 | -62.94 | -13.00 | -49.56 | 0.38 | Peak |
| 7 | 3800.00 | -55.11 | -47.33 | -13.00 | -42.11 | -7.78 | Peak |



A D T

Data: 6

Date: 2017-01-31

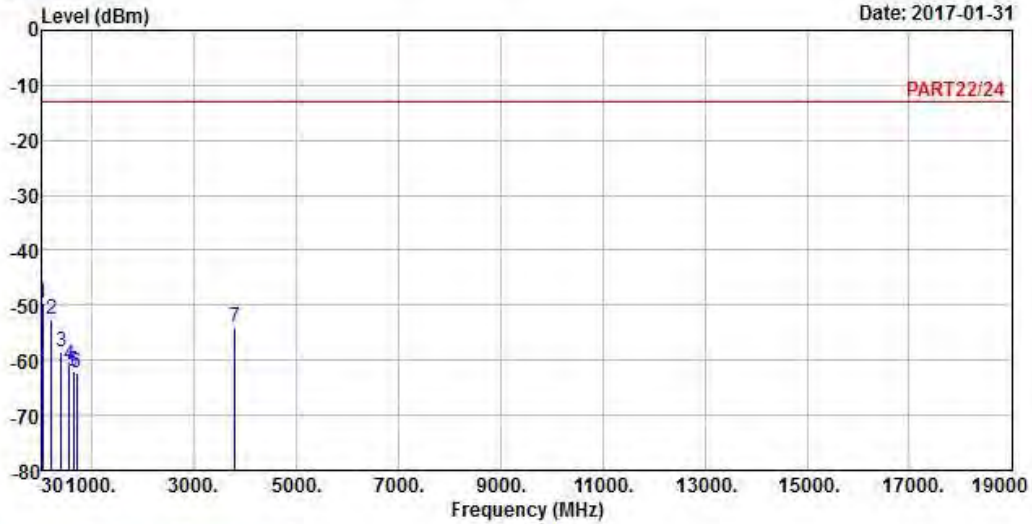

Site : 966 Chamber 5
 Condition: PART22/24 VERTICAL
 Remak : LTE Band II_QPSK_20M_H-CH Link
 Tested by: Geetaz Yang

| | Freq | Level | Read Level | Limit Line | Over Limit | Factor | Remark |
|------|---------|--------|------------|------------|------------|--------|--------|
| | MHz | dBm | dBm | dBm | dB | dB | |
| 1 pp | 41.64 | -49.51 | -49.10 | -13.00 | -36.51 | -0.41 | Peak |
| 2 | 208.48 | -52.40 | -44.73 | -13.00 | -39.40 | -7.67 | Peak |
| 3 | 398.60 | -58.51 | -52.56 | -13.00 | -45.51 | -5.95 | Peak |
| 4 | 551.86 | -60.71 | -57.94 | -13.00 | -47.71 | -2.77 | Peak |
| 5 | 634.31 | -61.86 | -61.02 | -13.00 | -48.86 | -0.84 | Peak |
| 6 | 705.12 | -62.38 | -62.38 | -13.00 | -49.38 | 0.00 | Peak |
| 7 | 3800.00 | -54.14 | -46.36 | -13.00 | -41.14 | -7.78 | Peak |

5 Pictures of Test Arrangements

Please refer to the attached file (Test Setup Photo).

Appendix – Information on the Testing Laboratories

We, Bureau Veritas Consumer Products Services (H.K.) Ltd., Taoyuan Branch, were founded in 1988 to provide our best service in EMC, Radio, Telecom and Safety consultation. Our laboratories are accredited and approved according to ISO/IEC 17025.

If you have any comments, please feel free to contact us at the following:

Linko EMC/RF Lab

Tel: 886-2-26052180

Fax: 886-2-26051924

Hsin Chu EMC/RF/Telecom Lab

Tel: 886-3-6668565

Fax: 886-3-6668323

Hwa Ya EMC/RF/Safety

Tel: 886-3-3183232

Fax: 886-3-3270892

Email: service.adt@tw.bureauveritas.com

Web Site: www.bureauveritas-adt.com

The address and road map of all our labs can be found in our web site also.

--- END ---