

ELECTROMAGNETIC EMISSIONS COMPLIANCE REPORT
INTENTIONAL RADIATOR CERTIFICATION TO
FCC PART 22 SUBPART H, PART 24 SUBPART E and PART 27 SUBPART
B, C & SUBPART L REQUIREMENT

OF

Product Name: Notebook Computer
Brand Name: HP
Model No.: HSN-I04C
Model Difference: N/A
FCC ID: B94HNI04CAMWP
Report No.: ER/2017/30117
Issue Date: Apr. 05, 2017
FCC Rule Part: 2 , 22H & 24E & 27B, C & L
Prepared for: HP Inc.
3390 East Harmony Road Fort Collins,
Colorado 80528 United States
Prepared by: SGS Taiwan Ltd.
Electronics & Communication Laboratory
No.134, Wu Kung Road, New Taipei Industrial
Park, Wuku District, New Taipei City, Taiwan
24803

Note: *This report shall not be reproduced except in full, without the written approval of SGS Taiwan Ltd. This document may be altered or revised by SGS Taiwan Ltd. personnel only, and shall be noted in the revision section of the document.*

Unless otherwise stated the results shown in this test report refer only to the sample(s) tested and such sample(s) are retained for 90 days only.

除非另有說明，此報告結果僅對測試之樣品負責，同時此樣品僅保留90天。本報告未經本公司書面許可，不可部份複製。

This document is issued by the Company subject to its General Conditions of Service printed overleaf, available on request or accessible at www.sgs.com/terms_and_conditions.htm and, for electronic format documents, subject to Terms and Conditions for Electronic Documents at www.sgs.com/terms_e-document.htm. Attention is drawn to the limitation of liability, indemnification and jurisdiction issues defined therein. Any holder of this document is advised that information contained hereon reflects the Company's findings at the time of its intervention only and within the limits of Client's instructions, if any. The Company's sole responsibility is to its Client and this document does not exonerate parties to a transaction from exercising all their rights and obligations under the transaction documents. This document cannot be reproduced except in full, without prior written approval of the Company. Any unauthorized alteration, forgery or falsification of the content or appearance of this document is unlawful and offenders may be prosecuted to the fullest extent of the law.

SGS Taiwan Ltd.

No.134,WuKungRoad,NewTaipeiIndustrialPark,WukuDistrict,NewTaipeiCity,Taiwan24803/新北市五股區新北產業園區五工路 134 號

台灣檢驗科技股份有限公司

t (886-2) 2299-3279

f (886-2) 2298-0488

www.tw.sgs.com

Member of SGS Group

VERIFICATION OF COMPLIANCE

Applicant: HP Inc.
3390 East Harmony Road Fort Collins, Colorado 80528 United States

Product Name: Notebook Computer

Brand Name: HP

Model No.: HSN-I04C

Model Difference: N/A

FCC ID: B94HNI04CAMWP

File Number: ER/2017/30117

Date of test: Mar. 17, 2017 ~ Mar. 29, 2017

Date of EUT Received: Mar. 17, 2017

We hereby certify that:

The above equipment was tested by SGS Taiwan Ltd. Electronics & Communication Laboratory. The test data, data evaluation, test procedures, and equipment configurations shown in this report were made in accordance with the procedures given in TIA/EIA-603-D-2010 and the energy emitted by the sample EUT tested as described in this report is in compliance with conducted and radiated emission limits.

The test results of this report relate only to the tested sample identified in this report.

Test By: *Louis Chen* **Date:** Apr. 05, 2017

Louis Chen / Engineer

Prepared By: *Tiffany Kao* **Date:** Apr. 05, 2017

Tiffany Kao / Clerk

Approved By: *Jim Chang* **Date:** Apr. 05, 2017

Jim Chang / Asst. Manager

Unless otherwise stated the results shown in this test report refer only to the sample(s) tested and such sample(s) are retained for 90 days only.

除非另有說明，此報告結果僅對測試之樣品負責，同時此樣品僅保留90天。本報告未經本公司書面許可，不可部份複製。

This document is issued by the Company subject to its General Conditions of Service printed overleaf, available on request or accessible at www.sgs.com/terms_and_conditions.htm and, for electronic format documents, subject to Terms and Conditions for Electronic Documents at www.sgs.com/terms_e-document.htm. Attention is drawn to the limitation of liability, indemnification and jurisdiction issues defined therein. Any holder of this document is advised that information contained hereon reflects the Company's findings at the time of its intervention only and within the limits of Client's instructions, if any. The Company's sole responsibility is to its Client and this document does not exonerate parties to a transaction from exercising all their rights and obligations under the transaction documents. This document cannot be reproduced except in full, without prior written approval of the Company. Any unauthorized alteration, forgery or falsification of the content or appearance of this document is unlawful and offenders may be prosecuted to the fullest extent of the law.

Revision History

Report Number	Revision	Description	Issue Date
ER/2017/30117	Rev.00	Initial creation of document	Apr. 05, 2017

Unless otherwise stated the results shown in this test report refer only to the sample(s) tested and such sample(s) are retained for 90 days only.

除非另有說明，此報告結果僅對測試之樣品負責，同時此樣品僅保留90天。本報告未經本公司書面許可，不可部份複製。

This document is issued by the Company subject to its General Conditions of Service printed overleaf, available on request or accessible at www.sgs.com/terms_and_conditions.htm and, for electronic format documents, subject to Terms and Conditions for Electronic Documents at www.sgs.com/terms_e-document.htm. Attention is drawn to the limitation of liability, indemnification and jurisdiction issues defined therein. Any holder of this document is advised that information contained hereon reflects the Company's findings at the time of its intervention only and within the limits of Client's instructions, if any. The Company's sole responsibility is to its Client and this document does not exonerate parties to a transaction from exercising all their rights and obligations under the transaction documents. This document cannot be reproduced except in full, without prior written approval of the Company. Any unauthorized alteration, forgery or falsification of the content or appearance of this document is unlawful and offenders may be prosecuted to the fullest extent of the law.

SGS Taiwan Ltd.

No.134,WuKungRoad,NewTaipeiIndustrialPark,WukuDistrict,NewTaipeiCity,Taiwan24803/新北市五股區新北產業園區五工路 134 號

台灣檢驗科技股份有限公司

t (886-2) 2299-3279

f (886-2) 2298-0488

www.tw.sgs.com

Member of SGS Group

Contents

1. GENERAL PRODUCT INFORMATION	5
2. SYSTEM TEST CONFIGURATION	14
3. SUMMARY OF TEST RESULTS	21
4. DESCRIPTION OF TEST MODES	22
5. MEASUREMENT UNCERTAINTY	31
6. RF CONDUCTED OUTPUT POWER MEASUREMENT	32
7. EFFECTIVE RADIATED POWER AND EQUIVALENT ISOTROPIC RADIATED POWER MEASUREMENT	45
8. OCCUPIED BANDWIDTH MEASUREMENT	84
9. OUT OF BAND EMISSION AT ANTENNA TERMINALS	129
10. FIELD STRENGTH OF SPURIOUS RADIATION MEASUREMENT	211
11. FREQUENCY STABILITY MEASUREMENT	299
12. PEAK TO AVERAGE RATIO	316

Unless otherwise stated the results shown in this test report refer only to the sample(s) tested and such sample(s) are retained for 90 days only.

除非另有說明，此報告結果僅對測試之樣品負責，同時此樣品僅保留90天。本報告未經本公司書面許可，不可部份複製。

This document is issued by the Company subject to its General Conditions of Service printed overleaf, available on request or accessible at www.sgs.com/terms_and_conditions.htm and, for electronic format documents, subject to Terms and Conditions for Electronic Documents at www.sgs.com/terms_e-document.htm. Attention is drawn to the limitation of liability, indemnification and jurisdiction issues defined therein. Any holder of this document is advised that information contained hereon reflects the Company's findings at the time of its intervention only and within the limits of Client's instructions, if any. The Company's sole responsibility is to its Client and this document does not exonerate parties to a transaction from exercising all their rights and obligations under the transaction documents. This document cannot be reproduced except in full, without prior written approval of the Company. Any unauthorized alteration, forgery or falsification of the content or appearance of this document is unlawful and offenders may be prosecuted to the fullest extent of the law.

SGS Taiwan Ltd.

No.134,WuKungRoad,NewTaipeiIndustrialPark,WukuDistrict,NewTaipeiCity,Taiwan24803/新北市五股區新北產業園區五工路 134 號

台灣檢驗科技股份有限公司

t (886-2) 2299-3279

f (886-2) 2298-0488

www.tw.sgs.com

Member of SGS Group

1. GENERAL PRODUCT INFORMATION

1.1. Product Description

General:

Product Name:	Notebook Computer	
Brand Name:	HP	
Model No.:	HSN-I04C	
Model difference:	N/A	
Product SW/HW version:	N/A / N/A	
Radio SW/HW version:	N/A / N/A	
Test SW Version:	N/A	
RF power setting in TEST SW:	N/A	
WWAN module:	Model No.: T77W595 Supplier: HON HAI PRECISION IND. CO., LTD.	
Power Supply:	11.55Vdc from Rechargeable Li-polymer Battery or 19.5V from AC/DC Adapter	
	Battery:	Model No.: HSTNN-IB70; Supplier: SIMPLO Technology (Chong Qing) Inc.
	Adapter:	Model No.: HSTNN-LA15, Supplier: LITE-ON TECHNOLOGY CORP.

Unless otherwise stated the results shown in this test report refer only to the sample(s) tested and such sample(s) are retained for 90 days only.

除非另有說明，此報告結果僅對測試之樣品負責，同時此樣品僅保留90天。本報告未經本公司書面許可，不可部份複製。

This document is issued by the Company subject to its General Conditions of Service printed overleaf, available on request or accessible at www.sgs.com/terms_and_conditions.htm and, for electronic format documents, subject to Terms and Conditions for Electronic Documents at www.sgs.com/terms_e-document.htm. Attention is drawn to the limitation of liability, indemnification and jurisdiction issues defined therein. Any holder of this document is advised that information contained hereon reflects the Company's findings at the time of its intervention only and within the limits of Client's instructions, if any. The Company's sole responsibility is to its Client and this document does not exonerate parties to a transaction from exercising all their rights and obligations under the transaction documents. This document cannot be reproduced except in full, without prior written approval of the Company. Any unauthorized alteration, forgery or falsification of the content or appearance of this document is unlawful and offenders may be prosecuted to the fullest extent of the law.

SGS Taiwan Ltd.

No.134,WuKungRoad,NewTaipeiIndustrialPark,WukuDistrict,NewTaipeiCity,Taiwan24803/新北市五股區新北產業園區五工路 134 號

台灣檢驗科技股份有限公司

t (886-2) 2299-3279

f (886-2) 2298-0488

www.tw.sgs.com

Member of SGS Group

WCDMA / LTE:

Cellular Phone Standards Frequency Range and Power	Operating Frequency		Rated Power
	GPRS 850	824.2 MHz– 848.8 MHz	
EDGE 850	824.2 MHz– 848.8 MHz		27dBm
GPRS 1900	1850.2MHz – 1909.8MHz		30dBm
EDGE 1900	1850.2MHz – 1909.8MHz		26dBm
WCDMA / HSPA+ Band II	1852.4MHz – 1907.6MHz		24dBm
WCDMA / HSPA+ Band IV	1712.4MHz – 1752.6MHz		24dBm
WCDMA / HSPA+ Band V	826.4MHz - 846.6MHz		24dBm
CDMA2000 Cellular BC0	824.7MHz – 848.31MHz		24dBm
CDMA2000 PCS BC1	1851.25 MHz – 1908.75 MHz		24dBm
CDMA2000 EVDO Cellular BC0	824.7MHz – 848.31MHz		24dBm
CDMA2000 EVDO PCS BC1	1851.25 MHz – 1908.75 MHz		24dBm
LTE-Band 2 (1.4MHz)	1850.7MHz– 1909.3MHz		23dBm
LTE-Band 2 (3MHz)	1851.5MHz – 1908.5MHz		23dBm
LTE-Band 2 (5MHz)	1852.5MHz – 1907.5MHz		23dBm
LTE-Band 2 (10MHz)	1855.0MHz – 1905.0MHz		23dBm
LTE-Band 2 (15MHz)	1857.5MHz – 1902.5MHz		23dBm
LTE-Band 2 (20MHz)	1860.0MHz – 1900.0MHz		23dBm
LTE-Band 4 (1.4MHz)	1710.7MHz– 1754.3MHz		23dBm
LTE-Band 4 (3MHz)	1711.5MHz – 1753.5MHz		23dBm
LTE-Band 4 (5MHz)	1712.5MHz – 1752.5MHz		23dBm
LTE-Band 4 (10MHz)	1715MHz – 1750MHz		23dBm
LTE-Band 4 (15MHz)	1717.5MHz – 1747.5MHz		23dBm
LTE-Band 4 (20MHz)	1720MHz – 1745MHz		23dBm
LTE-Band 5 (1.4MHz)	824.7MHz – 848.3MHz		23dBm
LTE-Band 5 (3MHz)	825.5MHz – 847.5MHz		23dBm
LTE-Band 5 (5MHz)	826.5MHz – 846.5MHz		23dBm
LTE-Band 5 (10MHz)	829.0MHz – 844.0MHz		23dBm

Unless otherwise stated the results shown in this test report refer only to the sample(s) tested and such sample(s) are retained for 90 days only.

除非另有說明，此報告結果僅對測試之樣品負責，同時此樣品僅保留90天。本報告未經本公司書面許可，不可部份複製。

This document is issued by the Company subject to its General Conditions of Service printed overleaf, available on request or accessible at www.sgs.com/terms_and_conditions.htm and, for electronic format documents, subject to Terms and Conditions for Electronic Documents at www.sgs.com/terms_e-document.htm. Attention is drawn to the limitation of liability, indemnification and jurisdiction issues defined therein. Any holder of this document is advised that information contained hereon reflects the Company's findings at the time of its intervention only and within the limits of Client's instructions, if any. The Company's sole responsibility is to its Client and this document does not exonerate parties to a transaction from exercising all their rights and obligations under the transaction documents. This document cannot be reproduced except in full, without prior written approval of the Company. Any unauthorized alteration, forgery or falsification of the content or appearance of this document is unlawful and offenders may be prosecuted to the fullest extent of the law.

SGS Taiwan Ltd.

No.134,WuKungRoad,NewTaipeiIndustrialPark,WukuDistrict,NewTaipeiCity,Taiwan24803/新北市五股區新北產業園區五工路 134 號

台灣檢驗科技股份有限公司

t (886-2) 2299-3279

f (886-2) 2298-0488

www.tw.sgs.com

Member of SGS Group

Cellular Phone Standards Frequency Range and Power	Operating Frequency		Rated Power
	LTE-Band 7 (5MHz)	2502.5MHz – 2567.5MHz	23dBm
	LTE-Band 7 (10MHz)	2505.0MHz – 2565.0MHz	23dBm
	LTE-Band 7 (15MHz)	2507.5MHz – 2562.5MHz	23dBm
	LTE-Band 7 (20MHz)	2510.0MHz – 2560MHz	23dBm
	LTE-Band 12 (1.4MHz)	699.7MHz– 715.3MHz	23dBm
	LTE-Band 12 (3MHz)	700.5MHz – 714.5MHz	23dBm
	LTE-Band 12 (5MHz)	701.5MHz – 713.5MHz	23dBm
	LTE-Band 12 (10MHz)	704.0MHz – 711.0MHz	23dBm
	LTE-Band 13 (5MHz)	779.5MHz - 784.5MHz	23dBm
	LTE-Band 13 (10MHz)	782.0MHz	23dBm
	LTE-Band 17 (5MHz)	706.5MHz – 713.5MHz	23dBm
	LTE-Band 17 (10MHz)	709.0MHz –711.0MHz	23dBm
IMEI:	358894062124520		

Type of Emission:

Frequency Band	Type of Emission:
GPRS 850	248KGXW
EDGE 850	247KG7W
GPRS 1900	247KGXW
EDGE 1900	247KG7W
CDMA 2000 Cellular (BC0)	1M27F9W
CDMA 2000 EVDO Cellular (BC0)	1M28F9W
CDMA 2000 PCS (BC1)	1M28F9W
CDMA 2000 EVDO PCS (BC1)	1M28F9W
WCDMA Band II	4M16F9W
HSDPA Band II	4M16F9W
HSUPA Band II	4M15F9W
WCDMA Band IV	4M16F9W
HSDPA Band IV	4M15F9W
HSUPA Band IV	4M15F9W
WCDMA Band V	4M15F9W
HSDPA Band V	4M15F9W
HSUPA Band V	4M15F9W

Unless otherwise stated the results shown in this test report refer only to the sample(s) tested and such sample(s) are retained for 90 days only.

除非另有說明，此報告結果僅對測試之樣品負責，同時此樣品僅保留90天。本報告未經本公司書面許可，不可部份複製。

This document is issued by the Company subject to its General Conditions of Service printed overleaf, available on request or accessible at www.sgs.com/terms_and_conditions.htm and, for electronic format documents, subject to Terms and Conditions for Electronic Documents at www.sgs.com/terms_e-document.htm. Attention is drawn to the limitation of liability, indemnification and jurisdiction issues defined therein. Any holder of this document is advised that information contained hereon reflects the Company's findings at the time of its intervention only and within the limits of Client's instructions, if any. The Company's sole responsibility is to its Client and this document does not exonerate parties to a transaction from exercising all their rights and obligations under the transaction documents. This document cannot be reproduced except in full, without prior written approval of the Company. Any unauthorized alteration, forgery or falsification of the content or appearance of this document is unlawful and offenders may be prosecuted to the fullest extent of the law.

SGS Taiwan Ltd.

No.134,WuKungRoad,NewTaipeiIndustrialPark,WukuDistrict,NewTaipeiCity,Taiwan24803/新北市五股區新北產業園區五工路 134 號

台灣檢驗科技股份有限公司

t (886-2) 2299-3279

f (886-2) 2298-0488

www.tw.sgs.com

Member of SGS Group

LTE Band	BW (MHz)	Modulation	Type of Emission
LTE Band 2	1.4MHz	QPSK	1M10G7D
LTE Band 2	1.4MHz	16QAM	1M10D7W
LTE Band 2	3MHz	QPSK	2M71G7D
LTE Band 2	3MHz	16QAM	2M71D7W
LTE Band 2	5MHz	QPSK	4M51G7D
LTE Band 2	5MHz	16QAM	4M51D7W
LTE Band 2	10MHz	QPSK	8M99G7D
LTE Band 2	10MHz	16QAM	8M98D7W
LTE Band 2	15MHz	QPSK	13M5G7D
LTE Band 2	15MHz	16QAM	13M4D7W
LTE Band 2	20MHz	QPSK	17M9G7D
LTE Band 2	20MHz	16QAM	17M9D7W
LTE Band 4	1.4MHz	QPSK	1M10G7D
LTE Band 4	1.4MHz	16QAM	1M10D7W
LTE Band 4	3MHz	QPSK	2M71G7D
LTE Band 4	3MHz	16QAM	2M71D7W
LTE Band 4	5MHz	QPSK	4M51G7D
LTE Band 4	5MHz	16QAM	4M51D7W
LTE Band 4	10MHz	QPSK	9M01G7D
LTE Band 4	10MHz	16QAM	8M99D7W
LTE Band 4	15MHz	QPSK	13M5G7D
LTE Band 4	15MHz	16QAM	13M5D7W
LTE Band 4	20MHz	QPSK	17M9G7D
LTE Band 4	20MHz	16QAM	17M9D7W
LTE Band 5	1.4MHz	QPSK	1M10G7D
LTE Band 5	1.4MHz	16QAM	1M11D7W
LTE Band 5	3MHz	QPSK	2M70G7D
LTE Band 5	3MHz	16QAM	2M71D7W
LTE Band 5	5MHz	QPSK	4M50G7D
LTE Band 5	5MHz	16QAM	4M51D7W
LTE Band 5	10MHz	QPSK	8M99G7D
LTE Band 5	10MHz	16QAM	8M98D7W
LTE Band 7	5MHz	QPSK	4M52G7D
LTE Band 7	5MHz	16QAM	4M51D7W
LTE Band 7	10MHz	QPSK	9M00G7D
LTE Band 7	10MHz	16QAM	8M99D7W
LTE Band 7	15MHz	QPSK	13M5G7D
LTE Band 7	15MHz	16QAM	13M5D7W
LTE Band 7	20MHz	QPSK	17M9G7D
LTE Band 7	20MHz	16QAM	17M9D7W

Unless otherwise stated the results shown in this test report refer only to the sample(s) tested and such sample(s) are retained for 90 days only.

除非另有說明，此報告結果僅對測試之樣品負責，同時此樣品僅保留90天。本報告未經本公司書面許可，不可部份複製。

This document is issued by the Company subject to its General Conditions of Service printed overleaf, available on request or accessible at www.sgs.com/terms_and_conditions.htm and, for electronic format documents, subject to Terms and Conditions for Electronic Documents at www.sgs.com/terms_e-document.htm. Attention is drawn to the limitation of liability, indemnification and jurisdiction issues defined therein. Any holder of this document is advised that information contained hereon reflects the Company's findings at the time of its intervention only and within the limits of Client's instructions, if any. The Company's sole responsibility is to its Client and this document does not exonerate parties to a transaction from exercising all their rights and obligations under the transaction documents. This document cannot be reproduced except in full, without prior written approval of the Company. Any unauthorized alteration, forgery or falsification of the content or appearance of this document is unlawful and offenders may be prosecuted to the fullest extent of the law.

SGS Taiwan Ltd.

No.134,WuKungRoad,NewTaipeiIndustrialPark,WukuDistrict,NewTaipeiCity,Taiwan24803/新北市五股區新北產業園區五工路 134 號

台灣檢驗科技股份有限公司

t (886-2) 2299-3279

f (886-2) 2298-0488

www.tw.sgs.com

Member of SGS Group

LTE Band	BW (MHz)	Modulation	Type of Emission
LTE Band 12	1.4MHz	QPSK	1M10G7D
LTE Band 12	1.4MHz	16QAM	1M10D7W
LTE Band 12	3MHz	QPSK	2M71G7D
LTE Band 12	3MHz	16QAM	2M71D7W
LTE Band 12	5MHz	QPSK	4M52G7D
LTE Band 12	5MHz	16QAM	4M52D7W
LTE Band 12	10MHz	QPSK	9M08G7D
LTE Band 12	10MHz	16QAM	9M06D7W
LTE Band 13	5MHz	QPSK	4M60G7D
LTE Band 13	5MHz	16QAM	4M59D7W
LTE Band 13	10MHz	QPSK	9M00G7D
LTE Band 13	10MHz	16QAM	8M96D7W
LTE Band 17	5MHz	QPSK	4M52G7D
LTE Band 17	5MHz	16QAM	4M53D7W
LTE Band 17	10MHz	QPSK	8M96G7D
LTE Band 17	10MHz	16QAM	8M93D7W

Unless otherwise stated the results shown in this test report refer only to the sample(s) tested and such sample(s) are retained for 90 days only.

除非另有說明，此報告結果僅對測試之樣品負責，同時此樣品僅保留90天。本報告未經本公司書面許可，不可部份複製。

This document is issued by the Company subject to its General Conditions of Service printed overleaf, available on request or accessible at www.sgs.com/terms_and_conditions.htm and, for electronic format documents, subject to Terms and Conditions for Electronic Documents at www.sgs.com/terms_e-document.htm. Attention is drawn to the limitation of liability, indemnification and jurisdiction issues defined therein. Any holder of this document is advised that information contained hereon reflects the Company's findings at the time of its intervention only and within the limits of Client's instructions, if any. The Company's sole responsibility is to its Client and this document does not exonerate parties to a transaction from exercising all their rights and obligations under the transaction documents. This document cannot be reproduced except in full, without prior written approval of the Company. Any unauthorized alteration, forgery or falsification of the content or appearance of this document is unlawful and offenders may be prosecuted to the fullest extent of the law.

SGS Taiwan Ltd.

No.134,WuKungRoad,NewTaipeiIndustrialPark,WukuDistrict,NewTaipeiCity,Taiwan24803/新北市五股區新北產業園區五工路 134 號

台灣檢驗科技股份有限公司

t (886-2) 2299-3279

f (886-2) 2298-0488

www.tw.sgs.com

Member of SGS Group

Max ERP/EIRP Power Measurement Result:

	dBm		W
GPRS 850	20.41	ERP	0.110
EDGE 850	18.65	ERP	0.073
GPRS 1900	23.33	EIRP	0.215
EDGE 1900	21.97	EIRP	0.157
CDMA 2000 Cellular (BC0)	12.30	ERP	0.017
CDMA 2000 EVDO Cellular (BC0)	11.70	ERP	0.015
CDMA 2000 PCS (BC1)	16.96	EIRP	0.050
CDMA 2000 EVDO PCS (BC1)	16.56	EIRP	0.045
WCDMA Band II	18.57	EIRP	0.072
HSDPA Band II	21.66	EIRP	0.147
HSUPA Band II	18.75	EIRP	0.075
WCDMA Band IV	19.09	EIRP	0.081
HSDPA Band IV	20.94	EIRP	0.124
HSUPA Band IV	20.23	EIRP	0.105
WCDMA Band V	13.25	ERP	0.021
HSDPA Band V	16.19	ERP	0.042
HSUPA Band V	15.20	ERP	0.033
LTE-Band 2 (Bandwidth 1.4MHz) QPSK	20.49	EIRP	0.112
LTE-Band 2 (Bandwidth 1.4MHz) 16QAM	20.40	EIRP	0.110
LTE-Band 2 (Bandwidth 3MHz) QPSK	20.03	EIRP	0.101
LTE-Band 2 (Bandwidth 3MHz) 16QAM	19.77	EIRP	0.095
LTE-Band 2 (Bandwidth 5MHz) QPSK	20.52	EIRP	0.113
LTE-Band 2 (Bandwidth 5MHz) 16QAM	19.86	EIRP	0.097
LTE-Band 2 (Bandwidth 10MHz) QPSK	20.32	EIRP	0.108
LTE-Band 2 (Bandwidth 10MHz) 16QAM	20.24	EIRP	0.106
LTE-Band 2 (Bandwidth 15MHz) QPSK	20.05	EIRP	0.101
LTE-Band 2 (Bandwidth 15MHz) 16QAM	19.77	EIRP	0.095
LTE-Band 2 (Bandwidth 20MHz) QPSK	19.75	EIRP	0.094
LTE-Band 2 (Bandwidth 20MHz) 16QAM	20.34	EIRP	0.108

Unless otherwise stated the results shown in this test report refer only to the sample(s) tested and such sample(s) are retained for 90 days only.

除非另有說明，此報告結果僅對測試之樣品負責，同時此樣品僅保留90天。本報告未經本公司書面許可，不可部份複製。

This document is issued by the Company subject to its General Conditions of Service printed overleaf, available on request or accessible at www.sgs.com/terms_and_conditions.htm and, for electronic format documents, subject to Terms and Conditions for Electronic Documents at www.sgs.com/terms_e-document.htm. Attention is drawn to the limitation of liability, indemnification and jurisdiction issues defined therein. Any holder of this document is advised that information contained hereon reflects the Company's findings at the time of its intervention only and within the limits of Client's instructions, if any. The Company's sole responsibility is to its Client and this document does not exonerate parties to a transaction from exercising all their rights and obligations under the transaction documents. This document cannot be reproduced except in full, without prior written approval of the Company. Any unauthorized alteration, forgery or falsification of the content or appearance of this document is unlawful and offenders may be prosecuted to the fullest extent of the law.

SGS Taiwan Ltd.

No.134,WuKungRoad,NewTaipeiIndustrialPark,WukuDistrict,NewTaipeiCity,Taiwan24803/新北市五股區新北產業園區五工路 134 號

台灣檢驗科技股份有限公司

t (886-2) 2299-3279

f (886-2) 2298-0488

www.tw.sgs.com

Member of SGS Group

	dBm		W
LTE-Band 4 (Bandwidth 1.4MHz) QPSK	23.82	EIRP	0.241
LTE-Band 4 (Bandwidth 1.4MHz) 16QAM	23.85	EIRP	0.243
LTE-Band 4 (Bandwidth 3MHz) QPSK	24.46	EIRP	0.279
LTE-Band 4 (Bandwidth 3MHz) 16QAM	24.72	EIRP	0.296
LTE-Band 4 (Bandwidth 5MHz) QPSK	24.36	EIRP	0.273
LTE-Band 4 (Bandwidth 5MHz) 16QAM	24.33	EIRP	0.271
LTE-Band 4 (Bandwidth 10MHz) QPSK	24.22	EIRP	0.264
LTE-Band 4 (Bandwidth 10MHz) 16QAM	25.08	EIRP	0.322
LTE-Band 4 (Bandwidth 15MHz) QPSK	23.46	EIRP	0.222
LTE-Band 4 (Bandwidth 15MHz) 16QAM	23.66	EIRP	0.232
LTE-Band 4 (Bandwidth 20MHz) QPSK	23.54	EIRP	0.226
LTE-Band 4 (Bandwidth 20MHz) 16QAM	23.76	EIRP	0.238
LTE-Band 5 (Bandwidth 1.4MHz) QPSK	28.61	ERP	0.726
LTE-Band 5 (Bandwidth 1.4MHz) 16QAM	28.44	ERP	0.698
LTE-Band 5 (Bandwidth 3MHz) QPSK	29.41	ERP	0.873
LTE-Band 5 (Bandwidth 3MHz) 16QAM	28.77	ERP	0.753
LTE-Band 5 (Bandwidth 5MHz) QPSK	29.57	ERP	0.906
LTE-Band 5 (Bandwidth 5MHz) 16QAM	29.44	ERP	0.879
LTE-Band 5 (Bandwidth 10MHz) QPSK	30.04	ERP	1.009
LTE-Band 5 (Bandwidth 10MHz) 16QAM	29.71	ERP	0.935
LTE-Band 7 (Bandwidth 5MHz) QPSK	25.14	EIRP	0.327
LTE-Band 7 (Bandwidth 5MHz) 16QAM	25.63	EIRP	0.366
LTE-Band 7 (Bandwidth 10MHz) QPSK	25.22	EIRP	0.333
LTE-Band 7 (Bandwidth 10MHz) 16QAM	25.68	EIRP	0.370
LTE-Band 7 (Bandwidth 15MHz) QPSK	26.06	EIRP	0.404
LTE-Band 7 (Bandwidth 15MHz) 16QAM	26.07	EIRP	0.405
LTE-Band 7 (Bandwidth 20MHz) QPSK	26.11	EIRP	0.408
LTE-Band 7 (Bandwidth 20MHz) 16QAM	26.21	EIRP	0.418

Unless otherwise stated the results shown in this test report refer only to the sample(s) tested and such sample(s) are retained for 90 days only.

除非另有說明，此報告結果僅對測試之樣品負責，同時此樣品僅保留90天。本報告未經本公司書面許可，不可部份複製。

This document is issued by the Company subject to its General Conditions of Service printed overleaf, available on request or accessible at www.sgs.com/terms_and_conditions.htm and, for electronic format documents, subject to Terms and Conditions for Electronic Documents at www.sgs.com/terms_e-document.htm. Attention is drawn to the limitation of liability, indemnification and jurisdiction issues defined therein. Any holder of this document is advised that information contained hereon reflects the Company's findings at the time of its intervention only and within the limits of Client's instructions, if any. The Company's sole responsibility is to its Client and this document does not exonerate parties to a transaction from exercising all their rights and obligations under the transaction documents. This document cannot be reproduced except in full, without prior written approval of the Company. Any unauthorized alteration, forgery or falsification of the content or appearance of this document is unlawful and offenders may be prosecuted to the fullest extent of the law.

SGS Taiwan Ltd.

No.134,WuKungRoad,NewTaipeiIndustrialPark,WukuDistrict,NewTaipeiCity,Taiwan24803/新北市五股區新北產業園區五工路 134 號

台灣檢驗科技股份有限公司

t (886-2) 2299-3279

f (886-2) 2298-0488

www.tw.sgs.com

Member of SGS Group

	dBm		W
LTE-Band 12 (Bandwidth 1.4MHz) QPSK	14.69	ERP	0.029
LTE-Band 12 (Bandwidth 1.4MHz) 16QAM	15.30	ERP	0.034
LTE-Band 12 (Bandwidth 3MHz) QPSK	15.89	ERP	0.039
LTE-Band 12 (Bandwidth 3MHz) 16QAM	15.66	ERP	0.037
LTE-Band 12 (Bandwidth 5MHz) QPSK	15.81	ERP	0.038
LTE-Band 12 (Bandwidth 5MHz) 16QAM	16.35	ERP	0.043
LTE-Band 12 (Bandwidth 10MHz) QPSK	16.32	ERP	0.043
LTE-Band 12 (Bandwidth 10MHz) 16QAM	16.21	ERP	0.042
LTE-Band 13 (Bandwidth 5MHz) QPSK	18.89	ERP	0.077
LTE-Band 13 (Bandwidth 5MHz) 16QAM	19.47	ERP	0.089
LTE-Band 13 (Bandwidth 10MHz) QPSK	17.68	ERP	0.059
LTE-Band 13 (Bandwidth 10MHz) 16QAM	17.78	ERP	0.060
LTE-Band 17 (Bandwidth 5MHz) QPSK	15.95	ERP	0.039
LTE-Band 17 (Bandwidth 5MHz) 16QAM	16.47	ERP	0.044
LTE-Band 17 (Bandwidth 10MHz) QPSK	16.78	ERP	0.048
LTE-Band 17 (Bandwidth 10MHz) 16QAM	16.98	ERP	0.050

Unless otherwise stated the results shown in this test report refer only to the sample(s) tested and such sample(s) are retained for 90 days only.

除非另有說明，此報告結果僅對測試之樣品負責，同時此樣品僅保留90天。本報告未經本公司書面許可，不可部份複製。

This document is issued by the Company subject to its General Conditions of Service printed overleaf, available on request or accessible at www.sgs.com/terms_and_conditions.htm and, for electronic format documents, subject to Terms and Conditions for Electronic Documents at www.sgs.com/terms_e-document.htm. Attention is drawn to the limitation of liability, indemnification and jurisdiction issues defined therein. Any holder of this document is advised that information contained hereon reflects the Company's findings at the time of its intervention only and within the limits of Client's instructions, if any. The Company's sole responsibility is to its Client and this document does not exonerate parties to a transaction from exercising all their rights and obligations under the transaction documents. This document cannot be reproduced except in full, without prior written approval of the Company. Any unauthorized alteration, forgery or falsification of the content or appearance of this document is unlawful and offenders may be prosecuted to the fullest extent of the law.

SGS Taiwan Ltd.

No.134,WuKungRoad,NewTaipeiIndustrialPark,WukuDistrict,NewTaipeiCity,Taiwan24803/新北市五股區新北產業園區五工路 134 號

台灣檢驗科技股份有限公司

t (886-2) 2299-3279

f (886-2) 2298-0488

www.tw.sgs.com

Member of SGS Group

1.2. Test Methodology of Applied Standards

FCC 47 CFR Part 2, 22, 24, 27

ANSI / TIA / EIA 603-D-2010

KDB971168 D01 Power Meas license Digital System

KDB941225 of the Output power Procedure of (SAR Measurement Procedures for 3G Devices, WCDMA / HSPA) was used for EUT and Base station setting.

TS 151 010-1 is used to set, and measure the output power.

Note: All test items have been performed and record as per the above standards.

1.3. Test Facility

SGS Taiwan Ltd. Electronics & Communication Laboratory No.134, Wu Kung Road, New Taipei Industrial Park, Wuku District, New Taipei City, Taiwan. (TAF code 0513)

FCC Registration Numbers are: 509634

1.4. Special Accessories

No special accessories were used during testing.

1.5. Equipment Modifications

There were no modifications incorporated into the EUT.

Unless otherwise stated the results shown in this test report refer only to the sample(s) tested and such sample(s) are retained for 90 days only.

除非另有說明，此報告結果僅對測試之樣品負責，同時此樣品僅保留90天。本報告未經本公司書面許可，不可部份複製。

This document is issued by the Company subject to its General Conditions of Service printed overleaf, available on request or accessible at www.sgs.com/terms_and_conditions.htm and, for electronic format documents, subject to Terms and Conditions for Electronic Documents at www.sgs.com/terms_e-document.htm. Attention is drawn to the limitation of liability, indemnification and jurisdiction issues defined therein. Any holder of this document is advised that information contained hereon reflects the Company's findings at the time of its intervention only and within the limits of Client's instructions, if any. The Company's sole responsibility is to its Client and this document does not exonerate parties to a transaction from exercising all their rights and obligations under the transaction documents. This document cannot be reproduced except in full, without prior written approval of the Company. Any unauthorized alteration, forgery or falsification of the content or appearance of this document is unlawful and offenders may be prosecuted to the fullest extent of the law.

SGS Taiwan Ltd.

No.134,WuKungRoad,NewTaipeiIndustrialPark,WukuDistrict,NewTaipeiCity,Taiwan24803/新北市五股區新北產業園區五工路 134 號

台灣檢驗科技股份有限公司

t (886-2) 2299-3279

f (886-2) 2298-0488

www.tw.sgs.com

Member of SGS Group

2. SYSTEM TEST CONFIGURATION

2.1. EUT Configuration

The EUT configuration for testing is installed on RF field strength measurement to meet the Commissions requirement and operating in a manner which intends to maximize its emission characteristics in a continuous normal application.

2.2. EUT Exercise

The EUT (Transmitter) was operated in the continuous transmission mode employed with the simulator of the Base Station that fixates at test default channels to fix the Tx frequency which was for the purpose of the measurements.

2.3. Test Procedure

2.3.1 Conducted Measurement at Antenna Port

According to measurement procured TIA/EIA 603C, the EUT is placed on a turn table which is 0.8 m above ground plane. A low loss of RF cable was used to connect the antenna port of EUT to measurement equipment.

2.3.2 Radiated Emissions (ERP/EIRP)

According to measurement procured TIA/EIA 603C, The EUT is a placed on as turn table which is 0.8 m above ground plane. The turn table shall rotate 360 degrees to determine the position of maximum emission level. EUT is set 3m away from the receiving antenna which varied from 1m to 4m to find out the highest emission. And also, each emission was to be maximized by changing the polarization of receiving antenna both Horizontal and Vertical. In order to find out the max. emission, the relative positions of this hand-held transmitter (EUT) was rotated through three orthogonal axes and measurement procedures for electric field radiated emissions above 1 GHz the EUT measurement is to be made "while keeping the antenna in the 'cone of radiation' from that area and pointed at the area both in azimuth and elevation, with polarization oriented for maximum response." is still within the 3dB illumination BW of the measurement antenna according to the requirements in Section 8 and 13.

2.4. Measurement Results Explanation Example

For all conducted test items:

The offset level is set in the spectrum analyzer to compensate the RF cable loss and attenuation factor between EUT conducted port and spectrum analyzer. With the offset compensation, the spectrum analyzer reading level is exactly EUT RF output level.

Unless otherwise stated the results shown in this test report refer only to the sample(s) tested and such sample(s) are retained for 90 days only.

除非另有說明，此報告結果僅對測試之樣品負責，同時此樣品僅保留90天。本報告未經本公司書面許可，不可部份複製。

This document is issued by the Company subject to its General Conditions of Service printed overleaf, available on request or accessible at www.sgs.com/terms_and_conditions.htm and, for electronic format documents, subject to Terms and Conditions for Electronic Documents at www.sgs.com/terms_e-document.htm. Attention is drawn to the limitation of liability, indemnification and jurisdiction issues defined therein. Any holder of this document is advised that information contained hereon reflects the Company's findings at the time of its intervention only and within the limits of Client's instructions, if any. The Company's sole responsibility is to its Client and this document does not exonerate parties to a transaction from exercising all their rights and obligations under the transaction documents. This document cannot be reproduced except in full, without prior written approval of the Company. Any unauthorized alteration, forgery or falsification of the content or appearance of this document is unlawful and offenders may be prosecuted to the fullest extent of the law.

Note:

The spectrum analyzer offset is derived from RF cable loss and attenuator factor.

Following shows an offset computation example with cable loss 1 dB for low band and 1 for high band with 10 dB attenuator and 3.2 splitter.

Low Band: Offset = RF cable loss (dB)+ attenuation factor(dB) =3.6+10=13.6(dB)

High Band: Offset = RF cable loss (dB)+ attenuation factor(dB) =4+10=14(dB)

2.5. Final Amplifier Voltage and Current Information:

Test Mode	DC voltage (V)	DC current (mA)
GPRS 850	11.55 Vdc	900
GPRS 1900	11.55 Vdc	928
EDGE 850	11.55 Vdc	921
EDGE 1900	11.55 Vdc	922
WCDMA B2	11.55 Vdc	884
WCDMA B4	11.55 Vdc	915
WCDMA B5	11.55 Vdc	939
HSUPA B2	11.55 Vdc	884
HSUPA B4	11.55 Vdc	931
HSUPA B5	11.55 Vdc	924
HSDPA B2	11.55 Vdc	882
HSDPA B4	11.55 Vdc	924
HSDPA B5	11.55 Vdc	886

Unless otherwise stated the results shown in this test report refer only to the sample(s) tested and such sample(s) are retained for 90 days only.

除非另有說明，此報告結果僅對測試之樣品負責，同時此樣品僅保留90天。本報告未經本公司書面許可，不可部份複製。

This document is issued by the Company subject to its General Conditions of Service printed overleaf, available on request or accessible at www.sgs.com/terms_and_conditions.htm and, for electronic format documents, subject to Terms and Conditions for Electronic Documents at www.sgs.com/terms_e-document.htm. Attention is drawn to the limitation of liability, indemnification and jurisdiction issues defined therein. Any holder of this document is advised that information contained hereon reflects the Company's findings at the time of its intervention only and within the limits of Client's instructions, if any. The Company's sole responsibility is to its Client and this document does not exonerate parties to a transaction from exercising all their rights and obligations under the transaction documents. This document cannot be reproduced except in full, without prior written approval of the Company. Any unauthorized alteration, forgery or falsification of the content or appearance of this document is unlawful and offenders may be prosecuted to the fullest extent of the law.

Test Mode	DC voltage (V)	DC current (mA)
CDMA BC0	11.55 Vdc	945
EVDO BC0	11.55 Vdc	936
CDMA BC1	11.55 Vdc	905
EVDO BC1	11.55 Vdc	910

Test Mode	DC voltage (V)	DC current (mA)
LTE Band 2_1.4M QPSK	11.55 Vdc	899
LTE Band 2_1.4M 16QAM	11.55 Vdc	927
LTE Band 2_3M QPSK	11.55 Vdc	929
LTE Band 2_3M 16QAM	11.55 Vdc	884
LTE Band 2_5M QPSK	11.55 Vdc	909
LTE Band 2_5M 16QAM	11.55 Vdc	916
LTE Band 2_10M QPSK	11.55 Vdc	880
LTE Band 2_10M 16QAM	11.55 Vdc	899
LTE Band 2_15M QPSK	11.55 Vdc	909
LTE Band 2_15M 16QAM	11.55 Vdc	893
LTE Band 2_20M QPSK	11.55 Vdc	909
LTE Band 2_20M 16QAM	11.55 Vdc	928

Unless otherwise stated the results shown in this test report refer only to the sample(s) tested and such sample(s) are retained for 90 days only.

除非另有說明，此報告結果僅對測試之樣品負責，同時此樣品僅保留90天。本報告未經本公司書面許可，不可部份複製。

This document is issued by the Company subject to its General Conditions of Service printed overleaf, available on request or accessible at www.sgs.com/terms_and_conditions.htm and, for electronic format documents, subject to Terms and Conditions for Electronic Documents at www.sgs.com/terms_e-document.htm. Attention is drawn to the limitation of liability, indemnification and jurisdiction issues defined therein. Any holder of this document is advised that information contained hereon reflects the Company's findings at the time of its intervention only and within the limits of Client's instructions, if any. The Company's sole responsibility is to its Client and this document does not exonerate parties to a transaction from exercising all their rights and obligations under the transaction documents. This document cannot be reproduced except in full, without prior written approval of the Company. Any unauthorized alteration, forgery or falsification of the content or appearance of this document is unlawful and offenders may be prosecuted to the fullest extent of the law.

SGS Taiwan Ltd.

No.134,WuKungRoad,NewTaipeiIndustrialPark,WukuDistrict,NewTaipeiCity,Taiwan24803/新北市五股區新北產業園區五工路 134 號

台灣檢驗科技股份有限公司

t (886-2) 2299-3279

f (886-2) 2298-0488

www.tw.sgs.com

Member of SGS Group

Test Mode	DC voltage (V)	DC current (mA)
LTE Band 4_1.4M QPSK	11.55 Vdc	898
LTE Band 4_1.4M 16QAM	11.55 Vdc	892
LTE Band 4_3M QPSK	11.55 Vdc	899
LTE Band 4_3M 16QAM	11.55 Vdc	903
LTE Band 4_5M QPSK	11.55 Vdc	875
LTE Band 4_5M 16QAM	11.55 Vdc	890
LTE Band 4_10M QPSK	11.55 Vdc	868
LTE Band 4_10M 16QAM	11.55 Vdc	901
LTE Band 4_15M QPSK	11.55 Vdc	917
LTE Band 4_15M 16QAM	11.55 Vdc	876
LTE Band 4_20M QPSK	11.55 Vdc	912
LTE Band 4_20M 16QAM	11.55 Vdc	879

Test Mode	DC voltage (V)	DC current (mA)
LTE Band 5_1.4M QPSK	11.55 Vdc	943
LTE Band 5_1.4M 16QAM	11.55 Vdc	949
LTE Band 5_3M QPSK	11.55 Vdc	971
LTE Band 5_3M 16QAM	11.55 Vdc	950
LTE Band 5_5M QPSK	11.55 Vdc	946
LTE Band 5_5M 16QAM	11.55 Vdc	928
LTE Band 5_10M QPSK	11.55 Vdc	937
LTE Band 5_10M 16QAM	11.55 Vdc	915

Unless otherwise stated the results shown in this test report refer only to the sample(s) tested and such sample(s) are retained for 90 days only.

除非另有說明，此報告結果僅對測試之樣品負責，同時此樣品僅保留90天。本報告未經本公司書面許可，不可部份複製。

This document is issued by the Company subject to its General Conditions of Service printed overleaf, available on request or accessible at www.sgs.com/terms_and_conditions.htm and, for electronic format documents, subject to Terms and Conditions for Electronic Documents at www.sgs.com/terms_e-document.htm. Attention is drawn to the limitation of liability, indemnification and jurisdiction issues defined therein. Any holder of this document is advised that information contained hereon reflects the Company's findings at the time of its intervention only and within the limits of Client's instructions, if any. The Company's sole responsibility is to its Client and this document does not exonerate parties to a transaction from exercising all their rights and obligations under the transaction documents. This document cannot be reproduced except in full, without prior written approval of the Company. Any unauthorized alteration, forgery or falsification of the content or appearance of this document is unlawful and offenders may be prosecuted to the fullest extent of the law.

SGS Taiwan Ltd.

No.134,WuKungRoad,NewTaipeiIndustrialPark,WukuDistrict,NewTaipeiCity,Taiwan24803/新北市五股區新北產業園區五工路 134 號

台灣檢驗科技股份有限公司

t (886-2) 2299-3279

f (886-2) 2298-0488

www.tw.sgs.com

Member of SGS Group

Test Mode	DC voltage (V)	DC current (mA)
LTE Band 7_5M QPSK	11.55 Vdc	952
LTE Band 7_5M 16QAM	11.55 Vdc	960
LTE Band 7_10M QPSK	11.55 Vdc	954
LTE Band 7_10M 16QAM	11.55 Vdc	925
LTE Band 7_15M QPSK	11.55 Vdc	944
LTE Band 7_15M 16QAM	11.55 Vdc	960
LTE Band 7_20M QPSK	11.55 Vdc	965
LTE Band 7_20M 16QAM	11.55 Vdc	935

Test Mode	DC voltage (V)	DC current (mA)
LTE Band 12_1.4M QPSK	11.55 Vdc	949
LTE Band 12_1.4M 16QAM	11.55 Vdc	960
LTE Band 12_3M QPSK	11.55 Vdc	976
LTE Band 12_3M 16QAM	11.55 Vdc	933
LTE Band 12_5M QPSK	11.55 Vdc	933
LTE Band 12_5M 16QAM	11.55 Vdc	950
LTE Band 12_10M QPSK	11.55 Vdc	976
LTE Band 12_10M 16QAM	11.55 Vdc	939

Unless otherwise stated the results shown in this test report refer only to the sample(s) tested and such sample(s) are retained for 90 days only.

除非另有說明，此報告結果僅對測試之樣品負責，同時此樣品僅保留90天。本報告未經本公司書面許可，不可部份複製。

This document is issued by the Company subject to its General Conditions of Service printed overleaf, available on request or accessible at www.sgs.com/terms_and_conditions.htm and, for electronic format documents, subject to Terms and Conditions for Electronic Documents at www.sgs.com/terms_e-document.htm. Attention is drawn to the limitation of liability, indemnification and jurisdiction issues defined therein. Any holder of this document is advised that information contained hereon reflects the Company's findings at the time of its intervention only and within the limits of Client's instructions, if any. The Company's sole responsibility is to its Client and this document does not exonerate parties to a transaction from exercising all their rights and obligations under the transaction documents. This document cannot be reproduced except in full, without prior written approval of the Company. Any unauthorized alteration, forgery or falsification of the content or appearance of this document is unlawful and offenders may be prosecuted to the fullest extent of the law.

SGS Taiwan Ltd.

No.134,WuKungRoad,NewTaipeiIndustrialPark,WukuDistrict,NewTaipeiCity,Taiwan24803/新北市五股區新北產業園區五工路 134 號

台灣檢驗科技股份有限公司

t (886-2) 2299-3279

f (886-2) 2298-0488

www.tw.sgs.com

Member of SGS Group

Test Mode	DC voltage (V)	DC current (mA)
LTE Band 13_5M QPSK	11.55 Vdc	962
LTE Band 13_5M 16QAM	11.55 Vdc	988
LTE Band 13_10M QPSK	11.55 Vdc	991
LTE Band 13_10M 16QAM	11.55 Vdc	953

Test Mode	DC voltage (V)	DC current (mA)
LTE Band 17_5M QPSK	11.55 Vdc	955
LTE Band 17_5M 16QAM	11.55 Vdc	951
LTE Band 17_10M QPSK	11.55 Vdc	973
LTE Band 17_10M 16QAM	11.55 Vdc	926

Unless otherwise stated the results shown in this test report refer only to the sample(s) tested and such sample(s) are retained for 90 days only.

除非另有說明，此報告結果僅對測試之樣品負責，同時此樣品僅保留90天。本報告未經本公司書面許可，不可部份複製。

This document is issued by the Company subject to its General Conditions of Service printed overleaf, available on request or accessible at www.sgs.com/terms_and_conditions.htm and, for electronic format documents, subject to Terms and Conditions for Electronic Documents at www.sgs.com/terms_e-document.htm. Attention is drawn to the limitation of liability, indemnification and jurisdiction issues defined therein. Any holder of this document is advised that information contained hereon reflects the Company's findings at the time of its intervention only and within the limits of Client's instructions, if any. The Company's sole responsibility is to its Client and this document does not exonerate parties to a transaction from exercising all their rights and obligations under the transaction documents. This document cannot be reproduced except in full, without prior written approval of the Company. Any unauthorized alteration, forgery or falsification of the content or appearance of this document is unlawful and offenders may be prosecuted to the fullest extent of the law.

SGS Taiwan Ltd.

No.134,WuKungRoad,NewTaipeiIndustrialPark,WukuDistrict,NewTaipeiCity,Taiwan24803/新北市五股區新北產業園區五工路 134 號

台灣檢驗科技股份有限公司

t (886-2) 2299-3279

f (886-2) 2298-0488

www.tw.sgs.com

Member of SGS Group

2.6. Configuration of Tested System

Fig. 2-1 Configuration of Tested System (Fixed Channel-Conducted)

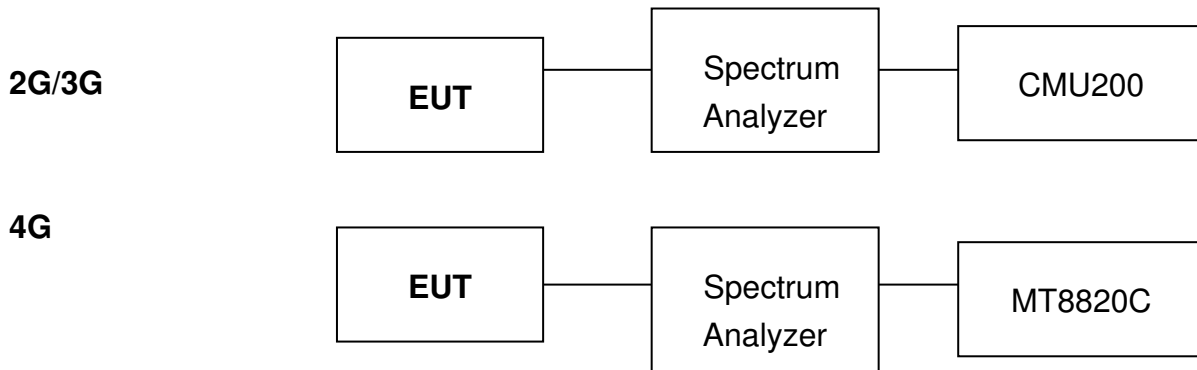

Fig. 2-2 Configuration of Tested System (Fixed Channel-Radiated)

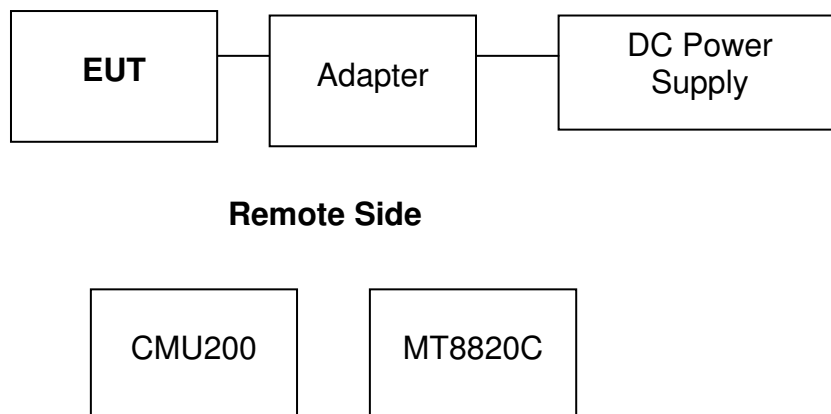

Table 2-1 Equipment Used in

Item	Equipment	Mfr/Brand	Model/ Type No.	Series No.	Data Cable	Power Cord
1.	Universal Radio Communication Tester	R&S	CMU200	102189	shielded	Un-shielded
2.	Universal Radio Communication Tester	Anritsu	MT8820C	6200307563	shielded	Un-shielded
3.	DC Power Supply	HP	E3640A	KR93300208	N/A	Un-shielded

Unless otherwise stated the results shown in this test report refer only to the sample(s) tested and such sample(s) are retained for 90 days only.

除非另有說明，此報告結果僅對測試之樣品負責，同時此樣品僅保留90天。本報告未經本公司書面許可，不可部份複製。

This document is issued by the Company subject to its General Conditions of Service printed overleaf, available on request or accessible at www.sgs.com/terms_and_conditions.htm and, for electronic format documents, subject to Terms and Conditions for Electronic Documents at www.sgs.com/terms_e-document.htm. Attention is drawn to the limitation of liability, indemnification and jurisdiction issues defined therein. Any holder of this document is advised that information contained hereon reflects the Company's findings at the time of its intervention only and within the limits of Client's instructions, if any. The Company's sole responsibility is to its Client and this document does not exonerate parties to a transaction from exercising all their rights and obligations under the transaction documents. This document cannot be reproduced except in full, without prior written approval of the Company. Any unauthorized alteration, forgery or falsification of the content or appearance of this document is unlawful and offenders may be prosecuted to the fullest extent of the law.

SGS Taiwan Ltd.

No.134,WuKungRoad,NewTaipeiIndustrialPark,WukuDistrict,NewTaipeiCity,Taiwan24803/新北市五股區新北產業園區五工路 134 號

台灣檢驗科技股份有限公司

t (886-2) 2299-3279

f (886-2) 2298-0488

www.tw.sgs.com

Member of SGS Group

3. SUMMARY OF TEST RESULTS

FCC Rules	Description Of Test	Result
§2.1046(a)	RF Power Output	Compliant
§2.1046(a) §22.913(a)(2) §24.232(c) §27.50(c)(9) §27.50(d)(4) §27.50(h)(2)	ERP/ EIRP measurement	Compliant
§2.1049(h)	99% & 26dB Occupied Bandwidth	Compliant
§2.1051 §22.917(a) §24.238(a) §27.53(g) §27.50(c)(5) §27.53(h) §27.53(m)(4)(6)	Out of Band Emissions at Antenna Terminals and Band Edge / Emission mask requirements	Compliant
§2.1053 §22.917(a) §24.238(a) §27.53(c)(2),(4) §27.50(c)(5) §27.53(g) §27.53(h) §27.53(m)(4)	Field Strength of Spurious Radiation	Compliant
§24.232(d) §27.53(d) (5) §27.50(i) (B)	Peak to Average Ratio	Compliant
§2.1055(a)(1) §22.355 §24.235 §27.54	Frequency Stability	Compliant

Unless otherwise stated the results shown in this test report refer only to the sample(s) tested and such sample(s) are retained for 90 days only.

除非另有說明，此報告結果僅對測試之樣品負責，同時此樣品僅保留90天。本報告未經本公司書面許可，不可部份複製。

This document is issued by the Company subject to its General Conditions of Service printed overleaf, available on request or accessible at www.sgs.com/terms_and_conditions.htm and, for electronic format documents, subject to Terms and Conditions for Electronic Documents at www.sgs.com/terms_e-document.htm. Attention is drawn to the limitation of liability, indemnification and jurisdiction issues defined therein. Any holder of this document is advised that information contained hereon reflects the Company's findings at the time of its intervention only and within the limits of Client's instructions, if any. The Company's sole responsibility is to its Client and this document does not exonerate parties to a transaction from exercising all their rights and obligations under the transaction documents. This document cannot be reproduced except in full, without prior written approval of the Company. Any unauthorized alteration, forgery or falsification of the content or appearance of this document is unlawful and offenders may be prosecuted to the fullest extent of the law.

4. DESCRIPTION OF TEST MODES

4.1. The Worst Test Modes and Channel Details

1. The EUT has been tested under operating condition.
2. Pre-Scan has been conducted to determine the worst-case mode from all possible combinations between available modulations, data rates, X(E1)Y(E2)Z(H) axis and antenna ports. The worst case was found as listed below. Following channel(s) was (were) selected for the final test as listed below:

BAND	ERP/EIRP	RADIATED EMISSION
GPRS/EDGE 850	E2-plan	E2-plan
GPRS/EDGE 1900	E2-plan	E2-plan
WCDMA/HSPA Band II	E2-plan	E2-plan
WCDMA/HSPA Band IV	E2-plan	E2-plan
WCDMA/HSPA Band V	E2-plan	E2-plan
CDMA 2000 Cellular (BC0) / CDMA 2000 EVDO Cellular (BC0)	E2-plan	E2-plan
CDMA 2000 PCS (BC1) / CDMA 2000 EVDO PCS (BC1)	E2-plan	E2-plan
LTE Band 2	E2-plan	E2-plan
LTE Band 4	E2-plan	E2-plan
LTE Band 5	E2-plan	E2-plan
LTE Band 7	E2-plan	E2-plan
LTE Band 12	E2-plan	E2-plan
LTE Band 13	E2-plan	E2-plan
LTE Band 17	E2-plan	E2-plan

Unless otherwise stated the results shown in this test report refer only to the sample(s) tested and such sample(s) are retained for 90 days only.

除非另有說明，此報告結果僅對測試之樣品負責，同時此樣品僅保留90天。本報告未經本公司書面許可，不可部份複製。

This document is issued by the Company subject to its General Conditions of Service printed overleaf, available on request or accessible at www.sgs.com/terms_and_conditions.htm and, for electronic format documents, subject to Terms and Conditions for Electronic Documents at www.sgs.com/terms_e-document.htm. Attention is drawn to the limitation of liability, indemnification and jurisdiction issues defined therein. Any holder of this document is advised that information contained hereon reflects the Company's findings at the time of its intervention only and within the limits of Client's instructions, if any. The Company's sole responsibility is to its Client and this document does not exonerate parties to a transaction from exercising all their rights and obligations under the transaction documents. This document cannot be reproduced except in full, without prior written approval of the Company. Any unauthorized alteration, forgery or falsification of the content or appearance of this document is unlawful and offenders may be prosecuted to the fullest extent of the law.

GPRS/EDGE MODE

TEST ITEM	AVAILABLE CHANNEL	TESTED CHANNEL	MODE
ERP	128 to 251	128, 190, 251	GPRS/EDGE 850
EIRP	512 to 810	512, 661, 810	GPRS/EDGE 1900
FREQUENCY STABILITY	128 to 251 512 to 810	190 661	GPRS 850 GPRS 1900
OCCUPIED BANDWIDTH	128 to 251 512 to 810	190 661	GPRS/EDGE 850 GPRS/EDGE 1900
PEAK TO AVERAGE RATIO	128 to 251 512 to 810	128, 190, 251 512, 661, 810	GPRS/EDGE 850 GPRS/EDGE 1900
BAND EDGE	128 to 251 512 to 810	128, 251 512, 810	GPRS/EDGE 850 GPRS/EDGE 1900
CONDCUDED EMISSION	128 to 251 512 to 810	128, 190, 251 512, 661, 810	GPRS/EDGE 850 GPRS/EDGE 1900
RADIATED EMISSION	128 to 251 512 to 810	128, 190, 251 512, 661, 810	GPRS 850 GPRS 1900

WCDMA/HSPA MODE

TEST ITEM	AVAILABLE CHANNEL	TESTED CHANNEL	MODE
ERP	4132 to 4233	4132, 4183, 4233	WCDMA/HSPA Band V
EIRP	9262 to 9538 1312 to 1513	9262, 9400, 9583 1312, 1413, 1513	WCDMA/HSPA Band II WCDMA/HSPA Band IV
FREQUENCY STABILITY	4132 to 4233 1312 to 1513 9262 to 9538	4183 1413 9400	WCDMA Band II WCDMA Band IV WCDMA Band V
OCCUPIED BANDWIDTH	4132 to 4233 1312 to 1513 9262 to 9538	4132, 4183, 4233 1312, 1413, 1513 9262, 9400, 9583	WCDMA/HSPA Band II WCDMA/HSPA Band IV WCDMA/HSPA Band V
PEAK TO AVERAGE RATIO	4132 to 4233 1312 to 1513 9262 to 9538	4132, 4183, 4233 1312, 1413, 1513 9262, 9400, 9583	WCDMA/HSPA Band II WCDMA/HSPA Band IV WCDMA/HSPA Band V
BAND EDGE	4132 to 4233 1312 to 1513 9262 to 9538	4132, 4233 1312, 1513 9262, 9583	WCDMA Band II WCDMA Band IV WCDMA Band V
CONDCUDED EMISSION	4132 to 4233 1312 to 1513 9262 to 9538	4132, 4183, 4233 1312, 1413, 1513 9262, 9400, 9583	WCDMA Band II WCDMA Band IV WCDMA Band V
RADIATED EMISSION	4132 to 4233 1312 to 1513 9262 to 9538	4132, 4183, 4233 1312, 1413, 1513 9262, 9400, 9583	HSDPA Band II HSDPA Band IV HSDPA Band V

Unless otherwise stated the results shown in this test report refer only to the sample(s) tested and such sample(s) are retained for 90 days only.

除非另有說明，此報告結果僅對測試之樣品負責，同時此樣品僅保留90天。本報告未經本公司書面許可，不可部份複製。

This document is issued by the Company subject to its General Conditions of Service printed overleaf, available on request or accessible at www.sgs.com/terms_and_conditions.htm and, for electronic format documents, subject to Terms and Conditions for Electronic Documents at www.sgs.com/terms_e-document.htm. Attention is drawn to the limitation of liability, indemnification and jurisdiction issues defined therein. Any holder of this document is advised that information contained hereon reflects the Company's findings at the time of its intervention only and within the limits of Client's instructions, if any. The Company's sole responsibility is to its Client and this document does not exonerate parties to a transaction from exercising all their rights and obligations under the transaction documents. This document cannot be reproduced except in full, without prior written approval of the Company. Any unauthorized alteration, forgery or falsification of the content or appearance of this document is unlawful and offenders may be prosecuted to the fullest extent of the law.

CDMA/EVDO MODE

TEST ITEM	AVAILABLE CHANNEL	TESTED CHANNEL	MODE
ERP	1013 to 777	1013, 384, 777	CDMA2000/ EVDO Cellular BC0
EIRP	25 to 1175	25, 600, 1175	CDMA2000/ EVDO PCS BC1
FREQUENCY STABILITY	1013 to 777 25 to 1175	384 600	CDMA2000/ EVDO Cellular BC0 CDMA2000/ EVDO PCS BC1
OCCUPIED BANDWIDTH	1013 to 777 25 to 1175	1013, 384, 777 25, 600, 1175	CDMA2000/ EVDO Cellular BC0 CDMA2000/ EVDO PCS BC1
PEAK TO AVERAGE RATIO	1013 to 777 25 to 1175	1013, 384, 777 25, 600, 1175	CDMA2000/ EVDO Cellular BC0 CDMA2000/ EVDO PCS BC1
BAND EDGE	1013 to 777 25 to 1175	1013, 777 25, 1175	CDMA2000/ EVDO Cellular BC0 CDMA2000/ EVDO PCS BC1
CONDUCTED EMISSION	1013 to 777 25 to 1175	1013, 384, 777 25, 600, 1175	CDMA2000/ EVDO Cellular BC0 CDMA2000/ EVDO PCS BC1
RADIATED EMISSION	1013 to 777 25 to 1175	1013, 384, 777 25, 600, 1175	CDMA2000 Cellular BC0 CDMA2000 PCS BC1

Unless otherwise stated the results shown in this test report refer only to the sample(s) tested and such sample(s) are retained for 90 days only.

除非另有說明，此報告結果僅對測試之樣品負責，同時此樣品僅保留90天。本報告未經本公司書面許可，不可部份複製。

This document is issued by the Company subject to its General Conditions of Service printed overleaf, available on request or accessible at www.sgs.com/terms_and_conditions.htm and, for electronic format documents, subject to Terms and Conditions for Electronic Documents at www.sgs.com/terms_e-document.htm. Attention is drawn to the limitation of liability, indemnification and jurisdiction issues defined therein. Any holder of this document is advised that information contained hereon reflects the Company's findings at the time of its intervention only and within the limits of Client's instructions, if any. The Company's sole responsibility is to its Client and this document does not exonerate parties to a transaction from exercising all their rights and obligations under the transaction documents. This document cannot be reproduced except in full, without prior written approval of the Company. Any unauthorized alteration, forgery or falsification of the content or appearance of this document is unlawful and offenders may be prosecuted to the fullest extent of the law.

SGS Taiwan Ltd.

No.134,WuKungRoad,NewTaipeiIndustrialPark,WukuDistrict,NewTaipeiCity,Taiwan24803/新北市五股區新北產業園區五工路 134 號

台灣檢驗科技股份有限公司

t (886-2) 2299-3279

f (886-2) 2298-0488

www.tw.sgs.com

Member of SGS Group

LTE Band 2 MODE

TEST ITEM	AVAILABLE CHANNEL	TESTED CHANNEL	CHANNEL BANDWIDTH	MODULATION	MODE
EIRP	18607 to 19193	18607, 18900, 19193	1.4MHz	QPSK, 16QAM	1 RB/ 0,5 RB Offest
	18615 to 19185	18615, 18900, 19185	3MHz	QPSK, 16QAM	1 RB/ 0,14 RB Offest
	18625 to 19175	18625, 18900, 19175	5MHz	QPSK, 16QAM	1 RB/ 0,24 RB Offest
	18650 to 19150	18650, 18900, 19150	10MHz	QPSK, 16QAM	1 RB/ 0,49 RB Offest
	18675 to 19125	18675, 18900, 19125	15MHz	QPSK, 16QAM	1 RB/ 0,74 RB Offest
	18700 to 19100	18700, 18900, 19100	20MHz	QPSK, 16QAM	1 RB/ 0,99 RB Offest
FREQUENCY STABILITY	18650 to 19150	18900	10MHz	QPSK,	Full RB
OCCUPIED BANDWIDTH	18607 to 19193	18607, 18900, 19193	1.4MHz	QPSK, 16QAM	Full RB
	18615 to 19185	18615, 18900, 19185	3MHz	QPSK, 16QAM	Full RB
	18625 to 19175	18625, 18900, 19175	5MHz	QPSK, 16QAM	Full RB
	18650 to 19150	18650, 18900, 19150	10MHz	QPSK, 16QAM	Full RB
	18675 to 19125	18675, 18900, 19125	15MHz	QPSK, 16QAM	Full RB
	18700 to 19100	18700, 18900, 19100	20MHz	QPSK, 16QAM	Full RB
PEAK TO AVERAGE RATIO	18607 to 19193	18607, 18900, 19193	1.4MHz	16QAM	Full RB
	18615 to 19185	18615, 18900, 19185	3MHz	16QAM	Full RB
	18625 to 19175	18625, 18900, 19175	5MHz	16QAM	Full RB
	18650 to 19150	18650, 18900, 19150	10MHz	16QAM	Full RB
	18675 to 19125	18675, 18900, 19125	15MHz	16QAM	Full RB
	18700 to 19100	18700, 18900, 19100	20MHz	16QAM	Full RB
BAND EDGE	18607 to 19193	18607, 19193	1.4MHz	QPSK,	1 RB/ 0,5 RB Offes Full RB
	18615 to 19185	18615, 19185	3MHz	QPSK,	1 RB/ 0,14 RB Offest Full RB
	18625 to 19175	18625, 19175	5MHz	QPSK,	1 RB/ 0,24 RB Offest Full RB
	18650 to 19150	18650, 19150	10MHz	QPSK,	1 RB/ 0,49 RB Offest Full RB
	18675 to 19125	18675, 19125	15MHz	QPSK,	1 RB/ 0,74 RB Offest Full RB
	18700 to 19100	18700, 19100	20MHz	QPSK,	1 RB/ 0,99 RB Offest Full RB
CONDCUDED EMISSION	18607 to 19193	18607, 18900, 19193	1.4MHz	QPSK,	1 RB, 0 RB Offest
	18615 to 19185	18615, 18900, 19185	3MHz	QPSK,	1 RB, 0 RB Offest
	18625 to 19175	18625, 18900, 19175	5MHz	QPSK,	1 RB, 0 RB Offest
	18650 to 19150	18650, 18900, 19150	10MHz	QPSK,	1 RB, 0 RB Offest
	18675 to 19125	18675, 18900, 19125	15MHz	QPSK,	1 RB, 0 RB Offest
	18700 to 19100	18700, 18900, 19100	20MHz	QPSK,	1 RB, 0 RB Offest
RADIATED EMISSION	18625 to 19175	18625, 18900, 19175	5MHz	QPSK	1 RB, 0 RB Offest

Unless otherwise stated the results shown in this test report refer only to the sample(s) tested and such sample(s) are retained for 90 days only.

除非另有說明，此報告結果僅對測試之樣品負責，同時此樣品僅保留90天。本報告未經本公司書面許可，不可部份複製。

This document is issued by the Company subject to its General Conditions of Service printed overleaf, available on request or accessible at www.sgs.com/terms_and_conditions.htm and, for electronic format documents, subject to Terms and Conditions for Electronic Documents at www.sgs.com/terms_e-document.htm. Attention is drawn to the limitation of liability, indemnification and jurisdiction issues defined therein. Any holder of this document is advised that information contained hereon reflects the Company's findings at the time of its intervention only and within the limits of Client's instructions, if any. The Company's sole responsibility is to its Client and this document does not exonerate parties to a transaction from exercising all their rights and obligations under the transaction documents. This document cannot be reproduced except in full, without prior written approval of the Company. Any unauthorized alteration, forgery or falsification of the content or appearance of this document is unlawful and offenders may be prosecuted to the fullest extent of the law.

SGS Taiwan Ltd.

No.134,WuKungRoad,NewTaipeiIndustrialPark,WukuDistrict,NewTaipeiCity,Taiwan24803/新北市五股區新北產業園區五工路 134 號

台灣檢驗科技股份有限公司

t (886-2) 2299-3279

f (886-2) 2298-0488

www.tw.sgs.com

Member of SGS Group

LTE Band 4 MODE

TEST ITEM	AVAILABLE CHANNEL	TESTED CHANNEL	CHANNEL BANDWIDTH	MODULATION	MODE
EIRP	19957 to 19393	19957, 20175, 19393	1.4MHz	QPSK, 16QAM	1 RB/ 0,5 RB Offest
	19965 to 22385	19965, 20175, 22385	3MHz	QPSK, 16QAM	1 RB/ 0,14 RB Offest
	19975 to 20375	19975, 20175, 20375	5MHz	QPSK, 16QAM	1 RB/ 0,24 RB Offest
	20000 to 20350	20000, 20175, 20350	10MHz	QPSK, 16QAM	1 RB/ 0,49 RB Offest
	20025 to 20325	20025, 20175, 20325	15MHz	QPSK, 16QAM	1 RB/ 0,74 RB Offest
	20050 to 20300	20050, 20175, 20300	20MHz	QPSK, 16QAM	1 RB/ 0,99 RB Offest
FREQUENCY STABILITY	20000 to 20350	20175	10MHz	QPSK,	Full RB
OCCUPIED BANDWIDTH	19957 to 19393	19957, 20175, 19393	1.4MHz	QPSK, 16QAM	Full RB
	19965 to 22385	19965, 20175, 22385	3MHz	QPSK, 16QAM	Full RB
	19975 to 20375	19975, 20175, 20375	5MHz	QPSK, 16QAM	Full RB
	20000 to 20350	20000, 20175, 20350	10MHz	QPSK, 16QAM	Full RB
	20025 to 20325	20025, 20175, 20325	15MHz	QPSK, 16QAM	Full RB
	20050 to 20300	20050, 20175, 20300	20MHz	QPSK, 16QAM	Full RB
PEAK TO AVERAGE RATIO	19957 to 19393	19957, 20175, 19393	1.4MHz	16QAM	Full RB
	19965 to 22385	19965, 20175, 22385	3MHz	16QAM	Full RB
	19975 to 20375	19975, 20175, 20375	5MHz	16QAM	Full RB
	20000 to 20350	20000, 20175, 20350	10MHz	16QAM	Full RB
	20025 to 20325	20025, 20175, 20325	15MHz	16QAM	Full RB
	20050 to 20300	20050, 20175, 20300	20MHz	16QAM	Full RB
BAND EDGE	19957 to 19393	19957, 19393	1.4MHz	QPSK,	1 RB/ 0,5 RB Offes Full RB
	19965 to 22385	19965, 22385	3MHz	QPSK,	1 RB/ 0,14 RB Offest Full RB
	19975 to 20375	19975, 20375	5MHz	QPSK,	1 RB/ 0,24 RB Offest Full RB
	20000 to 20350	20000, 20350	10MHz	QPSK,	1 RB/ 0,49 RB Offest Full RB
	20025 to 20325	20025, 20325	15MHz	QPSK,	1 RB/ 0,74 RB Offest Full RB
	20050 to 20300	20050, 20300	20MHz	QPSK,	1 RB/ 0,99 RB Offest Full RB
CONDCUDED EMISSION	19957 to 19393	19957, 20175, 19393	1.4MHz	QPSK,	1 RB, 0 RB Offest
	19965 to 22385	19965, 20175, 22385	3MHz	QPSK,	1 RB, 0 RB Offest
	19975 to 20375	19975, 20175, 20375	5MHz	QPSK,	1 RB, 0 RB Offest
	20000 to 20350	20000, 20175, 20350	10MHz	QPSK,	1 RB, 0 RB Offest
	20025 to 20325	20025, 20175, 20325	15MHz	QPSK,	1 RB, 0 RB Offest
	20050 to 20300	20050, 20175, 20300	20MHz	QPSK,	1 RB, 0 RB Offest
RADIATED EMISSION	20000 to 20350	20000, 20175, 20350	10MHz	16QAM,	1 RB, 49 RB Offest

Unless otherwise stated the results shown in this test report refer only to the sample(s) tested and such sample(s) are retained for 90 days only.

除非另有說明，此報告結果僅對測試之樣品負責，同時此樣品僅保留90天。本報告未經本公司書面許可，不可部份複製。

This document is issued by the Company subject to its General Conditions of Service printed overleaf, available on request or accessible at www.sgs.com/terms_and_conditions.htm and, for electronic format documents, subject to Terms and Conditions for Electronic Documents at www.sgs.com/terms_e-document.htm. Attention is drawn to the limitation of liability, indemnification and jurisdiction issues defined therein. Any holder of this document is advised that information contained hereon reflects the Company's findings at the time of its intervention only and within the limits of Client's instructions, if any. The Company's sole responsibility is to its Client and this document does not exonerate parties to a transaction from exercising all their rights and obligations under the transaction documents. This document cannot be reproduced except in full, without prior written approval of the Company. Any unauthorized alteration, forgery or falsification of the content or appearance of this document is unlawful and offenders may be prosecuted to the fullest extent of the law.

SGS Taiwan Ltd.

No.134,WuKungRoad,NewTaipeiIndustrialPark,WukuDistrict,NewTaipeiCity,Taiwan24803/新北市五股區新北產業園區五工路 134 號

台灣檢驗科技股份有限公司

t (886-2) 2299-3279

f (886-2) 2298-0488

www.tw.sgs.com

Member of SGS Group

LTE Band 5 MODE

TEST ITEM	AVAILABLE CHANNEL	TESTED CHANNEL	CHANNEL BANDWIDTH	MODULATION	MODE
ERP	20470 to 20643	20470, 20525, 20643	1.4MHz	QPSK, 16QAM	1 RB/ 0,5 RB Offest
	20415 to 20635	20415, 20525, 20635	3MHz	QPSK, 16QAM	1 RB/ 0,14 RB Offest
	20425 to 20625	20425, 20525, 20625	5MHz	QPSK, 16QAM	1 RB/ 0,24 RB Offest
	20450 to 20600	20450, 20525, 20600	10MHz	QPSK, 16QAM	1 RB/ 0,49 RB Offest
FREQUENCY STABILITY	20450 to 20600	20525	10MHz	QPSK,	Full RB
OCCUPIED BANDWIDTH	20470 to 20643	20470, 20525, 20643	1.4MHz	QPSK, 16QAM	Full RB
	20415 to 20635	20415, 20525, 20635	3MHz	QPSK, 16QAM	Full RB
	20425 to 20625	20425, 20525, 20625	5MHz	QPSK, 16QAM	Full RB
	20450 to 20600	20450, 20525, 20600	10MHz	QPSK, 16QAM	Full RB
PEAK TO AVERAGE RATIO	20470 to 20643	20470, 20525, 20643	1.4MHz	16QAM	Full RB
	20415 to 20635	20415, 20525, 20635	3MHz	16QAM	Full RB
	20425 to 20625	20425, 20525, 20625	5MHz	16QAM	Full RB
	20450 to 20600	20450, 20525, 20600	10MHz	16QAM	Full RB
BAND EDGE	20470 to 20643	20470, 20643	1.4MHz	QPSK,	1 RB/ 0,5 RB Offes Full RB
	20415 to 20635	20415, 20635	3MHz	QPSK,	1 RB/ 0,14 RB Offest Full RB
	20425 to 20625	20425, 20625	5MHz	QPSK,	1 RB/ 0,24 RB Offest Full RB
	20450 to 20600	20450, 20600	10MHz	QPSK,	1 RB/ 0,49 RB Offest Full RB
CONDCUDED EMISSION	20470 to 20643	20470, 20525, 20643	1.4MHz	QPSK,	1 RB, 0 RB Offest
	20415 to 20635	20415, 20525, 20635	3MHz	QPSK,	1 RB, 0 RB Offest
	20425 to 20625	20425, 20525, 20625	5MHz	QPSK,	1 RB, 0 RB Offest
	20450 to 20600	20450, 20525, 20600	10MHz	QPSK,	1 RB, 0 RB Offest
RADIATED EMISSION	20450 to 20600	20450, 20525, 20600	10MHz	QPSK	1 RB, 49 RB Offest

Unless otherwise stated the results shown in this test report refer only to the sample(s) tested and such sample(s) are retained for 90 days only.

除非另有說明，此報告結果僅對測試之樣品負責，同時此樣品僅保留90天。本報告未經本公司書面許可，不可部份複製。

This document is issued by the Company subject to its General Conditions of Service printed overleaf, available on request or accessible at www.sgs.com/terms_and_conditions.htm and, for electronic format documents, subject to Terms and Conditions for Electronic Documents at www.sgs.com/terms_e-document.htm. Attention is drawn to the limitation of liability, indemnification and jurisdiction issues defined therein. Any holder of this document is advised that information contained hereon reflects the Company's findings at the time of its intervention only and within the limits of Client's instructions, if any. The Company's sole responsibility is to its Client and this document does not exonerate parties to a transaction from exercising all their rights and obligations under the transaction documents. This document cannot be reproduced except in full, without prior written approval of the Company. Any unauthorized alteration, forgery or falsification of the content or appearance of this document is unlawful and offenders may be prosecuted to the fullest extent of the law.

SGS Taiwan Ltd.

No.134,WuKungRoad,NewTaipeiIndustrialPark,WukuDistrict,NewTaipeiCity,Taiwan24803/新北市五股區新北產業園區五工路 134 號

台灣檢驗科技股份有限公司

t (886-2) 2299-3279

f (886-2) 2298-0488

www.tw.sgs.com

Member of SGS Group

LTE Band 7 MODE

TEST ITEM	AVAILABLE CHANNEL	TESTED CHANNEL	CHANNEL BANDWIDTH	MODULATION	MODE
EIRP	20775 to 21425	20775, 21100, 21425	5MHz	QPSK, 16QAM	1 RB/ 0,24 RB Offest
	20800 to 21400	20800, 21100, 21400	10MHz	QPSK, 16QAM	1 RB/ 0,49 RB Offest
	20850 to 21375	20850, 21100, 21375	15MHz	QPSK, 16QAM	1 RB/ 0,74 RB Offest
	20850 to 21350	20850, 21100, 21350	20MHz	QPSK, 16QAM	1 RB/ 0,99 RB Offest
FREQUENCY STABILITY	20800 to 21400	21100	10MHz	QPSK,	Full RB
OCCUPIED BANDWIDTH	20775 to 21425	20775, 21100, 21425	5MHz	QPSK, 16QAM	Full RB
	20800 to 21400	20800, 21100, 21400	10MHz	QPSK, 16QAM	Full RB
	20850 to 21375	20850, 21100, 21375	15MHz	QPSK, 16QAM	Full RB
	20850 to 21350	20850, 21100, 21350	20MHz	QPSK, 16QAM	Full RB
PEAK TO AVERAGE RATIO	20775 to 21425	20775, 21100, 21425	5MHz	16QAM	Full RB
	20800 to 21400	20800, 21100, 21400	10MHz	16QAM	Full RB
	20850 to 21375	20850, 21100, 21375	15MHz	16QAM	Full RB
	20850 to 21350	20850, 21100, 21350	20MHz	16QAM	Full RB
BAND EDGE	20775 to 21425	20775, 21100, 21425	5MHz	QPSK,	1 RB/ 0,24 RB Offest Full RB
	20800 to 21400	20800, 21100, 21400	10MHz	QPSK,	1 RB/ 0,49 RB Offest Full RB
	20850 to 21375	20850, 21100, 21375	15MHz	QPSK,	1 RB/ 0,74 RB Offest Full RB
	20850 to 21350	20850, 21100, 21350	20MHz	QPSK,	1 RB/ 0,99 RB Offest Full RB
CONDCUDED EMISSION	20775 to 21425	20775, 21100, 21425	5MHz	QPSK,	1 RB, 0 RB Offest
	20800 to 21400	20800, 21100, 21400	10MHz	QPSK,	1 RB, 0 RB Offest
	20850 to 21375	20850, 21100, 21375	15MHz	QPSK,	1 RB, 0 RB Offest
	20850 to 21350	20850, 21100, 21350	20MHz	QPSK,	1 RB, 0 RB Offest
RADIATED EMISSION	20850 to 21350	20850, 21100, 21350	20MHz	16QAM	1 RB, 0 RB Offest
EMISSION MASK	20775 to 21425	20775, 21100, 21425	5MHz	QPSK,	1 RB/ 0,24 RB Offest 25 RB/ 0 Offset
	20800 to 21400	20800, 21100, 21400	10MHz	QPSK,	1 RB/ 0,49 RB Offest 50 RB/ 0 Offset
	20850 to 21375	20850, 21100, 21375	15MHz	QPSK,	1 RB/ 0,74 RB Offest 75 RB/ 0 Offset
	20850 to 21350	20850, 21100, 21350	20MHz	QPSK,	1 RB/ 0,99 RB Offest 100 RB/ 0 Offset

Unless otherwise stated the results shown in this test report refer only to the sample(s) tested and such sample(s) are retained for 90 days only.

除非另有說明，此報告結果僅對測試之樣品負責，同時此樣品僅保留90天。本報告未經本公司書面許可，不可部份複製。

This document is issued by the Company subject to its General Conditions of Service printed overleaf, available on request or accessible at www.sgs.com/terms_and_conditions.htm and, for electronic format documents, subject to Terms and Conditions for Electronic Documents at www.sgs.com/terms_e-document.htm. Attention is drawn to the limitation of liability, indemnification and jurisdiction issues defined therein. Any holder of this document is advised that information contained hereon reflects the Company's findings at the time of its intervention only and within the limits of Client's instructions, if any. The Company's sole responsibility is to its Client and this document does not exonerate parties to a transaction from exercising all their rights and obligations under the transaction documents. This document cannot be reproduced except in full, without prior written approval of the Company. Any unauthorized alteration, forgery or falsification of the content or appearance of this document is unlawful and offenders may be prosecuted to the fullest extent of the law.

SGS Taiwan Ltd.

No.134,WuKungRoad,NewTaipeiIndustrialPark,WukuDistrict,NewTaipeiCity,Taiwan24803/新北市五股區新北產業園區五工路 134 號

台灣檢驗科技股份有限公司

t (886-2) 2299-3279

f (886-2) 2298-0488

www.tw.sgs.com

Member of SGS Group

LTE Band 12 MODE

TEST ITEM	AVAILABLE CHANNEL	TESTED CHANNEL	CHANNEL BANDWIDTH	MODULATION	MODE
ERP	23017 to 23173	23017, 23095, 23173	1.4MHz	QPSK, 16QAM	1 RB/ 0,5 RB Offest
	23025 to 23165	23025, 23095, 23165	3MHz	QPSK, 16QAM	1 RB/ 0,14 RB Offest
	23035 to 23155	23035, 23095, 23155	5MHz	QPSK, 16QAM	1 RB/ 0,24 RB Offest
	23060 to 23130	23060, 23095, 23130	10MHz	QPSK, 16QAM	1 RB/ 0,49 RB Offest
FREQUENCY STABILITY	23060 to 23130	23095	10MHz	QPSK,	Full RB
OCCUPIED BANDWIDTH	23017 to 23173	23017, 23095, 23173	1.4MHz	QPSK, 16QAM	Full RB
	23025 to 23165	23025, 23095, 23165	3MHz	QPSK, 16QAM	Full RB
	23035 to 23155	23035, 23095, 23155	5MHz	QPSK, 16QAM	Full RB
	23060 to 23130	23060, 23095, 23130	10MHz	QPSK, 16QAM	Full RB
PEAK TO AVERAGE RATIO	23017 to 23173	23017, 23095, 23173	1.4MHz	16QAM	Full RB
	23025 to 23165	23025, 23095, 23165	3MHz	16QAM	Full RB
	23035 to 23155	23035, 23095, 23155	5MHz	16QAM	Full RB
	23060 to 23130	23060, 23095, 23130	10MHz	16QAM	Full RB
BAND EDGE	23017 to 23173	23017, 23095, 23173	1.4MHz	QPSK,	1 RB/ 0,5 RB Offes Full RB
	23025 to 23165	23025, 23095, 23165	3MHz	QPSK,	1 RB/ 0,14 RB Offest Full RB
	23035 to 23155	23035, 23095, 23155	5MHz	QPSK,	1 RB/ 0,24 RB Offest Full RB
	23060 to 23130	23060, 23095, 23130	10MHz	QPSK,	1 RB/ 0,49 RB Offest Full RB
CONDCUDED EMISSION	23017 to 23173	23017, 23095, 23173	1.4MHz	QPSK,	1 RB, 0 RB Offest
	23025 to 23165	23025, 23095, 23165	3MHz	QPSK,	1 RB, 0 RB Offest
	23035 to 23155	23035, 23095, 23155	5MHz	QPSK,	1 RB, 0 RB Offest
	23060 to 23130	23060, 23095, 23130	10MHz	QPSK,	1 RB, 0 RB Offest
RADIATED EMISSION	23035 to 23155	23035, 23095, 23155	5MHz	16QAM	1 RB, 24 RB Offest

Unless otherwise stated the results shown in this test report refer only to the sample(s) tested and such sample(s) are retained for 90 days only.

除非另有說明，此報告結果僅對測試之樣品負責，同時此樣品僅保留90天。本報告未經本公司書面許可，不可部份複製。

This document is issued by the Company subject to its General Conditions of Service printed overleaf, available on request or accessible at www.sgs.com/terms_and_conditions.htm and, for electronic format documents, subject to Terms and Conditions for Electronic Documents at www.sgs.com/terms_e-document.htm. Attention is drawn to the limitation of liability, indemnification and jurisdiction issues defined therein. Any holder of this document is advised that information contained hereon reflects the Company's findings at the time of its intervention only and within the limits of Client's instructions, if any. The Company's sole responsibility is to its Client and this document does not exonerate parties to a transaction from exercising all their rights and obligations under the transaction documents. This document cannot be reproduced except in full, without prior written approval of the Company. Any unauthorized alteration, forgery or falsification of the content or appearance of this document is unlawful and offenders may be prosecuted to the fullest extent of the law.

SGS Taiwan Ltd.

No.134,WuKungRoad,NewTaipeiIndustrialPark,WukuDistrict,NewTaipeiCity,Taiwan24803/新北市五股區新北產業園區五工路 134 號

台灣檢驗科技股份有限公司

t (886-2) 2299-3279

f (886-2) 2298-0488

www.tw.sgs.com

Member of SGS Group

LTE Band 13 MODE

TEST ITEM	AVAILABLE CHANNEL	TESTED CHANNEL	CHANNEL BANDWIDTH	MODULATION	MODE
ERP	23205 to 23255	23205, 23230, 23255	5MHz	QPSK, 16QAM	1 RB/ 0,24 RB Offest
	23230	23230	10MHz	QPSK, 16QAM	1 RB/ 0,49 RB Offest
FREQUENCY STABILITY	23230	23230	10MHz	QPSK,	Full RB
OCCUPIED BANDWIDTH	23205 to 23255	23205, 23230, 23255	5MHz	QPSK, 16QAM	Full RB
	23230	23230	10MHz	QPSK, 16QAM	Full RB
PEAK TO AVERAGE RATIO	23205 to 23255	23205, 23230, 23255	5MHz	16QAM	Full RB
	23230	23230	10MHz	16QAM	Full RB
BAND EDGE	23205 to 23255	23205, 23255	5MHz	QPSK,	1 RB/ 0,24 RB Offest Full RB
	23230	23230	10MHz	QPSK,	1 RB/ 0,49 RB Offest Full RB
CONDCUDED EMISSION	23205 to 23255	23205, 23230, 23255	5MHz	QPSK,	1 RB, 0 RB Offest
	23230	23230	10MHz	QPSK,	1 RB, 0 RB Offest
RADIATED EMISSION	23205 to 23255	23205, 23230, 23255	5MHz	16QAM	1 RB/ 24 RB Offest

LTE Band 17 MODE

TEST ITEM	AVAILABLE CHANNEL	TESTED CHANNEL	CHANNEL BANDWIDTH	MODULATION	MODE
ERP	23755 to 23825	23755, 23790, 23825	5MHz	QPSK, 16QAM	1 RB/ 0,24 RB Offest
	23780 to 23800	23780, 23790, 23800	10MHz	QPSK, 16QAM	1 RB/ 0,49 RB Offest
FREQUENCY STABILITY	23780 to 23800	23790	10MHz	QPSK,	Full RB
OCCUPIED BANDWIDTH	23755 to 23825	23755, 23790, 23825	5MHz	QPSK, 16QAM	Full RB
	23780 to 23800	23780, 23790, 23800	10MHz	QPSK, 16QAM	Full RB
PEAK TO AVERAGE RATIO	23755 to 23825	23755, 23790, 23825	5MHz	16QAM	Full RB
	23780 to 23800	23780, 23790, 23800	10MHz	16QAM	Full RB
BAND EDGE	23755 to 23825	23755, 23825	5MHz	QPSK,	1 RB/ 0,24 RB Offest Full RB
	23780 to 23800	23780, 23800	10MHz	QPSK,	1 RB/ 0,49 RB Offest Full RB
CONDCUDED EMISSION	23755 to 23825	23755, 23790, 23825	5MHz	QPSK,	1 RB, 0 RB Offest
	23780 to 23800	23780, 23790, 23800	10MHz	QPSK,	1 RB, 0 RB Offest
RADIATED EMISSION	23780 to 23800	23780, 23790, 23800	10MHz	16QAM	1 RB, 49 RB Offest

Unless otherwise stated the results shown in this test report refer only to the sample(s) tested and such sample(s) are retained for 90 days only.

除非另有說明，此報告結果僅對測試之樣品負責，同時此樣品僅保留90天。本報告未經本公司書面許可，不可部份複製。

This document is issued by the Company subject to its General Conditions of Service printed overleaf, available on request or accessible at www.sgs.com/terms_and_conditions.htm and, for electronic format documents, subject to Terms and Conditions for Electronic Documents at www.sgs.com/terms_e-document.htm. Attention is drawn to the limitation of liability, indemnification and jurisdiction issues defined therein. Any holder of this document is advised that information contained hereon reflects the Company's findings at the time of its intervention only and within the limits of Client's instructions, if any. The Company's sole responsibility is to its Client and this document does not exonerate parties to a transaction from exercising all their rights and obligations under the transaction documents. This document cannot be reproduced except in full, without prior written approval of the Company. Any unauthorized alteration, forgery or falsification of the content or appearance of this document is unlawful and offenders may be prosecuted to the fullest extent of the law.

SGS Taiwan Ltd.

No.134,WuKungRoad,NewTaipeiIndustrialPark,WukuDistrict,NewTaipeiCity,Taiwan24803/新北市五股區新北產業園區五工路 134 號

台灣檢驗科技股份有限公司

t (886-2) 2299-3279

f (886-2) 2298-0488

www.tw.sgs.com

Member of SGS Group

5. MEASUREMENT UNCERTAINTY

Test Items	Uncertainty
RF Power Output	+/- 1.10 dB
ERP/ EIRP measurement	Vertical Polarization = +/- 4.74dB Horizontal Polarization = +/- 4.62dB
99% Occupied Bandwidth	+/- 5.19 Hz
Out of Band Emissions at Antenna Terminals and Band Edge	+/- 0.70 dB
Peak to Average Ratio	+/- 0.70 dB
Frequency Stability vs. Temperature	+/- 5.19 Hz
Frequency Stability vs. Voltage	+/- 5.19 Hz
Temperature	+/- 0.65 °C
Humidity	+/- 4.6 %
DC / AC Power Source	DC= +/- 0.13%, AC= +/- 0.2%

Radiated Spurious Emission:

Measurement uncertainty (Polarization : Vertical)	9kHz – 30MHz: +/- 2.87 dB
	30MHz - 180MHz: +/- 3.37dB
	180MHz -417MHz: +/- 3.19dB
	0.417GHz-1GHz: +/- 3.19dB
	1GHz - 18GHz: +/- 4.04dB
	18GHz - 40GHz: +/- 4.04dB

Measurement uncertainty (Polarization : Horizontal)	9kHz – 30MHz: +/- 2.87 dB
	30MHz - 167MHz: +/- 4.22dB
	167MHz -500MHz: +/- 3.44dB
	0.5GHz-1GHz: +/- 3.39dB
	1GHz - 18GHz: +/- 4.08dB
	18GHz - 40GHz: +/- 4.08dB

This uncertainty represents an expanded uncertainty expressed at approximately the 95% confidence level using a coverage factor of k=2.

Unless otherwise stated the results shown in this test report refer only to the sample(s) tested and such sample(s) are retained for 90 days only.

除非另有說明，此報告結果僅對測試之樣品負責，同時此樣品僅保留90天。本報告未經本公司書面許可，不可部份複製。

This document is issued by the Company subject to its General Conditions of Service printed overleaf, available on request or accessible at www.sgs.com/terms_and_conditions.htm and, for electronic format documents, subject to Terms and Conditions for Electronic Documents at www.sgs.com/terms_e-document.htm. Attention is drawn to the limitation of liability, indemnification and jurisdiction issues defined therein. Any holder of this document is advised that information contained hereon reflects the Company's findings at the time of its intervention only and within the limits of Client's instructions, if any. The Company's sole responsibility is to its Client and this document does not exonerate parties to a transaction from exercising all their rights and obligations under the transaction documents. This document cannot be reproduced except in full, without prior written approval of the Company. Any unauthorized alteration, forgery or falsification of the content or appearance of this document is unlawful and offenders may be prosecuted to the fullest extent of the law.

6. RF CONDUCTED OUTPUT POWER MEASUREMENT

6.1. Standard Applicable

A base station simulator was used to establish communication with the EUT. Its parameters were set to transmit the maximum power on the EUT. The measured power in the radio frequency on the transmitter output terminals.

6.2. Test Set-up

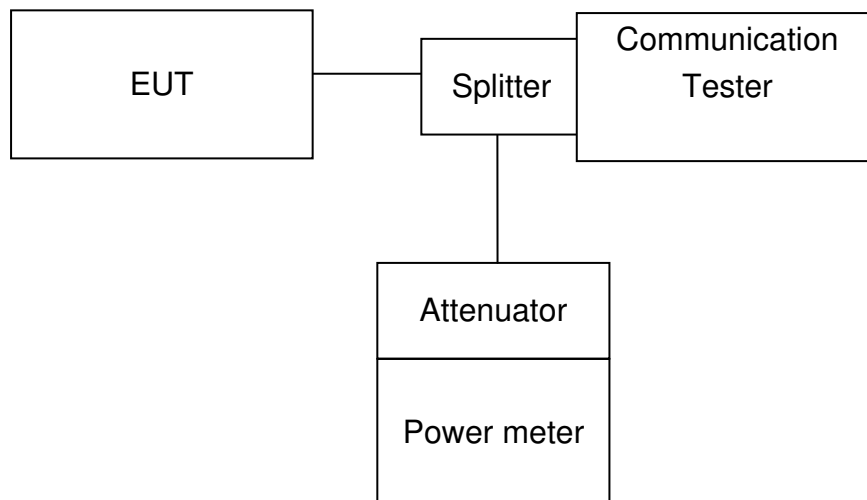

Note: Measurement setup for testing on Antenna connector

6.3. Measurement Procedure

The transmitter output was connected to a calibrated attenuator, the other end of which was connected to a power meter. Transmitter output was read off the power meter in dBm. The power output at the transmitter antenna port was determined by adding the value of the attenuator to the power meter reading. TS 151 010-1 is reference to conduct the test measurement of output power.

The Procedure of KDB941225 (SAR Measurement Procedures for 3G devices, (WCDMA/HSPA) was used for EUT and Base station setting. RMC 12.2kps is used for this testing, and KDB 971168 D01 Power Meas License Digital System as the supplemental test methodology to adjust the proper setting obtaining the measurement results

Unless otherwise stated the results shown in this test report refer only to the sample(s) tested and such sample(s) are retained for 90 days only.

除非另有說明，此報告結果僅對測試之樣品負責，同時此樣品僅保留90天。本報告未經本公司書面許可，不可部份複製。

This document is issued by the Company subject to its General Conditions of Service printed overleaf, available on request or accessible at www.sgs.com/terms_and_conditions.htm and, for electronic format documents, subject to Terms and Conditions for Electronic Documents at www.sgs.com/terms_e-document.htm. Attention is drawn to the limitation of liability, indemnification and jurisdiction issues defined therein. Any holder of this document is advised that information contained hereon reflects the Company's findings at the time of its intervention only and within the limits of Client's instructions, if any. The Company's sole responsibility is to its Client and this document does not exonerate parties to a transaction from exercising all their rights and obligations under the transaction documents. This document cannot be reproduced except in full, without prior written approval of the Company. Any unauthorized alteration, forgery or falsification of the content or appearance of this document is unlawful and offenders may be prosecuted to the fullest extent of the law.

SGS Taiwan Ltd.

No.134,WuKungRoad,NewTaipeiIndustrialPark,WukuDistrict,NewTaipeiCity,Taiwan24803/新北市五股區新北產業園區五工路 134 號

台灣檢驗科技股份有限公司

t (886-2) 2299-3279

f (886-2) 2298-0488

www.tw.sgs.com

Member of SGS Group

6.4. Measurement Equipment Used

Conducted Emission (measured at antenna port) Test Site					
EQUIPMENT TYPE	MFR	MODEL NUMBER	SERIAL NUMBER	LAST CAL.	CAL DUE.
Power Meter	Anritsu	ML2495A	1005007	12/15/2016	12/14/2017
Power Sensor	Anritsu	MA2411B	917032	12/15/2016	12/14/2017
EXA Spectrum Analyzer	Agilent	N9030A	MY53120760	03/21/2017	03/20/2018
DC Block	Mini-Circuits	BLK-18-S+	1	01/05/2017	01/04/2018
Coaxial Cable	HUBER+SUHNER	SUCOFLEX 102	23670/2	01/05/2017	01/04/2018
Attenuator	Mini-Circuit	BW-S10W2+	2	01/05/2017	01/04/2018
Splitter	Agilent	11636B	N/A	01/05/2017	01/04/2018
DC Power Supply	Agilent	E3640A	MY52410006	11/21/2016	11/20/2017
Temperature Chamber	TERCHY	MHG-120LF	911009	05/17/2016	05/16/2017
Radio Communication Analyser	Anritsu	MT8820C	6201465317	01/03/2017	01/02/2018
Radio Communication Analyzer	R&S	CMU200	102189	02/11/2017	02/10/2018

6.5. Measurement Result

RF Conducted Output Power

Unless otherwise stated the results shown in this test report refer only to the sample(s) tested and such sample(s) are retained for 90 days only.

除非另有說明，此報告結果僅對測試之樣品負責，同時此樣品僅保留90天。本報告未經本公司書面許可，不可部份複製。

This document is issued by the Company subject to its General Conditions of Service printed overleaf, available on request or accessible at www.sgs.com/terms_and_conditions.htm and, for electronic format documents, subject to Terms and Conditions for Electronic Documents at www.sgs.com/terms_e-document.htm. Attention is drawn to the limitation of liability, indemnification and jurisdiction issues defined therein. Any holder of this document is advised that information contained hereon reflects the Company's findings at the time of its intervention only and within the limits of Client's instructions, if any. The Company's sole responsibility is to its Client and this document does not exonerate parties to a transaction from exercising all their rights and obligations under the transaction documents. This document cannot be reproduced except in full, without prior written approval of the Company. Any unauthorized alteration, forgery or falsification of the content or appearance of this document is unlawful and offenders may be prosecuted to the fullest extent of the law.

SGS Taiwan Ltd.

No.134,WuKungRoad,NewTaipeiIndustrialPark,WukuDistrict,NewTaipeiCity,Taiwan24803/新北市五股區新北產業園區五工路 134 號

台灣檢驗科技股份有限公司

t (886-2) 2299-3279

f (886-2) 2298-0488

www.tw.sgs.com

Member of SGS Group

EUT Mode	Frequency (MHz)	CH	Average Burst Power	Average Burst Power	Average Burst Power	Average Burst Power
			(1DN 1UP) Class 8 (dBm)	(1DN 2UP) Class 10 (dBm)	(1DN 3UP) Class 10 (dBm)	(1DN 4UP) Class 12 (dBm)
GPRS 850	824.2	128	32.94	32.63	30.31	28.95
	836.6	190	33.07	32.84	30.21	28.96
	848.8	251	33.06	32.93	30.20	28.82
GPRS 1900	1850.2	512	29.60	29.28	26.85	24.95
	1880.0	661	29.59	29.20	26.83	24.93
	1909.8	810	29.58	29.21	26.96	25.03
EDGE 850	824.2	128	27.44	26.41	26.08	24.04
	836.6	190	27.47	26.49	26.28	24.15
	848.8	251	27.45	26.31	26.04	24.13
EDGE 1900	1850.2	512	26.02	25.52	25.34	23.08
	1880.0	661	25.97	25.78	25.33	23.57
	1909.8	810	25.89	25.16	25.04	23.49

Unless otherwise stated the results shown in this test report refer only to the sample(s) tested and such sample(s) are retained for 90 days only.

除非另有說明，此報告結果僅對測試之樣品負責，同時此樣品僅保留90天。本報告未經本公司書面許可，不可部份複製。

This document is issued by the Company subject to its General Conditions of Service printed overleaf, available on request or accessible at www.sgs.com/terms_and_conditions.htm and, for electronic format documents, subject to Terms and Conditions for Electronic Documents at www.sgs.com/terms_e-document.htm. Attention is drawn to the limitation of liability, indemnification and jurisdiction issues defined therein. Any holder of this document is advised that information contained hereon reflects the Company's findings at the time of its intervention only and within the limits of Client's instructions, if any. The Company's sole responsibility is to its Client and this document does not exonerate parties to a transaction from exercising all their rights and obligations under the transaction documents. This document cannot be reproduced except in full, without prior written approval of the Company. Any unauthorized alteration, forgery or falsification of the content or appearance of this document is unlawful and offenders may be prosecuted to the fullest extent of the law.

SGS Taiwan Ltd.

No.134,WuKungRoad,NewTaipeiIndustrialPark,WukuDistrict,NewTaipeiCity,Taiwan24803/新北市五股區新北產業園區五工路 134 號

台灣檢驗科技股份有限公司

t (886-2) 2299-3279

f (886-2) 2298-0488

www.tw.sgs.com

Member of SGS Group

WCDMA MODE:

The following tests were completed according to the test requirements outlined in section 5.2 of the 3GPP TS34.121-1 V8.4.0 specification. The EUT supports power Class 3, which has a nominal maximum output power of 24 dBm (+1.7/-3.7). RMC 12.2kps is used for this testing.

Results:

EUT Mode		WCDMA Band II	HSDPA Band II	HSUPA Band II
Frequency (MHz)	CH	Avg. Power (dBm)	Avg. Power (dBm)	Avg. Power (dBm)
1852.4	9262	23.75	22.70	22.29
1880.0	9400	23.93	22.83	22.45
1907.6	9538	23.79	22.97	22.41

EUT Mode		WCDMA Band IV	HSDPA Band IV	HSUPA Band IV
Frequency (MHz)	CH	Avg. Power (dBm)	Avg. Power (dBm)	Avg. Power (dBm)
1712.4	1312	24.15	23.52	23.22
1732.6	1412	24.03	23.18	22.64
1752.6	1513	24.06	23.41	22.87

EUT Mode		WCDMA Band V	HSDPA Band V	HSUPA Band V
Frequency (MHz)	CH	Avg. Power (dBm)	Avg. Power (dBm)	Avg. Power (dBm)
826.4	4132	23.90	22.69	22.41
836.6	4183	23.88	22.86	22.53
846.6	4233	23.87	22.94	22.41

Unless otherwise stated the results shown in this test report refer only to the sample(s) tested and such sample(s) are retained for 90 days only.

除非另有說明，此報告結果僅對測試之樣品負責，同時此樣品僅保留90天。本報告未經本公司書面許可，不可部份複製。

This document is issued by the Company subject to its General Conditions of Service printed overleaf, available on request or accessible at www.sgs.com/terms_and_conditions.htm and, for electronic format documents, subject to Terms and Conditions for Electronic Documents at www.sgs.com/terms_e-document.htm. Attention is drawn to the limitation of liability, indemnification and jurisdiction issues defined therein. Any holder of this document is advised that information contained hereon reflects the Company's findings at the time of its intervention only and within the limits of Client's instructions, if any. The Company's sole responsibility is to its Client and this document does not exonerate parties to a transaction from exercising all their rights and obligations under the transaction documents. This document cannot be reproduced except in full, without prior written approval of the Company. Any unauthorized alteration, forgery or falsification of the content or appearance of this document is unlawful and offenders may be prosecuted to the fullest extent of the law.

CDMA2000/EVDO MODE

Mode	Freq. (MHz)	CH	Avg. Power (dBm)
CDMA 2000 Cellular BC0	824.7	1013	23.75
	836.52	384	23.85
	848.31	777	24.12

Mode	Freq. (MHz)	CH	Avg. Power (dBm)
CDMA 2000 PCS BC1	1851.25	25	24.10
	1880	600	24.28
	1908.75	1175	24.22

Mode	Freq. (MHz)	CH	Avg. Power (dBm)
CDMA 2000 EVDO Cellular BC0	824.7	1013	23.66
	836.5	384	23.74
	848.3	777	23.99

Mode	Freq. (MHz)	CH	Avg. Power (dBm)
CDMA 2000 EVDO PCS BC1	1851.25	25	23.96
	1880	600	24.16
	1908.75	1175	24.09

Cable loss CDMA2000 Cell BC0:

13.6 dB

Cable loss CDMA PCS BC1:

14 dB

Unless otherwise stated the results shown in this test report refer only to the sample(s) tested and such sample(s) are retained for 90 days only.

除非另有說明，此報告結果僅對測試之樣品負責，同時此樣品僅保留90天。本報告未經本公司書面許可，不可部份複製。

This document is issued by the Company subject to its General Conditions of Service printed overleaf, available on request or accessible at www.sgs.com/terms_and_conditions.htm and, for electronic format documents, subject to Terms and Conditions for Electronic Documents at www.sgs.com/terms_e-document.htm. Attention is drawn to the limitation of liability, indemnification and jurisdiction issues defined therein. Any holder of this document is advised that information contained hereon reflects the Company's findings at the time of its intervention only and within the limits of Client's instructions, if any. The Company's sole responsibility is to its Client and this document does not exonerate parties to a transaction from exercising all their rights and obligations under the transaction documents. This document cannot be reproduced except in full, without prior written approval of the Company. Any unauthorized alteration, forgery or falsification of the content or appearance of this document is unlawful and offenders may be prosecuted to the fullest extent of the law.

LTE Result:

LTE Band 2

LTE Band 2_Uplink frequency band : 1850 to 1910 MHz								
BW (MHz)	RB Size	RB Offset	Conducted power(dBm)					
			QPSK			16QAM		
			Channel (Low) 18607	Channel (Mid) 18900	Channel (High) 19193	Channel (Low) 18607	Channel (Mid) 18900	Channel (High) 19193
1.4	1	0	23.09	23.15	23.12	21.92	21.9	21.7
	1	5	23.08	23.12	23.13	21.9	21.82	21.82
	3	2	22.94	22.97	23.01	21.91	21.99	22.06
	6	0	22.04	22.1	22.07	20.86	20.95	21.01

LTE Band 2_Uplink frequency band : 1850 to 1910 MHz								
BW (MHz)	RB Size	RB Offset	Conducted power(dBm)					
			QPSK			16QAM		
			Channe l (Low) 18615	Channe l (Mid) 18900	Channe l (High) 19185	Channe l (Low) 18615	Channe l (Mid) 18900	Channe l (High) 19185
3	1	0	23.07	22.95	23.16	21.86	21.26	21.94
	1	14	22.98	23.11	23.15	21.86	21.67	22.16
	8	4	21.8	21.72	22.07	20.94	21	21.07
	15	0	21.96	21.85	22.09	20.92	20.99	21.04

LTE Band 2_Uplink frequency band : 1850 to 1910 MHz								
BW (MHz)	RB Size	RB Offset	Conducted power(dBm)					
			QPSK			16QAM		
			Channel (Low) 18625	Channel (Mid) 18900	Channel (High) 19175	Channel (Low) 18625	Channel (Mid) 18900	Channel (High) 19175
5	1	0	23.08	23.11	23.13	21.68	21.82	21.3
	1	24	23.2	23.18	23.26	21.8	21.9	21.34
	12	6	21.86	22.01	22.07	21.04	21.11	21.07
	25	0	22.07	22.09	22.09	20.98	21.02	21.08

LTE Band 2_Uplink frequency band : 1850 to 1910 MHz								
BW (MHz)	RB Size	RB Offset	Conducted power(dBm)					
			QPSK			16QAM		
			Channe l (Low) 18650	Channe l (Mid) 18900	Channe l (High) 19150	Channe l (Low) 18650	Channe l (Mid) 18900	Channe l (High) 19150
10	1	0	23.05	23.12	23.13	21.74	21.92	21.9
	1	49	22.91	23.18	23.15	21.75	21.84	21.64
	25	12	22	22.07	22.08	21.06	21.05	21.09
	50	0	22.02	22.08	21.94	20.95	20.98	21.04

LTE Band 2_Uplink frequency band : 1850 to 1910 MHz								
BW (MHz)	RB Size	RB Offset	Conducted power(dBm)					
			QPSK			16QAM		
			Channel (Low) 18675	Channel (Mid) 18900	Channel (High) 19125	Channel (Low) 18675	Channel (Mid) 18900	Channel (High) 19125
15	1	0	22.91	22.97	23.08	21.6	21.85	22.03
	1	74	23.17	23.14	23.13	21.82	21.81	21.91
	36	19	22.03	22	22.09	20.95	21.07	21.06
	75	0	22.03	22.12	21.76	20.92	21.05	20.98

LTE Band 2_Uplink frequency band : 1850 to 1910 MHz								
BW (MHz)	RB Size	RB Offset	Conducted power(dBm)					
			QPSK			16QAM		
			Channe l (Low) 18700	Channe l (Mid) 18900	Channe l (High) 19100	Channe l (Low) 18700	Channe l (Mid) 18900	Channe l (High) 19100
20	1	0	22.57	22.79	22.99	21.83	21.82	21.8
	1	99	22.96	23.04	23.15	21.53	21.93	21.84
	50	25	22.03	22.17	22.08	20.97	21.12	21.14
	100	0	21.96	22.15	22.13	21.08	21.09	21.08

Unless otherwise stated the results shown in this test report refer only to the sample(s) tested and such sample(s) are retained for 90 days only.

除非另有說明，此報告結果僅對測試之樣品負責，同時此樣品僅保留90天。本報告未經本公司書面許可，不可部份複製。

This document is issued by the Company subject to its General Conditions of Service printed overleaf, available on request or accessible at www.sgs.com/terms_and_conditions.htm and, for electronic format documents, subject to Terms and Conditions for Electronic Documents at www.sgs.com/terms_e-document.htm. Attention is drawn to the limitation of liability, indemnification and jurisdiction issues defined therein. Any holder of this document is advised that information contained hereon reflects the Company's findings at the time of its intervention only and within the limits of Client's instructions, if any. The Company's sole responsibility is to its Client and this document does not exonerate parties to a transaction from exercising all their rights and obligations under the transaction documents. This document cannot be reproduced except in full, without prior written approval of the Company. Any unauthorized alteration, forgery or falsification of the content or appearance of this document is unlawful and offenders may be prosecuted to the fullest extent of the law.

LTE Band 4

LTE Band 4 Uplink frequency band : 1710 to 1755 MHz								
BW (MHz)	RB Size	RB Offset	Conducted power(dBm)					
			QPSK			16QAM		
			Channel (Low)	Channel (Mid)	Channel (High)	Channel (Low)	Channel (Mid)	Channel (High)
			19957	20175	20393	19957	20175	20393
1.4	1	0	22.99	23.16	23.05	21.44	21.96	21.98
	1	5	23.22	23.16	23.06	21.62	22.08	22.17
	3	2	23.22	22.97	23.26	22.18	21.91	21.78
	6	0	22.27	22.1	22.13	21.25	21.02	21.04

LTE Band 4 Uplink frequency band : 1710 to 1755 MHz								
BW (MHz)	RB Size	RB Offset	Conducted power(dBm)					
			QPSK			16QAM		
			Channel (Low)	Channel (Mid)	Channel (High)	Channel (Low)	Channel (Mid)	Channel (High)
			19965	20175	20385	19965	20175	20385
3	1	0	23.66	23.3	23.23	21.63	21.4	21.76
	1	14	23.32	23.17	22.11	22.12	21.66	22.03
	8	4	22.12	22.01	22.07	21.17	21.14	21.12
	15	0	22.16	22.11	22.12	21.17	21.05	21.03

LTE Band 4 Uplink frequency band : 1710 to 1755 MHz								
BW (MHz)	RB Size	RB Offset	Conducted power(dBm)					
			QPSK			16QAM		
			Channel (Low)	Channel (Mid)	Channel (High)	Channel (Low)	Channel (Mid)	Channel (High)
			19975	20175	20375	19975	20175	20375
5	1	0	23.38	23.22	23.24	22.36	22.08	21.95
	1	24	23.27	23.19	23.51	22.21	21.66	22.03
	12	6	22.2	22.11	22.08	21.24	21.17	20.93
	25	0	22.2	22.12	22.2	21.24	21.1	21.1

LTE Band 4 Uplink frequency band : 1710 to 1755 MHz								
BW (MHz)	RB Size	RB Offset	Conducted power(dBm)					
			QPSK			16QAM		
			Channel (Low)	Channel (Mid)	Channel (High)	Channel (Low)	Channel (Mid)	Channel (High)
			20000	20175	20350	20000	20175	20350
10	1	0	23.39	23.27	23.13	22.3	22.1	22.12
	1	49	23.32	23.13	22.56	21.96	22.11	22.06
	25	12	22.34	22.1	22.03	21.16	21.12	21.15
	50	0	22.34	22.17	22.23	21.3	21.26	21.2

LTE Band 4 Uplink frequency band : 1710 to 1755 MHz								
BW (MHz)	RB Size	RB Offset	Conducted power(dBm)					
			QPSK			16QAM		
			Channel (Low)	Channel (Mid)	Channel (High)	Channel (Low)	Channel (Mid)	Channel (High)
			20025	20175	20325	20025	20175	20325
15	1	0	23.36	23.27	23.19	22.33	22.3	21.92
	1	74	23.19	23.08	23.02	21.8	21.81	22.31
	36	19	22.12	22.09	22.03	21.02	21.11	21
	75	0	22.24	22.05	22.13	21.3	21.27	21.1

LTE Band 4 Uplink frequency band : 1710 to 1755 MHz								
BW (MHz)	RB Size	RB Offset	Conducted power(dBm)					
			QPSK			16QAM		
			Channel (Low)	Channel (Mid)	Channel (High)	Channel (Low)	Channel (Mid)	Channel (High)
			20050	20175	20300	20050	20175	20300
20	1	0	23.43	23.27	23.18	22.34	22.15	22.05
	1	99	23.06	22.95	23.56	21.69	21.69	21.99
	50	25	22.24	22.13	22.09	21.29	21.08	21.11
	100	0	22.33	22.18	22.19	21.27	21.12	21.09

Unless otherwise stated the results shown in this test report refer only to the sample(s) tested and such sample(s) are retained for 90 days only.

除非另有說明，此報告結果僅對測試之樣品負責，同時此樣品僅保留90天。本報告未經本公司書面許可，不可部份複製。

This document is issued by the Company subject to its General Conditions of Service printed overleaf, available on request or accessible at www.sgs.com/terms_and_conditions.htm and, for electronic format documents, subject to Terms and Conditions for Electronic Documents at www.sgs.com/terms_e-document.htm. Attention is drawn to the limitation of liability, indemnification and jurisdiction issues defined therein. Any holder of this document is advised that information contained hereon reflects the Company's findings at the time of its intervention only and within the limits of Client's instructions, if any. The Company's sole responsibility is to its Client and this document does not exonerate parties to a transaction from exercising all their rights and obligations under the transaction documents. This document cannot be reproduced except in full, without prior written approval of the Company. Any unauthorized alteration, forgery or falsification of the content or appearance of this document is unlawful and offenders may be prosecuted to the fullest extent of the law.

LTE Band 5

LTE Band 5 Uplink frequency band : 824 to 849 MHz								
BW (MHz)	RB Size	RB Offset	Conducted power(dBm)					
			QPSK			16QAM		
			Channel (Low)	Channel (Mid)	Channel (High)	Channel (Low)	Channel (Mid)	Channel (High)
1.4	1	0	20407	20525	20643	20407	20525	20643
	1	5	22.94	22.9	22.85	21.8	21.5	21.73
	1	5	22.98	22.94	22.87	21.67	21.81	21.89
	3	2	22.9	22.79	22.81	21.79	21.76	21.82
6	0	21.97	21.77	21.74	20.83	20.69	20.72	

LTE Band 5 Uplink frequency band : 824 to 849 MHz								
BW (MHz)	RB Size	RB Offset	Conducted power(dBm)					
			QPSK			16QAM		
			Channel (Low)	Channel (Mid)	Channel (High)	Channel (Low)	Channel (Mid)	Channel (High)
3	1	0	20415	20525	20635	20415	20525	20635
	1	0	23.01	22.92	22.86	21.82	21.71	21.4
	1	14	22.99	22.96	22.89	21.77	21.64	21.63
	8	4	21.86	21.77	21.81	20.68	20.85	20.82
15	0	21.93	21.79	21.83	20.63	20.79	20.81	

LTE Band 5 Uplink frequency band : 824 to 849 MHz								
BW (MHz)	RB Size	RB Offset	Conducted power(dBm)					
			QPSK			16QAM		
			Channel (Low)	Channel (Mid)	Channel (High)	Channel (Low)	Channel (Mid)	Channel (High)
5	1	0	20425	20525	20625	20425	20525	20625
	1	0	22.98	22.95	22.91	21.72	21.7	21.61
	1	24	22.93	22.94	22.93	21.48	21.87	21.71
	12	6	21.88	21.87	21.83	20.94	20.86	20.76
25	0	21.87	21.78	21.83	20.74	20.75	20.59	

LTE Band 5 Uplink frequency band : 824 to 849 MHz								
BW (MHz)	RB Size	RB Offset	Conducted power(dBm)					
			QPSK			16QAM		
			Channel (Low)	Channel (Mid)	Channel (High)	Channel (Low)	Channel (Mid)	Channel (High)
10	1	0	20450	20525	20600	20450	20525	20600
	1	0	23.02	22.56	23.02	21.57	21.5	21.79
	1	49	22.97	23.07	22.94	21.59	21.69	21.67
	25	12	21.76	21.88	21.81	20.84	20.85	20.78
50	0	21.91	21.85	21.86	20.85	20.82	20.79	

LTE Band 7

LTE Band 7 Uplink frequency band : 2500 to 2570 MHz								
BW (MHz)	RB Size	RB Offset	Conducted power(dBm)					
			QPSK			16QAM		
			Channel (Low)	Channel (Mid)	Channel (High)	Channel (Low)	Channel (Mid)	Channel (High)
5	1	0	20775	21100	21425	20775	21100	21425
	1	0	22.62	23.34	22.96	21.72	22.14	21.73
	1	24	23.11	23.32	22.35	21.77	22.15	21.57
	12	6	21.94	22.21	21.8	20.94	21.27	20.88
25	0	21.98	22.24	21.83	20.94	21.24	20.69	

LTE Band 7 Uplink frequency band : 2500 to 2570 MHz								
BW (MHz)	RB Size	RB Offset	Conducted power(dBm)					
			QPSK			16QAM		
			Channel (Low)	Channel (Mid)	Channel (High)	Channel (Low)	Channel (Mid)	Channel (High)
10	1	0	20800	21100	21400	20800	21100	21400
	1	0	22.91	23.19	23.11	21.9	22.04	21.42
	1	49	23.07	23.34	22.79	21.84	22.12	21.66
	25	12	21.85	22.23	21.89	20.7	21.32	20.91
50	0	21.84	22.24	21.9	20.93	21.25	20.52	

LTE Band 7 Uplink frequency band : 2500 to 2570 MHz								
BW (MHz)	RB Size	RB Offset	Conducted power(dBm)					
			QPSK			16QAM		
			Channel (Low)	Channel (Mid)	Channel (High)	Channel (Low)	Channel (Mid)	Channel (High)
15	1	0	20825	21100	21375	20825	21100	21375
	1	0	22.86	23.02	22.89	21.77	21.87	22.11
	1	74	23.03	23.33	23.02	22.04	21.81	21.65
	36	19	21.93	22.25	22	20.99	21.19	20.91
75	0	21.91	22.22	21.96	20.98	21.25	20.99	

LTE Band 7 Uplink frequency band : 2500 to 2570 MHz								
BW (MHz)	RB Size	RB Offset	Conducted power(dBm)					
			QPSK			16QAM		
			Channel (Low)	Channel (Mid)	Channel (High)	Channel (Low)	Channel (Mid)	Channel (High)
20	1	0	20850	21100	21350	20850	21100	21350
	1	0	22.87	22.43	23.11	21.9	22.21	21.8
	1	99	23.09	23.33	22.97	21.73	22.12	21.43
	50	25	22.01	22.25	22	21.01	21.19	20.91
100	0	21.92	22.17	22	20.99	21.22	20.93	

Unless otherwise stated the results shown in this test report refer only to the sample(s) tested and such sample(s) are retained for 90 days only.

除非另有說明，此報告結果僅對測試之樣品負責，同時此樣品僅保留90天。本報告未經本公司書面許可，不可部份複製。

This document is issued by the Company subject to its General Conditions of Service printed overleaf, available on request or accessible at www.sgs.com/terms_and_conditions.htm and, for electronic format documents, subject to Terms and Conditions for Electronic Documents at www.sgs.com/terms_e-document.htm. Attention is drawn to the limitation of liability, indemnification and jurisdiction issues defined therein. Any holder of this document is advised that information contained hereon reflects the Company's findings at the time of its intervention only and within the limits of Client's instructions, if any. The Company's sole responsibility is to its Client and this document does not exonerate parties to a transaction from exercising all their rights and obligations under the transaction documents. This document cannot be reproduced except in full, without prior written approval of the Company. Any unauthorized alteration, forgery or falsification of the content or appearance of this document is unlawful and offenders may be prosecuted to the fullest extent of the law.

LTE Band 12

LTE Band 12_Uplink frequency band : 699 to 716 MHz								
BW (MHz)	RB Size	RB Offset	Conducted power(dBm)					
			QPSK			16QAM		
			Channel (Low)	Channel (Mid)	Channel (High)	Channel (Low)	Channel (Mid)	Channel (High)
1.4	1	0	22.77	22.7	22.53	21.62	21.54	21.68
	1	5	22.47	22.82	22.96	21.63	21.68	21.41
	3	2	22.6	22.5	22.86	21.52	21.67	21.48
	6	0	21.69	21.76	21.6	20.63	20.62	20.76

LTE Band 12_Uplink frequency band : 699 to 716 MHz								
BW (MHz)	RB Size	RB Offset	Conducted power(dBm)					
			QPSK			16QAM		
			Channel (Low)	Channel (Mid)	Channel (High)	Channel (Low)	Channel (Mid)	Channel (High)
3	1	0	22.6	22.94	22.53	21.45	21.4	21.44
	1	14	22.81	22.5	22.79	21.37	21.54	21.02
	8	4	21.75	21.62	21.75	20.73	20.72	20.74
	15	0	21.86	21.78	21.78	20.7	20.71	20.74

LTE Band 12_Uplink frequency band : 699 to 716 MHz								
BW (MHz)	RB Size	RB Offset	Conducted power(dBm)					
			QPSK			16QAM		
			Channel (Low)	Channel (Mid)	Channel (High)	Channel (Low)	Channel (Mid)	Channel (High)
5	1	0	22.72	22.76	22.81	21.31	21.94	21.43
	1	24	22.35	22.77	22.83	21.95	21.36	21.65
	12	6	21.56	21.71	21.61	20.81	20.78	20.68
	25	0	21.72	21.75	21.75	20.71	20.78	20.88

LTE Band 12_Uplink frequency band : 699 to 716 MHz								
BW (MHz)	RB Size	RB Offset	Conducted power(dBm)					
			QPSK			16QAM		
			Channel (Low)	Channel (Mid)	Channel (High)	Channel (Low)	Channel (Mid)	Channel (High)
10	1	0	22.64	22.79	22.58	21.45	21.4	21.45
	1	49	22.69	22.77	22.99	21.44	21.29	21.7
	25	12	21.82	21.65	21.75	20.85	20.75	20.71
	50	0	21.73	21.69	21.7	20.59	20.77	20.63

LTE Band 13

LTE Band 13_Uplink frequency band : 777 to 787 MHz								
BW (MHz)	RB Size	RB Offset	Conducted power(dBm)					
			QPSK			16 QAM		
			Channel (Low)	Channel (Mid)	Channel (High)	Channel (Low)	Channel (Mid)	Channel (High)
5	1	0	22.45	22.5	22.57	21.36	21.16	21.52
	1	24	22.91	22.52	22.71	21.63	21.41	21.41
	12	6	21.61	21.59	21.66	20.59	20.48	20.67
	25	0	21.65	21.61	21.75	20.59	20.26	20.72

LTE Band 13_Uplink frequency band : 777 to 787 MHz								
BW (MHz)	RB Size	RB Offset	Conducted power(dBm)					
			QPSK			16 QAM		
			Channel (Low)	Channel (Mid)	Channel (High)	Channel (Low)	Channel (Mid)	Channel (High)
10	1	0		22.53				21.56
	1	49		22.7				21.61
	25	12		21.62				20.65
	50	0		21.66				20.75

LTE Band 17

LTE Band 17_Uplink frequency band : 704 to 716 MHz								
BW (MHz)	RB Size	RB Offset	Conducted power(dBm)					
			QPSK			16QAM		
			Channel (Low)	Channel (Mid)	Channel (High)	Channel (Low)	Channel (Mid)	Channel (High)
5	1	0	22.66	22.79	22.78	22	21.7	21.46
	1	24	22.89	22.88	22.71	21.78	21.6	21.47
	12	6	21.57	21.68	21.67	20.73	20.73	20.67
	25	0	21.67	21.69	21.67	20.75	20.53	20.53

LTE Band 17_Uplink frequency band : 704 to 716 MHz								
BW (MHz)	RB Size	RB Offset	Conducted power(dBm)					
			QPSK			16QAM		
			Channel (Low)	Channel (Mid)	Channel (High)	Channel (Low)	Channel (Mid)	Channel (High)
10	1	0	22.61	22.65	22.6	21.24	21.44	21.22
	1	49	22.75	22.94	22.84	21.59	21.29	21.72
	25	12	21.57	21.7	21.68	20.77	20.55	20.7
	50	0	21.63	21.52	21.67	20.67	20.57	20.73

Unless otherwise stated the results shown in this test report refer only to the sample(s) tested and such sample(s) are retained for 90 days only.

除非另有說明，此報告結果僅對測試之樣品負責，同時此樣品僅保留90天。本報告未經本公司書面許可，不可部份複製。

This document is issued by the Company subject to its General Conditions of Service printed overleaf, available on request or accessible at www.sgs.com/terms_and_conditions.htm and, for electronic format documents, subject to Terms and Conditions for Electronic Documents at www.sgs.com/terms_e-document.htm. Attention is drawn to the limitation of liability, indemnification and jurisdiction issues defined therein. Any holder of this document is advised that information contained hereon reflects the Company's findings at the time of its intervention only and within the limits of Client's instructions, if any. The Company's sole responsibility is to its Client and this document does not exonerate parties to a transaction from exercising all their rights and obligations under the transaction documents. This document cannot be reproduced except in full, without prior written approval of the Company. Any unauthorized alteration, forgery or falsification of the content or appearance of this document is unlawful and offenders may be prosecuted to the fullest extent of the law.

HSDPA Release 6 MODE:

The following 4 Sub-Tests were completed according to the test requirements outlined in section 5.2A of the 3GPP TS34.121-1 V8.4.0 specification. All TX RMS power requirements for Power Class 3 were met according to table 5.2AA.5 and 5.2B.5 All UE channels and power ratio's are set according to table C10.1.4 & C11.1.3 in the 3GPP TS34.121-1 V8.4.0. RMC 12.2kps is used for this testing.

HSDPA SUB-TEST Setting

Table C.10.1.4: β values for transmitter characteristics tests with HS-DPCCH(FOR HSDPA)

Sub-test	β_c	β_d	β_d (SF)	β_c/β_d	β_{HS} (Note 1, Note 2)	CM (dB) (Note 3)	MPR (dB) (Note 3)	RMC (Kbps)
1	2/15	15/15	64	2/15	4/15	0.0	0.0	12.2
2	12/15 (Note 4)	15/15 (Note 4)	64	12/15 (Note 4)	24/15	1.0	0.0	12.2
3	15/15	8/15	64	15/8	30/15	1.5	0.5	12.2
4	15/15	4/15	64	15/4	30/15	1.5	0.5	12.2

Note: The recommended HSDPA MPRs are implemented as per following sub-tests.

Unless otherwise stated the results shown in this test report refer only to the sample(s) tested and such sample(s) are retained for 90 days only.

除非另有說明，此報告結果僅對測試之樣品負責，同時此樣品僅保留90天。本報告未經本公司書面許可，不可部份複製。

This document is issued by the Company subject to its General Conditions of Service printed overleaf, available on request or accessible at www.sgs.com/terms_and_conditions.htm and, for electronic format documents, subject to Terms and Conditions for Electronic Documents at www.sgs.com/terms_e-document.htm. Attention is drawn to the limitation of liability, indemnification and jurisdiction issues defined therein. Any holder of this document is advised that information contained hereon reflects the Company's findings at the time of its intervention only and within the limits of Client's instructions, if any. The Company's sole responsibility is to its Client and this document does not exonerate parties to a transaction from exercising all their rights and obligations under the transaction documents. This document cannot be reproduced except in full, without prior written approval of the Company. Any unauthorized alteration, forgery or falsification of the content or appearance of this document is unlawful and offenders may be prosecuted to the fullest extent of the law.

Results:

Mode	Sub-test	Avg. Power (dBm) Channel			Power Class 3 Lim- itation (dBm)	Comments
		9262	9400	9538		
HSDPA (B2)	1	23.92	23.82	23.65	20.3dBm – 25.7dBm	Pass
	2	23.63	23.79	23.64	20.3dBm – 25.7dBm	Pass
	3	23.44	23.37	23.12	19.8dBm – 25.7dBm	Pass
	4	23.51	23.38	23.24	19.8dBm – 25.7dBm	Pass

Mode	Sub-test	Avg. Power (dBm) Channel			Power Class 3 Lim- itation (dBm)	Comments
		1312	1413	1513		
HSDPA (B4)	1	23.86	24.13	23.9	20.3dBm – 25.7dBm	Pass
	2	24.03	23.89	23.91	20.3dBm – 25.7dBm	Pass
	3	23.38	23.68	23.37	19.8dBm – 25.7dBm	Pass
	4	23.45	23.69	23.49	19.8dBm – 25.7dBm	Pass

Mode	Sub-test	Avg. Power (dBm) Channel			Power Class 3 Lim- itation (dBm)	Comments
		4132	4183	4233		
HSDPA (B5)	1	23.69	23.74	23.99	20.3dBm – 25.7dBm	Pass
	2	23.83	23.77	23.74	20.3dBm – 25.7dBm	Pass
	3	23.21	23.26	23.5	19.8dBm – 25.7dBm	Pass
	4	23.28	23.3	23.56	19.8dBm – 25.7dBm	Pass

Unless otherwise stated the results shown in this test report refer only to the sample(s) tested and such sample(s) are retained for 90 days only.

除非另有說明，此報告結果僅對測試之樣品負責，同時此樣品僅保留90天。本報告未經本公司書面許可，不可部份複製。

This document is issued by the Company subject to its General Conditions of Service printed overleaf, available on request or accessible at www.sgs.com/terms_and_conditions.htm and, for electronic format documents, subject to Terms and Conditions for Electronic Documents at www.sgs.com/terms_e-document.htm. Attention is drawn to the limitation of liability, indemnification and jurisdiction issues defined therein. Any holder of this document is advised that information contained hereon reflects the Company's findings at the time of its intervention only and within the limits of Client's instructions, if any. The Company's sole responsibility is to its Client and this document does not exonerate parties to a transaction from exercising all their rights and obligations under the transaction documents. This document cannot be reproduced except in full, without prior written approval of the Company. Any unauthorized alteration, forgery or falsification of the content or appearance of this document is unlawful and offenders may be prosecuted to the fullest extent of the law.

SGS Taiwan Ltd.

No.134,WuKungRoad,NewTaipeiIndustrialPark,WukuDistrict,NewTaipeiCity,Taiwan24803/新北市五股區新北產業園區五工路 134 號

台灣檢驗科技股份有限公司

t (886-2) 2299-3279

f (886-2) 2298-0488

www.tw.sgs.com

Member of SGS Group

HSPA (HSDPA & HSUPA) Release 6 MODE

The following 5 Sub-Tests were completed according to the test requirements outlined in section 5.2A of the 3GPP TS34.121-1 V8.4.0 specification. All TX RMS power requirements for Power Class 3 were met according to table 5.2AA.5 and 5.2B.5 All UE channels and power ratio's are set according to table C11.1.3 in the 3GPP TS34.121-1 V8.4.0. RMC 12.2kps is used for this testing

HSPA SUB-TEST Setting

Table C.11.1.3: β values for transmitter characteristics tests with HS-DPCCH and E-DCH(FOR HSUPA)

Sub-test	β_c	β_d	β_d (SF)	β_c/β_d	β_{HS}	β_{ec}	β_{ed}	β_{ed} (SF)	β_{ed} (Code s)	CM (dB)	MPR (dB)	AG Index	E-TFCI	RMC (Kbps)
1	11/15 (Note 3)	15/15 (Note 3)	64	11/15 (Note 3)	22/15	209/225	1309/225	4	1	1.0	0.0	20	75	12.2
2	6/15	15/15	64	6/15	12/15	12/15	94/75	4	1	3.0	2.0	12	67	12.2
3	15/15	9/15	64	15/9	30/15	30/15	$\beta_{ed1}: 47/15$ $\beta_{ed2}: 47/15$	4 4	2	2.0	1.0	15	92	12.2
4	2/15	15/15	64	2/15	4/15	2/15	56/75	4	1	3.0	2.0	17	71	12.2
5	15/15 (Note 4)	15/15 (Note 4)	64	15/15 (Note 4)	30/15	24/15	134/15	4	1	1.0	0.0	21	81	12.2

Note: The recommended HSUPA MPRs are implemented as per following sub-tests.

Results:

Mode	Sub-test	Avg. Power (dBm) Channel			Power Class 3 Limitation (dBm)	Comments
		9262	9400	9538		
HSUPA(B2)	1	23.67	23.91	23.73	18.8dBm – 25.7dBm	Pass
	2	21.72	21.98	21.77	16.8dBm – 25.7dBm	Pass
	3	22.73	22.93	22.81	17.8dBm – 25.7dBm	Pass
	4	21.85	22.03	21.81	16.8dBm – 25.7dBm	Pass
	5	23.56	23.77	23.64	18.8dBm – 25.7dBm	Pass

Unless otherwise stated the results shown in this test report refer only to the sample(s) tested and such sample(s) are retained for 90 days only.

除非另有說明，此報告結果僅對測試之樣品負責，同時此樣品僅保留90天。本報告未經本公司書面許可，不可部份複製。

This document is issued by the Company subject to its General Conditions of Service printed overleaf, available on request or accessible at www.sgs.com/terms_and_conditions.htm and, for electronic format documents, subject to Terms and Conditions for Electronic Documents at www.sgs.com/terms_e-document.htm. Attention is drawn to the limitation of liability, indemnification and jurisdiction issues defined therein. Any holder of this document is advised that information contained hereon reflects the Company's findings at the time of its intervention only and within the limits of Client's instructions, if any. The Company's sole responsibility is to its Client and this document does not exonerate parties to a transaction from exercising all their rights and obligations under the transaction documents. This document cannot be reproduced except in full, without prior written approval of the Company. Any unauthorized alteration, forgery or falsification of the content or appearance of this document is unlawful and offenders may be prosecuted to the fullest extent of the law.

Mode	Sub-test	Avg. Power (dBm) Channel			Power Class 3 Lim- itation (dBm)	Comments
		1312	1413	1513		
HSDPA (B4)	1	24.07	24.01	24	20.3dBm – 25.7dBm	Pass
	2	22.12	22.08	22.04	20.3dBm – 25.7dBm	Pass
	3	23.13	23.03	23.08	19.8dBm – 25.7dBm	Pass
	4	22.25	22.13	22.08	19.8dBm – 25.7dBm	Pass
	5	23.96	23.87	23.91	19.8dBm – 25.7dBm	Pass

Mode	Sub-test	Avg. Power (dBm) Channel			Power Class 3 Lim- itation (dBm)	Comments
		4132	4183	4233		
HSUPA(B5)	1	23.86	23.81	23.79	18.8dBm – 25.7dBm	Pass
	2	21.92	21.89	21.83	16.8dBm – 25.7dBm	Pass
	3	22.9	22.87	22.87	17.8dBm – 25.7dBm	Pass
	4	21.97	21.95	21.91	16.8dBm – 25.7dBm	Pass
	5	23.72	23.64	23.68	18.8dBm – 25.7dBm	Pass

WCDMA/HSDPA/HSUPA band II, IV, V

The EUT output power was controlled by simulator. Set Communication Tester [MT8820C](#) function key “UE Power Control” and enter max rated power 24dBm. The EUT is going to be set to max output power to 24dBm. Then record the read (see page 15 for measurement data). The min. power was measures by a function key “minimum power” then record the read. It is -52.3dBm. The power variation can be 0.1dB step by setting.

Unless otherwise stated the results shown in this test report refer only to the sample(s) tested and such sample(s) are retained for 90 days only.

除非另有說明，此報告結果僅對測試之樣品負責，同時此樣品僅保留90天。本報告未經本公司書面許可，不可部份複製。

This document is issued by the Company subject to its General Conditions of Service printed overleaf, available on request or accessible at www.sgs.com/terms_and_conditions.htm and, for electronic format documents, subject to Terms and Conditions for Electronic Documents at www.sgs.com/terms_e-document.htm. Attention is drawn to the limitation of liability, indemnification and jurisdiction issues defined therein. Any holder of this document is advised that information contained hereon reflects the Company's findings at the time of its intervention only and within the limits of Client's instructions, if any. The Company's sole responsibility is to its Client and this document does not exonerate parties to a transaction from exercising all their rights and obligations under the transaction documents. This document cannot be reproduced except in full, without prior written approval of the Company. Any unauthorized alteration, forgery or falsification of the content or appearance of this document is unlawful and offenders may be prosecuted to the fullest extent of the law.

SGS Taiwan Ltd.

No.134,WuKungRoad,NewTaipeiIndustrialPark,WukuDistrict,NewTaipeiCity,Taiwan24803/新北市五股區新北產業園區五工路 134 號

台灣檢驗科技股份有限公司

t (886-2) 2299-3279

f (886-2) 2298-0488

www.tw.sgs.com

Member of SGS Group

7. EFFECTIVE RADIATED POWER AND EQUIVALENT ISOTROPIC RADIATED POWER MEASUREMENT

7.1. Standard Applicable

According to FCC §2.1046

FCC 22.913(a) Mobile station is limited to 7W ERP.

FCC 24.232(b) Mobile and portable stations are limited to 2 W EIRP.

FCC 27.50(c) (9) Control stations and mobile stations are limited to 30 watts ERP.

FCC 27.50(d)(4) Fixed, mobile, and portable (hand-held) stations are limited to 1W EIRP.

FCC 27, 50(h)(2) Mobile and other user stations. Mobile stations are limited to 2 W EIRP

7.2. Test SET-UP

(A) Radiated Power Test Set-Up, Frequency Below 1000MHz

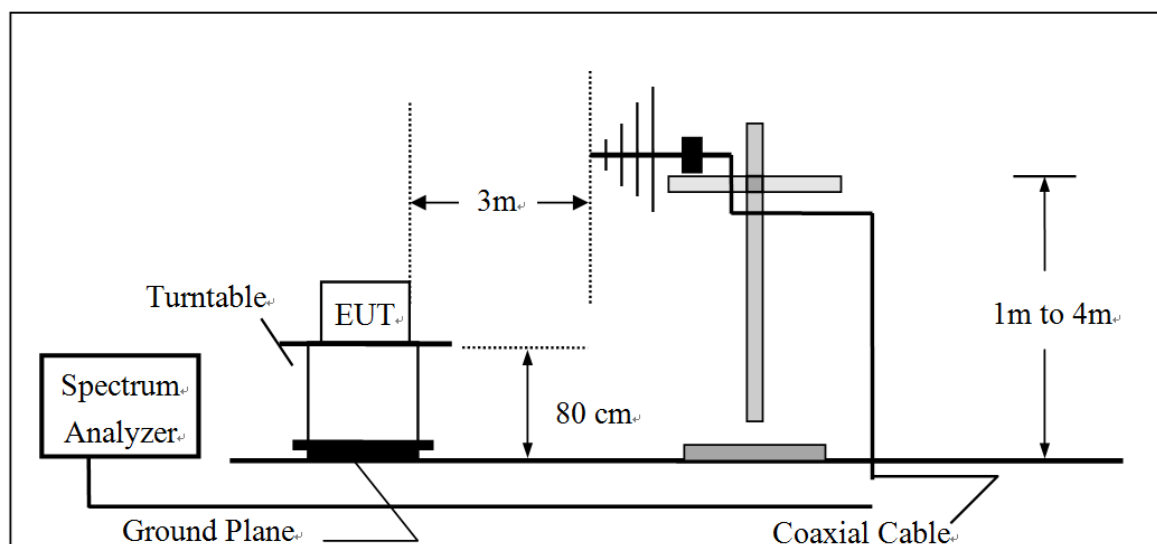

Unless otherwise stated the results shown in this test report refer only to the sample(s) tested and such sample(s) are retained for 90 days only.

除非另有說明，此報告結果僅對測試之樣品負責，同時此樣品僅保留90天。本報告未經本公司書面許可，不可部份複製。

This document is issued by the Company subject to its General Conditions of Service printed overleaf, available on request or accessible at www.sgs.com/terms_and_conditions.htm and, for electronic format documents, subject to Terms and Conditions for Electronic Documents at www.sgs.com/terms_e-document.htm. Attention is drawn to the limitation of liability, indemnification and jurisdiction issues defined therein. Any holder of this document is advised that information contained hereon reflects the Company's findings at the time of its intervention only and within the limits of Client's instructions, if any. The Company's sole responsibility is to its Client and this document does not exonerate parties to a transaction from exercising all their rights and obligations under the transaction documents. This document cannot be reproduced except in full, without prior written approval of the Company. Any unauthorized alteration, forgery or falsification of the content or appearance of this document is unlawful and offenders may be prosecuted to the fullest extent of the law.

SGS Taiwan Ltd.

No.134,WuKungRoad,NewTaipeiIndustrialPark,WukuDistrict,NewTaipeiCity,Taiwan24803/新北市五股區新北產業園區五工路 134 號

台灣檢驗科技股份有限公司

t (886-2) 2299-3279

f (886-2) 2298-0488

www.tw.sgs.com

Member of SGS Group

(B) Radiated Power Test Set-UP Frequency Over 1 GHz

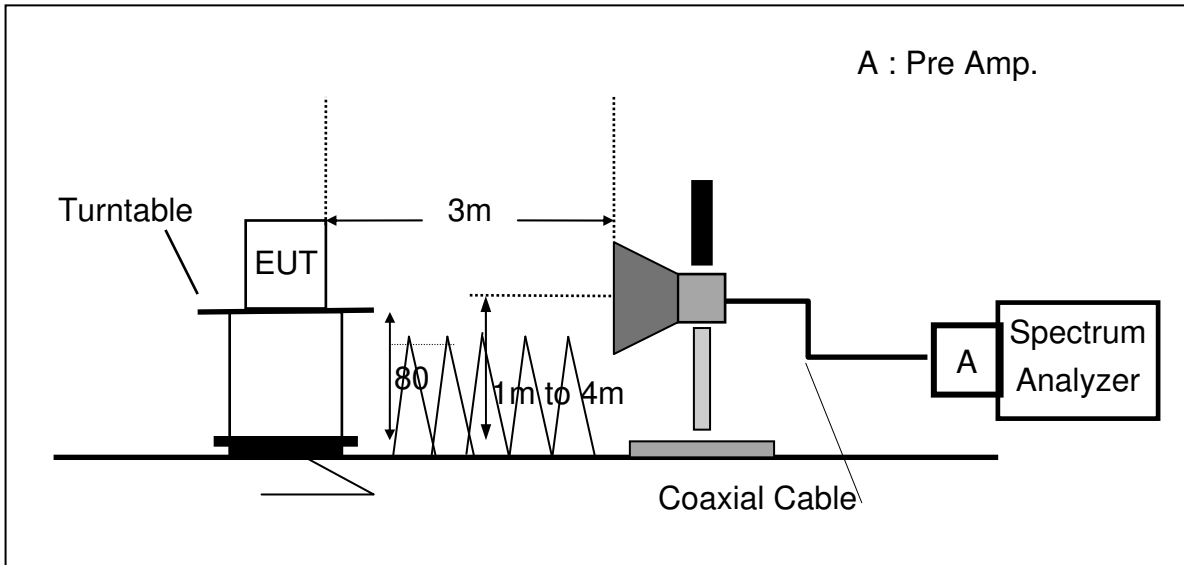

(C) Substituted Method Test Set-UP

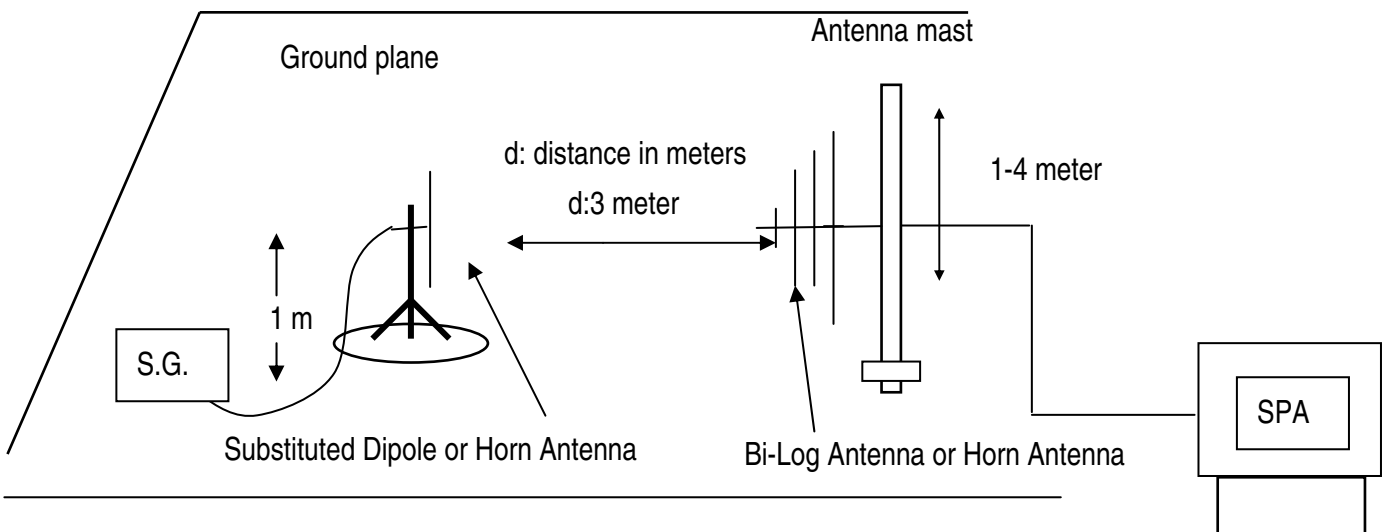

Unless otherwise stated the results shown in this test report refer only to the sample(s) tested and such sample(s) are retained for 90 days only.

除非另有說明，此報告結果僅對測試之樣品負責，同時此樣品僅保留90天。本報告未經本公司書面許可，不可部份複製。

This document is issued by the Company subject to its General Conditions of Service printed overleaf, available on request or accessible at www.sgs.com/terms_and_conditions.htm and, for electronic format documents, subject to Terms and Conditions for Electronic Documents at www.sgs.com/terms_e-document.htm. Attention is drawn to the limitation of liability, indemnification and jurisdiction issues defined therein. Any holder of this document is advised that information contained hereon reflects the Company's findings at the time of its intervention only and within the limits of Client's instructions, if any. The Company's sole responsibility is to its Client and this document does not exonerate parties to a transaction from exercising all their rights and obligations under the transaction documents. This document cannot be reproduced except in full, without prior written approval of the Company. Any unauthorized alteration, forgery or falsification of the content or appearance of this document is unlawful and offenders may be prosecuted to the fullest extent of the law.

7.3. Measurement Procedure

1. The testing follows the Measurement Procedure of FCC KDB 971168 D01
2. The EUT was placed on a non-conductive turntable using a non-conductive support. The radiated emission at the fundamental frequency was measured at 3 m with a test antenna and EMI spectrum analyzer.
3. During the measurement, the EUT was communication with the station. The highest emission was recorded with the rotation of the turntable and the lowering of the test antenna from 4m to 1m. The reading was recorded and the field strength (E in dBuV/m) was calculated
4. The testing follows the Measurement Procedure of FCC KDB 971168 D01
5. The substitution horn antenna is substituted for EUT at the same position and signals generator export the CW signal to the substitution antenna via a tx cable. Rotated the Turn Table and moved receiving antenna to find the maximum radiation power. Adjust output power level of S.G to get a Value of spectrum reading equal to "Read Value" of step b. Record the power level of S.G.
6. ERP = S.G. output (dBm) + Antenna Gain (dBd) – Cable Loss (dB)
7. ERP = S.G. output (dBm) + Antenna Gain (dBd) – Cable Loss (dB)
8. Spectrum setting:
 - (1) Detector = Peak, marker the highest value of the detector by maximum hold, set RBW wide enough to capture the entire signal of emission, and VBW > =3xRBW.
 - (2) KDB 971168 D01 is adopted, and the procedure as lists under item 4, Measurement of the Average Power over the Fundamental Signal Bandwidth, is followed to set correspondingly for the acquisition of proper measurement data.

Set frequency = nominal signal center frequency;
 Set span = 2 X occupied BW;
 Set RBW ≈ 1~5% of the span, not to exceed 1 MHz
 Set VBW = 3 x RBW;
 Select average power (RMS) detector
 Set sweep time and number of measurement points to achieve a minimum of 1 millisecond/pt integration time (ex. Point = 601points, then sweep time = 601*10⁻³ = 6s.

Activate trace averaging routine over a minimum of 10 sweeps;

Activate marker/span pair and set span = signal or channel bandwidth;

Activate the band/interval power marker function;

Record the band power level;

Record adjusted value as the average signal power level. Then activate the occupied bandwidth measurement function.

The proper adjustment due to limitation of spectrum capability is given compensated to spectrum with conversion factor of $10 \cdot \log(TBW/RBW)$, where TBW is the transmission of UE exceeding the maximum BW UE can extends, and RBW is the resolution BW in UE.

Unless otherwise stated the results shown in this test report refer only to the sample(s) tested and such sample(s) are retained for 90 days only.

除非另有說明，此報告結果僅對測試之樣品負責，同時此樣品僅保留90天。本報告未經本公司書面許可，不可部份複製。

This document is issued by the Company subject to its General Conditions of Service printed overleaf, available on request or accessible at www.sgs.com/terms_and_conditions.htm and, for electronic format documents, subject to Terms and Conditions for Electronic Documents at www.sgs.com/terms_e-document.htm. Attention is drawn to the limitation of liability, indemnification and jurisdiction issues defined therein. Any holder of this document is advised that information contained hereon reflects the Company's findings at the time of its intervention only and within the limits of Client's instructions, if any. The Company's sole responsibility is to its Client and this document does not exonerate parties to a transaction from exercising all their rights and obligations under the transaction documents. This document cannot be reproduced except in full, without prior written approval of the Company. Any unauthorized alteration, forgery or falsification of the content or appearance of this document is unlawful and offenders may be prosecuted to the fullest extent of the law.

7.4. Measurement Equipment Used

ERP, EIRP MEASUREMENT EQUIPMENT List 966 Chamber					
EQUIPMENT TYPE	MFR	MODEL NUMBER	SERIAL NUMBER	LAST CAL.	CAL DUE.
EMI Test Receiver	R&S	ESCI7	100760	05/10/2016	05/09/2017
Spectrum Analyzer	Agilent	E4446A	MY51100003	04/21/2016	04/20/2017
Loop Antenna	ETS-Lindgren	6502	148045	09/20/2016	09/19/2017
Bilog Antenna	SCHWAZBECK	VULB9168	378	12/19/2016	12/18/2017
Horn Antenna	Schwarzbeck	BBHA9120D	1441	08/01/2016	07/31/2017
Pre-Amplifier	Agilent	8447D	2944A07676	01/05/2017	01/04/2018
Pre-Amplifier	EMC Instruments Corp.	EMC0126530	980038	01/05/2017	01/04/2018
Turn Table	HD	DT420	N/A	N.C.R	N.C.R
Antenna Tower	ChamPro	AM-BS-4500-B	060776-ABS	N.C.R	N.C.R
Controller	ChamPro	EM1000	60776	N.C.R	N.C.R
Low Loss Cable	Huber Suhner	966_RX	9	01/05/2017	01/04/2018
3m Site NSA	SGS	966 chamber	N/A	07/01/2016	06/30/2017
Low Loss Cable	Huber Suhner	966 TX	1	01/05/2017	01/04/2018
Horn Antenna	Schwarzbeck	BBHA9170	184	12/12/2016	12/11/2017
Pre-Amplifier	EMC Instruments Corp.	EMC184045	980135	01/05/2017	01/04/2018
Radio Communication Analyzer	R&S	CMU200	102189	02/11/2017	02/10/2018
Radio Communication Analyer	Anritsu	MT8820C	6201465317	01/03/2017	01/02/2018

Unless otherwise stated the results shown in this test report refer only to the sample(s) tested and such sample(s) are retained for 90 days only.

除非另有說明，此報告結果僅對測試之樣品負責，同時此樣品僅保留90天。本報告未經本公司書面許可，不可部份複製。

This document is issued by the Company subject to its General Conditions of Service printed overleaf, available on request or accessible at www.sgs.com/terms_and_conditions.htm and, for electronic format documents, subject to Terms and Conditions for Electronic Documents at www.sgs.com/terms_e-document.htm. Attention is drawn to the limitation of liability, indemnification and jurisdiction issues defined therein. Any holder of this document is advised that information contained hereon reflects the Company's findings at the time of its intervention only and within the limits of Client's instructions, if any. The Company's sole responsibility is to its Client and this document does not exonerate parties to a transaction from exercising all their rights and obligations under the transaction documents. This document cannot be reproduced except in full, without prior written approval of the Company. Any unauthorized alteration, forgery or falsification of the content or appearance of this document is unlawful and offenders may be prosecuted to the fullest extent of the law.

SGS Taiwan Ltd.

No.134,WuKungRoad,NewTaipeiIndustrialPark,WukuDistrict,NewTaipeiCity,Taiwan24803/新北市五股區新北產業園區五工路 134 號

台灣檢驗科技股份有限公司

t (886-2) 2299-3279

f (886-2) 2298-0488

www.tw.sgs.com

Member of SGS Group

7.5. Measurement Result: (Peak) –using option of peak measurement

EUT			Measurement					
Operation Band	Fundamental Frequency	CH	Antenna Pol.	S.G. Output	Antenna Gain	Cable Loss	ERP	Limit

Unless otherwise stated the results shown in this test report refer only to the sample(s) tested and such sample(s) are retained for 90 days only.

除非另有說明，此報告結果僅對測試之樣品負責，同時此樣品僅保留90天。本報告未經本公司書面許可，不可部份複製。

This document is issued by the Company subject to its General Conditions of Service printed overleaf, available on request or accessible at www.sgs.com/terms_and_conditions.htm and, for electronic format documents, subject to Terms and Conditions for Electronic Documents at www.sgs.com/terms_e-document.htm. Attention is drawn to the limitation of liability, indemnification and jurisdiction issues defined therein. Any holder of this document is advised that information contained hereon reflects the Company's findings at the time of its intervention only and within the limits of Client's instructions, if any. The Company's sole responsibility is to its Client and this document does not exonerate parties to a transaction from exercising all their rights and obligations under the transaction documents. This document cannot be reproduced except in full, without prior written approval of the Company. Any unauthorized alteration, forgery or falsification of the content or appearance of this document is unlawful and offenders may be prosecuted to the fullest extent of the law.

SGS Taiwan Ltd.

No.134,WuKungRoad,NewTaipeiIndustrialPark,WukuDistrict,NewTaipeiCity,Taiwan24803/新北市五股區新北產業園區五工路 134 號

台灣檢驗科技股份有限公司

t (886-2) 2299-3279

f (886-2) 2298-0488

www.tw.sgs.com

Member of SGS Group

EUT			Measurement					
Operation Band	Fundamental Frequency	CH	Antenna Pol.	S.G. Output	Antenna Gain	Cable Loss	EIRP	Limit

Unless otherwise stated the results shown in this test report refer only to the sample(s) tested and such sample(s) are retained for 90 days only.

除非另有說明，此報告結果僅對測試之樣品負責，同時此樣品僅保留90天。本報告未經本公司書面許可，不可部份複製。

This document is issued by the Company subject to its General Conditions of Service printed overleaf, available on request or accessible at www.sgs.com/terms_and_conditions.htm and, for electronic format documents, subject to Terms and Conditions for Electronic Documents at www.sgs.com/terms_e-document.htm. Attention is drawn to the limitation of liability, indemnification and jurisdiction issues defined therein. Any holder of this document is advised that information contained hereon reflects the Company's findings at the time of its intervention only and within the limits of Client's instructions, if any. The Company's sole responsibility is to its Client and this document does not exonerate parties to a transaction from exercising all their rights and obligations under the transaction documents. This document cannot be reproduced except in full, without prior written approval of the Company. Any unauthorized alteration, forgery or falsification of the content or appearance of this document is unlawful and offenders may be prosecuted to the fullest extent of the law.

SGS Taiwan Ltd.

No.134,WuKungRoad,NewTaipeiIndustrialPark,WukuDistrict,NewTaipeiCity,Taiwan24803/新北市五股區新北產業園區五工路 134 號

台灣檢驗科技股份有限公司

t (886-2) 2299-3279

f (886-2) 2298-0488

www.tw.sgs.com

Member of SGS Group

EUT			Measurement					
Operation Band	Fundamental Frequency	CH	Antenna Pol.	S.G. Output	Antenna Gain	Cable Loss	ERP	Limit

Unless otherwise stated the results shown in this test report refer only to the sample(s) tested and such sample(s) are retained for 90 days only.

除非另有說明，此報告結果僅對測試之樣品負責，同時此樣品僅保留90天。本報告未經本公司書面許可，不可部份複製。

This document is issued by the Company subject to its General Conditions of Service printed overleaf, available on request or accessible at www.sgs.com/terms_and_conditions.htm and, for electronic format documents, subject to Terms and Conditions for Electronic Documents at www.sgs.com/terms_e-document.htm. Attention is drawn to the limitation of liability, indemnification and jurisdiction issues defined therein. Any holder of this document is advised that information contained hereon reflects the Company's findings at the time of its intervention only and within the limits of Client's instructions, if any. The Company's sole responsibility is to its Client and this document does not exonerate parties to a transaction from exercising all their rights and obligations under the transaction documents. This document cannot be reproduced except in full, without prior written approval of the Company. Any unauthorized alteration, forgery or falsification of the content or appearance of this document is unlawful and offenders may be prosecuted to the fullest extent of the law.

SGS Taiwan Ltd.

No.134,WuKungRoad,NewTaipeiIndustrialPark,WukuDistrict,NewTaipeiCity,Taiwan24803/新北市五股區新北產業園區五工路 134 號

台灣檢驗科技股份有限公司

t (886-2) 2299-3279

f (886-2) 2298-0488

www.tw.sgs.com

Member of SGS Group

EUT			Measurement					
Operation Band	Fundamental Frequency	CH	Antenna Pol.	S.G. Output	Antenna Gain	Cable Loss	ERP	Limit

Unless otherwise stated the results shown in this test report refer only to the sample(s) tested and such sample(s) are retained for 90 days only.

除非另有說明，此報告結果僅對測試之樣品負責，同時此樣品僅保留90天。本報告未經本公司書面許可，不可部份複製。

This document is issued by the Company subject to its General Conditions of Service printed overleaf, available on request or accessible at www.sgs.com/terms_and_conditions.htm and, for electronic format documents, subject to Terms and Conditions for Electronic Documents at www.sgs.com/terms_e-document.htm. Attention is drawn to the limitation of liability, indemnification and jurisdiction issues defined therein. Any holder of this document is advised that information contained hereon reflects the Company's findings at the time of its intervention only and within the limits of Client's instructions, if any. The Company's sole responsibility is to its Client and this document does not exonerate parties to a transaction from exercising all their rights and obligations under the transaction documents. This document cannot be reproduced except in full, without prior written approval of the Company. Any unauthorized alteration, forgery or falsification of the content or appearance of this document is unlawful and offenders may be prosecuted to the fullest extent of the law.

SGS Taiwan Ltd.

No.134,WuKungRoad,NewTaipeiIndustrialPark,WukuDistrict,NewTaipeiCity,Taiwan24803/新北市五股區新北產業園區五工路 134 號

台灣檢驗科技股份有限公司

t (886-2) 2299-3279

f (886-2) 2298-0488

www.tw.sgs.com

Member of SGS Group

EUT			Measurement					
Operation Band	Fundamental Frequency	CH	Antenna Pol.	S.G. Output	Antenna Gain	Cable Loss	EIRP	Limit

Unless otherwise stated the results shown in this test report refer only to the sample(s) tested and such sample(s) are retained for 90 days only.

除非另有說明，此報告結果僅對測試之樣品負責，同時此樣品僅保留90天。本報告未經本公司書面許可，不可部份複製。

This document is issued by the Company subject to its General Conditions of Service printed overleaf, available on request or accessible at www.sgs.com/terms_and_conditions.htm and, for electronic format documents, subject to Terms and Conditions for Electronic Documents at www.sgs.com/terms_e-document.htm. Attention is drawn to the limitation of liability, indemnification and jurisdiction issues defined therein. Any holder of this document is advised that information contained hereon reflects the Company's findings at the time of its intervention only and within the limits of Client's instructions, if any. The Company's sole responsibility is to its Client and this document does not exonerate parties to a transaction from exercising all their rights and obligations under the transaction documents. This document cannot be reproduced except in full, without prior written approval of the Company. Any unauthorized alteration, forgery or falsification of the content or appearance of this document is unlawful and offenders may be prosecuted to the fullest extent of the law.

SGS Taiwan Ltd.

No.134,WuKungRoad,NewTaipeiIndustrialPark,WukuDistrict,NewTaipeiCity,Taiwan24803/新北市五股區新北產業園區五工路 134 號

台灣檢驗科技股份有限公司

t (886-2) 2299-3279

f (886-2) 2298-0488

www.tw.sgs.com

Member of SGS Group

EUT			Measurement					
Operation Band	Fundamental Frequency	CH	Antenna Pol.	S.G. Output	Antenna Gain	Cable Loss	EIRP	Limit

Unless otherwise stated the results shown in this test report refer only to the sample(s) tested and such sample(s) are retained for 90 days only.

除非另有說明，此報告結果僅對測試之樣品負責，同時此樣品僅保留90天。本報告未經本公司書面許可，不可部份複製。

This document is issued by the Company subject to its General Conditions of Service printed overleaf, available on request or accessible at www.sgs.com/terms_and_conditions.htm and, for electronic format documents, subject to Terms and Conditions for Electronic Documents at www.sgs.com/terms_e-document.htm. Attention is drawn to the limitation of liability, indemnification and jurisdiction issues defined therein. Any holder of this document is advised that information contained hereon reflects the Company's findings at the time of its intervention only and within the limits of Client's instructions, if any. The Company's sole responsibility is to its Client and this document does not exonerate parties to a transaction from exercising all their rights and obligations under the transaction documents. This document cannot be reproduced except in full, without prior written approval of the Company. Any unauthorized alteration, forgery or falsification of the content or appearance of this document is unlawful and offenders may be prosecuted to the fullest extent of the law.

SGS Taiwan Ltd.

No.134,WuKungRoad,NewTaipeiIndustrialPark,WukuDistrict,NewTaipeiCity,Taiwan24803/新北市五股區新北產業園區五工路 134 號

台灣檢驗科技股份有限公司

t (886-2) 2299-3279

f (886-2) 2298-0488

www.tw.sgs.com

Member of SGS Group

EUT			Measurement					
Operation Band	Fundamental Frequency	CH	Antenna Pol.	S.G. Output	Antenna Gain	Cable Loss	ERP	Limit

Unless otherwise stated the results shown in this test report refer only to the sample(s) tested and such sample(s) are retained for 90 days only.

除非另有說明，此報告結果僅對測試之樣品負責，同時此樣品僅保留90天。本報告未經本公司書面許可，不可部份複製。

This document is issued by the Company subject to its General Conditions of Service printed overleaf, available on request or accessible at www.sgs.com/terms_and_conditions.htm and, for electronic format documents, subject to Terms and Conditions for Electronic Documents at www.sgs.com/terms_e-document.htm. Attention is drawn to the limitation of liability, indemnification and jurisdiction issues defined therein. Any holder of this document is advised that information contained hereon reflects the Company's findings at the time of its intervention only and within the limits of Client's instructions, if any. The Company's sole responsibility is to its Client and this document does not exonerate parties to a transaction from exercising all their rights and obligations under the transaction documents. This document cannot be reproduced except in full, without prior written approval of the Company. Any unauthorized alteration, forgery or falsification of the content or appearance of this document is unlawful and offenders may be prosecuted to the fullest extent of the law.

SGS Taiwan Ltd.

No.134,WuKungRoad,NewTaipeiIndustrialPark,WukuDistrict,NewTaipeiCity,Taiwan24803/新北市五股區新北產業園區五工路 134 號

台灣檢驗科技股份有限公司

t (886-2) 2299-3279

f (886-2) 2298-0488

www.tw.sgs.com

Member of SGS Group

EUT			Measurement					
Operation Band	Fundamental Frequency	CH	Antenna Pol.	S.G. Output	Antenna Gain	Cable Loss	EIRP	Limit
	MHz		V/H	dBm	dBi	dB	dBm	dBm
BAND 2 BW: 1.4M QPSK RB: 1,0	1850.7	18607	V	12.50	9.95	-4.46	17.99	33.01
			H	15.01	9.94	-4.46	20.49	33.01
	1880.0	18900	V	10.71	10.03	-4.51	16.23	33.01
			H	11.52	10.03	-4.51	17.04	33.01
	1909.3	19193	V	2.97	10.12	-4.55	8.54	33.01
			H	5.26	10.12	-4.55	10.83	33.01
BAND 2 BW: 1.4M QPSK RB: 1,5	1850.7	18607	V	11.91	9.94	-4.46	17.39	33.01
			H	14.24	9.94	-4.46	19.72	33.01
	1880.0	18900	V	9.86	10.03	-4.51	15.38	33.01
			H	11.81	10.03	-4.51	17.33	33.01
	1909.3	19193	V	1.58	10.12	-4.55	7.15	33.01
			H	4.80	10.12	-4.55	10.37	33.01
BAND 2 BW: 1.4M 16QAM RB: 1,0	1850.7	18607	V	11.36	9.95	-4.46	16.85	33.01
			H	14.91	9.95	-4.46	20.40	33.01
	1880.0	18900	V	10.85	10.03	-4.51	16.37	33.01
			H	12.51	10.03	-4.51	18.03	33.01
	1909.3	19193	V	2.44	10.12	-4.55	8.01	33.01
			H	5.21	10.12	-4.55	10.78	33.01
BAND 2 BW: 1.4M 16QAM RB: 1,5	1850.7	18607	V	11.92	9.94	-4.46	17.40	33.01
			H	14.68	9.94	-4.46	20.16	33.01
	1880.0	18900	V	9.95	10.03	-4.51	15.47	33.01
			H	11.43	10.03	-4.51	16.95	33.01
	1909.3	19193	V	1.82	10.12	-4.55	7.39	33.01
			H	4.62	10.12	-4.55	10.19	33.01

Remark

Unless otherwise stated the results shown in this test report refer only to the sample(s) tested and such sample(s) are retained for 90 days only.

除非另有說明，此報告結果僅對測試之樣品負責，同時此樣品僅保留90天。本報告未經本公司書面許可，不可部份複製。

This document is issued by the Company subject to its General Conditions of Service printed overleaf, available on request or accessible at www.sgs.com/terms_and_conditions.htm and, for electronic format documents, subject to Terms and Conditions for Electronic Documents at www.sgs.com/terms_e-document.htm. Attention is drawn to the limitation of liability, indemnification and jurisdiction issues defined therein. Any holder of this document is advised that information contained hereon reflects the Company's findings at the time of its intervention only and within the limits of Client's instructions, if any. The Company's sole responsibility is to its Client and this document does not exonerate parties to a transaction from exercising all their rights and obligations under the transaction documents. This document cannot be reproduced except in full, without prior written approval of the Company. Any unauthorized alteration, forgery or falsification of the content or appearance of this document is unlawful and offenders may be prosecuted to the fullest extent of the law.

SGS Taiwan Ltd.

No.134,WuKungRoad,NewTaipeiIndustrialPark,WukuDistrict,NewTaipeiCity,Taiwan24803/新北市五股區新北產業園區五工路 134 號

台灣檢驗科技股份有限公司

t (886-2) 2299-3279

f (886-2) 2298-0488

www.tw.sgs.com

Member of SGS Group

EUT			Measurement					
Operation Band	Fundamental Frequency	CH	Antenna Pol.	S.G. Output	Antenna Gain	Cable Loss	EIRP	Limit
	MHz		V/H	dBm	dBi	dB	dBm	dBm
BAND 2 BW: 3M QPSK RB: 1,0	1851.5	18615	V	12.37	9.95	-4.46	17.86	33.01
			H	14.54	9.95	-4.46	20.03	33.01
	1880.0	18900	V	10.32	10.03	-4.50	15.85	33.01
			H	12.34	10.03	-4.50	17.87	33.01
	1908.5	19185	V	4.32	10.11	-4.55	9.88	33.01
			H	5.70	10.11	-4.55	11.26	33.01
BAND 2 BW: 3M QPSK RB: 1,14	1851.5	18615	V	11.52	9.94	-4.46	17.00	33.01
			H	13.70	9.94	-4.46	19.18	33.01
	1880.0	18900	V	9.85	10.03	-4.51	15.37	33.01
			H	11.53	10.03	-4.51	17.05	33.01
	1908.5	19185	V	2.29	10.12	-4.55	7.86	33.01
			H	4.83	10.12	-4.55	10.40	33.01
BAND 2 BW: 3M 16QAM RB: 1,0	1851.5	18615	V	12.27	9.95	-4.46	17.76	33.01
			H	14.29	9.94	-4.46	19.77	33.01
	1880.0	18900	V	10.50	10.03	-4.50	16.03	33.01
			H	11.94	10.03	-4.50	17.47	33.01
	1908.5	19185	V	5.17	10.11	-4.55	10.73	33.01
			H	6.28	10.12	-4.55	11.85	33.01
BAND 2 BW: 3M 16QAM RB: 1,14	1851.5	18615	V	11.17	9.94	-4.46	16.65	33.01
			H	14.15	9.94	-4.46	19.63	33.01
	1880.0	18900	V	9.62	10.03	-4.51	15.14	33.01
			H	12.07	10.03	-4.51	17.59	33.01
	1908.5	19185	V	2.81	10.12	-4.55	8.38	33.01
			H	4.24	10.12	-4.55	9.81	33.01

Remark

Unless otherwise stated the results shown in this test report refer only to the sample(s) tested and such sample(s) are retained for 90 days only.

除非另有說明，此報告結果僅對測試之樣品負責，同時此樣品僅保留90天。本報告未經本公司書面許可，不可部份複製。

This document is issued by the Company subject to its General Conditions of Service printed overleaf, available on request or accessible at www.sgs.com/terms_and_conditions.htm and, for electronic format documents, subject to Terms and Conditions for Electronic Documents at www.sgs.com/terms_e-document.htm. Attention is drawn to the limitation of liability, indemnification and jurisdiction issues defined therein. Any holder of this document is advised that information contained hereon reflects the Company's findings at the time of its intervention only and within the limits of Client's instructions, if any. The Company's sole responsibility is to its Client and this document does not exonerate parties to a transaction from exercising all their rights and obligations under the transaction documents. This document cannot be reproduced except in full, without prior written approval of the Company. Any unauthorized alteration, forgery or falsification of the content or appearance of this document is unlawful and offenders may be prosecuted to the fullest extent of the law.

SGS Taiwan Ltd.

No.134,WuKungRoad,NewTaipeiIndustrialPark,WukuDistrict,NewTaipeiCity,Taiwan24803/新北市五股區新北產業園區五工路 134 號

台灣檢驗科技股份有限公司

t (886-2) 2299-3279

f (886-2) 2298-0488

www.tw.sgs.com

Member of SGS Group

EUT			Measurement					
Operation Band	Fundamental Frequency	CH	Antenna Pol.	S.G. Output	Antenna Gain	Cable Loss	EIRP	Limit
	MHz		V/H	dBm	dBi	dB	dBm	dBm
BAND 2 BW: 5M QPSK RB: 1,0	1852.5	18625	V	11.76	9.95	-4.46	17.25	33.01
			H	15.03	9.95	-4.46	20.52	33.01
	1880.0	18900	V	10.39	10.02	-4.50	15.91	33.01
			H	12.15	10.03	-4.51	17.67	33.01
	1907.5	19175	V	6.38	10.11	-4.54	11.95	33.01
			H	5.96	10.11	-4.54	11.53	33.01
BAND 2 BW: 5M QPSK RB: 1,24	1852.5	18625	V	11.29	9.95	-4.47	16.77	33.01
			H	13.74	9.95	-4.47	19.22	33.01
	1880.0	18900	V	9.63	10.04	-4.51	15.16	33.01
			H	11.72	10.04	-4.51	17.25	33.01
	1907.5	19175	V	3.14	10.12	-4.55	8.71	33.01
			H	4.82	10.12	-4.55	10.39	33.01
BAND 2 BW: 5M 16QAM RB: 1,0	1852.5	18625	V	11.99	9.95	-4.46	17.48	33.01
			H	14.37	9.95	-4.46	19.86	33.01
	1880.0	18900	V	10.85	10.02	-4.50	16.37	33.01
			H	11.94	10.02	-4.50	17.46	33.01
	1907.5	19175	V	5.70	10.11	-4.54	11.27	33.01
			H	6.60	10.11	-4.54	12.17	33.01
BAND 2 BW: 5M 16QAM RB: 1,24	1852.5	18625	V	10.79	9.95	-4.47	16.27	33.01
			H	13.82	9.95	-4.47	19.30	33.01
	1880.0	18900	V	9.45	10.04	-4.51	14.98	33.01
			H	10.90	10.04	-4.51	16.43	33.01
	1907.5	19175	V	2.88	10.12	-4.55	8.45	33.01
			H	5.08	10.12	-4.55	10.65	33.01

Remark

Unless otherwise stated the results shown in this test report refer only to the sample(s) tested and such sample(s) are retained for 90 days only.

除非另有說明，此報告結果僅對測試之樣品負責，同時此樣品僅保留90天。本報告未經本公司書面許可，不可部份複製。

This document is issued by the Company subject to its General Conditions of Service printed overleaf, available on request or accessible at www.sgs.com/terms_and_conditions.htm and, for electronic format documents, subject to Terms and Conditions for Electronic Documents at www.sgs.com/terms_e-document.htm. Attention is drawn to the limitation of liability, indemnification and jurisdiction issues defined therein. Any holder of this document is advised that information contained hereon reflects the Company's findings at the time of its intervention only and within the limits of Client's instructions, if any. The Company's sole responsibility is to its Client and this document does not exonerate parties to a transaction from exercising all their rights and obligations under the transaction documents. This document cannot be reproduced except in full, without prior written approval of the Company. Any unauthorized alteration, forgery or falsification of the content or appearance of this document is unlawful and offenders may be prosecuted to the fullest extent of the law.

SGS Taiwan Ltd.

No.134,WuKungRoad,NewTaipeiIndustrialPark,WukuDistrict,NewTaipeiCity,Taiwan24803/新北市五股區新北產業園區五工路 134 號

台灣檢驗科技股份有限公司

t (886-2) 2299-3279

f (886-2) 2298-0488

www.tw.sgs.com

Member of SGS Group

EUT			Measurement					
Operation Band	Fundamental Frequency	CH	Antenna Pol.	S.G. Output	Antenna Gain	Cable Loss	EIRP	Limit
	MHz		V/H	dBm	dBi	dB	dBm	dBm
BAND 2 BW: 10M QPSK RB: 1,0	1855.0	18650	V	11.57	9.95	-4.46	17.06	33.01
			H	14.83	9.95	-4.46	20.32	33.01
	1880.0	18900	V	10.20	10.02	-4.50	15.72	33.01
			H	12.60	10.02	-4.50	18.12	33.01
	1905.0	19150	V	6.09	10.09	-4.54	11.64	33.01
			H	5.97	10.09	-4.54	11.52	33.01
BAND 2 BW: 10M QPSK RB: 1,49	1855.0	18650	V	10.08	9.96	-4.47	15.57	33.01
			H	12.23	9.97	-4.47	17.73	33.01
	1880.0	18900	V	8.96	10.04	-4.51	14.49	33.01
			H	10.62	10.04	-4.51	16.15	33.01
	1905.0	19150	V	3.20	10.12	-4.55	8.77	33.01
			H	4.20	10.12	-4.55	9.77	33.01
BAND 2 BW: 10M 16QAM RB: 1,0	1855.0	18650	V	11.37	9.95	-4.46	16.86	33.01
			H	14.75	9.95	-4.46	20.24	33.01
	1880.0	18900	V	9.87	10.02	-4.50	15.39	33.01
			H	12.22	10.02	-4.50	17.74	33.01
	1905.0	19150	V	6.05	10.09	-4.54	11.60	33.01
			H	5.87	10.09	-4.54	11.42	33.01
BAND 2 BW: 10M 16QAM RB: 1,49	1855.0	18650	V	9.39	9.97	-4.47	14.89	33.01
			H	12.78	9.96	-4.47	18.27	33.01
	1880.0	18900	V	8.83	10.04	-4.51	14.36	33.01
			H	10.90	10.04	-4.51	16.43	33.01
	1905.0	19150	V	3.28	10.12	-4.55	8.85	33.01
			H	4.66	10.12	-4.55	10.23	33.01

Remark

Unless otherwise stated the results shown in this test report refer only to the sample(s) tested and such sample(s) are retained for 90 days only.

除非另有說明，此報告結果僅對測試之樣品負責，同時此樣品僅保留90天。本報告未經本公司書面許可，不可部份複製。

This document is issued by the Company subject to its General Conditions of Service printed overleaf, available on request or accessible at www.sgs.com/terms_and_conditions.htm and, for electronic format documents, subject to Terms and Conditions for Electronic Documents at www.sgs.com/terms_e-document.htm. Attention is drawn to the limitation of liability, indemnification and jurisdiction issues defined therein. Any holder of this document is advised that information contained hereon reflects the Company's findings at the time of its intervention only and within the limits of Client's instructions, if any. The Company's sole responsibility is to its Client and this document does not exonerate parties to a transaction from exercising all their rights and obligations under the transaction documents. This document cannot be reproduced except in full, without prior written approval of the Company. Any unauthorized alteration, forgery or falsification of the content or appearance of this document is unlawful and offenders may be prosecuted to the fullest extent of the law.

SGS Taiwan Ltd.

No.134,WuKungRoad,NewTaipeiIndustrialPark,WukuDistrict,NewTaipeiCity,Taiwan24803/新北市五股區新北產業園區五工路 134 號

台灣檢驗科技股份有限公司

t (886-2) 2299-3279

f (886-2) 2298-0488

www.tw.sgs.com

Member of SGS Group

EUT			Measurement					
Operation Band	Fundamental Frequency	CH	Antenna Pol.	S.G. Output	Antenna Gain	Cable Loss	EIRP	Limit
	MHz		V/H	dBm	dBi	dB	dBm	dBm
BAND 2 BW: 15M QPSK RB: 1,0	1857.5	18675	V	11.74	9.95	-4.46	17.23	33.01
			H	14.56	9.95	-4.46	20.05	33.01
	1880.0	18900	V	9.56	10.01	-4.50	15.07	33.01
			H	12.81	10.02	-4.50	18.33	33.01
	1902.5	19125	V	4.38	10.08	-4.53	9.93	33.01
			H	5.94	10.08	-4.53	11.49	33.01
BAND 2 BW: 15M QPSK RB: 1,74	1857.5	18675	V	8.59	9.98	-4.48	14.09	33.01
			H	11.83	9.98	-4.48	17.33	33.01
	1880.0	18900	V	6.81	10.05	-4.52	12.34	33.01
			H	9.18	10.05	-4.52	14.71	33.01
	1902.5	19125	V	3.00	10.12	-4.55	8.57	33.01
			H	3.46	10.12	-4.55	9.03	33.01
BAND 2 BW: 15M 16QAM RB: 1,0	1857.5	18675	V	11.55	9.95	-4.46	17.04	33.01
			H	14.28	9.95	-4.46	19.77	33.01
	1880.0	18900	V	9.47	10.01	-4.50	14.98	33.01
			H	12.74	10.01	-4.50	18.25	33.01
	1902.5	19125	V	5.40	10.08	-4.53	10.95	33.01
			H	6.26	10.08	-4.53	11.81	33.01
BAND 2 BW: 15M 16QAM RB: 1,74	1857.5	18675	V	9.59	9.98	-4.48	15.09	33.01
			H	11.61	9.98	-4.48	17.11	33.01
	1880.0	18900	V	7.26	10.05	-4.52	12.79	33.01
			H	10.01	10.05	-4.52	15.54	33.01
	1902.5	19125	V	3.51	10.12	-4.55	9.08	33.01
			H	3.65	10.12	-4.55	9.22	33.01

Remark

Unless otherwise stated the results shown in this test report refer only to the sample(s) tested and such sample(s) are retained for 90 days only.

除非另有說明，此報告結果僅對測試之樣品負責，同時此樣品僅保留90天。本報告未經本公司書面許可，不可部份複製。

This document is issued by the Company subject to its General Conditions of Service printed overleaf, available on request or accessible at www.sgs.com/terms_and_conditions.htm and, for electronic format documents, subject to Terms and Conditions for Electronic Documents at www.sgs.com/terms_e-document.htm. Attention is drawn to the limitation of liability, indemnification and jurisdiction issues defined therein. Any holder of this document is advised that information contained hereon reflects the Company's findings at the time of its intervention only and within the limits of Client's instructions, if any. The Company's sole responsibility is to its Client and this document does not exonerate parties to a transaction from exercising all their rights and obligations under the transaction documents. This document cannot be reproduced except in full, without prior written approval of the Company. Any unauthorized alteration, forgery or falsification of the content or appearance of this document is unlawful and offenders may be prosecuted to the fullest extent of the law.

SGS Taiwan Ltd.

No.134,WuKungRoad,NewTaipeiIndustrialPark,WukuDistrict,NewTaipeiCity,Taiwan24803/新北市五股區新北產業園區五工路 134 號

台灣檢驗科技股份有限公司

t (886-2) 2299-3279

f (886-2) 2298-0488

www.tw.sgs.com

Member of SGS Group

EUT			Measurement					
Operation Band	Fundamental Frequency	CH	Antenna Pol.	S.G. Output	Antenna Gain	Cable Loss	EIRP	Limit
	MHz		V/H	dBm	dBi	dB	dBm	dBm
BAND 2 BW: 20M QPSK RB: 1,0	1860.0	18700	V	11.64	9.95	-4.46	17.13	33.01
			H	14.26	9.95	-4.46	19.75	33.01
	1880.0	18900	V	9.60	10.00	-4.49	15.11	33.01
			H	12.47	10.01	-4.50	17.98	33.01
	1900.0	19100	V	6.15	10.07	-4.53	11.69	33.01
			H	7.71	10.07	-4.52	13.26	33.01
BAND 2 BW: 20M QPSK RB: 1,99	1860.0	18700	V	9.23	10.00	-4.49	14.74	33.01
			H	12.67	10.00	-4.49	18.18	33.01
	1880.0	18900	V	6.46	10.06	-4.52	12.00	33.01
			H	8.78	10.06	-4.52	14.32	33.01
	1900.0	19100	V	2.02	10.12	-4.55	7.59	33.01
			H	3.15	10.12	-4.55	8.72	33.01
BAND 2 BW: 20M 16QAM RB: 1,0	1860.0	18700	V	11.52	9.95	-4.46	17.01	33.01
			H	14.85	9.95	-4.46	20.34	33.01
	1880.0	18900	V	9.15	10.01	-4.50	14.66	33.01
			H	11.08	10.00	-4.49	16.59	33.01
	1900.0	19100	V	6.21	10.07	-4.53	11.75	33.01
			H	7.53	10.07	-4.53	13.07	33.01
BAND 2 BW: 20M 16QAM RB: 1,99	1860.0	18700	V	8.72	9.99	-4.49	14.22	33.01
			H	12.20	9.99	-4.49	17.70	33.01
	1880.0	18900	V	6.76	10.06	-4.52	12.30	33.01
			H	8.92	10.06	-4.52	14.46	33.01
	1900.0	19100	V	1.85	10.12	-4.55	7.42	33.01
			H	3.30	10.12	-4.55	8.87	33.01

Remark

Unless otherwise stated the results shown in this test report refer only to the sample(s) tested and such sample(s) are retained for 90 days only.

除非另有說明，此報告結果僅對測試之樣品負責，同時此樣品僅保留90天。本報告未經本公司書面許可，不可部份複製。

This document is issued by the Company subject to its General Conditions of Service printed overleaf, available on request or accessible at www.sgs.com/terms_and_conditions.htm and, for electronic format documents, subject to Terms and Conditions for Electronic Documents at www.sgs.com/terms_e-document.htm. Attention is drawn to the limitation of liability, indemnification and jurisdiction issues defined therein. Any holder of this document is advised that information contained hereon reflects the Company's findings at the time of its intervention only and within the limits of Client's instructions, if any. The Company's sole responsibility is to its Client and this document does not exonerate parties to a transaction from exercising all their rights and obligations under the transaction documents. This document cannot be reproduced except in full, without prior written approval of the Company. Any unauthorized alteration, forgery or falsification of the content or appearance of this document is unlawful and offenders may be prosecuted to the fullest extent of the law.

SGS Taiwan Ltd.

No.134,WuKungRoad,NewTaipeiIndustrialPark,WukuDistrict,NewTaipeiCity,Taiwan24803/新北市五股區新北產業園區五工路 134 號

台灣檢驗科技股份有限公司

t (886-2) 2299-3279

f (886-2) 2298-0488

www.tw.sgs.com

Member of SGS Group

EUT			Measurement					
Operation Band	Fundamental Frequency	CH	Antenna Pol.	S.G. Output	Antenna Gain	Cable Loss	EIRP	Limit
	MHz		V/H	dBm	dBi	dB	dBm	dBm
BAND 4 BW: 1.4M/ QPSK RB: 1,0	1710.7	19957	V	9.54	9.48	-4.31	14.71	30.00
			H	18.10	9.48	-4.31	23.27	30.00
	1732.5	20175	V	11.57	9.54	-4.31	16.80	30.00
			H	17.08	9.55	-4.31	22.32	30.00
	1754.3	20393	V	13.54	9.62	-4.34	18.82	30.00
			H	18.54	9.62	-4.34	23.82	30.00
BAND 4 BW: 1.4M QPSK RB: 1,5	1710.7	19957	V	10.50	9.47	-4.31	15.66	30.00
			H	17.71	9.47	-4.31	22.87	30.00
	1732.5	20175	V	12.02	9.55	-4.31	17.26	30.00
			H	17.04	9.55	-4.31	22.28	30.00
	1754.3	20393	V	13.50	9.62	-4.34	18.78	30.00
			H	17.59	9.62	-4.34	22.87	30.00
BAND 4 BW: 1.4M 16QAM RB: 1,0	1710.7	19957	V	9.57	9.48	-4.31	14.74	30.00
			H	18.27	9.48	-4.31	23.44	30.00
	1732.5	20175	V	12.02	9.55	-4.31	17.26	30.00
			H	16.82	9.55	-4.31	22.06	30.00
	1754.3	20393	V	13.66	9.62	-4.34	18.94	30.00
			H	18.57	9.62	-4.34	23.85	30.00
BAND 4 BW: 1.4M 16QAM RB: 1,5	1710.7	19957	V	9.71	9.47	-4.31	14.87	30.00
			H	18.43	9.48	-4.31	23.60	30.00
	1732.5	20175	V	11.99	9.55	-4.31	17.23	30.00
			H	17.13	9.56	-4.31	22.38	30.00
	1754.3	20393	V	13.55	9.62	-4.34	18.83	30.00
			H	17.87	9.62	-4.34	23.15	30.00

Remark

Unless otherwise stated the results shown in this test report refer only to the sample(s) tested and such sample(s) are retained for 90 days only.

除非另有說明，此報告結果僅對測試之樣品負責，同時此樣品僅保留90天。本報告未經本公司書面許可，不可部份複製。

This document is issued by the Company subject to its General Conditions of Service printed overleaf, available on request or accessible at www.sgs.com/terms_and_conditions.htm and, for electronic format documents, subject to Terms and Conditions for Electronic Documents at www.sgs.com/terms_e-document.htm. Attention is drawn to the limitation of liability, indemnification and jurisdiction issues defined therein. Any holder of this document is advised that information contained hereon reflects the Company's findings at the time of its intervention only and within the limits of Client's instructions, if any. The Company's sole responsibility is to its Client and this document does not exonerate parties to a transaction from exercising all their rights and obligations under the transaction documents. This document cannot be reproduced except in full, without prior written approval of the Company. Any unauthorized alteration, forgery or falsification of the content or appearance of this document is unlawful and offenders may be prosecuted to the fullest extent of the law.

SGS Taiwan Ltd.

No.134,WuKungRoad,NewTaipeiIndustrialPark,WukuDistrict,NewTaipeiCity,Taiwan24803/新北市五股區新北產業園區五工路 134 號

台灣檢驗科技股份有限公司

t (886-2) 2299-3279

f (886-2) 2298-0488

www.tw.sgs.com

Member of SGS Group

EUT			Measurement					
Operation Band	Fundamental Frequency	CH	Antenna Pol.	S.G. Output	Antenna Gain	Cable Loss	EIRP	Limit
	MHz		V/H	dBm	dBi	dB	dBm	dBm
BAND 4 BW: 3M QPSK RB: 1,0	1711.5	19965	V	12.10	9.48	-4.31	17.27	30.00
			H	17.79	9.48	-4.31	22.96	30.00
	1732.5	20175	V	13.87	9.54	-4.31	19.10	30.00
			H	17.78	9.55	-4.31	23.02	30.00
	1753.5	20385	V	14.62	9.61	-4.33	19.90	30.00
			H	18.94	9.61	-4.33	24.22	30.00
BAND 4 BW: 3M QPSK RB: 1,14	1711.5	19965	V	12.59	9.48	-4.31	17.76	30.00
			H	19.29	9.48	-4.31	24.46	30.00
	1732.5	20175	V	13.47	9.55	-4.31	18.71	30.00
			H	17.72	9.56	-4.31	22.97	30.00
	1753.5	20385	V	14.19	9.62	-4.34	19.47	30.00
			H	17.77	9.62	-4.34	23.05	30.00
BAND 4 BW: 3M 16QAM RB: 1,0	1711.5	19965	V	12.98	9.48	-4.31	18.15	30.00
			H	18.00	9.48	-4.31	23.17	30.00
	1732.5	20175	V	13.55	9.54	-4.31	18.78	30.00
			H	17.71	9.55	-4.31	22.95	30.00
	1753.5	20385	V	14.44	9.61	-4.33	19.72	30.00
			H	18.63	9.61	-4.33	23.91	30.00
BAND 4 BW: 3M 16QAM RB: 1,14	1711.5	19965	V	12.95	9.48	-4.31	18.12	30.00
			H	19.55	9.48	-4.31	24.72	30.00
	1732.5	20175	V	13.97	9.55	-4.31	19.21	30.00
			H	17.53	9.56	-4.31	22.78	30.00
	1753.5	20385	V	14.46	9.62	-4.34	19.74	30.00
			H	18.48	9.62	-4.34	23.76	30.00

Remark

Unless otherwise stated the results shown in this test report refer only to the sample(s) tested and such sample(s) are retained for 90 days only.

除非另有說明，此報告結果僅對測試之樣品負責，同時此樣品僅保留90天。本報告未經本公司書面許可，不可部份複製。

This document is issued by the Company subject to its General Conditions of Service printed overleaf, available on request or accessible at www.sgs.com/terms_and_conditions.htm and, for electronic format documents, subject to Terms and Conditions for Electronic Documents at www.sgs.com/terms_e-document.htm. Attention is drawn to the limitation of liability, indemnification and jurisdiction issues defined therein. Any holder of this document is advised that information contained hereon reflects the Company's findings at the time of its intervention only and within the limits of Client's instructions, if any. The Company's sole responsibility is to its Client and this document does not exonerate parties to a transaction from exercising all their rights and obligations under the transaction documents. This document cannot be reproduced except in full, without prior written approval of the Company. Any unauthorized alteration, forgery or falsification of the content or appearance of this document is unlawful and offenders may be prosecuted to the fullest extent of the law.

SGS Taiwan Ltd.

No.134,WuKungRoad,NewTaipeiIndustrialPark,WukuDistrict,NewTaipeiCity,Taiwan24803/新北市五股區新北產業園區五工路 134 號

台灣檢驗科技股份有限公司

t (886-2) 2299-3279

f (886-2) 2298-0488

www.tw.sgs.com

Member of SGS Group

EUT			Measurement					
Operation Band	Fundamental Frequency	CH	Antenna Pol.	S.G. Output	Antenna Gain	Cable Loss	EIRP	Limit
	MHz		V/H	dBm	dBi	dB	dBm	dBm
BAND 4 BW: 5M QPSK RB: 1,0	1712.5	19975	V	13.79	9.48	-4.31	18.96	30.00
			H	18.06	9.48	-4.31	23.23	30.00
	1732.5	20175	V	14.00	9.54	-4.31	19.23	30.00
			H	17.81	9.54	-4.31	23.04	30.00
	1752.5	20375	V	15.30	9.61	-4.33	20.58	30.00
			H	19.04	9.61	-4.33	24.32	30.00
BAND 4 BW: 5M QPSK RB: 1,24	1712.5	19975	V	14.70	9.49	-4.31	19.88	30.00
			H	19.18	9.49	-4.31	24.36	30.00
	1732.5	20175	V	14.15	9.55	-4.31	19.39	30.00
			H	17.37	9.56	-4.31	22.62	30.00
	1752.5	20375	V	13.53	9.62	-4.34	18.81	30.00
			H	17.96	9.62	-4.34	23.24	30.00
BAND 4 BW: 5M 16QAM RB: 1,0	1712.5	19975	V	14.54	9.48	-4.31	19.71	30.00
			H	18.76	9.48	-4.31	23.93	30.00
	1732.5	20175	V	13.61	9.54	-4.31	18.84	30.00
			H	18.21	9.54	-4.31	23.44	30.00
	1752.5	20375	V	14.66	9.61	-4.33	19.94	30.00
			H	18.72	9.61	-4.33	24.00	30.00
BAND 4 BW: 5M 16QAM RB: 1,24	1712.5	19975	V	15.63	9.49	-4.31	20.81	30.00
			H	19.16	9.48	-4.31	24.33	30.00
	1732.5	20175	V	14.51	9.55	-4.31	19.75	30.00
			H	18.08	9.56	-4.31	23.33	30.00
	1752.5	20375	V	14.02	9.62	-4.34	19.30	30.00
			H	18.64	9.62	-4.34	23.92	30.00

Remark

Unless otherwise stated the results shown in this test report refer only to the sample(s) tested and such sample(s) are retained for 90 days only.

除非另有說明，此報告結果僅對測試之樣品負責，同時此樣品僅保留90天。本報告未經本公司書面許可，不可部份複製。

This document is issued by the Company subject to its General Conditions of Service printed overleaf, available on request or accessible at www.sgs.com/terms_and_conditions.htm and, for electronic format documents, subject to Terms and Conditions for Electronic Documents at www.sgs.com/terms_e-document.htm. Attention is drawn to the limitation of liability, indemnification and jurisdiction issues defined therein. Any holder of this document is advised that information contained hereon reflects the Company's findings at the time of its intervention only and within the limits of Client's instructions, if any. The Company's sole responsibility is to its Client and this document does not exonerate parties to a transaction from exercising all their rights and obligations under the transaction documents. This document cannot be reproduced except in full, without prior written approval of the Company. Any unauthorized alteration, forgery or falsification of the content or appearance of this document is unlawful and offenders may be prosecuted to the fullest extent of the law.

SGS Taiwan Ltd.

No.134,WuKungRoad,NewTaipeiIndustrialPark,WukuDistrict,NewTaipeiCity,Taiwan24803/新北市五股區新北產業園區五工路 134 號

台灣檢驗科技股份有限公司

t (886-2) 2299-3279

f (886-2) 2298-0488

www.tw.sgs.com

Member of SGS Group

EUT			Measurement					
Operation Band	Fundamental Frequency	CH	Antenna Pol.	S.G. Output	Antenna Gain	Cable Loss	EIRP	Limit
	MHz		V/H	dBm	dBi	dB	dBm	dBm
BAND 4 BW: 10M QPSK RB: 1,0	1715.0	20000	V	14.16	9.48	-4.31	19.33	30.00
			H	18.54	9.48	-4.31	23.71	30.00
	1732.5	20175	V	13.95	9.54	-4.31	19.18	30.00
			H	17.62	9.54	-4.31	22.85	30.00
	1750.0	20350	V	14.88	9.60	-4.33	20.15	30.00
			H	18.55	9.60	-4.33	23.82	30.00
BAND 4 BW: 10M QPSK RB: 1,49	1715.0	20000	V	15.42	9.50	-4.31	20.61	30.00
			H	19.03	9.50	-4.31	24.22	30.00
	1732.5	20175	V	14.01	9.56	-4.31	19.26	30.00
			H	17.34	9.56	-4.31	22.59	30.00
	1750.0	20350	V	13.42	9.62	-4.34	18.70	30.00
			H	18.22	9.62	-4.34	23.50	30.00
BAND 4 BW: 10M 16QAM RB: 1,0	1715.0	20000	V	14.54	9.48	-4.31	19.71	30.00
			H	18.69	9.48	-4.31	23.86	30.00
	1732.5	20175	V	14.23	9.54	-4.31	19.46	30.00
			H	17.98	9.54	-4.31	23.21	30.00
	1750.0	20350	V	13.86	9.60	-4.33	19.13	30.00
			H	18.38	9.60	-4.33	23.65	30.00
BAND 4 BW: 10M 16QAM RB: 1,49	1715.0	20000	V	15.16	9.50	-4.31	20.35	30.00
			H	19.89	9.50	-4.31	25.08	30.00
	1732.5	20175	V	14.35	9.56	-4.31	19.60	30.00
			H	18.15	9.56	-4.31	23.40	30.00
	1750.0	20350	V	13.51	9.62	-4.34	18.79	30.00
			H	18.56	9.62	-4.34	23.84	30.00

Remark

Unless otherwise stated the results shown in this test report refer only to the sample(s) tested and such sample(s) are retained for 90 days only.

除非另有說明，此報告結果僅對測試之樣品負責，同時此樣品僅保留90天。本報告未經本公司書面許可，不可部份複製。

This document is issued by the Company subject to its General Conditions of Service printed overleaf, available on request or accessible at www.sgs.com/terms_and_conditions.htm and, for electronic format documents, subject to Terms and Conditions for Electronic Documents at www.sgs.com/terms_e-document.htm. Attention is drawn to the limitation of liability, indemnification and jurisdiction issues defined therein. Any holder of this document is advised that information contained hereon reflects the Company's findings at the time of its intervention only and within the limits of Client's instructions, if any. The Company's sole responsibility is to its Client and this document does not exonerate parties to a transaction from exercising all their rights and obligations under the transaction documents. This document cannot be reproduced except in full, without prior written approval of the Company. Any unauthorized alteration, forgery or falsification of the content or appearance of this document is unlawful and offenders may be prosecuted to the fullest extent of the law.

SGS Taiwan Ltd.

No.134,WuKungRoad,NewTaipeiIndustrialPark,WukuDistrict,NewTaipeiCity,Taiwan24803/新北市五股區新北產業園區五工路 134 號

台灣檢驗科技股份有限公司

t (886-2) 2299-3279

f (886-2) 2298-0488

www.tw.sgs.com

Member of SGS Group

EUT			Measurement					
Operation Band	Fundamental Frequency	CH	Antenna Pol.	S.G. Output	Antenna Gain	Cable Loss	EIRP	Limit
	MHz		V/H	dBm	dBi	dB	dBm	dBm
BAND 4 BW: 15M QPSK RB: 1,0	1717.5	20025	V	14.17	9.47	-4.31	19.33	30.00
			H	18.04	9.47	-4.31	23.20	30.00
	1732.5	20175	V	14.57	9.53	-4.31	19.79	30.00
			H	17.71	9.53	-4.31	22.93	30.00
	1747.5	20325	V	14.41	9.58	-4.32	19.67	30.00
			H	17.66	9.59	-4.32	22.93	30.00
BAND 4 BW: 15M QPSK RB: 1,74	1717.5	20025	V	14.57	9.52	-4.31	19.78	30.00
			H	18.25	9.52	-4.31	23.46	30.00
	1732.5	20175	V	13.80	9.57	-4.31	19.06	30.00
			H	17.03	9.57	-4.31	22.29	30.00
	1747.5	20325	V	13.56	9.62	-4.34	18.84	30.00
			H	17.90	9.62	-4.34	23.18	30.00
BAND 4 BW: 15M 16QAM RB: 1,0	1717.5	20025	V	14.22	9.48	-4.31	19.39	30.00
			H	18.18	9.48	-4.31	23.35	30.00
	1732.5	20175	V	13.96	9.53	-4.31	19.18	30.00
			H	18.33	9.53	-4.31	23.55	30.00
	1747.5	20325	V	14.86	9.59	-4.32	20.13	30.00
			H	17.84	9.59	-4.32	23.11	30.00
BAND 4 BW: 15M 16QAM RB: 1,74	1717.5	20025	V	15.13	9.52	-4.31	20.34	30.00
			H	18.10	9.52	-4.31	23.31	30.00
	1732.5	20175	V	14.40	9.57	-4.31	19.66	30.00
			H	17.49	9.57	-4.31	22.75	30.00
	1747.5	20325	V	13.61	9.62	-4.34	18.89	30.00
			H	18.38	9.62	-4.34	23.66	30.00

Remark

Unless otherwise stated the results shown in this test report refer only to the sample(s) tested and such sample(s) are retained for 90 days only.

除非另有說明，此報告結果僅對測試之樣品負責，同時此樣品僅保留90天。本報告未經本公司書面許可，不可部份複製。

This document is issued by the Company subject to its General Conditions of Service printed overleaf, available on request or accessible at www.sgs.com/terms_and_conditions.htm and, for electronic format documents, subject to Terms and Conditions for Electronic Documents at www.sgs.com/terms_e-document.htm. Attention is drawn to the limitation of liability, indemnification and jurisdiction issues defined therein. Any holder of this document is advised that information contained hereon reflects the Company's findings at the time of its intervention only and within the limits of Client's instructions, if any. The Company's sole responsibility is to its Client and this document does not exonerate parties to a transaction from exercising all their rights and obligations under the transaction documents. This document cannot be reproduced except in full, without prior written approval of the Company. Any unauthorized alteration, forgery or falsification of the content or appearance of this document is unlawful and offenders may be prosecuted to the fullest extent of the law.

SGS Taiwan Ltd.

No.134,WuKungRoad,NewTaipeiIndustrialPark,WukuDistrict,NewTaipeiCity,Taiwan24803/新北市五股區新北產業園區五工路 134 號

台灣檢驗科技股份有限公司

t (886-2) 2299-3279

f (886-2) 2298-0488

www.tw.sgs.com

Member of SGS Group

EUT			Measurement					
Operation Band	Fundamental Frequency	CH	Antenna Pol.	S.G. Output	Antenna Gain	Cable Loss	EIRP	Limit
	MHz		V/H	dBm	dBi	dB	dBm	dBm
BAND 4 BW: 20M QPSK RB: 1,0	1720.0	20050	V	14.00	9.48	-4.31	19.17	30.00
			H	18.10	9.48	-4.31	23.27	30.00
	1732.5	20175	V	14.31	9.53	-4.31	19.53	30.00
			H	18.32	9.53	-4.31	23.54	30.00
	1745.0	20300	V	13.97	9.56	-4.31	19.22	30.00
			H	17.86	9.57	-4.31	23.12	30.00
BAND 4 BW: 20M QPSK RB: 1,99	1720.0	20050	V	13.84	9.53	-4.31	19.06	30.00
			H	17.81	9.53	-4.31	23.03	30.00
	1732.5	20175	V	15.32	9.58	-4.31	20.59	30.00
			H	18.08	9.58	-4.31	23.35	30.00
	1745.0	20300	V	13.36	9.62	-4.34	18.64	30.00
			H	17.59	9.62	-4.34	22.87	30.00
BAND 4 BW: 20M 16QAM RB: 1,0	1720.0	20050	V	14.08	9.48	-4.31	19.25	30.00
			H	18.59	9.48	-4.31	23.76	30.00
	1732.5	20175	V	14.81	9.53	-4.31	20.03	30.00
			H	17.96	9.53	-4.31	23.18	30.00
	1745.0	20300	V	13.98	9.57	-4.31	19.24	30.00
			H	17.74	9.57	-4.31	23.00	30.00
BAND 4 BW: 20M 16QAM RB: 1,99	1720.0	20050	V	14.28	9.53	-4.31	19.50	30.00
			H	17.71	9.53	-4.31	22.93	30.00
	1732.5	20175	V	15.13	9.58	-4.31	20.40	30.00
			H	18.43	9.58	-4.31	23.70	30.00
	1745.0	20300	V	14.48	9.62	-4.34	19.76	30.00
			H	17.89	9.62	-4.34	23.17	30.00

Remark

Unless otherwise stated the results shown in this test report refer only to the sample(s) tested and such sample(s) are retained for 90 days only.

除非另有說明，此報告結果僅對測試之樣品負責，同時此樣品僅保留90天。本報告未經本公司書面許可，不可部份複製。

This document is issued by the Company subject to its General Conditions of Service printed overleaf, available on request or accessible at www.sgs.com/terms_and_conditions.htm and, for electronic format documents, subject to Terms and Conditions for Electronic Documents at www.sgs.com/terms_e-document.htm. Attention is drawn to the limitation of liability, indemnification and jurisdiction issues defined therein. Any holder of this document is advised that information contained hereon reflects the Company's findings at the time of its intervention only and within the limits of Client's instructions, if any. The Company's sole responsibility is to its Client and this document does not exonerate parties to a transaction from exercising all their rights and obligations under the transaction documents. This document cannot be reproduced except in full, without prior written approval of the Company. Any unauthorized alteration, forgery or falsification of the content or appearance of this document is unlawful and offenders may be prosecuted to the fullest extent of the law.

SGS Taiwan Ltd.

No.134,WuKungRoad,NewTaipeiIndustrialPark,WukuDistrict,NewTaipeiCity,Taiwan24803/新北市五股區新北產業園區五工路 134 號

台灣檢驗科技股份有限公司

t (886-2) 2299-3279

f (886-2) 2298-0488

www.tw.sgs.com

Member of SGS Group

EUT			Measurement					
Operation Band	Fundamental Frequency	CH	Antenna Pol.	S.G. Output	Antenna Gain	Cable Loss	ERP	Limit
	MHz		V/H	dBm	dBd	dB	dBm	dBm
BAND 5 BW: 1.4M QPSK RB: 1,0	824.7	20407	V	22.64	3.30	-2.93	23.01	38.45
			H	27.45	3.30	-2.93	27.82	38.45
	836.5	20525	V	20.44	3.29	-2.96	20.77	38.45
			H	27.97	3.29	-2.96	28.30	38.45
	848.3	20643	V	20.39	3.27	-3.00	20.66	38.45
			H	28.34	3.27	-3.00	28.61	38.45
BAND 5 BW: 1.4M QPSK RB: 1,5	824.7	20407	V	22.04	3.31	-2.92	22.43	38.45
			H	27.53	3.30	-2.93	27.90	38.45
	836.5	20525	V	21.03	3.29	-2.96	21.36	38.45
			H	28.11	3.29	-2.96	28.44	38.45
	848.3	20643	V	19.94	3.27	-3.00	20.21	38.45
			H	28.27	3.27	-3.00	28.54	38.45
BAND 5 BW: 1.4M 16QAM RB: 1,0	824.7	20407	V	23.60	3.30	-2.93	23.97	38.45
			H	28.07	3.30	-2.93	28.44	38.45
	836.5	20525	V	20.51	3.29	-2.96	20.84	38.45
			H	26.39	3.29	-2.96	26.72	38.45
	848.3	20643	V	20.11	3.27	-3.00	20.38	38.45
			H	27.88	3.27	-3.00	28.15	38.45
BAND 5 BW: 1.4M 16QAM RB: 1,5	824.7	20407	V	23.16	3.30	-2.93	23.53	38.45
			H	27.86	3.30	-2.93	28.23	38.45
	836.5	20525	V	21.58	3.29	-2.96	21.91	38.45
			H	27.61	3.29	-2.96	27.94	38.45
	848.3	20643	V	20.79	3.27	-3.00	21.06	38.45
			H	27.84	3.27	-3.00	28.11	38.45

Remark

Unless otherwise stated the results shown in this test report refer only to the sample(s) tested and such sample(s) are retained for 90 days only.

除非另有說明，此報告結果僅對測試之樣品負責，同時此樣品僅保留90天。本報告未經本公司書面許可，不可部份複製。

This document is issued by the Company subject to its General Conditions of Service printed overleaf, available on request or accessible at www.sgs.com/terms_and_conditions.htm and, for electronic format documents, subject to Terms and Conditions for Electronic Documents at www.sgs.com/terms_e-document.htm. Attention is drawn to the limitation of liability, indemnification and jurisdiction issues defined therein. Any holder of this document is advised that information contained hereon reflects the Company's findings at the time of its intervention only and within the limits of Client's instructions, if any. The Company's sole responsibility is to its Client and this document does not exonerate parties to a transaction from exercising all their rights and obligations under the transaction documents. This document cannot be reproduced except in full, without prior written approval of the Company. Any unauthorized alteration, forgery or falsification of the content or appearance of this document is unlawful and offenders may be prosecuted to the fullest extent of the law.

SGS Taiwan Ltd.

No.134,WuKungRoad,NewTaipeiIndustrialPark,WukuDistrict,NewTaipeiCity,Taiwan24803/新北市五股區新北產業園區五工路 134 號

台灣檢驗科技股份有限公司

t (886-2) 2299-3279

f (886-2) 2298-0488

www.tw.sgs.com

Member of SGS Group

EUT			Measurement					
Operation Band	Fundamental Frequency	CH	Antenna Pol.	S.G. Output	Antenna Gain	Cable Loss	ERP	Limit
	MHz		V/H	dBm	dBd	dB	dBm	dBm
BAND 5 BW: 3M QPSK RB: 1,0	825.5	20415	V	22.65	3.30	-2.93	23.02	38.45
			H	27.38	3.30	-2.93	27.75	38.45
	836.5	20525	V	20.24	3.29	-2.96	20.57	38.45
			H	27.38	3.29	-2.96	27.71	38.45
	847.5	20635	V	19.92	3.28	-2.99	20.21	38.45
			H	27.05	3.28	-2.99	27.34	38.45
BAND 5 BW: 3M QPSK RB: 1,14	825.5	20415	V	22.04	3.30	-2.93	22.41	38.45
			H	28.03	3.30	-2.93	28.40	38.45
	836.5	20525	V	21.31	3.29	-2.96	21.64	38.45
			H	29.08	3.29	-2.96	29.41	38.45
	847.5	20635	V	20.48	3.27	-3.00	20.75	38.45
			H	27.48	3.27	-3.00	27.75	38.45
BAND 5 BW: 3M 16QAM RB: 1,0	825.5	20415	V	23.16	3.30	-2.93	23.53	38.45
			H	27.31	3.30	-2.93	27.68	38.45
	836.5	20525	V	20.88	3.29	-2.95	21.22	38.45
			H	26.84	3.29	-2.96	27.17	38.45
	847.5	20635	V	20.39	3.28	-2.99	20.68	38.45
			H	27.82	3.28	-2.99	28.11	38.45
BAND 5 BW: 3M 16QAM RB: 1,14	825.5	20415	V	23.15	3.30	-2.93	23.52	38.45
			H	27.13	3.30	-2.93	27.50	38.45
	836.5	20525	V	21.87	3.29	-2.96	22.20	38.45
			H	28.44	3.29	-2.96	28.77	38.45
	847.5	20635	V	20.00	3.27	-3.00	20.27	38.45
			H	27.74	3.27	-3.00	28.01	38.45

Remark

Unless otherwise stated the results shown in this test report refer only to the sample(s) tested and such sample(s) are retained for 90 days only.

除非另有說明，此報告結果僅對測試之樣品負責，同時此樣品僅保留90天。本報告未經本公司書面許可，不可部份複製。

This document is issued by the Company subject to its General Conditions of Service printed overleaf, available on request or accessible at www.sgs.com/terms_and_conditions.htm and, for electronic format documents, subject to Terms and Conditions for Electronic Documents at www.sgs.com/terms_e-document.htm. Attention is drawn to the limitation of liability, indemnification and jurisdiction issues defined therein. Any holder of this document is advised that information contained hereon reflects the Company's findings at the time of its intervention only and within the limits of Client's instructions, if any. The Company's sole responsibility is to its Client and this document does not exonerate parties to a transaction from exercising all their rights and obligations under the transaction documents. This document cannot be reproduced except in full, without prior written approval of the Company. Any unauthorized alteration, forgery or falsification of the content or appearance of this document is unlawful and offenders may be prosecuted to the fullest extent of the law.

SGS Taiwan Ltd.

No.134,WuKungRoad,NewTaipeiIndustrialPark,WukuDistrict,NewTaipeiCity,Taiwan24803/新北市五股區新北產業園區五工路 134 號

台灣檢驗科技股份有限公司

t (886-2) 2299-3279

f (886-2) 2298-0488

www.tw.sgs.com

Member of SGS Group

EUT			Measurement					
Operation Band	Fundamental Frequency	CH	Antenna Pol.	S.G. Output	Antenna Gain	Cable Loss	ERP	Limit
	MHz		V/H	dBm	dBd	dB	dBm	dBm
BAND 5 BW: 5M QPSK RB: 1,0	826.5	20425	V	24.75	3.30	-2.93	25.12	38.45
			H	27.37	3.30	-2.93	27.74	38.45
	836.5	20525	V	22.73	3.29	-2.95	23.07	38.45
			H	26.58	3.29	-2.95	26.92	38.45
	846.5	20625	V	23.30	3.28	-2.98	23.60	38.45
			H	28.57	3.28	-2.98	28.87	38.45
BAND 5 BW: 5M QPSK RB: 1,24	826.5	20425	V	24.39	3.30	-2.93	24.76	38.45
			H	27.47	3.30	-2.93	27.84	38.45
	836.5	20525	V	24.18	3.29	-2.97	24.50	38.45
			H	29.25	3.29	-2.97	29.57	38.45
	846.5	20625	V	23.09	3.27	-3.00	23.36	38.45
			H	28.72	3.27	-3.00	28.99	38.45
BAND 5 BW: 5M 16QAM RB: 1,0	826.5	20425	V	24.55	3.30	-2.93	24.92	38.45
			H	27.38	3.30	-2.93	27.75	38.45
	836.5	20525	V	21.80	3.29	-2.95	22.14	38.45
			H	25.89	3.29	-2.95	26.23	38.45
	846.5	20625	V	23.26	3.28	-2.98	23.56	38.45
			H	28.25	3.28	-2.98	28.55	38.45
BAND 5 BW: 5M 16QAM RB: 1,24	826.5	20425	V	23.41	3.30	-2.93	23.78	38.45
			H	27.35	3.30	-2.93	27.72	38.45
	836.5	20525	V	24.35	3.29	-2.96	24.68	38.45
			H	29.12	3.29	-2.97	29.44	38.45
	846.5	20625	V	22.61	3.27	-3.00	22.88	38.45
			H	28.28	3.27	-3.00	28.55	38.45

Remark

Unless otherwise stated the results shown in this test report refer only to the sample(s) tested and such sample(s) are retained for 90 days only.

除非另有說明，此報告結果僅對測試之樣品負責，同時此樣品僅保留90天。本報告未經本公司書面許可，不可部份複製。

This document is issued by the Company subject to its General Conditions of Service printed overleaf, available on request or accessible at www.sgs.com/terms_and_conditions.htm and, for electronic format documents, subject to Terms and Conditions for Electronic Documents at www.sgs.com/terms_e-document.htm. Attention is drawn to the limitation of liability, indemnification and jurisdiction issues defined therein. Any holder of this document is advised that information contained hereon reflects the Company's findings at the time of its intervention only and within the limits of Client's instructions, if any. The Company's sole responsibility is to its Client and this document does not exonerate parties to a transaction from exercising all their rights and obligations under the transaction documents. This document cannot be reproduced except in full, without prior written approval of the Company. Any unauthorized alteration, forgery or falsification of the content or appearance of this document is unlawful and offenders may be prosecuted to the fullest extent of the law.

SGS Taiwan Ltd.

No.134,WuKungRoad,NewTaipeiIndustrialPark,WukuDistrict,NewTaipeiCity,Taiwan24803/新北市五股區新北產業園區五工路 134 號

台灣檢驗科技股份有限公司

t (886-2) 2299-3279

f (886-2) 2298-0488

www.tw.sgs.com

Member of SGS Group

EUT			Measurement					
Operation Band	Fundamental Frequency	CH	Antenna Pol.	S.G. Output	Antenna Gain	Cable Loss	ERP	Limit
	MHz		V/H	dBm	dBd	dB	dBm	dBm
BAND 5 BW: 10M QPSK RB: 1,0	829.0	20450	V	23.56	3.30	-2.93	23.93	38.45
			H	27.29	3.30	-2.93	27.66	38.45
	836.5	20525	V	21.27	3.30	-2.94	21.63	38.45
			H	25.86	3.30	-2.94	26.22	38.45
	844.0	20600	V	23.43	3.28	-2.98	23.73	38.45
			H	29.44	3.28	-2.98	29.74	38.45
BAND 5 BW: 10M QPSK RB: 1,49	829.0	20450	V	21.00	3.29	-2.95	21.34	38.45
			H	26.06	3.29	-2.96	26.39	38.45
	836.5	20525	V	24.54	3.28	-2.98	24.84	38.45
			H	29.74	3.28	-2.98	30.04	38.45
	844.0	20600	V	22.32	3.27	-3.00	22.59	38.45
			H	28.00	3.27	-3.00	28.27	38.45
BAND 5 BW: 10M 16QAM RB: 1,0	829.0	20450	V	23.82	3.30	-2.93	24.19	38.45
			H	27.52	3.30	-2.93	27.89	38.45
	836.5	20525	V	20.34	3.30	-2.94	20.70	38.45
			H	24.91	3.30	-2.94	25.27	38.45
	844.0	20600	V	23.83	3.28	-2.98	24.13	38.45
			H	28.91	3.28	-2.98	29.21	38.45
BAND 5 BW: 10M 16QAM RB: 1,49	829.0	20450	V	20.55	3.29	-2.95	20.89	38.45
			H	25.14	3.29	-2.95	25.48	38.45
	836.5	20525	V	24.26	3.28	-2.98	24.56	38.45
			H	29.40	3.28	-2.97	29.71	38.45
	844.0	20600	V	21.04	3.27	-3.00	21.31	38.45
			H	27.62	3.27	-3.00	27.89	38.45

Remark

Unless otherwise stated the results shown in this test report refer only to the sample(s) tested and such sample(s) are retained for 90 days only.

除非另有說明，此報告結果僅對測試之樣品負責，同時此樣品僅保留90天。本報告未經本公司書面許可，不可部份複製。

This document is issued by the Company subject to its General Conditions of Service printed overleaf, available on request or accessible at www.sgs.com/terms_and_conditions.htm and, for electronic format documents, subject to Terms and Conditions for Electronic Documents at www.sgs.com/terms_e-document.htm. Attention is drawn to the limitation of liability, indemnification and jurisdiction issues defined therein. Any holder of this document is advised that information contained hereon reflects the Company's findings at the time of its intervention only and within the limits of Client's instructions, if any. The Company's sole responsibility is to its Client and this document does not exonerate parties to a transaction from exercising all their rights and obligations under the transaction documents. This document cannot be reproduced except in full, without prior written approval of the Company. Any unauthorized alteration, forgery or falsification of the content or appearance of this document is unlawful and offenders may be prosecuted to the fullest extent of the law.

SGS Taiwan Ltd.

No.134,WuKungRoad,NewTaipeiIndustrialPark,WukuDistrict,NewTaipeiCity,Taiwan24803/新北市五股區新北產業園區五工路 134 號

台灣檢驗科技股份有限公司

t (886-2) 2299-3279

f (886-2) 2298-0488

www.tw.sgs.com

Member of SGS Group

EUT			Measurement					
Operation Band	Fundamental Frequency	CH	Antenna Pol.	S.G. Output	Antenna Gain	Cable Loss	EIRP	Limit
	MHz		V/H	dBm	dBi	dB	dBm	dBm
BAND 7 BW: 5M QPSK RB: 1,0	2502.5	20775	V	14.25	10.90	-5.26	19.89	33.01
			H	18.50	10.90	-5.26	24.14	33.01
	2535.0	21100	V	15.13	10.94	-5.30	20.77	33.01
			H	19.35	10.94	-5.30	24.99	33.01
	2567.5	21425	V	14.59	10.98	-5.34	20.23	33.01
			H	18.78	10.98	-5.34	24.42	33.01
BAND 7 BW: 5M QPSK RB: 1,24	2502.5	20775	V	14.52	10.90	-5.26	20.16	33.01
			H	19.50	10.90	-5.26	25.14	33.01
	2535.0	21100	V	14.38	10.95	-5.31	20.02	33.01
			H	18.83	10.95	-5.31	24.47	33.01
	2567.5	21425	V	13.80	10.99	-5.34	19.45	33.01
			H	18.83	10.99	-5.34	24.48	33.01
BAND 7 BW: 5M 16QAM RB: 1,0	2502.5	20775	V	14.02	10.90	-5.26	19.66	33.01
			H	18.82	10.90	-5.26	24.46	33.01
	2535.0	21100	V	15.20	10.94	-5.30	20.84	33.01
			H	19.23	10.94	-5.30	24.87	33.01
	2567.5	21425	V	13.97	10.98	-5.34	19.61	33.01
			H	19.23	10.98	-5.34	24.87	33.01
BAND 7 BW: 5M 16QAM RB: 1,24	2502.5	20775	V	15.22	10.90	-5.26	20.86	33.01
			H	19.05	10.90	-5.26	24.69	33.01
	2535.0	21100	V	14.70	10.95	-5.31	20.34	33.01
			H	19.99	10.95	-5.31	25.63	33.01
	2567.5	21425	V	13.51	10.99	-5.34	19.16	33.01
			H	18.57	10.99	-5.34	24.22	33.01

Remark

Unless otherwise stated the results shown in this test report refer only to the sample(s) tested and such sample(s) are retained for 90 days only.

除非另有說明，此報告結果僅對測試之樣品負責，同時此樣品僅保留90天。本報告未經本公司書面許可，不可部份複製。

This document is issued by the Company subject to its General Conditions of Service printed overleaf, available on request or accessible at www.sgs.com/terms_and_conditions.htm and, for electronic format documents, subject to Terms and Conditions for Electronic Documents at www.sgs.com/terms_e-document.htm. Attention is drawn to the limitation of liability, indemnification and jurisdiction issues defined therein. Any holder of this document is advised that information contained hereon reflects the Company's findings at the time of its intervention only and within the limits of Client's instructions, if any. The Company's sole responsibility is to its Client and this document does not exonerate parties to a transaction from exercising all their rights and obligations under the transaction documents. This document cannot be reproduced except in full, without prior written approval of the Company. Any unauthorized alteration, forgery or falsification of the content or appearance of this document is unlawful and offenders may be prosecuted to the fullest extent of the law.

SGS Taiwan Ltd.

No.134,WuKungRoad,NewTaipeiIndustrialPark,WukuDistrict,NewTaipeiCity,Taiwan24803/新北市五股區新北產業園區五工路 134 號

台灣檢驗科技股份有限公司

t (886-2) 2299-3279

f (886-2) 2298-0488

www.tw.sgs.com

Member of SGS Group

EUT			Measurement					
Operation Band	Fundamental Frequency	CH	Antenna Pol.	S.G. Output	Antenna Gain	Cable Loss	EIRP	Limit
	MHz		V/H	dBm	dBi	dB	dBm	dBm
BAND 7 BW: 10M QPSK RB: 1,0	2505.0	20800	V	14.08	10.90	-5.26	19.72	33.01
			H	18.92	10.90	-5.26	24.56	33.01
	2535.0	21100	V	15.41	10.94	-5.30	21.05	33.01
			H	19.38	10.94	-5.30	25.02	33.01
	2565.0	21400	V	14.54	10.98	-5.34	20.18	33.01
			H	19.14	10.98	-5.34	24.78	33.01
BAND 7 BW: 10M QPSK RB: 1,49	2505.0	20800	V	14.56	10.91	-5.26	20.21	33.01
			H	19.30	10.91	-5.26	24.95	33.01
	2535.0	21100	V	15.01	10.95	-5.31	20.65	33.01
			H	19.58	10.95	-5.31	25.22	33.01
	2565.0	21400	V	13.88	10.99	-5.34	19.53	33.01
			H	19.08	10.99	-5.34	24.73	33.01
BAND 7 BW: 10M 16QAM RB: 1,0	2505.0	20800	V	14.01	10.90	-5.26	19.65	33.01
			H	19.01	10.90	-5.26	24.65	33.01
	2535.0	21100	V	15.27	10.94	-5.29	20.92	33.01
			H	19.50	10.94	-5.29	25.15	33.01
	2565.0	21400	V	14.34	10.98	-5.34	19.98	33.01
			H	19.03	10.98	-5.34	24.67	33.01
BAND 7 BW: 10M 16QAM RB: 1,49	2505.0	20800	V	15.28	10.91	-5.26	20.93	33.01
			H	19.48	10.91	-5.26	25.13	33.01
	2535.0	21100	V	14.75	10.95	-5.31	20.39	33.01
			H	20.04	10.95	-5.31	25.68	33.01
	2565.0	21400	V	14.00	10.99	-5.34	19.65	33.01
			H	18.98	10.99	-5.34	24.63	33.01

Remark

Unless otherwise stated the results shown in this test report refer only to the sample(s) tested and such sample(s) are retained for 90 days only.

除非另有說明，此報告結果僅對測試之樣品負責，同時此樣品僅保留90天。本報告未經本公司書面許可，不可部份複製。

This document is issued by the Company subject to its General Conditions of Service printed overleaf, available on request or accessible at www.sgs.com/terms_and_conditions.htm and, for electronic format documents, subject to Terms and Conditions for Electronic Documents at www.sgs.com/terms_e-document.htm. Attention is drawn to the limitation of liability, indemnification and jurisdiction issues defined therein. Any holder of this document is advised that information contained hereon reflects the Company's findings at the time of its intervention only and within the limits of Client's instructions, if any. The Company's sole responsibility is to its Client and this document does not exonerate parties to a transaction from exercising all their rights and obligations under the transaction documents. This document cannot be reproduced except in full, without prior written approval of the Company. Any unauthorized alteration, forgery or falsification of the content or appearance of this document is unlawful and offenders may be prosecuted to the fullest extent of the law.

SGS Taiwan Ltd.

No.134,WuKungRoad,NewTaipeiIndustrialPark,WukuDistrict,NewTaipeiCity,Taiwan24803/新北市五股區新北產業園區五工路 134 號

台灣檢驗科技股份有限公司

t (886-2) 2299-3279

f (886-2) 2298-0488

www.tw.sgs.com

Member of SGS Group

EUT			Measurement					
Operation Band	Fundamental Frequency	CH	Antenna Pol.	S.G. Output	Antenna Gain	Cable Loss	EIRP	Limit
	MHz		V/H	dBm	dBi	dB	dBm	dBm
BAND 7 BW: 15M QPSK RB: 1,0	2507.5	20825	V	14.09	10.90	-5.25	19.74	33.01
			H	19.07	10.91	-5.26	24.72	33.01
	2535.0	21100	V	15.17	10.94	-5.29	20.82	33.01
			H	20.41	10.94	-5.29	26.06	33.01
	2562.5	21375	V	14.40	10.97	-5.34	20.03	33.01
			H	19.20	10.97	-5.34	24.83	33.01
BAND 7 BW: 15M QPSK RB: 1,74	2507.5	20825	V	14.79	10.92	-5.27	20.44	33.01
			H	19.47	10.92	-5.27	25.12	33.01
	2535.0	21100	V	14.20	10.95	-5.32	19.83	33.01
			H	19.23	10.95	-5.32	24.86	33.01
	2562.5	21375	V	13.95	10.99	-5.34	19.60	33.01
			H	18.60	10.99	-5.34	24.25	33.01
BAND 7 BW: 15M 16QAM RB: 1,0	2507.5	20825	V	15.02	10.91	-5.26	20.67	33.01
			H	19.04	10.90	-5.25	24.69	33.01
	2535.0	21100	V	15.94	10.93	-5.29	21.58	33.01
			H	20.42	10.94	-5.29	26.07	33.01
	2562.5	21375	V	14.42	10.97	-5.34	20.05	33.01
			H	19.45	10.97	-5.34	25.08	33.01
BAND 7 BW: 15M 16QAM RB: 1,74	2507.5	20825	V	15.35	10.92	-5.27	21.00	33.01
			H	20.01	10.92	-5.27	25.66	33.01
	2535.0	21100	V	14.51	10.95	-5.32	20.14	33.01
			H	19.56	10.95	-5.32	25.19	33.01
	2562.5	21375	V	14.12	10.99	-5.34	19.77	33.01
			H	19.43	10.99	-5.34	25.08	33.01

Remark

Unless otherwise stated the results shown in this test report refer only to the sample(s) tested and such sample(s) are retained for 90 days only.

除非另有說明，此報告結果僅對測試之樣品負責，同時此樣品僅保留90天。本報告未經本公司書面許可，不可部份複製。

This document is issued by the Company subject to its General Conditions of Service printed overleaf, available on request or accessible at www.sgs.com/terms_and_conditions.htm and, for electronic format documents, subject to Terms and Conditions for Electronic Documents at www.sgs.com/terms_e-document.htm. Attention is drawn to the limitation of liability, indemnification and jurisdiction issues defined therein. Any holder of this document is advised that information contained hereon reflects the Company's findings at the time of its intervention only and within the limits of Client's instructions, if any. The Company's sole responsibility is to its Client and this document does not exonerate parties to a transaction from exercising all their rights and obligations under the transaction documents. This document cannot be reproduced except in full, without prior written approval of the Company. Any unauthorized alteration, forgery or falsification of the content or appearance of this document is unlawful and offenders may be prosecuted to the fullest extent of the law.

SGS Taiwan Ltd.

No.134,WuKungRoad,NewTaipeiIndustrialPark,WukuDistrict,NewTaipeiCity,Taiwan24803/新北市五股區新北產業園區五工路 134 號

台灣檢驗科技股份有限公司

t (886-2) 2299-3279

f (886-2) 2298-0488

www.tw.sgs.com

Member of SGS Group

EUT			Measurement					
Operation Band	Fundamental Frequency	CH	Antenna Pol.	S.G. Output	Antenna Gain	Cable Loss	EIRP	Limit
	MHz		V/H	dBm	dBi	dB	dBm	dBm
BAND 7 BW: 20M QPSK RB: 1,0	2510.0	20850	V	14.09	10.90	-5.26	19.73	33.01
			H	18.87	10.90	-5.26	24.51	33.01
	2535.0	21100	V	14.94	10.93	-5.29	20.58	33.01
			H	20.47	10.93	-5.29	26.11	33.01
	2560.0	21350	V	14.50	10.96	-5.33	20.13	33.01
			H	19.30	10.96	-5.33	24.93	33.01
BAND 7 BW: 20M QPSK RB: 1,99	2510.0	20850	V	15.07	10.92	-5.27	20.72	33.01
			H	19.89	10.92	-5.27	25.54	33.01
	2535.0	21100	V	15.06	10.96	-5.32	20.70	33.01
			H	19.38	10.96	-5.32	25.02	33.01
	2560.0	21350	V	13.64	10.99	-5.34	19.29	33.01
			H	18.47	10.99	-5.34	24.12	33.01
BAND 7 BW: 20M 16QAM RB: 1,0	2510.0	20850	V	14.11	10.90	-5.26	19.75	33.01
			H	19.10	10.90	-5.26	24.74	33.01
	2535.0	21100	V	16.00	10.93	-5.29	21.64	33.01
			H	20.57	10.93	-5.29	26.21	33.01
	2560.0	21350	V	14.50	10.97	-5.33	20.14	33.01
			H	19.83	10.96	-5.33	25.46	33.01
BAND 7 BW: 20M 16QAM RB: 1,99	2510.0	20850	V	15.32	10.92	-5.27	20.97	33.01
			H	20.25	10.92	-5.27	25.90	33.01
	2535.0	21100	V	15.24	10.96	-5.32	20.88	33.01
			H	19.48	10.95	-5.32	25.11	33.01
	2560.0	21350	V	14.12	10.99	-5.34	19.77	33.01
			H	19.50	10.99	-5.34	25.15	33.01

Remark

Unless otherwise stated the results shown in this test report refer only to the sample(s) tested and such sample(s) are retained for 90 days only.

除非另有說明，此報告結果僅對測試之樣品負責，同時此樣品僅保留90天。本報告未經本公司書面許可，不可部份複製。

This document is issued by the Company subject to its General Conditions of Service printed overleaf, available on request or accessible at www.sgs.com/terms_and_conditions.htm and, for electronic format documents, subject to Terms and Conditions for Electronic Documents at www.sgs.com/terms_e-document.htm. Attention is drawn to the limitation of liability, indemnification and jurisdiction issues defined therein. Any holder of this document is advised that information contained hereon reflects the Company's findings at the time of its intervention only and within the limits of Client's instructions, if any. The Company's sole responsibility is to its Client and this document does not exonerate parties to a transaction from exercising all their rights and obligations under the transaction documents. This document cannot be reproduced except in full, without prior written approval of the Company. Any unauthorized alteration, forgery or falsification of the content or appearance of this document is unlawful and offenders may be prosecuted to the fullest extent of the law.

SGS Taiwan Ltd.

No.134,WuKungRoad,NewTaipeiIndustrialPark,WukuDistrict,NewTaipeiCity,Taiwan24803/新北市五股區新北產業園區五工路 134 號

台灣檢驗科技股份有限公司

t (886-2) 2299-3279

f (886-2) 2298-0488

www.tw.sgs.com

Member of SGS Group

EUT			Measurement					
Operation Band	Fundamental Frequency	CH	Antenna Pol.	S.G. Output	Antenna Gain	Cable Loss	ERP	Limit
	MHz		V/H	dBm	dBd	dB	dBm	dBm
BAND 12 BW: 1.4M QPSK RB: 1,0	699.7	23017	V	11.82	3.08	-2.96	11.94	34.77
			H	14.16	3.08	-2.96	14.28	34.77
	707.5	23095	V	12.80	3.08	-2.96	12.92	34.77
			H	14.57	3.08	-2.96	14.69	34.77
	715.3	23173	V	12.63	3.09	-3.04	12.68	34.77
			H	14.20	3.09	-3.04	14.25	34.77
BAND 12 BW: 1.4M QPSK RB: 1,5	699.7	23017	V	12.02	3.10	-3.04	12.08	34.77
			H	13.59	3.10	-3.04	13.65	34.77
	707.5	23095	V	13.19	3.11	-3.06	13.24	34.77
			H	14.10	3.11	-3.06	14.15	34.77
	715.3	23173	V	12.48	3.11	-3.06	12.53	34.77
			H	14.36	3.11	-3.06	14.41	34.77
BAND 12 BW: 1.4M 16QAM RB: 1,0	699.7	23017	V	12.35	3.08	-2.96	12.47	34.77
			H	14.95	3.08	-2.96	15.07	34.77
	707.5	23095	V	12.49	3.08	-2.96	12.61	34.77
			H	15.18	3.08	-2.96	15.30	34.77
	715.3	23173	V	12.17	3.09	-3.04	12.22	34.77
			H	13.96	3.09	-3.04	14.01	34.77
BAND 12 BW: 1.4M 16QAM RB: 1,5	699.7	23017	V	12.33	3.09	-3.04	12.38	34.77
			H	13.42	3.10	-3.04	13.48	34.77
	707.5	23095	V	13.03	3.11	-3.06	13.08	34.77
			H	14.97	3.11	-3.06	15.02	34.77
	715.3	23173	V	12.83	3.11	-3.06	12.88	34.77
			H	14.71	3.11	-3.07	14.75	34.77

Remark

Unless otherwise stated the results shown in this test report refer only to the sample(s) tested and such sample(s) are retained for 90 days only.

除非另有說明，此報告結果僅對測試之樣品負責，同時此樣品僅保留90天。本報告未經本公司書面許可，不可部份複製。

This document is issued by the Company subject to its General Conditions of Service printed overleaf, available on request or accessible at www.sgs.com/terms_and_conditions.htm and, for electronic format documents, subject to Terms and Conditions for Electronic Documents at www.sgs.com/terms_e-document.htm. Attention is drawn to the limitation of liability, indemnification and jurisdiction issues defined therein. Any holder of this document is advised that information contained hereon reflects the Company's findings at the time of its intervention only and within the limits of Client's instructions, if any. The Company's sole responsibility is to its Client and this document does not exonerate parties to a transaction from exercising all their rights and obligations under the transaction documents. This document cannot be reproduced except in full, without prior written approval of the Company. Any unauthorized alteration, forgery or falsification of the content or appearance of this document is unlawful and offenders may be prosecuted to the fullest extent of the law.

SGS Taiwan Ltd.

No.134,WuKungRoad,NewTaipeiIndustrialPark,WukuDistrict,NewTaipeiCity,Taiwan24803/新北市五股區新北產業園區五工路 134 號

台灣檢驗科技股份有限公司

t (886-2) 2299-3279

f (886-2) 2298-0488

www.tw.sgs.com

Member of SGS Group

EUT			Measurement					
Operation Band	Fundamental Frequency	CH	Antenna Pol.	S.G. Output	Antenna Gain	Cable Loss	ERP	Limit
	MHz		V/H	dBm	dBd	dB	dBm	dBm
BAND 12 BW: 3M QPSK RB: 1,0	700.5	23025	V	11.68	3.08	-2.99	11.77	34.77
			H	14.73	3.08	-2.96	14.85	34.77
	707.5	23095	V	13.25	3.09	-3.03	13.31	34.77
			H	14.24	3.09	-3.04	14.29	34.77
	714.5	23165	V	13.51	3.11	-3.06	13.56	34.77
			H	15.54	3.11	-3.07	15.58	34.77
BAND 12 BW: 3M QPSK RB: 1,14	700.5	23025	V	13.08	3.08	-2.98	13.18	34.77
			H	15.79	3.08	-2.98	15.89	34.77
	707.5	23095	V	11.65	3.10	-3.04	11.71	34.77
			H	13.60	3.10	-3.04	13.66	34.77
	714.5	23165	V	13.05	3.11	-3.06	13.10	34.77
			H	14.66	3.11	-3.07	14.70	34.77
BAND 12 BW: 3M 16QAM RB: 1,0	700.5	23025	V	11.92	3.08	-2.98	12.02	34.77
			H	14.58	3.08	-2.96	14.70	34.77
	707.5	23095	V	12.56	3.09	-3.04	12.61	34.77
			H	15.14	3.09	-3.04	15.19	34.77
	714.5	23165	V	14.27	3.11	-3.06	14.32	34.77
			H	15.56	3.11	-3.07	15.60	34.77
BAND 12 BW: 3M 16QAM RB: 1,14	700.5	23025	V	14.13	3.08	-2.98	14.23	34.77
			H	15.56	3.08	-2.98	15.66	34.77
	707.5	23095	V	12.00	3.10	-3.04	12.06	34.77
			H	13.09	3.10	-3.04	13.15	34.77
	714.5	23165	V	13.26	3.11	-3.06	13.31	34.77
			H	14.77	3.11	-3.06	14.82	34.77

Remark

Unless otherwise stated the results shown in this test report refer only to the sample(s) tested and such sample(s) are retained for 90 days only.

除非另有說明，此報告結果僅對測試之樣品負責，同時此樣品僅保留90天。本報告未經本公司書面許可，不可部份複製。

This document is issued by the Company subject to its General Conditions of Service printed overleaf, available on request or accessible at www.sgs.com/terms_and_conditions.htm and, for electronic format documents, subject to Terms and Conditions for Electronic Documents at www.sgs.com/terms_e-document.htm. Attention is drawn to the limitation of liability, indemnification and jurisdiction issues defined therein. Any holder of this document is advised that information contained hereon reflects the Company's findings at the time of its intervention only and within the limits of Client's instructions, if any. The Company's sole responsibility is to its Client and this document does not exonerate parties to a transaction from exercising all their rights and obligations under the transaction documents. This document cannot be reproduced except in full, without prior written approval of the Company. Any unauthorized alteration, forgery or falsification of the content or appearance of this document is unlawful and offenders may be prosecuted to the fullest extent of the law.

SGS Taiwan Ltd.

No.134,WuKungRoad,NewTaipeiIndustrialPark,WukuDistrict,NewTaipeiCity,Taiwan24803/新北市五股區新北產業園區五工路 134 號

台灣檢驗科技股份有限公司

t (886-2) 2299-3279

f (886-2) 2298-0488

www.tw.sgs.com

Member of SGS Group

EUT			Measurement					
Operation Band	Fundamental Frequency	CH	Antenna Pol.	S.G. Output	Antenna Gain	Cable Loss	ERP	Limit
	MHz		V/H	dBm	dBd	dB	dBm	dBm
BAND 12 BW: 5M QPSK RB: 1,0	701.5	23035	V	12.53	3.08	-2.96	12.65	34.77
			H	14.68	3.08	-2.96	14.80	34.77
	707.5	23095	V	13.23	3.09	-3.03	13.29	34.77
			H	15.70	3.09	-3.03	15.76	34.77
	713.5	23155	V	12.76	3.10	-3.05	12.81	34.77
			H	14.04	3.11	-3.06	14.09	34.77
BAND 12 BW: 5M QPSK RB: 1,24	701.5	23035	V	14.57	3.09	-3.01	14.65	34.77
			H	15.73	3.09	-3.01	15.81	34.77
	707.5	23095	V	11.35	3.10	-3.05	11.40	34.77
			H	13.39	3.10	-3.05	13.44	34.77
	713.5	23155	V	12.73	3.11	-3.06	12.78	34.77
			H	14.47	3.11	-3.06	14.52	34.77
BAND 12 BW: 5M 16QAM RB: 1,0	701.5	23035	V	12.34	3.08	-2.96	12.46	34.77
			H	15.09	3.08	-2.96	15.21	34.77
	707.5	23095	V	13.81	3.09	-3.03	13.87	34.77
			H	15.92	3.09	-3.03	15.98	34.77
	713.5	23155	V	12.07	3.10	-3.05	12.12	34.77
			H	13.78	3.11	-3.06	13.83	34.77
BAND 12 BW: 5M 16QAM RB: 1,24	701.5	23035	V	13.90	3.09	-3.01	13.98	34.77
			H	16.27	3.09	-3.01	16.35	34.77
	707.5	23095	V	12.02	3.10	-3.05	12.07	34.77
			H	13.69	3.10	-3.05	13.74	34.77
	713.5	23155	V	13.67	3.11	-3.06	13.72	34.77
			H	14.21	3.11	-3.06	14.26	34.77

Remark

Unless otherwise stated the results shown in this test report refer only to the sample(s) tested and such sample(s) are retained for 90 days only.

除非另有說明，此報告結果僅對測試之樣品負責，同時此樣品僅保留90天。本報告未經本公司書面許可，不可部份複製。

This document is issued by the Company subject to its General Conditions of Service printed overleaf, available on request or accessible at www.sgs.com/terms_and_conditions.htm and, for electronic format documents, subject to Terms and Conditions for Electronic Documents at www.sgs.com/terms_e-document.htm. Attention is drawn to the limitation of liability, indemnification and jurisdiction issues defined therein. Any holder of this document is advised that information contained hereon reflects the Company's findings at the time of its intervention only and within the limits of Client's instructions, if any. The Company's sole responsibility is to its Client and this document does not exonerate parties to a transaction from exercising all their rights and obligations under the transaction documents. This document cannot be reproduced except in full, without prior written approval of the Company. Any unauthorized alteration, forgery or falsification of the content or appearance of this document is unlawful and offenders may be prosecuted to the fullest extent of the law.

SGS Taiwan Ltd.

No.134,WuKungRoad,NewTaipeiIndustrialPark,WukuDistrict,NewTaipeiCity,Taiwan24803/新北市五股區新北產業園區五工路 134 號

台灣檢驗科技股份有限公司

t (886-2) 2299-3279

f (886-2) 2298-0488

www.tw.sgs.com

Member of SGS Group

EUT			Measurement					
Operation Band	Fundamental Frequency	CH	Antenna Pol.	S.G. Output	Antenna Gain	Cable Loss	ERP	Limit
	MHz		V/H	dBm	dBd	dB	dBm	dBm
BAND 12 BW: 10M QPSK RB: 1,0	704.0	23060	V	11.88	3.08	-2.96	12.00	34.77
			H	14.61	3.08	-2.96	14.73	34.77
	707.5	23095	V	13.45	3.09	-3.01	13.53	34.77
			H	16.24	3.09	-3.01	16.32	34.77
	711.0	23130	V	12.88	3.09	-3.04	12.93	34.77
			H	14.51	3.09	-3.04	14.56	34.77
BAND 12 BW: 10M QPSK RB: 1,49	704.0	23060	V	11.97	3.10	-3.04	12.03	34.77
			H	13.26	3.10	-3.04	13.32	34.77
	707.5	23095	V	12.91	3.10	-3.05	12.96	34.77
			H	14.54	3.11	-3.06	14.59	34.77
	711.0	23130	V	12.44	3.11	-3.06	12.49	34.77
			H	13.68	3.11	-3.06	13.73	34.77
BAND 12 BW: 10M 16QAM RB: 1,0	704.0	23060	V	12.70	3.08	-2.96	12.82	34.77
			H	15.22	3.08	-2.96	15.34	34.77
	707.5	23095	V	14.42	3.09	-3.01	14.50	34.77
			H	16.12	3.09	-3.00	16.21	34.77
	711.0	23130	V	12.91	3.09	-3.04	12.96	34.77
			H	15.21	3.09	-3.04	15.26	34.77
BAND 12 BW: 10M 16QAM RB: 1,49	704.0	23060	V	11.98	3.10	-3.04	12.04	34.77
			H	14.19	3.10	-3.04	14.25	34.77
	707.5	23095	V	13.03	3.10	-3.05	13.08	34.77
			H	14.39	3.10	-3.05	14.44	34.77
	711.0	23130	V	12.80	3.11	-3.06	12.85	34.77
			H	14.56	3.11	-3.06	14.61	34.77

Remark

Unless otherwise stated the results shown in this test report refer only to the sample(s) tested and such sample(s) are retained for 90 days only.

除非另有說明，此報告結果僅對測試之樣品負責，同時此樣品僅保留90天。本報告未經本公司書面許可，不可部份複製。

This document is issued by the Company subject to its General Conditions of Service printed overleaf, available on request or accessible at www.sgs.com/terms_and_conditions.htm and, for electronic format documents, subject to Terms and Conditions for Electronic Documents at www.sgs.com/terms_e-document.htm. Attention is drawn to the limitation of liability, indemnification and jurisdiction issues defined therein. Any holder of this document is advised that information contained hereon reflects the Company's findings at the time of its intervention only and within the limits of Client's instructions, if any. The Company's sole responsibility is to its Client and this document does not exonerate parties to a transaction from exercising all their rights and obligations under the transaction documents. This document cannot be reproduced except in full, without prior written approval of the Company. Any unauthorized alteration, forgery or falsification of the content or appearance of this document is unlawful and offenders may be prosecuted to the fullest extent of the law.

SGS Taiwan Ltd.

No.134,WuKungRoad,NewTaipeiIndustrialPark,WukuDistrict,NewTaipeiCity,Taiwan24803/新北市五股區新北產業園區五工路 134 號

台灣檢驗科技股份有限公司

t (886-2) 2299-3279

f (886-2) 2298-0488

www.tw.sgs.com

Member of SGS Group

EUT			Measurement					
Operation Band	Fundamental Frequency	CH	Antenna Pol.	S.G. Output	Antenna Gain	Cable Loss	ERP	Limit
	MHz		V/H	dBm	dBd	dB	dBm	dBm
BAND 13 BW: 5M QPSK RB: 1,0	779.5	23205	V	10.88	3.27	-2.91	11.24	34.77
			H	16.47	3.28	-2.91	16.84	34.77
	782.0	23230	V	10.72	3.27	-2.91	11.08	34.77
			H	16.70	3.29	-2.91	17.08	34.77
	784.5	23255	V	11.64	3.28	-2.91	12.01	34.77
			H	18.51	3.29	-2.91	18.89	34.77
BAND 13 BW: 5M QPSK RB: 1,24	779.5	23205	V	11.39	3.28	-2.91	11.76	34.77
			H	18.21	3.29	-2.91	18.59	34.77
	782.0	23230	V	11.49	3.29	-2.91	11.87	34.77
			H	17.93	3.30	-2.91	18.32	34.77
	784.5	23255	V	9.73	3.29	-2.91	10.11	34.77
			H	17.36	3.30	-2.91	17.75	34.77
BAND 13 BW: 5M 16QAM RB: 1,0	779.5	23205	V	10.54	3.27	-2.91	10.90	34.77
			H	16.30	3.28	-2.91	16.67	34.77
	782.0	23230	V	11.89	3.27	-2.91	12.25	34.77
			H	17.30	3.29	-2.91	17.68	34.77
	784.5	23255	V	12.27	3.28	-2.91	12.64	34.77
			H	18.48	3.29	-2.91	18.86	34.77
BAND 13 BW: 5M 16QAM RB: 1,24	779.5	23205	V	11.56	3.28	-2.91	11.93	34.77
			H	18.24	3.29	-2.91	18.62	34.77
	782.0	23230	V	11.22	3.29	-2.91	11.60	34.77
			H	19.07	3.30	-2.90	19.47	34.77
	784.5	23255	V	9.34	3.30	-2.91	9.73	34.77
			H	17.51	3.30	-2.91	17.90	34.77

Remark

Unless otherwise stated the results shown in this test report refer only to the sample(s) tested and such sample(s) are retained for 90 days only.

除非另有說明，此報告結果僅對測試之樣品負責，同時此樣品僅保留90天。本報告未經本公司書面許可，不可部份複製。

This document is issued by the Company subject to its General Conditions of Service printed overleaf, available on request or accessible at www.sgs.com/terms_and_conditions.htm and, for electronic format documents, subject to Terms and Conditions for Electronic Documents at www.sgs.com/terms_e-document.htm. Attention is drawn to the limitation of liability, indemnification and jurisdiction issues defined therein. Any holder of this document is advised that information contained hereon reflects the Company's findings at the time of its intervention only and within the limits of Client's instructions, if any. The Company's sole responsibility is to its Client and this document does not exonerate parties to a transaction from exercising all their rights and obligations under the transaction documents. This document cannot be reproduced except in full, without prior written approval of the Company. Any unauthorized alteration, forgery or falsification of the content or appearance of this document is unlawful and offenders may be prosecuted to the fullest extent of the law.

SGS Taiwan Ltd.

No.134,WuKungRoad,NewTaipeiIndustrialPark,WukuDistrict,NewTaipeiCity,Taiwan24803/新北市五股區新北產業園區五工路 134 號

台灣檢驗科技股份有限公司

t (886-2) 2299-3279

f (886-2) 2298-0488

www.tw.sgs.com

Member of SGS Group

EUT			Measurement					
Operation Band	Fundamental Frequency	CH	Antenna Pol.	S.G. Output	Antenna Gain	Cable Loss	ERP	Limit
	MHz		V/H	dBm	dBd	dB	dBm	dBm
BAND 13 BW: 10M QPSK RB: 1,0	782.0	23230	V	11.43	3.27	-2.91	11.79	34.77
			H	15.28	3.28	-2.91	15.65	34.77
BAND 13 BW: 10M QPSK RB: 1,49	782.0	23230	V	9.55	3.29	-2.91	9.93	34.77
			H	17.29	3.30	-2.91	17.68	34.77
BAND 13 BW: 10M 16QAM RB: 1,0	782.0	23230	V	11.69	3.27	-2.91	12.05	34.77
			H	17.16	3.27	-2.91	17.52	34.77
BAND 13 BW: 10M 16QAM RB: 1,49	782.0	23230	V	9.28	3.29	-2.91	9.66	34.77
			H	17.39	3.30	-2.91	17.78	34.77

Remark

Unless otherwise stated the results shown in this test report refer only to the sample(s) tested and such sample(s) are retained for 90 days only.

除非另有說明，此報告結果僅對測試之樣品負責，同時此樣品僅保留90天。本報告未經本公司書面許可，不可部份複製。

This document is issued by the Company subject to its General Conditions of Service printed overleaf, available on request or accessible at www.sgs.com/terms_and_conditions.htm and, for electronic format documents, subject to Terms and Conditions for Electronic Documents at www.sgs.com/terms_e-document.htm. Attention is drawn to the limitation of liability, indemnification and jurisdiction issues defined therein. Any holder of this document is advised that information contained hereon reflects the Company's findings at the time of its intervention only and within the limits of Client's instructions, if any. The Company's sole responsibility is to its Client and this document does not exonerate parties to a transaction from exercising all their rights and obligations under the transaction documents. This document cannot be reproduced except in full, without prior written approval of the Company. Any unauthorized alteration, forgery or falsification of the content or appearance of this document is unlawful and offenders may be prosecuted to the fullest extent of the law.

SGS Taiwan Ltd.

No.134,WuKungRoad,NewTaipeiIndustrialPark,WukuDistrict,NewTaipeiCity,Taiwan24803/新北市五股區新北產業園區五工路 134 號

台灣檢驗科技股份有限公司

t (886-2) 2299-3279

f (886-2) 2298-0488

www.tw.sgs.com

Member of SGS Group

EUT			Measurement					
Operation Band	Fundamental Frequency	CH	Antenna Pol.	S.G. Output	Antenna Gain	Cable Loss	ERP	Limit
	MHz		V/H	dBm	dBd	dB	dBm	dBm
BAND 17 BW: 5M QPSK RB: 1,0	706.5	23755	V	13.87	3.09	-3.03	13.93	34.77
			H	15.90	3.09	-3.04	15.95	34.77
	710.0	23790	V	11.86	3.09	-3.04	11.91	34.77
			H	14.44	3.09	-3.04	14.49	34.77
	713.5	23825	V	12.14	3.10	-3.05	12.19	34.77
			H	15.48	3.11	-3.06	15.53	34.77
BAND 17 BW: 5M QPSK RB: 1,24	706.5	23755	V	11.85	3.10	-3.04	11.91	34.77
			H	14.31	3.10	-3.04	14.37	34.77
	710.0	23790	V	13.38	3.10	-3.05	13.43	34.77
			H	15.81	3.11	-3.06	15.86	34.77
	713.5	23825	V	13.55	3.11	-3.06	13.60	34.77
			H	15.33	3.11	-3.06	15.38	34.77
BAND 17 BW: 5M 16QAM RB: 1,0	706.5	23755	V	14.01	3.09	-3.04	14.06	34.77
			H	16.42	3.09	-3.04	16.47	34.77
	710.0	23790	V	12.34	3.10	-3.04	12.40	34.77
			H	14.55	3.09	-3.04	14.60	34.77
	713.5	23825	V	12.62	3.10	-3.05	12.67	34.77
			H	15.77	3.11	-3.06	15.82	34.77
BAND 17 BW: 5M 16QAM RB: 1,24	706.5	23755	V	12.01	3.10	-3.04	12.07	34.77
			H	14.99	3.10	-3.04	15.05	34.77
	710.0	23790	V	13.05	3.10	-3.05	13.10	34.77
			H	16.38	3.11	-3.06	16.43	34.77
	713.5	23825	V	13.09	3.11	-3.06	13.14	34.77
			H	15.92	3.11	-3.06	15.97	34.77

Remark

Unless otherwise stated the results shown in this test report refer only to the sample(s) tested and such sample(s) are retained for 90 days only.

除非另有說明，此報告結果僅對測試之樣品負責，同時此樣品僅保留90天。本報告未經本公司書面許可，不可部份複製。

This document is issued by the Company subject to its General Conditions of Service printed overleaf, available on request or accessible at www.sgs.com/terms_and_conditions.htm and, for electronic format documents, subject to Terms and Conditions for Electronic Documents at www.sgs.com/terms_e-document.htm. Attention is drawn to the limitation of liability, indemnification and jurisdiction issues defined therein. Any holder of this document is advised that information contained hereon reflects the Company's findings at the time of its intervention only and within the limits of Client's instructions, if any. The Company's sole responsibility is to its Client and this document does not exonerate parties to a transaction from exercising all their rights and obligations under the transaction documents. This document cannot be reproduced except in full, without prior written approval of the Company. Any unauthorized alteration, forgery or falsification of the content or appearance of this document is unlawful and offenders may be prosecuted to the fullest extent of the law.

SGS Taiwan Ltd.

No.134,WuKungRoad,NewTaipeiIndustrialPark,WukuDistrict,NewTaipeiCity,Taiwan24803/新北市五股區新北產業園區五工路 134 號

台灣檢驗科技股份有限公司

t (886-2) 2299-3279

f (886-2) 2298-0488

www.tw.sgs.com

Member of SGS Group

EUT			Measurement					
Operation Band	Fundamental Frequency	CH	Antenna Pol.	S.G. Output	Antenna Gain	Cable Loss	ERP	Limit
	MHz		V/H	dBm	dBd	dB	dBm	dBm
BAND 17 BW: 10M QPSK RB: 1,0	709.0	23780	V	14.16	3.09	-3.03	14.22	34.77
			H	15.91	3.09	-3.04	15.96	34.77
	710.0	23790	V	12.49	3.09	-3.04	12.54	34.77
			H	15.42	3.09	-3.03	15.48	34.77
	711.0	23800	V	12.27	3.09	-3.04	12.32	34.77
			H	15.41	3.09	-3.04	15.46	34.77
BAND 17 BW: 10M QPSK RB: 1,49	709.0	23780	V	13.74	3.11	-3.06	13.79	34.77
			H	16.74	3.11	-3.07	16.78	34.77
	710.0	23790	V	13.58	3.11	-3.06	13.63	34.77
			H	16.16	3.11	-3.07	16.20	34.77
	711.0	23800	V	12.63	3.11	-3.06	12.68	34.77
			H	16.07	3.11	-3.06	16.12	34.77
BAND 17 BW: 10M 16QAM RB: 1,0	709.0	23780	V	14.09	3.09	-3.04	14.14	34.77
			H	16.59	3.09	-3.04	16.64	34.77
	710.0	23790	V	13.07	3.09	-3.04	13.12	34.77
			H	16.09	3.09	-3.03	16.15	34.77
	711.0	23800	V	12.71	3.09	-3.04	12.76	34.77
			H	15.05	3.09	-3.04	15.10	34.77
BAND 17 BW: 10M 16QAM RB: 1,49	709.0	23780	V	13.80	3.11	-3.06	13.85	34.77
			H	16.44	3.11	-3.07	16.48	34.77
	710.0	23790	V	14.15	3.11	-3.06	14.20	34.77
			H	16.94	3.11	-3.07	16.98	34.77
	711.0	23800	V	13.19	3.11	-3.06	13.24	34.77
			H	15.73	3.11	-3.06	15.78	34.77

Remark

Unless otherwise stated the results shown in this test report refer only to the sample(s) tested and such sample(s) are retained for 90 days only.

除非另有說明，此報告結果僅對測試之樣品負責，同時此樣品僅保留90天。本報告未經本公司書面許可，不可部份複製。

This document is issued by the Company subject to its General Conditions of Service printed overleaf, available on request or accessible at www.sgs.com/terms_and_conditions.htm and, for electronic format documents, subject to Terms and Conditions for Electronic Documents at www.sgs.com/terms_e-document.htm. Attention is drawn to the limitation of liability, indemnification and jurisdiction issues defined therein. Any holder of this document is advised that information contained hereon reflects the Company's findings at the time of its intervention only and within the limits of Client's instructions, if any. The Company's sole responsibility is to its Client and this document does not exonerate parties to a transaction from exercising all their rights and obligations under the transaction documents. This document cannot be reproduced except in full, without prior written approval of the Company. Any unauthorized alteration, forgery or falsification of the content or appearance of this document is unlawful and offenders may be prosecuted to the fullest extent of the law.

SGS Taiwan Ltd.

No.134,WuKungRoad,NewTaipeiIndustrialPark,WukuDistrict,NewTaipeiCity,Taiwan24803/新北市五股區新北產業園區五工路 134 號

台灣檢驗科技股份有限公司

t (886-2) 2299-3279

f (886-2) 2298-0488

www.tw.sgs.com

Member of SGS Group

8. OCCUPIED BANDWIDTH MEASUREMENT

8.1. Standard Applicable

The occupied bandwidth is the frequency bandwidth such that, below its lower and above its upper frequency limits, the mean powers radiated are each equal to 0.5 percent of the total mean power.

8.2. Test Set-up

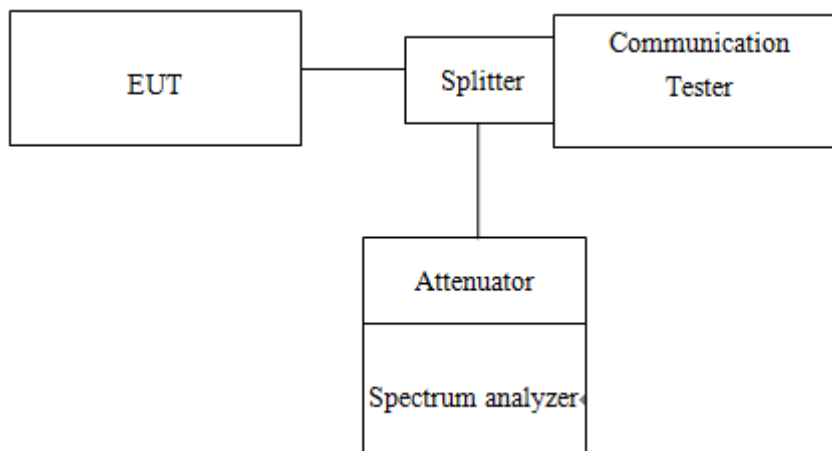

8.3. Measurement Procedure

99% & 26dB Bandwidth with detector peak

The EUT's output RF connector was connected with a short cable to the spectrum analyzer, RBW was set to about 1% of emission BW, VBW= 3 times RBW, -26dBc display line was placed on the screen (or 26dB bandwidth), the occupied bandwidth is the delta frequency between the two points where the display line intersects the signal trace. Then set RBW to 99% bandwidth, RBW= 1%, VBW= 3 RBW, with span > 2 * Signal BW, set % Power = 99%.

99% Bandwidth with detector sample

The EUT's output RF connector was connected with a short cable to the spectrum analyzer, RBW was set to about 1% ~ 5% of emission BW, VBW= 3 times RBW, -20dBc display line was placed on the screen (or 20dB bandwidth). Set RBW to 99% bandwidth, RBW= 1% ~ 5%, VBW= 3 RBW, with span > 2 * Signal BW, set % Power = 99%.

Unless otherwise stated the results shown in this test report refer only to the sample(s) tested and such sample(s) are retained for 90 days only.

除非另有說明，此報告結果僅對測試之樣品負責，同時此樣品僅保留90天。本報告未經本公司書面許可，不可部份複製。

This document is issued by the Company subject to its General Conditions of Service printed overleaf, available on request or accessible at www.sgs.com/terms_and_conditions.htm and, for electronic format documents, subject to Terms and Conditions for Electronic Documents at www.sgs.com/terms_e-document.htm. Attention is drawn to the limitation of liability, indemnification and jurisdiction issues defined therein. Any holder of this document is advised that information contained hereon reflects the Company's findings at the time of its intervention only and within the limits of Client's instructions, if any. The Company's sole responsibility is to its Client and this document does not exonerate parties to a transaction from exercising all their rights and obligations under the transaction documents. This document cannot be reproduced except in full, without prior written approval of the Company. Any unauthorized alteration, forgery or falsification of the content or appearance of this document is unlawful and offenders may be prosecuted to the fullest extent of the law.

8.4. Measurement Equipment Used

Conducted Emission (measured at antenna port) Test Site					
EQUIPMENT TYPE	MFR	MODEL NUMBER	SERIAL NUMBER	LAST CAL.	CAL DUE.
Power Meter	Anritsu	ML2495A	1005007	12/15/2016	12/14/2017
Power Sensor	Anritsu	MA2411B	917032	12/15/2016	12/14/2017
EXA Spectrum Analyzer	Agilent	N9030A	MY53120760	03/21/2017	03/20/2018
DC Block	Mini-Circuits	BLK-18-S+	1	01/05/2017	01/04/2018
Coaxial Cable	HUBER+SUHNER	SUCOFLEX 102	23670/2	01/05/2017	01/04/2018
Attenuator	Mini-Circuit	BW-S10W2+	2	01/05/2017	01/04/2018
Splitter	Agilent	11636B	N/A	01/05/2017	01/04/2018
DC Power Supply	Agilent	E3640A	MY52410006	11/21/2016	11/20/2017
Temperature Chamber	TERCHY	MHG-120LF	911009	05/17/2016	05/16/2017
Radio Communication Analyzer	Anritsu	MT8820C	6201465317	01/03/2017	01/02/2018
Radio Communication Analyzer	R&S	CMU200	102189	02/11/2017	02/10/2018

Unless otherwise stated the results shown in this test report refer only to the sample(s) tested and such sample(s) are retained for 90 days only.

除非另有說明，此報告結果僅對測試之樣品負責，同時此樣品僅保留90天。本報告未經本公司書面許可，不可部份複製。

This document is issued by the Company subject to its General Conditions of Service printed overleaf, available on request or accessible at www.sgs.com/terms_and_conditions.htm and, for electronic format documents, subject to Terms and Conditions for Electronic Documents at www.sgs.com/terms_e-document.htm. Attention is drawn to the limitation of liability, indemnification and jurisdiction issues defined therein. Any holder of this document is advised that information contained hereon reflects the Company's findings at the time of its intervention only and within the limits of Client's instructions, if any. The Company's sole responsibility is to its Client and this document does not exonerate parties to a transaction from exercising all their rights and obligations under the transaction documents. This document cannot be reproduced except in full, without prior written approval of the Company. Any unauthorized alteration, forgery or falsification of the content or appearance of this document is unlawful and offenders may be prosecuted to the fullest extent of the law.

SGS Taiwan Ltd.

No.134,WuKungRoad,NewTaipeiIndustrialPark,WukuDistrict,NewTaipeiCity,Taiwan24803/新北市五股區新北產業園區五工路 134 號

台灣檢驗科技股份有限公司

t (886-2) 2299-3279

f (886-2) 2298-0488

www.tw.sgs.com

Member of SGS Group

8.5. Measurement Result

Freq. (MHz)	CH	99% BW (MHz)	99% BW (MHz)	26 dB BW (MHz)	26 dB BW (MHz)
		GPRS 850	EDGE 850	GPRS 850	EDGE 850
824.2	128	0.24816	0.24293	0.3208	0.3163
836.6	190	0.24517	0.24663	0.3208	0.3149
848.8	251	0.24617	0.24163	0.3237	0.3075

Freq. (MHz)	CH	99% BW (MHz)	99% BW (MHz)	26 dB BW (MHz)	26 dB BW (MHz)
		GPRS 1900	EDGE 1900	GPRS 1900	EDGE 1900
1850.2	512	0.24411	0.2470	0.3231	0.3201
1880.0	661	0.24661	0.2446	0.3203	0.3153
1909.8	810	0.24346	0.2427	0.3252	0.3101

Freq. (MHz)	CH	99% BW (MHz)	99% BW (MHz)	26 dB BW (MHz)	26 dB BW (MHz)
		CDMA BC0	EVDO BC0	CDMA BC0	EVDO BC0
824.2	128	1.2719	1.274	1.422	1.422
836.6	190	1.2714	1.2708	1.423	1.425
848.8	251	1.2712	1.2763	1.428	1.424

Freq. (MHz)	CH	99% BW (MHz)	99% BW (MHz)	26 dB BW (MHz)	26 dB BW (MHz)
		CDMA BC1	EVDO BC1	CDMA BC1	EVDO BC1
1850.2	512	1.2748	1.2787	1.423	1.421
1880.0	661	1.2709	1.2685	1.425	1.419
1909.8	810	1.2784	1.2734	1.443	1.431

Unless otherwise stated the results shown in this test report refer only to the sample(s) tested and such sample(s) are retained for 90 days only.

除非另有說明，此報告結果僅對測試之樣品負責，同時此樣品僅保留90天。本報告未經本公司書面許可，不可部份複製。

This document is issued by the Company subject to its General Conditions of Service printed overleaf, available on request or accessible at www.sgs.com/terms_and_conditions.htm and, for electronic format documents, subject to Terms and Conditions for Electronic Documents at www.sgs.com/terms_e-document.htm. Attention is drawn to the limitation of liability, indemnification and jurisdiction issues defined therein. Any holder of this document is advised that information contained hereon reflects the Company's findings at the time of its intervention only and within the limits of Client's instructions, if any. The Company's sole responsibility is to its Client and this document does not exonerate parties to a transaction from exercising all their rights and obligations under the transaction documents. This document cannot be reproduced except in full, without prior written approval of the Company. Any unauthorized alteration, forgery or falsification of the content or appearance of this document is unlawful and offenders may be prosecuted to the fullest extent of the law.

Freq. (MHz)	CH	99% BW (MHz)	99% BW (MHz)	99% BW (MHz)	26 dB BW (MHz)	26 dB BW (MHz)	26 dB BW (MHz)
		WCDMA II	HSDPA II	HSUPA II	WCDMA II	HSDPA II	HSUPA II
1850.20	9262	4.1510	4.1637	4.1486	4.636	4.627	4.617
1880.00	9400	4.1537	4.1448	4.154	4.613	4.623	4.624
1909.80	9538	4.1559	4.1423	4.14	4.624	4.612	4.608

Freq. (MHz)	CH	99% BW (MHz)	99% BW (MHz)	99% BW (MHz)	26 dB BW (MHz)	26 dB BW (MHz)	26 dB BW (MHz)
		WCDMA IV	HSDPA IV	HSUPA IV	WCDMA IV	HSDPA IV	HSUPA IV
1712.40	1312	4.1584	4.1529	4.1472	4.636	4.618	4.623
1732.60	1413	4.1463	4.138	4.1491	4.640	4.619	4.627
1752.60	1513	4.1536	4.1424	4.1331	4.633	4.613	4.621

Freq. (MHz)	CH	99% BW (MHz)	99% BW (MHz)	99% BW (MHz)	26 dB BW (MHz)	26 dB BW (MHz)	26 dB BW (MHz)
		WCDMA V	HSDPA V	HSUPA V	WCDMA V	HSDPA V	HSUPA V
826.40	4132	4.1536	4.1477	4.1402	4.638	4.632	4.615
836.60	4183	4.1421	4.1445	4.1541	4.621	4.618	4.626
846.60	4233	4.1484	4.1216	4.1241	4.620	4.602	4.615

Unless otherwise stated the results shown in this test report refer only to the sample(s) tested and such sample(s) are retained for 90 days only.

除非另有說明，此報告結果僅對測試之樣品負責，同時此樣品僅保留90天。本報告未經本公司書面許可，不可部份複製。

This document is issued by the Company subject to its General Conditions of Service printed overleaf, available on request or accessible at www.sgs.com/terms_and_conditions.htm and, for electronic format documents, subject to Terms and Conditions for Electronic Documents at www.sgs.com/terms_e-document.htm. Attention is drawn to the limitation of liability, indemnification and jurisdiction issues defined therein. Any holder of this document is advised that information contained hereon reflects the Company's findings at the time of its intervention only and within the limits of Client's instructions, if any. The Company's sole responsibility is to its Client and this document does not exonerate parties to a transaction from exercising all their rights and obligations under the transaction documents. This document cannot be reproduced except in full, without prior written approval of the Company. Any unauthorized alteration, forgery or falsification of the content or appearance of this document is unlawful and offenders may be prosecuted to the fullest extent of the law.

LTE BAND 2 Channel bandwidth: 1.4MHz					
Freq. (MHz)	CH	99% BW (MHz)	99% BW (MHz)	26 dB BW (MHz)	26 dB BW (MHz)
		QPSK	16QAM	QPSK	16QAM
1850.7	18607	1.0990	1.1020	1.261	1.297
1880.0	18900	1.0998	1.0998	1.281	1.308
1909.3	19193	1.1005	1.1005	1.291	1.304

LTE BAND 2 Channel bandwidth: 3MHz					
Freq. (MHz)	CH	99% BW (MHz)	99% BW (MHz)	26 dB BW (MHz)	26 dB BW (MHz)
		QPSK	16QAM	QPSK	16QAM
1851.5	18615	2.7091	2.7081	2.987	2.999
1880.0	18900	2.7024	2.7042	2.980	3.004
1908.5	19185	2.7054	2.7024	3.009	3.000

LTE BAND 2 Channel bandwidth: 5MHz					
Freq. (MHz)	CH	99% BW (MHz)	99% BW (MHz)	26 dB BW (MHz)	26 dB BW (MHz)
		QPSK	16QAM	QPSK	16QAM
1852.5	18625	4.5103	4.5097	5.025	5.015
1880.0	18900	4.5148	4.5074	5.002	5.044
1907.5	19175	4.5090	4.5070	4.985	5.059

LTE BAND 2 Channel bandwidth: 10MHz					
Freq. (MHz)	CH	99% BW (MHz)	99% BW (MHz)	26 dB BW (MHz)	26 dB BW (MHz)
		QPSK	16QAM	QPSK	16QAM
1855.0	18650	8.9895	8.9751	9.883	9.778
1880.0	18900	8.9807	8.9693	9.854	9.803
1905.0	19150	8.9829	8.9733	9.807	9.885

LTE BAND 2 Channel bandwidth: 15MHz					
Freq. (MHz)	CH	99% BW (MHz)	99% BW (MHz)	26 dB BW (MHz)	26 dB BW (MHz)
		QPSK	16QAM	QPSK	16QAM
1857.5	18675	13.482	13.418	14.60	16.40
1880.0	18900	13.470	13.440	14.67	14.60
1902.5	19125	13.423	13.440	14.69	14.57

LTE BAND 2 Channel bandwidth: 20MHz					
Freq. (MHz)	CH	99% BW (MHz)	99% BW (MHz)	26 dB BW (MHz)	26 dB BW (MHz)
		QPSK	16QAM	QPSK	16QAM
1860.0	18700	17.884	17.867	19.36	19.35
1880.0	18900	17.925	17.942	19.43	19.41
1900.0	19100	17.878	17.874	19.30	19.41

Unless otherwise stated the results shown in this test report refer only to the sample(s) tested and such sample(s) are retained for 90 days only.

除非另有說明，此報告結果僅對測試之樣品負責，同時此樣品僅保留90天。本報告未經本公司書面許可，不可部份複製。

This document is issued by the Company subject to its General Conditions of Service printed overleaf, available on request or accessible at www.sgs.com/terms_and_conditions.htm and, for electronic format documents, subject to Terms and Conditions for Electronic Documents at www.sgs.com/terms_e-document.htm. Attention is drawn to the limitation of liability, indemnification and jurisdiction issues defined therein. Any holder of this document is advised that information contained hereon reflects the Company's findings at the time of its intervention only and within the limits of Client's instructions, if any. The Company's sole responsibility is to its Client and this document does not exonerate parties to a transaction from exercising all their rights and obligations under the transaction documents. This document cannot be reproduced except in full, without prior written approval of the Company. Any unauthorized alteration, forgery or falsification of the content or appearance of this document is unlawful and offenders may be prosecuted to the fullest extent of the law.

SGS Taiwan Ltd.

No.134,WuKungRoad,NewTaipeiIndustrialPark,WukuDistrict,NewTaipeiCity,Taiwan24803/新北市五股區新北產業園區五工路 134 號

台灣檢驗科技股份有限公司

t (886-2) 2299-3279

f (886-2) 2298-0488

www.tw.sgs.com

Member of SGS Group

LTE BAND 4 Channel bandwidth: 1.4MHz					
Freq. (MHz)	CH	99% BW (MHz)	99% BW (MHz)	26 dB BW (MHz)	26 dB BW (MHz)
		QPSK	16QAM	QPSK	16QAM
1710.7	19957	1.1007	1.1030	1.278	1.307
1732.5	20175	1.0999	1.1019	1.285	1.290
1754.3	20393	1.1004	1.1034	1.281	1.294

LTE BAND 4 Channel bandwidth: 3MHz					
Freq. (MHz)	CH	99% BW (MHz)	99% BW (MHz)	26 dB BW (MHz)	26 dB BW (MHz)
		QPSK	16QAM	QPSK	16QAM
1711.5	19965	2.7050	2.7057	2.978	3.002
1732.5	20175	2.7031	2.6994	2.982	2.982
1753.5	20385	2.7059	2.7081	2.972	2.980

LTE BAND 4 Channel bandwidth: 5MHz					
Freq. (MHz)	CH	99% BW (MHz)	99% BW (MHz)	26 dB BW (MHz)	26 dB BW (MHz)
		QPSK	16QAM	QPSK	16QAM
1712.5	19957	4.5065	4.5086	5.044	5.011
1732.5	20175	4.5067	4.5055	4.998	4.961
1752.5	20375	4.5087	4.5093	5.049	4.963

LTE BAND 4 Channel bandwidth: 10MHz					
Freq. (MHz)	CH	99% BW (MHz)	99% BW (MHz)	26 dB BW (MHz)	26 dB BW (MHz)
		QPSK	16QAM	QPSK	16QAM
1715.0	20000	9.0043	8.9782	9.793	9.823
1732.5	20175	8.9658	8.9522	9.766	9.848
1750.0	20350	9.0083	8.9595	9.803	9.729

LTE BAND 4 Channel bandwidth: 15MHz					
Freq. (MHz)	CH	99% BW (MHz)	99% BW (MHz)	26 dB BW (MHz)	26 dB BW (MHz)
		QPSK	16QAM	QPSK	16QAM
1717.5	20025	13.425	13.462	14.53	14.53
1732.5	20175	13.423	13.442	14.61	14.78
1747.5	20325	13.481	13.458	14.72	14.66

LTE BAND 4 Channel bandwidth: 20MHz					
Freq. (MHz)	CH	99% BW (MHz)	99% BW (MHz)	26 dB BW (MHz)	26 dB BW (MHz)
		QPSK	16QAM	QPSK	16QAM
1720.0	20050	17.869	17.917	19.36	19.36
1732.5	20175	17.867	17.925	19.32	19.34
1745.0	20300	17.878	17.898	19.41	19.41

Unless otherwise stated the results shown in this test report refer only to the sample(s) tested and such sample(s) are retained for 90 days only.

除非另有說明，此報告結果僅對測試之樣品負責，同時此樣品僅保留90天。本報告未經本公司書面許可，不可部份複製。

This document is issued by the Company subject to its General Conditions of Service printed overleaf, available on request or accessible at www.sgs.com/terms_and_conditions.htm and, for electronic format documents, subject to Terms and Conditions for Electronic Documents at www.sgs.com/terms_e-document.htm. Attention is drawn to the limitation of liability, indemnification and jurisdiction issues defined therein. Any holder of this document is advised that information contained hereon reflects the Company's findings at the time of its intervention only and within the limits of Client's instructions, if any. The Company's sole responsibility is to its Client and this document does not exonerate parties to a transaction from exercising all their rights and obligations under the transaction documents. This document cannot be reproduced except in full, without prior written approval of the Company. Any unauthorized alteration, forgery or falsification of the content or appearance of this document is unlawful and offenders may be prosecuted to the fullest extent of the law.

SGS Taiwan Ltd.

No.134,WuKungRoad,NewTaipeiIndustrialPark,WukuDistrict,NewTaipeiCity,Taiwan24803/新北市五股區新北產業園區五工路 134 號

台灣檢驗科技股份有限公司

t (886-2) 2299-3279

f (886-2) 2298-0488

www.tw.sgs.com

Member of SGS Group

LTE BAND 5 Channel bandwidth: 1.4MHz					
Freq. (MHz)	CH	99% BW (MHz)	99% BW (MHz)	26 dB BW (MHz)	26 dB BW (MHz)
		QPSK	16QAM	QPSK	16QAM
824.7	20407	1.0978	1.1009	1.279	1.285
836.5	20525	1.0971	1.0997	1.283	1.289
848.3	20643	1.0998	1.0988	1.288	1.274

LTE BAND 5 Channel bandwidth: 3MHz					
Freq. (MHz)	CH	99% BW (MHz)	99% BW (MHz)	26 dB BW (MHz)	26 dB BW (MHz)
		QPSK	16QAM	QPSK	16QAM
825.5	20415	2.7026	2.7003	2.984	2.984
836.5	20525	2.7034	2.7033	2.973	2.994
847.5	20635	2.6962	2.7057	2.955	2.971

LTE BAND 5 Channel bandwidth: 5MHz					
Freq. (MHz)	CH	99% BW (MHz)	99% BW (MHz)	26 dB BW (MHz)	26 dB BW (MHz)
		QPSK	16QAM	QPSK	16QAM
826.5	20425	4.4966	4.5052	4.955	5.034
836.5	20525	4.4911	4.5065	5.033	4.945
846.5	20625	4.4917	4.4865	5.001	4.967

LTE BAND 5 Channel bandwidth: 10MHz					
Freq. (MHz)	CH	99% BW (MHz)	99% BW (MHz)	26 dB BW (MHz)	26 dB BW (MHz)
		QPSK	16QAM	QPSK	16QAM
829.0	20450	8.9864	8.9845	9.872	9.773
836.5	20525	8.9914	8.9707	9.882	9.844
844.0	20600	8.9830	8.9531	9.853	9.770

LTE BAND 7 Channel bandwidth: 5MHz					
Freq. (MHz)	CH	99% BW (MHz)	99% BW (MHz)	26 dB BW (MHz)	26 dB BW (MHz)
		QPSK	16QAM	QPSK	16QAM
2502.5	20775	4.5109	4.5062	5.035	4.975
2535.0	21100	4.5123	4.4991	4.990	5.059
2567.5	21425	4.5214	4.5062	5.026	5.015

LTE BAND 7 Channel bandwidth: 10MHz					
Freq. (MHz)	CH	99% BW (MHz)	99% BW (MHz)	26 dB BW (MHz)	26 dB BW (MHz)
		QPSK	16QAM	QPSK	16QAM
2505.0	20800	8.9613	8.9628	9.928	9.699
2535.0	21100	8.9812	8.9926	9.790	9.739
2565.0	21400	8.9990	8.9678	9.822	9.754

LTE BAND 7 Channel bandwidth: 15MHz					
Freq. (MHz)	CH	99% BW (MHz)	99% BW (MHz)	26 dB BW (MHz)	26 dB BW (MHz)
		QPSK	16QAM	QPSK	16QAM
2507.5	20825	13.437	13.458	14.60	14.71
2535.0	21100	13.480	13.496	14.69	14.65
2562.5	21375	13.491	13.476	14.66	14.81

LTE BAND 7 Channel bandwidth: 20MHz					
Freq. (MHz)	CH	99% BW (MHz)	99% BW (MHz)	26 dB BW (MHz)	26 dB BW (MHz)
		QPSK	16QAM	QPSK	16QAM
2510.0	20850	17.860	17.875	19.36	19.34
2535.0	21100	17.924	17.918	19.42	19.28
2560.0	21350	17.883	17.887	19.25	19.36

Unless otherwise stated the results shown in this test report refer only to the sample(s) tested and such sample(s) are retained for 90 days only.

除非另有說明，此報告結果僅對測試之樣品負責，同時此樣品僅保留90天。本報告未經本公司書面許可，不可部份複製。

This document is issued by the Company subject to its General Conditions of Service printed overleaf, available on request or accessible at www.sgs.com/terms_and_conditions.htm and, for electronic format documents, subject to Terms and Conditions for Electronic Documents at www.sgs.com/terms_e-document.htm. Attention is drawn to the limitation of liability, indemnification and jurisdiction issues defined therein. Any holder of this document is advised that information contained hereon reflects the Company's findings at the time of its intervention only and within the limits of Client's instructions, if any. The Company's sole responsibility is to its Client and this document does not exonerate parties to a transaction from exercising all their rights and obligations under the transaction documents. This document cannot be reproduced except in full, without prior written approval of the Company. Any unauthorized alteration, forgery or falsification of the content or appearance of this document is unlawful and offenders may be prosecuted to the fullest extent of the law.

SGS Taiwan Ltd.

No.134,WuKungRoad,NewTaipeiIndustrialPark,WukuDistrict,NewTaipeiCity,Taiwan24803/新北市五股區新北產業園區五工路 134 號

台灣檢驗科技股份有限公司

t (886-2) 2299-3279

f (886-2) 2298-0488

www.tw.sgs.com

Member of SGS Group

LTE BAND 12 Channel bandwidth: 1.4MHz					
Freq. (MHz)	CH	99% BW (MHz)	99% BW (MHz)	26 dB BW (MHz)	26 dB BW (MHz)
		QPSK	16QAM	QPSK	16QAM
699.7	23017	1.0984	1.1018	1.295	1.289
707.5	23095	1.1001	1.1049	1.288	1.303
715.3	23173	1.1015	1.1049	1.294	1.306

LTE BAND 12 Channel bandwidth: 3MHz					
Freq. (MHz)	CH	99% BW (MHz)	99% BW (MHz)	26 dB BW (MHz)	26 dB BW (MHz)
		QPSK	16QAM	QPSK	16QAM
700.5	23025	2.7011	2.7089	2.974	2.982
707.5	23095	2.7045	2.7083	2.998	2.997
714.5	23165	2.7067	2.7051	2.983	2.978

LTE BAND 12 Channel bandwidth: 5MHz					
Freq. (MHz)	CH	99% BW (MHz)	99% BW (MHz)	26 dB BW (MHz)	26 dB BW (MHz)
		QPSK	16QAM	QPSK	16QAM
701.5	23035	4.5186	4.5221	5.005	4.977
707.5	23095	4.5111	4.4991	5.002	4.996
713.5	23155	4.5157	4.5120	5.000	4.981

LTE BAND 12 Channel bandwidth: 10MHz					
Freq. (MHz)	CH	99% BW (MHz)	99% BW (MHz)	26 dB BW (MHz)	26 dB BW (MHz)
		QPSK	16QAM	QPSK	16QAM
704.0	23060	9.0773	9.0580	10.025	9.935
707.5	23095	9.0199	8.9892	9.797	9.760
711.0	23130	8.9530	8.9200	9.744	9.728

LTE BAND 13 Channel bandwidth: 5MHz					
Freq. (MHz)	CH	99% BW (MHz)	99% BW (MHz)	26 dB BW (MHz)	26 dB BW (MHz)
		QPSK	16QAM	QPSK	16QAM
701.5	23035	4.506	4.490	6.365	5.133
707.5	23095	4.604	4.587	8.421	7.759
713.5	23155	4.523	4.504	6.379	5.498

LTE BAND 13 Channel bandwidth: 10MHz					
Freq. (MHz)	CH	99% BW (MHz)	99% BW (MHz)	26 dB BW (MHz)	26 dB BW (MHz)
		QPSK	16QAM	QPSK	16QAM
782.0	23230	8.9953	8.9594	11.967	9.947

LTE BAND 17 Channel bandwidth: 5MHz					
Freq. (MHz)	CH	99% BW (MHz)	99% BW (MHz)	26 dB BW (MHz)	26 dB BW (MHz)
		QPSK	16QAM	QPSK	16QAM
706.5	23755	4.5147	4.5252	5.019	5.023
710.0	23790	4.4928	4.4902	4.995	5.019
713.5	23825	4.5183	4.5097	5.036	5.025

LTE BAND 17 Channel bandwidth: 10MHz					
Freq. (MHz)	CH	99% BW (MHz)	99% BW (MHz)	26 dB BW (MHz)	26 dB BW (MHz)
		QPSK	16QAM	QPSK	16QAM
709.0	23780	8.9611	8.9338	9.744	9.727
710.0	23790	8.9537	8.9119	9.740	9.706
711.0	23780	8.9638	8.9088	9.787	9.772

Unless otherwise stated the results shown in this test report refer only to the sample(s) tested and such sample(s) are retained for 90 days only.

除非另有說明，此報告結果僅對測試之樣品負責，同時此樣品僅保留90天。本報告未經本公司書面許可，不可部份複製。

This document is issued by the Company subject to its General Conditions of Service printed overleaf, available on request or accessible at www.sgs.com/terms_and_conditions.htm and, for electronic format documents, subject to Terms and Conditions for Electronic Documents at www.sgs.com/terms_e-document.htm. Attention is drawn to the limitation of liability, indemnification and jurisdiction issues defined therein. Any holder of this document is advised that information contained hereon reflects the Company's findings at the time of its intervention only and within the limits of Client's instructions, if any. The Company's sole responsibility is to its Client and this document does not exonerate parties to a transaction from exercising all their rights and obligations under the transaction documents. This document cannot be reproduced except in full, without prior written approval of the Company. Any unauthorized alteration, forgery or falsification of the content or appearance of this document is unlawful and offenders may be prosecuted to the fullest extent of the law.

SGS Taiwan Ltd.

No.134,WuKungRoad,NewTaipeiIndustrialPark,WukuDistrict,NewTaipeiCity,Taiwan24803/新北市五股區新北產業園區五工路 134 號

台灣檢驗科技股份有限公司

t (886-2) 2299-3279

f (886-2) 2298-0488

www.tw.sgs.com

Member of SGS Group

GPRS_850MHz_LowCH128-824.2



EDGE_850MHz_LowCH128-824.2

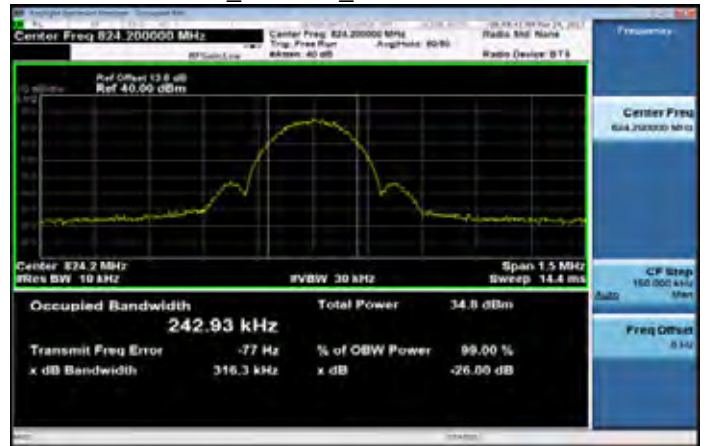

GPRS_850MHz_MidCH190-836.6



EDGE_850MHz_MidCH190-836.6



GPRS_850MHz_HighCH251-848.8



EDGE_850MHz_HighCH251-848.8



Unless otherwise stated the results shown in this test report refer only to the sample(s) tested and such sample(s) are retained for 90 days only.
除非另有說明，此報告結果僅對測試之樣品負責，同時此樣品僅保留90天。本報告未經本公司書面許可，不可部份複製。

This document is issued by the Company subject to its General Conditions of Service printed overleaf, available on request or accessible at www.sgs.com/terms_and_conditions.htm and, for electronic format documents, subject to Terms and Conditions for Electronic Documents at www.sgs.com/terms_e-document.htm. Attention is drawn to the limitation of liability, indemnification and jurisdiction issues defined therein. Any holder of this document is advised that information contained hereon reflects the Company's findings at the time of its intervention only and within the limits of Client's instructions, if any. The Company's sole responsibility is to its Client and this document does not exonerate parties to a transaction from exercising all their rights and obligations under the transaction documents. This document cannot be reproduced except in full, without prior written approval of the Company. Any unauthorized alteration, forgery or falsification of the content or appearance of this document is unlawful and offenders may be prosecuted to the fullest extent of the law.

GPRS_1900MHz_LowCH512-1850.2

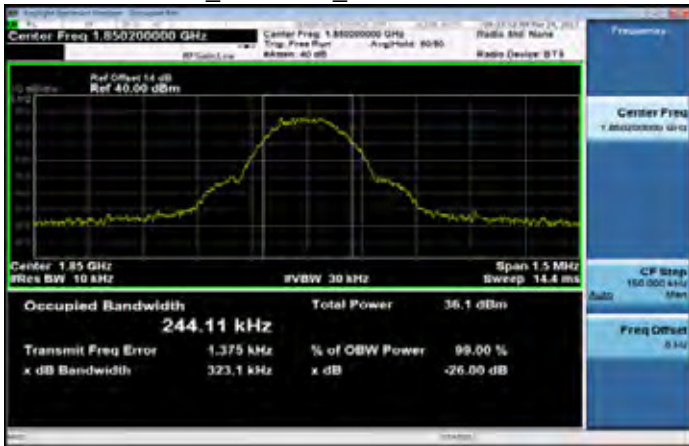

EDGE_1900MHz_LowCH512-1850.2



GPRS_1900MHz_MidCH661-1880

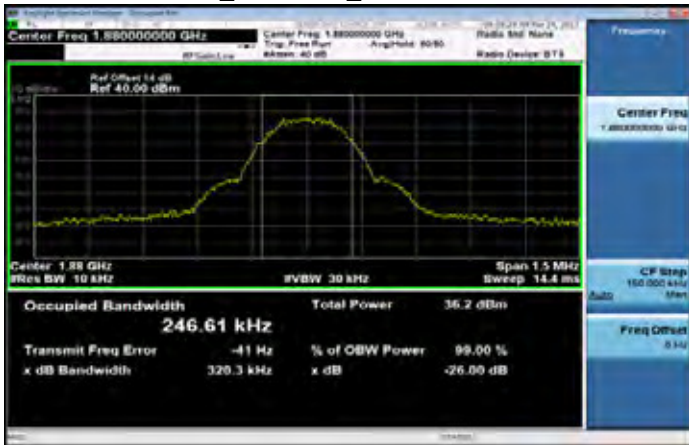

EDGE_1900MHz_MidCH661-1880



GPRS_1900MHz_HighCH810-1909.8



EDGE_1900MHz_HighCH810-1909.8



Unless otherwise stated the results shown in this test report refer only to the sample(s) tested and such sample(s) are retained for 90 days only.
除非另有說明，此報告結果僅對測試之樣品負責，同時此樣品僅保留90天。本報告未經本公司書面許可，不可部份複製。

This document is issued by the Company subject to its General Conditions of Service printed overleaf, available on request or accessible at www.sgs.com/terms_and_conditions.htm and, for electronic format documents, subject to Terms and Conditions for Electronic Documents at www.sgs.com/terms_e-document.htm. Attention is drawn to the limitation of liability, indemnification and jurisdiction issues defined therein. Any holder of this document is advised that information contained hereon reflects the Company's findings at the time of its intervention only and within the limits of Client's instructions, if any. The Company's sole responsibility is to its Client and this document does not exonerate parties to a transaction from exercising all their rights and obligations under the transaction documents. This document cannot be reproduced except in full, without prior written approval of the Company. Any unauthorized alteration, forgery or falsification of the content or appearance of this document is unlawful and offenders may be prosecuted to the fullest extent of the law.

CDMA2000_BC0_LowCH1013-824.7

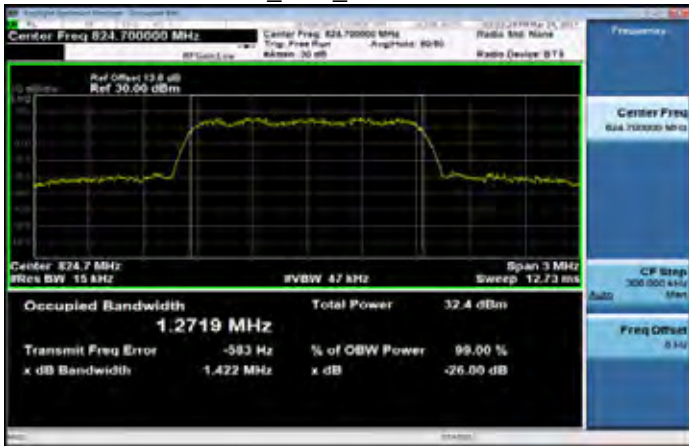

EVDO_BC0_LowCH1013-824.7

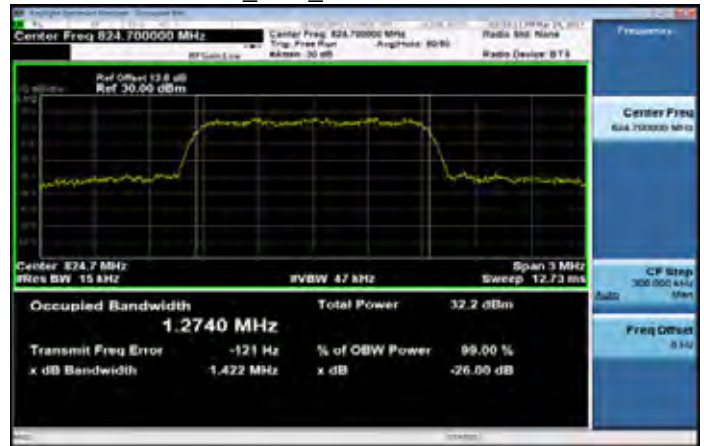

CDMA2000_BC0_MidCH384-836.52

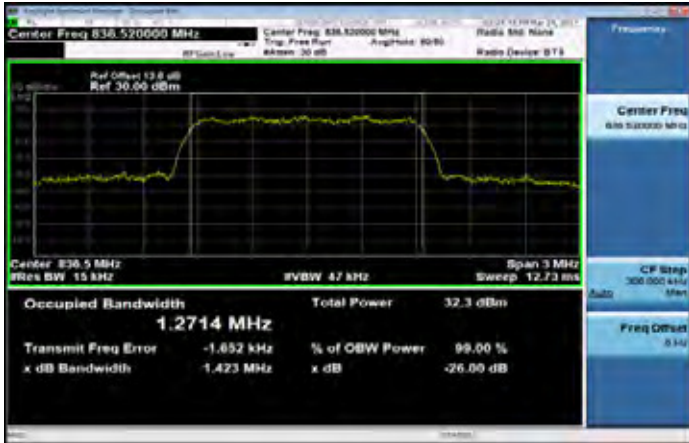

EVDO_BC0_MidCH384-836.52

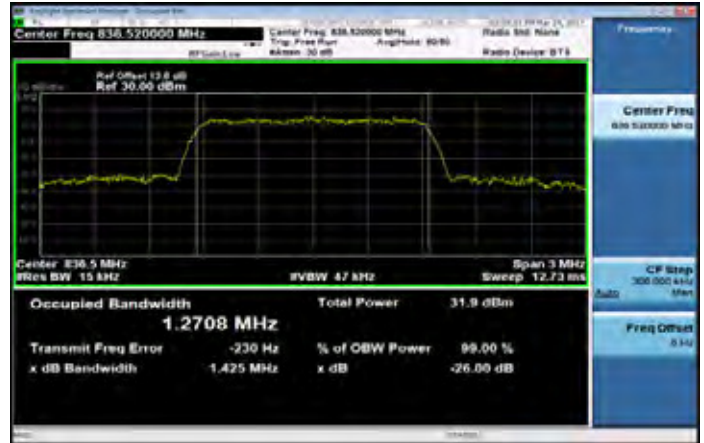

CDMA2000_BC0_HighCH777-848.31

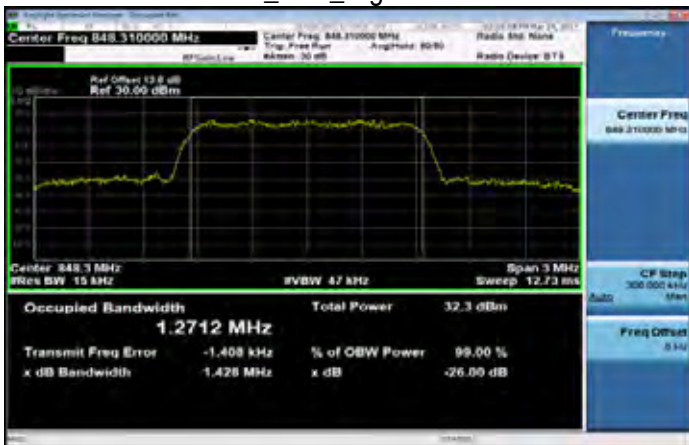

EVDO_BC0_HighCH777-848.31

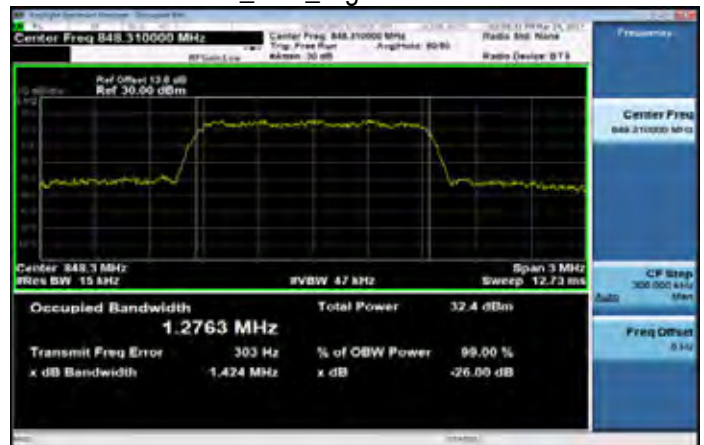

Unless otherwise stated the results shown in this test report refer only to the sample(s) tested and such sample(s) are retained for 90 days only.

除非另有說明，此報告結果僅對測試之樣品負責，同時此樣品僅保留90天。本報告未經本公司書面許可，不可部份複製。

This document is issued by the Company subject to its General Conditions of Service printed overleaf, available on request or accessible at www.sgs.com/terms_and_conditions.htm and, for electronic format documents, subject to Terms and Conditions for Electronic Documents at www.sgs.com/terms_e-document.htm. Attention is drawn to the limitation of liability, indemnification and jurisdiction issues defined therein. Any holder of this document is advised that information contained hereon reflects the Company's findings at the time of its intervention only and within the limits of Client's instructions, if any. The Company's sole responsibility is to its Client and this document does not exonerate parties to a transaction from exercising all their rights and obligations under the transaction documents. This document cannot be reproduced except in full, without prior written approval of the Company. Any unauthorized alteration, forgery or falsification of the content or appearance of this document is unlawful and offenders may be prosecuted to the fullest extent of the law.

SGS Taiwan Ltd.

No.134,WuKungRoad,NewTaipeiIndustrialPark,WukuDistrict,NewTaipeiCity,Taiwan24803/新北市五股區新北產業園區五工路 134 號

台灣檢驗科技股份有限公司

t (886-2) 2299-3279

f (886-2) 2298-0488

www.tw.sgs.com

Member of SGS Group

CDMA2000_BC1_LowCH25-1851.3

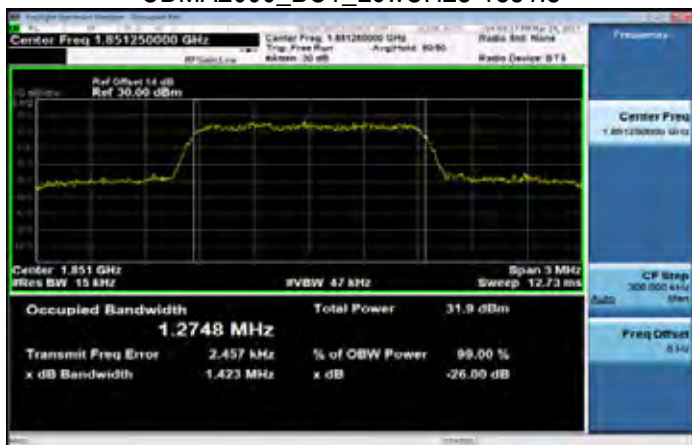

EVDO_BC1_LowCH25-1851.3



CDMA2000_BC1_MidCH600-1880

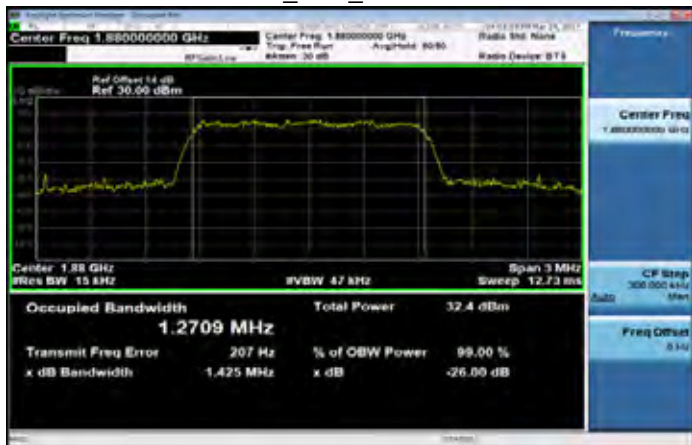

EVDO_BC1_MidCH600-1880

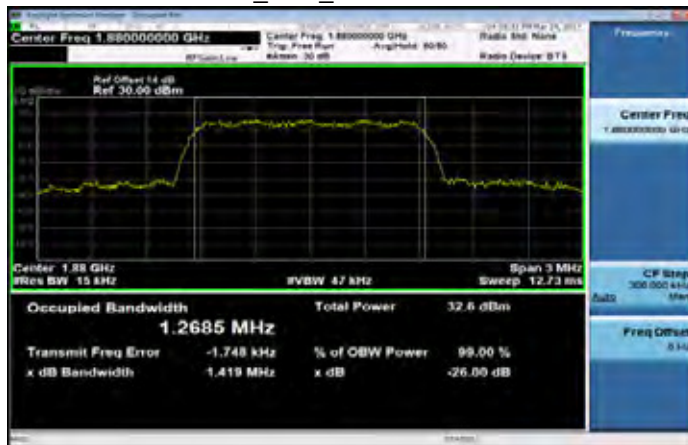

CDMA2000_BC1_HighCH1175-1908.8

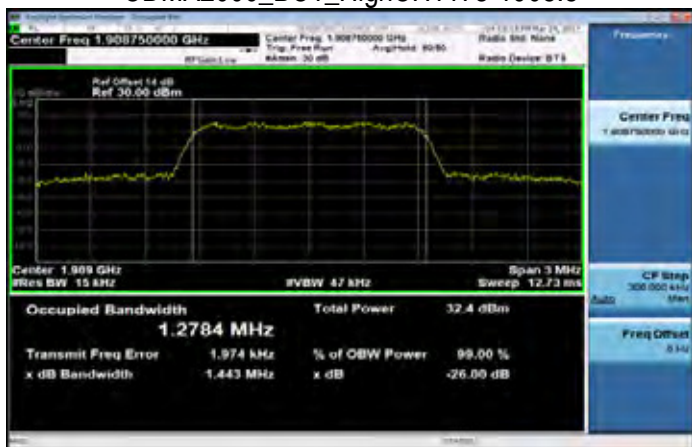

EVDO_BC1_HighCH1175-1908.8

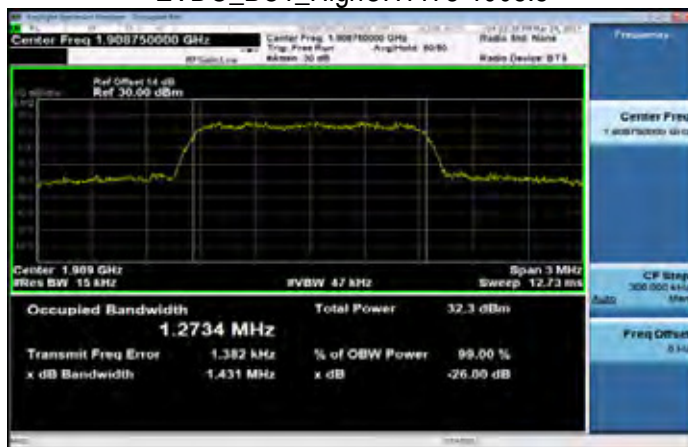

Unless otherwise stated the results shown in this test report refer only to the sample(s) tested and such sample(s) are retained for 90 days only.

除非另有說明，此報告結果僅對測試之樣品負責，同時此樣品僅保留90天。本報告未經本公司書面許可，不可部份複製。

This document is issued by the Company subject to its General Conditions of Service printed overleaf, available on request or accessible at www.sgs.com/terms_and_conditions.htm and, for electronic format documents, subject to Terms and Conditions for Electronic Documents at www.sgs.com/terms_e-document.htm. Attention is drawn to the limitation of liability, indemnification and jurisdiction issues defined therein. Any holder of this document is advised that information contained hereon reflects the Company's findings at the time of its intervention only and within the limits of Client's instructions, if any. The Company's sole responsibility is to its Client and this document does not exonerate parties to a transaction from exercising all their rights and obligations under the transaction documents. This document cannot be reproduced except in full, without prior written approval of the Company. Any unauthorized alteration, forgery or falsification of the content or appearance of this document is unlawful and offenders may be prosecuted to the fullest extent of the law.

SGS Taiwan Ltd.

No.134,WuKungRoad,NewTaipeiIndustrialPark,WukuDistrict,NewTaipeiCity,Taiwan24803/新北市五股區新北產業園區五工路 134 號

台灣檢驗科技股份有限公司

t (886-2) 2299-3279

f (886-2) 2298-0488

www.tw.sgs.com

Member of SGS Group

WCDMA_B2_LowCH9262-1852.4



HSDPA_B2_LowCH9262-1852.4



WCDMA_B2_MidCH9400-1880



HSDPA_B2_MidCH9400-1880

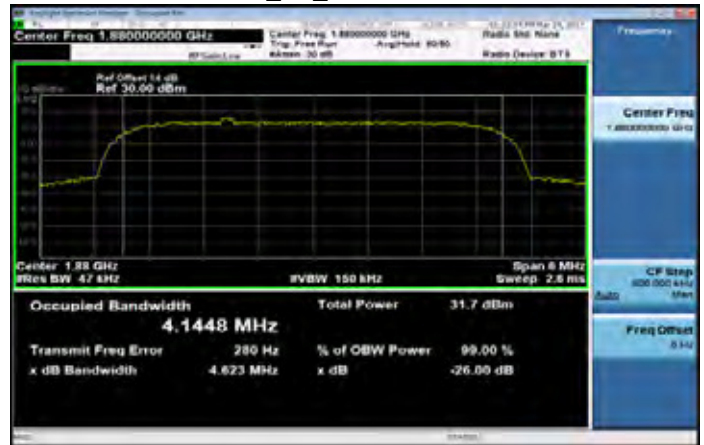

WCDMA_B2_HighCH9538-1907.6



HSDPA_B2_HighCH9538-1907.6



Unless otherwise stated the results shown in this test report refer only to the sample(s) tested and such sample(s) are retained for 90 days only.

除非另有說明，此報告結果僅對測試之樣品負責，同時此樣品僅保留90天。本報告未經本公司書面許可，不可部份複製。

This document is issued by the Company subject to its General Conditions of Service printed overleaf, available on request or accessible at www.sgs.com/terms_and_conditions.htm and, for electronic format documents, subject to Terms and Conditions for Electronic Documents at www.sgs.com/terms_e-document.htm. Attention is drawn to the limitation of liability, indemnification and jurisdiction issues defined therein. Any holder of this document is advised that information contained hereon reflects the Company's findings at the time of its intervention only and within the limits of Client's instructions, if any. The Company's sole responsibility is to its Client and this document does not exonerate parties to a transaction from exercising all their rights and obligations under the transaction documents. This document cannot be reproduced except in full, without prior written approval of the Company. Any unauthorized alteration, forgery or falsification of the content or appearance of this document is unlawful and offenders may be prosecuted to the fullest extent of the law.

SGS Taiwan Ltd.

No.134,WuKungRoad,NewTaipeiIndustrialPark,WukuDistrict,NewTaipeiCity,Taiwan24803/新北市五股區新北產業園區五工路 134 號

台灣檢驗科技股份有限公司

t (886-2) 2299-3279

f (886-2) 2298-0488

www.tw.sgs.com

Member of SGS Group

HSUPA_B2_LowCH9262-1852.4



WCDMA_B4_LowCH1312-1712.4

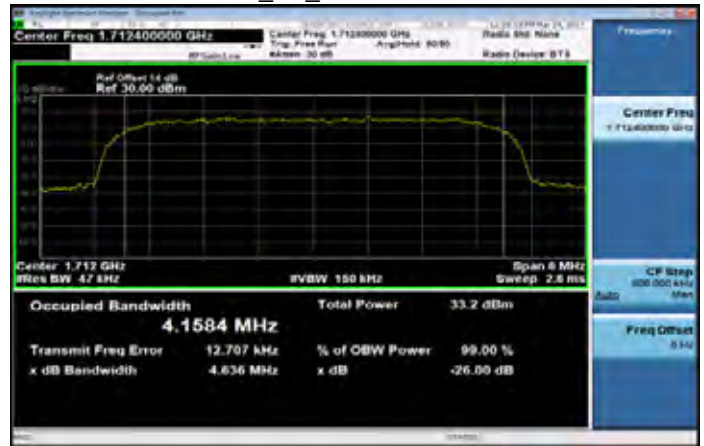

HSUPA_B2_MidCH9400-1880

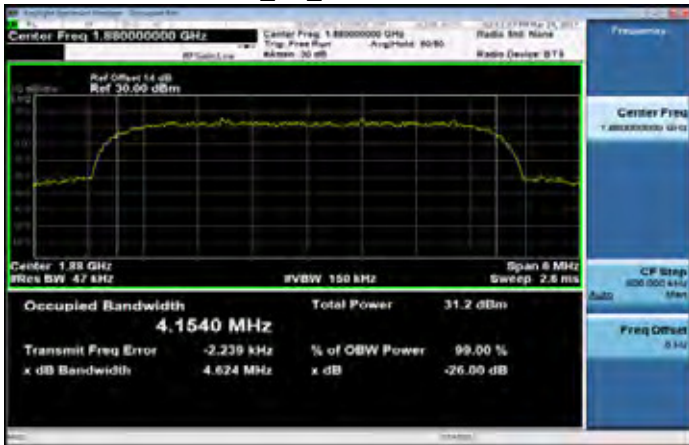

WCDMA_B4_MidCH1413-1732.6

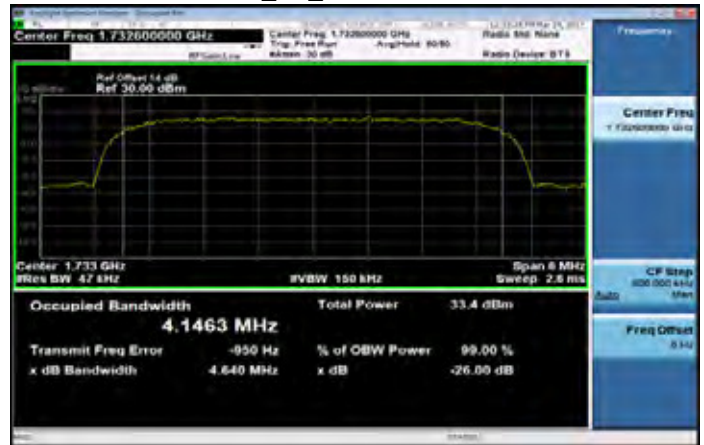

HSUPA_B2_HighCH9538-1907.6

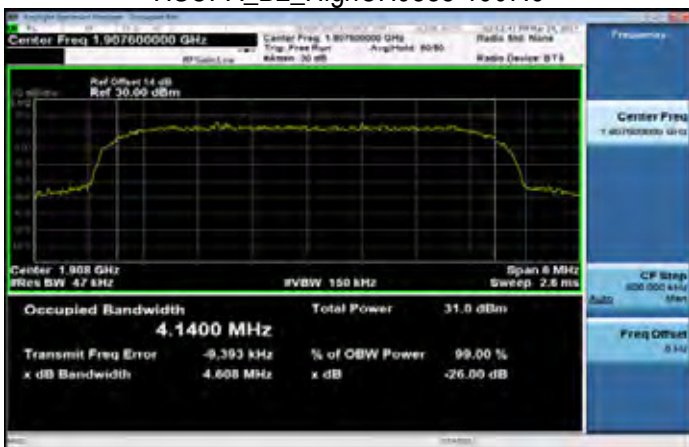

WCDMA_B4_HighCH1513-1752.6

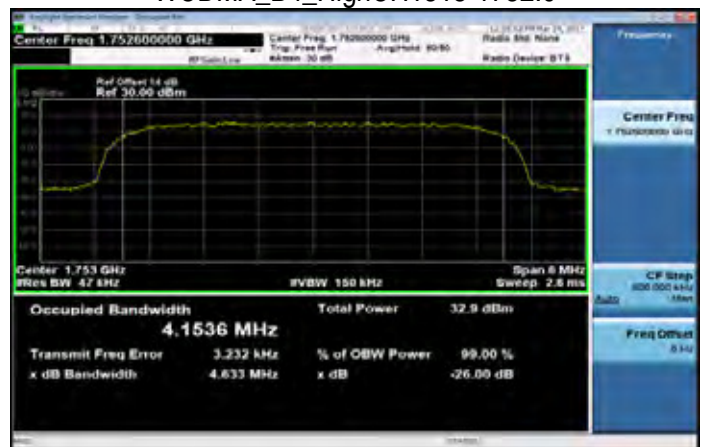

Unless otherwise stated the results shown in this test report refer only to the sample(s) tested and such sample(s) are retained for 90 days only.
除非另有說明，此報告結果僅對測試之樣品負責，同時此樣品僅保留90天。本報告未經本公司書面許可，不可部份複製。

This document is issued by the Company subject to its General Conditions of Service printed overleaf, available on request or accessible at www.sgs.com/terms_and_conditions.htm and, for electronic format documents, subject to Terms and Conditions for Electronic Documents at www.sgs.com/terms_e-document.htm. Attention is drawn to the limitation of liability, indemnification and jurisdiction issues defined therein. Any holder of this document is advised that information contained hereon reflects the Company's findings at the time of its intervention only and within the limits of Client's instructions, if any. The Company's sole responsibility is to its Client and this document does not exonerate parties to a transaction from exercising all their rights and obligations under the transaction documents. This document cannot be reproduced except in full, without prior written approval of the Company. Any unauthorized alteration, forgery or falsification of the content or appearance of this document is unlawful and offenders may be prosecuted to the fullest extent of the law.

HSDPA_B4_LowCH1312-1712.4



HSUPA_B4_LowCH1312-1712.4



HSDPA_B4_MidCH1413-1732.6



HSUPA_B4_MidCH1413-1732.6



HSDPA_B4_HighCH1513-1752.6



HSUPA_B4_HighCH1513-1752.6

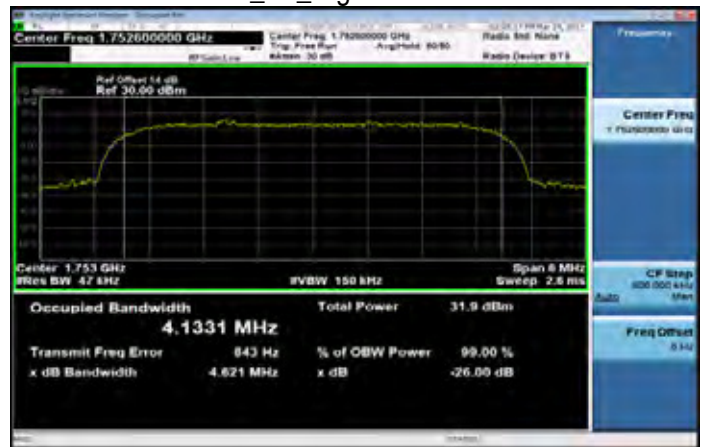

Unless otherwise stated the results shown in this test report refer only to the sample(s) tested and such sample(s) are retained for 90 days only.

除非另有說明，此報告結果僅對測試之樣品負責，同時此樣品僅保留90天。本報告未經本公司書面許可，不可部份複製。

This document is issued by the Company subject to its General Conditions of Service printed overleaf, available on request or accessible at www.sgs.com/terms_and_conditions.htm and, for electronic format documents, subject to Terms and Conditions for Electronic Documents at www.sgs.com/terms_e-document.htm. Attention is drawn to the limitation of liability, indemnification and jurisdiction issues defined therein. Any holder of this document is advised that information contained hereon reflects the Company's findings at the time of its intervention only and within the limits of Client's instructions, if any. The Company's sole responsibility is to its Client and this document does not exonerate parties to a transaction from exercising all their rights and obligations under the transaction documents. This document cannot be reproduced except in full, without prior written approval of the Company. Any unauthorized alteration, forgery or falsification of the content or appearance of this document is unlawful and offenders may be prosecuted to the fullest extent of the law.

SGS Taiwan Ltd.

No. 134, WuKungRoad, NewTaipeiIndustrialPark, WukuDistrict, NewTaipeiCity, Taiwan24803/新北市五股區新北產業園區五工路 134 號

台灣檢驗科技股份有限公司

t (886-2) 2299-3279

f (886-2) 2298-0488

www.tw.sgs.com

Member of SGS Group

HSUPA_B5_LowCH4132-826.4



HSUPA_B5_MidCH4183-836.6



HSUPA_B5_HighCH4233-846.6

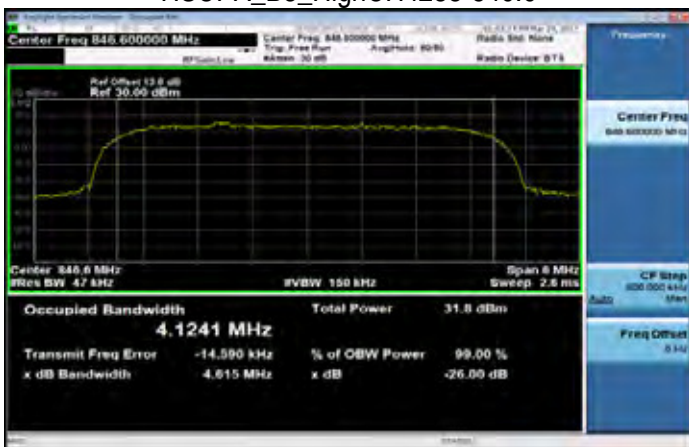

Unless otherwise stated the results shown in this test report refer only to the sample(s) tested and such sample(s) are retained for 90 days only.

除非另有說明，此報告結果僅對測試之樣品負責，同時此樣品僅保留90天。本報告未經本公司書面許可，不可部份複製。

This document is issued by the Company subject to its General Conditions of Service printed overleaf, available on request or accessible at www.sgs.com/terms_and_conditions.htm and, for electronic format documents, subject to Terms and Conditions for Electronic Documents at www.sgs.com/terms_e-document.htm. Attention is drawn to the limitation of liability, indemnification and jurisdiction issues defined therein. Any holder of this document is advised that information contained hereon reflects the Company's findings at the time of its intervention only and within the limits of Client's instructions, if any. The Company's sole responsibility is to its Client and this document does not exonerate parties to a transaction from exercising all their rights and obligations under the transaction documents. This document cannot be reproduced except in full, without prior written approval of the Company. Any unauthorized alteration, forgery or falsification of the content or appearance of this document is unlawful and offenders may be prosecuted to the fullest extent of the law.

SGS Taiwan Ltd.

No. 134, WuKungRoad, NewTaipeiIndustrialPark, WukuDistrict, NewTaipeiCity, Taiwan24803/新北市五股區新北產業園區五工路 134 號

台灣檢驗科技股份有限公司

t (886-2) 2299-3279

f (886-2) 2298-0488

www.tw.sgs.com

Member of SGS Group

Band2 1.4MHz_QPSK 6 0_LowCH18607-1850.7

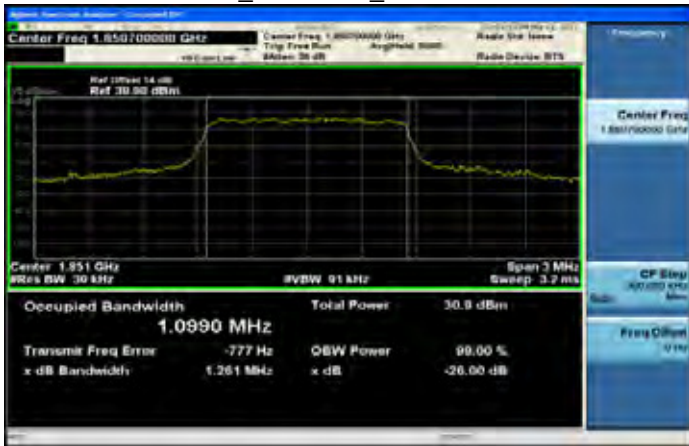

Band2 1.4MHz_16-QAM 6 0_LowCH18607-1850.7

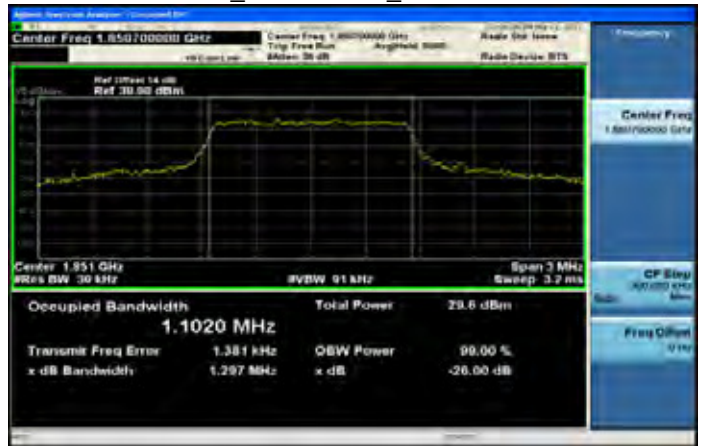

Band2 1.4MHz_QPSK 6 0_MidCH18900-1880

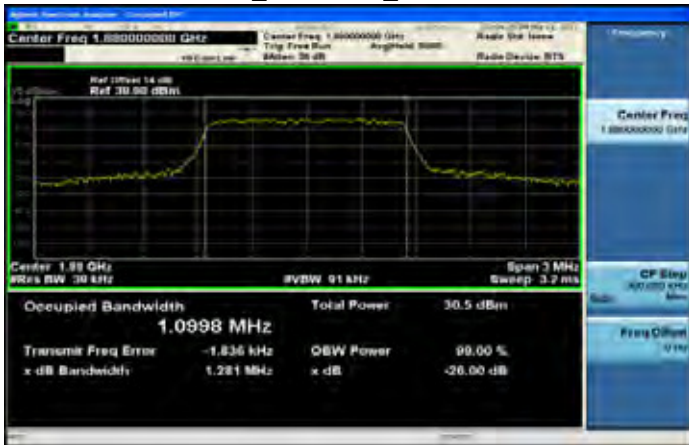

Band2 1.4MHz_16-QAM 6 0_MidCH18900-1880

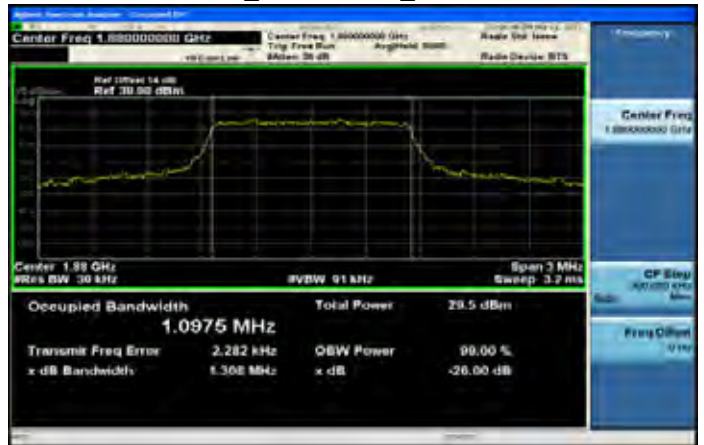

Band2 1.4MHz_QPSK 6 0_HighCH19193-1909.3



Band2 1.4MHz_16-QAM 6 0_HighCH19193-1909.3



Unless otherwise stated the results shown in this test report refer only to the sample(s) tested and such sample(s) are retained for 90 days only.
除非另有說明，此報告結果僅對測試之樣品負責，同時此樣品僅保留90天。本報告未經本公司書面許可，不可部份複製。

This document is issued by the Company subject to its General Conditions of Service printed overleaf, available on request or accessible at www.sgs.com/terms_and_conditions.htm and, for electronic format documents, subject to Terms and Conditions for Electronic Documents at www.sgs.com/terms_e-document.htm. Attention is drawn to the limitation of liability, indemnification and jurisdiction issues defined therein. Any holder of this document is advised that information contained hereon reflects the Company's findings at the time of its intervention only and within the limits of Client's instructions, if any. The Company's sole responsibility is to its Client and this document does not exonerate parties to a transaction from exercising all their rights and obligations under the transaction documents. This document cannot be reproduced except in full, without prior written approval of the Company. Any unauthorized alteration, forgery or falsification of the content or appearance of this document is unlawful and offenders may be prosecuted to the fullest extent of the law.

Band2 3MHz_QPSK 15 0_LowCH18615-1851.5

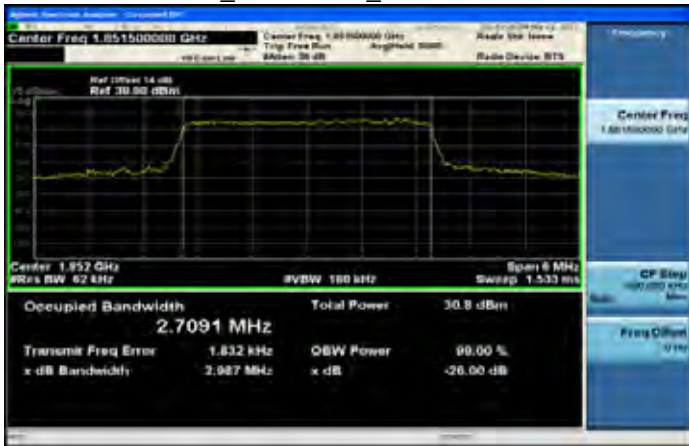

Band2 3MHz_16-QAM 15 0_LowCH18615-1851.5

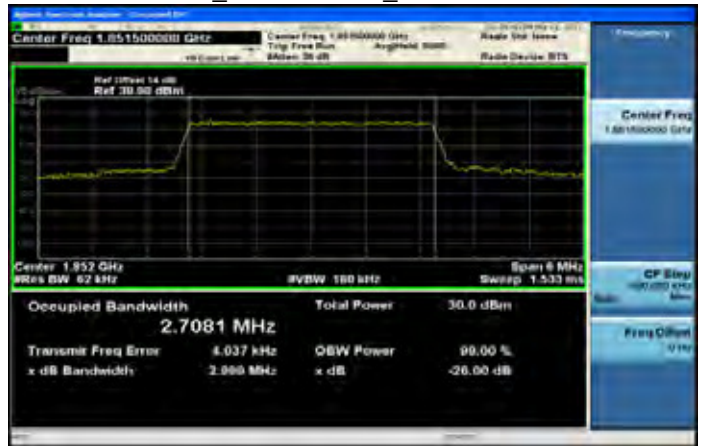

Band2 3MHz_QPSK 15 0_MidCH18900-1880

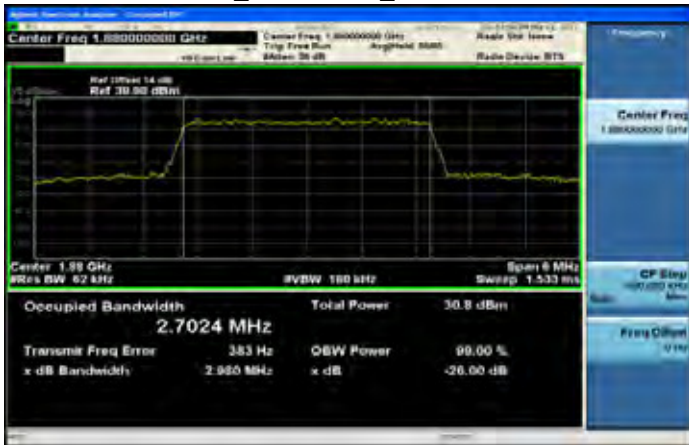

Band2 3MHz_16-QAM 15 0_MidCH18900-1880

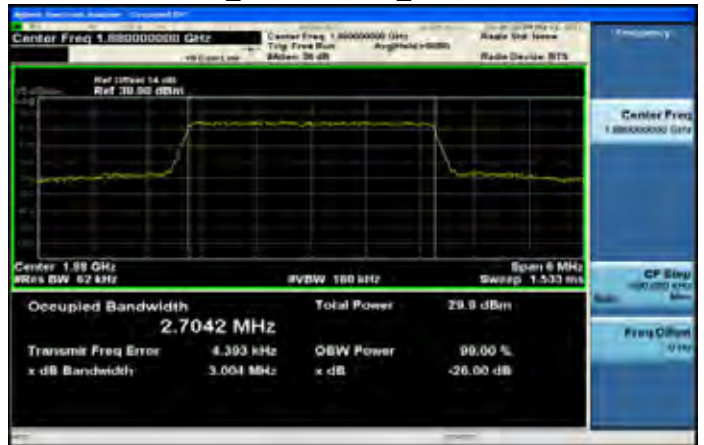

Band2 3MHz_QPSK 15 0_HighCH19185-1908.5



Band2 3MHz_16-QAM 15 0_HighCH19185-1908.5

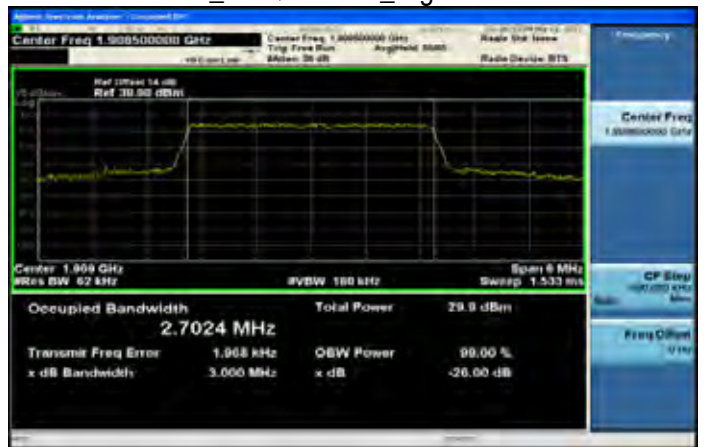

Unless otherwise stated the results shown in this test report refer only to the sample(s) tested and such sample(s) are retained for 90 days only.

除非另有說明，此報告結果僅對測試之樣品負責，同時此樣品僅保留90天。本報告未經本公司書面許可，不可部份複製。

This document is issued by the Company subject to its General Conditions of Service printed overleaf, available on request or accessible at www.sgs.com/terms_and_conditions.htm and, for electronic format documents, subject to Terms and Conditions for Electronic Documents at www.sgs.com/terms_e-document.htm. Attention is drawn to the limitation of liability, indemnification and jurisdiction issues defined therein. Any holder of this document is advised that information contained hereon reflects the Company's findings at the time of its intervention only and within the limits of Client's instructions, if any. The Company's sole responsibility is to its Client and this document does not exonerate parties to a transaction from exercising all their rights and obligations under the transaction documents. This document cannot be reproduced except in full, without prior written approval of the Company. Any unauthorized alteration, forgery or falsification of the content or appearance of this document is unlawful and offenders may be prosecuted to the fullest extent of the law.

SGS Taiwan Ltd.

No. 134, WuKungRoad, NewTaipeiIndustrialPark, WukuDistrict, NewTaipeiCity, Taiwan24803/新北市五股區新北產業園區五工路 134 號

台灣檢驗科技股份有限公司

t (886-2) 2299-3279

f (886-2) 2298-0488

www.tw.sgs.com

Member of SGS Group

Band2 10MHz_QPSK 50 0_LowCH18650-1855



Band2 10MHz_16-QAM 50 0_LowCH18650-1855



Band2 10MHz_QPSK 50 0_MidCH18900-1880

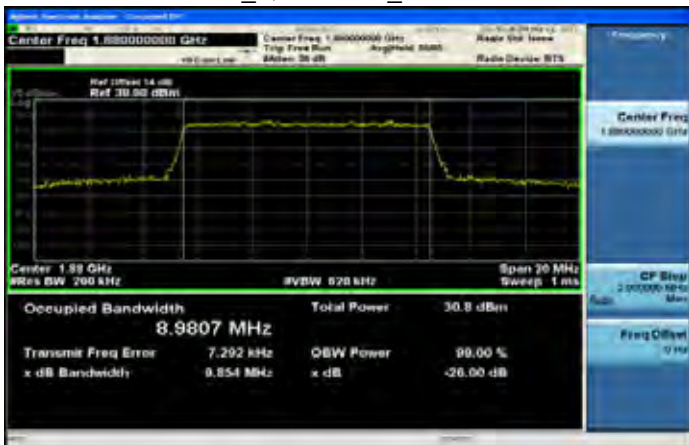

Band2 10MHz_16-QAM 50 0_MidCH18900-1880



Band2 10MHz_QPSK 50 0_HighCH19150-1905

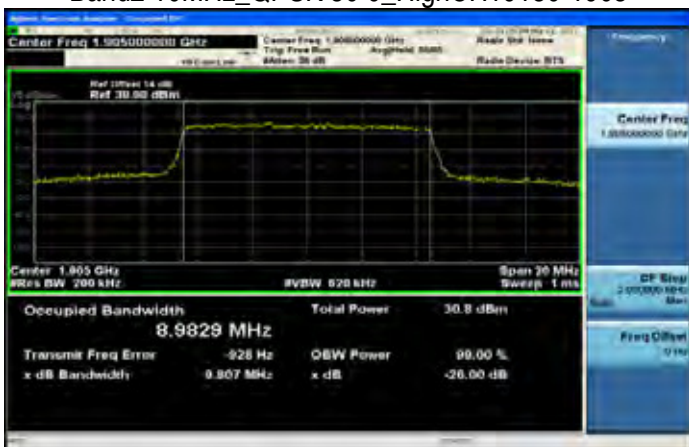

Band2 10MHz_16-QAM 50 0_HighCH19150-1905

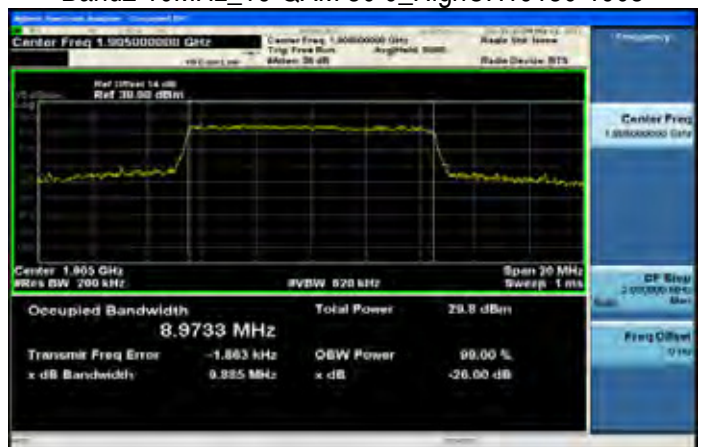

Unless otherwise stated the results shown in this test report refer only to the sample(s) tested and such sample(s) are retained for 90 days only.

除非另有說明，此報告結果僅對測試之樣品負責，同時此樣品僅保留90天。本報告未經本公司書面許可，不可部份複製。

This document is issued by the Company subject to its General Conditions of Service printed overleaf, available on request or accessible at www.sgs.com/terms_and_conditions.htm and, for electronic format documents, subject to Terms and Conditions for Electronic Documents at www.sgs.com/terms_e-document.htm. Attention is drawn to the limitation of liability, indemnification and jurisdiction issues defined therein. Any holder of this document is advised that information contained hereon reflects the Company's findings at the time of its intervention only and within the limits of Client's instructions, if any. The Company's sole responsibility is to its Client and this document does not exonerate parties to a transaction from exercising all their rights and obligations under the transaction documents. This document cannot be reproduced except in full, without prior written approval of the Company. Any unauthorized alteration, forgery or falsification of the content or appearance of this document is unlawful and offenders may be prosecuted to the fullest extent of the law.

SGS Taiwan Ltd.

No. 134, WuKungRoad, NewTaipeiIndustrialPark, WukuDistrict, NewTaipeiCity, Taiwan24803/新北市五股區新北產業園區五工路 134 號

台灣檢驗科技股份有限公司

t (886-2) 2299-3279

f (886-2) 2298-0488

www.tw.sgs.com

Member of SGS Group

Band4 1.4MHz_QPSK 6 0_LowCH19957-1710.7

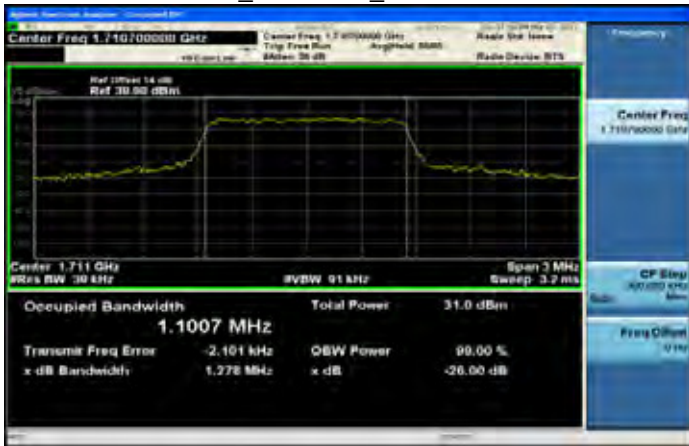

Band4 1.4MHz_16-QAM 6 0_LowCH19957-1710.7

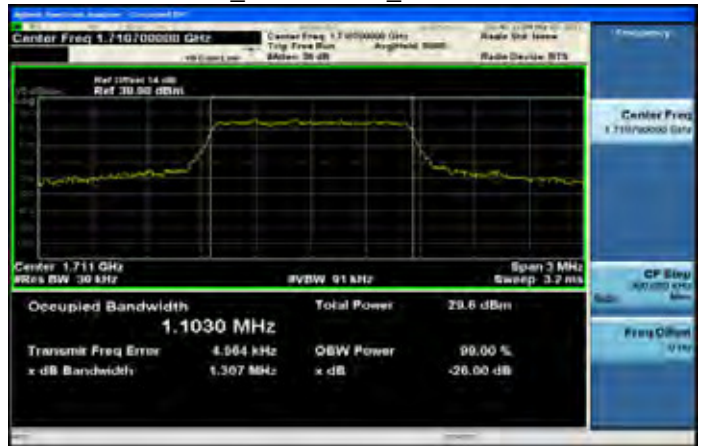

Band4 1.4MHz_QPSK 6 0_MidCH20175-1732.5

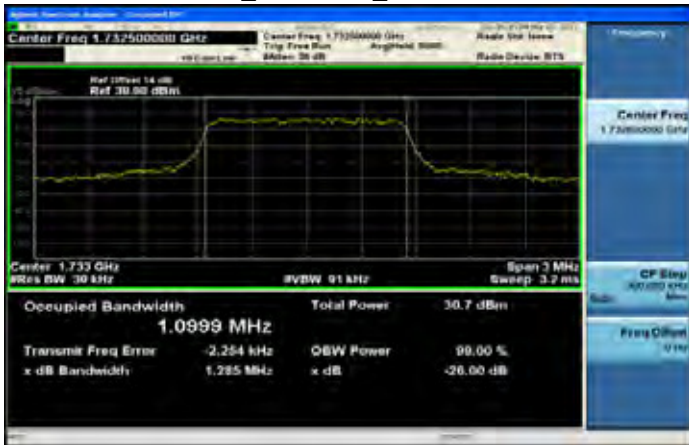

Band4 1.4MHz_16-QAM 6 0_MidCH20175-1732.5

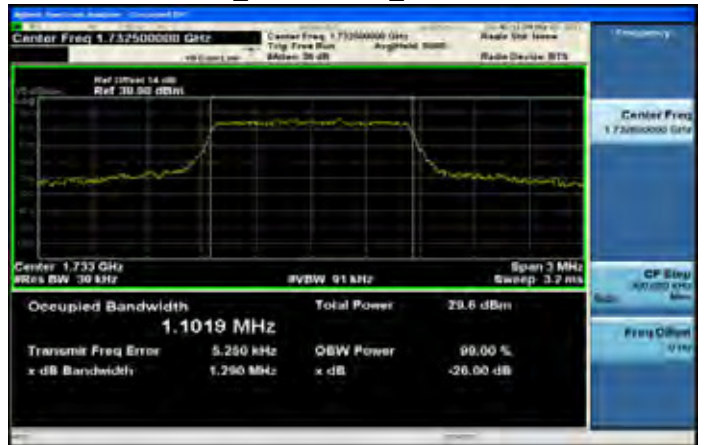

Band4 1.4MHz_QPSK 6 0_HighCH20393-1754.3

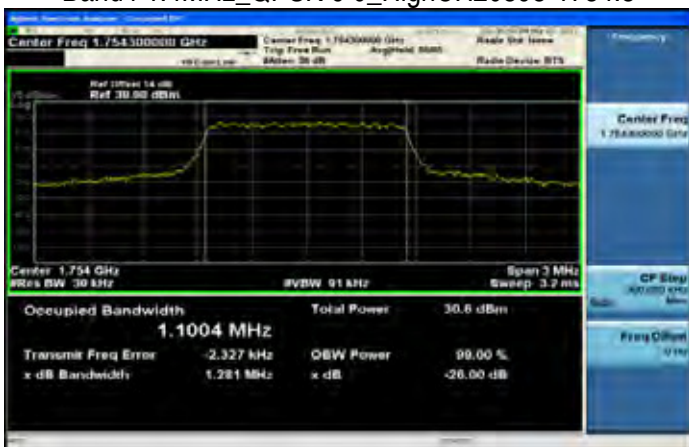

Band4 1.4MHz_16-QAM 6 0_HighCH20393-1754.3

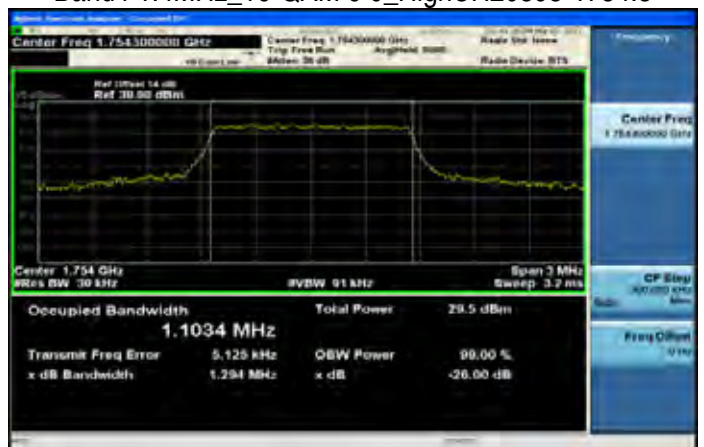

Unless otherwise stated the results shown in this test report refer only to the sample(s) tested and such sample(s) are retained for 90 days only.

除非另有說明，此報告結果僅對測試之樣品負責，同時此樣品僅保留90天。本報告未經本公司書面許可，不可部份複製。

This document is issued by the Company subject to its General Conditions of Service printed overleaf, available on request or accessible at www.sgs.com/terms_and_conditions.htm and, for electronic format documents, subject to Terms and Conditions for Electronic Documents at www.sgs.com/terms_e-document.htm. Attention is drawn to the limitation of liability, indemnification and jurisdiction issues defined therein. Any holder of this document is advised that information contained hereon reflects the Company's findings at the time of its intervention only and within the limits of Client's instructions, if any. The Company's sole responsibility is to its Client and this document does not exonerate parties to a transaction from exercising all their rights and obligations under the transaction documents. This document cannot be reproduced except in full, without prior written approval of the Company. Any unauthorized alteration, forgery or falsification of the content or appearance of this document is unlawful and offenders may be prosecuted to the fullest extent of the law.

SGS Taiwan Ltd.

No. 134, WuKungRoad, NewTaipeiIndustrialPark, WukuDistrict, NewTaipeiCity, Taiwan24803/新北市五股區新北產業園區五工路 134 號

台灣檢驗科技股份有限公司

t (886-2) 2299-3279

f (886-2) 2298-0488

www.tw.sgs.com

Member of SGS Group

Band4 3MHz_QPSK 15 0_LowCH19965-1711.5

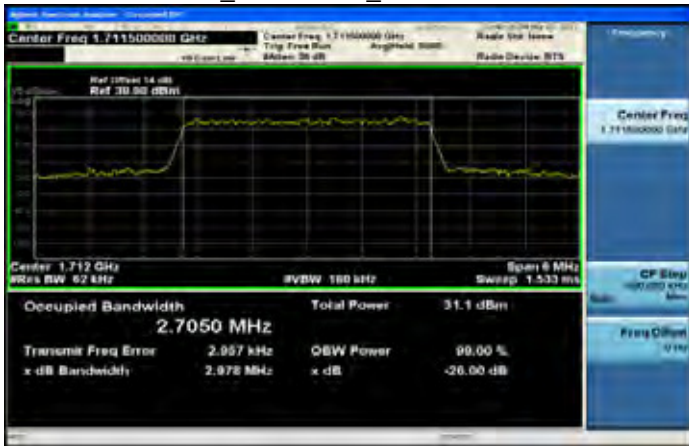

Band4 3MHz_16-QAM 15 0_LowCH19965-1711.5

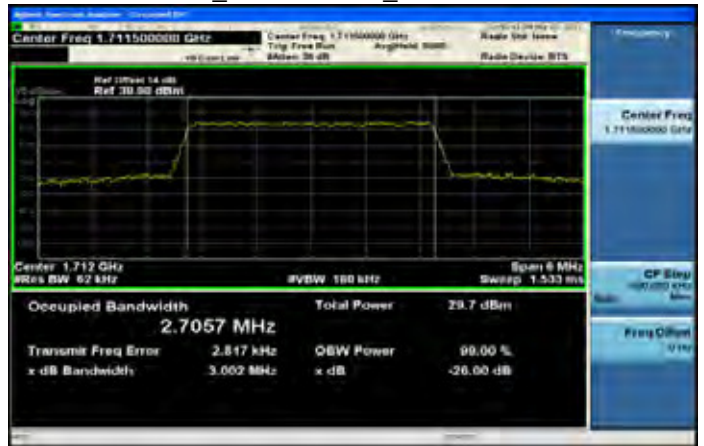

Band4 3MHz_QPSK 15 0_MidCH20175-1732.5

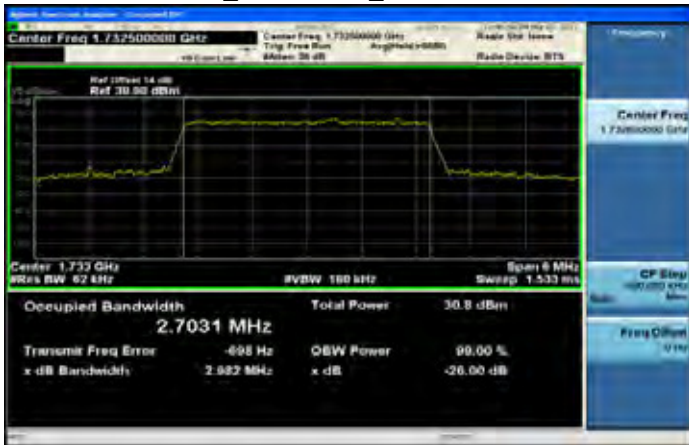

Band4 3MHz_16-QAM 15 0_MidCH20175-1732.5

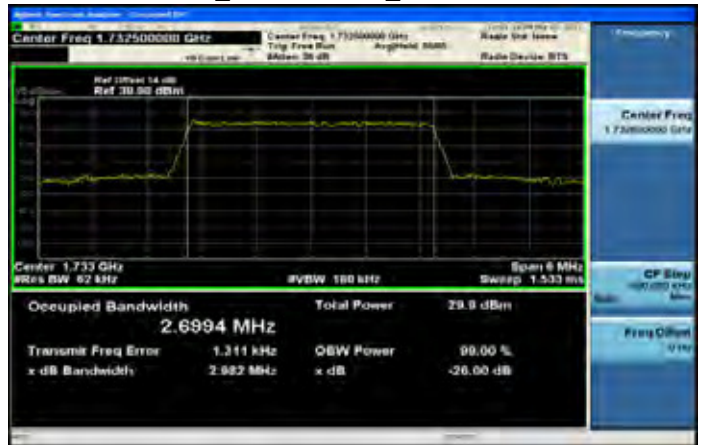

Band4 3MHz_QPSK 15 0_HighCH20385-1753.5



Band4 3MHz_16-QAM 15 0_HighCH20385-1753.5



Unless otherwise stated the results shown in this test report refer only to the sample(s) tested and such sample(s) are retained for 90 days only.

除非另有說明，此報告結果僅對測試之樣品負責，同時此樣品僅保留90天。本報告未經本公司書面許可，不可部份複製。

This document is issued by the Company subject to its General Conditions of Service printed overleaf, available on request or accessible at www.sgs.com/terms_and_conditions.htm and, for electronic format documents, subject to Terms and Conditions for Electronic Documents at www.sgs.com/terms_e-document.htm. Attention is drawn to the limitation of liability, indemnification and jurisdiction issues defined therein. Any holder of this document is advised that information contained hereon reflects the Company's findings at the time of its intervention only and within the limits of Client's instructions, if any. The Company's sole responsibility is to its Client and this document does not exonerate parties to a transaction from exercising all their rights and obligations under the transaction documents. This document cannot be reproduced except in full, without prior written approval of the Company. Any unauthorized alteration, forgery or falsification of the content or appearance of this document is unlawful and offenders may be prosecuted to the fullest extent of the law.

SGS Taiwan Ltd.

No.134,WuKungRoad,NewTaipeiIndustrialPark,WukuDistrict,NewTaipeiCity,Taiwan24803/新北市五股區新北產業園區五工路 134 號

台灣檢驗科技股份有限公司

t (886-2) 2299-3279

f (886-2) 2298-0488

www.tw.sgs.com

Member of SGS Group

Band4 5MHz_QPSK 25 0_LowCH19975-1712.5

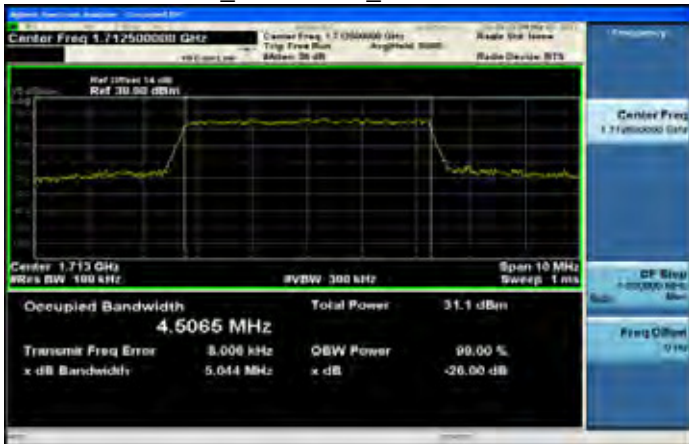

Band4 5MHz_16-QAM 25 0_LowCH19975-1712.5



Band4 5MHz_QPSK 25 0_MidCH20175-1732.5

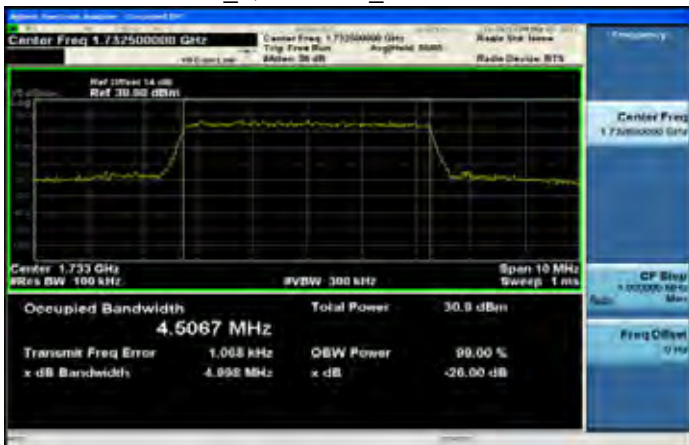

Band4 5MHz_16-QAM 25 0_MidCH20175-1732.5

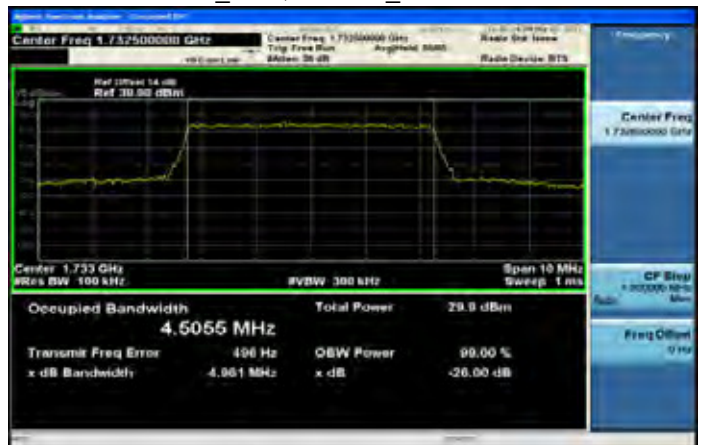

Band4 5MHz_QPSK 25 0_HighCH20375-1752.5

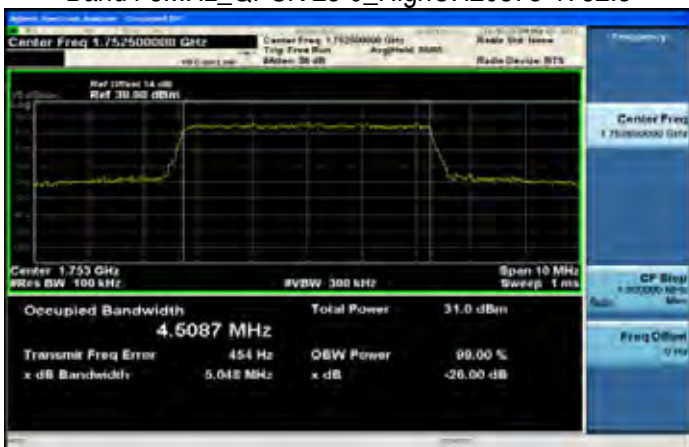

Band4 5MHz_16-QAM 25 0_HighCH20375-1752.5

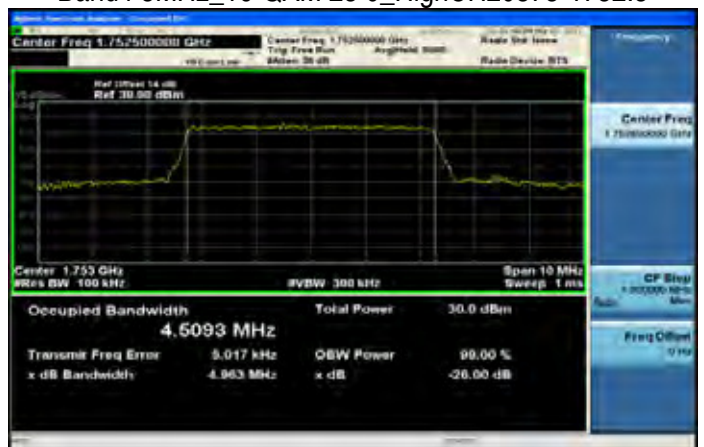

Unless otherwise stated the results shown in this test report refer only to the sample(s) tested and such sample(s) are retained for 90 days only.

除非另有說明，此報告結果僅對測試之樣品負責，同時此樣品僅保留90天。本報告未經本公司書面許可，不可部份複製。

This document is issued by the Company subject to its General Conditions of Service printed overleaf, available on request or accessible at www.sgs.com/terms_and_conditions.htm and, for electronic format documents, subject to Terms and Conditions for Electronic Documents at www.sgs.com/terms_e-document.htm. Attention is drawn to the limitation of liability, indemnification and jurisdiction issues defined therein. Any holder of this document is advised that information contained hereon reflects the Company's findings at the time of its intervention only and within the limits of Client's instructions, if any. The Company's sole responsibility is to its Client and this document does not exonerate parties to a transaction from exercising all their rights and obligations under the transaction documents. This document cannot be reproduced except in full, without prior written approval of the Company. Any unauthorized alteration, forgery or falsification of the content or appearance of this document is unlawful and offenders may be prosecuted to the fullest extent of the law.

SGS Taiwan Ltd.

No.134,WuKungRoad,NewTaipeiIndustrialPark,WukuDistrict,NewTaipeiCity,Taiwan24803/新北市五股區新北產業園區五工路 134 號

台灣檢驗科技股份有限公司

t (886-2) 2299-3279

f (886-2) 2298-0488

www.tw.sgs.com

Member of SGS Group

Band4 10MHz_QPSK 50 0_LowCH20000-1715

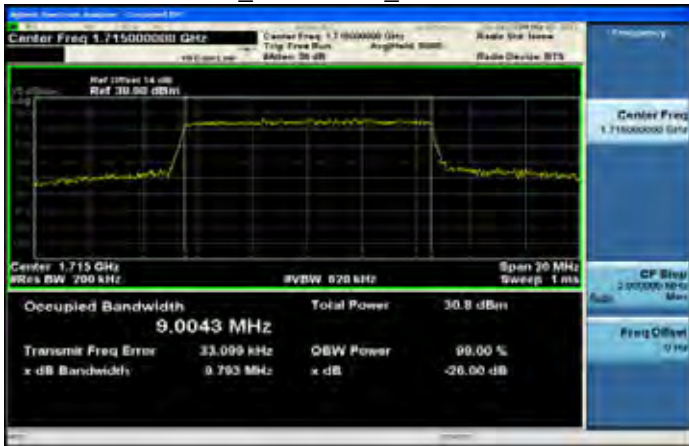

Band4 10MHz_16-QAM 50 0_LowCH20000-1715

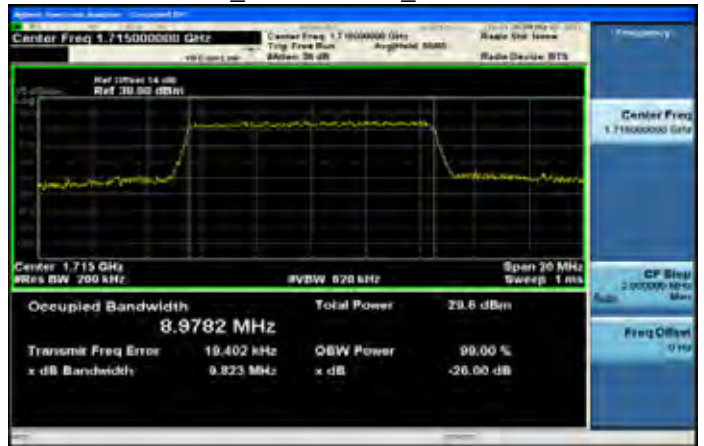

Band4 10MHz_QPSK 50 0_MidCH20175-1732.5

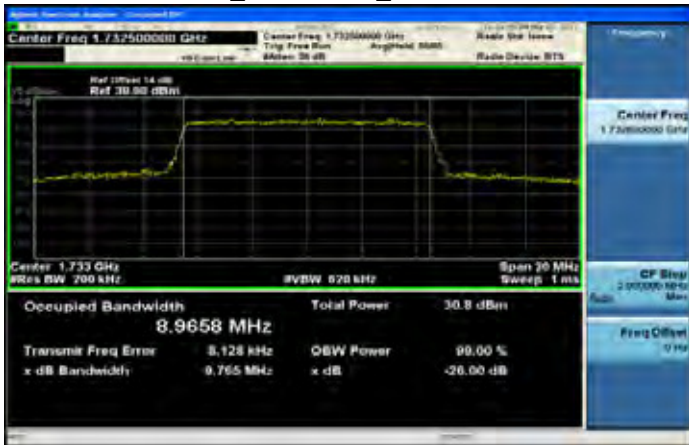

Band4 10MHz_16-QAM 50 0_MidCH20175-1732.5

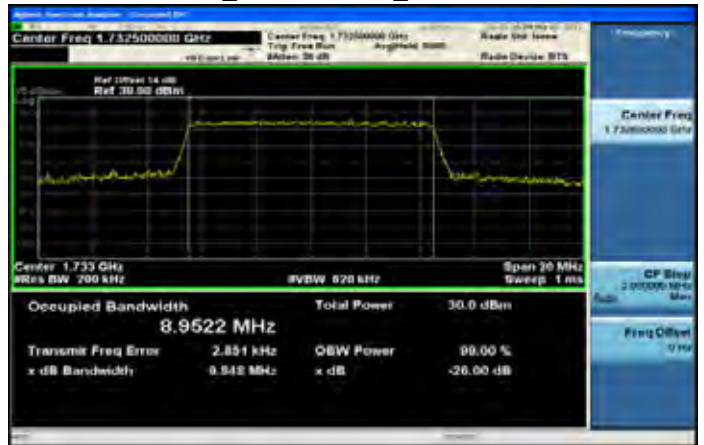

Band4 10MHz_QPSK 50 0_HighCH20350-1750

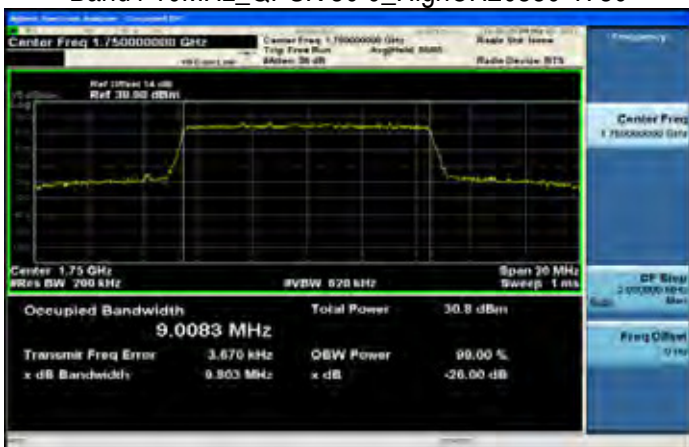

Band4 10MHz_16-QAM 50 0_HighCH20350-1750

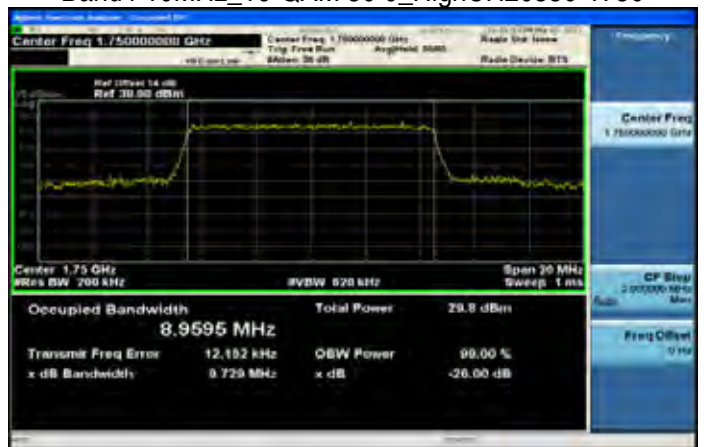

Unless otherwise stated the results shown in this test report refer only to the sample(s) tested and such sample(s) are retained for 90 days only.

除非另有說明，此報告結果僅對測試之樣品負責，同時此樣品僅保留90天。本報告未經本公司書面許可，不可部份複製。

This document is issued by the Company subject to its General Conditions of Service printed overleaf, available on request or accessible at www.sgs.com/terms_and_conditions.htm and, for electronic format documents, subject to Terms and Conditions for Electronic Documents at www.sgs.com/terms_e-document.htm. Attention is drawn to the limitation of liability, indemnification and jurisdiction issues defined therein. Any holder of this document is advised that information contained hereon reflects the Company's findings at the time of its intervention only and within the limits of Client's instructions, if any. The Company's sole responsibility is to its Client and this document does not exonerate parties to a transaction from exercising all their rights and obligations under the transaction documents. This document cannot be reproduced except in full, without prior written approval of the Company. Any unauthorized alteration, forgery or falsification of the content or appearance of this document is unlawful and offenders may be prosecuted to the fullest extent of the law.

SGS Taiwan Ltd.

No.134,WuKungRoad,NewTaipeiIndustrialPark,WukuDistrict,NewTaipeiCity,Taiwan24803/新北市五股區新北產業園區五工路 134 號

台灣檢驗科技股份有限公司

t (886-2) 2299-3279

f (886-2) 2298-0488

www.tw.sgs.com

Member of SGS Group

Band4 15MHz_QPSK 75 0_LowCH20025-1717.5

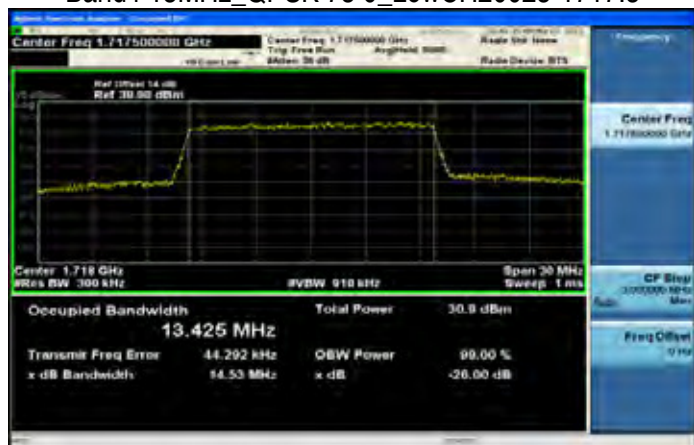

Band4 15MHz_16-QAM 75 0_LowCH20025-1717.5

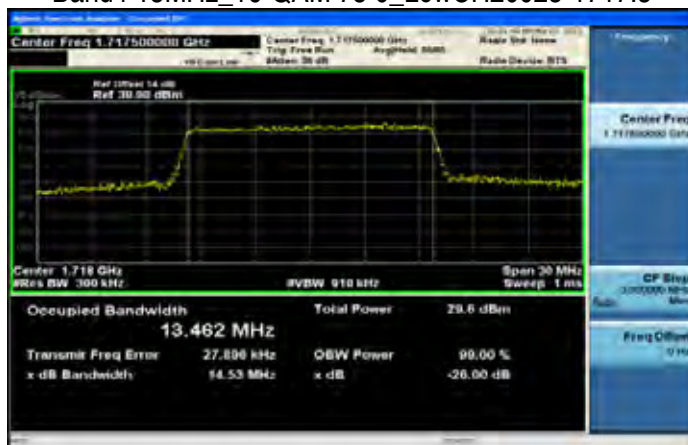

Band4 15MHz_QPSK 75 0_MidCH20175-1732.5



Band4 15MHz_16-QAM 75 0_MidCH20175-1732.5



Band4 15MHz_QPSK 75 0_HighCH20325-1747.5

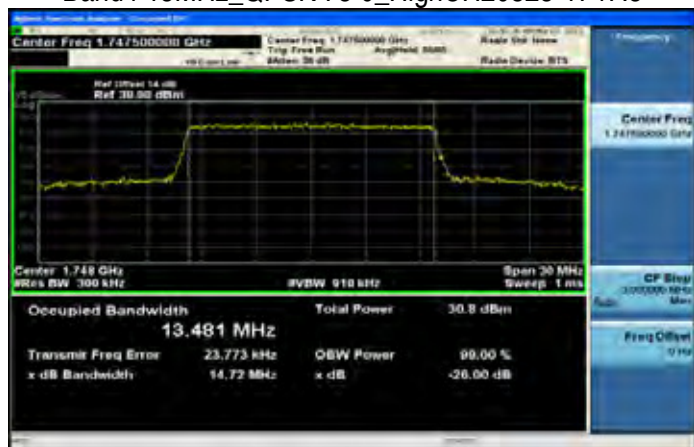

Band4 15MHz_16-QAM 75 0_HighCH20325-1747.5

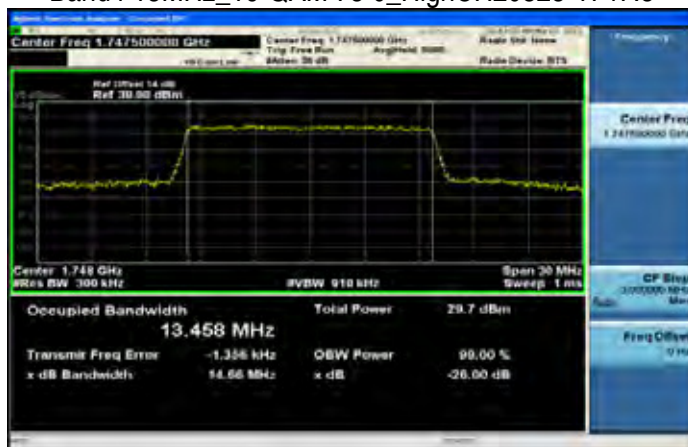

Unless otherwise stated the results shown in this test report refer only to the sample(s) tested and such sample(s) are retained for 90 days only.

除非另有說明，此報告結果僅對測試之樣品負責，同時此樣品僅保留90天。本報告未經本公司書面許可，不可部份複製。

This document is issued by the Company subject to its General Conditions of Service printed overleaf, available on request or accessible at www.sgs.com/terms_and_conditions.htm and, for electronic format documents, subject to Terms and Conditions for Electronic Documents at www.sgs.com/terms_e-document.htm. Attention is drawn to the limitation of liability, indemnification and jurisdiction issues defined therein. Any holder of this document is advised that information contained hereon reflects the Company's findings at the time of its intervention only and within the limits of Client's instructions, if any. The Company's sole responsibility is to its Client and this document does not exonerate parties to a transaction from exercising all their rights and obligations under the transaction documents. This document cannot be reproduced except in full, without prior written approval of the Company. Any unauthorized alteration, forgery or falsification of the content or appearance of this document is unlawful and offenders may be prosecuted to the fullest extent of the law.

SGS Taiwan Ltd.

No. 134, WuKungRoad, NewTaipeiIndustrialPark, WukuDistrict, NewTaipeiCity, Taiwan24803/新北市五股區新北產業園區五工路 134 號

台灣檢驗科技股份有限公司

t (886-2) 2299-3279

f (886-2) 2298-0488

www.tw.sgs.com

Member of SGS Group

Band4 20MHz_QPSK 100 0_LowCH20050-1720

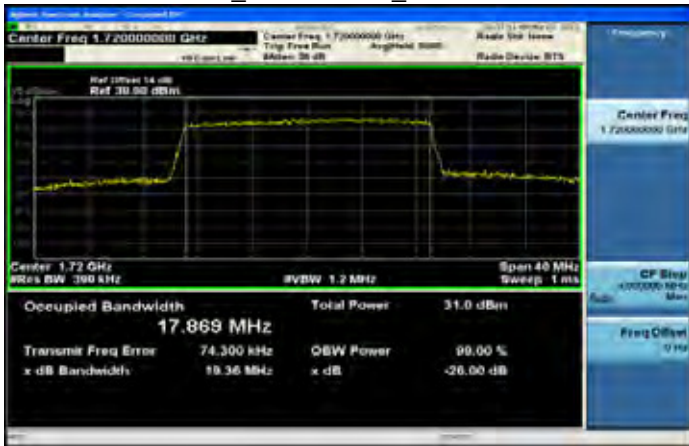

Band4 20MHz_16-QAM 100 0_LowCH20050-1720

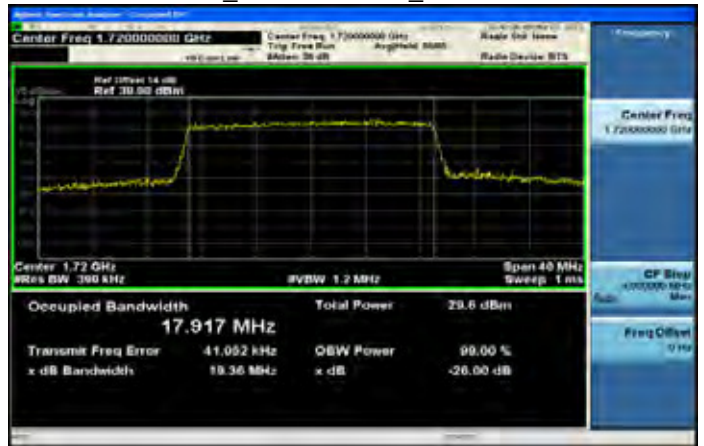

Band4 20MHz_QPSK 100 0_MidCH20175-1732.5

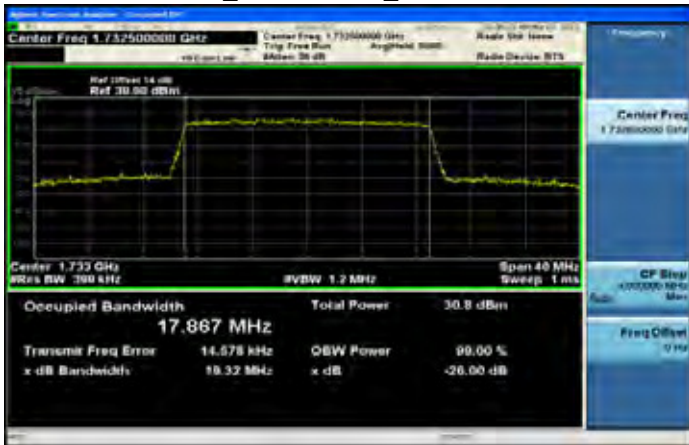

Band4 20MHz_16-QAM 100 0_MidCH20175-1732.5

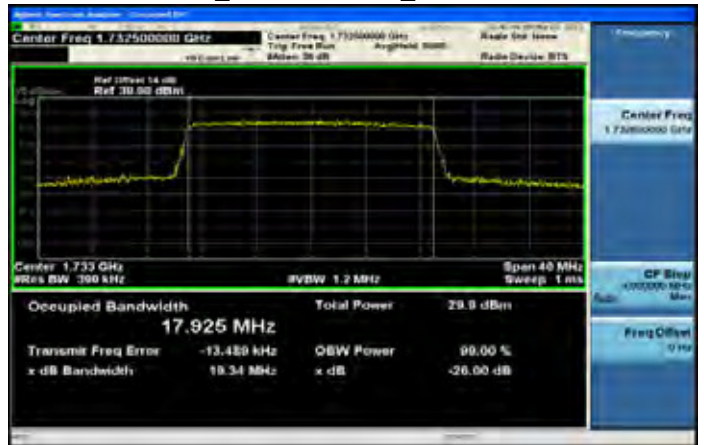

Band4 20MHz_QPSK 100 0_HighCH20300-1745

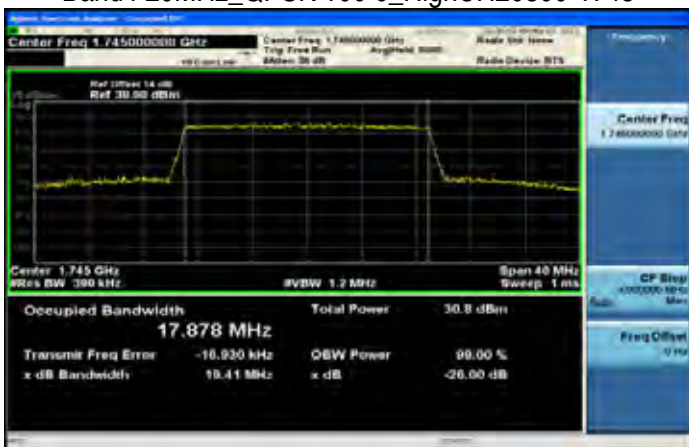

Band4 20MHz_16-QAM 100 0_HighCH20300-1745

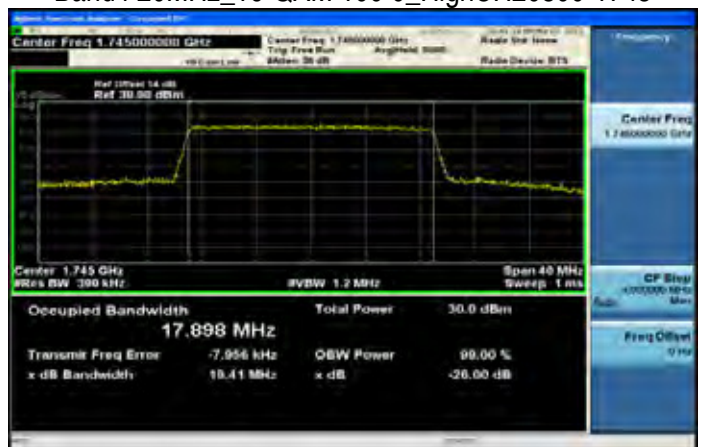

Unless otherwise stated the results shown in this test report refer only to the sample(s) tested and such sample(s) are retained for 90 days only.

除非另有說明，此報告結果僅對測試之樣品負責，同時此樣品僅保留90天。本報告未經本公司書面許可，不可部份複製。

This document is issued by the Company subject to its General Conditions of Service printed overleaf, available on request or accessible at www.sgs.com/terms_and_conditions.htm and, for electronic format documents, subject to Terms and Conditions for Electronic Documents at www.sgs.com/terms_e-document.htm. Attention is drawn to the limitation of liability, indemnification and jurisdiction issues defined therein. Any holder of this document is advised that information contained hereon reflects the Company's findings at the time of its intervention only and within the limits of Client's instructions, if any. The Company's sole responsibility is to its Client and this document does not exonerate parties to a transaction from exercising all their rights and obligations under the transaction documents. This document cannot be reproduced except in full, without prior written approval of the Company. Any unauthorized alteration, forgery or falsification of the content or appearance of this document is unlawful and offenders may be prosecuted to the fullest extent of the law.

SGS Taiwan Ltd.

No.134,WuKungRoad,NewTaipeiIndustrialPark,WukuDistrict,NewTaipeiCity,Taiwan24803/新北市五股區新北產業園區五工路 134 號

台灣檢驗科技股份有限公司

t (886-2) 2299-3279

f (886-2) 2298-0488

www.tw.sgs.com

Member of SGS Group

Band5 1.4MHz_QPSK 6 0_LowCH20407-824.7

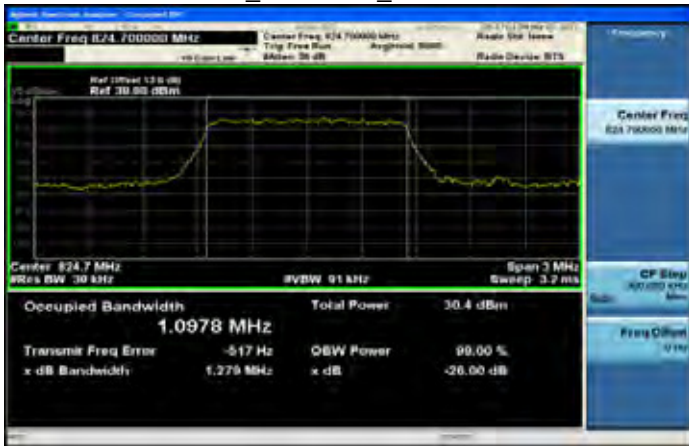

Band5 1.4MHz_16-QAM 6 0_LowCH20407-824.7

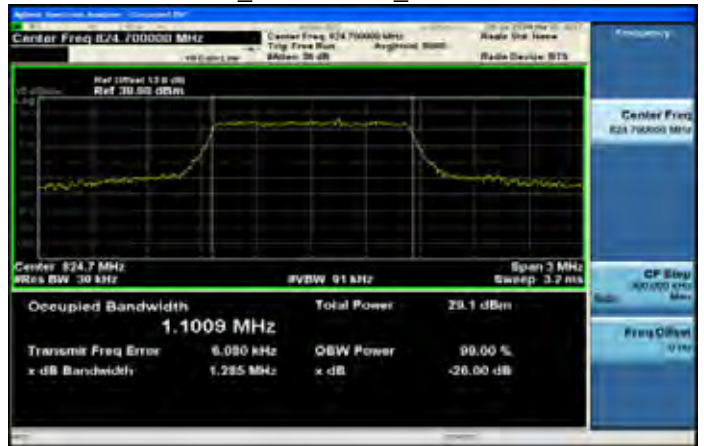

Band5 1.4MHz_QPSK 6 0_MidCH20525-836.5

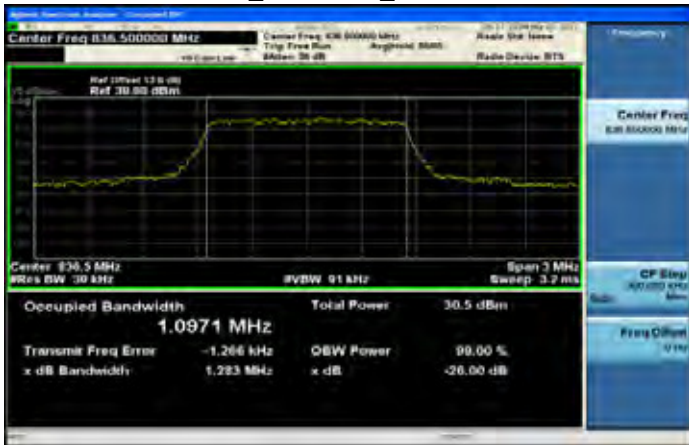

Band5 1.4MHz_16-QAM 6 0_MidCH20525-836.5

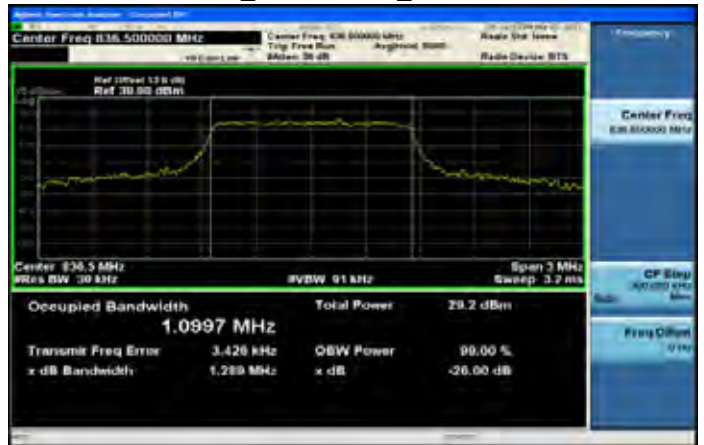

Band5 1.4MHz_QPSK 6 0_HighCH20643-848.3

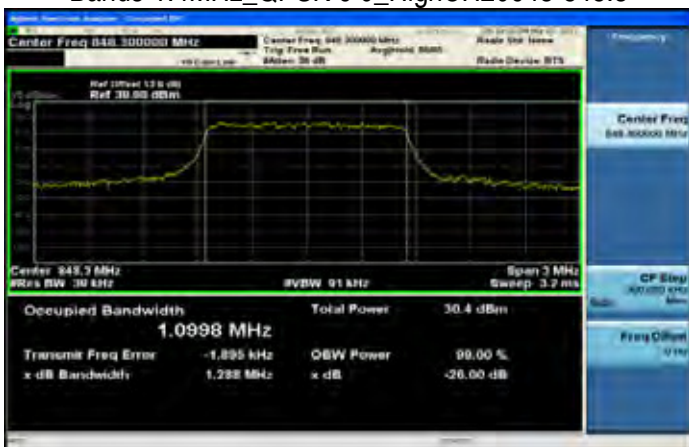

Band5 1.4MHz_16-QAM 6 0_HighCH20643-848.3

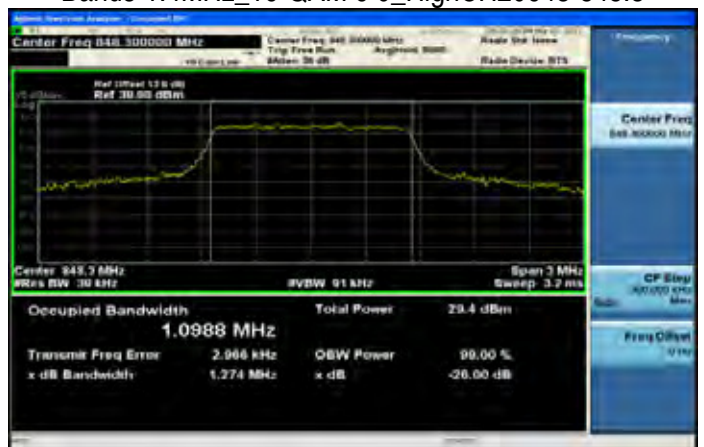

Unless otherwise stated the results shown in this test report refer only to the sample(s) tested and such sample(s) are retained for 90 days only.

除非另有說明，此報告結果僅對測試之樣品負責，同時此樣品僅保留90天。本報告未經本公司書面許可，不可部份複製。

This document is issued by the Company subject to its General Conditions of Service printed overleaf, available on request or accessible at www.sgs.com/terms_and_conditions.htm and, for electronic format documents, subject to Terms and Conditions for Electronic Documents at www.sgs.com/terms_e-document.htm. Attention is drawn to the limitation of liability, indemnification and jurisdiction issues defined therein. Any holder of this document is advised that information contained hereon reflects the Company's findings at the time of its intervention only and within the limits of Client's instructions, if any. The Company's sole responsibility is to its Client and this document does not exonerate parties to a transaction from exercising all their rights and obligations under the transaction documents. This document cannot be reproduced except in full, without prior written approval of the Company. Any unauthorized alteration, forgery or falsification of the content or appearance of this document is unlawful and offenders may be prosecuted to the fullest extent of the law.

SGS Taiwan Ltd.

No. 134, WuKungRoad, NewTaipeiIndustrialPark, WukuDistrict, NewTaipeiCity, Taiwan24803/新北市五股區新北產業園區五工路 134 號

台灣檢驗科技股份有限公司

t (886-2) 2299-3279

f (886-2) 2298-0488

www.tw.sgs.com

Member of SGS Group

Band5 3MHz_QPSK 15 0_LowCH20415-825.5

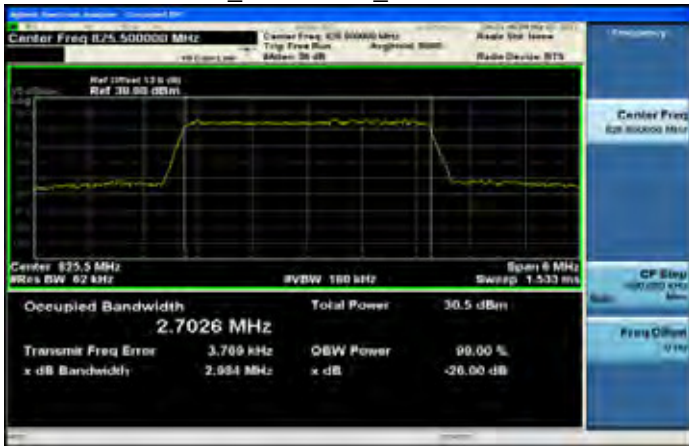

Band5 3MHz_16-QAM 15 0_LowCH20415-825.5

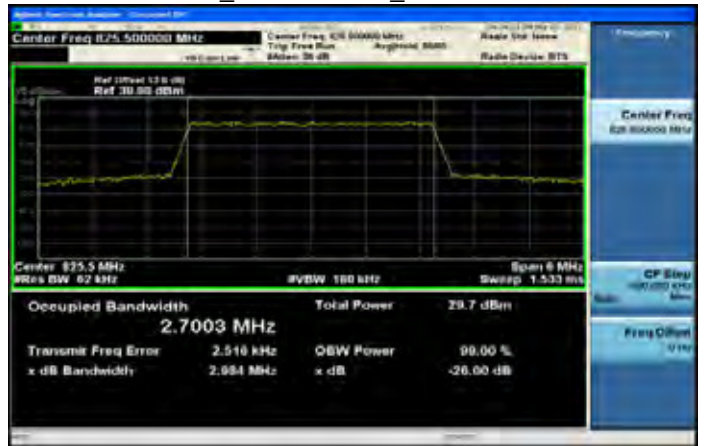

Band5 3MHz_QPSK 15 0_MidCH20525-836.5

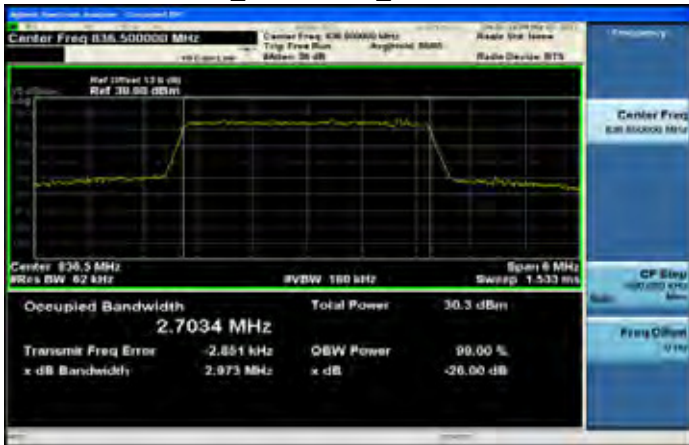

Band5 3MHz_16-QAM 15 0_MidCH20525-836.5

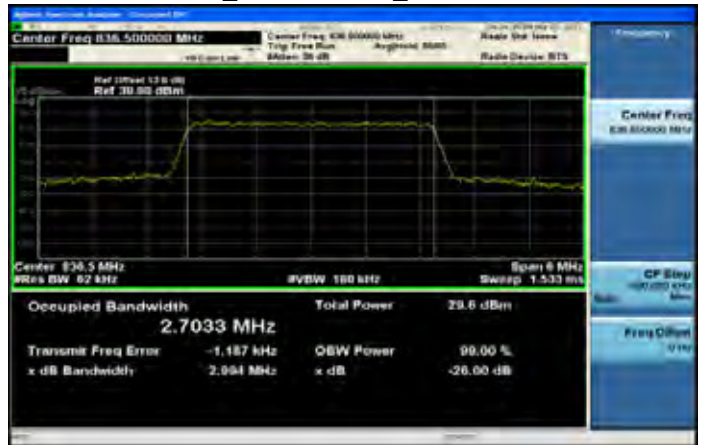

Band5 3MHz_QPSK 15 0_HighCH20635-847.5

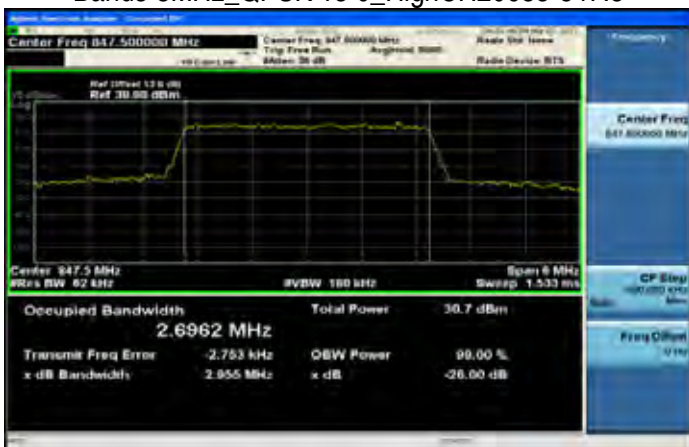

Band5 3MHz_16-QAM 15 0_HighCH20635-847.5

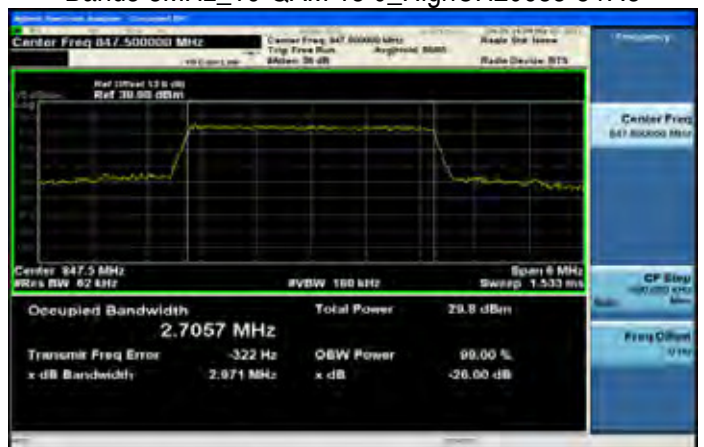

Unless otherwise stated the results shown in this test report refer only to the sample(s) tested and such sample(s) are retained for 90 days only.

除非另有說明，此報告結果僅對測試之樣品負責，同時此樣品僅保留90天。本報告未經本公司書面許可，不可部份複製。

This document is issued by the Company subject to its General Conditions of Service printed overleaf, available on request or accessible at www.sgs.com/terms_and_conditions.htm and, for electronic format documents, subject to Terms and Conditions for Electronic Documents at www.sgs.com/terms_e-document.htm. Attention is drawn to the limitation of liability, indemnification and jurisdiction issues defined therein. Any holder of this document is advised that information contained hereon reflects the Company's findings at the time of its intervention only and within the limits of Client's instructions, if any. The Company's sole responsibility is to its Client and this document does not exonerate parties to a transaction from exercising all their rights and obligations under the transaction documents. This document cannot be reproduced except in full, without prior written approval of the Company. Any unauthorized alteration, forgery or falsification of the content or appearance of this document is unlawful and offenders may be prosecuted to the fullest extent of the law.

SGS Taiwan Ltd.

No. 134, WuKungRoad, NewTaipeiIndustrialPark, WukuDistrict, NewTaipeiCity, Taiwan24803/新北市五股區新北產業園區五工路 134 號

台灣檢驗科技股份有限公司

t (886-2) 2299-3279

f (886-2) 2298-0488

www.tw.sgs.com

Member of SGS Group

Band5 5MHz_QPSK 25 0_LowCH20425-826.5

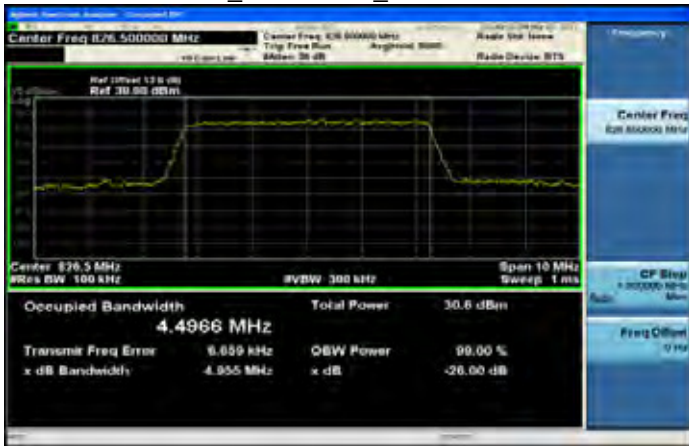

Band5 5MHz_16-QAM 25 0_LowCH20425-826.5

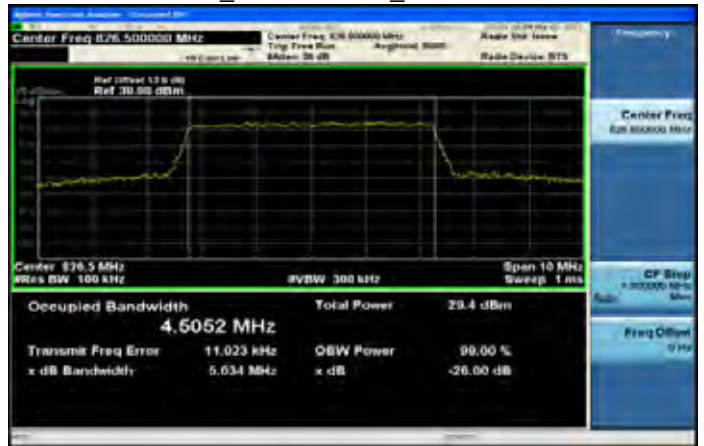

Band5 5MHz_QPSK 25 0_MidCH20525-836.5

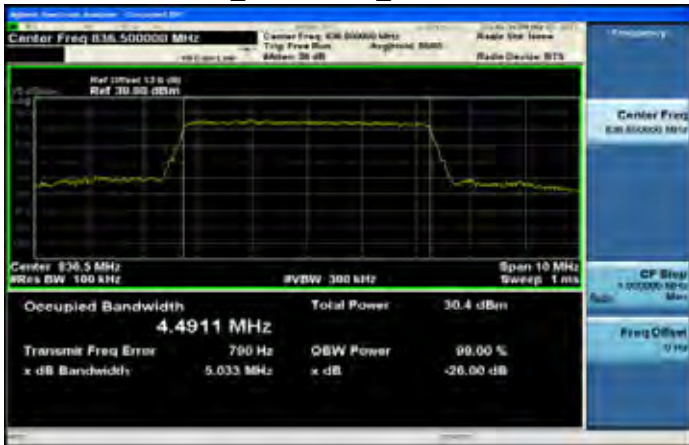

Band5 5MHz_16-QAM 25 0_MidCH20525-836.5

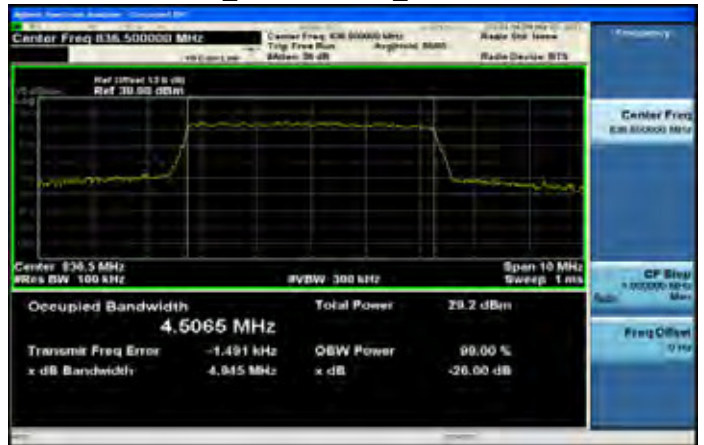

Band5 5MHz_QPSK 25 0_HighCH20625-846.5

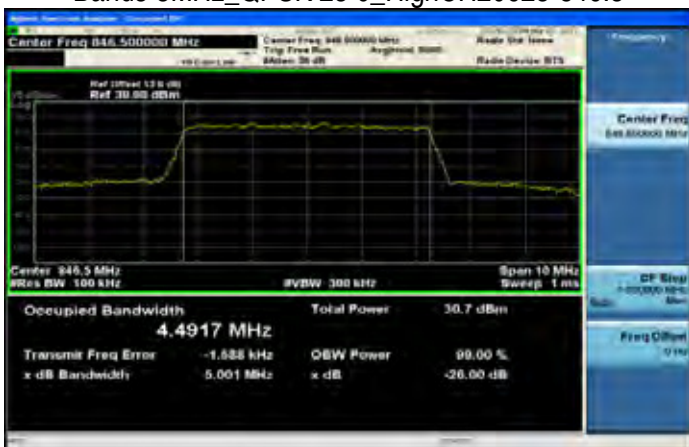

Band5 5MHz_16-QAM 25 0_HighCH20625-846.5

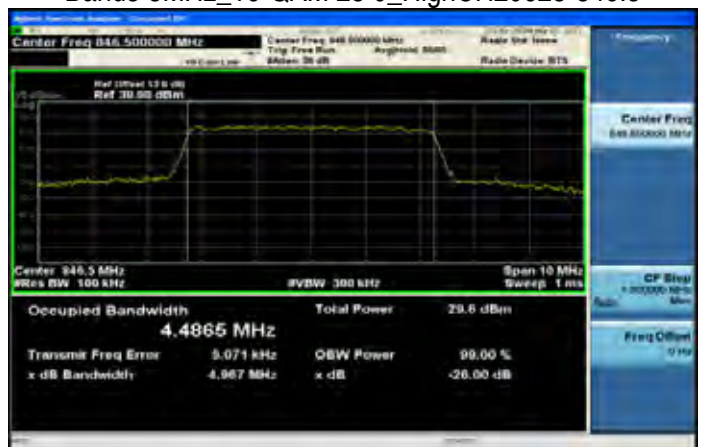

Unless otherwise stated the results shown in this test report refer only to the sample(s) tested and such sample(s) are retained for 90 days only.

除非另有說明，此報告結果僅對測試之樣品負責，同時此樣品僅保留90天。本報告未經本公司書面許可，不可部份複製。

This document is issued by the Company subject to its General Conditions of Service printed overleaf, available on request or accessible at www.sgs.com/terms_and_conditions.htm and, for electronic format documents, subject to Terms and Conditions for Electronic Documents at www.sgs.com/terms_e-document.htm. Attention is drawn to the limitation of liability, indemnification and jurisdiction issues defined therein. Any holder of this document is advised that information contained hereon reflects the Company's findings at the time of its intervention only and within the limits of Client's instructions, if any. The Company's sole responsibility is to its Client and this document does not exonerate parties to a transaction from exercising all their rights and obligations under the transaction documents. This document cannot be reproduced except in full, without prior written approval of the Company. Any unauthorized alteration, forgery or falsification of the content or appearance of this document is unlawful and offenders may be prosecuted to the fullest extent of the law.

SGS Taiwan Ltd.

No. 134, WuKungRoad, NewTaipeiIndustrialPark, WukuDistrict, NewTaipeiCity, Taiwan24803/新北市五股區新北產業園區五工路 134 號

台灣檢驗科技股份有限公司

t (886-2) 2299-3279

f (886-2) 2298-0488

www.tw.sgs.com

Member of SGS Group

Band5 10MHz_QPSK 50 0_LowCH20450-829

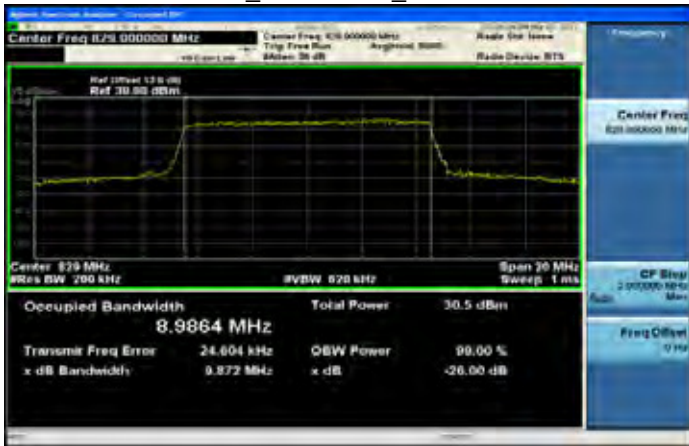

Band5 10MHz_16-QAM 50 0_LowCH20450-829

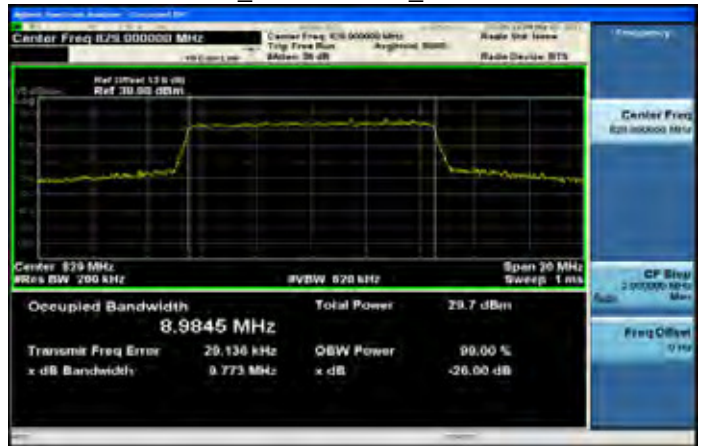

Band5 10MHz_QPSK 50 0_MidCH20525-836.5

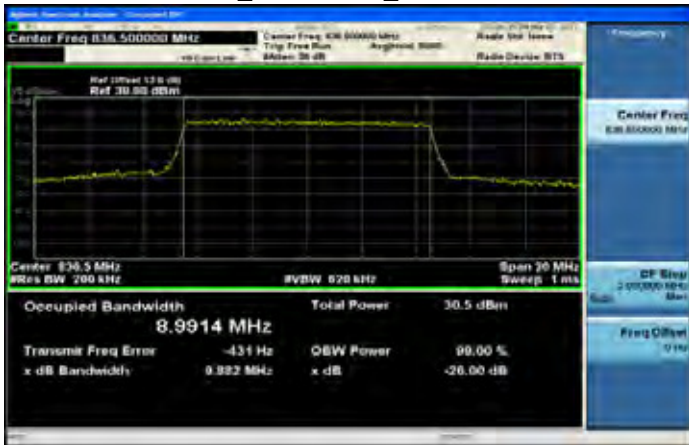

Band5 10MHz_16-QAM 50 0_MidCH20525-836.5

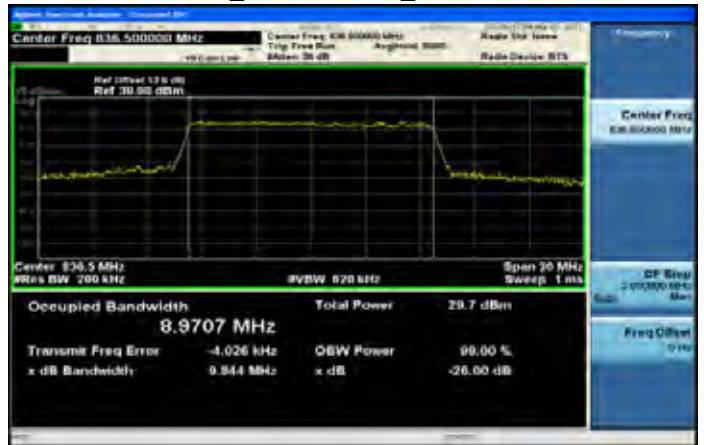

Band5 10MHz_QPSK 50 0_HighCH20600-844



Band5 10MHz_16-QAM 50 0_HighCH20600-844

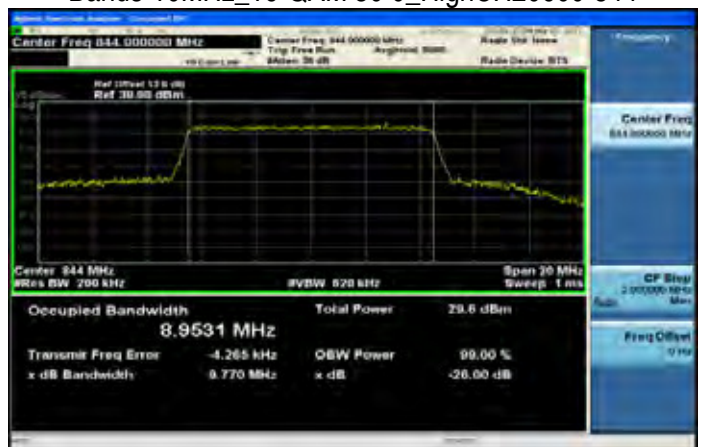

Unless otherwise stated the results shown in this test report refer only to the sample(s) tested and such sample(s) are retained for 90 days only.

除非另有說明，此報告結果僅對測試之樣品負責，同時此樣品僅保留90天。本報告未經本公司書面許可，不可部份複製。

This document is issued by the Company subject to its General Conditions of Service printed overleaf, available on request or accessible at www.sgs.com/terms_and_conditions.htm and, for electronic format documents, subject to Terms and Conditions for Electronic Documents at www.sgs.com/terms_e-document.htm. Attention is drawn to the limitation of liability, indemnification and jurisdiction issues defined therein. Any holder of this document is advised that information contained hereon reflects the Company's findings at the time of its intervention only and within the limits of Client's instructions, if any. The Company's sole responsibility is to its Client and this document does not exonerate parties to a transaction from exercising all their rights and obligations under the transaction documents. This document cannot be reproduced except in full, without prior written approval of the Company. Any unauthorized alteration, forgery or falsification of the content or appearance of this document is unlawful and offenders may be prosecuted to the fullest extent of the law.

SGS Taiwan Ltd.

No. 134, WuKungRoad, NewTaipeiIndustrialPark, WukuDistrict, NewTaipeiCity, Taiwan24803/新北市五股區新北產業園區五工路 134 號

台灣檢驗科技股份有限公司

t (886-2) 2299-3279

f (886-2) 2298-0488

www.tw.sgs.com

Member of SGS Group

Band7 5MHz_QPSK 25 0_LowCH20775-2502.5

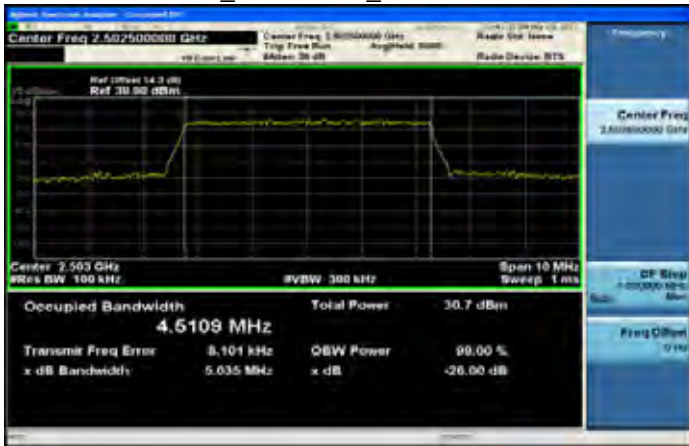

Band7 5MHz_16-QAM 25 0_LowCH20775-2502.5

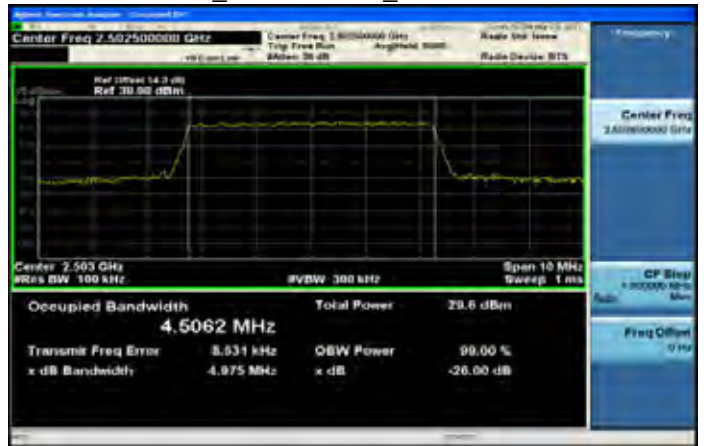

Band7 5MHz_QPSK 25 0_MidCH21100-2535

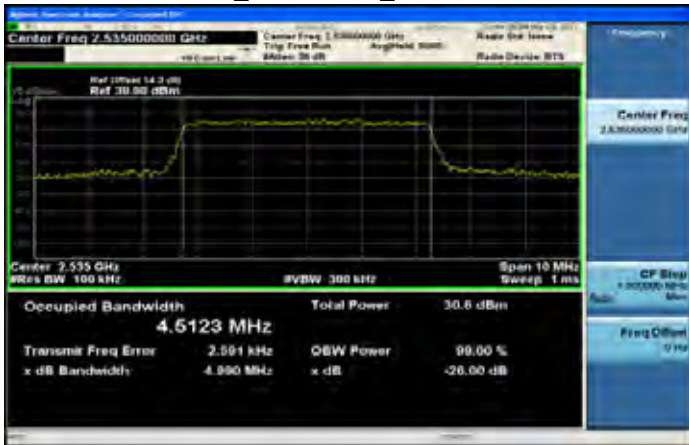

Band7 5MHz_16-QAM 25 0_MidCH21100-2535

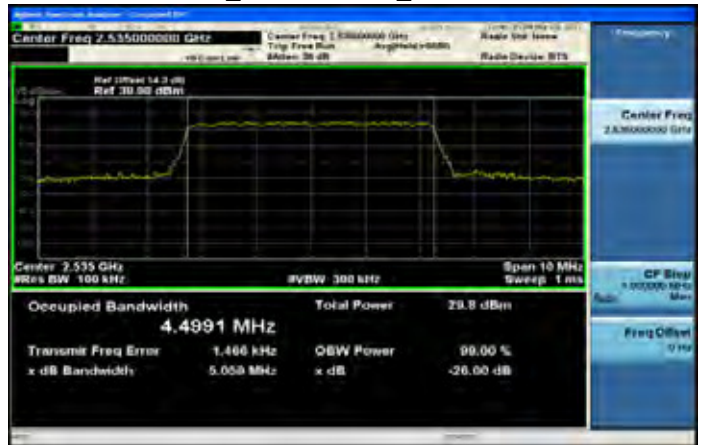

Band7 5MHz_QPSK 25 0_HighCH21425-2567.5

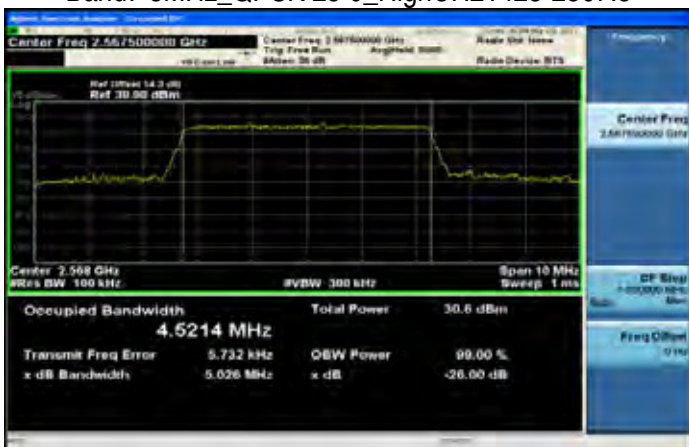

Band7 5MHz_16-QAM 25 0_HighCH21425-2567.5

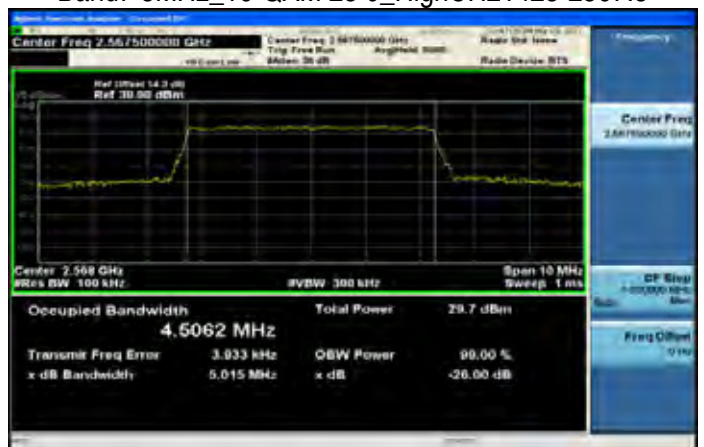

Unless otherwise stated the results shown in this test report refer only to the sample(s) tested and such sample(s) are retained for 90 days only.
除非另有說明，此報告結果僅對測試之樣品負責，同時此樣品僅保留90天。本報告未經本公司書面許可，不可部份複製。

This document is issued by the Company subject to its General Conditions of Service printed overleaf, available on request or accessible at www.sgs.com/terms_and_conditions.htm and, for electronic format documents, subject to Terms and Conditions for Electronic Documents at www.sgs.com/terms_e-document.htm. Attention is drawn to the limitation of liability, indemnification and jurisdiction issues defined therein. Any holder of this document is advised that information contained hereon reflects the Company's findings at the time of its intervention only and within the limits of Client's instructions, if any. The Company's sole responsibility is to its Client and this document does not exonerate parties to a transaction from exercising all their rights and obligations under the transaction documents. This document cannot be reproduced except in full, without prior written approval of the Company. Any unauthorized alteration, forgery or falsification of the content or appearance of this document is unlawful and offenders may be prosecuted to the fullest extent of the law.

Band7 10MHz_QPSK 50 0_LowCH20800-2505

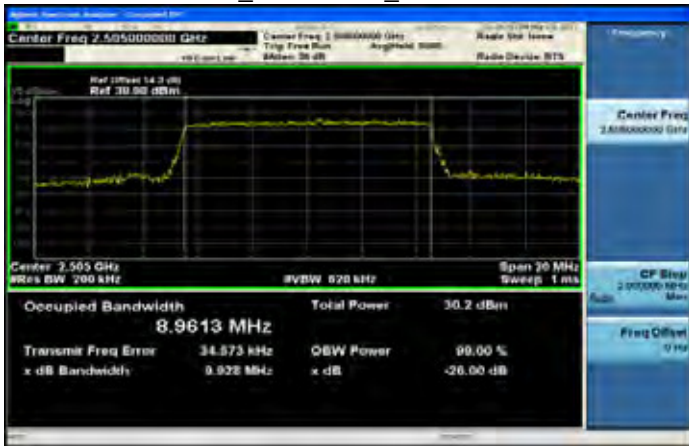

Band7 10MHz_16-QAM 50 0_LowCH20800-2505

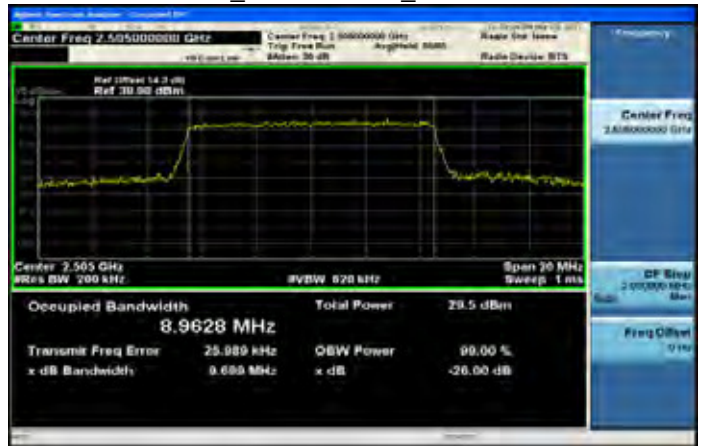

Band7 10MHz_QPSK 50 0_MidCH21100-2535

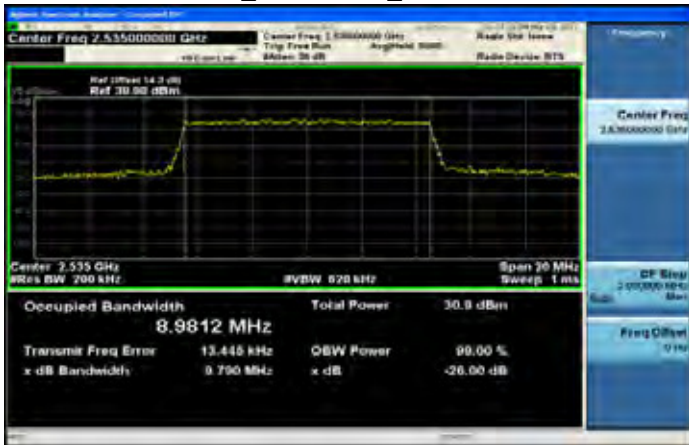

Band7 10MHz_16-QAM 50 0_MidCH21100-2535

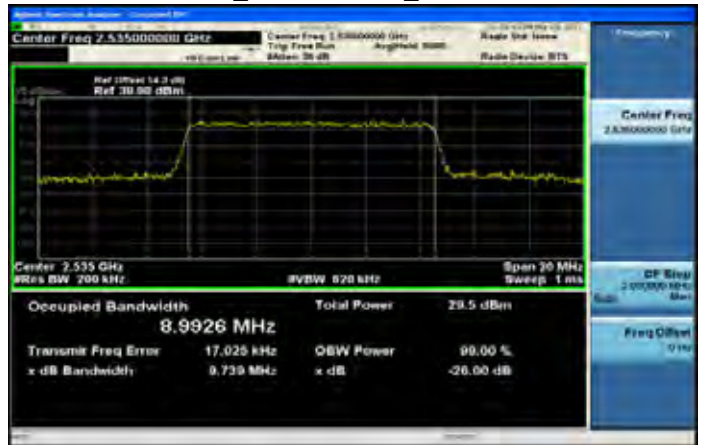

Band7 10MHz_QPSK 50 0_HighCH21400-2565



Band7 10MHz_16-QAM 50 0_HighCH21400-2565



Unless otherwise stated the results shown in this test report refer only to the sample(s) tested and such sample(s) are retained for 90 days only.

除非另有說明，此報告結果僅對測試之樣品負責，同時此樣品僅保留90天。本報告未經本公司書面許可，不可部份複製。

This document is issued by the Company subject to its General Conditions of Service printed overleaf, available on request or accessible at www.sgs.com/terms_and_conditions.htm and, for electronic format documents, subject to Terms and Conditions for Electronic Documents at www.sgs.com/terms_e-document.htm. Attention is drawn to the limitation of liability, indemnification and jurisdiction issues defined therein. Any holder of this document is advised that information contained hereon reflects the Company's findings at the time of its intervention only and within the limits of Client's instructions, if any. The Company's sole responsibility is to its Client and this document does not exonerate parties to a transaction from exercising all their rights and obligations under the transaction documents. This document cannot be reproduced except in full, without prior written approval of the Company. Any unauthorized alteration, forgery or falsification of the content or appearance of this document is unlawful and offenders may be prosecuted to the fullest extent of the law.

SGS Taiwan Ltd.

No. 134, WuKungRoad, NewTaipeiIndustrialPark, WukuDistrict, NewTaipeiCity, Taiwan24803/新北市五股區新北產業園區五工路 134 號

台灣檢驗科技股份有限公司

t (886-2) 2299-3279

f (886-2) 2298-0488

www.tw.sgs.com

Member of SGS Group

Band7 15MHz_QPSK 75 0_LowCH20825-2507.5

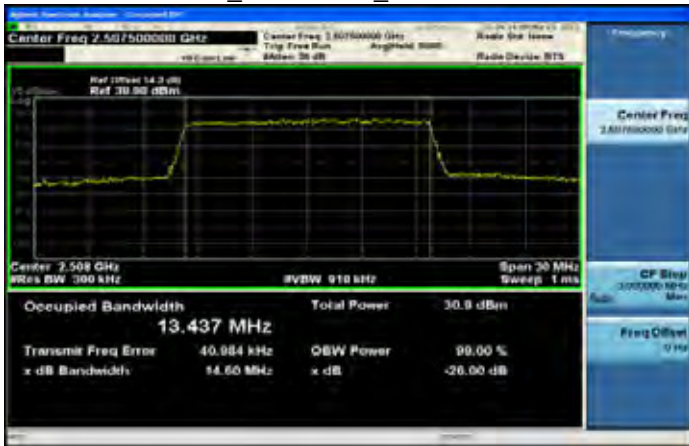

Band7 15MHz_16-QAM 75 0_LowCH20825-2507.5

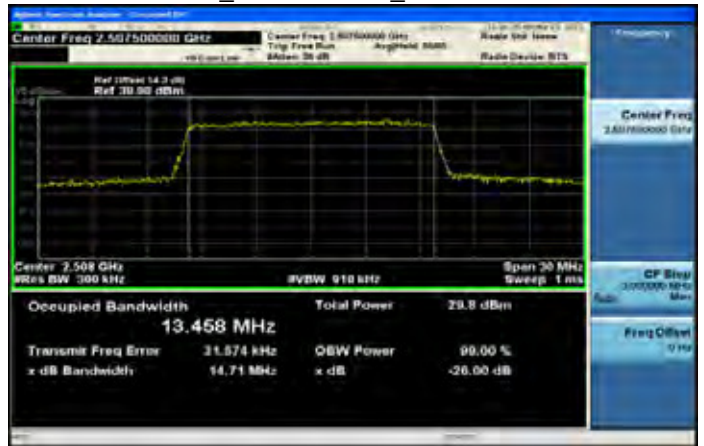

Band7 15MHz_QPSK 75 0_MidCH21100-2535

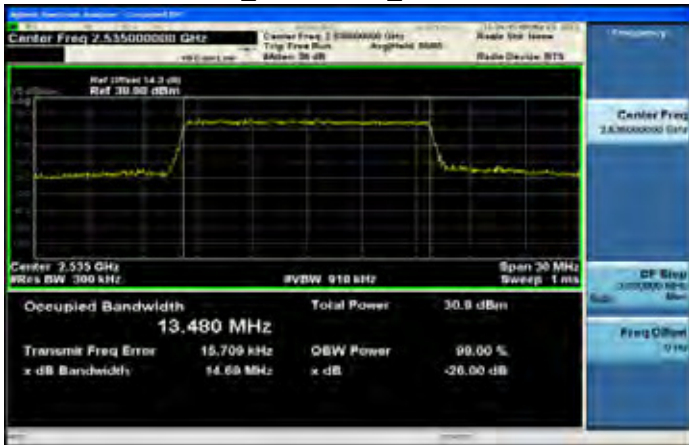

Band7 15MHz_16-QAM 75 0_MidCH21100-2535

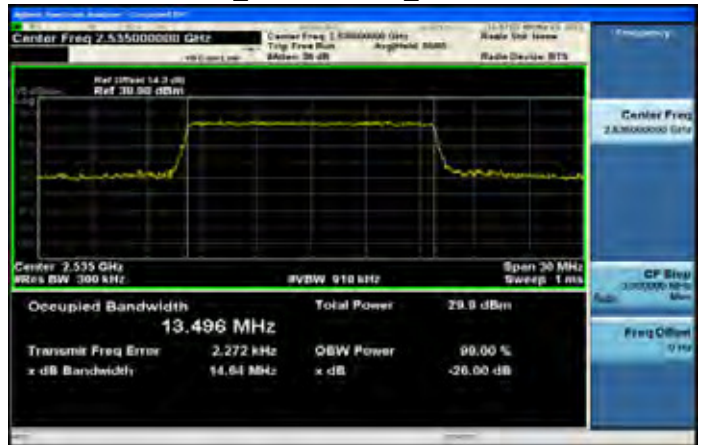

Band7 15MHz_QPSK 75 0_HighCH21375-2562.5

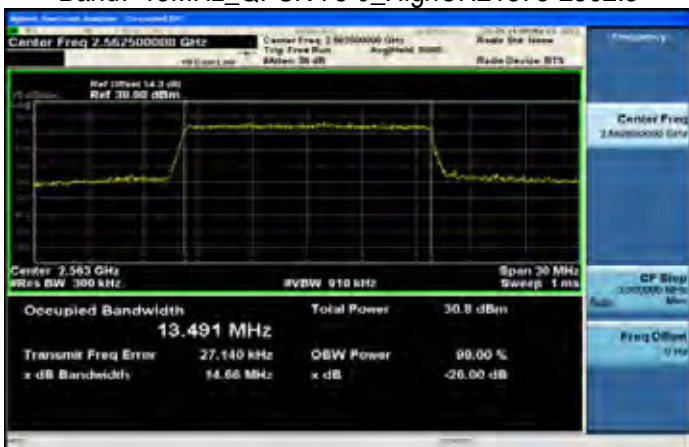

Band7 15MHz_16-QAM 75 0_HighCH21375-2562.5

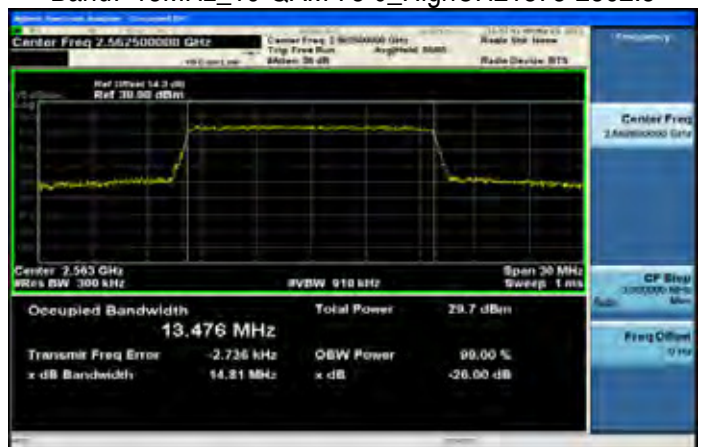

Unless otherwise stated the results shown in this test report refer only to the sample(s) tested and such sample(s) are retained for 90 days only.
除非另有說明，此報告結果僅對測試之樣品負責，同時此樣品僅保留90天。本報告未經本公司書面許可，不可部份複製。

This document is issued by the Company subject to its General Conditions of Service printed overleaf, available on request or accessible at www.sgs.com/terms_and_conditions.htm and, for electronic format documents, subject to Terms and Conditions for Electronic Documents at www.sgs.com/terms_e-document.htm. Attention is drawn to the limitation of liability, indemnification and jurisdiction issues defined therein. Any holder of this document is advised that information contained hereon reflects the Company's findings at the time of its intervention only and within the limits of Client's instructions, if any. The Company's sole responsibility is to its Client and this document does not exonerate parties to a transaction from exercising all their rights and obligations under the transaction documents. This document cannot be reproduced except in full, without prior written approval of the Company. Any unauthorized alteration, forgery or falsification of the content or appearance of this document is unlawful and offenders may be prosecuted to the fullest extent of the law.

Band7 20MHz_QPSK 100 0_LowCH20850-2510

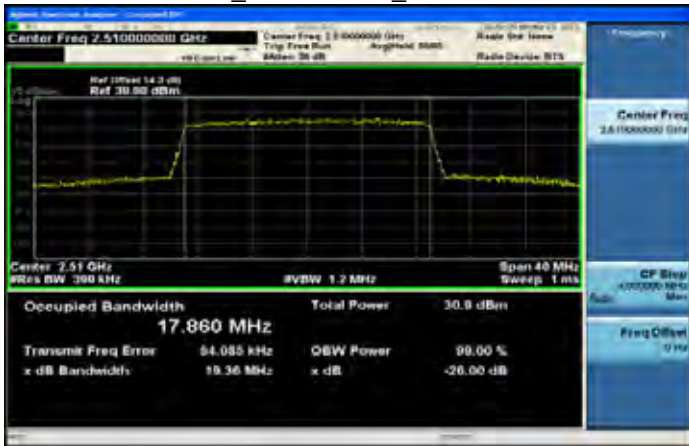

Band7 20MHz_16-QAM 100 0_LowCH20850-2510

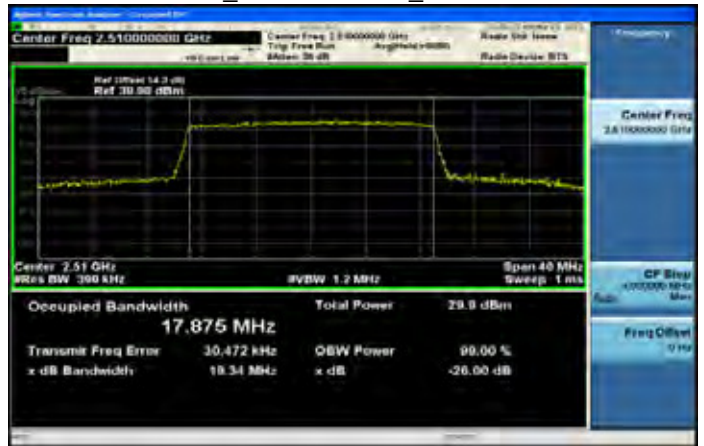

Band7 20MHz_QPSK 100 0_MidCH21100-2535

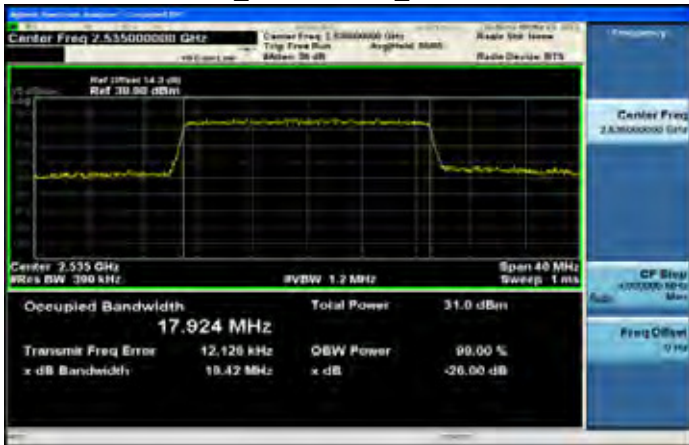

Band7 20MHz_16-QAM 100 0_MidCH21100-2535

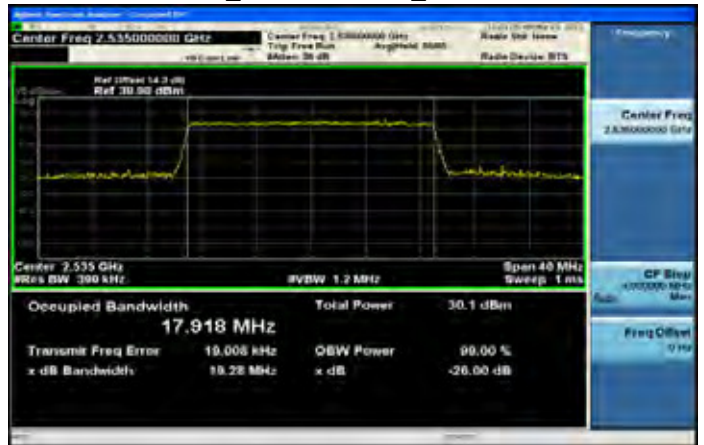

Band7 20MHz_QPSK 100 0_HighCH21350-2560

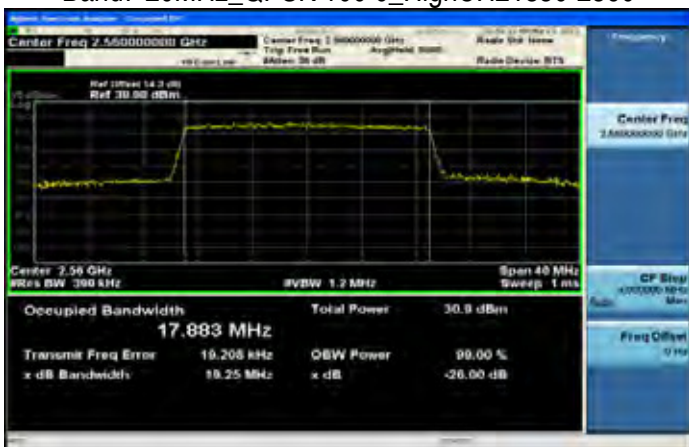

Band7 20MHz_16-QAM 100 0_HighCH21350-2560

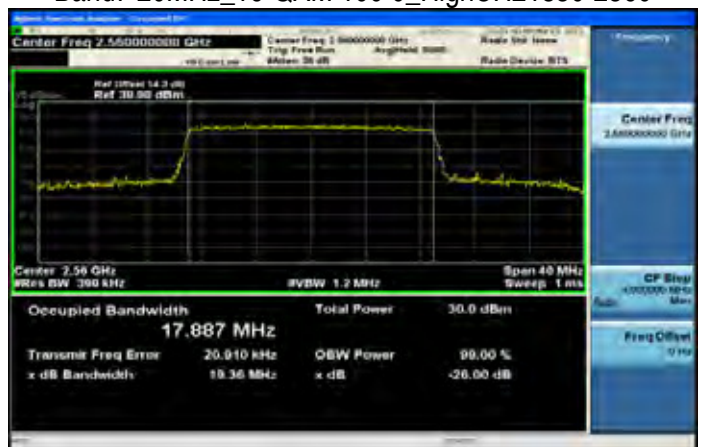

Unless otherwise stated the results shown in this test report refer only to the sample(s) tested and such sample(s) are retained for 90 days only.

除非另有說明，此報告結果僅對測試之樣品負責，同時此樣品僅保留90天。本報告未經本公司書面許可，不可部份複製。

This document is issued by the Company subject to its General Conditions of Service printed overleaf, available on request or accessible at www.sgs.com/terms_and_conditions.htm and, for electronic format documents, subject to Terms and Conditions for Electronic Documents at www.sgs.com/terms_e-document.htm. Attention is drawn to the limitation of liability, indemnification and jurisdiction issues defined therein. Any holder of this document is advised that information contained hereon reflects the Company's findings at the time of its intervention only and within the limits of Client's instructions, if any. The Company's sole responsibility is to its Client and this document does not exonerate parties to a transaction from exercising all their rights and obligations under the transaction documents. This document cannot be reproduced except in full, without prior written approval of the Company. Any unauthorized alteration, forgery or falsification of the content or appearance of this document is unlawful and offenders may be prosecuted to the fullest extent of the law.

SGS Taiwan Ltd.

No. 134, WuKungRoad, NewTaipeiIndustrialPark, WukuDistrict, NewTaipeiCity, Taiwan24803/新北市五股區新北產業園區五工路 134 號

台灣檢驗科技股份有限公司

t (886-2) 2299-3279

f (886-2) 2298-0488

www.tw.sgs.com

Member of SGS Group

Band12 1.4MHz_QPSK 6 0_LowCH23017-699.7

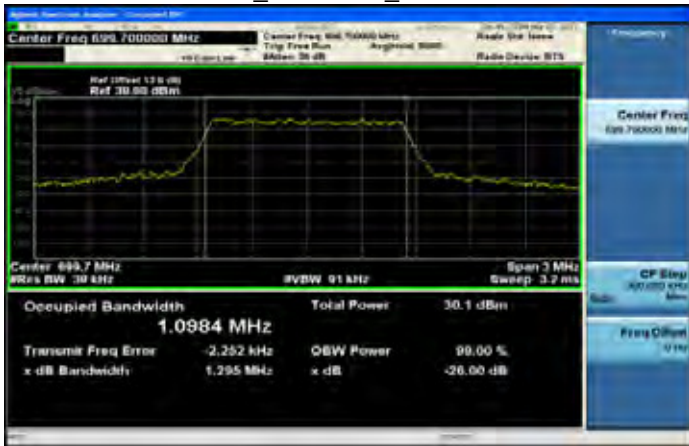

Band12 1.4MHz_16-QAM 6 0_LowCH23017-699.7

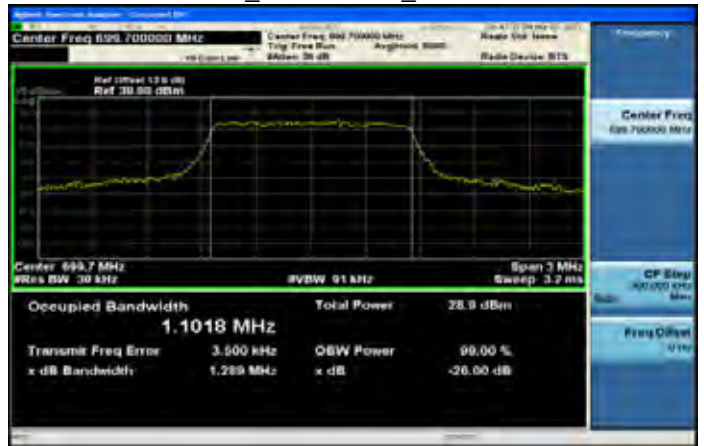

Band12 1.4MHz_QPSK 6 0_MidCH23095-707.5

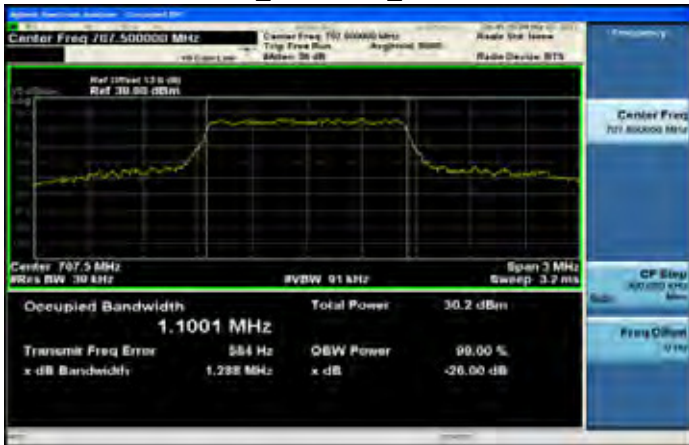

Band12 1.4MHz_16-QAM 6 0_MidCH23095-707.5

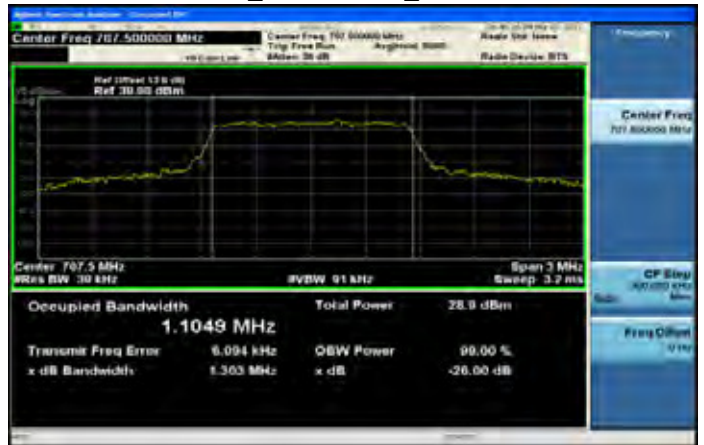

Band12 1.4MHz_QPSK 6 0_HighCH23173-715.3

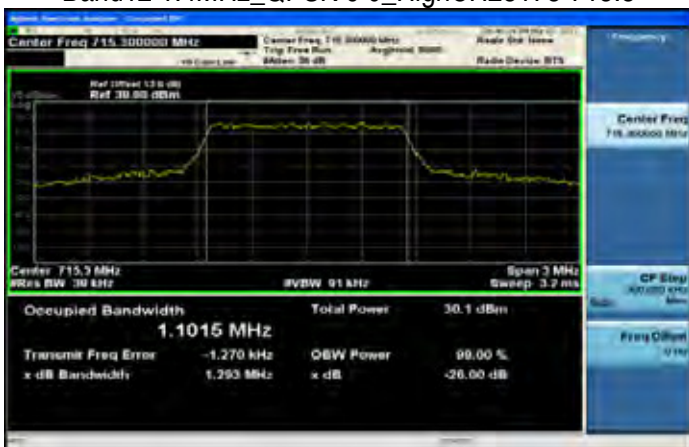

Band12 1.4MHz_16-QAM 6 0_HighCH23173-715.3

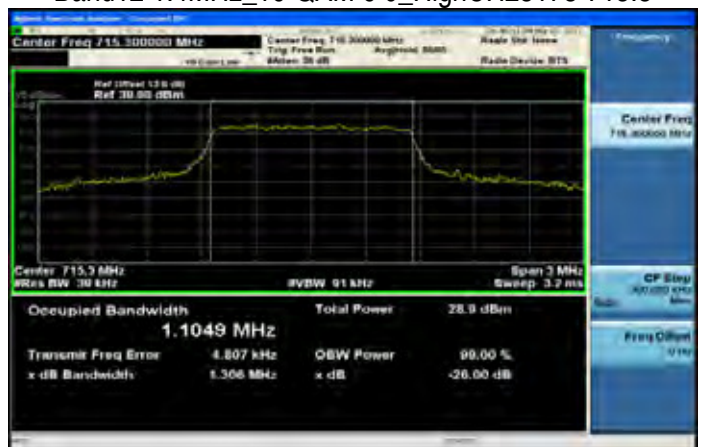

Unless otherwise stated the results shown in this test report refer only to the sample(s) tested and such sample(s) are retained for 90 days only.
除非另有說明，此報告結果僅對測試之樣品負責，同時此樣品僅保留90天。本報告未經本公司書面許可，不可部份複製。

This document is issued by the Company subject to its General Conditions of Service printed overleaf, available on request or accessible at www.sgs.com/terms_and_conditions.htm and, for electronic format documents, subject to Terms and Conditions for Electronic Documents at www.sgs.com/terms_e-document.htm. Attention is drawn to the limitation of liability, indemnification and jurisdiction issues defined therein. Any holder of this document is advised that information contained hereon reflects the Company's findings at the time of its intervention only and within the limits of Client's instructions, if any. The Company's sole responsibility is to its Client and this document does not exonerate parties to a transaction from exercising all their rights and obligations under the transaction documents. This document cannot be reproduced except in full, without prior written approval of the Company. Any unauthorized alteration, forgery or falsification of the content or appearance of this document is unlawful and offenders may be prosecuted to the fullest extent of the law.

Band12 3MHz_QPSK 15 0_LowCH23025-700.5

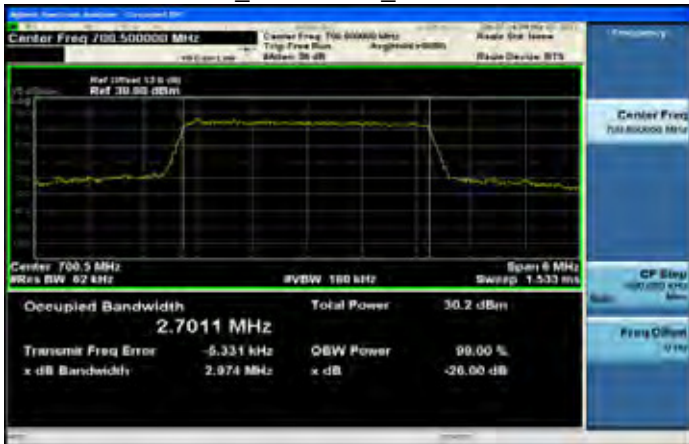

Band12 3MHz_16-QAM 15 0_LowCH23025-700.5

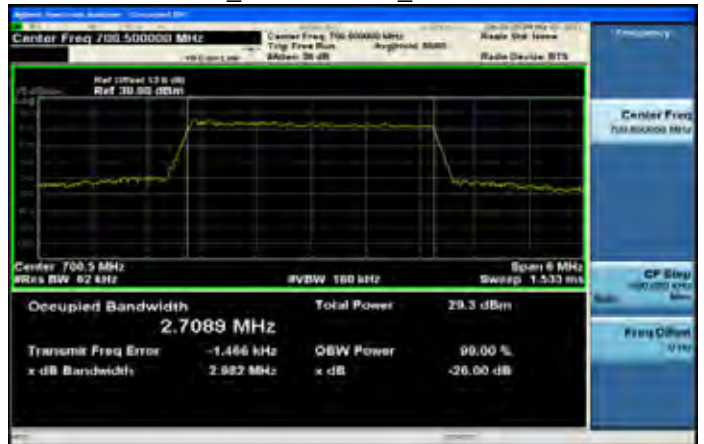

Band12 3MHz_QPSK 15 0_MidCH23095-707.5

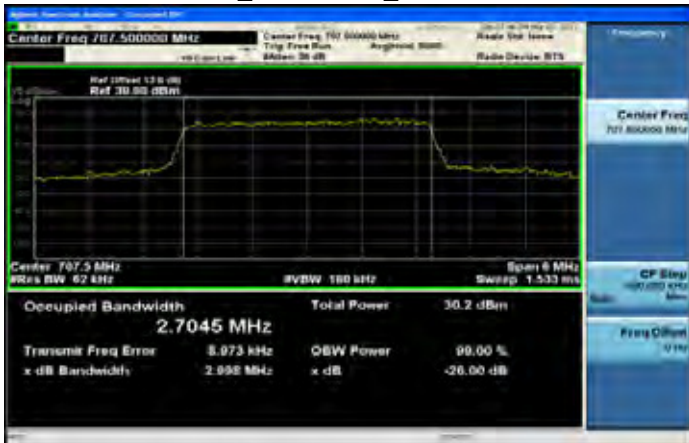

Band12 3MHz_16-QAM 15 0_MidCH23095-707.5



Band12 3MHz_QPSK 15 0_HighCH23165-714.5

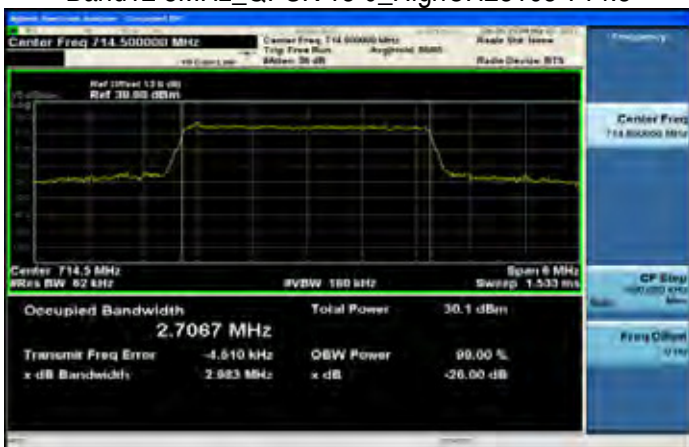

Band12 3MHz_16-QAM 15 0_HighCH23165-714.5

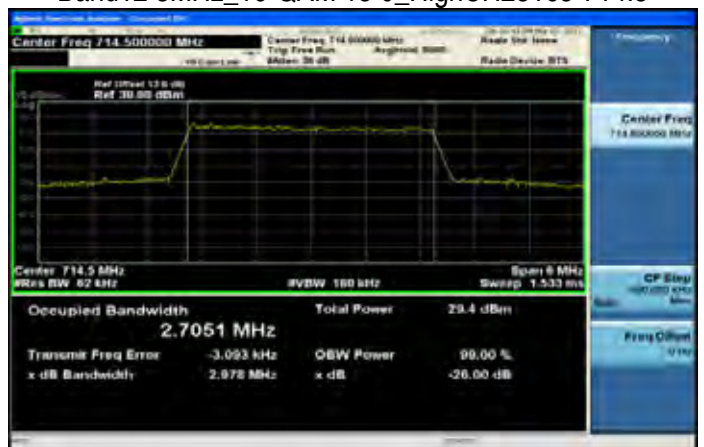

Unless otherwise stated the results shown in this test report refer only to the sample(s) tested and such sample(s) are retained for 90 days only.
除非另有說明，此報告結果僅對測試之樣品負責，同時此樣品僅保留90天。本報告未經本公司書面許可，不可部份複製。

This document is issued by the Company subject to its General Conditions of Service printed overleaf, available on request or accessible at www.sgs.com/terms_and_conditions.htm and, for electronic format documents, subject to Terms and Conditions for Electronic Documents at www.sgs.com/terms_e-document.htm. Attention is drawn to the limitation of liability, indemnification and jurisdiction issues defined therein. Any holder of this document is advised that information contained hereon reflects the Company's findings at the time of its intervention only and within the limits of Client's instructions, if any. The Company's sole responsibility is to its Client and this document does not exonerate parties to a transaction from exercising all their rights and obligations under the transaction documents. This document cannot be reproduced except in full, without prior written approval of the Company. Any unauthorized alteration, forgery or falsification of the content or appearance of this document is unlawful and offenders may be prosecuted to the fullest extent of the law.

Band12 5MHz_QPSK 25 0_LowCH23035-701.5

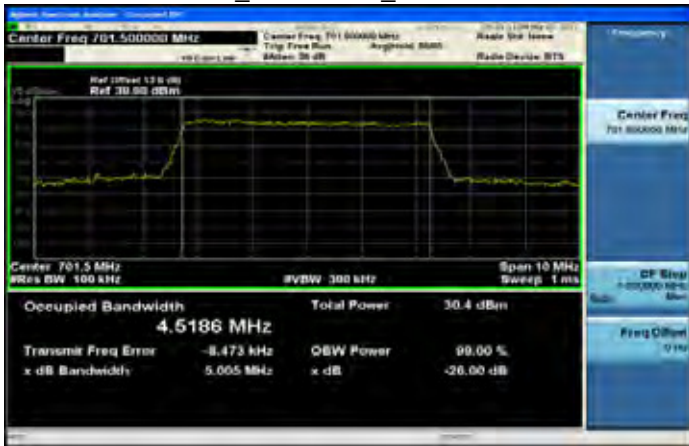

Band12 5MHz_16-QAM 25 0_LowCH23035-701.5

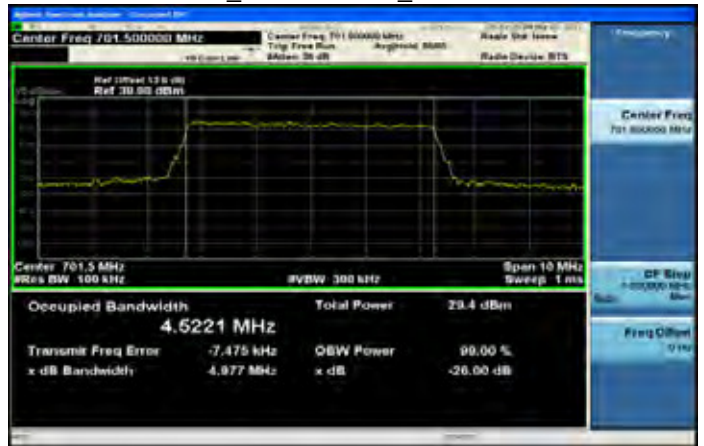

Band12 5MHz_QPSK 25 0_MidCH23095-707.5

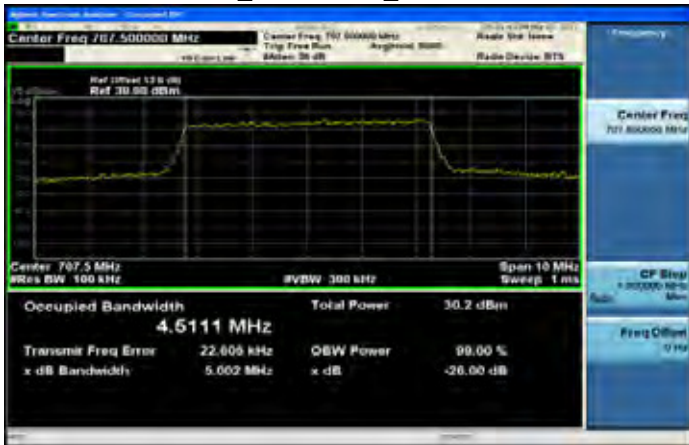

Band12 5MHz_16-QAM 25 0_MidCH23095-707.5

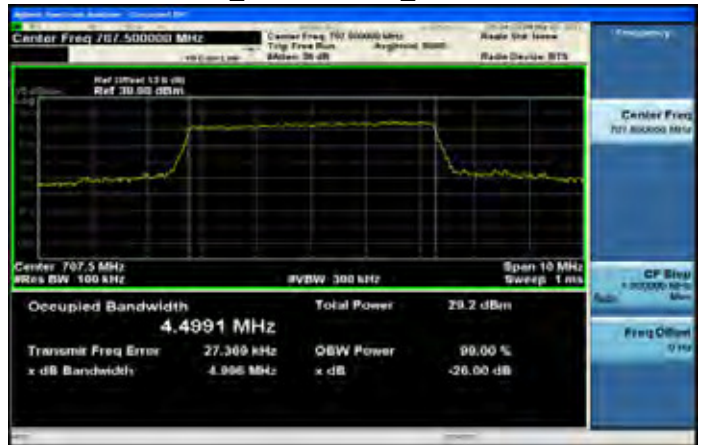

Band12 5MHz_QPSK 25 0_HighCH23155-713.5

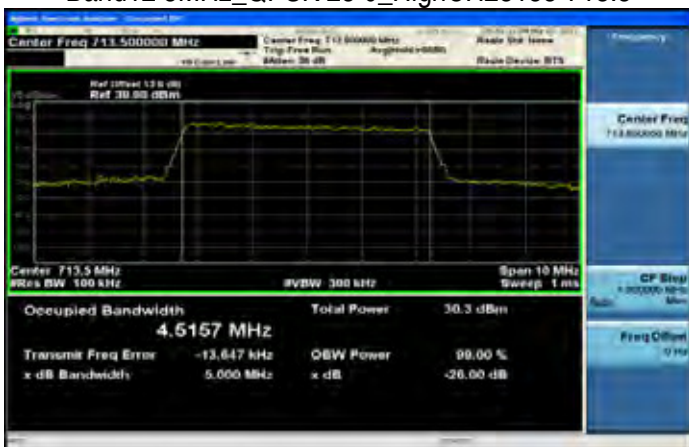

Band12 5MHz_16-QAM 25 0_HighCH23155-713.5

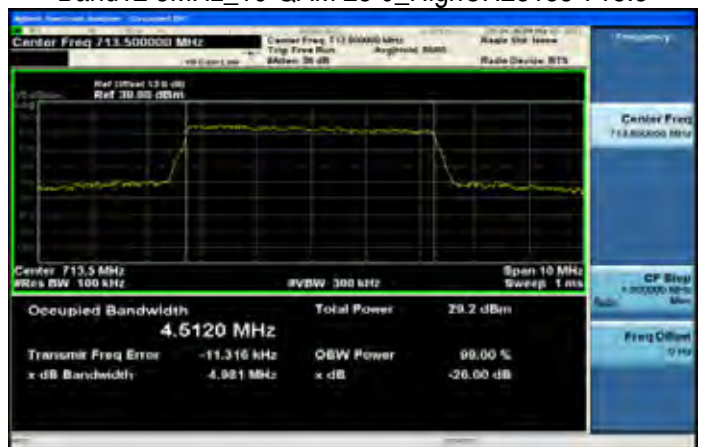

Unless otherwise stated the results shown in this test report refer only to the sample(s) tested and such sample(s) are retained for 90 days only.

除非另有說明，此報告結果僅對測試之樣品負責，同時此樣品僅保留90天。本報告未經本公司書面許可，不可部份複製。

This document is issued by the Company subject to its General Conditions of Service printed overleaf, available on request or accessible at www.sgs.com/terms_and_conditions.htm and, for electronic format documents, subject to Terms and Conditions for Electronic Documents at www.sgs.com/terms_e-document.htm. Attention is drawn to the limitation of liability, indemnification and jurisdiction issues defined therein. Any holder of this document is advised that information contained hereon reflects the Company's findings at the time of its intervention only and within the limits of Client's instructions, if any. The Company's sole responsibility is to its Client and this document does not exonerate parties to a transaction from exercising all their rights and obligations under the transaction documents. This document cannot be reproduced except in full, without prior written approval of the Company. Any unauthorized alteration, forgery or falsification of the content or appearance of this document is unlawful and offenders may be prosecuted to the fullest extent of the law.

SGS Taiwan Ltd.

No. 134, WuKungRoad, NewTaipeiIndustrialPark, WukuDistrict, NewTaipeiCity, Taiwan24803/新北市五股區新北產業園區五工路 134 號

台灣檢驗科技股份有限公司

t (886-2) 2299-3279

f (886-2) 2298-0488

www.tw.sgs.com

Member of SGS Group

Band12 10MHz_QPSK 50 0_LowCH23060-704

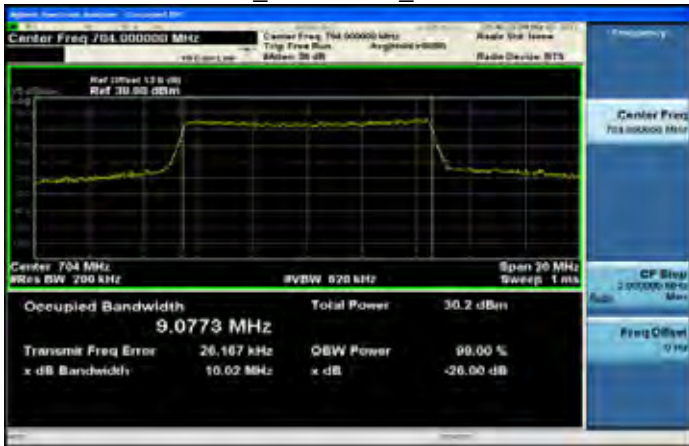

Band12 10MHz_16-QAM 50 0_LowCH23060-704

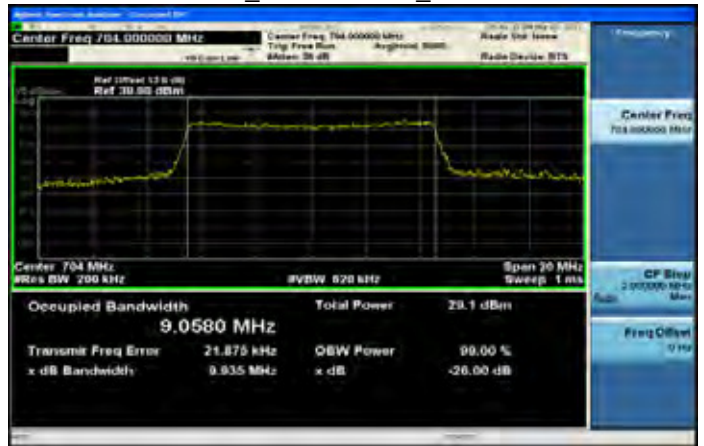

Band12 10MHz_QPSK 50 0_MidCH23095-707.5

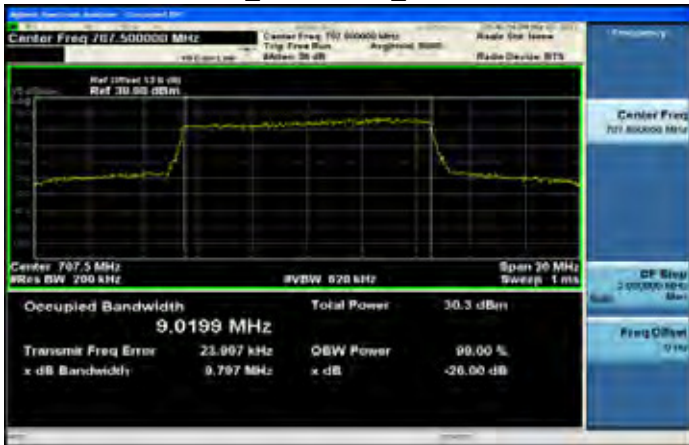

Band12 10MHz_16-QAM 50 0_MidCH23095-707.5

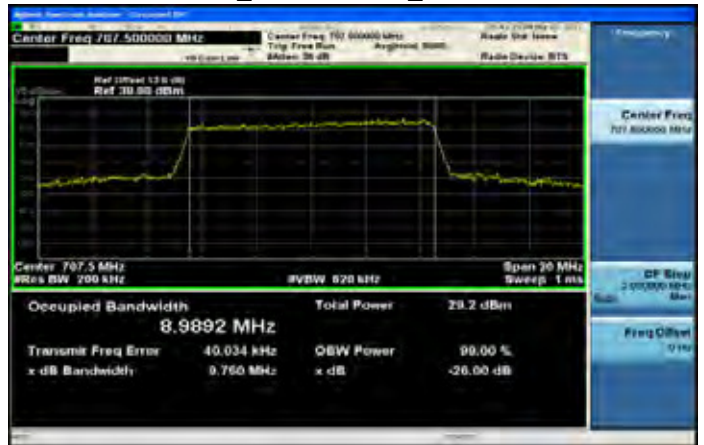

Band12 10MHz_QPSK 50 0_HighCH23130-711



Band12 10MHz_16-QAM 50 0_HighCH23130-711

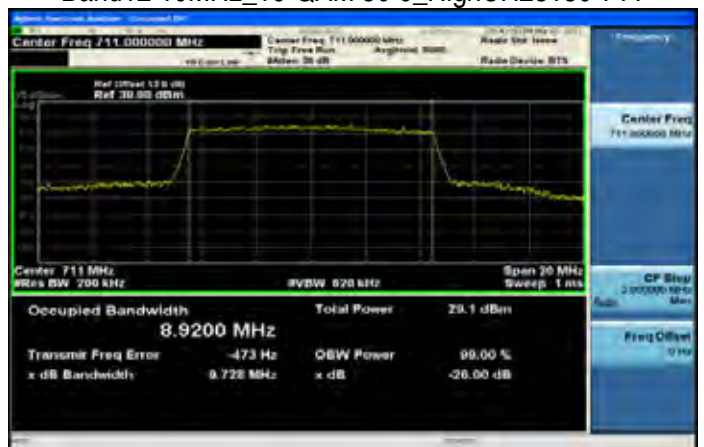

Unless otherwise stated the results shown in this test report refer only to the sample(s) tested and such sample(s) are retained for 90 days only.

除非另有說明，此報告結果僅對測試之樣品負責，同時此樣品僅保留90天。本報告未經本公司書面許可，不可部份複製。

This document is issued by the Company subject to its General Conditions of Service printed overleaf, available on request or accessible at www.sgs.com/terms_and_conditions.htm and, for electronic format documents, subject to Terms and Conditions for Electronic Documents at www.sgs.com/terms_e-document.htm. Attention is drawn to the limitation of liability, indemnification and jurisdiction issues defined therein. Any holder of this document is advised that information contained hereon reflects the Company's findings at the time of its intervention only and within the limits of Client's instructions, if any. The Company's sole responsibility is to its Client and this document does not exonerate parties to a transaction from exercising all their rights and obligations under the transaction documents. This document cannot be reproduced except in full, without prior written approval of the Company. Any unauthorized alteration, forgery or falsification of the content or appearance of this document is unlawful and offenders may be prosecuted to the fullest extent of the law.

SGS Taiwan Ltd.

No. 134, WuKungRoad, NewTaipeiIndustrialPark, WukuDistrict, NewTaipeiCity, Taiwan24803/新北市五股區新北產業園區五工路 134 號

台灣檢驗科技股份有限公司

t (886-2) 2299-3279

f (886-2) 2298-0488

www.tw.sgs.com

Member of SGS Group

Band13 5MHz_QPSK 25 0_LowCH23205-779.5

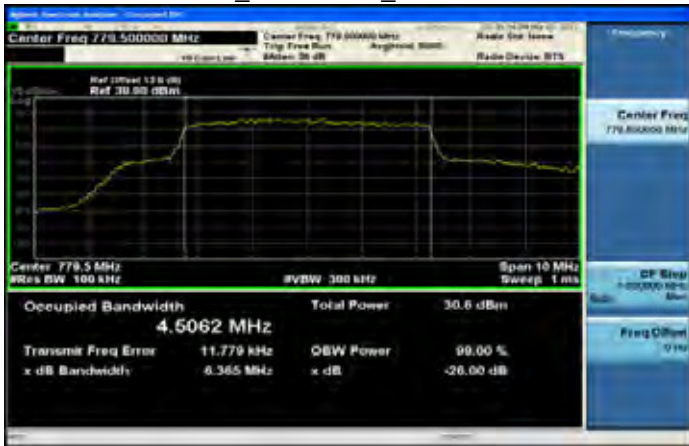

Band13 5MHz_16-QAM 25 0_LowCH23205-779.5

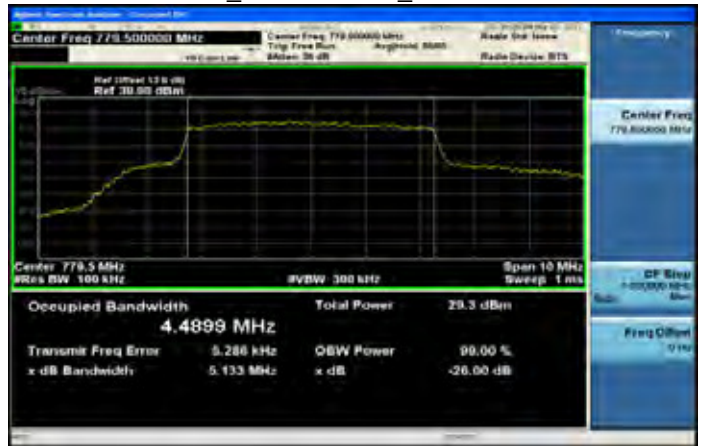

Band13 5MHz_QPSK 25 0_MidCH23230-782

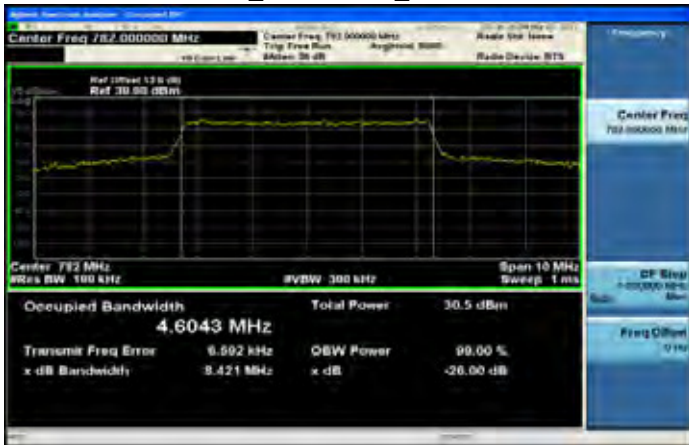

Band13 5MHz_16-QAM 25 0_MidCH23230-782

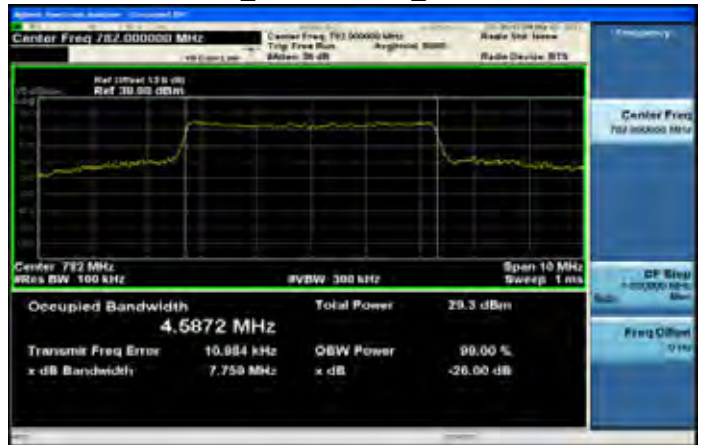

Band13 5MHz_QPSK 25 0_HighCH23255-784.5

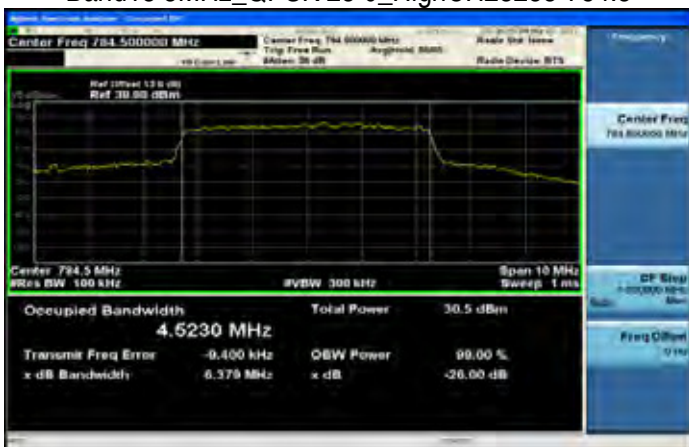

Band13 5MHz_16-QAM 25 0_HighCH23255-784.5

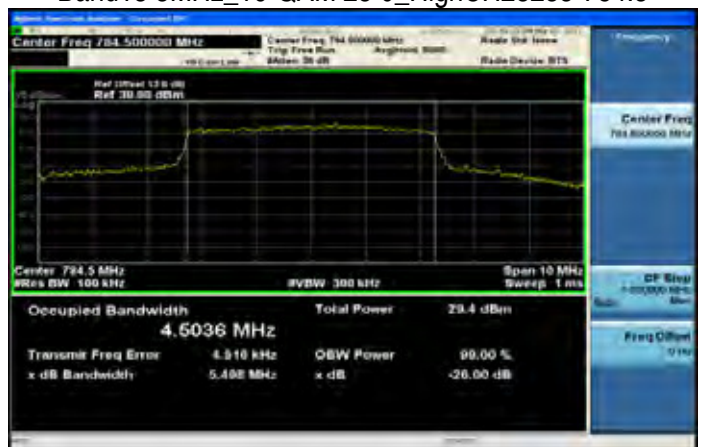

Unless otherwise stated the results shown in this test report refer only to the sample(s) tested and such sample(s) are retained for 90 days only.
除非另有說明，此報告結果僅對測試之樣品負責，同時此樣品僅保留90天。本報告未經本公司書面許可，不可部份複製。

This document is issued by the Company subject to its General Conditions of Service printed overleaf, available on request or accessible at www.sgs.com/terms_and_conditions.htm and, for electronic format documents, subject to Terms and Conditions for Electronic Documents at www.sgs.com/terms_e-document.htm. Attention is drawn to the limitation of liability, indemnification and jurisdiction issues defined therein. Any holder of this document is advised that information contained hereon reflects the Company's findings at the time of its intervention only and within the limits of Client's instructions, if any. The Company's sole responsibility is to its Client and this document does not exonerate parties to a transaction from exercising all their rights and obligations under the transaction documents. This document cannot be reproduced except in full, without prior written approval of the Company. Any unauthorized alteration, forgery or falsification of the content or appearance of this document is unlawful and offenders may be prosecuted to the fullest extent of the law.

Band13 10MHz_QPSK 50 0_MidCH23230-782



Band17 5MHz_QPSK 25 0_LowCH23755-706.5

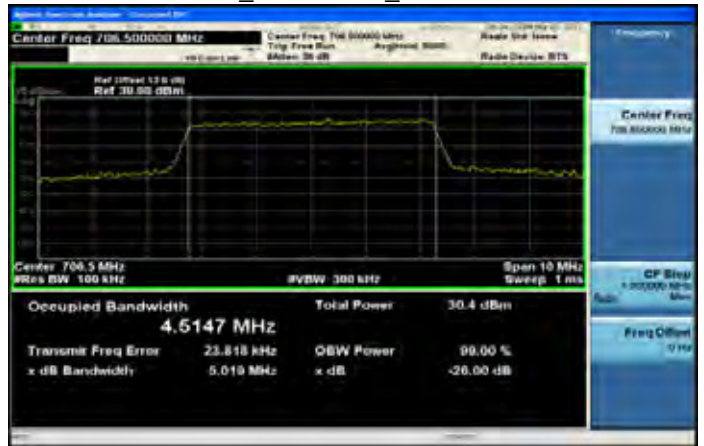

Band13 10MHz_16-QAM 50 0_MidCH23230-782

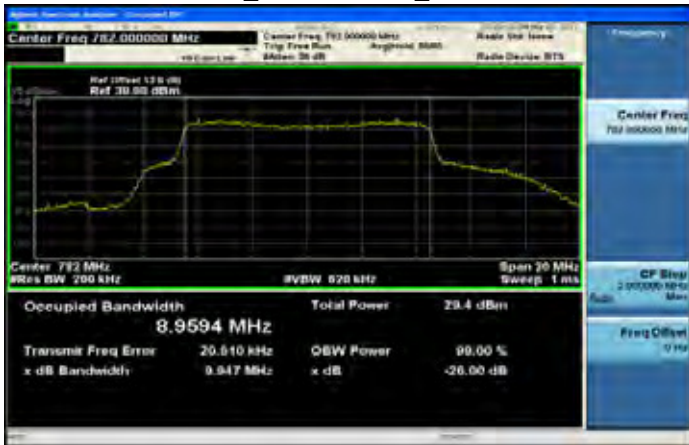

Band17 5MHz_QPSK 25 0_MidCH23790-710

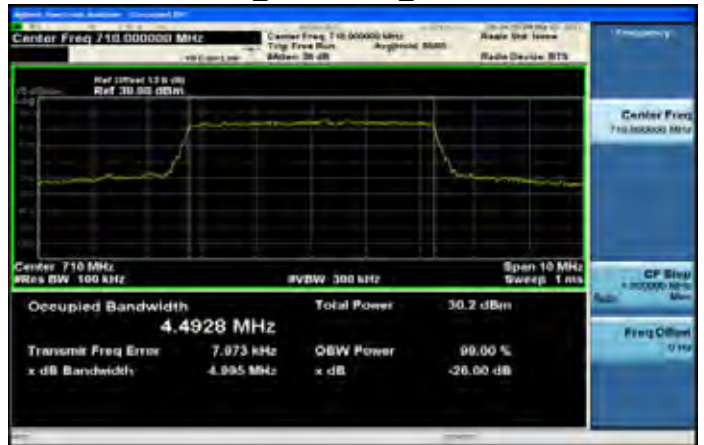

Band17 5MHz_QPSK 25 0_HighCH23825-713.5

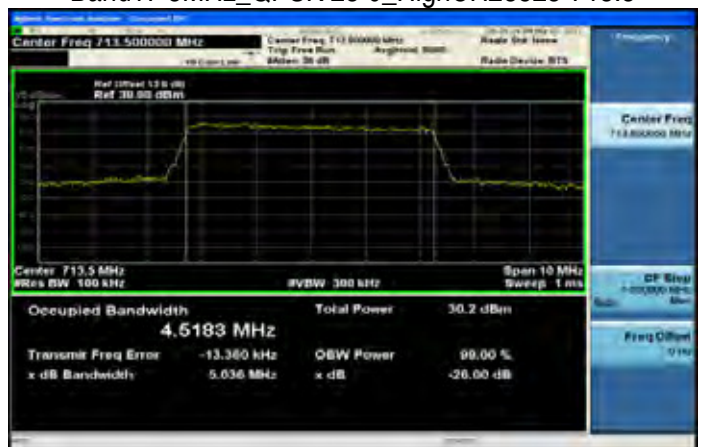

Unless otherwise stated the results shown in this test report refer only to the sample(s) tested and such sample(s) are retained for 90 days only.

除非另有說明，此報告結果僅對測試之樣品負責，同時此樣品僅保留90天。本報告未經本公司書面許可，不可部份複製。

This document is issued by the Company subject to its General Conditions of Service printed overleaf, available on request or accessible at www.sgs.com/terms_and_conditions.htm and, for electronic format documents, subject to Terms and Conditions for Electronic Documents at www.sgs.com/terms_e-document.htm. Attention is drawn to the limitation of liability, indemnification and jurisdiction issues defined therein. Any holder of this document is advised that information contained hereon reflects the Company's findings at the time of its intervention only and within the limits of Client's instructions, if any. The Company's sole responsibility is to its Client and this document does not exonerate parties to a transaction from exercising all their rights and obligations under the transaction documents. This document cannot be reproduced except in full, without prior written approval of the Company. Any unauthorized alteration, forgery or falsification of the content or appearance of this document is unlawful and offenders may be prosecuted to the fullest extent of the law.

SGS Taiwan Ltd.

No. 134, WuKungRoad, NewTaipeiIndustrialPark, WukuDistrict, NewTaipeiCity, Taiwan24803/新北市五股區新北產業園區五工路 134 號

台灣檢驗科技股份有限公司

t (886-2) 2299-3279

f (886-2) 2298-0488

www.tw.sgs.com

Member of SGS Group

Band17 5MHz_16-QAM 25 0_LowCH23755-706.5

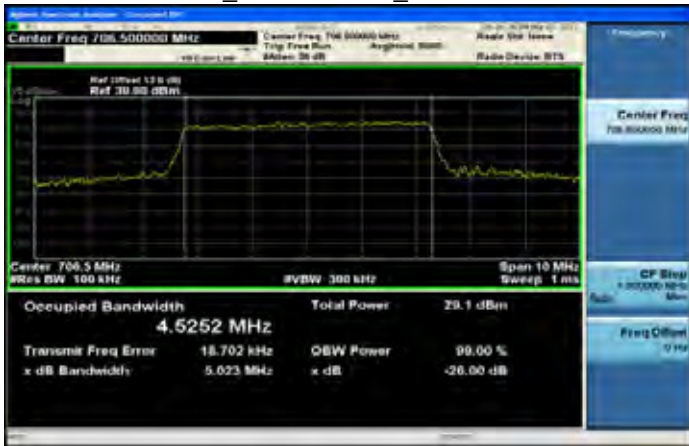

Band17 10MHz_QPSK 50 0_LowCH23780-709

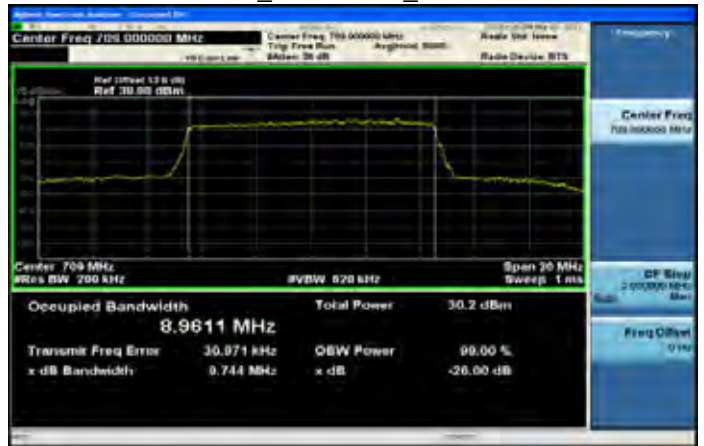

Band17 5MHz_16-QAM 25 0_MidCH23790-710

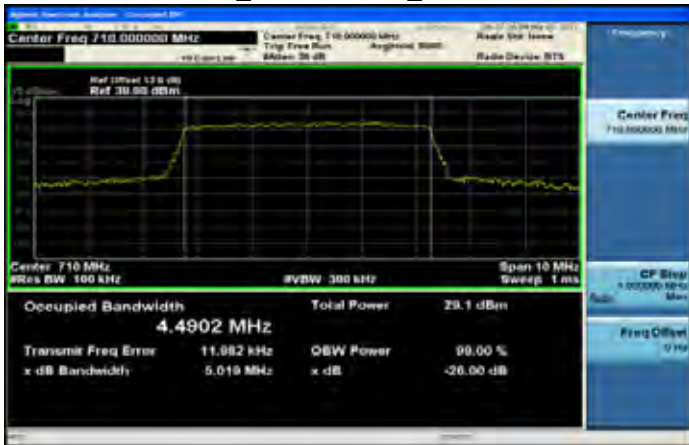

Band17 10MHz_QPSK 50 0_MidCH23790-710

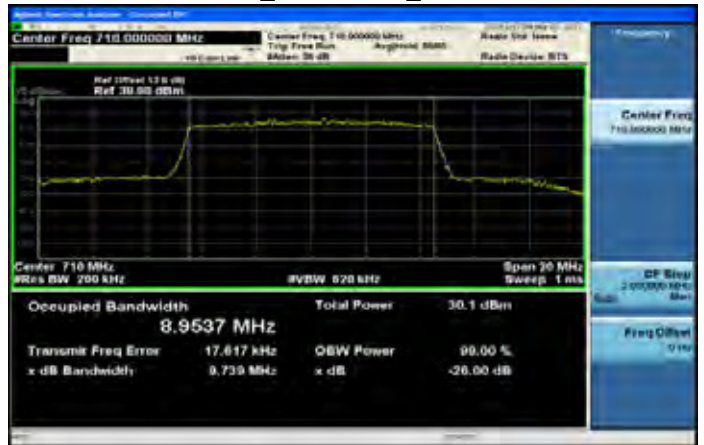

Band17 5MHz_16-QAM 25 0_HighCH23825-713.5



Band17 10MHz_QPSK 50 0_HighCH23800-711

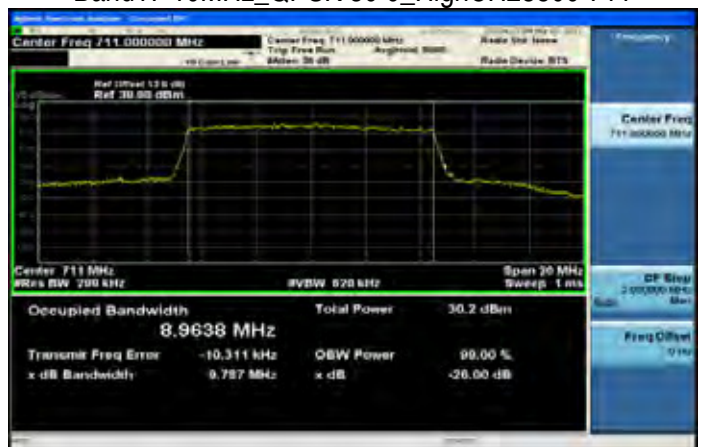

Unless otherwise stated the results shown in this test report refer only to the sample(s) tested and such sample(s) are retained for 90 days only.

除非另有說明，此報告結果僅對測試之樣品負責，同時此樣品僅保留90天。本報告未經本公司書面許可，不可部份複製。

This document is issued by the Company subject to its General Conditions of Service printed overleaf, available on request or accessible at www.sgs.com/terms_and_conditions.htm and, for electronic format documents, subject to Terms and Conditions for Electronic Documents at www.sgs.com/terms_e-document.htm. Attention is drawn to the limitation of liability, indemnification and jurisdiction issues defined therein. Any holder of this document is advised that information contained hereon reflects the Company's findings at the time of its intervention only and within the limits of Client's instructions, if any. The Company's sole responsibility is to its Client and this document does not exonerate parties to a transaction from exercising all their rights and obligations under the transaction documents. This document cannot be reproduced except in full, without prior written approval of the Company. Any unauthorized alteration, forgery or falsification of the content or appearance of this document is unlawful and offenders may be prosecuted to the fullest extent of the law.

SGS Taiwan Ltd.

No. 134, WuKungRoad, NewTaipeiIndustrialPark, WukuDistrict, NewTaipeiCity, Taiwan24803/新北市五股區新北產業園區五工路 134 號

台灣檢驗科技股份有限公司

t (886-2) 2299-3279

f (886-2) 2298-0488

www.tw.sgs.com

Member of SGS Group

Band17 10MHz_16-QAM 50 0_LowCH23780-709

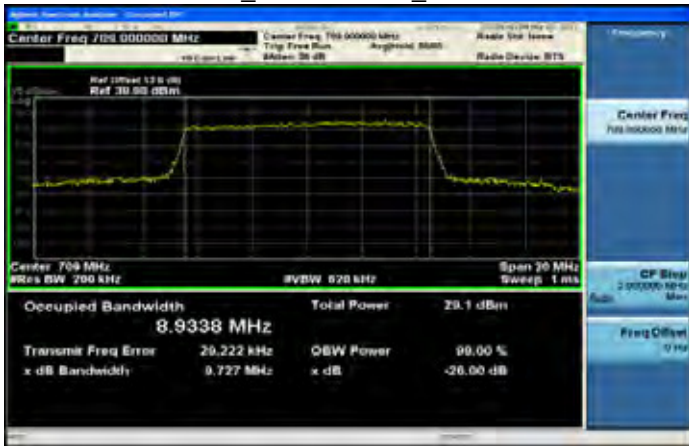

Band17 10MHz_16-QAM 50 0_HighCH23800-711

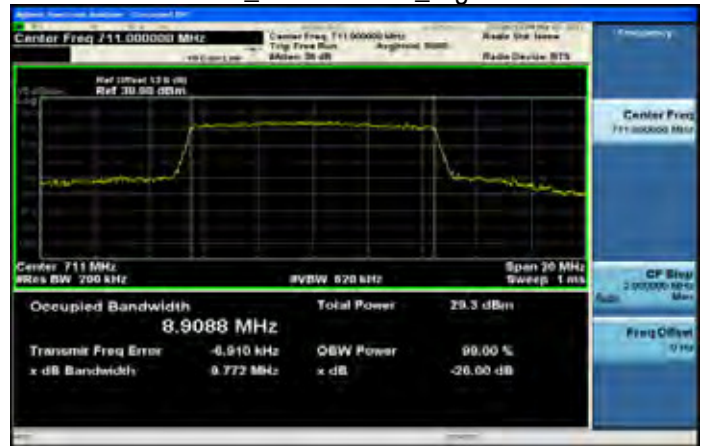

Band17 10MHz_16-QAM 50 0_MidCH23790-710

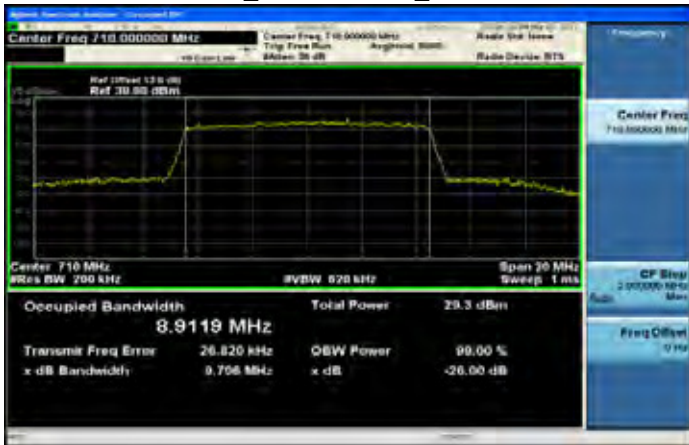

Unless otherwise stated the results shown in this test report refer only to the sample(s) tested and such sample(s) are retained for 90 days only.

除非另有說明，此報告結果僅對測試之樣品負責，同時此樣品僅保留90天。本報告未經本公司書面許可，不可部份複製。

This document is issued by the Company subject to its General Conditions of Service printed overleaf, available on request or accessible at www.sgs.com/terms_and_conditions.htm and, for electronic format documents, subject to Terms and Conditions for Electronic Documents at www.sgs.com/terms_e-document.htm. Attention is drawn to the limitation of liability, indemnification and jurisdiction issues defined therein. Any holder of this document is advised that information contained hereon reflects the Company's findings at the time of its intervention only and within the limits of Client's instructions, if any. The Company's sole responsibility is to its Client and this document does not exonerate parties to a transaction from exercising all their rights and obligations under the transaction documents. This document cannot be reproduced except in full, without prior written approval of the Company. Any unauthorized alteration, forgery or falsification of the content or appearance of this document is unlawful and offenders may be prosecuted to the fullest extent of the law.

SGS Taiwan Ltd.

No.134,WuKungRoad,NewTaipeiIndustrialPark,WukuDistrict,NewTaipeiCity,Taiwan24803/新北市五股區新北產業園區五工路 134 號

台灣檢驗科技股份有限公司

t (886-2) 2299-3279

f (886-2) 2298-0488

www.tw.sgs.com

Member of SGS Group

9. OUT OF BAND EMISSION AT ANTENNA TERMINALS

9.1. Standard Applicable

FCC §22.917(a), §24.238(a), §27.53(g)(h), the magnitude of each spurious and harmonic emission that can be detected when the equipment is operated under the conditions specified in the instruction manual and/ or alignment procedure, shall not be less than $43 + 10 \log$ (mean output power in watts) dBc below the mean power output outside a license's frequency block (-13dBm).

§27.53 (m) (4) shall not be less than $55 + 10 \log$ (mean output power in watt) dBc below the mean power output outside a license's frequency block (-25dBm).

FCC §27.53(c) (2) (4)

(c) For operations in the 746–758 MHz band and the 776–788 MHz band, the power of any emission outside the licensee's frequency band(s) of operation shall be attenuated below the transmitter power (P) within the licensed band(s) of operation, measured in watts, in accordance with the following:

(2) On any frequency outside the 776– 788 MHz band, the power of any emission shall be attenuated outside the band below the transmitter power (P) by at least $43 + 10 \log$ (P) dB (-13dBm)

(4) On all frequencies between 763-775 MHz and 793-805 MHz, by a factor not less than $65 + 10 \log$ (P) dB in a 6.25 kHz band segment, for mobile and portable stations;

FCC §27.53(c) (5) & FCC §27.53(g)

Compliance with this provision is based on the use of measurement instrumentation employing a resolution bandwidth of 100 kilohertz or greater. However, in the 100 kilohertz bands immediately outside and adjacent to a licensee's frequency block, a resolution bandwidth of at least 30 kHz may be employed.

FCC §27.53(h)

Compliance with this provision is based on the use of measurement instrumentation employing a resolution bandwidth of 1 megahertz or greater. However, in the 1 megahertz bands immediately outside and adjacent to the licensee's frequency block, a resolution bandwidth of at least one percent of the emission bandwidth of the fundamental emission of the transmitter may be employed. The emission bandwidth is defined as the width of the signal between two points, one below the carrier center frequency and one above the carrier center frequency, outside of which all emissions are attenuated at least 26 dB below the transmitter power.

Unless otherwise stated the results shown in this test report refer only to the sample(s) tested and such sample(s) are retained for 90 days only.

除非另有說明，此報告結果僅對測試之樣品負責，同時此樣品僅保留90天。本報告未經本公司書面許可，不可部份複製。

This document is issued by the Company subject to its General Conditions of Service printed overleaf, available on request or accessible at www.sgs.com/terms_and_conditions.htm and, for electronic format documents, subject to Terms and Conditions for Electronic Documents at www.sgs.com/terms_e-document.htm. Attention is drawn to the limitation of liability, indemnification and jurisdiction issues defined therein. Any holder of this document is advised that information contained hereon reflects the Company's findings at the time of its intervention only and within the limits of Client's instructions, if any. The Company's sole responsibility is to its Client and this document does not exonerate parties to a transaction from exercising all their rights and obligations under the transaction documents. This document cannot be reproduced except in full, without prior written approval of the Company. Any unauthorized alteration, forgery or falsification of the content or appearance of this document is unlawful and offenders may be prosecuted to the fullest extent of the law.

SGS Taiwan Ltd.

No.134,WuKungRoad,NewTaipeiIndustrialPark,WukuDistrict,NewTaipeiCity,Taiwan24803/新北市五股區新北產業園區五工路 134 號

台灣檢驗科技股份有限公司

t (886-2) 2299-3279

f (886-2) 2298-0488

www.tw.sgs.com

Member of SGS Group

FCC §27.53(m) (4) (6)

For mobile digital stations, the attenuation factor shall be not less than $40 + 10 \log (P)$ dB on all frequencies between the channel edge and 5 megahertz from the channel edge, $43 + 10 \log (P)$ dB on all frequencies between 5 megahertz and X megahertz from the channel edge, and $55 + 10 \log (P)$ dB on all frequencies more than X megahertz from the channel edge, where X is the greater of 6 megahertz or the actual emission bandwidth as defined in § 27.53(m)(6). In addition, the attenuation factor shall not be less that $43 + 10 \log (P)$ dB on all frequencies between 2490.5 MHz and 2496 MHz and $55 + 10 \log (P)$ dB at or below 2490.5 MHz.

Measurement procedure. Compliance with these rules is based on the use of measurement instrumentation employing a resolution bandwidth of 1 megahertz or greater. However, in the 1 MHz bands immediately outside and adjacent to the frequency block a resolution bandwidth of at least one percent of the emission bandwidth of the fundamental emission of the transmitter may be employed; for mobile digital stations, in the 1 megahertz bands immediately outside and adjacent to the frequency block a resolution bandwidth of at least two percent may be employed, except when the 1 megahertz band is 2495-2496 MHz, in which case a resolution bandwidth of at least one percent may be employed. A narrower resolution bandwidth is permitted in all cases to improve measurement accuracy provided the measured power is integrated over the full required measurement bandwidth (i.e. 1 megahertz or 1 percent of emission bandwidth, as specified; or 1 megahertz or 2 percent for mobile digital stations, except in the band 2495-2496 MHz). The emission bandwidth is defined as the width of the signal between two points, one below the carrier center frequency and one above the carrier center frequency, outside of which all emissions are attenuated at least 26 dB below the transmitter power. With respect to television operations, measurements must be made of the separate visual and aural operating powers at sufficiently frequent intervals to ensure compliance with the rules.

9.2. Test SET-UP

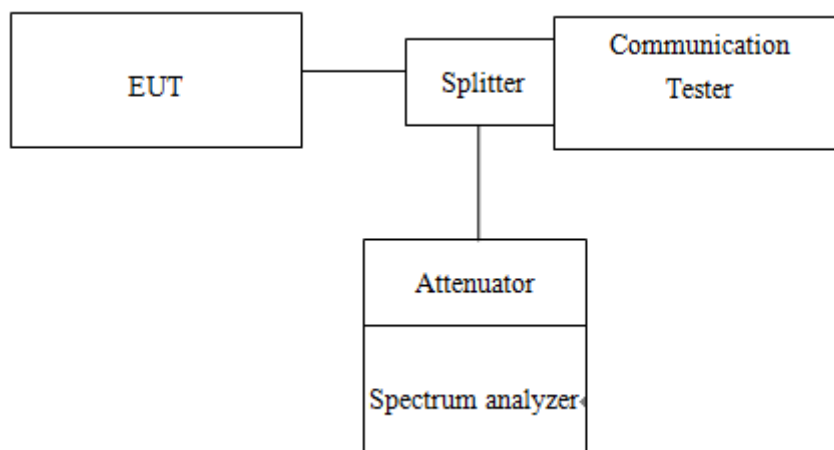

Unless otherwise stated the results shown in this test report refer only to the sample(s) tested and such sample(s) are retained for 90 days only.

除非另有說明，此報告結果僅對測試之樣品負責，同時此樣品僅保留90天。本報告未經本公司書面許可，不可部份複製。

This document is issued by the Company subject to its General Conditions of Service printed overleaf, available on request or accessible at www.sgs.com/terms_and_conditions.htm and, for electronic format documents, subject to Terms and Conditions for Electronic Documents at www.sgs.com/terms_e-document.htm. Attention is drawn to the limitation of liability, indemnification and jurisdiction issues defined therein. Any holder of this document is advised that information contained hereon reflects the Company's findings at the time of its intervention only and within the limits of Client's instructions, if any. The Company's sole responsibility is to its Client and this document does not exonerate parties to a transaction from exercising all their rights and obligations under the transaction documents. This document cannot be reproduced except in full, without prior written approval of the Company. Any unauthorized alteration, forgery or falsification of the content or appearance of this document is unlawful and offenders may be prosecuted to the fullest extent of the law.

9.3. Measurement Procedure

Conducted Emission

The RF output of the transceiver was connected to a spectrum analyzer through appropriate attenuation. The resolution bandwidth of the spectrum analyzer was set at 1MHz, sufficient scans were taken to show the out of band Emissions if any up to 10th harmonic.

1. To connect Antenna Port of EUT to Spectrum.
2. Set RBW = 1MHz & VBW = 1MHz on Spectrum.
3. Allow trace to fully stabilize
4. Repeat above procedures until all default test channel measured were complete.

Band Edge

1. To connect Antenna Port of EUT to Spectrum.
2. The band edge of low and high channels for the highest RF powers was measured. Setting $RBW \geq 1\% EBW$.
3. Allow trace to fully stabilize
4. Repeat above procedures until all default test channel measured were complete.

Unless otherwise stated the results shown in this test report refer only to the sample(s) tested and such sample(s) are retained for 90 days only.

除非另有說明，此報告結果僅對測試之樣品負責，同時此樣品僅保留90天。本報告未經本公司書面許可，不可部份複製。

This document is issued by the Company subject to its General Conditions of Service printed overleaf, available on request or accessible at www.sgs.com/terms_and_conditions.htm and, for electronic format documents, subject to Terms and Conditions for Electronic Documents at www.sgs.com/terms_e-document.htm. Attention is drawn to the limitation of liability, indemnification and jurisdiction issues defined therein. Any holder of this document is advised that information contained hereon reflects the Company's findings at the time of its intervention only and within the limits of Client's instructions, if any. The Company's sole responsibility is to its Client and this document does not exonerate parties to a transaction from exercising all their rights and obligations under the transaction documents. This document cannot be reproduced except in full, without prior written approval of the Company. Any unauthorized alteration, forgery or falsification of the content or appearance of this document is unlawful and offenders may be prosecuted to the fullest extent of the law.

SGS Taiwan Ltd.

No.134,WuKungRoad,NewTaipeiIndustrialPark,WukuDistrict,NewTaipeiCity,Taiwan24803/新北市五股區新北產業園區五工路 134 號

台灣檢驗科技股份有限公司

t (886-2) 2299-3279

f (886-2) 2298-0488

www.tw.sgs.com

Member of SGS Group

9.4. Measurement Equipment Used

Conducted Emission (measured at antenna port) Test Site					
EQUIPMENT TYPE	MFR	MODEL NUMBER	SERIAL NUMBER	LAST CAL.	CAL DUE.
Power Meter	Anritsu	ML2495A	1005007	12/15/2016	12/14/2017
Power Sensor	Anritsu	MA2411B	917032	12/15/2016	12/14/2017
EXA Spectrum Analyzer	Agilent	N9030A	MY53120760	03/21/2017	03/20/2018
DC Block	Mini-Circuits	BLK-18-S+	1	01/05/2017	01/04/2018
Coaxial Cable	HUBER+SUHNER	SUCOFLEX 102	23670/2	01/05/2017	01/04/2018
Attenuator	Mini-Circuit	BW-S10W2+	2	01/05/2017	01/04/2018
Splitter	Agilent	11636B	N/A	01/05/2017	01/04/2018
DC Power Supply	Agilent	E3640A	MY52410006	11/21/2016	11/20/2017
Temperature Chamber	TERCHY	MHG-120LF	911009	05/17/2016	05/16/2017
Radio Communication Analyser	Anritsu	MT8820C	6201465317	01/03/2017	01/02/2018
Radio Communication Analyzer	R&S	CMU200	102189	02/11/2017	02/10/2018

9.5. Measurement Result:

Refer to next pages.

NOTE: The occurrence of the spike on the conducted emission is the signal of the fundamental emission.

Unless otherwise stated the results shown in this test report refer only to the sample(s) tested and such sample(s) are retained for 90 days only.

除非另有說明，此報告結果僅對測試之樣品負責，同時此樣品僅保留90天。本報告未經本公司書面許可，不可部份複製。

This document is issued by the Company subject to its General Conditions of Service printed overleaf, available on request or accessible at www.sgs.com/terms_and_conditions.htm and, for electronic format documents, subject to Terms and Conditions for Electronic Documents at www.sgs.com/terms_e-document.htm. Attention is drawn to the limitation of liability, indemnification and jurisdiction issues defined therein. Any holder of this document is advised that information contained hereon reflects the Company's findings at the time of its intervention only and within the limits of Client's instructions, if any. The Company's sole responsibility is to its Client and this document does not exonerate parties to a transaction from exercising all their rights and obligations under the transaction documents. This document cannot be reproduced except in full, without prior written approval of the Company. Any unauthorized alteration, forgery or falsification of the content or appearance of this document is unlawful and offenders may be prosecuted to the fullest extent of the law.

SGS Taiwan Ltd.

No. 134, WuKungRoad, NewTaipeiIndustrialPark, WukuDistrict, NewTaipeiCity, Taiwan24803/新北市五股區新北產業園區五工路 134 號

台灣檢驗科技股份有限公司

t (886-2) 2299-3279

f (886-2) 2298-0488

www.tw.sgs.com

Member of SGS Group

Band Edge_GPRS_850MHz_LowCH128-824.2

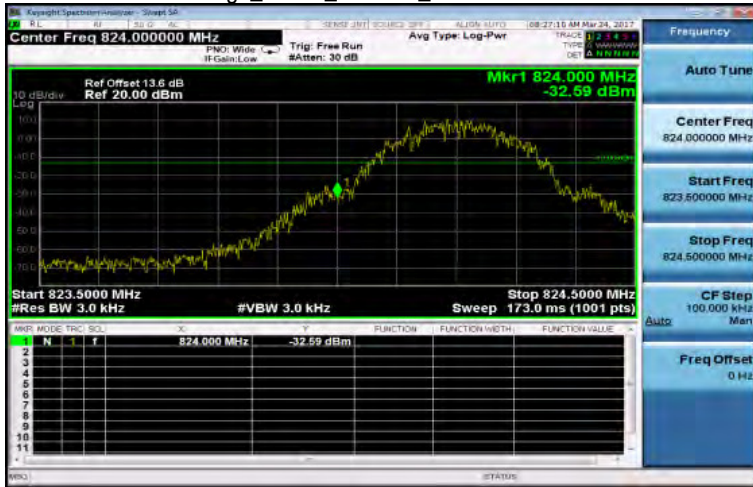

Band Edge_EDGE_850MHz_HighCH251-848.8

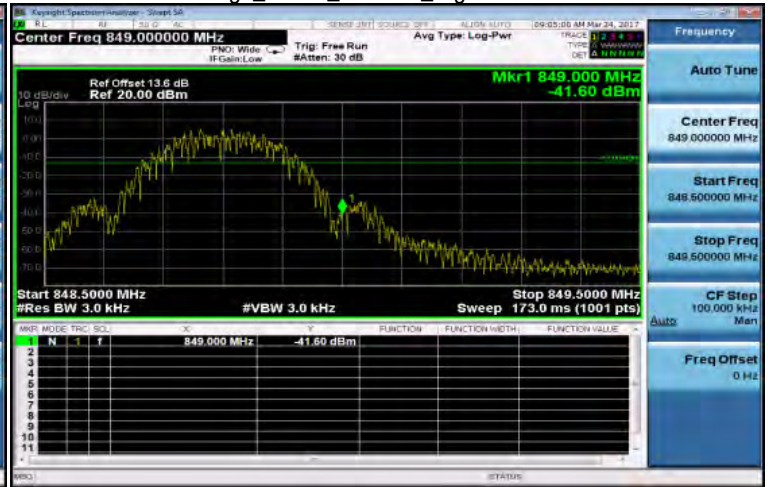

Band Edge_GPRS_850MHz_HighCH251-848.8

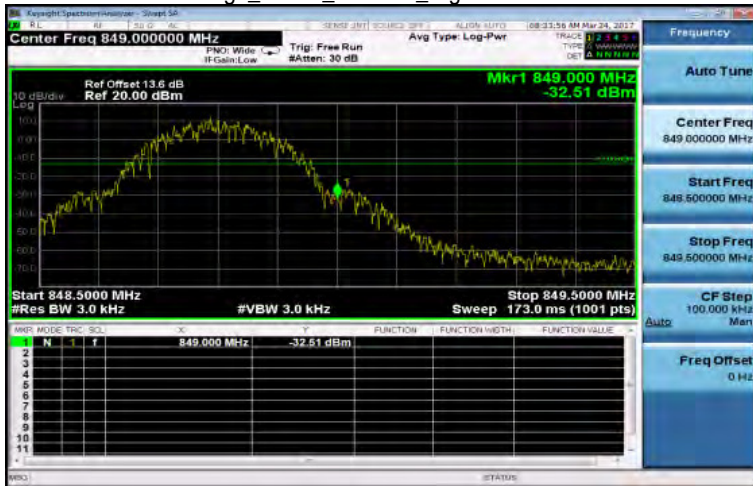

Band Edge_GPRS_1900MHz_LowCH512-1850.2

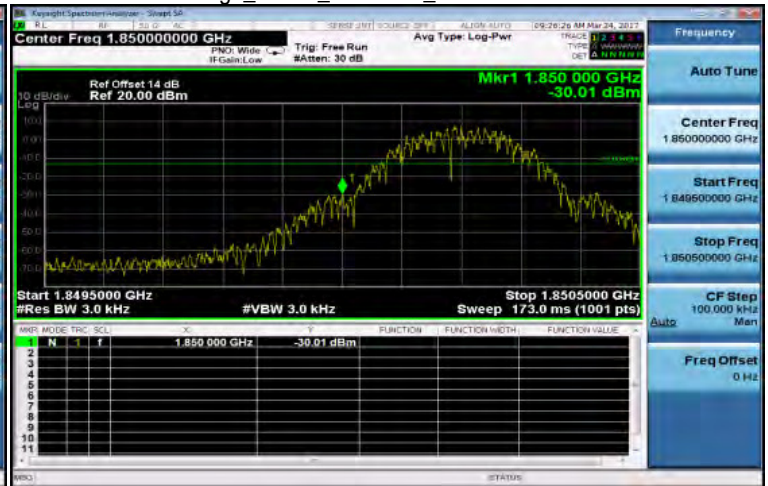

Band Edge_EDGE_850MHz_LowCH128-824.2

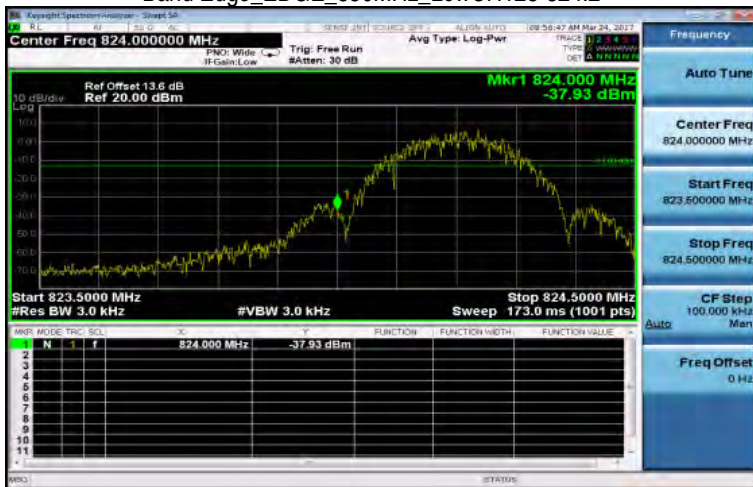

Band Edge_GPRS_1900MHz_HighCH810-1909.8

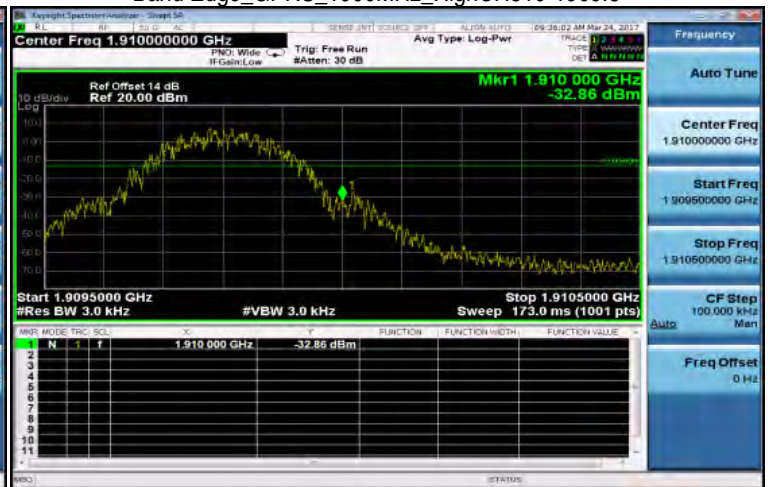

Unless otherwise stated the results shown in this test report refer only to the sample(s) tested and such sample(s) are retained for 90 days only. 除非另有說明，此報告結果僅對測試之樣品負責，同時此樣品僅保留90天。本報告未經本公司書面許可，不可部份複製。

This document is issued by the Company subject to its General Conditions of Service printed overleaf, available on request or accessible at www.sgs.com/terms_and_conditions.htm and, for electronic format documents, subject to Terms and Conditions for Electronic Documents at www.sgs.com/terms_e-document.htm. Attention is drawn to the limitation of liability, indemnification and jurisdiction issues defined therein. Any holder of this document is advised that information contained hereon reflects the Company's findings at the time of its intervention only and within the limits of Client's instructions, if any. The Company's sole responsibility is to its Client and this document does not exonerate parties to a transaction from exercising all their rights and obligations under the transaction documents. This document cannot be reproduced except in full, without prior written approval of the Company. Any unauthorized alteration, forgery or falsification of the content or appearance of this document is unlawful and offenders may be prosecuted to the fullest extent of the law.

Band Edge_EDGE_1900MHz_LowCH512-1850.2

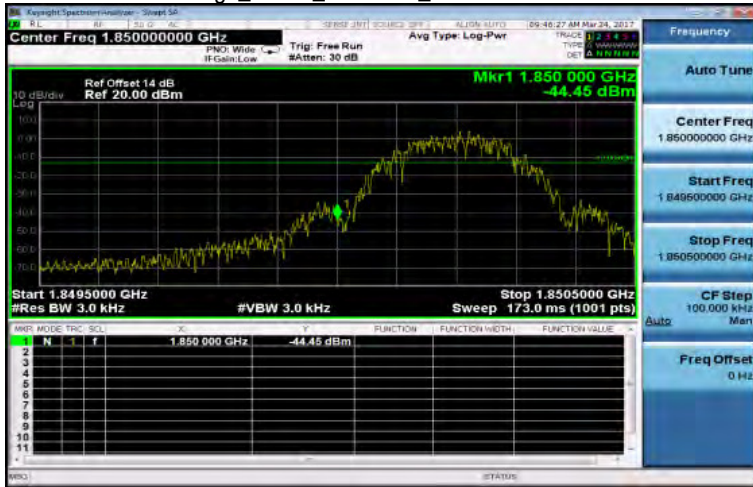

Band Edge_EDGE_1900MHz_HighCH810-1909.8

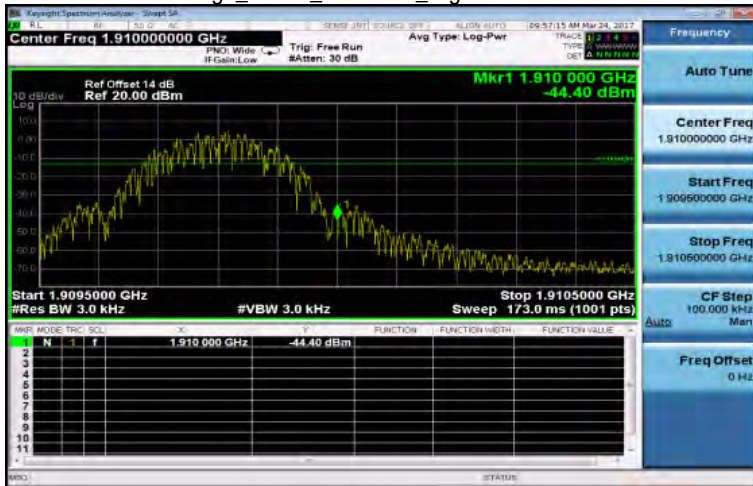

Unless otherwise stated the results shown in this test report refer only to the sample(s) tested and such sample(s) are retained for 90 days only.
除非另有說明，此報告結果僅對測試之樣品負責，同時此樣品僅保留90天。本報告未經本公司書面許可，不可部份複製。

This document is issued by the Company subject to its General Conditions of Service printed overleaf, available on request or accessible at www.sgs.com/terms_and_conditions.htm and, for electronic format documents, subject to Terms and Conditions for Electronic Documents at www.sgs.com/terms_e-document.htm. Attention is drawn to the limitation of liability, indemnification and jurisdiction issues defined therein. Any holder of this document is advised that information contained hereon reflects the Company's findings at the time of its intervention only and within the limits of Client's instructions, if any. The Company's sole responsibility is to its Client and this document does not exonerate parties to a transaction from exercising all their rights and obligations under the transaction documents. This document cannot be reproduced except in full, without prior written approval of the Company. Any unauthorized alteration, forgery or falsification of the content or appearance of this document is unlawful and offenders may be prosecuted to the fullest extent of the law.

Band Edge_CDMA2000_BC0_LowCH1013-824.7

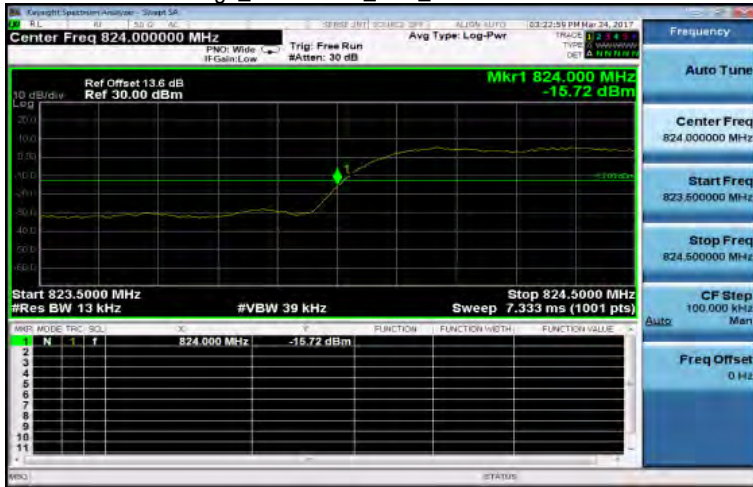

Band Edge_EVDO_BC0_HighCH777-848.31

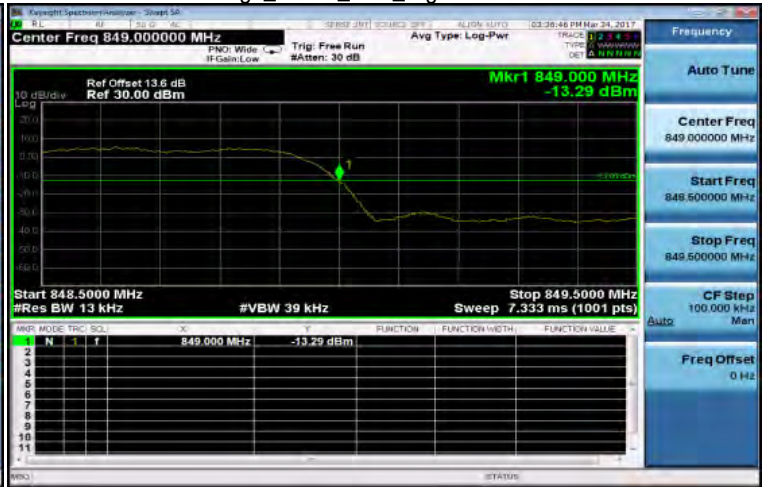

Band Edge_CDMA2000_BC0_HighCH777-848.31



Band Edge_CDMA2000_BC1_LowCH25-1851.3



Band Edge_EVDO_BC0_LowCH1013-824.7



Band Edge_CDMA2000_BC1_HighCH1175-1908.8



Unless otherwise stated the results shown in this test report refer only to the sample(s) tested and such sample(s) are retained for 90 days only.
除非另有說明，此報告結果僅對測試之樣品負責，同時此樣品僅保留90天。本報告未經本公司書面許可，不可部份複製。

This document is issued by the Company subject to its General Conditions of Service printed overleaf, available on request or accessible at www.sgs.com/terms_and_conditions.htm and, for electronic format documents, subject to Terms and Conditions for Electronic Documents at www.sgs.com/terms_e-document.htm. Attention is drawn to the limitation of liability, indemnification and jurisdiction issues defined therein. Any holder of this document is advised that information contained hereon reflects the Company's findings at the time of its intervention only and within the limits of Client's instructions, if any. The Company's sole responsibility is to its Client and this document does not exonerate parties to a transaction from exercising all their rights and obligations under the transaction documents. This document cannot be reproduced except in full, without prior written approval of the Company. Any unauthorized alteration, forgery or falsification of the content or appearance of this document is unlawful and offenders may be prosecuted to the fullest extent of the law.

Band Edge_EVDO_BC1_LowCH25-1851.3

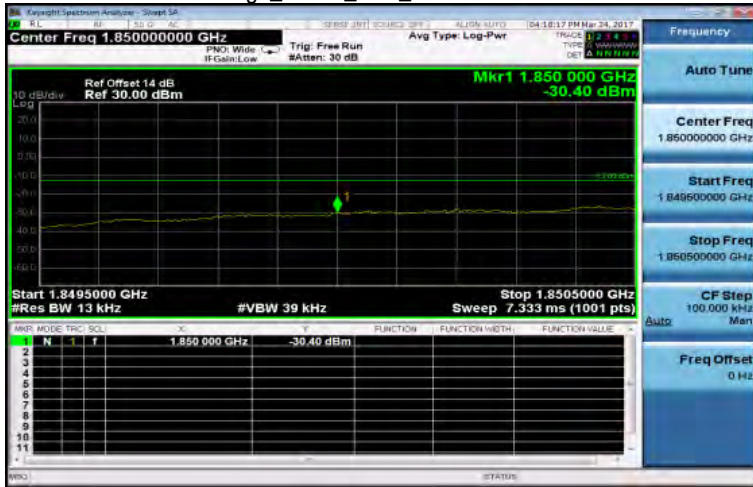

Band Edge_EVDO_BC1_HighCH1175-1908.8



Unless otherwise stated the results shown in this test report refer only to the sample(s) tested and such sample(s) are retained for 90 days only.
除非另有說明，此報告結果僅對測試之樣品負責，同時此樣品僅保留90天。本報告未經本公司書面許可，不可部份複製。

This document is issued by the Company subject to its General Conditions of Service printed overleaf, available on request or accessible at www.sgs.com/terms_and_conditions.htm and, for electronic format documents, subject to Terms and Conditions for Electronic Documents at www.sgs.com/terms_e-document.htm. Attention is drawn to the limitation of liability, indemnification and jurisdiction issues defined therein. Any holder of this document is advised that information contained hereon reflects the Company's findings at the time of its intervention only and within the limits of Client's instructions, if any. The Company's sole responsibility is to its Client and this document does not exonerate parties to a transaction from exercising all their rights and obligations under the transaction documents. This document cannot be reproduced except in full, without prior written approval of the Company. Any unauthorized alteration, forgery or falsification of the content or appearance of this document is unlawful and offenders may be prosecuted to the fullest extent of the law.

Band Edge_WCDMA_B2_LowCH9262-1852.4



Band Edge_HSDPA_B2_HighCH9538-1907.6



Band Edge_WCDMA_B2_HighCH9538-1907.6



Band Edge_HSPA_B2_LowCH9262-1852.4



Band Edge_HSDPA_B2_LowCH9262-1852.4



Band Edge_HSPA_B2_HighCH9538-1907.6



Unless otherwise stated the results shown in this test report refer only to the sample(s) tested and such sample(s) are retained for 90 days only. 除非另有說明，此報告結果僅對測試之樣品負責，同時此樣品僅保留90天。本報告未經本公司書面許可，不可部份複製。

This document is issued by the Company subject to its General Conditions of Service printed overleaf, available on request or accessible at www.sgs.com/terms_and_conditions.htm and, for electronic format documents, subject to Terms and Conditions for Electronic Documents at www.sgs.com/terms_e-document.htm. Attention is drawn to the limitation of liability, indemnification and jurisdiction issues defined therein. Any holder of this document is advised that information contained hereon reflects the Company's findings at the time of its intervention only and within the limits of Client's instructions, if any. The Company's sole responsibility is to its Client and this document does not exonerate parties to a transaction from exercising all their rights and obligations under the transaction documents. This document cannot be reproduced except in full, without prior written approval of the Company. Any unauthorized alteration, forgery or falsification of the content or appearance of this document is unlawful and offenders may be prosecuted to the fullest extent of the law.

Band Edge_WCDMA_B4_LowCH1312-1712.4



Band Edge_HSDPA_B4_HighCH1513-1752.6



Band Edge_WCDMA_B4_HighCH1513-1752.6



Band Edge_HSPA_B4_LowCH1312-1712.4



Band Edge_HSDPA_B4_LowCH1312-1712.4



Band Edge_HSPA_B4_HighCH1513-1752.6



Unless otherwise stated the results shown in this test report refer only to the sample(s) tested and such sample(s) are retained for 90 days only.
除非另有說明，此報告結果僅對測試之樣品負責，同時此樣品僅保留90天。本報告未經本公司書面許可，不可部份複製。

This document is issued by the Company subject to its General Conditions of Service printed overleaf, available on request or accessible at www.sgs.com/terms_and_conditions.htm and, for electronic format documents, subject to Terms and Conditions for Electronic Documents at www.sgs.com/terms_e-document.htm. Attention is drawn to the limitation of liability, indemnification and jurisdiction issues defined therein. Any holder of this document is advised that information contained hereon reflects the Company's findings at the time of its intervention only and within the limits of Client's instructions, if any. The Company's sole responsibility is to its Client and this document does not exonerate parties to a transaction from exercising all their rights and obligations under the transaction documents. This document cannot be reproduced except in full, without prior written approval of the Company. Any unauthorized alteration, forgery or falsification of the content or appearance of this document is unlawful and offenders may be prosecuted to the fullest extent of the law.

Band Edge_WCDMA_B5_LowCH4132-826.4



Band Edge_HSDPA_B5_HighCH4233-846.6



Band Edge_WCDMA_B5_HighCH4233-846.6



Band Edge_HSUPA_B5_LowCH4132-826.4

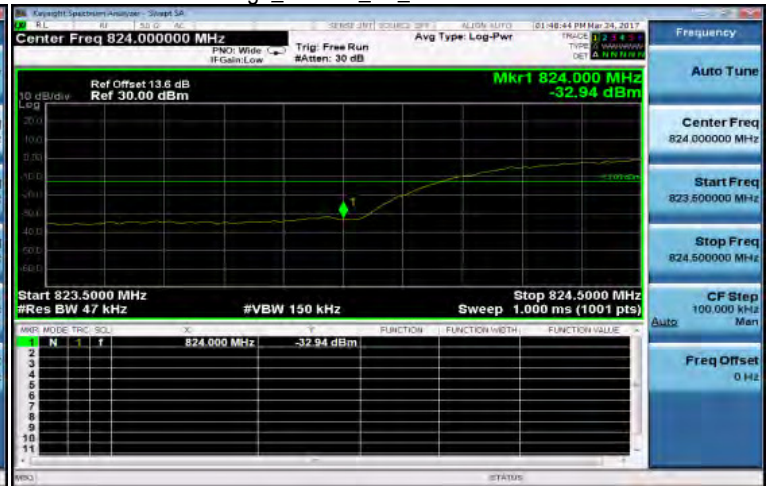

Band Edge_HSDPA_B5_LowCH4132-826.4



Band Edge_HSUPA_B5_HighCH4233-846.6



Unless otherwise stated the results shown in this test report refer only to the sample(s) tested and such sample(s) are retained for 90 days only.

除非另有說明，此報告結果僅對測試之樣品負責，同時此樣品僅保留90天。本報告未經本公司書面許可，不可部份複製。

This document is issued by the Company subject to its General Conditions of Service printed overleaf, available on request or accessible at www.sgs.com/terms_and_conditions.htm and, for electronic format documents, subject to Terms and Conditions for Electronic Documents at www.sgs.com/terms_e-document.htm. Attention is drawn to the limitation of liability, indemnification and jurisdiction issues defined therein. Any holder of this document is advised that information contained hereon reflects the Company's findings at the time of its intervention only and within the limits of Client's instructions, if any. The Company's sole responsibility is to its Client and this document does not exonerate parties to a transaction from exercising all their rights and obligations under the transaction documents. This document cannot be reproduced except in full, without prior written approval of the Company. Any unauthorized alteration, forgery or falsification of the content or appearance of this document is unlawful and offenders may be prosecuted to the fullest extent of the law.

Band Edge_Band2 1.4MHz_QPSK 1_0_LowCH18607-1850.7



Band Edge_Band2 1.4MHz_QPSK 6_0_HighCH19193-1909.3



Band Edge_Band2 1.4MHz_QPSK 1_5_HighCH19193-1909.3



Band Edge_Band2 3MHz_QPSK 1_0_LowCH18615-1851.5



Band Edge_Band2 1.4MHz_QPSK 6_0_LowCH18607-1850.7



Band Edge_Band2 3MHz_QPSK 1_14_HighCH19185-1908.5



Unless otherwise stated the results shown in this test report refer only to the sample(s) tested and such sample(s) are retained for 90 days only.
除非另有說明，此報告結果僅對測試之樣品負責，同時此樣品僅保留90天。本報告未經本公司書面許可，不可部份複製。

This document is issued by the Company subject to its General Conditions of Service printed overleaf, available on request or accessible at www.sgs.com/terms_and_conditions.htm and, for electronic format documents, subject to Terms and Conditions for Electronic Documents at www.sgs.com/terms_e-document.htm. Attention is drawn to the limitation of liability, indemnification and jurisdiction issues defined therein. Any holder of this document is advised that information contained hereon reflects the Company's findings at the time of its intervention only and within the limits of Client's instructions, if any. The Company's sole responsibility is to its Client and this document does not exonerate parties to a transaction from exercising all their rights and obligations under the transaction documents. This document cannot be reproduced except in full, without prior written approval of the Company. Any unauthorized alteration, forgery or falsification of the content or appearance of this document is unlawful and offenders may be prosecuted to the fullest extent of the law.

Band Edge_Band2 3MHz_QPSK 15 0_LowCH18615-1851.5



Band Edge_Band2 5MHz_QPSK 1 24_HighCH19175-1907.5



Band Edge_Band2 3MHz_QPSK 15 0_HighCH19185-1908.5



Band Edge_Band2 5MHz_QPSK 25 0_LowCH18625-1852.5



Band Edge_Band2 5MHz_QPSK 1 0_LowCH18625-1852.5



Band Edge_Band2 5MHz_QPSK 25 0_HighCH19175-1907.5



Unless otherwise stated the results shown in this test report refer only to the sample(s) tested and such sample(s) are retained for 90 days only.

除非另有說明，此報告結果僅對測試之樣品負責，同時此樣品僅保留90天。本報告未經本公司書面許可，不可部份複製。

This document is issued by the Company subject to its General Conditions of Service printed overleaf, available on request or accessible at www.sgs.com/terms_and_conditions.htm and, for electronic format documents, subject to Terms and Conditions for Electronic Documents at www.sgs.com/terms_e-document.htm. Attention is drawn to the limitation of liability, indemnification and jurisdiction issues defined therein. Any holder of this document is advised that information contained hereon reflects the Company's findings at the time of its intervention only and within the limits of Client's instructions, if any. The Company's sole responsibility is to its Client and this document does not exonerate parties to a transaction from exercising all their rights and obligations under the transaction documents. This document cannot be reproduced except in full, without prior written approval of the Company. Any unauthorized alteration, forgery or falsification of the content or appearance of this document is unlawful and offenders may be prosecuted to the fullest extent of the law.

Band Edge_Band2 10MHz_QPSK 1 0_LowCH18650-1855



Band Edge_Band2 10MHz_QPSK 50 0_HighCH19150-1905



Band Edge_Band2 10MHz_QPSK 1 49_HighCH19150-1905



Band Edge_Band2 15MHz_QPSK 1 0_LowCH18675-1857.5



Band Edge_Band2 10MHz_QPSK 50 0_LowCH18650-1855



Band Edge_Band2 15MHz_QPSK 1 74_HighCH19125-1902.5



Unless otherwise stated the results shown in this test report refer only to the sample(s) tested and such sample(s) are retained for 90 days only.

除非另有說明，此報告結果僅對測試之樣品負責，同時此樣品僅保留90天。本報告未經本公司書面許可，不可部份複製。

This document is issued by the Company subject to its General Conditions of Service printed overleaf, available on request or accessible at www.sgs.com/terms_and_conditions.htm and, for electronic format documents, subject to Terms and Conditions for Electronic Documents at www.sgs.com/terms_e-document.htm. Attention is drawn to the limitation of liability, indemnification and jurisdiction issues defined therein. Any holder of this document is advised that information contained hereon reflects the Company's findings at the time of its intervention only and within the limits of Client's instructions, if any. The Company's sole responsibility is to its Client and this document does not exonerate parties to a transaction from exercising all their rights and obligations under the transaction documents. This document cannot be reproduced except in full, without prior written approval of the Company. Any unauthorized alteration, forgery or falsification of the content or appearance of this document is unlawful and offenders may be prosecuted to the fullest extent of the law.

Band Edge_Band2 15MHz_QPSK 75_0_LowCH18675-1857.5



Band Edge_Band2 20MHz_QPSK 1_99_HighCH19100-1900



Band Edge_Band2 15MHz_QPSK 75_0_HighCH19125-1902.5



Band Edge_Band2 20MHz_QPSK 100_0_LowCH18700-1860



Band Edge_Band2 20MHz_QPSK 1_0_LowCH18700-1860



Band Edge_Band2 20MHz_QPSK 100_0_HighCH19100-1900



Unless otherwise stated the results shown in this test report refer only to the sample(s) tested and such sample(s) are retained for 90 days only.
除非另有說明，此報告結果僅對測試之樣品負責，同時此樣品僅保留90天。本報告未經本公司書面許可，不可部份複製。

This document is issued by the Company subject to its General Conditions of Service printed overleaf, available on request or accessible at www.sgs.com/terms_and_conditions.htm and, for electronic format documents, subject to Terms and Conditions for Electronic Documents at www.sgs.com/terms_e-document.htm. Attention is drawn to the limitation of liability, indemnification and jurisdiction issues defined therein. Any holder of this document is advised that information contained hereon reflects the Company's findings at the time of its intervention only and within the limits of Client's instructions, if any. The Company's sole responsibility is to its Client and this document does not exonerate parties to a transaction from exercising all their rights and obligations under the transaction documents. This document cannot be reproduced except in full, without prior written approval of the Company. Any unauthorized alteration, forgery or falsification of the content or appearance of this document is unlawful and offenders may be prosecuted to the fullest extent of the law.

Band Edge_Band4 1.4MHz_QPSK 1_0_LowCH19957-1710.7



Band Edge_Band4 1.4MHz_QPSK 6_0_HighCH20393-1754.3



Band Edge_Band4 1.4MHz_QPSK 1_5_HighCH20393-1754.3



Band Edge_Band4 3MHz_QPSK 1_0_LowCH19965-1711.5



Band Edge_Band4 1.4MHz_QPSK 6_0_LowCH19957-1710.7



Band Edge_Band4 3MHz_QPSK 1_14_HighCH20385-1753.5



Unless otherwise stated the results shown in this test report refer only to the sample(s) tested and such sample(s) are retained for 90 days only.
除非另有說明，此報告結果僅對測試之樣品負責，同時此樣品僅保留90天。本報告未經本公司書面許可，不可部份複製。

This document is issued by the Company subject to its General Conditions of Service printed overleaf, available on request or accessible at www.sgs.com/terms_and_conditions.htm and, for electronic format documents, subject to Terms and Conditions for Electronic Documents at www.sgs.com/terms_e-document.htm. Attention is drawn to the limitation of liability, indemnification and jurisdiction issues defined therein. Any holder of this document is advised that information contained hereon reflects the Company's findings at the time of its intervention only and within the limits of Client's instructions, if any. The Company's sole responsibility is to its Client and this document does not exonerate parties to a transaction from exercising all their rights and obligations under the transaction documents. This document cannot be reproduced except in full, without prior written approval of the Company. Any unauthorized alteration, forgery or falsification of the content or appearance of this document is unlawful and offenders may be prosecuted to the fullest extent of the law.

Band Edge_Band4 3MHz_QPSK 15 0_LowCH19965-1711.5



Band Edge_Band4 5MHz_QPSK 1 24_HighCH20375-1752.5



Band Edge_Band4 3MHz_QPSK 15 0_HighCH20385-1753.5



Band Edge_Band4 5MHz_QPSK 25 0_LowCH19975-1712.5



Band Edge_Band4 5MHz_QPSK 1 0_LowCH19975-1712.5



Band Edge_Band4 5MHz_QPSK 25 0_HighCH20375-1752.5



Unless otherwise stated the results shown in this test report refer only to the sample(s) tested and such sample(s) are retained for 90 days only.
除非另有說明，此報告結果僅對測試之樣品負責，同時此樣品僅保留90天。本報告未經本公司書面許可，不可部份複製。

This document is issued by the Company subject to its General Conditions of Service printed overleaf, available on request or accessible at www.sgs.com/terms_and_conditions.htm and, for electronic format documents, subject to Terms and Conditions for Electronic Documents at www.sgs.com/terms_e-document.htm. Attention is drawn to the limitation of liability, indemnification and jurisdiction issues defined therein. Any holder of this document is advised that information contained hereon reflects the Company's findings at the time of its intervention only and within the limits of Client's instructions, if any. The Company's sole responsibility is to its Client and this document does not exonerate parties to a transaction from exercising all their rights and obligations under the transaction documents. This document cannot be reproduced except in full, without prior written approval of the Company. Any unauthorized alteration, forgery or falsification of the content or appearance of this document is unlawful and offenders may be prosecuted to the fullest extent of the law.

Band Edge_Band4 10MHz_QPSK 1 0_LowCH20000-1715



Band Edge_Band4 10MHz_QPSK 50 0_HighCH20350-1750



Band Edge_Band4 10MHz_QPSK 1 49_HighCH20350-1750



Band Edge_Band4 15MHz_QPSK 1 0_LowCH20025-1717.5



Band Edge_Band4 10MHz_QPSK 50 0_LowCH20000-1715



Band Edge_Band4 15MHz_QPSK 1 74_HighCH20325-1747.5



Unless otherwise stated the results shown in this test report refer only to the sample(s) tested and such sample(s) are retained for 90 days only. 除非另有說明，此報告結果僅對測試之樣品負責，同時此樣品僅保留90天。本報告未經本公司書面許可，不可部份複製。

This document is issued by the Company subject to its General Conditions of Service printed overleaf, available on request or accessible at www.sgs.com/terms_and_conditions.htm and, for electronic format documents, subject to Terms and Conditions for Electronic Documents at www.sgs.com/terms_e-document.htm. Attention is drawn to the limitation of liability, indemnification and jurisdiction issues defined therein. Any holder of this document is advised that information contained hereon reflects the Company's findings at the time of its intervention only and within the limits of Client's instructions, if any. The Company's sole responsibility is to its Client and this document does not exonerate parties to a transaction from exercising all their rights and obligations under the transaction documents. This document cannot be reproduced except in full, without prior written approval of the Company. Any unauthorized alteration, forgery or falsification of the content or appearance of this document is unlawful and offenders may be prosecuted to the fullest extent of the law.

Band Edge_Band4 15MHz_QPSK 75 0_LowCH20025-1717.5



Band Edge_Band4 20MHz_QPSK 1 99_HighCH20300-1745



Band Edge_Band4 15MHz_QPSK 75 0_HighCH20325-1747.5



Band Edge_Band4 20MHz_QPSK 100 0_LowCH20050-1720



Band Edge_Band4 20MHz_QPSK 1 0_LowCH20050-1720



Band Edge_Band4 20MHz_QPSK 100 0_HighCH20300-1745



Unless otherwise stated the results shown in this test report refer only to the sample(s) tested and such sample(s) are retained for 90 days only.

除非另有說明，此報告結果僅對測試之樣品負責，同時此樣品僅保留90天。本報告未經本公司書面許可，不可部份複製。

This document is issued by the Company subject to its General Conditions of Service printed overleaf, available on request or accessible at www.sgs.com/terms_and_conditions.htm and, for electronic format documents, subject to Terms and Conditions for Electronic Documents at www.sgs.com/terms_e-document.htm. Attention is drawn to the limitation of liability, indemnification and jurisdiction issues defined therein. Any holder of this document is advised that information contained hereon reflects the Company's findings at the time of its intervention only and within the limits of Client's instructions, if any. The Company's sole responsibility is to its Client and this document does not exonerate parties to a transaction from exercising all their rights and obligations under the transaction documents. This document cannot be reproduced except in full, without prior written approval of the Company. Any unauthorized alteration, forgery or falsification of the content or appearance of this document is unlawful and offenders may be prosecuted to the fullest extent of the law.

Band Edge_Band5 1.4MHz_QPSK 1 0_LowCH20407-824.7



Band Edge_Band5 1.4MHz_QPSK 6 0_HighCH20643-848.3



Band Edge_Band5 1.4MHz_QPSK 1 5_HighCH20643-848.3



Band Edge_Band5 3MHz_QPSK 1 0_LowCH20415-825.5



Band Edge_Band5 1.4MHz_QPSK 6 0_LowCH20407-824.7



Band Edge_Band5 3MHz_QPSK 1 14_HighCH20635-847.5



Unless otherwise stated the results shown in this test report refer only to the sample(s) tested and such sample(s) are retained for 90 days only.
除非另有說明，此報告結果僅對測試之樣品負責，同時此樣品僅保留90天。本報告未經本公司書面許可，不可部份複製。

This document is issued by the Company subject to its General Conditions of Service printed overleaf, available on request or accessible at www.sgs.com/terms_and_conditions.htm and, for electronic format documents, subject to Terms and Conditions for Electronic Documents at www.sgs.com/terms_e-document.htm. Attention is drawn to the limitation of liability, indemnification and jurisdiction issues defined therein. Any holder of this document is advised that information contained hereon reflects the Company's findings at the time of its intervention only and within the limits of Client's instructions, if any. The Company's sole responsibility is to its Client and this document does not exonerate parties to a transaction from exercising all their rights and obligations under the transaction documents. This document cannot be reproduced except in full, without prior written approval of the Company. Any unauthorized alteration, forgery or falsification of the content or appearance of this document is unlawful and offenders may be prosecuted to the fullest extent of the law.

Band Edge_Band5 3MHz_QPSK 15 0_LowCH20415-825.5



Band Edge_Band5 5MHz_QPSK 1 24_HighCH20625-846.5



Band Edge_Band5 3MHz_QPSK 15 0_HighCH20635-847.5



Band Edge_Band5 5MHz_QPSK 25 0_LowCH20425-826.5



Band Edge_Band5 5MHz_QPSK 1 0_LowCH20425-826.5



Band Edge_Band5 5MHz_QPSK 25 0_HighCH20625-846.5



Unless otherwise stated the results shown in this test report refer only to the sample(s) tested and such sample(s) are retained for 90 days only.

除非另有說明，此報告結果僅對測試之樣品負責，同時此樣品僅保留90天。本報告未經本公司書面許可，不可部份複製。

This document is issued by the Company subject to its General Conditions of Service printed overleaf, available on request or accessible at www.sgs.com/terms_and_conditions.htm and, for electronic format documents, subject to Terms and Conditions for Electronic Documents at www.sgs.com/terms_e-document.htm. Attention is drawn to the limitation of liability, indemnification and jurisdiction issues defined therein. Any holder of this document is advised that information contained hereon reflects the Company's findings at the time of its intervention only and within the limits of Client's instructions, if any. The Company's sole responsibility is to its Client and this document does not exonerate parties to a transaction from exercising all their rights and obligations under the transaction documents. This document cannot be reproduced except in full, without prior written approval of the Company. Any unauthorized alteration, forgery or falsification of the content or appearance of this document is unlawful and offenders may be prosecuted to the fullest extent of the law.

Band Edge_Band5 10MHz_QPSK 1 0_LowCH20450-829



Band Edge_Band5 10MHz_QPSK 50 0_HighCH20600-844



Band Edge_Band5 10MHz_QPSK 1 49_HighCH20600-844



Band Edge_Band7 5MHz_QPSK 1 0_LowCH20775-2502.5



Band Edge_Band5 10MHz_QPSK 50 0_LowCH20450-829



Band Edge_Band7 5MHz_QPSK 1 24_HighCH21425-2567.5



Unless otherwise stated the results shown in this test report refer only to the sample(s) tested and such sample(s) are retained for 90 days only.
除非另有說明，此報告結果僅對測試之樣品負責，同時此樣品僅保留90天。本報告未經本公司書面許可，不可部份複製。

This document is issued by the Company subject to its General Conditions of Service printed overleaf, available on request or accessible at www.sgs.com/terms_and_conditions.htm and, for electronic format documents, subject to Terms and Conditions for Electronic Documents at www.sgs.com/terms_e-document.htm. Attention is drawn to the limitation of liability, indemnification and jurisdiction issues defined therein. Any holder of this document is advised that information contained hereon reflects the Company's findings at the time of its intervention only and within the limits of Client's instructions, if any. The Company's sole responsibility is to its Client and this document does not exonerate parties to a transaction from exercising all their rights and obligations under the transaction documents. This document cannot be reproduced except in full, without prior written approval of the Company. Any unauthorized alteration, forgery or falsification of the content or appearance of this document is unlawful and offenders may be prosecuted to the fullest extent of the law.

Band Edge_Band7 5MHz_QPSK 25 0_LowCH20775-2502.5



Band Edge_Band7 10MHz_QPSK 1 49_HighCH21400-2565



Band Edge_Band7 5MHz_QPSK 25 0_HighCH21425-2567.5



Band Edge_Band7 10MHz_QPSK 50 0_LowCH20800-2505



Band Edge_Band7 10MHz_QPSK 1 0_LowCH20800-2505



Band Edge_Band7 10MHz_QPSK 50 0_HighCH21400-2565



Unless otherwise stated the results shown in this test report refer only to the sample(s) tested and such sample(s) are retained for 90 days only.
除非另有說明，此報告結果僅對測試之樣品負責，同時此樣品僅保留90天。本報告未經本公司書面許可，不可部份複製。

This document is issued by the Company subject to its General Conditions of Service printed overleaf, available on request or accessible at www.sgs.com/terms_and_conditions.htm and, for electronic format documents, subject to Terms and Conditions for Electronic Documents at www.sgs.com/terms_e-document.htm. Attention is drawn to the limitation of liability, indemnification and jurisdiction issues defined therein. Any holder of this document is advised that information contained hereon reflects the Company's findings at the time of its intervention only and within the limits of Client's instructions, if any. The Company's sole responsibility is to its Client and this document does not exonerate parties to a transaction from exercising all their rights and obligations under the transaction documents. This document cannot be reproduced except in full, without prior written approval of the Company. Any unauthorized alteration, forgery or falsification of the content or appearance of this document is unlawful and offenders may be prosecuted to the fullest extent of the law.

Band Edge_Band7 15MHz_QPSK 1 0_LowCH20825-2507.5



Band Edge_Band7 15MHz_QPSK 75 0_HighCH21375-2562.5



Band Edge_Band7 15MHz_QPSK 1 74_HighCH21375-2562.5



Band Edge_Band7 20MHz_QPSK 1 0_LowCH20850-2510



Band Edge_Band7 15MHz_QPSK 75 0_LowCH20825-2507.5



Band Edge_Band7 20MHz_QPSK 1 99_HighCH21350-2560

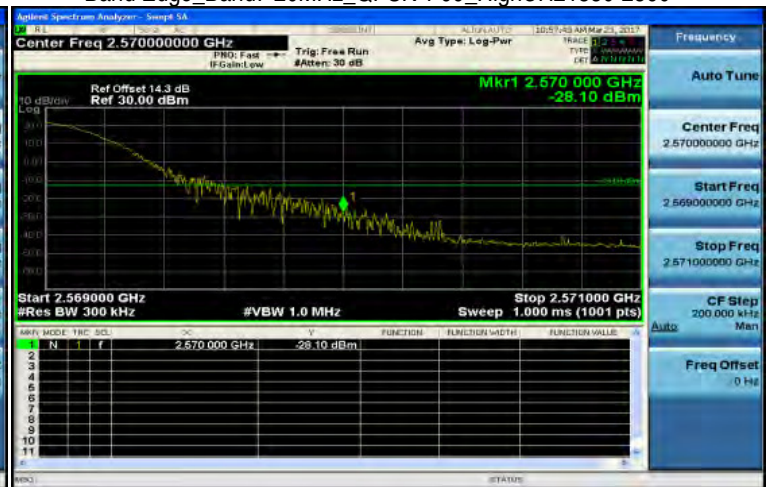

Unless otherwise stated the results shown in this test report refer only to the sample(s) tested and such sample(s) are retained for 90 days only.
除非另有說明，此報告結果僅對測試之樣品負責，同時此樣品僅保留90天。本報告未經本公司書面許可，不可部份複製。

This document is issued by the Company subject to its General Conditions of Service printed overleaf, available on request or accessible at www.sgs.com/terms_and_conditions.htm and, for electronic format documents, subject to Terms and Conditions for Electronic Documents at www.sgs.com/terms_e-document.htm. Attention is drawn to the limitation of liability, indemnification and jurisdiction issues defined therein. Any holder of this document is advised that information contained hereon reflects the Company's findings at the time of its intervention only and within the limits of Client's instructions, if any. The Company's sole responsibility is to its Client and this document does not exonerate parties to a transaction from exercising all their rights and obligations under the transaction documents. This document cannot be reproduced except in full, without prior written approval of the Company. Any unauthorized alteration, forgery or falsification of the content or appearance of this document is unlawful and offenders may be prosecuted to the fullest extent of the law.

Band Edge_Band7 20MHz_QPSK 100 0_LowCH20850-2510



Band Edge_Band12 1.4MHz_QPSK 1 5_HighCH23173-715.3



Band Edge_Band7 20MHz_QPSK 100 0_HighCH21350-2560



Band Edge_Band12 1.4MHz_QPSK 6 0_LowCH23017-699.7



Band Edge_Band12 1.4MHz_QPSK 1 0_LowCH23017-699.7



Band Edge_Band12 1.4MHz_QPSK 6 0_HighCH23173-715.3



Unless otherwise stated the results shown in this test report refer only to the sample(s) tested and such sample(s) are retained for 90 days only.

除非另有說明，此報告結果僅對測試之樣品負責，同時此樣品僅保留90天。本報告未經本公司書面許可，不可部份複製。

This document is issued by the Company subject to its General Conditions of Service printed overleaf, available on request or accessible at www.sgs.com/terms_and_conditions.htm and, for electronic format documents, subject to Terms and Conditions for Electronic Documents at www.sgs.com/terms_e-document.htm. Attention is drawn to the limitation of liability, indemnification and jurisdiction issues defined therein. Any holder of this document is advised that information contained hereon reflects the Company's findings at the time of its intervention only and within the limits of Client's instructions, if any. The Company's sole responsibility is to its Client and this document does not exonerate parties to a transaction from exercising all their rights and obligations under the transaction documents. This document cannot be reproduced except in full, without prior written approval of the Company. Any unauthorized alteration, forgery or falsification of the content or appearance of this document is unlawful and offenders may be prosecuted to the fullest extent of the law.

Band Edge_Band12 3MHz_QPSK 1 0_LowCH23025-700.5



Band Edge_Band12 3MHz_QPSK 15 0_HighCH23165-714.5



Band Edge_Band12 3MHz_QPSK 1 14_HighCH23165-714.5



Band Edge_Band12 5MHz_QPSK 1 0_LowCH23035-701.5



Band Edge_Band12 3MHz_QPSK 15 0_LowCH23025-700.5

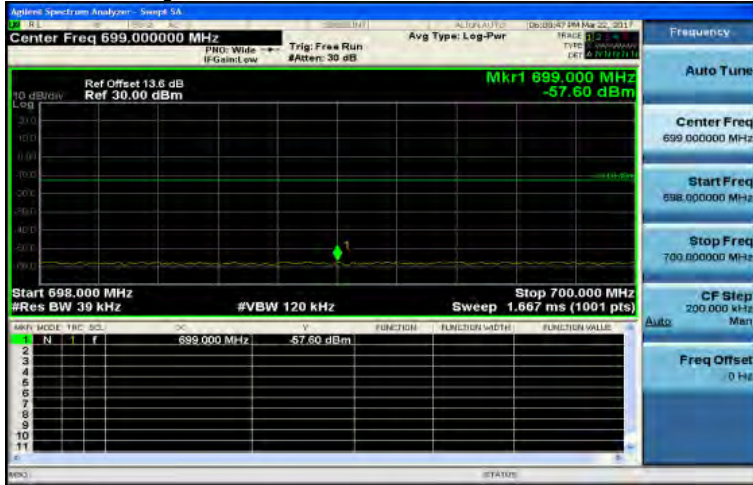

Band Edge_Band12 5MHz_QPSK 1 24_HighCH23155-713.5



Unless otherwise stated the results shown in this test report refer only to the sample(s) tested and such sample(s) are retained for 90 days only.

除非另有說明，此報告結果僅對測試之樣品負責，同時此樣品僅保留90天。本報告未經本公司書面許可，不可部份複製。

This document is issued by the Company subject to its General Conditions of Service printed overleaf, available on request or accessible at www.sgs.com/terms_and_conditions.htm and, for electronic format documents, subject to Terms and Conditions for Electronic Documents at www.sgs.com/terms_e-document.htm. Attention is drawn to the limitation of liability, indemnification and jurisdiction issues defined therein. Any holder of this document is advised that information contained hereon reflects the Company's findings at the time of its intervention only and within the limits of Client's instructions, if any. The Company's sole responsibility is to its Client and this document does not exonerate parties to a transaction from exercising all their rights and obligations under the transaction documents. This document cannot be reproduced except in full, without prior written approval of the Company. Any unauthorized alteration, forgery or falsification of the content or appearance of this document is unlawful and offenders may be prosecuted to the fullest extent of the law.

Band Edge_Band12 5MHz_QPSK 25 0_LowCH23035-701.5



Band Edge_Band12 10MHz_QPSK 1 49_HighCH23130-711



Band Edge_Band12 5MHz_QPSK 25 0_HighCH23155-713.5



Band Edge_Band12 10MHz_QPSK 50 0_LowCH23060-704



Band Edge_Band12 10MHz_QPSK 1 0_LowCH23060-704



Band Edge_Band12 10MHz_QPSK 50 0_HighCH23130-711



Unless otherwise stated the results shown in this test report refer only to the sample(s) tested and such sample(s) are retained for 90 days only.

除非另有說明，此報告結果僅對測試之樣品負責，同時此樣品僅保留90天。本報告未經本公司書面許可，不可部份複製。

This document is issued by the Company subject to its General Conditions of Service printed overleaf, available on request or accessible at www.sgs.com/terms_and_conditions.htm and, for electronic format documents, subject to Terms and Conditions for Electronic Documents at www.sgs.com/terms_e-document.htm. Attention is drawn to the limitation of liability, indemnification and jurisdiction issues defined therein. Any holder of this document is advised that information contained hereon reflects the Company's findings at the time of its intervention only and within the limits of Client's instructions, if any. The Company's sole responsibility is to its Client and this document does not exonerate parties to a transaction from exercising all their rights and obligations under the transaction documents. This document cannot be reproduced except in full, without prior written approval of the Company. Any unauthorized alteration, forgery or falsification of the content or appearance of this document is unlawful and offenders may be prosecuted to the fullest extent of the law.

Band Edge_Band13 5MHz_QPSK 1 0_LowCH23205-779.5



Band Edge_Band13 5MHz_QPSK 25 0_HighCH23255-784.5

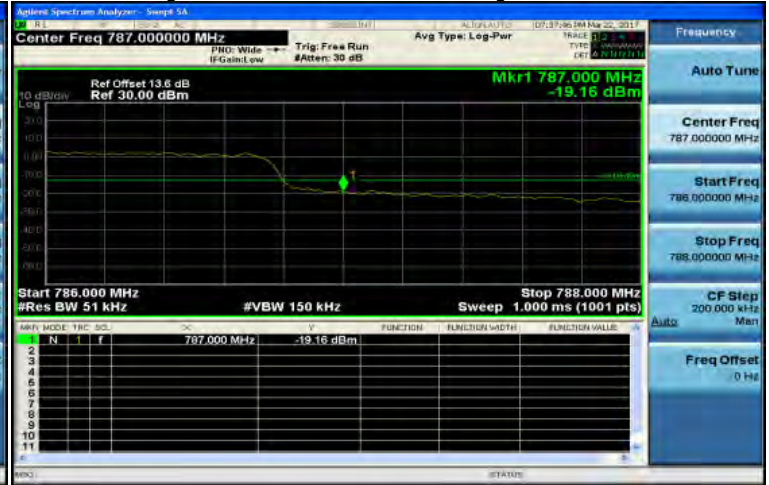

Band Edge_Band13 5MHz_QPSK 1 24_HighCH23255-784.5



Band Edge_Band13 10MHz_QPSK 1 0_LowCH23230-782



Band Edge_Band13 5MHz_QPSK 25 0_LowCH23205-779.5



Band Edge_Band13 10MHz_QPSK 1 49_HighCH23230-782



Unless otherwise stated the results shown in this test report refer only to the sample(s) tested and such sample(s) are retained for 90 days only.

除非另有說明，此報告結果僅對測試之樣品負責，同時此樣品僅保留90天。本報告未經本公司書面許可，不可部份複製。

This document is issued by the Company subject to its General Conditions of Service printed overleaf, available on request or accessible at www.sgs.com/terms_and_conditions.htm and, for electronic format documents, subject to Terms and Conditions for Electronic Documents at www.sgs.com/terms_e-document.htm. Attention is drawn to the limitation of liability, indemnification and jurisdiction issues defined therein. Any holder of this document is advised that information contained hereon reflects the Company's findings at the time of its intervention only and within the limits of Client's instructions, if any. The Company's sole responsibility is to its Client and this document does not exonerate parties to a transaction from exercising all their rights and obligations under the transaction documents. This document cannot be reproduced except in full, without prior written approval of the Company. Any unauthorized alteration, forgery or falsification of the content or appearance of this document is unlawful and offenders may be prosecuted to the fullest extent of the law.