

FCC Test Report (Part 90)

Report No.: RF200109E02-3

FCC ID: 2AQ68T99W175

Test Model: T99W175

Received Date: Jan. 10, 2020

Test Date: Feb. 11 ~ Feb. 25, 2020

Issued Date: Mar. 16, 2020

Applicant: Hon Lin Technology Co., Ltd.

Address: 11F, No. 32, Jihu Rd., Neihu Dist., Taipei City 114, Taiwan R.O.C.

Issued By: Bureau Veritas Consumer Products Services (H.K.) Ltd., Taoyuan Branch
Lin Kou Laboratories

Lab Address: No. 47-2, 14th Ling, Chia Pau Vil., Lin Kou Dist., New Taipei City, Taiwan

Test Location: No.19, Hwa Ya 2nd Rd., Wen Hwa Vil., Kwei Shan Dist., Taoyuan City
33383, Taiwan

FCC Registration / 788550 / TW0003

Designation Number:



This report is for your exclusive use. Any copying or replication of this report to or for any other person or entity, or use of our name or trademark, is permitted only with our prior written permission. This report sets forth our findings solely with respect to the test samples identified herein. The results set forth in this report are not indicative or representative of the quality or characteristics of the lot from which a test sample was taken or any similar or identical product specifically and expressly noted. Our report includes all of the tests requested by you and the results thereof based upon the information that you provided to us. You have 60 days from date of issuance of this report to notify us of any material error or omission caused by our negligence, provided, however, that such notice shall be in writing and shall specifically address the issue you wish to raise. A failure to raise such issue within the prescribed time shall constitute your unqualified acceptance of the completeness of this report, the tests conducted and the correctness of the report contents. Unless specific mention, the uncertainty of measurement has been explicitly taken into account to declare the compliance or non-compliance to the specification. The report must not be used by the client to claim product certification, approval, or endorsement by TAF or any government agencies

Table of Contents

Release Control Record	4
1 Certificate of Conformity	5
2 Summary of Test Results	6
2.1 Measurement Uncertainty.....	7
2.2 Test Site and Instruments.....	8
3 General Information	9
3.1 General Description of EUT.....	9
3.2 Configuration of System under Test.....	12
3.2.1 Description of Support Units.....	12
3.3 Test Mode Applicability and Tested Channel Detail.....	13
3.4 EUT Operating Conditions.....	16
3.5 General Description of Applied Standards and References.....	16
4 Test Types and Results	17
4.1 Output Power Measurement.....	17
4.1.1 Limits of Output Power Measurement.....	17
4.1.2 Test Procedures.....	17
4.1.3 Test Setup.....	17
4.1.4 Test Results.....	18
4.2 Modulation Characteristics Measurement.....	30
4.2.1 Limits of Modulation Characteristics.....	30
4.2.2 Test Procedure.....	30
4.2.3 Test Setup.....	30
4.2.4 Test Results.....	31
4.3 Frequency Stability Measurement.....	33
4.3.1 Limits of Frequency Stability Measurement.....	33
4.3.2 Test Procedure.....	33
4.3.3 Test Setup.....	33
4.3.4 Test Results.....	34
4.4 Occupied Bandwidth Measurement.....	40
4.4.1 Limits of Occupied Bandwidth Measurement.....	40
4.4.2 Test Procedure.....	40
4.4.3 Test Setup.....	40
4.4.4 Test Result.....	41
4.5 Emission Mask Measurement.....	47
4.5.1 Limits of Emission Mask Measurement.....	47
4.5.2 Test Setup.....	47
4.5.3 Test Procedures.....	47
4.5.4 Test Results.....	48
4.6 Band Edge Measurement.....	56
4.6.1 Limits of Band Edge Measurement.....	56
4.6.2 Test Setup.....	56
4.6.3 Test Procedures.....	56
4.6.4 Test Results.....	57
4.7 Conducted Spurious Emissions.....	59
4.7.1 Limits of Conducted Spurious Emissions Measurement.....	59
4.7.2 Test Setup.....	59
4.7.3 Test Procedure.....	59
4.7.4 Test Results.....	60
4.8 Radiated Emission Measurement.....	68
4.8.1 Limits of Radiated Emission Measurement.....	68
4.8.2 Test Procedure.....	68
4.8.3 Deviation from Test Standard.....	68
4.8.4 Test Setup.....	69

4.8.5 Test Results	70
5 Pictures of Test Arrangements.....	80
Appendix – Information of the Testing Laboratories	81

Release Control Record

Issue No.	Description	Date Issued
RF200109E02-3	Original release	Mar. 16, 2020

1 Certificate of Conformity

Product: 5G WWAN Module

Brand: Foxconn

Test Model: T99W175

Sample Status: Engineering Sample

Applicant: Hon Lin Technology Co., Ltd.

Test Date: Feb. 11 ~ Feb. 25, 2020

Standards: FCC Part 90, Subpart I, R, S

The above equipment has been tested by **Bureau Veritas Consumer Products Services (H.K.) Ltd., Taoyuan Branch**, and found compliance with the requirement of the above standards. The test record, data evaluation & Equipment Under Test (EUT) configurations represented herein are true and accurate accounts of the measurements of the sample's RF characteristics under the conditions specified in this report.

Prepared by : Pettie Chen , **Date:** Mar. 16, 2020
Pettie Chen / Senior Specialist

Approved by : Bruce Chen , **Date:** Mar. 16, 2020
Bruce Chen / Senior Project Engineer

2 Summary of Test Results

LTE Band 14

Applied Standard: FCC Part 90 & Part 2			
FCC Clause	Test Item	Result	Remarks
2.1046 90.542 (a)	Effective Radiated Power	Pass	Meet the requirement of limit.
2.1047	Modulation Characteristics	Pass	Meet the requirement.
2.1055 90.539 (d)	Frequency Stability	Pass	Meet the requirement of limit.
2.1049	Occupied Bandwidth (*)	Pass	Meet the requirement of limit.
90.210 (n) & (b)	Emission Masks	Pass	Meet the requirement of limit.
2.1051 90.543 (e) (2) & (3)	Band Edge Measurements	Pass	Meet the requirement of limit.
2.1051 90.543 (c) & (f)	Conducted Spurious Emissions	Pass	Meet the requirement of limit.
2.1053 90.543 (c) & (f)	Radiated Spurious Emissions	Pass	Meet the requirement of limit. Minimum passing margin is -11.0dB at 1581.00MHz.

LTE Band 26

Applied Standard: FCC Part 90 & Part 2			
FCC Clause	Test Item	Result	Remarks
2.1046 90.635(b)	Effective Radiated Power	Pass	Meet the requirement of limit.
2.1047	Modulation Characteristics	Pass	Meet the requirement.
2.1055 90.213	Frequency Stability	Pass	Meet the requirement of limit.
2.1049	Occupied Bandwidth	Pass	Meet the requirement of limit.
2.1051 90.691(a)	Emission Masks	Pass	Meet the requirement of limit.
2.1051 90.691	Conducted Spurious Emissions	Pass	Meet the requirement of limit.
2.1053 90.691	Radiated Spurious Emissions	Pass	Meet the requirement of limit. Minimum passing margin is -27.0dB at 30.00MHz.

Note: Determining compliance based on the results of the compliance measurement, not taking into account measurement instrumentation uncertainty.

2.1 Measurement Uncertainty

Where relevant, the following measurement uncertainty levels have been estimated for tests performed on the EUT as specified in CISPR 16-4-2:

Measurement	Frequency	Expanded Uncertainty (k=2) (\pm)
Radiated Emissions up to 1 GHz	9kHz ~ 30MHz	3.04 dB
	30MHz ~ 200MHz	3.59 dB
	200MHz ~ 1000MHz	3.60 dB
Radiated Emissions above 1 GHz	1GHz ~ 18GHz	2.29 dB
	18GHz ~ 40GHz	2.29 dB

2.2 Test Site and Instruments

Description & Manufacturer	Model No.	Serial No.	Cal. Date	Cal. Due
Test Receiver ROHDE & SCHWARZ	ESCI	100424	Dec. 31, 2019	Dec. 30, 2020
Spectrum Analyzer ROHDE & SCHWARZ	FSP40	100040	Sep. 23, 2019	Sep. 22, 2020
Spectrum Analyzer KEYSIGHT	N9030B	MY57140953	Jul. 03, 2019	Jul. 02, 2020
Radio Communication Analyzer Anritsu	MT8821C	6261806803	Jan. 18, 2020	Jan. 17, 2021
MXG Vector signal generator Agilent	N5182B	MY53050162	Jan. 14, 2020	Jan. 13, 2021
BILOG Antenna SCHWARZBECK	VULB9168	9168-158	Nov. 08, 2019	Nov. 07, 2020
BILOG Antenna SCHWARZBECK	VULB9168	9168-155	Nov. 11, 2019	Nov. 10, 2020
HORN Antenna SCHWARZBECK	BBHA 9120D	9120D-1170	Nov. 24, 2019	Nov. 23, 2020
HORN Antenna SCHWARZBECK	BBHA 9170	BBHA9170241	Nov. 24, 2019	Nov. 23, 2020
Loop Antenna TESEQ	HLA 6121	45745	Jul. 01, 2019	Jun. 30, 2020
Preamplifier Agilent (Below 1GHz)	8447D	2944A10631	Jul. 11, 2019	Jul. 10, 2020
Preamplifier KEYSIGHT (Above 1GHz)	83017A	MY53270295	Jun. 11, 2019	Jun. 10, 2020
RF Coaxial Cable WOKEN With 5dB PAD	8D-FB	Cable-CH4-01	Aug. 20, 2019	Aug. 19, 2020
RF Coaxial Cable EMCI	EMC102-KM-KM-3000	150929	Aug. 20, 2019	Aug. 19, 2020
RF Coaxial Cable EMCI	EMC102-KM-KM-600	150928	Aug. 20, 2019	Aug. 19, 2020
RF signal cable HUBER+SUHNER	SUCOFLEX 104	MY 13380+295012/04	Jul. 11, 2019	Jul. 10, 2020
RF signal cable HUBER+SUHNER	SUCOFLEX 104	Cable-CH4-03 (250724)	Jul. 11, 2019	Jul. 10, 2020
Software BV ADT	ADT_Radiated_ V7.6.15.9.5	NA	NA	NA
Antenna Tower inn-co GmbH	MA 4000	010303	NA	NA
Antenna Tower Controller BV ADT	AT100	AT93021703	NA	NA
Boresight Antenna Fixture	FBA-01	FBA-SIP01	NA	NA
Standard Temperature And Humidity Chamber	MHU-225AU	920842	May 31, 2019	May 30, 2020
JFW 20dB attenuation	50HF-020-SMA	NA	NA	NA
True RMS Clamp Meter Fluke	325	31130711WS	May 21, 2019	May 20, 2020
DC power supply	U8002A	MY56330015	NA	NA

Note: 1. The calibration interval of the above test instruments is 12 months and the calibrations are traceable to NML/ROC and NIST/USA.
2. The test was performed in HwaYa Chamber 4.

3 General Information

3.1 General Description of EUT

Product	5G WWAN Module			
Brand	Foxconn			
Test Model	T99W175			
Sample Status	Engineering Sample			
Power Supply Rating	5 Vdc (Host equipment) 3.135Vdc~3.63Vdc (Module)			
Modulation Type	QPSK, 16QAM, 64QAM			
Operating Frequency	LTE Band 14 (Channel Bandwidth 5MHz)	790.5MHz ~ 795.5MHz		
	LTE Band 14 (Channel Bandwidth 10MHz)	793MHz		
	LTE Band 26 (Channel Bandwidth 1.4MHz)	814.7MHz ~ 823.3MHz		
	LTE Band 26 (Channel Bandwidth 3MHz)	815.5MHz ~ 822.5MHz		
	LTE Band 26 (Channel Bandwidth 5MHz)	816.5MHz ~ 821.5MHz		
	LTE Band 26 (Channel Bandwidth 10MHz)	819.0MHz		
Max. ERP Power		QPSK	16QAM	64QAM
	LTE Band 14 (Channel Bandwidth 5MHz)	437.522mW (26.41dBm)	377.572mW (25.77dBm)	266.073mW (24.25dBm)
	LTE Band 14 (Channel Bandwidth 10MHz)	425.598mW (26.29dBm)	364.754mW (25.62dBm)	244.906mW (23.89dBm)
	LTE Band 26 (Channel Bandwidth 1.4MHz)	366.438mW (25.64dBm)	320.627mW (25.06dBm)	226.464mW (23.55dBm)
	LTE Band 26 (Channel Bandwidth 3MHz)	365.595mW (25.63dBm)	336.512mW (25.27dBm)	224.905mW (23.52dBm)
	LTE Band 26 (Channel Bandwidth 5MHz)	378.443mW (25.78dBm)	325.087mW (25.12dBm)	229.087mW (23.60dBm)
	LTE Band 26 (Channel Bandwidth 10MHz)	358.096mW (25.54dBm)	337.287mW (25.28dBm)	220.800mW (23.44dBm)
		QPSK	16QAM	64QAM
Emission Designator	LTE Band 14 (Channel Bandwidth 5MHz)	4M49G7D	4M49D7W	4M49D7W
	LTE Band 14 (Channel Bandwidth 10MHz)	8M96G7D	8M96D7W	8M96D7W
	LTE Band 26 (Channel Bandwidth 1.4MHz)	1M09G7D	1M09W7D	1M09W7D
	LTE Band 26 (Channel Bandwidth 3MHz)	2M70G7D	2M70W7D	2M70W7D
	LTE Band 26 (Channel Bandwidth 5MHz)	4M49G7D	4M49W7D	4M49W7D
	LTE Band 26 (Channel Bandwidth 10MHz)	8M95G7D	8M95W7D	8M95W7D
Antenna Type	Refer to Note as below			
Antenna Connector	Refer to Note as below			
Accessory Device	NA			
Cable Supplied	NA			

Note:

1. There has five Difference HW of T99W175.

Brand	Model	HW
Foxconn	T99W175	1. 3G+LTE+Sub6+mmWave+eSIM
		2. 3G+LTE+Sub6+eSIM
		3. 3G+LTE+Sub6 only w/o eSIM
		4. 3G+LTE+Sub6+eSIM+GNSS connector
		5. 3G+LTE+Sub6 only+w/o eSIM+GNSS connector

*After pre-testing, "HW: 1. 3G+LTE+Sub6+mmWave+eSIM" is the worst for the final tests.

2. The following antennas were provided to the EUT.

Antenna No.	RF Chain No.	Brand	Model	Antenna Net Gain(dBi)	Frequency range (MHz)	Antenna Type	Connector Type
1		WHA YU	C107-511720-A	4.41	660~803	PCB	I-PEX
2		WHA YU	C107-511721-A	3.81 4.03	791~960 1447.9~1606	PCB	I-PEX
3		WHA YU	C107-511722-A	4.27 5.31	1710~2170 2500~2690	PCB	I-PEX
4		WHA YU	C107-511723-A	2.99 0.92	2300~2400 3500~3700	PCB	I-PEX
5		WHA YU	C107-511724-A	6.45	5150~5925	PCB	I-PEX
6		WHA YU	C107-511725-A	4.89	3400~3700	PCB	I-PEX
7		AVX	5000106-R1-X01	2.91	699~803	Monopole	I-PEX
8		AVX	5000107-R1-X01	2.59	791~960	Monopole	I-PEX
9		AVX	5000108-R1-X01	2.85	1427~1610	Monopole	I-PEX
10		AVX	5000109-R1-X01	2.23 2.94	1710~2200 5150~5925	Monopole	I-PEX
11		AVX	5000110-R1-X01	0.9	2300~2690	Monopole	I-PEX
12		AVX	5000111-R1-X01	0.87	3300~5000	Monopole	I-PEX
13	Tx1/ Rx1	Ethertronics	5003806	0.4 -1.61 0.39 2.95 1.98 0.38 0.83 2.31	698-821 824-960 1425-1515 1710-2200 2300-2690 3300-4200 4400-5000 5150-5925	PIFA	I-PEX
	Rx2	Ethertronics	5003807	-2.24 -4.52 2.87 2.99 2.93 2.91 2.23 -0.85 -3.04	716-821 824-960 1425-1515 1557-1610 1805-2200 2300-2690 3300-4200 4400-5000 5150-5925	PIFA	I-PEX
	Tx2/ Rx3	Ethertronics	5003806	2.21 2.25 -0.45 2.6	1710-2200 2300-2690 3300-4200 4400-5000	PIFA	I-PEX
	Rx4	Ethertronics	5003700	1.38 2.87 0.6 -2.09	1805-2200 2300-2690 3300-4200 4400-5000	PIFA	I-PEX

Antenna No.	RF Chain No.	Brand	Model	Antenna Net Gain(dBi)	Frequency range (MHz)	Antenna Type	Connector Type
14	Ant. 0 (TX/RX)	Master Wave	NA	2.4 2.2 2.9 2.9 2.9 NA	880~960 1020~2170 2545~2595 3565~3600 3900~4000 GPS	PCB	I-PEX
	Ant. 2 (TX/RX)	Master Wave	NA	NA 2.2 2.8 2.9 2.8 NA	880~960 1020~2170 2545~2595 3565~3600 3900~4000 GPS	PCB	I-PEX
	Ant. 1 (RX)	Master Wave	NA	NA 5.3 5.1 4.3 4.5 NA	880~960 1020~2170 2545~2595 3565~3600 3900~4000 GPS	PCB	I-PEX
	Ant. 3 (RX)	Master Wave	NA	1.3 6.8 3.7 6.4 6.2 3.7	880~960 1020~2170 2545~2595 3565~3600 3900~4000 GPS	PCB	I-PEX

3.2 Configuration of System under Test

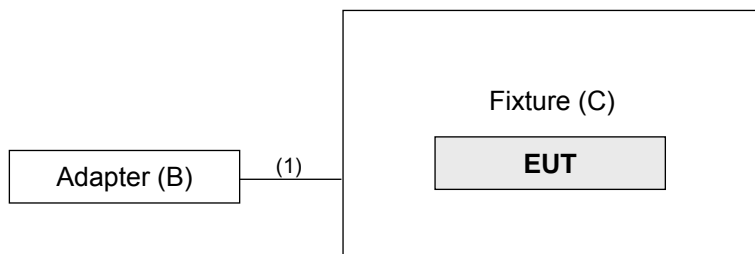

Remote site



3.2.1 Description of Support Units

The EUT has been tested as an independent unit together with other necessary accessories or support units. The following support units or accessories were used to form a representative test configuration during the tests.

ID	Product	Brand	Model No.	Serial No.	FCC ID	Remarks
A.	Radio Communication Analyzer	Anritsu	MT8821C	6261806803	NA	-
B.	Adapter	LITEON	PA-1050-39	NA	NA	-
C.	Fixture	NA	NA	NA	NA	Provided by client.

Note:

1. All power cords of the above support units are non-shielded (1.8m).
2. Item A acted as a communication partner to transfer data.

ID	Descriptions	Qty.	Length (m)	Shielding (Yes/No)	Cores (Qty.)	Remarks
1.	USB cable	1	1.5	Y	0	-

3.3 Test Mode Applicability and Tested Channel Detail

Pre-Scan has been conducted to determine the worst-case mode from all possible combinations between available modulations, data rates, XYZ axis and antenna ports. The worst case was found when positioned on Z-plane. Following channel(s) was (were) selected for the final test as listed below.

LTE Band 14

EUT Configure Mode	Test item	Available channel	Tested channel	Channel Bandwidth	Modulation	Mode
-	ERP	23305 to 23355	23305(790.5MHz), 23330(793.0MHz), 23355(795.5MHz)	5MHz	QPSK / 16QAM / 64QAM	1 RB / 12 RB Offset
		23330	23330(793.0MHz)	10MHz	QPSK / 16QAM / 64QAM	1 RB / 24 RB Offset
-	Modulation Characteristics	23330	23330(793.0MHz)	10MHz	QPSK / 16QAM / 64QAM	50RB / 0RB Offset
-	Frequency Stability	23305 to 23355	23305(790.5MHz), 23355(795.5MHz)	5MHz	QPSK	25RB / 0RB Offset
		23330	23330(793.0MHz)	10MHz	QPSK	50RB / 0RB Offset
-	Occupied Bandwidth	23305 to 23355	23305(790.5MHz), 23330(793.0MHz), 23355(795.5MHz)	5MHz	QPSK / 16QAM / 64QAM	25RB / 0RB Offset
		23330	23330(793.0MHz)	10MHz	QPSK / 16QAM / 64QAM	50RB / 0RB Offset
-	Emission Mask	23305 to 23355	23305(790.5MHz), 23330(793.0MHz), 23355(795.5MHz)	5MHz	QPSK	25RB / 0RB Offset
		23330	23330(793.0MHz)	10MHz	QPSK	50RB / 0RB Offset
-	Band Edge	23305 to 23355	23305(790.5MHz), 23330(793.0MHz), 23355(795.5MHz)	5MHz	QPSK	1 RB / 0 RB Offset 1 RB / 24 RB Offset 25RB / 0RB Offset
		23330	23330(793.0MHz)	10MHz	QPSK	1 RB / 0 RB Offset 1 RB / 49 RB Offset 50RB / 0RB Offset
-	Conducted Emission	23305 to 23355	23305(790.5MHz), 23330(793.0MHz), 23355(795.5MHz)	5MHz	QPSK	1 RB / 12 RB Offset
		23330	23330(793.0MHz)	10MHz	QPSK	1 RB / 24 RB Offset
-	Radiated Emission below 1GHz	23305 to 23355	23330(793.0MHz)	5MHz	QPSK	1 RB / 12 RB Offset
-	Radiated Emission above 1GHz	23305 to 23355	23305(790.5MHz), 23330(793.0MHz), 23355(795.5MHz)	5MHz	QPSK	1 RB / 12 RB Offset
		23330	23330(793.0MHz)	10MHz	QPSK	1 RB / 24 RB Offset

Note:

1. The conducted output power for QPSK, 16QAM and 64QAM measured value of QPSK is higher than 16QAM and 64QAM mode. Therefore, only ERP, Modulation Characteristics, and Emission Bandwidth items had been tested under QPSK, 16QAM and 64QAM modes, the other test items were performed under QPSK mode only.
2. For radiated emission below 1GHz, select the worst radiated emission (above 1GHz) channel for final testing.
3. For radiated emission above 1GHz, according to 3GPP 36.521 Section 6.6.3.1.4, choose the lowest, 5MHz & highest channel bandwidth for final test.

LTE Band 26

EUT Configure Mode	Test item	Available channel	Tested channel	Channel Bandwidth	Modulation	Mode
-	ERP	26697 to 26783	26697 (814.7MHz), 26740 (819.0MHz), 26783 (823.3MHz)	1.4MHz	QPSK / 16QAM / 64QAM	1 RB / 2 RB Offset
		26705 to 26775	26705 (815.5MHz), 26740 (819.0MHz), 26775 (822.5MHz)	3MHz	QPSK / 16QAM / 64QAM	1 RB / 14 RB Offset
		26715 to 26765	26715 (816.5MHz), 26740 (819.0MHz), 26765 (821.5MHz)	5MHz	QPSK / 16QAM / 64QAM	1 RB / 12 RB Offset
		26740	26740 (819.0MHz)	10MHz	QPSK / 16QAM / 64QAM	1 RB / 0 RB Offset
-	Modulation Characteristics	26740	26740 (819.0MHz)	10MHz	QPSK / 16QAM / 64QAM	50 RB / 0 RB Offset
-	Frequency Stability	26697 to 26783	26697 (814.7MHz), 26783 (823.3MHz)	1.4MHz	QPSK	6 RB / 0 RB Offset
		26705 to 26775	26705 (815.5MHz), 26775 (822.5MHz)	3MHz	QPSK	15 RB / 0 RB Offset
		26715 to 26765	26715 (816.5MHz), 26765 (821.5MHz)	5MHz	QPSK	25 RB / 0 RB Offset
		26740	26740 (819.0MHz)	10MHz	QPSK	50 RB / 0 RB Offset
-	Occupied Bandwidth	26697 to 26783	26697 (814.7MHz), 26740 (819.0MHz), 26783 (823.3MHz)	1.4MHz	QPSK / 16QAM / 64QAM	6 RB / 0 RB Offset
		26705 to 26775	26705 (815.5MHz), 26740 (819.0MHz), 26775 (822.5MHz)	3MHz	QPSK / 16QAM / 64QAM	15 RB / 0 RB Offset
		26715 to 26765	26715 (816.5MHz), 26740 (819.0MHz), 26765 (821.5MHz)	5MHz	QPSK / 16QAM / 64QAM	25 RB / 0 RB Offset
		26740	26740 (819.0MHz)	10MHz	QPSK / 16QAM / 64QAM	50 RB / 0 RB Offset
-	Emission Masks	26697 to 26783	26697 (814.7MHz), 26783 (823.3MHz)	1.4MHz	QPSK / 16QAM / 64QAM	1 RB / 0 RB Offset 6 RB / 0 RB Offset
		26705 to 26775	26705 (815.5MHz), 26775 (822.5MHz)	3MHz	QPSK / 16QAM / 64QAM	1 RB / 0 RB Offset 15 RB / 0 RB Offset
		26715 to 26765	26715 (816.5MHz), 26765 (821.5MHz)	5MHz	QPSK / 16QAM / 64QAM	1 RB / 0 RB Offset 25 RB / 0 RB Offset
		26740	26740 (819.0MHz)	10MHz	QPSK / 16QAM / 64QAM	1 RB / 0 RB Offset 50 RB / 0 RB Offset

EUT Configure Mode	Test item	Available channel	Tested channel	Channel Bandwidth	Modulation	Mode
-	Conducted Emission	26697 to 26783	26697 (814.7MHz), 26740 (819.0MHz), 26783 (823.3MHz)	1.4MHz	QPSK	1 RB / 2 RB Offset
		26705 to 26775	26705 (815.5MHz), 26740 (819.0MHz), 26775 (822.5MHz)	3MHz	QPSK	1 RB / 14 RB Offset
		26715 to 26765	26715 (816.5MHz), 26740 (819.0MHz), 26765 (821.5MHz)	5MHz	QPSK	1 RB / 12 RB Offset
		26740	26740 (819.0MHz)	10MHz	QPSK	1 RB / 0 RB Offset
-	Radiated Emission Below 1GHz	26715 to 26765	26765 (821.5MHz)	5MHz	QPSK	1 RB / 12 RB Offset
-	Radiated Emission Above 1GHz	26697 to 26783	26697 (814.7MHz), 26740 (819.0MHz), 26783 (823.3MHz)	1.4MHz	QPSK	1 RB / 2 RB Offset
		26715 to 26765	26715 (816.5MHz), 26740 (819.0MHz), 26765 (821.5MHz)	5MHz	QPSK	1 RB / 12 RB Offset
		26740	26740 (819.0MHz)	10MHz	QPSK	1 RB / 0 RB Offset

Note:

1. For radiated emission above 1GHz, according to 3GPP 36.521 Section 6.6.3.1.4, choose the lowest, 5MHz & highest channel bandwidth for final test.
2. For radiated emission below 1GHz, select the worst radiated emission (above 1GHz) channel for final testing.
3. The conducted output power for QPSK, 16QAM and 64QAM, measured value of QPSK is higher than 16QAM and 64QAM mode. Therefore, only ERP, Modulation Characteristics and Emission Bandwidth had been tested under QPSK, 16QAM and 64QAM modes, the other test items were performed under QPSK mode only.

Test Condition:

Test Item	Environmental Conditions	Input Power	Tested By
ERP	25deg. C, 70%RH	5Vdc	James Yang
Modulation characteristics	24deg. C, 64%RH	5Vdc	James Yang
Frequency Stability	24deg. C, 64%RH	5Vdc	James Yang
Occupied Bandwidth	24deg. C, 64%RH	5Vdc	James Yang
Emission Mask	24deg. C, 64%RH	5Vdc	James Yang
Conducted Emission	24deg. C, 64%RH	5Vdc	James Yang
Radiated Emission	22deg. C, 68%RH 25deg. C, 70%RH	120Vac, 60Hz	Greg Lin Luis Lee

3.4 EUT Operating Conditions

The EUT makes a call to the communication simulator. The communication simulator station system controlled a EUT to export maximum output power under transmission mode and specific channel frequency

3.5 General Description of Applied Standards and References

The EUT is a RF Product. According to the specifications of the manufacturer, it must comply with the requirements of the following standards:

Test Standard:

FCC 47 CFR Part 2

FCC 47 CFR Part 90

ANSI/TIA/EIA-603-E 2016

ANSI 63.26-2015

All test items have been performed and recorded as per the above standards.

References Test Guidance:

KDB 971168 D01 Power Meas License Digital Systems v03r01

KDB 971168 D02 Misc Rev Approv License Devices v02r01

All test items have been performed as a reference to the above KDB test guidance.

4 Test Types and Results

4.1 Output Power Measurement

4.1.1 Limits of Output Power Measurement

LTE Band 14:

The output power shall be according to the specific rule Part 90.635 that “Mobile station are limited to 100 watts e.r.p”.

LTE Band 26:

Control stations and mobile stations transmitting in the 758-768 MHz band and the 788-798 MHz band are limited to 30 watts ERP. Portable stations (hand-held devices) transmitting in the 758-768 MHz band and the 788-798 MHz band are limited to 3 watts ERP.

4.1.2 Test Procedures

Conducted Power Measurement:

The EUT was set up for the maximum power with LTE link data modulation and link up with simulator. Set the EUT to transmit under low, middle and high channel and record the power level shown on simulator.

$$\text{ERP or EIRP} = \text{PMeas} + \text{GT}$$

Where

ERP or EIRP effective radiated power or equivalent isotropically radiated power, respectively (expressed in the same units as PMeas, e.g., dBm or dBW)

PMeas measured transmitter output power or PSD, in dBm or dBW

GT gain of the transmitting antenna, in dBd (ERP) or dBi (EIRP)

4.1.3 Test Setup

Conducted Power Measurement:



For the actual test configuration, please refer to the attached file (Test Setup Photo).

4.1.4 Test Results

Conducted Output Power (dBm)

LTE Band 14						
BW	MCS Index	Channel		23305	23330	23355
		Frequency (MHz)		790.5	793	795.5
5M	QPSK	1	0	23.95	23.91	23.92
		1	12	24.15	24.03	24.10
		1	24	24.05	23.99	24.03
		12	0	23.13	23.11	23.08
		12	6	23.17	23.15	23.06
		12	13	23.07	23.04	22.99
		25	0	23.09	23.08	22.96
	16QAM	1	0	23.09	23.19	23.22
		1	12	23.08	23.31	23.23
		1	24	23.13	23.51	23.12
		12	0	22.11	22.17	22.04
		12	6	22.12	22.11	22.02
		12	13	22.03	22.08	22.08
		25	0	22.06	22.11	22.00
	64QAM	1	0	21.56	21.85	21.49
		1	12	21.50	21.99	21.71
		1	24	21.56	21.98	21.75
		12	0	20.38	20.33	20.28
		12	6	20.49	20.41	20.36
		12	13	20.44	20.45	20.33
		25	0	20.48	20.44	20.27

LTE Band 14				
BW	MCS Index	Channel		23330
		Frequency (MHz)		793
10M	QPSK	1	0	23.97
		1	24	24.03
		1	49	23.87
		25	0	22.96
		25	12	23.11
		25	25	23.07
		50	0	22.93
	16QAM	1	0	23.36
		1	24	23.25
		1	49	23.28
		25	0	21.94
		25	12	22.08
		25	25	22.10
		50	0	22.12
	64QAM	1	0	21.63
		1	24	21.48
		1	49	21.57
		25	0	20.43
		25	12	20.51
		25	25	20.30
		50	0	20.44

LTE Band 26						
BW	MCS Index	RB Size	RB Offset	Low	Mid	High
		Channel		26697	26740	26783
		Frequency (MHz)		814.7	819	823.3
1.4M	QPSK	1	0	23.90	23.77	23.62
		1	2	23.98	23.90	23.73
		1	5	23.84	23.75	23.74
		3	0	23.95	23.79	23.71
		3	1	23.89	23.83	23.83
		3	3	23.83	23.82	23.70
		6	0	22.99	22.83	22.80
	16QAM	1	0	23.07	23.29	22.88
		1	2	23.26	23.40	22.77
		1	5	23.16	23.36	22.78
		3	0	23.04	22.95	22.87
		3	1	23.10	22.89	23.02
		3	3	23.03	22.86	22.89
		6	0	22.07	21.86	21.82
	64QAM	1	0	21.85	21.45	21.49
		1	2	21.89	21.55	21.57
		1	5	21.78	21.51	21.53
		3	0	21.39	21.47	21.20
		3	1	21.39	21.50	21.30
		3	3	21.29	21.48	21.30
		6	0	20.39	20.46	20.36

LTE Band 26						
BW	MCS Index	Channel		26705	26740	26775
		Frequency (MHz)		815.5	819	822.5
3M	QPSK	1	0	23.95	23.89	23.82
		1	7	23.95	23.89	23.89
		1	14	23.87	23.81	23.97
		8	0	23.01	22.93	22.93
		8	3	23.05	23.01	23.00
		8	7	23.00	22.93	22.81
		15	0	23.00	22.96	22.91
	16QAM	1	0	23.61	23.14	23.39
		1	7	23.18	23.32	23.46
		1	14	23.48	23.30	23.42
		8	0	22.16	22.04	22.01
		8	3	22.12	22.08	22.11
		8	7	22.01	21.97	22.11
		15	0	22.04	21.82	22.09
	64QAM	1	0	21.56	21.84	21.81
		1	7	21.52	21.63	21.75
		1	14	21.86	21.68	21.84
		8	0	20.51	20.49	20.47
		8	3	20.54	20.45	20.52
		8	7	20.48	20.56	20.45
		15	0	20.45	20.48	20.35

LTE Band 26						
BW	MCS Index	Channel		26715	26740	26765
		Frequency (MHz)		816.5	819	821.5
5M	QPSK	1	0	24.04	23.93	23.76
		1	12	24.12	23.91	23.93
		1	24	24.00	23.91	23.93
		12	0	23.10	22.99	22.88
		12	6	23.05	22.98	22.96
		12	13	23.00	22.87	22.91
		25	0	22.97	22.95	22.98
	16QAM	1	0	23.15	23.03	23.44
		1	12	23.16	22.95	23.46
		1	24	22.78	23.03	23.13
		12	0	22.08	22.08	22.00
		12	6	22.13	22.02	22.04
		12	13	21.99	21.91	21.89
		25	0	22.03	22.01	22.02
	64QAM	1	0	21.38	21.85	21.46
		1	12	21.41	21.91	21.51
		1	24	21.41	21.94	21.59
		12	0	20.42	20.34	20.22
		12	6	20.39	20.43	20.31
		12	13	20.40	20.50	20.33
		25	0	20.37	20.39	20.29

LTE Band 26				
BW	MCS Index	Channel		26740
		Frequency (MHz)		819
10M	QPSK	1	0	23.88
		1	24	23.57
		1	49	23.77
		25	0	22.99
		25	12	22.94
		25	25	22.86
		50	0	22.89
	16QAM	1	0	23.62
		1	24	23.50
		1	49	23.40
		25	0	21.91
		25	12	21.95
		25	25	21.69
		50	0	21.81
	64QAM	1	0	21.67
		1	24	21.78
		1	49	21.58
		25	0	20.40
		25	12	20.42
		25	25	20.35
		50	0	20.45

ERP Power (dBm)

LTE Band 14						
BW	MCS Index	Channel		23305	23330	23355
		Frequency (MHz)		790.5	793	795.5
5M	QPSK	1	0	26.21	26.17	26.18
		1	12	26.41	26.29	26.36
		1	24	26.31	26.25	26.29
		12	0	25.39	25.37	25.34
		12	6	25.43	25.41	25.32
		12	13	25.33	25.30	25.25
		25	0	25.35	25.34	25.22
	16QAM	1	0	25.35	25.45	25.48
		1	12	25.34	25.57	25.49
		1	24	25.39	25.77	25.38
		12	0	24.37	24.43	24.30
		12	6	24.38	24.37	24.28
		12	13	24.29	24.34	24.34
		25	0	24.32	24.37	24.26
	64QAM	1	0	23.82	24.11	23.75
		1	12	23.76	24.25	23.97
		1	24	23.82	24.24	24.01
		12	0	22.64	22.59	22.54
		12	6	22.75	22.67	22.62
		12	13	22.70	22.71	22.59
		25	0	22.74	22.70	22.53

*ERP = Conducted + antenna gain (4.41dBi)-2.15

LTE Band 14				
BW	MCS Index	Channel		23330
		Frequency (MHz)		793
10M	QPSK	1	0	26.23
		1	24	26.29
		1	49	26.13
		25	0	25.22
		25	12	25.37
		25	25	25.33
		50	0	25.19
	16QAM	1	0	25.62
		1	24	25.51
		1	49	25.54
		25	0	24.20
		25	12	24.34
		25	25	24.36
		50	0	24.38
	64QAM	1	0	23.89
		1	24	23.74
		1	49	23.83
		25	0	22.69
		25	12	22.77
		25	25	22.56
		50	0	22.70

*ERP = Conducted + antenna gain (4.41dBi)-2.15

LTE Band 26						
BW	MCS Index	RB Size	RB Offset	Low	Mid	High
		Channel		26697	26740	26783
		Frequency (MHz)		814.7	819	823.3
1.4M	QPSK	1	0	25.56	25.43	25.28
		1	2	25.64	25.56	25.39
		1	5	25.50	25.41	25.40
		3	0	25.61	25.45	25.37
		3	1	25.55	25.49	25.49
		3	3	25.49	25.48	25.36
		6	0	24.65	24.49	24.46
	16QAM	1	0	24.73	24.95	24.54
		1	2	24.92	25.06	24.43
		1	5	24.82	25.02	24.44
		3	0	24.70	24.61	24.53
		3	1	24.76	24.55	24.68
		3	3	24.69	24.52	24.55
		6	0	23.73	23.52	23.48
	64QAM	1	0	23.51	23.11	23.15
		1	2	23.55	23.21	23.23
		1	5	23.44	23.17	23.19
		3	0	23.05	23.13	22.86
		3	1	23.05	23.16	22.96
		3	3	22.95	23.14	22.96
		6	0	22.05	22.12	22.02

*ERP = Conducted + antenna gain (3.81dBi)-2.15

LTE Band 26						
BW	MCS Index	Channel		26705	26740	26775
		Frequency (MHz)		815.5	819	822.5
3M	QPSK	1	0	25.61	25.55	25.48
		1	7	25.61	25.55	25.55
		1	14	25.53	25.47	25.63
		8	0	24.67	24.59	24.59
		8	3	24.71	24.67	24.66
		8	7	24.66	24.59	24.47
		15	0	24.66	24.62	24.57
	16QAM	1	0	25.27	24.80	25.05
		1	7	24.84	24.98	25.12
		1	14	25.14	24.96	25.08
		8	0	23.82	23.70	23.67
		8	3	23.78	23.74	23.77
		8	7	23.67	23.63	23.77
		15	0	23.70	23.48	23.75
	64QAM	1	0	23.22	23.50	23.47
		1	7	23.18	23.29	23.41
		1	14	23.52	23.34	23.50
		8	0	22.17	22.15	22.13
		8	3	22.20	22.11	22.18
		8	7	22.14	22.22	22.11
		15	0	22.11	22.14	22.01

*ERP = Conducted + antenna gain (3.81dBi)-2.15

LTE Band 26						
BW	MCS Index	Channel		26715	26740	26765
		Frequency (MHz)		816.5	819	821.5
5M	QPSK	1	0	25.70	25.59	25.42
		1	12	25.78	25.57	25.59
		1	24	25.66	25.57	25.59
		12	0	24.76	24.65	24.54
		12	6	24.71	24.64	24.62
		12	13	24.66	24.53	24.57
		25	0	24.63	24.61	24.64
	16QAM	1	0	24.81	24.69	25.10
		1	12	24.82	24.61	25.12
		1	24	24.44	24.69	24.79
		12	0	23.74	23.74	23.66
		12	6	23.79	23.68	23.70
		12	13	23.65	23.57	23.55
		25	0	23.69	23.67	23.68
	64QAM	1	0	23.04	23.51	23.12
		1	12	23.07	23.57	23.17
		1	24	23.07	23.60	23.25
		12	0	22.08	22.00	21.88
		12	6	22.05	22.09	21.97
		12	13	22.06	22.16	21.99
		25	0	22.03	22.05	21.95

*ERP = Conducted + antenna gain (3.81dBi)-2.15

LTE Band 26				
BW	MCS Index	Channel		26740
		Frequency (MHz)		819
10M	QPSK	1	0	25.54
		1	24	25.23
		1	49	25.43
		25	0	24.65
		25	12	24.60
		25	25	24.52
		50	0	24.55
	16QAM	1	0	25.28
		1	24	25.16
		1	49	25.06
		25	0	23.57
		25	12	23.61
		25	25	23.35
		50	0	23.47
	64QAM	1	0	23.33
		1	24	23.44
		1	49	23.24
		25	0	22.06
		25	12	22.08
		25	25	22.01
		50	0	22.11

*ERP = Conducted + antenna gain (3.81dBi)-2.15

4.2 Modulation Characteristics Measurement

4.2.1 Limits of Modulation Characteristics

N/A

4.2.2 Test Procedure

Connect the EUT to Communication Simulator via the antenna connector, The frequency band is set as EUT supported Modulation and Channels, the EUT output is matched with 50 ohm load, the waveform quality and constellation of the EUT was tested.

4.2.3 Test Setup



4.2.4 Test Results

LTE Band 14

Spectrum Plot of Measurement Value

Channel: 23330 / Frequency (MHz): 793.0MHz

QPSK

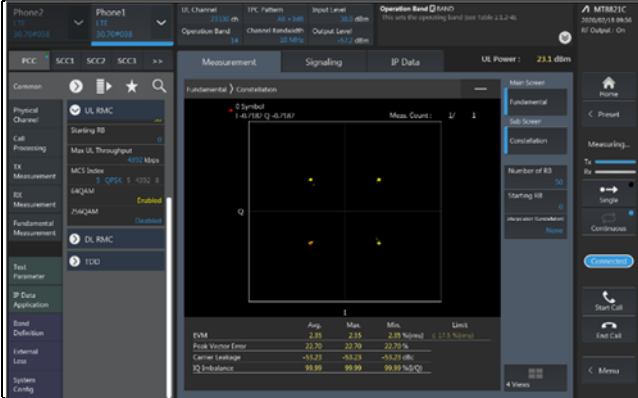

16QAM

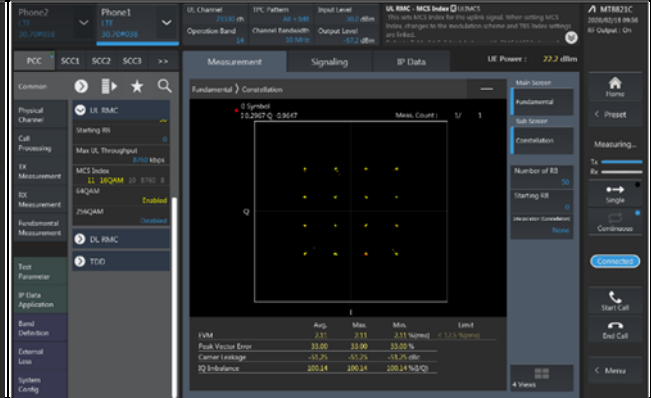

64QAM

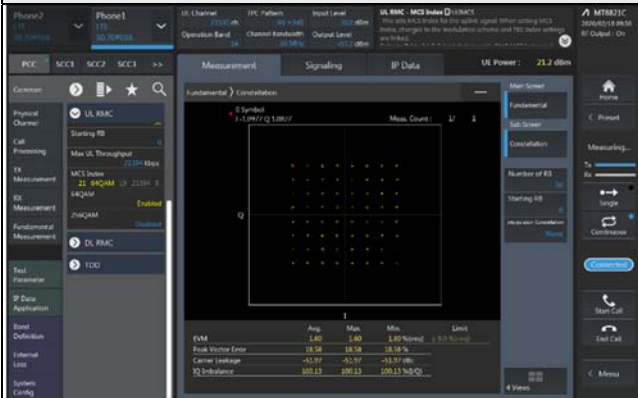

LTE Band 26

Spectrum Plot of Measurement Value

Channel: 26740 / Frequency (MHz): 819.0MHz

Channel Bandwidth 10MHz / QPSK

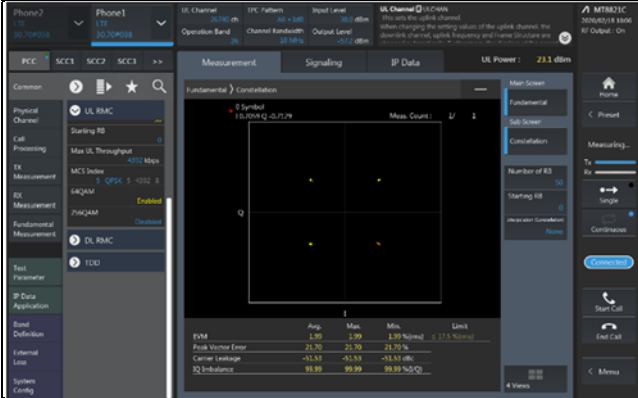

Channel Bandwidth 10MHz / 16QAM

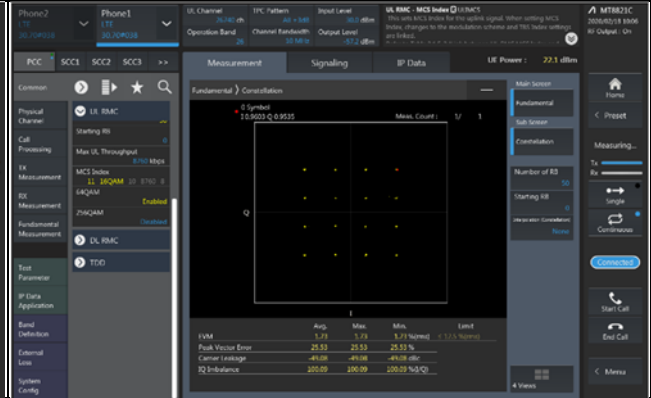

Channel Bandwidth 10MHz / 64QAM

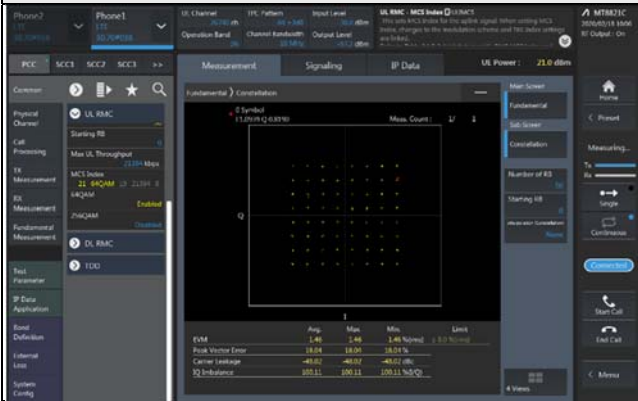

4.3 Frequency Stability Measurement

4.3.1 Limits of Frequency Stability Measurement

LTE Band 14:

The frequency stability of mobile, portable and control transmitters operating in the wideband segment must be 1.25 parts per million or better when AFC is locked to a base station, and 5 parts per million or better when AFC is not locked.

LTE Band 26:

1.5 ppm is for base and fixed station. 2.5 ppm is for mobile station.

4.3.2 Test Procedure

- Device is placed at the oven room. The oven room could control the temperatures and humidity. Power warm up is at least 15 min and power applied should perform before recording frequency error.
- EUT is connected the external power supply to control the DC input power. The test voltage range is from minimum to maximum working voltage. Each step shall be record the frequency error rate.
- The temperature range step is 10 degrees in this test items. All temperature levels shall be hold the ± 0.5 °C during the measurement testing. The each temperature step shall be at least 0.5 hours, consider the EUT could be test under the stability condition.

Note: The frequency error was recorded frequency error from the communication simulator.

4.3.3 Test Setup

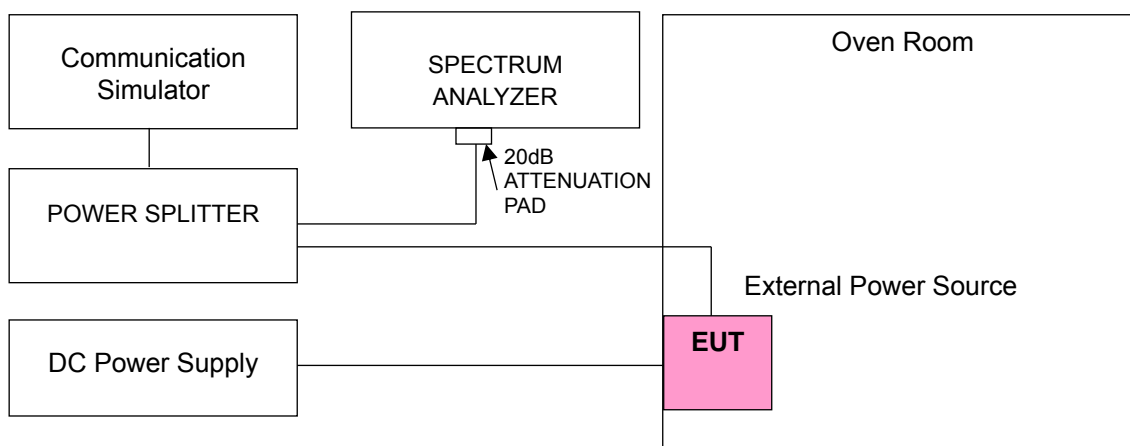

4.3.4 Test Results

Frequency Error vs. Voltage

Voltage (Volts)	LTE Band 14			
	Channel Bandwidth: 5MHz			
	Low Channel		High Channel	
	Frequency (MHz)	Frequency Error (ppm)	Frequency (MHz)	Frequency Error (ppm)
4.25	790.500004	0.004	795.500003	0.004
5	790.500002	0.002	795.500003	0.004
5.75	790.500004	0.005	795.500002	0.003

Note: The applicant defined the normal working voltage is from 4.25Vdc to 5.75Vdc.

Frequency Error vs. Temperature

Temp. (°C)	LTE Band 14			
	Channel Bandwidth: 5 MHz			
	Low Channel		High Channel	
	Frequency (MHz)	Frequency Error (ppm)	Frequency (MHz)	Frequency Error (ppm)
-30	790.500003	0.004	795.500001	0.002
-20	790.500003	0.004	795.500002	0.003
-10	790.500003	0.004	795.500002	0.002
0	790.500003	0.004	795.500004	0.005
10	790.500003	0.004	795.500003	0.003
20	790.499997	-0.004	795.499998	-0.003
30	790.499997	-0.004	795.499997	-0.003
40	790.499998	-0.002	795.499998	-0.003
50	790.499996	-0.005	795.499998	-0.002

Frequency Error vs. Voltage

Voltage (Volts)	LTE Band 14	
	Channel Bandwidth: 10 MHz	
	Frequency (MHz)	Frequency Error (ppm)
4.25	793.000002	0.003
5	793.000002	0.002
5.75	793.000002	0.003

Note: The applicant defined the normal working voltage is from 4.25Vdc to 5.75Vdc.

Frequency Error vs. Temperature

Temp. (°C)	LTE Band 14	
	Channel Bandwidth: 10 MHz	
	Frequency (MHz)	Frequency Error (ppm)
-30	793.000002	0.002
-20	793.000003	0.004
-10	793.000001	0.001
0	793.000002	0.002
10	793.000004	0.005
20	792.999998	-0.002
30	792.999996	-0.005
40	792.999998	-0.003
50	792.999997	-0.004

Frequency Error vs. Voltage

Voltage (Volts)	LTE Band 26			
	Channel Bandwidth: 1.4 MHz			
	Low Channel		High Channel	
	Frequency (MHz)	Frequency Error (ppm)	Frequency (MHz)	Frequency Error (ppm)
4.25	814.700001	0.002	823.300001	0.002
5	814.700002	0.003	823.300001	0.001
5.75	814.700002	0.003	823.300003	0.003

Note: The applicant defined the normal working voltage is from 4.25Vdc to 5.75Vdc.

Frequency Error vs. Temperature

Temp. (°C)	LTE Band 26			
	Channel Bandwidth: 1.4 MHz			
	Low Channel		High Channel	
	Frequency (MHz)	Frequency Error (ppm)	Frequency (MHz)	Frequency Error (ppm)
-30	814.700002	0.003	823.300001	0.001
-20	814.700004	0.005	823.300003	0.003
-10	814.700004	0.004	823.300002	0.002
0	814.700001	0.002	823.300001	0.002
10	814.700002	0.003	823.300003	0.004
20	814.699998	-0.002	823.299998	-0.003
30	814.699996	-0.004	823.299996	-0.004
40	814.699996	-0.005	823.299997	-0.003
50	814.699998	-0.002	823.299997	-0.004

Frequency Error vs. Voltage

Voltage (Volts)	LTE Band 26			
	Channel Bandwidth: 3MHz			
	Low Channel		High Channel	
	Frequency (MHz)	Frequency Error (ppm)	Frequency (MHz)	Frequency Error (ppm)
4.25	815.500002	0.003	822.500001	0.001
5	815.500003	0.004	822.500001	0.004
5.75	815.500002	0.002	822.500003	0.003

Note: The applicant defined the normal working voltage is from 4.25Vdc to 5.75Vdc.

Frequency Error vs. Temperature

Temp. (°C)	LTE Band 26			
	Channel Bandwidth: 3MHz			
	Low Channel		High Channel	
	Frequency (MHz)	Frequency Error (ppm)	Frequency (MHz)	Frequency Error (ppm)
-30	815.500002	0.003	822.500001	0.004
-20	815.500002	0.003	822.500003	0.003
-10	815.500002	0.003	822.500002	0.004
0	815.500003	0.004	822.500001	0.004
10	815.500003	0.004	822.500003	0.002
20	815.499997	-0.004	822.499998	-0.003
30	815.499996	-0.005	822.499996	-0.003
40	815.499998	-0.002	822.499997	-0.005
50	815.499997	-0.003	822.499997	-0.003

Frequency Error vs. Voltage

Voltage (Volts)	LTE Band 26			
	Channel Bandwidth: 5MHz			
	Low Channel		High Channel	
	Frequency (MHz)	Frequency Error (ppm)	Frequency (MHz)	Frequency Error (ppm)
4.25	816.500003	0.003	821.500002	0.003
5	816.500002	0.002	821.500004	0.004
5.75	816.500001	0.002	821.500001	0.001

Note: The applicant defined the normal working voltage is from 4.25Vdc to 5.75Vdc.

Frequency Error vs. Temperature

Temp. (°C)	LTE Band 26			
	Channel Bandwidth: 5MHz			
	Low Channel		High Channel	
	Frequency (MHz)	Frequency Error (ppm)	Frequency (MHz)	Frequency Error (ppm)
-30	816.500001	0.001	821.500003	0.004
-20	816.500003	0.004	821.500002	0.002
-10	816.500002	0.002	821.500002	0.002
0	816.500003	0.004	821.500002	0.003
10	816.500002	0.002	821.500002	0.003
20	816.499998	-0.003	821.499996	-0.005
30	816.499997	-0.004	821.499997	-0.004
40	816.499999	-0.001	821.499996	-0.005
50	816.499999	-0.002	821.499998	-0.003

Frequency Error vs. Voltage

Voltage (Volts)	LTE Band 26	
	Channel Bandwidth: 10 MHz	
	Frequency (MHz)	Frequency Error (ppm)
4.25	819.000001	0.001
5	819.000004	0.005
5.75	819.000004	0.004

Note: The applicant defined the normal working voltage is from 4.25Vdc to 5.75Vdc.

Frequency Error vs. Temperature

Temp. (°C)	LTE Band 26	
	Channel Bandwidth: 10 MHz	
	Frequency (MHz)	Frequency Error (ppm)
-30	819.000004	0.005
-20	819.000003	0.004
-10	819.000001	0.002
0	819.000004	0.005
10	819.000003	0.004
20	818.999996	-0.005
30	818.999999	-0.001
40	818.999998	-0.003
50	818.999997	-0.004

4.4 Occupied Bandwidth Measurement

4.4.1 Limits of Occupied Bandwidth Measurement

The width of a frequency band such that, below the lower and above the upper frequency limits, the mean powers emitted are each equal to a specified percentage 0.5 % of the total mean power of a given emission.

4.4.2 Test Procedure

The width of a frequency band such that, below the lower and above the upper frequency limits, the mean powers emitted are each equal to a specified percentage 0.5 % of the total mean power of a given emission.

4.4.3 Test Setup

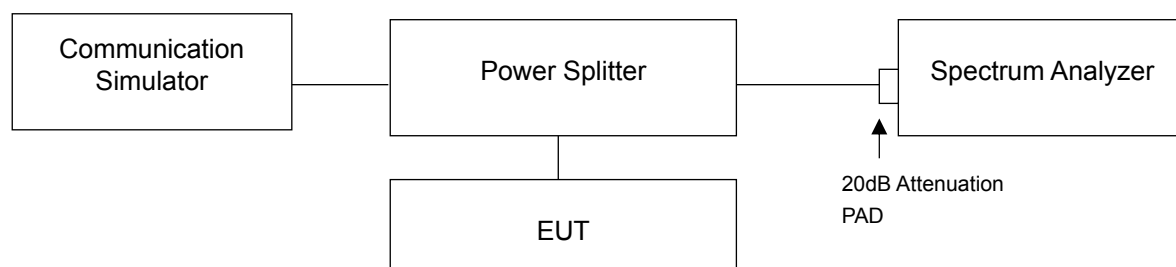

4.4.4 Test Result

Occupied Bandwidth

LTE Band 14, Channel Bandwidth 5MHz				
Channel	Frequency (MHz)	99% Occupied Bandwidth (MHz)		
		QPSK	16QAM	64QAM
23305	790.5	4.48	4.49	4.49
23330	793	4.49	4.49	4.49
23355	795.5	4.49	4.49	4.49

LTE Band 14, Channel Bandwidth 10MHz				
Channel	Frequency (MHz)	99% Occupied Bandwidth (MHz)		
		QPSK	16QAM	64QAM
23330	793	8.96	8.96	8.96

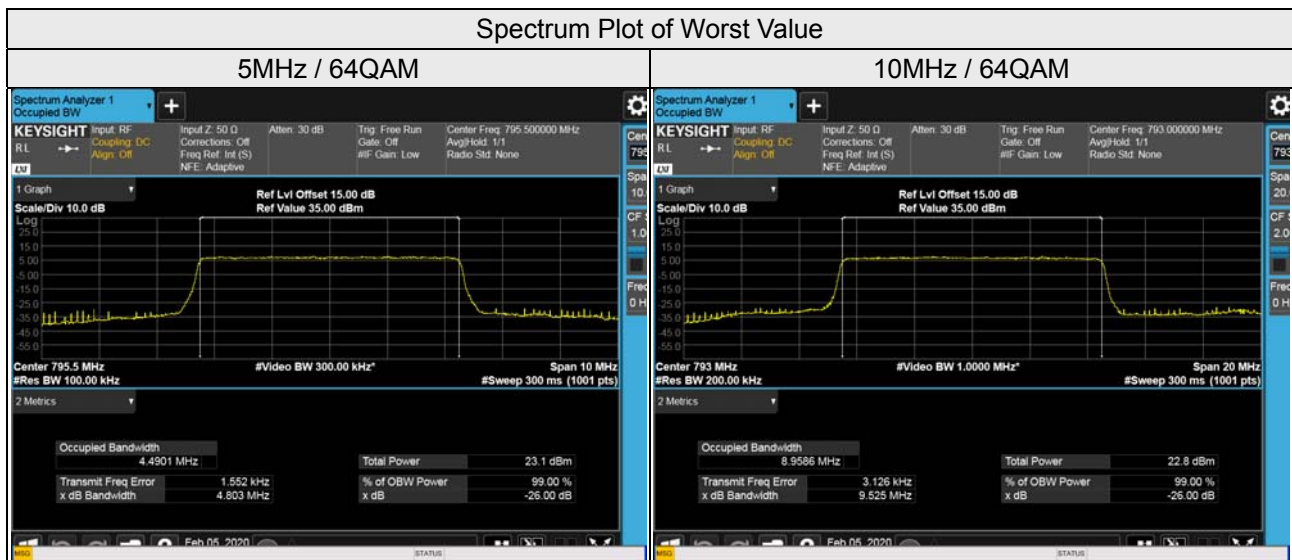

LTE Band 26, Channel Bandwidth 1.4MHz				
Channel	Frequency (MHz)	99% Occupied Bandwidth (MHz)		
		QPSK	16QAM	64QAM
26697	814.7	1.09	1.09	1.09
26740	819.0	1.09	1.09	1.09
26783	823.3	1.09	1.09	1.09

LTE Band 26, Channel Bandwidth 3MHz				
Channel	Frequency (MHz)	99% Occupied Bandwidth (MHz)		
		QPSK	16QAM	64QAM
26705	815.5	2.70	2.70	2.69
26740	819.0	2.70	2.69	2.70
26775	822.5	2.70	2.69	2.69

LTE Band 26, Channel Bandwidth 5MHz				
Channel	Frequency (MHz)	99% Occupied Bandwidth (MHz)		
		QPSK	16QAM	64QAM
26715	816.5	4.48	4.49	4.49
26740	819.0	4.49	4.49	4.49
26765	821.5	4.49	4.48	4.49

LTE Band 26, Channel Bandwidth 10MHz				
Channel	Frequency (MHz)	99% Occupied Bandwidth (MHz)		
		QPSK	16QAM	64QAM
26740	819.0	8.95	8.95	8.95

Spectrum Plot of Worst Value

1.4MHz / 16QAM



3MHz / QPSK

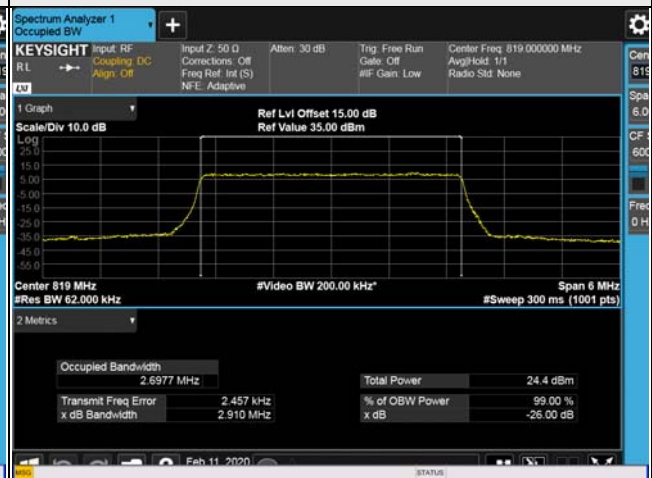

5MHz / 64QAM



10MHz / 64QAM

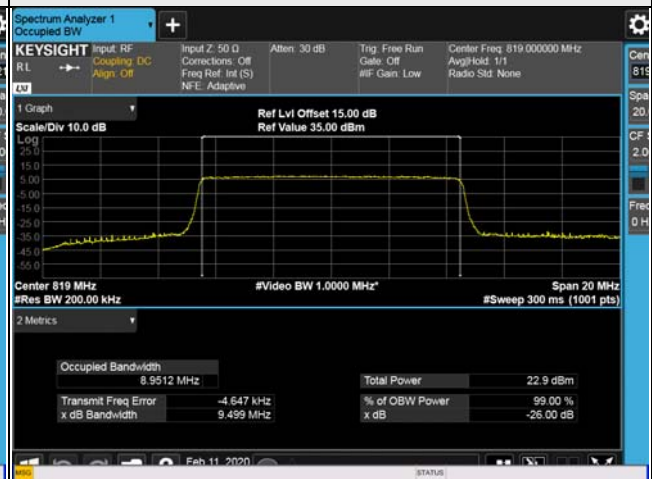

26dB Bandwidth

LTE Band 14, Channel Bandwidth 5MHz				
Channel	Frequency (MHz)	26dB Bandwidth (MHz)		
		QPSK	16QAM	64QAM
23305	790.5	4.80	4.80	4.81
23330	793	4.79	4.79	4.80
23355	795.5	4.82	4.81	4.80

LTE Band 14, Channel Bandwidth 10MHz				
Channel	Frequency (MHz)	26dB Bandwidth (MHz)		
		QPSK	16QAM	64QAM
23330	793	9.52	9.51	9.53

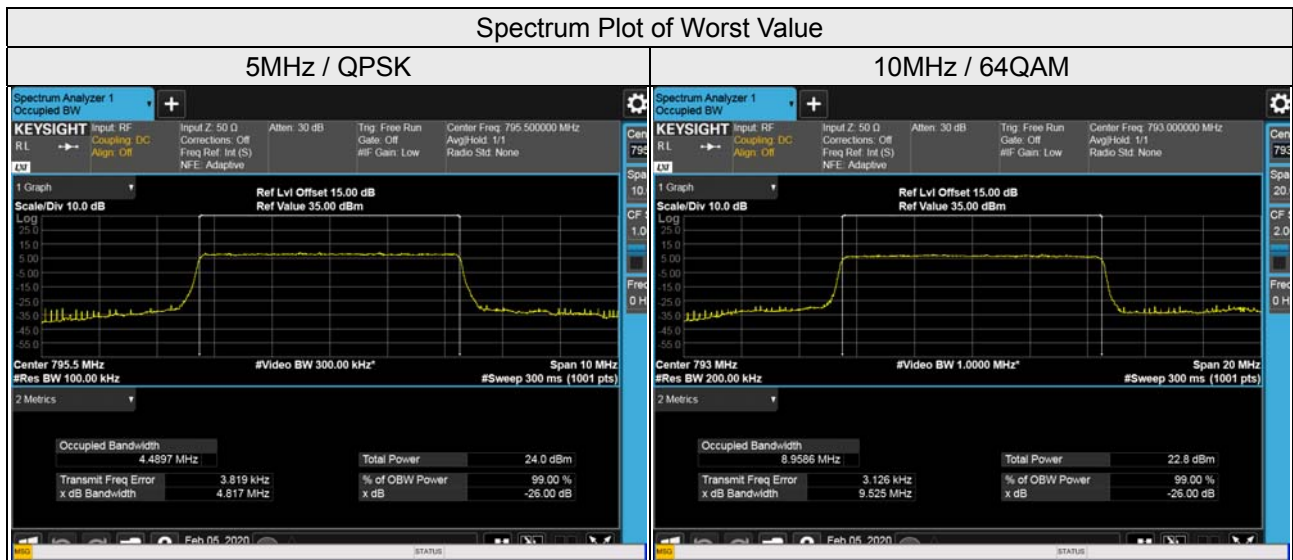

LTE Band 26, Channel Bandwidth 1.4MHz				
Channel	Frequency (MHz)	26dB Bandwidth (MHz)		
		QPSK	16QAM	64QAM
26697	814.7	1.21	1.22	1.21
26740	819.0	1.21	1.21	1.21
26783	823.3	1.21	1.22	1.21

LTE Band 26, Channel Bandwidth 3MHz				
Channel	Frequency (MHz)	26dB Bandwidth (MHz)		
		QPSK	16QAM	64QAM
26705	815.5	2.93	2.93	2.93
26740	819.0	2.91	2.93	2.93
26775	822.5	2.91	2.91	2.92

LTE Band 26, Channel Bandwidth 5MHz				
Channel	Frequency (MHz)	26dB Bandwidth (MHz)		
		QPSK	16QAM	64QAM
26715	816.5	4.79	4.80	4.80
26740	819.0	4.80	4.80	4.80
26765	821.5	4.80	4.80	4.80

LTE Band 26, Channel Bandwidth 10MHz				
Channel	Frequency (MHz)	26dB Bandwidth (MHz)		
		QPSK	16QAM	64QAM
26740	819.0	9.49	9.51	9.50

Spectrum Plot of Worst Value

1.4MHz / 16QAM



3MHz / 64QAM

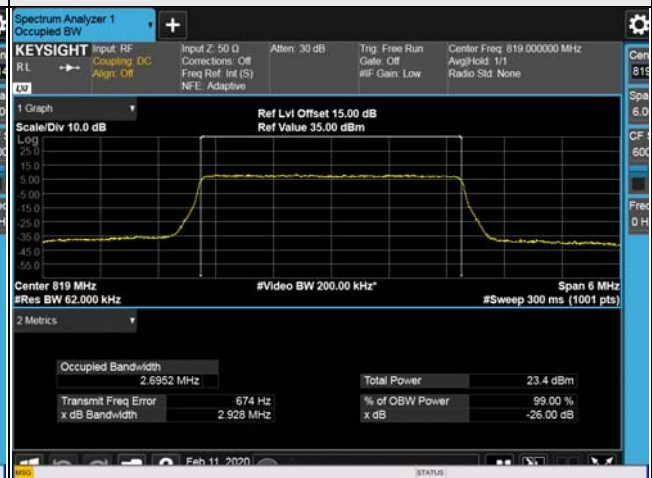

5MHz / QPSK

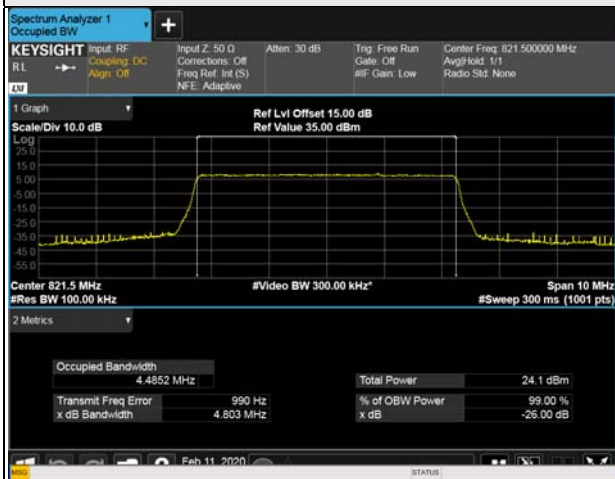

10MHz / 16QAM

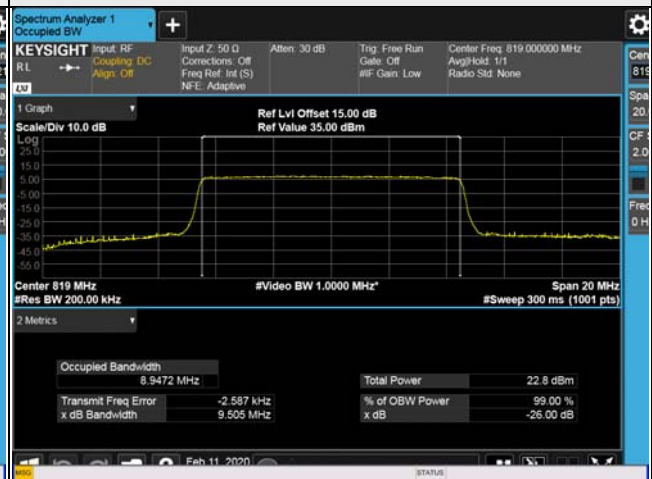

4.5 Emission Mask Measurement

4.5.1 Limits of Emission Mask Measurement

LTE Band 14:

According to FCC part 90.210 (b) shall be tested the emission mask. For transmitters that are equipped with an audio low-pass filter, the power of any emission must be attenuated below the unmodulated carrier power (P) as follows:

- (1) On any frequency removed from the assigned frequency by more than 50 percent, but not more than 100 percent of the authorized bandwidth: At least 25 dB.
- (2) On any frequency removed from the assigned frequency by more than 100 percent, but not more than 250 percent of the authorized bandwidth: At least 35 dB.
- (3) On any frequency removed from the assigned frequency by more than 250 percent of the authorized bandwidth: At least $43 + 10 \log (P)$ dB.

LTE Band 26:

According to FCC part 90.691 shall be tested the emission mask. For any frequency removed from the EA licensee's frequency block by up to and including 37.5 kHz, the power of any emission shall be attenuated below the transmitter power (P) in watts by at least $116 \log_{10}(f/6.1)$ decibels or $50 + 10 \log_{10}(P)$ decibels or 80 decibels, whichever is the lesser attenuation, where f is the frequency removed from the center of the outer channel in the block in kilohertz and where f is greater than 12.5 kHz.

For any frequency removed from the EA licensee's frequency block greater than 37.5 kHz, the power of any emission shall be attenuated below the transmitter power (P) in watts by at least $43 + 10 \log_{10}(P)$ decibels or 80 decibels, whichever is the lesser attenuation, where f is the frequency removed from the center of the outer channel in the block in kilohertz and where f is greater than 37.5 kHz.

For § 90.691(a), RBW=300 Hz for offset less than 37.5 kHz from channel edge and RBW=100 kHz for offsets greater than 37.5 kHz is allowed, tested in accordance with FCC KDB 971168 D02 section VIII.

4.5.2 Test Setup

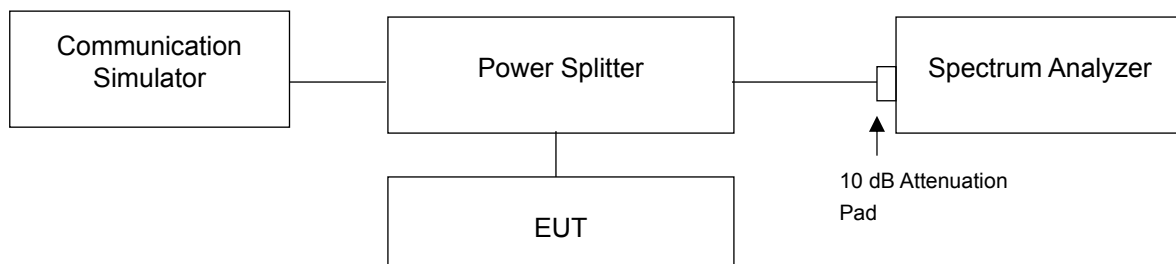

4.5.3 Test Procedures

- a. The measurement used the power splitter via EUT RF power connector between simulation base station and spectrum analyzer.
- b. Record the test plot.

4.5.4 Test Results

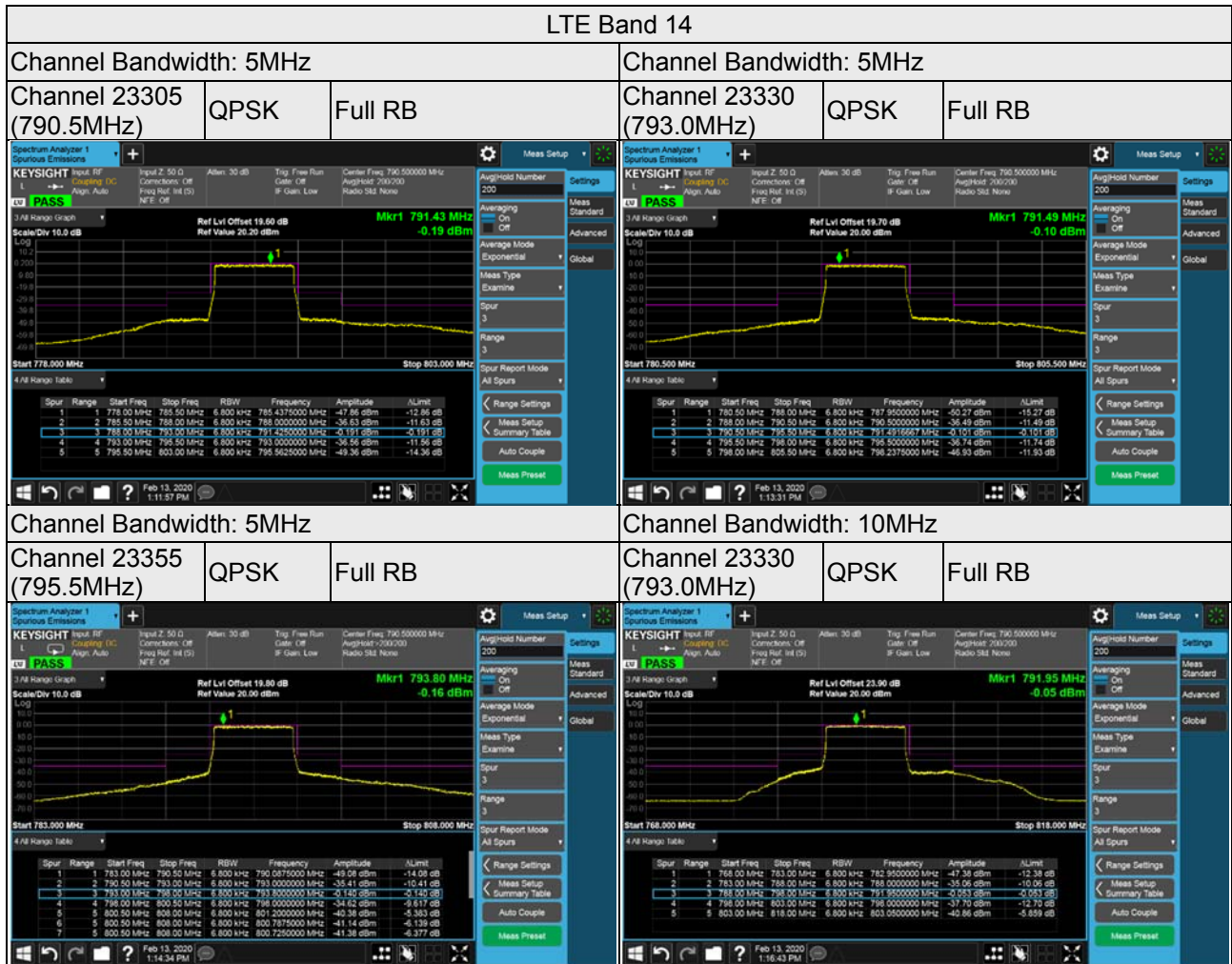

LTE Band 26

Channel Bandwidth: 1.4 MHz / QPSK

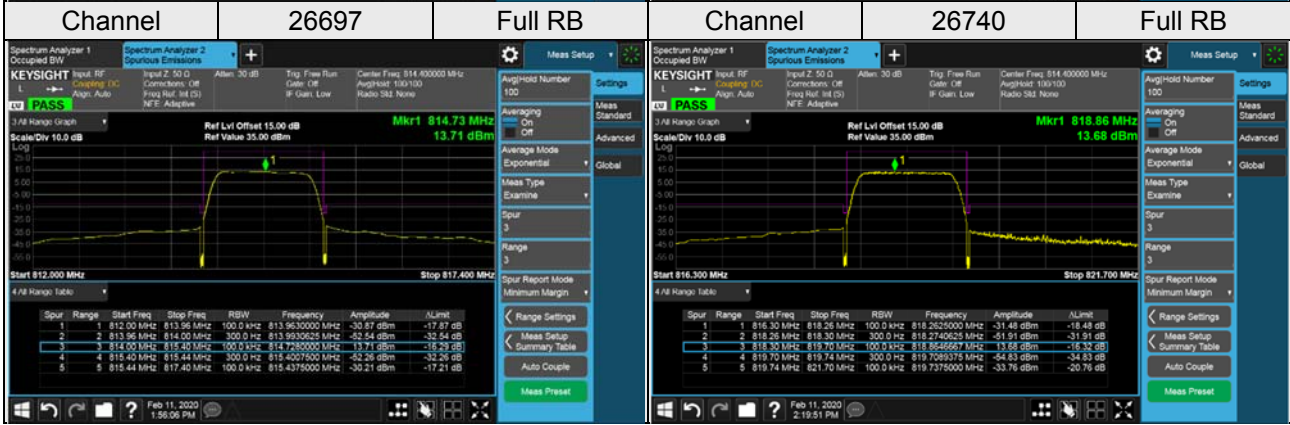
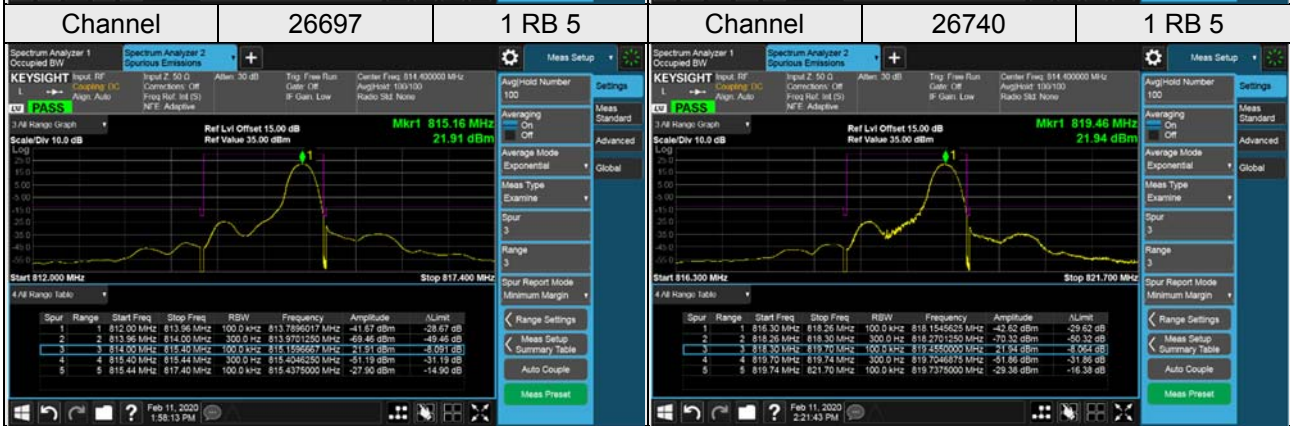
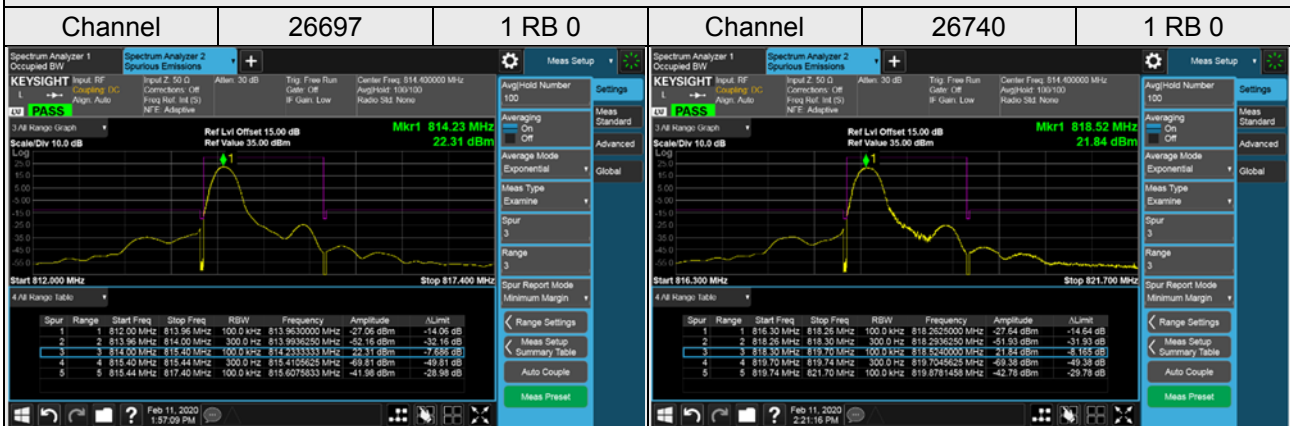

LTE Band 26

Channel Bandwidth: 1.4 MHz / QPSK

Channel 26783 1 RB 0

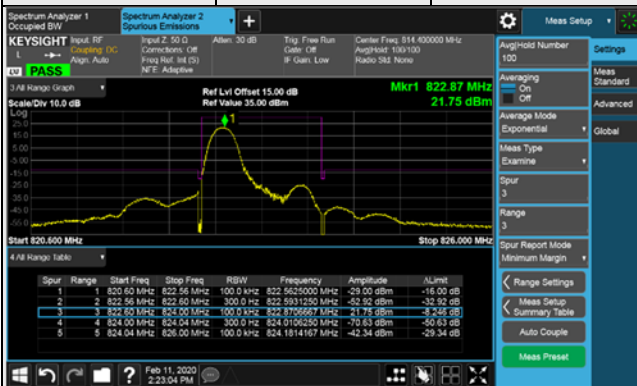

Channel 26783 1 RB 5

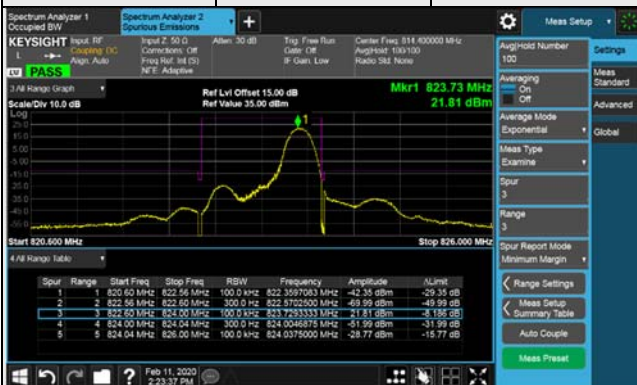

Channel 26783 Full RB

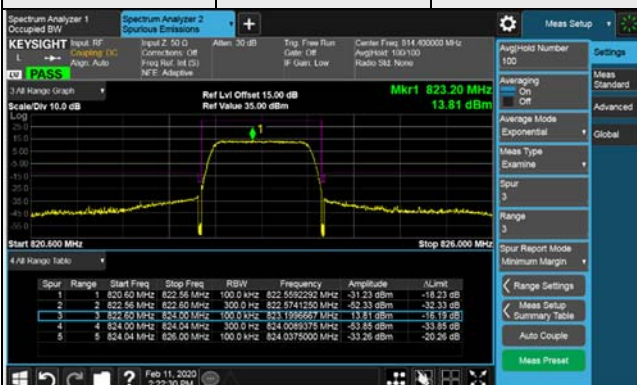

LTE Band 26

Channel Bandwidth: 3 MHz / QPSK

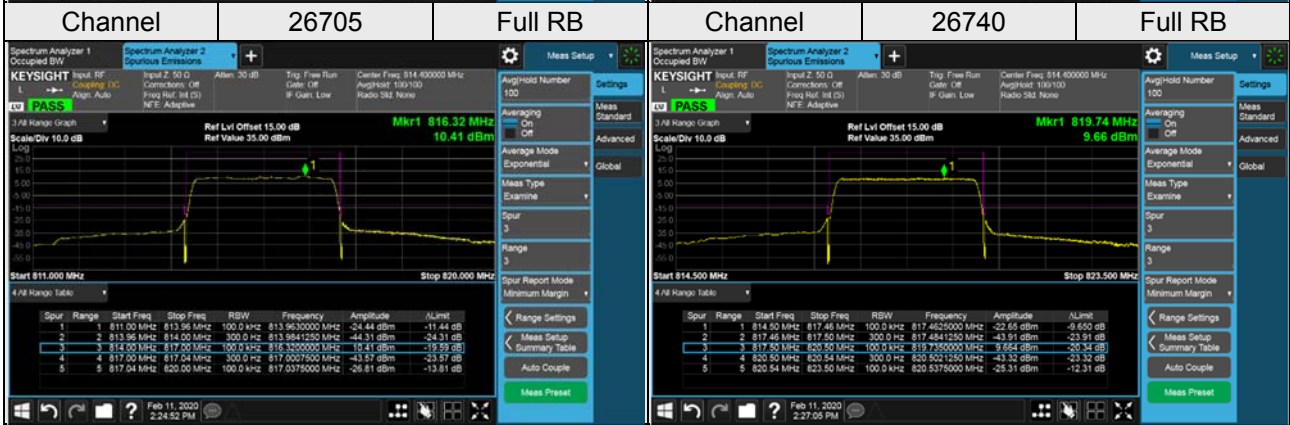
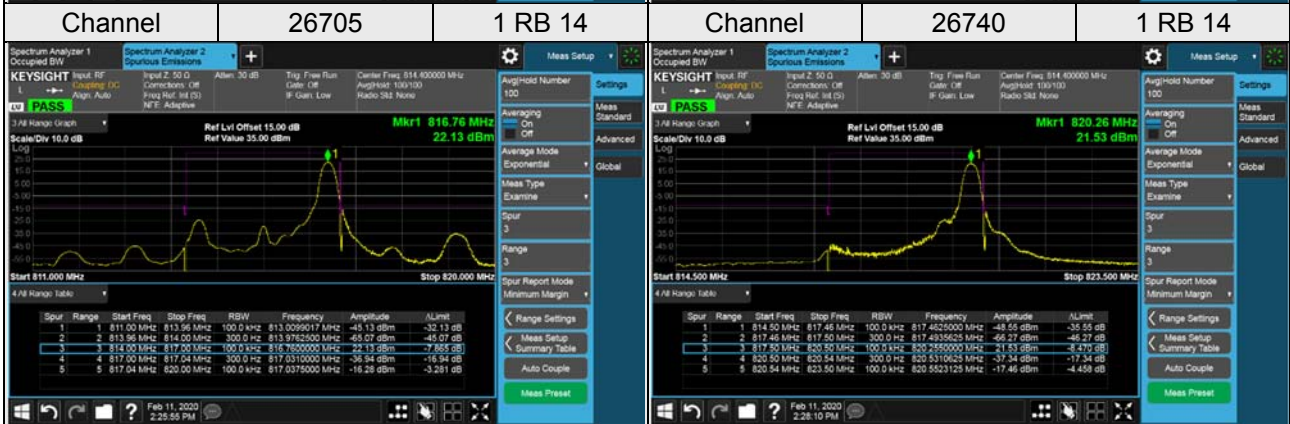
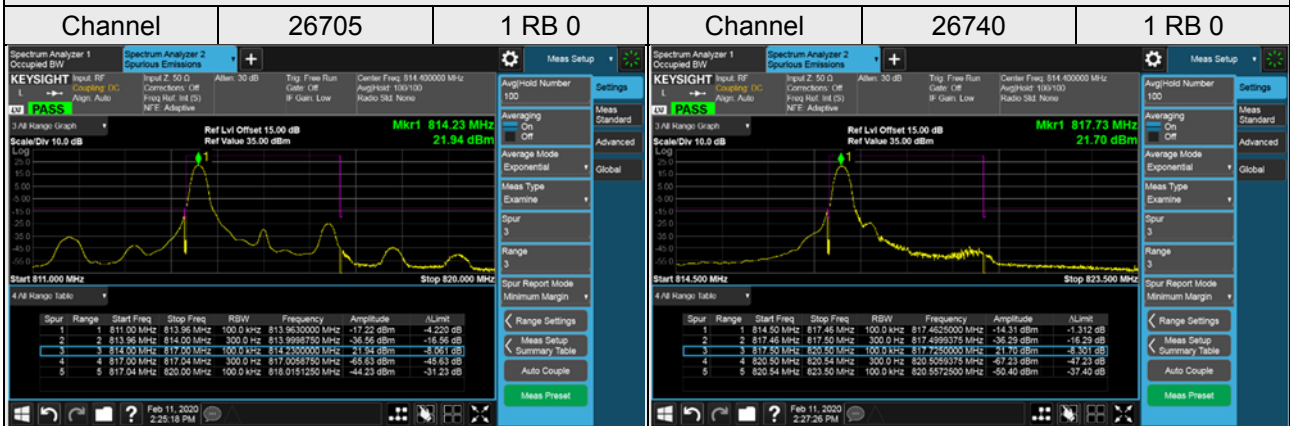

LTE Band 26

Channel Bandwidth: 3 MHz / QPSK

Channel

26775

1 RB 0

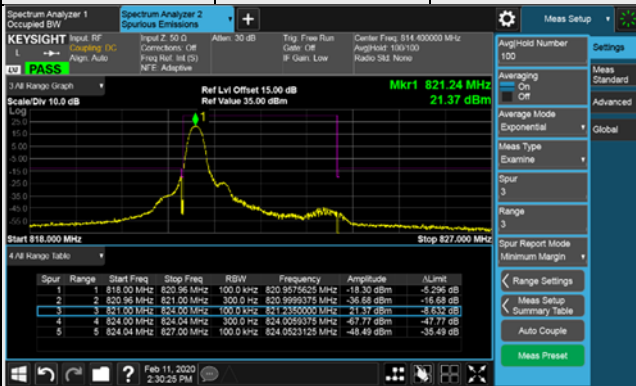

Channel

26775

1 RB 14

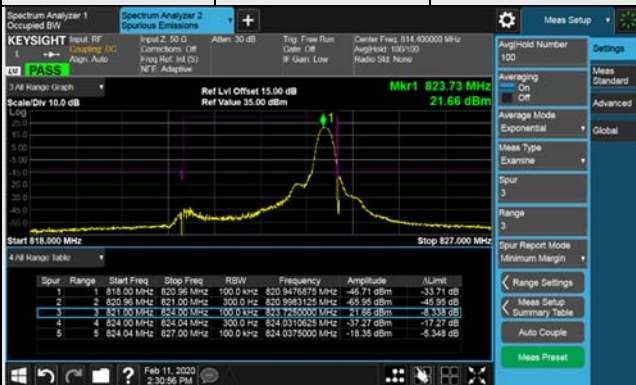

Channel

26775

Full RB

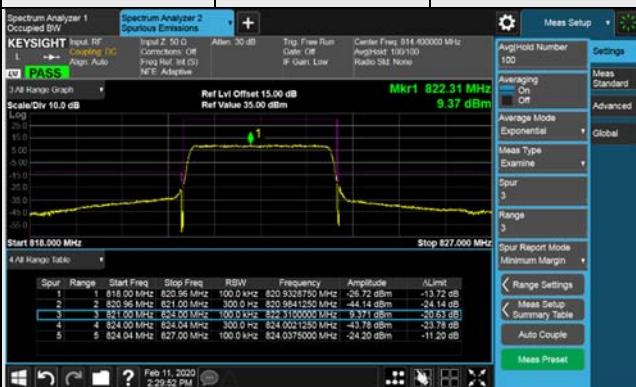

LTE Band 26

Channel Bandwidth: 5 MHz / QPSK

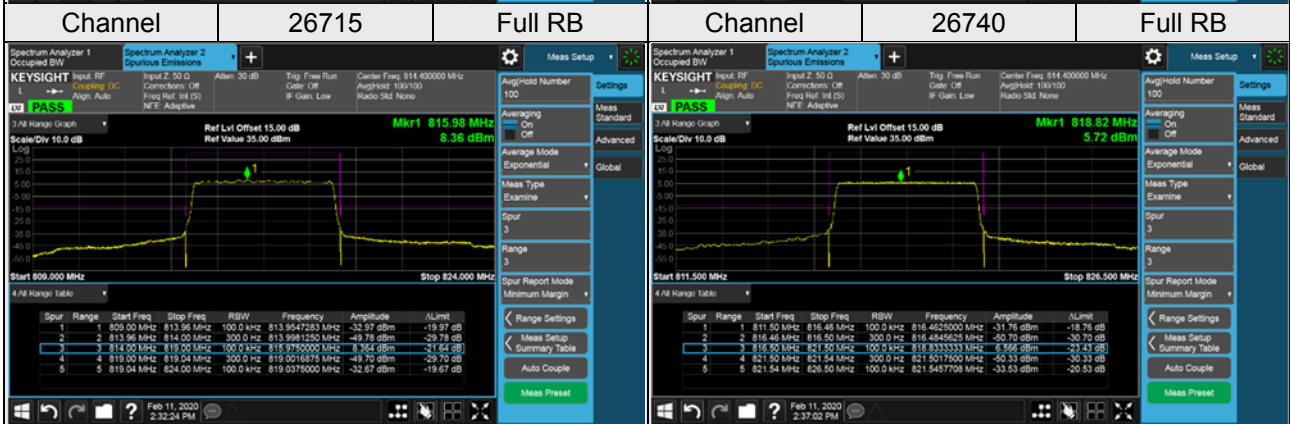
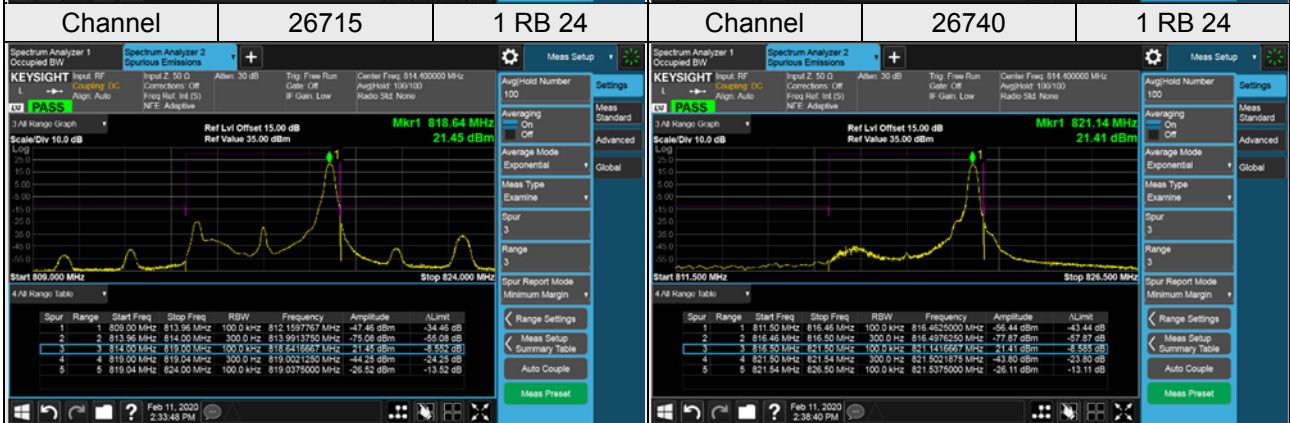
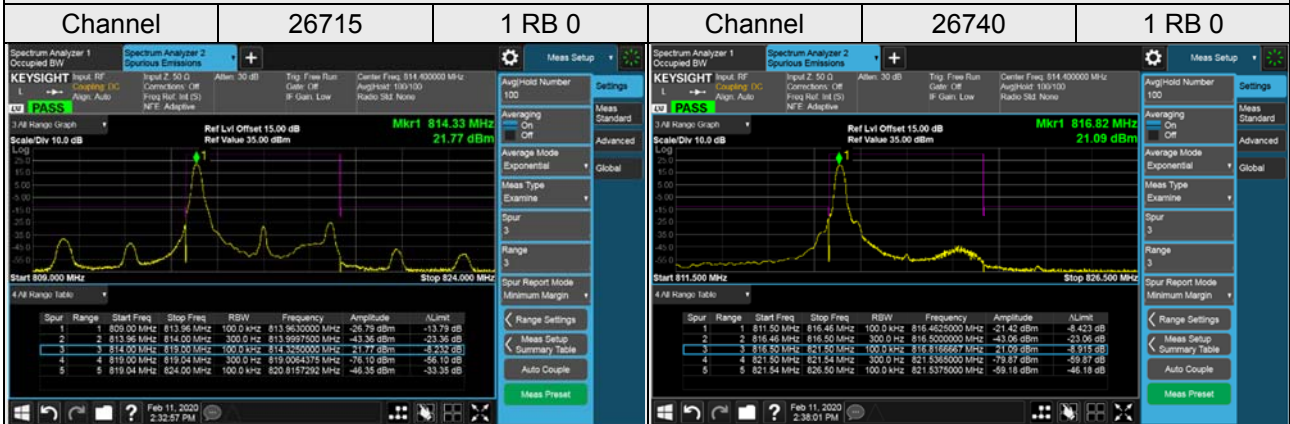

LTE Band 26

Channel Bandwidth: 5 MHz / QPSK

Channel 26765 1 RB 0

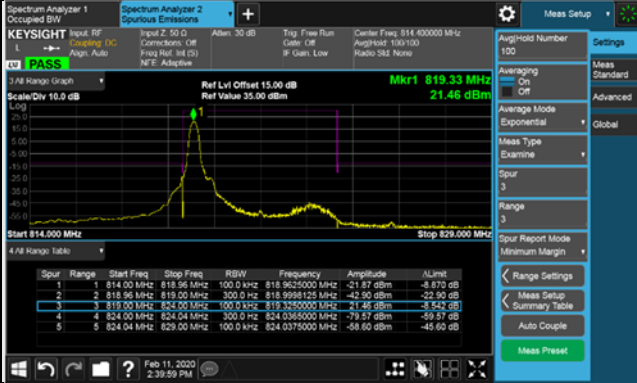

Channel 26765 1 RB 24

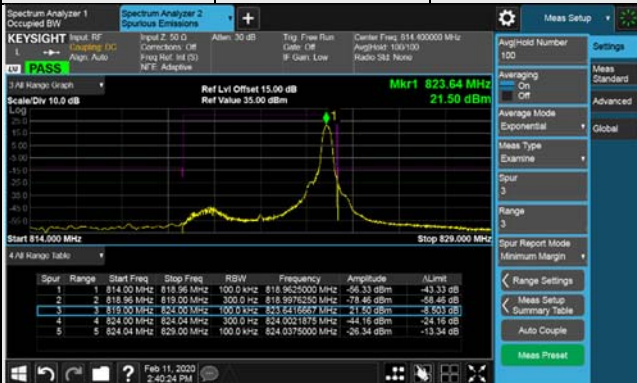

Channel 26765 Full RB

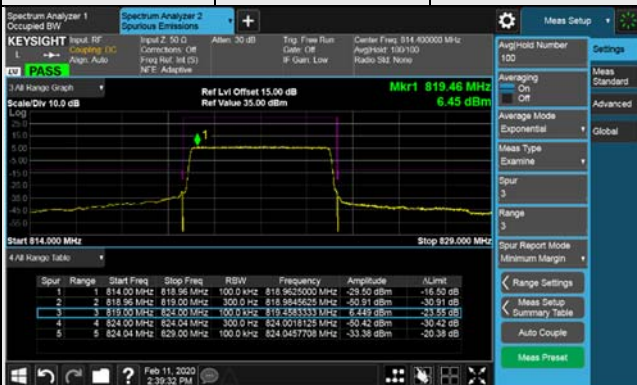

LTE Band 26

Channel Bandwidth: 10 MHz / QPSK

Channel 26740

1 RB 0

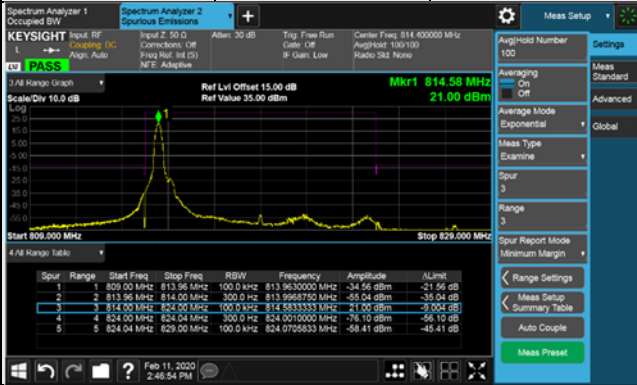

Channel 26740

1 RB 49

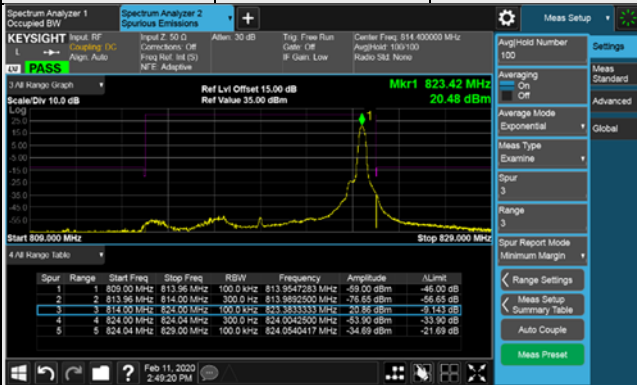

Channel 26740

Full RB

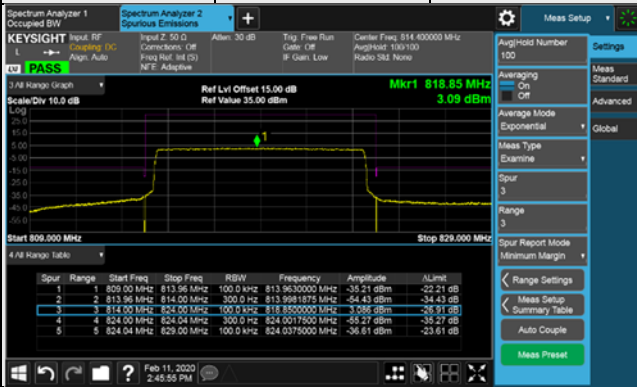

4.6 Band Edge Measurement

4.6.1 Limits of Band Edge Measurement

- (1) On all frequencies between 769-775 MHz and 799-805 MHz, by a factor not less than $65 + 10 \log (P)$ dB in a 6.25 kHz band segment, for mobile and portable stations.
- (2) On any frequency between 775-788 MHz, above 805 MHz, and below 758 MHz, by at least $43 + 10 \log (P)$ dB.

4.6.2 Test Setup

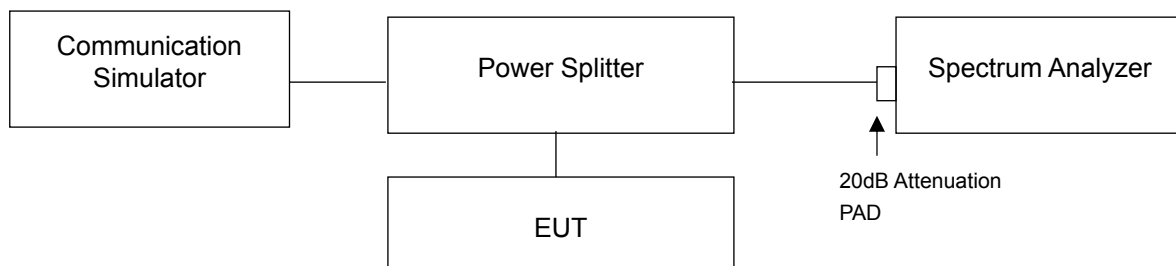

4.6.3 Test Procedures

- a. All measurements were done at low, middle and high operational frequency range.
- b. The band edge measurement used the power splitter via EUT RF power connector between signal generator and spectrum analyzer. This splitter loss, attenuator loss and cable loss are the worst loss 21 dB in the transmitted path track.
- c. Record the max trace plot into the test report.

4.6.4 Test Results

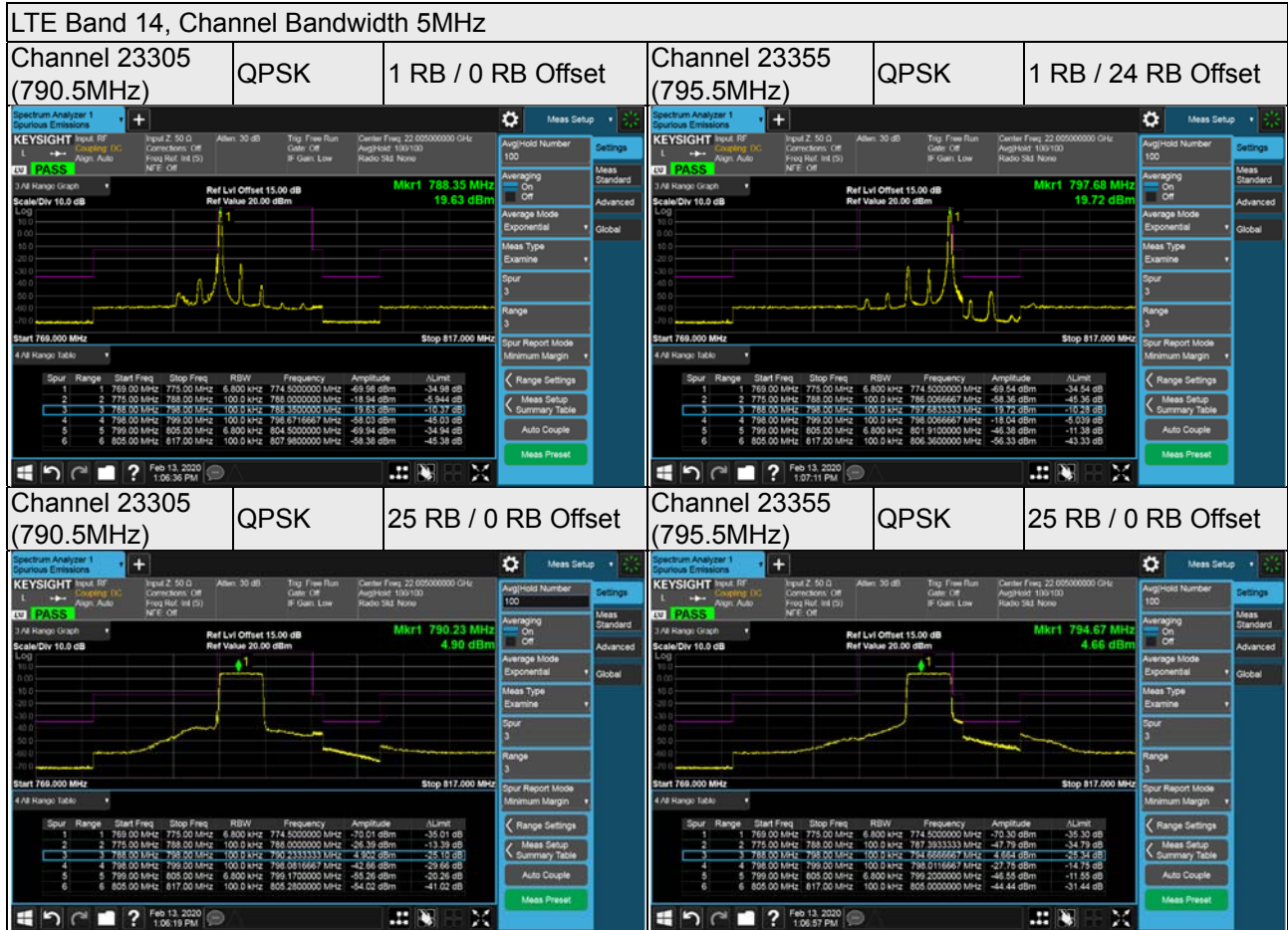

LTE Band 14, Channel Bandwidth 10MHz

Channel 23330
(793.0MHz)

QPSK

1 RB / 0 RB Offset

Channel 23330
(793.0MHz)

QPSK

1 RB / 49 RB Offset

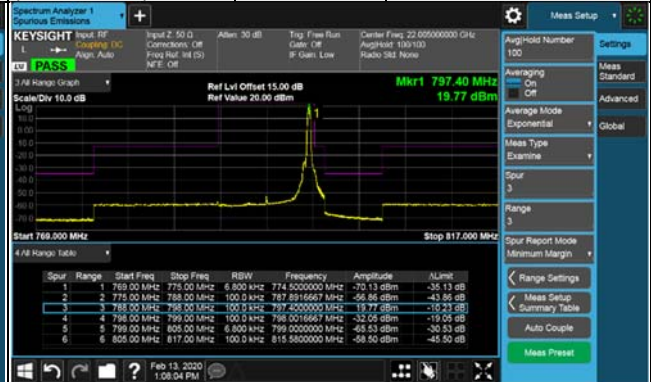
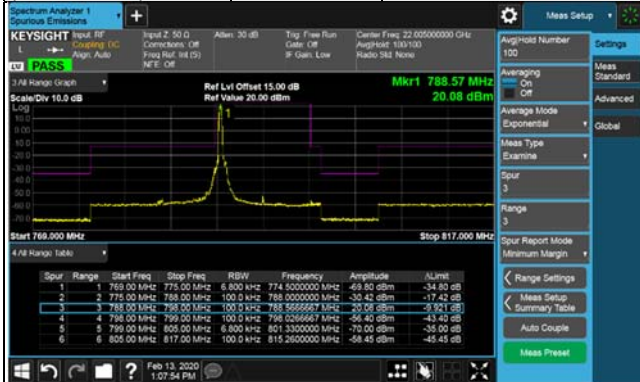

Channel 23330
(793.0MHz)

QPSK

50 RB / 0 RB Offset

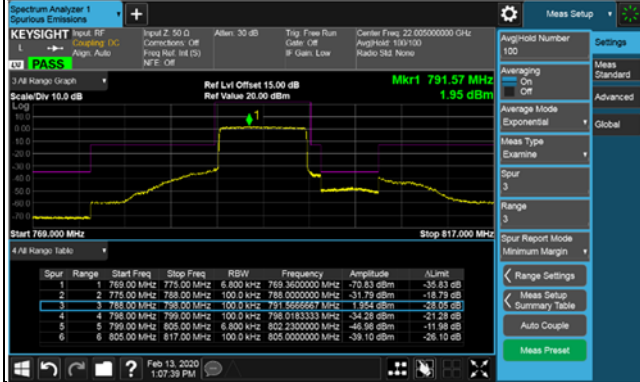

4.7 Conducted Spurious Emissions

4.7.1 Limits of Conducted Spurious Emissions Measurement

The power of any emission outside a licensee's frequency block shall be attenuated below the transmitter power (P) by at least $43 + 10 \log_{10}(P)$ dB. The limit of emission equal to -13dBm .

For operations in the 758-775 MHz and 788-805 MHz bands, all emissions including harmonics in the band 1559-1610 MHz shall be limited to -70 dBW/MHz. The limit of emissions is equal to -40 dBm.

4.7.2 Test Setup

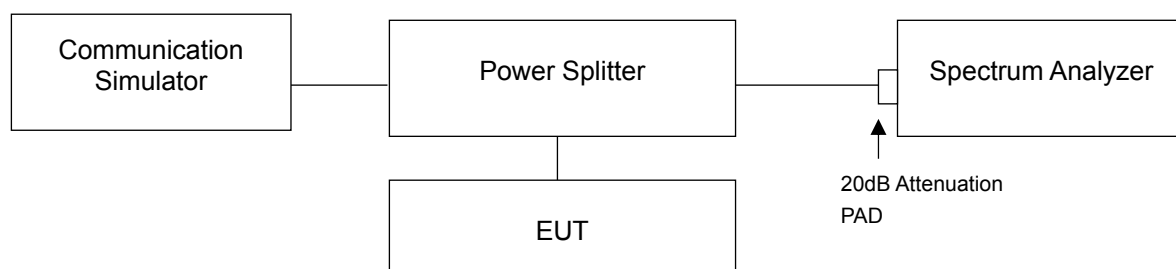

4.7.3 Test Procedure

- The EUT was set up for the maximum peak power with LTE link data modulation. The power was measured with Agilent Spectrum Analyzer.
- The conducted spurious emission used the power splitter via EUT RF power connector between signal generator and spectrum analyzer.
- When the spectrum scanned from 9 kHz to 8GHz or 9GHz. 10 dB attenuation pad is connected with spectrum. RBW = 1 MHz and VBW = 3 MHz are used for conducted emission measurement.

4.7.4 Test Results

LTE Band 14, Channel Band width: 5MHz

Channel 23305 (790.5MHz)

Frequency Range : 9kHz~1GHz

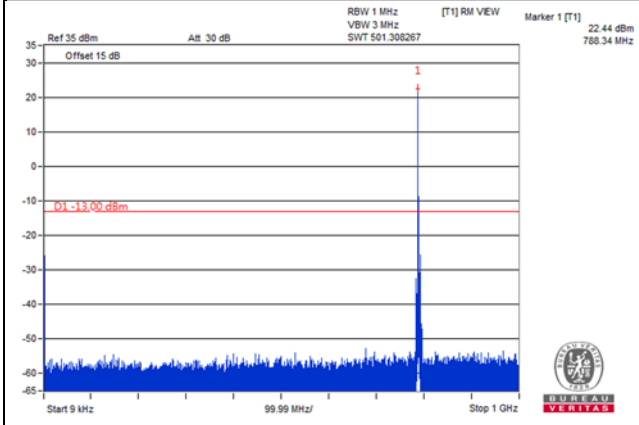

Frequency Range : 1GHz~1.559GHz

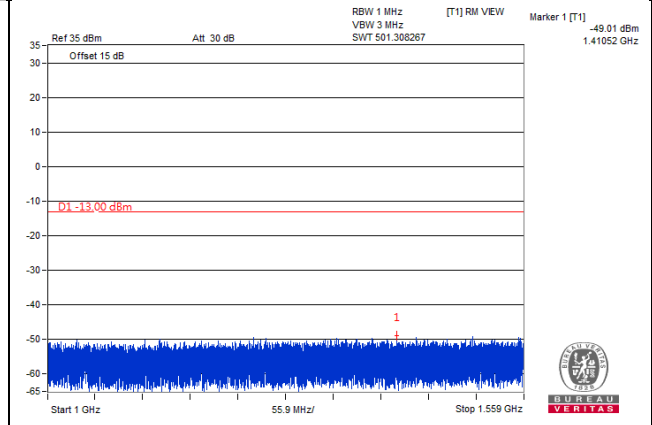

Frequency Range : 1.559GHz~1.61GHz

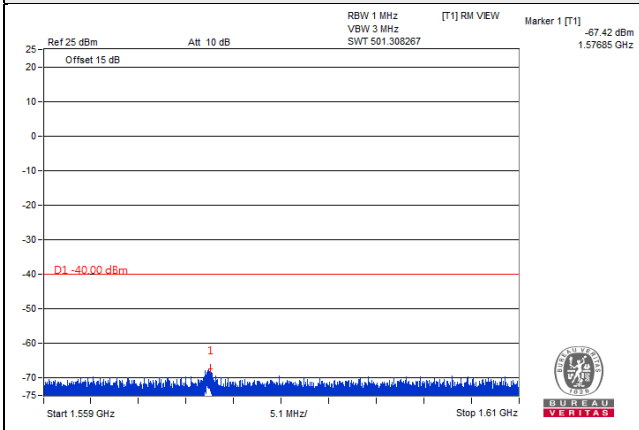

Frequency Range : 1.61GHz~8GHz

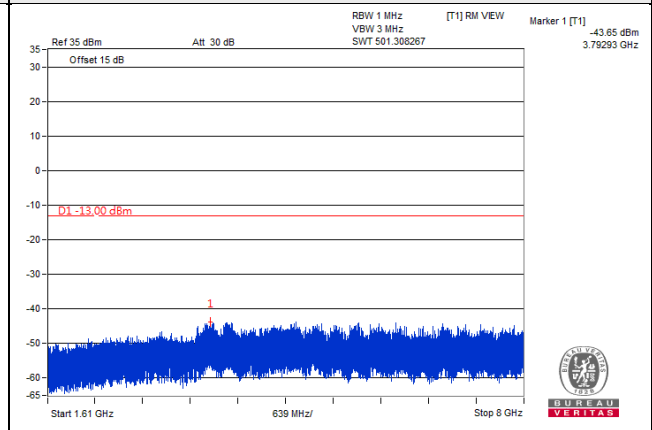

LTE Band 14, Channel Band width: 5MHz

Channel 23330 (793.0MHz)

Frequency Range : 9kHz~1GHz

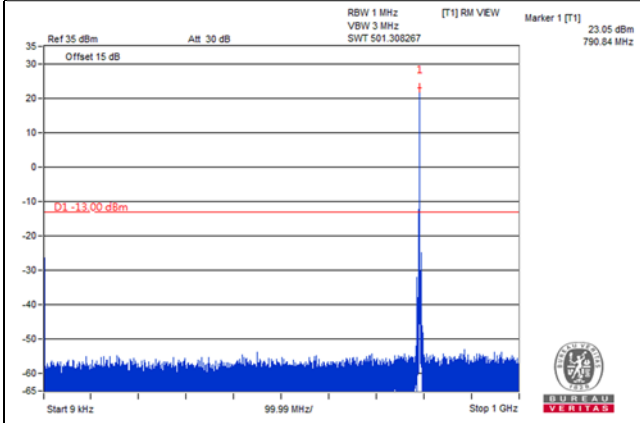

Frequency Range : 1GHz~1.559GHz

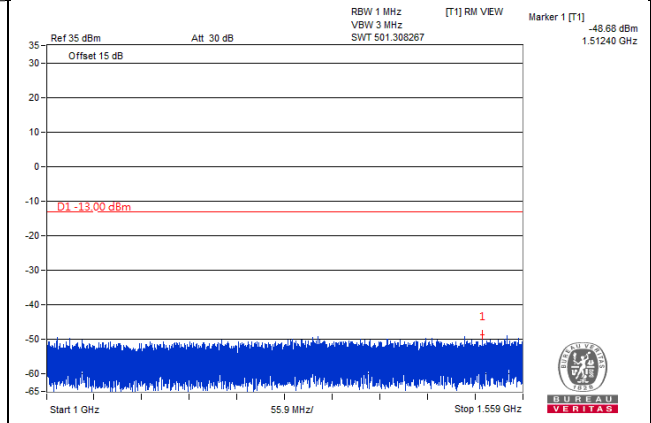

Frequency Range : 1.559GHz~1.61GHz

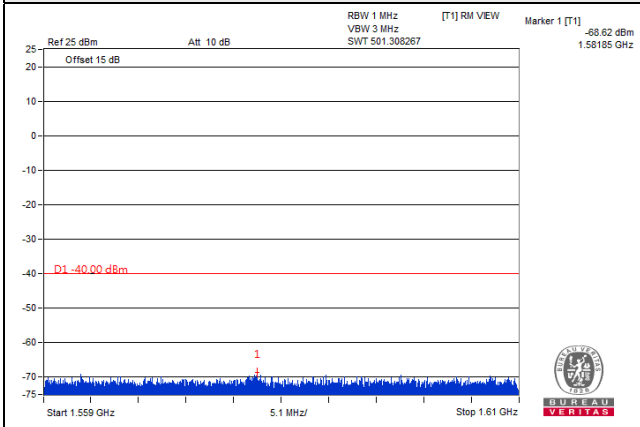

Frequency Range : 1.61GHz~8GHz

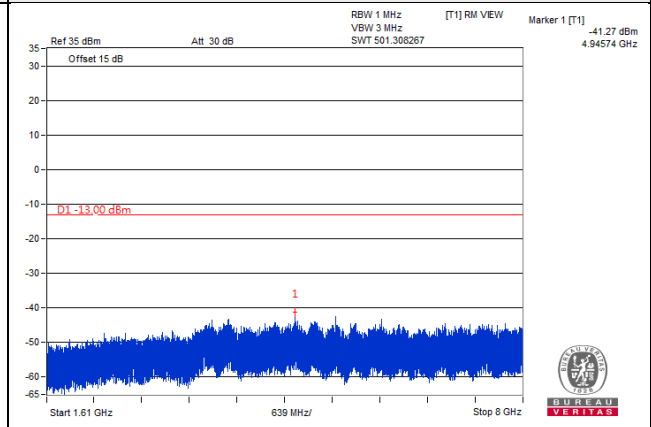

LTE Band 14, Channel Band width: 5MHz

Channel 23355 (795.5MHz)

Frequency Range : 9kHz~1GHz

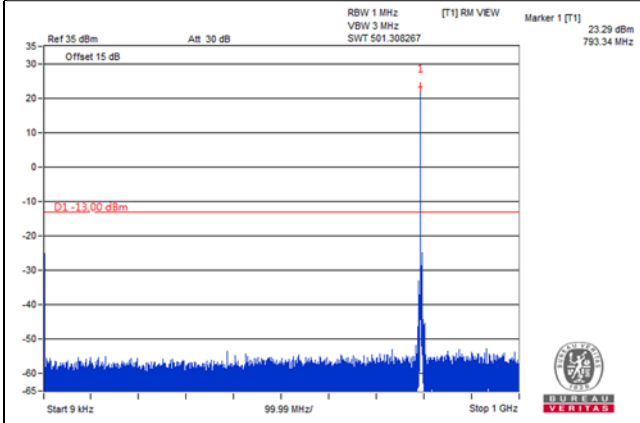

Frequency Range : 1GHz~1.559GHz

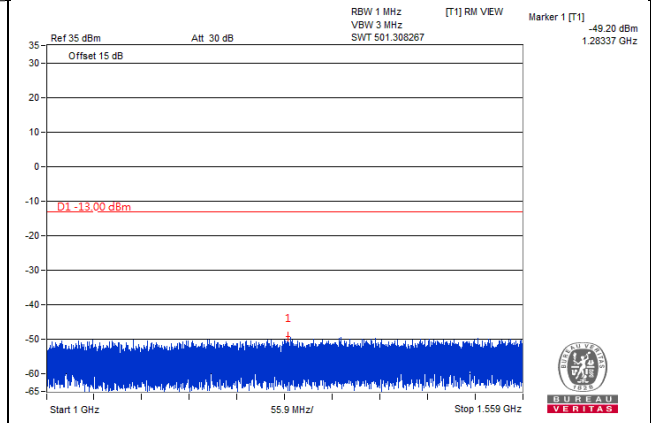

Frequency Range : 1.559GHz~1.61GHz

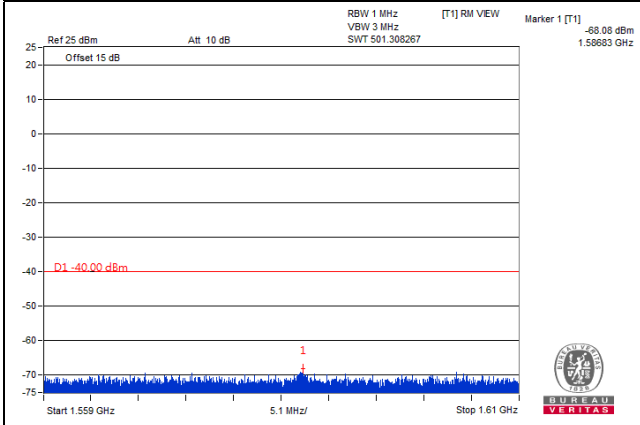

Frequency Range : 1.61GHz~8GHz

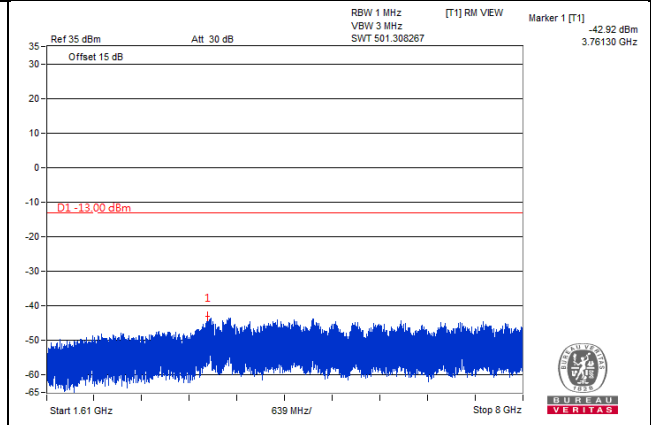

LTE Band 14, Channel Band width: 10MHz

Channel 23330 (793.0MHz)

Frequency Range : 9kHz~1GHz

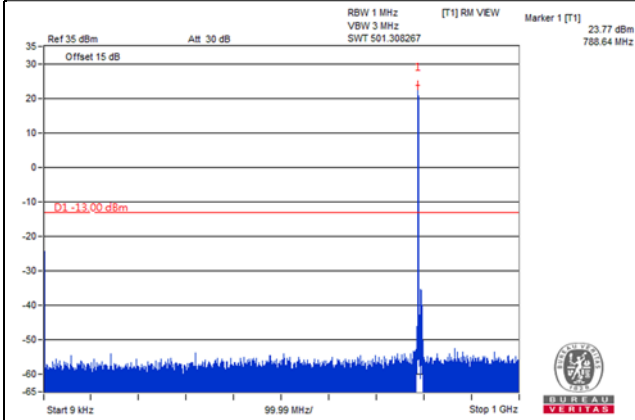

Frequency Range : 1GHz~1.559GHz

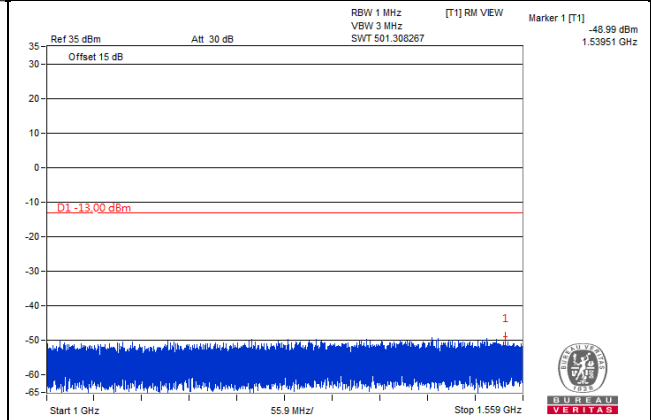

Frequency Range : 1.559GHz~1.61GHz

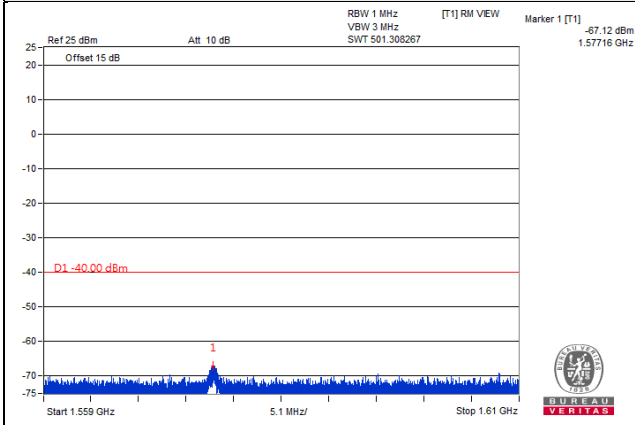

Frequency Range : 1.61GHz~8GHz

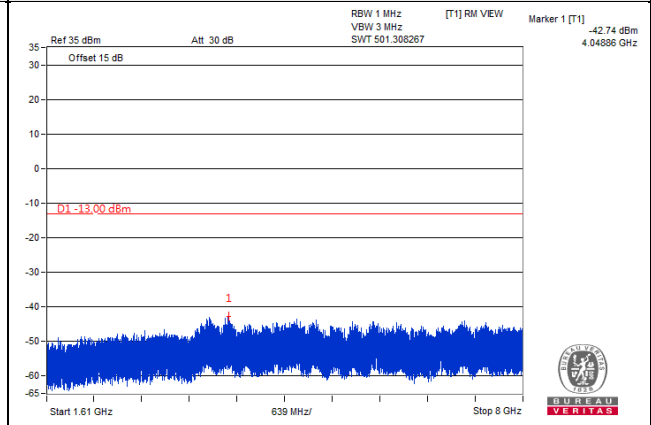

LTE Band 26, Channel Bandwidth 1.4MHz

Channel 26697 (814.7MHz)

Frequency Range : 9kHz~1GHz

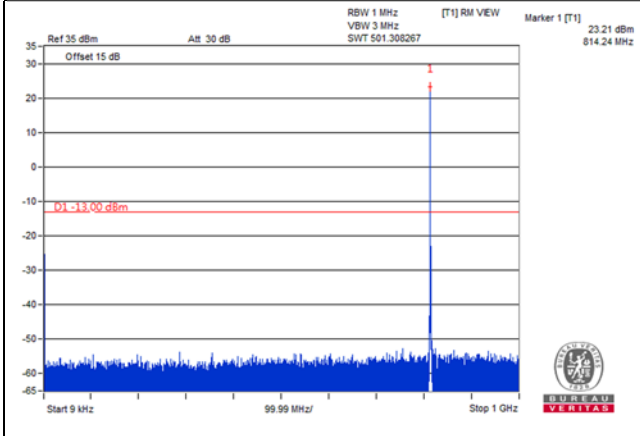

Frequency Range : 1GHz~9GHz

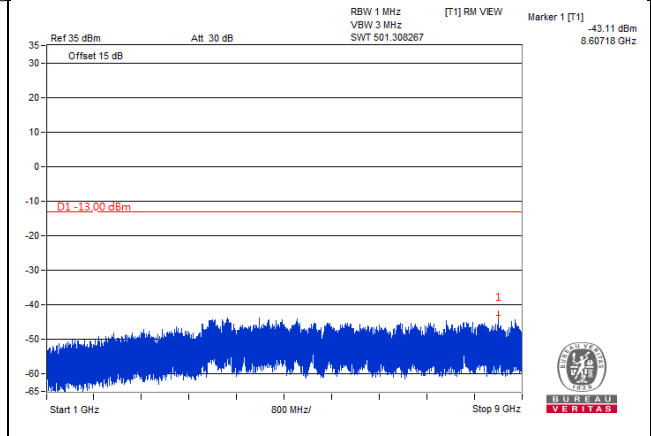

Channel 26740 (819.0MHz)

Frequency Range : 9kHz~1GHz

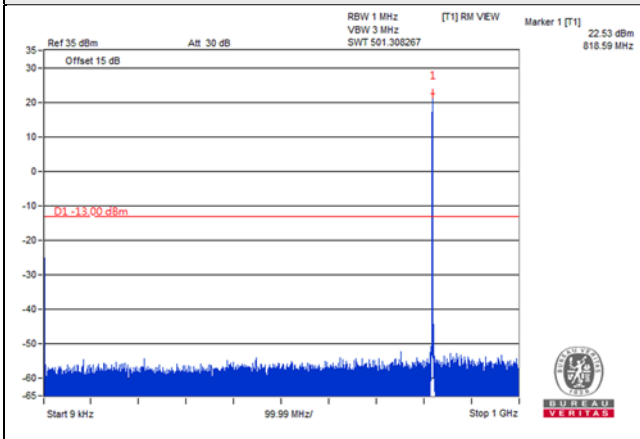

Frequency Range : 1GHz~9GHz

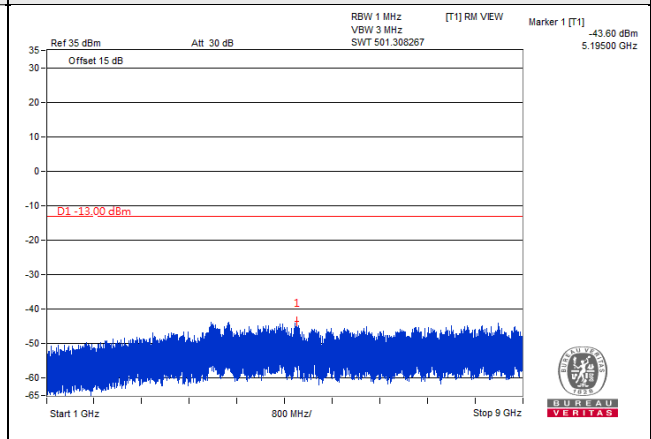

Channel 26783 (823.3MHz)

Frequency Range : 9kHz~1GHz

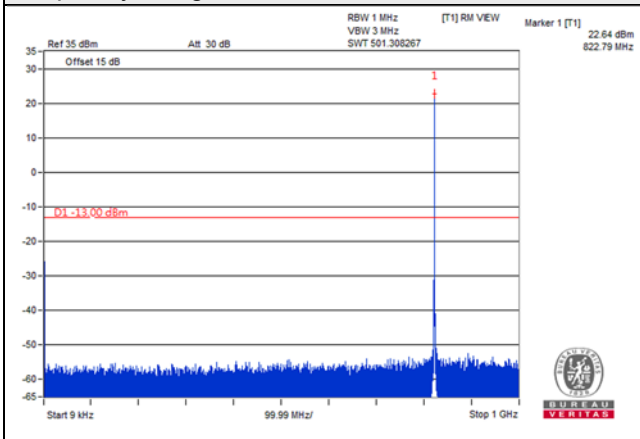

Frequency Range : 1GHz~9GHz

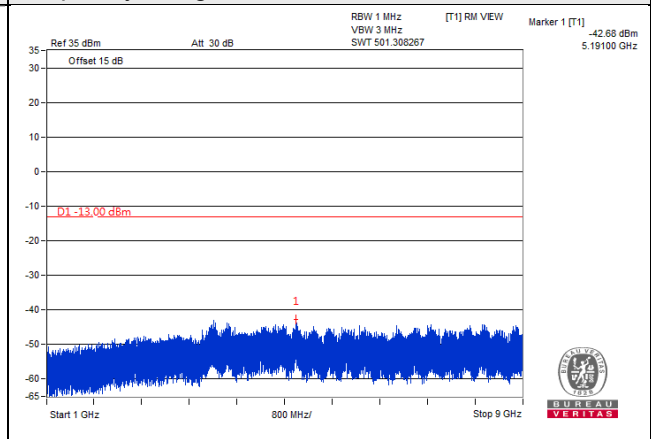

LTE Band 26, Channel Bandwidth 3MHz

Channel 26705 (815.5MHz)

Frequency Range : 9kHz~1GHz

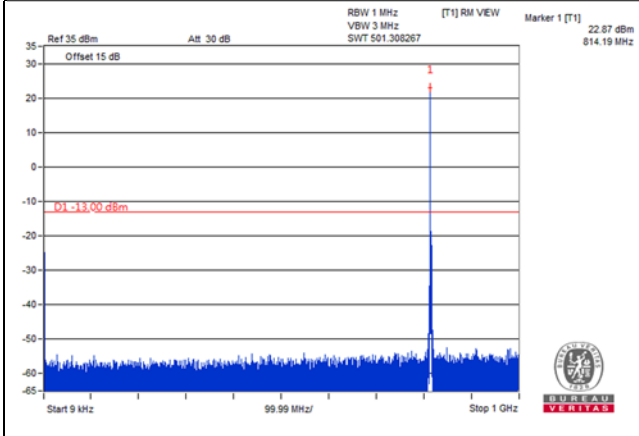

Frequency Range : 1GHz~9GHz

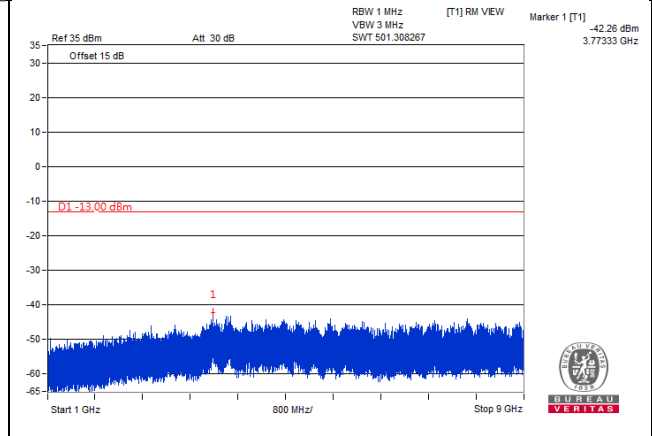

Channel 26740 (819.0MHz)

Frequency Range : 9kHz~1GHz

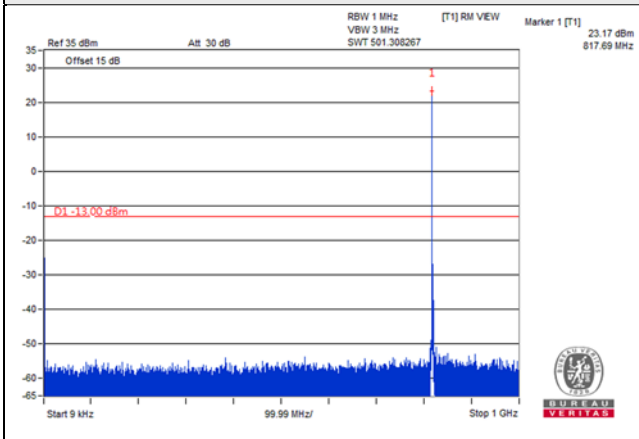

Frequency Range : 1GHz~9GHz

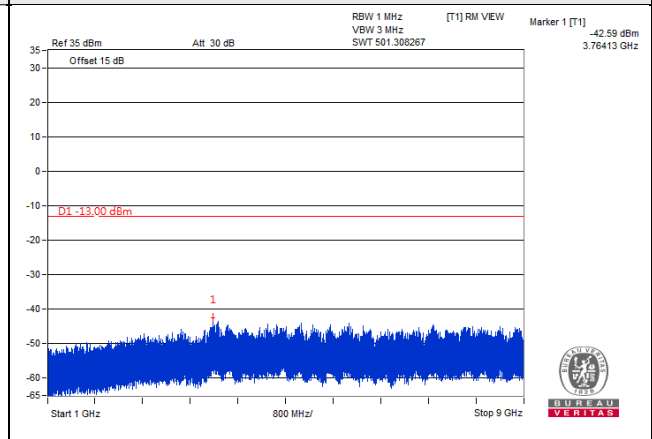

Channel 26775 (822.5MHz)

Frequency Range : 9kHz~1GHz

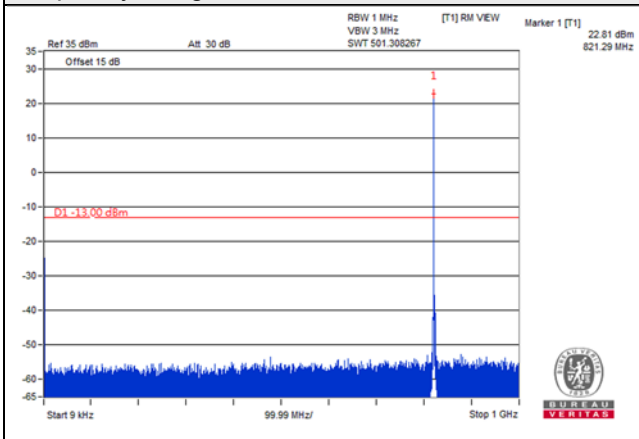

Frequency Range : 1GHz~9GHz

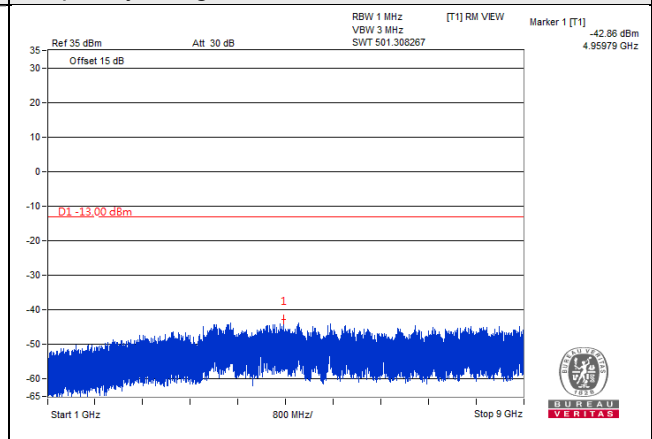

LTE Band 26, Channel Bandwidth 5MHz

Channel 26715 (816.5MHz)

Frequency Range : 9kHz~1GHz

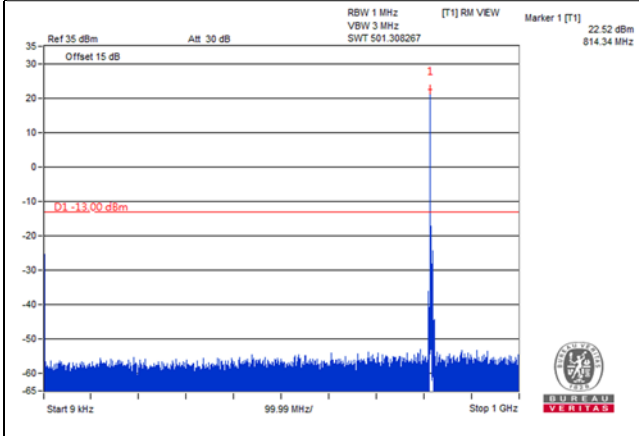

Frequency Range : 1GHz~9GHz

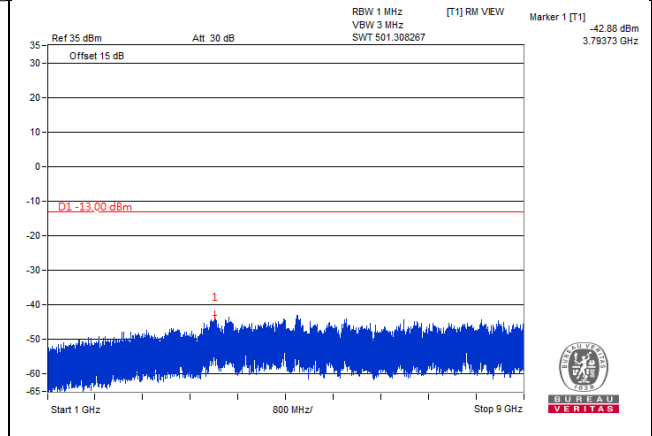

Channel 26740 (819.0MHz)

Frequency Range : 9kHz~1GHz

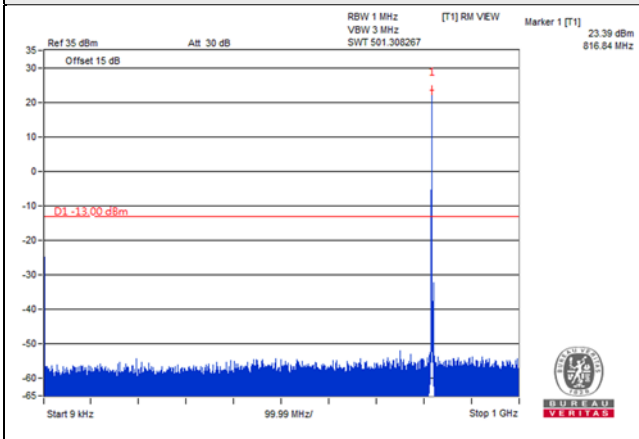

Frequency Range : 1GHz~9GHz

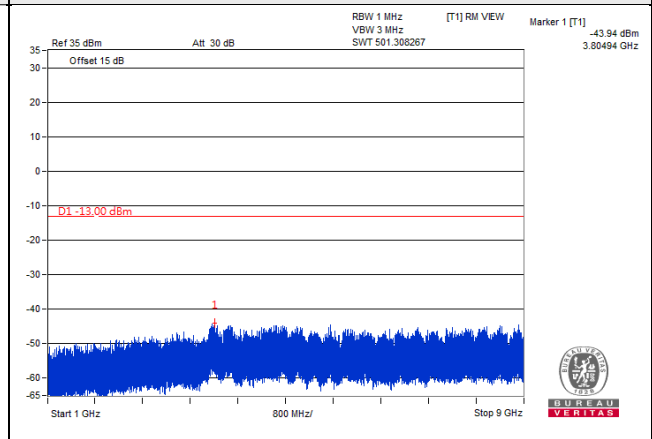

Channel 26765 (821.5MHz)

Frequency Range : 9kHz~1GHz

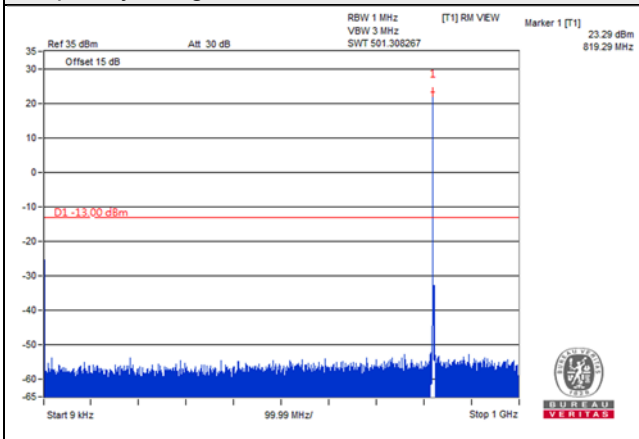

Frequency Range : 1GHz~9GHz

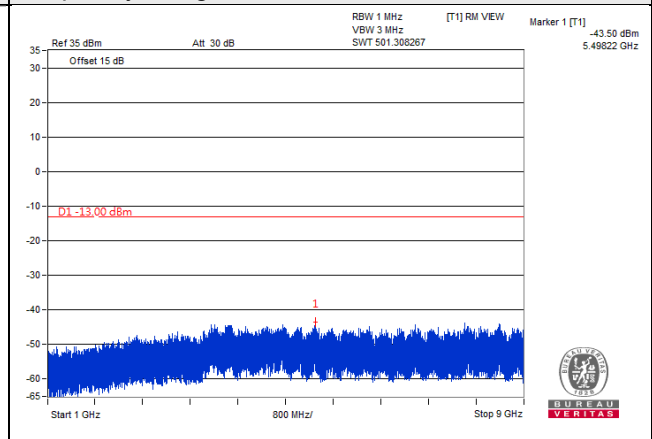

LTE Band 26, Channel Bandwidth 10MHz

Channel 26740 (819.0MHz)

Frequency Range : 9kHz~1GHz

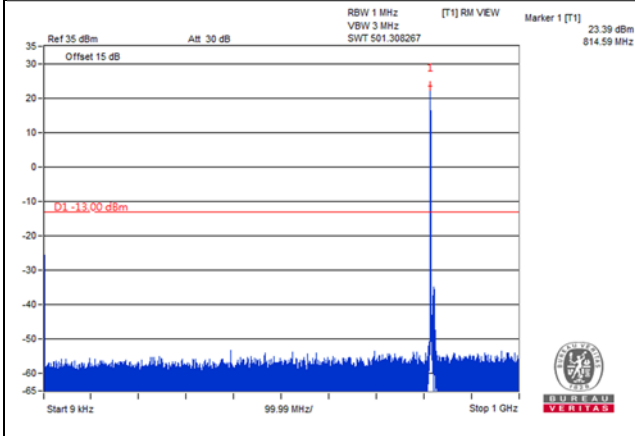

Frequency Range : 1GHz~9GHz

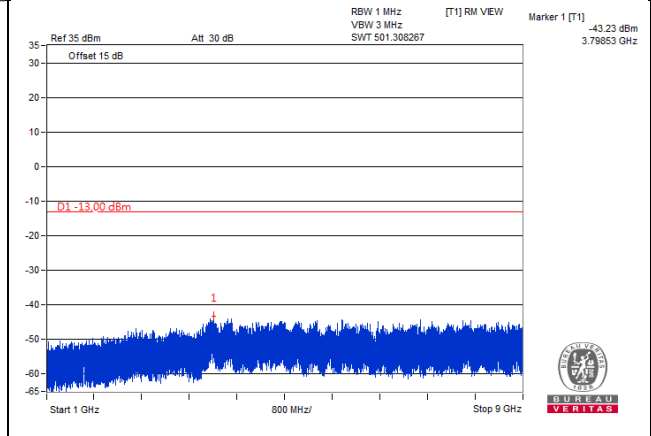

4.8 Radiated Emission Measurement

4.8.1 Limits of Radiated Emission Measurement

The power of any emission outside a licensee's frequency block shall be attenuated below the transmitter power (P) by at least $43 + 10 \log_{10}(P)$ dB. The limit of emission equal to -13 dBm.

For operations in the 758-775 MHz and 788-805 MHz bands, all emissions including harmonics in the band 1559-1610 MHz shall be limited to -70 dBW/MHz. The limit of emissions is equal to -40 dBm.

4.8.2 Test Procedure

- a. Substitution method is used for E.I.R.P measurement. In the semi-anechoic chamber, EUT placed on the 0.8m (below or equal 1 GHz) and/or 1.5 m (above 1 GHz) height of Turn Table, rotated the table around 360 degrees to search the maximum radiation power and receiver antenna shall be rotated vertical and horizontal polarization and moved height from 1m to 4m to find the maximum polar radiated power. The "Read Value" is the spectrum reading the maximum power value.
- b. The substitution horn antenna is substituted for EUT at the same position and signals generator export the CW signal to the substitution antenna via a TX cable. Rotated the Turn Table and moved receiving antenna to find the maximum radiation power. Adjust output power level of S.G to get a Value of spectrum reading equal to "Read Value" of step a. Record the power level of S.G
- c. $EIRP = \text{Output power level of S.G} - \text{TX cable loss} + \text{Antenna gain of substitution horn.}$
- d. E.R.P power can be calculated form E.I.R.P power by subtracting the gain of dipole, $E.R.P \text{ power} = E.I.R.P \text{ power} - 2.15\text{dBi.}$

NOTE: The resolution bandwidth and video bandwidth of test receiver/spectrum analyzer is 1MHz/3MHz.

4.8.3 Deviation from Test Standard

No deviation.

4.8.4 Test Setup

For radiated emission 30MHz to 1GHz

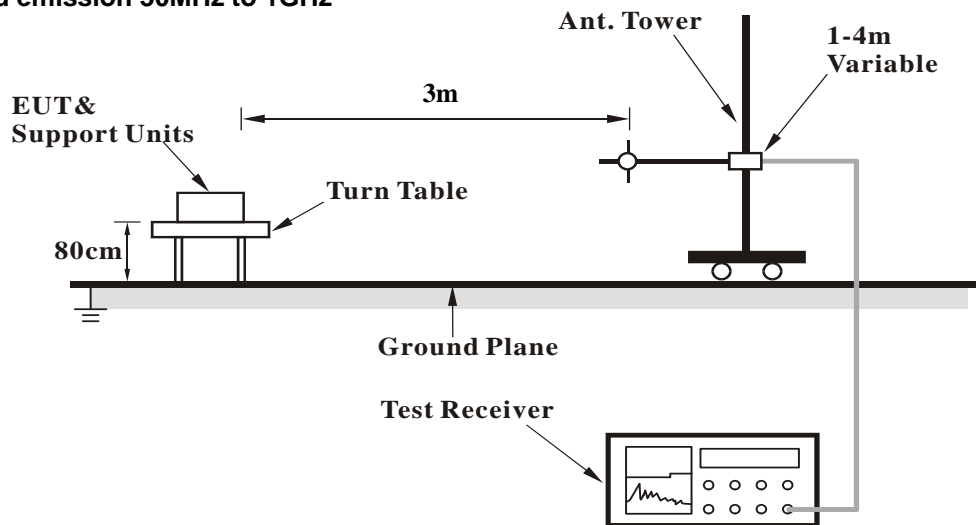

For radiated emission above 1GHz

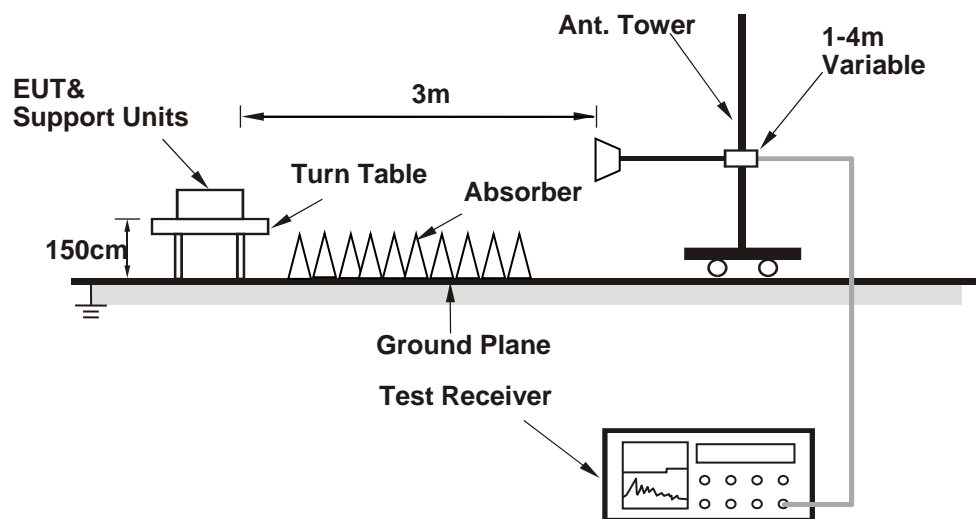

For the actual test configuration, please refer to the attached file (Test Setup Photo).

4.8.5 Test Results

Below 1GHz

LTE Band 14, Channel Bandwidth: 5MHz

Mode	TX channel 23305 (790.5MHz)	Frequency Range	Below 1000 MHz
Environmental Conditions	22deg. C, 68%RH	Input Power	120Vac, 60Hz
Tested By	Greg Lin		

Antenna Polarity & Test Distance: Horizontal at 3 M							
No.	Freq. (MHz)	Reading (dBm)	S.G Power Value (dBm)	Correction Factor (dB)	ERP (dBm)	Limit (dBm)	Margin (dB)
1	34.85	-51.4	-33.9	-16.5	-50.4	-13.0	-37.4
2	91.11	-38.9	-49.0	-0.4	-49.4	-13.0	-36.4
3	209.45	-55.2	-63.7	-2.0	-65.7	-13.0	-52.7
4	294.81	-61.7	-65.1	-1.8	-66.9	-13.0	-53.9
5	543.13	-68.8	-74.4	3.9	-70.5	-13.0	-57.5
6	886.51	-54.8	-53.2	3.4	-49.8	-13.0	-36.8

Remarks:

- ERP (dBm) = S.G Value (dBm) + Correction Factor (dB).
- Correction Factor (dB) = Substitution Antenna Gain (dB) + Cable Loss (dB).

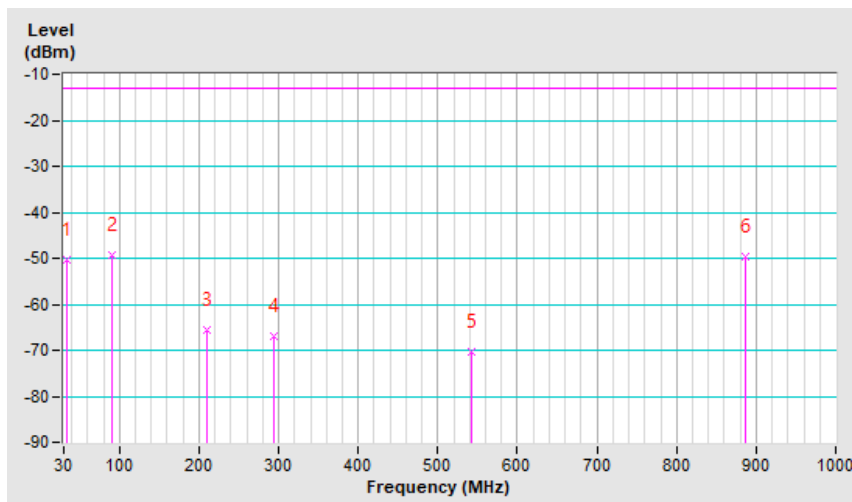

Mode	TX channel 23305 (790.5MHz)	Frequency Range	Below 1000 MHz
Environmental Conditions	22deg. C, 68%RH	Input Power	120Vac, 60Hz
Tested By	Greg Lin		

Antenna Polarity & Test Distance: Vertical at 3 M							
No.	Freq. (MHz)	Reading (dBm)	S.G Power Value (dBm)	Correction Factor (dB)	ERP (dBm)	Limit (dBm)	Margin (dB)
1	30.00	-47.2	-39.9	-19.4	-59.3	-13.0	-46.3
2	75.59	-41.0	-49.2	0.2	-49.0	-13.0	-36.0
3	187.14	-53.1	-54.9	-2.7	-57.6	-13.0	-44.6
4	264.74	-62.9	-62.5	-1.6	-64.1	-13.0	-51.1
5	611.03	-69.2	-70.4	3.7	-66.7	-13.0	-53.7
6	893.30	-60.0	-57.4	3.5	-53.9	-13.0	-40.9

Remarks:

1. ERP (dBm) = S.G Value (dBm) + Correction Factor (dB).
2. Correction Factor (dB) = Substitution Antenna Gain (dB) + Cable Loss (dB).

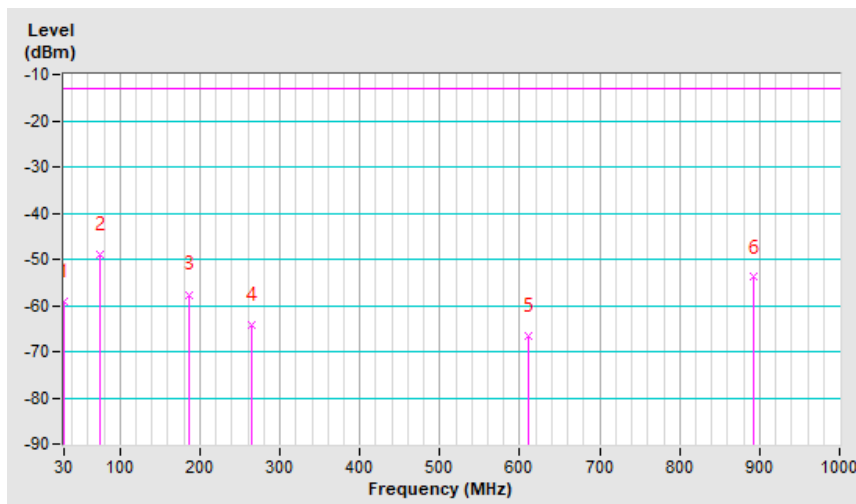

LTE Band 26, Channel Bandwidth 5MHz

Mode	TX channel 26697 (814.7MHz)	Frequency Range	Below 1000 MHz
Environmental Conditions	22deg. C, 68%RH	Input Power	120Vac, 60Hz
Tested By	Greg Lin		

Antenna Polarity & Test Distance: Horizontal at 3 M							
No.	Freq. (MHz)	Reading (dBm)	S.G Power Value (dBm)	Correction Factor (dB)	ERP (dBm)	Limit (dBm)	Margin (dB)
1	30.00	-41.9	-20.6	-19.4	-40.0	-13.0	-27.0
2	79.47	-44.0	-51.6	0.6	-51.0	-13.0	-38.0
3	154.16	-57.8	-61.3	-2.9	-64.2	-13.0	-51.2
4	384.05	-67.0	-73.6	3.5	-70.1	-13.0	-57.1
5	740.04	-61.6	-63.3	3.7	-59.6	-13.0	-46.6
6	974.78	-70.5	-67.3	3.6	-63.7	-13.0	-50.7

Remarks:

- ERP (dBm) = S.G Value (dBm) + Correction Factor (dB).
- Correction Factor (dB) = Substitution Antenna Gain (dB) + Cable Loss (dB).

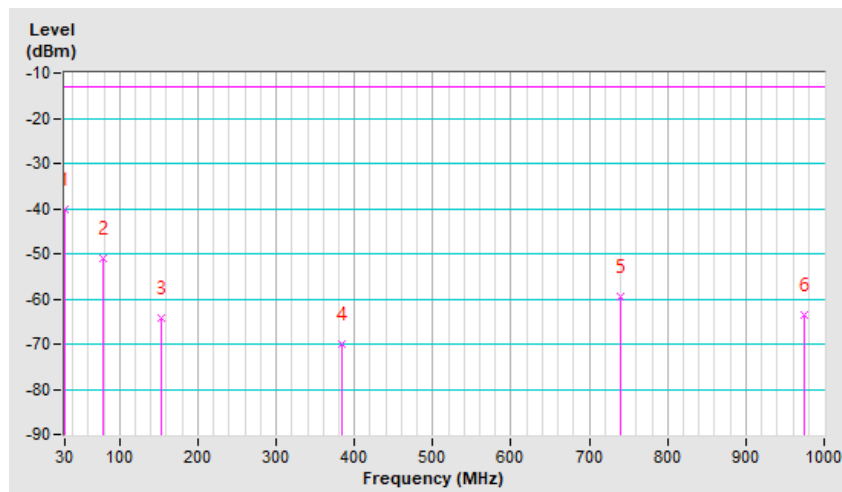

Mode	TX channel 26697 (814.7MHz)	Frequency Range	Below 1000 MHz
Environmental Conditions	22deg. C, 68%RH	Input Power	120Vac, 60Hz
Tested By	Greg Lin		

Antenna Polarity & Test Distance: Vertical at 3 M							
No.	Freq. (MHz)	Reading (dBm)	S.G Power Value (dBm)	Correction Factor (dB)	ERP (dBm)	Limit (dBm)	Margin (dB)
1	31.94	-44.9	-39.2	-18.3	-57.5	-13.0	-44.5
2	161.92	-59.4	-61.5	-2.9	-64.4	-13.0	-51.4
3	276.38	-66.0	-63.2	-1.6	-64.8	-13.0	-51.8
4	612.97	-69.8	-70.7	3.6	-67.1	-13.0	-54.1
5	734.22	-61.8	-61.0	3.7	-57.3	-13.0	-44.3
6	864.20	-58.7	-56.9	3.2	-53.7	-13.0	-40.7

Remarks:

1. ERP (dBm) = S.G Value (dBm) + Correction Factor (dB).
2. Correction Factor (dB) = Substitution Antenna Gain (dB) + Cable Loss (dB).

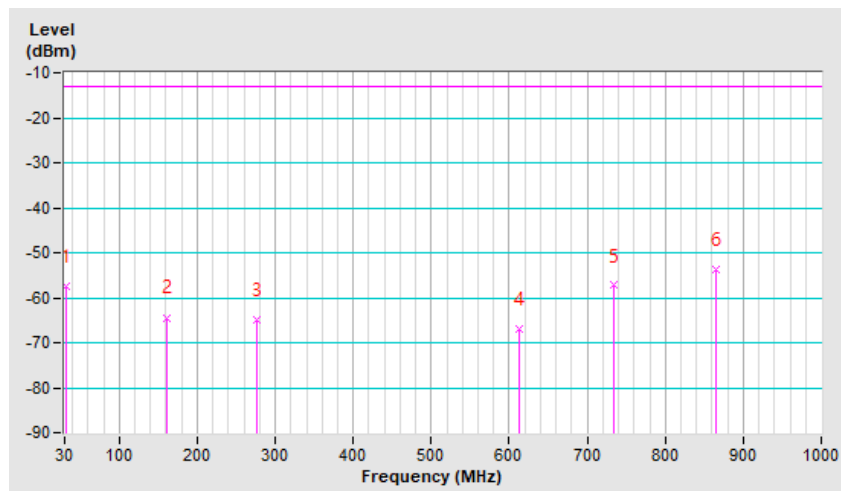

Above 1GHz

LTE Band 14, Channel Bandwidth: 5MHz

Mode	TX channel 23305 (790.5MHz)	Frequency Range	1 ~ 10GHz
Environmental Conditions	22deg. C, 68%RH	Input Power	120Vac, 60Hz
Tested By	Greg Lin		

Antenna Polarity & Test Distance: Horizontal at 3 M							
No.	Freq. (MHz)	Reading (dBm)	S.G Power Value (dBm)	Correction Factor (dB)	ERP (dBm)	Limit (dBm)	Margin (dB)
1	1581.00	-62.2	-54.4	1.2	-53.2	-40.0	-13.2
Antenna Polarity & Test Distance: Vertical at 3 M							
No.	Freq. (MHz)	Reading (dBm)	S.G Power Value (dBm)	Correction Factor (dB)	ERP (dBm)	Limit (dBm)	Margin (dB)
1	1581.00	-59.2	-52.2	1.2	-51.0	-40.0	-11.0

Remarks:

1. ERP (dBm) = S.G Value (dBm) + Correction Factor (dB).
2. Correction Factor (dB) = Substitution Antenna Gain (dB) + Cable Loss (dB).

Mode	TX channel 23330 (793.0MHz)	Frequency Range	1 ~ 10GHz
Environmental Conditions	22deg. C, 68%RH	Input Power	120Vac, 60Hz
Tested By	Greg Lin		

Antenna Polarity & Test Distance: Horizontal at 3 M							
No.	Freq. (MHz)	Reading (dBm)	S.G Power Value (dBm)	Correction Factor (dB)	ERP (dBm)	Limit (dBm)	Margin (dB)
1	1586.00	-61.8	-53.9	1.1	-52.8	-40.0	-12.8
Antenna Polarity & Test Distance: Vertical at 3 M							
No.	Freq. (MHz)	Reading (dBm)	S.G Power Value (dBm)	Correction Factor (dB)	ERP (dBm)	Limit (dBm)	Margin (dB)
1	1586.00	-59.5	-52.3	1.1	-51.2	-40.0	-11.2

Remarks:

1. ERP (dBm) = S.G Value (dBm) + Correction Factor (dB).
2. Correction Factor (dB) = Substitution Antenna Gain (dB) + Cable Loss (dB).

Mode	TX channel 23355 (795.5MHz)	Frequency Range	1 ~ 10GHz
Environmental Conditions	22deg. C, 68%RH	Input Power	120Vac, 60Hz
Tested By	Greg Lin		

Antenna Polarity & Test Distance: Horizontal at 3 M							
No.	Freq. (MHz)	Reading (dBm)	S.G Power Value (dBm)	Correction Factor (dB)	ERP (dBm)	Limit (dBm)	Margin (dB)
1	1591.00	-61.8	-53.9	1.1	-52.8	-40.0	-12.8
Antenna Polarity & Test Distance: Vertical at 3 M							
No.	Freq. (MHz)	Reading (dBm)	S.G Power Value (dBm)	Correction Factor (dB)	ERP (dBm)	Limit (dBm)	Margin (dB)
1	1591.00	-60.2	-53.1	1.1	-52.0	-40.0	-12.0

Remarks:

1. ERP (dBm) = S.G Value (dBm) + Correction Factor (dB).
2. Correction Factor (dB) = Substitution Antenna Gain (dB) + Cable Loss (dB).

LTE Band 14, Channel Bandwidth: 10MHz

Mode	TX channel 23330 (793.0MHz)	Frequency Range	1 ~ 10GHz
Environmental Conditions	22deg. C, 68%RH	Input Power	120Vac, 60Hz
Tested By	Greg Lin		

Antenna Polarity & Test Distance: Horizontal at 3 M							
No.	Freq. (MHz)	Reading (dBm)	S.G Power Value (dBm)	Correction Factor (dB)	ERP (dBm)	Limit (dBm)	Margin (dB)
1	1586.00	-62.5	-54.6	1.1	-53.5	-40.0	-13.5
Antenna Polarity & Test Distance: Vertical at 3 M							
No.	Freq. (MHz)	Reading (dBm)	S.G Power Value (dBm)	Correction Factor (dB)	ERP (dBm)	Limit (dBm)	Margin (dB)
1	1586.00	-59.4	-52.2	1.1	-51.1	-40.0	-11.1

Remarks:

1. ERP (dBm) = S.G Value (dBm) + Correction Factor (dB).
2. Correction Factor (dB) = Substitution Antenna Gain (dB) + Cable Loss (dB).

LTE Band 26, Channel Bandwidth 1.4MHz

Mode	TX channel 26697 (814.7MHz)	Frequency Range	1 ~ 10GHz
Environmental Conditions	22deg. C, 68%RH	Input Power	120Vac, 60Hz
Tested By	Greg Lin		

Antenna Polarity & Test Distance: Horizontal at 3 M							
No.	Freq. (MHz)	Reading (dBm)	S.G Power Value (dBm)	Correction Factor (dB)	ERP (dBm)	Limit (dBm)	Margin (dB)
1	1629.40	-62.0	-54.1	1.0	-53.1	-13.0	-40.1
Antenna Polarity & Test Distance: Vertical at 3 M							
No.	Freq. (MHz)	Reading (dBm)	S.G Power Value (dBm)	Correction Factor (dB)	ERP (dBm)	Limit (dBm)	Margin (dB)
1	1629.40	-59.2	-52.0	1.0	-51.0	-13.0	-38.0

Remarks:

1. ERP (dBm) = S.G Value (dBm) + Correction Factor (dB).
2. Correction Factor (dB) = Substitution Antenna Gain (dB) + Cable Loss (dB).

Mode	TX channel 26740 (819.0MHz)	Frequency Range	1 ~ 10GHz
Environmental Conditions	22deg. C, 68%RH	Input Power	120Vac, 60Hz
Tested By	Greg Lin		

Antenna Polarity & Test Distance: Horizontal at 3 M							
No.	Freq. (MHz)	Reading (dBm)	S.G Power Value (dBm)	Correction Factor (dB)	ERP (dBm)	Limit (dBm)	Margin (dB)
1	1638.00	-62.2	-54.5	1.0	-53.5	-13.0	-40.5
Antenna Polarity & Test Distance: Vertical at 3 M							
No.	Freq. (MHz)	Reading (dBm)	S.G Power Value (dBm)	Correction Factor (dB)	ERP (dBm)	Limit (dBm)	Margin (dB)
1	1638.00	-59.8	-52.5	1.0	-51.5	-13.0	-38.5

Remarks:

1. ERP (dBm) = S.G Value (dBm) + Correction Factor (dB).
2. Correction Factor (dB) = Substitution Antenna Gain (dB) + Cable Loss (dB).

Mode	TX channel 26783 (823.3MHz)	Frequency Range	1 ~ 10GHz
Environmental Conditions	22deg. C, 68%RH	Input Power	120Vac, 60Hz
Tested By	Greg Lin		

Antenna Polarity & Test Distance: Horizontal at 3 M							
No.	Freq. (MHz)	Reading (dBm)	S.G Power Value (dBm)	Correction Factor (dB)	ERP (dBm)	Limit (dBm)	Margin (dB)
1	1646.60	-61.6	-53.9	0.9	-53.0	-13.0	-40.0
Antenna Polarity & Test Distance: Vertical at 3 M							
No.	Freq. (MHz)	Reading (dBm)	S.G Power Value (dBm)	Correction Factor (dB)	ERP (dBm)	Limit (dBm)	Margin (dB)
1	1646.60	-59.4	-52.0	0.9	-51.1	-13.0	-38.1

Remarks:

1. ERP (dBm) = S.G Value (dBm) + Correction Factor (dB).
2. Correction Factor (dB) = Substitution Antenna Gain (dB) + Cable Loss (dB).

LTE Band 26, Channel Bandwidth 5MHz

Mode	TX channel 26715 (816.5MHz)	Frequency Range	1 ~ 10GHz
Environmental Conditions	22deg. C, 68%RH	Input Power	120Vac, 60Hz
Tested By	Greg Lin		

Antenna Polarity & Test Distance: Horizontal at 3 M							
No.	Freq. (MHz)	Reading (dBm)	S.G Power Value (dBm)	Correction Factor (dB)	ERP (dBm)	Limit (dBm)	Margin (dB)
1	1633.00	-61.9	-54.0	1.0	-53.0	-13.0	-40.0
Antenna Polarity & Test Distance: Vertical at 3 M							
No.	Freq. (MHz)	Reading (dBm)	S.G Power Value (dBm)	Correction Factor (dB)	ERP (dBm)	Limit (dBm)	Margin (dB)
1	1633.00	-59.2	-52.0	1.0	-51.0	-13.0	-38.0

Remarks:

1. ERP (dBm) = S.G Value (dBm) + Correction Factor (dB).
2. Correction Factor (dB) = Substitution Antenna Gain (dB) + Cable Loss (dB).

Mode	TX channel 26740 (819MHz)	Frequency Range	1 ~ 10GHz
Environmental Conditions	22deg. C, 68%RH	Input Power	120Vac, 60Hz
Tested By	Greg Lin		

Antenna Polarity & Test Distance: Horizontal at 3 M							
No.	Freq. (MHz)	Reading (dBm)	S.G Power Value (dBm)	Correction Factor (dB)	ERP (dBm)	Limit (dBm)	Margin (dB)
1	1638.00	-61.9	-54.1	1.0	-53.1	-13.0	-40.1
Antenna Polarity & Test Distance: Vertical at 3 M							
No.	Freq. (MHz)	Reading (dBm)	S.G Power Value (dBm)	Correction Factor (dB)	ERP (dBm)	Limit (dBm)	Margin (dB)
1	1638.00	-59.2	-52.0	1.0	-51.0	-13.0	-38.0

Remarks:

1. ERP (dBm) = S.G Value (dBm) + Correction Factor (dB).
2. Correction Factor (dB) = Substitution Antenna Gain (dB) + Cable Loss (dB).

Mode	TX channel 26765 (821.5MHz)	Frequency Range	1 ~ 10GHz
Environmental Conditions	22deg. C, 68%RH	Input Power	120Vac, 60Hz
Tested By	Greg Lin		

Antenna Polarity & Test Distance: Horizontal at 3 M							
No.	Freq. (MHz)	Reading (dBm)	S.G Power Value (dBm)	Correction Factor (dB)	ERP (dBm)	Limit (dBm)	Margin (dB)
1	1643.00	-61.6	-53.9	1.0	-52.9	-13.0	-39.9
Antenna Polarity & Test Distance: Vertical at 3 M							
No.	Freq. (MHz)	Reading (dBm)	S.G Power Value (dBm)	Correction Factor (dB)	ERP (dBm)	Limit (dBm)	Margin (dB)
1	1643.00	-59.0	-51.8	1.0	-50.8	-13.0	-37.8

Remarks:

1. ERP (dBm) = S.G Value (dBm) + Correction Factor (dB).
2. Correction Factor (dB) = Substitution Antenna Gain (dB) + Cable Loss (dB).

LTE Band 26, Channel Bandwidth 10MHz

Mode	TX channel 26740 (819.0MHz)	Frequency Range	1 ~ 10GHz
Environmental Conditions	22deg. C, 68%RH	Input Power	120Vac, 60Hz
Tested By	Greg Lin		

Antenna Polarity & Test Distance: Horizontal at 3 M							
No.	Freq. (MHz)	Reading (dBm)	S.G Power Value (dBm)	Correction Factor (dB)	ERP (dBm)	Limit (dBm)	Margin (dB)
1	1638.00	-61.8	-54.0	1.0	-53.0	-13.0	-40.0
Antenna Polarity & Test Distance: Vertical at 3 M							
No.	Freq. (MHz)	Reading (dBm)	S.G Power Value (dBm)	Correction Factor (dB)	ERP (dBm)	Limit (dBm)	Margin (dB)
1	1638.00	-59.4	-52.1	1.0	-51.1	-13.0	-38.1

Remarks:

1. ERP (dBm) = S.G Value (dBm) + Correction Factor (dB).
2. Correction Factor (dB) = Substitution Antenna Gain (dB) + Cable Loss (dB).

5 Pictures of Test Arrangements

Please refer to the attached file (Test Setup Photo).

Appendix – Information of the Testing Laboratories

We, Bureau Veritas Consumer Products Services (H.K.) Ltd., Taoyuan Branch, were founded in 1988 to provide our best service in EMC, Radio, Telecom and Safety consultation. Our laboratories are FCC recognized accredited test firms and accredited and approved according to ISO/IEC 17025.

If you have any comments, please feel free to contact us at the following:

Linko EMC/RF Lab

Tel: 886-2-26052180

Fax: 886-2-26051924

Hsin Chu EMC/RF/Telecom Lab

Tel: 886-3-6668565

Fax: 886-3-6668323

Hwa Ya EMC/RF/Safety Lab

Tel: 886-3-3183232

Fax: 886-3-3270892

Email: service.adt@tw.bureauveritas.com

Web Site: www.bureauveritas-adt.com

The address and road map of all our labs can be found in our web site also.

--- END ---