

FCC Test Report (Part 27: 5G NR)

Report No.: RF200109E02B-15

FCC ID: 2AQ68T99W175

Test Model: T99W175

Received Date: Jan. 10, 2020

Test Date: May 19 ~ May 27, 2020

Issued Date: May 29, 2020

Applicant: Hon Lin Technology Co., Ltd.

Address: 11F, No. 32, Jihu Rd., Neihu Dist., Taipei City 114, Taiwan R.O.C.

Issued By: Bureau Veritas Consumer Products Services (H.K.) Ltd., Taoyuan Branch
Lin Kou Laboratories

Lab Address: No. 47-2, 14th Ling, Chia Pau Vil., Lin Kou Dist., New Taipei City, Taiwan

Test Location: No. 19, Hwa Ya 2nd Rd., Wen Hwa Vil., Kwei Shan Dist., Taoyuan City
33383, Taiwan

FCC Registration / 788550 / TW0003

Designation Number:



This report is for your exclusive use. Any copying or replication of this report to or for any other person or entity, or use of our name or trademark, is permitted only with our prior written permission. This report sets forth our findings solely with respect to the test samples identified herein. The results set forth in this report are not indicative or representative of the quality or characteristics of the lot from which a test sample was taken or any similar or identical product unless specifically and expressly noted. Our report includes all of the tests requested by you and the results thereof based upon the information that you provided to us. You have 60 days from date of issuance of this report to notify us of any material error or omission caused by our negligence, provided, however, that such notice shall be in writing and shall specifically address the issue you wish to raise. A failure to raise such issue within the prescribed time shall constitute your unqualified acceptance of the completeness of this report, the tests conducted and the correctness of the report contents. Unless specific mention, the uncertainty of measurement has been explicitly taken into account to declare the compliance or non-compliance to the specification. The report must not be used by the client to claim product certification, approval, or endorsement by TAF or any government agency

Table of Contents

Release Control Record	3
1 Certificate of Conformity	4
2 Summary of Test Results	5
2.1 Measurement Uncertainty.....	5
2.2 Test Site and Instruments.....	6
3 General Information	7
3.1 General Description of EUT.....	7
3.2 Configuration of System under Test.....	11
3.2.1 Description of Support Units.....	11
3.3 Test Mode Applicability and Tested Channel Detail.....	12
3.4 EUT Operating Conditions.....	16
3.5 General Description of Applied Standards and References.....	16
4 Test Types and Results	17
4.1 Output Power Measurement.....	17
4.1.1 Limits of Output Power Measurement.....	17
4.1.2 Test Procedures.....	17
4.1.3 Test Setup.....	17
4.1.4 Test Results.....	18
4.2 Frequency Stability Measurement.....	32
4.2.1 Limits of Frequency Stability Measurement.....	32
4.2.2 Test Procedure.....	32
4.2.3 Test Setup.....	32
4.2.4 Test Results.....	33
4.3 Occupied Bandwidth Measurement.....	40
4.3.1 Limits of Occupied Bandwidth Measurement.....	40
4.3.2 Test Procedure.....	40
4.3.3 Test Setup.....	40
4.3.4 Test Result.....	41
4.4 Channel Edge Measurement.....	47
4.4.1 Limits of Band Edge Measurement.....	47
4.4.2 Test Setup.....	47
4.4.3 Test Procedures.....	47
4.4.4 Test Results.....	48
4.5 Peak to Average Ratio.....	62
4.5.1 Limits of Peak to Average Ratio Measurement.....	62
4.5.2 Test Setup.....	62
4.5.3 Test Procedures.....	62
4.5.4 Test Results.....	63
4.6 Conducted Spurious Emissions.....	66
4.6.1 Limits of Conducted Spurious Emissions Measurement.....	66
4.6.2 Test Setup.....	66
4.6.3 Test Procedure.....	66
4.6.4 Test Results.....	67
4.7 Radiated Emission Measurement.....	88
4.7.1 Limits of Radiated Emission Measurement.....	88
4.7.2 Test Procedure.....	88
4.7.3 Deviation from Test Standard.....	88
4.7.4 Test Setup.....	89
4.7.5 Test Results.....	90
5 Pictures of Test Arrangements	99
Appendix – Information of the Testing Laboratories	100

Release Control Record

Issue No.	Description	Date Issued
RF200109E02B-15	Original release	May 29, 2020

1 Certificate of Conformity

Product: 5G WWAN Module

Brand: Foxconn

Test Model: T99W175

Sample Status: Engineering Sample

Applicant: Hon Lin Technology Co., Ltd.

Test Date: May 19 ~ May 27, 2020

Standards: FCC Part 27, Subpart M

The above equipment has been tested by **Bureau Veritas Consumer Products Services (H.K.) Ltd., Taoyuan Branch**, and found compliance with the requirement of the above standards. The test record, data evaluation & Equipment Under Test (EUT) configurations represented herein are true and accurate accounts of the measurements of the sample's RF characteristics under the conditions specified in this report.

Prepared by : Pettie Chen , **Date:** May 29, 2020
Pettie Chen / Senior Specialist

Approved by : Bruce Chen , **Date:** May 29, 2020
Bruce Chen / Senior Project Engineer

2 Summary of Test Results

Applied Standard: FCC Part 27 & Part 2			
FCC Clause	Test Item	Result	Remarks
n41			
2.1046 27.50 (h)(2)	Equivalent Isotropically Radiated Power / Equivalent Radiated Power	Pass	Meet the requirement of limit.
2.1047	Modulation Characteristics	Pass	Meet the requirement of limit.
----	Peak To Average Ratio	Pass	Meet the requirement of limit.
2.1055 27.54	Frequency Stability Stay with the authorized bands of operation	Pass	Meet the requirement of limit.
2.1049	Occupied Bandwidth	Pass	Meet the requirement of limit.
2.1051 27.53 (m)(4)(6)	Band Edge Measurements	Pass	Meet the requirement of limit.
2.1051 27.53 (m)(4)(6)	Conducted Spurious Emissions	Pass	Meet the requirement of limit.
2.1053 27.53 (m)(4)(6)	Radiated Spurious Emissions	Pass	Meet the requirement of limit. Minimum passing margin is -19.1dB at 5185.98MHz.

Note: Determining compliance based on the results of the compliance measurement, not taking into account measurement instrumentation uncertainty.

2.1 Measurement Uncertainty

Where relevant, the following measurement uncertainty levels have been estimated for tests performed on the EUT as specified in CISPR 16-4-2:

Measurement	Frequency	Expanded Uncertainty (k=2) (\pm)
Radiated Emissions up to 1 GHz	9kHz ~ 30MHz	3.04 dB
	30MHz ~ 200MHz	3.63 dB
	200MHz ~ 1000MHz	3.64 dB
Radiated Emissions above 1 GHz	1GHz ~ 18GHz	2.29 dB
	18GHz ~ 40GHz	2.29 dB

2.2 Test Site and Instruments

Description & Manufacturer	Model No.	Serial No.	Cal. Date	Cal. Due
Test Receiver ROHDE & SCHWARZ	ESCI	100424	Dec. 31, 2019	Dec. 30, 2020
Spectrum Analyzer ROHDE & SCHWARZ	FSP40	100040	Sep. 23, 2019	Sep. 22, 2020
Spectrum Analyzer KEYSIGHT	N9030B	MY57140953	Jul. 03, 2019	Jul. 02, 2020
Radio Communication Analyzer Anritsu	MT8000A	6262012865	Dec. 12, 2019	Dec. 11, 2020
MXG Vector signal generator Agilent	N5182B	MY53050162	Jan. 14, 2020	Jan. 13, 2021
HORN Antenna ETS	3117	00034128	Nov. 24, 2019	Nov. 23, 2020
BILOG Antenna SCHWARZBECK	VULB9168	9168-155	Nov. 11, 2019	Nov. 10, 2020
HORN Antenna SCHWARZBECK	BBHA 9120D	9120D-1170	Nov. 24, 2019	Nov. 23, 2020
HORN Antenna ETS	3117	00034128	Nov. 24, 2019	Nov. 23, 2020
HORN Antenna SCHWARZBECK	BBHA 9170	BBHA9170241	Nov. 24, 2019	Nov. 23, 2020
Loop Antenna TESEQ	HLA 6121	45745	Jul. 01, 2019	Jun. 30, 2020
Preamplifier Agilent (Below 1GHz)	8447D	2944A10631	Jul. 11, 2019	Jul. 10, 2020
Preamplifier KEYSIGHT (Above 1GHz)	83017A	MY53270295	Jun. 11, 2019	Jun. 10, 2020
RF Coaxial Cable WOKEN With 5dB PAD	8D-FB	Cable-CH4-01	Aug. 20, 2019	Aug. 19, 2020
RF Coaxial Cable EMCI	EMC102-KM-KM-3000	150929	Aug. 20, 2019	Aug. 19, 2020
RF Coaxial Cable EMCI	EMC102-KM-KM-600	150928	Aug. 20, 2019	Aug. 19, 2020
RF signal cable HUBER+SUHNER	SUCOFLEX 104	MY 13380+295012/04	Jul. 11, 2019	Jul. 10, 2020
RF signal cable HUBER+SUHNER	SUCOFLEX 104	Cable-CH4-03 (250724)	Jul. 11, 2019	Jul. 10, 2020
Software BV ADT	ADT_Radiated_ V7.6.15.9.5	NA	NA	NA
Antenna Tower inn-co GmbH	MA 4000	010303	NA	NA
Antenna Tower Controller BV ADT	AT100	AT93021703	NA	NA
Boresight Antenna Fixture	FBA-01	FBA-SIP01	NA	NA
Standard Temperature And Humidity Chamber	MHU-225AU	920842	May 31, 2019	May 30, 2020
JFW 20dB attenuation	50HF-020-SMA	NA	NA	NA
Digital Multimeter Fluke	87-III	70360742	Jun. 27, 2019	Jun. 26, 2020
DC power supply	U8002A	MY56330015	NA	NA

Note: 1. The calibration interval of the above test instruments is 12 months and the calibrations are traceable to NML/ROC and NIST/USA.

2. The test was performed in HwaYa Chamber 4.

3 General Information

3.1 General Description of EUT

Product	5G WWAN Module						
Brand	Foxconn						
Test Model	T99W175						
Status of EUT	Engineering Sample						
Power Supply Rating	5 Vdc (Host equipment) 3.135Vdc~3.63Vdc (Module)						
Modulation Type	$\pi/2$ BPSK, QPSK, 16QAM, 64QAM, 256QAM						
Waveform Type	CP-OFDM, DFT-s-OFDM						
Operating Frequency	n41	Channel Bandwidth 20MHz	2506.02MHz ~ 2679.99MHz				
		Channel Bandwidth 40MHz	2516.01MHz ~ 2670.00MHz				
		Channel Bandwidth 50MHz	2521.02MHz ~ 2664.99MHz				
		Channel Bandwidth 60MHz	2526.00MHz ~ 2659.98MHz				
		Channel Bandwidth 80MHz	2536.02MHz ~ 2649.99MHz				
		Channel Bandwidth 90MHz	2541.00MHz ~ 2644.98MHz				
		Channel Bandwidth 100MHz	2546.01MHz ~ 2640.00MHz				
Max. EIRP Power	n41		$\pi/2$ BPSK	QPSK	16QAM	64QAM	256QAM
		Channel Bandwidth 20MHz	1196.741mW (30.78dBm)	1174.898mW (30.70dBm)	1093.956mW (30.39dBm)	954.993mW (29.80dBm)	603.949mW (27.81dBm)
		Channel Bandwidth 40MHz	1205.036mW (30.81dBm)	1177.606mW (30.71dBm)	1096.478mW (30.40dBm)	954.993mW (29.80dBm)	603.949mW (27.81dBm)
		Channel Bandwidth 50MHz	1199.499mW (30.79dBm)	1174.898mW (30.70dBm)	1083.927mW (30.35dBm)	957.194mW (29.81dBm)	602.560mW (27.80dBm)
		Channel Bandwidth 60MHz	1205.036mW (30.81dBm)	1177.606mW (30.71dBm)	1086.426mW (30.36dBm)	957.194mW (29.81dBm)	603.949mW (27.81dBm)
		Channel Bandwidth 80MHz	1205.036mW (30.81dBm)	1172.195mW (30.69dBm)	1093.956mW (30.39dBm)	954.993mW (29.80dBm)	603.949mW (27.81dBm)
		Channel Bandwidth 90MHz	1193.988mW (30.77dBm)	1174.898mW (30.70dBm)	1099.006mW (30.41dBm)	957.194mW (29.81dBm)	603.949mW (27.81dBm)
Channel Bandwidth 100MHz	1185.769mW (30.74dBm)	1172.195mW (30.69dBm)	1093.956mW (30.39dBm)	950.605mW (29.78dBm)	602.560mW (27.80dBm)		
Emission Designator	n41		$\pi/2$ BPSK	QPSK	16QAM	64QAM	256QAM
		Channel Bandwidth 20MHz	18M2G7D	18M2G7D	18M2D7W	18M2D7W	18M2D7W
		Channel Bandwidth 40MHz	37M8G7D	37M9G7D	37M8D7W	37M8D7W	37M9D7W
		Channel Bandwidth 50MHz	47M5G7D	47M4G7D	47M4D7W	47M5D7W	47M4D7W
		Channel Bandwidth 60MHz	58M0G7D	57M8G7D	57M7D7W	57M7D7W	57M7D7W
		Channel Bandwidth 80MHz	77M5G7D	77M3G7D	77M6D7W	77M3D7W	77M3D7W
		Channel Bandwidth 90MHz	87M3G7D	87M4G7D	87M3D7W	87M3D7W	87M2D7W
Channel Bandwidth 100MHz	97M4G7D	97M2G7D	97M3D7W	97M4D7W	97M2D7W		
Antenna Type	Refer to Note as below						
Antenna Connector	Refer to Note as below						
Accessory Device	NA						
Cable Supplied	NA						

Note:

1. This report is prepared for FCC class II permissive change. This report is issued as a supplementary report of BV CPS report no.: RF200109E02A-2. Difference compared with the original report is adding 5GNR n41 (Standalone) by software. Therefore, the EUT was tested all tests for 5GNR n41 (Standalone) and presented in the test report.
2. There are four Difference HW of T99W175.

Brand	Model	HW
Foxconn	T99W175	1. 3G+LTE+Sub6+eSIM
		2. 3G+LTE+Sub6 only w/o eSIM
		3. 3G+LTE+Sub6+eSIM+GNSS connector
		4. 3G+LTE+Sub6 only+w/o eSIM+GNSS connector

*After pre-testing, "HW: 1. 3G+LTE+Sub6+eSIM" is the worst for the final tests.

3. After pre-testing, "DFT-s-OFDM" is the worst for the final tests.

4. The following antennas were provided to the EUT.

Antenna No.	RF Chain No.	Brand	Model	Antenna Net Gain(dBi)	Frequency range (MHz)	Antenna Type	Connector Type
1		WHA YU	C107-511720-A	4.41	660~803	PCB	I-PEX
2		WHA YU	C107-511721-A	3.81 4.03	791~960 1447.9~1606	PCB	I-PEX
3		WHA YU	C107-511722-A	4.27 5.31	1710~2170 2500~2690	PCB	I-PEX
4		WHA YU	C107-511723-A	2.99 0.92	2300~2400 3500~3700	PCB	I-PEX
5		WHA YU	C107-511724-A	6.45	5150~5925	PCB	I-PEX
6		WHA YU	C107-511725-A	4.89	3400~3700	PCB	I-PEX
7		AVX	5000106-R1-X01	2.91	699~803	Monopole	I-PEX
8		AVX	5000107-R1-X01	2.59	791~960	Monopole	I-PEX
9		AVX	5000108-R1-X01	2.85	1427~1610	Monopole	I-PEX
10		AVX	5000109-R1-X01	2.23 2.94	1710~2200 5150~5925	Monopole	I-PEX
11		AVX	5000110-R1-X01	0.9	2300~2690	Monopole	I-PEX
12		AVX	5000111-R1-X01	0.87	3300~5000	Monopole	I-PEX
13	Tx1/ Rx1	Ethertronics	5003806	0.4 -1.61 0.39 2.95 1.98 0.38 0.83 2.31	698-821 824-960 1425-1515 1710-2200 2300-2690 3300-4200 4400-5000 5150-5925	PIFA	I-PEX
	Rx2	Ethertronics	5003807	-2.24 -4.52 2.87 2.99 2.93 2.91 2.23 -0.85 -3.04	716-821 824-960 1425-1515 1557-1610 1805-2200 2300-2690 3300-4200 4400-5000 5150-5925	PIFA	I-PEX
	Tx2/ Rx3	Ethertronics	5003806	2.21 2.25 -0.45 2.6	1710-2200 2300-2690 3300-4200 4400-5000	PIFA	I-PEX
	Rx4	Ethertronics	5003700	1.38 2.87 0.6 -2.09	1805-2200 2300-2690 3300-4200 4400-5000	PIFA	I-PEX

Antenna No.	RF Chain No.	Brand	Model	Antenna Net Gain(dBi)	Frequency range (MHz)	Antenna Type	Connector Type
14	Ant. 0 (TX/RX)	Master Wave	NA	2.4 2.2 2.9 2.9 2.9 NA	880~960 1020~2170 2545~2595 3565~3600 3900~4000 GPS	PCB	I-PEX
	Ant. 2 (TX/RX)	Master Wave	NA	NA 2.2 2.8 2.9 2.8 NA	880~960 1020~2170 2545~2595 3565~3600 3900~4000 GPS	PCB	I-PEX
	Ant. 1 (RX)	Master Wave	NA	NA 5.3 5.1 4.3 4.5 NA	880~960 1020~2170 2545~2595 3565~3600 3900~4000 GPS	PCB	I-PEX
	Ant. 3 (RX)	Master Wave	NA	1.3 6.8 3.7 6.4 6.2 3.7	880~960 1020~2170 2545~2595 3565~3600 3900~4000 GPS	PCB	I-PEX

*The antenna for the final tests as following table.

	Band	Antenna
5GNR	41 (30kHz) /20/40/50/60/80/90/100	Antenna 3

3.2 Configuration of System under Test

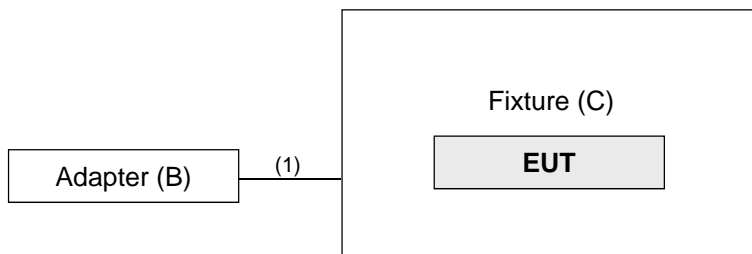

Remote site



3.2.1 Description of Support Units

The EUT has been tested as an independent unit together with other necessary accessories or support units. The following support units or accessories were used to form a representative test configuration during the tests.

ID	Product	Brand	Model No.	Serial No.	FCC ID	Remarks
A.	Radio Communication Analyzer	Anritsu	MT8821C	6261806803	NA	-
B.	Adapter	LITEON	PA-1050-39	NA	NA	-
C.	Fixture	NA	NA	NA	NA	Provided by client.

Note:

1. All power cords of the above support units are non-shielded (1.8m).
2. Item A acted as a communication partner to transfer data.

ID	Descriptions	Qty.	Length (m)	Shielding (Yes/No)	Cores (Qty.)	Remarks
1.	USB cable	1	1.5	Y	0	-

3.3 Test Mode Applicability and Tested Channel Detail

Pre-Scan has been conducted to determine the worst-case mode from all possible combinations between available modulations, data rates, XYZ axis and antenna ports. The worst case was found when positioned on Z-plane. Following channel(s) was (were) selected for the final test as listed below.

n41

EUT Configure Mode	Test item	Available channel	Tested channel	Channel Bandwidth	Modulation	Mode
-	EIRP	501204 to 535998	501204 (2506.02MHz), 518598 (2592.99MHz), 535998 (2679.99MHz)	20MHz	$\pi/2$ BPSK / QPSK / 16QAM / 64QAM / 256QAM	1 RB / 0 RB Offset 1 RB / 50 RB Offset 1 RB / 99 RB Offset 50 RB / 0 RB Offset 50 RB / 25 RB Offset 50 RB / 50 RB Offset 100 RB / 0 RB Offset
		503202 to 534000	503202 (2516.01MHz), 518598 (2592.99MHz), 534000 (2670.00MHz)	40MHz	$\pi/2$ BPSK / QPSK / 16QAM / 64QAM / 256QAM	1 RB / 0 RB Offset 1 RB / 53 RB Offset 1 RB / 105 RB Offset 53 RB / 0 RB Offset 53 RB / 26 RB Offset 53 RB / 53 RB Offset 106 RB / 0 RB Offset
		504204 to 532998	504204 (2521.02MHz), 518598 (2592.99MHz), 532998 (2664.99MHz)	50MHz	$\pi/2$ BPSK / QPSK / 16QAM / 64QAM / 256QAM	1 RB / 0 RB Offset 1 RB / 66 RB Offset 1 RB / 132 RB Offset 66 RB / 0 RB Offset 66 RB / 33 RB Offset 66 RB / 66 RB Offset 133 RB / 0 RB Offset
		505200 to 531996	505200 (2526.00MHz), 518598 (2592.99MHz), 531996 (2659.98MHz)	60MHz	$\pi/2$ BPSK / QPSK / 16QAM / 64QAM / 256QAM	1 RB / 0 RB Offset 1 RB / 81 RB Offset 1 RB / 161 RB Offset 81 RB / 0 RB Offset 81 RB / 40 RB Offset 81 RB / 81 RB Offset 162 RB / 0 RB Offset
		507204 to 529998	507204 (2536.02MHz), 518598 (2592.99MHz), 529998 (2649.99MHz)	80MHz	$\pi/2$ BPSK / QPSK / 16QAM / 64QAM / 256QAM	1 RB / 0 RB Offset 1 RB / 108 RB Offset 1 RB / 216 RB Offset 108 RB / 0 RB Offset 108 RB / 54 RB Offset 108 RB / 108 RB Offset 217 RB / 0 RB Offset
		508200 to 528996	508200 (2541.00MHz), 518598 (2592.99MHz), 528996 (2644.98MHz)	90MHz	$\pi/2$ BPSK / QPSK / 16QAM / 64QAM / 256QAM	1 RB / 0 RB Offset 1 RB / 122 RB Offset 1 RB / 244 RB Offset 122 RB / 0 RB Offset 122 RB / 61 RB Offset 122 RB / 122 RB Offset 245 RB / 0 RB Offset
		509202 to 528000	509202 (2546.01MHz), 518598 (2592.99MHz), 528000 (2640.00MHz)	100MHz	$\pi/2$ BPSK / QPSK / 16QAM / 64QAM / 256QAM	1 RB / 0 RB Offset 1 RB / 136 RB Offset 1 RB / 272 RB Offset 136 RB / 0 RB Offset 136 RB / 68 RB Offset 136 RB / 136 RB Offset 273 RB / 0 RB Offset

EUT Configure Mode	Test item	Available channel	Tested channel	Channel Bandwidth	Modulation	Mode
-	Frequency Stability	501204 to 535998	501204 (2506.02MHz), 535998 (2679.99MHz)	20MHz	$\pi/2$ BPSK	1 RB / 0 RB Offset
		503202 to 534000	503202 (2516.01MHz), 534000 (2670.00MHz)	40MHz	$\pi/2$ BPSK	1 RB / 0 RB Offset
		504204 to 532998	504204 (2521.02MHz), 532998 (2664.99MHz)	50MHz	$\pi/2$ BPSK	1 RB / 0 RB Offset
		505200 to 531996	505200 (2526.00MHz), 531996 (2659.98MHz)	60MHz	$\pi/2$ BPSK	1 RB / 0 RB Offset
		507204 to 529998	507204 (2536.02MHz), 529998 (2649.99MHz)	80MHz	$\pi/2$ BPSK	1 RB / 0 RB Offset
		508200 to 528996	508200 (2541.00MHz), 528996 (2644.98MHz)	90MHz	$\pi/2$ BPSK	1 RB / 0 RB Offset
		509202 to 528000	509202 (2546.01MHz), 528000 (2640.00MHz)	100MHz	$\pi/2$ BPSK	1 RB / 0 RB Offset
-	Emission Bandwidth	501204 to 535998	501204 (2506.02MHz), 518598 (2592.99MHz), 535998 (2679.99MHz)	20MHz	$\pi/2$ BPSK / QPSK / 16QAM / 64QAM / 256QAM	51 RB / 0 RB Offset
		503202 to 534000	503202 (2516.01MHz), 518598 (2592.99MHz), 534000 (2670.00MHz)	40MHz	$\pi/2$ BPSK / QPSK / 16QAM / 64QAM / 256QAM	106 RB / 0 RB Offset
		504204 to 532998	504204 (2521.02MHz), 518598 (2592.99MHz), 532998 (2664.99MHz)	50MHz	$\pi/2$ BPSK / QPSK / 16QAM / 64QAM / 256QAM	133 RB / 0 RB Offset
		505200 to 531996	505200 (2526.00MHz), 518598 (2592.99MHz), 531996 (2659.98MHz)	60MHz	$\pi/2$ BPSK / QPSK / 16QAM / 64QAM / 256QAM	162 RB / 0 RB Offset
		507204 to 529998	507204 (2536.02MHz), 518598 (2592.99MHz), 529998 (2649.99MHz)	80MHz	$\pi/2$ BPSK / QPSK / 16QAM / 64QAM / 256QAM	217 RB / 0 RB Offset
		508200 to 528996	508200 (2541.00MHz), 518598 (2592.99MHz), 528996 (2644.98MHz)	90MHz	$\pi/2$ BPSK / QPSK / 16QAM / 64QAM / 256QAM	245 RB / 0 RB Offset
		509202 to 528000	509202 (2546.01MHz), 518598 (2592.99MHz), 528000 (2640.00MHz)	100MHz	$\pi/2$ BPSK / QPSK / 16QAM / 64QAM / 256QAM	273 RB / 0 RB Offset

EUT Configure Mode	Test item	Available channel	Tested channel	Channel Bandwidth	Modulation	Mode
-	Emission Mask	501204 to 535998	501204 (2506.02MHz), 518598 (2592.99MHz), 535998 (2679.99MHz)	20MHz	$\pi/2$ BPSK / QPSK / 16QAM / 64QAM / 256QAM	1 RB / 0 RB Offset 1 RB / 50 RB Offset 51 RB / 0 RB Offset
		503202 to 534000	503202 (2516.01MHz), 518598 (2592.99MHz), 534000 (2670.00MHz)	40MHz	$\pi/2$ BPSK / QPSK / 16QAM / 64QAM / 256QAM	1 RB / 0 RB Offset 1 RB / 105 RB Offset 106 RB / 0 RB Offset
		504204 to 532998	504204 (2521.02MHz), 518598 (2592.99MHz), 532998 (2664.99MHz)	50MHz	$\pi/2$ BPSK / QPSK / 16QAM / 64QAM / 256QAM	1 RB / 0 RB Offset 1 RB / 132 RB Offset 133 RB / 0 RB Offset
		505200 to 531996	505200 (2526.00MHz), 518598 (2592.99MHz), 531996 (2659.98MHz)	60MHz	$\pi/2$ BPSK / QPSK / 16QAM / 64QAM / 256QAM	1 RB / 0 RB Offset 1 RB / 161 RB Offset 162 RB / 0 RB Offset
		507204 to 529998	507204 (2536.02MHz), 518598 (2592.99MHz), 529998 (2649.99MHz)	80MHz	$\pi/2$ BPSK / QPSK / 16QAM / 64QAM / 256QAM	1 RB / 0 RB Offset 1 RB / 216 RB Offset 217 RB / 0 RB Offset
		508200 to 528996	508200 (2541.00MHz), 518598 (2592.99MHz), 528996 (2644.98MHz)	90MHz	$\pi/2$ BPSK / QPSK / 16QAM / 64QAM / 256QAM	1 RB / 0 RB Offset 1 RB / 244 RB Offset 245 RB / 0 RB Offset
		509202 to 528000	509202 (2546.01MHz), 518598 (2592.99MHz), 528000 (2640.00MHz)	100MHz	$\pi/2$ BPSK / QPSK / 16QAM / 64QAM / 256QAM	1 RB / 0 RB Offset 1 RB / 272 RB Offset 273 RB / 0 RB Offset
-	Peak to Average Ratio	501204 to 535998	501204 (2506.02MHz), 518598 (2592.99MHz), 535998 (2679.99MHz)	20MHz	$\pi/2$ BPSK / QPSK / 16QAM / 64QAM / 256QAM	1 RB / 0 RB Offset
		503202 to 534000	503202 (2516.01MHz), 518598 (2592.99MHz), 534000 (2670.00MHz)	40MHz	$\pi/2$ BPSK / QPSK / 16QAM / 64QAM / 256QAM	1 RB / 0 RB Offset
		504204 to 532998	504204 (2521.02MHz), 518598 (2592.99MHz), 532998 (2664.99MHz)	50MHz	$\pi/2$ BPSK / QPSK / 16QAM / 64QAM / 256QAM	1 RB / 0 RB Offset
		505200 to 531996	505200 (2526.00MHz), 518598 (2592.99MHz), 531996 (2659.98MHz)	60MHz	$\pi/2$ BPSK / QPSK / 16QAM / 64QAM / 256QAM	1 RB / 0 RB Offset
		507204 to 529998	507204 (2536.02MHz), 518598 (2592.99MHz), 529998 (2649.99MHz)	80MHz	$\pi/2$ BPSK / QPSK / 16QAM / 64QAM / 256QAM	1 RB / 0 RB Offset
		508200 to 528996	508200 (2541.00MHz), 518598 (2592.99MHz), 528996 (2644.98MHz)	90MHz	$\pi/2$ BPSK / QPSK / 16QAM / 64QAM / 256QAM	1 RB / 0 RB Offset
		509202 to 528000	509202 (2546.01MHz), 518598 (2592.99MHz), 528000 (2640.00MHz)	100MHz	$\pi/2$ BPSK / QPSK / 16QAM / 64QAM / 256QAM	1 RB / 0 RB Offset

EUT Configure Mode	Test item	Available channel	Tested channel	Channel Bandwidth	Modulation	Mode
-	Conducted Emission	501204 to 535998	501204 (2506.02MHz), 518598 (2592.99MHz), 535998 (2679.99MHz)	20MHz	$\pi/2$ BPSK	1 RB / 0 RB Offset
		503202 to 534000	503202 (2516.01MHz), 518598 (2592.99MHz), 534000 (2670.00MHz)	40MHz	$\pi/2$ BPSK	1 RB / 0 RB Offset
		504204 to 532998	504204 (2521.02MHz), 518598 (2592.99MHz), 532998 (2664.99MHz)	50MHz	$\pi/2$ BPSK	1 RB / 0 RB Offset
		505200 to 531996	505200 (2526.00MHz), 518598 (2592.99MHz), 531996 (2659.98MHz)	60MHz	$\pi/2$ BPSK	1 RB / 0 RB Offset
		507204 to 529998	507204 (2536.02MHz), 518598 (2592.99MHz), 529998 (2649.99MHz)	80MHz	$\pi/2$ BPSK	1 RB / 0 RB Offset
		508200 to 528996	508200 (2541.00MHz), 518598 (2592.99MHz), 528996 (2644.98MHz)	90MHz	$\pi/2$ BPSK	1 RB / 0 RB Offset
		509202 to 528000	509202 (2546.01MHz), 518598 (2592.99MHz), 528000 (2640.00MHz)	100MHz	$\pi/2$ BPSK	1 RB / 0 RB Offset
-	Radiated Emission Below 1GHz	501204 to 535998	518598 (2592.99MHz)	20MHz	$\pi/2$ BPSK	1 RB / 0 RB Offset
-	Radiated Emission Above 1GHz	501204 to 535998	501204 (2506.02MHz), 518598 (2592.99MHz), 535998 (2679.99MHz)	20MHz	$\pi/2$ BPSK	1 RB / 0 RB Offset
		503202 to 534000	503202 (2516.01MHz), 518598 (2592.99MHz), 534000 (2670.00MHz)	40MHz	$\pi/2$ BPSK	1 RB / 0 RB Offset
		504204 to 532998	504204 (2521.02MHz), 518598 (2592.99MHz), 532998 (2664.99MHz)	50MHz	$\pi/2$ BPSK	1 RB / 0 RB Offset
		505200 to 531996	505200 (2526.00MHz), 518598 (2592.99MHz), 531996 (2659.98MHz)	60MHz	$\pi/2$ BPSK	1 RB / 0 RB Offset
		507204 to 529998	507204 (2536.02MHz), 518598 (2592.99MHz), 529998 (2649.99MHz)	80MHz	$\pi/2$ BPSK	1 RB / 0 RB Offset
		508200 to 528996	508200 (2541.00MHz), 518598 (2592.99MHz), 528996 (2644.98MHz)	90MHz	$\pi/2$ BPSK	1 RB / 0 RB Offset
		509202 to 528000	509202 (2546.01MHz), 518598 (2592.99MHz), 528000 (2640.00MHz)	100MHz	$\pi/2$ BPSK	1 RB / 0 RB Offset

Note:

1. The conducted output power for $\pi/2$ BPSK, QPSK, 16QAM, 64QAM and 256QAM, measured value of $\pi/2$ BPSK is higher than QPSK, 16QAM, 64QAM and 256QAM mode. Therefore, only EIRP, Modulation characteristics, occupied bandwidth and Peak to average ratio items had been tested under $\pi/2$ BPSK, QPSK, 16QAM, 64QAM and 256QAM modes, the other test items were performed under $\pi/2$ BPSK mode only.
2. 5GNR mode is the same as digital modulation in ENDC 5GNR, so please refer to BV CPS report no.: RF200109E02B-12 for the modulation characteristics data of 5GNR mode.

Test Condition:

Test Item	Environmental Conditions	Input Power	Tested By
EIRP	25deg. C, 70%RH	5Vdc	James Yang
Frequency Stability	24deg. C, 64%RH	5Vdc	James Yang
Occupied Bandwidth	24deg. C, 64%RH	5Vdc	James Yang
Band Edge	24deg. C, 64%RH	5Vdc	James Yang
Peak To Average Ratio	24deg. C, 64%RH	5Vdc	James Yang
Conducted Emission	24deg. C, 64%RH	5Vdc	James Yang
Radiated Emission	22deg. C, 68%RH	120Vac, 60Hz	Greg Lin

3.4 EUT Operating Conditions

The EUT makes a call to the communication simulator. The communication simulator station system controlled a EUT to export maximum output power under transmission mode and specific channel frequency

3.5 General Description of Applied Standards and References

The EUT is a RF Product. According to the specifications of the manufacturer, it must comply with the requirements of the following standards and References:

Test Standard:

FCC 47 CFR Part 2

FCC 47 CFR Part 27

ANSI/TIA/EIA-603-E 2016

ANSI 63.26-2015

All test items have been performed and recorded as per the above standards.

References Test Guidance:

KDB 971168 D01 Power Meas License Digital Systems v03r01

All test items have been performed as a reference to the above KDB test guidance.

4 Test Types and Results

4.1 Output Power Measurement

4.1.1 Limits of Output Power Measurement

Mobile stations are limited to 2.0 watts EIRP. All user stations are limited to 2.0 watts transmitter output power.

4.1.2 Test Procedures

Conducted Power Measurement:

The EUT was set up for the maximum power with 5GNR link data modulation and link up with simulator. Set the EUT to transmit under low, middle and high channel and record the power level shown on simulator.

Maximum EIRP / ERP

The relevant equation for determining the maximum ERP or EIRP from the measured RF output power is

given in Equation as follows:

$$\text{ERP or EIRP} = P_{\text{Meas}} + G_{\text{T}}$$

where

ERP or EIRP effective radiated power or equivalent isotropically radiated power, respectively
(expressed in the same units as P_{Meas} , e.g., dBm or dBW)

P_{Meas} measured transmitter output power or PSD, in dBm or dBW

G_{T} gain of the transmitting antenna, in dBd (ERP) or dBi (EIRP)

4.1.3 Test Setup

Conducted Power Measurement:

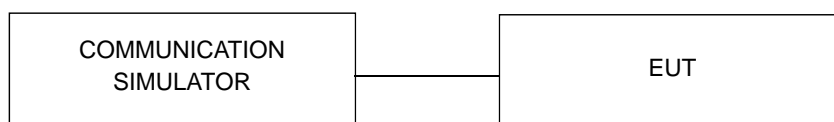

For the actual test configuration, please refer to the attached file (Test Setup Photo).

4.1.4 Test Results

Conducted Output Power (dBm)

n41						
BW	MCS Index	Channel		501204	518598	535998
		Frequency (MHz)		2506.02	2592.99	2679.99
20M	$\pi/2$ BPSK	1	0	25.30	25.34	25.40
		1	25	25.44	25.35	25.41
		1	50	25.45	25.36	25.47
		25	0	24.88	24.81	24.83
		25	12	24.95	24.81	24.90
		25	25	24.90	24.90	24.92
		51	0	24.82	24.84	24.88
	QPSK	1	0	25.23	25.32	25.29
		1	25	25.36	25.26	25.25
		1	50	25.39	25.21	25.22
		25	0	24.81	24.88	24.85
		25	12	24.73	24.73	24.86
		25	25	24.76	24.81	24.73
		51	0	24.90	24.81	24.70
	16QAM	1	0	25.05	25.00	24.94
		1	25	24.97	24.94	24.99
		1	50	25.02	25.08	25.05
		25	0	24.66	24.53	24.60
		25	12	24.59	24.50	24.67
		25	25	24.68	24.51	24.70
		51	0	24.59	24.58	24.52
	64QAM	1	0	24.43	24.38	24.44
		1	25	24.35	24.38	24.36
		1	50	24.37	24.49	24.46
		25	0	23.85	23.80	23.94
		25	12	23.92	23.85	23.84
		25	25	23.86	23.82	23.98
		51	0	23.99	23.98	23.82
	256QAM	1	0	22.36	22.34	22.49
		1	25	22.32	22.38	22.31
1		50	22.34	22.44	22.50	
25		0	21.85	21.84	21.95	
25		12	21.97	21.85	21.97	
25		25	21.95	21.98	21.93	
51		0	21.80	22.00	21.80	

n41						
BW	MCS Index	Channel		503202	518598	534000
		Frequency (MHz)		2516.01	2592.99	2670
40M	$\pi/2$ BPSK	1	0	25.49	25.30	25.50
		1	53	25.42	25.37	25.37
		1	105	25.50	25.46	25.42
		53	0	24.87	24.84	24.84
		53	26	24.92	24.88	24.86
		53	53	24.90	25.00	24.84
		106	0	24.98	24.92	24.96
	QPSK	1	0	25.20	25.23	25.24
		1	53	25.28	25.40	25.33
		1	105	25.33	25.24	25.23
		53	0	24.75	24.85	24.90
		53	26	24.75	24.80	24.76
		53	53	24.77	24.89	24.85
		106	0	24.89	24.71	24.87
	16QAM	1	0	25.08	25.01	25.07
		1	53	25.06	24.93	25.08
		1	105	24.95	25.09	24.90
		53	0	24.54	24.66	24.60
		53	26	24.60	24.67	24.50
		53	53	24.61	24.62	24.67
		106	0	24.58	24.57	24.63
	64QAM	1	0	24.40	24.42	24.42
		1	53	24.37	24.47	24.47
		1	105	24.46	24.49	24.47
		53	0	23.91	23.83	23.93
		53	26	23.89	23.82	23.81
		53	53	23.98	23.91	23.86
		106	0	23.93	23.94	23.95
	256QAM	1	0	22.41	22.50	22.34
		1	53	22.38	22.47	22.45
1		105	22.30	22.32	22.44	
53		0	21.98	21.89	21.94	
53		26	21.97	21.84	21.83	
53		53	21.93	21.86	21.95	
106		0	21.89	21.94	21.93	

n41						
BW	MCS Index	Channel		504204	518598	532998
		Frequency (MHz)		2521.02	2592.99	2664.99
50M	$\pi/2$ BPSK	1	0	25.30	25.46	25.30
		1	66	25.45	25.45	25.44
		1	132	25.37	25.48	25.32
		66	0	24.82	25.00	24.96
		66	33	24.80	24.85	24.91
		66	66	24.97	24.94	24.99
		133	0	24.89	24.82	24.86
	QPSK	1	0	25.31	25.34	25.30
		1	66	25.39	25.38	25.20
		1	132	25.23	25.28	25.35
		66	0	24.90	24.77	24.86
		66	33	24.79	24.82	24.76
		66	66	24.79	24.76	24.87
		133	0	24.78	24.72	24.70
	16QAM	1	0	24.97	24.98	25.04
		1	66	24.92	25.02	25.04
		1	132	24.93	24.96	24.90
		66	0	24.61	24.50	24.51
		66	33	24.62	24.55	24.64
		66	66	24.61	24.51	24.53
		133	0	24.61	24.70	24.69
	64QAM	1	0	24.43	24.35	24.34
		1	66	24.31	24.40	24.33
		1	132	24.50	24.50	24.50
		66	0	23.80	23.90	23.84
		66	33	23.85	24.00	23.92
		66	66	23.83	23.80	23.88
		133	0	23.88	23.89	23.81
	256QAM	1	0	22.36	22.40	22.42
		1	66	22.49	22.40	22.31
1		132	22.30	22.35	22.39	
66		0	21.91	21.85	21.88	
66		33	21.94	21.83	21.80	
66		66	21.98	21.95	21.94	
133		0	21.84	21.91	21.88	

n41						
BW	MCS Index	Channel		505200	518598	531996
		Frequency (MHz)		2526	2592.99	2659.98
60M	$\pi/2$ BPSK	1	0	25.34	25.32	25.50
		1	81	25.35	25.33	25.32
		1	161	25.30	25.35	25.31
		81	0	24.80	24.92	24.88
		81	40	24.98	24.98	25.00
		81	81	24.94	24.88	24.80
		162	0	25.00	24.90	24.86
	QPSK	1	0	25.40	25.36	25.37
		1	81	25.26	25.39	25.30
		1	161	25.35	25.37	25.40
		81	0	24.81	24.84	24.90
		81	40	24.82	24.86	24.88
		81	81	24.79	24.76	24.82
		162	0	24.76	24.81	24.71
	16QAM	1	0	25.00	24.96	24.97
		1	81	25.04	24.91	24.92
		1	161	25.00	25.05	24.90
		81	0	24.55	24.57	24.67
		81	40	24.68	24.53	24.64
		81	81	24.70	24.57	24.69
		162	0	24.64	24.56	24.51
	64QAM	1	0	24.50	24.50	24.31
		1	81	24.31	24.35	24.40
		1	161	24.34	24.49	24.34
		81	0	23.80	23.98	23.94
		81	40	23.91	23.85	23.88
		81	81	23.83	23.92	23.92
		162	0	23.99	23.94	23.89
	256QAM	1	0	22.50	22.37	22.31
		1	81	22.31	22.49	22.43
1		161	22.50	22.50	22.41	
81		0	21.93	21.88	21.84	
81		40	22.00	21.86	21.87	
81		81	21.98	21.87	22.00	
162		0	21.83	21.85	21.80	

n41						
BW	MCS Index	Channel		507204	518598	529998
		Frequency (MHz)		2536.02	2592.99	2649.99
80M	$\pi/2$ BPSK	1	0	25.39	25.32	25.38
		1	108	25.49	25.37	25.39
		1	216	25.50	25.49	25.34
		108	0	24.96	24.91	24.84
		108	54	24.97	24.87	24.85
		108	108	24.99	24.98	24.84
		217	0	24.98	24.94	24.98
	QPSK	1	0	25.31	25.37	25.28
		1	108	25.38	25.29	25.27
		1	216	25.21	25.33	25.38
		108	0	24.79	24.78	24.81
		108	54	24.76	24.86	24.90
		108	108	24.73	24.70	24.72
		217	0	24.88	24.74	24.89
	16QAM	1	0	25.07	25.03	25.08
		1	108	24.93	25.02	24.98
		1	216	25.02	24.92	24.94
		108	0	24.63	24.50	24.62
		108	54	24.52	24.60	24.50
		108	108	24.53	24.56	24.61
		217	0	24.58	24.62	24.59
	64QAM	1	0	24.42	24.43	24.33
		1	108	24.49	24.37	24.32
		1	216	24.46	24.41	24.35
		108	0	23.83	23.95	23.81
		108	54	23.94	23.94	23.99
		108	108	23.95	24.00	23.98
		217	0	23.98	23.99	23.97
	256QAM	1	0	22.34	22.44	22.41
		1	108	22.45	22.35	22.45
1		216	22.40	22.42	22.50	
108		0	21.96	21.94	21.97	
108		54	21.82	21.90	21.80	
108		108	21.85	21.91	21.83	
217		0	21.91	21.90	21.94	

n41						
BW	MCS Index	Channel		508200	518598	528996
		Frequency (MHz)		2541	2592.99	2644.98
90M	$\pi/2$ BPSK	1	0	25.42	25.34	25.41
		1	122	25.36	25.40	25.46
		1	244	25.44	25.41	25.33
		122	0	24.97	24.98	24.96
		122	61	24.90	24.89	24.90
		122	122	24.92	24.83	24.82
		245	0	24.83	24.91	24.82
	QPSK	1	0	25.29	25.28	25.22
		1	122	25.38	25.20	25.24
		1	244	25.39	25.25	25.27
		122	0	24.89	24.84	24.73
		122	61	24.90	24.84	24.84
		122	122	24.83	24.72	24.84
		245	0	24.86	24.83	24.79
	16QAM	1	0	24.91	25.07	24.96
		1	122	25.10	24.90	24.94
		1	244	25.10	24.99	25.09
		122	0	24.50	24.60	24.51
		122	61	24.54	24.69	24.61
		122	122	24.52	24.64	24.54
		245	0	24.63	24.64	24.63
	64QAM	1	0	24.38	24.50	24.48
		1	122	24.43	24.50	24.39
		1	244	24.43	24.48	24.44
		122	0	23.86	23.91	23.92
		122	61	23.80	23.87	23.97
		122	122	23.95	23.91	23.96
		245	0	23.87	23.80	23.84
	256QAM	1	0	22.50	22.37	22.34
		1	122	22.34	22.50	22.33
1		244	22.49	22.31	22.42	
122		0	21.86	21.80	21.88	
122		61	21.90	21.85	21.83	
122		122	21.94	21.95	21.98	
245		0	21.89	21.88	21.99	

n41						
BW	MCS Index	Channel		509202	518598	528000
		Frequency (MHz)		2546.01	2592.99	2640
100M	$\pi/2$ BPSK	1	0	25.36	25.39	25.33
		1	136	25.42	25.36	25.38
		1	272	25.35	25.38	25.43
		136	0	24.90	24.89	24.89
		136	68	24.88	24.86	24.92
		136	136	24.96	24.92	24.94
		273	0	24.81	24.88	24.88
	QPSK	1	0	25.37	25.26	25.38
		1	136	25.26	25.27	25.21
		1	272	25.33	25.25	25.31
		136	0	24.81	24.79	24.89
		136	68	24.76	24.74	24.83
		136	136	24.89	24.71	24.72
		273	0	24.72	24.85	24.73
	16QAM	1	0	25.02	24.92	25.06
		1	136	24.99	24.95	25.07
		1	272	25.08	24.90	24.92
		136	0	24.66	24.59	24.54
		136	68	24.50	24.57	24.64
		136	136	24.51	24.62	24.56
		273	0	24.54	24.63	24.61
	64QAM	1	0	24.41	24.43	24.47
		1	136	24.30	24.31	24.33
		1	272	24.31	24.32	24.41
		136	0	23.83	23.99	23.95
		136	68	23.81	23.87	23.99
		136	136	23.82	23.92	23.93
		273	0	23.87	23.96	23.95
	256QAM	1	0	22.48	22.34	22.48
		1	136	22.32	22.36	22.47
1		272	22.49	22.46	22.45	
136		0	21.89	21.88	21.93	
136		68	21.89	21.91	21.83	
136		136	21.91	21.94	21.81	
273		0	21.80	21.95	21.89	

EIRP Power(dBm)

n41						
BW	MCS Index	Channel		501204	518598	535998
		Frequency (MHz)		2506.02	2592.99	2679.99
20M	$\pi/2$ BPSK	1	0	30.61	30.65	30.71
		1	25	30.75	30.66	30.72
		1	50	30.76	30.67	30.78
		25	0	30.19	30.12	30.14
		25	12	30.26	30.12	30.21
		25	25	30.21	30.21	30.23
		51	0	30.13	30.15	30.19
	QPSK	1	0	30.54	30.63	30.60
		1	25	30.67	30.57	30.56
		1	50	30.70	30.52	30.53
		25	0	30.12	30.19	30.16
		25	12	30.04	30.04	30.17
		25	25	30.07	30.12	30.04
		51	0	30.21	30.12	30.01
	16QAM	1	0	30.36	30.31	30.25
		1	25	30.28	30.25	30.30
		1	50	30.33	30.39	30.36
		25	0	29.97	29.84	29.91
		25	12	29.90	29.81	29.98
		25	25	29.99	29.82	30.01
		51	0	29.90	29.89	29.83
	64QAM	1	0	29.74	29.69	29.75
		1	25	29.66	29.69	29.67
		1	50	29.68	29.80	29.77
		25	0	29.16	29.11	29.25
		25	12	29.23	29.16	29.15
		25	25	29.17	29.13	29.29
		51	0	29.30	29.29	29.13
	256QAM	1	0	27.67	27.65	27.80
		1	25	27.63	27.69	27.62
		1	50	27.65	27.75	27.81
		25	0	27.16	27.15	27.26
		25	12	27.28	27.16	27.28
		25	25	27.26	27.29	27.24
		51	0	27.11	27.31	27.11

*EIRP = Conducted + antenna gain (5.31dBi)

n41						
BW	MCS Index	Channel		503202	518598	534000
		Frequency (MHz)		2516.01	2592.99	2670
40M	$\pi/2$ BPSK	1	0	30.80	30.61	30.81
		1	53	30.73	30.68	30.68
		1	105	30.81	30.77	30.73
		53	0	30.18	30.15	30.15
		53	26	30.23	30.19	30.17
		53	53	30.21	30.31	30.15
		106	0	30.29	30.23	30.27
	QPSK	1	0	30.51	30.54	30.55
		1	53	30.59	30.71	30.64
		1	105	30.64	30.55	30.54
		53	0	30.06	30.16	30.21
		53	26	30.06	30.11	30.07
		53	53	30.08	30.20	30.16
		106	0	30.20	30.02	30.18
	16QAM	1	0	30.39	30.32	30.38
		1	53	30.37	30.24	30.39
		1	105	30.26	30.40	30.21
		53	0	29.85	29.97	29.91
		53	26	29.91	29.98	29.81
		53	53	29.92	29.93	29.98
		106	0	29.89	29.88	29.94
	64QAM	1	0	29.71	29.73	29.73
		1	53	29.68	29.78	29.78
		1	105	29.77	29.80	29.78
		53	0	29.22	29.14	29.24
		53	26	29.20	29.13	29.12
		53	53	29.29	29.22	29.17
		106	0	29.24	29.25	29.26
	256QAM	1	0	27.72	27.81	27.65
		1	53	27.69	27.78	27.76
1		105	27.61	27.63	27.75	
53		0	27.29	27.20	27.25	
53		26	27.28	27.15	27.14	
53		53	27.24	27.17	27.26	
106		0	27.20	27.25	27.24	

*EIRP = Conducted + antenna gain (5.31dBi)

n41						
BW	MCS Index	Channel		504204	518598	532998
		Frequency (MHz)		2521.02	2592.99	2664.99
50M	$\pi/2$ BPSK	1	0	30.61	30.77	30.61
		1	66	30.76	30.76	30.75
		1	132	30.68	30.79	30.63
		66	0	30.13	30.31	30.27
		66	33	30.11	30.16	30.22
		66	66	30.28	30.25	30.30
		133	0	30.20	30.13	30.17
	QPSK	1	0	30.62	30.65	30.61
		1	66	30.70	30.69	30.51
		1	132	30.54	30.59	30.66
		66	0	30.21	30.08	30.17
		66	33	30.10	30.13	30.07
		66	66	30.10	30.07	30.18
		133	0	30.09	30.03	30.01
	16QAM	1	0	30.28	30.29	30.35
		1	66	30.23	30.33	30.35
		1	132	30.24	30.27	30.21
		66	0	29.92	29.81	29.82
		66	33	29.93	29.86	29.95
		66	66	29.92	29.82	29.84
		133	0	29.92	30.01	30.00
	64QAM	1	0	29.74	29.66	29.65
		1	66	29.62	29.71	29.64
		1	132	29.81	29.81	29.81
		66	0	29.11	29.21	29.15
		66	33	29.16	29.31	29.23
		66	66	29.14	29.11	29.19
		133	0	29.19	29.20	29.12
	256QAM	1	0	27.67	27.71	27.73
		1	66	27.80	27.71	27.62
1		132	27.61	27.66	27.70	
66		0	27.22	27.16	27.19	
66		33	27.25	27.14	27.11	
66		66	27.29	27.26	27.25	
133		0	27.15	27.22	27.19	

*EIRP = Conducted + antenna gain (5.31dBi)

n41						
BW	MCS Index	Channel		505200	518598	531996
		Frequency (MHz)		2526	2592.99	2659.98
60M	$\pi/2$ BPSK	1	0	30.65	30.63	30.81
		1	81	30.66	30.64	30.63
		1	161	30.61	30.66	30.62
		81	0	30.11	30.23	30.19
		81	40	30.29	30.29	30.31
		81	81	30.25	30.19	30.11
		162	0	30.31	30.21	30.17
	QPSK	1	0	30.71	30.67	30.68
		1	81	30.57	30.70	30.61
		1	161	30.66	30.68	30.71
		81	0	30.12	30.15	30.21
		81	40	30.13	30.17	30.19
		81	81	30.10	30.07	30.13
		162	0	30.07	30.12	30.02
	16QAM	1	0	30.31	30.27	30.28
		1	81	30.35	30.22	30.23
		1	161	30.31	30.36	30.21
		81	0	29.86	29.88	29.98
		81	40	29.99	29.84	29.95
		81	81	30.01	29.88	30.00
		162	0	29.95	29.87	29.82
	64QAM	1	0	29.81	29.81	29.62
		1	81	29.62	29.66	29.71
		1	161	29.65	29.80	29.65
		81	0	29.11	29.29	29.25
		81	40	29.22	29.16	29.19
		81	81	29.14	29.23	29.23
		162	0	29.30	29.25	29.20
	256QAM	1	0	27.81	27.68	27.62
		1	81	27.62	27.80	27.74
1		161	27.81	27.81	27.72	
81		0	27.24	27.19	27.15	
81		40	27.31	27.17	27.18	
81		81	27.29	27.18	27.31	
162		0	27.14	27.16	27.11	

*EIRP = Conducted + antenna gain (5.31dBi)

n41						
BW	MCS Index	Channel		507204	518598	529998
		Frequency (MHz)		2536.02	2592.99	2649.99
80M	$\pi/2$ BPSK	1	0	30.70	30.63	30.69
		1	108	30.80	30.68	30.70
		1	216	30.81	30.80	30.65
		108	0	30.27	30.22	30.15
		108	54	30.28	30.18	30.16
		108	108	30.30	30.29	30.15
		217	0	30.29	30.25	30.29
	QPSK	1	0	30.62	30.68	30.59
		1	108	30.69	30.60	30.58
		1	216	30.52	30.64	30.69
		108	0	30.10	30.09	30.12
		108	54	30.07	30.17	30.21
		108	108	30.04	30.01	30.03
		217	0	30.19	30.05	30.20
	16QAM	1	0	30.38	30.34	30.39
		1	108	30.24	30.33	30.29
		1	216	30.33	30.23	30.25
		108	0	29.94	29.81	29.93
		108	54	29.83	29.91	29.81
		108	108	29.84	29.87	29.92
		217	0	29.89	29.93	29.90
	64QAM	1	0	29.73	29.74	29.64
		1	108	29.80	29.68	29.63
		1	216	29.77	29.72	29.66
		108	0	29.14	29.26	29.12
		108	54	29.25	29.25	29.30
		108	108	29.26	29.31	29.29
		217	0	29.29	29.30	29.28
	256QAM	1	0	27.65	27.75	27.72
		1	108	27.76	27.66	27.76
1		216	27.71	27.73	27.81	
108		0	27.27	27.25	27.28	
108		54	27.13	27.21	27.11	
108		108	27.16	27.22	27.14	
217		0	27.22	27.21	27.25	

*EIRP = Conducted + antenna gain (5.31dBi)

n41						
BW	MCS Index	Channel		508200	518598	528996
		Frequency (MHz)		2541	2592.99	2644.98
90M	$\pi/2$ BPSK	1	0	30.73	30.65	30.72
		1	122	30.67	30.71	30.77
		1	244	30.75	30.72	30.64
		122	0	30.28	30.29	30.27
		122	61	30.21	30.20	30.21
		122	122	30.23	30.14	30.13
		245	0	30.14	30.22	30.13
	QPSK	1	0	30.60	30.59	30.53
		1	122	30.69	30.51	30.55
		1	244	30.70	30.56	30.58
		122	0	30.20	30.15	30.04
		122	61	30.21	30.15	30.15
		122	122	30.14	30.03	30.15
		245	0	30.17	30.14	30.10
	16QAM	1	0	30.22	30.38	30.27
		1	122	30.41	30.21	30.25
		1	244	30.41	30.30	30.40
		122	0	29.81	29.91	29.82
		122	61	29.85	30.00	29.92
		122	122	29.83	29.95	29.85
		245	0	29.94	29.95	29.94
	64QAM	1	0	29.69	29.81	29.79
		1	122	29.74	29.81	29.70
		1	244	29.74	29.79	29.75
		122	0	29.17	29.22	29.23
		122	61	29.11	29.18	29.28
		122	122	29.26	29.22	29.27
		245	0	29.18	29.11	29.15
	256QAM	1	0	27.81	27.68	27.65
		1	122	27.65	27.81	27.64
1		244	27.80	27.62	27.73	
122		0	27.17	27.11	27.19	
122		61	27.21	27.16	27.14	
122		122	27.25	27.26	27.29	
245		0	27.20	27.19	27.30	

*EIRP = Conducted + antenna gain (5.31dBi)

n41						
BW	MCS Index	Channel		509202	518598	528000
		Frequency (MHz)		2546.01	2592.99	2640
100M	$\pi/2$ BPSK	1	0	30.67	30.70	30.64
		1	136	30.73	30.67	30.69
		1	272	30.66	30.69	30.74
		136	0	30.21	30.20	30.20
		136	68	30.19	30.17	30.23
		136	136	30.27	30.23	30.25
		273	0	30.12	30.19	30.19
	QPSK	1	0	30.68	30.57	30.69
		1	136	30.57	30.58	30.52
		1	272	30.64	30.56	30.62
		136	0	30.12	30.10	30.20
		136	68	30.07	30.05	30.14
		136	136	30.20	30.02	30.03
		273	0	30.03	30.16	30.04
	16QAM	1	0	30.33	30.23	30.37
		1	136	30.30	30.26	30.38
		1	272	30.39	30.21	30.23
		136	0	29.97	29.90	29.85
		136	68	29.81	29.88	29.95
		136	136	29.82	29.93	29.87
		273	0	29.85	29.94	29.92
	64QAM	1	0	29.72	29.74	29.78
		1	136	29.61	29.62	29.64
		1	272	29.62	29.63	29.72
		136	0	29.14	29.30	29.26
		136	68	29.12	29.18	29.30
		136	136	29.13	29.23	29.24
		273	0	29.18	29.27	29.26
	256QAM	1	0	27.79	27.65	27.79
		1	136	27.63	27.67	27.78
1		272	27.80	27.77	27.76	
136		0	27.20	27.19	27.24	
136		68	27.20	27.22	27.14	
136		136	27.22	27.25	27.12	
273		0	27.11	27.26	27.20	

*EIRP = Conducted + antenna gain (5.31dBi)

4.2 Frequency Stability Measurement

4.2.1 Limits of Frequency Stability Measurement

According to the FCC part 2.1055 shall be tested the frequency stability. The rule is defined that "The frequency stability shall be sufficient to ensure that the fundamental emission stays within the authorized frequency block." The test extreme voltage is according to the 2.1055(d)(1) Vary primary supply voltage from 85 to 115 percent of the nominal value for other than hand carried battery equipment and the extreme temperature rule is comply with specification of EUT $-30^{\circ}\text{C} \sim 50^{\circ}\text{C}$.

4.2.2 Test Procedure

- Device is placed at the oven room. The oven room could control the temperatures and humidity. Power warm up is at least 15 min and power applied should perform before recording frequency error.
- EUT is connected the external power supply to control the DC input power. The test voltage range is from minimum to maximum working voltage. Each step shall be record the frequency error rate.
- The temperature range step is 10 degrees in this test items. All temperature levels shall be hold the $\pm 0.5^{\circ}\text{C}$ during the measurement testing. The each temperature step shall be at least 0.5 hours, consider the EUT could be test under the stability condition.

Note: The frequency error was recorded frequency error from the communication simulator.

4.2.3 Test Setup

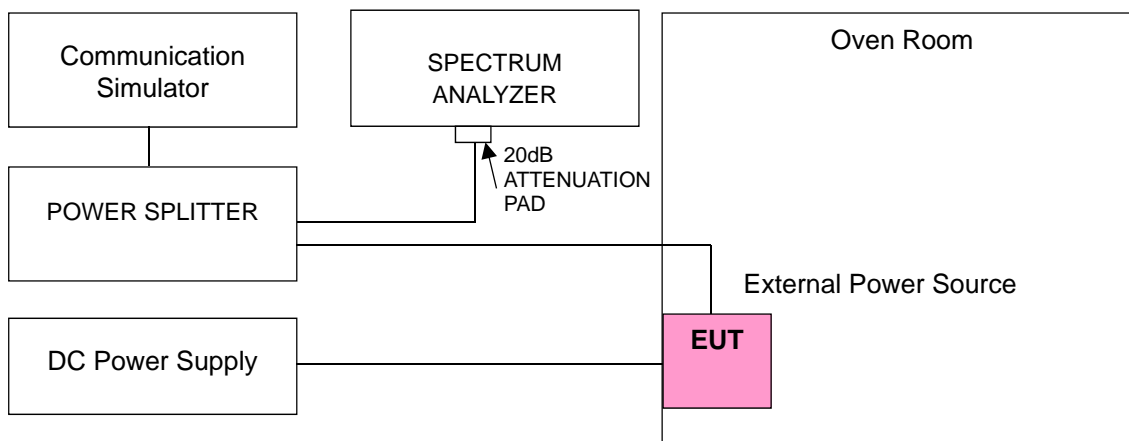

4.2.4 Test Results

Frequency Error vs. Voltage

Voltage (Volts)	n41			
	Channel Bandwidth: 20 MHz			
	Low Channel		High Channel	
	Frequency (MHz)	Frequency Error (ppm)	Frequency (MHz)	Frequency Error (ppm)
4.25	2506.020003	0.001	2679.990001	0.000
5	2506.020002	0.001	2679.990004	0.001
5.75	2506.020004	0.002	2679.990003	0.001

Note: The applicant defined the normal working voltage is from 4.25Vdc to 5.75Vdc.

Frequency Error vs. Temperature

Temp. (°C)	n41			
	Channel Bandwidth: 20 MHz			
	Low Channel		High Channel	
	Frequency (MHz)	Frequency Error (ppm)	Frequency (MHz)	Frequency Error (ppm)
-30	2506.020002	0.001	2679.990003	0.001
-20	2506.020004	0.001	2679.990004	0.001
-10	2506.020003	0.001	2679.990003	0.001
0	2506.020002	0.001	2679.990004	0.001
10	2506.020004	0.002	2679.990003	0.001
20	2506.019998	-0.001	2679.989999	0.000
30	2506.019998	-0.001	2679.989998	-0.001
40	2506.019997	-0.001	2679.989998	-0.001
50	2506.019999	0.000	2679.989997	-0.001

Frequency Error vs. Voltage

Voltage (Volts)	n41			
	Channel Bandwidth: 40 MHz			
	Low Channel		High Channel	
	Frequency (MHz)	Frequency Error (ppm)	Frequency (MHz)	Frequency Error (ppm)
4.25	2516.010002	0.001	2670.000002	0.001
5	2516.010003	0.001	2670.000004	0.001
5.75	2516.010002	0.001	2670.000002	0.001

Note: The applicant defined the normal working voltage is from 4.25Vdc to 5.75Vdc.

Frequency Error vs. Temperature

Temp. (°C)	n41			
	Channel Bandwidth: 40 MHz			
	Low Channel		High Channel	
	Frequency (MHz)	Frequency Error (ppm)	Frequency (MHz)	Frequency Error (ppm)
-30	2516.010003	0.001	2670.000003	0.001
-20	2516.010004	0.002	2670.000004	0.001
-10	2516.010002	0.001	2670.000002	0.001
0	2516.010001	0.001	2670.000004	0.001
10	2516.010003	0.001	2670.000004	0.001
20	2516.009997	-0.001	2669.999998	-0.001
30	2516.009998	-0.001	2669.999998	-0.001
40	2516.009998	-0.001	2669.999998	-0.001
50	2516.009999	0.000	2669.999997	-0.001

Frequency Error vs. Voltage

Voltage (Volts)	n41			
	Channel Bandwidth: 50 MHz			
	Low Channel		High Channel	
	Frequency (MHz)	Frequency Error (ppm)	Frequency (MHz)	Frequency Error (ppm)
4.25	2521.020001	0.000	2664.990003	0.001
5	2521.020004	0.001	2664.990001	0.000
5.75	2521.020001	0.001	2664.990004	0.001

Note: The applicant defined the normal working voltage is from 4.25Vdc to 5.75Vdc.

Frequency Error vs. Temperature

Temp. (°C)	n41			
	Channel Bandwidth: 50 MHz			
	Low Channel		High Channel	
	Frequency (MHz)	Frequency Error (ppm)	Frequency (MHz)	Frequency Error (ppm)
-30	2521.020001	0.000	2664.990002	0.001
-20	2521.020003	0.001	2664.990003	0.001
-10	2521.020002	0.001	2664.990001	0.001
0	2521.020002	0.001	2664.990003	0.001
10	2521.020002	0.001	2664.990003	0.001
20	2521.019997	-0.001	2664.989996	-0.001
30	2521.019997	-0.001	2664.989997	-0.001
40	2521.019999	-0.001	2664.989998	-0.001
50	2521.019997	-0.001	2664.989996	-0.001

Frequency Error vs. Voltage

Voltage (Volts)	n41			
	Channel Bandwidth: 60 MHz			
	Low Channel		High Channel	
	Frequency (MHz)	Frequency Error (ppm)	Frequency (MHz)	Frequency Error (ppm)
4.25	2526.000003	0.001	2659.980003	0.001
5	2526.000002	0.001	2659.980002	0.001
5.75	2526.000001	0.000	2659.980002	0.001

Note: The applicant defined the normal working voltage is from 4.25Vdc to 5.75Vdc.

Frequency Error vs. Temperature

Temp. (°C)	n41			
	Channel Bandwidth: 60 MHz			
	Low Channel		High Channel	
	Frequency (MHz)	Frequency Error (ppm)	Frequency (MHz)	Frequency Error (ppm)
-30	2526.000001	0.000	2659.980002	0.001
-20	2526.000004	0.002	2659.980001	0.000
-10	2526.000003	0.001	2659.980004	0.002
0	2526.000003	0.001	2659.980003	0.001
10	2526.000001	0.001	2659.980002	0.001
20	2525.999998	-0.001	2659.979998	-0.001
30	2525.999998	-0.001	2659.979998	-0.001
40	2525.999998	-0.001	2659.979996	-0.002
50	2525.999998	-0.001	2659.979998	-0.001

Frequency Error vs. Voltage

Voltage (Volts)	n41			
	Channel Bandwidth: 80 MHz			
	Low Channel		High Channel	
	Frequency (MHz)	Frequency Error (ppm)	Frequency (MHz)	Frequency Error (ppm)
4.25	2536.020003	0.001	2649.990001	0.000
5	2536.020003	0.001	2649.990001	0.000
5.75	2536.020001	0.000	2649.990002	0.001

Note: The applicant defined the normal working voltage is from 4.25Vdc to 5.75Vdc.

Frequency Error vs. Temperature

Temp. (°C)	n41			
	Channel Bandwidth: 80 MHz			
	Low Channel		High Channel	
	Frequency (MHz)	Frequency Error (ppm)	Frequency (MHz)	Frequency Error (ppm)
-30	2536.020003	0.001	2649.990001	0.000
-20	2536.020004	0.001	2649.990003	0.001
-10	2536.020001	0.000	2649.990003	0.001
0	2536.020003	0.001	2649.990002	0.001
10	2536.020003	0.001	2649.990003	0.001
20	2536.019999	-0.001	2649.989997	-0.001
30	2536.019998	-0.001	2649.989998	-0.001
40	2536.019997	-0.001	2649.989997	-0.001
50	2536.019998	-0.001	2649.989998	-0.001

Frequency Error vs. Voltage

Voltage (Volts)	n41			
	Channel Bandwidth: 90 MHz			
	Low Channel		High Channel	
	Frequency (MHz)	Frequency Error (ppm)	Frequency (MHz)	Frequency Error (ppm)
4.25	2541.000004	0.002	2644.980001	0.001
5	2541.000002	0.001	2644.980003	0.001
5.75	2541.000003	0.001	2644.980003	0.001

Note: The applicant defined the normal working voltage is from 4.25Vdc to 5.75Vdc.

Frequency Error vs. Temperature

Temp. (°C)	n41			
	Channel Bandwidth: 90 MHz			
	Low Channel		High Channel	
	Frequency (MHz)	Frequency Error (ppm)	Frequency (MHz)	Frequency Error (ppm)
-30	2541.000003	0.001	2644.980002	0.001
-20	2541.000002	0.001	2644.980003	0.001
-10	2541.000002	0.001	2644.980003	0.001
0	2541.000004	0.002	2644.980003	0.001
10	2541.000004	0.002	2644.980002	0.001
20	2540.999998	-0.001	2644.979998	-0.001
30	2540.999999	0.000	2644.979998	-0.001
40	2540.999997	-0.001	2644.979998	-0.001
50	2540.999998	-0.001	2644.979996	-0.001

Frequency Error vs. Voltage

Voltage (Volts)	n41			
	Channel Bandwidth: 100 MHz			
	Low Channel		High Channel	
	Frequency (MHz)	Frequency Error (ppm)	Frequency (MHz)	Frequency Error (ppm)
4.25	2546.010003	0.001	2640.000003	0.001
5	2546.010003	0.001	2640.000003	0.001
5.75	2546.010001	0.000	2640.000003	0.001

Note: The applicant defined the normal working voltage is from 4.25Vdc to 5.75Vdc.

Frequency Error vs. Temperature

Temp. (°C)	n41			
	Channel Bandwidth: 100 MHz			
	Low Channel		High Channel	
	Frequency (MHz)	Frequency Error (ppm)	Frequency (MHz)	Frequency Error (ppm)
-30	2546.010002	0.001	2640.000004	0.001
-20	2546.010004	0.001	2640.000001	0.000
-10	2546.010003	0.001	2640.000002	0.001
0	2546.010001	0.000	2640.000004	0.001
10	2546.010003	0.001	2640.000001	0.001
20	2546.009998	-0.001	2639.999999	0.000
30	2546.009998	-0.001	2639.999998	-0.001
40	2546.009996	-0.001	2639.999997	-0.001
50	2546.009996	-0.002	2639.999998	-0.001

4.3 Occupied Bandwidth Measurement

4.3.1 Limits of Occupied Bandwidth Measurement

The occupied bandwidth (OBW), that is the frequency bandwidth such that, below its lower and above its upper frequency limits, the mean powers radiated are each equal to 0.5 % of the total mean power radiated by a given emission.

4.3.2 Test Procedure

The transmitter output was connected to the spectrum analyzer through an attenuator. The bandwidth of the fundamental frequency was measured by spectrum analyzer with RBW = 100kHz and VBW = 300kHz (Channel Bandwidth: 5MHz), RBW = 200kHz and VBW = 1MHz (Channel Bandwidth: 10MHz), RBW = 300kHz and VBW = 1MHz (Channel Bandwidth: 15MHz) and RBW = 430kHz and VBW = 1.3MHz (Channel Bandwidth: 20MHz). The 26dB bandwidth is defined as the total spectrum the power of which is higher than peak power minus 26dB.

4.3.3 Test Setup

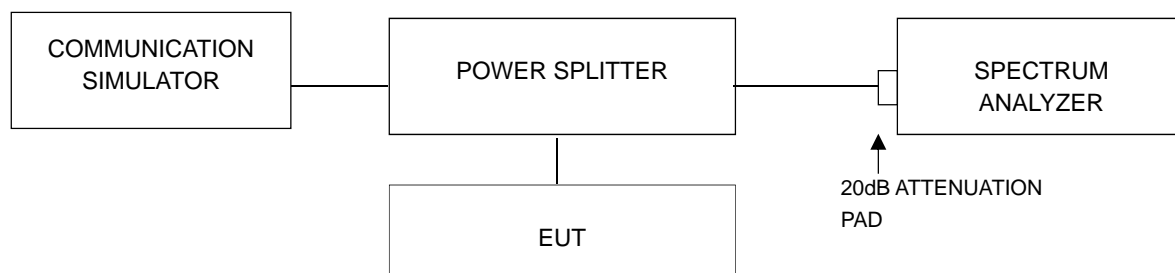

4.3.4 Test Result

Occupied Bandwidth

n41

n41, Channel Bandwidth 20MHz						
Channel	Frequency (MHz)	99% Occupied Bandwidth (MHz)				
		$\pi/2$ BPSK	QPSK	16QAM	64QAM	256QAM
501204	2506.02	18.23	18.14	18.20	18.10	18.19
518598	2592.99	18.18	18.17	18.19	18.14	18.21
535998	2679.99	18.17	18.20	18.14	18.17	18.16
n41, Channel Bandwidth 40MHz						
Channel	Frequency (MHz)	99% Occupied Bandwidth (MHz)				
		$\pi/2$ BPSK	QPSK	16QAM	64QAM	256QAM
503202	2516.01	37.73	37.73	37.76	37.74	37.78
518598	2592.99	37.78	37.93	37.77	37.78	37.78
534000	2670.00	37.80	37.71	37.80	37.77	37.85
n41, Channel Bandwidth 50MHz						
Channel	Frequency (MHz)	99% Occupied Bandwidth (MHz)				
		$\pi/2$ BPSK	QPSK	16QAM	64QAM	256QAM
504204	2521.02	47.45	47.42	47.40	47.32	47.38
518598	2592.99	47.43	47.42	47.41	47.47	47.41
532998	2664.99	47.43	47.41	47.41	47.40	47.41
n41, Channel Bandwidth 60MHz						
Channel	Frequency (MHz)	99% Occupied Bandwidth (MHz)				
		$\pi/2$ BPSK	QPSK	16QAM	64QAM	256QAM
505200	2526.00	57.95	57.65	57.65	57.59	57.61
518598	2592.99	57.80	57.78	57.63	57.73	57.71
531996	2659.98	57.74	57.69	57.71	57.69	57.71
n41, Channel Bandwidth 80MHz						
Channel	Frequency (MHz)	99% Occupied Bandwidth (MHz)				
		$\pi/2$ BPSK	QPSK	16QAM	64QAM	256QAM
507204	2536.02	77.48	77.33	77.11	77.28	77.30
518598	2592.99	77.29	77.33	77.58	77.31	77.19
529998	2649.99	77.34	77.22	77.24	77.20	77.04

n41, Channel Bandwidth 90MHz						
Channel	Frequency (MHz)	99% Occupied Bandwidth (MHz)				
		$\pi/2$ BPSK	QPSK	16QAM	64QAM	256QAM
508200	2541.00	87.24	87.18	87.19	87.17	87.13
518598	2592.99	87.33	87.36	87.31	87.33	87.23
528996	2644.98	87.20	87.15	87.20	87.22	87.09
n41, Channel Bandwidth 100MHz						
Channel	Frequency (MHz)	99% Occupied Bandwidth (MHz)				
		$\pi/2$ BPSK	QPSK	16QAM	64QAM	256QAM
509202	2546.01	97.38	97.18	97.16	97.14	97.13
518598	2592.99	97.23	97.21	97.32	97.44	97.17
528000	2640.00	97.06	97.20	97.04	97.11	97.07

Spectrum Plot of Worst Value

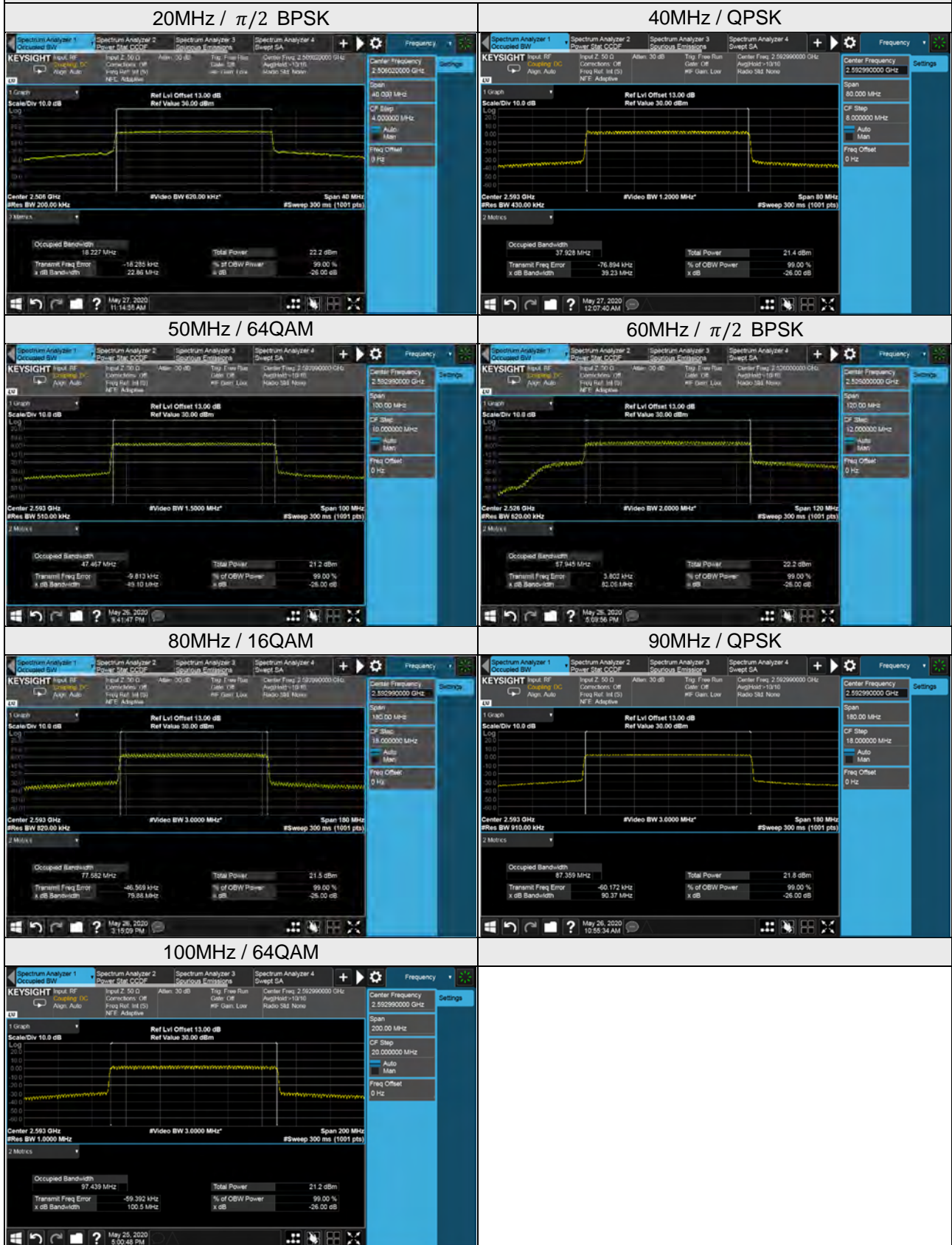

26dB Bandwidth

n41

n41, Channel Bandwidth 20MHz						
Channel	Frequency (MHz)	26dB Bandwidth (MHz)				
		$\pi/2$ BPSK	QPSK	16QAM	64QAM	256QAM
501204	2506.02	22.86	18.91	18.96	18.86	18.92
518598	2592.99	18.94	18.94	18.97	18.88	18.96
535998	2679.99	18.92	18.96	18.89	18.92	18.92
n41, Channel Bandwidth 40MHz						
Channel	Frequency (MHz)	26dB Bandwidth (MHz)				
		$\pi/2$ BPSK	QPSK	16QAM	64QAM	256QAM
503202	2516.01	39.16	39.16	39.14	39.18	39.13
518598	2592.99	39.18	39.23	39.12	39.21	39.19
534000	2670.00	39.18	39.16	39.14	39.20	39.14
n41, Channel Bandwidth 50MHz						
Channel	Frequency (MHz)	26dB Bandwidth (MHz)				
		$\pi/2$ BPSK	QPSK	16QAM	64QAM	256QAM
504204	2521.02	59.29	49.11	49.10	49.03	49.06
518598	2592.99	49.08	49.07	49.07	49.10	49.05
532998	2664.99	49.11	49.08	49.07	49.07	49.05
n41, Channel Bandwidth 60MHz						
Channel	Frequency (MHz)	26dB Bandwidth (MHz)				
		$\pi/2$ BPSK	QPSK	16QAM	64QAM	256QAM
505200	2526.00	82.05	59.72	59.73	59.69	59.74
518598	2592.99	59.84	59.79	59.71	59.74	59.74
531996	2659.98	59.82	59.79	59.72	59.78	59.69
n41, Channel Bandwidth 80MHz						
Channel	Frequency (MHz)	26dB Bandwidth (MHz)				
		$\pi/2$ BPSK	QPSK	16QAM	64QAM	256QAM
507204	2536.02	79.95	79.99	80.02	79.97	79.92
518598	2592.99	80.06	80.07	79.88	80.03	80.03
529998	2649.99	79.96	80.02	80.01	79.97	79.99

n41, Channel Bandwidth 90MHz						
Channel	Frequency (MHz)	26dB Bandwidth (MHz)				
		$\pi/2$ BPSK	QPSK	16QAM	64QAM	256QAM
508200	2541.00	90.48	90.34	90.31	90.32	90.30
518598	2592.99	90.39	90.37	90.38	90.37	90.32
528996	2644.98	90.21	90.26	90.16	90.17	90.25
n41, Channel Bandwidth 100MHz						
Channel	Frequency (MHz)	26dB Bandwidth (MHz)				
		$\pi/2$ BPSK	QPSK	16QAM	64QAM	256QAM
509202	2546.01	138.40	100.70	100.70	100.60	100.60
518598	2592.99	100.60	100.70	100.50	100.50	100.60
528000	2640.00	100.50	100.40	100.50	100.40	100.50

Spectrum Plot of Worst Value

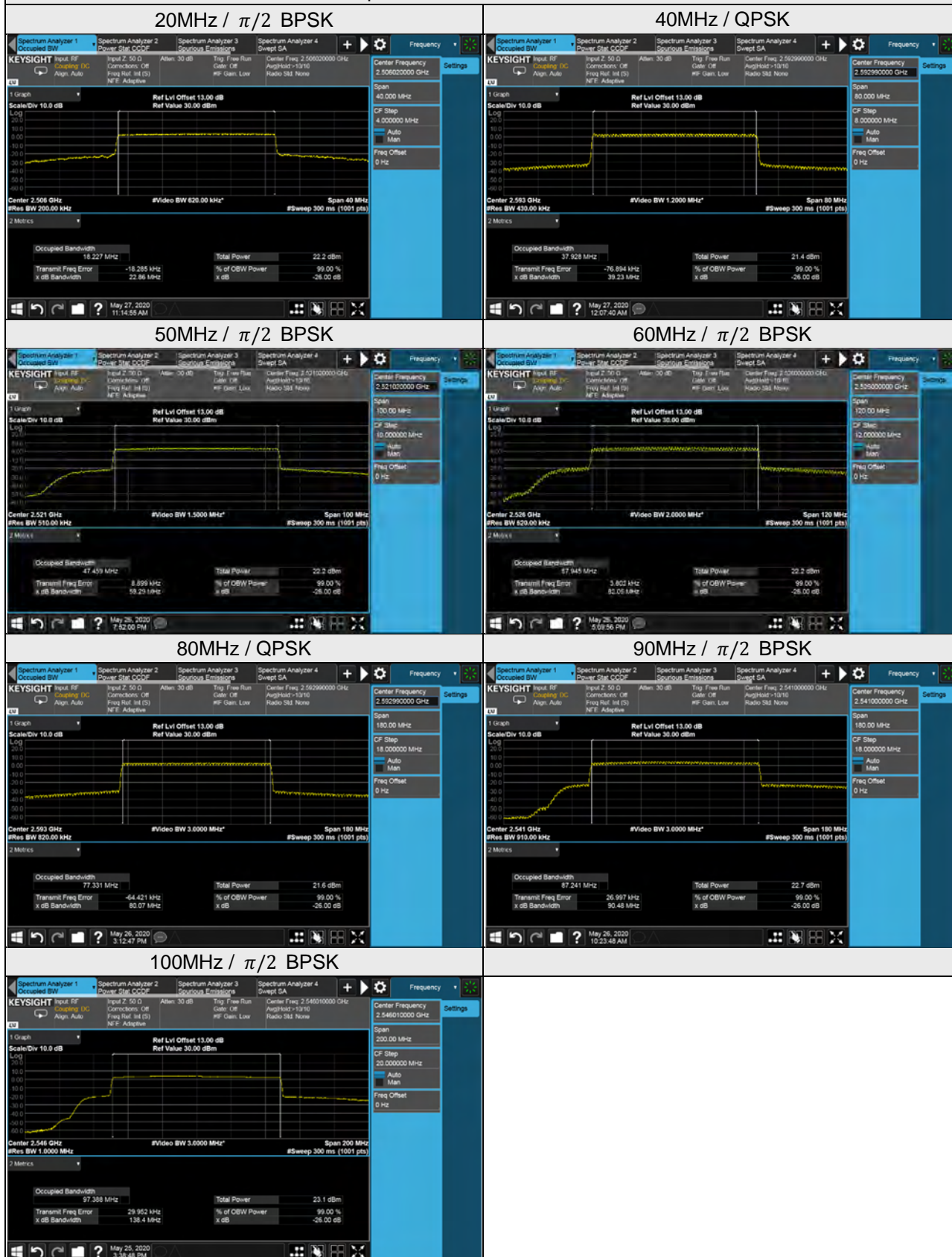

4.4 Channel Edge Measurement

4.4.1 Limits of Band Edge Measurement

According to FCC 27.53(m)(4) specified that power of any emission outside of the channel edge must be attenuated below the transmitting power (P) by a factor shall be not less than $40 + 10 \log (P)$ dB on all frequencies between the channel edge and 5 megahertz from the channel edge, $43 + 10 \log (P)$ dB on all frequencies between 5 megahertz and X megahertz from the channel edge, and $55 + 10 \log (P)$ dB on all frequencies more than X megahertz from the channel edge, where X is the greater of 6 megahertz or the actual emission bandwidth. In addition, the attenuation factor shall not be less that $43 + 10 \log (P)$ dB on all frequencies between 2490.5 MHz and 2496 MHz and $55 + 10 \log (P)$ dB at or below 2490.5 MHz. In the 1 MHz bands immediately outside and adjacent to the frequency block a resolution bandwidth of at least two percent may be employed, except when the 1 megahertz band is 2495-2496 MHz, in which case a resolution bandwidth of at least one percent may be employed.

4.4.2 Test Setup

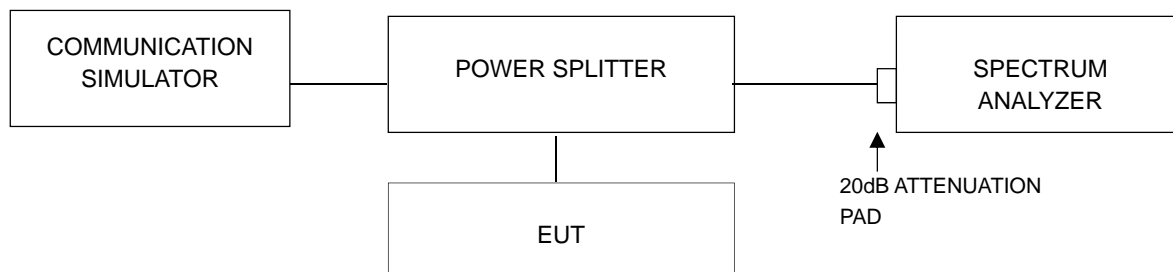

4.4.3 Test Procedures

- The EUT was set up for the rated peak power. The power was measured with Spectrum Analyzer. Band edge measurements were done at 3 channels: low, middle and high operational frequency range. Emission mask measurements were done at 2 channels: low and high operational frequency range.
- The center frequency of spectrum is the band edge frequency and span is 1MHz. RB of the spectrum is 51kHz and VB of the spectrum is 160kHz (Channel Bandwidth 5MHz).
- The center frequency of spectrum is the band edge frequency and span is 1MHz. RB of the spectrum is 100kHz and VB of the spectrum is 300kHz (Channel Bandwidth 10MHz).
- The center frequency of spectrum is the band edge frequency and span is 1MHz. RB of the spectrum is 150kHz and VB of the spectrum is 470kHz (Channel Bandwidth 15MHz).
- The center frequency of spectrum is the band edge frequency and span is 1MHz. RB of the spectrum is 200kHz and VB of the spectrum is 1MHz (Channel Bandwidth 20MHz).
- n41 operations in the 20 MHz to 100 MHz channel BW mode, extend the 1% range from 1M to 2M above and below the channel edge and then reduce the limit. As an alternative, the highest power level measured in a narrower RBW (relative to the specified reference bandwidth) can be scaled by applying a correction factor determined from: $10 \log [(reference\ bandwidth) / (resolution\ or\ measurement\ bandwidth)]$ measurement procedure refer to ANSI 63.26 section 5.7.2 a)
- Record the max trace plot into the test report.

4.4.4 Test Results

n41

Emission Mask:

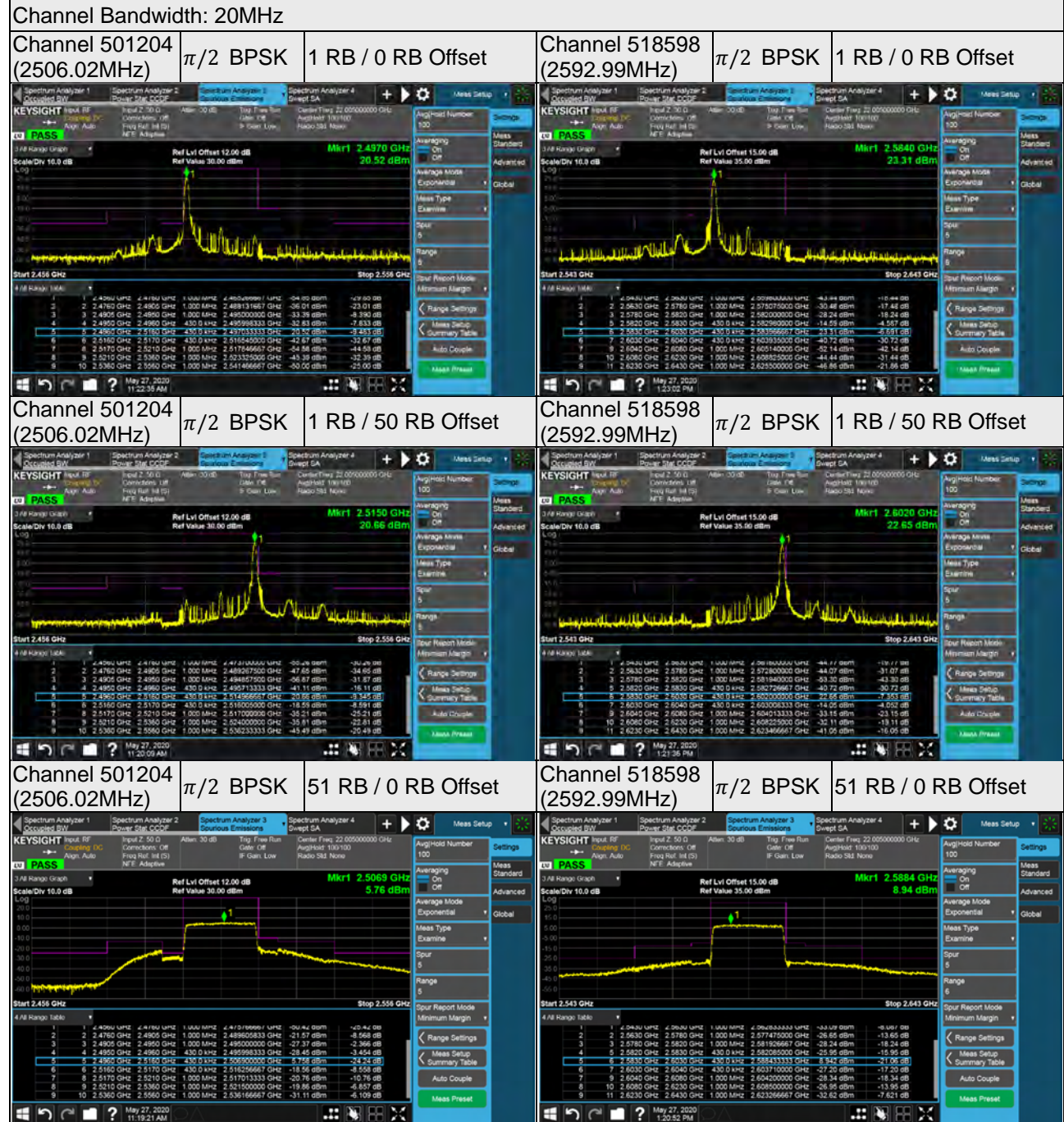

Channel Bandwidth: 20MHz

Channel 535998 (2679.99MHz) $\pi/2$ BPSK 1 RB / 0 RB Offset

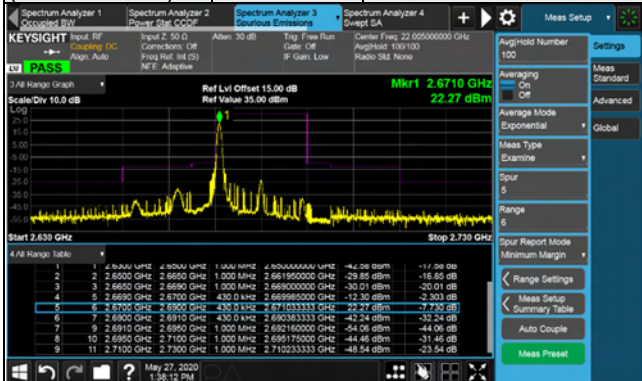

Channel 535998 (2679.99MHz) $\pi/2$ BPSK 1 RB / 50 RB Offset



Channel 535998 (2679.99MHz) $\pi/2$ BPSK 51 RB / 0 RB Offset

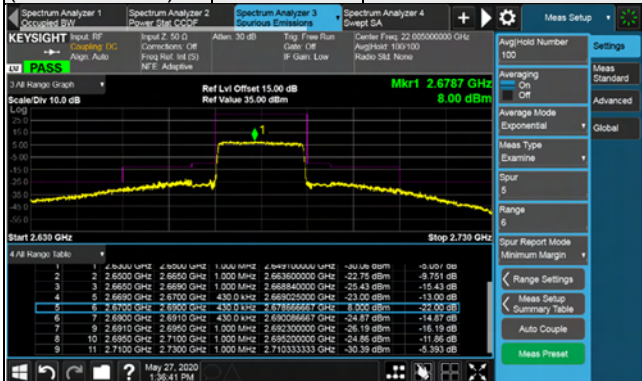

Channel Bandwidth: 40MHz

Channel 503202 (2516.01MHz) $\pi/2$ BPSK 1 RB / 0 RB Offset



Channel 518598 (2592.99MHz) $\pi/2$ BPSK 1 RB / 0 RB Offset

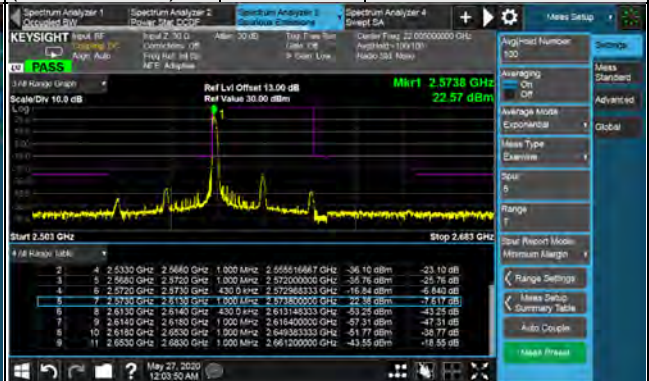

Channel 503202 (2516.01MHz) $\pi/2$ BPSK 1 RB / 105 RB Offset

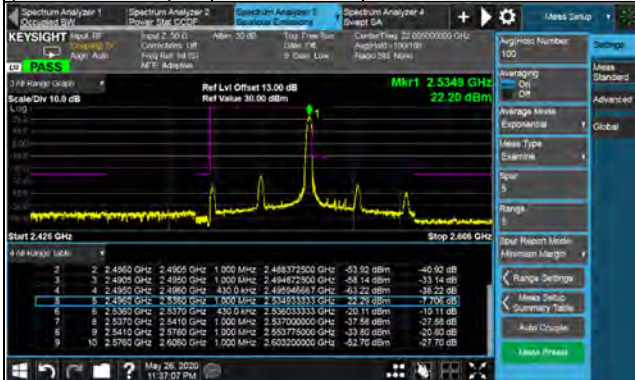

Channel 518598 (2592.99MHz) $\pi/2$ BPSK 1 RB / 105 RB Offset

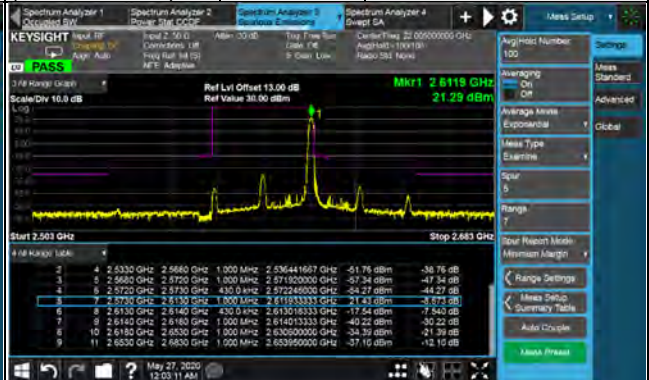

Channel 503202 (2516.01MHz) $\pi/2$ BPSK 106 RB / 0 RB Offset

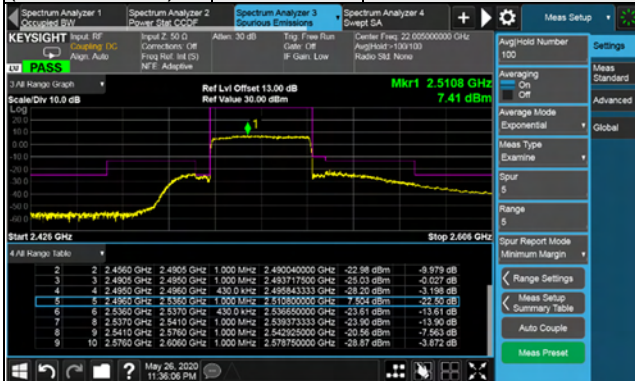

Channel 518598 (2592.99MHz) $\pi/2$ BPSK 106 RB / 0 RB Offset

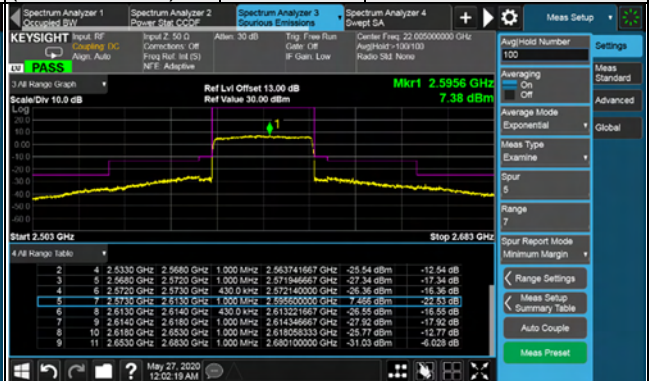

Channel Bandwidth: 40MHz

Channel 534000 (2670.00MHz) $\pi/2$ BPSK 1 RB / 0 RB Offset



Channel 534000 (2670.00MHz) $\pi/2$ BPSK 1 RB / 105 RB Offset

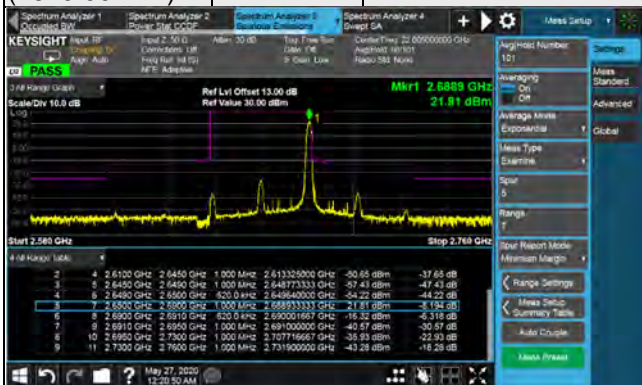

Channel 534000 (2670.00MHz) $\pi/2$ BPSK 106 RB / 0 RB Offset

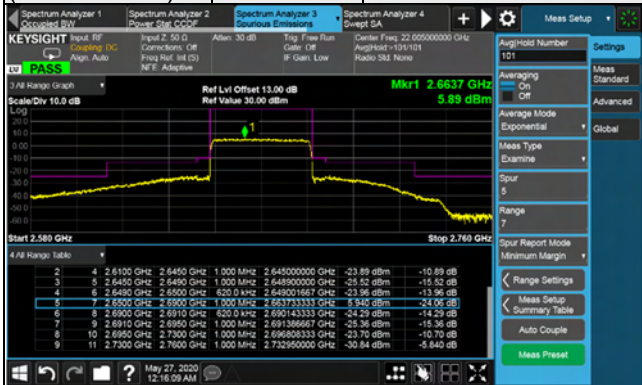

Channel Bandwidth: 50MHz

Channel 504204 (2521.02MHz) $\pi/2$ BPSK 1 RB / 0 RB Offset

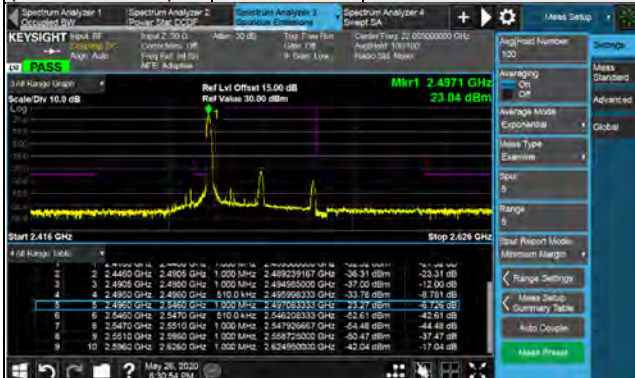

Channel 518598 (2592.99MHz) $\pi/2$ BPSK 1 RB / 0 RB Offset



Channel 504204 (2521.02MHz) $\pi/2$ BPSK 1 RB / 132 RB Offset



Channel 518598 (2592.99MHz) $\pi/2$ BPSK 1 RB / 132 RB Offset

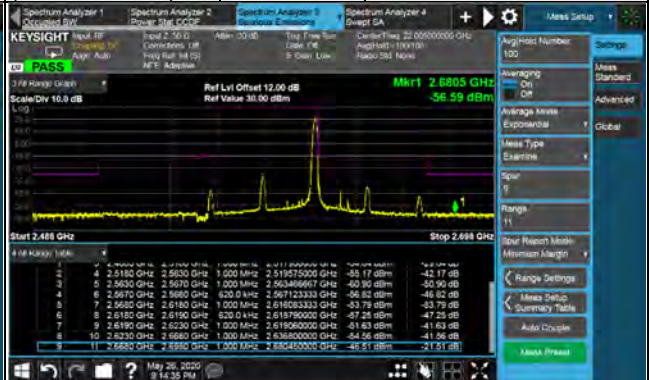

Channel 504204 (2521.02MHz) $\pi/2$ BPSK 133 RB / 0 RB Offset

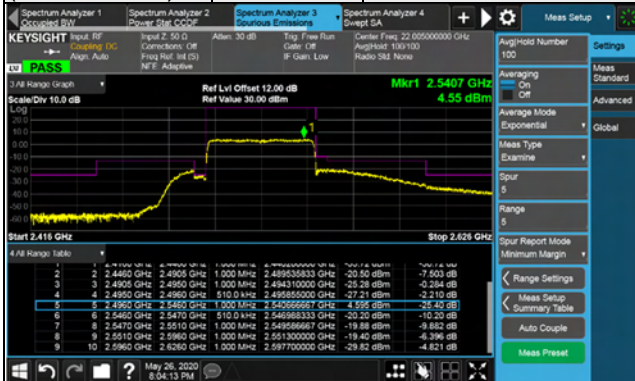

Channel 518598 (2592.99MHz) $\pi/2$ BPSK 133 RB / 0 RB Offset

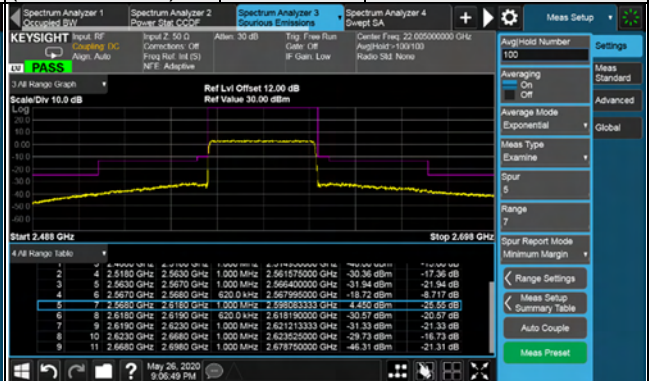

Channel Bandwidth: 50MHz

Channel 532998 (2664.99MHz) $\pi/2$ BPSK 1 RB / 0 RB Offset

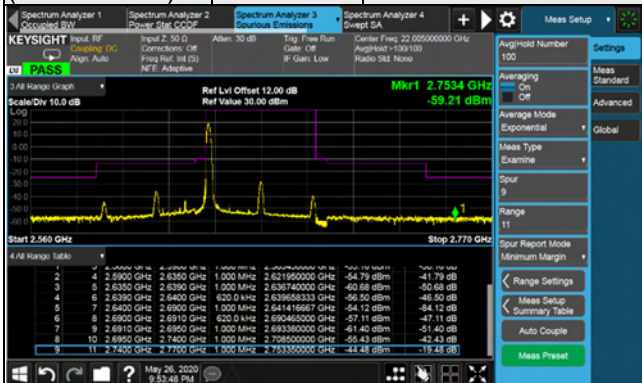

Channel 532998 (2664.99MHz) $\pi/2$ BPSK 1 RB / 132 RB Offset



Channel 532998 (2664.99MHz) $\pi/2$ BPSK 133 RB / 0 RB Offset

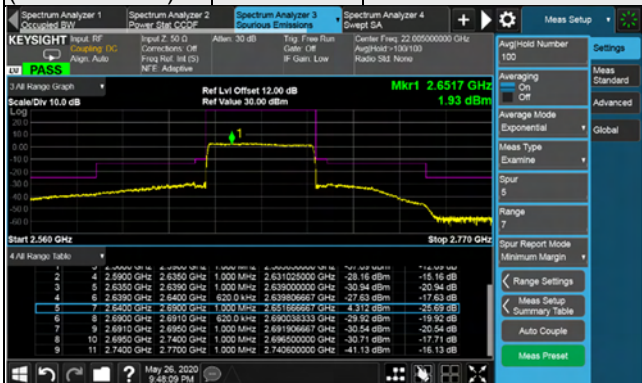

Channel Bandwidth: 60MHz

Channel 505200 (2526.00MHz) $\pi/2$ BPSK 1 RB / 0 RB Offset



Channel 518598 (2592.99MHz) $\pi/2$ BPSK 1 RB / 0 RB Offset



Channel 505200 (2526.00MHz) $\pi/2$ BPSK 1 RB / 161 RB Offset

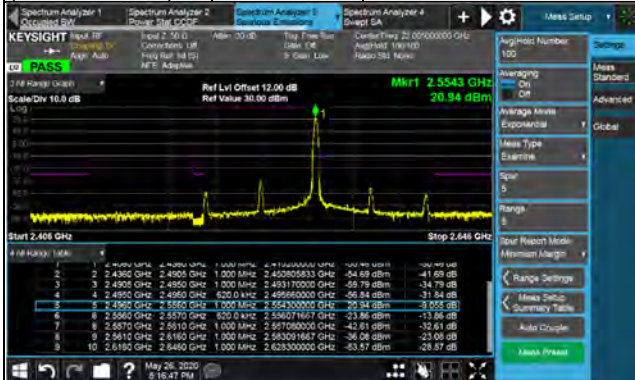

Channel 518598 (2592.99MHz) $\pi/2$ BPSK 1 RB / 161 RB Offset



Channel 505200 (2526.00MHz) $\pi/2$ BPSK 162 RB / 0 RB Offset

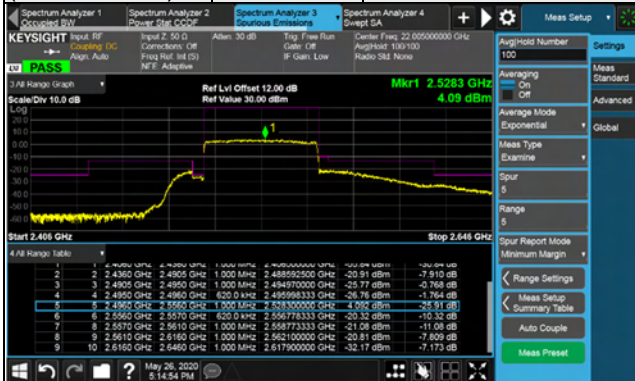

Channel 518598 (2592.99MHz) $\pi/2$ BPSK 162 RB / 0 RB Offset

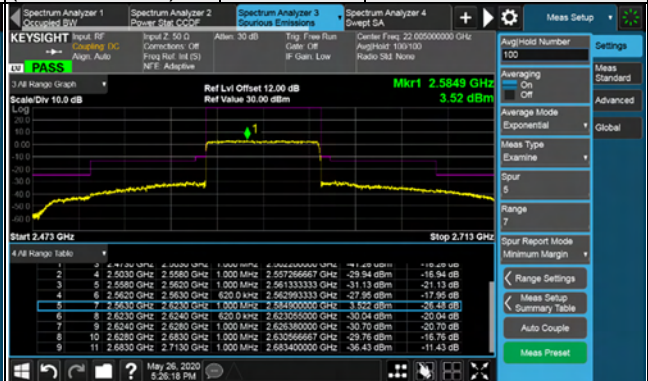

Channel Bandwidth: 60MHz

Channel 531996 (2659.98MHz) $\pi/2$ BPSK 1 RB / 0 RB Offset

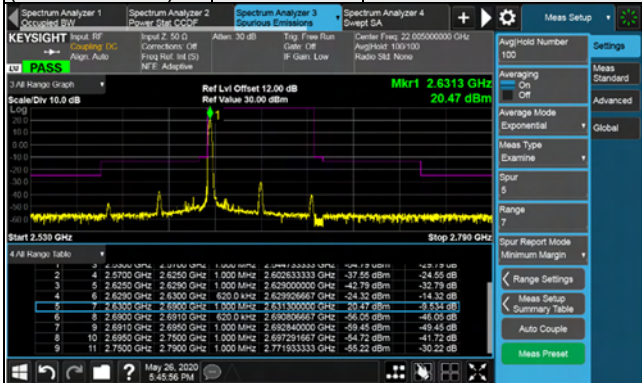

Channel 531996 (2659.98MHz) $\pi/2$ BPSK 1 RB / 161 RB Offset

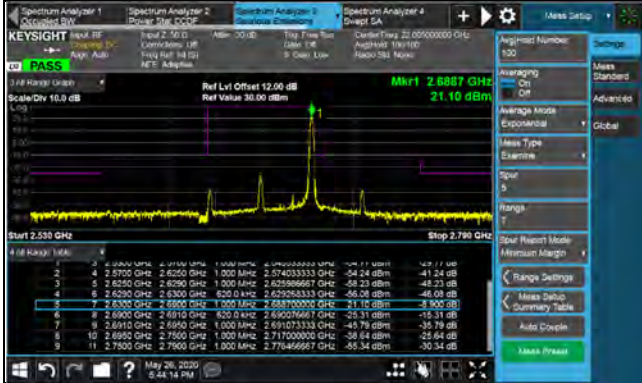

Channel 531996 (2659.98MHz) $\pi/2$ BPSK 162 RB / 0 RB Offset

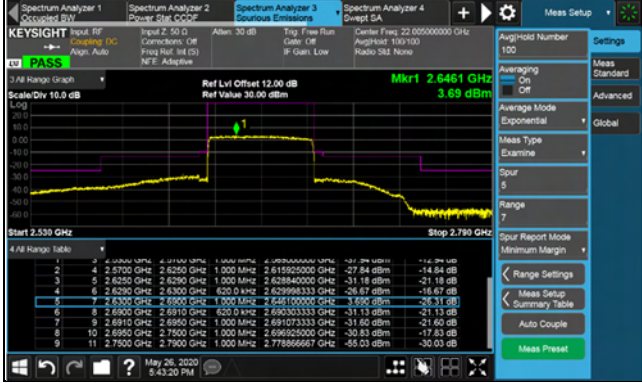

Channel Bandwidth: 80MHz

Channel 507204 (2536.02MHz) $\pi/2$ BPSK 1 RB / 0 RB Offset



Channel 518598 (2592.99MHz) $\pi/2$ BPSK 1 RB / 0 RB Offset



Channel 507204 (2536.02MHz) $\pi/2$ BPSK 1 RB / 216 RB Offset

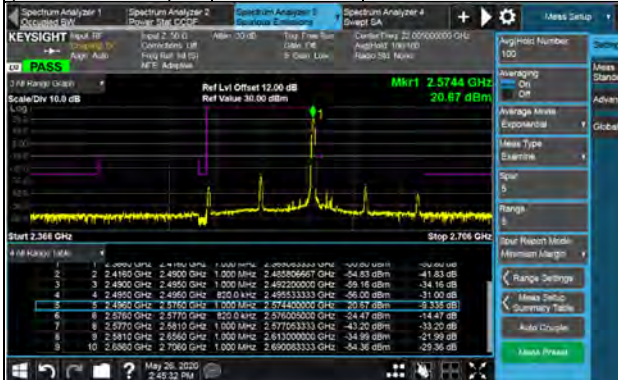

Channel 518598 (2592.99MHz) $\pi/2$ BPSK 1 RB / 216 RB Offset

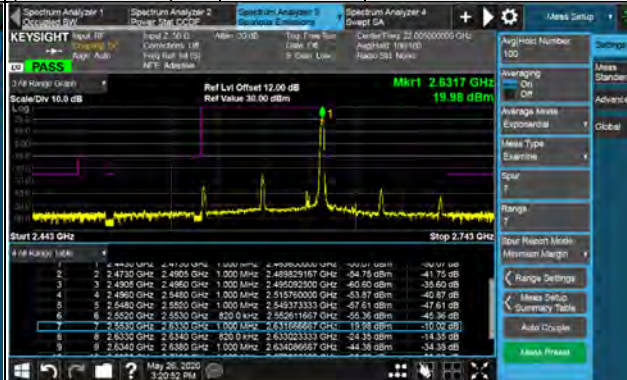

Channel 507204 (2536.02MHz) $\pi/2$ BPSK 217 RB / 0 RB Offset

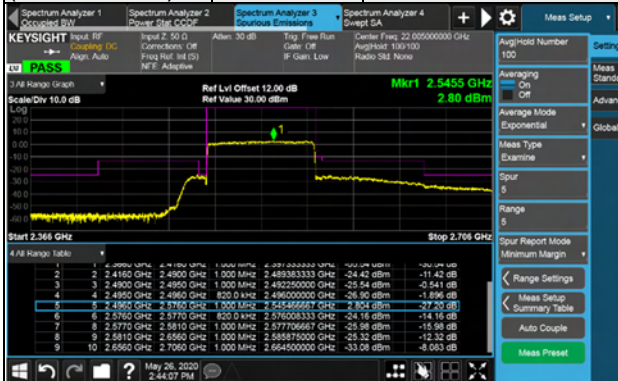

Channel 518598 (2592.99MHz) $\pi/2$ BPSK 217 RB / 0 RB Offset

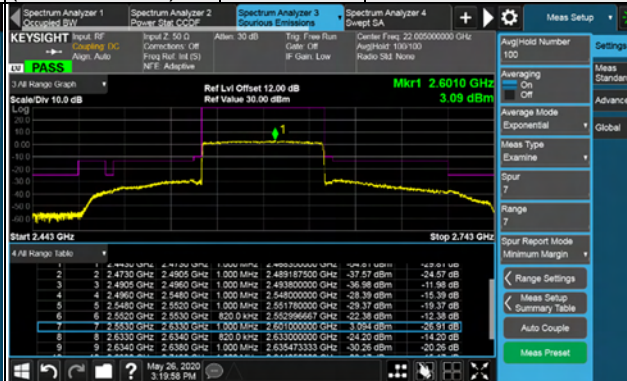

Channel Bandwidth: 80MHz

Channel 529998 (2649.99MHz) $\pi/2$ BPSK 1 RB / 0 RB Offset

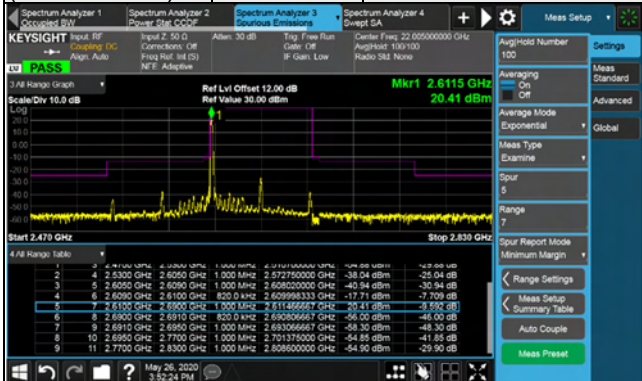

Channel 529998 (2649.99MHz) $\pi/2$ BPSK 1 RB / 216 RB Offset



Channel 529998 (2649.99MHz) $\pi/2$ BPSK 217 RB / 0 RB Offset

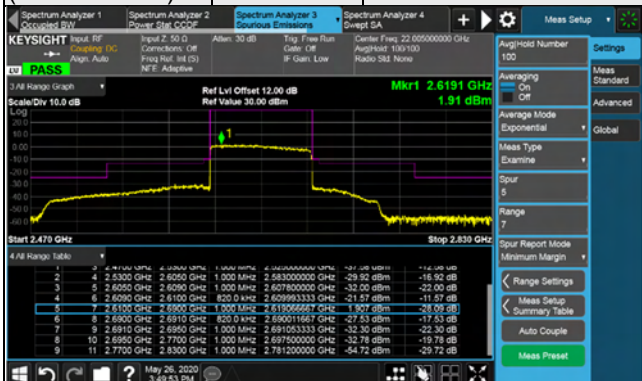

Channel Bandwidth: 90MHz

Channel 508200 (2541.00MHz) $\pi/2$ BPSK 1 RB / 0 RB Offset

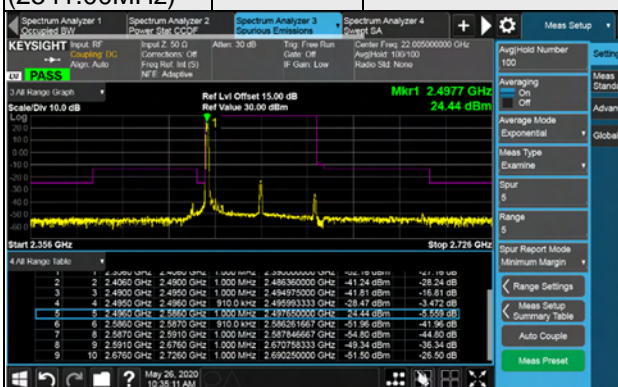

Channel 518598 (2592.99MHz) $\pi/2$ BPSK 1 RB / 0 RB Offset

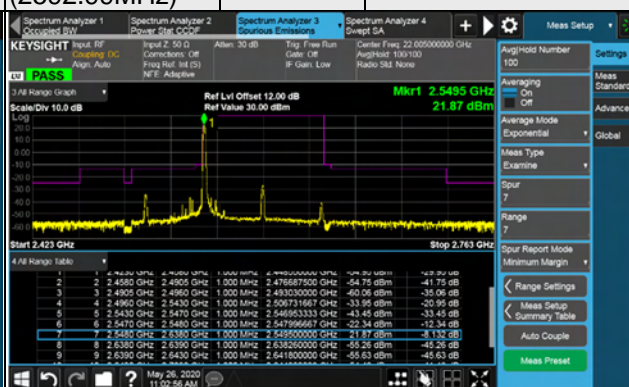

Channel 508200 (2541.00MHz) $\pi/2$ BPSK 1 RB / 244 RB Offset



Channel 518598 (2592.99MHz) $\pi/2$ BPSK 1 RB / 244 RB Offset



Channel 508200 (2541.00MHz) $\pi/2$ BPSK 245 RB / 0 RB Offset

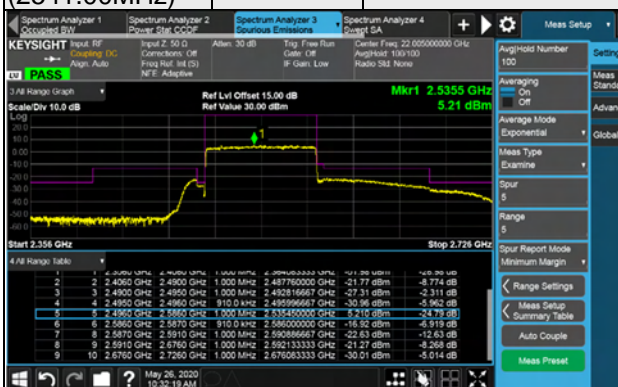

Channel 518598 (2592.99MHz) $\pi/2$ BPSK 245 RB / 0 RB Offset

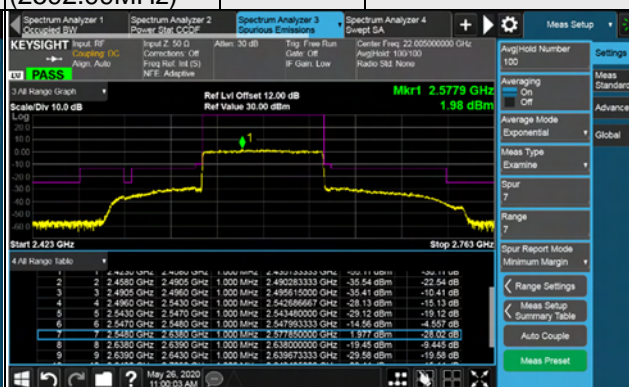

Channel Bandwidth: 90MHz

Channel 528996 (2644.98MHz) $\pi/2$ BPSK 1 RB / 0 RB Offset

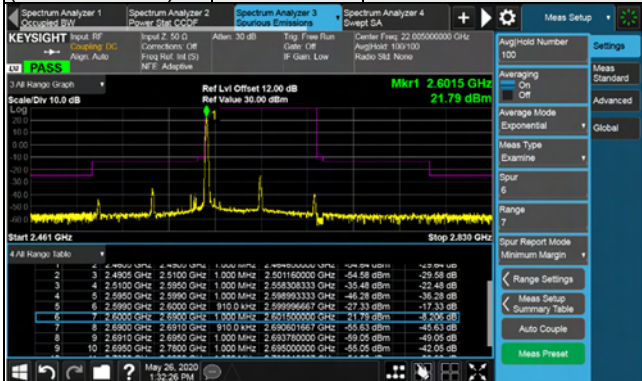

Channel 528996 (2644.98MHz) $\pi/2$ BPSK 1 RB / 244 RB Offset

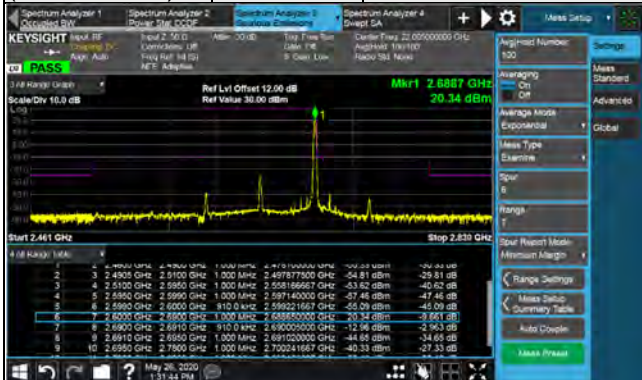

Channel 528996 (2644.98MHz) $\pi/2$ BPSK 245 RB / 0 RB Offset



Channel Bandwidth: 100MHz

Channel 509202 (2546.01MHz) $\pi/2$ BPSK 1 RB / 0 RB Offset



Channel 518598 (2592.99MHz) $\pi/2$ BPSK 1 RB / 0 RB Offset



Channel 509202 (2546.01MHz) $\pi/2$ BPSK 1 RB / 272 RB Offset

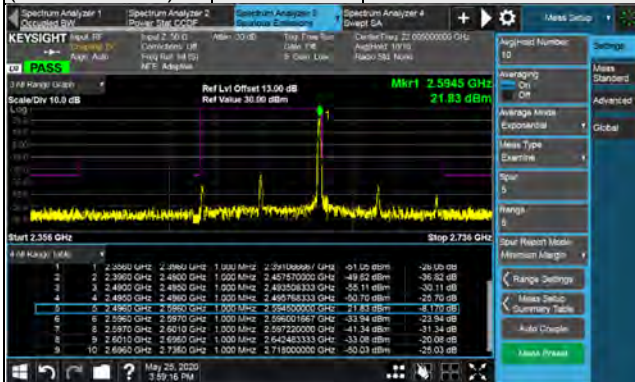

Channel 518598 (2592.99MHz) $\pi/2$ BPSK 1 RB / 272 RB Offset



Channel 509202 (2546.01MHz) $\pi/2$ BPSK 273 RB / 0 RB Offset

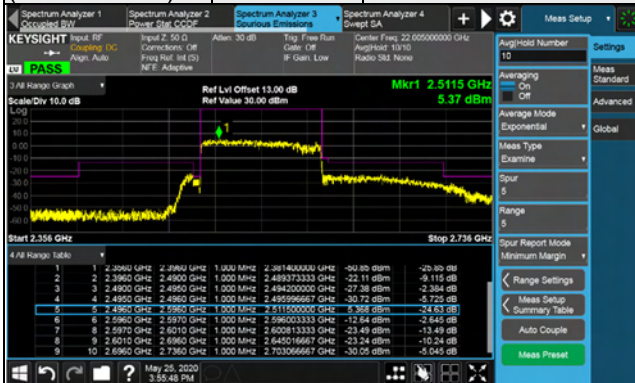

Channel 518598 (2592.99MHz) $\pi/2$ BPSK 273 RB / 0 RB Offset

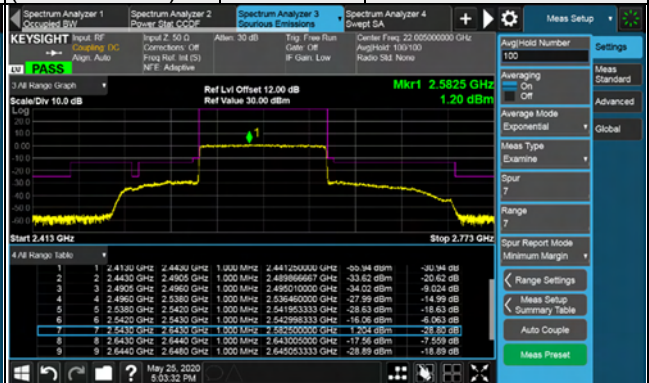

Channel Bandwidth: 100MHz

Channel 528000 (2640.00MHz) $\pi/2$ BPSK 1 RB / 0 RB Offset

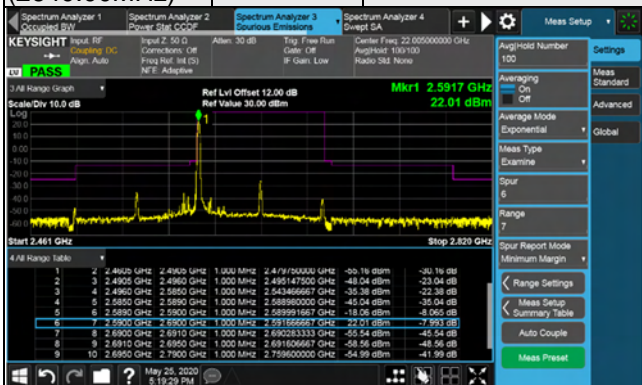

Channel 528000 (2640.00MHz) $\pi/2$ BPSK 1 RB / 272 RB Offset

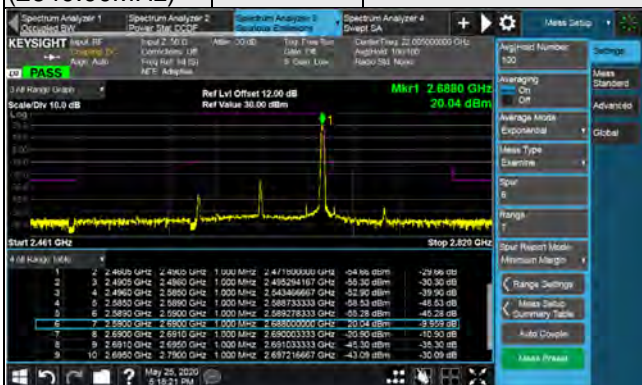

Channel 528000 (2640.00MHz) $\pi/2$ BPSK 273 RB / 0 RB Offset



4.5 Peak to Average Ratio

4.5.1 Limits of Peak to Average Ratio Measurement

In measuring transmissions in this band using an average power technique, the peak to-average ratio (PAR) of the transmission may not exceed 13 dB

4.5.2 Test Setup

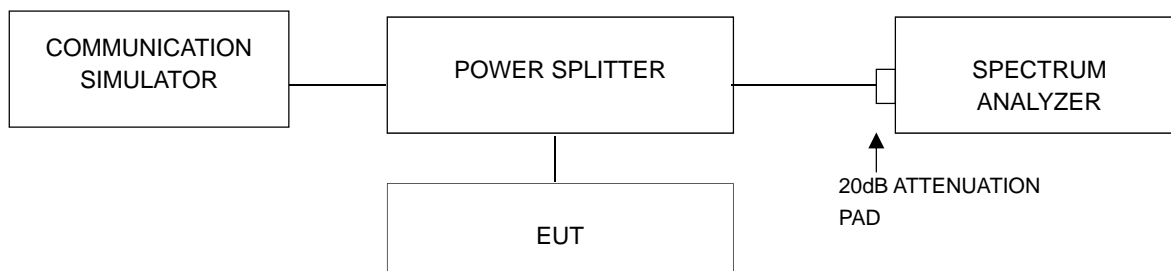

4.5.3 Test Procedures

- Set resolution/measurement bandwidth \geq signal's occupied bandwidth;
- Set the number of counts to a value that stabilizes the measured CCDF curve;
- Record the maximum PAPR level associated with a probability of 0.1%.

4.5.4 Test Results

n41

n41, Channel Bandwidth 20MHz						
Channel	Frequency (MHz)	Peak To Average Ratio (dB)				
		$\pi/2$ BPSK	QPSK	16QAM	64QAM	256QAM
501204	2506.02	5.69	7.38	7.71	7.84	8.99
518598	2592.99	7.75	7.43	7.54	7.82	9.42
535998	2679.99	7.35	7.63	8.07	8.14	9.23
n41, Channel Bandwidth 40MHz						
Channel	Frequency (MHz)	Peak To Average Ratio (dB)				
		$\pi/2$ BPSK	QPSK	16QAM	64QAM	256QAM
503202	2516.01	6.89	6.72	6.89	7.79	9.31
518598	2592.99	6.79	7.77	7.03	8.06	9.14
534000	2670.00	7.59	7.71	7.74	8.04	9.38
n41, Channel Bandwidth 50MHz						
Channel	Frequency (MHz)	Peak To Average Ratio (dB)				
		$\pi/2$ BPSK	QPSK	16QAM	64QAM	256QAM
504204	2521.02	5.75	7.52	7.73	8.13	9.12
518598	2592.99	7.89	7.53	7.82	8.20	8.97
532998	2664.99	8.25	7.70	7.99	8.39	9.34
n41, Channel Bandwidth 60MHz						
Channel	Frequency (MHz)	Peak To Average Ratio (dB)				
		$\pi/2$ BPSK	QPSK	16QAM	64QAM	256QAM
505200	2526.00	5.89	7.75	7.66	8.51	9.46
518598	2592.99	8.07	7.05	7.65	8.34	9.24
531996	2659.98	8.23	7.65	7.67	8.31	9.36
n41, Channel Bandwidth 80MHz						
Channel	Frequency (MHz)	Peak To Average Ratio (dB)				
		$\pi/2$ BPSK	QPSK	16QAM	64QAM	256QAM
507204	2536.02	7.97	8.50	7.73	8.56	9.27
518598	2592.99	8.19	7.75	8.06	8.09	9.74
529998	2649.99	8.74	7.95	8.92	8.49	9.29

n41, Channel Bandwidth 90MHz						
Channel	Frequency (MHz)	Peak To Average Ratio (dB)				
		$\pi/2$ BPSK	QPSK	16QAM	64QAM	256QAM
508200	2541.00	8.07	8.08	7.95	8.44	9.14
518598	2592.99	8.64	7.84	7.91	8.23	9.22
528996	2644.98	8.32	7.94	6.98	6.98	9.48
n41, Channel Bandwidth 100MHz						
Channel	Frequency (MHz)	Peak To Average Ratio (dB)				
		$\pi/2$ BPSK	QPSK	16QAM	64QAM	256QAM
509202	2546.01	6.14	7.03	7.06	7.27	8.47
518598	2592.99	8.04	7.80	7.73	8.21	9.28
528000	2640.00	7.98	7.83	7.96	8.55	9.07

Spectrum Plot of Worst Value

20MHz / 256QAM

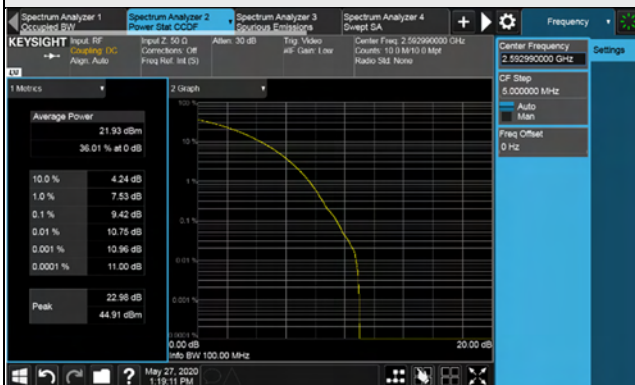

40MHz / 256QAM

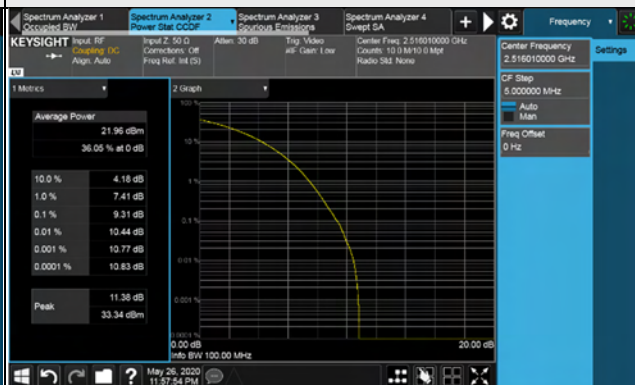

50MHz / 256QAM

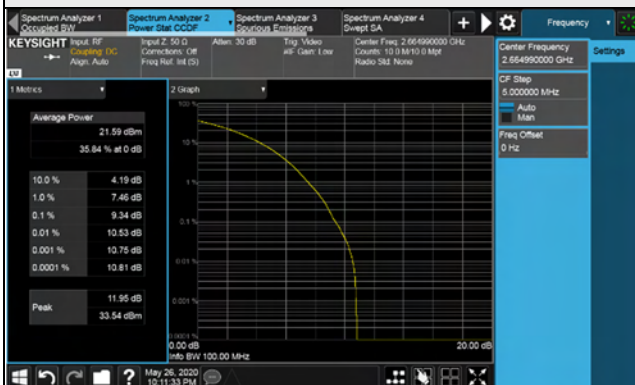

60MHz / 256QAM

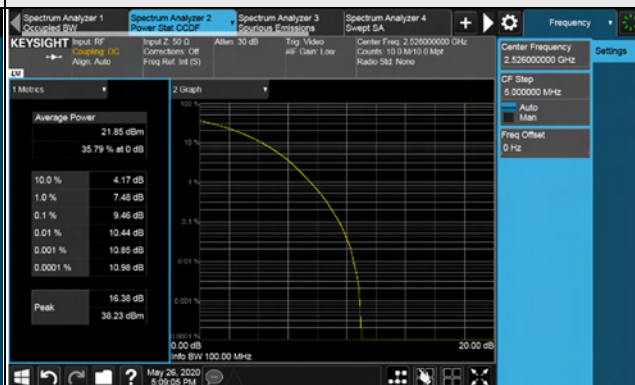

80MHz / 256QAM



90MHz / 256QAM

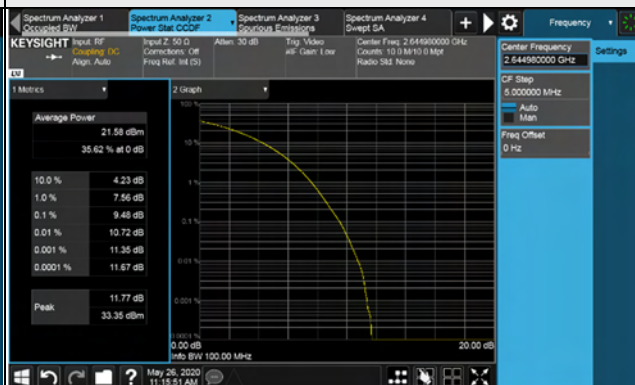

100MHz / 256QAM

