

FCC Test Report (Part 22: 5G NR)

Report No.: RF200109E02A

FCC ID: 2AQ68T99W175

Test Model: T99W175

Received Date: Jan. 10, 2020

Test Date: Feb. 26 ~ Mar. 14, 2020

Issued Date: Apr. 08, 2020

Applicant: Hon Lin Technology Co., Ltd.

Address: 11F, No. 32, Jihu Rd., Neihu Dist., Taipei City 114, Taiwan R.O.C.

Issued By: Bureau Veritas Consumer Products Services (H.K.) Ltd., Taoyuan Branch
Lin Kou Laboratories

Lab Address: No. 47-2, 14th Ling, Chia Pau Vil., Lin Kou Dist., New Taipei City, Taiwan

Test Location: No.19, Hwa Ya 2nd Rd., Wen Hwa Vil., Kwei Shan Dist., Taoyuan City
33383, Taiwan

FCC Registration / 788550 / TW0003

Designation Number:



This report is for your exclusive use. Any copying or replication of this report to or for any other person or entity, or use of our name or trademark, is permitted only with our prior written permission. This report sets forth our findings solely with respect to the test samples identified herein. The results set forth in this report are not indicative or representative of the quality or characteristics of the lot from which a test sample was taken or any similar or identical product unless specifically and expressly noted. Our report includes all of the tests requested by you and the results thereof based upon the information that you provided to us. You have 60 days from date of issuance of this report to notify us of any material error or omission caused by our negligence, provided, however, that such notice shall be in writing and shall specifically address the issue you wish to raise. A failure to raise such issue within the prescribed time shall constitute your unqualified acceptance of the completeness of this report, the tests conducted and the correctness of the report contents. Unless specific mention, the uncertainty of measurement has been explicitly taken into account to declare the compliance or non-compliance to the specification. The report must not be used by the client to claim product certification, approval, or endorsement by TAF or any government agencies

Table of Contents

Release Control Record	4
1 Certificate of Conformity	5
2 Summary of Test Results	6
2.1 Measurement Uncertainty.....	6
2.2 Test Site and Instruments.....	7
3 General Information	8
3.1 General Description of EUT.....	8
3.2 Configuration of System under Test.....	12
3.2.1 Description of Support Units.....	12
3.3 Test Mode Applicability and Tested Channel Detail.....	13
3.4 EUT Operating Conditions.....	15
3.5 General Description of Applied Standards and References.....	15
4 Test Types and Results	16
4.1 Output Power Measurement.....	16
4.1.1 Limits of Output Power Measurement.....	16
4.1.2 Test Procedures.....	16
4.1.3 Test Setup.....	16
4.1.4 Test Results.....	17
4.2 Modulation Characteristics Measurement.....	25
4.2.1 Limits of Modulation Characteristics.....	25
4.2.2 Test Procedure.....	25
4.2.3 Test Setup.....	25
4.2.4 Test Results.....	26
4.3 Frequency Stability Measurement.....	27
4.3.1 Limits of Frequency Stability Measurement.....	27
4.3.2 Test Procedure.....	27
4.3.3 Test Setup.....	27
4.3.4 Test Results.....	28
4.4 Occupied Bandwidth Measurement.....	32
4.4.1 Test Procedure.....	32
4.4.2 Test Setup.....	32
4.4.3 Test Result.....	33
4.5 Band Edge Measurement.....	37
4.5.1 Limits of Band Edge Measurement.....	37
4.5.2 Test Setup.....	37
4.5.3 Test Procedures.....	37
4.5.4 Test Results.....	38
4.6 Peak to Average Ratio.....	42
4.6.1 Limits of Peak to Average Ratio Measurement.....	42
4.6.2 Test Setup.....	42
4.6.3 Test Procedures.....	42
4.6.4 Test Results.....	43
4.7 Conducted Spurious Emissions.....	45
4.7.1 Limits of Conducted Spurious Emissions Measurement.....	45
4.7.2 Test Setup.....	45
4.7.3 Test Procedure.....	45
4.7.4 Test Results.....	46
4.8 Radiated Emission Measurement.....	50
4.8.1 Limits of Radiated Emission Measurement.....	50
4.8.2 Test Procedure.....	50
4.8.3 Deviation from Test Standard.....	50
4.8.4 Test Setup.....	51
4.8.5 Test Results.....	52

5	Pictures of Test Arrangements.....	62
	Appendix – Information of the Testing Laboratories	63

Release Control Record

Issue No.	Description	Date Issued
RF200109E02A	Original release	Apr. 08, 2020

1 Certificate of Conformity

Product: 5G WWAN Module

Brand: Foxconn

Test Model: T99W175

Sample Status: Engineering Sample

Applicant: Hon Lin Technology Co., Ltd.

Test Date: Feb. 26 ~ Mar. 14, 2020

Standards: FCC Part 22, Subpart H

The above equipment has been tested by **Bureau Veritas Consumer Products Services (H.K.) Ltd., Taoyuan Branch**, and found compliance with the requirement of the above standards. The test record, data evaluation & Equipment Under Test (EUT) configurations represented herein are true and accurate accounts of the measurements of the sample's RF characteristics under the conditions specified in this report.

Prepared by : Pettie Chen , **Date:** Apr. 08, 2020
Pettie Chen / Senior Specialist

Approved by : Bruce Chen , **Date:** Apr. 08, 2020
Bruce Chen / Senior Project Engineer

2 Summary of Test Results

Applied Standard: FCC Part 22 & Part 2			
FCC Clause	Test Item	Result	Remarks
2.1046 22.913 (a)	Effective radiated power	Pass	Meet the requirement of limit.
2.1047	Modulation Characteristics	Pass	Meet the requirement
22.913 (d)	Peak To Average Ratio	Pass	Meet the requirement of limit.
2.1055 22.355	Frequency Stability	Pass	Meet the requirement of limit.
2.1049	Occupied Bandwidth	Pass	Meet the requirement of limit.
22.917	Band Edge Measurements	Pass	Meet the requirement of limit.
2.1051 22.917	Conducted Spurious Emissions	Pass	Meet the requirement of limit.
2.1053 22.917	Radiated Spurious Emissions	Pass	Meet the requirement of limit. Minimum passing margin is -16.2dB at 30.00MHz.

Note: Determining compliance based on the results of the compliance measurement, not taking into account measurement instrumentation uncertainty.

2.1 Measurement Uncertainty

Where relevant, the following measurement uncertainty levels have been estimated for tests performed on the EUT as specified in CISPR 16-4-2:

Measurement	Frequency	Expanded Uncertainty (k=2) (\pm)
Radiated Emissions up to 1 GHz	9kHz ~ 30MHz	3.04 dB
	30MHz ~ 200MHz	3.63 dB
	200MHz ~ 1000MHz	3.64 dB
Radiated Emissions above 1 GHz	1GHz ~ 18GHz	2.29 dB
	18GHz ~ 40GHz	2.29 dB

2.2 Test Site and Instruments

Description & Manufacturer	Model No.	Serial No.	Cal. Date	Cal. Due
Test Receiver ROHDE & SCHWARZ	ESCI	100424	Dec. 31, 2019	Dec. 30, 2020
Spectrum Analyzer ROHDE & SCHWARZ	FSP40	100040	Sep. 23, 2019	Sep. 22, 2020
Spectrum Analyzer KEYSIGHT	N9030B	MY57140953	Jul. 03, 2019	Jul. 02, 2020
Radio Communication Analyzer Anritsu	MT8000A	6262012865	Dec. 12, 2019	Dec. 11, 2020
MXG Vector signal generator Agilent	N5182B	MY53050162	Jan. 14, 2020	Jan. 13, 2021
BILOG Antenna SCHWARZBECK	VULB9168	9168-158	Nov. 08, 2019	Nov. 07, 2020
BILOG Antenna SCHWARZBECK	VULB9168	9168-155	Nov. 11, 2019	Nov. 10, 2020
HORN Antenna SCHWARZBECK	BBHA 9120D	9120D-1170	Nov. 24, 2019	Nov. 23, 2020
HORN Antenna SCHWARZBECK	BBHA 9170	BBHA9170241	Nov. 24, 2019	Nov. 23, 2020
Loop Antenna TESEQ	HLA 6121	45745	Jul. 01, 2019	Jun. 30, 2020
Preamplifier Agilent (Below 1GHz)	8447D	2944A10631	Jul. 11, 2019	Jul. 10, 2020
Preamplifier KEYSIGHT (Above 1GHz)	83017A	MY53270295	Jun. 11, 2019	Jun. 10, 2020
RF Coaxial Cable WOKEN With 5dB PAD	8D-FB	Cable-CH4-01	Aug. 20, 2019	Aug. 19, 2020
RF Coaxial Cable EMCI	EMC102-KM-KM-3000	150929	Aug. 20, 2019	Aug. 19, 2020
RF Coaxial Cable EMCI	EMC102-KM-KM-600	150928	Aug. 20, 2019	Aug. 19, 2020
RF signal cable HUBER+SUHNER	SUCOFLEX 104	MY 13380+295012/04	Jul. 11, 2019	Jul. 10, 2020
RF signal cable HUBER+SUHNER	SUCOFLEX 104	Cable-CH4-03 (250724)	Jul. 11, 2019	Jul. 10, 2020
Software BV ADT	ADT_Radiated_V7.6.15.9.5	NA	NA	NA
Antenna Tower inn-co GmbH	MA 4000	010303	NA	NA
Antenna Tower Controller BV ADT	AT100	AT93021703	NA	NA
Boresight Antenna Fixture	FBA-01	FBA-SIP01	NA	NA
Standard Temperature And Humidity Chamber	MHU-225AU	920842	May 31, 2019	May 30, 2020
JFW 20dB attenuation	50HF-020-SMA	NA	NA	NA
True RMS Clamp Meter Fluke	325	31130711WS	May 21, 2019	May 20, 2020
DC power supply	U8002A	MY56330015	NA	NA

Note: 1. The calibration interval of the above test instruments is 12 months and the calibrations are traceable to NML/ROC and NIST/USA.

2. The test was performed in HwaYa Chamber 4.

3 General Information

3.1 General Description of EUT

Product	5G WWAN Module			
Brand	Foxconn			
Test Model	T99W175			
Sample Status	Engineering Sample			
Power Supply Rating	5 Vdc (Host equipment) 3.135Vdc~3.63Vdc (Module)			
Modulation Type	QPSK, 16QAM, 64QAM			
Operating Frequency	n5 (Channel Bandwidth 5MHz)	826.5~846.5MHz		
	n5 (Channel Bandwidth 10MHz)	829.0~844.0MHz		
	n5 (Channel Bandwidth 15MHz)	831.5~841.5MHz		
	n5 (Channel Bandwidth 20MHz)	834.0~839.0MHz		
Max. ERP Power		QPSK	16QAM	64QAM
	n5 (Channel Bandwidth 5MHz)	325.837mW (25.13dBm)	309.742mW (24.91dBm)	280.543mW (24.48dBm)
	n5 (Channel Bandwidth 10MHz)	322.849mW (25.09dBm)	312.608mW (24.95dBm)	285.102mW (24.55dBm)
	n5 (Channel Bandwidth 15MHz)	328.095mW (25.16dBm)	313.329mW (24.96dBm)	284.446mW (24.54dBm)
	n5 (Channel Bandwidth 20MHz)	324.340mW (25.11dBm)	309.030mW (24.90dBm)	284.446mW (24.54dBm)
Emission Designator		QPSK	16QAM	64QAM
	n5 (Channel Bandwidth 5MHz)	4M49G7D	4M49D7W	4M49D7W
	n5 (Channel Bandwidth 10MHz)	8M95G7D	8M96D7W	8M95D7W
	n5 (Channel Bandwidth 15MHz)	13M5G7D	13M4D7W	13M4D7W
	n5 (Channel Bandwidth 20MHz)	17M9G7D	18M0D7W	17M9D7W
Antenna Type	Refer to Note as below			
Antenna Connector	Refer to Note as below			
Accessory Device	NA			
Cable Supplied	NA			

Note:

1. There are four Difference HW of T99W175.

Brand	Model	HW
Foxconn	T99W175	1. 3G+LTE+Sub6+eSIM
		2. 3G+LTE+Sub6 only w/o eSIM
		3. 3G+LTE+Sub6+eSIM+GNSS connector
		4. 3G+LTE+Sub6 only+w/o eSIM+GNSS connector

*After pre-testing, "HW: 1. 3G+LTE+Sub6+eSIM" is the worst for the final tests.

2. The following antennas were provided to the EUT.

Antenna No.	RF Chain No.	Brand	Model	Antenna Net Gain(dBi)	Frequency range (MHz)	Antenna Type	Connector Type
1		WHA YU	C107-511720-A	4.41	660~803	PCB	I-PEX
2		WHA YU	C107-511721-A	3.81 4.03	791~960 1447.9~1606	PCB	I-PEX
3		WHA YU	C107-511722-A	4.27 5.31	1710~2170 2500~2690	PCB	I-PEX
4		WHA YU	C107-511723-A	2.99 0.92	2300~2400 3500~3700	PCB	I-PEX
5		WHA YU	C107-511724-A	6.45	5150~5925	PCB	I-PEX
6		WHA YU	C107-511725-A	4.89	3400~3700	PCB	I-PEX
7		AVX	5000106-R1-X01	2.91	699~803	Monopole	I-PEX
8		AVX	5000107-R1-X01	2.59	791~960	Monopole	I-PEX
9		AVX	5000108-R1-X01	2.85	1427~1610	Monopole	I-PEX
10		AVX	5000109-R1-X01	2.23 2.94	1710~2200 5150~5925	Monopole	I-PEX
11		AVX	5000110-R1-X01	0.9	2300~2690	Monopole	I-PEX
12		AVX	5000111-R1-X01	0.87	3300~5000	Monopole	I-PEX
13	Tx1/ Rx1	Ethertronics	5003806	0.4 -1.61 0.39 2.95 1.98 0.38 0.83 2.31	698-821 824-960 1425-1515 1710-2200 2300-2690 3300-4200 4400-5000 5150-5925	PIFA	I-PEX
	Rx2	Ethertronics	5003807	-2.24 -4.52 2.87 2.99 2.93 2.91 2.23 -0.85 -3.04	716-821 824-960 1425-1515 1557-1610 1805-2200 2300-2690 3300-4200 4400-5000 5150-5925	PIFA	I-PEX
	Tx2/ Rx3	Ethertronics	5003806	2.21 2.25 -0.45 2.6	1710-2200 2300-2690 3300-4200 4400-5000	PIFA	I-PEX
	Rx4	Ethertronics	5003700	1.38 2.87 0.6 -2.09	1805-2200 2300-2690 3300-4200 4400-5000	PIFA	I-PEX

Antenna No.	RF Chain No.	Brand	Model	Antenna Net Gain(dBi)	Frequency range (MHz)	Antenna Type	Connector Type
14	Ant. 0 (TX/RX)	Master Wave	NA	2.4 2.2 2.9 2.9 2.9 NA	880~960 1020~2170 2545~2595 3565~3600 3900~4000 GPS	PCB	I-PEX
	Ant. 2 (TX/RX)	Master Wave	NA	NA 2.2 2.8 2.9 2.8 NA	880~960 1020~2170 2545~2595 3565~3600 3900~4000 GPS	PCB	I-PEX
	Ant. 1 (RX)	Master Wave	NA	NA 5.3 5.1 4.3 4.5 NA	880~960 1020~2170 2545~2595 3565~3600 3900~4000 GPS	PCB	I-PEX
	Ant. 3 (RX)	Master Wave	NA	1.3 6.8 3.7 6.4 6.2 3.7	880~960 1020~2170 2545~2595 3565~3600 3900~4000 GPS	PCB	I-PEX

3. ENDC configuration.

The EUT supports the following ENDC configuration.

5G NR	FCC 5G FR1			ENDC
	Band	SCS	Bandwidth (MHz)	
	n2	15kHz	5/10/15/20	Band 5/12/13/48
	n5	15kHz	5/10/15/20	Band 2/7/12/48/66
	n7	15kHz	5/10/15/20	Band 5/12
	n12	15kHz	5/10/15	Band 2/66
	n38	30kHz	20	Standalone
	n41	30kHz	20/40/50/60/80/90/100	Standalone/ Band 2/41/66
	n66	15kHz	5/10/15/20	Band 5/12/13/48/71
	n71	15kHz	5/10/15/20	Band 2/41/66

The following ENDC configuration was the worst for the final tests.

5G NR	FCC 5G FR1			ENDC
	Band	SCS	Bandwidth (MHz)	
	n2	15kHz	5/10/15/20	Band 5
	n5	15kHz	5/10/15/20	Band 2
	n7	15kHz	5/10/15/20	Band 5
	n12	15kHz	5/10/15	Band 2
	n38	30kHz	20	Standalone
	n41	30kHz	20/40/50/60/80/90/100	Standalone
	n66	15kHz	5/10/15/20	Band 5
	n71	15kHz	5/10/15/20	Band 2

3.2 Configuration of System under Test

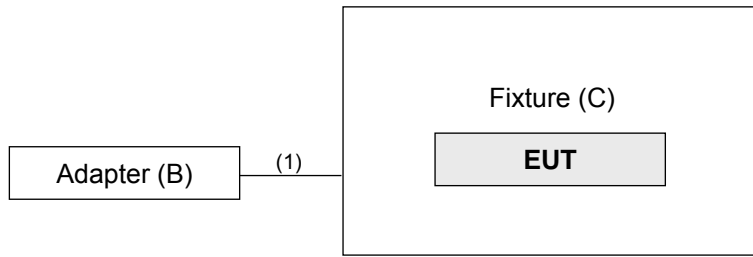

Remote site

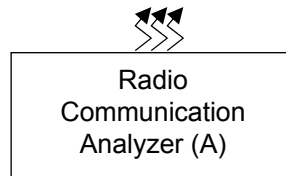

3.2.1 Description of Support Units

The EUT has been tested as an independent unit together with other necessary accessories or support units. The following support units or accessories were used to form a representative test configuration during the tests.

ID	Product	Brand	Model No.	Serial No.	FCC ID	Remarks
A.	Radio Communication Analyzer	Anritsu	MT8821C	6261806803	NA	-
B.	Adapter	LITEON	PA-1050-39	NA	NA	-
C.	Fixture	NA	NA	NA	NA	Provided by client.

Note:

1. All power cords of the above support units are non-shielded (1.8m).
2. Item A acted as a communication partner to transfer data.

ID	Descriptions	Qty.	Length (m)	Shielding (Yes/No)	Cores (Qty.)	Remarks
1.	USB cable	1	1.5	Y	0	-

3.3 Test Mode Applicability and Tested Channel Detail

Pre-Scan has been conducted to determine the worst-case mode from all possible combinations between available modulations, data rates, XYZ axis and antenna ports. The worst case was found when positioned on Z-plane. Following channel(s) was (were) selected for the final test as listed below.

n5

EUT Configure Mode	Test item	Available channel	Tested channel	Channel Bandwidth	Modulation	Mode
-	ERP	165300 to 169300	165300(826.5MHz), 167300(836.5MHz), 169300(846.5MHz)	5MHz	QPSK / 16QAM / 64QAM	1 RB / 0 RB Offset
		165800 to 168800	165800(829.0MHz), 167300(836.5MHz), 168800(844.0MHz)	10MHz	QPSK / 16QAM / 64QAM	1 RB / 0 RB Offset
		166300 to 168300	166300(831.5MHz), 167300(836.5MHz), 168300(841.5MHz)	15MHz	QPSK / 16QAM / 64QAM	1 RB / 0 RB Offset
		166800 to 167800	166800(834.0MHz), 167300(836.5MHz), 167800(839.0MHz)	20MHz	QPSK / 16QAM / 64QAM	1 RB / 0 RB Offset
-	Modulation characteristics	166800 to 167800	167300(836.5MHz)	20MHz	QPSK / 16QAM / 64QAM	106 RB / 0 RB Offset
-	Frequency Stability	165300 to 169300	165300(826.5MHz), 169300(846.5MHz)	5MHz	QPSK	12 RB / 0 RB Offset
		165800 to 168800	165800(829.0MHz), 168800(844.0MHz)	10MHz	QPSK	26 RB / 0 RB Offset
		166300 to 168300	166300(831.5MHz), 168300(841.5MHz)	15MHz	QPSK	39 RB / 0 RB Offset
		166800 to 167800	166800(834.0MHz), 167800(839.0MHz)	20MHz	QPSK	50 RB / 0 RB Offset
-	Occupied Bandwidth	165300 to 169300	165300(826.5MHz), 167300(836.5MHz), 169300(846.5MHz)	5MHz	QPSK / 16QAM / 64QAM	12 RB / 0 RB Offset
		165800 to 168800	165800(829.0MHz), 167300(836.5MHz), 168800(844.0MHz)	10MHz	QPSK / 16QAM / 64QAM	26 RB / 0 RB Offset
		166300 to 168300	166300(831.5MHz), 167300(836.5MHz), 168300(841.5MHz)	15MHz	QPSK / 16QAM / 64QAM	39 RB / 0 RB Offset
		166800 to 167800	166800(834.0MHz), 167300(836.5MHz), 167800(839.0MHz)	20MHz	QPSK / 16QAM / 64QAM	50 RB / 0 RB Offset
-	Band Edge	165300 to 169300	165300(826.5MHz), 169300(846.5MHz)	5MHz	QPSK	1 RB / 0 RB Offset 1 RB / 24 RB Offset 25 RB / 0 RB Offset
		165800 to 168800	165800(829.0MHz), 168800(844.0MHz)	10MHz	QPSK	1 RB / 0 RB Offset 1 RB / 51 RB Offset 52 RB / 0 RB Offset
		166300 to 168300	166300(831.5MHz), 168300(841.5MHz)	15MHz	QPSK	1 RB / 0 RB Offset 1 RB / 78 RB Offset 79 RB / 0 RB Offset
		166800 to 167800	166800(834.0MHz), 167800(839.0MHz)	20MHz	QPSK	1 RB / 0 RB Offset 1 RB / 105 RB Offset 106 RB / 0 RB Offset

EUT Configure Mode	Test item	Available channel	Tested channel	Channel Bandwidth	Modulation	Mode
-	Peak to Average Ratio	165300 to 169300	165300(826.5MHz), 167300(836.5MHz), 169300(846.5MHz)	5MHz	QPSK / 16QAM / 64QAM	1 RB / 0 RB Offset
		165800 to 168800	165800(829.0MHz), 167300(836.5MHz), 168800(844.0MHz)	10MHz	QPSK / 16QAM / 64QAM	1 RB / 0 RB Offset
		166300 to 168300	166300(831.5MHz), 167300(836.5MHz), 168300(841.5MHz)	15MHz	QPSK / 16QAM / 64QAM	1 RB / 0 RB Offset
		166800 to 167800	166800(834.0MHz), 167300(836.5MHz), 167800(839.0MHz)	20MHz	QPSK / 16QAM / 64QAM	1 RB / 0 RB Offset
-	Conducted Emission	165300 to 169300	165300(826.5MHz), 167300(836.5MHz), 169300(846.5MHz)	5MHz	QPSK	1 RB / 0 RB Offset
		165800 to 168800	165800(829.0MHz), 167300(836.5MHz), 168800(844.0MHz)	10MHz	QPSK	1 RB / 0 RB Offset
		166300 to 168300	166300(831.5MHz), 167300(836.5MHz), 168300(841.5MHz)	15MHz	QPSK	1 RB / 0 RB Offset
		166800 to 167800	166800(834.0MHz), 167300(836.5MHz), 167800(839.0MHz)	20MHz	QPSK	1 RB / 0 RB Offset
-	Radiated Emission Below 1GHz	165300 to 169300	165300(826.5MHz)	5MHz	QPSK	1 RB / 0 RB Offset
		166800 to 167800	166800(834.0MHz)	20MHz	QPSK	1 RB / 0 RB Offset
-	Radiated Emission Above 1GHz	165300 to 169300	165300(826.5MHz), 167300(836.5MHz), 169300(846.5MHz)	5MHz	QPSK	1 RB / 0 RB Offset
		166300 to 168300	166300(831.5MHz), 167300(836.5MHz), 168300(841.5MHz)	15MHz	QPSK	1 RB / 0 RB Offset
		166800 to 167800	166800(834.0MHz), 167300(836.5MHz), 167800(839.0MHz)	20MHz	QPSK	1 RB / 0 RB Offset

Note:

1. The conducted output power for QPSK, 16QAM and 64QAM, measured value of QPSK is higher than 16QAM and 64QAM mode. Therefore, only Modulation characteristics, occupied bandwidth and Peak to average ratio items had been tested under QPSK, 16QAM and 64QAM modes, the other test items were performed under QPSK mode only.

Test Condition:

Test Item	Environmental Conditions	Input Power (system)	Tested By
ERP	25deg. C, 70%RH	5Vdc	James Yang
Modulation Characteristics	24deg. C, 64%RH	5Vdc	James Yang
Frequency Stability	24deg. C, 64%RH	5Vdc	James Yang
Occupied Bandwidth	24deg. C, 64%RH	5Vdc	James Yang
Band Edge	24deg. C, 64%RH	5Vdc	James Yang
Peak To Average Ratio	24deg. C, 64%RH	5Vdc	James Yang
Conducted Emission	24deg. C, 64%RH	5Vdc	James Yang
Radiated Emission	22deg. C, 68%RH	120Vac, 60Hz	Greg Lin

3.4 EUT Operating Conditions

The EUT makes a call to the communication simulator. The communication simulator station system controlled a EUT to export maximum output power under transmission mode and specific channel frequency

3.5 General Description of Applied Standards and References

The EUT is a RF Product. According to the specifications of the manufacturer, it must comply with the requirements of the following standards and References:

Test Standard:

FCC 47 CFR Part 2

FCC 47 CFR Part 22

ANSI/TIA/EIA-603-E 2016

ANSI 63.26-2015

All test items have been performed and recorded as per the above standards.

References Test Guidance:

KDB 971168 D01 Power Meas License Digital Systems v03r01

All test items have been performed as a reference to the above KDB test guidance.

4 Test Types and Results

4.1 Output Power Measurement

4.1.1 Limits of Output Power Measurement

Mobile / Portable station are limited to 7 watts e.r.p.

4.1.2 Test Procedures

Conducted Power Measurement:

The EUT was set up for the maximum power with 5GNR link data modulation and link up with simulator.
Set the EUT to transmit under low, middle and high channel and record the power level shown on simulator.

Maximum EIRP

The relevant equation for determining the maximum ERP or EIRP from the measured RF output power is given in Equation as follows:

$$\text{ERP or EIRP} = P_{\text{Meas}} + G_{\text{T}}$$

where

ERP or EIRP effective radiated power or equivalent isotropically radiated power, respectively
(expressed in the same units as P_{Meas} , e.g., dBm or dBW)

P_{Meas} measured transmitter output power or PSD, in dBm or dBW

G_{T} gain of the transmitting antenna, in dBd (ERP) or dBi (EIRP)

4.1.3 Test Setup

Conducted Power Measurement:



For the actual test configuration, please refer to the attached file (Test Setup Photo).

4.1.4 Test Results

Conducted Output Power (dBm)

		n5				
BW	MCS Index	RB Size	RB Offset	Low	Mid	High
		Channel		165300	167300	169300
		Frequency (MHz)		826.5	836.5	846.5
5M	QPSK	1	0	23.22	23.09	23.47
		1	12	23.19	23.46	23.01
		1	24	23.26	23.16	23.11
		12	0	23.05	23.00	23.08
		12	6	22.71	23.09	22.76
		12	13	23.09	22.80	23.01
		25	0	23.12	23.18	22.83
	16QAM	1	0	23.03	23.23	23.16
		1	12	23.12	22.91	23.25
		1	24	23.05	23.07	22.89
		12	0	22.94	22.98	23.06
		12	6	22.85	23.03	22.75
		12	13	22.71	23.00	22.93
		25	0	22.88	22.64	22.91
	64QAM	1	0	22.57	22.65	22.65
		1	12	22.82	22.79	22.40
		1	24	22.54	22.65	22.51
		12	0	22.64	22.47	22.53
		12	6	22.37	22.20	22.21
		12	13	22.29	22.57	22.66
		25	0	22.28	22.57	22.63

n5						
BW	MCS Index	RB Size	RB Offset	Low	Mid	High
		Channel		165800	167300	168800
		Frequency (MHz)		829.0	836.5	844.0
10M	QPSK	1	0	23.18	23.43	23.34
		1	26	23.25	23.37	23.17
		1	51	23.31	23.38	23.18
		26	0	22.78	23.20	22.70
		26	13	23.17	22.76	22.77
		26	26	22.87	22.86	23.13
		52	0	23.17	22.93	22.97
	16QAM	1	0	23.01	22.97	23.17
		1	26	23.29	23.02	23.02
		1	51	23.01	22.82	22.99
		26	0	22.91	22.98	22.62
		26	13	22.81	22.93	22.79
		26	26	22.72	22.76	22.67
		52	0	22.76	22.74	22.61
	64QAM	1	0	22.41	22.43	22.63
		1	26	22.54	22.82	22.78
		1	51	22.89	22.82	22.71
		26	0	22.57	22.47	22.68
		26	13	22.63	22.34	22.12
		26	26	22.67	22.16	22.68
		52	0	22.48	22.60	22.46

n5						
BW	MCS Index	RB Size	RB Offset	Low	Mid	High
		Channel		166300	167300	168300
		Frequency (MHz)		831.5	836.5	841.5
15M	QPSK	1	0	23.22	23.28	23.50
		1	39	23.05	23.33	23.35
		1	78	23.10	23.36	23.10
		39	0	23.15	22.91	22.73
		39	19	23.12	22.80	23.16
		39	40	22.95	23.20	23.12
		79	0	22.94	23.16	22.91
	16QAM	1	0	23.04	22.90	23.28
		1	39	22.83	23.26	23.30
		1	78	23.09	22.97	23.00
		39	0	22.74	23.05	22.89
		39	19	22.80	22.90	22.90
		39	40	22.82	22.73	22.99
		79	0	22.60	22.67	22.64
	64QAM	1	0	22.59	22.57	22.73
		1	39	22.44	22.79	22.71
		1	78	22.88	22.73	22.85
		39	0	22.12	22.18	22.57
		39	19	22.56	22.62	22.66
		39	40	22.35	22.67	22.33
		79	0	22.44	22.42	22.32

n5						
BW	MCS Index	RB Size	RB Offset	Low	Mid	High
		Channel		166800	167300	167800
		Frequency (MHz)		834	836.5	839
20M	QPSK	1	0	23.42	23.35	23.28
		1	53	23.22	23.45	23.16
		1	105	23.44	23.27	23.23
		50	0	23.15	22.75	22.83
		50	25	22.77	23.05	22.70
		50	50	23.06	23.16	23.10
		106	0	22.70	23.19	22.81
	16QAM	1	0	22.93	22.89	23.11
		1	53	23.03	23.04	23.19
		1	105	22.99	23.06	23.24
		50	0	22.86	22.97	22.68
		50	25	22.65	22.69	22.96
		50	50	22.91	23.06	22.63
		106	0	22.71	22.99	22.86
	64QAM	1	0	22.71	22.55	22.88
		1	53	22.54	22.73	22.85
		1	105	22.58	22.62	22.50
		50	0	22.28	22.29	22.43
		50	25	22.16	22.11	22.23
		50	50	22.22	22.36	22.36
		106	0	22.50	22.56	22.60

ERP Power (dBm)

		n5				
BW	MCS Index	RB Size	RB Offset	Low	Mid	High
		Channel		165300	167300	169300
		Frequency (MHz)		826.5	836.5	846.5
5M	QPSK	1	0	24.88	24.75	25.13
		1	12	24.85	25.12	24.67
		1	24	24.92	24.82	24.77
		12	0	24.71	24.66	24.74
		12	6	24.37	24.75	24.42
		12	13	24.75	24.46	24.67
		25	0	24.78	24.84	24.49
	16QAM	1	0	24.69	24.89	24.82
		1	12	24.78	24.57	24.91
		1	24	24.71	24.73	24.55
		12	0	24.60	24.64	24.72
		12	6	24.51	24.69	24.41
		12	13	24.37	24.66	24.59
		25	0	24.54	24.30	24.57
	64QAM	1	0	24.23	24.31	24.31
		1	12	24.48	24.45	24.06
		1	24	24.20	24.31	24.17
		12	0	24.30	24.13	24.19
		12	6	24.03	23.86	23.87
		12	13	23.95	24.23	24.32
		25	0	23.94	24.23	24.29

*ERP = Conducted + antenna gain (3.81dBi)-2.15

n5						
BW	MCS Index	RB Size	RB Offset	Low	Mid	High
		Channel		165800	167300	168800
		Frequency (MHz)		829.0	836.5	844.0
10M	QPSK	1	0	24.84	25.09	25.00
		1	26	24.91	25.03	24.83
		1	51	24.97	25.04	24.84
		26	0	24.44	24.86	24.36
		26	13	24.83	24.42	24.43
		26	26	24.53	24.52	24.79
		52	0	24.83	24.59	24.63
	16QAM	1	0	24.67	24.63	24.83
		1	26	24.95	24.68	24.68
		1	51	24.67	24.48	24.65
		26	0	24.57	24.64	24.28
		26	13	24.47	24.59	24.45
		26	26	24.38	24.42	24.33
		52	0	24.42	24.40	24.27
	64QAM	1	0	24.07	24.09	24.29
		1	26	24.20	24.48	24.44
		1	51	24.55	24.48	24.37
		26	0	24.23	24.13	24.34
		26	13	24.29	24.00	23.78
		26	26	24.33	23.82	24.34
		52	0	24.14	24.26	24.12

*ERP = Conducted + antenna gain (3.81dBi)-2.15

n5						
BW	MCS Index	RB Size	RB Offset	Low	Mid	High
		Channel		166300	167300	168300
		Frequency (MHz)		831.5	836.5	841.5
15M	QPSK	1	0	24.88	24.94	25.16
		1	39	24.71	24.99	25.01
		1	78	24.76	25.02	24.76
		39	0	24.81	24.57	24.39
		39	19	24.78	24.46	24.82
		39	40	24.61	24.86	24.78
		79	0	24.60	24.82	24.57
	16QAM	1	0	24.70	24.56	24.94
		1	39	24.49	24.92	24.96
		1	78	24.75	24.63	24.66
		39	0	24.40	24.71	24.55
		39	19	24.46	24.56	24.56
		39	40	24.48	24.39	24.65
		79	0	24.26	24.33	24.30
	64QAM	1	0	24.25	24.23	24.39
		1	39	24.10	24.45	24.37
		1	78	24.54	24.39	24.51
		39	0	23.78	23.84	24.23
		39	19	24.22	24.28	24.32
		39	40	24.01	24.33	23.99
		79	0	24.10	24.08	23.98

*ERP = Conducted + antenna gain (3.81dBi)-2.15

n5						
BW	MCS Index	RB Size	RB Offset	Low	Mid	High
		Channel		166800	167300	167800
		Frequency (MHz)		829	836.5	844
20M	QPSK	1	0	25.08	25.01	24.94
		1	53	24.88	25.11	24.82
		1	105	25.10	24.93	24.89
		50	0	24.81	24.41	24.49
		50	25	24.43	24.71	24.36
		50	50	24.72	24.82	24.76
		106	0	24.36	24.85	24.47
	16QAM	1	0	24.59	24.55	24.77
		1	53	24.69	24.70	24.85
		1	105	24.65	24.72	24.90
		50	0	24.52	24.63	24.34
		50	25	24.31	24.35	24.62
		50	50	24.57	24.72	24.29
		106	0	24.37	24.65	24.52
	64QAM	1	0	24.37	24.21	24.54
		1	53	24.20	24.39	24.51
		1	105	24.24	24.28	24.16
		50	0	23.94	23.95	24.09
		50	25	23.82	23.77	23.89
		50	50	23.88	24.02	24.02
		106	0	24.16	24.22	24.26

*ERP = Conducted + antenna gain (3.81dBi)-2.15

4.2 Modulation Characteristics Measurement

4.2.1 Limits of Modulation Characteristics

N/A

4.2.2 Test Procedure

Connect the EUT to Communication Simulator via the antenna connector, The frequency band is set as EUT supported Modulation and Channels, the EUT output is matched with 50 ohm load, the waveform quality and constellation of the EUT was tested.

4.2.3 Test Setup



4.2.4 Test Results

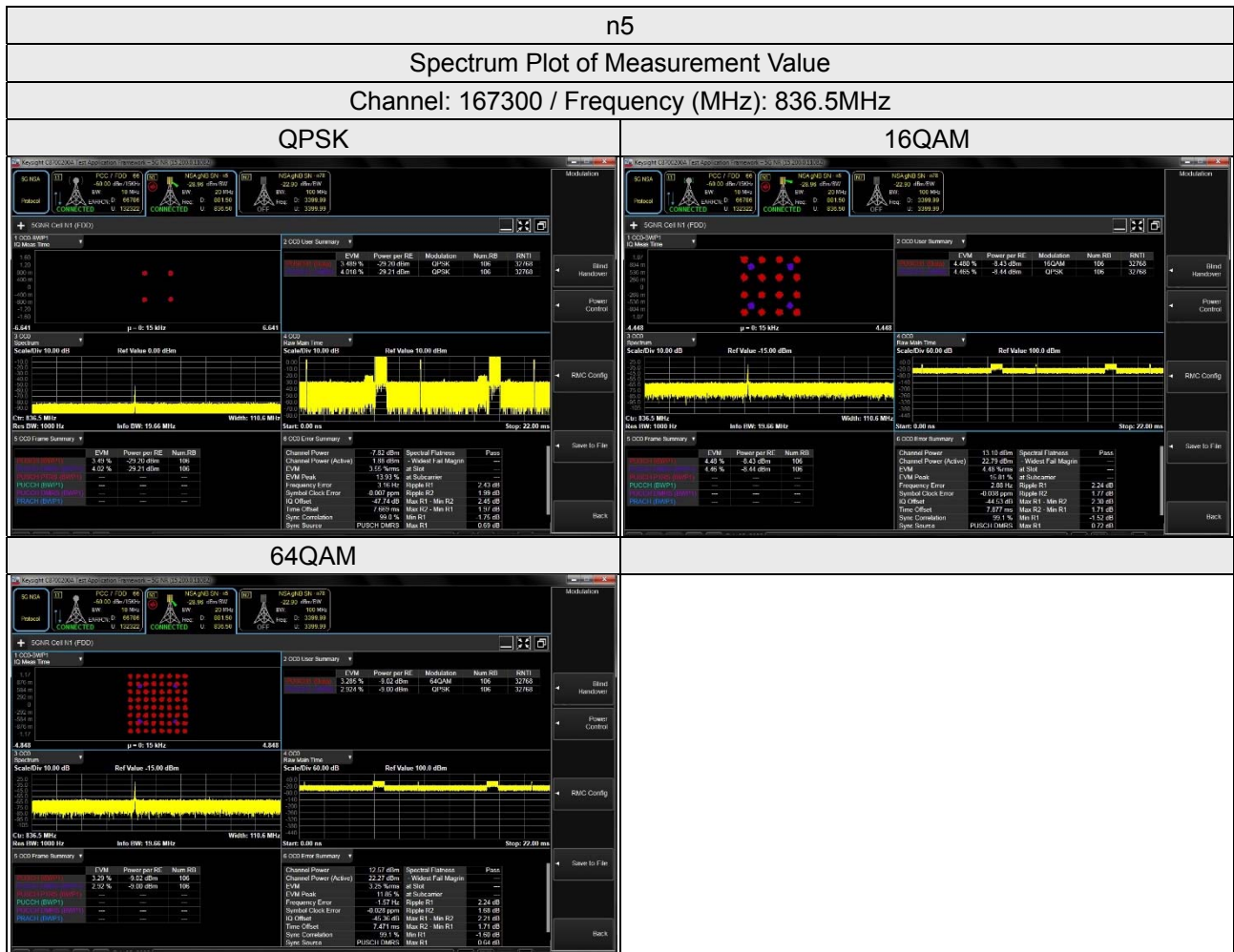

4.3 Frequency Stability Measurement

4.3.1 Limits of Frequency Stability Measurement

1.5 ppm is for base and fixed station. 2.5 ppm is for mobile station.

4.3.2 Test Procedure

- Device is placed at the oven room. The oven room could control the temperatures and humidity. Power warm up is at least 15 min and power applied should perform before recording frequency error.
- EUT is connected the external power supply to control the DC input power. The test voltage range is from minimum to maximum working voltage. Each step shall be record the frequency error rate.
- The temperature range step is 10 degrees in this test items. All temperature levels shall be hold the ± 0.5 °C during the measurement testing. The each temperature step shall be at least 0.5 hours, consider the EUT could be test under the stability condition.

Note: The frequency error was recorded frequency error from the communication simulator.

4.3.3 Test Setup

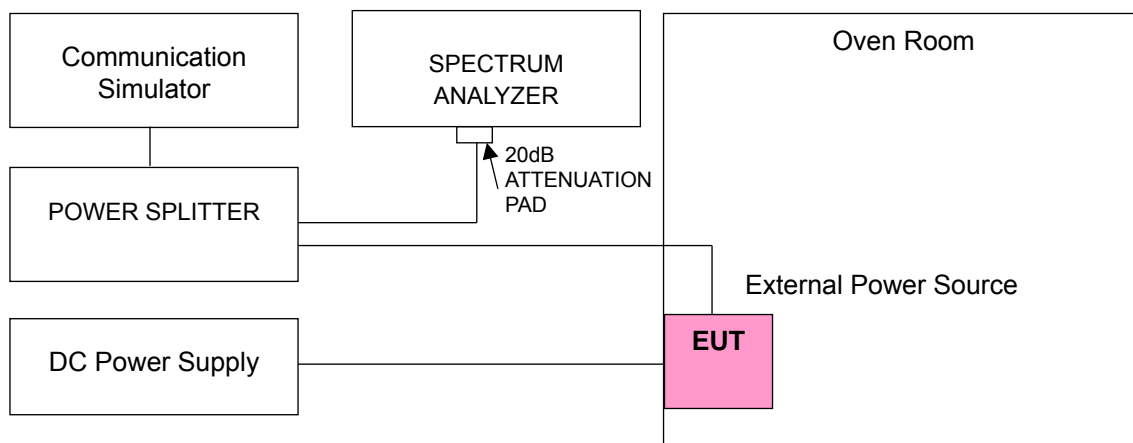

4.3.4 Test Results

Frequency Error vs. Voltage

Voltage (Volts)	n5			
	Channel Bandwidth: 5MHz			
	Low Channel		High Channel	
	Frequency (MHz)	Frequency Error (ppm)	Frequency (MHz)	Frequency Error (ppm)
4.25	826.500003	0.003	846.500004	0.004
5	826.500002	0.003	846.500002	0.002
5.75	826.500001	0.001	846.500002	0.002

Note: The applicant defined the normal working voltage is from 4.25Vdc to 5.75Vdc.

Frequency Error vs. Temperature

Temp. (°C)	n5			
	Channel Bandwidth: 5MHz			
	Low Channel		High Channel	
	Frequency (MHz)	Frequency Error (ppm)	Frequency (MHz)	Frequency Error (ppm)
-30	826.500002	0.003	846.500002	0.002
-20	826.500003	0.004	846.500002	0.002
-10	826.500004	0.005	846.500003	0.004
0	826.500002	0.003	846.500002	0.002
10	826.500002	0.002	846.500004	0.005
20	826.499997	-0.004	846.499998	-0.002
30	826.499998	-0.003	846.499997	-0.004
40	826.499996	-0.004	846.499997	-0.004
50	826.499998	-0.002	846.499997	-0.004

Frequency Error vs. Voltage

Voltage (Volts)	n5			
	Channel Bandwidth: 10MHz			
	Low Channel		High Channel	
	Frequency (MHz)	Frequency Error (ppm)	Frequency (MHz)	Frequency Error (ppm)
4.25	829.000003	0.003	844.000003	0.003
5	829.000003	0.004	844.000004	0.005
5.75	829.000003	0.004	844.000003	0.003

Note: The applicant defined the normal working voltage is from 4.25Vdc to 5.75Vdc.

Frequency Error vs. Temperature

Temp. (°C)	n5			
	Channel Bandwidth: 10 MHz			
	Low Channel		High Channel	
	Frequency (MHz)	Frequency Error (ppm)	Frequency (MHz)	Frequency Error (ppm)
-30	829.000002	0.002	844.000002	0.002
-20	829.000002	0.002	844.000004	0.004
-10	829.000002	0.002	844.000003	0.003
0	829.000002	0.003	844.000004	0.005
10	829.000002	0.002	844.000003	0.004
20	828.999998	-0.003	843.999997	-0.004
30	828.999996	-0.004	843.999999	-0.002
40	828.999997	-0.004	843.999996	-0.004
50	828.999999	-0.001	843.999999	-0.002

Frequency Error vs. Voltage

Voltage (Volts)	n5			
	Channel Bandwidth: 15MHz			
	Low Channel		High Channel	
	Frequency (MHz)	Frequency Error (ppm)	Frequency (MHz)	Frequency Error (ppm)
4.25	831.500002	0.002	841.500001	0.001
5	831.500002	0.002	841.500003	0.003
5.75	831.500001	0.001	841.500003	0.004

Note: The applicant defined the normal working voltage is from 4.25Vdc to 5.75Vdc.

Frequency Error vs. Temperature

Temp. (°C)	n5			
	Channel Bandwidth: 15MHz			
	Low Channel		High Channel	
	Frequency (MHz)	Frequency Error (ppm)	Frequency (MHz)	Frequency Error (ppm)
-30	831.500003	0.004	841.500002	0.003
-20	831.500003	0.003	841.500002	0.003
-10	831.500002	0.002	841.500003	0.004
0	831.500004	0.004	841.500002	0.003
10	831.500002	0.002	841.500002	0.003
20	831.499998	-0.003	841.499997	-0.004
30	831.499998	-0.002	841.499998	-0.003
40	831.499997	-0.003	841.499996	-0.005
50	831.499998	-0.002	841.499997	-0.003

Frequency Error vs. Voltage

Voltage (Volts)	n5			
	Channel Bandwidth: 20MHz			
	Low Channel		High Channel	
	Frequency (MHz)	Frequency Error (ppm)	Frequency (MHz)	Frequency Error (ppm)
4.25	834.000002	0.002	839.000001	0.001
5	834.000002	0.003	839.000002	0.002
5.75	834.000003	0.003	839.000002	0.002

Note: The applicant defined the normal working voltage is from 4.25Vdc to 5.75Vdc.

Frequency Error vs. Temperature

Temp. (°C)	n5			
	Channel Bandwidth: 20MHz			
	Low Channel		High Channel	
	Frequency (MHz)	Frequency Error (ppm)	Frequency (MHz)	Frequency Error (ppm)
-30	834.000002	0.002	839.000002	0.002
-20	834.000003	0.003	839.000002	0.002
-10	834.000001	0.001	839.000004	0.004
0	834.000004	0.004	839.000002	0.002
10	834.000003	0.004	839.000003	0.003
20	833.999999	-0.002	838.999997	-0.004
30	833.999999	-0.001	838.999997	-0.004
40	833.999997	-0.003	838.999997	-0.004
50	833.999998	-0.002	838.999998	-0.003

4.4 Occupied Bandwidth Measurement

4.4.1 Test Procedure

The EUT makes a call to the communication simulator. All measurements were done at low, middle and high operational frequency range. The communication simulator station system controlled a EUT to export maximum output power under transmission mode and specific channel frequency. Use OBW measurement function of Spectrum analyzer to measure 99 % occupied bandwidth.

4.4.2 Test Setup

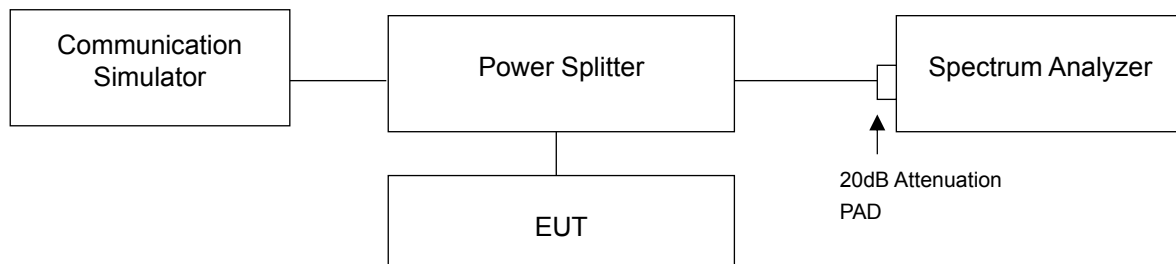

4.4.3 Test Result

Occupied Bandwidth

n5

n5, Channel Bandwidth 5MHz				
Channel	Frequency (MHz)	99% Occupied Bandwidth (MHz)		
		QPSK	16QAM	64QAM
165300	826.5	4.4853	4.4844	4.4865
167300	836.5	4.4876	4.4882	4.4898
169300	846.5	4.4845	4.4865	4.4850
n5, Channel Bandwidth 10MHz				
Channel	Frequency (MHz)	99% Occupied Bandwidth (MHz)		
		QPSK	16QAM	64QAM
165800	829.0	8.9445	8.9497	8.9449
167300	836.5	8.9541	8.9588	8.9485
168800	844.0	8.9406	8.9377	8.9391
n5, Channel Bandwidth 15MHz				
Channel	Frequency (MHz)	99% Occupied Bandwidth (MHz)		
		QPSK	16QAM	64QAM
166300	831.5	13.453	13.433	13.432
167300	836.5	13.449	13.435	13.433
168300	841.5	13.451	13.442	13.441
n5, Channel Bandwidth 20MHz				
Channel	Frequency (MHz)	99% Occupied Bandwidth (MHz)		
		QPSK	16QAM	64QAM
166800	834.0	17.903	17.921	17.915
167300	836.5	17.900	17.918	17.922
167800	839.0	17.923	17.951	17.942

Spectrum Plot of Worst Value

5MHz / 64QAM

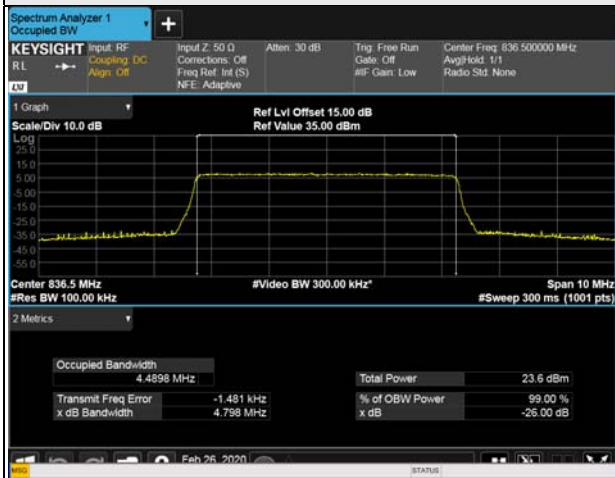

10MHz / 16QAM

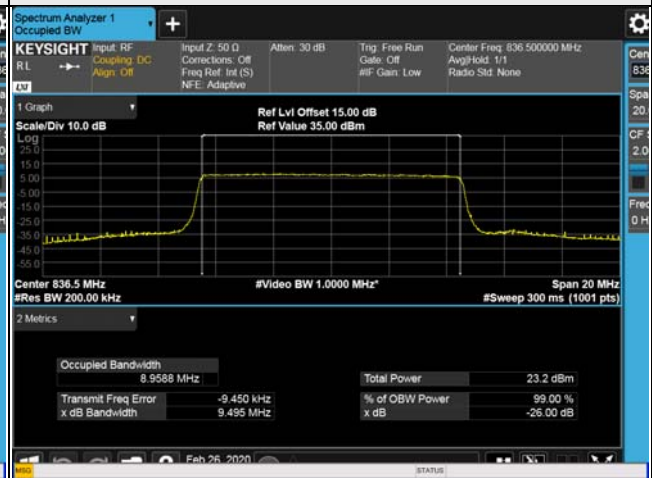

15MHz / QPSK



20MHz / 16QAM

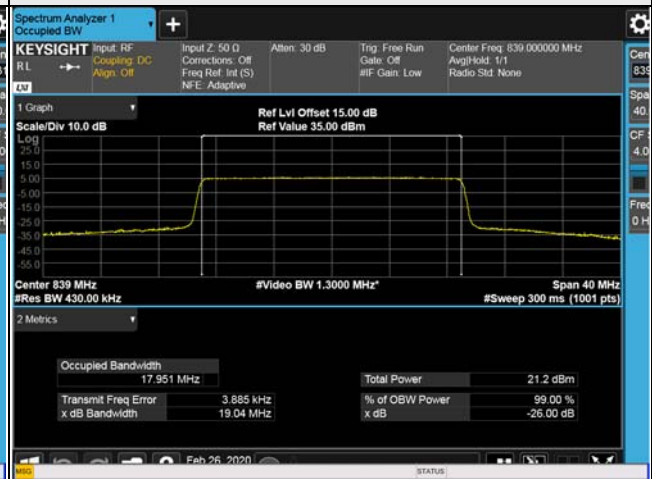

26dB Bandwidth

n5

n5, Channel Bandwidth 5MHz				
Channel	Frequency (MHz)	26dB Bandwidth (MHz)		
		QPSK	16QAM	64QAM
165300	826.5	4.776	4.797	4.803
167300	836.5	4.791	4.791	4.798
169300	846.5	4.792	4.785	4.803
n5, Channel Bandwidth 10MHz				
Channel	Frequency (MHz)	26dB Bandwidth (MHz)		
		QPSK	16QAM	64QAM
165800	829.0	9.477	9.511	9.499
167300	836.5	9.504	9.495	9.502
168800	844.0	9.493	9.493	9.496
n5, Channel Bandwidth 15MHz				
Channel	Frequency (MHz)	26dB Bandwidth (MHz)		
		QPSK	16QAM	64QAM
166300	831.5	14.25	14.24	14.23
167300	836.5	14.24	14.25	14.24
168300	841.5	14.27	14.25	14.26
n5, Channel Bandwidth 20MHz				
Channel	Frequency (MHz)	26dB Bandwidth (MHz)		
		QPSK	16QAM	64QAM
166800	834.0	19.01	19.02	19.00
167300	836.5	19.01	19.00	19.03
167800	839.0	19.03	19.04	19.04

Spectrum Plot of Worst Value

5MHz / 64QAM



10MHz / 16QAM



15MHz / QPSK



20MHz / 64QAM

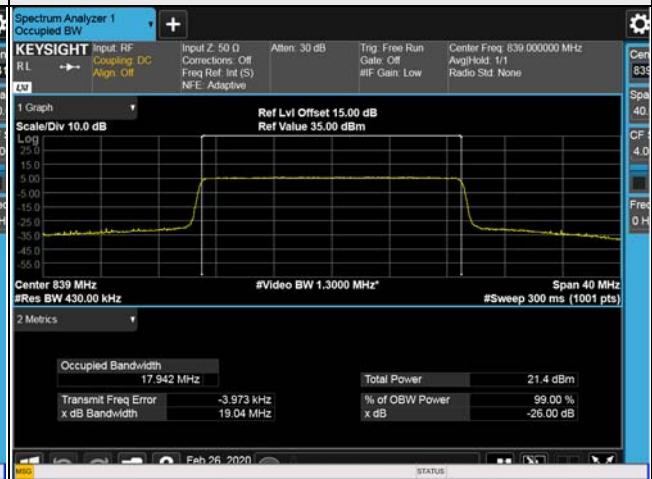

4.5 Band Edge Measurement

4.5.1 Limits of Band Edge Measurement

Power of any emission outside of the authorized operating frequency ranges must be attenuated below the transmitting power (P) by a factor of at least $43 + 10 \log(P)$ dB. In the 1 MHz bands immediately outside and adjacent to the frequency block a resolution bandwidth of at least one percent of the emission bandwidth of the fundamental emission of the transmitter may be employed.

4.5.2 Test Setup

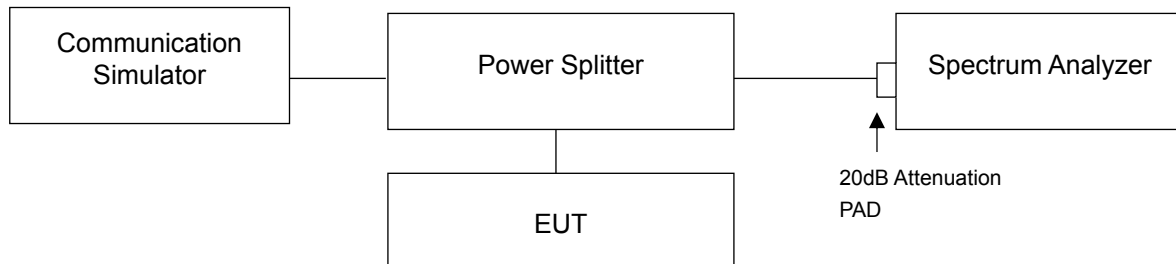

4.5.3 Test Procedures

- All measurements were done at low and high operational frequency range.
- The center frequency of spectrum is the band edge frequency and span is 1MHz. RB of the spectrum is 51kHz and VB of the spectrum is 160kHz (Channel Bandwidth 5MHz).
- The center frequency of spectrum is the band edge frequency and span is 1MHz. RB of the spectrum is 100kHz and VB of the spectrum is 300kHz (Channel Bandwidth 10MHz).
- The center frequency of spectrum is the band edge frequency and span is 1MHz. RB of the spectrum is 150kHz and VB of the spectrum is 470kHz (Channel Bandwidth 15MHz).
- The center frequency of spectrum is the band edge frequency and span is 1MHz. RB of the spectrum is 200kHz and VB of the spectrum is 1MHz (Channel Bandwidth 20MHz).
- Record the max trace plot into the test report.

4.5.4 Test Results

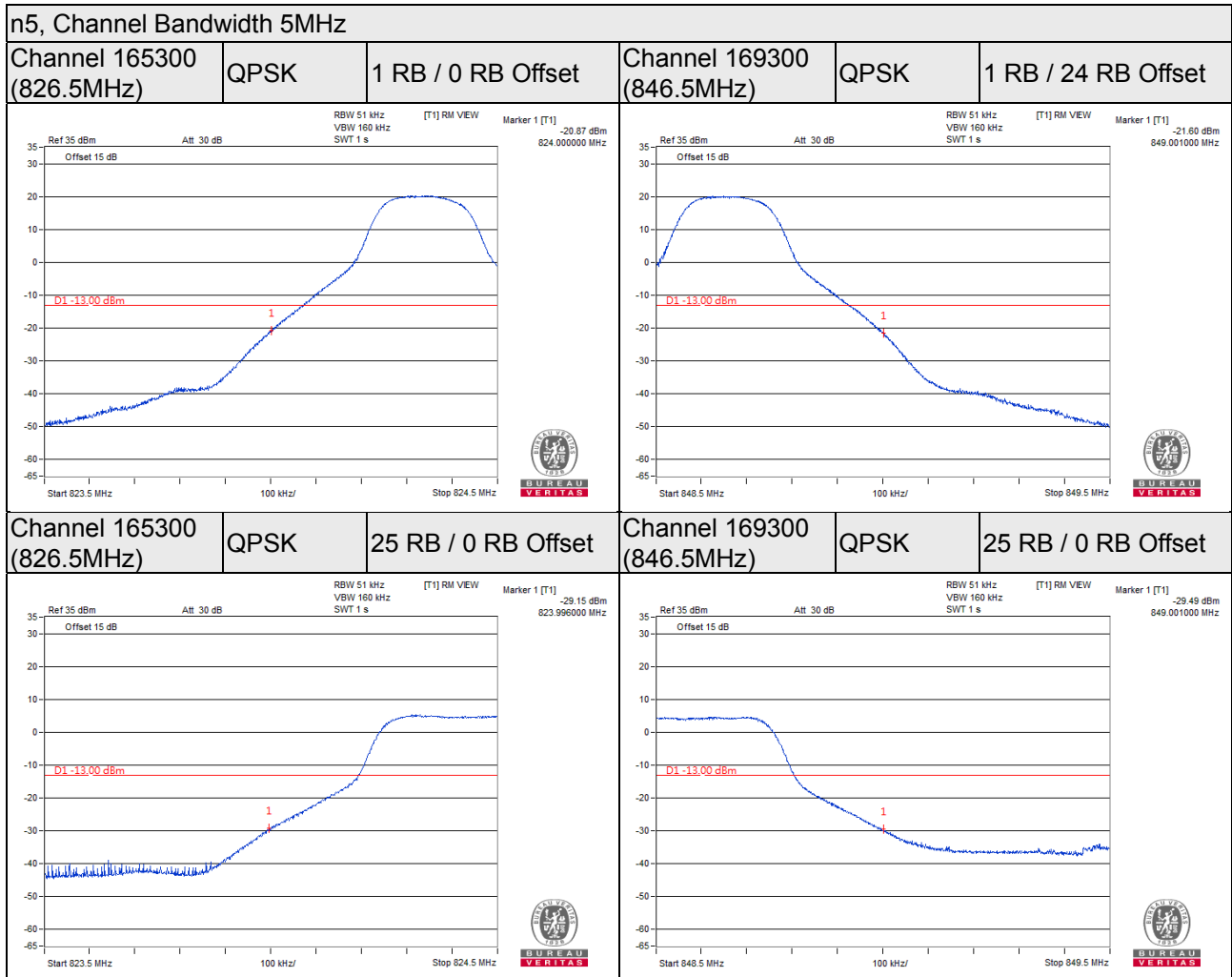

n5, Channel Bandwidth 10MHz

Channel 165800
(829.0MHz)

QPSK

1 RB / 0 RB Offset

Channel 168800
(844.0MHz)

QPSK

1 RB / 51 RB Offset

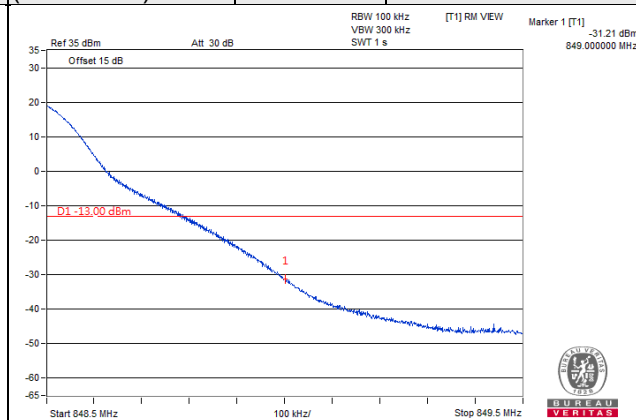
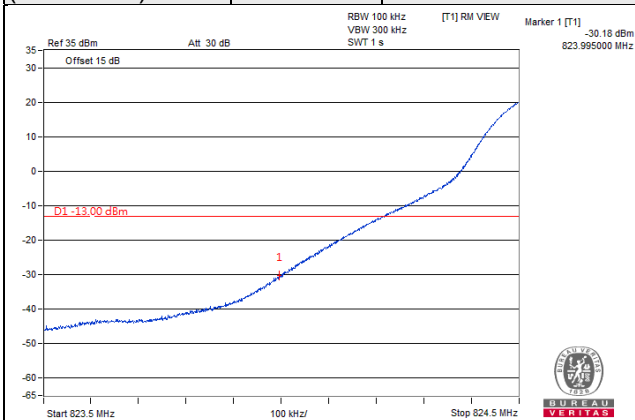

Channel 165800
(829.0MHz)

QPSK

52 RB / 0 RB Offset

Channel 168800
(844.0MHz)

QPSK

52 RB / 0 RB Offset

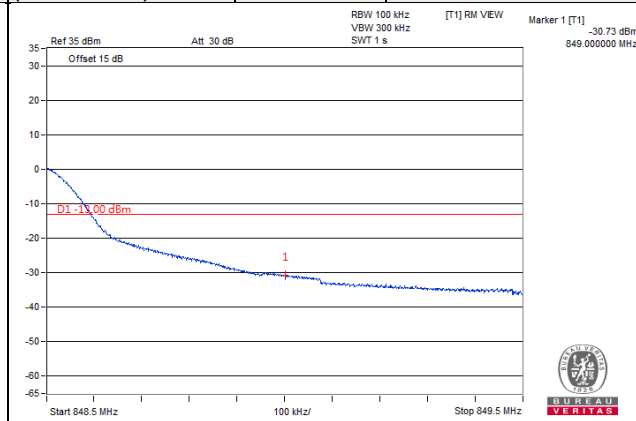
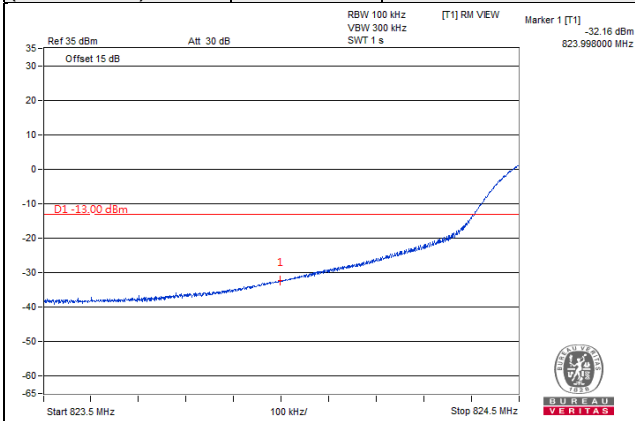

n5, Channel Bandwidth 15MHz

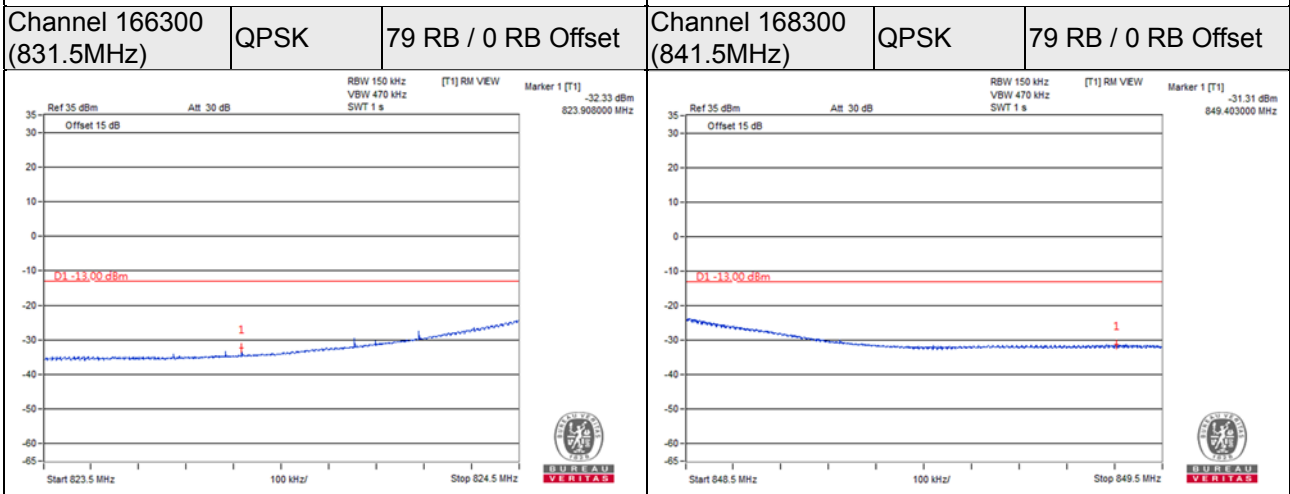
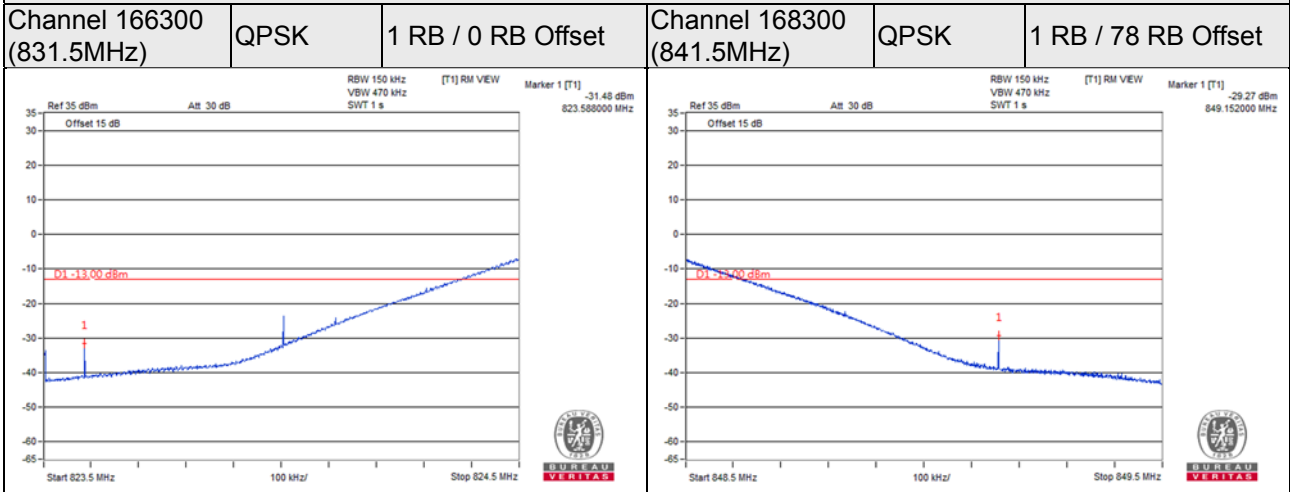

n5, Channel Bandwidth 20MHz

Channel 166800 (834.0MHz)	QPSK	1 RB / 0 RB Offset	Channel 167800 (839.0MHz)	QPSK	1 RB / 105 RB Offset
------------------------------	------	--------------------	------------------------------	------	----------------------

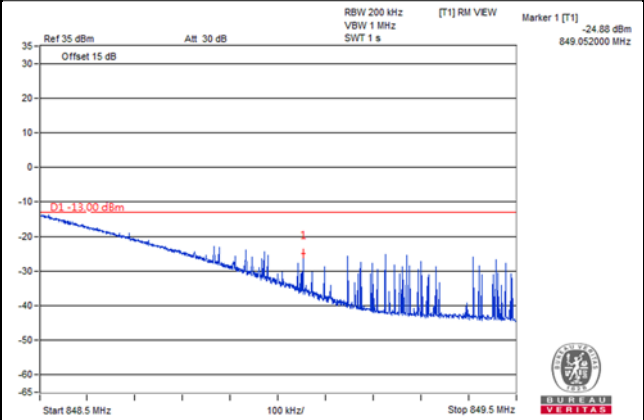
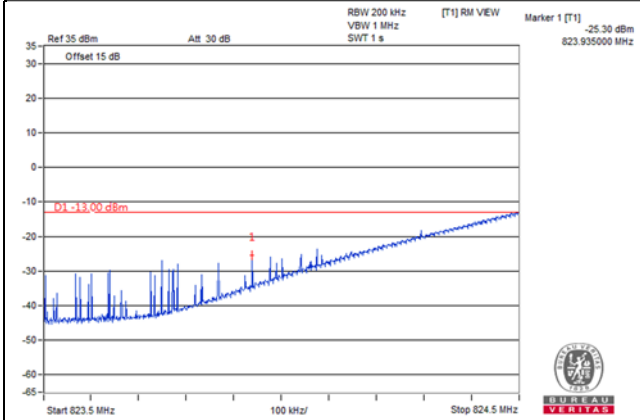

Channel 166800 (834.0MHz)	QPSK	106 RB / 0 RB Offset	Channel 167800 (839.0MHz)	QPSK	106 RB / 0 RB Offset
------------------------------	------	----------------------	------------------------------	------	----------------------

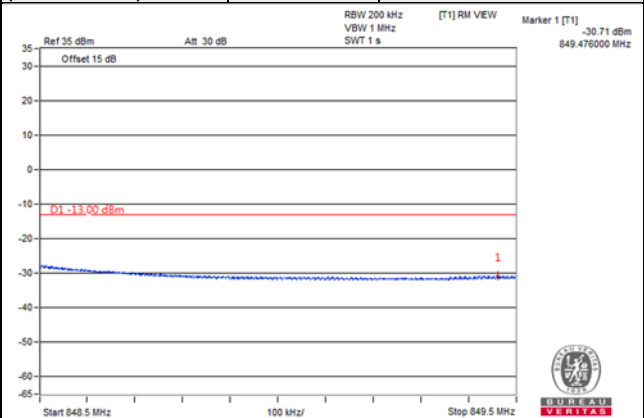
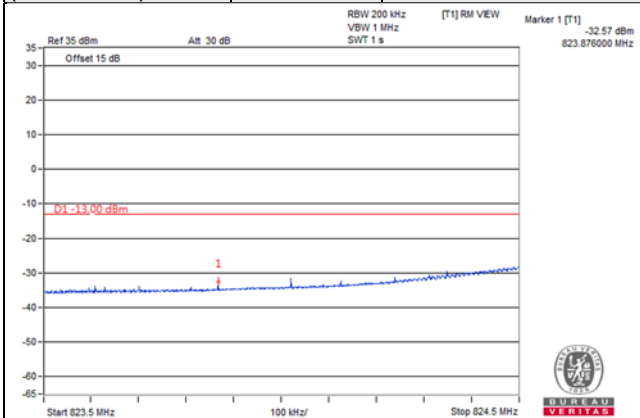

4.6 Peak to Average Ratio

4.6.1 Limits of Peak to Average Ratio Measurement

In measuring transmissions in this band using an average power technique, the peak to-average ratio (PAR) of the transmission may not exceed 13 dB

4.6.2 Test Setup

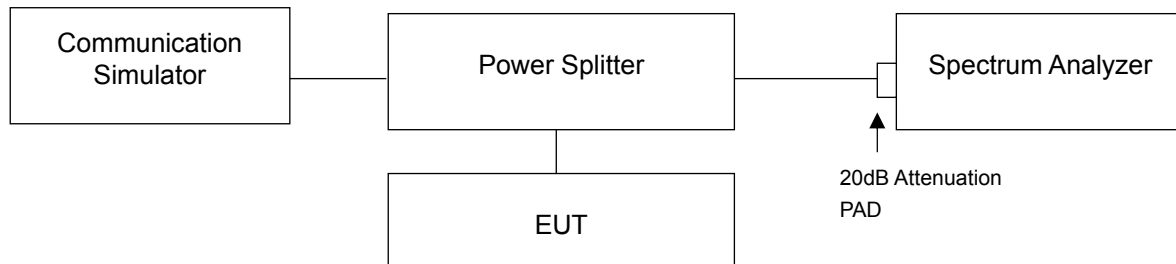

4.6.3 Test Procedures

- Set resolution/measurement bandwidth \geq signal's occupied bandwidth;
- Set the number of counts to a value that stabilizes the measured CCDF curve;
- Record the maximum PAPR level associated with a probability of 0.1%.

4.6.4 Test Results

n5

n5, Channel Bandwidth 5MHz				
Channel	Frequency (MHz)	Peak To Average Ratio (dB)		
		QPSK	16QAM	64QAM
165300	826.5	3.59	5.35	5.40
167300	836.5	3.62	5.39	5.50
169300	846.5	3.53	5.22	5.30
n5, Channel Bandwidth 10MHz				
Channel	Frequency (MHz)	Peak To Average Ratio (dB)		
		QPSK	16QAM	64QAM
165800	829.0	3.50	5.15	5.33
167300	836.5	3.76	5.37	5.60
168800	844.0	3.45	4.97	5.17
n5, Channel Bandwidth 15MHz				
Channel	Frequency (MHz)	Peak To Average Ratio (dB)		
		QPSK	16QAM	64QAM
166300	831.5	3.61	4.93	5.06
167300	836.5	3.46	5.24	5.32
168300	841.5	3.30	3.96	4.07
n5, Channel Bandwidth 20MHz				
Channel	Frequency (MHz)	Peak To Average Ratio (dB)		
		QPSK	16QAM	64QAM
166800	834.0	3.64	5.01	5.20
167300	836.5	3.36	5.13	5.22
167800	839.0	3.30	4.03	4.04

Spectrum Plot of Worst Value

5MHz / 64QAM

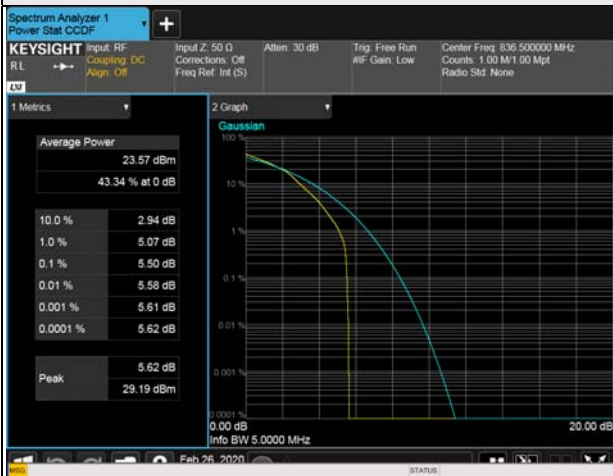

10MHz / 64QAM



15MHz / 64QAM

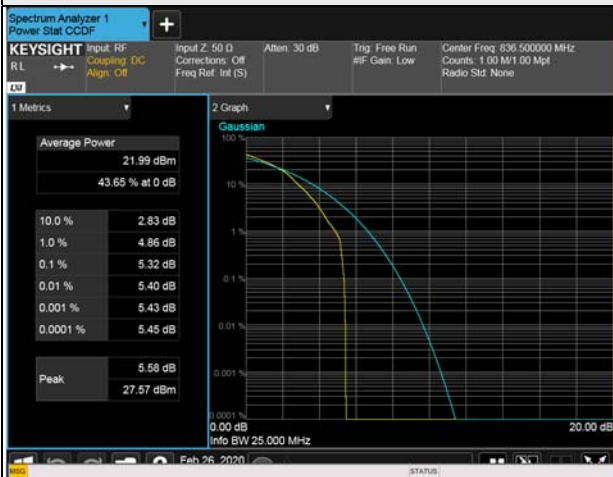

20MHz / 64QAM



4.7 Conducted Spurious Emissions

4.7.1 Limits of Conducted Spurious Emissions Measurement

The power of any emission outside of the authorized operating frequency ranges must be attenuated below the transmitting power (P) by a factor of at least $43 + 10 \log(P)$ dB. The emission limit equal to -13dBm .

4.7.2 Test Setup

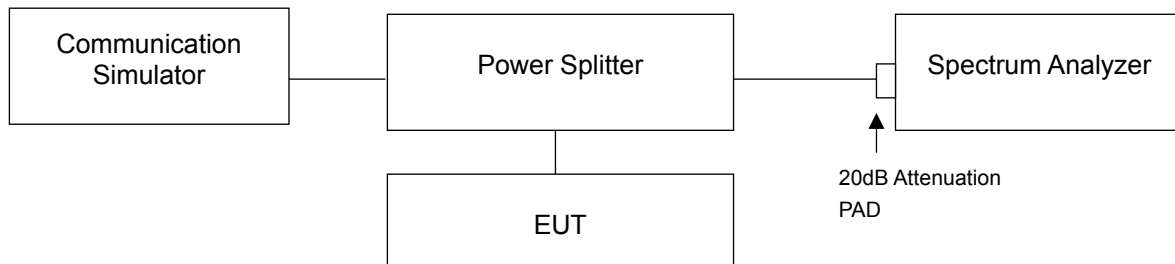

4.7.3 Test Procedure

- The EUT makes a phone call to the communication simulator. All measurements were done at low, middle and high operational frequency range.
- Measuring frequency range is from 9kHz to 9GHz. 20dB attenuation pad is connected with spectrum. RBW=1MHz and VBW=3MHz is used for conducted emission measurement.

4.7.4 Test Results

n5, Channel Bandwidth 5MHz

Channel 165300 (826.5MHz)

Frequency Range : 9kHz~1GHz

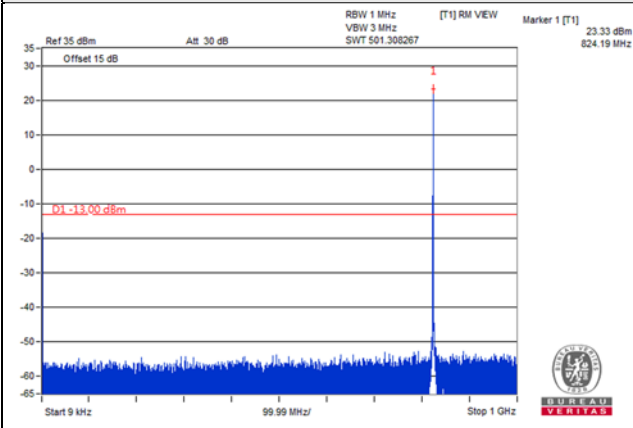

Frequency Range : 1GHz~9GHz

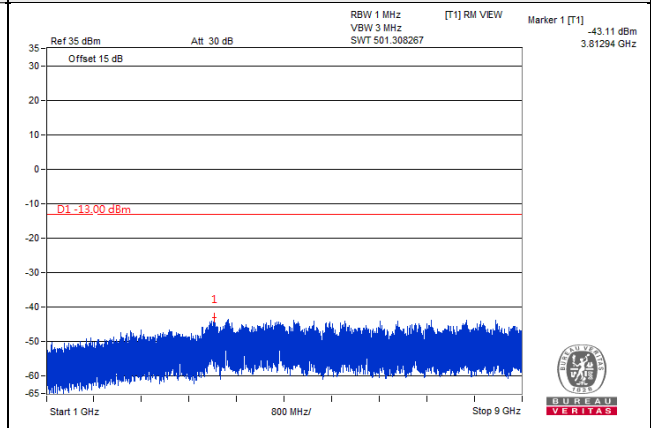

Channel 167300 (836.5MHz)

Frequency Range : 9kHz~1GHz

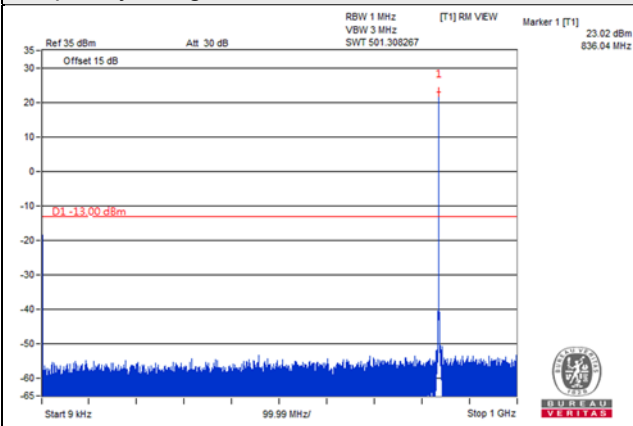

Frequency Range : 1GHz~9GHz

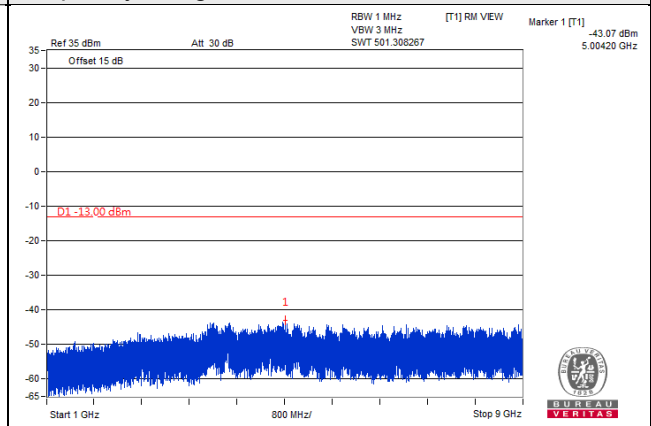

Channel 169300 (846.5MHz)

Frequency Range : 9kHz~1GHz

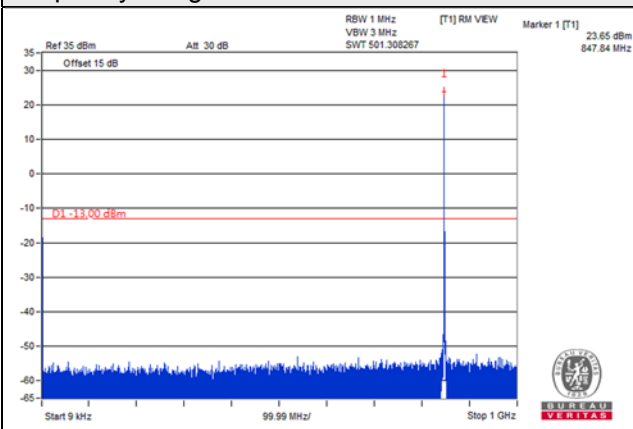

Frequency Range : 1GHz~9GHz

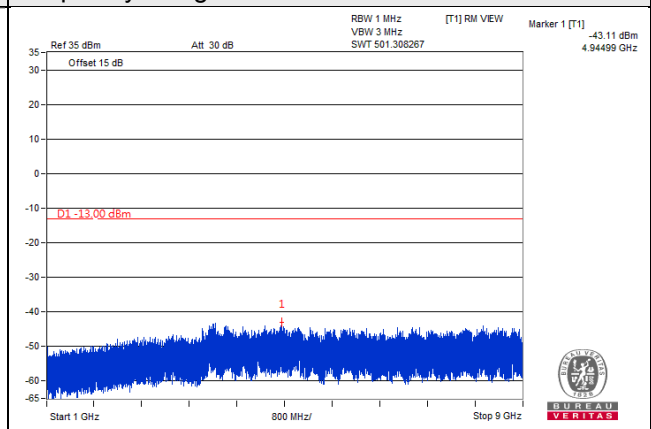

*The 9kHz signal over the limit is from Spectrum.

n5, Channel Bandwidth 10MHz

Channel 165800 (829.0MHz)

Frequency Range : 9kHz~1GHz

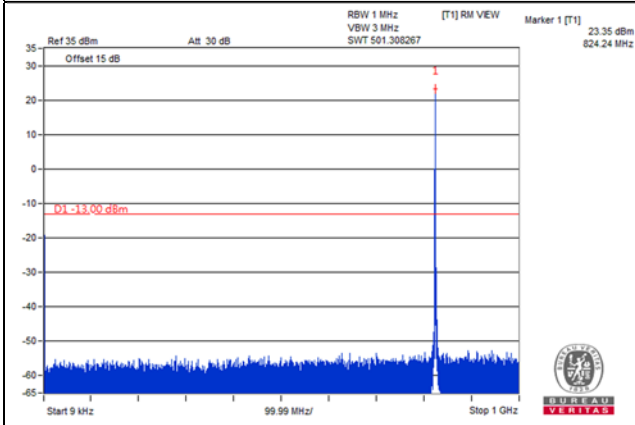

Frequency Range : 1GHz~9GHz

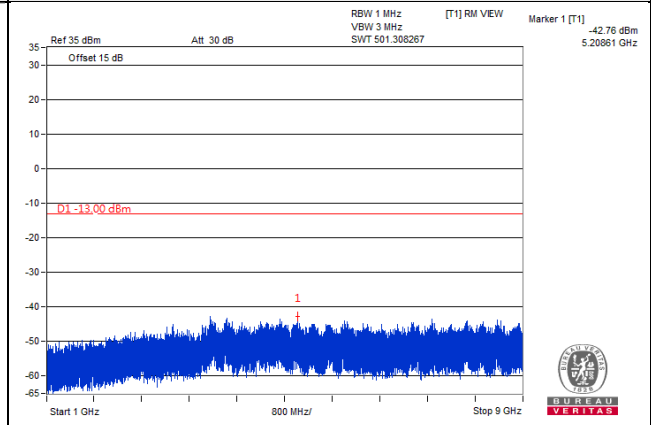

Channel 167300 (836.5MHz)

Frequency Range : 9kHz~1GHz

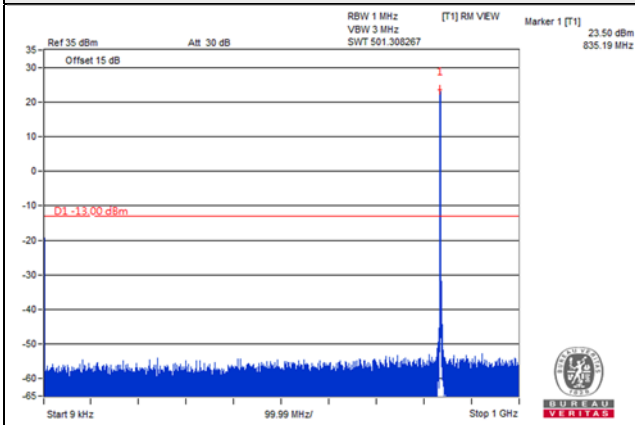

Frequency Range : 1GHz~9GHz

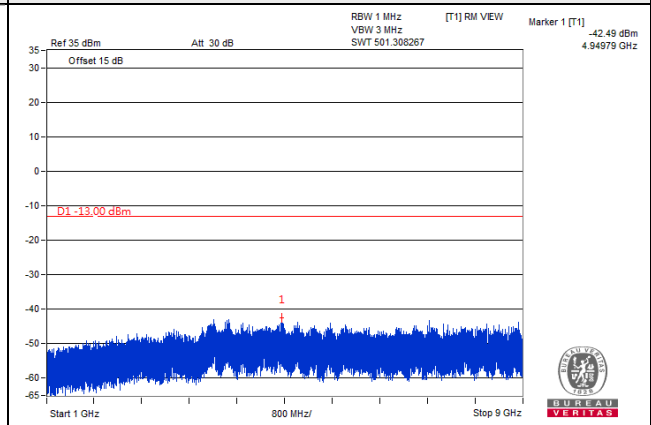

Channel 168800 (844.0MHz)

Frequency Range : 9kHz~1GHz

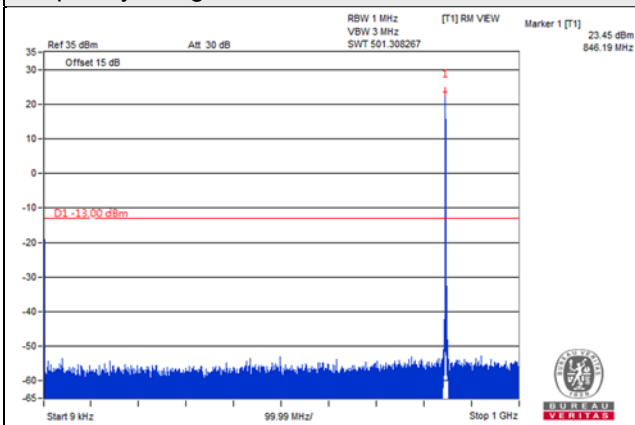

Frequency Range : 1GHz~9GHz

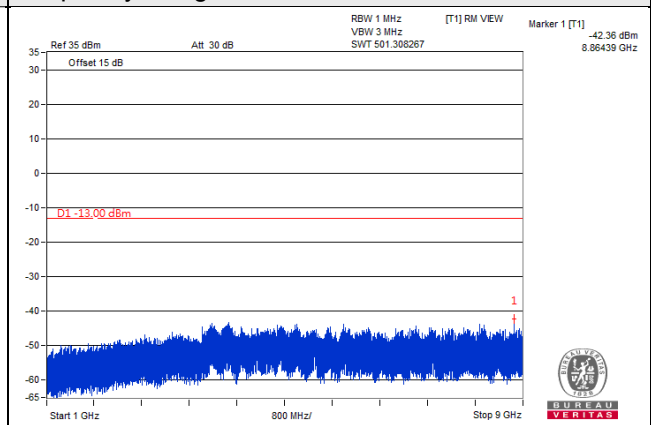

*The 9kHz signal over the limit is from Spectrum.

n5, Channel Bandwidth 15MHz

Channel 166300 (831.5MHz)

Frequency Range : 9kHz~1GHz

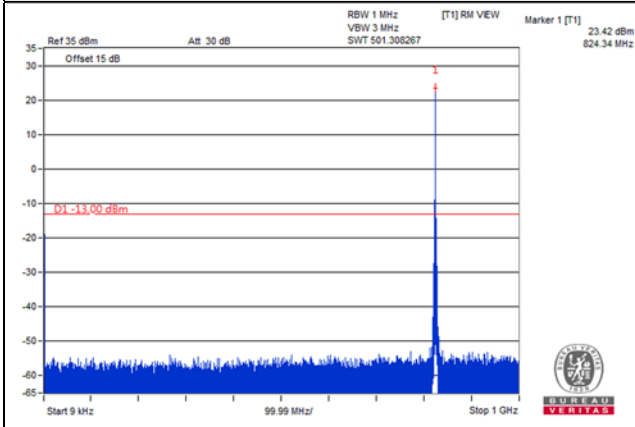

Frequency Range : 1GHz~9GHz

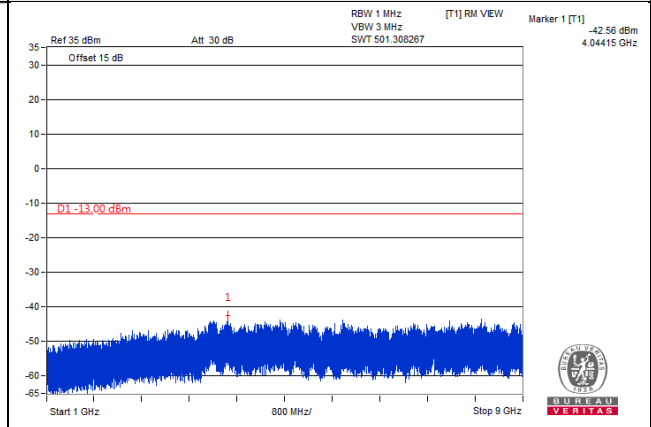

Channel 167300 (836.5MHz)

Frequency Range : 9kHz~1GHz

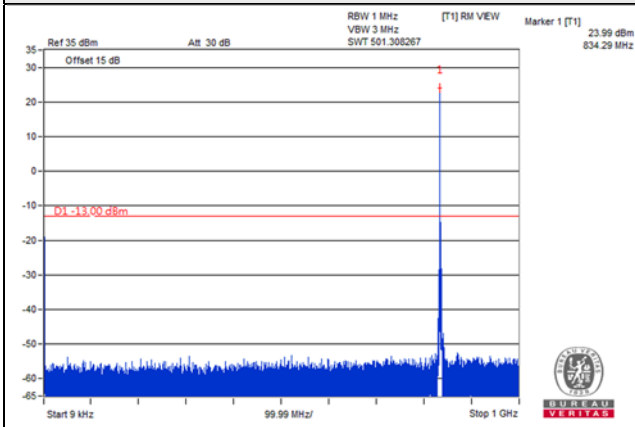

Frequency Range : 1GHz~9GHz

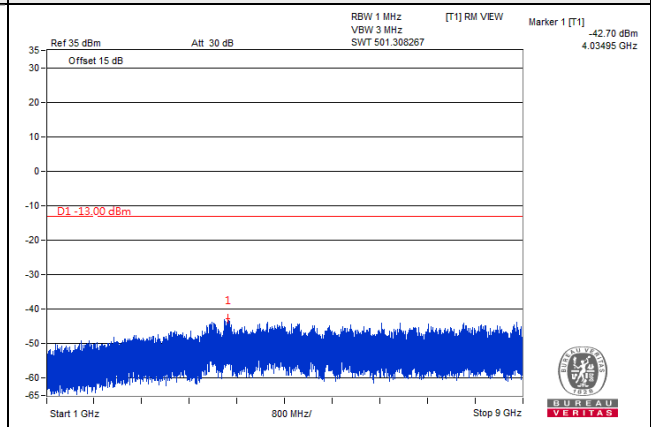

Channel 168300 (841.5MHz)

Frequency Range : 9kHz~1GHz

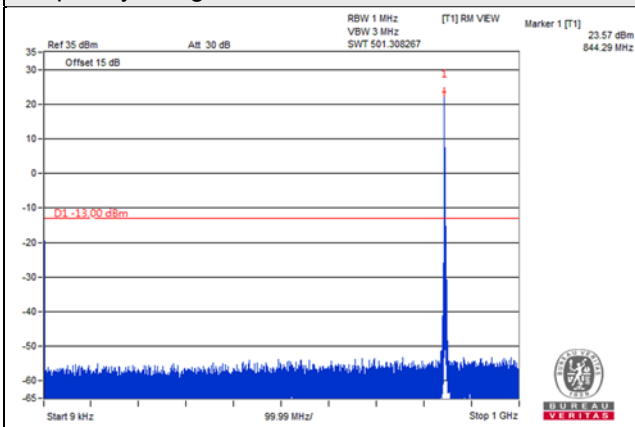

Frequency Range : 1GHz~9GHz

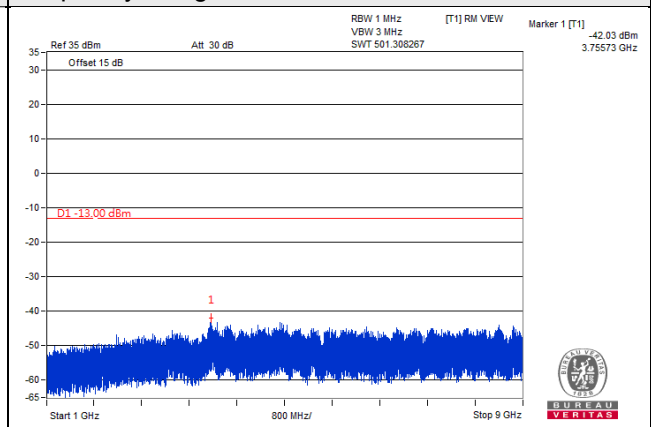

*The 9kHz signal over the limit is from Spectrum.

n5, Channel Bandwidth 20MHz

Channel 166800 (834.0MHz)

Frequency Range : 9kHz~1GHz

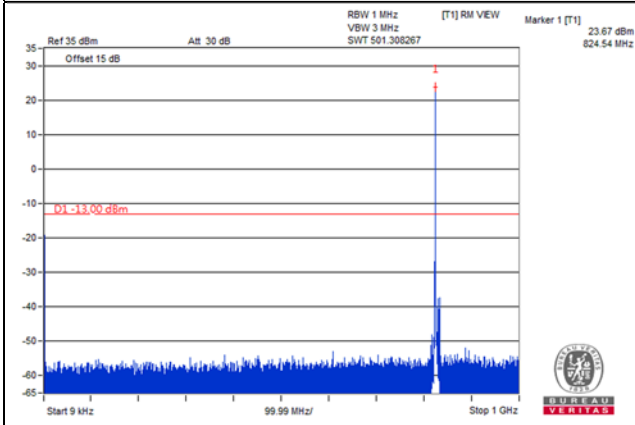

Frequency Range : 1GHz~9GHz

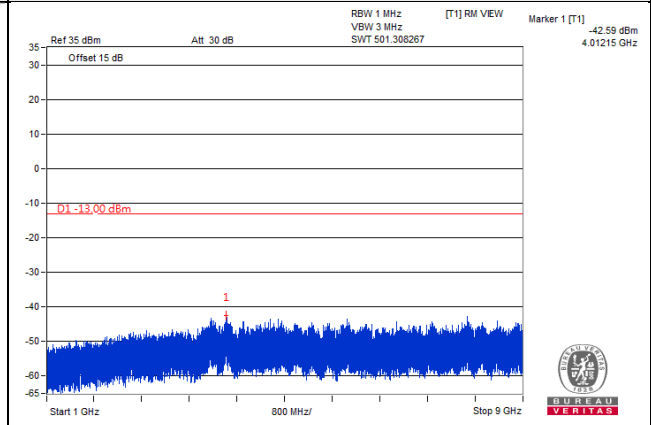

Channel 167300 (836.5MHz)

Frequency Range : 9kHz~1GHz

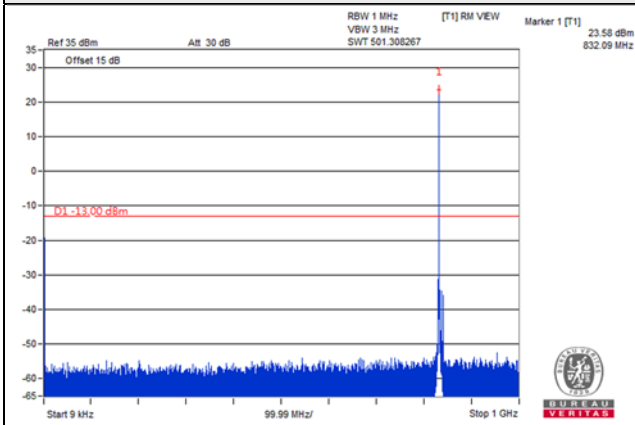

Frequency Range : 1GHz~9GHz

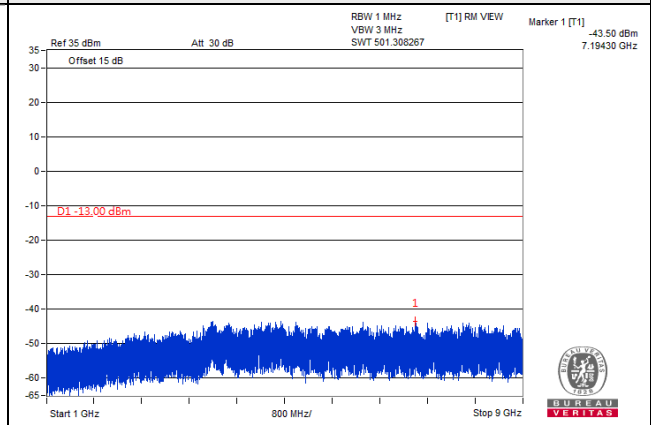

Channel 167800 (839.0MHz)

Frequency Range : 9kHz~1GHz

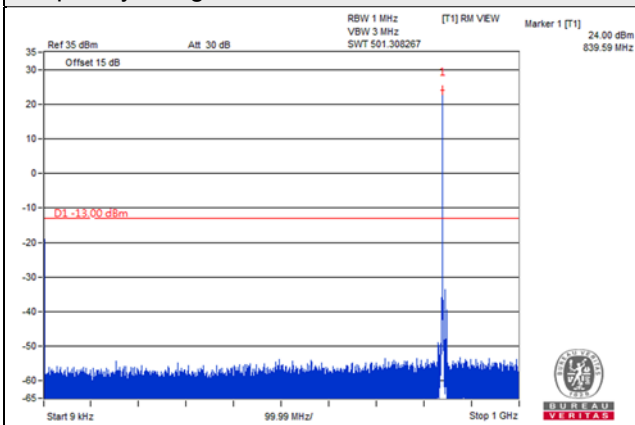

Frequency Range : 1GHz~9GHz

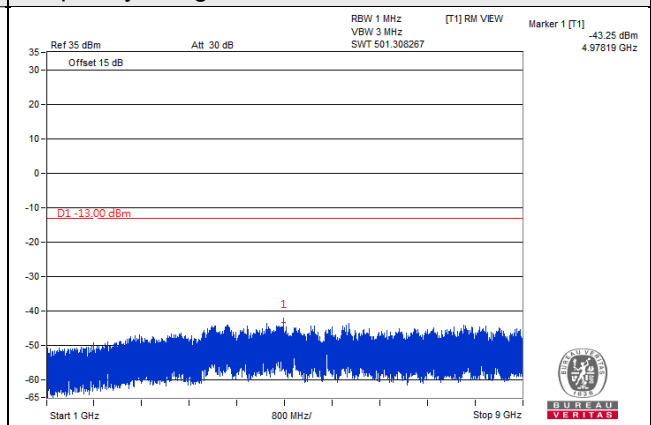

*The 9kHz signal over the limit is from Spectrum.

4.8 Radiated Emission Measurement

4.8.1 Limits of Radiated Emission Measurement

The power of any emission outside of the authorized operating frequency ranges must be attenuated below the transmitting power (P) by a factor of at least $43 + 10 \log(P)$ dB. The emission limit equal to -13dBm .

4.8.2 Test Procedure

- a. Substitution method is used for E.I.R.P measurement. In the semi-anechoic chamber, EUT placed on the 0.8m (below or equal 1 GHz) and/or 1.5 m (above 1 GHz) height of Turn Table, rotated the table around 360 degrees to search the maximum radiation power and receiver antenna shall be rotated vertical and horizontal polarization and moved height from 1m to 4m to find the maximum polar radiated power. The "Read Value" is the spectrum reading the maximum power value.
- b. The substitution horn antenna is substituted for EUT at the same position and signals generator export the CW signal to the substitution antenna via a TX cable. Rotated the Turn Table and moved receiving antenna to find the maximum radiation power. Adjust output power level of S.G to get a Value of spectrum reading equal to "Read Value" of step a. Record the power level of S.G
- c. $\text{EIRP} = \text{Output power level of S.G} - \text{TX cable loss} + \text{Antenna gain of substitution horn.}$
- d. E.R.P power can be calculated form E.I.R.P power by subtracting the gain of dipole, $\text{E.R.P power} = \text{E.I.R.P power} - 2.15\text{dBi.}$

NOTE: The resolution bandwidth and video bandwidth of test receiver/spectrum analyzer is 1MHz/3MHz.

4.8.3 Deviation from Test Standard

No deviation.

4.8.4 Test Setup

For radiated emission 30MHz to 1GHz

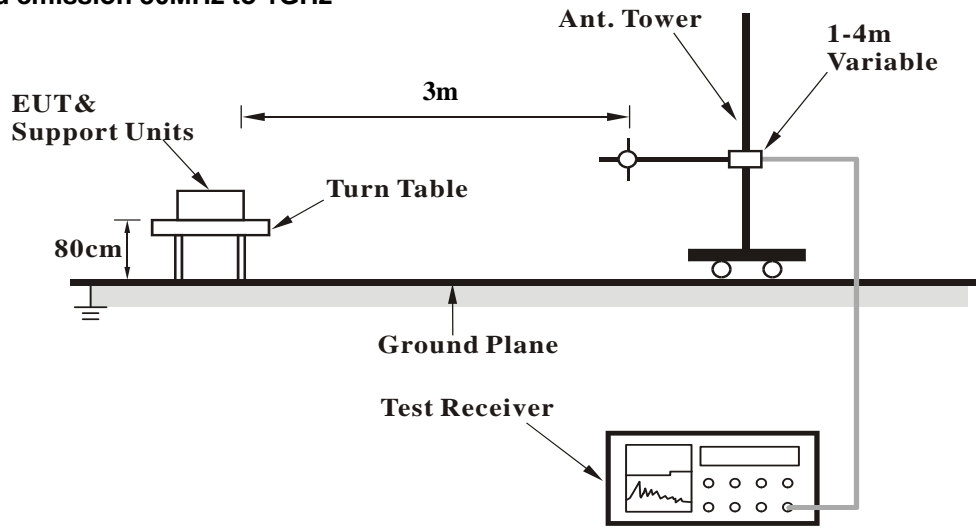

For radiated emission above 1GHz

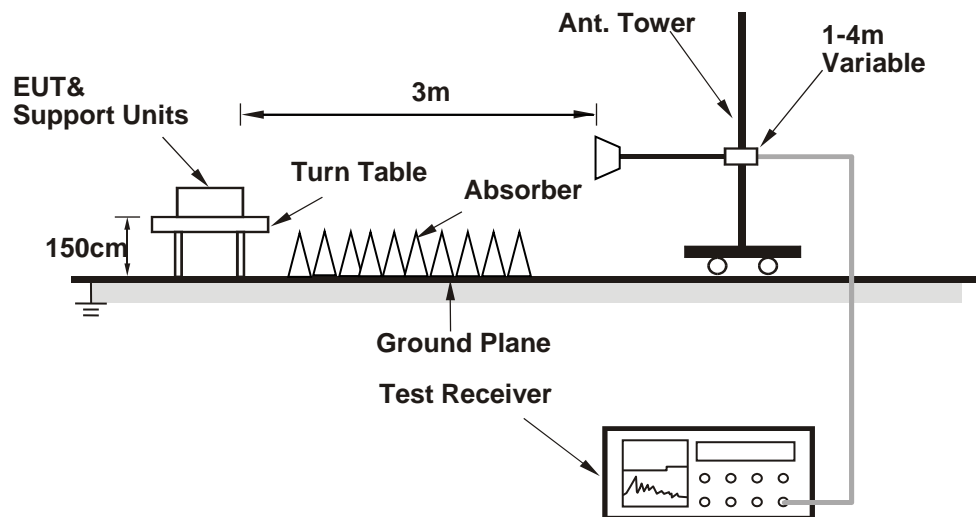

For the actual test configuration, please refer to the attached file (Test Setup Photo).

4.8.5 Test Results

Below 1GHz

n5, Channel Bandwidth: 5MHz

Mode	TX channel 165300 (826.5MHz)	Frequency Range	Below 1000 MHz
Environmental Conditions	22deg. C, 68%RH	Input Power	120Vac, 60Hz
Tested By	Greg Lin		

Antenna Polarity & Test Distance: Horizontal at 3 M							
No.	Freq. (MHz)	Reading (dBm)	S.G Power Value (dBm)	Correction Factor (dB)	ERP (dBm)	Limit (dBm)	Margin (dB)
1	30.00	-31.1	-9.8	-19.4	-29.2	-13.0	-16.2
2	132.82	-46.9	-51.8	-3.3	-55.1	-13.0	-42.1
3	258.92	-44.4	-50.0	-1.5	-51.5	-13.0	-38.5
4	469.41	-62.4	-68.2	3.5	-64.7	-13.0	-51.7
5	726.46	-61.0	-63.2	3.7	-59.5	-13.0	-46.5
6	927.25	-61.5	-59.2	3.7	-55.5	-13.0	-42.5

Remarks:

- ERP (dBm) = S.G Value (dBm) + Correction Factor (dB).
- Correction Factor (dB) = Substitution Antenna Gain (dB) + Cable Loss (dB).

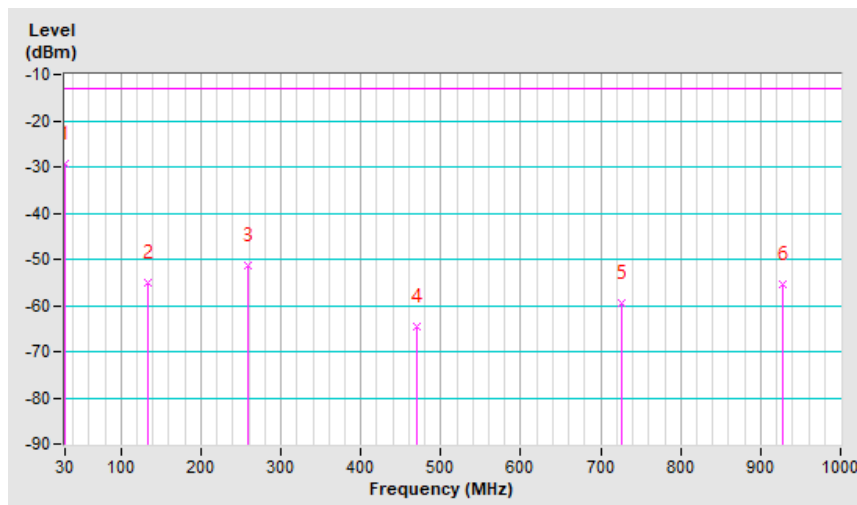

Mode	TX channel 165300 (826.5MHz)	Frequency Range	Below 1000 MHz
Environmental Conditions	22deg. C, 66%RH	Input Power	120Vac, 60Hz
Tested By	Greg Lin		

Antenna Polarity & Test Distance: Vertical at 3 M							
No.	Freq. (MHz)	Reading (dBm)	S.G Power Value (dBm)	Correction Factor (dB)	ERP (dBm)	Limit (dBm)	Margin (dB)
1	69.77	-45.8	-53.8	-0.6	-54.4	-13.0	-41.4
2	147.37	-59.1	-60.5	-2.9	-63.4	-13.0	-50.4
3	277.35	-60.4	-57.6	-1.6	-59.2	-13.0	-46.2
4	646.92	-60.4	-60.6	3.7	-56.9	-13.0	-43.9
5	762.35	-60.5	-59.3	3.8	-55.5	-13.0	-42.5
6	983.51	-61.2	-57.5	3.5	-54.0	-13.0	-41.0

Remarks:

1. ERP (dBm) = S.G Value (dBm) + Correction Factor (dB).
2. Correction Factor (dB) = Substitution Antenna Gain (dB) + Cable Loss (dB).

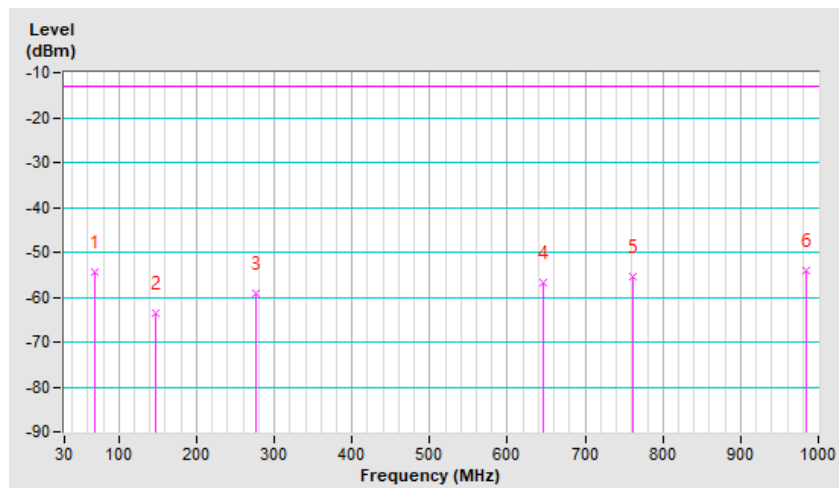

n5, Channel Bandwidth: 20MHz

Mode	TX channel 166800 (834.0MHz)	Frequency Range	Below 1000 MHz
Environmental Conditions	22deg. C, 68%RH	Input Power	120Vac, 60Hz
Tested By	Greg Lin		

Antenna Polarity & Test Distance: Horizontal at 3 M							
No.	Freq. (MHz)	Reading (dBm)	S.G Power Value (dBm)	Correction Factor (dB)	ERP (dBm)	Limit (dBm)	Margin (dB)
1	39.70	-44.1	-30.3	-13.7	-44.0	-13.0	-31.0
2	190.05	-44.6	-52.4	-2.8	-55.2	-13.0	-42.2
3	286.08	-50.8	-55.0	-1.7	-56.7	-13.0	-43.7
4	583.87	-61.6	-66.4	3.8	-62.6	-13.0	-49.6
5	821.52	-60.9	-60.4	3.9	-56.5	-13.0	-43.5
6	989.33	-60.1	-56.9	3.4	-53.5	-13.0	-40.5

Remarks:

- ERP (dBm) = S.G Value (dBm) + Correction Factor (dB).
- Correction Factor (dB) = Substitution Antenna Gain (dB) + Cable Loss (dB).

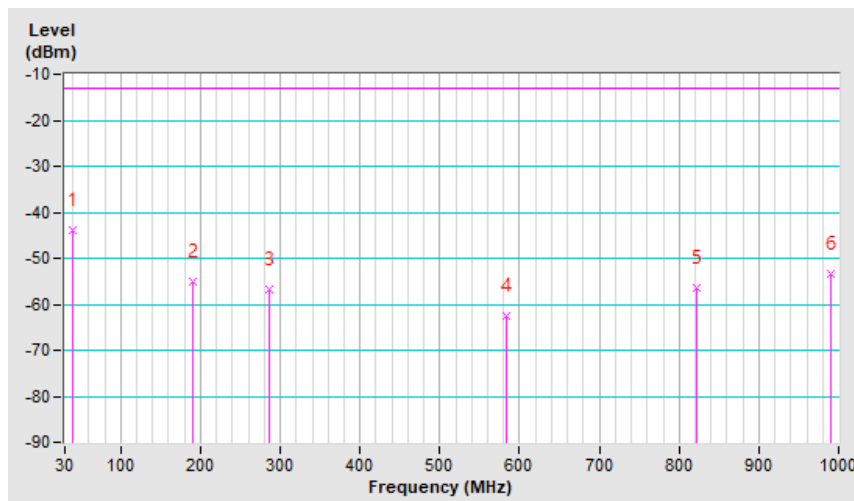

Mode	TX channel 166800 (834.0MHz)	Frequency Range	Below 1000 MHz
Environmental Conditions	22deg. C, 66%RH	Input Power	120Vac, 60Hz
Tested By	Greg Lin		

Antenna Polarity & Test Distance: Vertical at 3 M							
No.	Freq. (MHz)	Reading (dBm)	S.G Power Value (dBm)	Correction Factor (dB)	ERP (dBm)	Limit (dBm)	Margin (dB)
1	30.00	-48.5	-41.1	-19.4	-60.5	-13.0	-47.5
2	88.20	-39.0	-47.3	-0.2	-47.5	-13.0	-34.5
3	259.89	-54.5	-54.3	-1.5	-55.8	-13.0	-42.8
4	608.12	-61.4	-62.9	3.6	-59.3	-13.0	-46.3
5	728.40	-60.0	-59.4	3.6	-55.8	-13.0	-42.8
6	909.79	-58.6	-55.9	3.5	-52.4	-13.0	-39.4

Remarks:

1. ERP (dBm) = S.G Value (dBm) + Correction Factor (dB).
2. Correction Factor (dB) = Substitution Antenna Gain (dB) + Cable Loss (dB).

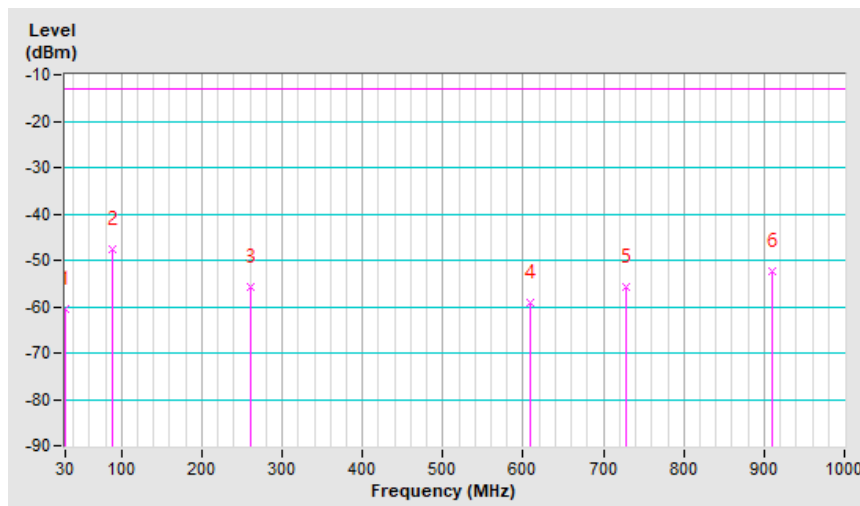

Above 1GHz
n5, Channel Bandwidth: 5MHz

Mode	TX channel 165300 (826.5MHz)	Frequency Range	1GHz ~ 10GHz
Environmental Conditions	22deg. C, 68%RH	Input Power	120Vac, 60Hz
Tested By	Greg Lin		

Antenna Polarity & Test Distance: Horizontal at 3 M							
No.	Freq. (MHz)	Reading (dBm)	S.G Power Value (dBm)	Correction Factor (dB)	ERP (dBm)	Limit (dBm)	Margin (dB)
1	1653.00	-63.2	-55.5	0.9	-54.6	-13.0	-41.6
Antenna Polarity & Test Distance: Vertical at 3 M							
No.	Freq. (MHz)	Reading (dBm)	S.G Power Value (dBm)	Correction Factor (dB)	ERP (dBm)	Limit (dBm)	Margin (dB)
1	1653.00	-59.5	-52.3	0.9	-51.4	-13.0	-38.4

Remarks:

1. ERP (dBm) = S.G Value (dBm) + Correction Factor (dB).
2. Correction Factor (dB) = Substitution Antenna Gain (dB) + Cable Loss (dB).

Mode	TX channel 167300 (836.5MHz)	Frequency Range	1GHz ~ 10GHz
Environmental Conditions	22deg. C, 68%RH	Input Power	120Vac, 60Hz
Tested By	Greg Lin		

Antenna Polarity & Test Distance: Horizontal at 3 M							
No.	Freq. (MHz)	Reading (dBm)	S.G Power Value (dBm)	Correction Factor (dB)	ERP (dBm)	Limit (dBm)	Margin (dB)
1	1673.00	-63.0	-55.4	0.8	-54.6	-13.0	-41.6
Antenna Polarity & Test Distance: Vertical at 3 M							
No.	Freq. (MHz)	Reading (dBm)	S.G Power Value (dBm)	Correction Factor (dB)	ERP (dBm)	Limit (dBm)	Margin (dB)
1	1673.00	-59.8	-52.4	0.8	-51.6	-13.0	-38.6

Remarks:

1. ERP (dBm) = S.G Value (dBm) + Correction Factor (dB).
2. Correction Factor (dB) = Substitution Antenna Gain (dB) + Cable Loss (dB).

Mode	TX channel 169300 (846.5MHz)	Frequency Range	1GHz ~ 10GHz
Environmental Conditions	22deg. C, 68%RH	Input Power	120Vac, 60Hz
Tested By	Greg Lin		

Antenna Polarity & Test Distance: Horizontal at 3 M							
No.	Freq. (MHz)	Reading (dBm)	S.G Power Value (dBm)	Correction Factor (dB)	ERP (dBm)	Limit (dBm)	Margin (dB)
1	1693.00	-63.1	-55.6	0.7	-54.9	-13.0	-41.9
Antenna Polarity & Test Distance: Vertical at 3 M							
No.	Freq. (MHz)	Reading (dBm)	S.G Power Value (dBm)	Correction Factor (dB)	ERP (dBm)	Limit (dBm)	Margin (dB)
1	1693.00	-59.9	-52.6	0.7	-51.9	-13.0	-38.9

Remarks:

1. ERP (dBm) = S.G Value (dBm) + Correction Factor (dB).
2. Correction Factor (dB) = Substitution Antenna Gain (dB) + Cable Loss (dB).

n5, Channel Bandwidth: 15MHz

Mode	TX channel 166300 (831.5MHz)	Frequency Range	1GHz ~ 10GHz
Environmental Conditions	22deg. C, 68%RH	Input Power	120Vac, 60Hz
Tested By	Greg Lin		

Antenna Polarity & Test Distance: Horizontal at 3 M

No.	Freq. (MHz)	Reading (dBm)	S.G Power Value (dBm)	Correction Factor (dB)	ERP (dBm)	Limit (dBm)	Margin (dB)
1	1663.00	-63.1	-55.5	0.9	-54.6	-13.0	-41.6

Antenna Polarity & Test Distance: Vertical at 3 M

No.	Freq. (MHz)	Reading (dBm)	S.G Power Value (dBm)	Correction Factor (dB)	ERP (dBm)	Limit (dBm)	Margin (dB)
1	1663.00	-60.2	-53.0	0.9	-52.1	-13.0	-39.1

Remarks:

1. ERP (dBm) = S.G Value (dBm) + Correction Factor (dB).
2. Correction Factor (dB) = Substitution Antenna Gain (dB) + Cable Loss (dB).

Mode	TX channel 167300 (836.5MHz)	Frequency Range	1GHz ~ 10GHz
Environmental Conditions	22deg. C, 68%RH	Input Power	120Vac, 60Hz
Tested By	Greg Lin		

Antenna Polarity & Test Distance: Horizontal at 3 M

No.	Freq. (MHz)	Reading (dBm)	S.G Power Value (dBm)	Correction Factor (dB)	ERP (dBm)	Limit (dBm)	Margin (dB)
1	1673.00	-62.8	-55.2	0.8	-54.4	-13.0	-41.4

Antenna Polarity & Test Distance: Vertical at 3 M

No.	Freq. (MHz)	Reading (dBm)	S.G Power Value (dBm)	Correction Factor (dB)	ERP (dBm)	Limit (dBm)	Margin (dB)
1	1673.00	-60.0	-52.7	0.8	-51.9	-13.0	-38.9

Remarks:

1. ERP (dBm) = S.G Value (dBm) + Correction Factor (dB).
2. Correction Factor (dB) = Substitution Antenna Gain (dB) + Cable Loss (dB).

Mode	TX channel 168300 (841.5MHz)	Frequency Range	1GHz ~ 10GHz
Environmental Conditions	22deg. C, 68%RH	Input Power	120Vac, 60Hz
Tested By	Greg Lin		

Antenna Polarity & Test Distance: Horizontal at 3 M							
No.	Freq. (MHz)	Reading (dBm)	S.G Power Value (dBm)	Correction Factor (dB)	ERP (dBm)	Limit (dBm)	Margin (dB)
1	1683.00	-63.0	-55.4	0.8	-54.6	-13.0	-41.6
Antenna Polarity & Test Distance: Vertical at 3 M							
No.	Freq. (MHz)	Reading (dBm)	S.G Power Value (dBm)	Correction Factor (dB)	ERP (dBm)	Limit (dBm)	Margin (dB)
1	1683.00	-59.8	-52.4	0.8	-51.6	-13.0	-38.6

Remarks:

1. ERP (dBm) = S.G Value (dBm) + Correction Factor (dB).
2. Correction Factor (dB) = Substitution Antenna Gain (dB) + Cable Loss (dB).

n5, Channel Bandwidth: 20MHz

Mode	TX channel 166800 (834.0MHz)	Frequency Range	1GHz ~ 10GHz
Environmental Conditions	22deg. C, 68%RH	Input Power	120Vac, 60Hz
Tested By	Greg Lin		

Antenna Polarity & Test Distance: Horizontal at 3 M

No.	Freq. (MHz)	Reading (dBm)	S.G Power Value (dBm)	Correction Factor (dB)	ERP (dBm)	Limit (dBm)	Margin (dB)
1	1668.00	-62.8	-55.1	0.8	-54.3	-13.0	-41.3

Antenna Polarity & Test Distance: Vertical at 3 M

No.	Freq. (MHz)	Reading (dBm)	S.G Power Value (dBm)	Correction Factor (dB)	ERP (dBm)	Limit (dBm)	Margin (dB)
1	1668.00	-59.8	-52.4	0.8	-51.6	-13.0	-38.6

Remarks:

1. ERP (dBm) = S.G Value (dBm) + Correction Factor (dB).
2. Correction Factor (dB) = Substitution Antenna Gain (dB) + Cable Loss (dB).

Mode	TX channel 167300 (836.5MHz)	Frequency Range	1GHz ~ 10GHz
Environmental Conditions	22deg. C, 68%RH	Input Power	120Vac, 60Hz
Tested By	Greg Lin		

Antenna Polarity & Test Distance: Horizontal at 3 M

No.	Freq. (MHz)	Reading (dBm)	S.G Power Value (dBm)	Correction Factor (dB)	ERP (dBm)	Limit (dBm)	Margin (dB)
1	1673.00	-63.3	-55.7	0.8	-54.9	-13.0	-41.9

Antenna Polarity & Test Distance: Vertical at 3 M

No.	Freq. (MHz)	Reading (dBm)	S.G Power Value (dBm)	Correction Factor (dB)	ERP (dBm)	Limit (dBm)	Margin (dB)
1	1673.00	-60.2	-52.9	0.8	-52.1	-13.0	-39.1

Remarks:

1. ERP (dBm) = S.G Value (dBm) + Correction Factor (dB).
2. Correction Factor (dB) = Substitution Antenna Gain (dB) + Cable Loss (dB).

Mode	TX channel 167800 (839.0MHz)	Frequency Range	1GHz ~ 10GHz
Environmental Conditions	22deg. C, 68%RH	Input Power	120Vac, 60Hz
Tested By	Greg Lin		

Antenna Polarity & Test Distance: Horizontal at 3 M							
No.	Freq. (MHz)	Reading (dBm)	S.G Power Value (dBm)	Correction Factor (dB)	ERP (dBm)	Limit (dBm)	Margin (dB)
1	1678.00	-63.2	-55.6	0.8	-54.8	-13.0	-41.8
Antenna Polarity & Test Distance: Vertical at 3 M							
No.	Freq. (MHz)	Reading (dBm)	S.G Power Value (dBm)	Correction Factor (dB)	ERP (dBm)	Limit (dBm)	Margin (dB)
1	1678.00	-60.1	-52.8	0.8	-52.0	-13.0	-39.0

Remarks:

1. ERP (dBm) = S.G Value (dBm) + Correction Factor (dB).
2. Correction Factor (dB) = Substitution Antenna Gain (dB) + Cable Loss (dB).

5 Pictures of Test Arrangements

Please refer to the attached file (Test Setup Photo).

Appendix – Information of the Testing Laboratories

We, Bureau Veritas Consumer Products Services (H.K.) Ltd., Taoyuan Branch, were founded in 1988 to provide our best service in EMC, Radio, Telecom and Safety consultation. Our laboratories are FCC recognized accredited test firms and accredited and approved according to ISO/IEC 17025.

If you have any comments, please feel free to contact us at the following:

Lin Kou EMC/RF Lab

Tel: 886-2-26052180

Fax: 886-2-26051924

Hsin Chu EMC/RF/Telecom Lab

Tel: 886-3-6668565

Fax: 886-3-6668323

Hwa Ya EMC/RF/Safety Lab

Tel: 886-3-3183232

Fax: 886-3-3270892

Email: service.adt@tw.bureauveritas.com

Web Site: www.bureauveritas-adt.com

The address and road map of all our labs can be found in our web site also.

--- END ---