

FCC Test Report

(PART 27)

Report No.: RF170106C02-2

FCC ID: ZMOL850GL

Test Model: L850-GL

Received Date: Jan. 06, 2017

Test Date: Jan. 12, 2017 ~ Feb. 16, 2017

Issued Date: Feb. 21, 2017

Applicant: Fibocom Wireless Inc.

Address: 5/F, Tower A, Technology Building II, 1057 Nanhai Blvd, Nanshan,
Shenzhen, China

Issued By: Bureau Veritas Consumer Products Services (H.K.) Ltd., Taoyuan Branch

Lab Address: No. 47-2, 14th Ling, Chia Pau Vil., Lin Kou Dist., New Taipei City, Taiwan
(R.O.C)

Test Location: No. 19, Hwa Ya 2nd Rd, Wen Hwa Tsuen, Kwei Shan Hsiang, Taoyuan
Hsien 333, Taiwan, R.O.C.



This report is for your exclusive use. Any copying or replication of this report to or for any other person or entity, or use of our name or trademark, is permitted only with our prior written permission. This report sets forth our findings solely with respect to the test samples identified herein. The results set forth in this report are not indicative or representative of the quality or characteristics of the lot from which a test sample was taken or any similar or identical product unless specifically and expressly noted. Our report includes all of the tests requested by you and the results thereof based upon the information that you provided to us. You have 60 days from date of issuance of this report to notify us of any material error or omission caused by our negligence, provided, however, that such notice shall be in writing and shall specifically address the issue you wish to raise. A failure to raise such issue within the prescribed time shall constitute your unqualified acceptance of the completeness of this report, the tests conducted and the correctness of the report contents. Unless specific mention, the uncertainty of measurement has been explicitly taken into account to declare the compliance or non-compliance to the specification. The report must not be used by the client to claim product certification, approval, or endorsement by TAF or any government agency

Table of Contents

Release Control Record	3
1 Certificate of Conformity	4
2 Summary of Test Results	5
2.1 Measurement Uncertainty	5
2.2 Test Site and Instruments	6
3 General Information	8
3.1 General Description of EUT	8
3.2 Configuration of System under Test	9
3.2.1 Description of Support Units	9
3.3 Test Mode Applicability and Tested Channel Detail	10
3.4 EUT Operating Conditions	13
3.5 General Description of Applied Standards	13
4 Test Types and Results	14
4.1 Output Power Measurement	14
4.1.1 Limits of Output Power Measurement	14
4.1.2 Test Procedures	14
4.1.3 Test Setup	15
4.1.4 Test Results	16
4.2 Frequency Stability Measurement	25
4.2.1 Limits of Frequency Stability Measurement	25
4.2.2 Test Procedure	25
4.2.3 Test Setup	25
4.2.4 Test Results	26
4.3 Occupied Bandwidth Measurement	38
4.3.1 Limits of Occupied Bandwidth Measurement	38
4.3.2 Test Procedure	38
4.3.3 Test Setup	38
4.3.4 Test Result	39
4.4 Band Edge Measurement	45
4.4.1 Limits of Band Edge Measurement	45
4.4.2 Test Setup	45
4.4.3 Test Procedures	45
4.4.4 Test Results	46
4.5 Peak to Average Ratio	70
4.5.1 Limits of Peak to Average Ratio Measurement	70
4.5.2 Test Setup	70
4.5.3 Test Procedures	70
4.5.4 Test Results	71
4.6 Conducted Spurious Emissions	77
4.6.1 Limits of Conducted Spurious Emissions Measurement	77
4.6.2 Test Setup	77
4.6.3 Test Procedure	77
4.6.4 Test Results	78
4.7 Radiated Emission Measurement	90
4.7.1 Limits of Radiated Emission Measurement	90
4.7.2 Test Procedure	90
4.7.3 Deviation from Test Standard	90
4.7.4 Test Setup	90
4.7.5 Test Results	91
5 Pictures of Test Arrangements	109
Appendix – Information on the Testing Laboratories	110

Release Control Record

Issue No.	Description	Date Issued
RF170106C02-2	Original Release	Feb. 21, 2017

1 Certificate of Conformity

Product: LTE module

Brand: Fibocom

Test Model: L850-GL

Sample Status: Identical Prototype

Applicant: Fibocom Wireless Inc.

Test Date: Jan. 12, 2017 ~ Feb. 16, 2017

Standards: FCC Part 27, Subpart C, M

The above equipment has been tested by **Bureau Veritas Consumer Products Services (H.K.) Ltd., Taoyuan Branch**, and found compliance with the requirement of the above standards. The test record, data evaluation & Equipment Under Test (EUT) configurations represented herein are true and accurate accounts of the measurements of the sample's EMC characteristics under the conditions specified in this report.

Prepared by :  , **Date:** Feb. 21, 2017
Gina Liu / Specialist

Approved by :  , **Date:** Feb. 21, 2017
David Huang / Project Engineer

2 Summary of Test Results

Applied Standard: FCC Part 27 & Part 2			
FCC Clause	Test Item	Result	Remarks
2.1046 27.50(h)	Equivalent Isotropic Radiated Power	Pass	Meet the requirement of limit.
2.1055 27.54	Frequency Stability	Pass	Meet the requirement of limit.
2.1049	Occupied Bandwidth	Pass	Meet the requirement of limit.
--	Peak to Average Ratio	Pass	Meet the requirement of limit.
2.1051 27.53(l)	Band Edge Measurements	Pass	Meet the requirement of limit.
2.1051 27.53(m)	Conducted Spurious Emissions	Pass	Meet the requirement of limit.
2.1053 27.53(m)	Radiated Spurious Emissions	Pass	Meet the requirement of limit. Minimum passing margin is -5.68 dB at 8040 MHz.

2.1 Measurement Uncertainty

Where relevant, the following measurement uncertainty levels have been estimated for tests performed on the EUT as specified in CISPR 16-4-2:

Measurement	Frequency	Expanded Uncertainty (k=2) (\pm)
Conducted Emissions at mains ports	150 kHz ~ 30 MHz	2.44 dB
Radiated Emissions up to 1 GHz	30 MHz ~ 200 MHz	2.93 dB
	200 MHz ~ 1000 MHz	2.95 dB
Radiated Emissions above 1 GHz	1 GHz ~ 18 GHz	2.26 dB
	18 GHz ~ 40 GHz	1.94 dB

2.2 Test Site and Instruments

Description & Manufacturer	Model No.	Serial No.	Date of Calibration	Due Date of Calibration
Test Receiver Agilent Technologies	N9038A	MY52260177	Jun. 21, 2016	Jun. 20, 2017
Spectrum Analyzer Agilent	N9010A	MY52220314	Dec. 16, 2016	Dec. 15, 2017
Spectrum Analyzer ROHDE & SCHWARZ	FSU43	101261	Dec. 13, 2016	Dec. 12, 2017
BILOG Antenna SCHWARZBECK	VULB9168	9168-472	Dec. 26, 2016	Dec. 27, 2017
HORN Antenna SCHWARZBECK	BBHA 9120 D	9120D-969	Dec. 12, 2016	Dec. 13, 2017
Double Ridge Guide Horn Antenna EMCO	3115	5619	Dec. 26, 2016	Dec. 27, 2017
BILOG Antenna SCHWARZBECK	VULB 9168	9168-153	Dec. 12, 2016	Dec. 13, 2017
Agilent Communications Tester-Wireless	8960 Series 10	MY53201073	Jul. 03, 2015	Jul. 02, 2017
Preamplifier EMCI	EMC 012645	980115	Oct. 21, 2016	Oct. 20, 2017
Preamplifier EMCI	EMC 184045	980116	Oct. 21, 2016	Oct. 20, 2017
Preamplifier EMCI	EMC 330H	980112	Oct. 21, 2016	Oct. 20, 2017
Power Meter Anritsu	ML2495A	1232002	Sep. 08, 2016	Sep. 07, 2017
Power Sensor Anritsu	MA2411B	1207325	Sep. 08, 2016	Sep. 07, 2017
RF signal cable HUBER+SUHNNER	SUCOFLEX 104	309219/4 2950114	Oct. 21, 2016	Oct. 20, 2017
RF signal cable HUBER+SUHNNER	SUCOFLEX 104	250130/4	Oct. 21, 2016	Oct. 20, 2017
RF Coaxial Cable Worken	8D-FB	Cable-Ch10-01	Oct. 21, 2016	Oct. 20, 2017
Software BV ADT	E3 6.120103	NA	NA	NA
Antenna Tower MF	MFA-440H	NA	NA	NA
Turn Table MF	MFT-201SS	NA	NA	NA
Antenna Tower & Turn Table Controller MF	MF-7802	NA	NA	NA
Radio Communication Analyzer	MT8820C	6201300640	Aug. 10, 2015	Aug. 09, 2017
Temperature & Humidity Chamber	GTH-120-40-CP-A R	MAA1306-019	Sep. 02, 2016	Sep. 01, 2017
DC Power Supply Topward	33010D	807748	Oct. 25, 2016	Oct. 24, 2018
Digital Multimeter Fluke	87-III	70360742	Jul. 01, 2016	Jun. 30, 2017

- Note:
1. The calibration interval of the above test instruments is 12 / 24 months and the calibrations are traceable to NML/ROC and NIST/USA.
 2. The test was performed in HwaYa Chamber 10.
 3. The horn antenna and preamplifier (model: EMC 184045) are used only for the measurement of emission frequency above 1 GHz if tested.
 4. The FCC Site Registration No. is 690701.
 5. The IC Site Registration No. is IC7450F-10.

3 General Information

3.1 General Description of EUT

Product	LTE module	
Brand	Fibocom	
Test Model	L850-GL	
Status of EUT	Identical Prototype	
Power Supply Rating	3.3 Vdc (from Host Equipment)	
Modulation Type	QPSK, 16QAM	
Frequency Range	LTE Band 7 (Channel Bandwidth: 5 MHz)	2502.5 ~ 2567.5 MHz
	LTE Band 7 (Channel Bandwidth: 10 MHz)	2505 ~ 2565 MHz
	LTE Band 7 (Channel Bandwidth: 15 MHz)	2507.5 ~ 2562.5 MHz
	LTE Band 7 (Channel Bandwidth: 20 MHz)	2510 ~ 2560 MHz
	LTE Band 38 (Channel Bandwidth: 5 MHz)	2572.5 ~ 2617.5 MHz
	LTE Band 38 (Channel Bandwidth: 10 MHz)	2575 ~ 2615 MHz
	LTE Band 38 (Channel Bandwidth: 15 MHz)	2577.5 ~ 2612.5 MHz
	LTE Band 38 (Channel Bandwidth: 20 MHz)	2580 ~ 2610 MHz
	LTE Band 41 (Channel Bandwidth: 5 MHz)	2498.5 ~ 2687.5 MHz
	LTE Band 41 (Channel Bandwidth: 10 MHz)	2501 ~ 2685 MHz
	LTE Band 41 (Channel Bandwidth: 15 MHz)	2503.5 ~ 2682.5 MHz
	LTE Band 41 (Channel Bandwidth: 20 MHz)	2506 ~ 2680 MHz
Max. EIRP Power	LTE Band 7 (Channel Bandwidth: 5 MHz)	67.31 mW
	LTE Band 7 (Channel Bandwidth: 10 MHz)	71.75 mW
	LTE Band 7 (Channel Bandwidth: 15 MHz)	74.83 mW
	LTE Band 7 (Channel Bandwidth: 20 MHz)	76.93 mW
	LTE Band 38 (Channel Bandwidth: 5 MHz)	113.24 mW
	LTE Band 38 (Channel Bandwidth: 10 MHz)	115.61 mW
	LTE Band 38 (Channel Bandwidth: 15 MHz)	118.58 mW
	LTE Band 38 (Channel Bandwidth: 20 MHz)	120.23 mW
	LTE Band 41 (Channel Bandwidth: 5 MHz)	82.04 mW
	LTE Band 41 (Channel Bandwidth: 10 MHz)	84.53 mW
	LTE Band 41 (Channel Bandwidth: 15 MHz)	87.30 mW
	LTE Band 41 (Channel Bandwidth: 20 MHz)	90.16 mW
Emission Designator	LTE Band 7 (Channel Bandwidth: 5 MHz)	4M51G7D
	LTE Band 7 (Channel Bandwidth: 10 MHz)	8M99G7D
	LTE Band 7 (Channel Bandwidth: 15 MHz)	13M4G7D
	LTE Band 7 (Channel Bandwidth: 20 MHz)	18M0G7D
	LTE Band 38 (Channel Bandwidth: 5 MHz)	4M50G7D
	LTE Band 38 (Channel Bandwidth: 10 MHz)	8M99G7D
	LTE Band 38 (Channel Bandwidth: 15 MHz)	13M4G7D
	LTE Band 38 (Channel Bandwidth: 20 MHz)	17M9W7D

Emission Designator	LTE Band 41 (Channel Bandwidth: 5 MHz)	4M50G7D
	LTE Band 41 (Channel Bandwidth: 10 MHz)	8M99G7D
	LTE Band 41 (Channel Bandwidth: 15 MHz)	13M4G7D
	LTE Band 41 (Channel Bandwidth: 20 MHz)	17M9G7D
Antenna Type	External Antenna	
Accessory Device	Refer to Note as below	
Data Cable Supplied	Refer to Note as below	

Note:

- The above EUT information is declared by manufacturer and for more detailed features description, please refer to the manufacturer's specifications or user's manual.

3.2 Configuration of System under Test

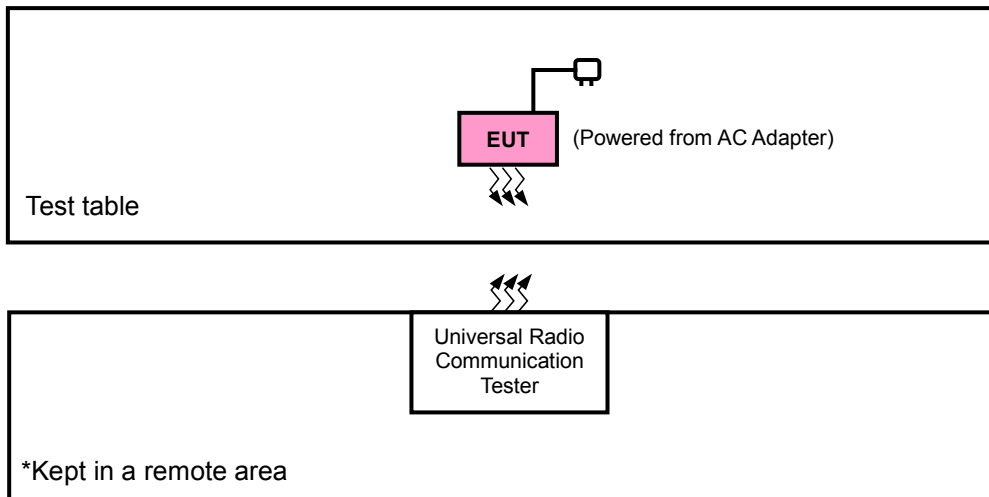

3.2.1 Description of Support Units

The EUT has been tested as an independent unit together with other necessary accessories or support units.

3.3 Test Mode Applicability and Tested Channel Detail

Pre-Scan has been conducted to determine the worst-case mode from all possible combinations between available modulations, data rates, XYZ axis, and antenna ports.

The worst case was found when positioned as the table below. Following channel(s) was (were) selected for the final test as listed below:

Band	EIRP	Radiated Emission
LTE Band 7	X-plane	Z-axis
LTE Band 38	X-plane	Z-axis
LTE Band 41	X-plane	Z-axis

LTE Band 7

EUT Configure Mode	Test Item	Available Channel	Tested Channel	Channel Bandwidth	Modulation	Mode
-	EIRP	20775 to 21425	20775, 21100, 21425	5 MHz	QPSK, 16QAM	1 RB / 12 RB Offset
		20800 to 21400	20800, 21100, 21400	10 MHz	QPSK, 16QAM	1 RB / 24 RB Offset
		20825 to 21375	20825, 21100, 21375	15 MHz	QPSK, 16QAM	1 RB / 37 RB Offset
		20850 to 21350	20850, 21100 21350	20 MHz	QPSK, 16QAM	1 RB / 50 RB Offset
-	Frequency Stability	20775 to 21425	20775, 21425	5 MHz	QPSK	1 RB / 12 RB Offset
		20800 to 21400	20800, 21400	10 MHz	QPSK	1 RB / 24 RB Offset
		20825 to 21375	20825, 21375	15 MHz	QPSK	1 RB / 37 RB Offset
		20850 to 21350	20850, 21350	20 MHz	QPSK	1 RB / 50 RB Offset
-	Occupied Bandwidth	20775 to 21425	20775, 21100, 21425	5 MHz	QPSK, 16QAM	25 RB / 0 RB Offset
		20800 to 21400	20800, 21100, 21400	10 MHz	QPSK, 16QAM	50 RB / 0 RB Offset
		20825 to 21375	20825, 21100, 21375	15 MHz	QPSK, 16QAM	75 RB / 0 RB Offset
		20850 to 21350	20850, 21100 21350	20 MHz	QPSK, 16QAM	100 RB / 0 RB Offset
-	Peak to Average Ratio	20775 to 21425	20775, 21100, 21425	5 MHz	QPSK, 16QAM	1 RB / 12 RB Offset
		20800 to 21400	20800, 21100, 21400	10 MHz	QPSK, 16QAM	1 RB / 24 RB Offset
		20825 to 21375	20825, 21100, 21375	15 MHz	QPSK, 16QAM	1 RB / 37 RB Offset
		20850 to 21350	20850, 21100 21350	20 MHz	QPSK, 16QAM	1 RB / 50 RB Offset
-	Band Edge	20775 to 21425	20775, 21425	5 MHz	QPSK, 16QAM	25 RB / 0 RB Offset
		20800 to 21400	20800, 21400	10 MHz	QPSK, 16QAM	50 RB / 0 RB Offset
		20825 to 21375	20825, 21375	15 MHz	QPSK, 16QAM	75 RB / 0 RB Offset
		20850 to 21350	20850, 21350	20 MHz	QPSK, 16QAM	100 RB / 0 RB Offset
-	Conducted Emission	20775 to 21425	20775, 21100, 21425	5 MHz	QPSK	1 RB / 12 RB Offset
		20800 to 21400	20800, 21100, 21400	10 MHz	QPSK	1 RB / 24 RB Offset
		20825 to 21375	20825, 21100, 21375	15 MHz	QPSK	1 RB / 37 RB Offset
		20850 to 21350	20850, 21100 21350	20 MHz	QPSK	1 RB / 50 RB Offset
-	Radiated Emission	20850 to 21350	20850, 21100 21350	20 MHz	QPSK	1 RB / 50 RB Offset

Note: This device was tested under all bandwidths, RB configurations and modulations. The worst case was found in QPSK modulation.

LTE Band 38

EUT Configure Mode	Test Item	Available Channel	Tested Channel	Channel Bandwidth	Modulation	Mode
-	EIRP	37775 to 38225	37775, 38000, 38225	5 MHz	QPSK, 16QAM	1 RB / 12 RB Offset
		37800 to 38200	37800, 38000, 38200	10 MHz	QPSK, 16QAM	1 RB / 24 RB Offset
		37825 to 38175	37825, 38000, 38175	15 MHz	QPSK, 16QAM	1 RB / 37 RB Offset
		37850 to 38150	37850, 38000, 38150	20 MHz	QPSK, 16QAM	1 RB / 50 RB Offset
-	Frequency Stability	37775 to 38225	37775, 38225	5 MHz	QPSK	1 RB / 12 RB Offset
		37800 to 38200	37800, 38200	10 MHz	QPSK	1 RB / 24 RB Offset
		37825 to 38175	37825, 38175	15 MHz	QPSK	1 RB / 37 RB Offset
		37850 to 38150	37850, 38150	20 MHz	QPSK	1 RB / 50 RB Offset
-	Occupied Bandwidth	37775 to 38225	37775, 38000, 38225	5 MHz	QPSK, 16QAM	25 RB / 0 RB Offset
		37800 to 38200	37800, 38000, 38200	10 MHz	QPSK, 16QAM	50 RB / 0 RB Offset
		37825 to 38175	37825, 38000, 38175	15 MHz	QPSK, 16QAM	75 RB / 0 RB Offset
		37850 to 38150	37850, 38000, 38150	20 MHz	QPSK, 16QAM	100 RB / 0 RB Offset
-	Peak to Average Ratio	37775 to 38225	37775, 38000, 38225	5 MHz	QPSK, 16QAM	25 RB / 0 RB Offset
		37800 to 38200	37800, 38000, 38200	10 MHz	QPSK, 16QAM	1 RB / 0 RB Offset
		37825 to 38175	37825, 38000, 38175	15 MHz	QPSK, 16QAM	1 RB / 0 RB Offset
		37850 to 38150	37850, 38000, 38150	20 MHz	QPSK, 16QAM	1 RB / 0 RB Offset
-	Band Edge	37775 to 38225	37775, 38225	5 MHz	QPSK, 16QAM	25 RB / 0 RB Offset
		37800 to 38200	37800, 38200	10 MHz	QPSK, 16QAM	50 RB / 0 RB Offset
		37825 to 38175	37825, 38175	15 MHz	QPSK, 16QAM	75 RB / 0 RB Offset
		37850 to 38150	37850, 38150	20 MHz	QPSK, 16QAM	100 RB / 0 RB Offset
-	Conducted Emission	37775 to 38225	37775, 38000, 38225	5 MHz	QPSK	1 RB / 12 RB Offset
		37800 to 38200	37800, 38000, 38200	10 MHz	QPSK	1 RB / 24 RB Offset
		37825 to 38175	37825, 38000, 38175	15 MHz	QPSK	1 RB / 37 RB Offset
		37850 to 38150	37850, 38000, 38150	20 MHz	QPSK	1 RB / 50 RB Offset
-	Radiated Emission	37850 to 38150	37850, 38000, 38150	20 MHz	QPSK	1 RB / 50 RB Offset

Note: This device was tested under all bandwidths, RB configurations and modulations. The worst case was found in QPSK modulation.

LTE Band 41

EUT Configure Mode	Test Item	Available Channel	Tested Channel	Channel Bandwidth	Modulation	Mode
-	EIRP	39675 to 41565	39675, 40620, 41565	5 MHz	QPSK, 16QAM	1 RB / 12 RB Offset
		39700 to 41540	39700, 40620, 41540	10 MHz	QPSK, 16QAM	1 RB / 24 RB Offset
		39725 to 41515	39725, 40620, 41515	15 MHz	QPSK, 16QAM	1 RB / 37 RB Offset
		39750 to 41490	39750, 40620, 41490	20 MHz	QPSK, 16QAM	1 RB / 50 RB Offset
-	Frequency Stability	39675 to 41565	39675, 41565	5 MHz	QPSK	1 RB / 12 RB Offset
		39700 to 41540	39700, 41540	10 MHz	QPSK	1 RB / 24 RB Offset
		39725 to 41515	39725, 41515	15 MHz	QPSK	1 RB / 37 RB Offset
		39750 to 41490	39750, 41490	20 MHz	QPSK	1 RB / 50 RB Offset
-	Occupied Bandwidth	39675 to 41565	39675, 40620, 41565	5 MHz	QPSK, 16QAM	25 RB / 0 RB Offset
		39700 to 41540	39700, 40620, 41540	10 MHz	QPSK, 16QAM	50 RB / 0 RB Offset
		39725 to 41515	39725, 40620, 41515	15 MHz	QPSK, 16QAM	75 RB / 0 RB Offset
		39750 to 41490	39750, 40620, 41490	20 MHz	QPSK, 16QAM	100 RB / 0 RB Offset
-	Peak to Average Ratio	39675 to 41565	39675, 40620, 41565	5 MHz	QPSK, 16QAM	25 RB / 0 RB Offset
		39700 to 41540	39700, 40620, 41540	10 MHz	QPSK, 16QAM	1 RB / 0 RB Offset
		39725 to 41515	39725, 40620, 41515	15 MHz	QPSK, 16QAM	1 RB / 0 RB Offset
		39750 to 41490	39750, 40620, 41490	20 MHz	QPSK, 16QAM	1 RB / 0 RB Offset
-	Band Edge	39675 to 41565	39675, 41565	5 MHz	QPSK, 16QAM	25 RB / 0 RB Offset
		39700 to 41540	39700, 41540	10 MHz	QPSK, 16QAM	50 RB / 0 RB Offset
		39725 to 41515	39725, 41515	15 MHz	QPSK, 16QAM	75 RB / 0 RB Offset
		39750 to 41490	39750, 41490	20 MHz	QPSK, 16QAM	100 RB / 0 RB Offset
-	Conducted Emission	39675 to 41565	39675, 40620, 41565	5 MHz	QPSK	1 RB / 12 RB Offset
		39700 to 41540	39700, 40620, 41540	10 MHz	QPSK	1 RB / 24 RB Offset
		39725 to 41515	39725, 40620, 41515	15 MHz	QPSK	1 RB / 37 RB Offset
		39750 to 41490	39750, 40620, 41490	20 MHz	QPSK	1 RB / 50 RB Offset
-	Radiated Emission	39750 to 41490	39750, 40620, 41490	20 MHz	QPSK	1 RB / 50 RB Offset

Note: This device was tested under all bandwidths, RB configurations and modulations. The worst case was found in QPSK modulation.

Test Condition:

Test Item	Environmental Conditions	Input Power	Tested By
EIRP	25 deg. C, 65 % RH	3.3 Vdc	Getaz Yang
Frequency Stability	25 deg. C, 65 % RH	3.3 Vdc	Carlos Chen
Occupied Bandwidth	25 deg. C, 65 % RH	3.3 Vdc	Carlos Chen
Band Edge	25 deg. C, 65 % RH	3.3 Vdc	Carlos Chen
Peak to Average Ratio	25 deg. C, 65 % RH	3.3 Vdc	Carlos Chen
Condcudeted Emission	25 deg. C, 65 % RH	3.3 Vdc	Carlos Chen
Radiated Emission	25 deg. C, 65 % RH	120 Vac, 60 Hz	Getaz Yang

3.4 EUT Operating Conditions

The EUT makes a call to the communication simulator. The communication simulator station system controlled a EUT to export maximum output power under transmission mode and specific channel frequency

3.5 General Description of Applied Standards

The EUT is a RF Product. According to the specifications of the manufacturer, it must comply with the requirements of the following standards:

FCC 47 CFR Part 2

FCC 47 CFR Part 27

KDB 971168 D01 Power Meas License Digital Systems v02r02

ANSI/TIA/EIA-603-D 2010

Note: All test items have been performed and recorded as per the above standards.

4 Test Types and Results

4.1 Output Power Measurement

4.1.1 Limits of Output Power Measurement

The radiated peak output power shall be according to the specific rule Part 27.50(h)(2) that “User stations are limited to 2 watts” and 27.50(i) specific that “Peak transmit power must be measure over any interval of continuous transmission using instrumentation calibration in terms of rms-equivalent voltage.”

4.1.2 Test Procedures

EIRP Measurement:

- a. All measurements were done at low, middle and high operational frequency range. RBW and VBW is 10 MHz for LTE mode.
- b. Substitution method is used for E.I.R.P measurement. In the semi-anechoic chamber, EUT placed on the 0.8 m height of Turn Table, rotated the table around 360 degrees to search the maximum radiation power and receiver antenna shall be rotated vertical and horizontal polarization and moved height from 1 m to 4 m to find the maximum polar radiated power. The “Read Value” is the spectrum reading the maximum power value.
- c. The substitution horn antenna is substituted for EUT at the same position and signals generator export the CW signal to the substitution antenna via a tx cable. Rotated the Turn Table and moved receiving antenna to find the maximum radiation power. Adjust output power level of S.G to get a Value of spectrum reading equal to “Read Value“ of step b. Record the power level of S.G.
- d. $EIRP = \text{Output power level of S.G} - \text{TX cable loss} + \text{Antenna gain of substitution horn}.$

Conducted Power Measurement:

- a. The EUT was set up for the maximum power with LTE link data modulation and link up with simulator.
- b. Set the EUT to transmit under low, middle and high channel and record the power level shown on simulator.

4.1.3 Test Setup

EIRP / ERP Measurement:

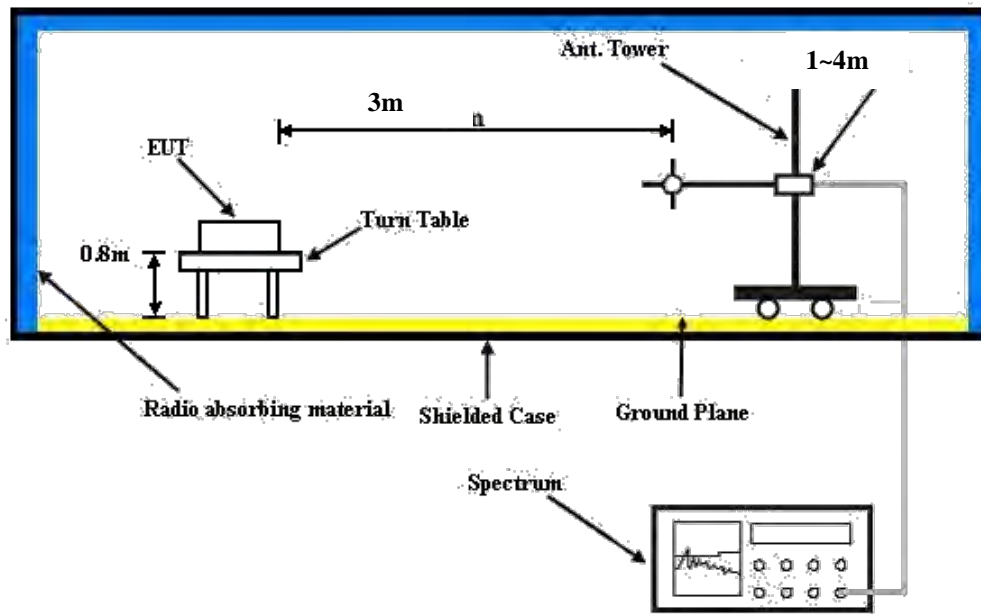

For the actual test configuration, please refer to the attached file (Test Setup Photo).

Conducted Power Measurement:



4.1.4 Test Results

Conducted Output Power (dBm)

Band / BW	RB Size	RB Offset	QPSK			3GPP MPR (dB)	16QAM			3GPP MPR (dB)
			Low Ch 20775	Mid Ch 21100	High Ch 21425		Low Ch 20775	Mid Ch 21100	High Ch 21425	
			2502.5 MHz	2535.0 MHz	2567.5 MHz		2502.5 MHz	2535.0 MHz	2567.5 MHz	
7 / 5M	1	0	22.74	22.62	22.77	0	21.68	21.55	21.71	1
	1	12	22.60	22.53	22.66	0	21.60	21.45	21.66	1
	1	24	22.43	22.34	22.41	0	21.35	21.31	21.45	1
	12	0	21.59	21.52	21.73	1	20.44	20.46	20.51	2
	12	6	21.48	21.41	21.59	1	20.37	20.31	20.54	2
	12	13	21.23	21.15	21.47	1	20.13	20.06	20.40	2
	25	0	21.52	21.43	21.68	1	20.60	20.50	20.51	2

Band / BW	RB Size	RB Offset	QPSK			3GPP MPR (dB)	16QAM			3GPP MPR (dB)
			Low Ch 20800	Mid Ch 21100	High Ch 21400		Low Ch 20800	Mid Ch 21100	High Ch 21400	
			2505.0 MHz	2535.0 MHz	2565.0 MHz		2505.0 MHz	2535.0 MHz	2565.0 MHz	
7 / 10M	1	0	22.75	22.73	22.87	0	21.72	21.65	21.81	1
	1	24	22.62	22.60	22.72	0	21.59	21.58	21.68	1
	1	49	22.45	22.47	22.56	0	21.38	21.34	21.54	1
	25	0	21.65	21.63	21.69	1	20.53	20.46	20.64	2
	25	12	21.52	21.52	21.60	1	20.50	20.45	20.51	2
	25	25	21.32	21.40	21.40	1	20.24	20.24	20.24	2
	50	0	21.59	21.52	21.85	1	20.55	20.57	20.70	2

Band / BW	RB Size	RB Offset	QPSK			3GPP MPR (dB)	16QAM			3GPP MPR (dB)
			Low Ch 20825	Mid Ch 21100	High Ch 21375		Low Ch 20825	Mid Ch 21100	High Ch 21375	
			2507.5 MHz	2535.0 MHz	2562.5 MHz		2507.5 MHz	2535.0 MHz	2562.5 MHz	
7 / 15M	1	0	22.70	22.62	22.90	0	21.63	21.57	21.88	1
	1	37	22.60	22.46	22.81	0	21.53	21.47	21.76	1
	1	74	22.34	22.34	22.57	0	21.41	21.37	21.53	1
	36	0	21.65	21.58	21.73	1	20.62	20.37	20.66	2
	36	19	21.55	21.49	21.64	1	20.49	20.41	20.59	2
	36	39	21.31	21.29	21.50	1	20.22	20.20	20.39	2
	75	0	21.67	21.46	21.78	1	20.62	20.44	20.67	2

Band / BW	RB Size	RB Offset	QPSK			3GPP MPR (dB)	16QAM			3GPP MPR (dB)
			Low Ch 20850	Mid Ch 21100	High Ch 21350		Low Ch 20850	Mid Ch 21100	High Ch 21350	
			2510.0 MHz	2535.0 MHz	2560.0 MHz		2510.0 MHz	2535.0 MHz	2560.0 MHz	
7 / 20M	1	0	22.77	22.66	23.01	0	21.72	21.58	21.94	1
	1	50	22.67	22.53	22.92	0	21.59	21.53	21.86	1
	1	99	22.39	22.32	22.78	0	21.39	21.27	21.66	1
	50	0	21.72	21.59	21.86	1	20.53	20.40	20.74	2
	50	25	21.58	21.48	21.71	1	20.61	20.39	20.64	2
	50	50	21.49	21.23	21.60	1	20.40	20.23	20.51	2
	100	0	21.68	21.51	21.82	1	20.56	20.46	20.91	2

Band / BW	RB Size	RB Offset	QPSK			3GPP MPR (dB)	16QAM			3GPP MPR (dB)
			Low Ch 37775	Mid Ch 38000	High Ch 38255		Low Ch 37775	Mid Ch 38000	High Ch 38255	
			2572.5 MHz	2595.0 MHz	2617.5 MHz		2572.5 MHz	2595.0 MHz	2617.5 MHz	
38 / 5M	1	0	22.38	22.61	22.43	0	21.34	21.57	21.35	1
	1	12	22.29	22.50	22.27	0	21.16	21.43	21.30	1
	1	24	22.13	22.23	22.06	0	21.04	21.32	21.14	1
	12	0	21.29	21.54	21.35	1	20.20	20.52	20.17	2
	12	6	21.20	21.38	21.26	1	20.13	20.38	20.13	2
	12	13	21.00	21.30	21.02	1	19.89	20.27	20.04	2
	25	0	21.29	21.47	21.42	1	20.22	20.46	20.35	2

Band / BW	RB Size	RB Offset	QPSK			3GPP MPR (dB)	16QAM			3GPP MPR (dB)
			Low Ch 37800	Mid Ch 38000	High Ch 38200		Low Ch 37800	Mid Ch 38000	High Ch 38200	
			2575.0 MHz	2595.0 MHz	2615.0 MHz		2575.0 MHz	2595.0 MHz	2615.0 MHz	
38 / 10M	1	0	22.48	22.75	22.57	0	21.45	21.71	21.50	1
	1	24	22.37	22.60	22.45	0	21.30	21.57	21.42	1
	1	49	22.22	22.38	22.29	0	21.21	21.39	21.22	1
	25	0	21.45	21.56	21.48	1	20.28	20.55	20.26	2
	25	12	21.34	21.41	21.39	1	20.23	20.35	20.28	2
	25	25	21.12	21.29	21.27	1	20.21	20.29	20.15	2
	50	0	21.44	21.56	21.35	1	20.40	20.62	20.49	2

Band / BW	RB Size	RB Offset	QPSK			3GPP MPR (dB)	16QAM			3GPP MPR (dB)
			Low Ch 37825	Mid Ch 38000	High Ch 38175		Low Ch 37825	Mid Ch 38000	High Ch 38175	
			2577.5 MHz	2595.0 MHz	2612.5 MHz		2577.5 MHz	2595.0 MHz	2612.5 MHz	
38 / 15M	1	0	22.58	22.82	22.69	0	21.53	21.78	21.62	1
	1	37	22.42	22.70	22.55	0	21.43	21.62	21.49	1
	1	74	22.25	22.49	22.40	0	21.33	21.53	21.26	1
	36	0	21.52	21.66	21.56	1	20.50	20.48	20.34	2
	36	19	21.43	21.51	21.44	1	20.38	20.47	20.35	2
	36	39	21.23	21.37	21.18	1	20.13	20.35	20.19	2
	75	0	21.49	21.68	21.63	1	20.49	20.66	20.60	2

Band / BW	RB Size	RB Offset	QPSK			3GPP MPR (dB)	16QAM			3GPP MPR (dB)
			Low Ch 37850	Mid Ch 38000	High Ch 38150		Low Ch 37850	Mid Ch 38000	High Ch 38150	
			2580.0 MHz	2595.0 MHz	2610.0 MHz		2580.0 MHz	2595.0 MHz	2610.0 MHz	
38 / 20M	1	0	22.63	22.96	22.81	0	21.62	21.92	21.79	1
	1	50	22.48	22.87	22.67	0	21.48	21.78	21.63	1
	1	99	22.37	22.68	22.49	0	21.36	21.66	21.38	1
	50	0	21.66	21.75	21.70	1	20.62	20.72	20.64	2
	50	25	21.53	21.66	21.54	1	20.50	20.60	20.54	2
	50	50	21.34	21.49	21.33	1	20.39	20.36	20.47	2
	100	0	21.61	21.95	21.60	1	20.48	20.83	20.51	2

Band / BW	RB Size	RB Offset	QPSK			3GPP MPR (dB)	16QAM			3GPP MPR (dB)
			Low Ch 39675	Mid Ch 40620	High Ch 41565		Low Ch 39675	Mid Ch 40620	High Ch 41565	
			2498.5 MHz	2593.0 MHz	2687.5 MHz		2498.5 MHz	2593.0 MHz	2687.5 MHz	
41 / 5M	1	0	22.64	22.83	22.71	0	21.58	21.76	21.66	1
	1	12	22.48	22.68	22.59	0	21.51	21.64	21.54	1
	1	24	22.41	22.60	22.48	0	21.25	21.50	21.35	1
	12	0	21.62	21.63	21.55	1	20.54	20.52	20.40	2
	12	6	21.50	21.51	21.45	1	20.44	20.45	20.31	2
	12	13	21.33	21.38	21.21	1	20.36	20.26	20.18	2
	25	0	21.42	21.79	21.61	1	20.56	20.69	20.48	2

Band / BW	RB Size	RB Offset	QPSK			3GPP MPR (dB)	16QAM			3GPP MPR (dB)
			Low Ch 39700	Mid Ch 40620	High Ch 41540		Low Ch 39700	Mid Ch 40620	High Ch 41540	
			2501.0 MHz	2593.0 MHz	2685.0 MHz		2501.0 MHz	2593.0 MHz	2685.0 MHz	
41 / 10M	1	0	22.71	22.82	22.81	0	21.66	21.73	21.70	1
	1	24	22.58	22.73	22.65	0	21.54	21.58	21.56	1
	1	49	22.37	22.52	22.51	0	21.36	21.48	21.35	1
	25	0	21.67	21.69	21.74	1	20.53	20.61	20.41	2
	25	12	21.53	21.55	21.58	1	20.49	20.49	20.33	2
	25	25	21.31	21.47	21.37	1	20.28	20.33	20.27	2
	50	0	21.68	21.77	21.77	1	20.55	20.76	20.54	2

Band / BW	RB Size	RB Offset	QPSK			3GPP MPR (dB)	16QAM			3GPP MPR (dB)
			Low Ch 39725	Mid Ch 40620	High Ch 41515		Low Ch 39725	Mid Ch 40620	High Ch 41515	
			2503.5 MHz	2593.0 MHz	2682.5 MHz		2503.5 MHz	2593.0 MHz	2682.5 MHz	
41 / 15M	1	0	22.75	22.68	22.68	0	21.74	21.59	21.64	1
	1	37	22.59	22.54	22.56	0	21.59	21.46	21.44	1
	1	74	22.39	22.46	22.46	0	21.46	21.44	21.23	1
	36	0	21.59	21.66	21.58	1	20.43	20.61	20.39	2
	36	19	21.43	21.50	21.47	1	20.42	20.46	20.36	2
	36	39	21.32	21.36	21.20	1	20.27	20.37	20.22	2
	75	0	21.68	21.51	21.64	1	20.69	20.54	20.45	2

Band / BW	RB Size	RB Offset	QPSK			3GPP MPR (dB)	16QAM			3GPP MPR (dB)
			Low Ch 39750	Mid Ch 40620	High Ch 41490		Low Ch 39750	Mid Ch 40620	High Ch 41490	
			2506.0 MHz	2593.0 MHz	2680.0 MHz		2506.0 MHz	2593.0 MHz	2680.0 MHz	
41 / 20M	1	0	22.75	22.86	22.71	0	21.74	21.67	21.66	1
	1	50	22.66	22.64	22.62	0	21.58	21.60	21.53	1
	1	99	22.42	22.39	22.47	0	21.50	21.45	21.41	1
	50	0	21.73	21.71	21.62	1	20.67	20.70	20.47	2
	50	25	21.59	21.57	21.48	1	20.50	20.51	20.40	2
	50	50	21.38	21.46	21.38	1	20.44	20.35	20.28	2
	100	0	21.67	21.63	21.49	1	20.59	20.46	20.60	2

EIRP Power (dBm)

LTE Band 7							
Channel Bandwidth: 5 MHz / QPSK							
Plane	Channel	Frequency (MHz)	LVL (dBm)	Correction Factor (dB)	EIRP (dBm)	EIRP (mW)	Polarization (H/V)
X	20775	2502.5	-20.36	38.52	18.16	65.43	H
	21100	2535.0	-20.08	38.36	18.28	67.31	
	21425	2567.5	-20.33	38.58	18.25	66.88	
	20775	2502.5	-24.71	38.92	14.21	26.39	V
	21100	2535.0	-24.92	39.26	14.34	27.16	
	21425	2567.5	-24.89	39.22	14.33	27.08	
Channel Bandwidth: 5 MHz / 16QAM							
X	20775	2502.5	-20.90	38.52	17.62	57.78	H
	21100	2535.0	-20.67	38.36	17.69	58.76	
	21425	2567.5	-20.91	38.58	17.67	58.52	
	20775	2502.5	-25.54	38.92	13.38	21.80	V
	21100	2535.0	-25.84	39.26	13.42	21.98	
	21425	2567.5	-25.89	39.22	13.33	21.51	

LTE Band 7							
Channel Bandwidth: 10 MHz / QPSK							
Plane	Channel	Frequency (MHz)	LVL (dBm)	Correction Factor (dB)	EIRP (dBm)	EIRP (mW)	Polarization (H/V)
X	20800	2505.0	-20.11	38.65	18.54	71.43	H
	21100	2535.0	-19.71	38.36	18.65	73.28	
	21400	2565.0	-19.93	38.49	18.56	71.75	
	20800	2505.0	-24.51	38.84	14.33	27.11	V
	21100	2535.0	-24.81	39.26	14.45	27.88	
	21400	2565.0	-24.71	39.10	14.39	27.48	
Channel Bandwidth: 10 MHz / 16QAM							
X	20800	2505.0	-20.71	38.52	17.81	60.37	H
	21100	2535.0	-20.46	38.36	17.90	61.67	
	21400	2565.0	-20.72	38.58	17.86	61.14	
	20800	2505.0	-25.43	38.92	13.49	22.36	V
	21100	2535.0	-25.76	39.26	13.50	22.39	
	21400	2565.0	-25.77	39.22	13.45	22.12	

LTE Band 7							
Channel Bandwidth: 15 MHz / QPSK							
Plane	Channel	Frequency (MHz)	LVL (dBm)	Correction Factor (dB)	EIRP (dBm)	EIRP (mW)	Polarization (H/V)
X	20825	2507.5	-19.87	38.52	18.65	73.25	H
	21100	2535.0	-19.62	38.36	18.74	74.83	
	21375	2562.5	-19.88	38.58	18.70	74.18	
	20825	2507.5	-24.43	38.92	14.49	28.14	V
	21100	2535.0	-24.71	39.26	14.55	28.51	
	21375	2562.5	-24.68	39.22	14.54	28.42	
Channel Bandwidth: 15 MHz / 16QAM							
X	20825	2507.5	-20.59	38.52	17.93	62.06	H
	21100	2535.0	-20.32	38.36	18.04	63.69	
	21375	2562.5	-20.62	38.58	17.96	62.56	
	20825	2507.5	-25.36	38.92	13.56	22.72	V
	21100	2535.0	-25.68	39.26	13.58	22.80	
	21375	2562.5	-25.69	39.22	13.53	22.53	

LTE Band 7							
Channel Bandwidth: 20 MHz / QPSK							
Plane	Channel	Frequency (MHz)	LVL (dBm)	Correction Factor (dB)	EIRP (dBm)	EIRP (mW)	Polarization (H/V)
X	20850.0	2510.0	-19.72	38.52	18.80	75.82	H
	21100.0	2535.0	-19.50	38.36	18.86	76.93	
	21350.0	2560.0	-19.73	38.58	18.85	76.79	
	20850.0	2510.0	-24.35	38.92	14.57	28.67	V
	21100.0	2535.0	-24.66	39.26	14.60	28.84	
	21350.0	2560.0	-24.69	39.22	14.53	28.36	
Channel Bandwidth: 20 MHz / 16QAM							
X	20850.0	2510.0	-20.40	38.52	18.12	64.83	H
	21100.0	2535.0	-20.19	38.36	18.17	65.63	
	21350.0	2560.0	-20.53	38.58	18.05	63.87	
	20850.0	2510.0	-25.24	38.92	13.68	23.36	V
	21100.0	2535.0	-25.57	39.26	13.69	23.39	
	21350.0	2560.0	-25.58	39.22	13.64	23.10	

LTE Band 38							
Channel Bandwidth: 5 MHz / QPSK							
Plane	Channel	Frequency (MHz)	LVL (dBm)	Correction Factor (dB)	EIRP (dBm)	EIRP (mW)	Polarization (H/V)
X	37775	2572.5	-18.59	38.99	20.40	109.65	H
	38000	2595	-17.66	38.17	20.51	112.46	
	38225	2617.5	-18.01	38.55	20.54	113.24	
	37775	2572.5	-18.99	39.27	20.28	106.59	V
	38000	2595	-18.38	38.68	20.30	107.15	
	38225	2617.5	-18.32	38.55	20.23	105.44	
Channel Bandwidth: 5 MHz / 16QAM							
X	37775	2572.5	-19.03	38.99	19.96	99.08	H
	38000	2595	-18.14	38.17	20.03	100.69	
	38225	2617.5	-18.58	38.55	19.97	99.31	
	37775	2572.5	-20.02	39.27	19.25	84.08	V
	38000	2595	-19.39	38.68	19.29	84.92	
	38225	2617.5	-19.31	38.55	19.24	83.95	

LTE Band 38							
Channel Bandwidth: 10 MHz / QPSK							
Plane	Channel	Frequency (MHz)	LVL (dBm)	Correction Factor (dB)	EIRP (dBm)	EIRP (mW)	Polarization (H/V)
X	37800	2575	-18.43	38.98	20.55	113.50	H
	38000	2595	-17.54	38.17	20.63	115.61	
	38200	2615	-17.90	38.45	20.55	113.50	
	37800	2575	-18.80	39.04	20.24	105.68	V
	38000	2595	-18.32	38.68	20.36	108.64	
	38200	2615	-18.31	38.60	20.29	106.91	
Channel Bandwidth: 10 MHz / 16QAM							
X	37800	2575	-18.89	38.98	20.09	102.09	H
	38000	2595	-18.05	38.17	20.12	102.80	
	38200	2615	-18.41	38.45	20.04	100.93	
	37800	2575	-19.81	39.04	19.23	83.75	V
	38000	2595	-19.31	38.68	19.37	86.50	
	38200	2615	-19.25	38.60	19.35	86.10	

LTE Band 38							
Channel Bandwidth: 15 MHz / QPSK							
Plane	Channel	Frequency (MHz)	LVL (dBm)	Correction Factor (dB)	EIRP (dBm)	EIRP (mW)	Polarization (H/V)
X	37825	2577.5	-18.39	39.09	20.70	117.49	H
	38000	2595	-17.43	38.17	20.74	118.58	
	38175	2612.5	-17.81	38.52	20.71	117.76	
	37825	2577.5	-18.69	39.04	20.35	108.39	V
	38000	2595	-18.27	38.68	20.41	109.90	
	38175	2612.5	-18.33	38.66	20.33	107.89	
Channel Bandwidth: 15 MHz / 16QAM							
X	37825	2577.5	-18.91	39.09	20.18	104.23	H
	38000	2595	-17.97	38.17	20.20	104.71	
	38175	2612.5	-18.35	38.52	20.17	103.99	
	37825	2577.5	-19.62	39.04	19.42	87.50	V
	38000	2595	-19.22	38.68	19.46	88.31	
	38175	2612.5	-19.23	38.66	19.43	87.70	

LTE Band 38							
Channel Bandwidth: 20 MHz / QPSK							
Plane	Channel	Frequency (MHz)	LVL (dBm)	Correction Factor (dB)	EIRP (dBm)	EIRP (mW)	Polarization (H/V)
X	37850	2580	-18.48	39.26	20.78	119.67	H
	38000	2595	-17.37	38.17	20.80	120.23	
	38150	2610	-17.92	38.71	20.79	119.95	
	37850	2580	-18.88	39.33	20.45	110.92	V
	38000	2595	-18.19	38.68	20.49	111.94	
	38150	2610	-18.29	38.76	20.47	111.43	
Channel Bandwidth: 20 MHz / 16QAM							
X	37850	2580	-19.05	39.26	20.21	104.95	H
	38000	2595	-17.90	38.17	20.27	106.41	
	38150	2610	-18.46	38.71	20.25	105.93	
	37850	2580	-19.82	39.33	19.51	89.33	V
	38000	2595	-19.13	38.68	19.55	90.16	
	38150	2610	-19.22	38.76	19.54	89.95	

LTE Band 41							
Channel Bandwidth: 5 MHz / QPSK							
Plane	Channel	Frequency (MHz)	LVL (dBm)	Correction Factor (dB)	EIRP (dBm)	EIRP (mW)	Polarization (H/V)
X	39675	2498.5	-19.93	38.99	19.06	80.54	H
	40620	2593.0	-19.03	38.17	19.14	82.04	
	41565	2687.5	-19.50	38.55	19.05	80.35	
	39675	2498.5	-22.80	39.27	16.47	44.33	V
	40620	2593.0	-22.11	38.68	16.57	45.39	
	41565	2687.5	-22.06	38.55	16.49	44.57	
Channel Bandwidth: 5 MHz / 16QAM							
X	39675	2498.5	-21.02	38.99	17.97	62.66	H
	40620	2593.0	-20.11	38.17	18.06	63.97	
	41565	2687.5	-20.55	38.55	18.00	63.10	
	39675	2498.5	-23.93	39.27	15.34	34.17	V
	40620	2593.0	-23.24	38.68	15.44	34.99	
	41565	2687.5	-23.15	38.55	15.40	34.67	

LTE Band 41							
Channel Bandwidth: 10 MHz / QPSK							
Plane	Channel	Frequency (MHz)	LVL (dBm)	Correction Factor (dB)	EIRP (dBm)	EIRP (mW)	Polarization (H/V)
X	39700	2501.0	-19.83	38.98	19.15	82.22	H
	40620	2593.0	-18.90	38.17	19.27	84.53	
	41540	2685.0	-19.21	38.45	19.24	83.95	
	39700	2501.0	-22.34	39.04	16.70	46.77	V
	40620	2593.0	-21.95	38.68	16.73	47.10	
	41540	2685.0	-21.92	38.60	16.68	46.56	
Channel Bandwidth: 10 MHz / 16QAM							
X	39700	2501.0	-20.90	38.98	18.08	64.27	H
	40620	2593.0	-20.02	38.17	18.15	65.31	
	41540	2685.0	-20.31	38.45	18.14	65.16	
	39700	2501.0	-23.54	39.04	15.50	35.48	V
	40620	2593.0	-23.14	38.68	15.54	35.81	
	41540	2685.0	-23.09	38.60	15.51	35.56	

LTE Band 41							
Channel Bandwidth: 15 MHz / QPSK							
Plane	Channel	Frequency (MHz)	LVL (dBm)	Correction Factor (dB)	EIRP (dBm)	EIRP (mW)	Polarization (H/V)
X	39725	2503.5	-19.71	39.09	19.38	86.70	H
	40620	2593.0	-18.76	38.17	19.41	87.30	
	41515	2682.5	-19.15	38.52	19.37	86.50	
	39725	2503.5	-22.21	39.04	16.83	48.19	V
	40620	2593.0	-21.84	38.68	16.84	48.31	
	41515	2682.5	-21.89	38.66	16.77	47.53	
Channel Bandwidth: 15 MHz / 16QAM							
X	39725	2503.5	-20.89	39.09	18.20	66.07	H
	40620	2593.0	-19.95	38.17	18.22	66.37	
	41515	2682.5	-20.33	38.52	18.19	65.92	
	39725	2503.5	-23.43	39.04	15.61	36.39	V
	40620	2593.0	-23.01	38.68	15.67	36.90	
	41515	2682.5	-23.01	38.66	15.65	36.73	

LTE Band 41							
Channel Bandwidth: 20 MHz / QPSK							
Plane	Channel	Frequency (MHz)	LVL (dBm)	Correction Factor (dB)	EIRP (dBm)	EIRP (mW)	Polarization (H/V)
X	39750	2506.0	-19.73	39.26	19.53	89.74	H
	40620	2593.0	-18.62	38.17	19.55	90.16	
	41490	2680.0	-19.23	38.71	19.48	88.72	
	39750	2506.0	-22.46	39.33	16.87	48.64	V
	40620	2593.0	-21.73	38.68	16.95	49.55	
	41490	2680.0	-21.86	38.76	16.90	48.98	
Channel Bandwidth: 20 MHz / 16QAM							
X	39750	2506.0	-20.94	39.26	18.32	67.92	H
	40620	2593.0	-19.83	38.17	18.34	68.23	
	41490	2680.0	-20.40	38.71	18.31	67.76	
	39750	2506.0	-23.61	39.33	15.72	37.33	V
	40620	2593.0	-22.87	38.68	15.81	38.11	
	41490	2680.0	-22.99	38.76	15.77	37.76	

4.2 Frequency Stability Measurement

4.2.1 Limits of Frequency Stability Measurement

The frequency stability shall be sufficient to ensure that the fundamental emissions stay within the authorized bands of operation.

4.2.2 Test Procedure

- a. Device is placed at the oven room. The oven room could control the temperatures and humidity. Power warm up is at least 15 min and power applied should perform before recording frequency error.
- b. EUT is connected the external power supply to control the DC input power. The test voltage range is from minimum to maximum working voltage. Each step shall be record the frequency error rate.
- c. The temperature range step is 10 degrees in this test items. All temperature levels shall be hold the ± 0.5 °C during the measurement testing. The each temperature step shall be at least 0.5 hours, consider the EUT could be test under the stability condition.

NOTE: The frequency error was recorded frequency error from the communication simulator.

4.2.3 Test Setup

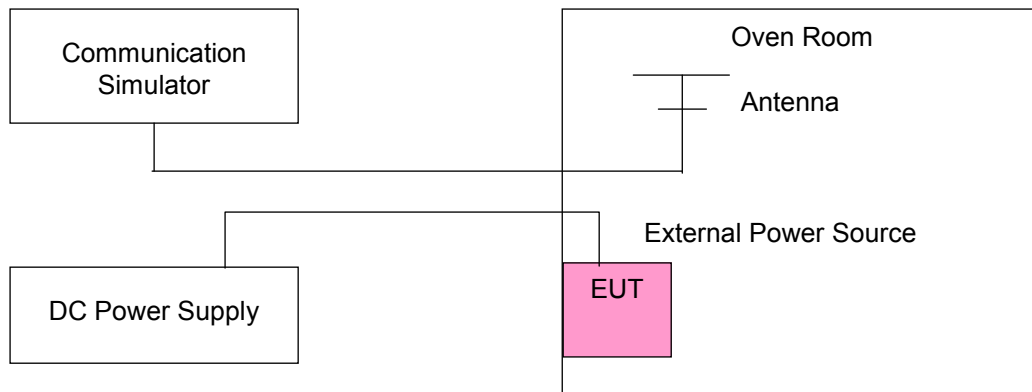

4.2.4 Test Results

Frequency Error vs. Voltage

Voltage (Volts)	LTE Band 7				Limit (ppm)
	Channel Bandwidth: 5 MHz				
	Low Channel		High Channel		
	Frequency (MHz)	Frequency Error (ppm)	Frequency (MHz)	Frequency Error (ppm)	
3.3	2502.500003	0.001	2567.500004	0.001	2.5
3.14	2502.500002	0.001	2567.500003	0.001	2.5
4.4	2502.500002	0.001	2567.500001	0.001	2.5

Note: The applicant defined the normal working voltage of the battery is from 3.14 Vdc to 4.4 Vdc.

Frequency Error vs. Temperature

Temp. (°C)	LTE Band 7				Limit (ppm)
	Channel Bandwidth: 5 MHz				
	Low Channel		High Channel		
	Frequency (MHz)	Frequency Error (ppm)	Frequency (MHz)	Frequency Error (ppm)	
-20	2502.500003	0.001	2567.500002	0.001	2.5
-10	2502.500002	0.001	2567.500003	0.001	2.5
0	2502.500003	0.001	2567.500001	0.000	2.5
10	2502.500004	0.002	2567.500003	0.001	2.5
20	2502.499998	-0.001	2567.499999	-0.001	2.5
30	2502.499997	-0.001	2567.499998	-0.001	2.5
40	2502.499998	-0.001	2567.499999	-0.001	2.5
50	2502.499997	-0.001	2567.499998	-0.001	2.5
55	2502.499998	-0.001	2567.499998	-0.001	2.5

Frequency Error vs. Voltage

Voltage (Volts)	LTE Band 7				Limit (ppm)
	Channel Bandwidth: 10 MHz				
	Low Channel		High Channel		
	Frequency (MHz)	Frequency Error (ppm)	Frequency (MHz)	Frequency Error (ppm)	
3.3	2505.000003	0.001	2565.000003	0.001	2.5
3.14	2505.000002	0.001	2565.000002	0.001	2.5
4.4	2505.000002	0.001	2565.000002	0.001	2.5

Note: The applicant defined the normal working voltage of the battery is from 3.14 Vdc to 4.4 Vdc.

Frequency Error vs. Temperature

Temp. (°C)	LTE Band 7				Limit (ppm)
	Channel Bandwidth: 10 MHz				
	Low Channel		High Channel		
	Frequency (MHz)	Frequency Error (ppm)	Frequency (MHz)	Frequency Error (ppm)	
-20	2505.000003	0.001	2565.000001	0.000	2.5
-10	2505.000003	0.001	2565.000003	0.001	2.5
0	2505.000002	0.001	2565.000001	0.000	2.5
10	2505.000002	0.001	2565.000001	0.001	2.5
20	2504.999998	-0.001	2564.999999	0.000	2.5
30	2504.999998	-0.001	2564.999998	-0.001	2.5
40	2504.999997	-0.001	2564.999996	-0.001	2.5
50	2504.999997	-0.001	2564.999997	-0.001	2.5
55	2504.999998	-0.001	2564.999997	-0.001	2.5

Frequency Error vs. Voltage

Voltage (Volts)	LTE Band 7				Limit (ppm)
	Channel Bandwidth: 15 MHz				
	Low Channel		High Channel		
	Frequency (MHz)	Frequency Error (ppm)	Frequency (MHz)	Frequency Error (ppm)	
3.3	2507.500003	0.001	2562.500001	0.001	2.5
3.14	2507.500001	0.001	2562.500002	0.001	2.5
4.4	2507.500001	0.001	2562.500003	0.001	2.5

Note: The applicant defined the normal working voltage of the battery is from 3.14 Vdc to 4.4 Vdc.

Frequency Error vs. Temperature

Temp. (°C)	LTE Band 7				Limit (ppm)
	Channel Bandwidth: 15 MHz				
	Low Channel		High Channel		
	Frequency (MHz)	Frequency Error (ppm)	Frequency (MHz)	Frequency Error (ppm)	
-20	2507.500004	0.002	2562.500003	0.001	2.5
-10	2507.500004	0.002	2562.500002	0.001	2.5
0	2507.500004	0.002	2562.500003	0.001	2.5
10	2507.500004	0.002	2562.500004	0.002	2.5
20	2507.499998	-0.001	2562.499997	-0.001	2.5
30	2507.499998	-0.001	2562.499996	-0.001	2.5
40	2507.499998	-0.001	2562.499997	-0.001	2.5
50	2507.499998	-0.001	2562.499997	-0.001	2.5
55	2507.499998	-0.001	2562.499998	-0.001	2.5

Frequency Error vs. Voltage

Voltage (Volts)	LTE Band 7				Limit (ppm)
	Channel Bandwidth: 20 MHz				
	Low Channel		High Channel		
	Frequency (MHz)	Frequency Error (ppm)	Frequency (MHz)	Frequency Error (ppm)	
3.3	2510.000004	0.001	2560.000004	0.001	2.5
3.14	2510.000003	0.001	2560.000002	0.001	2.5
4.4	2510.000001	0.000	2560.000002	0.001	2.5

Note: The applicant defined the normal working voltage of the battery is from 3.14 Vdc to 4.4 Vdc.

Frequency Error vs. Temperature

Temp. (°C)	LTE Band 7				Limit (ppm)
	Channel Bandwidth: 20 MHz				
	Low Channel		High Channel		
	Frequency (MHz)	Frequency Error (ppm)	Frequency (MHz)	Frequency Error (ppm)	
-20	2510.000001	0.001	2560.000003	0.001	2.5
-10	2510.000001	0.000	2560.000003	0.001	2.5
0	2510.000002	0.001	2560.000001	0.001	2.5
10	2510.000003	0.001	2560.000004	0.001	2.5
20	2509.999996	-0.002	2559.999996	-0.002	2.5
30	2509.999997	-0.001	2559.999997	-0.001	2.5
40	2509.999998	-0.001	2559.999998	-0.001	2.5
50	2509.999998	-0.001	2559.999996	-0.002	2.5
55	2509.999999	-0.001	2559.999997	-0.001	2.5

Frequency Error vs. Voltage

Voltage (Volts)	LTE Band 38				Limit (ppm)
	Channel Bandwidth: 5 MHz				
	Low Channel		High Channel		
	Frequency (MHz)	Frequency Error (ppm)	Frequency (MHz)	Frequency Error (ppm)	
3.3	2572.500003	0.001	2617.500003	0.001	2.5
3.14	2572.500001	0.001	2617.500003	0.001	2.5
4.4	2572.500004	0.001	2617.500003	0.001	2.5

Note: The applicant defined the normal working voltage of the battery is from 3.14 Vdc to 4.4 Vdc.

Frequency Error vs. Temperature

Temp. (°C)	LTE Band 38				Limit (ppm)
	Channel Bandwidth: 5 MHz				
	Low Channel		High Channel		
	Frequency (MHz)	Frequency Error (ppm)	Frequency (MHz)	Frequency Error (ppm)	
-20	2572.500003	0.001	2617.500002	0.001	2.5
-10	2572.500002	0.001	2617.500003	0.001	2.5
0	2572.500001	0.000	2617.500004	0.001	2.5
10	2572.500003	0.001	2617.500002	0.001	2.5
20	2572.499998	-0.001	2617.499998	-0.001	2.5
30	2572.499997	-0.001	2617.499997	-0.001	2.5
40	2572.499997	-0.001	2617.499999	0.000	2.5
50	2572.499998	-0.001	2617.499999	0.000	2.5
55	2572.499997	-0.001	2617.499998	-0.001	2.5

Frequency Error vs. Voltage

Voltage (Volts)	LTE Band 38				Limit (ppm)
	Channel Bandwidth: 10 MHz				
	Low Channel		High Channel		
	Frequency (MHz)	Frequency Error (ppm)	Frequency (MHz)	Frequency Error (ppm)	
3.3	2575.000001	0.000	2615.000004	0.001	2.5
3.14	2575.000003	0.001	2615.000001	0.001	2.5
4.4	2575.000001	0.000	2615.000001	0.000	2.5

Note: The applicant defined the normal working voltage of the battery is from 3.14 Vdc to 4.4 Vdc.

Frequency Error vs. Temperature

Temp. (°C)	LTE Band 38				Limit (ppm)
	Channel Bandwidth: 10 MHz				
	Low Channel		High Channel		
	Frequency (MHz)	Frequency Error (ppm)	Frequency (MHz)	Frequency Error (ppm)	
-20	2575.000002	0.001	2615.000002	0.001	2.5
-10	2575.000002	0.001	2615.000004	0.001	2.5
0	2575.000001	0.000	2615.000002	0.001	2.5
10	2575.000004	0.001	2615.000004	0.001	2.5
20	2574.999997	-0.001	2614.999998	-0.001	2.5
30	2574.999996	-0.001	2614.999996	-0.002	2.5
40	2574.999997	-0.001	2614.999998	-0.001	2.5
50	2574.999996	-0.001	2614.999997	-0.001	2.5
55	2574.999998	-0.001	2614.999998	-0.001	2.5

Frequency Error vs. Voltage

Voltage (Volts)	LTE Band 38				Limit (ppm)
	Channel Bandwidth: 15 MHz				
	Low Channel		High Channel		
	Frequency (MHz)	Frequency Error (ppm)	Frequency (MHz)	Frequency Error (ppm)	
3.3	2577.500002	0.001	2612.500002	0.001	2.5
3.14	2577.500003	0.001	2612.500002	0.001	2.5
4.4	2577.500001	0.000	2612.500002	0.001	2.5

Note: The applicant defined the normal working voltage of the battery is from 3.14 Vdc to 4.4 Vdc.

Frequency Error vs. Temperature

Temp. (°C)	LTE Band 38				Limit (ppm)
	Channel Bandwidth: 15 MHz				
	Low Channel		High Channel		
	Frequency (MHz)	Frequency Error (ppm)	Frequency (MHz)	Frequency Error (ppm)	
-20	2577.500001	0.000	2612.500003	0.001	2.5
-10	2577.500003	0.001	2612.500004	0.001	2.5
0	2577.500003	0.001	2612.500003	0.001	2.5
10	2577.500003	0.001	2612.500002	0.001	2.5
20	2577.499998	-0.001	2612.499999	0.000	2.5
30	2577.499997	-0.001	2612.499998	-0.001	2.5
40	2577.499996	-0.001	2612.499996	-0.001	2.5
50	2577.499998	-0.001	2612.499998	-0.001	2.5
55	2577.499997	-0.001	2612.499997	-0.001	2.5

Frequency Error vs. Voltage

Voltage (Volts)	LTE Band 38				Limit (ppm)
	Channel Bandwidth: 20 MHz				
	Low Channel		High Channel		
	Frequency (MHz)	Frequency Error (ppm)	Frequency (MHz)	Frequency Error (ppm)	
3.3	2580.000004	0.002	2610.000004	0.001	2.5
3.14	2580.000004	0.001	2610.000002	0.001	2.5
4.4	2580.000003	0.001	2610.000003	0.001	2.5

Note: The applicant defined the normal working voltage of the battery is from 3.14 Vdc to 4.4 Vdc.

Frequency Error vs. Temperature

Temp. (°C)	LTE Band 38				Limit (ppm)
	Channel Bandwidth: 20 MHz				
	Low Channel		High Channel		
	Frequency (MHz)	Frequency Error (ppm)	Frequency (MHz)	Frequency Error (ppm)	
-20	2580.000002	0.001	2610.000002	0.001	2.5
-10	2580.000002	0.001	2610.000002	0.001	2.5
0	2580.000003	0.001	2610.000001	0.000	2.5
10	2580.000004	0.001	2610.000004	0.002	2.5
20	2579.999997	-0.001	2609.999998	-0.001	2.5
30	2579.999998	-0.001	2609.999998	-0.001	2.5
40	2579.999997	-0.001	2609.999997	-0.001	2.5
50	2579.999998	-0.001	2609.999999	0.000	2.5
55	2579.999998	-0.001	2609.999997	-0.001	2.5

Frequency Error vs. Voltage

Voltage (Volts)	LTE Band 41				Limit (ppm)
	Channel Bandwidth: 5 MHz				
	Low Channel		High Channel		
	Frequency (MHz)	Frequency Error (ppm)	Frequency (MHz)	Frequency Error (ppm)	
3.3	2498.500003	0.001	2687.500002	0.001	2.5
3.14	2498.500002	0.001	2687.500002	0.001	2.5
4.4	2498.500002	0.001	2687.500002	0.001	2.5

Note: The applicant defined the normal working voltage of the battery is from 3.14 Vdc to 4.4 Vdc.

Frequency Error vs. Temperature

Temp. (°C)	LTE Band 41				Limit (ppm)
	Channel Bandwidth: 5 MHz				
	Low Channel		High Channel		
	Frequency (MHz)	Frequency Error (ppm)	Frequency (MHz)	Frequency Error (ppm)	
-20	2498.500001	0.000	2687.500002	0.001	2.5
-10	2498.500002	0.001	2687.500003	0.001	2.5
0	2498.500002	0.001	2687.500004	0.001	2.5
10	2498.500004	0.001	2687.500001	0.000	2.5
20	2498.499999	-0.001	2687.499999	0.000	2.5
30	2498.499996	-0.002	2687.499997	-0.001	2.5
40	2498.499998	-0.001	2687.499998	-0.001	2.5
50	2498.499999	0.000	2687.499998	-0.001	2.5
55	2498.499996	-0.002	2687.499999	0.000	2.5

Frequency Error vs. Voltage

Voltage (Volts)	LTE Band 41				Limit (ppm)
	Channel Bandwidth: 10 MHz				
	Low Channel		High Channel		
	Frequency (MHz)	Frequency Error (ppm)	Frequency (MHz)	Frequency Error (ppm)	
3.3	2501.000002	0.001	2685.000001	0.001	2.5
3.14	2501.000003	0.001	2685.000002	0.001	2.5
4.4	2501.000003	0.001	2685.000002	0.001	2.5

Note: The applicant defined the normal working voltage of the battery is from 3.14 Vdc to 4.4 Vdc.

Frequency Error vs. Temperature

Temp. (°C)	LTE Band 41				Limit (ppm)
	Channel Bandwidth: 10 MHz				
	Low Channel		High Channel		
	Frequency (MHz)	Frequency Error (ppm)	Frequency (MHz)	Frequency Error (ppm)	
-20	2501.000003	0.001	2685.000002	0.001	2.5
-10	2501.000003	0.001	2685.000001	0.000	2.5
0	2501.000003	0.001	2685.000001	0.000	2.5
10	2501.000002	0.001	2685.000002	0.001	2.5
20	2500.999997	-0.001	2684.999998	-0.001	2.5
30	2500.999997	-0.001	2684.999997	-0.001	2.5
40	2500.999998	-0.001	2684.999998	-0.001	2.5
50	2500.999998	-0.001	2684.999997	-0.001	2.5
55	2500.999996	-0.002	2684.999998	-0.001	2.5

Frequency Error vs. Voltage

Voltage (Volts)	LTE Band 41				Limit (ppm)
	Channel Bandwidth: 15 MHz				
	Low Channel		High Channel		
	Frequency (MHz)	Frequency Error (ppm)	Frequency (MHz)	Frequency Error (ppm)	
3.3	2503.500003	0.001	2682.500003	0.001	2.5
3.14	2503.500002	0.001	2682.500004	0.001	2.5
4.4	2503.500003	0.001	2682.500004	0.001	2.5

Note: The applicant defined the normal working voltage of the battery is from 3.14 Vdc to 4.4 Vdc.

Frequency Error vs. Temperature

Temp. (°C)	LTE Band 41				Limit (ppm)
	Channel Bandwidth: 15 MHz				
	Low Channel		High Channel		
	Frequency (MHz)	Frequency Error (ppm)	Frequency (MHz)	Frequency Error (ppm)	
-20	2503.500003	0.001	2682.500003	0.001	2.5
-10	2503.500003	0.001	2682.500003	0.001	2.5
0	2503.500002	0.001	2682.500003	0.001	2.5
10	2503.500001	0.000	2682.500003	0.001	2.5
20	2503.499999	-0.001	2682.499996	-0.001	2.5
30	2503.499996	-0.001	2682.499997	-0.001	2.5
40	2503.499999	0.000	2682.499997	-0.001	2.5
50	2503.499998	-0.001	2682.499999	0.000	2.5
55	2503.499997	-0.001	2682.499999	-0.001	2.5

Frequency Error vs. Voltage

Voltage (Volts)	LTE Band 41				Limit (ppm)
	Channel Bandwidth: 20 MHz				
	Low Channel		High Channel		
	Frequency (MHz)	Frequency Error (ppm)	Frequency (MHz)	Frequency Error (ppm)	
3.3	2506.000003	0.001	2680.000002	0.001	2.5
3.14	2506.000003	0.001	2680.000002	0.001	2.5
4.4	2506.000002	0.001	2680.000003	0.001	2.5

Note: The applicant defined the normal working voltage of the battery is from 3.14 Vdc to 4.4 Vdc.

Frequency Error vs. Temperature

Temp. (°C)	LTE Band 41				Limit (ppm)
	Channel Bandwidth: 20 MHz				
	Low Channel		High Channel		
	Frequency (MHz)	Frequency Error (ppm)	Frequency (MHz)	Frequency Error (ppm)	
-20	2506.000002	0.001	2680.000001	0.000	2.5
-10	2506.000002	0.001	2680.000004	0.001	2.5
0	2506.000004	0.001	2680.000004	0.001	2.5
10	2506.000003	0.001	2680.000002	0.001	2.5
20	2505.999998	-0.001	2679.999997	-0.001	2.5
30	2505.999998	-0.001	2679.999998	-0.001	2.5
40	2505.999998	-0.001	2679.999998	-0.001	2.5
50	2505.999999	0.000	2679.999997	-0.001	2.5
55	2505.999997	-0.001	2679.999999	0.000	2.5

4.3 Occupied Bandwidth Measurement

4.3.1 Limits of Occupied Bandwidth Measurement

The width of a frequency band such that, below the lower and above the upper frequency limits, the mean powers emitted are each equal to a specified percentage 0.5 % of the total mean power of a given emission.

4.3.2 Test Procedure

- The conducted occupied bandwidth used the power splitter via EUT RF power connector between simulation base station and spectrum analyzer.
- Use OBW measurement function of Spectrum analyzer to measure 99 % occupied bandwidth.

4.3.3 Test Setup

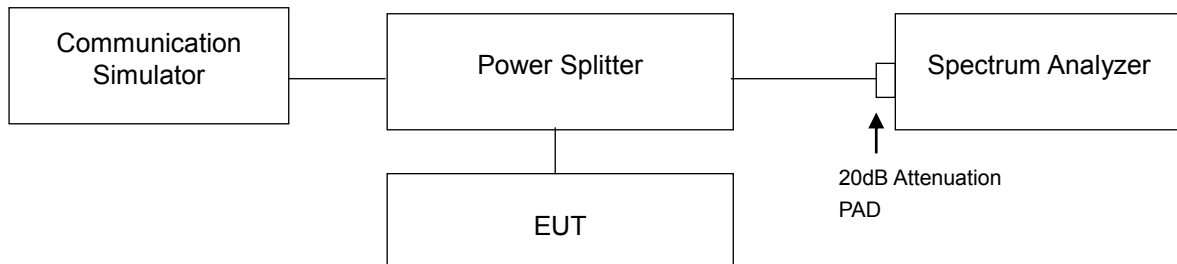

4.3.4 Test Result

LTE Band 7							
Channel Bandwidth: 5 MHz				Channel Bandwidth: 10 MHz			
Channel	Frequency (MHz)	99 % Occupied Bandwidth (MHz)		Channel	Frequency (MHz)	99 % Occupied Bandwidth (MHz)	
		QPSK	16QAM			QPSK	16QAM
20775	2502.5	4.50	4.50	20800	2505.0	8.97	8.98
21100	2535.0	4.51	4.50	21100	2535.0	8.99	8.98
21425	2567.5	4.51	4.50	21400	2565.0	8.99	8.98

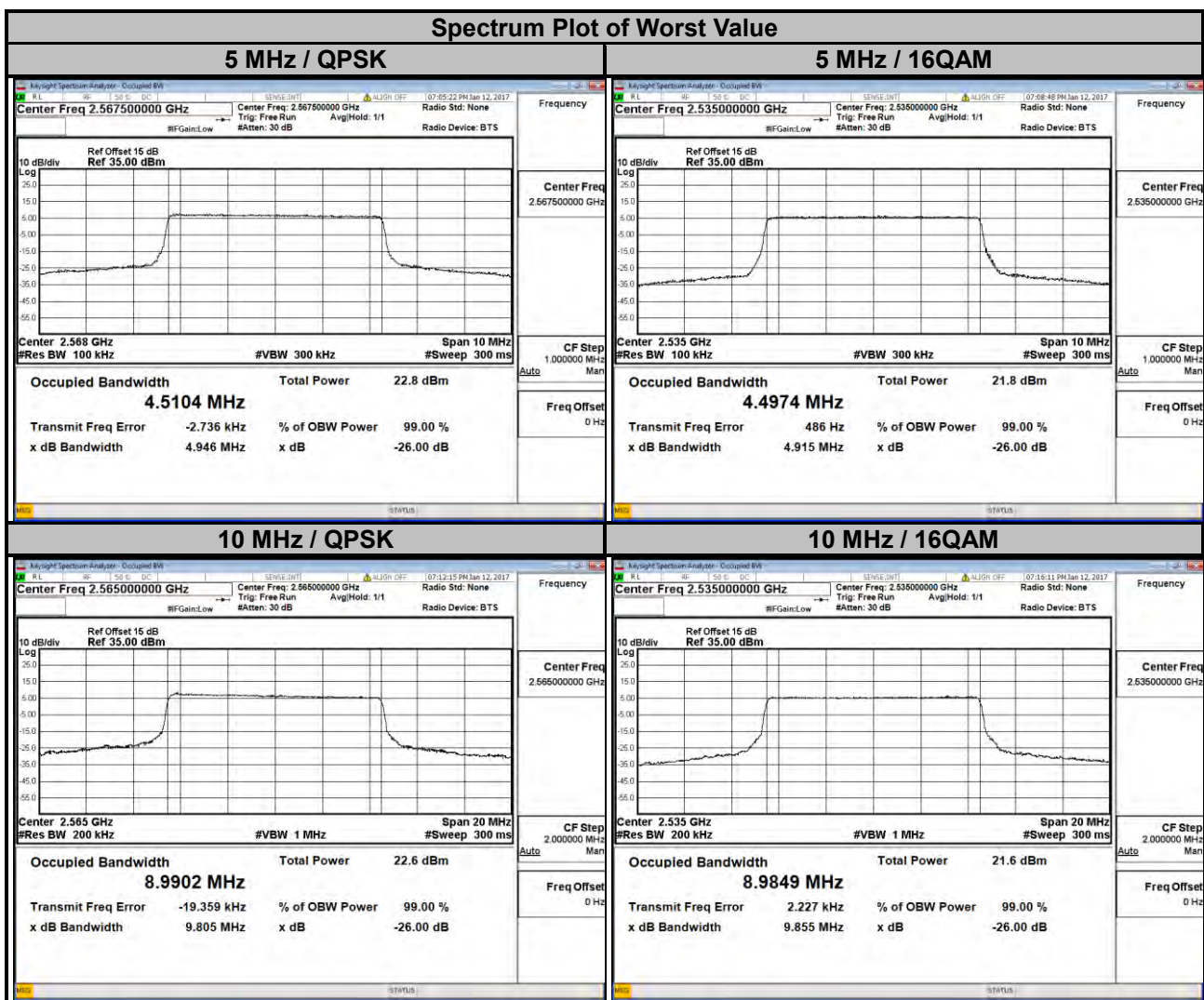

LTE Band 7

Channel Bandwidth: 15 MHz				Channel Bandwidth: 20 MHz			
Channel	Frequency (MHz)	99 % Occupied Bandwidth (MHz)		Channel	Frequency (MHz)	99 % Occupied Bandwidth (MHz)	
		QPSK	16QAM			QPSK	16QAM
20825	2507.5	13.43	13.44	20850	2510.0	17.91	17.91
21100	2535.0	13.48	13.48	21100	2535.0	18.01	18.00
21375	2562.5	13.46	13.45	21350	2560.0	17.93	17.93

Spectrum Plot of Worst Value

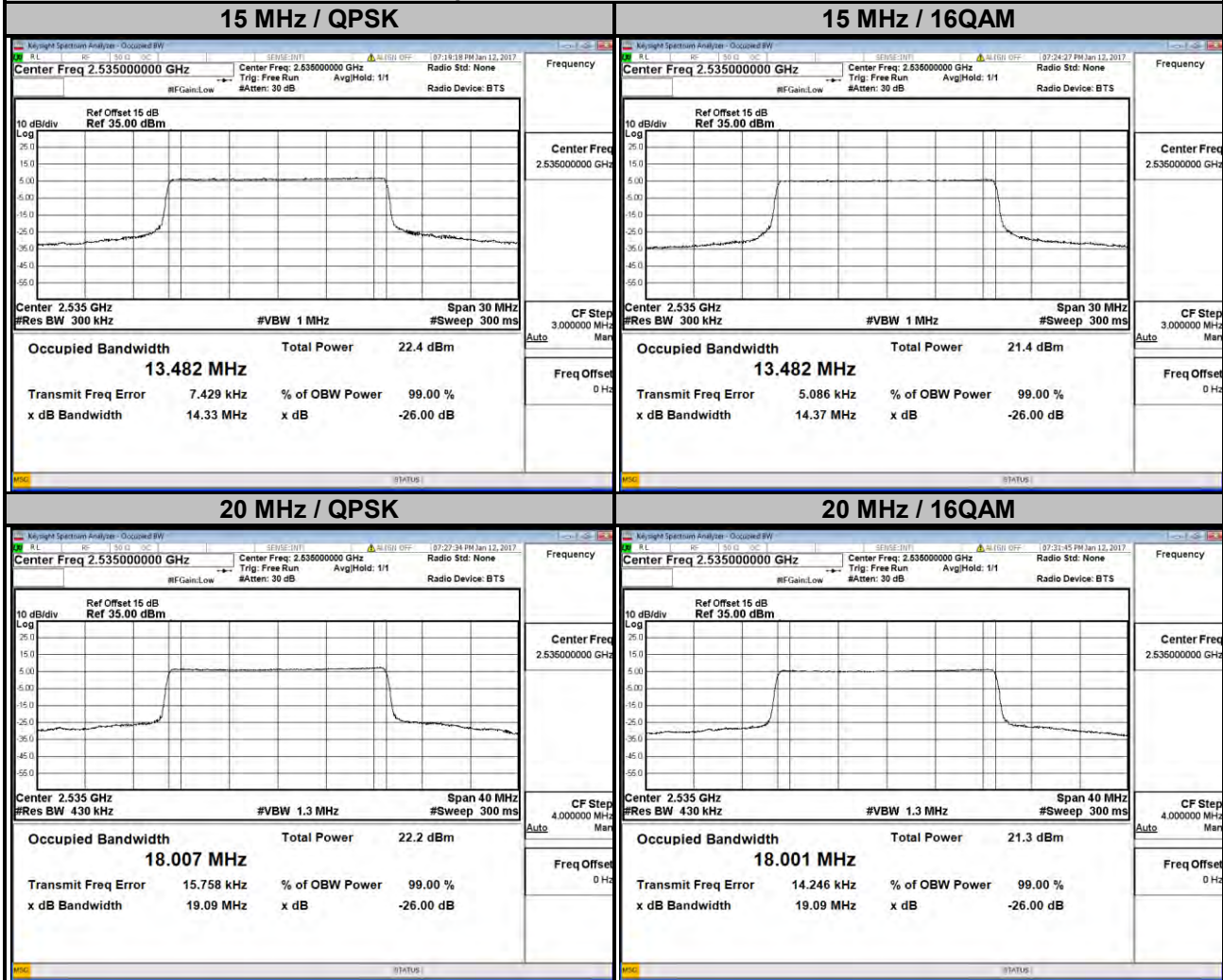

LTE Band 38

Channel Bandwidth: 5 MHz				Channel Bandwidth: 10 MHz			
Channel	Frequency (MHz)	99 % Occupied Bandwidth (MHz)		Channel	Frequency (MHz)	99 % Occupied Bandwidth (MHz)	
		QPSK	16QAM			QPSK	16QAM
37775	2572.5	4.50	4.49	37800	2575	8.99	8.99
38000	2595	4.49	4.49	38000	2595	8.98	8.99
38225	2617.5	4.49	4.48	38200	2615	8.99	8.99

Spectrum Plot of Worst Value

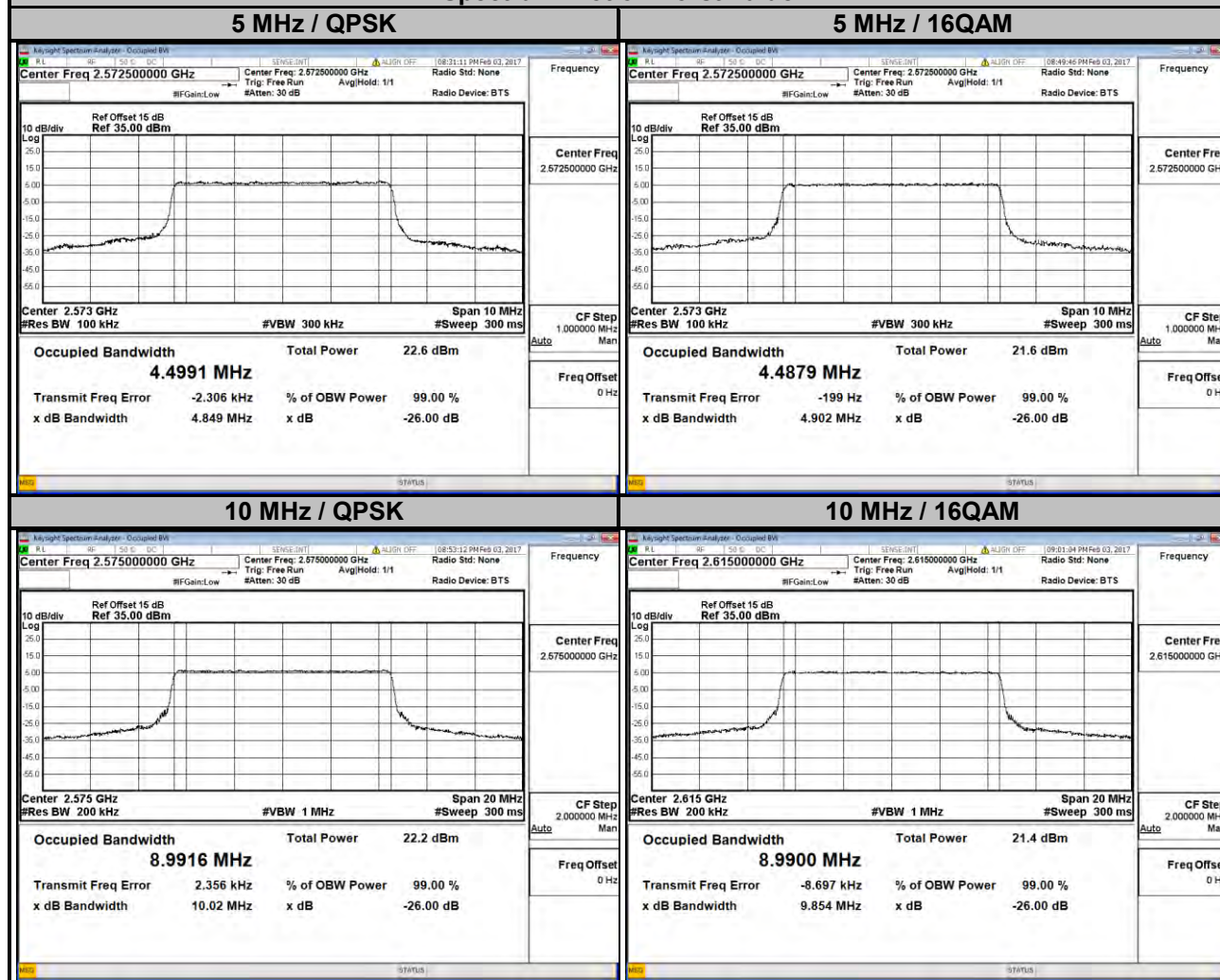

LTE Band 38

Channel Bandwidth: 15 MHz				Channel Bandwidth: 20 MHz			
Channel	Frequency (MHz)	99 % Occupied Bandwidth (MHz)		Channel	Frequency (MHz)	99 % Occupied Bandwidth (MHz)	
		QPSK	16QAM			QPSK	16QAM
37825	2577.5	13.47	13.46	37850	2580	17.97	17.98
38000	2595	13.46	13.47	38000	2595	17.96	17.98
38175	2612.5	13.47	13.46	38150	2610	17.97	17.99

Spectrum Plot of Worst Value

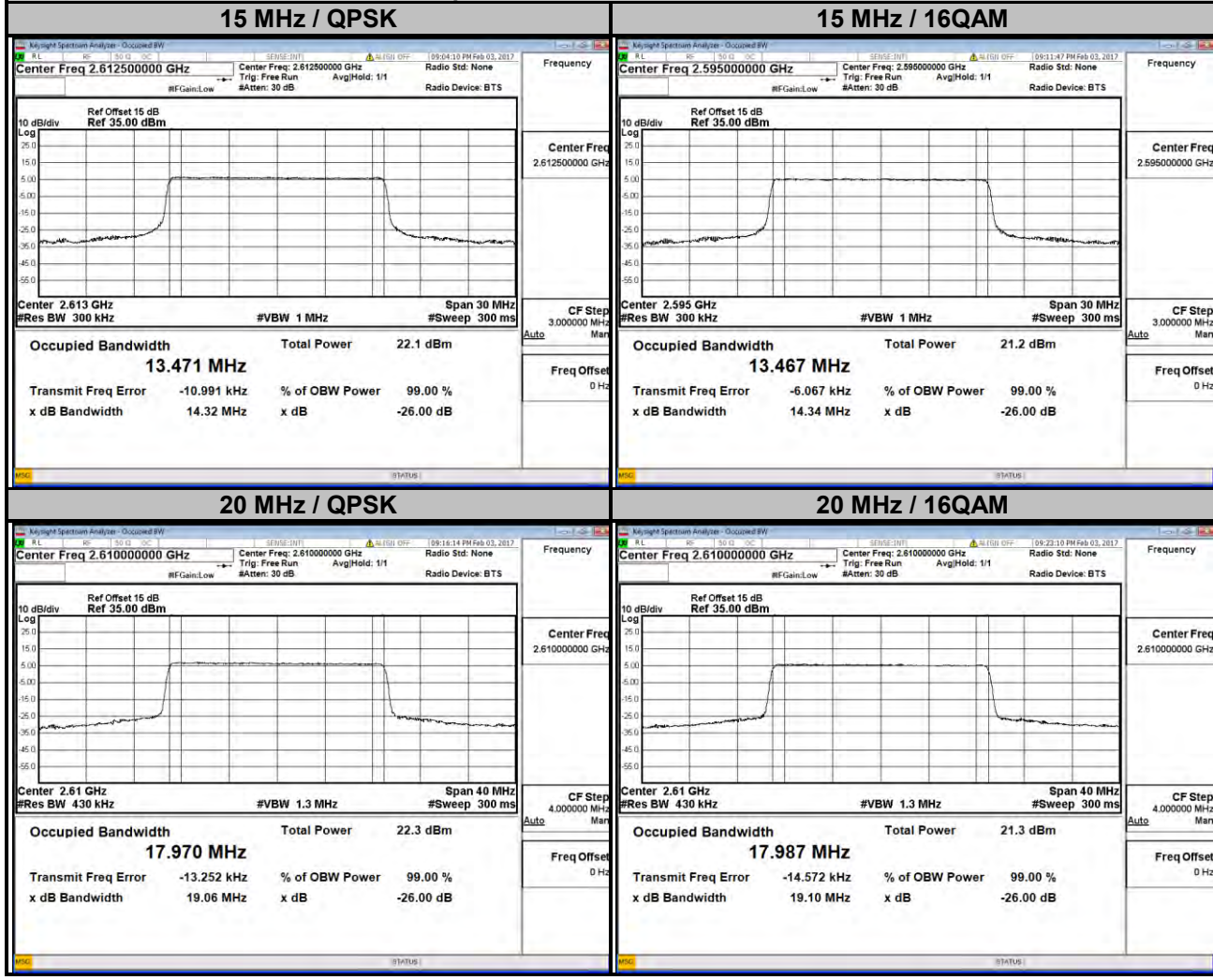

LTE Band 41

Channel Bandwidth: 5 MHz				Channel Bandwidth: 10 MHz			
Channel	Frequency (MHz)	99 % Occupied Bandwidth (MHz)		Channel	Frequency (MHz)	99 % Occupied Bandwidth (MHz)	
		QPSK	16QAM			QPSK	16QAM
39675	2498.5	4.50	4.49	39700	2501.0	8.99	8.97
40620	2593.0	4.50	4.49	40620	2593.0	8.99	8.97
41565	2687.5	4.50	4.49	41540	2685.0	8.99	8.98

Spectrum Plot of Worst Value

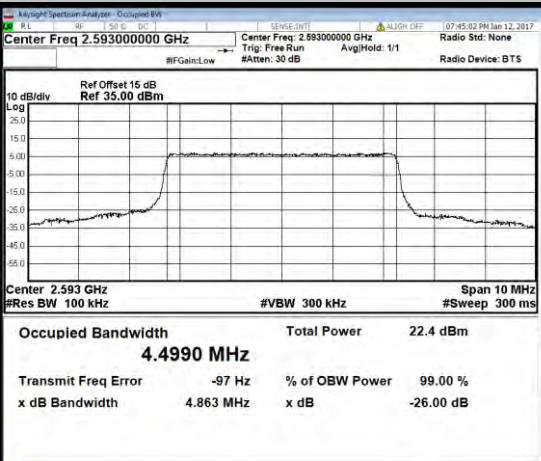
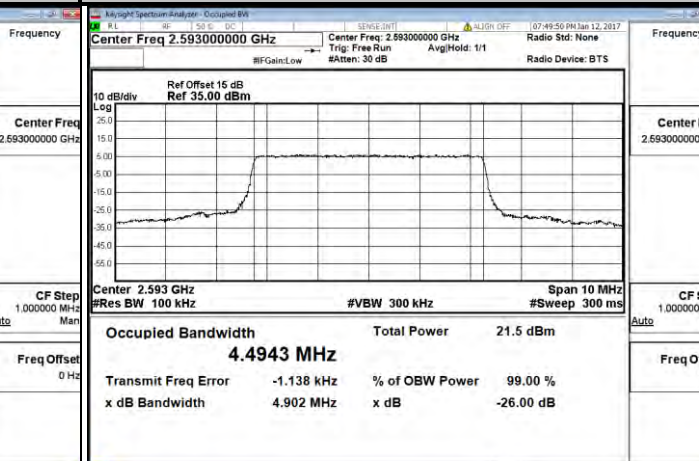
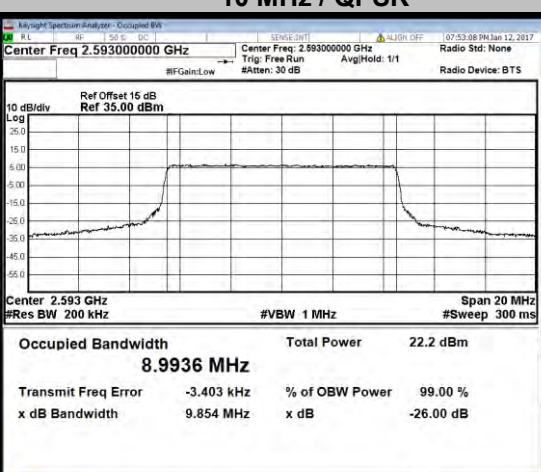
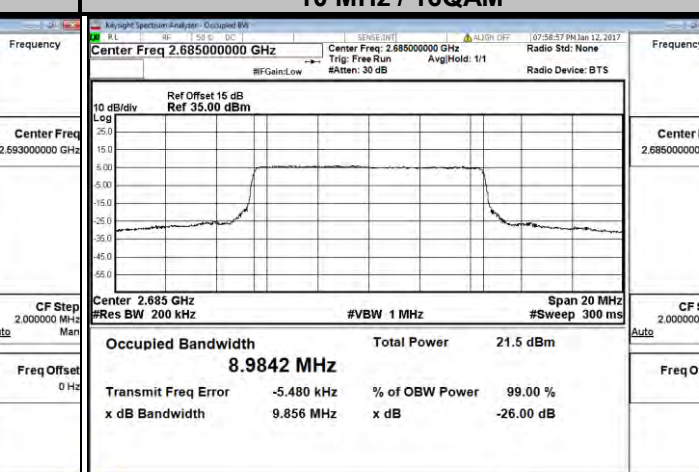
5 MHz / QPSK	5 MHz / 16QAM
 <p>Center Freq 2.593000000 GHz</p> <p>Occupied Bandwidth: 4.4990 MHz</p> <p>Total Power: 22.4 dBm</p> <p>Transmit Freq Error: -97 Hz</p> <p>x dB Bandwidth: 4.863 MHz</p>	 <p>Center Freq 2.593000000 GHz</p> <p>Occupied Bandwidth: 4.4943 MHz</p> <p>Total Power: 21.5 dBm</p> <p>Transmit Freq Error: -1.138 kHz</p> <p>x dB Bandwidth: 4.902 MHz</p>
 <p>Center Freq 2.593000000 GHz</p> <p>Occupied Bandwidth: 8.9936 MHz</p> <p>Total Power: 22.2 dBm</p> <p>Transmit Freq Error: -3.403 kHz</p> <p>x dB Bandwidth: 9.854 MHz</p>	 <p>Center Freq 2.685000000 GHz</p> <p>Occupied Bandwidth: 8.9842 MHz</p> <p>Total Power: 21.5 dBm</p> <p>Transmit Freq Error: -5.480 kHz</p> <p>x dB Bandwidth: 9.856 MHz</p>

LTE Band 41

Channel Bandwidth: 15 MHz				Channel Bandwidth: 20 MHz			
Channel	Frequency (MHz)	99 % Occupied Bandwidth (MHz)		Channel	Frequency (MHz)	99 % Occupied Bandwidth (MHz)	
		QPSK	16QAM			QPSK	16QAM
39725	2503.5	13.48	13.47	39750	2506.0	17.97	17.97
40620	2593.0	13.47	13.46	40620	2593.0	17.97	17.97
41515	2682.5	13.47	13.46	41490	2680.0	17.95	17.96

Spectrum Plot of Worst Value

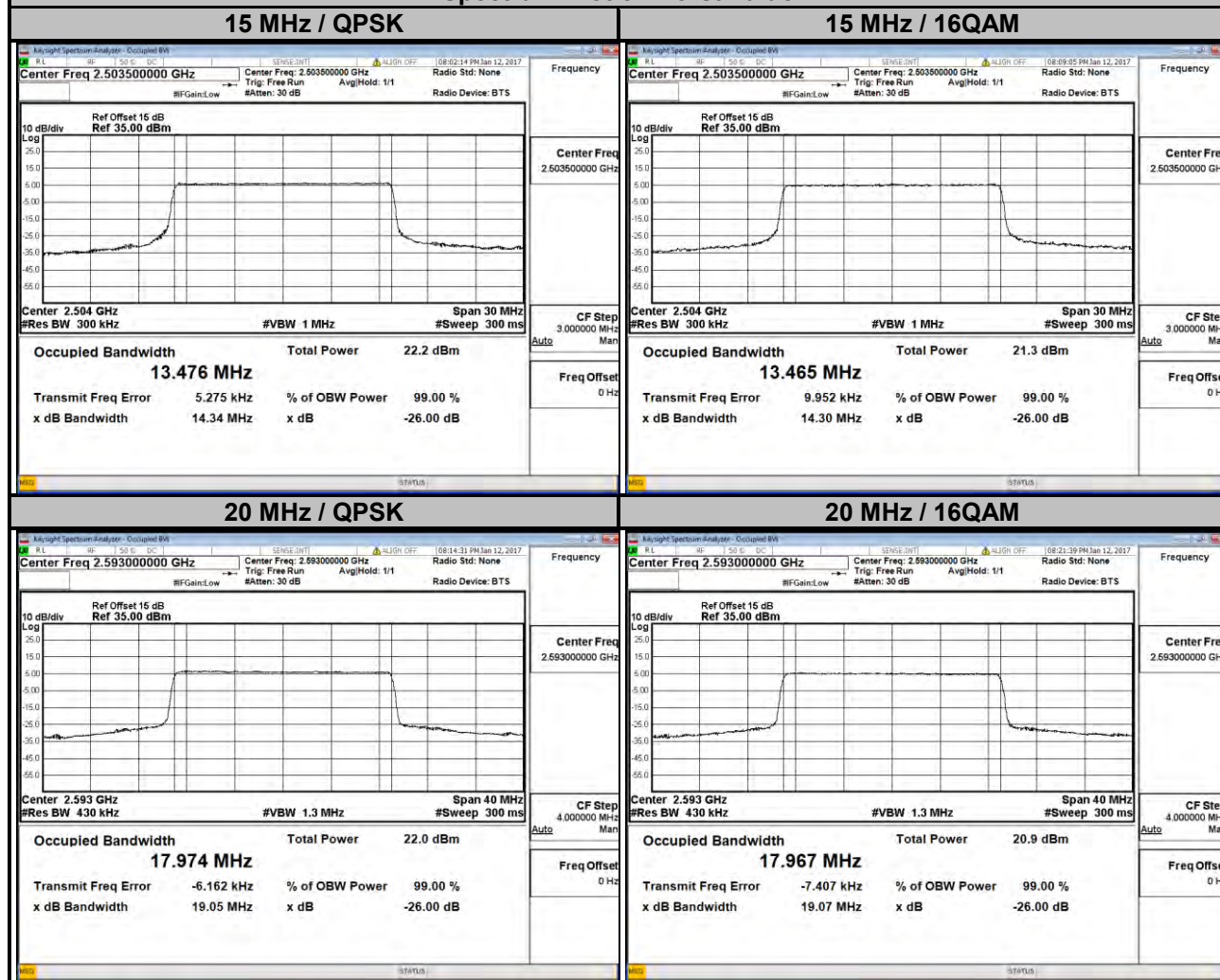

4.4 Band Edge Measurement

4.4.1 Limits of Band Edge Measurement

According to FCC 27.53(l)(4) specified that power of any emission outside of the channel edge must be attenuated below the transmitting power (P) by a factor shall be not less than $40 + 10 \log (P)$ dB on all frequencies between the channel edge and 5 megahertz from the channel edge, $43 + 10 \log (P)$ dB on all frequencies between 5 megahertz and X megahertz from the channel edge, and $55 + 10 \log (P)$ dB on all frequencies more than X megahertz from the channel edge, where X is the greater of 6 megahertz or the actual emission bandwidth. In addition, the attenuation factor shall not be less that $43 + 10 \log (P)$ dB on all frequencies between 2490.5 MHz and 2496 MHz and $55 + 10 \log (P)$ dB at or below 2490.5 MHz. In the 1 MHz bands immediately outside and adjacent to the frequency block a resolution bandwidth of at least two percent may be employed, except when the 1 megahertz band is 2495-2496 MHz, in which case a resolution bandwidth of at least one percent may be employed.

4.4.2 Test Setup

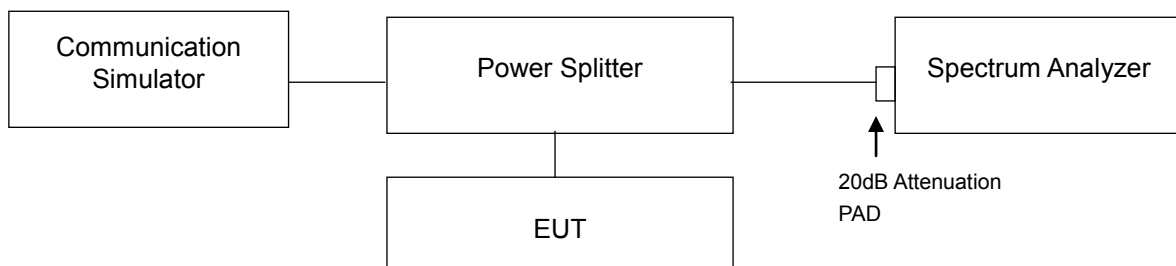

4.4.3 Test Procedures

- a. The EUT was set up for the maximum peak power with LTE link data modulation. The power was measured with R&S Spectrum Analyzer. All measurements were done at 2 channels (low and high operational frequency range.).
- b. The band edge measurement used the power splitter via EUT RF power connector between simulation base station and spectrum analyzer.
- c. The center frequency of spectrum is the band edge frequency and span is 20 MHz. RB of the spectrum is 100 kHz and VB of the spectrum is 300 kHz (Channel bandwidth 5 MHz).
- d. The center frequency of spectrum is the band edge frequency and span is 40 MHz. RB of the spectrum is 100 kHz and VB of the spectrum is 300 kHz (Channel bandwidth 10 MHz).
- e. The center frequency of spectrum is the band edge frequency and span is 60 MHz. RB of the spectrum is 200 kHz and VB of the spectrum is 1 MHz (Channel bandwidth 15 MHz).
- f. The center frequency of spectrum is the band edge frequency and span is 80 MHz. RB of the spectrum is 200 kHz and VB of the spectrum is 1 MHz (Channel bandwidth 20 MHz).
- g. Record the max trace plot into the test report.

4.4.4 Test Results

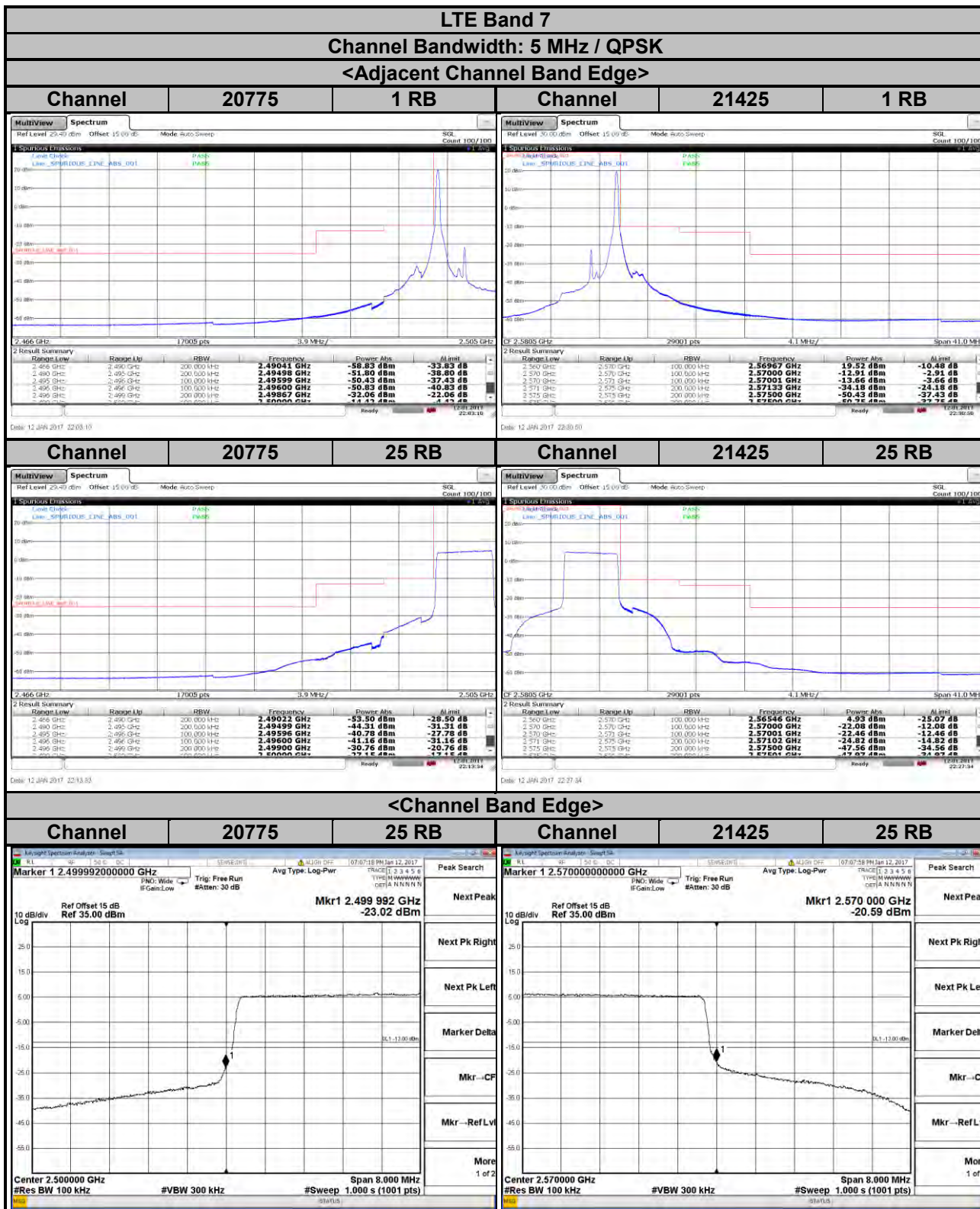

LTE Band 7

Channel Bandwidth: 5 MHz / 16QAM

<Adjacent Channel Band Edge>

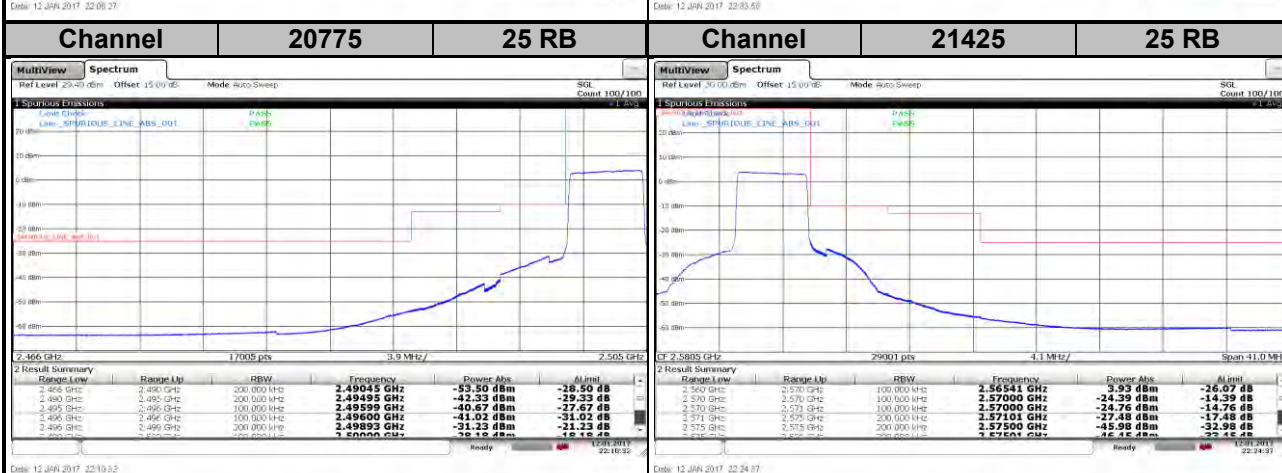
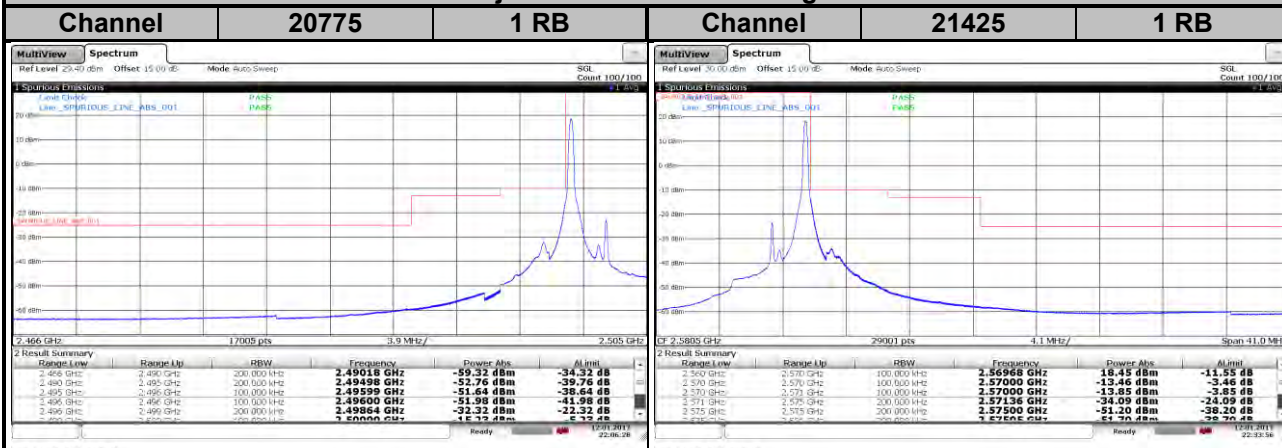

<Channel Band Edge>

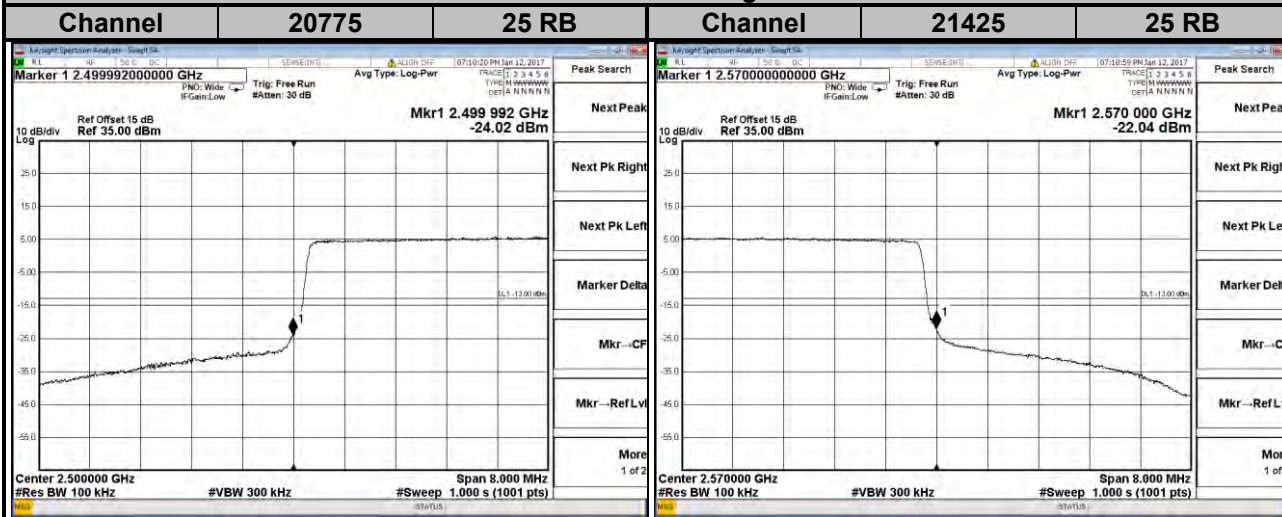

LTE Band 7
Channel Bandwidth: 10 MHz / QPSK
<Adjacent Channel Band Edge>

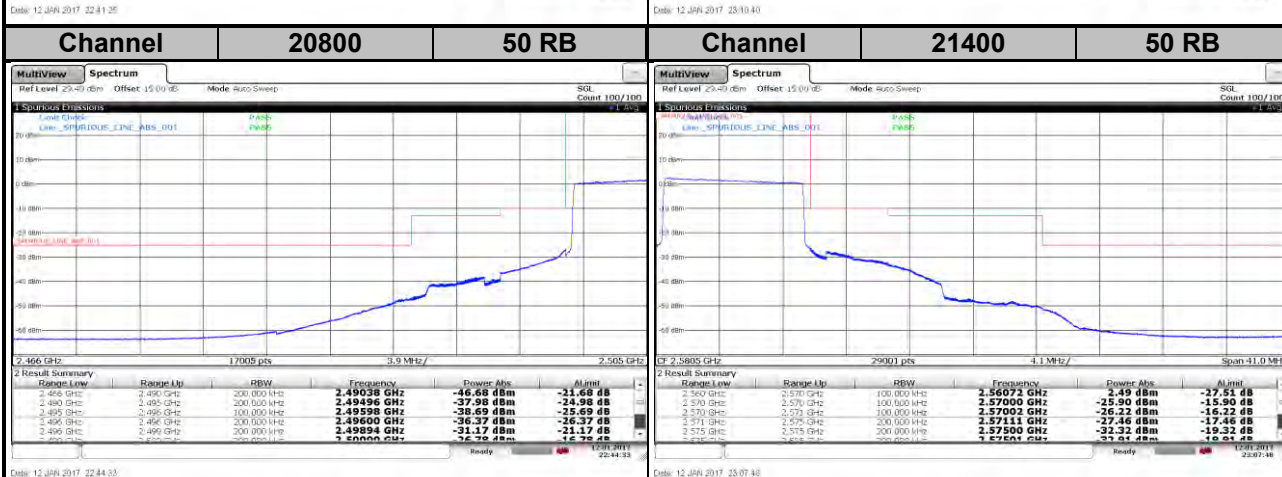
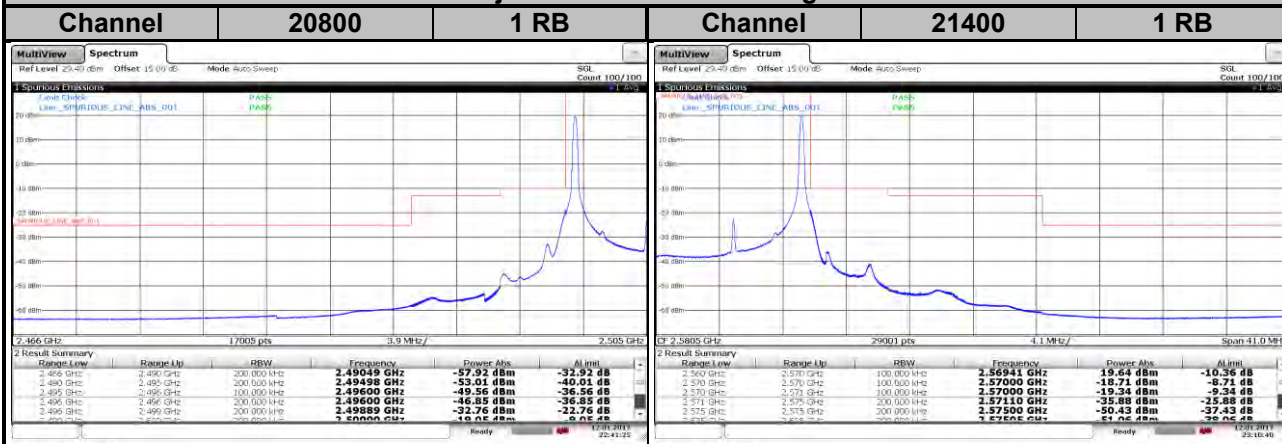

<Channel Band Edge>

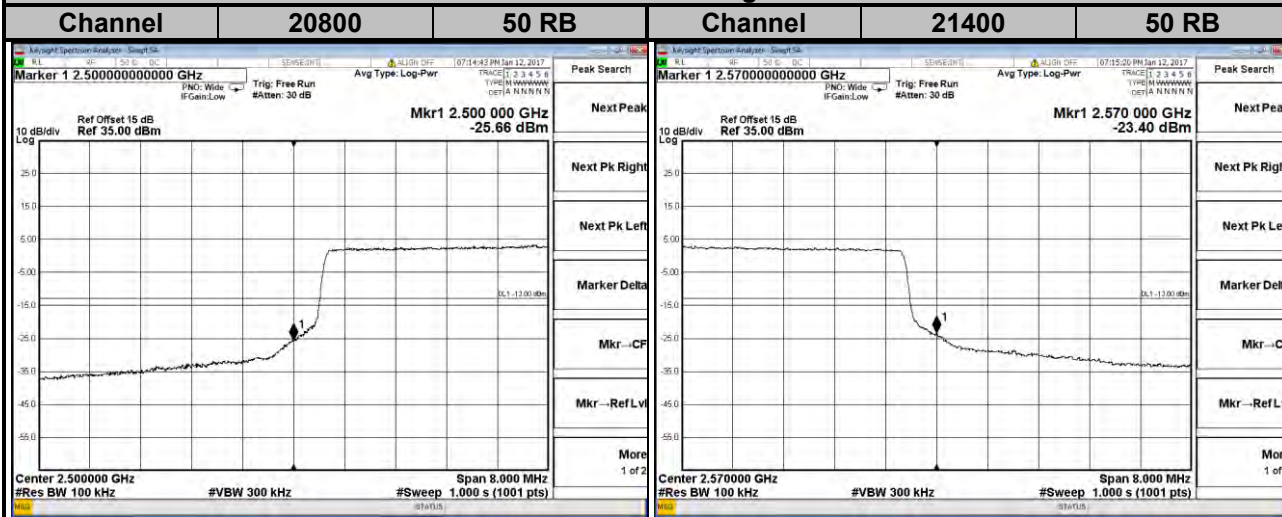

LTE Band 7
Channel Bandwidth: 10 MHz / 16QAM
<Adjacent Channel Band Edge>

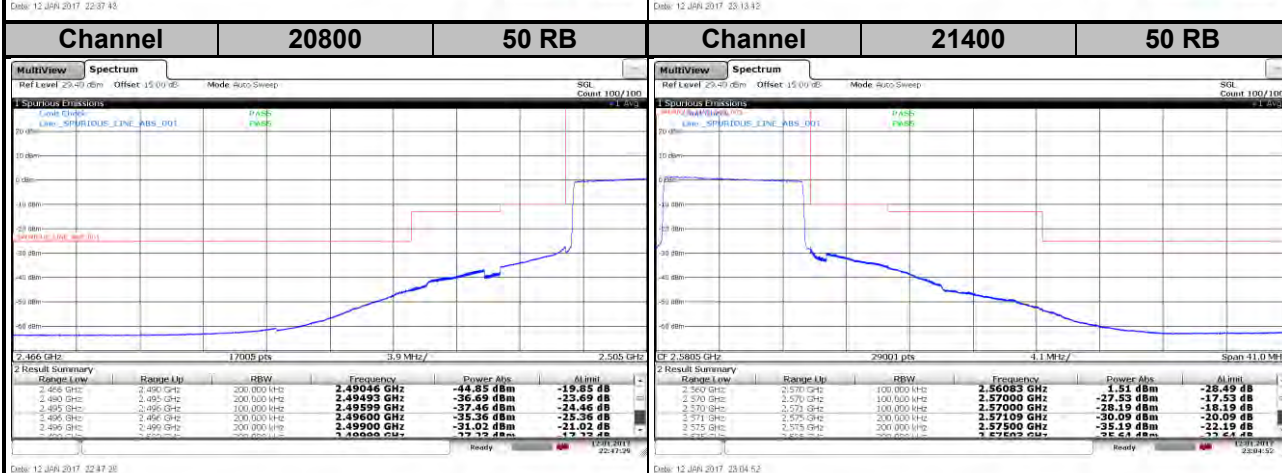
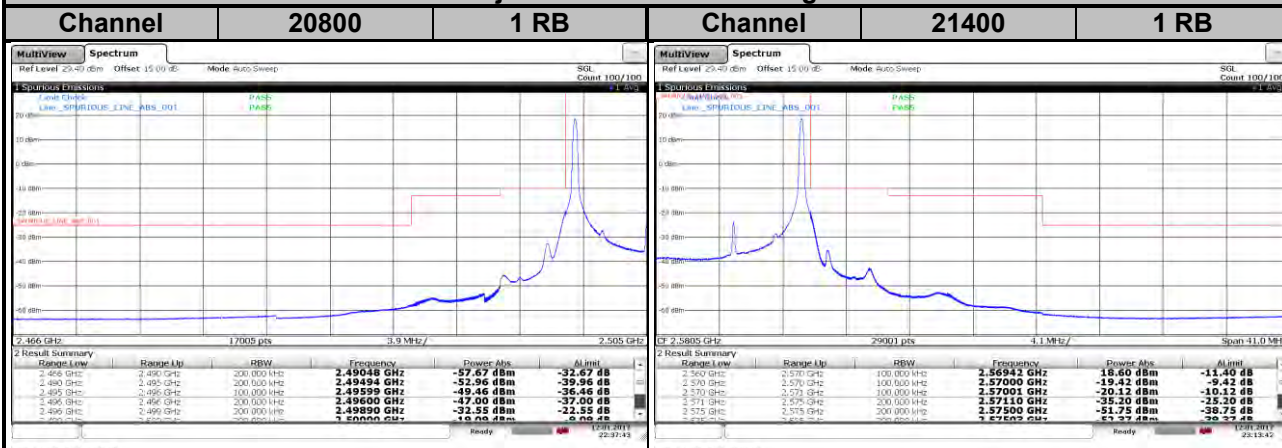

<Channel Band Edge>

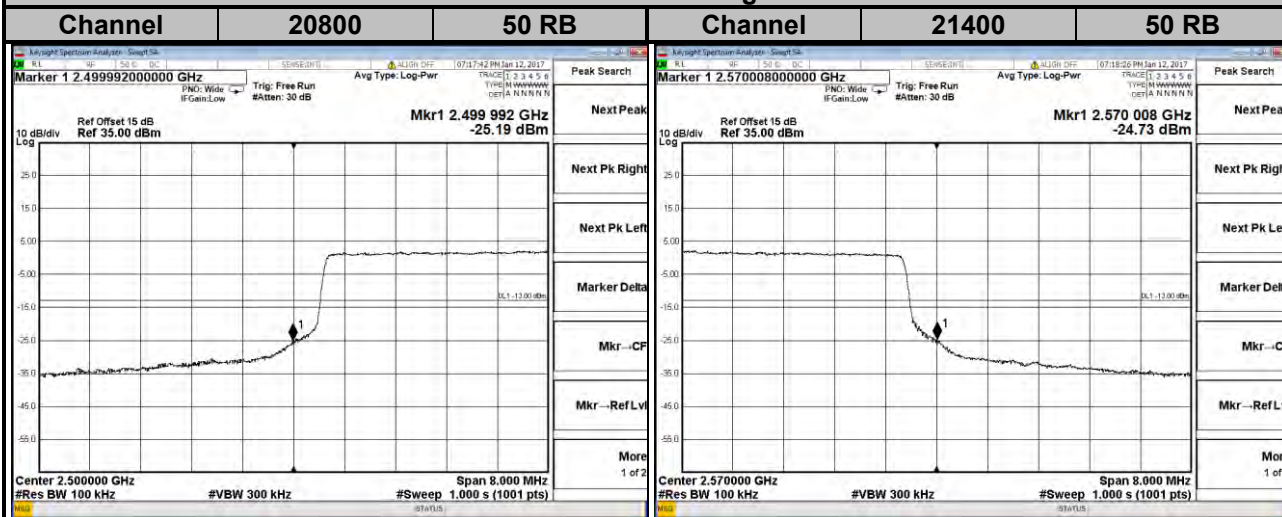

LTE Band 7

Channel Bandwidth: 15 MHz / QPSK

<Adjacent Channel Band Edge>

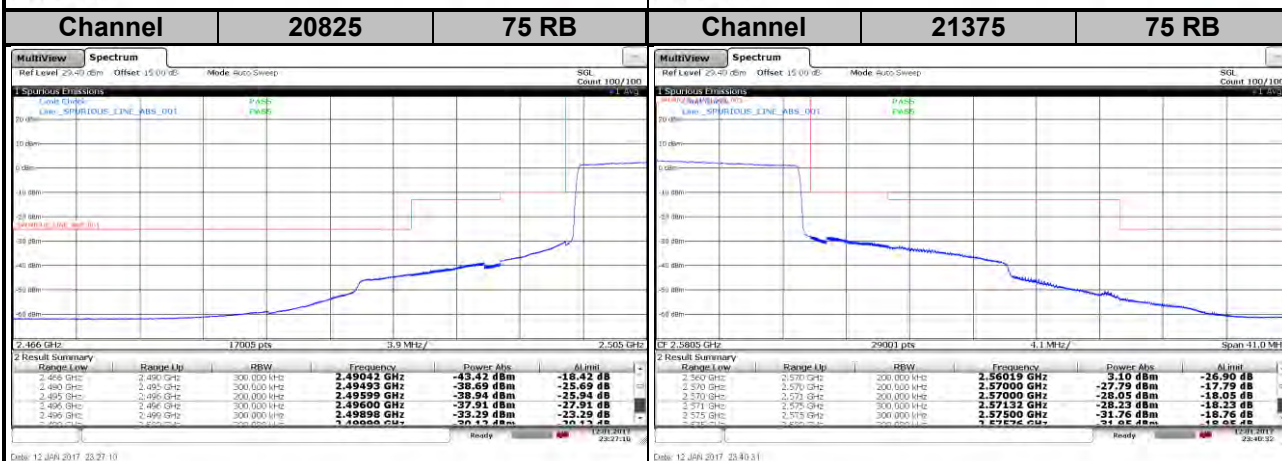
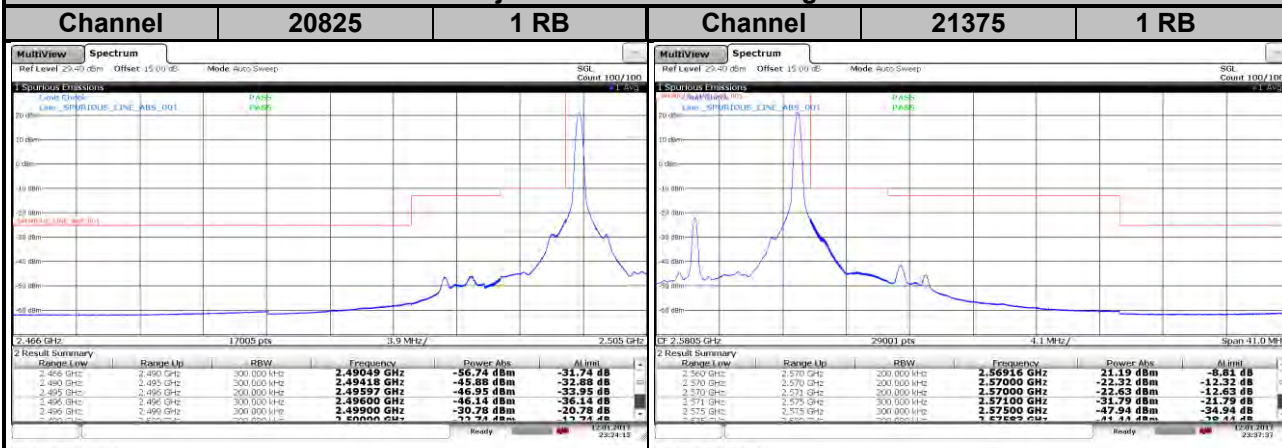

<Channel Band Edge>

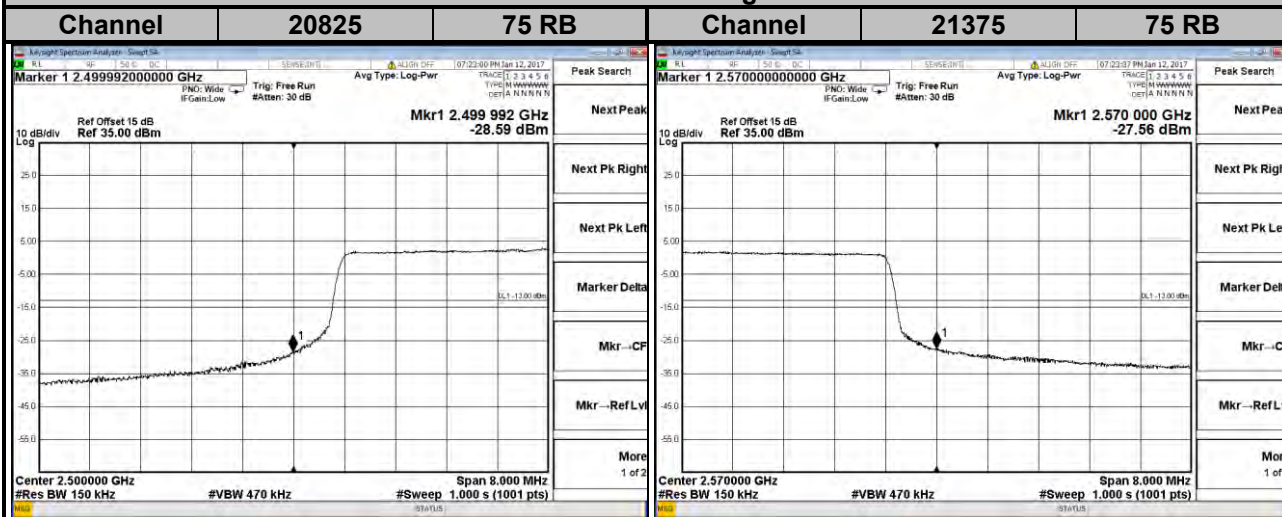

LTE Band 7

Channel Bandwidth: 15 MHz / 16QAM

<Adjacent Channel Band Edge>

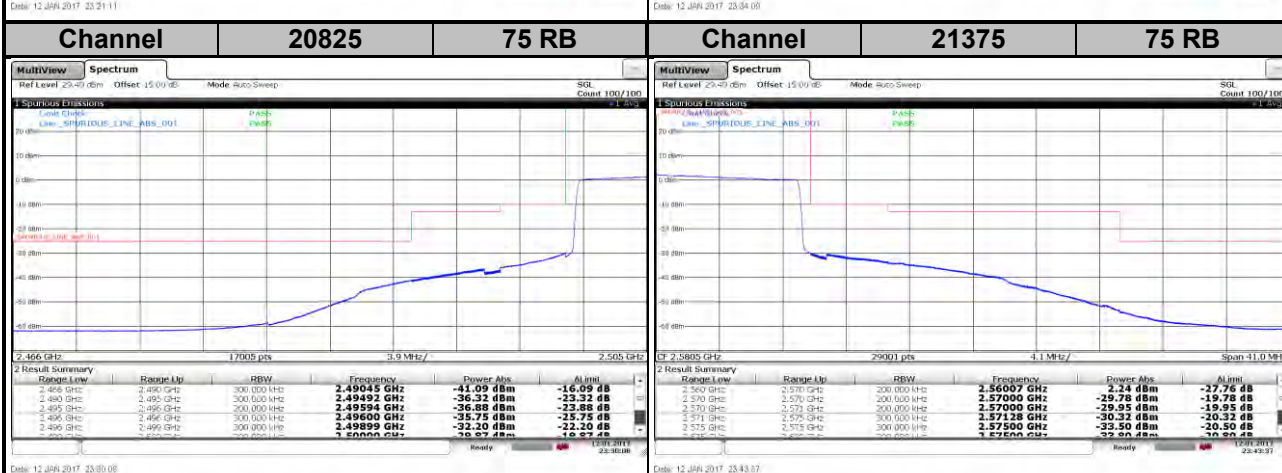
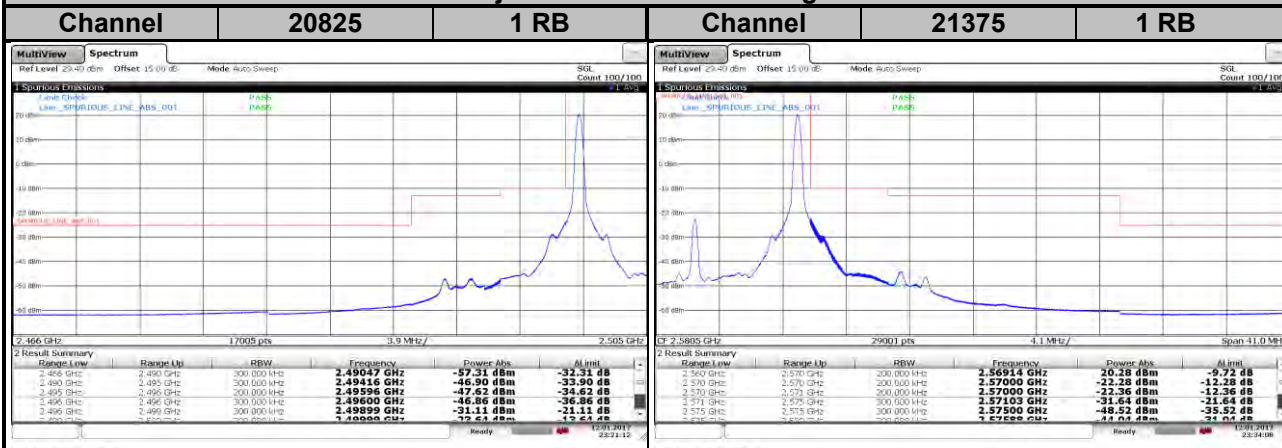

<Channel Band Edge>

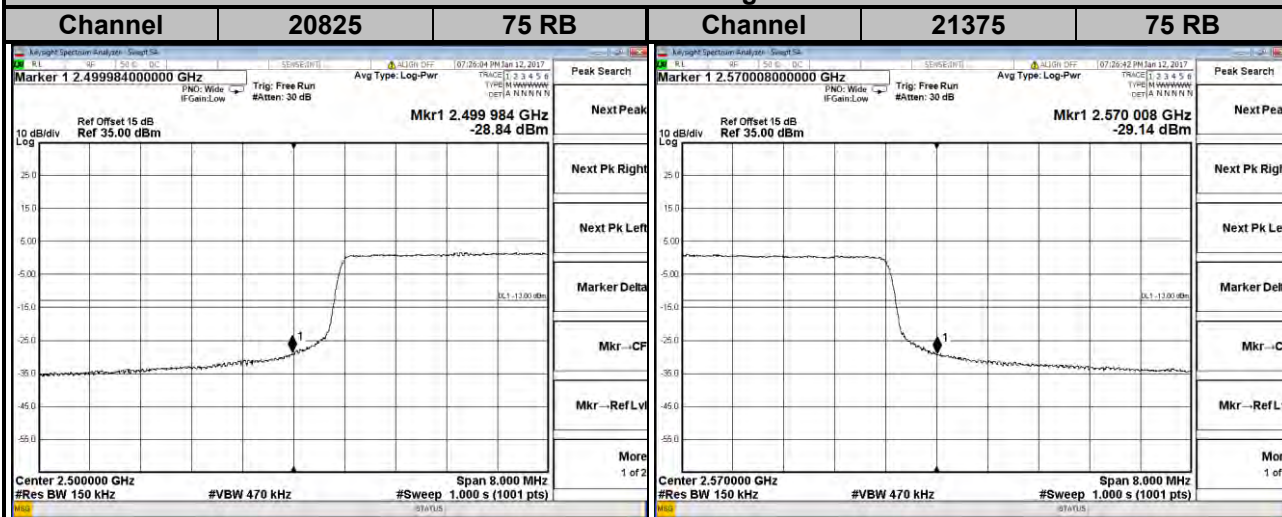

LTE Band 7
Channel Bandwidth: 20 MHz / QPSK
<Adjacent Channel Band Edge>

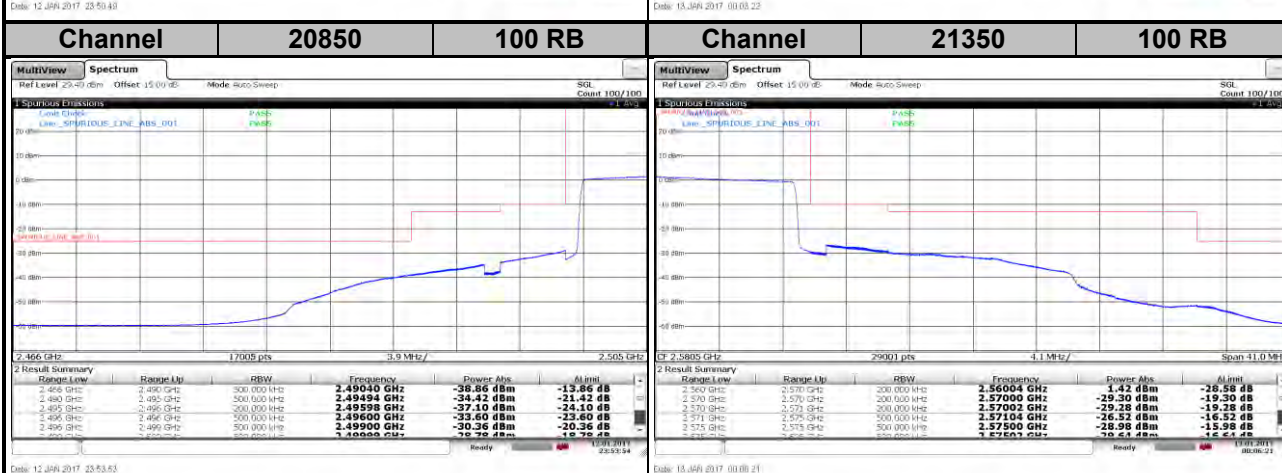
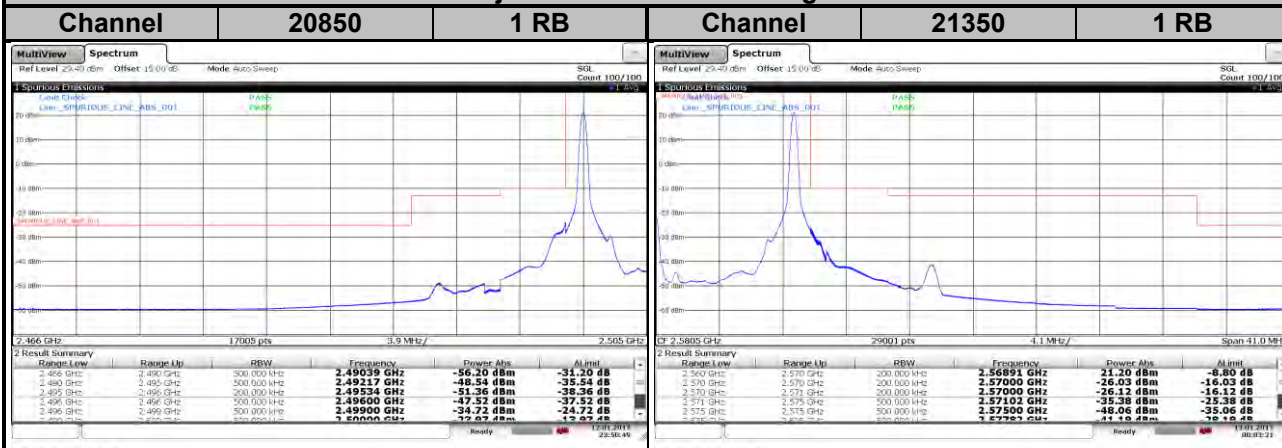

<Channel Band Edge>

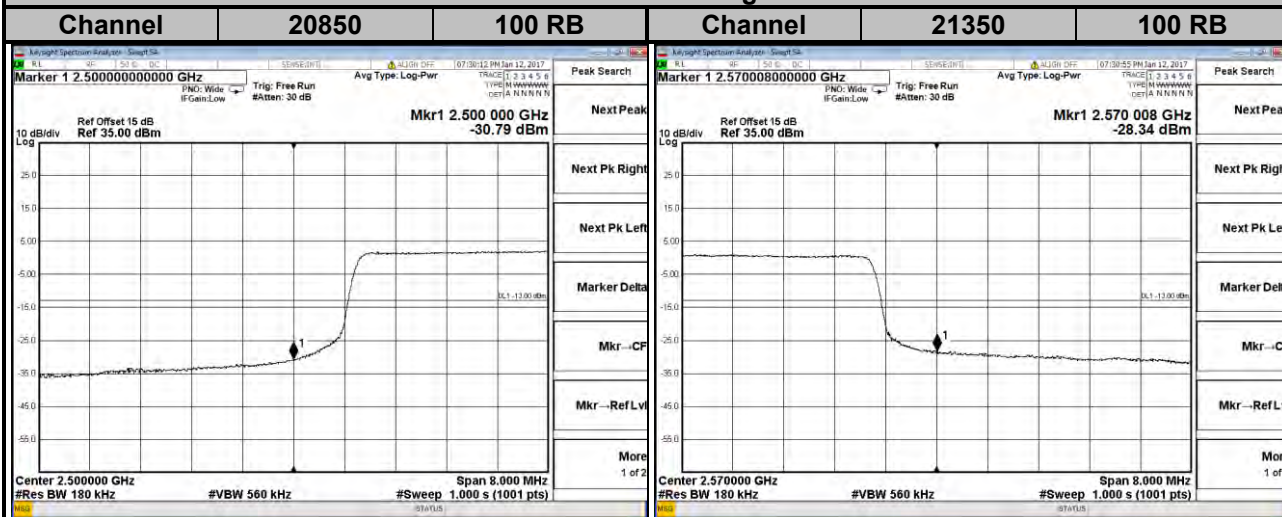

LTE Band 7
Channel Bandwidth: 20 MHz / 16QAM
<Adjacent Channel Band Edge>

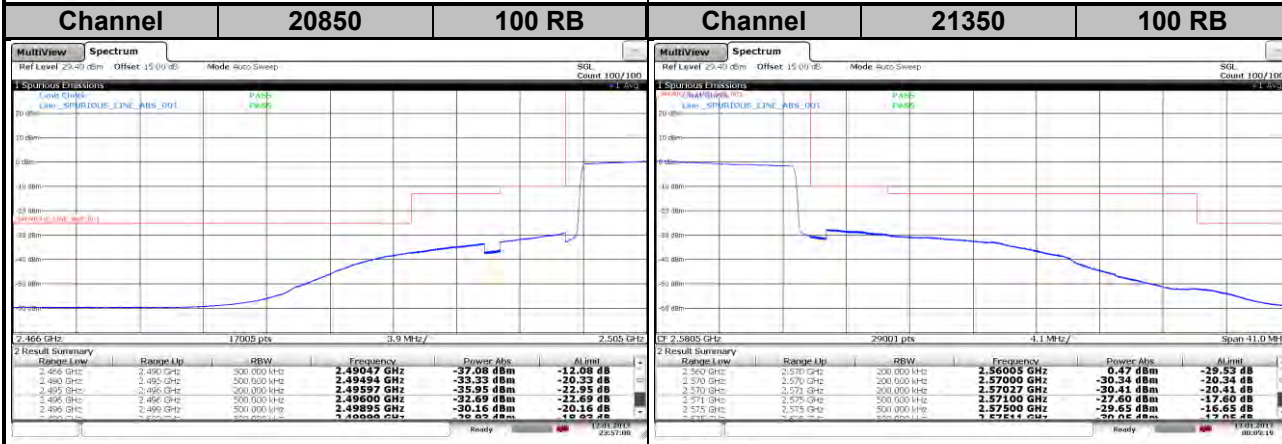
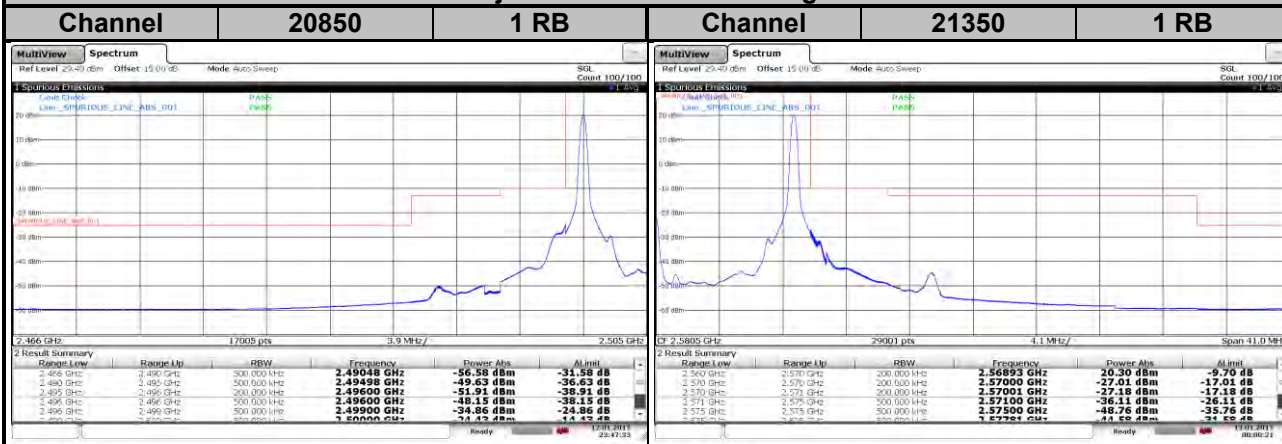

<Channel Band Edge>

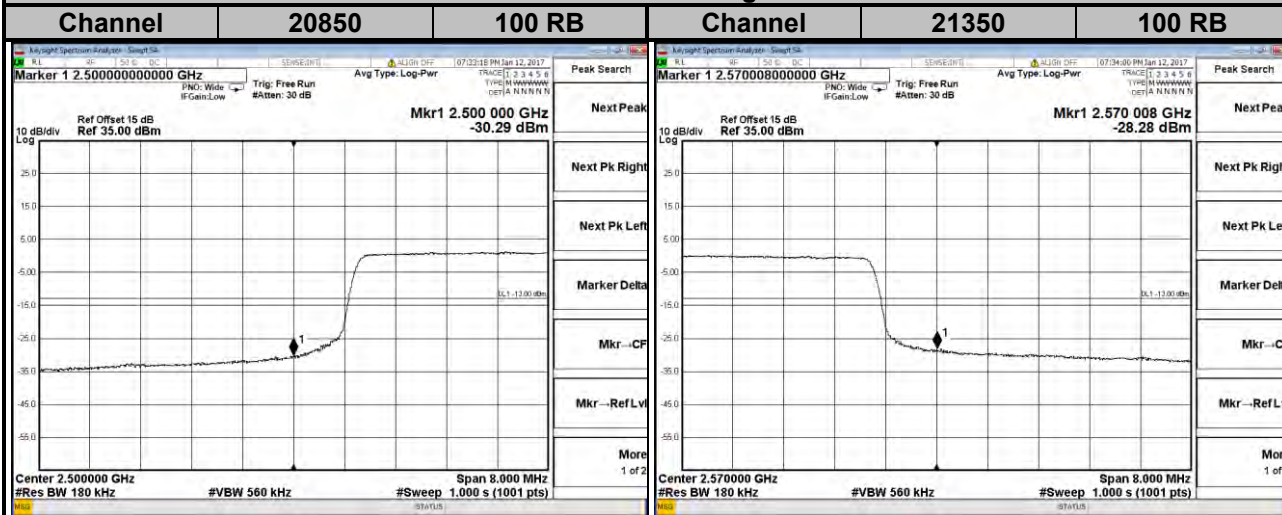

LTE Band 38
Channel Bandwidth: 5 MHz / QPSK
<Adjacent Channel Band Edge>

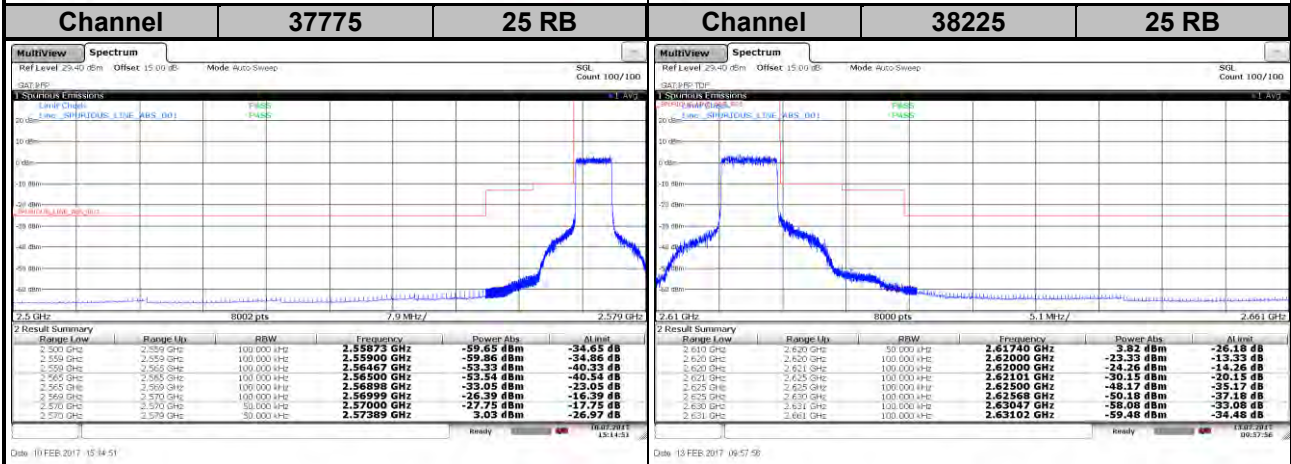
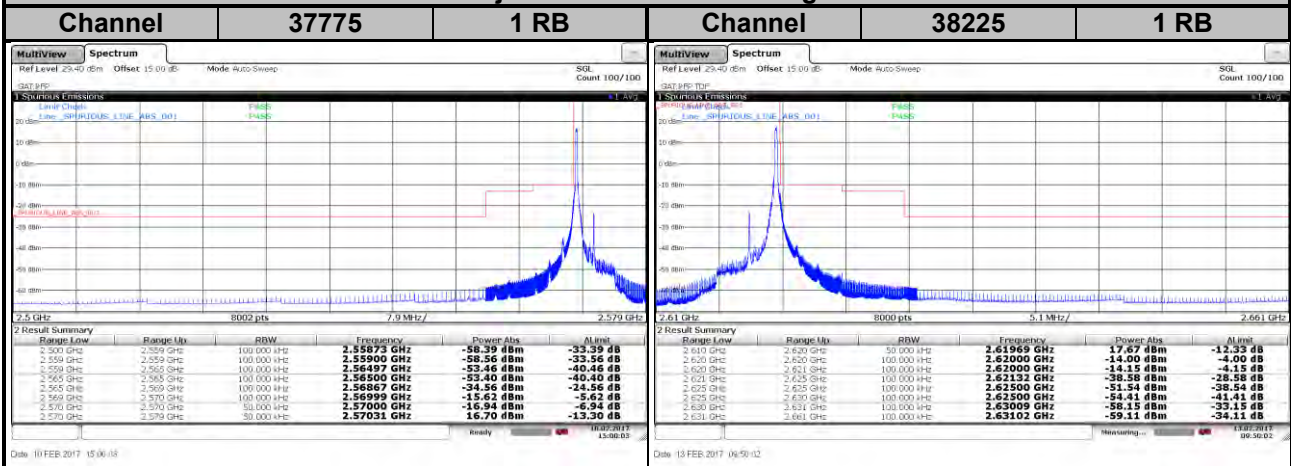

<Channel Band Edge>

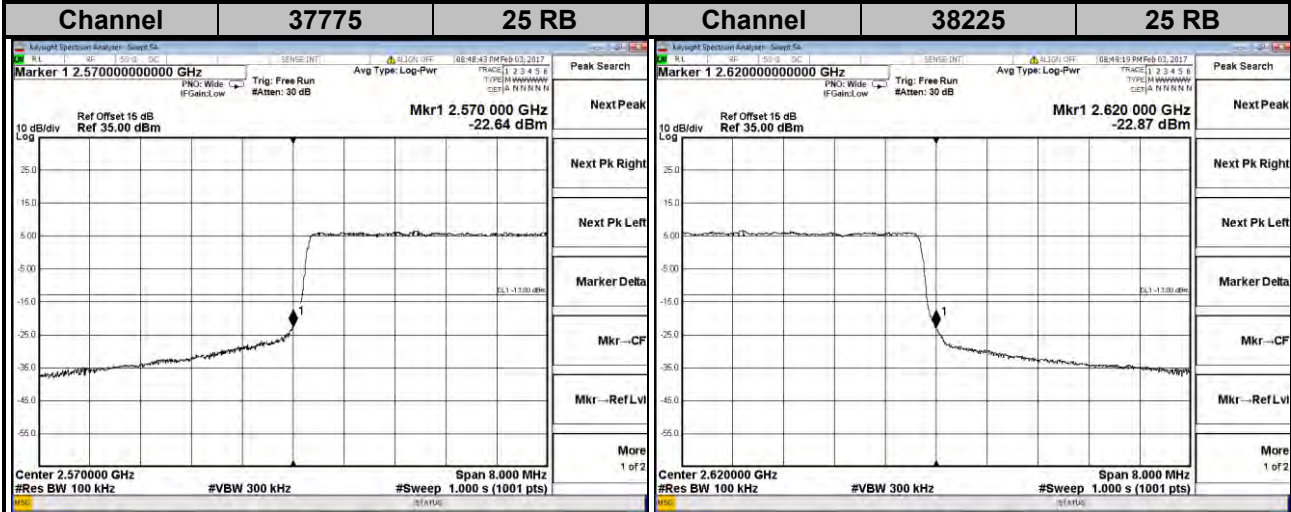

LTE Band 38
Channel Bandwidth: 5 MHz / 16QAM
<Adjacent Channel Band Edge>

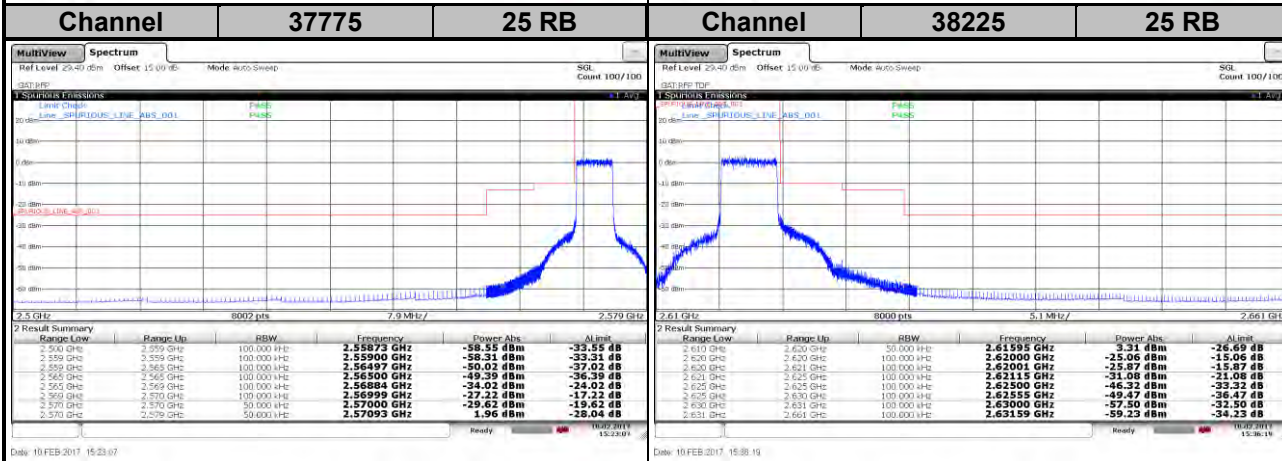
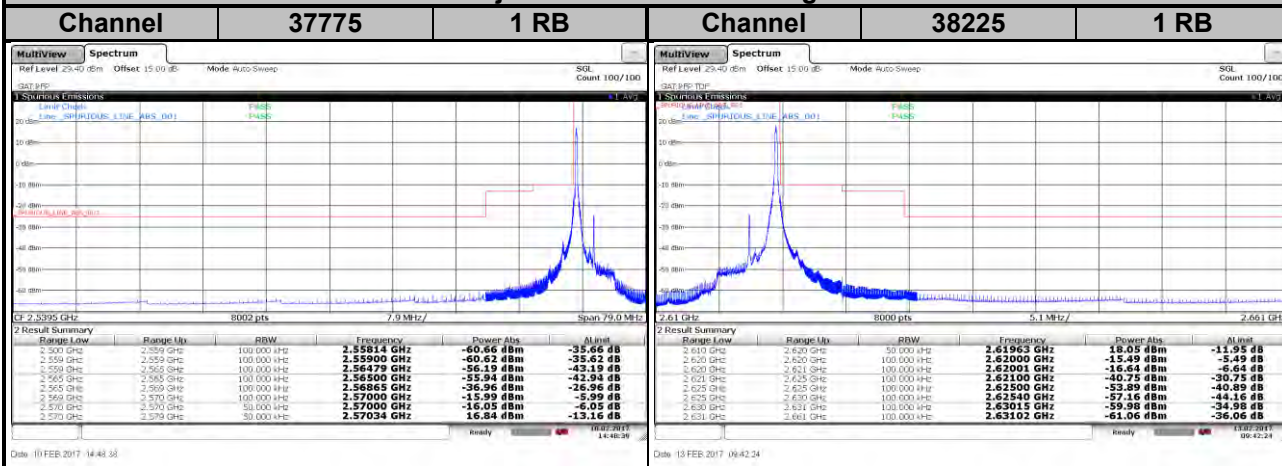

<Channel Band Edge>

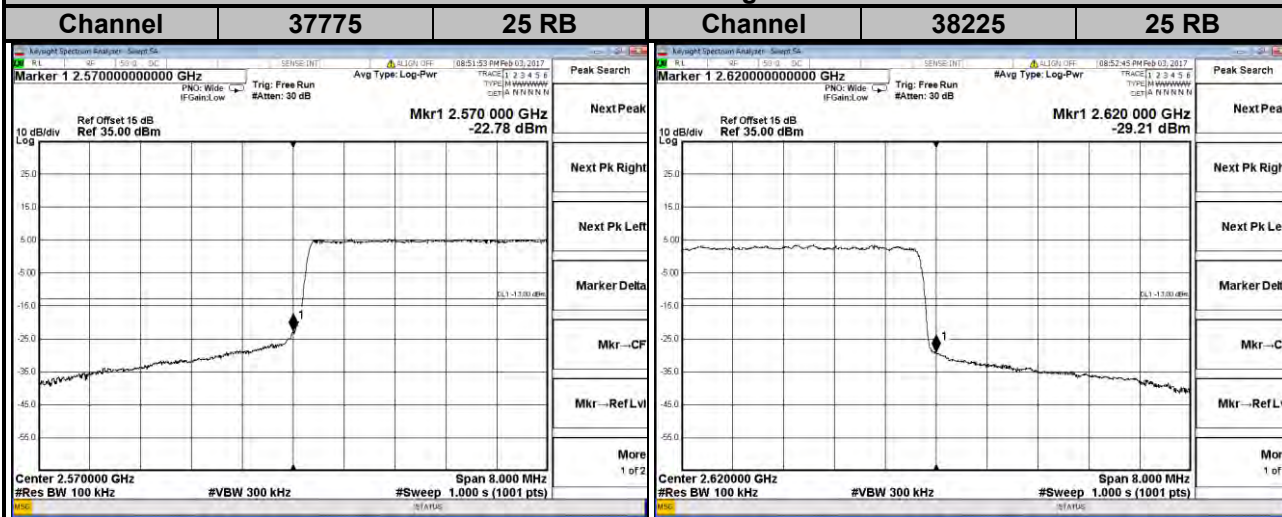

LTE Band 38
Channel Bandwidth: 10 MHz / QPSK
<Adjacent Channel Band Edge>

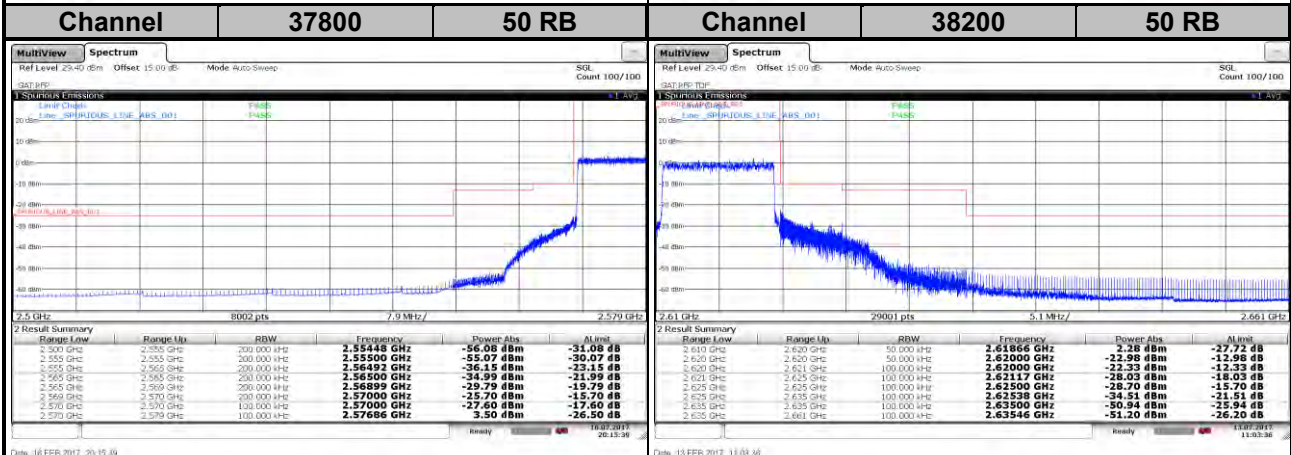
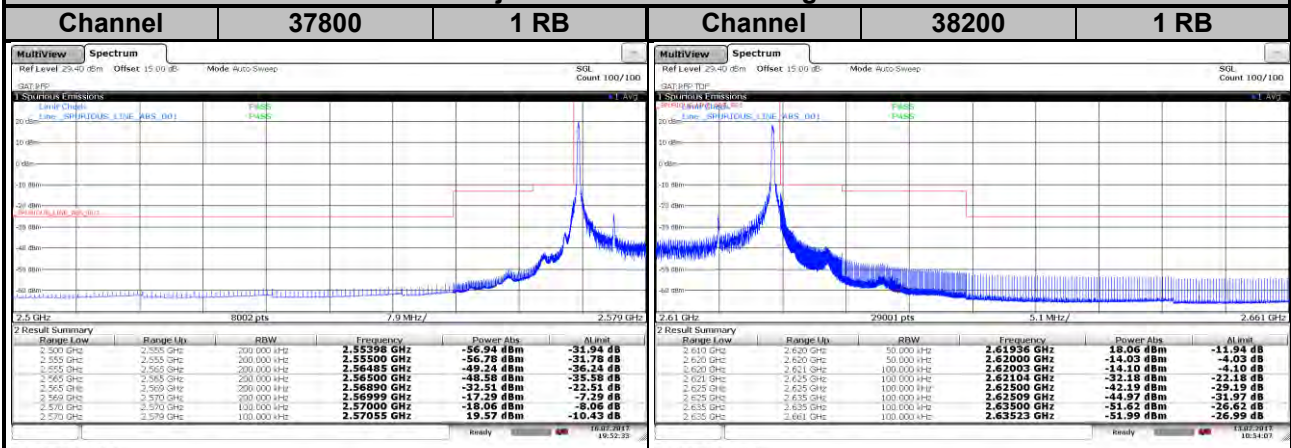

<Channel Band Edge>

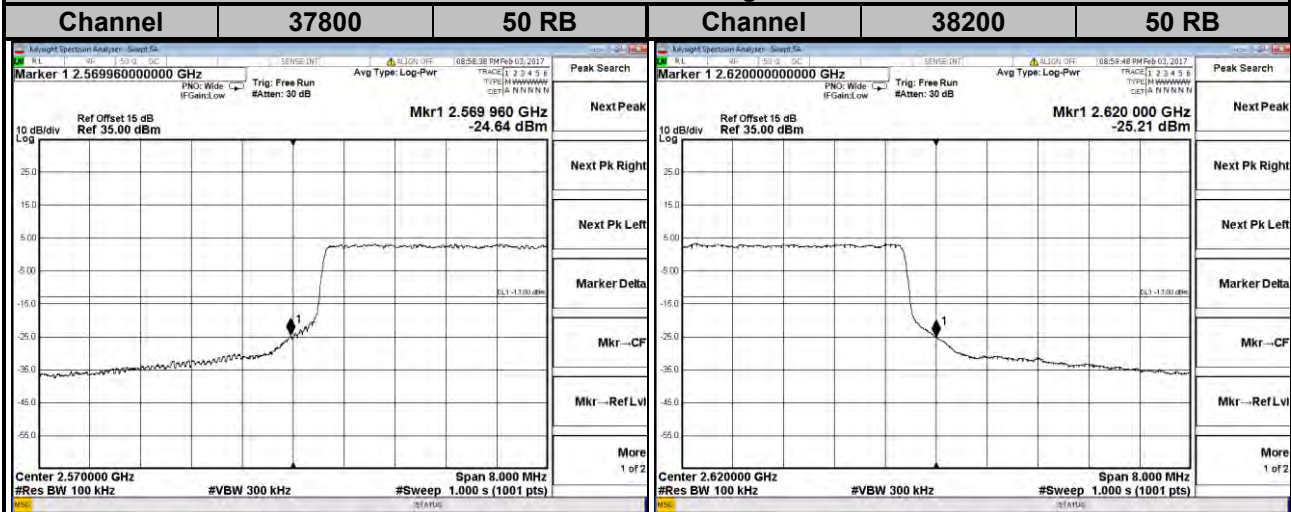

LTE Band 38

Channel Bandwidth: 10 MHz / 16QAM

<Adjacent Channel Band Edge>

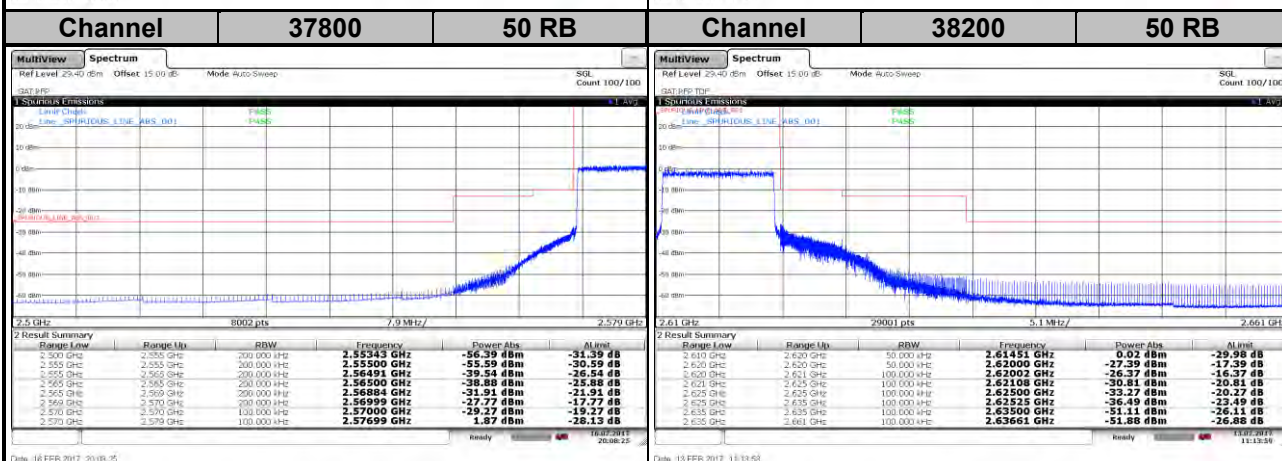
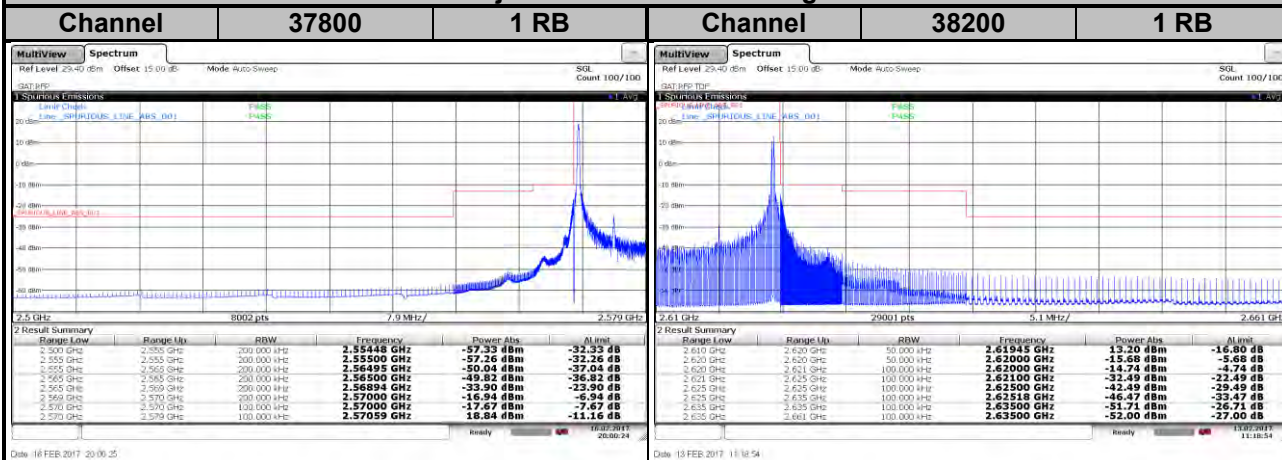

<Channel Band Edge>

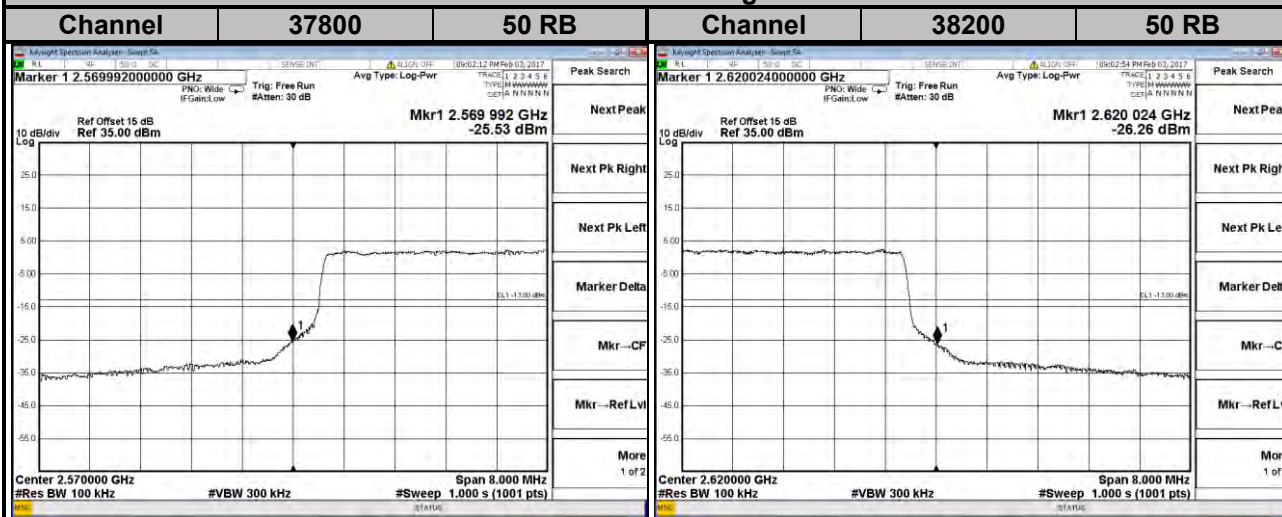

LTE Band 38
Channel Bandwidth: 15 MHz / QPSK
<Adjacent Channel Band Edge>

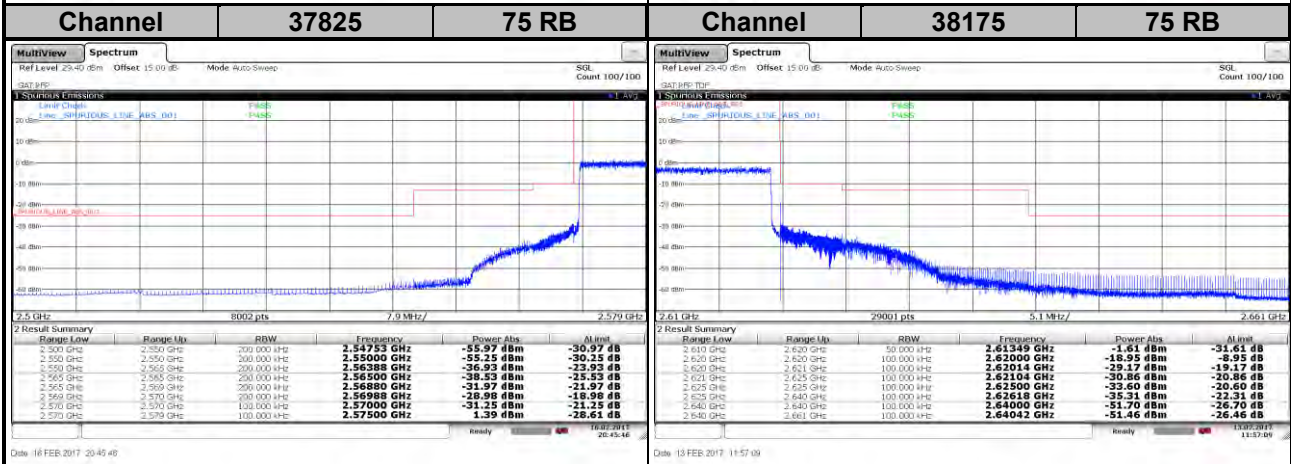
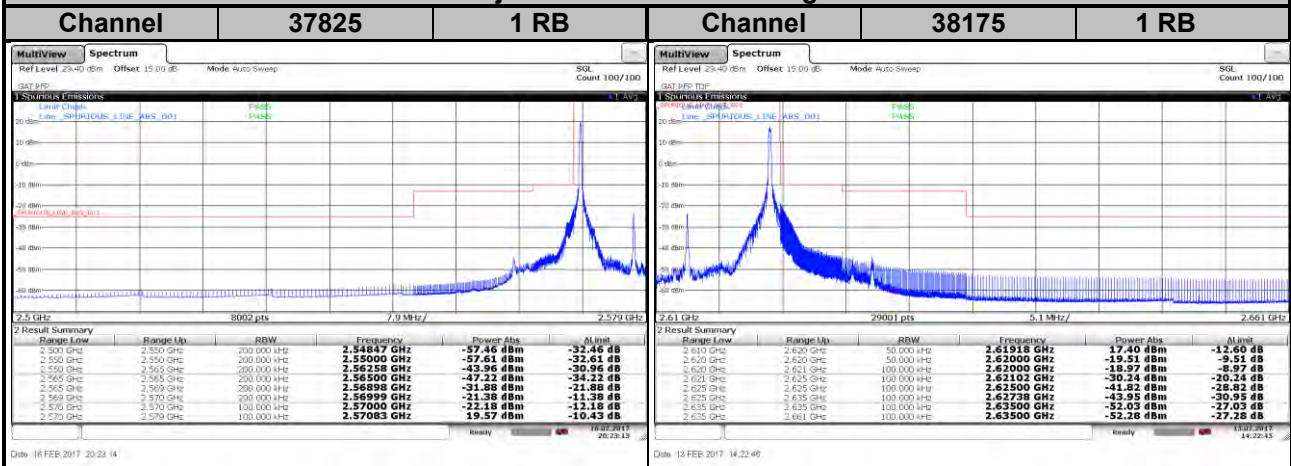

<Channel Band Edge>

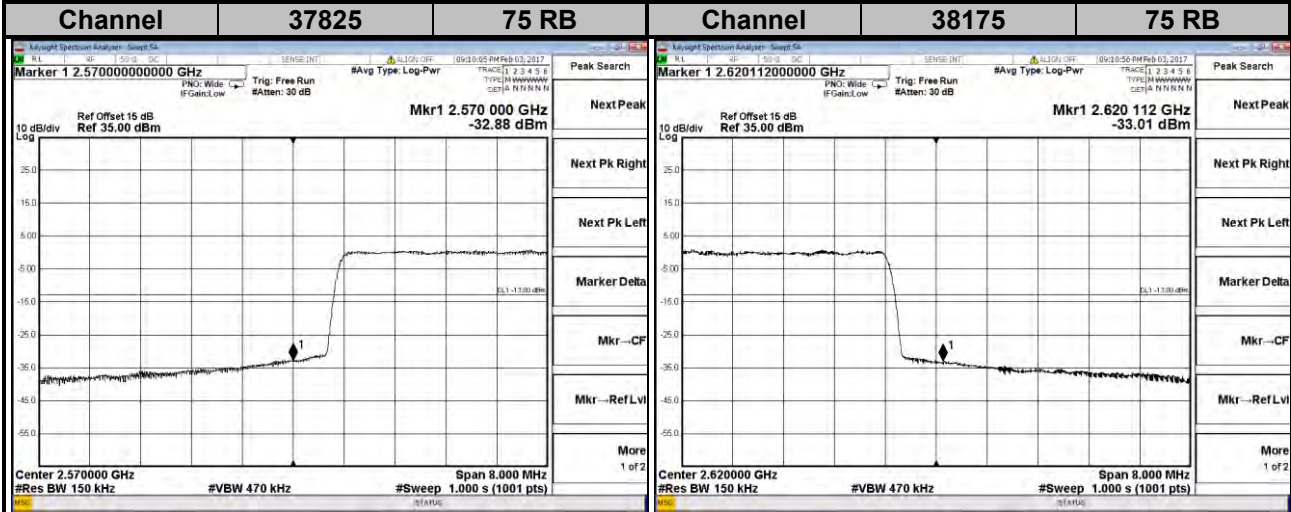

LTE Band 38
Channel Bandwidth: 15 MHz / 16QAM
<Adjacent Channel Band Edge>

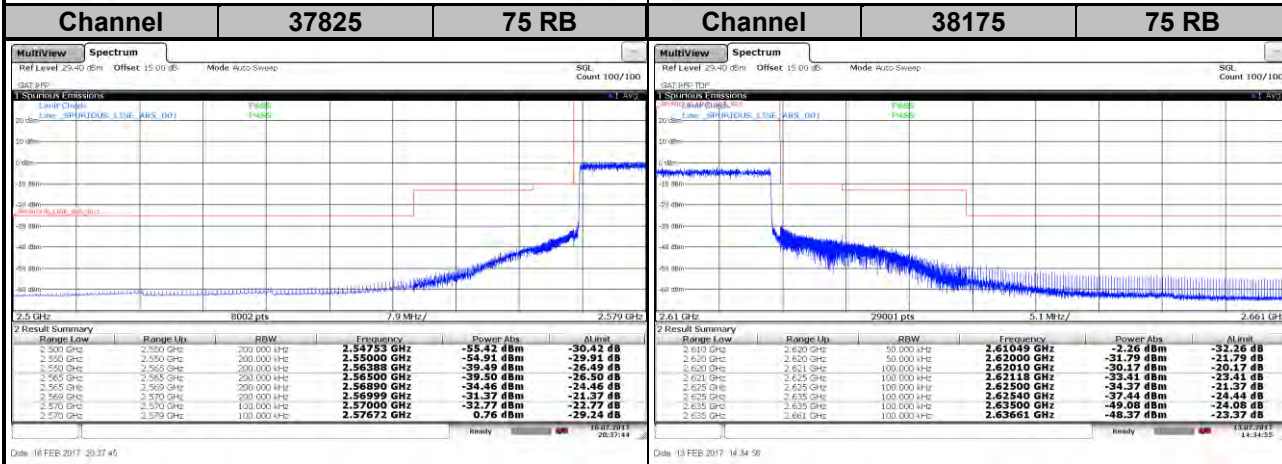
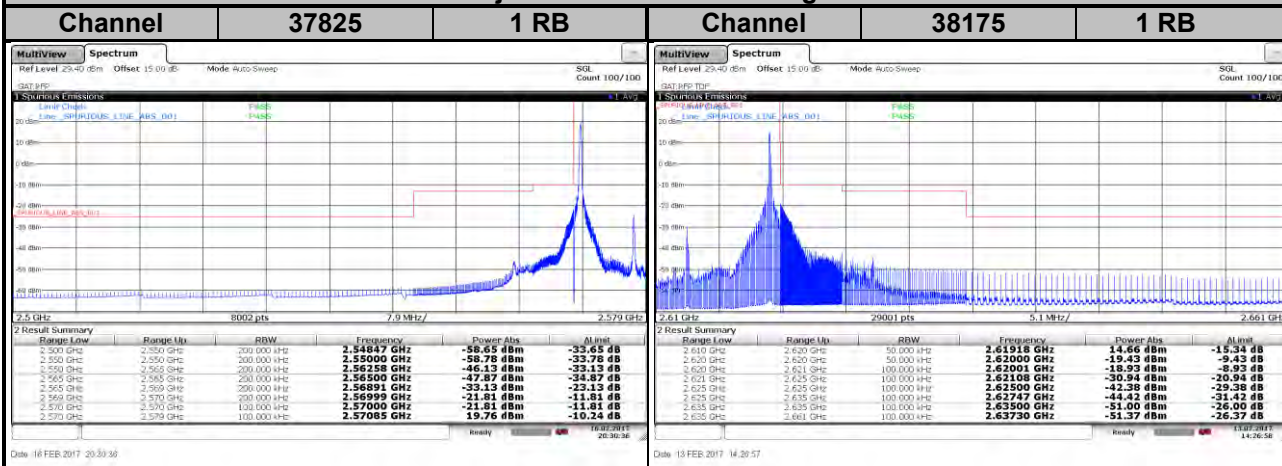

<Channel Band Edge>

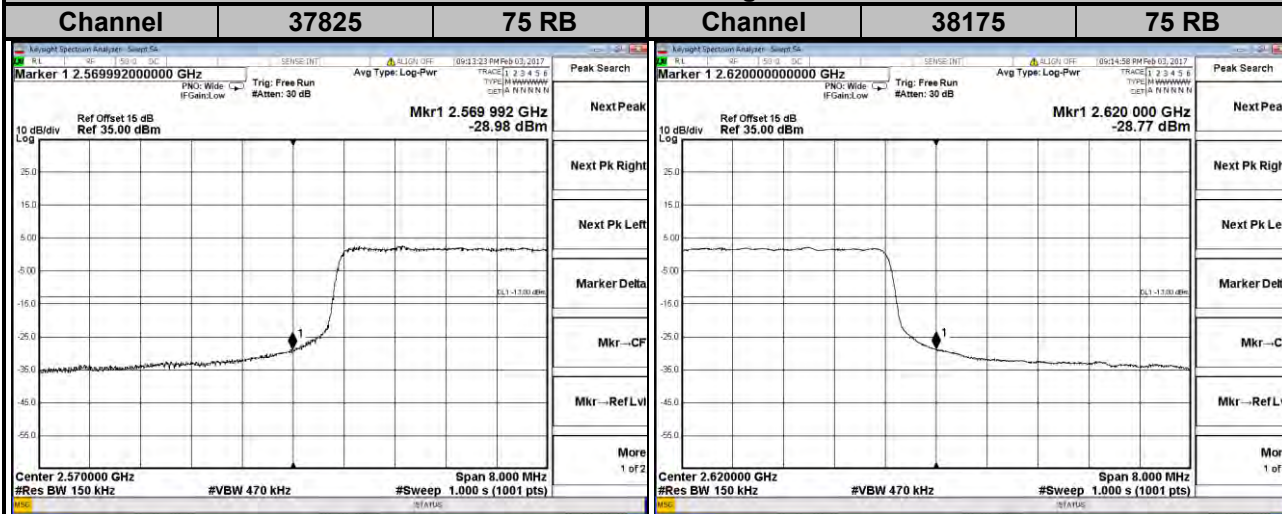

LTE Band 38
Channel Bandwidth: 20 MHz / QPSK
<Adjacent Channel Band Edge>

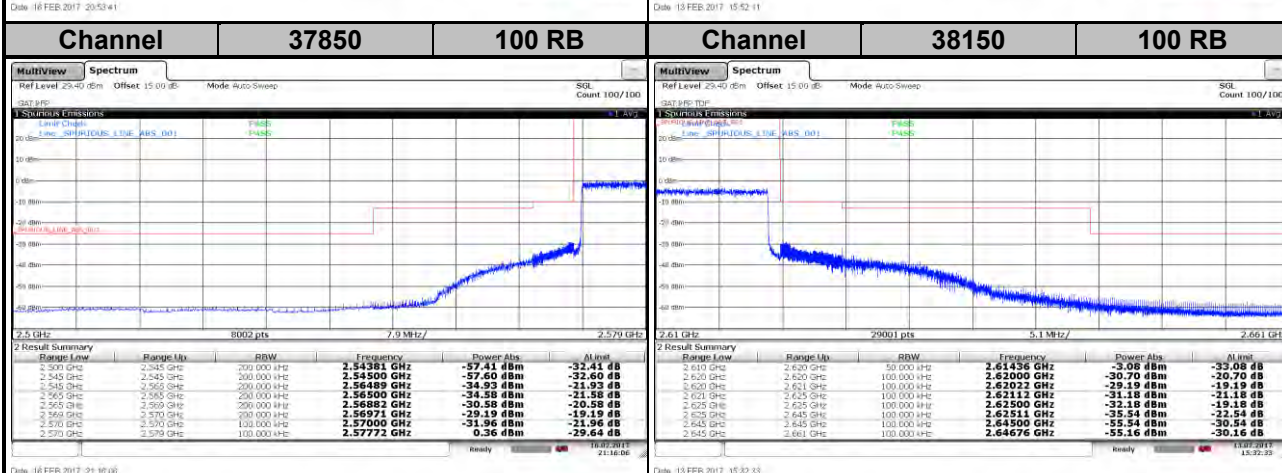
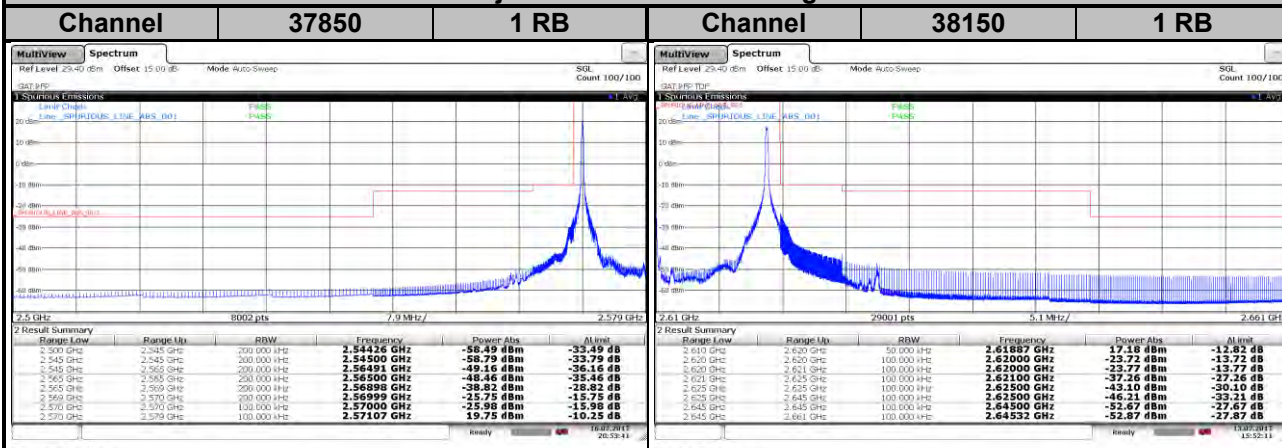

<Channel Band Edge>

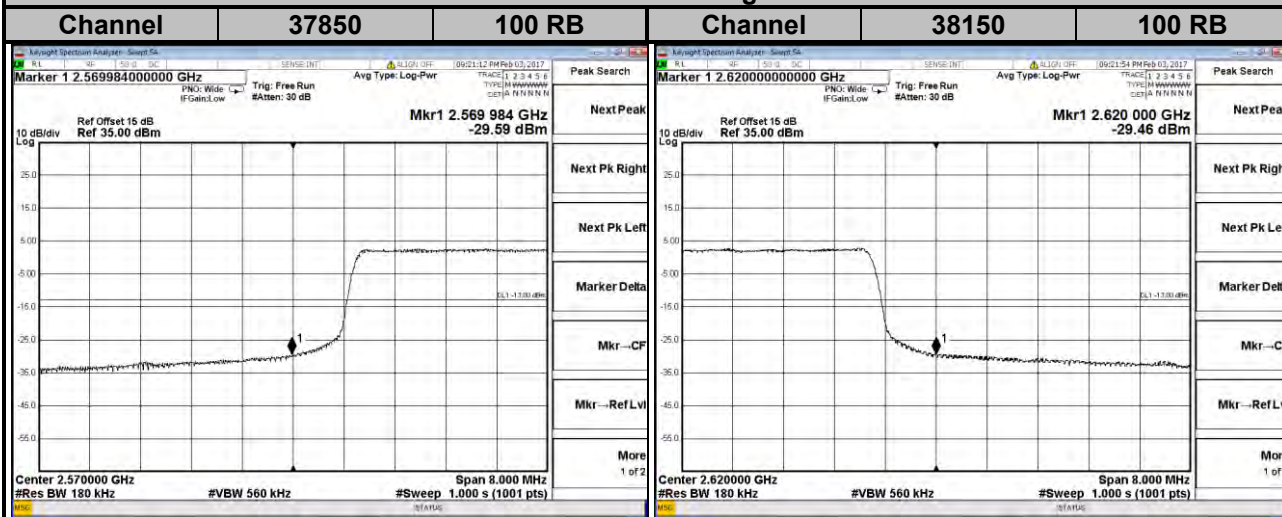

LTE Band 38
Channel Bandwidth: 20 MHz / 16QAM
<Adjacent Channel Band Edge>

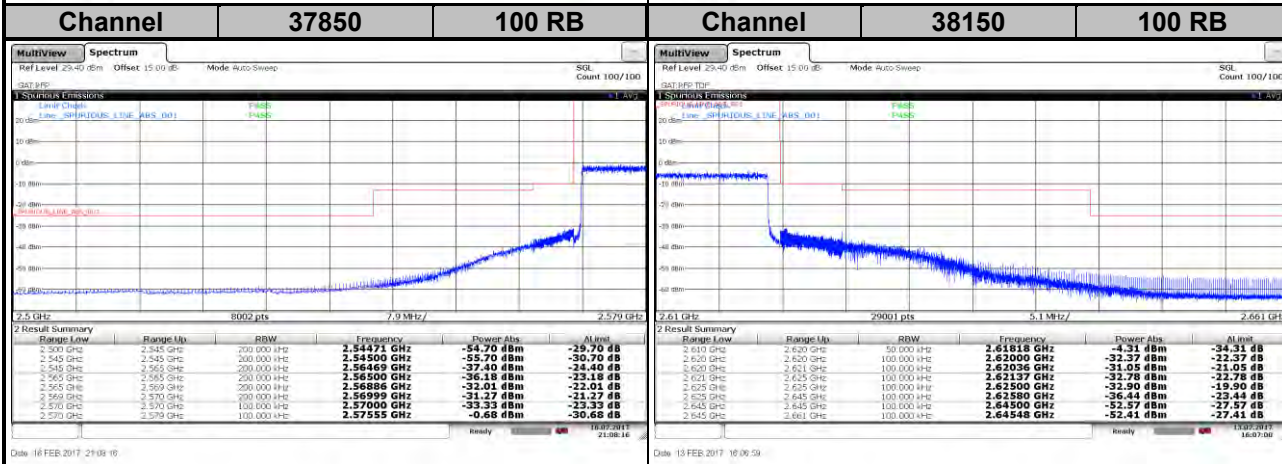
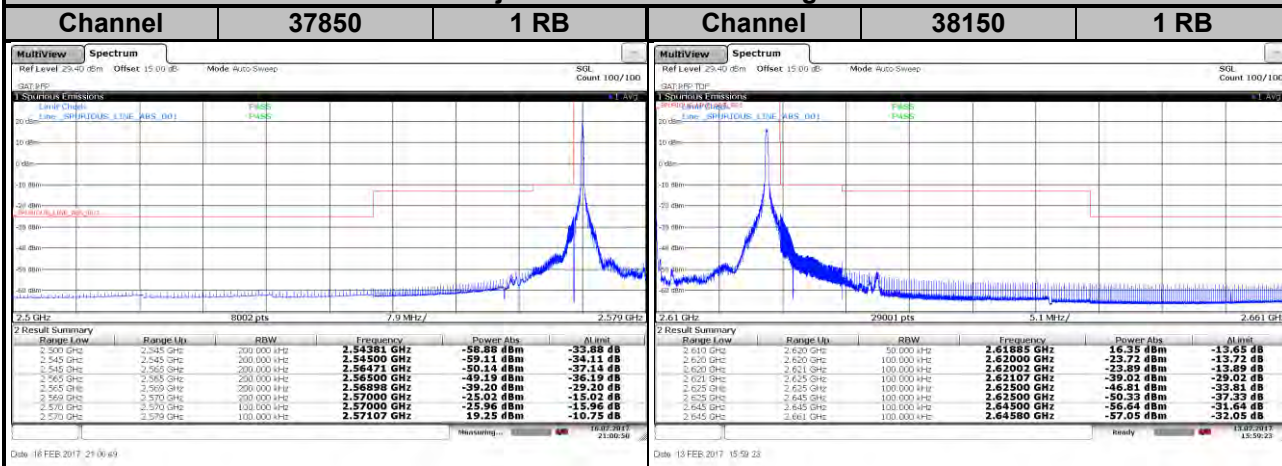

<Channel Band Edge>

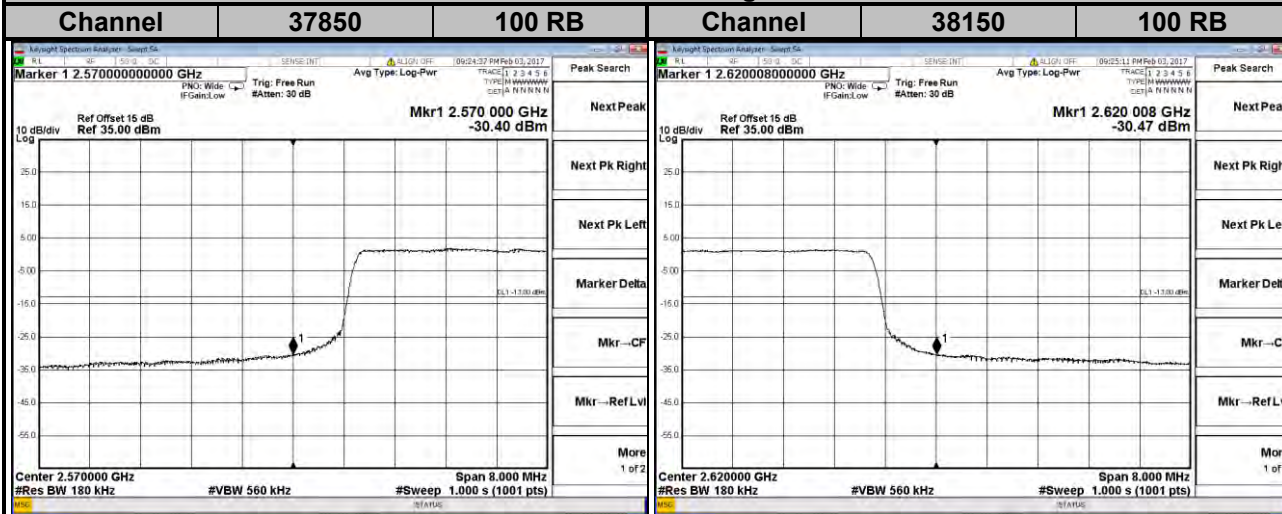

LTE Band 41
Channel Bandwidth: 5 MHz / QPSK
<Adjacent Channel Band Edge>

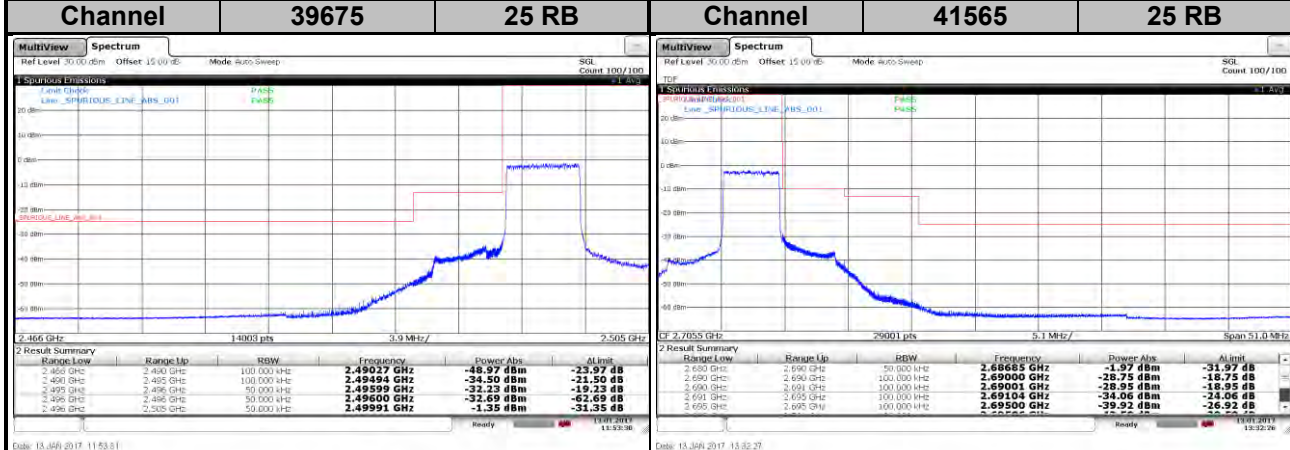
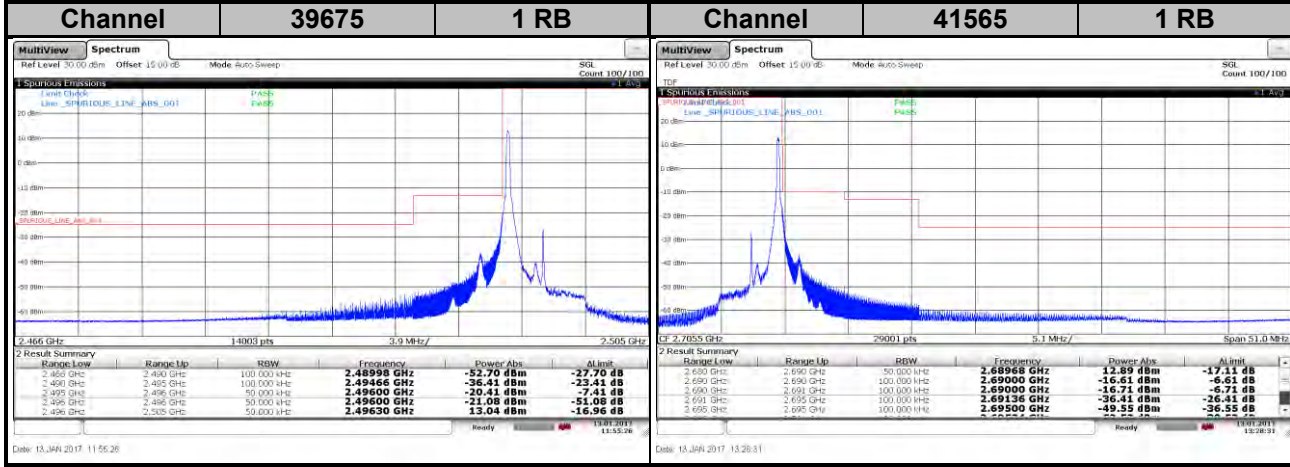

<Channel Band Edge>

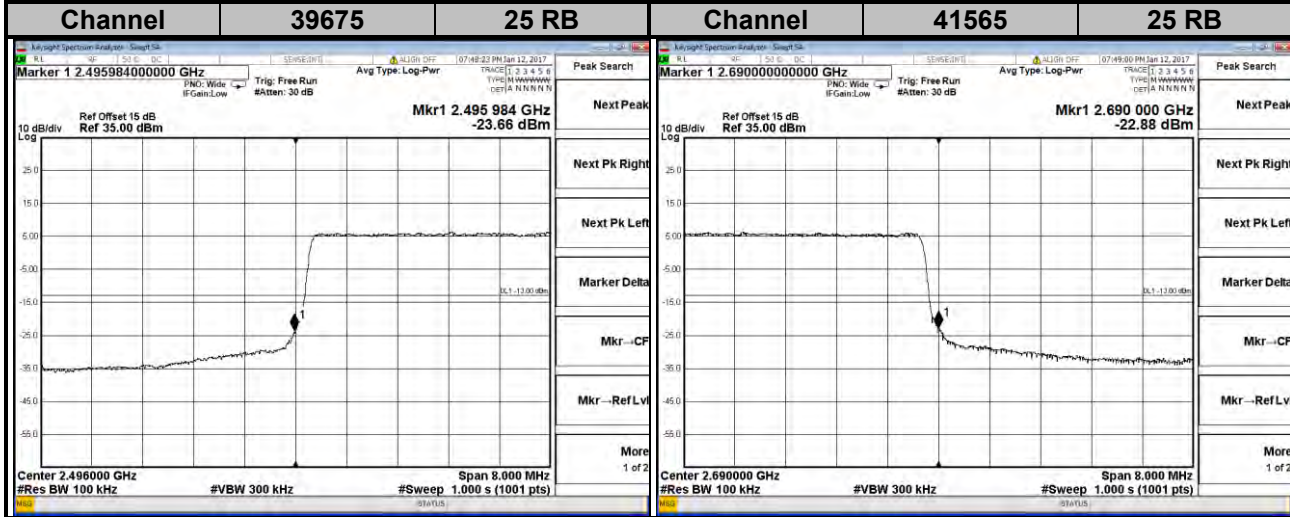

LTE Band 41
Channel Bandwidth: 5 MHz / 16QAM
<Adjacent Channel Band Edge>

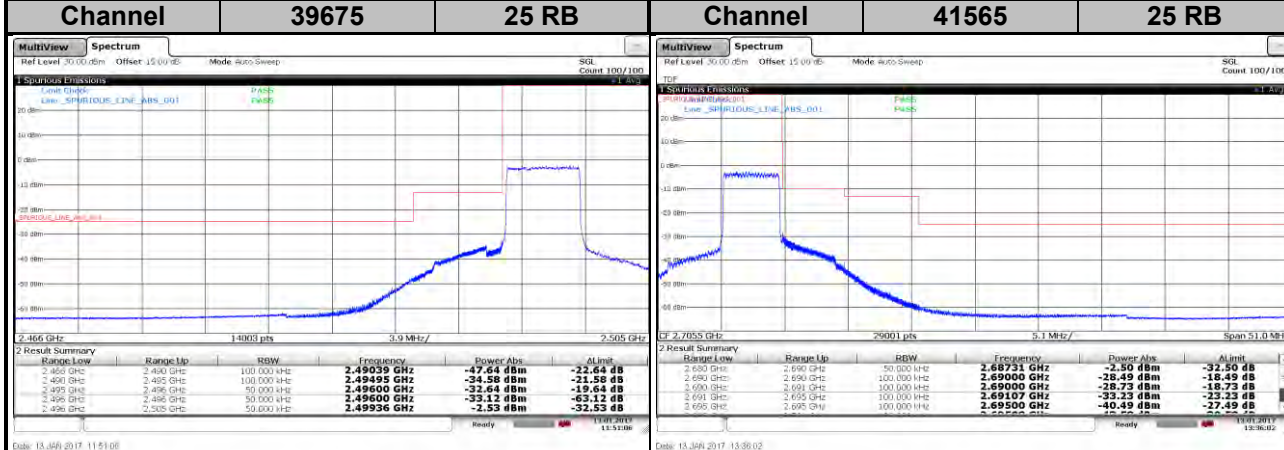
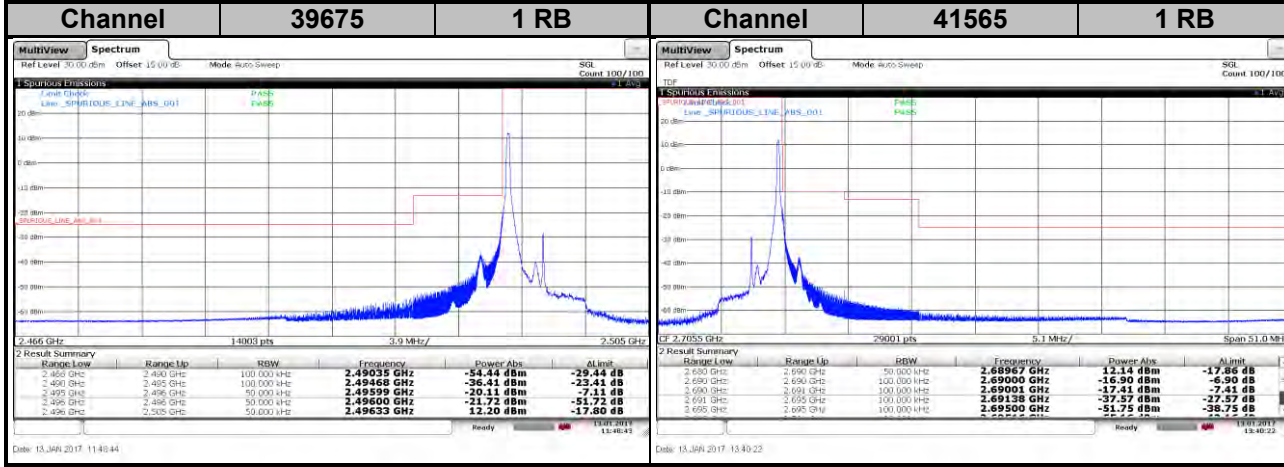

<Channel Band Edge>

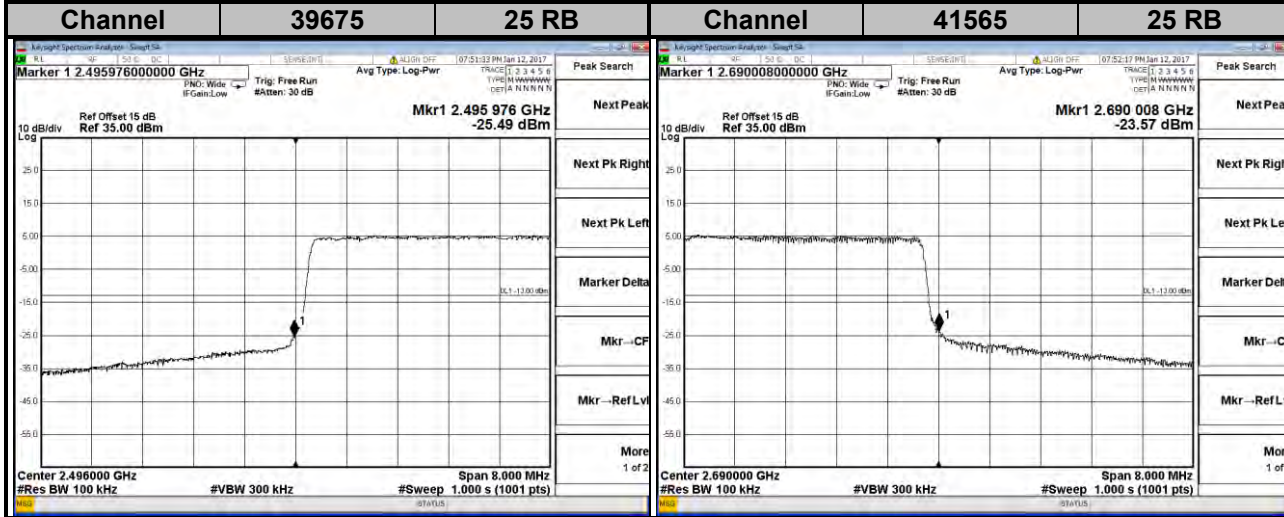

LTE Band 41

Channel Bandwidth: 10 MHz / QPSK

<Adjacent Channel Band Edge>

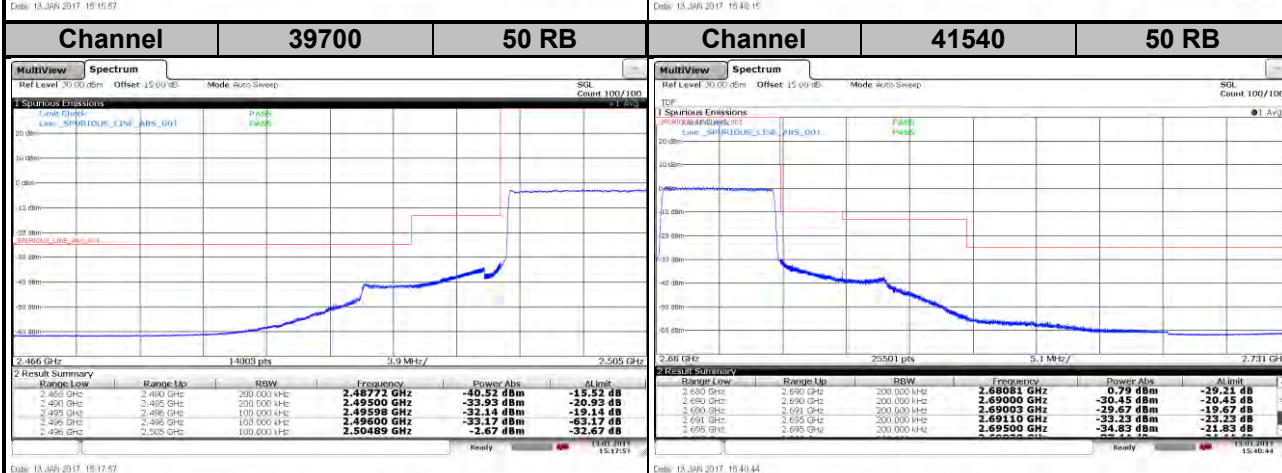
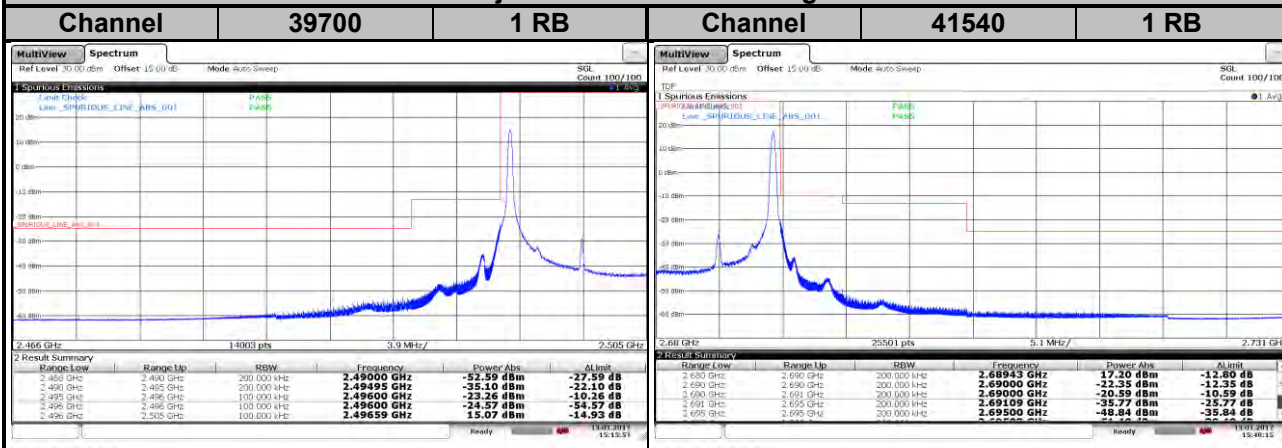

<Channel Band Edge>

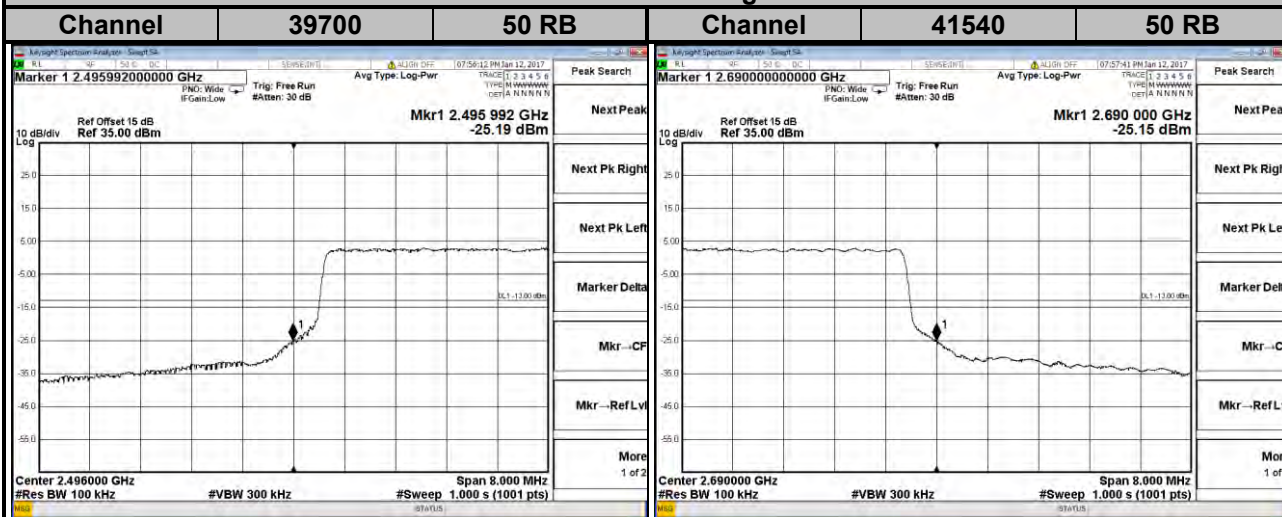

LTE Band 41
Channel Bandwidth: 10 MHz / 16QAM
<Adjacent Channel Band Edge>

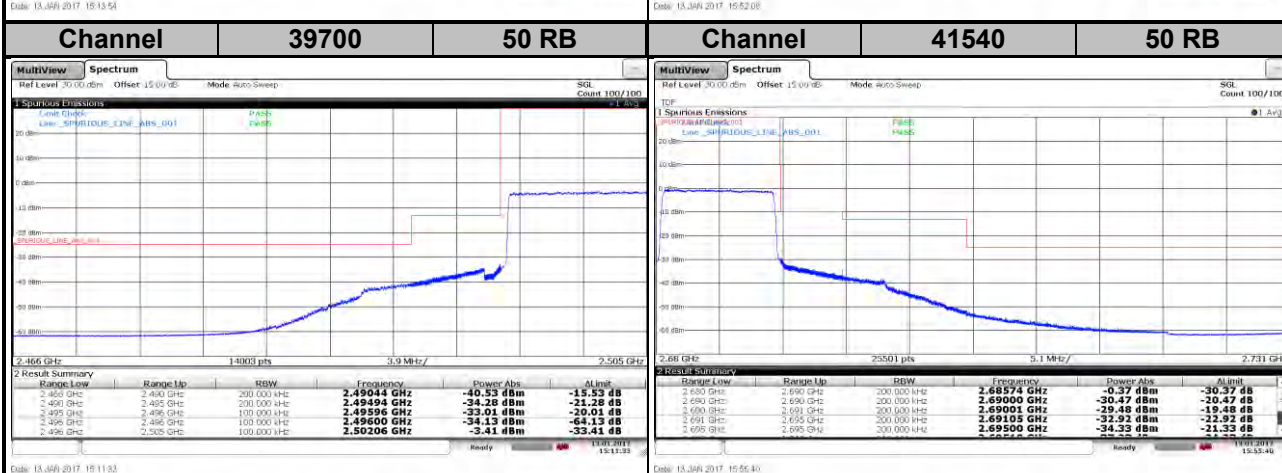
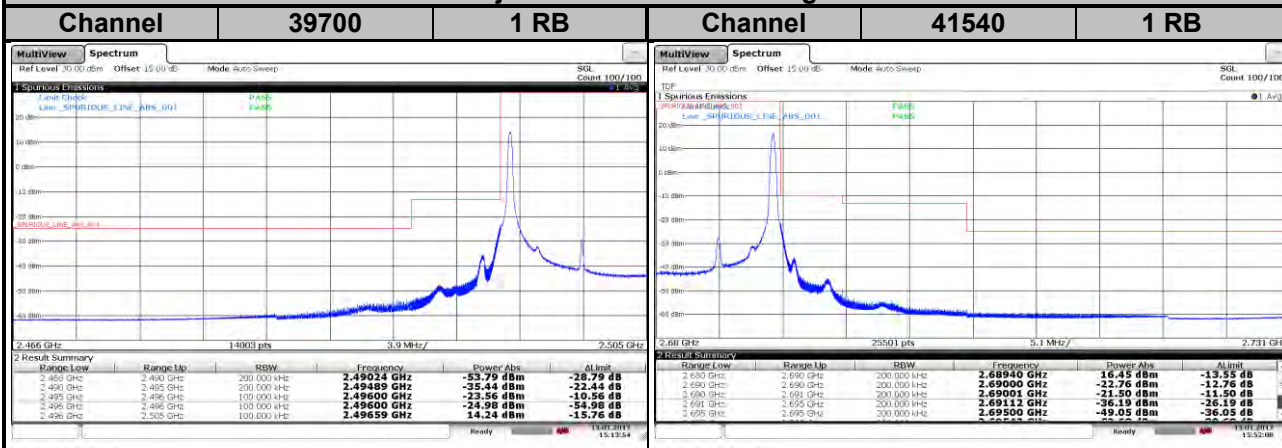

<Channel Band Edge>

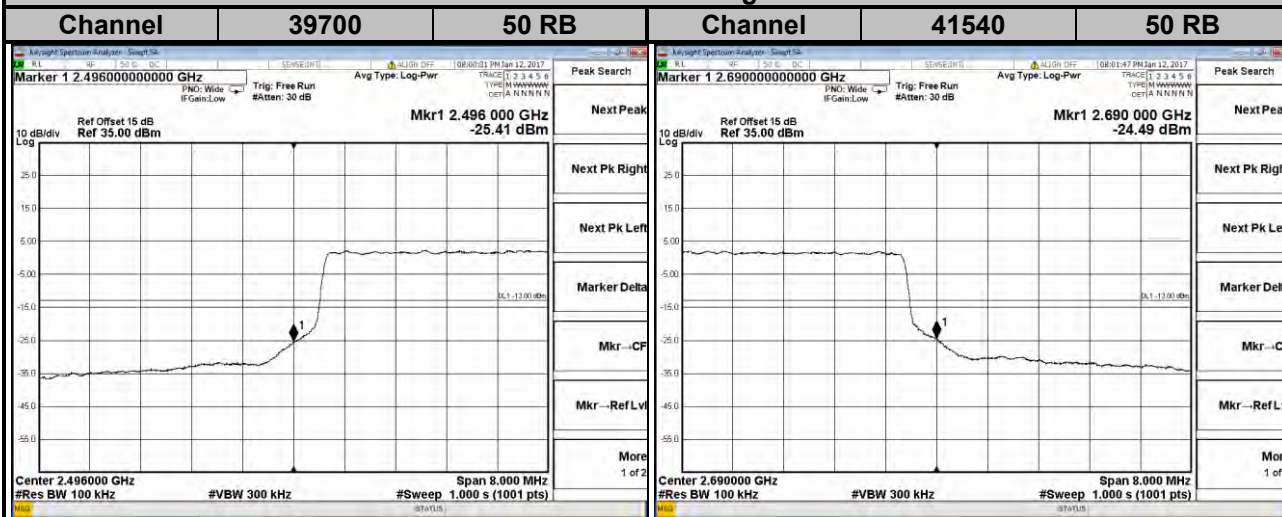

LTE Band 41
Channel Bandwidth: 15 MHz / QPSK
<Adjacent Channel Band Edge>

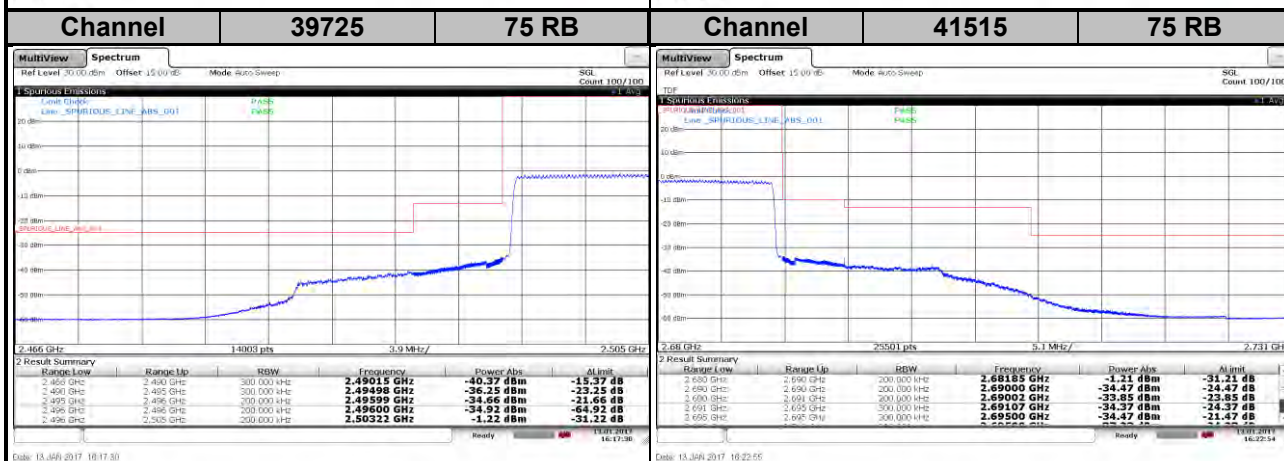
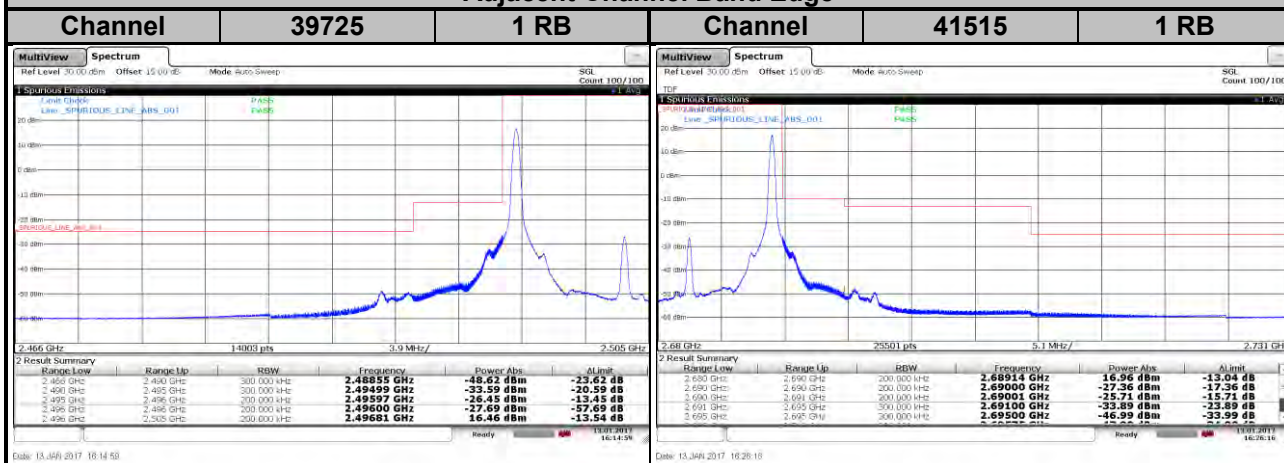

<Channel Band Edge>

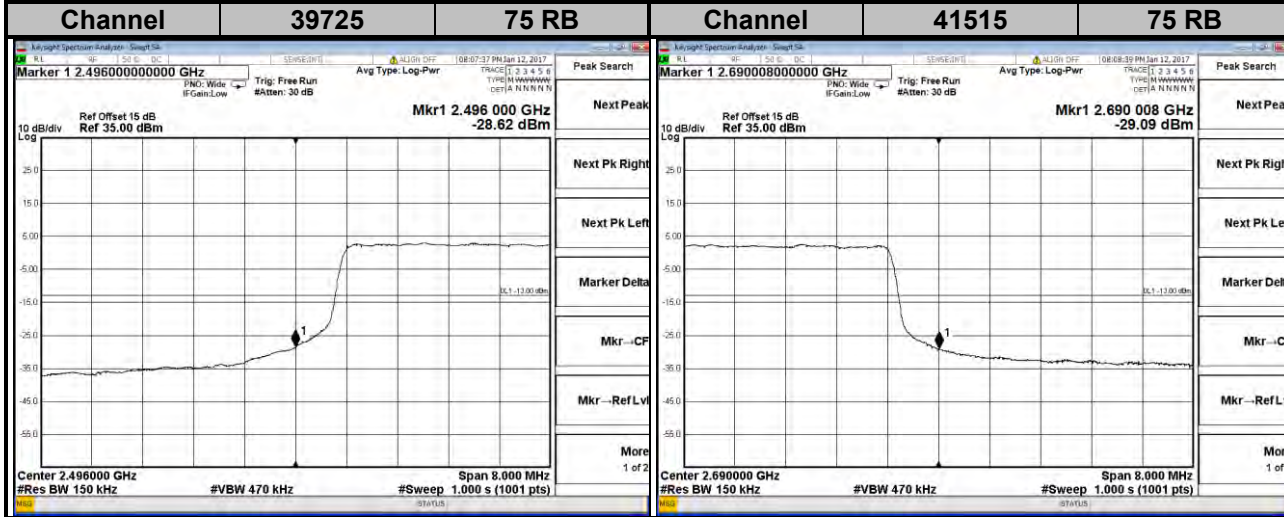

LTE Band 41
Channel Bandwidth: 15 MHz / 16QAM
<Adjacent Channel Band Edge>

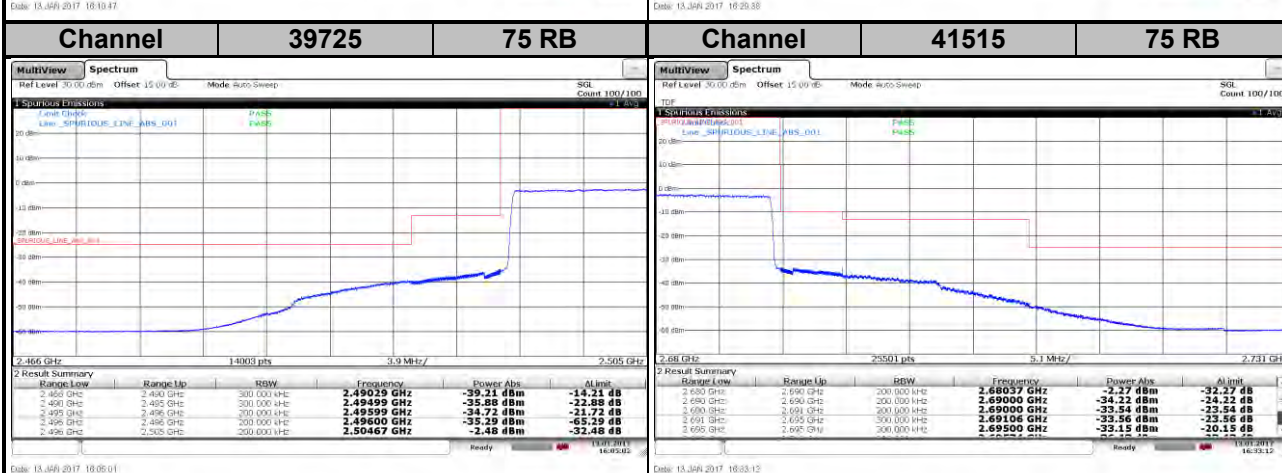
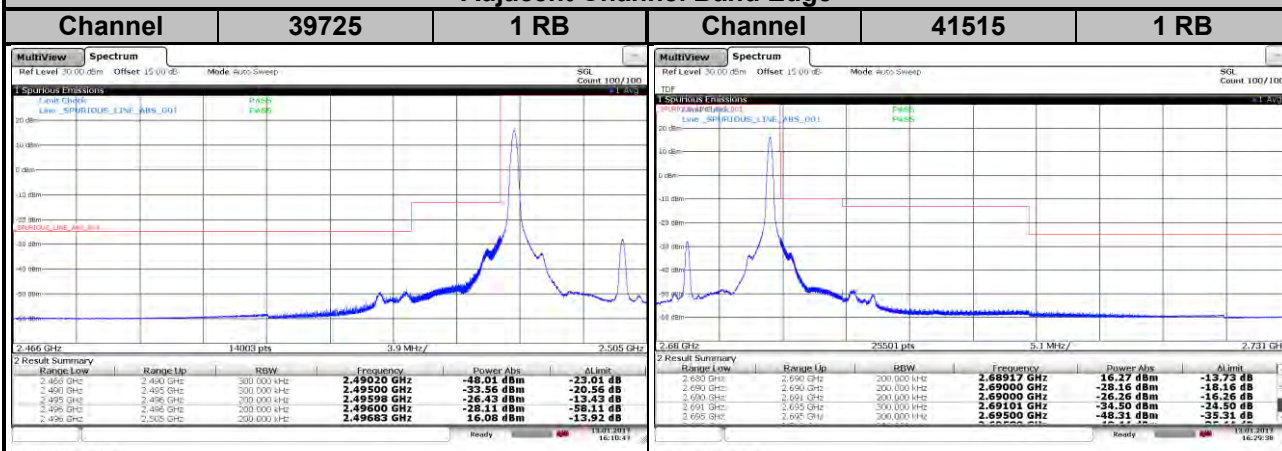

<Channel Band Edge>

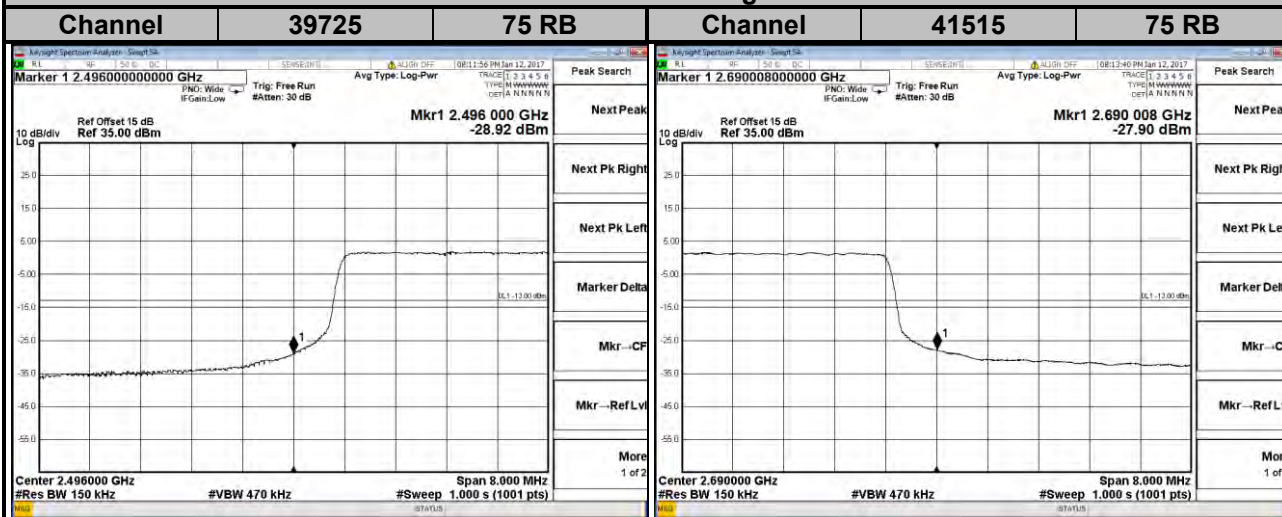

LTE Band 41

Channel Bandwidth: 20 MHz / QPSK

<Adjacent Channel Band Edge>

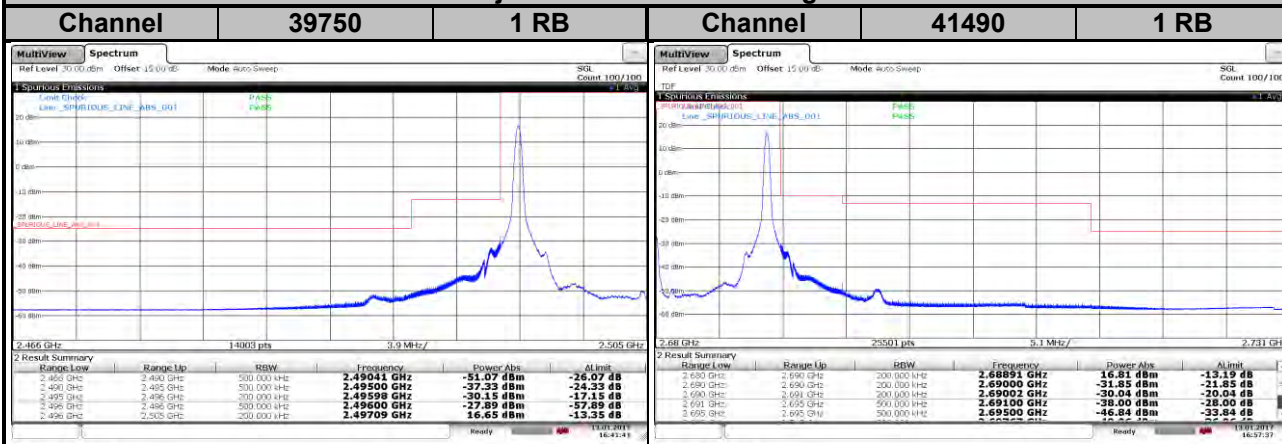

<Channel Band Edge>

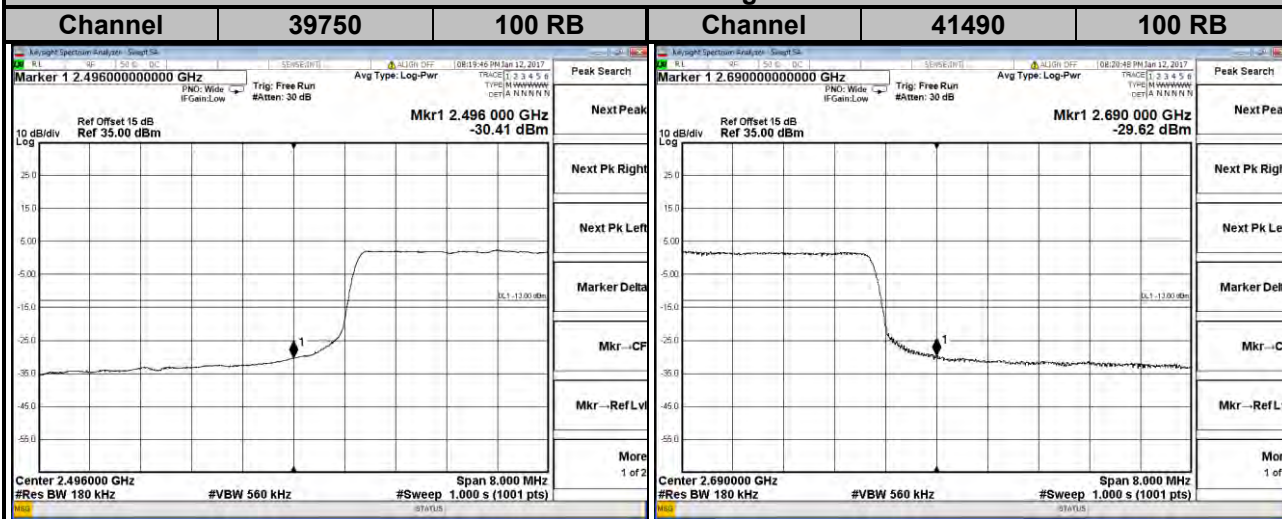

LTE Band 41
Channel Bandwidth: 20 MHz / 16QAM
<Adjacent Channel Band Edge>

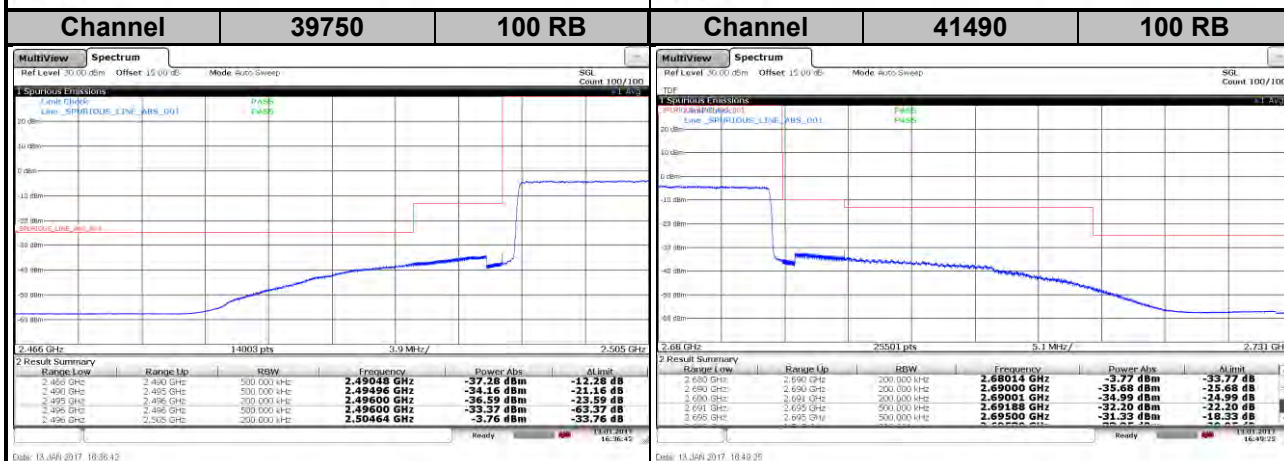
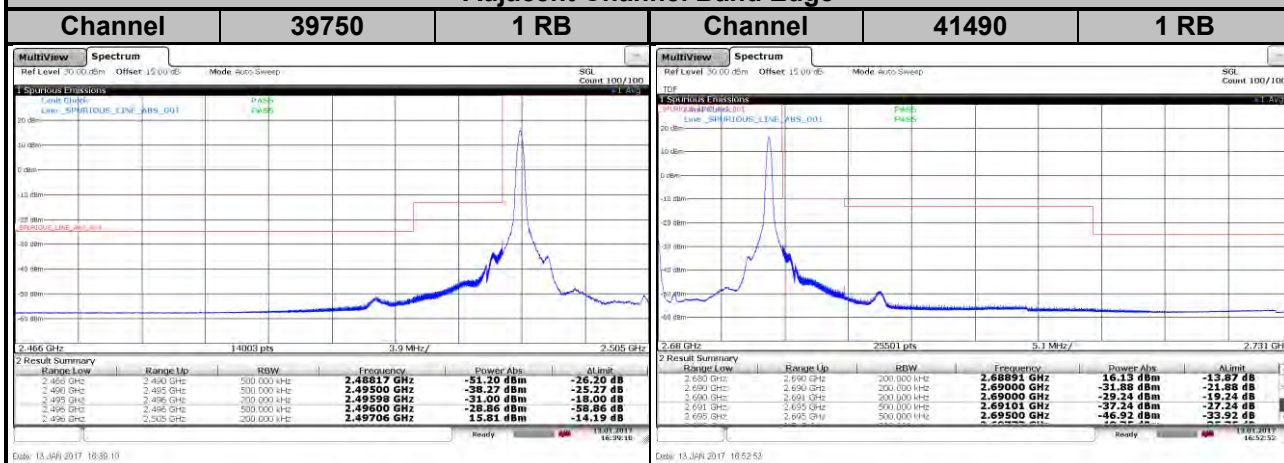

<Channel Band Edge>

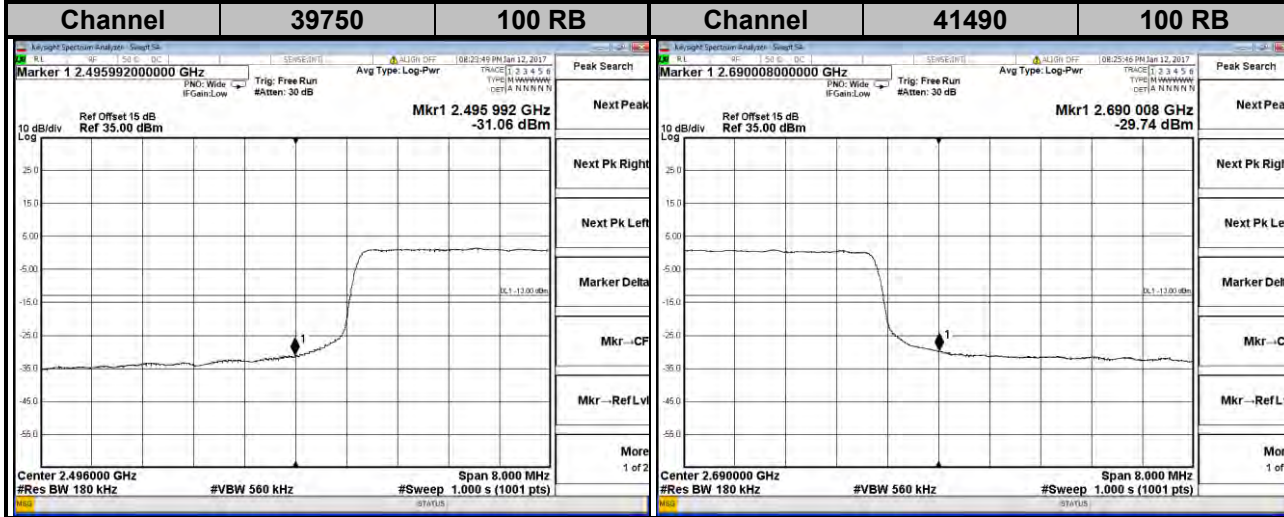

4.5 Peak to Average Ratio

4.5.1 Limits of Peak to Average Ratio Measurement

In measuring transmissions in this band using an average power technique, the peak to-average ratio (PAR) of the transmission may not exceed 13 dB.

4.5.2 Test Setup

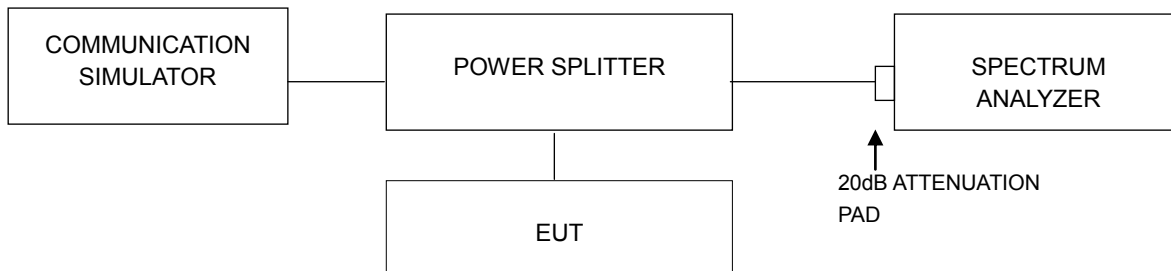

4.5.3 Test Procedures

1. Set resolution/measurement bandwidth \geq signal's occupied bandwidth;
2. Set the number of counts to a value that stabilizes the measured CCDF curve;
3. Record the maximum PAPR level associated with a probability of 0.1 %.

4.5.4 Test Results

LTE Band 7							
Channel Bandwidth: 5 MHz				Channel Bandwidth: 10 MHz			
Channel	Frequency (MHz)	Peak to Average Ratio (dB)		Channel	Frequency (MHz)	Peak to Average Ratio (dB)	
		QPSK	16QAM			QPSK	16QAM
20775	2502.5	4.17	4.59	20800	2505.0	4.13	4.59
21100	2535.0	4.61	5.41	21100	2535.0	4.58	5.50
21425	2567.5	4.42	5.14	21400	2565.0	4.18	4.58

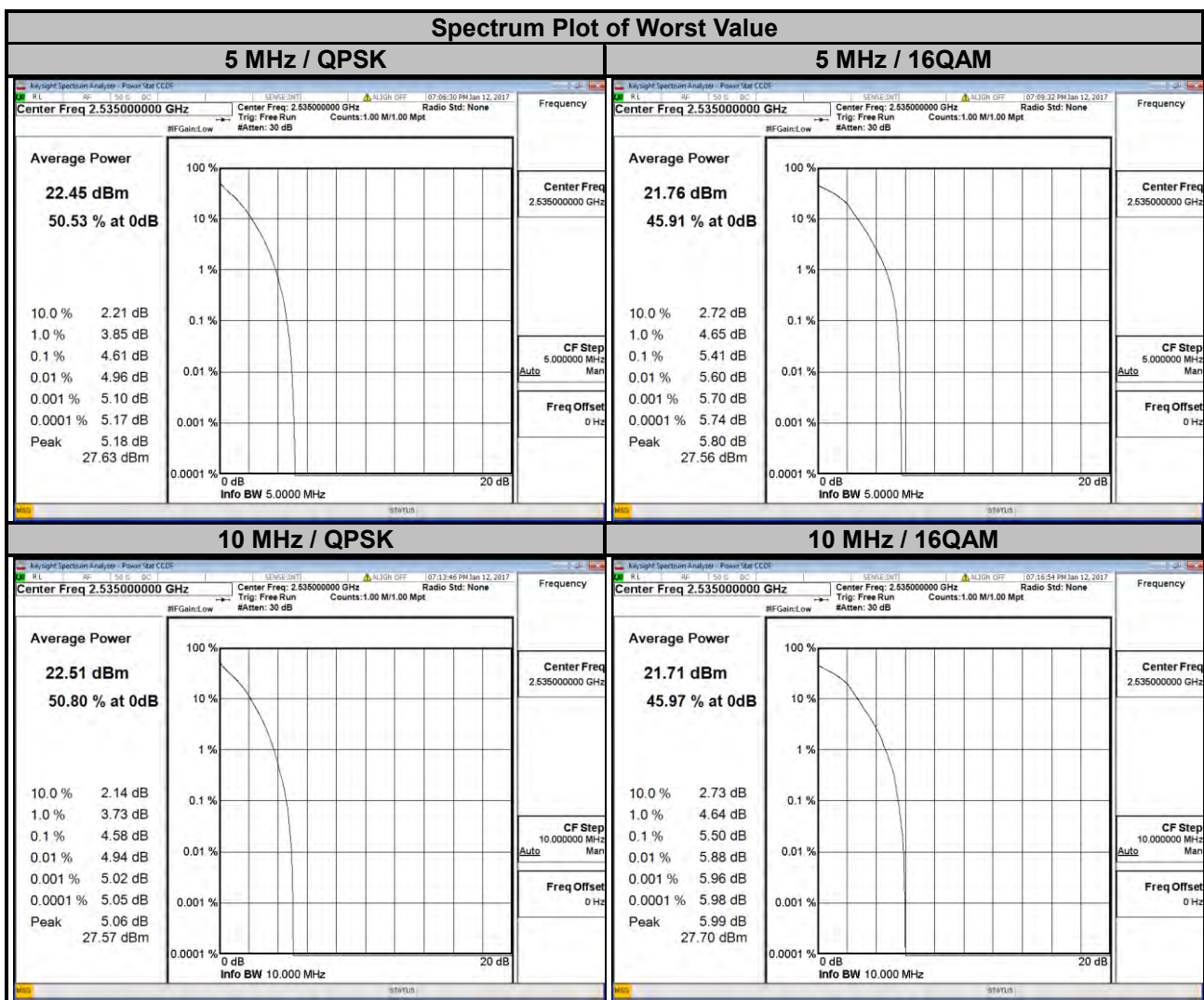

LTE Band 7

Channel Bandwidth: 15 MHz

Channel Bandwidth: 20 MHz

Channel	Frequency (MHz)	Peak to Average Ratio (dB)		Channel	Frequency (MHz)	Peak to Average Ratio (dB)	
		QPSK	16QAM			QPSK	16QAM
20825	2507.5	4.16	4.54	20850	2510.0	4.15	4.57
21100	2535.0	4.68	5.65	21100	2535.0	4.85	5.80
21375	2562.5	3.60	3.90	21350	2560.0	3.35	3.71

Spectrum Plot of Worst Value

15 MHz / QPSK

15 MHz / 16QAM

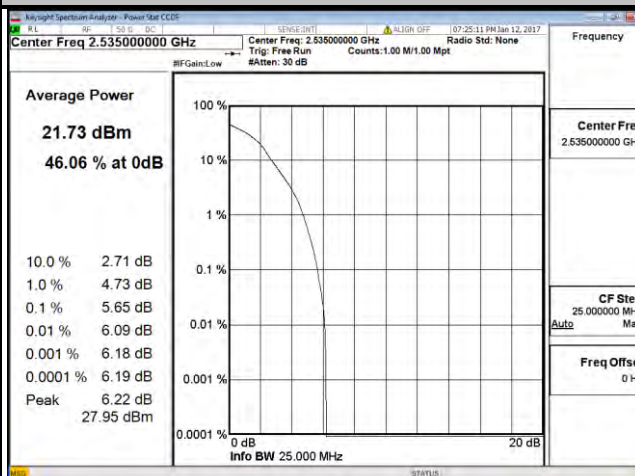
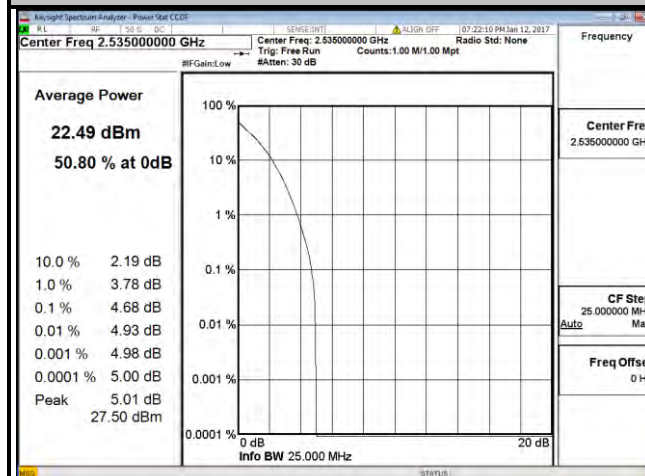

20 MHz / QPSK

20 MHz / 16QAM

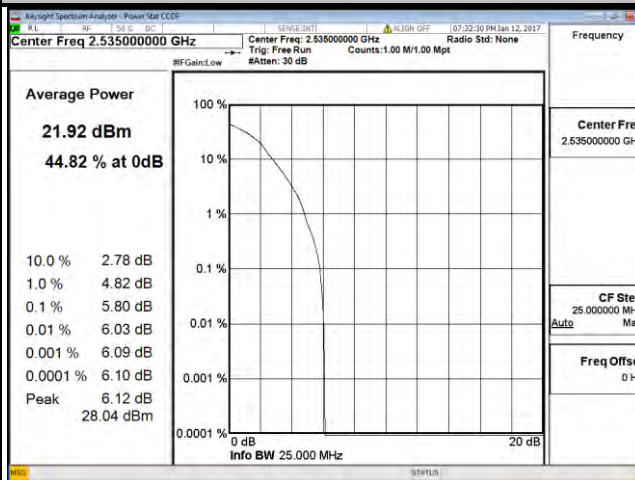
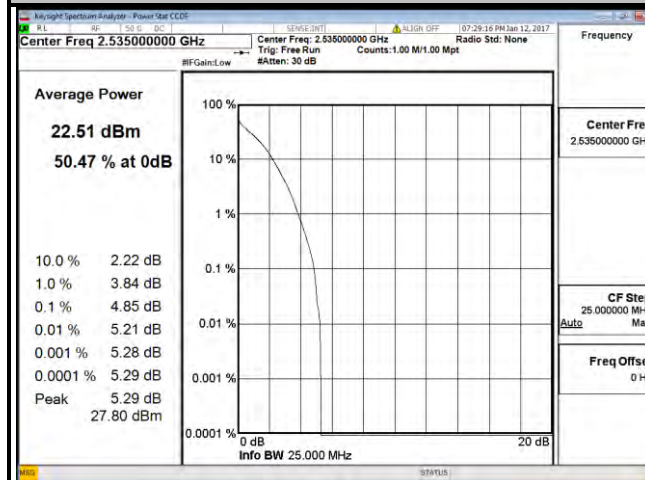

LTE Band 38

Channel Bandwidth: 5 MHz				Channel Bandwidth: 10 MHz			
Channel	Frequency (MHz)	Peak to Average Ratio (dB)		Channel	Frequency (MHz)	Peak to Average Ratio (dB)	
		QPSK	16QAM			QPSK	16QAM
37775	2572.5	9.00	9.57	37800	2575	9.11	9.11
38000	2595	8.62	9.26	38000	2595	9.01	8.88
38225	2617.5	8.89	8.12	38200	2615	8.95	8.55

Spectrum Plot of Worst Value

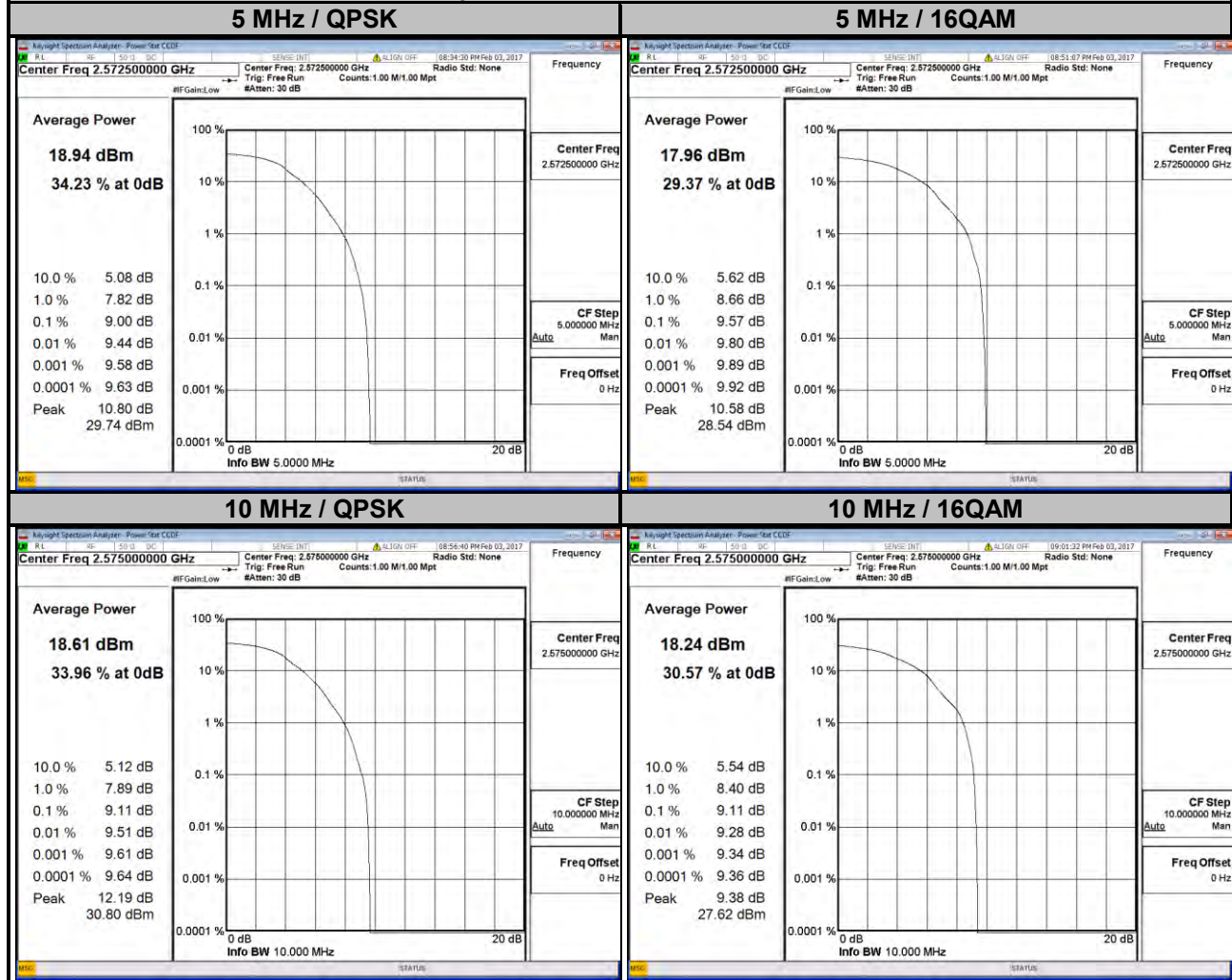

LTE Band 38

Channel Bandwidth: 15 MHz				Channel Bandwidth: 20 MHz			
Channel	Frequency (MHz)	Peak to Average Ratio (dB)		Channel	Frequency (MHz)	Peak to Average Ratio (dB)	
		QPSK	16QAM			QPSK	16QAM
37825	2577.5	8.95	8.68	37850	2580	8.35	8.65
38000	2595	8.07	8.78	38000	2595	9.73	9.22
38175	2612.5	9.83	9.48	38150	2610	9.81	8.56

Spectrum Plot of Worst Value

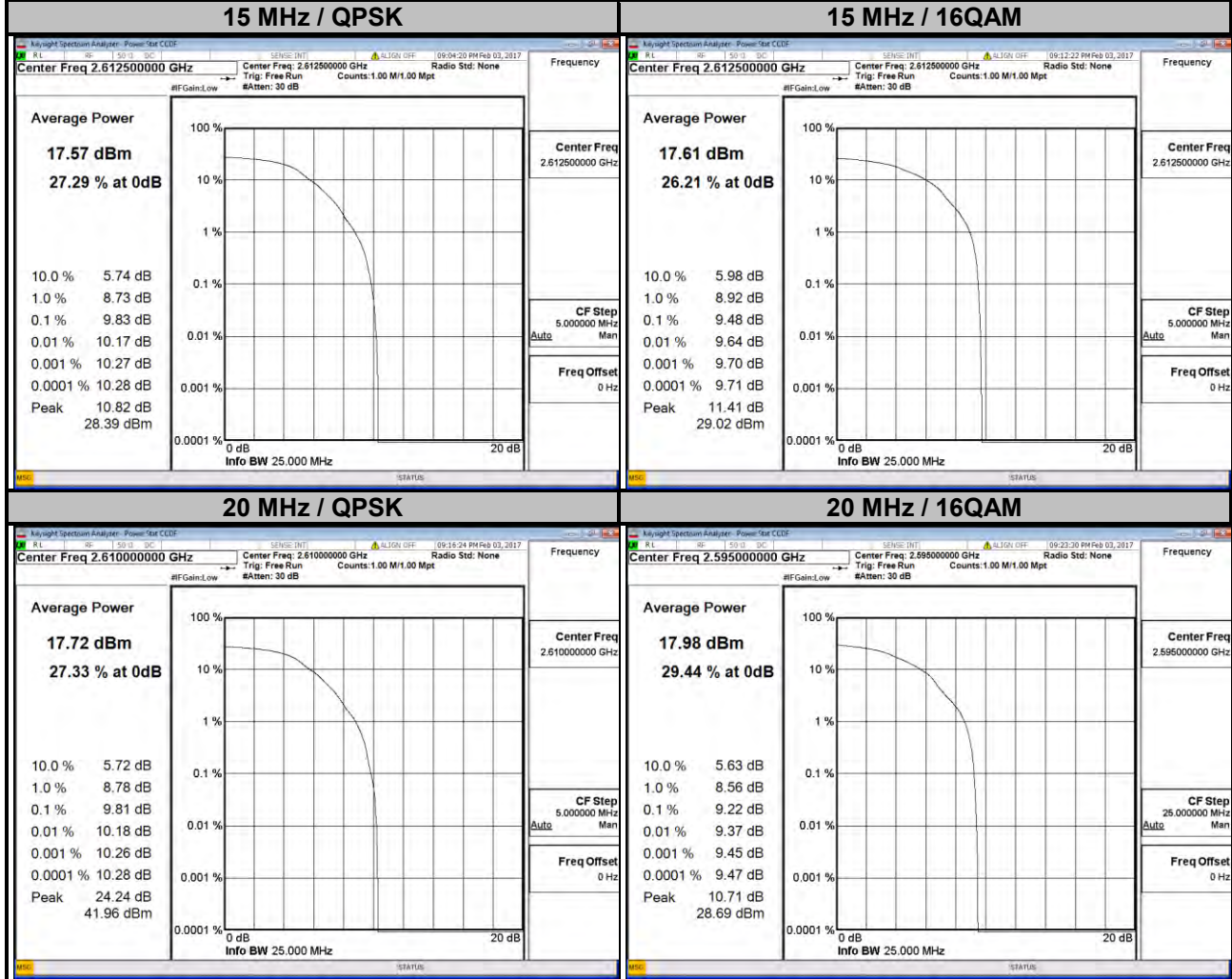

LTE Band 41

Channel Bandwidth: 5 MHz				Channel Bandwidth: 10 MHz			
Channel	Frequency (MHz)	Peak to Average Ratio (dB)		Channel	Frequency (MHz)	Peak to Average Ratio (dB)	
		QPSK	16QAM			QPSK	16QAM
39675	2498.5	8.56	8.23	39700	2501.0	8.31	8.05
40620	2593.0	9.28	8.93	40620	2593.0	8.46	8.04
41565	2687.5	7.71	7.57	41540	2685.0	8.19	8.03

Spectrum Plot of Worst Value

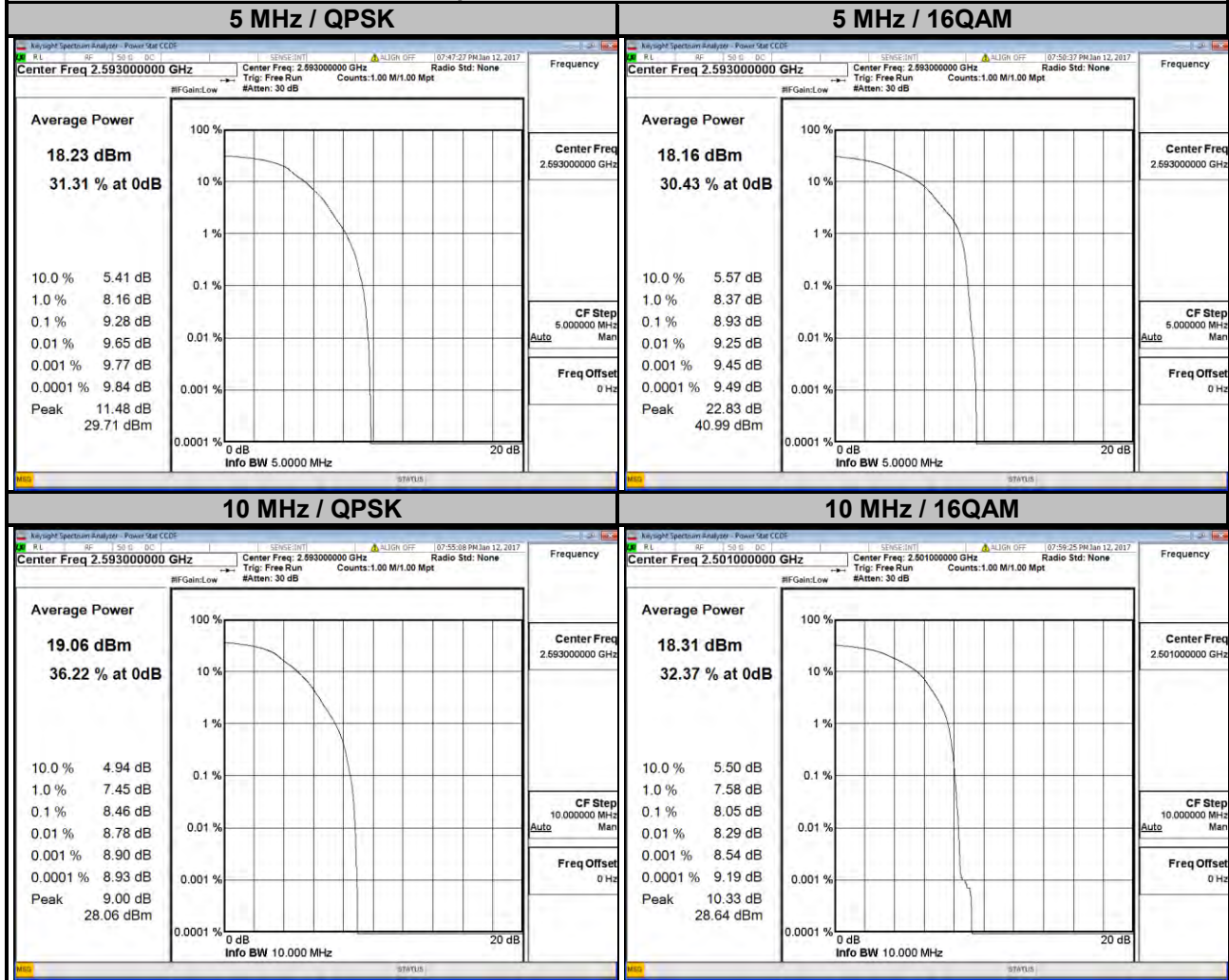

LTE Band 41

Channel Bandwidth: 15 MHz				Channel Bandwidth: 20 MHz			
Channel	Frequency (MHz)	Peak to Average Ratio (dB)		Channel	Frequency (MHz)	Peak to Average Ratio (dB)	
		QPSK	16QAM			QPSK	16QAM
39725	2503.5	8.20	7.82	39750	2506.0	8.60	7.54
40620	2593.0	7.88	8.15	40620	2593.0	8.64	7.99
41515	2682.5	8.55	7.81	41490	2680.0	7.97	7.89

Spectrum Plot of Worst Value

