

FCC Test Report (Part 96: CA mode)

Report No.: RF200109E02B-7

FCC ID: 2AQ68T99W175

Test Model: T99W175

Received Date: Jan. 10, 2020

Test Date: Apr. 30 ~ May 28, 2020

Issued Date: May 29, 2020

Applicant: Hon Lin Technology Co., Ltd.

Address: 11F, No. 32, Jihu Rd., Neihu Dist., Taipei City 114, Taiwan R.O.C.

Issued By: Bureau Veritas Consumer Products Services (H.K.) Ltd., Taoyuan Branch
Lin Kou Laboratories

Lab Address: No. 47-2, 14th Ling, Chia Pau Vil., Lin Kou Dist., New Taipei City, Taiwan

Test Location: No. 19, Hwa Ya 2nd Rd., Wen Hwa Vil., Kwei Shan Dist., Taoyuan City
33383, Taiwan

**FCC Registration/
Designation Number:** 788550 / TW0003



This report is for your exclusive use. Any copying or replication of this report to or for any other person or entity, or use of our name or trademark, is permitted only with our prior written permission. This report sets forth our findings solely with respect to the test samples identified herein. The results set forth in this report are not indicative or representative of the quality or characteristics of the lot from which a test sample was taken or any similar or identical product specifically and expressly noted. Our report includes all of the tests requested by you and the results thereof based upon the information that you provided to us. You have 60 days from date of issuance of this report to notify us of any material error or omission caused by our negligence, provided, however, that such notice shall be in writing and shall specifically address the issue you wish to raise. A failure to raise such issue within the prescribed time shall constitute your unqualified acceptance of the completeness of this report, the tests conducted and the correctness of the report contents. Unless specific mention, the uncertainty of measurement has been explicitly taken into account to declare the compliance or non-compliance to the specification. The report must not be used by the client to claim product certification, approval, or endorsement by TAF or any government agencies.

Table of Contents

Release Control Record	3
1 Certificate of Conformity	4
2 Summary of Test Results	5
2.1 Measurement Uncertainty	5
2.2 Modification Record	5
3 General Information	6
3.1 General Description of EUT	6
3.2 Test Mode Applicability and Tested Channel Detail	10
3.3 Description of Support Units	14
3.3.1 Configuration of System under Test	14
3.4 General Description of Applied Standards and References.....	15
4 Test Types and Results	16
4.1 Maximum Output Power Measurement	16
4.1.1 Limits of Maximum Output Power Measurement	16
4.1.2 Test Setup.....	16
4.1.3 Test Instruments	17
4.1.4 Test Procedures.....	18
4.1.5 Deviation from Test Standard	18
4.1.6 EUT Operating Conditions.....	18
4.1.7 Test Results	19
4.2 Frequency Stability Measurement.....	27
4.2.1 Limits of Frequency Stability Measurement.....	27
4.2.2 Test Procedure	27
4.2.3 Test Setup.....	27
4.2.4 Test Results	28
4.3 Emission Bandwidth Measurement.....	30
4.3.1 Emission Bandwidth Measurement	30
4.3.2 Test Setup.....	30
4.3.3 Test Instruments	30
4.3.4 Test Procedure	30
4.3.5 Deviation from Test Standard	30
4.3.6 EUT Operating Conditions.....	30
4.3.7 Test Result.....	31
4.4 Peak to Average Ratio Measurement	39
4.4.1 Limits of Peak to Average Ratio Measurement	39
4.4.2 Test Setup.....	39
4.4.3 Test Procedures.....	39
4.4.4 Test Results	40
4.5 Conducted Spurious Emissions	42
4.5.1 Limits of Conducted Spurious Emissions Measurement	42
4.5.2 Test Setup.....	42
4.5.3 Test Procedure	42
4.5.4 Test Results	43
4.6 Radiated Emission Measurement	46
4.6.1 Limits of Radiated Emission Measurement	46
4.6.2 Test Instruments	46
4.6.3 Test Procedures.....	46
4.6.4 Deviation from Test Standard	46
4.6.5 Test Set Up.....	47
4.6.6 Test Results	48
5 Pictures of Test Arrangements	51
Appendix – Information of the Testing Laboratories	52

Release Control Record

Issue No.	Description	Date Issued
RF200109E02B-7	Original release	May 29, 2020

1 Certificate of Conformity

Product: 5G WWAN Module

Brand: Foxconn

Test Model: T99W175

Sample Status: Engineering sample

Applicant: Hon Lin Technology Co., Ltd.

Test Date: Apr. 30 ~ May 28, 2020

Standards: 47 CFR FCC Part 96

The above equipment has been tested by **Bureau Veritas Consumer Products Services (H.K.) Ltd., Taoyuan Branch**, and found compliance with the requirement of the above standards. The test record, data evaluation & Equipment Under Test (EUT) configurations represented herein are true and accurate accounts of the measurements of the sample's RF characteristics under the conditions specified in this report.

Prepared by : Pettie Chen , **Date:** May 29, 2020
Pettie Chen / Senior Specialist

Approved by : Bruce Chen , **Date:** May 29, 2020
Bruce Chen / Senior Project Engineer

2 Summary of Test Results

47 CFR FCC Part 96			
FCC Clause	Test Item	Result	Remarks
2.1046 96.41(b)	Maximum Peak Output Power	Pass	Meet the requirement of limit.
2.1047 96.41(a)	Modulation Characteristics	Pass	Meet the requirement
96.41(g)	Peak to Average Ration	Pass	Meet the requirement of limit.
2.1049	Emission Bandwidth	Pass	Meet the requirement of limit.
2.1055	Frequency Stability	Pass	Meet the requirement of limit.
2.1051 96.41(e)	Conducted Spurious Emissions	Pass	Meet the requirement of limit.
2.1053 96.41(e)	Radiated Spurious Emissions	Pass	Meet the requirement of limit. Minimum passing margin is -5.4dB at 7360.00MHz.

Note:

Determining compliance based on the results of the compliance measurement, not taking into account measurement instrumentation uncertainty.

2.1 Measurement Uncertainty

Where relevant, the following measurement uncertainty levels have been estimated for tests performed on the EUT as specified in CISPR 16-4-2:

Measurement	Frequency	Expanded Uncertainty (k=2) (±)
Radiated Emissions up to 1 GHz	9 kHz ~ 30MHz	3.04 dB
	30 MHz ~ 200 MHz	3.59 dB
	200 MHz ~ 1000 MHz	3.60 dB
Radiated Emissions above 1 GHz	1 GHz ~ 18 GHz	2.29 dB
	18 GHz ~ 40 GHz	2.29 dB

2.2 Modification Record

There were no modifications required for compliance.

3 General Information

3.1 General Description of EUT

Product	5G WWAN Module				
Brand	Foxconn				
Test Model	T99W175				
Status of EUT	Engineering sample				
Power Supply Rating	5 Vdc (Host equipment) 3.135Vdc~3.63Vdc (Module)				
Modulation Type	QPSK, 16QAM, 64QAM, 256QAM				
Operating Frequency	LTE Band 48C	3553.3 ~ 3696.7 MHz			
	LTE Band 42C	3552.5 ~ 3596.7 MHz			
Max. EIRP Power		QPSK	16QAM	64QAM	256QAM
	LTE Band 48C (Full Power) (20MHz+20MHz)	194.536mW (22.89dBm)	174.582mW (22.42dBm)	159.221mW (22.02dBm)	163.305mW (22.13dBm)
	LTE Band 48C (Per 10M Power) (20MHz+20MHz)	179.061mW (22.53dBm)	167.494mW (22.24dBm)	151.008mW (21.79dBm)	129.122mW (21.11dBm)
	LTE Band 42C (Full Power) (20MHz+20MHz)	185.353mW (22.68dBm)	165.959mW (22.20dBm)	152.405mW (21.83dBm)	127.644mW (21.06dBm)
	LTE Band 42C (Per 10M Power) (20MHz+20MHz)	167.880mW (22.25dBm)	151.356mW (21.80dBm)	139.637mW (21.45dBm)	116.681mW (20.67dBm)
Emission Designator	LTE Band 48C (20MHz+20MHz)	37M5G7D	37M5D7W	37M4D7W	37M5D7W
	LTE Band 42C (20MHz+20MHz)	37M5G7D	37M5D7W	37M5D7W	37M4D7W
Antenna Type	Refer to Note as below				
Antenna Connector	Refer to Note as below				
Accessory Device	NA				
Cable Supplied	NA				

Note:

1. This report is prepared for FCC class II permissive change. This report is issued as a supplementary report of BV CPS report no.: RF200109E02-8. Difference compared with the original report is adding Modulation Type 256QAM by software. Therefore, the EUT was tested all tests for 256QAM and presented in the test report.
2. There are four Difference HW of T99W175.

Brand	Model	HW
Foxconn	T99W175	1. 3G+LTE+Sub6+eSIM
		2. 3G+LTE+Sub6 only w/o eSIM
		3. 3G+LTE+Sub6+eSIM+GNSS connector
		4. 3G+LTE+Sub6 only+w/o eSIM+GNSS connector

*After pre-testing, "HW: 1. 3G+LTE+Sub6+eSIM" is the worst for the final tests.

3. For CA mode configuration, please consult the manufacturer to declare the test mode.

4. E-UTRA CA configuration / Bandwidth combination set.

E-UTRA CA configuration / Bandwidth combination set					
E-UTRA CA configuration	Uplink CA configurations	Component carriers in order of increasing carrier frequency		Maximum aggregated bandwidth [MHz]	Bandwidth combination set
		Channel bandwidths for carrier [MHz]	Channel bandwidths for carrier [MHz]		
CA_48C	CA_48C	5, 10, 15, 20	20	40	0
		20	5, 10, 15		
CA_42C	CA_42C	5, 10, 15, 20	20	40	0
		20	5, 10, 15		
		10, 15, 20	20	40	1
		20	10, 15		

*48C/42C is continuous CA and maximum combination is 20M+20M.

5. The following antennas were provided to the EUT.

Antenna No.	RF Chain No.	Brand	Model	Antenna Net Gain(dBi)	Frequency range (MHz)	Antenna Type	Connector Type
1		WHA YU	C107-511720-A	4.41	660~803	PCB	I-PEX
2		WHA YU	C107-511721-A	3.81 4.03	791~960 1447.9~1606	PCB	I-PEX
3		WHA YU	C107-511722-A	4.27 5.31	1710~2170 2500~2690	PCB	I-PEX
4		WHA YU	C107-511723-A	2.99 0.92	2300~2400 3500~3700	PCB	I-PEX
5		WHA YU	C107-511724-A	6.45	5150~5925	PCB	I-PEX
6		WHA YU	C107-511725-A	4.89	3400~3700	PCB	I-PEX
7		AVX	5000106-R1-X01	2.91	699~803	Monopole	I-PEX
8		AVX	5000107-R1-X01	2.59	791~960	Monopole	I-PEX
9		AVX	5000108-R1-X01	2.85	1427~1610	Monopole	I-PEX
10		AVX	5000109-R1-X01	2.23 2.94	1710~2200 5150~5925	Monopole	I-PEX
11		AVX	5000110-R1-X01	0.9	2300~2690	Monopole	I-PEX
12		AVX	5000111-R1-X01	0.87	3300~5000	Monopole	I-PEX
13	Tx1/ Rx1	Ethertronics	5003806	0.4 -1.61 0.39 2.95 1.98 0.38 0.83 2.31	698-821 824-960 1425-1515 1710-2200 2300-2690 3300-4200 4400-5000 5150-5925	PIFA	I-PEX
	Rx2	Ethertronics	5003807	-2.24 -4.52 2.87 2.99 2.93 2.91 2.23 -0.85 -3.04	716-821 824-960 1425-1515 1557-1610 1805-2200 2300-2690 3300-4200 4400-5000 5150-5925	PIFA	I-PEX
	Tx2/ Rx3	Ethertronics	5003806	2.21 2.25 -0.45 2.6	1710-2200 2300-2690 3300-4200 4400-5000	PIFA	I-PEX
	Rx4	Ethertronics	5003700	1.38 2.87 0.6 -2.09	1805-2200 2300-2690 3300-4200 4400-5000	PIFA	I-PEX

Antenna No.	RF Chain No.	Brand	Model	Antenna Net Gain(dBi)	Frequency range (MHz)	Antenna Type	Connector Type
14	Ant. 0 (TX/RX)	Master Wave	NA	2.4 2.2 2.9 2.9 2.9 NA	880~960 1020~2170 2545~2595 3565~3600 3900~4000 GPS	PCB	I-PEX
	Ant. 2 (TX/RX)	Master Wave	NA	NA 2.2 2.8 2.9 2.8 NA	880~960 1020~2170 2545~2595 3565~3600 3900~4000 GPS	PCB	I-PEX
	Ant. 1 (RX)	Master Wave	NA	NA 5.3 5.1 4.3 4.5 NA	880~960 1020~2170 2545~2595 3565~3600 3900~4000 GPS	PCB	I-PEX
	Ant. 3 (RX)	Master Wave	NA	1.3 6.8 3.7 6.4 6.2 3.7	880~960 1020~2170 2545~2595 3565~3600 3900~4000 GPS	PCB	I-PEX

*The antenna for the final tests as following table.

	Band	Antenna
WCDMA	2	Antenna 3
	4	Antenna 3
	5	Antenna 2
LTE	2	Antenna 3
	4	Antenna 3
	5	Antenna 2
	7	Antenna 3
	12	Antenna 1
	13	Antenna 1
	14	Antenna 1
	17	Antenna 1
	25	Antenna 3
	26	Antenna 2
	30	Antenna 4
	66	Antenna 3
	71	Antenna 1
	38	Antenna 3
	41	Antenna 3
42	Antenna 4	
48	Antenna 4	

3.2 Test Mode Applicability and Tested Channel Detail

Pre-Scan has been conducted to determine the worst-case mode from all possible combinations between available modulations, data rates, XYZ axis and antenna ports

The worst case was found when positioned on Z-plane. Following channel(s) was (were) selected for the final test as listed below:

LTE Band 48 (CA 48C)

Test Item	Available Channel	Tested Channel	Channel Bandwidth	Modulation
Maximum Output Power	55340 to 56442 55538 to 56640	55340 (3560.0MHz)+ 55538 (3579.8MHz), 55891 (3615.1MHz)+ 56089 (3634.9MHz), 56642 (3670.2MHz)+ 56640 (3690.0MHz)	20MHz+20MHz	256QAM
	55340 to 56491 55511 to 56662	55340 (3560.0MHz)+ 55511 (3577.1MHz), 55916 (3617.6MHz)+ 56087 (3634.7MHz), 56491 (3675.1MHz)+ 56662 (3692.2MHz)	20MHz+15MHz	256QAM
	55340 to 56541 55484 to 56685	55340 (3560.0MHz)+ 55484 (3574.4MHz), 55941 (3620.1MHz)+ 56085 (3634.5MHz), 56541 (3680.1MHz)+ 56685 (3694.5MHz)	20MHz+10MHz	256QAM
	55340 to 56590 55457 to 56707	55340 (3560.0MHz)+ 55457 (3571.7MHz), 55965 (3622.5MHz)+ 56082 (3634.2MHz), 56590 (3685.0MHz)+ 56707 (3696.7MHz)	20MHz+5MHz	256QAM
	55273 to 56523 55390 to 56640	55273 (3553.3MHz)+ 55390 (3565.0MHz), 55898 (3615.8MHz)+ 56015 (3627.5MHz), 56523 (3678.3MHz)+ 56640 (3690.0MHz)	5MHz+20MHz	256QAM
	55295 to 56496 55439 to 56640	55295 (3555.5MHz)+ 55439 (3569.9MHz), 55896 (3615.6MHz)+ 56040 (3630.0MHz), 56496 (3675.6MHz)+ 56640 (3690.0MHz)	10MHz+20MHz	256QAM
	55318 to 56469 55489 to 56640	55318 (3557.8MHz)+ 55489 (3574.9MHz), 55893 (3615.3MHz)+ 56064 (3632.4MHz), 56469 (3672.9MHz)+ 56640 (3690.0MHz)	15MHz+20MHz	256QAM
Frequency Stability	55340 to 56442 55538 to 56640	55891 (3615.1MHz)+ 56089 (3634.9MHz)	20MHz+20MHz	256QAM

Test Item	Available Channel	Tested Channel	Channel Bandwidth	Modulation
Occupied Bandwidth	55340 to 56442 55538 to 56640	55340 (3560.0MHz)+ 55538 (3579.8MHz), 55891 (3615.1MHz)+ 56089 (3634.9MHz), 56642 (3670.2MHz)+ 56640 (3690.0MHz)	20MHz+20MHz	256QAM
	55340 to 56491 55511 to 56662	55340 (3560.0MHz)+ 55511 (3577.1MHz), 55916 (3617.6MHz)+ 56087 (3634.7MHz), 56491 (3675.1MHz)+ 56662 (3692.2MHz)	20MHz+15MHz	256QAM
	55340 to 56541 55484 to 56685	55340 (3560.0MHz)+ 55484 (3574.4MHz), 55941 (3620.1MHz)+ 56085 (3634.5MHz), 56541 (3680.1MHz)+ 56685 (3694.5MHz)	20MHz+10MHz	256QAM
	55340 to 56590 55457 to 56707	55340 (3560.0MHz)+ 55457 (3571.7MHz), 55965 (3622.5MHz)+ 56082 (3634.2MHz), 56590 (3685.0MHz)+ 56707 (3696.7MHz)	20MHz+5MHz	256QAM
	55273 to 56523 55390 to 56640	55273 (3553.3MHz)+ 55390 (3565.0MHz), 55898 (3615.8MHz)+ 56015 (3627.5MHz), 56523 (3678.3MHz)+ 56640 (3690.0MHz)	5MHz+20MHz	256QAM
	55295 to 56496 55439 to 56640	55295 (3555.5MHz)+ 55439 (3569.9MHz), 55896 (3615.6MHz)+ 56040 (3630.0MHz), 56496 (3675.6MHz)+ 56640 (3690.0MHz)	10MHz+20MHz	256QAM
	55318 to 56469 55489 to 56640	55318 (3557.8MHz)+ 55489 (3574.9MHz), 55893 (3615.3MHz)+ 56064 (3632.4MHz), 56469 (3672.9MHz)+ 56640 (3690.0MHz)	15MHz+20MHz	256QAM
Peak to Average Ratio	55340 to 56442 55538 to 56640	55340 (3560.0MHz)+ 55538 (3579.8MHz), 55891 (3615.1MHz)+ 56089 (3634.9MHz), 56642 (3670.2MHz)+ 56640 (3690.0MHz)	20MHz+20MHz	256QAM
Conducted Emission	55340 to 56442 55538 to 56640	55340 (3560.0MHz)+ 55538 (3579.8MHz), 55891 (3615.1MHz)+ 56089 (3634.9MHz), 56642 (3670.2MHz)+ 56640 (3690.0MHz)	20MHz+20MHz	256QAM
Radiated Emission Below 1GHz	55340 to 56442 55538 to 56640	56642 (3670.2MHz)+ 56640 (3690.0MHz)	20MHz+20MHz	256QAM
Radiated Emission Above 1GHz	55340 to 56442 55538 to 56640	55340 (3560.0MHz)+ 55538 (3579.8MHz), 55891 (3615.1MHz)+ 56089 (3634.9MHz), 56642 (3670.2MHz)+ 56640 (3690.0MHz)	20MHz+20MHz	256QAM

Note:

1. For conducted emission and radiated emission test, select the band with the maximum power for final test.
2. LTE CA mode is similar to digital modulation in LTE single frequency band, so please refer to BV CPS report no.: RF200109E02B-4 for the modulation characteristics data of CA mode.

LTE Band 42 (CA 42C)

Test Item	Available Channel	Tested Channel	Channel Bandwidth	Modulation
Maximum Output Power	43190 to 43292 43388 to 43490	43190 (3560.0MHz)+ 43388 (3579.8MHz), 43241 (3565.1MHz)+ 43439 (3584.9MHz), 43292 (3570.2MHz)+ 43490 (3590.0MHz)	20MHz+20MHz	256QAM
	43190 to 43341 43361 to 43512	43190 (3560.0MHz)+ 43361 (3577.1MHz), 43265 (3567.5MHz)+ 43436 (3584.6MHz), 43341 (3575.1MHz)+ 43512 (3592.2MHz)	20MHz+15MHz	256QAM
	43190 to 43391 43334 to 43535	43190 (3560.0MHz)+ 43334 (3574.4MHz), 43335 (3574.5MHz)+ 43479 (3588.9MHz), 43391 (3580.1MHz)+ 43535 (3594.5MHz)	20MHz+10MHz	256QAM
	43190 to 43440 43307 to 43557	43190 (3560.0MHz)+ 43307 (3571.7MHz), 43315 (3572.5MHz)+ 43432 (3584.2MHz), 43440 (3585.0MHz)+ 43557 (3596.7MHz)	20MHz+5MHz	256QAM
	43115 to 43373 43232 to 43490	43115 (3553.3MHz)+ 43232 (3565.0MHz), 43244 (3565.4MHz)+ 43361 (3577.1MHz), 43373 (3578.3MHz)+ 43490 (3590.0MHz)	5MHz+20MHz	256QAM
	43140 to 43346 43284 to 43490	43140 (3555.5MHz)+ 43284 (3569.9MHz), 43242 (3565.2MHz)+ 43386 (3579.6MHz), 43346 (3575.6MHz)+ 43490 (3590.0MHz)	10MHz+20MHz	256QAM
	43165 to 43319 43336 to 43490	43165 (3557.8MHz)+ 43336 (3574.9MHz), 43242 (3565.2MHz)+ 43413 (3582.3MHz), 43319 (3572.9MHz)+ 43490 (3590.0MHz)	15MHz+20MHz	256QAM
Frequency Stability	43190 to 43292 43388 to 43490	43241 (3565.1MHz)+ 43439 (3584.9MHz)	20MHz+20MHz	256QAM

Test Item	Available Channel	Tested Channel	Channel Bandwidth	Modulation
Occupied Bandwidth	43190 to 43292 43388 to 43490	43190 (3560.0MHz)+ 43388 (3579.8MHz), 43241 (3565.1MHz)+ 43439 (3584.9MHz), 43292 (3570.2MHz)+ 43490 (3590.0MHz)	20MHz+20MHz	256QAM
	43190 to 43341 43361 to 43512	43190 (3560.0MHz)+ 43361 (3577.1MHz), 43265 (3567.5MHz)+ 43436 (3584.6MHz), 43341 (3575.1MHz)+ 43512 (3592.2MHz)	20MHz+15MHz	256QAM
	43190 to 43391 43334 to 43535	43190 (3560.0MHz)+ 43334 (3574.4MHz), 43335 (3574.5MHz)+ 43479 (3588.9MHz), 43391 (3580.1MHz)+ 43535 (3594.5MHz)	20MHz+10MHz	256QAM
	43190 to 43440 43307 to 43557	43190 (3560.0MHz)+ 43307 (3571.7MHz), 43315 (3572.5MHz)+ 43432 (3584.2MHz), 43440 (3585.0MHz)+ 43557 (3596.7MHz)	20MHz+5MHz	256QAM
	43115 to 43373 43232 to 43490	43115 (3553.3MHz)+ 43232 (3565.0MHz), 43244 (3565.4MHz)+ 43361 (3577.1MHz), 43373 (3578.3MHz)+ 43490 (3590.0MHz)	5MHz+20MHz	256QAM
	43140 to 43346 43284 to 43490	43140 (3555.5MHz)+ 43284 (3569.9MHz), 43242 (3565.2MHz)+ 43386 (3579.6MHz), 43346 (3575.6MHz)+ 43490 (3590.0MHz)	10MHz+20MHz	256QAM
	43165 to 43319 43336 to 43490	43165 (3557.8MHz)+ 43336 (3574.9MHz), 43242 (3565.2MHz)+ 43413 (3582.3MHz), 43319 (3572.9MHz)+ 43490 (3590.0MHz)	15MHz+20MHz	256QAM
Peak to Average Ratio	43190 to 43292 43388 to 43490	43190 (3560.0MHz)+ 43388 (3579.8MHz), 43241 (3565.1MHz)+ 43439 (3584.9MHz), 43292 (3570.2MHz)+ 43490 (3590.0MHz)	20MHz+20MHz	256QAM

Note: LTE CA mode is similar to digital modulation in LTE single frequency band, so please refer to BV CPS report no.: RF200109E02-4 for the modulation characteristics data of CA mode.

Test Condition:

Test Item	Environmental Conditions	Input Power	Tested By
Maximum Output Power	25deg. C, 70%RH	5Vdc	James Yang
Modulation characteristics	24deg. C, 64%RH	5Vdc	James Yang
Frequency Stability	24deg. C, 64%RH	5Vdc	James Yang
Occupied Bandwidth	24deg. C, 64%RH	5Vdc	James Yang
Peak to Average Ratio	24deg. C, 64%RH	5Vdc	James Yang
Concludeted Emission	24deg. C, 64%RH	5Vdc	James Yang
Radiated Emission	22deg. C, 68%RH	120Vac, 60Hz	Greg Lin

3.3 Description of Support Units

The EUT has been tested as an independent unit together with other necessary accessories or support units. The following support units or accessories were used to form a representative test configuration during the tests.

ID	Product	Brand	Model No.	Serial No.	FCC ID	Remarks
A.	Wideband Radio Communication Tester	R&S	CMW500	151084	NA	-
B.	Adapter	LITEON	PA-1050-39	NA	NA	-
C.	Fixture	NA	NA	NA	NA	Provided by client.

Note:

1. All power cords of the above support units are non-shielded (1.8m).
2. Items A acted as communication partners to transfer data.

ID	Descriptions	Qty.	Length (m)	Shielding (Yes/No)	Cores (Qty.)	Remarks
1.	USB cable	1	1.5	Y	0	-

3.3.1 Configuration of System under Test

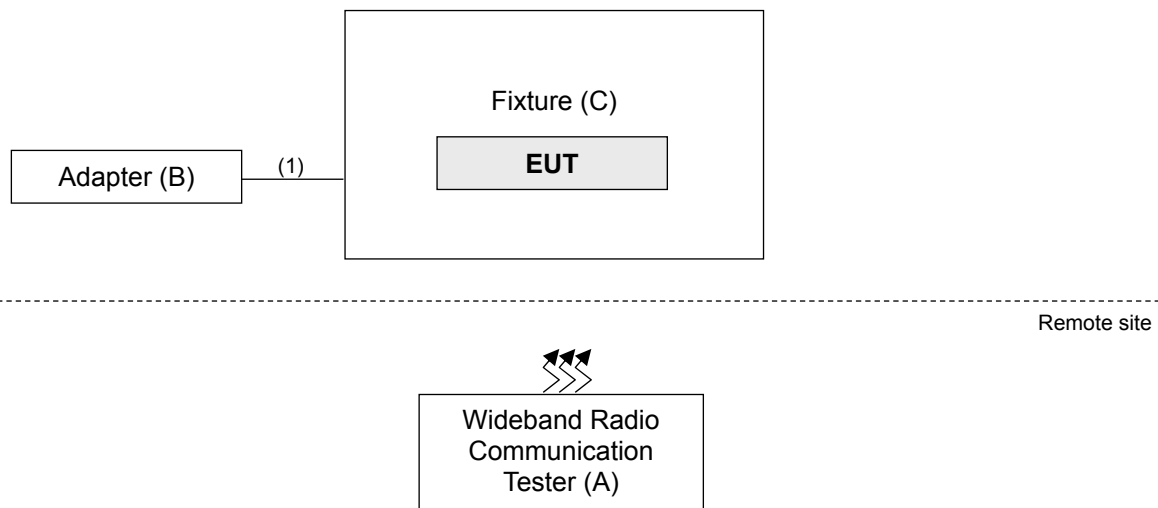

3.4 General Description of Applied Standards and References

The EUT is a RF Product. According to the specifications of the manufacturer, it must comply with the requirements of the following standards:

Test Standard:

FCC 47 CFR Part 2

FCC 47 CFR Part 96

ANSI/TIA/EIA-603-D-2010

All test items have been performed and recorded as per the above standards.

References Test Guidance:

KDB 971168 D01 Power Meas License Digital Systems v03r01

KDB 940660 D01 Part 96 CBRS Eqpt v02

All test items have been performed as a reference to the above KDB test guidance.

4 Test Types and Results

4.1 Maximum Output Power Measurement

4.1.1 Limits of Maximum Output Power Measurement

Device		Maximum Output Power (dBm/10 MHz)
<input checked="" type="checkbox"/>	End User Device	23
<input type="checkbox"/>	Category A CBSD	30
<input type="checkbox"/>	Category B CBSD	47

4.1.2 Test Setup

Radiated Measurement Method

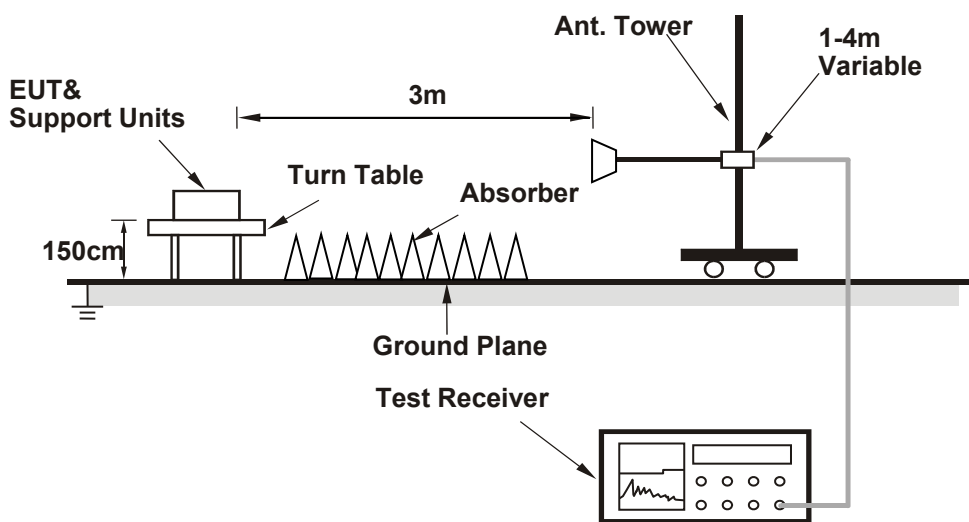

Conducted Measurement Method

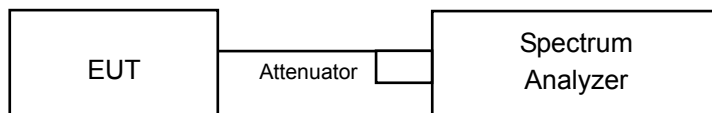

4.1.3 Test Instruments

Description & Manufacturer	Model No.	Serial No.	Cal. Date	Cal. Due
Test Receiver ROHDE & SCHWARZ	ESIB7	100187	May 30, 2019	May 29, 2020
Spectrum Analyzer ROHDE & SCHWARZ	FSP40	100269	Jun. 04, 2019	Jun. 03, 2020
Spectrum Analyzer KEYSIGHT	N9030B	MY57140953	Jul. 03, 2019	Jul. 02, 2020
Radio Communication Analyzer Anritsu	MT8821C	6261806803	Jan. 18, 2020	Jan. 17, 2021
MXG Vector signal generator Agilent	N5182B	MY53050162	Jan. 14, 2020	Jan. 13, 2021
BILOG Antenna SCHWARZBECK	VULB9168	9168-160	Nov. 07, 2019	Nov. 06, 2020
HORN Antenna SCHWARZBECK	BBHA 9120 D	9120D-1169	Nov. 24, 2019	Nov. 23, 2020
HORN Antenna SCHWARZBECK	BBHA 9170	BBHA9170241	Nov. 24, 2019	Nov. 23, 2020
Preamplifier Agilent (Below 1GHz)	8447D	2944A10638	Jul. 11, 2019	Jul. 10, 2020
Preamplifier Agilent (Above 1GHz)	8449B	3008A02367	Feb. 18, 2020	Feb. 17, 2021
RF signal cable HUBER+SUHNER&EMCI	SUCOFLEX 104 & EMC104-SM-SM8 000	CABLE-CH9-02 (248780+171006)	Jan. 18, 2020	Jan. 17, 2021
RF signal cable HUBER+SUHNER	SUCOFLEX 104	CABLE-CH9-(250795/4)	Jul. 11, 2019	Jul. 10, 2020
RF signal cable Woken	8D-FB	Cable-CH9-01	Jul. 30, 2019	Jul. 29, 2020
Software BV ADT	ADT_Radiated_ V7.6.15.9.5	NA	NA	NA
Antenna Tower EMCO	2070/2080	512.835.4684	NA	NA
Turn Table EMCO	2087-2.03	NA	NA	NA
Antenna Tower & Turn BV ADT	AT100	AT93021705	NA	NA
Turn Table BV ADT	TT100	TT93021705	NA	NA
Turn Table Controller BV ADT	SC100	SC93021705	NA	NA
Boresight Antenna Fixture	FBA-01	FBA-SIP01	NA	NA
Standard Temperature And Humidity Chamber	MHU-225AU	920842	May 31, 2019	May 30, 2020
JFW 20dB attenuation	50HF-020-SMA	NA	NA	NA
True RMS Clamp Meter Fluke	325	31130711WS	May 21, 2019	May 20, 2020
DC power supply	U8002A	MY56330015	NA	NA

Note: 1. The calibration interval of the above test instruments is 12 months and the calibrations are traceable to NML/ROC and NIST/USA.
2. The test was performed in HwaYa Chamber 9.

4.1.4 Test Procedures

Radiated Measurement Method

1. The EUT was placed on the top of a rotating table 1.5 meters above the ground at 3 meter chamber room for test. The table was rotated 360 degrees to determine the position of the highest radiation.
2. The EUT was set 3 meters away from the interference-receiving antenna, which was mounted on the top of a variable-height antenna tower.
3. The height of antenna is varied from one meter to four meters above the ground to determine the maximum value of the field strength. Both horizontal and vertical polarizations of the antenna are set to make the measurement.
4. For each suspected emission, the EUT was arranged to its worst case and then the antenna was tuned to heights from 1 meter to 4 meters and the rotatable table was turned from 0 degrees to 360 degrees to find the maximum reading.
5. The test-receiver system was set to peak and/or average detects function and specified bandwidth with maximum hold mode when the test frequency is above 1 GHz.
6. EIRP = Output power level of S.G + Correction Factor (including Cable loss, Antenna gain, etc...)

Conducted Measurement Method

1. Connect the DUT transmitter output to the spectrum analyzer via coaxial cable while ensuring proper impedance matching.
2. Set span to at least 1.5 times the OBW.
3. Set RBW = 1-5% of the OBW, not to exceed 1 MHz.
4. Set VBW $\geq 3 \times$ RBW.
5. Set number of points in sweep $\geq 2 \times$ span / RBW.
6. Sweep time = auto-couple.
7. Detector = RMS (power averaging).
8. If the EUT can be configured to transmit continuously (i.e., burst duty cycle $\geq 98\%$), then set the trigger to free run.
9. If the EUT cannot be configured to transmit continuously (i.e., burst duty cycle $< 98\%$), then use a sweep trigger with the level set to enable triggering only on full power bursts and configure the EUT to transmit at full power for the entire duration of each sweep. Ensure that the sweep time is less than or equal to the transmission burst duration.
10. Trace average at least 100 traces in power averaging (i.e., RMS) mode.
11. Compute the power by integrating the spectrum across the OBW of the signal using the instrument's band power measurement function, with the band limits set equal to the OBW band edges. If the instrument does not have a band power function, then sum the spectrum levels (in linear power units) at intervals equal to the RBW extending across the entire OBW of the spectrum.

4.1.5 Deviation from Test Standard

No deviation.

4.1.6 EUT Operating Conditions

The software provided by client to enable the EUT under transmission condition continuously at lowest, middle and highest channel frequencies individually.

4.1.7 Test Results

Conducted Output Power (dBm)

LTE Band 48 (CA 48C) Full Power

Con- figure	Com- bination	PCC							SCC							Measurement Power
		Band	BW (MHz)	Modu- lation	RB Size	RB Offset	UL Chan.	UL Freq. (MHz)	Band	BW (MHz)	Modu- lation	RB Size	RB Offset	UL Chan.	UL Freq. (MHz)	Tx Power with UL-CA Active (dBm)
															Total	
Intra Band Conti- guous	CA_48C	48	20	256 QAM	1	0	55340	3560	48	20	256 QAM	1	99	55538	3579.8	7.55
					1	99						6.99				
		48	20	256 QAM	1	0	55891	3615.1	48	20	256 QAM	1	99	56089	3634.9	12.15
					1	99						21.21				
		48	20	256 QAM	1	0	56442	3670.2	48	20	256 QAM	1	99	56640	3690	6.62
					1	99						6.38				
Intra Band Conti- guous	CA_48C	48	20	256 QAM	1	0	55340	3560	48	15	256 QAM	1	99	55511	3577.1	7.27
					1	99						6.77				
		48	20	256 QAM	1	0	55916	3617.6	48	15	256 QAM	1	99	56087	3634.7	11.79
					1	99						20.64				
		48	20	256 QAM	1	0	56491	3675.1	48	15	256 QAM	1	99	56662	3692.2	6.25
					1	99						6.25				
Intra Band Conti- guous	CA_48C	48	20	256 QAM	1	0	55340	3560	48	10	256 QAM	1	99	55484	3574.4	7.21
					1	99						6.59				
		48	20	256 QAM	1	0	55941	3620.1	48	10	256 QAM	1	99	56085	3634.5	11.24
					1	99						20.62				
		48	20	256 QAM	1	0	56541	3680.1	48	10	256 QAM	1	99	56685	3694.5	6.11
					1	99						5.58				
Intra Band Conti- guous	CA_48C	48	20	256 QAM	1	0	55340	3560	48	5	256 QAM	1	24	55457	3571.7	7.30
					1	99						6.55				
		48	20	256 QAM	1	0	55965	3622.5	48	5	256 QAM	1	24	56082	3634.2	11.42
					1	99						20.40				
		48	20	256 QAM	1	0	56590	3685	48	5	256 QAM	1	24	56707	3696.7	5.57
					1	99						5.72				
Intra Band Conti- guous	CA_48C	48	5	256 QAM	1	0	55273	3553.3	48	20	256 QAM	1	99	55390	3565	7.00
					1	24						6.76				
		48	5	256 QAM	1	0	55898	3615.8	48	20	256 QAM	1	99	56015	3627.5	11.62
					1	24						20.25				
		48	5	256 QAM	1	0	56523	3678.3	48	20	256 QAM	1	99	56640	3690	5.95
					1	24						5.54				
Intra Band Conti- guous	CA_48C	48	10	256 QAM	1	0	55295	3555.5	48	20	256 QAM	1	99	55439	3569.9	6.89
					1	49						6.65				
		48	10	256 QAM	1	0	55896	3615.6	48	20	256 QAM	1	99	56040	3630	11.73
					1	49						20.99				
		48	10	256 QAM	1	0	56496	3675.6	48	20	256 QAM	1	99	56640	3690	5.71
					1	49						5.70				
Intra Band Conti- guous	CA_48C	48	15	256 QAM	1	0	55318	3557.8	48	20	256 QAM	1	99	55489	3574.9	6.99
					1	74						6.29				
		48	15	256 QAM	1	0	55893	3615.3	48	20	256 QAM	1	99	56064	3632.4	11.57
					1	74						20.74				
		48	15	256 QAM	1	0	56469	3672.9	48	20	256 QAM	1	99	56640	3690	5.87
					1	74						5.63				

LTE Band 48 (CA 48C)_Per 10M Power

Con- figure	Com- bination	PCC							SCC							Measurement Power
		Band	BW (MHz)	Modu- lation	RB Size	RB Offset	UL Chan.	UL Freq. (MHz)	Band	BW (MHz)	Modu- lation	RB Size	RB Offset	UL Chan.	UL Freq. (MHz)	Tx Power with UL-CA Active (dBm)
																Total
Intra Band Conti- guous	CA_48C	48	20	256 QAM	1	0	55340	3560	48	20	256 QAM	1	99	55538	3579.8	7.11
					1	99						7.02				
		48	20	256 QAM	1	0	55891	3615.1	48	20	256 QAM	1	99	56089	3634.9	11.57
					1	99						20.19				
		48	20	256 QAM	1	0	56442	3670.2	48	20	256 QAM	1	99	56640	3690	6.35
					1	99						6.25				
Intra Band Conti- guous	CA_48C	48	20	256 QAM	1	0	55340	3560	48	15	256 QAM	1	99	55511	3577.1	7.09
					1	99						6.45				
		48	20	256 QAM	1	0	55916	3617.6	48	15	256 QAM	1	99	56087	3634.7	11.49
					1	99						20.17				
		48	20	256 QAM	1	0	56491	3675.1	48	15	256 QAM	1	99	56662	3692.2	6.11
					1	99						6.33				
Intra Band Conti- guous	CA_48C	48	20	256 QAM	1	0	55340	3560	48	10	256 QAM	1	99	55484	3574.4	7.23
					1	99						6.65				
		48	20	256 QAM	1	0	55941	3620.1	48	10	256 QAM	1	99	56085	3634.5	11.48
					1	99						19.99				
		48	20	256 QAM	1	0	56541	3680.1	48	10	256 QAM	1	99	56685	3694.5	6.38
					1	99						6.18				
Intra Band Conti- guous	CA_48C	48	20	256 QAM	1	0	55340	3560	48	5	256 QAM	1	24	55457	3571.7	6.84
					1	99						6.76				
		48	20	256 QAM	1	0	55965	3622.5	48	5	256 QAM	1	24	56082	3634.2	11.72
					1	99						19.65				
		48	20	256 QAM	1	0	56590	3685	48	5	256 QAM	1	24	56707	3696.7	6.27
					1	99						6.56				
Intra Band Conti- guous	CA_48C	48	5	256 QAM	1	0	55273	3553.3	48	20	256 QAM	1	99	55390	3565	6.92
					1	24						6.54				
		48	5	256 QAM	1	0	55898	3615.8	48	20	256 QAM	1	99	56015	3627.5	11.43
					1	24						19.82				
		48	5	256 QAM	1	0	56523	3678.3	48	20	256 QAM	1	99	56640	3690	6.14
					1	24						6.49				
Intra Band Conti- guous	CA_48C	48	10	256 QAM	1	0	55295	3555.5	48	20	256 QAM	1	99	55439	3569.9	7.03
					1	49						6.88				
		48	10	256 QAM	1	0	55896	3615.6	48	20	256 QAM	1	99	56040	3630	11.74
					1	49						20.15				
		48	10	256 QAM	1	0	56496	3675.6	48	20	256 QAM	1	99	56640	3690	6.52
					1	49						6.22				
Intra Band Conti- guous	CA_48C	48	15	256 QAM	1	0	55318	3557.8	48	20	256 QAM	1	99	55489	3574.9	6.95
					1	74						6.59				
		48	15	256 QAM	1	0	55893	3615.3	48	20	256 QAM	1	99	56064	3632.4	11.73
					1	74						20.13				
		48	15	256 QAM	1	0	56469	3672.9	48	20	256 QAM	1	99	56640	3690	6.49
					1	74						6.53				

LTE Band 42 (CA 42C)_ Full Power

Con- figure	Com- bination	PCC							SCC							Measurement Power
		Band	BW (MHz)	Modu- lation	RB Size	RB Offset	UL Chan.	UL Freq. (MHz)	Band	BW (MHz)	Modu- lation	RB Size	RB Offset	UL Chan.	UL Freq. (MHz)	Tx Power with UL-CA Active (dBm)
																Total
Intra Band Conti- guous	CA_42C	42	20	256 QAM	1	0	43190	3560	42	20	256 QAM	1	99	43388	3579.8	6.49
					1	99						5.87				
		42	20	256 QAM	1	0	43241	3565.1	42	20	256 QAM	1	99	43439	3584.9	10.96
					1	99						20.14				
		42	20	256 QAM	1	0	43292	3570.2	42	20	256 QAM	1	99	43490	3590	5.50
					1	99						5.17				
Intra Band Conti- guous	CA_42C	42	20	256 QAM	1	0	43190	3560	42	15	256 QAM	1	99	43361	3577.1	6.22
					1	99						5.64				
		42	20	256 QAM	1	0	43265	3567.5	42	15	256 QAM	1	99	43436	3584.6	10.60
					1	99						19.54				
		42	20	256 QAM	1	0	43341	3575.1	42	15	256 QAM	1	99	43512	3592.2	5.17
					1	99						5.14				
Intra Band Conti- guous	CA_42C	42	20	256 QAM	1	0	43190	3560	42	10	256 QAM	1	99	43334	3574.4	6.12
					1	99						5.48				
		42	20	256 QAM	1	0	43335	3574.5	42	10	256 QAM	1	99	43479	3588.9	10.14
					1	99						19.48				
		42	20	256 QAM	1	0	43391	3580.1	42	10	256 QAM	1	99	43535	3594.5	4.98
					1	99						4.40				
Intra Band Conti- guous	CA_42C	42	20	256 QAM	1	0	43190	3560	42	5	256 QAM	1	24	43307	3571.7	6.24
					1	99						5.44				
		42	20	256 QAM	1	0	43315	3572.5	42	5	256 QAM	1	24	43432	3584.2	10.26
					1	99						19.29				
		42	20	256 QAM	1	0	43440	3585	42	5	256 QAM	1	24	43557	3596.7	4.44
					1	99						4.60				
Intra Band Conti- guous	CA_42C	42	5	256 QAM	1	0	43115	3552.5	42	20	256 QAM	1	99	43232	3564.2	5.87
					1	24						5.65				
		42	5	256 QAM	1	0	43244	3565.4	42	20	256 QAM	1	99	43361	3577.1	10.58
					1	24						19.16				
		42	5	256 QAM	1	0	43373	3578.3	42	20	256 QAM	1	99	43490	3590	4.86
					1	24						4.38				
Intra Band Conti- guous	CA_42C	42	10	256 QAM	1	0	43140	3555	42	20	256 QAM	1	99	43284	3569.4	5.79
					1	49						5.47				
		42	10	256 QAM	1	0	43242	3565.2	42	20	256 QAM	1	99	43386	3579.6	10.60
					1	49						19.89				
		42	10	256 QAM	1	0	43346	3575.6	42	20	256 QAM	1	99	43490	3590	4.59
					1	49						4.57				
Intra Band Conti- guous	CA_42C	42	15	256 QAM	1	0	43165	3557.5	42	20	256 QAM	1	99	43336	3574.6	5.81
					1	74						5.18				
		42	15	256 QAM	1	0	43242	3565.2	42	20	256 QAM	1	99	43413	3582.3	10.49
					1	74						19.61				
		42	15	256 QAM	1	0	43319	3572.9	42	20	256 QAM	1	99	43490	3590	4.75
					1	74						4.46				

LTE Band 42 (CA 42C)_Per 10M Power

Con- figure	Com- bination	PCC							SCC							Measurement Power
		Band	BW (MHz)	Modu- lation	RB Size	RB Offset	UL Chan.	UL Freq. (MHz)	Band	BW (MHz)	Modu- lation	RB Size	RB Offset	UL Chan.	UL Freq. (MHz)	Tx Power with UL-CA Active (dBm)
																Total
Intra Band Conti- guous	CA_42C	42	20	256 QAM	1	0	43190	3560	42	20	256 QAM	1	99	43388	3579.8	6.07
					1	99						5.49				
		42	20	256 QAM	1	0	43241	3565.1	42	20	256 QAM	1	99	43439	3584.9	10.54
					1	99						19.75				
		42	20	256 QAM	1	0	43292	3570.2	42	20	256 QAM	1	99	43490	3590	5.09
					1	99						4.84				
Intra Band Conti- guous	CA_42C	42	20	256 QAM	1	0	43190	3560	42	15	256 QAM	1	99	43361	3577.1	5.77
					1	99						5.19				
		42	20	256 QAM	1	0	43265	3567.5	42	15	256 QAM	1	99	43436	3584.6	10.19
					1	99						19.11				
		42	20	256 QAM	1	0	43341	3575.1	42	15	256 QAM	1	99	43512	3592.2	4.76
					1	99						4.67				
Intra Band Conti- guous	CA_42C	42	20	256 QAM	1	0	43190	3560	42	10	256 QAM	1	99	43334	3574.4	5.77
					1	99						5.05				
		42	20	256 QAM	1	0	43335	3574.5	42	10	256 QAM	1	99	43479	3588.9	9.83
					1	99						19.05				
		42	20	256 QAM	1	0	43391	3580.1	42	10	256 QAM	1	99	43535	3594.5	4.57
					1	99						3.98				
Intra Band Conti- guous	CA_42C	42	20	256 QAM	1	0	43190	3560	42	5	256 QAM	1	24	43307	3571.7	5.82
					1	99						5.04				
		42	20	256 QAM	1	0	43315	3572.5	42	5	256 QAM	1	24	43432	3584.2	9.90
					1	99						18.92				
		42	20	256 QAM	1	0	43440	3585	42	5	256 QAM	1	24	43557	3596.7	4.10
					1	99						4.23				
Intra Band Conti- guous	CA_42C	42	5	256 QAM	1	0	43115	3552.5	42	20	256 QAM	1	99	43232	3564.2	5.45
					1	24						5.34				
		42	5	256 QAM	1	0	43244	3565.4	42	20	256 QAM	1	99	43361	3577.1	10.17
					1	24						18.76				
		42	5	256 QAM	1	0	43373	3578.3	42	20	256 QAM	1	99	43490	3590	4.36
					1	24						4.01				
Intra Band Conti- guous	CA_42C	42	10	256 QAM	1	0	43140	3555	42	20	256 QAM	1	99	43284	3569.4	5.49
					1	49						5.11				
		42	10	256 QAM	1	0	43242	3565.2	42	20	256 QAM	1	99	43386	3579.6	10.15
					1	49						19.50				
		42	10	256 QAM	1	0	43346	3575.6	42	20	256 QAM	1	99	43490	3590	4.22
					1	49						4.08				
Intra Band Conti- guous	CA_42C	42	15	256 QAM	1	0	43165	3557.5	42	20	256 QAM	1	99	43336	3574.6	5.34
					1	74						4.80				
		42	15	256 QAM	1	0	43242	3565.2	42	20	256 QAM	1	99	43413	3582.3	10.05
					1	74						19.24				
		42	15	256 QAM	1	0	43319	3572.9	42	20	256 QAM	1	99	43490	3590	4.39
					1	74						4.04				

EIRP Power (dBm)
LTE Band 48 (CA 48C) Full Power

Con- figure	Com- bination	PCC							SCC							Measurement Power
		Band	BW (MHz)	Modu- lation	RB Size	RB Offset	UL Chan.	UL Freq. (MHz)	Band	BW (MHz)	Modu- lation	RB Size	RB Offset	UL Chan.	UL Freq. (MHz)	EIRP (dBm)
																Total
Intra Band Conti- guous	CA_48C	48	20	256 QAM	1	0	55340	3560	48	20	256 QAM	1	99	55538	3579.8	8.47
					1	99						7.91				
		48	20	256 QAM	1	0	55891	3615.1	48	20	256 QAM	1	99	56089	3634.9	13.07
					1	99						22.13				
		48	20	256 QAM	1	0	56442	3670.2	48	20	256 QAM	1	99	56640	3690	7.54
					1	99						7.30				
Intra Band Conti- guous	CA_48C	48	20	256 QAM	1	0	55340	3560	48	15	256 QAM	1	99	55511	3577.1	8.19
					1	99						7.69				
		48	20	256 QAM	1	0	55916	3617.6	48	15	256 QAM	1	99	56087	3634.7	12.71
					1	99						21.56				
		48	20	256 QAM	1	0	56491	3675.1	48	15	256 QAM	1	99	56662	3692.2	7.17
					1	99						7.17				
Intra Band Conti- guous	CA_48C	48	20	256 QAM	1	0	55340	3560	48	10	256 QAM	1	99	55484	3574.4	8.13
					1	99						7.51				
		48	20	256 QAM	1	0	55941	3620.1	48	10	256 QAM	1	99	56085	3634.5	12.16
					1	99						21.54				
		48	20	256 QAM	1	0	56541	3680.1	48	10	256 QAM	1	99	56685	3694.5	7.03
					1	99						6.50				
Intra Band Conti- guous	CA_48C	48	20	256 QAM	1	0	55340	3560	48	5	256 QAM	1	24	55457	3571.7	8.22
					1	99						7.47				
		48	20	256 QAM	1	0	55965	3622.5	48	5	256 QAM	1	24	56082	3634.2	12.34
					1	99						21.32				
		48	20	256 QAM	1	0	56590	3685	48	5	256 QAM	1	24	56707	3696.7	6.49
					1	99						6.64				
Intra Band Conti- guous	CA_48C	48	5	256 QAM	1	0	55273	3553.3	48	20	256 QAM	1	99	55390	3565	7.92
					1	24						7.68				
		48	5	256 QAM	1	0	55898	3615.8	48	20	256 QAM	1	99	56015	3627.5	12.54
					1	24						21.17				
		48	5	256 QAM	1	0	56523	3678.3	48	20	256 QAM	1	99	56640	3690	6.87
					1	24						6.46				
Intra Band Conti- guous	CA_48C	48	10	256 QAM	1	0	55295	3555.5	48	20	256 QAM	1	99	55439	3569.9	7.81
					1	49						7.57				
		48	10	256 QAM	1	0	55896	3615.6	48	20	256 QAM	1	99	56040	3630	12.65
					1	49						21.91				
		48	10	256 QAM	1	0	56496	3675.6	48	20	256 QAM	1	99	56640	3690	6.63
					1	49						6.62				
Intra Band Conti- guous	CA_48C	48	15	256 QAM	1	0	55318	3557.8	48	20	256 QAM	1	99	55489	3574.9	7.91
					1	74						7.21				
		48	15	256 QAM	1	0	55893	3615.3	48	20	256 QAM	1	99	56064	3632.4	12.49
					1	74						21.66				
		48	15	256 QAM	1	0	56469	3672.9	48	20	256 QAM	1	99	56640	3690	6.79
					1	74						6.55				

*EIRP = Conducted + antenna gain(0.92dBi).

LTE Band 48 (CA 48C) Per 10M Power

Con- figure	Com- bination	PCC							SCC							Measurement Power
		Band	BW (MHz)	Modu- lation	RB Size	RB Offset	UL Chan.	UL Freq. (MHz)	Band	BW (MHz)	Modu- lation	RB Size	RB Offset	UL Chan.	UL Freq. (MHz)	EIRP (dBm)
															Total	
Intra Band Conti- guous	CA_48C	48	20	256 QAM	1	0	55340	3560	48	20	256 QAM	1	99	55538	3579.8	8.03
					1	99						7.94				
		48	20	256 QAM	1	0	55891	3615.1	48	20	256 QAM	1	99	56089	3634.9	12.49
					1	99						21.11				
		48	20	256 QAM	1	0	56442	3670.2	48	20	256 QAM	1	99	56640	3690	7.27
					1	99						7.17				
Intra Band Conti- guous	CA_48C	48	20	256 QAM	1	0	55340	3560	48	15	256 QAM	1	99	55511	3577.1	8.01
					1	99						7.37				
		48	20	256 QAM	1	0	55916	3617.6	48	15	256 QAM	1	99	56087	3634.7	12.41
					1	99						21.09				
		48	20	256 QAM	1	0	56491	3675.1	48	15	256 QAM	1	99	56662	3692.2	7.03
					1	99						7.25				
Intra Band Conti- guous	CA_48C	48	20	256 QAM	1	0	55340	3560	48	10	256 QAM	1	99	55484	3574.4	8.15
					1	99						7.57				
		48	20	256 QAM	1	0	55941	3620.1	48	10	256 QAM	1	99	56085	3634.5	12.40
					1	99						20.91				
		48	20	256 QAM	1	0	56541	3680.1	48	10	256 QAM	1	99	56685	3694.5	7.30
					1	99						7.10				
Intra Band Conti- guous	CA_48C	48	20	256 QAM	1	0	55340	3560	48	5	256 QAM	1	24	55457	3571.7	7.76
					1	99						7.68				
		48	20	256 QAM	1	0	55965	3622.5	48	5	256 QAM	1	24	56082	3634.2	12.64
					1	99						20.57				
		48	20	256 QAM	1	0	56590	3685	48	5	256 QAM	1	24	56707	3696.7	7.19
					1	99						7.48				
Intra Band Conti- guous	CA_48C	48	5	256 QAM	1	0	55273	3553.3	48	20	256 QAM	1	99	55390	3565	7.84
					1	24						7.46				
		48	5	256 QAM	1	0	55898	3615.8	48	20	256 QAM	1	99	56015	3627.5	12.35
					1	24						20.74				
		48	5	256 QAM	1	0	56523	3678.3	48	20	256 QAM	1	99	56640	3690	7.06
					1	24						7.41				
Intra Band Conti- guous	CA_48C	48	10	256 QAM	1	0	55295	3555.5	48	20	256 QAM	1	99	55439	3569.9	7.95
					1	49						7.80				
		48	10	256 QAM	1	0	55896	3615.6	48	20	256 QAM	1	99	56040	3630	12.66
					1	49						21.07				
		48	10	256 QAM	1	0	56496	3675.6	48	20	256 QAM	1	99	56640	3690	7.44
					1	49						7.14				
Intra Band Conti- guous	CA_48C	48	15	256 QAM	1	0	55318	3557.8	48	20	256 QAM	1	99	55489	3574.9	7.87
					1	74						7.51				
		48	15	256 QAM	1	0	55893	3615.3	48	20	256 QAM	1	99	56064	3632.4	12.65
					1	74						21.05				
		48	15	256 QAM	1	0	56469	3672.9	48	20	256 QAM	1	99	56640	3690	7.41
					1	74						7.45				

*EIRP = Conducted + antenna gain(0.92dBi).

LTE Band 42 (CA 42C)_Full Power

Con- figure	Com- bination	PCC							SCC							Measurement Power
		Band	BW (MHz)	Modu- lation	RB Size	RB Offset	UL Chan.	UL Freq. (MHz)	Band	BW (MHz)	Modu- lation	RB Size	RB Offset	UL Chan.	UL Freq. (MHz)	EIRP (dBm)
																Total
Intra Band Conti- guous	CA_42C	42	20	256 QAM	1	0	43190	3560	42	20	256 QAM	1	99	43388	3579.8	7.41
					1	99						6.79				
		42	20	256 QAM	1	0	43241	3565.1	42	20	256 QAM	1	99	43439	3584.9	11.88
					1	99						21.06				
		42	20	256 QAM	1	0	43292	3570.2	42	20	256 QAM	1	99	43490	3590	6.42
					1	99						6.09				
Intra Band Conti- guous	CA_42C	42	20	256 QAM	1	0	43190	3560	42	15	256 QAM	1	99	43361	3577.1	7.14
					1	99						6.56				
		42	20	256 QAM	1	0	43265	3567.5	42	15	256 QAM	1	99	43436	3584.6	11.52
					1	99						20.46				
		42	20	256 QAM	1	0	43341	3575.1	42	15	256 QAM	1	99	43512	3592.2	6.09
					1	99						6.06				
Intra Band Conti- guous	CA_42C	42	20	256 QAM	1	0	43190	3560	42	10	256 QAM	1	99	43334	3574.4	7.04
					1	99						6.40				
		42	20	256 QAM	1	0	43335	3574.5	42	10	256 QAM	1	99	43479	3588.9	11.06
					1	99						20.40				
		42	20	256 QAM	1	0	43391	3580.1	42	10	256 QAM	1	99	43535	3594.5	5.90
					1	99						5.32				
Intra Band Conti- guous	CA_42C	42	20	256 QAM	1	0	43190	3560	42	5	256 QAM	1	24	43307	3571.7	7.16
					1	99						6.36				
		42	20	256 QAM	1	0	43315	3572.5	42	5	256 QAM	1	24	43432	3584.2	11.18
					1	99						20.21				
		42	20	256 QAM	1	0	43440	3585	42	5	256 QAM	1	24	43557	3596.7	5.36
					1	99						5.52				
Intra Band Conti- guous	CA_42C	42	5	256 QAM	1	0	43115	3552.5	42	20	256 QAM	1	99	43232	3564.2	6.79
					1	24						6.57				
		42	5	256 QAM	1	0	43244	3565.4	42	20	256 QAM	1	99	43361	3577.1	11.50
					1	24						20.08				
		42	5	256 QAM	1	0	43373	3578.3	42	20	256 QAM	1	99	43490	3590	5.78
					1	24						5.30				
Intra Band Conti- guous	CA_42C	42	10	256 QAM	1	0	43140	3555	42	20	256 QAM	1	99	43284	3569.4	6.71
					1	49						6.39				
		42	10	256 QAM	1	0	43242	3565.2	42	20	256 QAM	1	99	43386	3579.6	11.52
					1	49						20.81				
		42	10	256 QAM	1	0	43346	3575.6	42	20	256 QAM	1	99	43490	3590	5.51
					1	49						5.49				
Intra Band Conti- guous	CA_42C	42	15	256 QAM	1	0	43165	3557.5	42	20	256 QAM	1	99	43336	3574.6	6.73
					1	74						6.10				
		42	15	256 QAM	1	0	43242	3565.2	42	20	256 QAM	1	99	43413	3582.3	11.41
					1	74						20.53				
		42	15	256 QAM	1	0	43319	3572.9	42	20	256 QAM	1	99	43490	3590	5.67
					1	74						5.38				

*EIRP = Conducted + antenna gain(0.92dBi).

LTE Band 42 (CA 42C)_Per 10M Power

Con- figure	Com- bination	PCC							SCC							Measurement Power
		Band	BW (MHz)	Modu- lation	RB Size	RB Offset	UL Chan.	UL Freq. (MHz)	Band	BW (MHz)	Modu- lation	RB Size	RB Offset	UL Chan.	UL Freq. (MHz)	EIRP (dBm)
																Total
Intra Band Conti- guous	CA_42C	42	20	256 QAM	1	0	43190	3560	42	20	256 QAM	1	99	43388	3579.8	6.99
					1	99						6.41				
		42	20	256 QAM	1	0	43241	3565.1	42	20	256 QAM	1	99	43439	3584.9	11.46
					1	99						20.67				
		42	20	256 QAM	1	0	43292	3570.2	42	20	256 QAM	1	99	43490	3590	6.01
					1	99						5.76				
Intra Band Conti- guous	CA_42C	42	20	256 QAM	1	0	43190	3560	42	15	256 QAM	1	99	43361	3577.1	6.69
					1	99						6.11				
		42	20	256 QAM	1	0	43265	3567.5	42	15	256 QAM	1	99	43436	3584.6	11.11
					1	99						20.03				
		42	20	256 QAM	1	0	43341	3575.1	42	15	256 QAM	1	99	43512	3592.2	5.68
					1	99						5.59				
Intra Band Conti- guous	CA_42C	42	20	256 QAM	1	0	43190	3560	42	10	256 QAM	1	99	43334	3574.4	6.69
					1	99						5.97				
		42	20	256 QAM	1	0	43335	3574.5	42	10	256 QAM	1	99	43479	3588.9	10.75
					1	99						19.97				
		42	20	256 QAM	1	0	43391	3580.1	42	10	256 QAM	1	99	43535	3594.5	5.49
					1	99						4.90				
Intra Band Conti- guous	CA_42C	42	20	256 QAM	1	0	43190	3560	42	5	256 QAM	1	24	43307	3571.7	6.74
					1	99						5.96				
		42	20	256 QAM	1	0	43315	3572.5	42	5	256 QAM	1	24	43432	3584.2	10.82
					1	99						19.84				
		42	20	256 QAM	1	0	43440	3585	42	5	256 QAM	1	24	43557	3596.7	5.02
					1	99						5.15				
Intra Band Conti- guous	CA_42C	42	5	256 QAM	1	0	43115	3552.5	42	20	256 QAM	1	99	43232	3564.2	6.37
					1	24						6.26				
		42	5	256 QAM	1	0	43244	3565.4	42	20	256 QAM	1	99	43361	3577.1	11.09
					1	24						19.68				
		42	5	256 QAM	1	0	43373	3578.3	42	20	256 QAM	1	99	43490	3590	5.28
					1	24						4.93				
Intra Band Conti- guous	CA_42C	42	10	256 QAM	1	0	43140	3555	42	20	256 QAM	1	99	43284	3569.4	6.41
					1	49						6.03				
		42	10	256 QAM	1	0	43242	3565.2	42	20	256 QAM	1	99	43386	3579.6	11.07
					1	49						20.42				
		42	10	256 QAM	1	0	43346	3575.6	42	20	256 QAM	1	99	43490	3590	5.14
					1	49						5.00				
Intra Band Conti- guous	CA_42C	42	15	256 QAM	1	0	43165	3557.5	42	20	256 QAM	1	99	43336	3574.6	6.26
					1	74						5.72				
		42	15	256 QAM	1	0	43242	3565.2	42	20	256 QAM	1	99	43413	3582.3	10.97
					1	74						20.16				
		42	15	256 QAM	1	0	43319	3572.9	42	20	256 QAM	1	99	43490	3590	5.31
					1	74						4.96				

*EIRP = Conducted + antenna gain(0.92dBi).

4.2 Frequency Stability Measurement

4.2.1 Limits of Frequency Stability Measurement

The frequency stability shall be sufficient to ensure that the fundamental emission stays within the authorized frequency band.

4.2.2 Test Procedure

- Device is placed at the oven room. The oven room could control the temperatures and humidity. Power warm up is at least 15 min and power applied should perform before recording frequency error.
- EUT is connected the external power supply to control the DC input power. The test voltage range is from minimum to maximum working voltage. Each step shall be record the frequency error rate.
- The temperature range step is 10 degrees in this test items. All temperature levels shall be hold the ± 0.5 °C during the measurement testing. The each temperature step shall be at least 0.5 hours, consider the EUT could be test under the stability condition.

NOTE: The frequency error was recorded frequency error from the communication simulator.

4.2.3 Test Setup

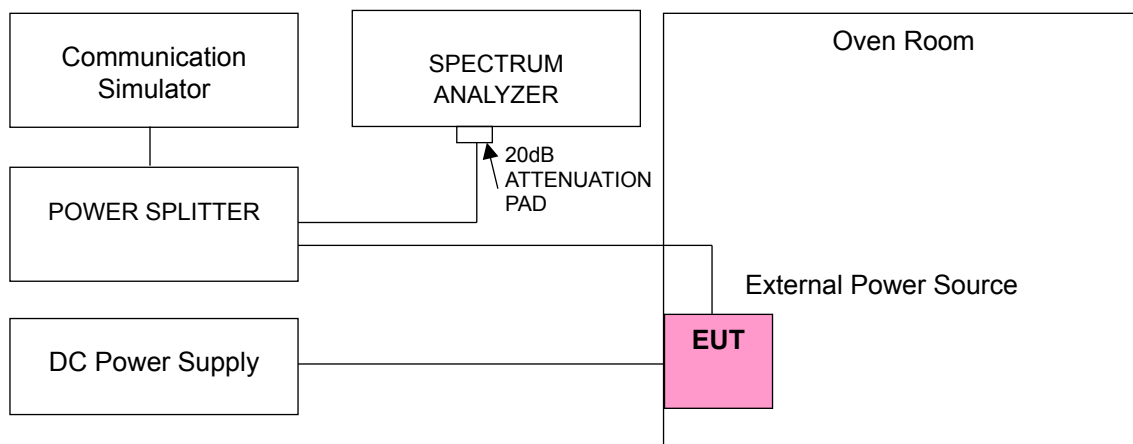

4.2.4 Test Results

Frequency Error vs. Voltage

Voltage (Volts)	LTE Band 48 (CA48C)			
	Channel Bandwidth: 20MHz+20MHz			
	Low Channel		High Channel	
	Frequency (MHz)	Frequency Error (ppm)	Frequency (MHz)	Frequency Error (ppm)
4.25	3615.100004	0.001	3634.900002	0.001
5	3615.100002	0.001	3634.900002	0.000
5.75	3615.100002	0.000	3634.900001	0.000

Note: The applicant defined the normal working voltage is from 4.25Vdc to 5.75Vdc.

Frequency Error vs. Temperature

Temp. (°C)	LTE Band 48 (CA48C)			
	Channel Bandwidth: 20MHz+20MHz			
	Low Channel		High Channel	
	Frequency (MHz)	Frequency Error (ppm)	Frequency (MHz)	Frequency Error (ppm)
-30	3615.100004	0.001	3634.900004	0.001
-20	3615.100002	0.001	3634.900003	0.001
-10	3615.100001	0.000	3634.900004	0.001
0	3615.100002	0.001	3634.900003	0.001
10	3615.100003	0.001	3634.900002	0.001
20	3615.099997	-0.001	3634.899999	0.000
30	3615.099998	0.000	3634.899996	-0.001
40	3615.099996	-0.001	3634.899997	-0.001
50	3615.099997	-0.001	3634.899999	0.000

Frequency Error vs. Voltage

Voltage (Volts)	LTE Band 42 (CA42C)			
	Channel Bandwidth: 20MHz+20MHz			
	Low Channel		High Channel	
	Frequency (MHz)	Frequency Error (ppm)	Frequency (MHz)	Frequency Error (ppm)
4.25	3565.100003	0.001	3584.900003	0.001
5	3565.100001	0.000	3584.900004	0.001
5.75	3565.100003	0.001	3584.900003	0.001

Note: The applicant defined the normal working voltage is from 4.25Vdc to 5.75Vdc.

Frequency Error vs. Temperature

Temp. (°C)	LTE Band 42 (CA42C)			
	Channel Bandwidth: 20MHz+20MHz			
	Low Channel		High Channel	
	Frequency (MHz)	Frequency Error (ppm)	Frequency (MHz)	Frequency Error (ppm)
-30	3565.100001	0.000	3584.900003	0.001
-20	3565.100001	0.000	3584.900003	0.001
-10	3565.100003	0.001	3584.900002	0.001
0	3565.100002	0.001	3584.900004	0.001
10	3565.100001	0.000	3584.900003	0.001
20	3565.099997	-0.001	3584.899998	-0.001
30	3565.099998	-0.001	3584.899998	0.000
40	3565.099998	-0.001	3584.899997	-0.001
50	3565.099998	0.000	3584.899997	-0.001

4.3 Emission Bandwidth Measurement

4.3.1 Emission Bandwidth Measurement

Reference only

4.3.2 Test Setup

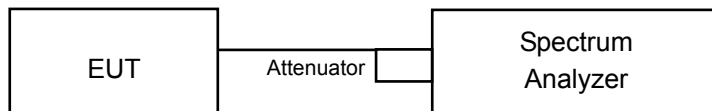

4.3.3 Test Instruments

Refer to section 4.1.3 to get information of above instrument.

4.3.4 Test Procedure

Occupied Bandwidth:

All measurements were done at low, middle and high operational frequency range. The communication simulator station system controlled a EUT to export maximum output power under transmission mode and specific channel frequency. Use OBW measurement function of Spectrum analyzer to measure 99 % occupied bandwidth.

26dBc Bandwidth:

The transmitter output was connected to the spectrum analyzer through an attenuator. The bandwidth of the fundamental frequency was measured by spectrum analyzer with RBW =51 kHz (5 MHz bandwidth), 100 kHz (10 MHz bandwidth), 150 kHz (15 MHz bandwidth), 200 kHz (20 MHz bandwidth). The emission bandwidth is defined as the width of the signal between two points, one below the carrier center frequency and one above the carrier center frequency, outside of which all emissions are attenuated at least 26 dB below the transmitter power.

4.3.5 Deviation from Test Standard

No deviation.

4.3.6 EUT Operating Conditions

The software provided by client to enable the EUT under transmission condition continuously at lowest, middle and highest channel frequencies individually.

4.3.7 Test Result

LTE Band 48 (CA 48C)

LTE Band 48 (CA 48C), Channel Bandwidth 20MHz+20MHz			
Channel	Frequency (MHz)	99% Occupied Bandwidth (MHz)	26dB Bandwidth (MHz)
		256QAM_Full RB	256QAM_Full RB
55340+55538	3560.0+3579.8	37.45	38.78
55891+56089	3615.1+3634.9	37.47	38.76
56442+56640	3670.2+3690.0	37.44	38.77

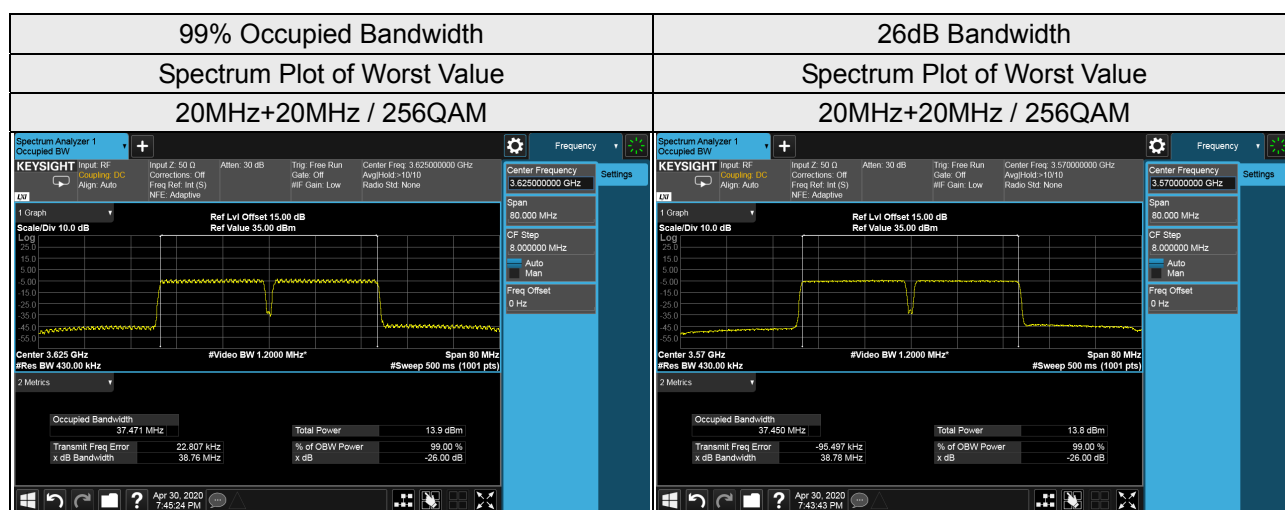

LTE Band 48 (CA 48C), Channel Bandwidth 20MHz+15MHz

Channel	Frequency (MHz)	99% Occupied Bandwidth (MHz)	26dB Bandwidth (MHz)
		256QAM_Full RB	256QAM_Full RB
55340+55511	3560.0+3577.1	32.53	33.67
55916+56087	3617.6+3634.7	32.55	33.67
56491+56662	3675.1+3692.2	32.53	33.68

99% Occupied Bandwidth

Spectrum Plot of Worst Value

20MHz+15MHz / 256QAM

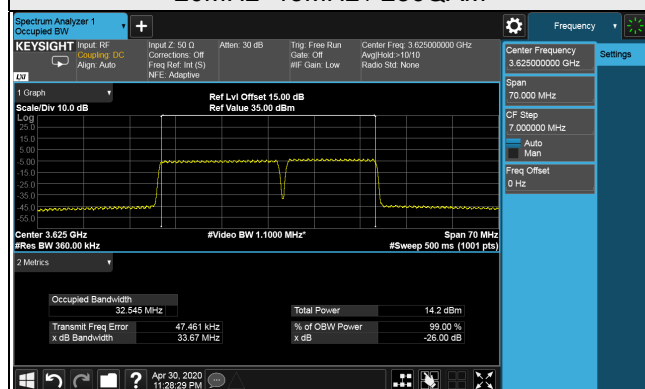

26dB Bandwidth

Spectrum Plot of Worst Value

20MHz+15MHz / 256QAM

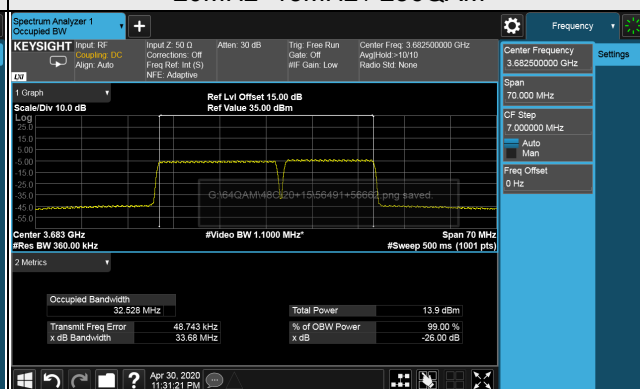

LTE Band 48 (CA 48C), Channel Bandwidth 20MHz+10MHz

Channel	Frequency (MHz)	99% Occupied Bandwidth (MHz)	26dB Bandwidth (MHz)
		256QAM_Full RB	256QAM_Full RB
55340+55484	3560.0+3574.4	27.64	28.57
55941+56085	3620.1+3634.5	27.64	28.57
56541+56685	3680.1+3694.5	27.63	28.56

99% Occupied Bandwidth

Spectrum Plot of Worst Value

20MHz+10MHz / 256QAM

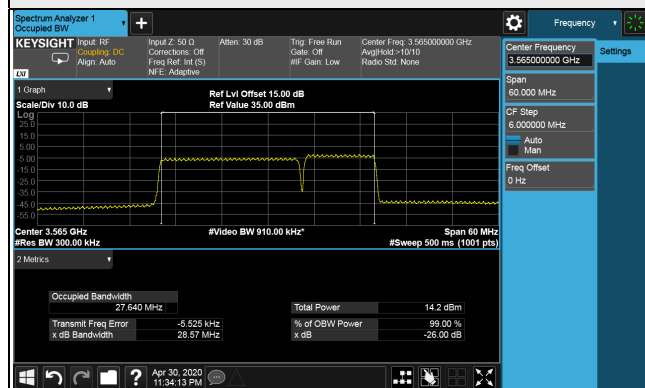

26dB Bandwidth

Spectrum Plot of Worst Value

20MHz+10MHz / 256QAM

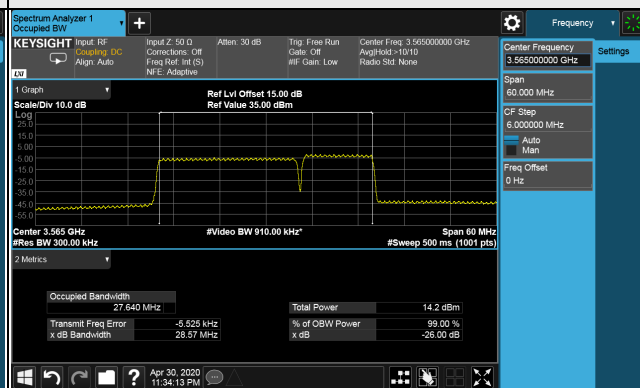

LTE Band 48 (CA 48C), Channel Bandwidth 20MHz+5MHz

Channel	Frequency (MHz)	99% Occupied Bandwidth (MHz)	26dB Bandwidth (MHz)
		256QAM_Full RB	256QAM_Full RB
55340+55457	3560.0+3571.7	22.75	23.53
55965+56082	3622.5+3634.2	22.77	23.50
56590+56707	3685.0+3696.7	22.74	23.54

99% Occupied Bandwidth
Spectrum Plot of Worst Value
20MHz+5MHz / 256QAM

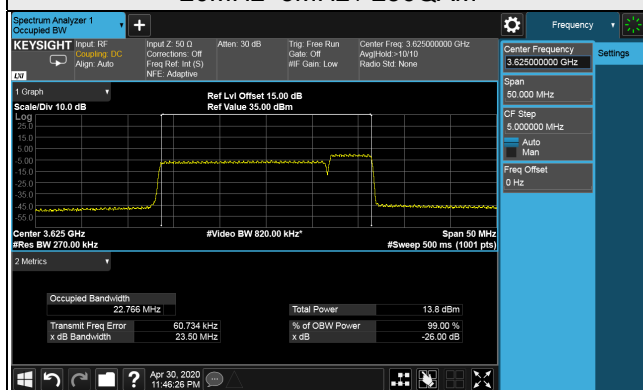

26dB Bandwidth
Spectrum Plot of Worst Value
20MHz+5MHz / 256QAM

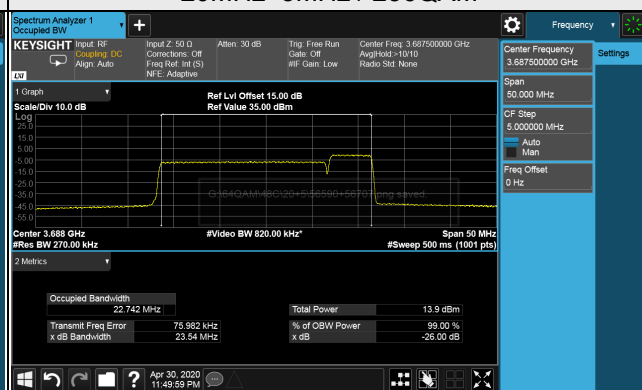

LTE Band 48 (CA 48C), Channel Bandwidth 5MHz+20MHz

Channel	Frequency (MHz)	99% Occupied Bandwidth (MHz)	26dB Bandwidth (MHz)
		256QAM_Full RB	256QAM_Full RB
55273+55390	3553.3+3565.0	22.77	23.49
55898+56015	3615.8+3627.5	22.74	23.50
56523+56640	3678.3+3690.0	22.71	23.54

99% Occupied Bandwidth
Spectrum Plot of Worst Value
5MHz+20MHz / 256QAM

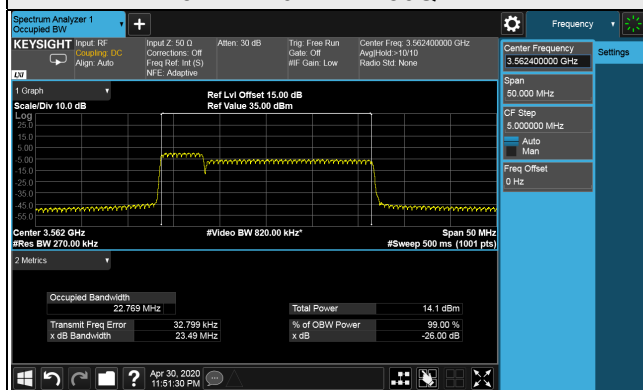

26dB Bandwidth
Spectrum Plot of Worst Value
5MHz+20MHz / 256QAM

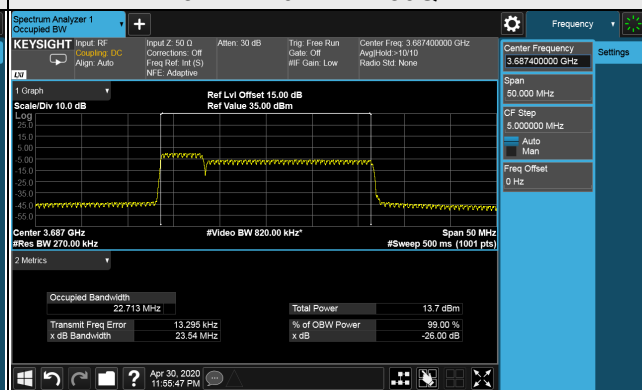

LTE Band 48 (CA 48C), Channel Bandwidth 10MHz+20MHz

Channel	Frequency (MHz)	99% Occupied Bandwidth (MHz)	26dB Bandwidth (MHz)
		256QAM_Full RB	256QAM_Full RB
55295+55439	3555.5+3569.9	27.611	28.53
55896+56040	3615.6+3630.0	27.605	28.57
56496+56640	3675.6+3690.0	27.637	28.58

99% Occupied Bandwidth
Spectrum Plot of Worst Value
10MHz+20MHz / 256QAM

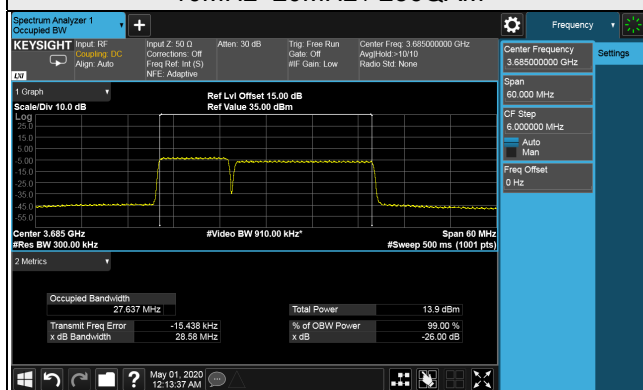

26dB Bandwidth
Spectrum Plot of Worst Value
10MHz+20MHz / 256QAM

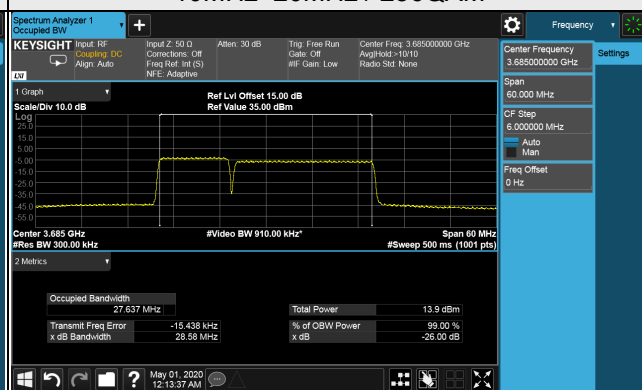

LTE Band 48 (CA 48C), Channel Bandwidth 15MHz+20MHz

Channel	Frequency (MHz)	99% Occupied Bandwidth (MHz)	26dB Bandwidth (MHz)
		256QAM_Full RB	256QAM_Full RB
55318+55489	3557.8+3574.9	32.45	33.68
55893+56064	3615.3+3632.4	32.52	33.69
56469+56640	3672.9+3690.0	32.55	33.69

99% Occupied Bandwidth
Spectrum Plot of Worst Value
15MHz+20MHz / 256QAM

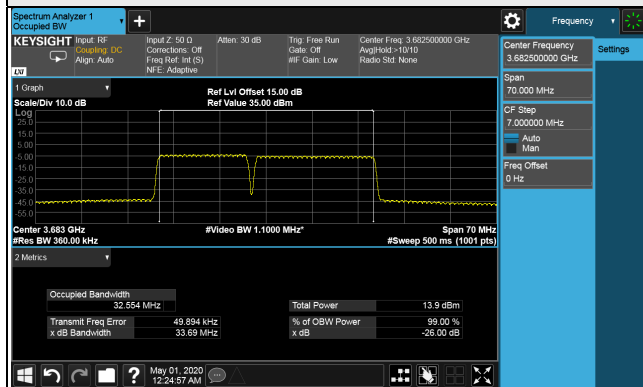

26dB Bandwidth
Spectrum Plot of Worst Value
15MHz+20MHz / 256QAM

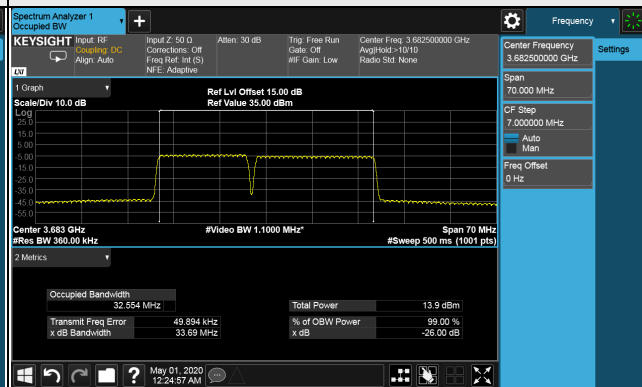

LTE Band 42 (CA 42C)

LTE Band 42 (CA 42C), Channel Bandwidth 20MHz+20MHz			
Channel	Frequency (MHz)	99% Occupied Bandwidth (MHz)	26dB Bandwidth (MHz)
		256QAM_Full RB	256QAM_Full RB
43190+43388	3560.0+3579.8	37.44	38.77
43241+43439	3565.1+3584.9	37.44	38.78
43292+43490	3570.2+3590.0	37.44	38.78

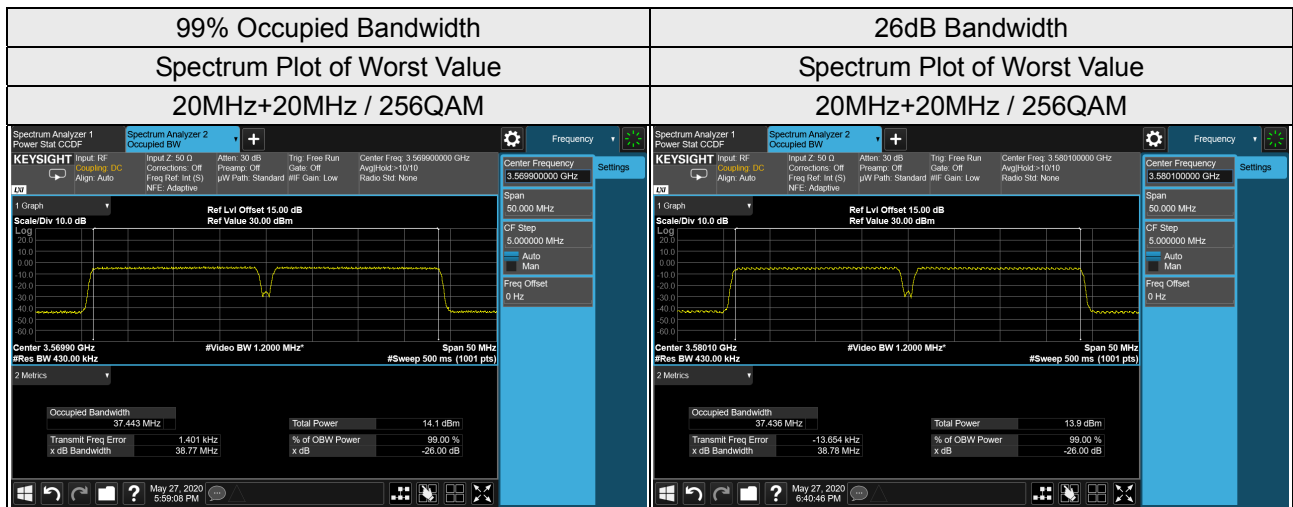

LTE Band 42 (CA 42C), Channel Bandwidth 20MHz+15MHz			
Channel	Frequency (MHz)	99% Occupied Bandwidth (MHz)	26dB Bandwidth (MHz)
		256QAM_Full RB	256QAM_Full RB
43190+43361	3560.0+3577.1	32.52	33.66
43265+43436	3567.5+3584.6	32.52	33.67
43341+43512	3575.1+3592.2	32.49	33.62

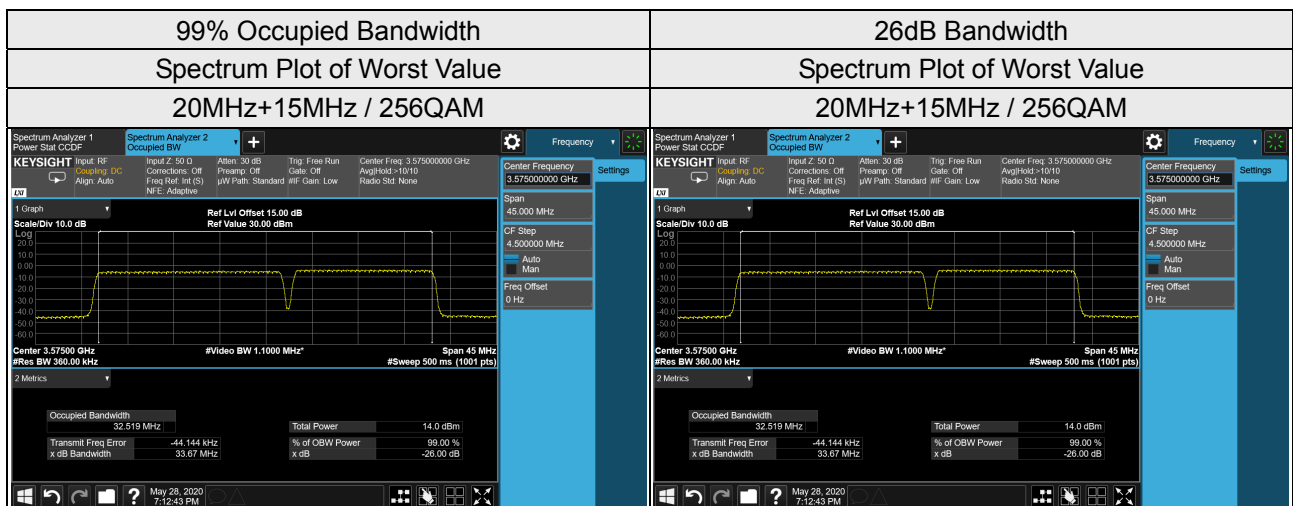

LTE Band 42 (CA 42C), Channel Bandwidth 20MHz+10MHz

Channel	Frequency (MHz)	99% Occupied Bandwidth (MHz)	26dB Bandwidth (MHz)
		256QAM_Full RB	256QAM_Full RB
43190+43334	3560.0+3574.4	27.63	28.56
43335+43479	3574.5+3588.9	27.63	28.57
43391+43535	3580.1+3594.5	27.63	28.56

99% Occupied Bandwidth

Spectrum Plot of Worst Value

20MHz+10MHz / 256QAM

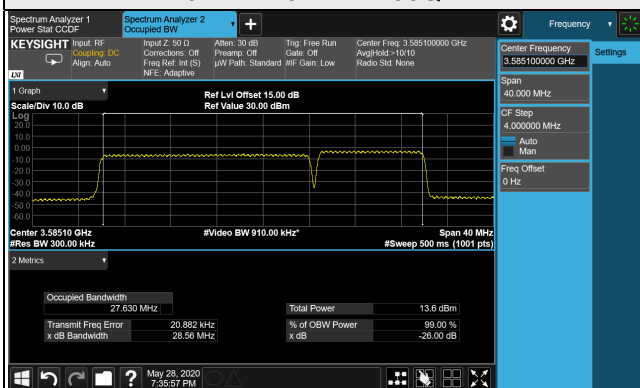

26dB Bandwidth

Spectrum Plot of Worst Value

20MHz+10MHz / 256QAM

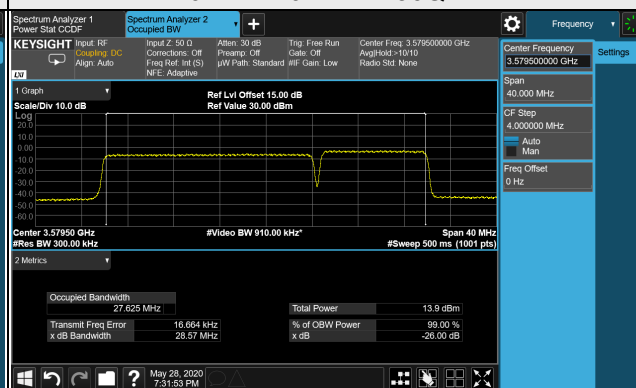

LTE Band 42 (CA 42C), Channel Bandwidth 20MHz+5MHz

Channel	Frequency (MHz)	99% Occupied Bandwidth (MHz)	26dB Bandwidth (MHz)
		256QAM_Full RB	256QAM_Full RB
43190+43307	3560.0+3571.7	22.75	23.55
43315+43432	3572.5+3584.2	22.74	23.53
43440+43557	3585.0+3596.7	22.75	23.55

99% Occupied Bandwidth

Spectrum Plot of Worst Value

20MHz+5MHz / 256QAM

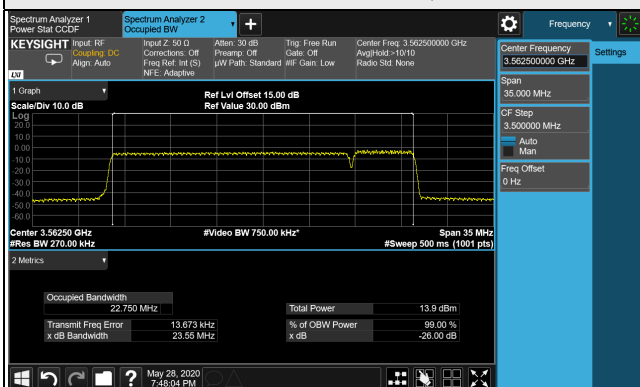

26dB Bandwidth

Spectrum Plot of Worst Value

20MHz+5MHz / 256QAM

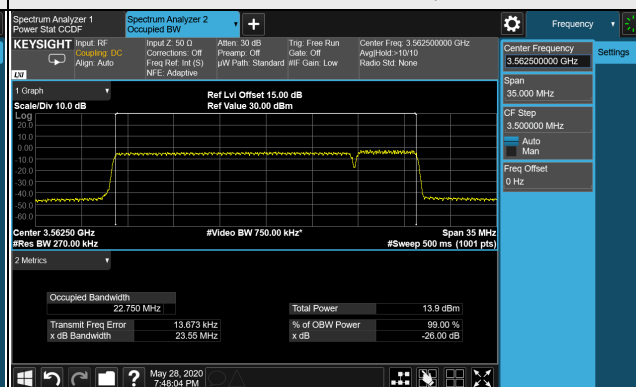

LTE Band 42 (CA 42C), Channel Bandwidth 5MHz+20MHz

Channel	Frequency (MHz)	99% Occupied Bandwidth (MHz)	26dB Bandwidth (MHz)
		256QAM_Full RB	256QAM_Full RB
43115+43232	3553.3+3565.0	22.75	23.51
43244+43361	3565.4+3577.1	22.75	23.52
43373+43490	3578.3+3590.0	22.75	23.52

99% Occupied Bandwidth
Spectrum Plot of Worst Value
5MHz+20MHz / 256QAM

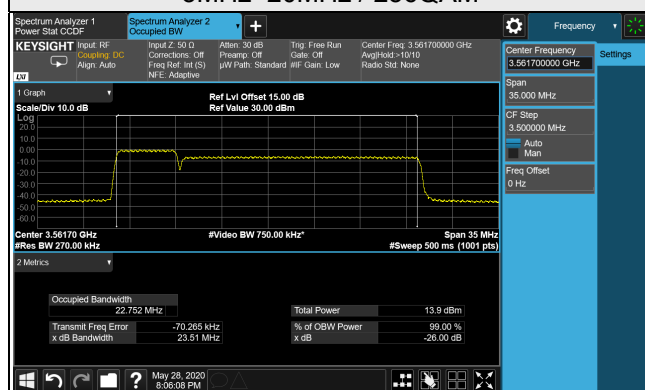

26dB Bandwidth
Spectrum Plot of Worst Value
5MHz+20MHz / 256QAM

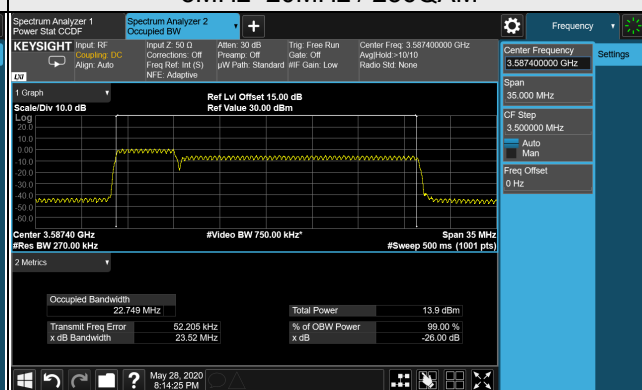

LTE Band 42 (CA 42C), Channel Bandwidth 10MHz+20MHz

Channel	Frequency (MHz)	99% Occupied Bandwidth (MHz)	26dB Bandwidth (MHz)
		256QAM_Full RB	256QAM_Full RB
43140+43284	3555.5+3569.9	27.63	28.55
43242+43386	3565.2+3579.6	27.63	28.53
43346+43490	3575.6+3590.0	27.62	28.57

99% Occupied Bandwidth
Spectrum Plot of Worst Value
10MHz+20MHz / 256QAM

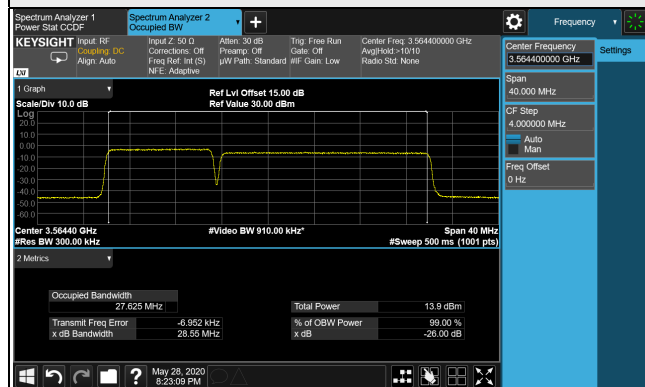

26dB Bandwidth
Spectrum Plot of Worst Value
10MHz+20MHz / 256QAM

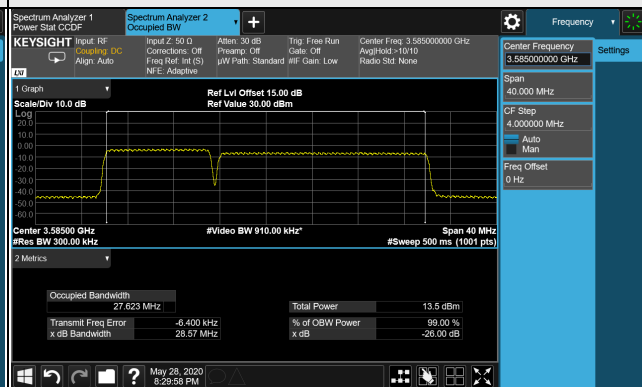

LTE Band 42 (CA 42C), Channel Bandwidth 15MHz+20MHz

Channel	Frequency (MHz)	99% Occupied Bandwidth (MHz)	26dB Bandwidth (MHz)
		256QAM_Full RB	256QAM_Full RB
43165+43336	3557.8+3574.9	32.54	33.68
43242+43413	3565.2+3582.3	32.52	33.67
43319+43490	3572.9+3590.0	32.50	33.63

99% Occupied Bandwidth	26dB Bandwidth
Spectrum Plot of Worst Value	Spectrum Plot of Worst Value
15MHz+20MHz / 256QAM	15MHz+20MHz / 256QAM

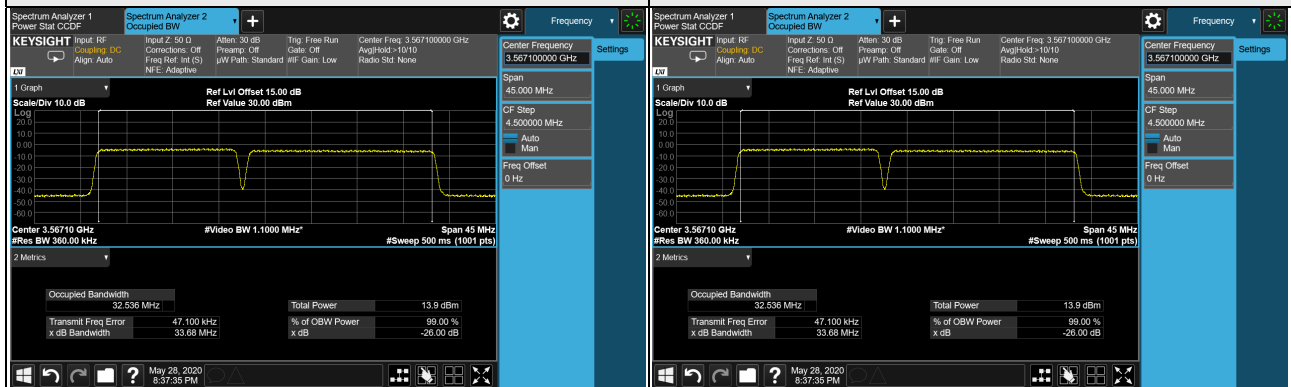

4.4 Peak to Average Ratio Measurement

4.4.1 Limits of Peak to Average Ratio Measurement

In measuring transmissions in this band using an average power technique, the peak to-average ratio (PAR) of the transmission may not exceed 13 dB

4.4.2 Test Setup

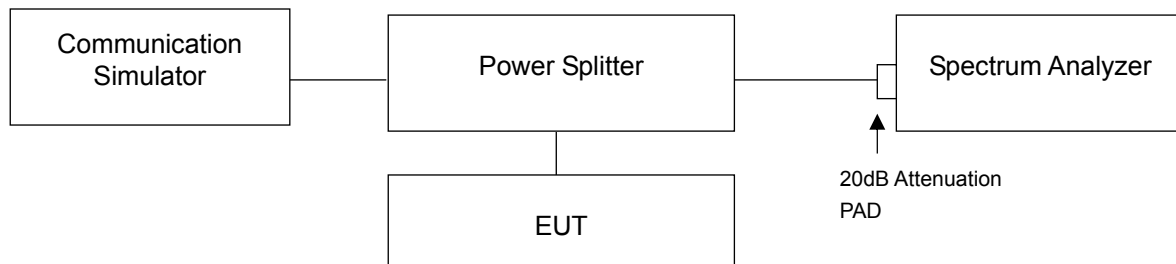

4.4.3 Test Procedures

- Set resolution/measurement bandwidth \geq signal's occupied bandwidth;
- Set the number of counts to a value that stabilizes the measured CCDF curve;
- Record the maximum PAPR level associated with a probability of 0.1%.

4.4.4 Test Results

LTE Band 48 (CA 48C)

LTE Band 48 (CA 48C), Channel Bandwidth 20MHz+20MHz		
Channel	Frequency (MHz)	Peak To Average Ratio (dB)
		256QAM_Full RB
55340+55538	3560.0+3579.8	9.38
55891+56089	3615.1+3634.9	8.59
56442+56640	3670.2+3690.0	8.55

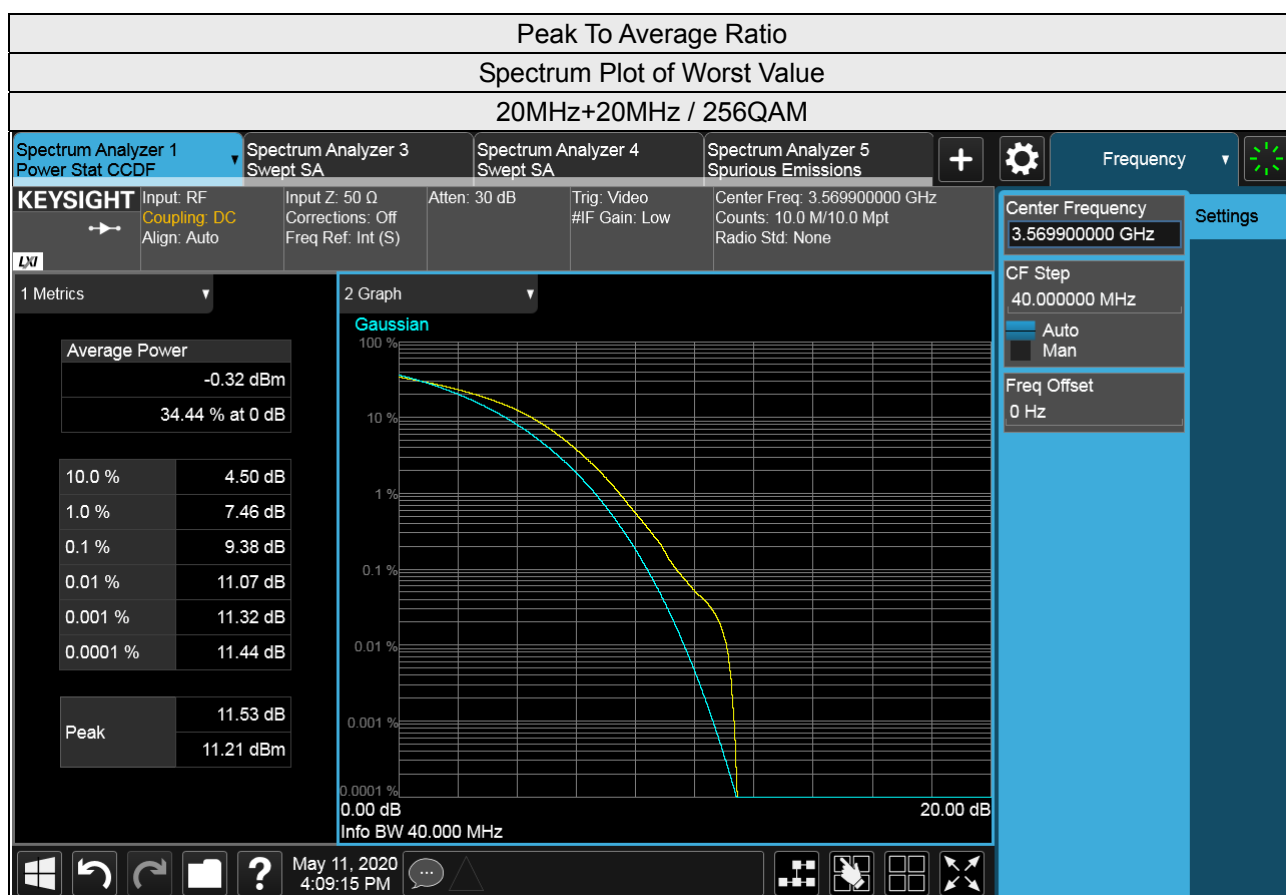

LTE Band 42 (CA 42C)

LTE Band 42 (CA 42C), Channel Bandwidth 20MHz+20MHz		
Channel	Frequency (MHz)	Peak To Average Ratio (dB)
		256QAM_Full RB
43190+43388	3560.0+3579.8	9.33
43241+43439	3565.1+3584.9	9.31
43292+43490	3570.2+3590.0	9.57

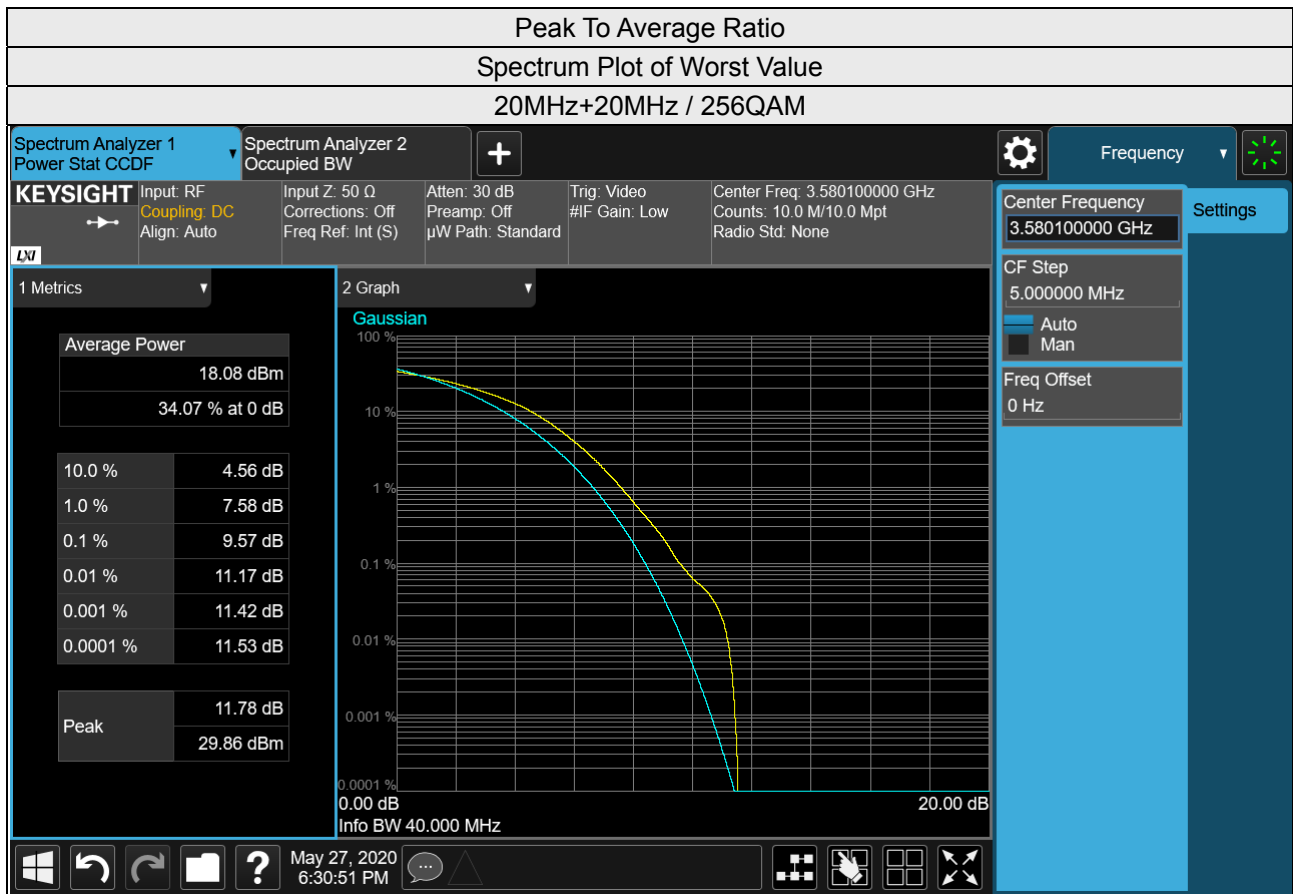

4.5 Conducted Spurious Emissions

4.5.1 Limits of Conducted Spurious Emissions Measurement

Power of any emissions outside the Fundamental	Limit
Within 0-10MHz above the Assigned Channel	-13 dBm/MHz
Within 0-10MHz below the Assigned Channel	
Greater than 0-10MHz above the Assigned Channel	-25 dBm/MHz
Greater than 0-10MHz below the Assigned Channel	
Power of any emission below 3530MHz	-40 dBm/MHz
Power of any emission above 3720MHz	

4.5.2 Test Setup

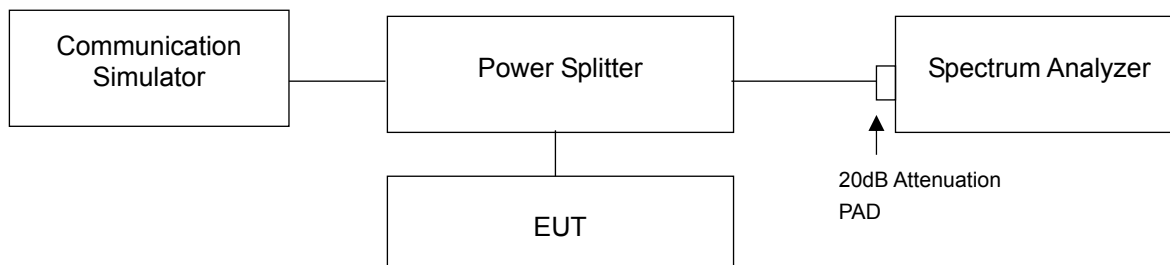

4.5.3 Test Procedure

- The EUT makes a phone call to the communication simulator. All measurements were done at low, middle and high operational frequency range.
- Measuring frequency range is from 9 kHz to 40 GHz. 20dB attenuation pad is connected with spectrum. RBW=1MHz and VBW=3MHz is used for conducted emission measurement.
- Measuring frequency band edge, 20dB attenuation pad is connected with spectrum. 1% of the fundamental emission bandwidth is used for conducted emission measurement.
- For 5MHz channel BW mode, extend the 1% range from 1M to 2M above and below the channel edge and then reduce the limit further by $10 \log(1000/51) = 13\text{dB}$ (i.e. total $-13 + -13 = -26\text{dB}$) to compensate for the integration from 51k to 1M.

4.5.4 Test Results

LTE Band 48 (CA 48C)

LTE Band 48, Channel Bandwidth 20MHz+20MHz

Channel 55340 (3560.0MHz)+55538 (3579.8MHz)

Channel 55891 (3615.1MHz)+56089 (3634.9MHz)

1RB

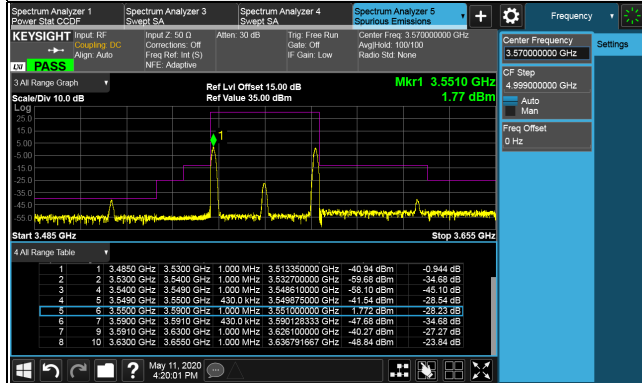

1RB

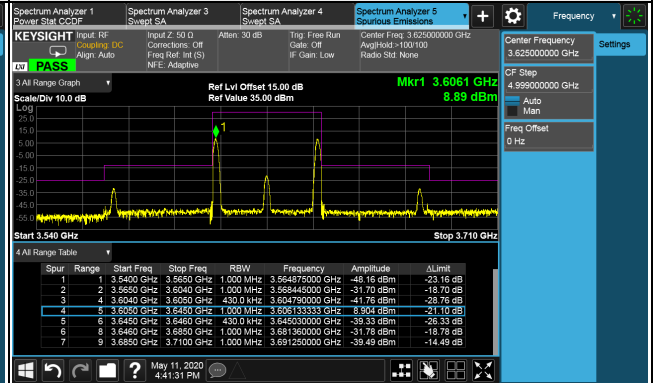

1RB 99

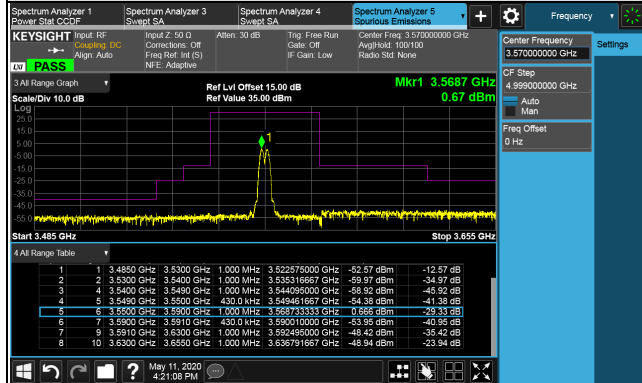

1RB 99

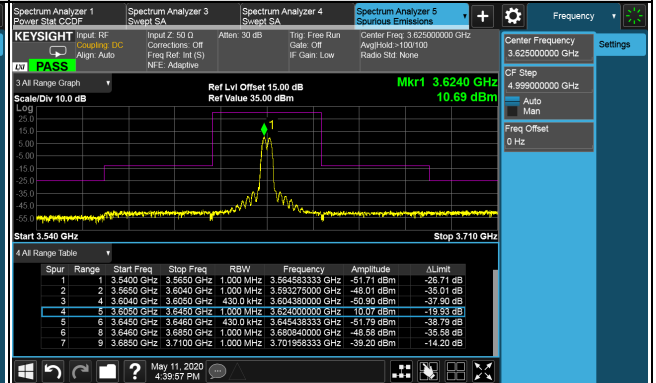

Full RB

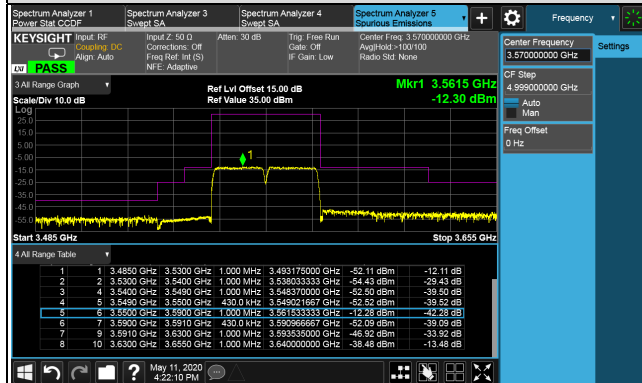

Full RB

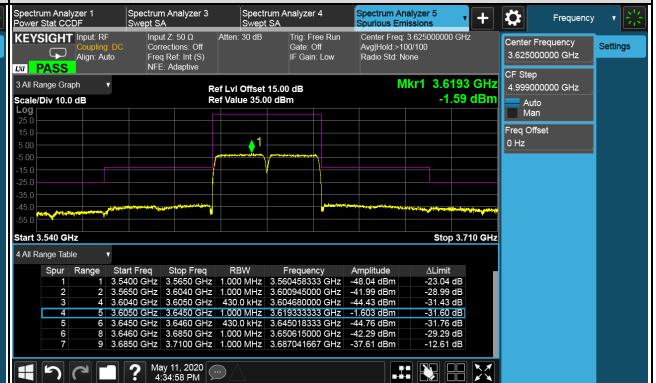

LTE Band 48, Channel Bandwidth 20MHz+20MHz

Channel 56642 (3670.2MHz)+56640 (3690.0MHz)

1RB

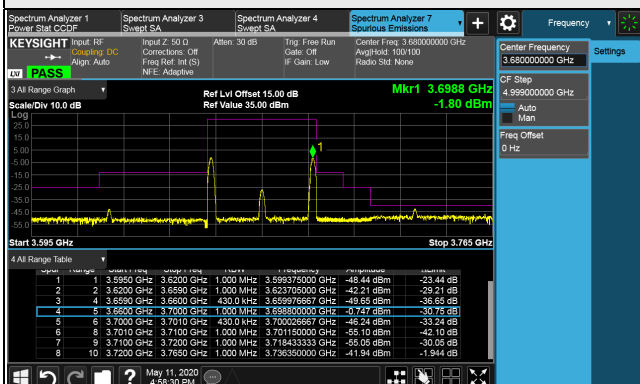

1RB 99

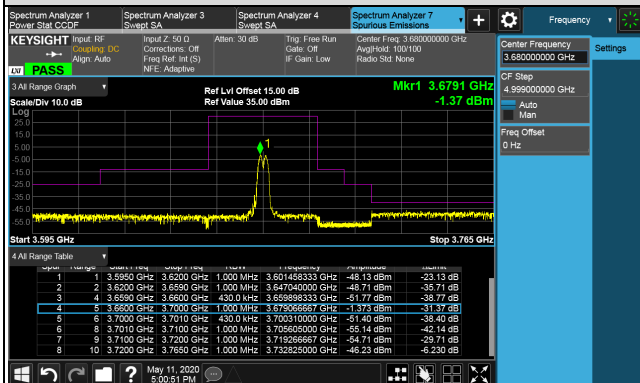

Full RB

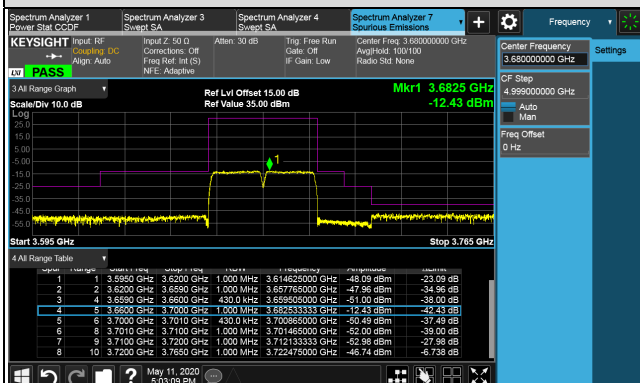

Channel Band width: 20MHz+20MHz

Channel 55340 (3560.0MHz)+55538 (3579.8MHz)

Frequency Range : 9kHz~1GHz

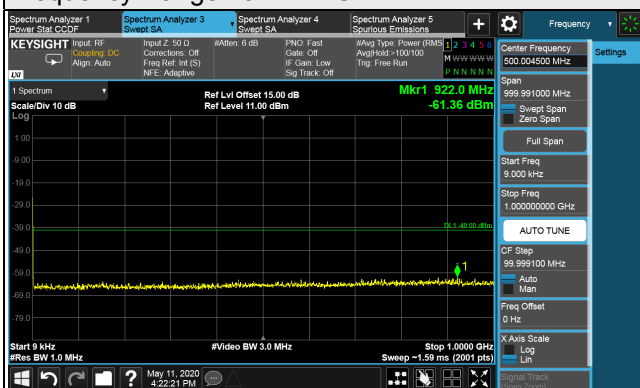

Frequency Range : 1GHz~40GHz

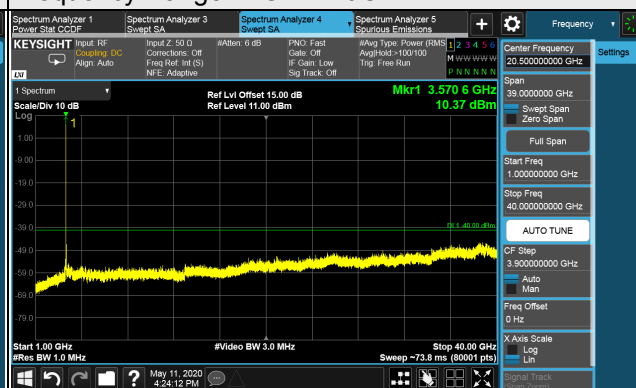

Channel 55891 (3615.1MHz)+56089 (3634.9MHz)

Frequency Range : 9kHz~1GHz

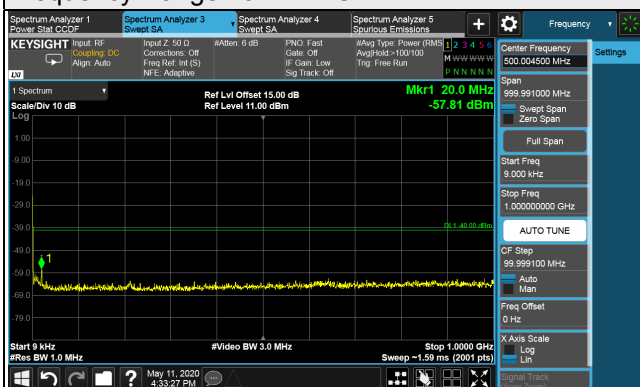

Frequency Range : 1GHz~40GHz

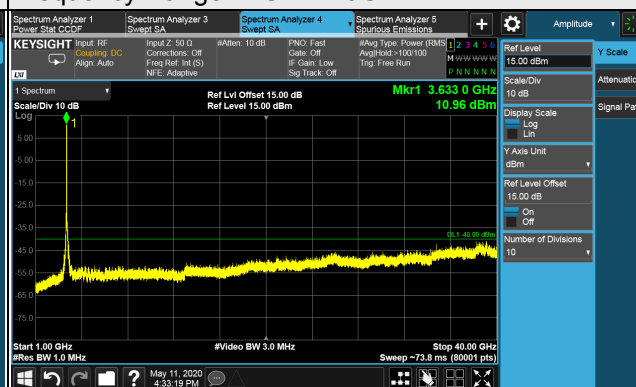

Channel 56642 (3670.2MHz)+56640 (3690.0MHz)

Frequency Range : 9kHz~1GHz

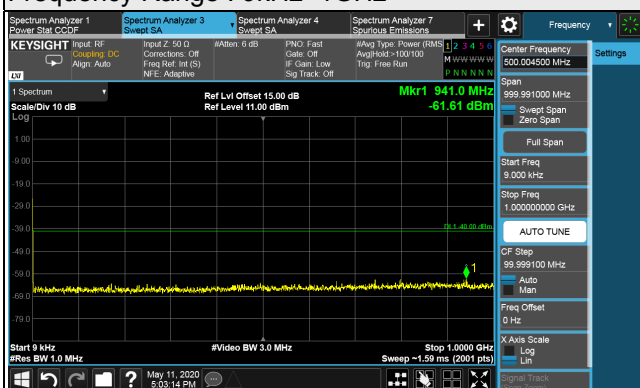

Frequency Range : 1GHz~40GHz

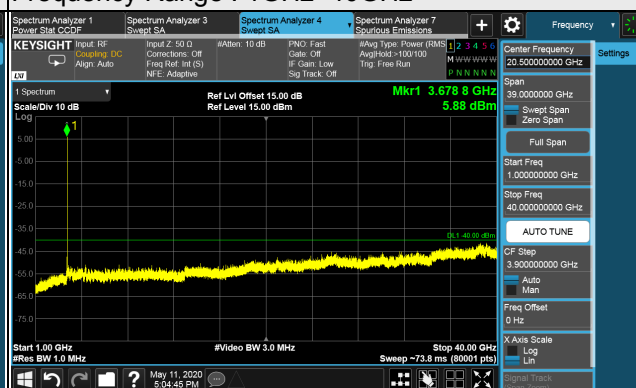

*The 9kHz signal over the limit is from Spectrum.

4.6 Radiated Emission Measurement

4.6.1 Limits of Radiated Emission Measurement

The power of any emissions below 3530 MHz or above 3720 MHz shall not exceed -40dBm/MHz .

4.6.2 Test Instruments

Refer to section 4.1.3 to get information of above instrument.

4.6.3 Test Procedures

- a. Substitution method is used for EIRP measurement. In the semi-anechoic chamber, EUT placed on the 0.8 meters (for 30MHz ~ 1GHz) / 1.5 meters (for above 1GHz) height of Turn Table, rotated the table around 360 degrees to search the maximum radiation power and receiver antenna shall be rotated vertical and horizontal polarization and moved height from 1m to 4m to find the maximum polar radiated power. The "Read Value" is the spectrum reading the maximum power value.
- b. The substitution antenna is substituted for EUT at the same position and signals generator export the CW signal to the substitution antenna via a TX cable. Rotated the Turn Table and moved receiving antenna to find the maximum radiation power. Adjust output power level of S.G to get a Value of spectrum reading equal to "Read Value" of step a. Record the power level of S.G
- c. $\text{EIRP} = \text{Output power level of S.G} - \text{TX cable loss} + \text{Antenna gain of substitution horn}$.
- d. ERP power can be calculated form EIRP power by subtracting the gain of dipole, $\text{ERP power} = \text{EIRP power} - 2.15\text{dBi}$.

Note: The resolution bandwidth of spectrum analyzer is 1 MHz and the video bandwidth is 3 MHz.

4.6.4 Deviation from Test Standard

No deviation.

4.6.5 Test Set Up

<Frequency Range below 1GHz>

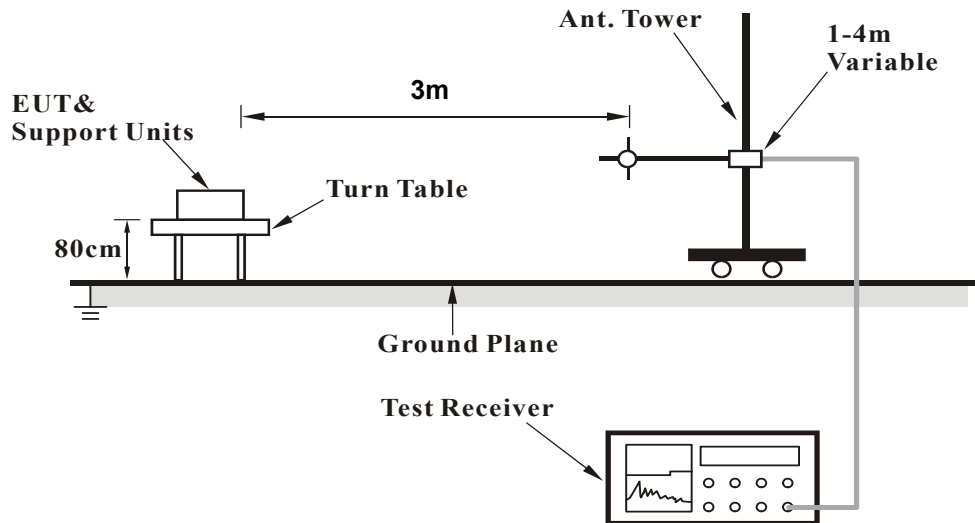

<Frequency Range above 1GHz>

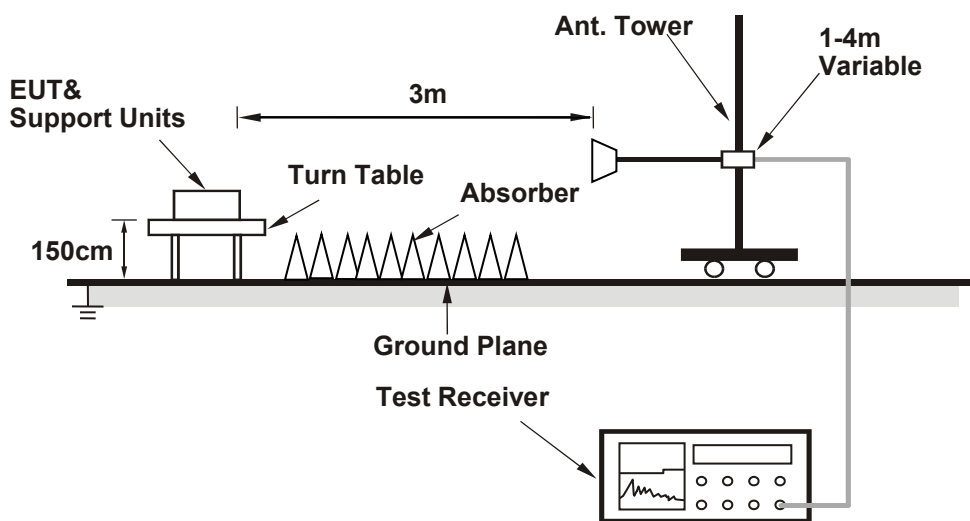

For the actual test configuration, please refer to the attached file (Test Setup Photo).

4.6.6 Test Results

Below 1GHz Data :

LTE Band 48 (CA 48C)

Mode	TX channel 56642 (3670.2MHz)+ TX channel 56640 (3690.0MHz)	Frequency Range	Below 1000 MHz
Environmental Conditions	22deg. C, 68%RH	Input Power	120Vac, 60Hz
Tested By	Greg Lin		

Antenna Polarity & Test Distance: Horizontal at 3 M							
No.	Freq. (MHz)	Reading (dBm)	S.G Power Value (dBm)	Correction Factor (dB)	EIRP (dBm)	Limit (dBm)	Margin (dB)
1	33.10	-52.9	-32.2	-17.6	-49.8	-40.0	-9.8
2	97.90	-46.5	-53.8	-1.4	-55.2	-40.0	-15.2
3	273.47	-61.0	-63.8	-1.6	-65.4	-40.0	-25.4
4	620.73	-68.9	-70.6	3.7	-66.9	-40.0	-26.9
5	797.27	-70.1	-68.4	3.9	-64.5	-40.0	-24.5
6	967.02	-71.3	-66.5	3.6	-62.9	-40.0	-22.9

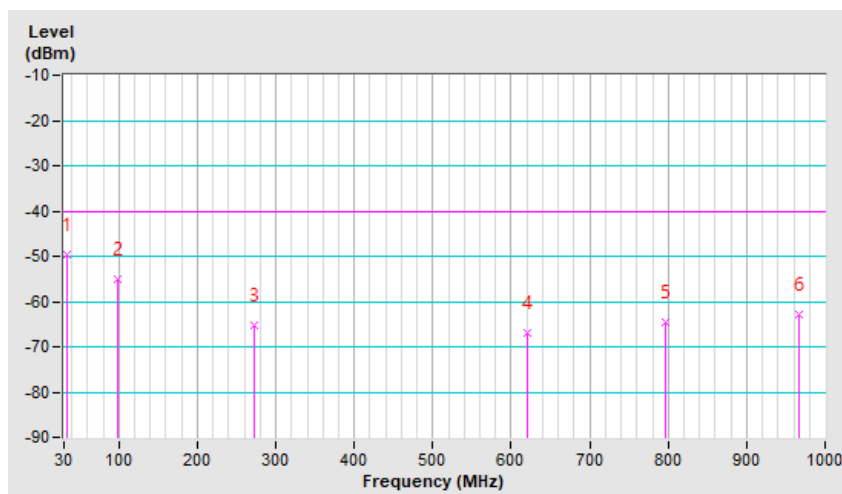

Mode	TX channel 56642 (3670.2MHz)+ TX channel 56640 (3690.0MHz)	Frequency Range	Below 1000 MHz
Environmental Conditions	22deg. C, 68%RH	Input Power	120Vac, 60Hz
Tested By	Greg Lin		

Antenna Polarity & Test Distance: Vertical at 3 M

No.	Freq. (MHz)	Reading (dBm)	S.G Power Value (dBm)	Correction Factor (dB)	EIRP (dBm)	Limit (dBm)	Margin (dB)
1	33.85	-48.5	-41.9	-17.2	-59.1	-40.0	-19.1
2	200.72	-62.3	-61.2	-2.3	-63.5	-40.0	-23.5
3	336.52	-64.9	-69.5	4.0	-65.5	-40.0	-25.5
4	709.97	-67.0	-64.6	3.5	-61.1	-40.0	-21.1
5	814.73	-69.5	-66.4	3.9	-62.5	-40.0	-22.5
6	1000.00	-70.4	-63.5	3.2	-60.3	-40.0	-20.3

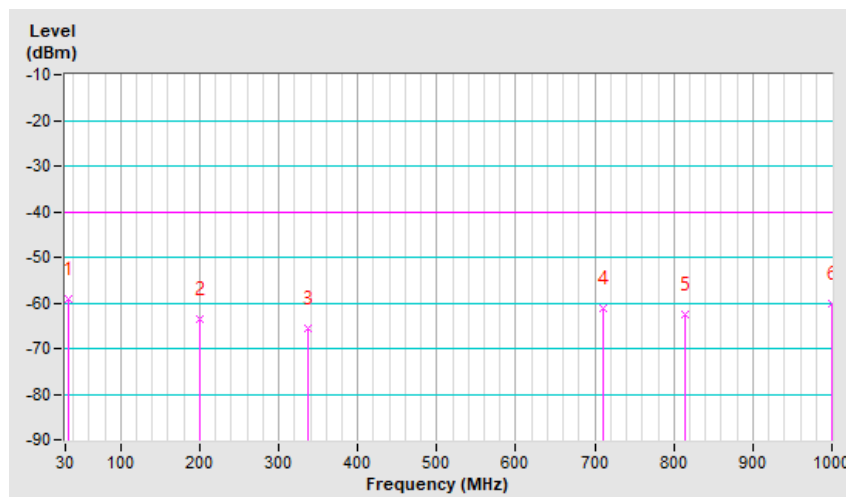

Above 1GHz

LTE Band 48 (CA 48C)

Mode	TX channel 55340 (3560.0MHz)+ TX channel 55538 (3579.8MHz)	Frequency Range	1GHz ~ 40GHz
Environmental Conditions	22deg. C, 68%RH	Input Power	120Vac, 60Hz
Tested By	Greg Lin		

Antenna Polarity & Test Distance: Horizontal at 3 M

No.	Freq. (MHz)	Reading (dBm)	S.G Power Value (dBm)	Correction Factor (dB)	EIRP (dBm)	Limit (dBm)	Margin (dB)
1	7140.00	-67.2	-49.3	0.8	-48.5	-40.0	-8.5

Antenna Polarity & Test Distance: Vertical at 3 M

No.	Freq. (MHz)	Reading (dBm)	S.G Power Value (dBm)	Correction Factor (dB)	EIRP (dBm)	Limit (dBm)	Margin (dB)
1	7140.00	-65.5	-47.8	0.8	-47.0	-40.0	-7.0

Mode	TX channel 55891 (3615.1MHz)+ TX channel 56089 (3634.9MHz)	Frequency Range	1GHz ~ 40GHz
Environmental Conditions	22deg. C, 68%RH	Input Power	120Vac, 60Hz
Tested By	Greg Lin		

Antenna Polarity & Test Distance: Horizontal at 3 M

No.	Freq. (MHz)	Reading (dBm)	S.G Power Value (dBm)	Correction Factor (dB)	EIRP (dBm)	Limit (dBm)	Margin (dB)
1	7250.00	-66.3	-48.5	0.9	-47.6	-40.0	-7.6

Antenna Polarity & Test Distance: Vertical at 3 M

No.	Freq. (MHz)	Reading (dBm)	S.G Power Value (dBm)	Correction Factor (dB)	EIRP (dBm)	Limit (dBm)	Margin (dB)
1	7250.00	-64.4	-46.5	0.9	-45.6	-40.0	-5.6

Mode	TX channel 56642 (3670.2MHz)+ TX channel 56640 (3690.0MHz)	Frequency Range	1GHz ~ 40GHz
Environmental Conditions	22deg. C, 68%RH	Input Power	120Vac, 60Hz
Tested By	Greg Lin		

Antenna Polarity & Test Distance: Horizontal at 3 M

No.	Freq. (MHz)	Reading (dBm)	S.G Power Value (dBm)	Correction Factor (dB)	EIRP (dBm)	Limit (dBm)	Margin (dB)
1	7360.00	-66.3	-47.9	0.9	-47.0	-40.0	-7.0

Antenna Polarity & Test Distance: Vertical at 3 M

No.	Freq. (MHz)	Reading (dBm)	S.G Power Value (dBm)	Correction Factor (dB)	EIRP (dBm)	Limit (dBm)	Margin (dB)
1	7360.00	-64.1	-46.3	0.9	-45.4	-40.0	-5.4

5 Pictures of Test Arrangements

Please refer to the attached file (Test Setup Photo).

Appendix – Information of the Testing Laboratories

We, Bureau Veritas Consumer Products Services (H.K.) Ltd., Taoyuan Branch, were founded in 1988 to provide our best service in EMC, Radio, Telecom and Safety consultation. Our laboratories are accredited and approved according to ISO/IEC 17025.

If you have any comments, please feel free to contact us at the following:

Lin Kou EMC/RF Lab

Tel: 886-2-26052180

Fax: 886-2-26051924

Hsin Chu EMC/RF Lab/Telecom Lab

Tel: 886-3-6668565

Fax: 886-3-6668323

Hwa Ya EMC/RF/Safety Lab

Tel: 886-3-3183232

Fax: 886-3-3270892

Email: service.adt@tw.bureauveritas.com

Web Site: www.bureauveritas-adt.com

The address and road map of all our labs can be found in our web site also.

--- END ---