

## FCC Test Report (ENDC: n7+Band 5/12)

**Report No.:** RF200109E02-11

**FCC ID:** 2AQ68T99W175

**Test Model:** T99W175

**Received Date:** Jan. 10, 2020

**Test Date:** Apr. 23 ~ Apr. 26, 2020

**Issued Date:** Apr. 27, 2020

**Applicant:** Hon Lin Technology Co., Ltd.

**Address:** 11F, No. 32, Jihu Rd., Neihu Dist., Taipei City 114, Taiwan R.O.C.

**Issued By:** Bureau Veritas Consumer Products Services (H.K.) Ltd., Taoyuan Branch  
Lin Kou Laboratories

**Lab Address:** No. 47-2, 14th Ling, Chia Pau Vil., Lin Kou Dist., New Taipei City, Taiwan

**Test Location:** No.19, Hwa Ya 2nd Rd., Wen Hwa Vil., Kwei Shan Dist., Taoyuan City  
33383, Taiwan

**FCC Registration /** 788550 / TW0003

**Designation Number:**



This report is for your exclusive use. Any copying or replication of this report to or for any other person or entity, or use of our name or trademark, is permitted only with our prior written permission. This report sets forth our findings solely with respect to the test samples identified herein. The results set forth in this report are not indicative or representative of the quality or characteristics of the lot from which a test sample was taken or any similar or identical product specifically and expressly noted. Our report includes all of the tests requested by you and the results thereof based upon the information that you provided to us. You have 60 days from date of issuance of this report to notify us of any material error or omission caused by our negligence, provided, however, that such notice shall be in writing and shall specifically address the issue you wish to raise. A failure to raise such issue within the prescribed time shall constitute your unqualified acceptance of the completeness of this report, the tests conducted and the correctness of the report contents. Unless specific mention, the uncertainty of measurement has been explicitly taken into account to declare the compliance or non-compliance to the specification. The report must not be used by the client to claim product certification, approval, or endorsement by TAF or any government agencies

## Table of Contents

<b>Release Control Record</b> .....	<b>4</b>
<b>1 Certificate of Conformity</b> .....	<b>5</b>
<b>2 Summary of Test Results</b> .....	<b>6</b>
2.1 Measurement Uncertainty.....	7
2.2 Test Site and Instruments.....	8
<b>3 General Information</b> .....	<b>9</b>
3.1 General Description of EUT.....	9
3.2 Configuration of System under Test.....	14
3.2.1 Description of Support Units.....	14
3.3 Test Mode Applicability and Tested Channel Detail.....	15
3.4 EUT Operating Conditions.....	21
3.5 General Description of Applied Standards and References.....	21
<b>4 Test Types and Results</b> .....	<b>22</b>
4.1 Output Power Measurement.....	22
4.1.1 Limits of Output Power Measurement.....	22
4.1.2 Test Procedures.....	22
4.1.3 Test Setup.....	22
4.1.4 Test Results.....	23
4.2 Modulation Characteristics Measurement.....	47
4.2.1 Limits of Modulation Characteristics.....	47
4.2.2 Test Procedure.....	47
4.2.3 Test Setup.....	47
4.2.4 Test Results.....	48
4.3 Frequency Stability Measurement.....	49
4.3.1 Limits of Frequency Stability Measurement.....	49
4.3.2 Test Procedure.....	49
4.3.3 Test Setup.....	49
4.3.4 Test Results.....	50
4.4 Occupied Bandwidth Measurement.....	62
4.4.1 Test Procedure.....	62
4.4.2 Test Setup.....	62
4.4.3 Test Result.....	63
4.5 Band Edge Measurement.....	75
4.5.1 Limits of Band Edge Measurement.....	75
4.5.2 Test Setup.....	75
4.5.3 Test Procedures.....	75
4.5.4 Test Results.....	76
4.6 Peak to Average Ratio.....	92
4.6.1 Limits of Peak to Average Ratio Measurement.....	92
4.6.2 Test Setup.....	92
4.6.3 Test Procedures.....	92
4.6.4 Test Results.....	93
4.7 Conducted Spurious Emissions.....	99
4.7.1 Limits of Conducted Spurious Emissions Measurement.....	99
4.7.2 Test Setup.....	99
4.7.3 Test Procedure.....	99
4.7.4 Test Results.....	100
4.8 Radiated Emission Measurement.....	120
4.8.1 Limits of Radiated Emission Measurement.....	120
4.8.2 Test Procedure.....	120
4.8.3 Deviation from Test Standard.....	120
4.8.4 Test Setup.....	121
4.8.5 Test Results.....	122

<b>5</b>	<b>Pictures of Test Arrangements.....</b>	<b>150</b>
	<b>Appendix – Information of the Testing Laboratories .....</b>	<b>151</b>



### Release Control Record

Issue No.	Description	Date Issued
RF200109E02-11	Original release	Apr. 27, 2020

## 1 Certificate of Conformity

**Product:** 5G WWAN Module

**Brand:** Foxconn

**Test Model:** T99W175

**Sample Status:** Engineering Sample

**Applicant:** Hon Lin Technology Co., Ltd.

**Test Date:** Apr. 23 ~ Apr. 26, 2020

**Standards:** FCC Part 22, Subpart H  
FCC Part 27, Subpart H, M

The above equipment has been tested by **Bureau Veritas Consumer Products Services (H.K.) Ltd., Taoyuan Branch**, and found compliance with the requirement of the above standards. The test record, data evaluation & Equipment Under Test (EUT) configurations represented herein are true and accurate accounts of the measurements of the sample's RF characteristics under the conditions specified in this report.

**Prepared by :** Pettie Chen, **Date:** Apr. 27, 2020  
Pettie Chen / Senior Specialist

**Approved by :** Bruce Chen, **Date:** Apr. 27, 2020  
Bruce Chen / Senior Project Engineer

## 2 Summary of Test Results

Applied Standard: FCC Part 22 & Part 2			
FCC Clause	Test Item	Result	Remarks
2.1046 22.913 (a)	Effective radiated power	Pass	Meet the requirement of limit.
22.913 (d)	Peak To Average Ratio	Pass	Meet the requirement of limit.
2.1055 22.355	Frequency Stability	Pass	Meet the requirement of limit.
2.1049	Occupied Bandwidth	Pass	Meet the requirement of limit.
22.917	Band Edge Measurements	Pass	Meet the requirement of limit.
2.1051 22.917	Conducted Spurious Emissions	Pass	Meet the requirement of limit.
2.1053 22.917	Radiated Spurious Emissions	Pass	Meet the requirement of limit. Minimum passing margin is -37.8dB at 37.76MHz.

Note: Determining compliance based on the results of the compliance measurement, not taking into account measurement instrumentation uncertainty.

Applied Standard: FCC Part 27 & Part 2				
FCC Clause		Test Item	Result	Remarks
n7	LTE B12			
2.1046 27.50 (h)(2)	2.1046 27.50 (c)	Equivalent Isotropically Radiated Power / Equivalent Radiated Power	Pass	Meet the requirement of limit.
2.1047	----	Modulation Characteristics	Pass	Meet the requirement of limit.
----	----	Peak To Average Ratio	Pass	Meet the requirement of limit.
2.1055 27.54	2.1055 27.54	Frequency Stability Stay with the authorized bands of operation	Pass	Meet the requirement of limit.
2.1049	2.1049	Occupied Bandwidth	Pass	Meet the requirement of limit.
2.1051 27.53 (m)(4)(6)	2.1051 27.53(g)	Band Edge Measurements	Pass	Meet the requirement of limit.
2.1051 27.53 (m)(4)(6)	2.1051 27.53(g)	Conducted Spurious Emissions	Pass	Meet the requirement of limit.
2.1053 27.53 (m)(4)(6)	2.1053 27.53(g)	Radiated Spurious Emissions	Pass	Meet the requirement of limit. Minimum passing margin is -16.4dB at 30.00MHz.

Note: Determining compliance based on the results of the compliance measurement, not taking into account measurement instrumentation uncertainty.

## 2.1 Measurement Uncertainty

Where relevant, the following measurement uncertainty levels have been estimated for tests performed on the EUT as specified in CISPR 16-4-2:

Measurement	Frequency	Expanded Uncertainty (k=2) ( $\pm$ )
Radiated Emissions up to 1 GHz	9kHz ~ 30MHz	3.04 dB
	30MHz ~ 200MHz	3.63 dB
	200MHz ~ 1000MHz	3.64 dB
Radiated Emissions above 1 GHz	1GHz ~ 18GHz	2.29 dB
	18GHz ~ 40GHz	2.29 dB

## 2.2 Test Site and Instruments

Description & Manufacturer	Model No.	Serial No.	Cal. Date	Cal. Due
Test Receiver ROHDE & SCHWARZ	ESCI	100424	Dec. 31, 2019	Dec. 30, 2020
Spectrum Analyzer ROHDE & SCHWARZ	FSP40	100040	Sep. 23, 2019	Sep. 22, 2020
Spectrum Analyzer KEYSIGHT	N9030B	MY57140953	Jul. 03, 2019	Jul. 02, 2020
Radio Communication Analyzer Anritsu	MT8821C	6261806803	Jan. 18, 2020	Jan. 17, 2021
MXG Vector signal generator Agilent	N5182B	MY53050162	Jan. 14, 2020	Jan. 13, 2021
BILOG Antenna SCHWARZBECK	VULB9168	9168-158	Nov. 08, 2019	Nov. 07, 2020
BILOG Antenna SCHWARZBECK	VULB9168	9168-155	Nov. 11, 2019	Nov. 10, 2020
HORN Antenna SCHWARZBECK	BBHA 9120D	9120D-1170	Nov. 24, 2019	Nov. 23, 2020
HORN Antenna SCHWARZBECK	BBHA 9170	BBHA9170241	Nov. 24, 2019	Nov. 23, 2020
Loop Antenna TESEQ	HLA 6121	45745	Jul. 01, 2019	Jun. 30, 2020
Preamplifier Agilent (Below 1GHz)	8447D	2944A10631	Jul. 11, 2019	Jul. 10, 2020
Preamplifier KEYSIGHT (Above 1GHz)	83017A	MY53270295	Jun. 11, 2019	Jun. 10, 2020
RF Coaxial Cable WOKEN With 5dB PAD	8D-FB	Cable-CH4-01	Aug. 20, 2019	Aug. 19, 2020
RF Coaxial Cable EMCI	EMC102-KM-KM-3000	150929	Aug. 20, 2019	Aug. 19, 2020
RF Coaxial Cable EMCI	EMC102-KM-KM-600	150928	Aug. 20, 2019	Aug. 19, 2020
RF signal cable HUBER+SUHNER	SUCOFLEX 104	MY 13380+295012/04	Jul. 11, 2019	Jul. 10, 2020
RF signal cable HUBER+SUHNER	SUCOFLEX 104	Cable-CH4-03 (250724)	Jul. 11, 2019	Jul. 10, 2020
Software BV ADT	ADT_Radiated_V7.6.15.9.5	NA	NA	NA
Antenna Tower inn-co GmbH	MA 4000	010303	NA	NA
Antenna Tower Controller BV ADT	AT100	AT93021703	NA	NA
Boresight Antenna Fixture	FBA-01	FBA-SIP01	NA	NA
Standard Temperature And Humidity Chamber	MHU-225AU	920842	May 31, 2019	May 30, 2020
JFW 20dB attenuation	50HF-020-SMA	NA	NA	NA
True RMS Clamp Meter Fluke	325	31130711WS	May 21, 2019	May 20, 2020
DC power supply	U8002A	MY56330015	NA	NA

Note: 1. The calibration interval of the above test instruments is 12 months and the calibrations are traceable to NML/ROC and NIST/USA.

2. The test was performed in HwaYa Chamber 4.



### 3 General Information

#### 3.1 General Description of EUT

Product	5G WWAN Module
Brand	Foxconn
Test Model	T99W175
Sample Status	Engineering Sample
Power Supply Rating	5 Vdc (Host equipment) 3.135Vdc~3.63Vdc (Module)

#### n7

Modulation Type	$\pi/2$ BPSK, QPSK, 16QAM, 64QAM, 256QAM					
Waveform Type	CP-OFDM, DFT-s-OFDM					
Operating Frequency	n7 Channel Bandwidth 5MHz	2502.5MHz ~ 2567.5MHz				
	n7 Channel Bandwidth 10MHz	2505.0MHz ~ 2565.0MHz				
	n7 Channel Bandwidth 15MHz	2507.5MHz ~ 2562.5MHz				
	n7 Channel Bandwidth 20MHz	2510.0MHz ~ 2560.0MHz				
Max. EIRP Power		$\pi/2$ BPSK	QPSK	16QAM	64QAM	256QAM
	n7 Channel Bandwidth 5MHz	704.693mW (28.48dBm)	693.426mW (28.41dBm)	665.273mW (28.23dBm)	613.762mW (27.88dBm)	362.243mW (25.59dBm)
	n7 Channel Bandwidth 10MHz	709.578mW (28.51dBm)	690.240mW (28.39dBm)	666.807mW (28.24dBm)	628.058mW (27.98dBm)	363.915mW (25.61dBm)
	n7 Channel Bandwidth 15MHz	703.072mW (28.47dBm)	688.652mW (28.38dBm)	672.977mW (28.28dBm)	623.735mW (27.95dBm)	363.915mW (25.61dBm)
	n7 Channel Bandwidth 20MHz	707.946mW (28.50dBm)	654.636mW (28.16dBm)	623.735mW (27.95dBm)	623.735mW (27.95dBm)	360.579mW (25.57dBm)
Emission Designator		$\pi/2$ BPSK	QPSK	16QAM	64QAM	256QAM
	n7 Channel Bandwidth 5MHz	4M47G7D	4M49G7D	4M49D7W	4M49D7W	4M47D7W
	n7 Channel Bandwidth 10MHz	9M20G7D	8M96G7D	8M96D7W	8M95D7W	9M21D7W
	n7 Channel Bandwidth 15MHz	14M0G7D	13M5G7D	13M4D7W	13M4D7W	14M1D7W
	n7 Channel Bandwidth 20MHz	18M8G7D	17M9G7D	17M9D7W	17M9D7W	18M8D7W

#### LTE Band

Modulation Type	QPSK, 16QAM, 64QAM					
Operating Frequency	LTE Band 5	Channel Bandwidth 1.4MHz	824.7MHz ~ 848.3MHz			
		Channel Bandwidth 3MHz	825.5MHz ~ 847.5MHz			
		Channel Bandwidth 5MHz	826.5MHz ~ 846.5MHz			
		Channel Bandwidth 10MHz	829.0MHz ~ 844.0MHz			
	LTE Band 12	Channel Bandwidth 1.4MHz	699.7MHz ~ 715.3MHz			
		Channel Bandwidth 3MHz	700.5MHz ~ 714.5MHz			
		Channel Bandwidth 5MHz	701.5MHz ~ 713.5MHz			
		Channel Bandwidth 10MHz	704.0MHz ~ 711.0MHz			
Max. ERP Power	LTE Band 5		QPSK	16QAM	64QAM	
		Channel Bandwidth 1.4MHz	320.627mW (25.06dBm)	252.930mW (24.03dBm)	199.986mW (23.01dBm)	
		Channel Bandwidth 3MHz	318.420mW (25.03dBm)	246.037mW (23.91dBm)	201.372mW (23.04dBm)	
		Channel Bandwidth 5MHz	319.890mW (25.05dBm)	254.683mW (24.06dBm)	199.526mW (23.00dBm)	
	LTE Band 12	Channel Bandwidth 10MHz	318.420mW (25.03dBm)	253.513mW (24.04dBm)	200.447mW (23.02dBm)	
		Channel Bandwidth 1.4MHz	349.945mW (25.44dBm)	277.332mW (24.43dBm)	215.278mW (23.33dBm)	
		Channel Bandwidth 3MHz	350.752mW (25.45dBm)	277.971mW (24.44dBm)	221.309mW (23.45dBm)	
		Channel Bandwidth 5MHz	345.939mW (25.39dBm)	279.254mW (24.46dBm)	221.820mW (23.46dBm)	
		Channel Bandwidth 10MHz	349.140mW (25.43dBm)	279.254mW (24.46dBm)	219.786mW (23.42dBm)	

Emission Designator	LTE Band 5	Channel Bandwidth 1.4MHz	QPSK 1M09G7D	16QAM 1M09D7W	64QAM 1M09D7W
		Channel Bandwidth 3MHz	2M70G7D	2M70D7W	2M70D7W
		Channel Bandwidth 5MHz	4M49G7D	4M49D7W	4M49D7W
		Channel Bandwidth 10MHz	8M96G7D	8M96D7W	8M96D7W
	LTE Band 12	Channel Bandwidth 1.4MHz	1M09G7D	1M09D7W	1M09D7W
		Channel Bandwidth 3MHz	2M70G7D	2M70D7W	2M70D7W
		Channel Bandwidth 5MHz	4M49G7D	4M49D7W	4M49D7W
		Channel Bandwidth 10MHz	8M96G7D	8M96D7W	8M96D7W
Antenna Type	Refer to Note as below				
Antenna Connector	Refer to Note as below				
Accessory Device	NA				
Cable Supplied	NA				

Output Power / Emission Designator	n7+LTE Band 5		MAX EIRP / ERP	Sum Bandwidth
		n7 (EIRP)	709.578mW (28.51dBm)	10M3D7W
		LTE Band 5 (ERP)	320.627mW (25.06dBm)	
			EIRP / ERP	MAX Sum Bandwidth
	n7 (EIRP)	296.483mW (24.72dBm)	27M7D7W	
	LTE Band 5 (ERP)	199.067mW (22.99dBm)		
	n7+LTE Band 12		MAX EIRP / ERP	Sum Bandwidth
		n7 (EIRP)	709.578mW (28.51dBm)	11M9D7W
		LTE Band 12 (ERP)	350.752mW (25.45dBm)	
			EIRP / ERP	MAX Sum Bandwidth
n7 (EIRP)		296.483mW (24.72dBm)	27M7D7W	
LTE Band 12 (ERP)		237.684mW (23.76dBm)		

Note:

1. There are four Difference HW of T99W175.

Brand	Model	HW
Foxconn	T99W175	1. 3G+LTE+Sub6+eSIM
		2. 3G+LTE+Sub6 only w/o eSIM
		3. 3G+LTE+Sub6+eSIM+GNSS connector
		4. 3G+LTE+Sub6 only+w/o eSIM+GNSS connector

\*After pre-testing, "HW: 1. 3G+LTE+Sub6+eSIM" is the worst for the final tests.

2. After pre-testing, "DFT-s-OFDM" is the worst for the final tests.

3. The following antennas were provided to the EUT.

Antenna No.	RF Chain No.	Brand	Model	Antenna Net Gain(dBi)	Frequency range (MHz)	Antenna Type	Connector Type
1		WHA YU	C107-511720-A	4.41	660~803	PCB	I-PEX
2		WHA YU	C107-511721-A	3.81 4.03	791~960 1447.9~1606	PCB	I-PEX
3		WHA YU	C107-511722-A	4.27 5.31	1710~2170 2500~2690	PCB	I-PEX
4		WHA YU	C107-511723-A	2.99 0.92	2300~2400 3500~3700	PCB	I-PEX
5		WHA YU	C107-511724-A	6.45	5150~5925	PCB	I-PEX
6		WHA YU	C107-511725-A	4.89	3400~3700	PCB	I-PEX
7		AVX	5000106-R1-X01	2.91	699~803	Monopole	I-PEX
8		AVX	5000107-R1-X01	2.59	791~960	Monopole	I-PEX
9		AVX	5000108-R1-X01	2.85	1427~1610	Monopole	I-PEX
10		AVX	5000109-R1-X01	2.23 2.94	1710~2200 5150~5925	Monopole	I-PEX
11		AVX	5000110-R1-X01	0.9	2300~2690	Monopole	I-PEX
12		AVX	5000111-R1-X01	0.87	3300~5000	Monopole	I-PEX

Antenna No.	RF Chain No.	Brand	Model	Antenna Net Gain(dBi)	Frequency range (MHz)	Antenna Type	Connector Type
13	Tx1/ Rx1	Ethertronics	5003806	0.4 -1.61 0.39 2.95 1.98 0.38 0.83 2.31	698-821 824-960 1425-1515 1710-2200 2300-2690 3300-4200 4400-5000 5150-5925	PIFA	I-PEX
	Rx2	Ethertronics	5003807	-2.24 -4.52 2.87 2.99 2.93 2.91 2.23 -0.85 -3.04	716-821 824-960 1425-1515 1557-1610 1805-2200 2300-2690 3300-4200 4400-5000 5150-5925	PIFA	I-PEX
	Tx2/ Rx3	Ethertronics	5003806	2.21 2.25 -0.45 2.6	1710-2200 2300-2690 3300-4200 4400-5000	PIFA	I-PEX
	Rx4	Ethertronics	5003700	1.38 2.87 0.6 -2.09	1805-2200 2300-2690 3300-4200 4400-5000	PIFA	I-PEX
14	Ant. 0 (TX/RX)	Master Wave	NA	2.4 2.2 2.9 2.9 2.9 NA	880~960 1020~2170 2545~2595 3565~3600 3900~4000 GPS	PCB	I-PEX
	Ant. 2 (TX/RX)	Master Wave	NA	NA 2.2 2.8 2.9 2.8 NA	880~960 1020~2170 2545~2595 3565~3600 3900~4000 GPS	PCB	I-PEX
	Ant. 1 (RX)	Master Wave	NA	NA 5.3 5.1 4.3 4.5 NA	880~960 1020~2170 2545~2595 3565~3600 3900~4000 GPS	PCB	I-PEX
	Ant. 3 (RX)	Master Wave	NA	1.3 6.8 3.7 6.4 6.2 3.7	880~960 1020~2170 2545~2595 3565~3600 3900~4000 GPS	PCB	I-PEX

\*The antenna for the final tests as following table.

	Band	Antenna
5G NR	7 (15kHz) /5/10/15/20	Antenna 3

	Band	Antenna
LTE	5	Antenna 2
	12	Antenna 1

4. The EUT supports the following ENDC configuration.

	FCC 5G FR1			ENDC
	Band	SCS	Bandwidth (MHz)	
5G NR	n2	15kHz	5/10/15/20	Band 5/12/13/30/48/66
	n5	15kHz	5/10/15/20	Band 2/7/12/48/66
	n7	15kHz	5/10/15/20	Band 5/12
	n12	15kHz	5/10/15	Band 2/66
	n41	30kHz	20/40/50/60/80/90/100	Band 2/25/26/66/41
	n66	15kHz	5/10/15/20	Band 5/12/13/30/48/71
	n71	15kHz	5/10/15/20	Band 2/7/66

### 3.2 Configuration of System under Test

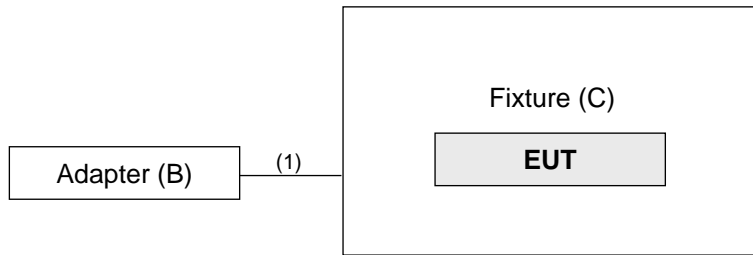

Remote site

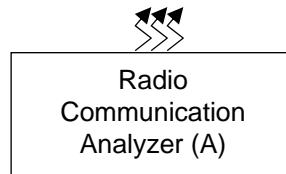

#### 3.2.1 Description of Support Units

The EUT has been tested as an independent unit together with other necessary accessories or support units. The following support units or accessories were used to form a representative test configuration during the tests.

ID	Product	Brand	Model No.	Serial No.	FCC ID	Remarks
A.	Radio Communication Analyzer	Anritsu	MT8821C	6261806803	NA	-
B.	Adapter	LITEON	PA-1050-39	NA	NA	-
C.	Fixture	NA	NA	NA	NA	Provided by client.

Note:

1. All power cords of the above support units are non-shielded (1.8m).
2. Item A acted as a communication partner to transfer data.

ID	Descriptions	Qty.	Length (m)	Shielding (Yes/No)	Cores (Qty.)	Remarks
1.	USB cable	1	1.5	Y	0	-

### 3.3 Test Mode Applicability and Tested Channel Detail

Pre-Scan has been conducted to determine the worst-case mode from all possible combinations between available modulations, data rates, XYZ axis and antenna ports. The worst case was found when positioned on Z-plane. Following channel(s) was (were) selected for the final test as listed below.

n7

EUT Configure Mode	Test item	Available channel	Tested channel	Channel Bandwidth	Modulation	Mode
-	EIRP	500500 to 513500	500500 (2502.5MHz), 507000 (2535.0MHz), 513500 (2567.5MHz)	5 MHz	$\pi/2$ BPSK / QPSK / 16QAM / 64QAM / 256QAM	1 RB / 0 RB Offset 1 RB / 12 RB Offset 1 RB / 24 RB Offset 12 RB / 0 RB Offset 12 RB / 6 RB Offset 12 RB / 13 RB Offset 25 RB / 0 RB Offset
		501000 to 513000	501000 (2505.0MHz), 507000 (2535.0MHz), 513000 (2565.0MHz)	10 MHz	$\pi/2$ BPSK / QPSK / 16QAM / 64QAM / 256QAM	1 RB / 0 RB Offset 1 RB / 24 RB Offset 1 RB / 49 RB Offset 25 RB / 0 RB Offset 25 RB / 12 RB Offset 25 RB / 25 RB Offset 50 RB / 0 RB Offset
		501500 to 512500	501500 (2507.5MHz), 507000 (2535.0MHz), 512500 (2562.5MHz)	15 MHz	$\pi/2$ BPSK / QPSK / 16QAM / 64QAM / 256QAM	1 RB / 0 RB Offset 1 RB / 37 RB Offset 1 RB / 74 RB Offset 36 RB / 0 RB Offset 36 RB / 19 RB Offset 36 RB / 39 RB Offset 75 RB / 0 RB Offset
		502000 to 512000	502000 (2510.0MHz), 507000 (2535.0MHz), 512000 (2560.0MHz)	20 MHz	$\pi/2$ BPSK / QPSK / 16QAM / 64QAM / 256QAM	1 RB / 0 RB Offset 1 RB / 50 RB Offset 1 RB / 99 RB Offset 50 RB / 0 RB Offset 50 RB / 25 RB Offset 50 RB / 50 RB Offset 100 RB / 0 RB Offset
-	Modulation Characteristics	502000 to 512000	507000 (2535.0MHz)	20MHz	$\pi/2$ BPSK / QPSK / 16QAM / 64QAM / 256QAM	106 RB / 0 RB Offset
-	Frequency Stability	500500 to 513500	500500 (2502.5MHz), 513500 (2567.5MHz)	5 MHz	$\pi/2$ BPSK	25 RB / 0 RB Offset
		501000 to 513000	501000 (2505.0MHz), 513000 (2565.0MHz)	10 MHz	$\pi/2$ BPSK	52 RB / 0 RB Offset
		501500 to 512500	501500 (2507.5MHz), 512500 (2562.5MHz)	15 MHz	$\pi/2$ BPSK	79 RB / 0 RB Offset
		502000 to 512000	502000 (2510.0MHz), 512000 (2560.0MHz)	20 MHz	$\pi/2$ BPSK	106 RB / 0 RB Offset
-	Emission Bandwidth	500500 to 513500	500500 (2502.5MHz), 507000 (2535.0MHz), 513500 (2567.5MHz)	5 MHz	$\pi/2$ BPSK / QPSK / 16QAM / 64QAM / 256QAM	25 RB / 0 RB Offset
		501000 to 513000	501000 (2505.0MHz), 507000 (2535.0MHz), 513000 (2565.0MHz)	10 MHz	$\pi/2$ BPSK / QPSK / 16QAM / 64QAM / 256QAM	52 RB / 0 RB Offset
		501500 to 512500	501500 (2507.5MHz), 507000 (2535.0MHz), 512500 (2562.5MHz)	15 MHz	$\pi/2$ BPSK / QPSK / 16QAM / 64QAM / 256QAM	79 RB / 0 RB Offset
		502000 to 512000	502000 (2510.0MHz), 507000 (2535.0MHz), 512000 (2560.0MHz)	20 MHz	$\pi/2$ BPSK / QPSK / 16QAM / 64QAM / 256QAM	106 RB / 0 RB Offset

EUT Configure Mode	Test item	Available channel	Tested channel	Channel Bandwidth	Modulation	Mode
-	Emission Mask	500500 to 513500	500500 (2502.5MHz), 507000 (2535.0MHz), 513500 (2567.5MHz)	5 MHz	$\pi/2$ BPSK	1 RB / 0 RB Offset 1 RB / 24 RB Offset 25 RB / 0 RB Offset
		501000 to 513000	501000 (2505.0MHz), 507000 (2535.0MHz), 513000 (2565.0MHz)	10 MHz	$\pi/2$ BPSK	1 RB / 0 RB Offset 1 RB / 51 RB Offset 52 RB / 0 RB Offset
		501500 to 512500	501500 (2507.5MHz), 507000 (2535.0MHz), 512500 (2562.5MHz)	15 MHz	$\pi/2$ BPSK	1 RB / 0 RB Offset 1 RB / 78 RB Offset 79 RB / 0 RB Offset
		502000 to 512000	502000 (2510.0MHz), 507000 (2535.0MHz), 512000 (2560.0MHz)	20 MHz	$\pi/2$ BPSK	1 RB / 0 RB Offset 1 RB / 105 RB Offset 106 RB / 0 RB Offset
-	Peak to Average Ratio	500500 to 513500	500500 (2502.5MHz), 507000 (2535.0MHz), 513500 (2567.5MHz)	5 MHz	$\pi/2$ BPSK / QPSK / 16QAM / 64QAM / 256QAM	1 RB / 0 RB Offset
		501000 to 513000	501000 (2505.0MHz), 507000 (2535.0MHz), 513000 (2565.0MHz)	10 MHz	$\pi/2$ BPSK / QPSK / 16QAM / 64QAM / 256QAM	1 RB / 0 RB Offset
		501500 to 512500	501500 (2507.5MHz), 507000 (2535.0MHz), 512500 (2562.5MHz)	15 MHz	$\pi/2$ BPSK / QPSK / 16QAM / 64QAM / 256QAM	1 RB / 0 RB Offset
		502000 to 512000	502000 (2510.0MHz), 507000 (2535.0MHz), 512000 (2560.0MHz)	20 MHz	$\pi/2$ BPSK / QPSK / 16QAM / 64QAM / 256QAM	1 RB / 0 RB Offset
-	Conducted Emission	500500 to 513500	500500 (2502.5MHz), 507000 (2535.0MHz), 513500 (2567.5MHz)	5 MHz	$\pi/2$ BPSK	1 RB / 0 RB Offset
		501000 to 513000	501000 (2505.0MHz), 507000 (2535.0MHz), 513000 (2565.0MHz)	10 MHz	$\pi/2$ BPSK	1 RB / 0 RB Offset
		501500 to 512500	501500 (2507.5MHz), 507000 (2535.0MHz), 512500 (2562.5MHz)	15 MHz	$\pi/2$ BPSK	1 RB / 0 RB Offset
		502000 to 512000	502000 (2510.0MHz), 507000 (2535.0MHz), 512000 (2560.0MHz)	20 MHz	$\pi/2$ BPSK	1 RB / 0 RB Offset
-	Radiated Emission Below 1GHz	500500 to 513500	513500 (2567.5MHz)	5MHz	$\pi/2$ BPSK	1 RB / 0 RB Offset
		502000 to 512000	512000 (2560.0MHz)	20MHz	$\pi/2$ BPSK	1 RB / 0 RB Offset
-	Radiated Emission Above 1GHz	500500 to 513500	500500 (2502.5MHz), 507000 (2535.0MHz), 513500 (2567.5MHz)	5 MHz	$\pi/2$ BPSK	1 RB / 0 RB Offset
		501000 to 513000	501000 (2505.0MHz), 507000 (2535.0MHz), 513000 (2565.0MHz)	10 MHz	$\pi/2$ BPSK	1 RB / 0 RB Offset
		501500 to 512500	501500 (2507.5MHz), 507000 (2535.0MHz), 512500 (2562.5MHz)	15 MHz	$\pi/2$ BPSK	1 RB / 0 RB Offset
		502000 to 512000	502000 (2510.0MHz), 507000 (2535.0MHz), 512000 (2560.0MHz)	20 MHz	$\pi/2$ BPSK	1 RB / 0 RB Offset

Note: The conducted output power for  $\pi/2$  BPSK, QPSK, 16QAM, 64QAM and 256QAM, measured value of  $\pi/2$  BPSK is higher than QPSK, 16QAM, 64QAM and 256QAM mode. Therefore, only EIRP, Modulation characteristics, occupied bandwidth and Peak to average ratio items had been tested under  $\pi/2$  BPSK, QPSK, 16QAM, 64QAM and 256QAM modes, the other test items were performed under  $\pi/2$  BPSK mode only.



LTE Band 5

EUT Configure Mode	Test item	Available channel	Tested channel	Channel Bandwidth	Modulation	Mode
-	ERP	20407 to 20643	20407(824.7MHz), 20525(836.5MHz), 20643(848.3MHz)	1.4MHz	QPSK / 16QAM / 64QAM	1 RB / 0 RB Offset 1 RB / 2 RB Offset 1 RB / 5 RB Offset 3 RB / 0 RB Offset 3 RB / 1 RB Offset 3 RB / 3 RB Offset 6 RB / 0 RB Offset
		20415 to 20635	20415(825.5MHz), 20525(836.5MHz), 20635(847.5MHz)	3MHz	QPSK / 16QAM / 64QAM	1 RB / 0 RB Offset 1 RB / 7 RB Offset 1 RB / 14 RB Offset 8 RB / 0 RB Offset 8 RB / 3 RB Offset 8 RB / 7 RB Offset 15 RB / 0 RB Offset
		20425 to 20625	20425(826.5MHz), 20525(836.5MHz), 20625(846.5MHz)	5MHz	QPSK / 16QAM / 64QAM	1 RB / 0 RB Offset 1 RB / 12 RB Offset 1 RB / 24 RB Offset 12 RB / 0 RB Offset 12 RB / 6 RB Offset 12 RB / 13 RB Offset 25 RB / 0 RB Offset
		20450 to 20600	20450(829.0MHz), 20525(836.5MHz), 20600(844.0MHz)	10MHz	QPSK / 16QAM / 64QAM	1 RB / 0 RB Offset 1 RB / 24 RB Offset 1 RB / 49 RB Offset 25 RB / 0 RB Offset 25 RB / 12 RB Offset 25 RB / 25 RB Offset 50 RB / 0 RB Offset
-	Frequency Stability	20407 to 20643	20407(824.7MHz), 20643(848.3MHz)	1.4MHz	QPSK	6 RB / 0 RB Offset
		20415 to 20635	20415(825.5MHz), 20635(847.5MHz)	3MHz	QPSK	15 RB / 0 RB Offset
		20425 to 20625	20425(826.5MHz), 20625(846.5MHz)	5MHz	QPSK	25 RB / 0 RB Offset
		20450 to 20600	20450(829.0MHz), 20600(844.0MHz)	10MHz	QPSK	50 RB / 0 RB Offset
-	Occupied Bandwidth	20407 to 20643	20407(824.7MHz), 20525(836.5MHz), 20643(848.3MHz)	1.4MHz	QPSK / 16QAM / 64QAM	6 RB / 0RB Offset
		20415 to 20635	20415(825.5MHz), 20525(836.5MHz), 20635(847.5MHz)	3MHz	QPSK / 16QAM / 64QAM	15 RB / 0RB Offset
		20425 to 20625	20425(826.5MHz), 20525(836.5MHz), 20625(846.5MHz)	5MHz	QPSK / 16QAM / 64QAM	25RB / 0RB Offset
		20450 to 20600	20450(829.0MHz), 20525(836.5MHz), 20600(844.0MHz)	10MHz	QPSK / 16QAM / 64QAM	50RB / 0RB Offset

EUT Configure Mode	Test item	Available channel	Tested channel	Channel Bandwidth	Modulation	Mode
-	Band Edge	20407 to 20643	20407(824.7MHz), 20643(848.3MHz)	1.4MHz	QPSK	1 RB / 0 RB Offset 1 RB / 5 RB Offset 6 RB / 0 RB Offset
		20415 to 20635	20415(825.5MHz), 20635(847.5MHz)	3MHz	QPSK	1 RB / 0 RB Offset 1 RB / 14 RB Offset 15 RB / 0 RB Offset
		20425 to 20625	20425(826.5MHz), 20625(846.5MHz)	5MHz	QPSK	1 RB / 0 RB Offset 1 RB / 24 RB Offset 25 RB / 0 RB Offset
		20450 to 20600	20450(829.0MHz), 20600(844.0MHz)	10MHz	QPSK	1 RB / 0 RB Offset 1 RB / 49 RB Offset 50 RB / 0 RB Offset
-	Peak to Average Ratio	20407 to 20643	20407(824.7MHz), 20525(836.5MHz), 20643(848.3MHz)	1.4MHz	QPSK / 16QAM / 64QAM	3 RB / 1 RB Offset
		20415 to 20635	20415(825.5MHz), 20525(836.5MHz), 20635(847.5MHz)	3MHz	QPSK / 16QAM / 64QAM	1 RB / 0 RB Offset
		20425 to 20625	20425(826.5MHz), 20525(836.5MHz), 20625(846.5MHz)	5MHz	QPSK / 16QAM / 64QAM	1 RB / 12 RB Offset
		20450 to 20600	20450(829.0MHz), 20525(836.5MHz), 20600(844.0MHz)	10MHz	QPSK / 16QAM / 64QAM	1 RB / 0 RB Offset
-	Conducted Emission	20407 to 20643	20407(824.7MHz), 20525(836.5MHz), 20643(848.3MHz)	1.4MHz	QPSK	3 RB / 1 RB Offset
		20415 to 20635	20415(825.5MHz), 20525(836.5MHz), 20635(847.5MHz)	3MHz	QPSK	1 RB / 0 RB Offset
		20425 to 20625	20425(826.5MHz), 20525(836.5MHz), 20625(846.5MHz)	5MHz	QPSK	1 RB / 12 RB Offset
		20450 to 20600	20450(829.0MHz), 20525(836.5MHz), 20600(844.0MHz)	10MHz	QPSK	1 RB / 0 RB Offset
-	Radiated Emission Below 1GHz	20450 to 20600	20600(844.0MHz)	10MHz	QPSK	1 RB / 0 RB Offset
-	Radiated Emission Above 1GHz	20407 to 20643	20407(824.7MHz), 20525(836.5MHz), 20643(848.3MHz)	1.4MHz	QPSK	3 RB / 1 RB Offset
		20425 to 20625	20425(826.5MHz), 20525(836.5MHz), 20625(846.5MHz)	5MHz	QPSK	1 RB / 12 RB Offset
		20450 to 20600	20450(829.0MHz), 20525(836.5MHz), 20600(844.0MHz)	10MHz	QPSK	1 RB / 0 RB Offset

Note:

1. For radiated emission above 1GHz, according to 3GPP 36.521 Section 6.6.3.1.4, choose the lowest, 5MHz & highest channel bandwidth for final test.
2. The conducted output power for QPSK, 16QAM and 64QAM, measured value of QPSK is higher than 16QAM and 64QAM mode. Therefore, only ERP, occupied bandwidth and Peak to average ratio items had been tested under QPSK, 16QAM and 64QAM modes, the other test items were performed under QPSK mode only.

LTE Band 12

EUT Configure Mode	Test item	Available channel	Tested channel	Channel Bandwidth	Modulation	Mode
-	ERP	23017 to 23173	23017(699.7MHz), 23095(707.5MHz), 23173(715.3MHz)	1.4MHz	QPSK / 16QAM / 64QAM	1 RB / 0 RB Offset 1 RB / 2 RB Offset 1 RB / 5 RB Offset 3 RB / 0 RB Offset 3 RB / 1 RB Offset 3 RB / 3 RB Offset 6 RB / 0 RB Offset
		23025 to 23165	23025(700.5MHz), 23095(707.5MHz), 23165(714.5MHz)	3MHz	QPSK / 16QAM / 64QAM	1 RB / 0 RB Offset 1 RB / 7 RB Offset 1 RB / 14 RB Offset 8 RB / 0 RB Offset 8 RB / 3 RB Offset 8 RB / 7 RB Offset 15 RB / 0 RB Offset
		23035 to 23155	23035(701.5MHz), 23095(707.5MHz), 23155(713.5MHz)	5MHz	QPSK / 16QAM / 64QAM	1 RB / 0 RB Offset 1 RB / 12 RB Offset 1 RB / 24 RB Offset 12 RB / 0 RB Offset 12 RB / 6 RB Offset 12 RB / 13 RB Offset 25 RB / 0 RB Offset
		23060 to 23130	23060(704.0MHz), 23095(707.5 MHz), 23130(711.0 MHz)	10MHz	QPSK / 16QAM / 64QAM	1 RB / 0 RB Offset 1 RB / 24 RB Offset 1 RB / 49 RB Offset 25 RB / 0 RB Offset 25 RB / 12 RB Offset 25 RB / 25 RB Offset 50 RB / 0 RB Offset
-	Frequency Stability	23017 to 23173	23017(699.7MHz), 23173(715.3MHz)	1.4MHz	QPSK	6 RB / 0 RB Offset
		23025 to 23165	23025(700.5MHz), 23165(714.5MHz)	3MHz	QPSK	15 RB / 0 RB Offset
		23035 to 23155	23035(701.5MHz), 23155(713.5MHz)	5MHz	QPSK	25 RB / 0 RB Offset
		23060 to 23130	23060(704.0MHz), 23130(711.0MHz)	10MHz	QPSK	50 RB / 0 RB Offset
-	Emission Bandwidth	23017 to 23173	23017(699.7MHz), 23095(707.5MHz), 23173(715.3MHz)	1.4MHz	QPSK / 16QAM / 64QAM	6 RB / 0 RB Offset
		23025 to 23165	23025(700.5MHz), 23095(707.5MHz), 23165(714.5MHz)	3MHz	QPSK / 16QAM / 64QAM	15 RB / 0 RB Offset
		23035 to 23155	23035(701.5MHz), 23095(707.5MHz), 23155(713.5MHz)	5MHz	QPSK / 16QAM / 64QAM	25 RB / 0 RB Offset
		23060 to 23130	23060(704.0MHz), 23095(707.5MHz), 23130(711.0MHz)	10MHz	QPSK / 16QAM / 64QAM	50 RB / 0 RB Offset
-	Band Edge	23017 to 23173	23017(699.7MHz), 23173(715.3MHz)	1.4MHz	QPSK	1 RB / 0 RB Offset 1 RB / 5 RB Offset 6 RB / 0 RB Offset
		23025 to 23165	23025(700.5MHz), 23165(714.5MHz)	3MHz	QPSK	1 RB / 0 RB Offset 1 RB / 14 RB Offset 15 RB / 0 RB Offset
		23035 to 23155	23035(701.5MHz), 23155(713.5MHz)	5MHz	QPSK	1 RB / 0 RB Offset 1 RB / 24 RB Offset 25 RB / 0 RB Offset
		23060 to 23130	23060(704.0MHz), 23130(711.0MHz)	10MHz	QPSK	1 RB / 0 RB Offset 1 RB / 49 RB Offset 50 RB / 0 RB Offset

EUT Configure Mode	Test item	Available channel	Tested channel	Channel Bandwidth	Modulation	Mode
-	Peak to Average Ratio	23017 to 23173	23017(699.7MHz), 23095(707.5MHz), 23173(715.3MHz)	1.4MHz	QPSK / 16QAM / 64QAM	1 RB / 2 RB Offset
		23025 to 23165	23025(700.5MHz), 23095(707.5MHz), 23165(714.5MHz)	3MHz	QPSK / 16QAM / 64QAM	1 RB / 0 RB Offset
		23035 to 23155	23035(701.5MHz), 23095(707.5MHz), 23155(713.5MHz)	5MHz	QPSK / 16QAM / 64QAM	1 RB / 12 RB Offset
		23060 to 23130	23060(704.0MHz), 23095(707.5MHz), 23130(711.0MHz)	10MHz	QPSK / 16QAM / 64QAM	1 RB / 49 RB Offset
-	Conducted Emission	23017 to 23173	23017(699.7MHz), 23095(707.5MHz), 23173(715.3MHz)	1.4MHz	QPSK	1 RB / 2 RB Offset
		23025 to 23165	23025(700.5MHz), 23095(707.5MHz), 23165(714.5MHz)	3MHz	QPSK	1 RB / 0 RB Offset
		23035 to 23155	23035(701.5MHz), 23095(707.5MHz), 23155(713.5MHz)	5MHz	QPSK	1 RB / 12 RB Offset
		23060 to 23130	23060(704.0MHz), 23095(707.5MHz), 23130(711.0MHz)	10MHz	QPSK	1 RB / 49 RB Offset
-	Radiated Emission Below 1GHz	23017 to 23173	23017(699.7MHz)	1.4MHz	QPSK	1 RB / 2 RB Offset
-	Radiated Emission Above 1GHz	23017 to 23173	23017(699.7MHz), 23095(707.5MHz), 23173(715.3MHz)	1.4MHz	QPSK	1 RB / 2 RB Offset
		23035 to 23155	23035(701.5MHz), 23095(707.5MHz), 23155(713.5MHz)	5MHz	QPSK	1 RB / 12 RB Offset
		23060 to 23130	23060(704.0MHz), 23095(707.5MHz), 23130(711.0MHz)	10MHz	QPSK	1 RB / 49 RB Offset

**Note:**

1. For radiated emission above 1GHz, according to 3GPP 36.521 Section 6.6.3.1.4, choose the 1.4MHz & highest channel bandwidth for final test.
2. The conducted output power for QPSK, 16QAM and 64QAM measured value of QPSK is higher than 16QAM and 64QAM mode. Therefore, only ERP, occupied bandwidth and Peak to average ratio items had been tested under QPSK, 16QAM and 64QAM modes, the other test items were performed under QPSK mode only.

**Test Condition:**

Test Item	Environmental Conditions	Input Power (system)	Tested By
ERP / EIRP	25deg. C, 70%RH	5Vdc	James Yang
Modulation characteristics	24deg. C, 64%RH	5Vdc	James Yang
Frequency Stability	24deg. C, 64%RH	5Vdc	James Yang
Occupied Bandwidth	24deg. C, 64%RH	5Vdc	James Yang
Band Edge	24deg. C, 64%RH	5Vdc	James Yang
Peak To Average Ratio	24deg. C, 64%RH	5Vdc	James Yang
Conducted Emission	24deg. C, 64%RH	5Vdc	James Yang
Radiated Emission	22deg. C, 68%RH 25deg. C, 70%RH	120Vac, 60Hz	Greg Lin Luis Lee

### **3.4 EUT Operating Conditions**

The EUT makes a call to the communication simulator. The communication simulator station system controlled a EUT to export maximum output power under transmission mode and specific channel frequency

### **3.5 General Description of Applied Standards and References**

The EUT is a RF Product. According to the specifications of the manufacturer, it must comply with the requirements of the following standards and References:

#### **Test Standard:**

**FCC 47 CFR Part 2**

**FCC 47 CFR Part 22**

**FCC 47 CFR Part 27**

**ANSI/TIA/EIA-603-D-2010**

**ANSI/TIA/EIA-603-E 2016**

**ANSI 63.26-2015**

All test items have been performed and recorded as per the above standards.

#### **References Test Guidance:**

**KDB 971168 D01 Power Meas License Digital Systems v03r01**

**KDB 971168 D02 Misc Rev Approv License Devices v02r01**

**KDB 662911 D01 Multiple Transmitter Output v02r01**

**KDB 940660 D01 Part 96 CBRS Eqpt v02**

All test items have been performed as a reference to the above KDB test guidance.

## 4 Test Types and Results

### 4.1 Output Power Measurement

#### 4.1.1 Limits of Output Power Measurement

For n7:

Mobile stations are limited to 2.0 watts EIRP. All user stations are limited to 2.0 watts transmitter output power.

For LTE Band 5:

Mobile / Portable station are limited to 7 watts e.r.p.

For LTE Band 12:

Control and mobile stations in the 698-746 MHz, 746-757 MHz, 787-788 MHz and 805-806 MHz band are limited to 30 watts ERP.

Portable stations (hand-held devices) in the 600 MHz uplink band and the 698-746 MHz band, and fixed and mobile stations in the 600 MHz uplink, 746-757 MHz, 787-788 MHz and 805-806 MHz band are limited to 3 watts ERP.

#### 4.1.2 Test Procedures

##### Conducted Power Measurement:

The EUT was set up for the maximum power with WCDMA, LTE link data modulation and link up with simulator. Set the EUT to transmit under low, middle and high channel and record the power level shown on simulator.

##### Maximum EIRP

The relevant equation for determining the maximum ERP or EIRP from the measured RF output power is given in Equation as follows:

$$\text{ERP or EIRP} = P_{\text{Meas}} + G_{\text{T}}$$

where

ERP or EIRP effective radiated power or equivalent isotropically radiated power, respectively (expressed in the same units as  $P_{\text{Meas}}$ , e.g., dBm or dBW)

$P_{\text{Meas}}$  measured transmitter output power or PSD, in dBm or dBW

$G_{\text{T}}$  gain of the transmitting antenna, in dBd (ERP) or dBi (EIRP)

#### 4.1.3 Test Setup

Conducted Power Measurement:



For the actual test configuration, please refer to the attached file (Test Setup Photo).

#### 4.1.4 Test Results

##### Conducted Output Power (dBm)

		n7				
BW	MCS Index	Channel		500500	507000	513500
		Frequency (MHz)		2502.5	2535	2567.5
5M	$\pi/2$ BPSK	1	0	23.02	22.84	22.85
		1	12	22.82	22.88	22.74
		1	24	<b>23.17</b>	22.93	23.09
		12	0	22.82	22.56	22.95
		12	6	22.71	22.71	22.68
		12	13	22.85	22.95	22.65
		25	0	22.62	22.98	22.65
	QPSK	1	0	22.87	23.04	22.95
		1	12	<b>23.01</b>	22.92	22.80
		1	24	23.10	23.04	23.06
		12	0	22.90	22.71	22.88
		12	6	22.69	22.66	22.78
		12	13	22.70	22.82	22.90
		25	0	22.51	22.86	22.63
	16QAM	1	0	<b>22.92</b>	22.51	22.73
		1	12	22.78	22.71	22.51
		1	24	22.86	22.75	22.77
		12	0	22.38	22.30	22.40
		12	6	22.30	22.55	22.39
		12	13	22.50	22.43	22.26
		25	0	22.42	22.58	22.40
	64QAM	1	0	22.35	22.37	22.55
		1	12	22.29	22.25	<b>22.57</b>
		1	24	22.47	22.20	22.22
		12	0	22.03	22.12	22.23
		12	6	22.40	22.03	22.26
		12	13	22.40	22.06	22.31
		25	0	22.41	22.37	22.19
	256QAM	1	0	20.14	19.96	19.81
		1	12	19.75	20.04	19.78
		1	24	20.02	<b>20.28</b>	19.98
		12	0	19.86	19.83	19.69
		12	6	19.83	20.00	19.50
		12	13	19.64	19.33	19.69
		25	0	19.73	19.85	19.39

n7						
BW	MCS Index	Channel		501000	507000	513000
		Frequency (MHz)		2505	2535	2565
10M	$\pi/2$ BPSK	1	0	22.89	22.91	23.16
		1	26	23.14	23.13	23.12
		1	51	23.08	23.11	<b>23.20</b>
		26	0	22.72	22.64	22.42
		26	13	22.62	22.61	22.67
		26	26	22.58	22.93	22.76
		52	0	22.98	22.69	22.89
	QPSK	1	0	22.90	22.84	23.07
		1	26	<b>23.08</b>	22.95	22.80
		1	51	22.98	23.03	22.80
		26	0	22.69	22.80	22.90
		26	13	22.80	22.83	22.61
		26	26	22.82	22.78	22.79
		52	0	22.74	22.64	22.61
	16QAM	1	0	22.78	22.75	22.76
		1	26	22.60	22.89	22.59
		1	51	<b>22.93</b>	22.86	22.67
		26	0	22.40	22.53	22.42
		26	13	22.23	22.24	22.42
		26	26	22.51	22.59	22.27
		52	0	22.23	22.34	22.63
	64QAM	1	0	22.49	22.39	22.22
		1	26	<b>22.67</b>	22.61	22.47
		1	51	22.58	22.39	22.22
		26	0	22.35	22.20	22.46
		26	13	22.00	22.21	22.45
		26	26	22.17	22.19	22.08
		52	0	22.21	22.26	22.15
	256QAM	1	0	19.68	19.66	19.68
		1	26	20.11	19.65	19.74
		1	51	<b>20.30</b>	20.26	20.28
		26	0	19.53	19.60	19.70
		26	13	19.29	19.19	19.64
		26	26	19.56	19.67	19.36
		52	0	19.18	19.48	19.57



n7						
BW	MCS Index	Channel		501500	507000	512500
		Frequency (MHz)		2507.5	2535	2562.5
15M	$\pi/2$ BPSK	1	0	22.88	22.86	23.04
		1	39	22.89	23.15	22.82
		1	78	<b>23.16</b>	22.95	22.99
		39	0	22.79	22.49	22.76
		39	19	22.96	22.59	22.80
		39	40	22.52	22.80	22.83
		79	0	22.42	22.47	22.52
	QPSK	1	0	22.87	<b>23.07</b>	22.98
		1	39	23.07	22.99	23.02
		1	78	22.87	22.95	22.90
		39	0	22.67	22.87	22.88
		39	19	22.64	22.86	22.72
		39	40	22.65	22.80	22.71
		79	0	22.52	22.77	22.78
	16QAM	1	0	22.72	22.89	22.50
		1	39	22.74	22.73	22.68
		1	78	22.55	<b>22.97</b>	22.93
		39	0	22.59	22.52	22.39
		39	19	22.28	22.60	22.40
		39	40	22.32	22.58	22.21
		79	0	22.66	22.31	22.45
	64QAM	1	0	22.46	<b>22.64</b>	22.51
		1	39	22.26	22.57	22.41
		1	78	22.53	22.49	22.58
		39	0	22.35	22.34	22.22
		39	19	22.19	22.21	22.43
		39	40	22.32	22.16	22.28
		79	0	22.26	22.43	22.17
	256QAM	1	0	19.85	19.76	<b>20.30</b>
		1	39	19.88	19.81	19.65
1		78	19.67	20.20	19.89	
39		0	19.66	19.49	19.27	
39		19	20.00	19.93	19.66	
39		40	19.85	19.27	19.99	
79		0	19.94	19.36	19.47	

n7						
BW	MCS Index	Channel		502000	507000	512000
		Frequency (MHz)		2510	2535	2560
20M	$\pi/2$ BPSK	1	0	23.19	22.85	23.12
		1	53	23.12	22.74	23.02
		1	105	23.10	22.85	22.88
		50	0	22.65	22.42	22.71
		50	25	22.43	22.75	22.87
		50	50	22.68	22.51	22.55
		106	0	22.99	22.59	22.71
	QPSK	1	0	22.94	22.98	22.93
		1	53	23.08	22.90	23.08
		1	105	22.80	22.81	22.86
		50	0	22.67	22.62	22.73
		50	25	22.79	22.78	22.83
		50	50	22.62	22.86	22.79
		106	0	22.55	22.79	22.68
	16QAM	1	0	22.67	22.65	22.63
		1	53	22.85	22.63	22.61
		1	105	22.65	22.73	22.55
		50	0	22.23	22.70	22.28
		50	25	22.62	22.29	22.62
		50	50	22.25	22.20	22.41
		106	0	22.45	22.34	22.49
	64QAM	1	0	22.34	22.62	22.62
		1	53	22.29	22.42	22.64
		1	105	22.36	22.35	22.58
		50	0	22.24	22.04	22.23
		50	25	22.38	22.28	22.33
		50	50	22.10	22.27	22.43
		106	0	22.39	22.36	22.48
	256QAM	1	0	19.69	19.96	19.94
		1	53	19.91	19.95	20.14
1		105	20.26	19.91	20.13	
50		0	19.16	19.20	19.76	
50		25	19.70	19.78	19.87	
50		50	19.46	19.39	19.38	
106		0	19.61	19.21	19.41	

LTE Band 5						
BW	MCS Index	RB Size	RB Offset	Low	Mid	High
		Channel		20407	20525	20643
		Frequency (MHz)		824.7	836.5	848.3
1.4M	QPSK	1	0	23.28	23.37	23.33
		1	2	23.20	23.09	23.29
		1	5	<b>23.40</b>	23.39	23.15
		3	0	22.39	22.22	22.22
		3	1	22.32	22.89	22.48
		3	3	22.24	22.72	22.33
		6	0	22.75	22.33	22.79
	16QAM	1	0	22.15	22.03	22.08
		1	2	22.15	22.20	22.36
		1	5	22.03	22.04	<b>22.37</b>
		3	0	21.71	21.89	21.99
		3	1	21.79	21.32	21.64
		3	3	22.00	21.67	21.78
		6	0	21.65	21.43	21.93
	64QAM	1	0	21.02	21.01	21.00
		1	2	21.11	21.05	21.31
		1	5	<b>21.35</b>	21.03	21.24
		3	0	20.42	20.46	20.84
		3	1	20.38	20.26	20.44
		3	3	20.87	20.62	20.90
		6	0	20.57	20.33	20.52

LTE Band 5						
BW	MCS Index	RB Size	RB Offset	Low	Mid	High
		Channel		20415	20525	20635
		Frequency (MHz)		825.5	836.5	847.5
3M	QPSK	1	0	23.03	23.18	23.37
		1	7	23.02	23.08	23.08
		1	14	23.15	23.06	23.00
		8	0	22.76	22.35	22.51
		8	3	22.21	23.00	22.25
		8	7	22.58	22.68	22.74
		15	0	22.32	22.21	22.85
	16QAM	1	0	22.07	22.00	22.21
		1	7	22.24	22.23	22.10
		1	14	22.25	22.15	22.12
		8	0	21.27	21.29	21.93
		8	3	21.77	21.98	21.24
		8	7	21.48	21.95	21.55
		15	0	21.79	21.63	21.86
	64QAM	1	0	21.30	21.32	21.00
		1	7	21.38	21.04	21.35
		1	14	21.04	21.18	21.09
		8	0	20.23	20.74	20.80
		8	3	20.36	20.20	20.32
		8	7	20.42	20.62	20.55
		15	0	20.20	20.69	20.58

LTE Band 5						
BW	MCS Index	RB Size	RB Offset	Low	Mid	High
		Channel		20425	20525	20625
		Frequency (MHz)		826.5	836.5	846.5
5M	QPSK	1	0	23.10	23.31	23.03
		1	12	23.20	23.18	23.25
		1	24	23.05	23.05	<b>23.39</b>
		12	0	22.98	22.23	22.85
		12	6	22.49	22.88	22.89
		12	13	22.49	22.26	22.20
		25	0	22.79	22.63	22.51
	16QAM	1	0	22.06	22.15	22.36
		1	12	22.02	<b>22.40</b>	22.16
		1	24	22.24	22.07	22.09
		12	0	21.32	21.99	21.31
		12	6	21.24	21.76	21.20
		12	13	21.83	21.80	21.33
		25	0	21.79	21.28	21.77
	64QAM	1	0	<b>21.34</b>	21.27	21.03
		1	12	21.19	21.28	21.25
		1	24	21.24	21.09	21.09
		12	0	20.33	20.58	20.36
		12	6	20.79	20.38	20.67
		12	13	20.56	20.27	20.88
		25	0	20.62	20.46	20.43

LTE Band 5						
BW	MCS Index	RB Size	RB Offset	Low	Mid	High
		Channel		20450	20525	20600
		Frequency (MHz)		829	836.5	844
10M	QPSK	1	0	23.11	23.18	<b>23.37</b>
		1	24	23.02	23.08	23.07
		1	49	23.36	23.07	23.01
		25	0	22.22	22.77	22.73
		25	12	22.78	22.63	22.58
		25	25	22.87	22.32	22.76
		50	0	22.20	22.37	22.96
	16QAM	1	0	22.30	22.28	22.13
		1	24	<b>22.38</b>	22.18	22.16
		1	49	22.15	22.19	22.32
		25	0	21.88	21.24	21.91
		25	12	21.85	21.30	21.97
		25	25	21.73	21.66	21.83
		50	0	21.43	21.33	21.62
	64QAM	1	0	21.19	21.23	21.04
		1	24	21.09	21.35	21.25
		1	49	21.27	<b>21.36</b>	21.00
		25	0	20.55	20.71	20.91
		25	12	20.22	20.84	20.46
		25	25	20.37	20.49	20.92
		50	0	20.94	20.87	20.39

LTE Band 12						
BW	MCS Index	Channel		23017	23095	23173
		Frequency (MHz)		699.7	707.5	715.3
1.4M	QPSK	1	0	22.80	22.91	<b>23.18</b>
		1	2	22.82	22.87	22.82
		1	5	22.87	22.90	<b>23.18</b>
		3	0	22.27	22.54	22.63
		3	1	22.72	22.43	22.46
		3	3	22.53	22.23	22.31
		6	0	22.61	22.60	22.21
	16QAM	1	0	22.11	21.96	22.16
		1	2	21.94	21.91	22.01
		1	5	<b>22.17</b>	21.82	22.01
		3	0	21.40	21.27	21.37
		3	1	21.43	21.82	21.87
		3	3	21.82	21.78	21.77
		6	0	21.49	21.67	21.61
	64QAM	1	0	20.80	20.97	20.90
		1	2	20.94	20.97	<b>21.07</b>
		1	5	20.85	20.85	<b>21.07</b>
		3	0	20.59	20.37	20.70
		3	1	20.39	20.27	20.57
		3	3	20.83	20.56	20.41
		6	0	20.72	20.68	20.48

LTE Band 12						
BW	MCS Index	Channel		23025	23095	23165
		Frequency (MHz)		700.5	707.5	714.5
3M	QPSK	1	0	22.81	<b>23.19</b>	22.95
		1	7	22.87	22.81	22.87
		1	14	22.94	22.84	23.05
		8	0	22.79	22.61	22.60
		8	3	22.89	22.23	22.75
		8	7	22.27	22.26	22.27
		15	0	22.38	22.76	22.56
	16QAM	1	0	22.06	21.83	<b>22.18</b>
		1	7	21.99	21.91	22.01
		1	14	21.98	21.80	22.06
		8	0	21.38	21.55	21.87
		8	3	21.50	21.62	21.30
		8	7	21.77	21.30	21.70
		15	0	21.87	21.58	21.23
	64QAM	1	0	21.15	21.13	20.88
		1	7	20.86	21.07	20.80
		1	14	<b>21.19</b>	21.02	20.85
		8	0	20.68	20.54	20.82
		8	3	20.86	20.33	20.53
		8	7	20.36	20.53	20.42
		15	0	20.23	20.27	20.33



LTE Band 12						
BW	MCS Index	Channel		23035	23095	23155
		Frequency (MHz)		701.5	707.5	713.5
5M	QPSK	1	0	<b>23.13</b>	23.04	23.01
		1	12	23.11	22.82	22.86
		1	24	22.88	23.00	22.90
		12	0	22.76	22.53	22.40
		12	6	22.52	22.37	22.49
		12	13	22.23	22.53	22.45
		25	0	22.88	22.61	22.58
	16QAM	1	0	<b>22.20</b>	21.94	21.89
		1	12	22.08	22.17	21.83
		1	24	22.14	21.90	21.82
		12	0	21.57	21.49	21.73
		12	6	21.87	21.76	21.49
		12	13	21.59	21.76	21.38
		25	0	21.22	21.48	21.63
	64QAM	1	0	20.89	21.10	20.99
		1	12	<b>21.20</b>	21.10	21.00
		1	24	20.80	21.06	21.03
		12	0	20.67	20.27	20.74
		12	6	20.27	20.42	20.21
		12	13	20.67	20.34	20.53
		25	0	20.38	20.52	20.29

LTE Band 12						
BW	MCS Index	Channel		23060	23095	23130
		Frequency (MHz)		704	707.5	711
10M	QPSK	1	0	22.96	23.07	22.90
		1	24	23.03	23.09	22.97
		1	49	<b>23.17</b>	22.83	23.10
		25	0	22.66	22.80	22.67
		25	12	22.65	22.45	22.48
		25	25	22.69	22.44	22.26
		50	0	22.72	22.79	22.30
	16QAM	1	0	21.93	22.11	21.95
		1	24	21.83	22.13	21.84
		1	49	22.13	21.98	<b>22.20</b>
		25	0	21.60	21.88	21.56
		25	12	21.39	21.33	21.34
		25	25	21.45	21.49	21.74
		50	0	21.50	21.44	21.48
	64QAM	1	0	20.98	20.94	21.13
		1	24	21.00	21.04	21.08
		1	49	21.08	<b>21.16</b>	21.12
		25	0	20.32	20.81	20.77
		25	12	20.86	20.62	20.30
		25	25	20.77	20.54	20.64
		50	0	20.45	20.67	20.75

**EIRP Power (dBm)**

		n7				
BW	MCS Index	Channel		500500	507000	513500
		Frequency (MHz)		2502.5	2535	2567.5
5M	$\pi/2$ BPSK	1	0	28.33	28.15	28.16
		1	12	28.13	28.19	28.05
		1	24	<b>28.48</b>	28.24	28.40
		12	0	28.13	27.87	28.26
		12	6	28.02	28.02	27.99
		12	13	28.16	28.26	27.96
		25	0	27.93	28.29	27.96
	QPSK	1	0	28.18	28.35	28.26
		1	12	28.32	28.23	28.11
		1	24	<b>28.41</b>	28.35	28.37
		12	0	28.21	28.02	28.19
		12	6	28.00	27.97	28.09
		12	13	28.01	28.13	28.21
		25	0	27.82	28.17	27.94
	16QAM	1	0	<b>28.23</b>	27.82	28.04
		1	12	28.09	28.02	27.82
		1	24	28.17	28.06	28.08
		12	0	27.69	27.61	27.71
		12	6	27.61	27.86	27.70
		12	13	27.81	27.74	27.57
		25	0	27.73	27.89	27.71
	64QAM	1	0	27.66	27.68	27.86
		1	12	27.60	27.56	<b>27.88</b>
		1	24	27.78	27.51	27.53
		12	0	27.34	27.43	27.54
		12	6	27.71	27.34	27.57
		12	13	27.71	27.37	27.62
		25	0	27.72	27.68	27.50
	256QAM	1	0	25.45	25.27	25.12
		1	12	25.06	25.35	25.09
		1	24	25.33	<b>25.59</b>	25.29
		12	0	25.17	25.14	25.00
		12	6	25.14	25.31	24.81
		12	13	24.95	24.64	25.00
		25	0	25.04	25.16	24.70

\*EIRP = Conducted + antenna gain (5.31dBi)

n7						
BW	MCS Index	Channel		501000	507000	513000
		Frequency (MHz)		2505	2535	2565
10M	$\pi/2$ BPSK	1	0	28.20	28.22	28.47
		1	26	28.45	28.44	28.43
		1	51	28.39	28.42	<b>28.51</b>
		26	0	28.03	27.95	27.73
		26	13	27.93	27.92	27.98
		26	26	27.89	28.24	28.07
		52	0	28.29	28.00	28.20
	QPSK	1	0	28.21	28.15	28.38
		1	26	<b>28.39</b>	28.26	28.11
		1	51	28.29	28.34	28.11
		26	0	28.00	28.11	28.21
		26	13	28.11	28.14	27.92
		26	26	28.13	28.09	28.10
		52	0	28.05	27.95	27.92
	16QAM	1	0	28.09	28.06	28.07
		1	26	27.91	28.20	27.90
		1	51	<b>28.24</b>	28.17	27.98
		26	0	27.71	27.84	27.73
		26	13	27.54	27.55	27.73
		26	26	27.82	27.90	27.58
		52	0	27.54	27.65	27.94
	64QAM	1	0	27.80	27.70	27.53
		1	26	<b>27.98</b>	27.92	27.78
		1	51	27.89	27.70	27.53
		26	0	27.66	27.51	27.77
		26	13	27.31	27.52	27.76
		26	26	27.48	27.50	27.39
		52	0	27.52	27.57	27.46
	256QAM	1	0	24.99	24.97	24.99
		1	26	25.42	24.96	25.05
		1	51	<b>25.61</b>	25.57	25.59
		26	0	24.84	24.91	25.01
		26	13	24.60	24.50	24.95
		26	26	24.87	24.98	24.67
		52	0	24.49	24.79	24.88

\*EIRP = Conducted + antenna gain (5.31dBi)

n7						
BW	MCS Index	Channel		501500	507000	512500
		Frequency (MHz)		2507.5	2535	2562.5
15M	$\pi/2$ BPSK	1	0	28.19	28.17	28.35
		1	39	28.20	28.46	28.13
		1	78	<b>28.47</b>	28.26	28.30
		39	0	28.10	27.80	28.07
		39	19	28.27	27.90	28.11
		39	40	27.83	28.11	28.14
		79	0	27.73	27.78	27.83
	QPSK	1	0	28.18	28.38	28.29
		1	39	<b>28.38</b>	28.30	28.33
		1	78	28.18	28.26	28.21
		39	0	27.98	28.18	28.19
		39	19	27.95	28.17	28.03
		39	40	27.96	28.11	28.02
		79	0	27.83	28.08	28.09
	16QAM	1	0	28.03	28.20	27.81
		1	39	28.05	28.04	27.99
		1	78	27.86	<b>28.28</b>	28.24
		39	0	27.90	27.83	27.70
		39	19	27.59	27.91	27.71
		39	40	27.63	27.89	27.52
		79	0	27.97	27.62	27.76
	64QAM	1	0	27.77	<b>27.95</b>	27.82
		1	39	27.57	27.88	27.72
		1	78	27.84	27.80	27.89
		39	0	27.66	27.65	27.53
		39	19	27.50	27.52	27.74
		39	40	27.63	27.47	27.59
		79	0	27.57	27.74	27.48
	256QAM	1	0	25.16	25.07	<b>25.61</b>
		1	39	25.19	25.12	24.96
1		78	24.98	25.51	25.20	
39		0	24.97	24.80	24.58	
39		19	25.31	25.24	24.97	
39		40	25.16	24.58	25.30	
79		0	25.25	24.67	24.78	

\*EIRP = Conducted + antenna gain (5.31dBi)

n7						
BW	MCS Index	Channel		502000	507000	512000
		Frequency (MHz)		2510	2535	2560
20M	$\pi/2$ BPSK	1	0	28.50	28.16	28.43
		1	53	28.43	28.05	28.33
		1	105	28.41	28.16	28.19
		50	0	27.96	27.73	28.02
		50	25	27.74	28.06	28.18
		50	50	27.99	27.82	27.86
		106	0	28.30	27.90	28.02
	QPSK	1	0	27.98	27.96	27.94
		1	53	28.16	27.94	27.92
		1	105	27.96	28.04	27.86
		50	0	27.54	28.01	27.59
		50	25	27.93	27.60	27.93
		50	50	27.56	27.51	27.72
		106	0	27.76	27.65	27.80
	16QAM	1	0	27.65	27.93	27.93
		1	53	27.60	27.73	27.95
		1	105	27.67	27.66	27.89
		50	0	27.55	27.35	27.54
		50	25	27.69	27.59	27.64
		50	50	27.41	27.58	27.74
		106	0	27.70	27.67	27.79
	64QAM	1	0	27.65	27.93	27.93
		1	53	27.60	27.73	27.95
		1	105	27.67	27.66	27.89
		50	0	27.55	27.35	27.54
		50	25	27.69	27.59	27.64
		50	50	27.41	27.58	27.74
		106	0	27.70	27.67	27.79
	256QAM	1	0	25.00	25.27	25.25
		1	53	25.22	25.26	25.45
1		105	25.57	25.22	25.44	
50		0	24.47	24.51	25.07	
50		25	25.01	25.09	25.18	
50		50	24.77	24.70	24.69	
106		0	24.92	24.52	24.72	

\*EIRP = Conducted + antenna gain (5.31dBi)

**ERP Power (dBm)**

LTE Band 5						
BW	MCS Index	RB Size	RB Offset	Low	Mid	High
		Channel		20407	20525	20643
		Frequency (MHz)		824.7	836.5	848.3
1.4M	QPSK	1	0	24.94	25.03	24.99
		1	2	24.86	24.75	24.95
		1	5	<b>25.06</b>	25.05	24.81
		3	0	24.05	23.88	23.88
		3	1	23.98	24.55	24.14
		3	3	23.90	24.38	23.99
		6	0	24.41	23.99	24.45
	16QAM	1	0	23.81	23.69	23.74
		1	2	23.81	23.86	24.02
		1	5	23.69	23.70	<b>24.03</b>
		3	0	23.37	23.55	23.65
		3	1	23.45	22.98	23.30
		3	3	23.66	23.33	23.44
		6	0	23.31	23.09	23.59
	64QAM	1	0	22.68	22.67	22.66
		1	2	22.77	22.71	22.97
		1	5	<b>23.01</b>	22.69	22.90
		3	0	22.08	22.12	22.50
		3	1	22.04	21.92	22.10
		3	3	22.53	22.28	22.56
		6	0	22.23	21.99	22.18

\*ERP = Conducted + antenna gain (3.81dBi)-2.15

LTE Band 5						
BW	MCS Index	RB Size	RB Offset	Low	Mid	High
		Channel		20415	20525	20635
		Frequency (MHz)		825.5	836.5	847.5
3M	QPSK	1	0	24.69	24.84	<b>25.03</b>
		1	7	24.68	24.74	24.74
		1	14	24.81	24.72	24.66
		8	0	24.42	24.01	24.17
		8	3	23.87	24.66	23.91
		8	7	24.24	24.34	24.40
		15	0	23.98	23.87	24.51
	16QAM	1	0	23.73	23.66	23.87
		1	7	23.90	23.89	23.76
		1	14	<b>23.91</b>	23.81	23.78
		8	0	22.93	22.95	23.59
		8	3	23.43	23.64	22.90
		8	7	23.14	23.61	23.21
		15	0	23.45	23.29	23.52
	64QAM	1	0	22.96	22.98	22.66
		1	7	<b>23.04</b>	22.70	23.01
		1	14	22.70	22.84	22.75
		8	0	21.89	22.40	22.46
		8	3	22.02	21.86	21.98
		8	7	22.08	22.28	22.21
		15	0	21.86	22.35	22.24

\*ERP = Conducted + antenna gain (3.81dBi)-2.15



LTE Band 5						
BW	MCS Index	RB Size	RB Offset	Low	Mid	High
		Channel		20425	20525	20625
		Frequency (MHz)		826.5	836.5	846.5
5M	QPSK	1	0	24.76	24.97	24.69
		1	12	24.86	24.84	24.91
		1	24	24.71	24.71	<b>25.05</b>
		12	0	24.64	23.89	24.51
		12	6	24.15	24.54	24.55
		12	13	24.15	23.92	23.86
		25	0	24.45	24.29	24.17
	16QAM	1	0	23.72	23.81	24.02
		1	12	23.68	<b>24.06</b>	23.82
		1	24	23.90	23.73	23.75
		12	0	22.98	23.65	22.97
		12	6	22.90	23.42	22.86
		12	13	23.49	23.46	22.99
		25	0	23.45	22.94	23.43
	64QAM	1	0	<b>23.00</b>	22.93	22.69
		1	12	22.85	22.94	22.91
		1	24	22.90	22.75	22.75
		12	0	21.99	22.24	22.02
		12	6	22.45	22.04	22.33
		12	13	22.22	21.93	22.54
		25	0	22.28	22.12	22.09

\*ERP = Conducted + antenna gain (3.81dBi)-2.15

LTE Band 5						
BW	MCS Index	RB Size	RB Offset	Low	Mid	High
		Channel		20450	20525	20600
		Frequency (MHz)		829	836.5	844
10M	QPSK	1	0	24.77	24.84	<b>25.03</b>
		1	24	24.68	24.74	24.73
		1	49	25.02	24.73	24.67
		25	0	23.88	24.43	24.39
		25	12	24.44	24.29	24.24
		25	25	24.53	23.98	24.42
		50	0	23.86	24.03	24.62
	16QAM	1	0	23.96	23.94	23.79
		1	24	<b>24.04</b>	23.84	23.82
		1	49	23.81	23.85	23.98
		25	0	23.54	22.90	23.57
		25	12	23.51	22.96	23.63
		25	25	23.39	23.32	23.49
		50	0	23.09	22.99	23.28
	64QAM	1	0	22.85	22.89	22.70
		1	24	22.75	23.01	22.91
		1	49	22.93	<b>23.02</b>	22.66
		25	0	22.21	22.37	22.57
		25	12	21.88	22.50	22.12
		25	25	22.03	22.15	22.58
		50	0	22.60	22.53	22.05

\*ERP = Conducted + antenna gain (3.81dBi)-2.15

LTE Band 12						
BW	MCS Index	Channel		23017	23095	23173
		Frequency (MHz)		699.7	707.5	715.3
1.4M	QPSK	1	0	25.06	25.17	<b>25.44</b>
		1	2	25.08	25.13	25.08
		1	5	25.13	25.16	<b>25.44</b>
		3	0	24.53	24.80	24.89
		3	1	24.98	24.69	24.72
		3	3	24.79	24.49	24.57
		6	0	24.87	24.86	24.47
	16QAM	1	0	24.37	24.22	24.42
		1	2	24.20	24.17	24.27
		1	5	<b>24.43</b>	24.08	24.27
		3	0	23.66	23.53	23.63
		3	1	23.69	24.08	24.13
		3	3	24.08	24.04	24.03
		6	0	23.75	23.93	23.87
	64QAM	1	0	23.06	23.23	23.16
		1	2	23.20	23.23	<b>23.33</b>
		1	5	23.11	23.11	<b>23.33</b>
		3	0	22.85	22.63	22.96
		3	1	22.65	22.53	22.83
		3	3	23.09	22.82	22.67
		6	0	22.98	22.94	22.74

\*ERP = Conducted + antenna gain (4.41dBi)-2.15

LTE Band 12						
BW	MCS Index	Channel		23025	23095	23165
		Frequency (MHz)		700.5	707.5	714.5
3M	QPSK	1	0	25.07	<b>25.45</b>	25.21
		1	7	25.13	25.07	25.13
		1	14	25.20	25.10	25.31
		8	0	25.05	24.87	24.86
		8	3	25.15	24.49	25.01
		8	7	24.53	24.52	24.53
		15	0	24.64	25.02	24.82
	16QAM	1	0	24.32	24.09	<b>24.44</b>
		1	7	24.25	24.17	24.27
		1	14	24.24	24.06	24.32
		8	0	23.64	23.81	24.13
		8	3	23.76	23.88	23.56
		8	7	24.03	23.56	23.96
		15	0	24.13	23.84	23.49
	64QAM	1	0	23.41	23.39	23.14
		1	7	23.12	23.33	23.06
		1	14	<b>23.45</b>	23.28	23.11
		8	0	22.94	22.80	23.08
		8	3	23.12	22.59	22.79
		8	7	22.62	22.79	22.68
		15	0	22.49	22.53	22.59

\*ERP = Conducted + antenna gain (4.41dBi)-2.15

LTE Band 12						
BW	MCS Index	Channel		23035	23095	23155
		Frequency (MHz)		701.5	707.5	713.5
5M	QPSK	1	0	25.39	25.30	25.27
		1	12	25.37	25.08	25.12
		1	24	25.14	25.26	25.16
		12	0	25.02	24.79	24.66
		12	6	24.78	24.63	24.75
		12	13	24.49	24.79	24.71
		25	0	25.14	24.87	24.84
	16QAM	1	0	24.46	24.20	24.15
		1	12	24.34	24.43	24.09
		1	24	24.40	24.16	24.08
		12	0	23.83	23.75	23.99
		12	6	24.13	24.02	23.75
		12	13	23.85	24.02	23.64
		25	0	23.48	23.74	23.89
	64QAM	1	0	23.15	23.36	23.25
		1	12	23.46	23.36	23.26
		1	24	23.06	23.32	23.29
		12	0	22.93	22.53	23.00
		12	6	22.53	22.68	22.47
		12	13	22.93	22.60	22.79
		25	0	22.64	22.78	22.55

\*ERP = Conducted + antenna gain (4.41dBi)-2.15

LTE Band 12						
BW	MCS Index	Channel		23060	23095	23130
		Frequency (MHz)		704	707.5	711
10M	QPSK	1	0	25.22	25.33	25.16
		1	24	25.29	25.35	25.23
		1	49	<b>25.43</b>	25.09	25.36
		25	0	24.92	25.06	24.93
		25	12	24.91	24.71	24.74
		25	25	24.95	24.70	24.52
		50	0	24.98	25.05	24.56
	16QAM	1	0	24.19	24.37	24.21
		1	24	24.09	24.39	24.10
		1	49	24.39	24.24	<b>24.46</b>
		25	0	23.86	24.14	23.82
		25	12	23.65	23.59	23.60
		25	25	23.71	23.75	24.00
		50	0	23.76	23.70	23.74
	64QAM	1	0	23.24	23.20	23.39
		1	24	23.26	23.30	23.34
		1	49	23.34	<b>23.42</b>	23.38
		25	0	22.58	23.07	23.03
		25	12	23.12	22.88	22.56
		25	25	23.03	22.80	22.90
		50	0	22.71	22.93	23.01

\*ERP = Conducted + antenna gain (4.41dBi)-2.15

## 4.2 Modulation Characteristics Measurement

### 4.2.1 Limits of Modulation Characteristics

N/A

### 4.2.2 Test Procedure

Connect the EUT to Communication Simulator via the antenna connector, The frequency band is set as EUT supported Modulation and Channels, the EUT output is matched with 50 ohm load, the waveform quality and constellation of the EUT was tested.

### 4.2.3 Test Setup

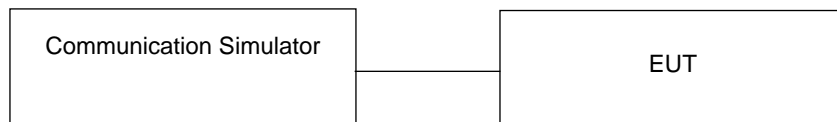

## 4.2.4 Test Results





### 4.3 Frequency Stability Measurement

#### 4.3.1 Limits of Frequency Stability Measurement

For LTE Band 5

1.5 ppm is for base and fixed station. 2.5 ppm is for mobile station.

For n7, LTE Band 12

According to the FCC part 2.1055 shall be tested the frequency stability. The rule is defined that "The frequency stability shall be sufficient to ensure that the fundamental emission stays within the authorized frequency block." The test extreme voltage is according to the 2.1055(d)(1) Vary primary supply voltage from 85 to 115 percent of the nominal value for other than hand carried battery equipment and the extreme temperature rule is comply with specification of EUT  $-30^{\circ}\text{C} \sim 50^{\circ}\text{C}$ .

#### 4.3.2 Test Procedure

- Device is placed at the oven room. The oven room could control the temperatures and humidity. Power warm up is at least 15 min and power applied should perform before recording frequency error.
- EUT is connected the external power supply to control the DC input power. The test voltage range is from minimum to maximum working voltage. Each step shall be record the frequency error rate.
- The temperature range step is 10 degrees in this test items. All temperature levels shall be hold the  $\pm 0.5^{\circ}\text{C}$  during the measurement testing. The each temperature step shall be at least 0.5 hours, consider the EUT could be test under the stability condition.

Note: The frequency error was recorded frequency error from the communication simulator.

#### 4.3.3 Test Setup

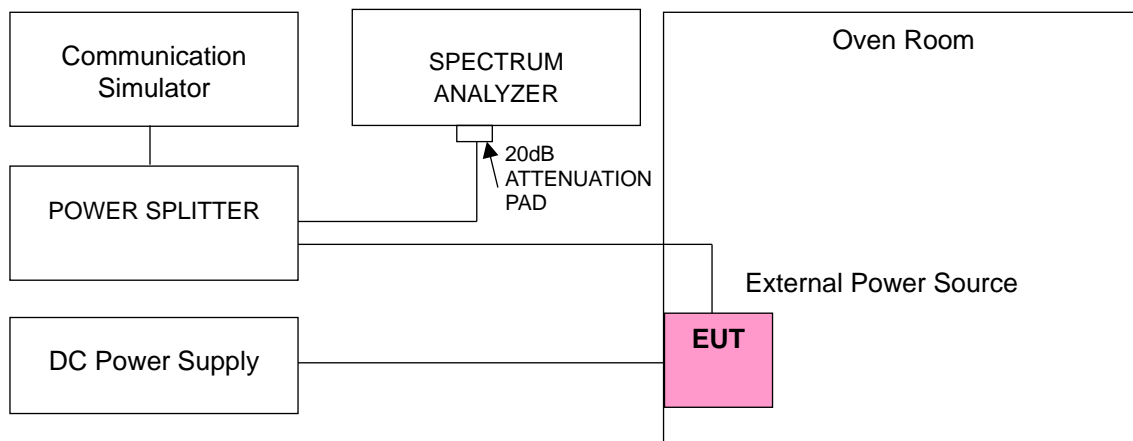

#### 4.3.4 Test Results

##### Frequency Error vs. Voltage

Voltage (Volts)	n7			
	Channel Bandwidth: 5 MHz			
	Low Channel		High Channel	
	Frequency (MHz)	Frequency Error (ppm)	Frequency (MHz)	Frequency Error (ppm)
4.25	2502.500002	0.001	2567.500003	0.001
5	2502.500003	0.001	2567.500004	0.002
5.75	2502.500003	0.001	2567.500004	0.001

Note: The applicant defined the normal working voltage is from 4.25Vdc to 5.75Vdc.

##### Frequency Error vs. Temperature

Temp. (°C)	n7			
	Channel Bandwidth: 5 MHz			
	Low Channel		High Channel	
	Frequency (MHz)	Frequency Error (ppm)	Frequency (MHz)	Frequency Error (ppm)
-30	2502.500004	0.001	2567.500002	0.001
-20	2502.500003	0.001	2567.500003	0.001
-10	2502.500003	0.001	2567.500004	0.001
0	2502.500003	0.001	2567.500001	0.000
10	2502.500003	0.001	2567.500003	0.001
20	2502.499997	-0.001	2567.499997	-0.001
30	2502.499997	-0.001	2567.499997	-0.001
40	2502.499998	-0.001	2567.499998	-0.001
50	2502.499996	-0.002	2567.499998	-0.001

### Frequency Error vs. Voltage

Voltage (Volts)	n7			
	Channel Bandwidth: 10 MHz			
	Low Channel		High Channel	
	Frequency (MHz)	Frequency Error (ppm)	Frequency (MHz)	Frequency Error (ppm)
4.25	2505.000004	0.002	2565.000003	0.001
5	2505.000002	0.001	2565.000003	0.001
5.75	2505.000003	0.001	2565.000003	0.001

Note: The applicant defined the normal working voltage is from 4.25Vdc to 5.75Vdc.

### Frequency Error vs. Temperature

Temp. (°C)	n7			
	Channel Bandwidth: 10 MHz			
	Low Channel		High Channel	
	Frequency (MHz)	Frequency Error (ppm)	Frequency (MHz)	Frequency Error (ppm)
-30	2505.000003	0.001	2565.000003	0.001
-20	2505.000004	0.001	2565.000003	0.001
-10	2505.000003	0.001	2565.000003	0.001
0	2505.000004	0.002	2565.000001	0.001
10	2505.000002	0.001	2565.000002	0.001
20	2504.999999	-0.001	2564.999997	-0.001
30	2504.999997	-0.001	2564.999997	-0.001
40	2504.999996	-0.001	2564.999996	-0.002
50	2504.999997	-0.001	2564.999999	-0.001

### Frequency Error vs. Voltage

Voltage (Volts)	n7			
	Channel Bandwidth: 15 MHz			
	Low Channel		High Channel	
	Frequency (MHz)	Frequency Error (ppm)	Frequency (MHz)	Frequency Error (ppm)
4.25	2507.500004	0.002	2562.500001	0.000
5	2507.500004	0.001	2562.500004	0.002
5.75	2507.500002	0.001	2562.500002	0.001

Note: The applicant defined the normal working voltage is from 4.25Vdc to 5.75Vdc.

### Frequency Error vs. Temperature

Temp. (°C)	n7			
	Channel Bandwidth: 15 MHz			
	Low Channel		High Channel	
	Frequency (MHz)	Frequency Error (ppm)	Frequency (MHz)	Frequency Error (ppm)
-30	2507.500001	0.000	2562.500001	0.000
-20	2507.500002	0.001	2562.500003	0.001
-10	2507.500001	0.000	2562.500003	0.001
0	2507.500004	0.002	2562.500002	0.001
10	2507.500003	0.001	2562.500003	0.001
20	2507.499999	0.000	2562.499999	-0.001
30	2507.499999	-0.001	2562.499997	-0.001
40	2507.499997	-0.001	2562.499998	-0.001
50	2507.499997	-0.001	2562.499996	-0.001

### Frequency Error vs. Voltage

Voltage (Volts)	n7			
	Channel Bandwidth: 20 MHz			
	Low Channel		High Channel	
	Frequency (MHz)	Frequency Error (ppm)	Frequency (MHz)	Frequency Error (ppm)
4.25	2510.000002	0.001	2560.000001	0.000
5	2510.000003	0.001	2560.000001	0.000
5.75	2510.000001	0.000	2560.000003	0.001

Note: The applicant defined the normal working voltage is from 4.25Vdc to 5.75Vdc.

### Frequency Error vs. Temperature

Temp. (°C)	n7			
	Channel Bandwidth: 20 MHz			
	Low Channel		High Channel	
	Frequency (MHz)	Frequency Error (ppm)	Frequency (MHz)	Frequency Error (ppm)
-30	2510.000003	0.001	2560.000003	0.001
-20	2510.000002	0.001	2560.000004	0.001
-10	2510.000002	0.001	2560.000001	0.001
0	2510.000002	0.001	2560.000003	0.001
10	2510.000001	0.000	2560.000004	0.001
20	2509.999997	-0.001	2559.999998	-0.001
30	2509.999998	-0.001	2559.999998	-0.001
40	2509.999998	-0.001	2559.999998	-0.001
50	2509.999998	-0.001	2559.999996	-0.002

Frequency Error vs. Voltage

Voltage (Volts)	LTE Band 5			
	Channel Bandwidth: 1.4 MHz			
	Low Channel		High Channel	
	Frequency (MHz)	Frequency Error (ppm)	Frequency (MHz)	Frequency Error (ppm)
4.25	824.700003	0.003	848.300003	0.003
5	824.700004	0.005	848.300002	0.002
5.75	824.700003	0.004	848.300002	0.002

Note: The applicant defined the normal working voltage is from 4.25Vdc to 5.75Vdc.

Frequency Error vs. Temperature

Temp. (°C)	LTE Band 5			
	Channel Bandwidth: 1.4 MHz			
	Low Channel		High Channel	
	Frequency (MHz)	Frequency Error (ppm)	Frequency (MHz)	Frequency Error (ppm)
-30	824.700004	0.004	848.300003	0.003
-20	824.700002	0.003	848.300004	0.005
-10	824.700002	0.002	848.300003	0.004
0	824.700002	0.002	848.300004	0.005
10	824.700004	0.004	848.300002	0.002
20	824.699996	-0.005	848.299996	-0.005
30	824.699999	-0.002	848.299998	-0.002
40	824.699997	-0.003	848.299998	-0.003
50	824.699999	-0.002	848.299996	-0.004

### Frequency Error vs. Voltage

Voltage (Volts)	LTE Band 5			
	Channel Bandwidth: 3 MHz			
	Low Channel		High Channel	
	Frequency (MHz)	Frequency Error (ppm)	Frequency (MHz)	Frequency Error (ppm)
4.25	825.500004	0.005	847.500002	0.002
5	825.500002	0.002	847.500003	0.003
5.75	825.500003	0.004	847.500004	0.004

Note: The applicant defined the normal working voltage is from 4.25Vdc to 5.75Vdc.

### Frequency Error vs. Temperature

Temp. (°C)	LTE Band 5			
	Channel Bandwidth: 3 MHz			
	Low Channel		High Channel	
	Frequency (MHz)	Frequency Error (ppm)	Frequency (MHz)	Frequency Error (ppm)
-30	825.500001	0.002	847.500004	0.005
-20	825.500002	0.003	847.500003	0.003
-10	825.500003	0.004	847.500004	0.004
0	825.500004	0.004	847.500004	0.004
10	825.500001	0.001	847.500004	0.004
20	825.499998	-0.002	847.499998	-0.002
30	825.499996	-0.005	847.499999	-0.001
40	825.499999	-0.001	847.499996	-0.004
50	825.499997	-0.004	847.499997	-0.003

### Frequency Error vs. Voltage

Voltage (Volts)	LTE Band 5			
	Channel Bandwidth: 5 MHz			
	Low Channel		High Channel	
	Frequency (MHz)	Frequency Error (ppm)	Frequency (MHz)	Frequency Error (ppm)
4.25	826.500004	0.005	846.500002	0.002
5	826.500003	0.004	846.500003	0.003
5.75	826.500003	0.004	846.500003	0.004

Note: The applicant defined the normal working voltage is from 4.25Vdc to 5.75Vdc.

### Frequency Error vs. Temperature

Temp. (°C)	LTE Band 5			
	Channel Bandwidth: 5 MHz			
	Low Channel		High Channel	
	Frequency (MHz)	Frequency Error (ppm)	Frequency (MHz)	Frequency Error (ppm)
-30	826.500004	0.004	846.500004	0.005
-20	826.500002	0.002	846.500004	0.004
-10	826.500002	0.002	846.500002	0.002
0	826.500003	0.003	846.500003	0.003
10	826.500003	0.004	846.500004	0.005
20	826.499997	-0.003	846.499999	-0.002
30	826.499998	-0.002	846.499997	-0.003
40	826.499997	-0.003	846.499999	-0.002
50	826.499997	-0.004	846.499997	-0.003



### Frequency Error vs. Voltage

Voltage (Volts)	LTE Band 5			
	Channel Bandwidth: 10 MHz			
	Low Channel		High Channel	
	Frequency (MHz)	Frequency Error (ppm)	Frequency (MHz)	Frequency Error (ppm)
4.25	829.000003	0.004	844.000004	0.004
5	829.000002	0.003	844.000004	0.005
5.75	829.000002	0.002	844.000001	0.001

Note: The applicant defined the normal working voltage is from 4.25Vdc to 5.75Vdc.

### Frequency Error vs. Temperature

Temp. (°C)	LTE Band 5			
	Channel Bandwidth: 10 MHz			
	Low Channel		High Channel	
	Frequency (MHz)	Frequency Error (ppm)	Frequency (MHz)	Frequency Error (ppm)
-30	829.000003	0.004	844.000002	0.002
-20	829.000002	0.003	844.000003	0.004
-10	829.000004	0.004	844.000003	0.004
0	829.000004	0.005	844.000003	0.003
10	829.000002	0.003	844.000004	0.004
20	828.999997	-0.003	843.999999	-0.002
30	828.999999	-0.002	843.999996	-0.005
40	828.999998	-0.003	843.999998	-0.003
50	828.999998	-0.002	843.999998	-0.002

Frequency Error vs. Voltage

Voltage (Volts)	LTE Band 12			
	Channel Bandwidth: 1.4 MHz			
	Low Channel		High Channel	
	Frequency (MHz)	Frequency Error (ppm)	Frequency (MHz)	Frequency Error (ppm)
4.25	699.700001	0.002	715.300004	0.005
5	699.700002	0.002	715.300004	0.006
5.75	699.700004	0.005	715.300002	0.003

Note: The applicant defined the normal working voltage is from 4.25Vdc to 5.75Vdc.

Frequency Error vs. Temperature

Temp. (°C)	LTE Band 12			
	Channel Bandwidth: 1.4 MHz			
	Low Channel		High Channel	
	Frequency (MHz)	Frequency Error (ppm)	Frequency (MHz)	Frequency Error (ppm)
-30	699.700003	0.005	715.300002	0.003
-20	699.700003	0.004	715.300002	0.002
-10	699.700003	0.004	715.300003	0.004
0	699.700001	0.002	715.300002	0.003
10	699.700003	0.004	715.300003	0.005
20	699.699997	-0.004	715.299997	-0.005
30	699.699996	-0.006	715.299997	-0.004
40	699.699998	-0.004	715.299997	-0.005
50	699.699998	-0.003	715.299998	-0.003

### Frequency Error vs. Voltage

Voltage (Volts)	LTE Band 12			
	Channel Bandwidth: 3 MHz			
	Low Channel		High Channel	
	Frequency (MHz)	Frequency Error (ppm)	Frequency (MHz)	Frequency Error (ppm)
4.25	700.500002	0.003	714.500003	0.005
5	700.500002	0.002	714.500003	0.004
5.75	700.500002	0.002	714.500001	0.002

Note: The applicant defined the normal working voltage is from 4.25Vdc to 5.75Vdc.

### Frequency Error vs. Temperature

Temp. (°C)	LTE Band 12			
	Channel Bandwidth: 3 MHz			
	Low Channel		High Channel	
	Frequency (MHz)	Frequency Error (ppm)	Frequency (MHz)	Frequency Error (ppm)
-30	700.500001	0.002	714.500003	0.004
-20	700.500003	0.004	714.500003	0.004
-10	700.500002	0.003	714.500004	0.005
0	700.500003	0.005	714.500002	0.003
10	700.500002	0.003	714.500001	0.002
20	700.499998	-0.002	714.499998	-0.003
30	700.499999	-0.002	714.499998	-0.003
40	700.499997	-0.005	714.499996	-0.005
50	700.499996	-0.005	714.499996	-0.006

### Frequency Error vs. Voltage

Voltage (Volts)	LTE Band 12			
	Channel Bandwidth: 5 MHz			
	Low Channel		High Channel	
	Frequency (MHz)	Frequency Error (ppm)	Frequency (MHz)	Frequency Error (ppm)
4.25	701.500002	0.003	713.500002	0.003
5	701.500002	0.003	713.500002	0.003
5.75	701.500002	0.002	713.500001	0.002

Note: The applicant defined the normal working voltage is from 4.25Vdc to 5.75Vdc.

### Frequency Error vs. Temperature

Temp. (°C)	LTE Band 12			
	Channel Bandwidth: 5 MHz			
	Low Channel		High Channel	
	Frequency (MHz)	Frequency Error (ppm)	Frequency (MHz)	Frequency Error (ppm)
-30	701.500002	0.003	713.500003	0.004
-20	701.500002	0.003	713.500003	0.004
-10	701.500001	0.002	713.500003	0.004
0	701.500002	0.003	713.500002	0.003
10	701.500002	0.003	713.500003	0.004
20	701.499999	-0.002	713.499997	-0.005
30	701.499997	-0.004	713.499999	-0.002
40	701.499996	-0.005	713.499998	-0.003
50	701.499996	-0.005	713.499997	-0.004

### Frequency Error vs. Voltage

Voltage (Volts)	LTE Band 12			
	Channel Bandwidth: 10 MHz			
	Low Channel		High Channel	
	Frequency (MHz)	Frequency Error (ppm)	Frequency (MHz)	Frequency Error (ppm)
4.25	704.000002	0.003	711.000002	0.003
5	704.000002	0.003	711.000002	0.002
5.75	704.000002	0.002	711.000001	0.002

Note: The applicant defined the normal working voltage is from 4.25Vdc to 5.75Vdc.

### Frequency Error vs. Temperature

Temp. (°C)	LTE Band 12			
	Channel Bandwidth: 10 MHz			
	Low Channel		High Channel	
	Frequency (MHz)	Frequency Error (ppm)	Frequency (MHz)	Frequency Error (ppm)
-30	704.000003	0.005	711.000002	0.003
-20	704.000002	0.003	711.000004	0.005
-10	704.000002	0.003	711.000002	0.003
0	704.000004	0.005	711.000001	0.002
10	704.000004	0.005	711.000003	0.004
20	703.999999	-0.002	710.999999	-0.002
30	703.999998	-0.002	710.999997	-0.005
40	703.999998	-0.003	710.999996	-0.006
50	703.999998	-0.003	710.999999	-0.001

## 4.4 Occupied Bandwidth Measurement

### 4.4.1 Test Procedure

For LTB Band 5:

The EUT makes a call to the communication simulator. All measurements were done at low, middle and high operational frequency range. The communication simulator station system controlled a EUT to export maximum output power under transmission mode and specific channel frequency. Use OBW measurement function of Spectrum analyzer to measure 99 % occupied bandwidth.

For LTB Band 12:

The occupied bandwidth (OBW), that is the frequency bandwidth such that, below its lower and above its upper frequency limits, the mean powers radiated are each equal to 0.5 % of the total mean power radiated by a given emission.

### 4.4.2 Test Setup

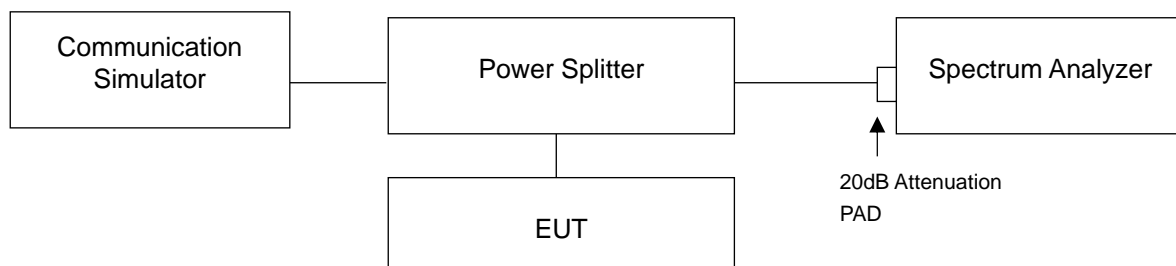

#### 4.4.3 Test Result

##### Occupied Bandwidth

n7

n7, Channel Bandwidth 5MHz						
Channel	Frequency (MHz)	99% Occupied Bandwidth (MHz)				
		$\pi/2$ BPSK	QPSK	16QAM	64QAM	256QAM
500500	2502.5	4.4683	4.4869	4.4868	4.4896	4.4673
507000	2535.0	4.4696	4.4865	4.4861	4.4887	4.4664
513500	2567.5	4.4682	4.4848	4.4839	4.4884	4.4666
n7, Channel Bandwidth 10MHz						
Channel	Frequency (MHz)	99% Occupied Bandwidth (MHz)				
		$\pi/2$ BPSK	QPSK	16QAM	64QAM	256QAM
501000	2505.0	9.1711	8.9561	8.9580	8.9517	9.2008
507000	2535.0	9.1781	8.9508	8.9524	8.9471	9.2140
513000	2565.0	9.2016	8.9484	8.9527	8.9463	9.2109
n7, Channel Bandwidth 15MHz						
Channel	Frequency (MHz)	99% Occupied Bandwidth (MHz)				
		$\pi/2$ BPSK	QPSK	16QAM	64QAM	256QAM
501500	2507.5	13.987	13.453	13.433	13.431	14.113
507000	2535.0	14.008	13.452	13.440	13.435	13.996
512500	2562.5	14.008	13.454	13.446	13.437	14.003
n7, Channel Bandwidth 20MHz						
Channel	Frequency (MHz)	99% Occupied Bandwidth (MHz)				
		$\pi/2$ BPSK	QPSK	16QAM	64QAM	256QAM
502000	2510.0	18.669	17.897	17.918	17.924	18.644
507000	2535.0	18.749	17.908	17.928	17.915	18.747
512000	2560.0	18.753	17.928	17.943	17.936	18.753

### Spectrum Plot of Worst Value

**5MHz / 64QAM**



**10MHz / 256QAM**



**15MHz / 256QAM**



**20MHz / 256QAM**





LTE Band 5

LTE Band 5, Channel Bandwidth 1.4MHz				
Channel	Frequency (MHz)	99% Occupied Bandwidth (MHz)		
		QPSK	16QAM	64QAM
20407	824.7	1.0864	1.0891	1.0862
20525	836.5	1.0859	1.0897	1.0867
20643	848.3	1.0869	1.0887	1.0872
LTE Band 5, Channel Bandwidth 3MHz				
Channel	Frequency (MHz)	99% Occupied Bandwidth (MHz)		
		QPSK	16QAM	64QAM
20415	825.5	2.6980	2.6948	2.6996
20525	836.5	2.6978	2.6935	2.7025
20635	847.5	2.6995	2.6939	2.7026
LTE Band 5, Channel Bandwidth 5MHz				
Channel	Frequency (MHz)	99% Occupied Bandwidth (MHz)		
		QPSK	16QAM	64QAM
20425	826.5	4.4859	4.4862	4.4862
20525	836.5	4.4873	4.4875	4.4870
20625	846.5	4.4874	4.4895	4.4879
LTE Band 5, Channel Bandwidth 10MHz				
Channel	Frequency (MHz)	99% Occupied Bandwidth (MHz)		
		QPSK	16QAM	64QAM
20450	829.0	8.9482	8.9527	8.9461
20525	836.5	8.9567	8.9624	8.9565
20600	844.0	8.9414	8.9468	8.9387

### Spectrum Plot of Worst Value

**1.4MHz / 16QAM**



**3MHz / 64QAM**



**5MHz / 16QAM**



**10MHz / 16QAM**



LTE Band 12

LTE Band 12, Channel Bandwidth 1.4MHz				
Channel	Frequency (MHz)	99% Occupied Bandwidth (MHz)		
		QPSK	16QAM	64QAM
23017	699.7	1.0865	1.0882	1.0858
23095	707.5	1.0860	1.0892	1.0871
23173	715.3	1.0867	1.0897	1.0869
LTE Band 12, Channel Bandwidth 3MHz				
Channel	Frequency (MHz)	99% Occupied Bandwidth (MHz)		
		QPSK	16QAM	64QAM
23025	700.5	2.6996	2.6961	2.7008
23095	707.5	2.6989	2.6954	2.7011
23165	714.5	2.7012	2.6930	2.7005
LTE Band 12, Channel Bandwidth 5MHz				
Channel	Frequency (MHz)	99% Occupied Bandwidth (MHz)		
		QPSK	16QAM	64QAM
23035	701.5	4.4857	4.4855	4.4892
23095	707.5	4.4834	4.4851	4.4885
23155	713.5	4.4857	4.4862	4.4881
LTE Band 12, Channel Bandwidth 10MHz				
Channel	Frequency (MHz)	99% Occupied Bandwidth (MHz)		
		QPSK	16QAM	64QAM
23060	704.0	8.9555	8.9615	8.9555
23095	707.5	8.9518	8.9517	8.9464
23130	711.0	8.9460	8.9518	8.9450

### Spectrum Plot of Worst Value

1.4MHz / 16QAM



3MHz / QPSK



5MHz / 64QAM

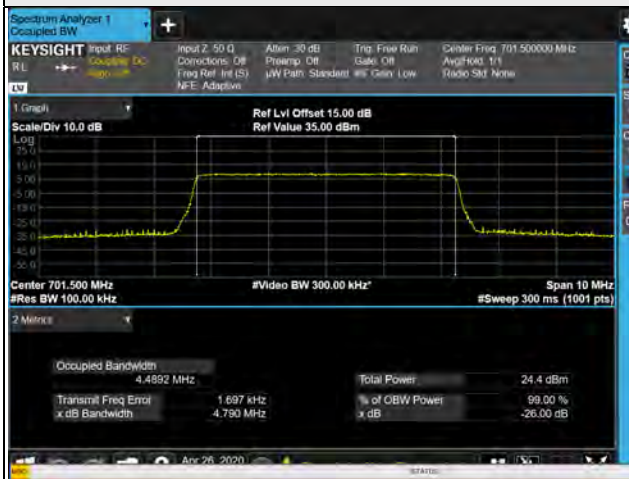

10MHz / 16QAM

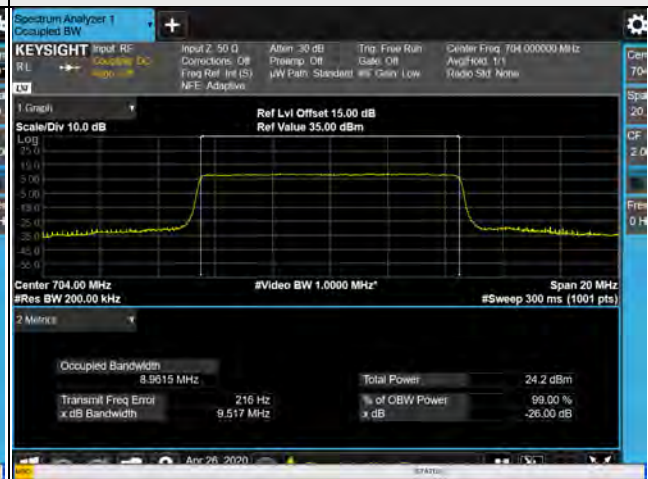

## 26dB Bandwidth

n7

n7, Channel Bandwidth 5MHz						
Channel	Frequency (MHz)	26dB Bandwidth (MHz)				
		$\pi/2$ BPSK	QPSK	16QAM	64QAM	256QAM
500500	2502.5	4.818	4.802	4.794	4.806	4.719
507000	2535.0	4.802	4.788	4.795	4.800	4.710
513500	2567.5	4.824	4.800	4.809	4.809	4.710
n7, Channel Bandwidth 10MHz						
Channel	Frequency (MHz)	26dB Bandwidth (MHz)				
		$\pi/2$ BPSK	QPSK	16QAM	64QAM	256QAM
501000	2505.0	9.252	9.494	9.497	9.496	9.281
507000	2535.0	9.309	9.494	9.500	9.511	9.301
513000	2565.0	9.285	9.513	9.496	9.494	9.286
n7, Channel Bandwidth 15MHz						
Channel	Frequency (MHz)	26dB Bandwidth (MHz)				
		$\pi/2$ BPSK	QPSK	16QAM	64QAM	256QAM
501500	2507.5	13.89	14.25	14.24	14.23	14.61
507000	2535.0	13.89	14.25	14.24	14.24	13.88
512500	2562.5	13.89	14.25	14.25	14.24	13.87
n7, Channel Bandwidth 20MHz						
Channel	Frequency (MHz)	26dB Bandwidth (MHz)				
		$\pi/2$ BPSK	QPSK	16QAM	64QAM	256QAM
502000	2510.0	18.58	19.00	19.02	19.02	18.47
507000	2535.0	18.51	19.01	19.02	19.03	18.50
512000	2560.0	18.51	19.03	19.03	19.04	18.49

### Spectrum Plot of Worst Value

5MHz /  $\pi/2$  BPSK



10MHz / QPSK



15MHz / 256QAM



20MHz / 64QAM



LTE Band 5

LTE Band 5, Channel Bandwidth 1.4MHz				
Channel	Frequency (MHz)	26dB Bandwidth (MHz)		
		QPSK	16QAM	64QAM
20407	824.7	1.215	1.213	1.213
20525	836.5	1.209	1.217	1.213
20643	848.3	1.217	1.211	1.213
LTE Band 5, Channel Bandwidth 3MHz				
Channel	Frequency (MHz)	26dB Bandwidth (MHz)		
		QPSK	16QAM	64QAM
20415	825.5	2.905	2.922	2.926
20525	836.5	2.916	2.919	2.928
20635	847.5	2.927	2.926	2.905
LTE Band 5, Channel Bandwidth 5MHz				
Channel	Frequency (MHz)	26dB Bandwidth (MHz)		
		QPSK	16QAM	64QAM
20425	826.5	4.804	4.804	4.790
20525	836.5	4.786	4.796	4.797
20625	846.5	4.803	4.788	4.804
LTE Band 5, Channel Bandwidth 10MHz				
Channel	Frequency (MHz)	26dB Bandwidth (MHz)		
		QPSK	16QAM	64QAM
20450	829.0	9.484	9.503	9.510
20525	836.5	9.509	9.501	9.516
20600	844.0	9.482	9.487	9.496

### Spectrum Plot of Worst Value

**1.4MHz / QPSK**



**3MHz / 64QAM**



**5MHz / QPSK**



**10MHz / 64QAM**





LTE Band 12

LTE Band 12, Channel Bandwidth 1.4MHz				
Channel	Frequency (MHz)	26dB Bandwidth (MHz)		
		QPSK	16QAM	64QAM
23017	699.7	1.213	1.216	1.217
23095	707.5	1.214	1.216	1.215
23173	715.3	1.217	1.216	1.212
LTE Band 12, Channel Bandwidth 3MHz				
Channel	Frequency (MHz)	26dB Bandwidth (MHz)		
		QPSK	16QAM	64QAM
23025	700.5	2.914	2.920	2.919
23095	707.5	2.918	2.921	2.919
23165	714.5	2.924	2.920	2.918
LTE Band 12, Channel Bandwidth 5MHz				
Channel	Frequency (MHz)	26dB Bandwidth (MHz)		
		QPSK	16QAM	64QAM
23035	701.5	4.783	4.806	4.790
23095	707.5	4.801	4.800	4.804
23155	713.5	4.801	4.798	4.795
LTE Band 12, Channel Bandwidth 10MHz				
Channel	Frequency (MHz)	26dB Bandwidth (MHz)		
		QPSK	16QAM	64QAM
23060	704.0	9.510	9.517	9.499
23095	707.5	9.500	9.502	9.493
23130	711.0	9.498	9.505	9.496

### Spectrum Plot of Worst Value

1.4MHz / QPSK

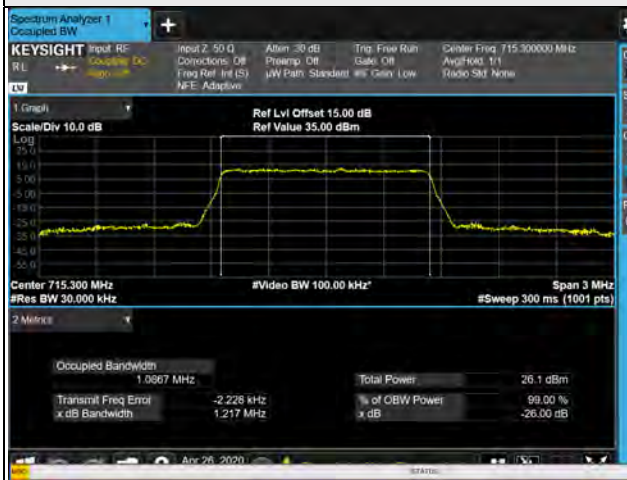

3MHz / QPSK

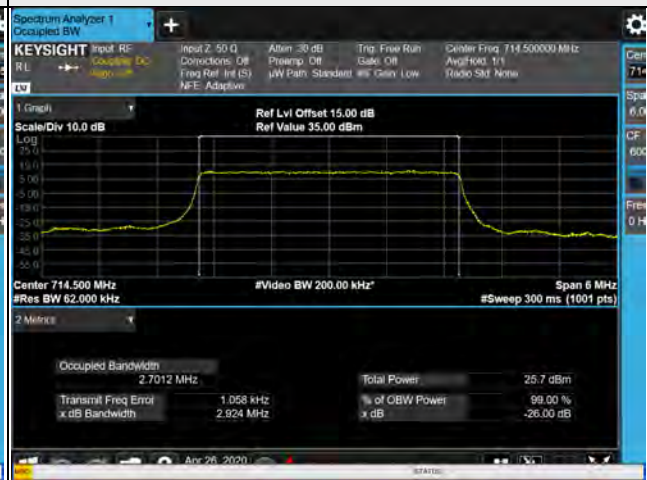

5MHz / 16QAM



10MHz / 16QAM

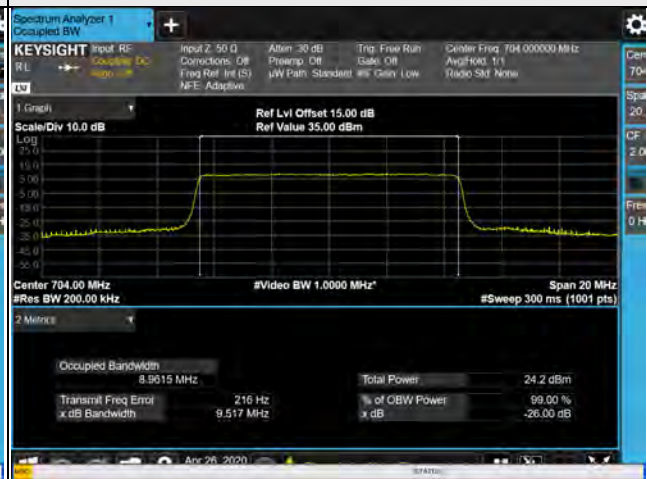

## 4.5 Band Edge Measurement

### 4.5.1 Limits of Band Edge Measurement

For n7

According to FCC 27.53(m)(4) specified that power of any emission outside of the channel edge must be attenuated below the transmitting power (P) by a factor shall be not less than  $40 + 10 \log (P)$  dB on all frequencies between the channel edge and 5 megahertz from the channel edge,  $43 + 10 \log (P)$  dB on all frequencies between 5 megahertz and X megahertz from the channel edge, and  $55 + 10 \log (P)$  dB on all frequencies more than X megahertz from the channel edge, where X is the greater of 6 megahertz or the actual emission bandwidth. In addition, the attenuation factor shall not be less that  $43 + 10 \log (P)$  dB on all frequencies between 2490.5 MHz and 2496 MHz and  $55 + 10 \log (P)$  dB at or below 2490.5 MHz. In the 1 MHz bands immediately outside and adjacent to the frequency block a resolution bandwidth of at least two percent may be employed, except when the 1 megahertz band is 2495-2496 MHz, in which case a resolution bandwidth of at least one percent may be employed.

For LTE Band 5

Power of any emission outside of the authorized operating frequency ranges must be attenuated below the transmitting power (P) by a factor of at least  $43 + 10 \log (P)$  dB. In the 1 MHz bands immediately outside and adjacent to the frequency block a resolution bandwidth of at least one percent of the emission bandwidth of the fundamental emission of the transmitter may be employed.

For LTE Band 12

According to FCC 27.53(g) for operations in the 600 MHz band and the 698-746 MHz band, the power of any emission outside a licensee's frequency band(s) of operation shall be attenuated below the transmitter power (P) within the licensed band(s) of operation, measured in watts, by at least  $43 + 10 \log (P)$  dB. Compliance with this provision is based on the use of measurement instrumentation employing a resolution bandwidth of 100 kilohertz or greater.

### 4.5.2 Test Setup

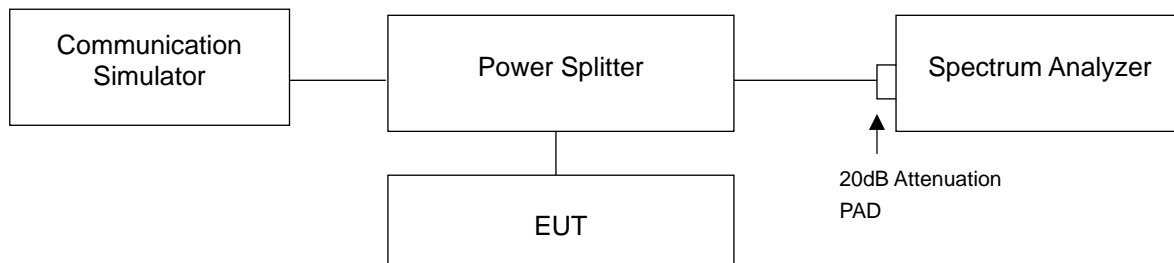

### 4.5.3 Test Procedures

- All measurements were done at low and high operational frequency range.
- The center frequency of spectrum is the band edge frequency and span is 1MHz. RB of the spectrum is 15kHz and VB of the spectrum is 51kHz (LTE Channel Bandwidth 1.4MHz).
- The center frequency of spectrum is the band edge frequency and span is 1MHz. RB of the spectrum is 30kHz and VB of the spectrum is 100kHz (LTE Channel Bandwidth 3MHz).
- The center frequency of spectrum is the band edge frequency and span is 1MHz. RB of the spectrum is 51kHz and VB of the spectrum is 160kHz (LTE Channel Bandwidth 5MHz).
- The center frequency of spectrum is the band edge frequency and span is 1MHz. RB of the spectrum is 100kHz and VB of the spectrum is 300kHz (LTE Channel Bandwidth 10MHz).
- The center frequency of spectrum is the band edge frequency and span is 1MHz. RB of the spectrum is 150kHz and VB of the spectrum is 470kHz (LTE Channel Bandwidth 15MHz).
- Record the max trace plot into the test report.

### 4.5.4 Test Results

n7

Emission Mask:

Channel Bandwidth: 5MHz

Channel 500500 (2502.5MHz)	$\pi/2$ BPSK	1 RB / 0 RB Offset	Channel 507000 (2535.0MHz)	$\pi/2$ BPSK	1 RB / 0 RB Offset																																				
<table border="1"> <thead> <tr> <th>Freq (MHz)</th> <th>Power (dBm)</th> </tr> </thead> <tbody> <tr><td>2.4860</td><td>-34.57</td></tr> <tr><td>2.4890</td><td>-35.26</td></tr> <tr><td>2.4990</td><td>-8.724</td></tr> <tr><td>2.5000</td><td>19.59</td></tr> <tr><td>2.5010</td><td>-42.11</td></tr> <tr><td>2.5060</td><td>-52.51</td></tr> <tr><td>2.5070</td><td>-38.47</td></tr> <tr><td>2.5100</td><td>-33.22</td></tr> </tbody> </table>	Freq (MHz)	Power (dBm)	2.4860	-34.57	2.4890	-35.26	2.4990	-8.724	2.5000	19.59	2.5010	-42.11	2.5060	-52.51	2.5070	-38.47	2.5100	-33.22			<table border="1"> <thead> <tr> <th>Freq (MHz)</th> <th>Power (dBm)</th> </tr> </thead> <tbody> <tr><td>2.5275</td><td>-28.96</td></tr> <tr><td>2.5305</td><td>-35.30</td></tr> <tr><td>2.5315</td><td>-44.89</td></tr> <tr><td>2.5328</td><td>20.13</td></tr> <tr><td>2.5335</td><td>-18.47</td></tr> <tr><td>2.5378</td><td>-42.41</td></tr> <tr><td>2.5385</td><td>-44.73</td></tr> <tr><td>2.5395</td><td>-37.38</td></tr> </tbody> </table>	Freq (MHz)	Power (dBm)	2.5275	-28.96	2.5305	-35.30	2.5315	-44.89	2.5328	20.13	2.5335	-18.47	2.5378	-42.41	2.5385	-44.73	2.5395	-37.38		
Freq (MHz)	Power (dBm)																																								
2.4860	-34.57																																								
2.4890	-35.26																																								
2.4990	-8.724																																								
2.5000	19.59																																								
2.5010	-42.11																																								
2.5060	-52.51																																								
2.5070	-38.47																																								
2.5100	-33.22																																								
Freq (MHz)	Power (dBm)																																								
2.5275	-28.96																																								
2.5305	-35.30																																								
2.5315	-44.89																																								
2.5328	20.13																																								
2.5335	-18.47																																								
2.5378	-42.41																																								
2.5385	-44.73																																								
2.5395	-37.38																																								
<table border="1"> <thead> <tr> <th>Freq (MHz)</th> <th>Power (dBm)</th> </tr> </thead> <tbody> <tr><td>2.4860</td><td>-37.18</td></tr> <tr><td>2.4890</td><td>-33.74</td></tr> <tr><td>2.4990</td><td>-50.61</td></tr> <tr><td>2.5000</td><td>19.87</td></tr> <tr><td>2.5010</td><td>-19.41</td></tr> <tr><td>2.5060</td><td>-47.99</td></tr> <tr><td>2.5070</td><td>-38.87</td></tr> <tr><td>2.5100</td><td>-47.25</td></tr> </tbody> </table>	Freq (MHz)	Power (dBm)	2.4860	-37.18	2.4890	-33.74	2.4990	-50.61	2.5000	19.87	2.5010	-19.41	2.5060	-47.99	2.5070	-38.87	2.5100	-47.25			<table border="1"> <thead> <tr> <th>Freq (MHz)</th> <th>Power (dBm)</th> </tr> </thead> <tbody> <tr><td>2.5285</td><td>-44.89</td></tr> <tr><td>2.5305</td><td>-46.99</td></tr> <tr><td>2.5315</td><td>-27.90</td></tr> <tr><td>2.5328</td><td>20.30</td></tr> <tr><td>2.5335</td><td>-22.54</td></tr> <tr><td>2.5378</td><td>-9.602</td></tr> <tr><td>2.5385</td><td>-16.84</td></tr> <tr><td>2.5395</td><td>-44.61</td></tr> </tbody> </table>	Freq (MHz)	Power (dBm)	2.5285	-44.89	2.5305	-46.99	2.5315	-27.90	2.5328	20.30	2.5335	-22.54	2.5378	-9.602	2.5385	-16.84	2.5395	-44.61		
Freq (MHz)	Power (dBm)																																								
2.4860	-37.18																																								
2.4890	-33.74																																								
2.4990	-50.61																																								
2.5000	19.87																																								
2.5010	-19.41																																								
2.5060	-47.99																																								
2.5070	-38.87																																								
2.5100	-47.25																																								
Freq (MHz)	Power (dBm)																																								
2.5285	-44.89																																								
2.5305	-46.99																																								
2.5315	-27.90																																								
2.5328	20.30																																								
2.5335	-22.54																																								
2.5378	-9.602																																								
2.5385	-16.84																																								
2.5395	-44.61																																								
<table border="1"> <thead> <tr> <th>Freq (MHz)</th> <th>Power (dBm)</th> </tr> </thead> <tbody> <tr><td>2.4860</td><td>-26.30</td></tr> <tr><td>2.4890</td><td>-18.26</td></tr> <tr><td>2.4990</td><td>-28.49</td></tr> <tr><td>2.5000</td><td>5.09</td></tr> <tr><td>2.5010</td><td>-29.91</td></tr> <tr><td>2.5060</td><td>-38.38</td></tr> <tr><td>2.5070</td><td>-32.72</td></tr> <tr><td>2.5100</td><td>-39.96</td></tr> </tbody> </table>	Freq (MHz)	Power (dBm)	2.4860	-26.30	2.4890	-18.26	2.4990	-28.49	2.5000	5.09	2.5010	-29.91	2.5060	-38.38	2.5070	-32.72	2.5100	-39.96			<table border="1"> <thead> <tr> <th>Freq (MHz)</th> <th>Power (dBm)</th> </tr> </thead> <tbody> <tr><td>2.5285</td><td>-38.96</td></tr> <tr><td>2.5305</td><td>-35.30</td></tr> <tr><td>2.5315</td><td>-39.57</td></tr> <tr><td>2.5360</td><td>5.60</td></tr> <tr><td>2.5370</td><td>-24.42</td></tr> <tr><td>2.5378</td><td>-26.48</td></tr> <tr><td>2.5385</td><td>-18.06</td></tr> <tr><td>2.5395</td><td>-25.70</td></tr> </tbody> </table>	Freq (MHz)	Power (dBm)	2.5285	-38.96	2.5305	-35.30	2.5315	-39.57	2.5360	5.60	2.5370	-24.42	2.5378	-26.48	2.5385	-18.06	2.5395	-25.70		
Freq (MHz)	Power (dBm)																																								
2.4860	-26.30																																								
2.4890	-18.26																																								
2.4990	-28.49																																								
2.5000	5.09																																								
2.5010	-29.91																																								
2.5060	-38.38																																								
2.5070	-32.72																																								
2.5100	-39.96																																								
Freq (MHz)	Power (dBm)																																								
2.5285	-38.96																																								
2.5305	-35.30																																								
2.5315	-39.57																																								
2.5360	5.60																																								
2.5370	-24.42																																								
2.5378	-26.48																																								
2.5385	-18.06																																								
2.5395	-25.70																																								

Channel Bandwidth: 5MHz

Channel 513500 (2567.5MHz)  $\pi/2$  BPSK 1 RB / 0 RB Offset



Channel 513500 (2567.5MHz)  $\pi/2$  BPSK 1 RB / 24 RB Offset

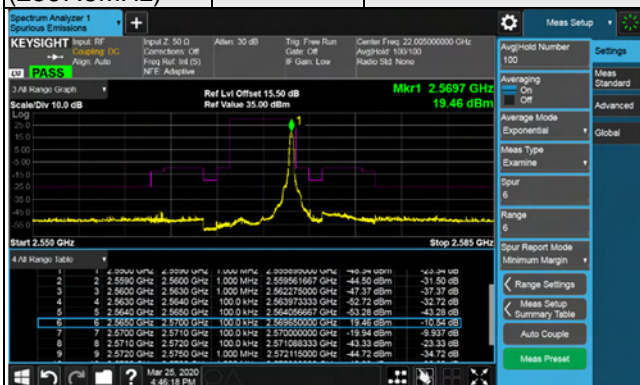

Channel 513500 (2567.5MHz)  $\pi/2$  BPSK 25 RB / 0 RB Offset



Channel Bandwidth: 10MHz

Channel 501000  
(2505.0MHz)

$\pi/2$  BPSK

1 RB / 0 RB Offset

Channel 507000  
(2535.0MHz)

$\pi/2$  BPSK

1 RB / 0 RB Offset

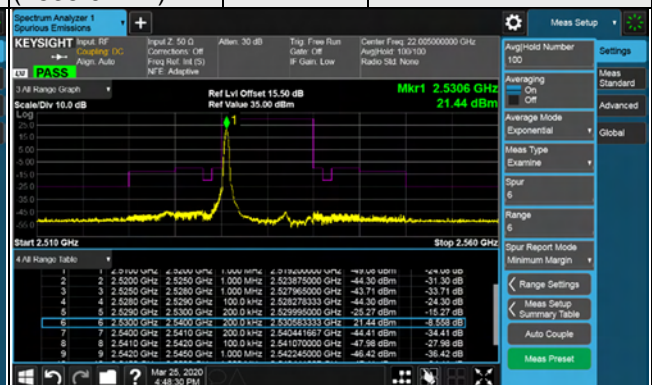
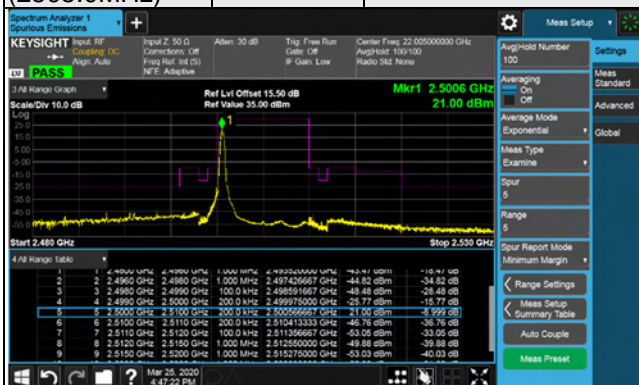

Channel 501000  
(2505.0MHz)

$\pi/2$  BPSK

1 RB / 51 RB Offset

Channel 507000  
(2535.0MHz)

$\pi/2$  BPSK

1 RB / 51 RB Offset

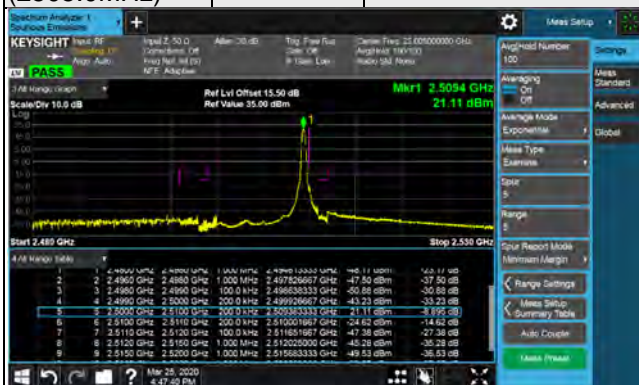

Channel 501000  
(2505.0MHz)

$\pi/2$  BPSK

52 RB / 0 RB Offset

Channel 507000  
(2535.0MHz)

$\pi/2$  BPSK

52 RB / 0 RB Offset

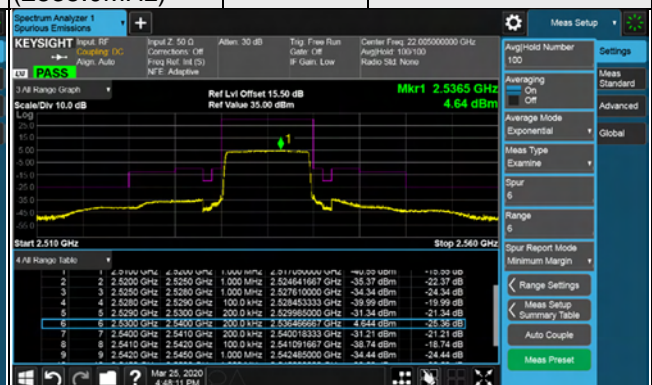
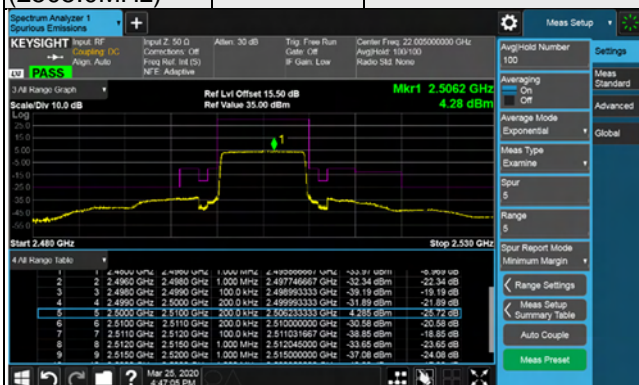

Channel Bandwidth: 10MHz

Channel 513000 (2565.0MHz)  $\pi/2$  BPSK 1 RB / 0 RB Offset

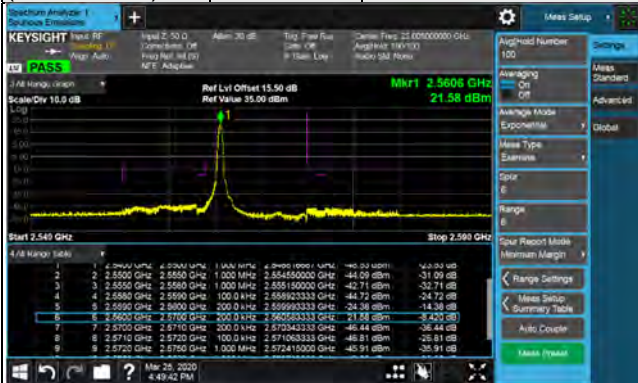

Channel 513000 (2565.0MHz)  $\pi/2$  BPSK 1 RB / 51 RB Offset

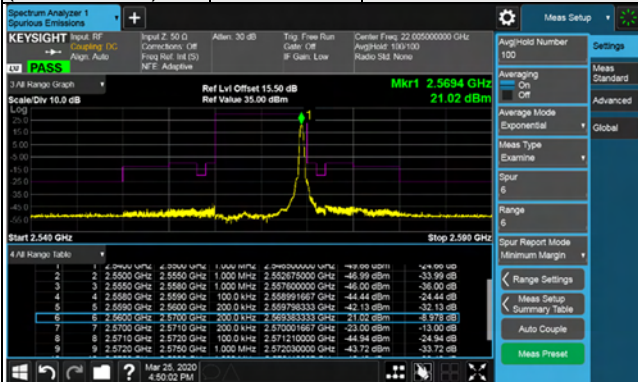

Channel 513000 (2565.0MHz)  $\pi/2$  BPSK 52 RB / 0 RB Offset



Channel Bandwidth: 15MHz

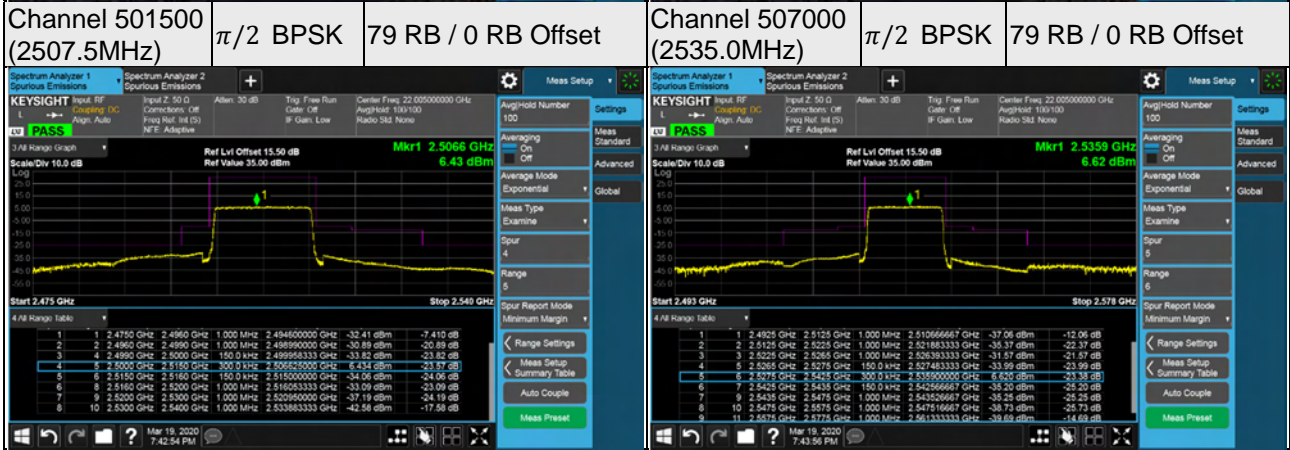
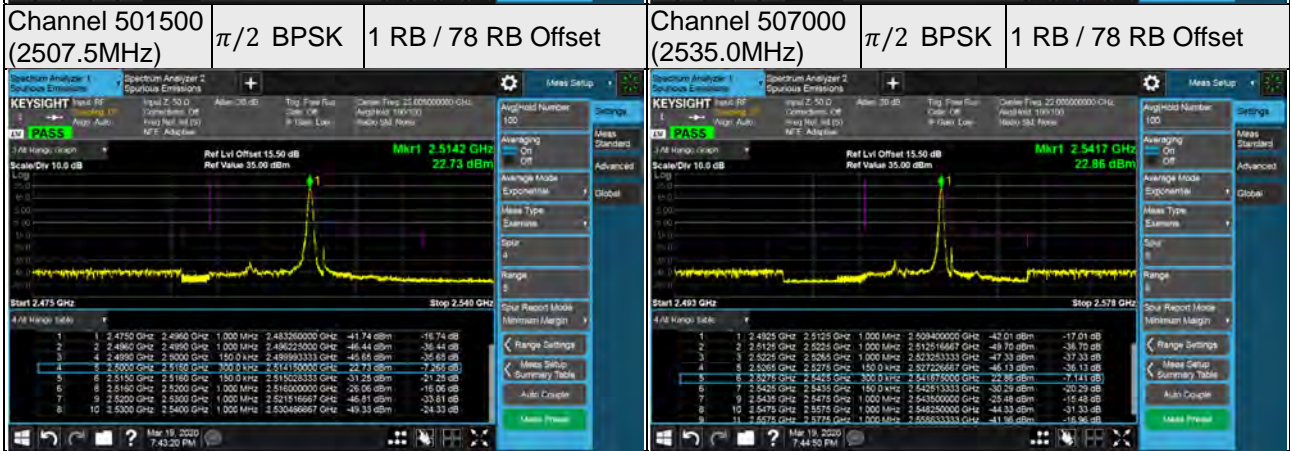
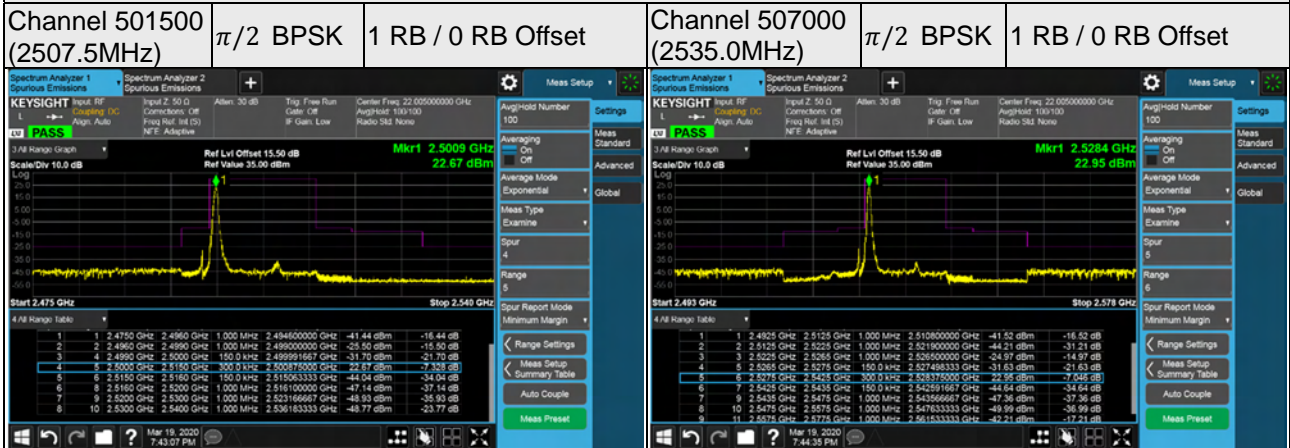



Channel Bandwidth: 15MHz

Channel 512500 (2562.5MHz)  $\pi/2$  BPSK 1 RB / 0 RB Offset



Channel 512500 (2562.5MHz)  $\pi/2$  BPSK 1 RB / 78 RB Offset

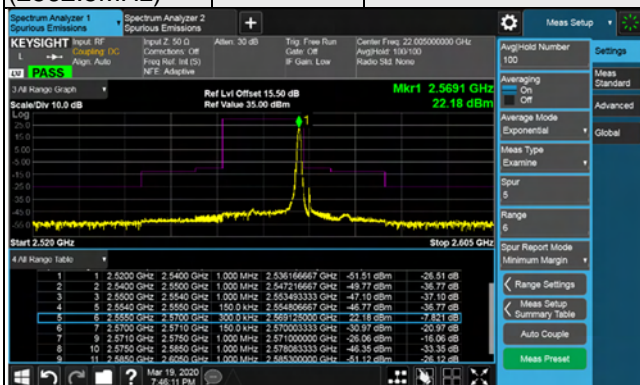

Channel 512500 (2562.5MHz)  $\pi/2$  BPSK 79 RB / 0 RB Offset

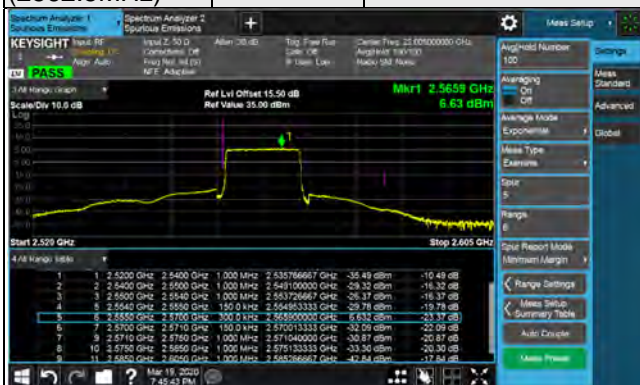

Channel Bandwidth: 20MHz

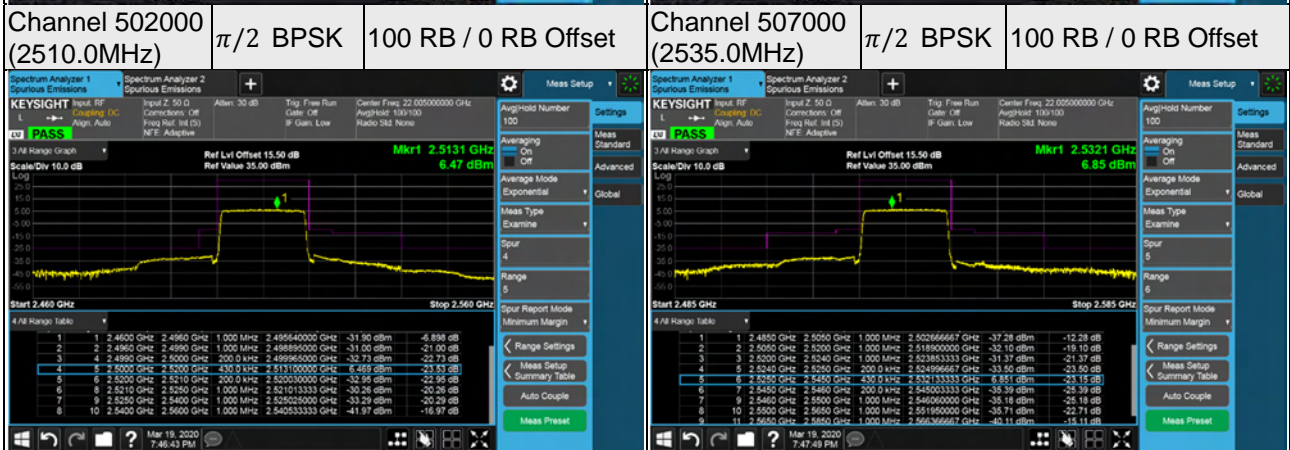
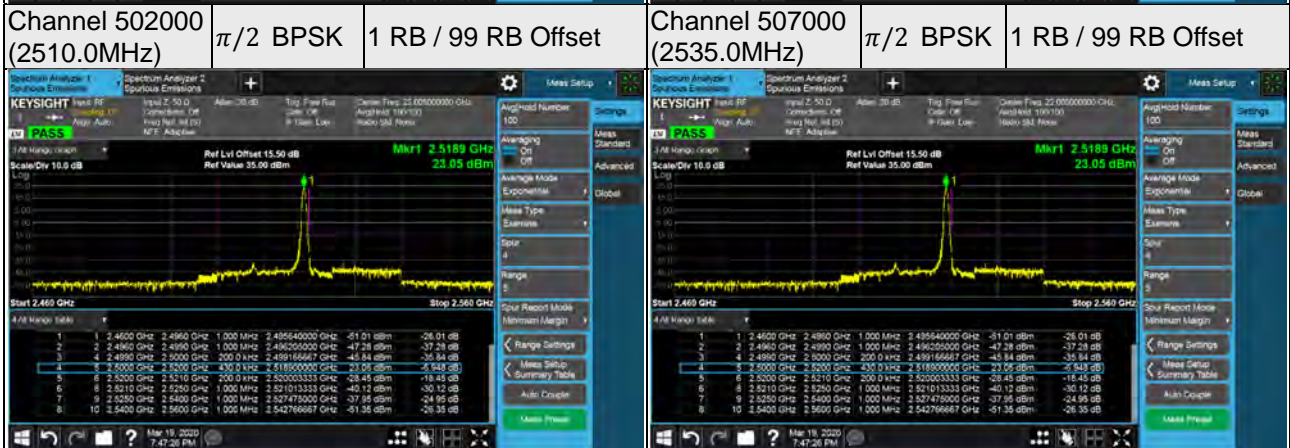
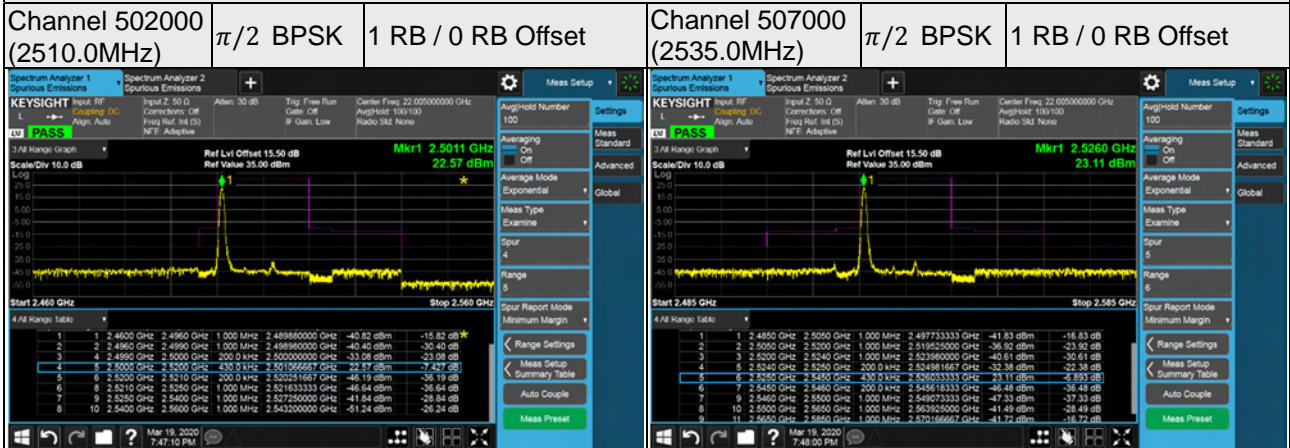

Channel Bandwidth: 20MHz

Channel 512000 (2560.0MHz)  $\pi/2$  BPSK 1 RB / 0 RB Offset

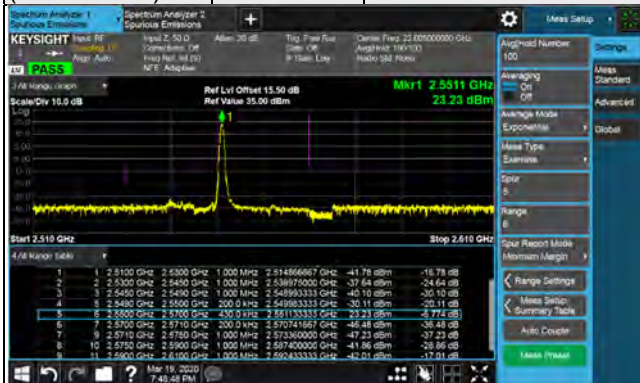

Channel 512000 (2560.0MHz)  $\pi/2$  BPSK 1 RB / 99 RB Offset

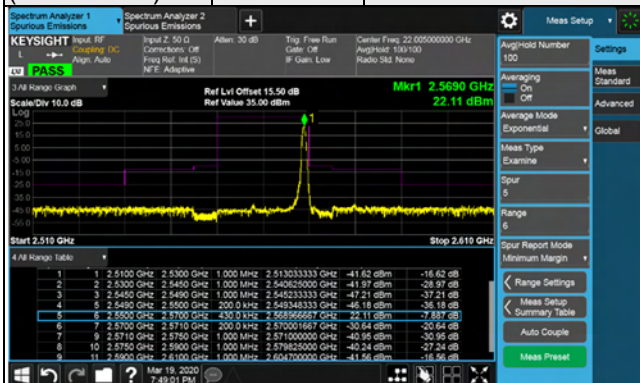

Channel 512000 (2560.0MHz)  $\pi/2$  BPSK 100 RB / 0 RB Offset



LTE Band 5

Channel Bandwidth 1.4MHz

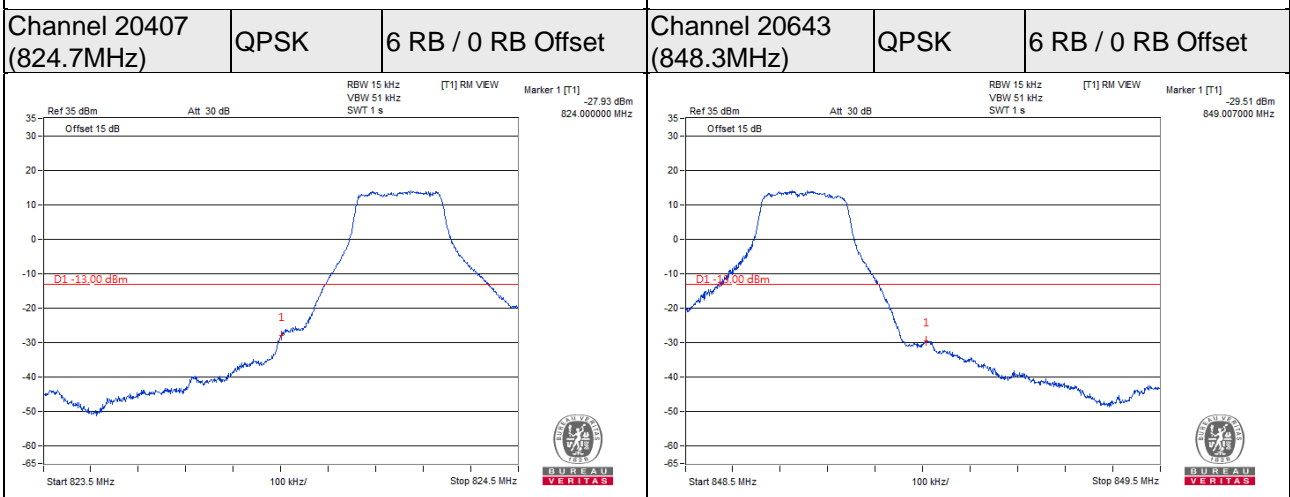
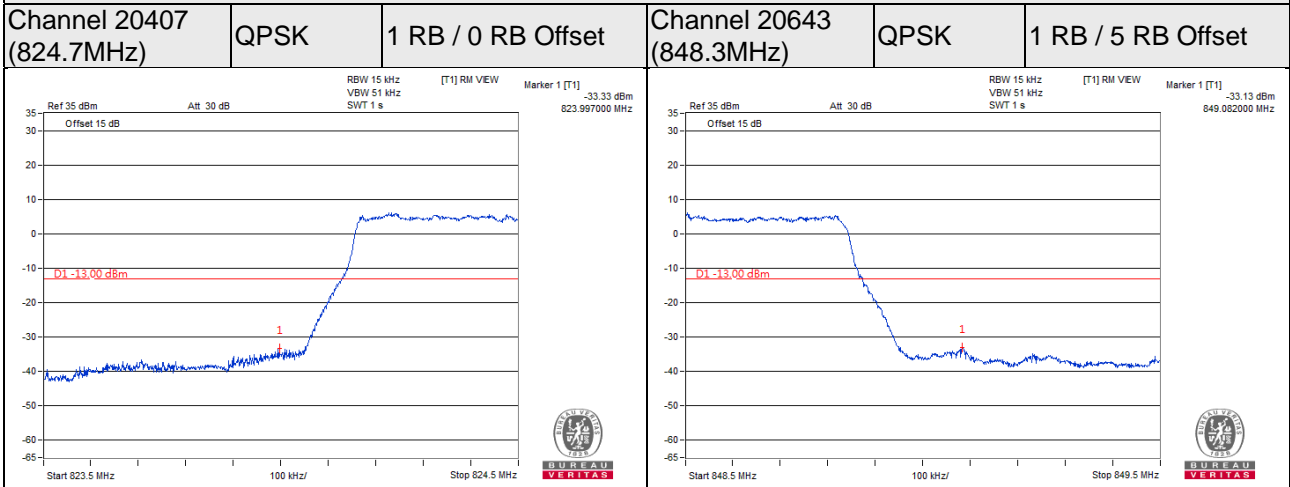

**Channel Bandwidth 3MHz**

**Channel 20415  
(825.5MHz)**

**QPSK**

**1 RB / 0 RB Offset**

**Channel 20635  
(847.5MHz)**

**QPSK**

**1 RB / 14 RB Offset**

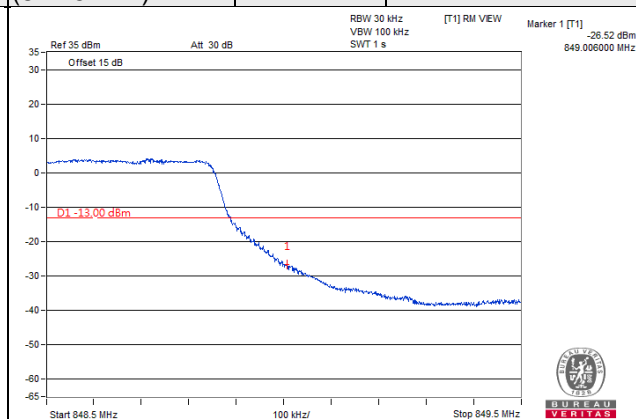
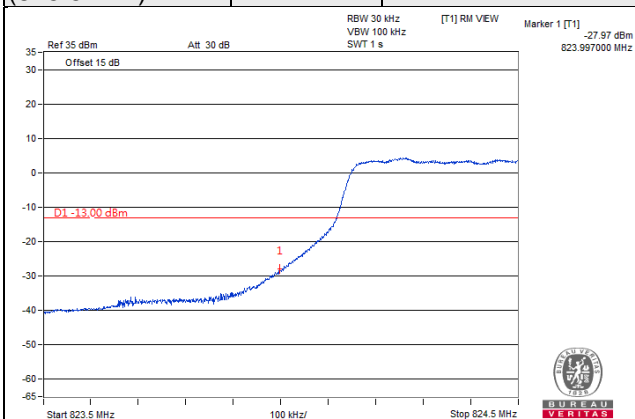

**Channel 20415  
(825.5MHz)**

**QPSK**

**15 RB / 0 RB Offset**

**Channel 20635  
(847.5MHz)**

**QPSK**

**15 RB / 0 RB Offset**

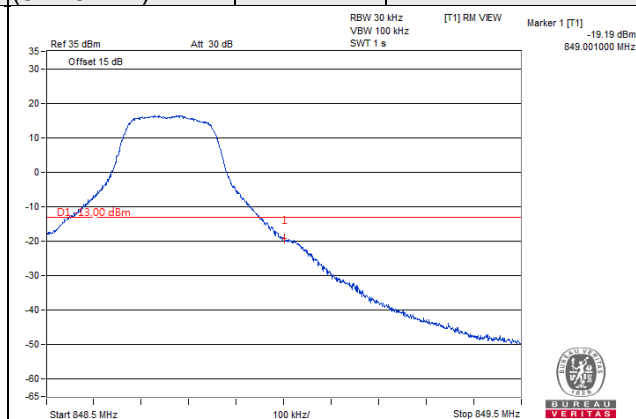
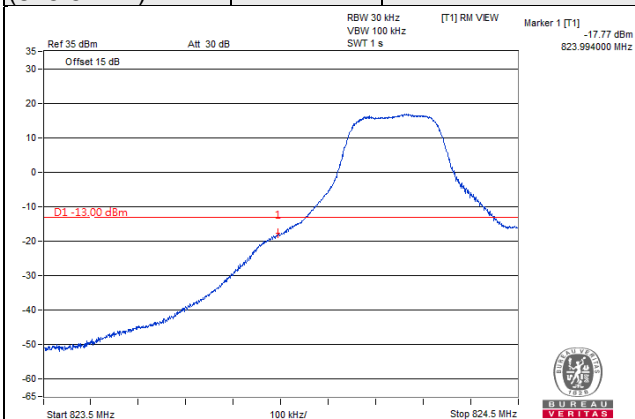

**Channel Bandwidth 5MHz**

**Channel 20425  
(826.5MHz)**

**QPSK**

**1 RB / 0 RB Offset**

**Channel 20625  
(846.5MHz)**

**QPSK**

**1 RB / 24 RB Offset**

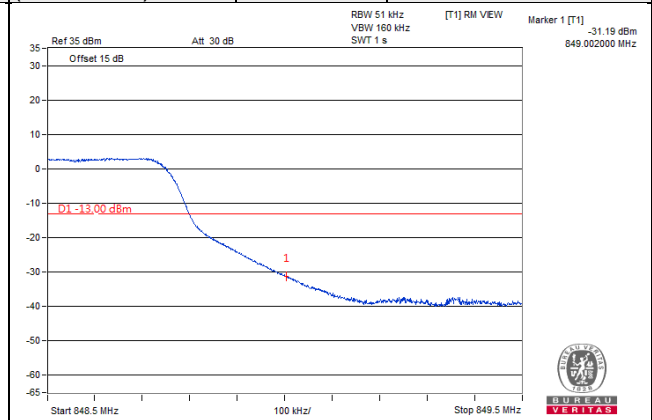
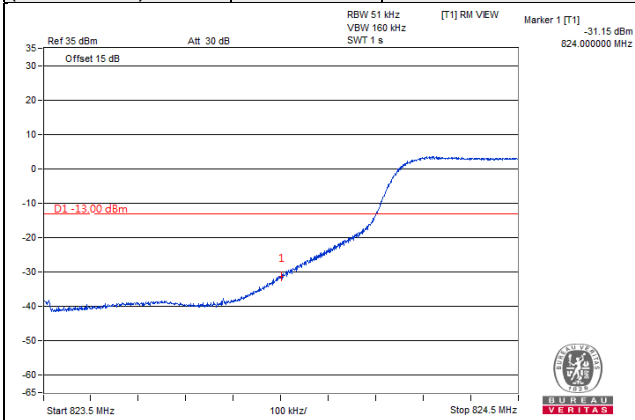

**Channel 20425  
(826.5MHz)**

**QPSK**

**25 RB / 0 RB Offset**

**Channel 20625  
(846.5MHz)**

**QPSK**

**25 RB / 0 RB Offset**

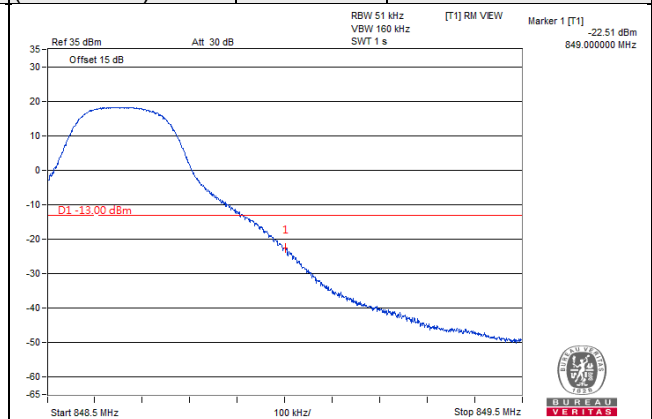
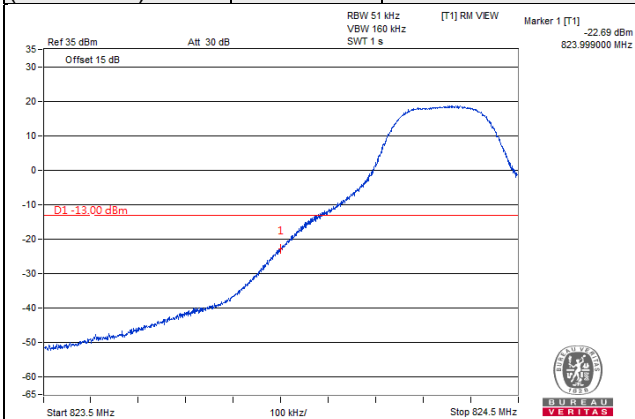

**Channel Bandwidth 10MHz**

**Channel 20450  
(829.0MHz)**

**QPSK**

**1 RB / 0 RB Offset**

**Channel 20600  
(844.0MHz)**

**QPSK**

**1 RB / 49 RB Offset**

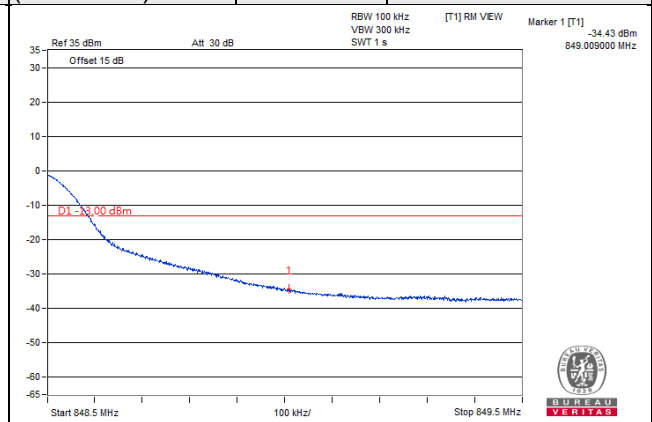
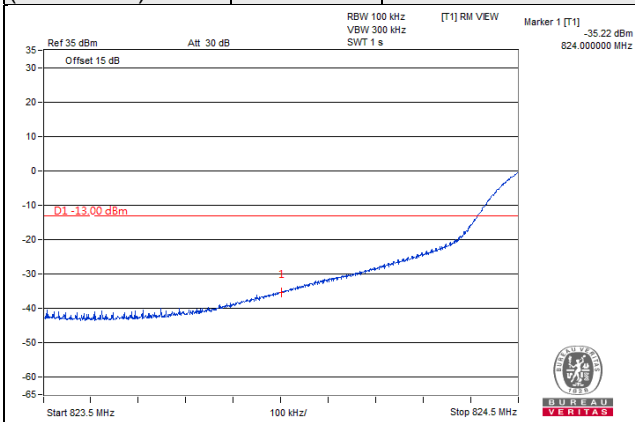

**Channel 20450  
(829.0MHz)**

**QPSK**

**50 RB / 0 RB Offset**

**Channel 20600  
(844.0MHz)**

**QPSK**

**50 RB / 0 RB Offset**

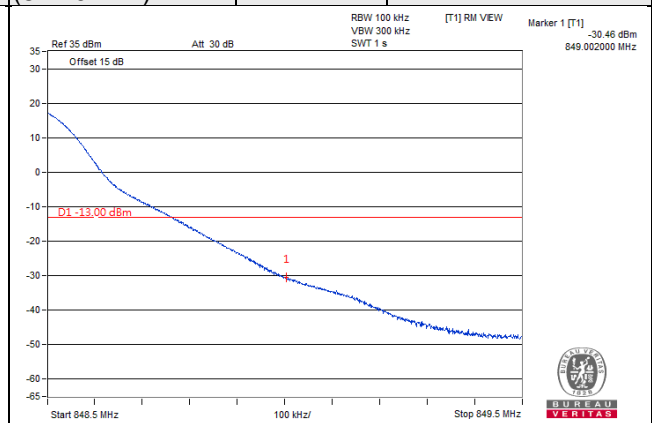
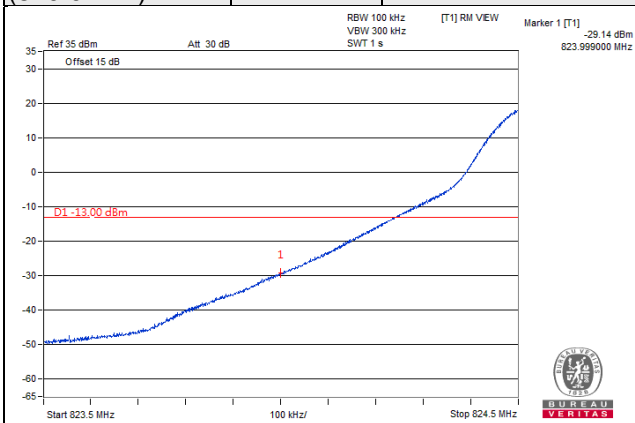

LTE Band 12

Channel Bandwidth: 1.4MHz

Channel 23017 (699.7MHz)	QPSK	1 RB / 0 RB Offset	Channel 23173 (715.3MHz)	QPSK	1 RB / 5 RB Offset
-----------------------------	------	--------------------	-----------------------------	------	--------------------

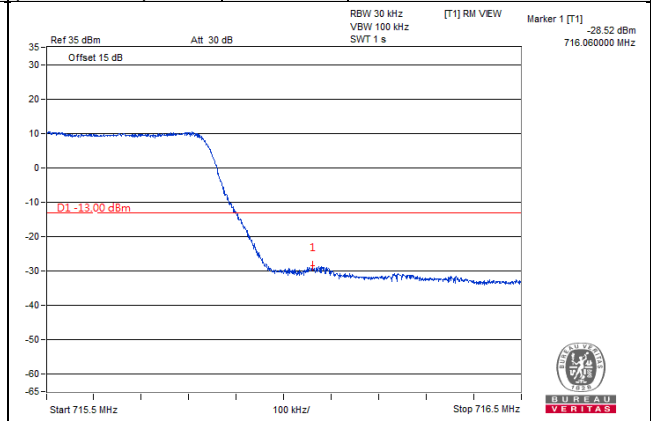
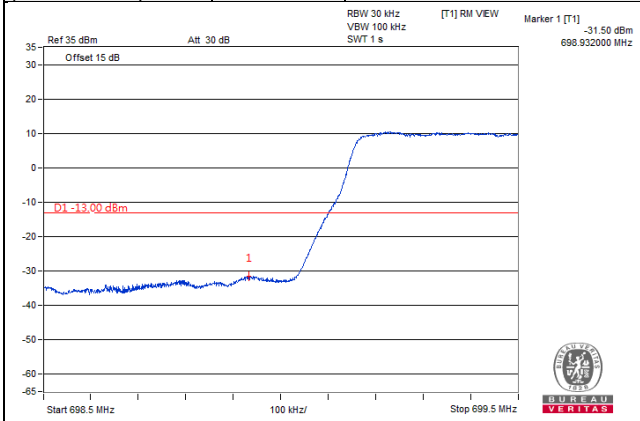

Channel 23017 (699.7MHz)	QPSK	6 RB / 0 RB Offset	Channel 23173 (715.3MHz)	QPSK	6 RB / 0 RB Offset
-----------------------------	------	--------------------	-----------------------------	------	--------------------

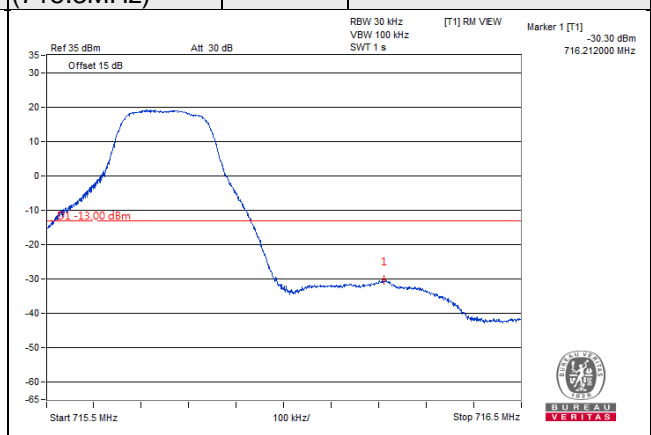
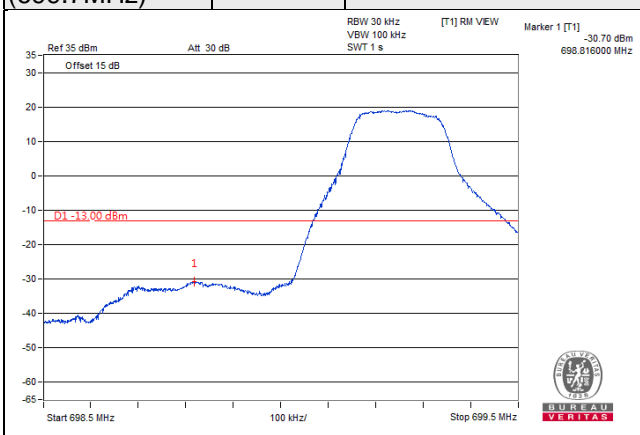



**Channel Bandwidth: 3MHz**

**Channel 23025  
(700.5MHz)**

**QPSK**

**1 RB / 0 RB Offset**

**Channel 23165  
(714.5MHz)**

**QPSK**

**1 RB / 14RB Offset**

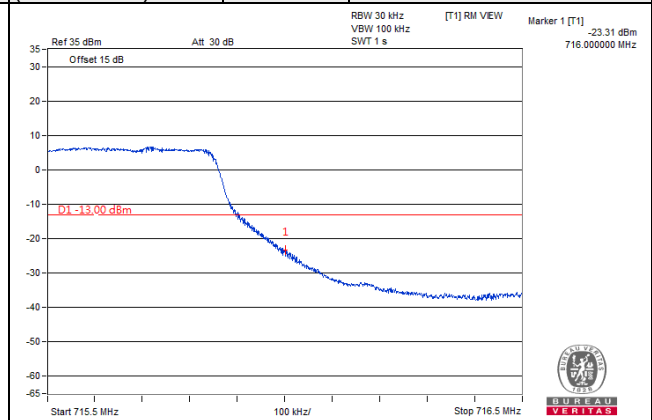
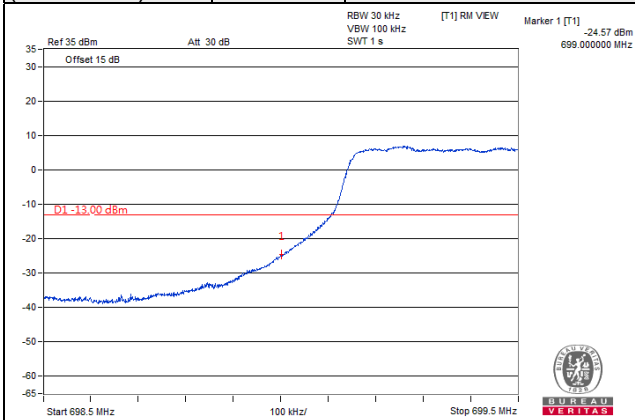

**Channel 23025  
(700.5MHz)**

**QPSK**

**15 RB / 0 RB Offset**

**Channel 23165  
(714.5MHz)**

**QPSK**

**15 RB / 0 RB Offset**

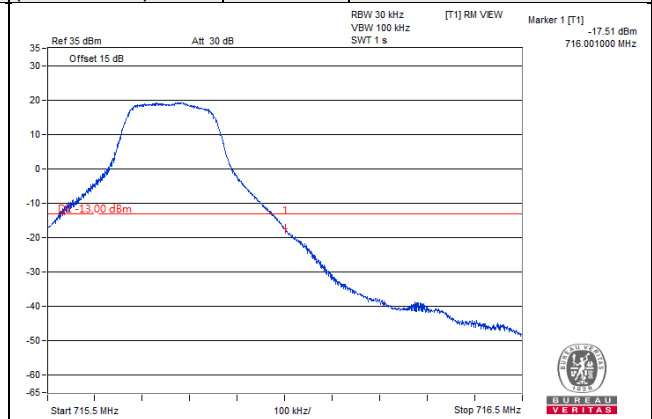
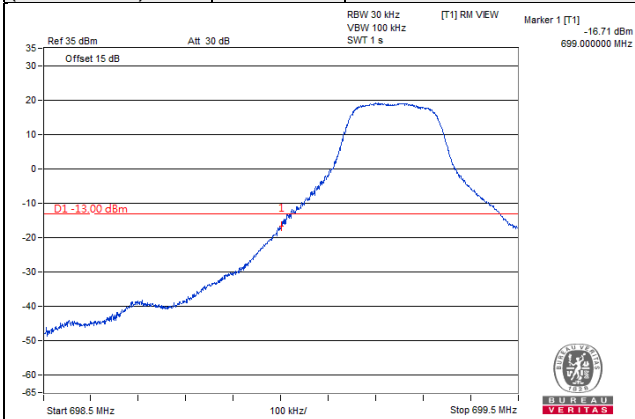

**Channel Bandwidth: 5MHz**

**Channel 23035  
(701.5MHz)**

**QPSK**

**1 RB / 0 RB Offset**

**Channel 23155  
(713.5MHz)**

**QPSK**

**1 RB / 24RB Offset**

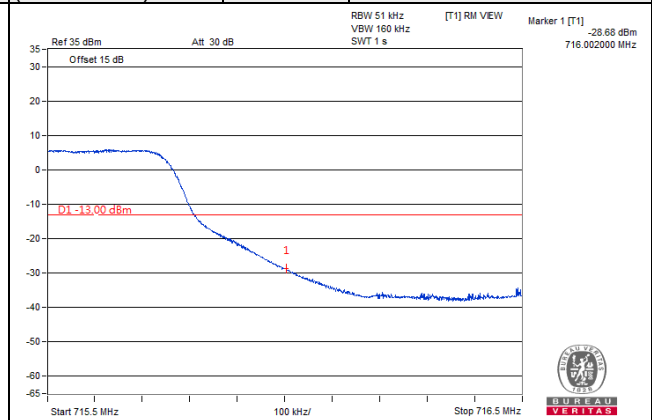
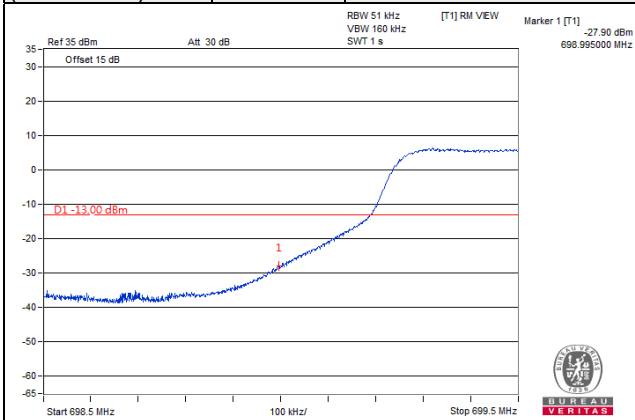

**Channel 23035  
(701.5MHz)**

**QPSK**

**25 RB / 0 RB Offset**

**Channel 23155  
(713.5MHz)**

**QPSK**

**25 RB / 0 RB Offset**

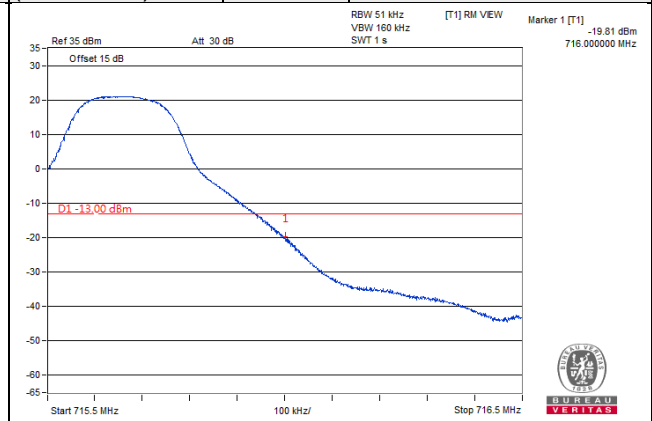
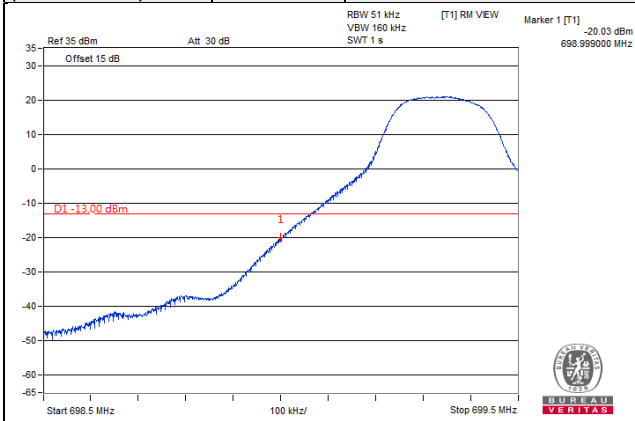

Channel Bandwidth: 10MHz

Channel 23060  
(704MHz)

QPSK

1 RB / 0 RB Offset

Channel 23130  
(711MHz)

QPSK

1 RB / 24RB Offset

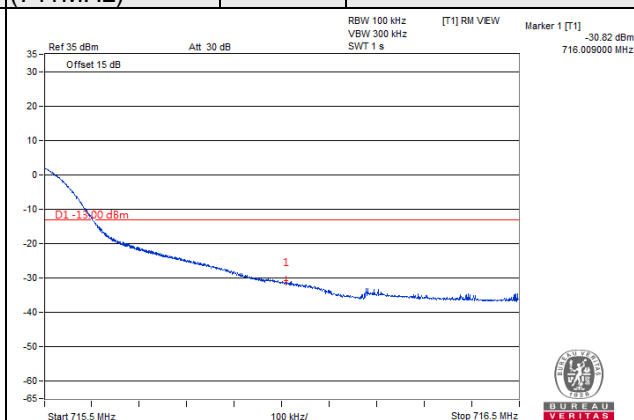
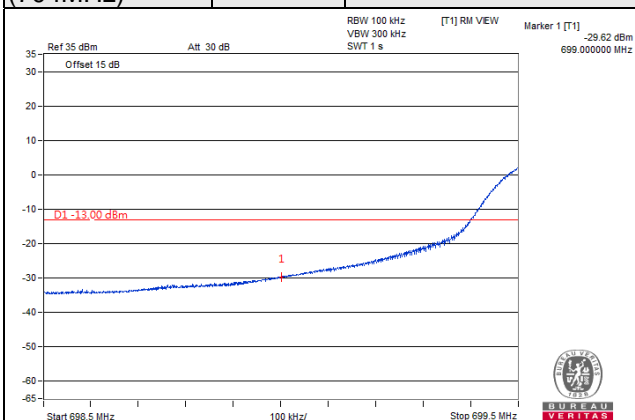

Channel 23060  
(704MHz)

QPSK

50 RB / 0 RB Offset

Channel 23130  
(711MHz)

QPSK

25 RB / 0 RB Offset

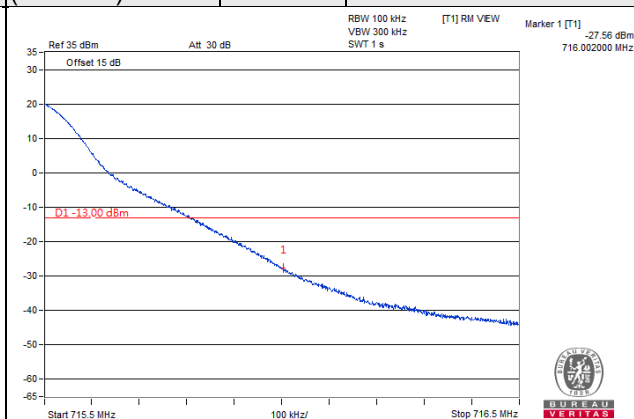
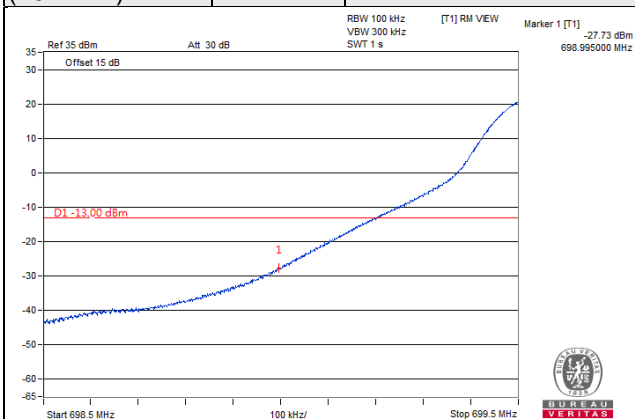

## 4.6 Peak to Average Ratio

### 4.6.1 Limits of Peak to Average Ratio Measurement

In measuring transmissions in this band using an average power technique, the peak to-average ratio (PAR) of the transmission may not exceed 13 dB

### 4.6.2 Test Setup

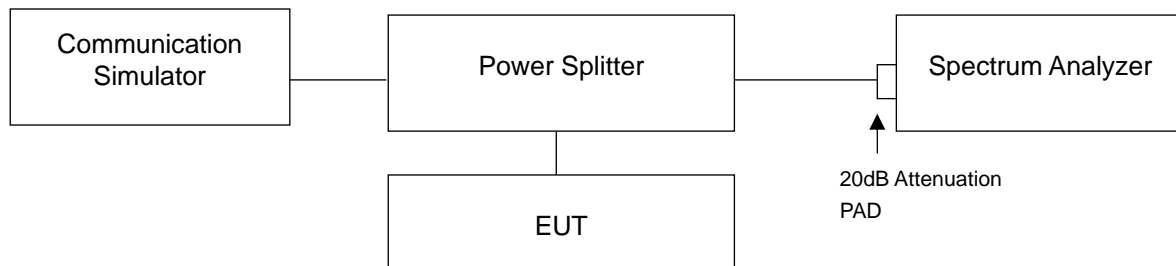

### 4.6.3 Test Procedures

- Set resolution/measurement bandwidth  $\geq$  signal's occupied bandwidth;
- Set the number of counts to a value that stabilizes the measured CCDF curve;
- Record the maximum PAPR level associated with a probability of 0.1%.

#### 4.6.4 Test Results

n7

n7, Channel Bandwidth 5MHz						
Channel	Frequency (MHz)	Peak To Average Ratio (dB)				
		$\pi/2$ BPSK	QPSK	16QAM	64QAM	256QAM
500500	2502.5	4.18	3.60	5.34	5.43	8.54
507000	2535.0	4.23	3.61	5.34	5.49	8.37
513500	2567.5	4.22	3.36	4.13	4.18	8.20
n7, Channel Bandwidth 10MHz						
Channel	Frequency (MHz)	Peak To Average Ratio (dB)				
		$\pi/2$ BPSK	QPSK	16QAM	64QAM	256QAM
501000	2505.0	4.23	3.53	5.16	5.32	8.30
507000	2535.0	4.26	3.66	5.25	5.44	8.30
513000	2565.0	4.34	3.31	4.07	4.12	8.34
n7, Channel Bandwidth 15MHz						
Channel	Frequency (MHz)	Peak To Average Ratio (dB)				
		$\pi/2$ BPSK	QPSK	16QAM	64QAM	256QAM
501500	2507.5	4.33	3.62	4.95	5.01	8.73
507000	2535.0	4.41	3.47	5.22	5.26	8.49
512500	2562.5	4.43	3.30	3.94	4.10	8.53
n7, Channel Bandwidth 20MHz						
Channel	Frequency (MHz)	Peak To Average Ratio (dB)				
		$\pi/2$ BPSK	QPSK	16QAM	64QAM	256QAM
502000	2510.0	4.40	3.61	5.08	5.42	8.90
507000	2535.0	4.36	3.40	5.17	5.17	8.62
512000	2560.0	4.40	3.27	3.96	4.11	8.77

### Spectrum Plot of Worst Value

#### 5MHz / 256QAM



#### 10MHz / 256QAM



#### 15MHz / 256QAM



#### 20MHz / 256QAM



LTE Band 5

LTE Band 5, Channel Bandwidth 1.4MHz				
Channel	Frequency (MHz)	Peak To Average Ratio (dB)		
		QPSK	16QAM	64QAM
20407	824.7	4.12	5.40	5.47
20525	836.5	3.94	5.17	5.26
20643	848.3	3.50	4.22	4.30
LTE Band 5, Channel Bandwidth 3MHz				
Channel	Frequency (MHz)	Peak To Average Ratio (dB)		
		QPSK	16QAM	64QAM
20415	825.5	3.92	4.76	4.87
20525	836.5	3.84	4.56	4.91
20635	847.5	3.51	4.23	4.32
LTE Band 5, Channel Bandwidth 5MHz				
Channel	Frequency (MHz)	Peak To Average Ratio (dB)		
		QPSK	16QAM	64QAM
20425	826.5	3.81	5.29	5.16
20525	836.5	3.79	4.97	5.26
20625	846.5	3.72	5.05	5.08
LTE Band 5, Channel Bandwidth 10MHz				
Channel	Frequency (MHz)	Peak To Average Ratio (dB)		
		QPSK	16QAM	64QAM
20450	829.0	3.78	5.56	5.58
20525	836.5	3.98	5.45	5.70
20600	844.0	3.72	5.32	5.43

### Spectrum Plot of Worst Value

**1.4MHz / 64QAM**



**3MHz / 64QAM**



**5MHz / 16QAM**

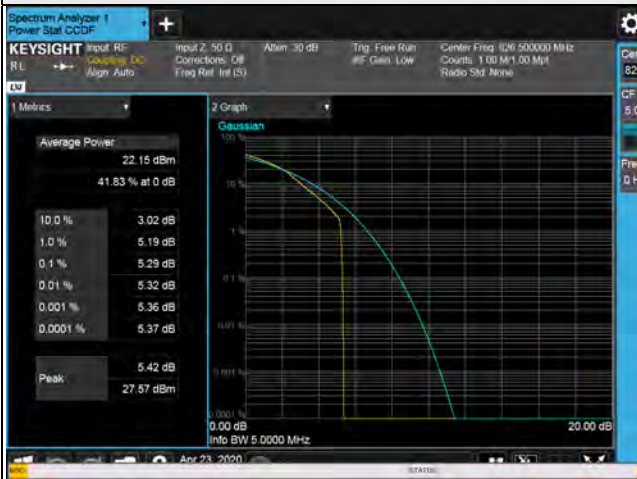

**10MHz / 64QAM**

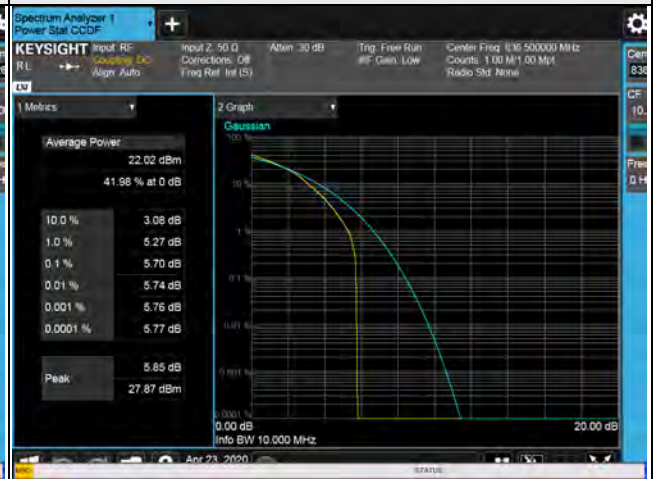



LTE Band 12

LTE Band 12, Channel Bandwidth 1.4MHz				
Channel	Frequency (MHz)	Peak To Average Ratio (dB)		
		QPSK	16QAM	64QAM
23017	699.7	3.73	4.53	4.74
23095	707.5	3.59	5.10	5.20
23173	715.3	3.63	4.45	4.49
LTE Band 12, Channel Bandwidth 3MHz				
Channel	Frequency (MHz)	Peak To Average Ratio (dB)		
		QPSK	16QAM	64QAM
23025	700.5	3.49	4.36	4.54
23095	707.5	3.42	5.09	5.13
23165	714.5	3.46	4.60	4.64
LTE Band 12, Channel Bandwidth 5MHz				
Channel	Frequency (MHz)	Peak To Average Ratio (dB)		
		QPSK	16QAM	64QAM
23035	701.5	3.50	4.38	4.48
23095	707.5	3.44	4.99	5.08
23155	713.5	3.53	4.99	5.05
LTE Band 12, Channel Bandwidth 10MHz				
Channel	Frequency (MHz)	Peak To Average Ratio (dB)		
		QPSK	16QAM	64QAM
23060	704.0	3.26	4.74	4.71
23095	707.5	3.27	4.77	4.86
23130	711.0	3.57	5.17	5.19

### Spectrum Plot of Worst Value

1.4MHz / 64QAM

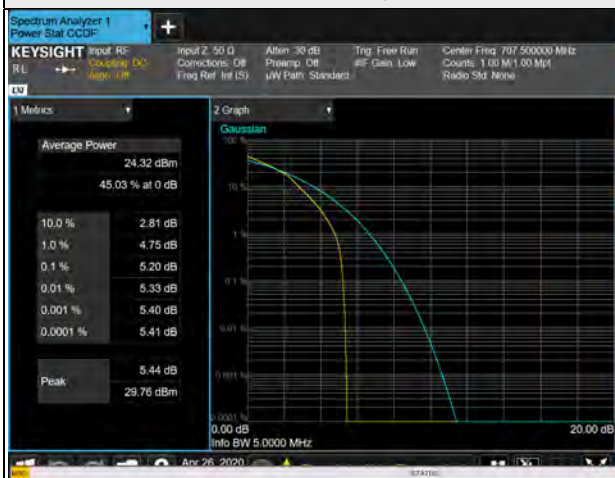

3MHz / 16QAM

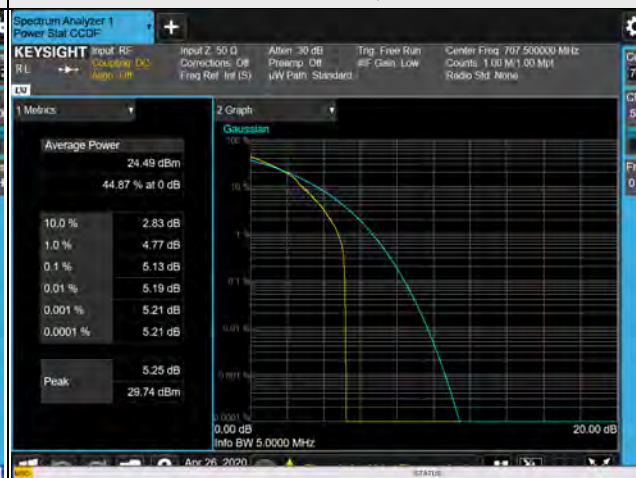

5MHz / 64QAM

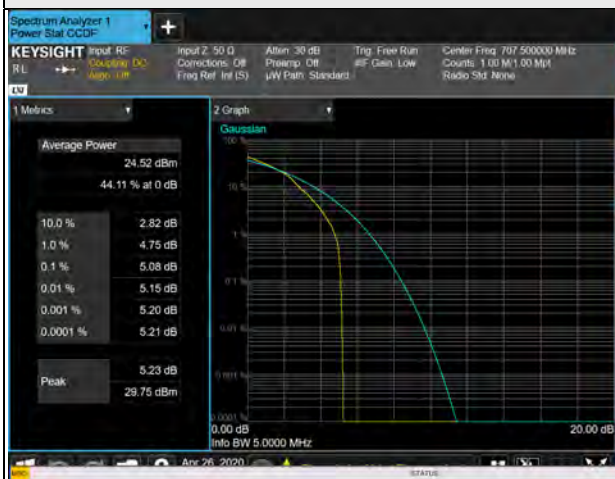

10MHz / 64QAM

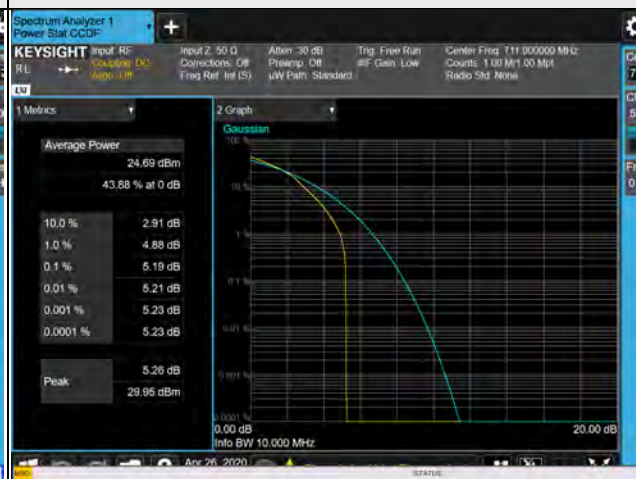

## 4.7 Conducted Spurious Emissions

### 4.7.1 Limits of Conducted Spurious Emissions Measurement

For LTE Band 5

The power of any emission outside of the authorized operating frequency ranges must be attenuated below the transmitting power (P) by a factor of at least  $43 + 10 \log(P)$  dB. The emission limit equal to  $-13\text{dBm}$ .

For LTE Band 12

According to FCC 27.53(g) for operations in the 600 MHz band and the 698-746 MHz band, the power of any emission outside a licensee's frequency band(s) of operation shall be attenuated below the transmitter power (P) within the licensed band(s) of operation, measured in watts, by at least  $43 + 10 \log(P)$  dB. Compliance with this provision is based on the use of measurement instrumentation employing a resolution bandwidth of 100 kilohertz or greater.

### 4.7.2 Test Setup

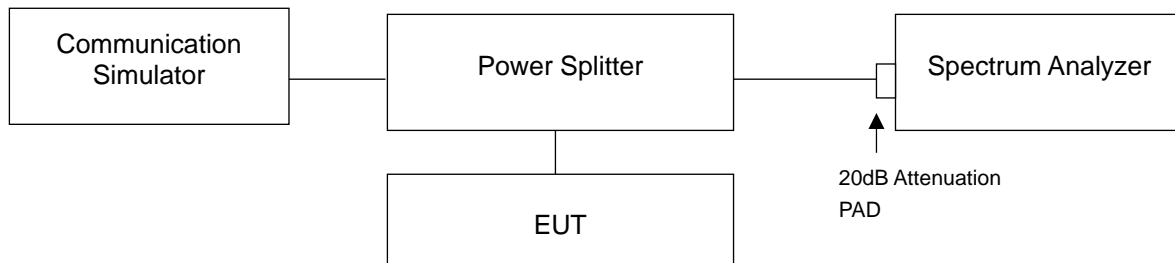

### 4.7.3 Test Procedure

- The EUT makes a phone call to the communication simulator. All measurements were done at low, middle and high operational frequency range.
- Measuring frequency range is from 9kHz to 8GHz / 9GHz / 26GHz. 20dB attenuation pad is connected with spectrum. RBW=1MHz and VBW=3MHz is used for conducted emission measurement.

### 4.7.4 Test Results

n7

Channel Band width: 5MHz

Channel 500500(2502.5MHz)

Frequency Range : 9kHz~1GHz

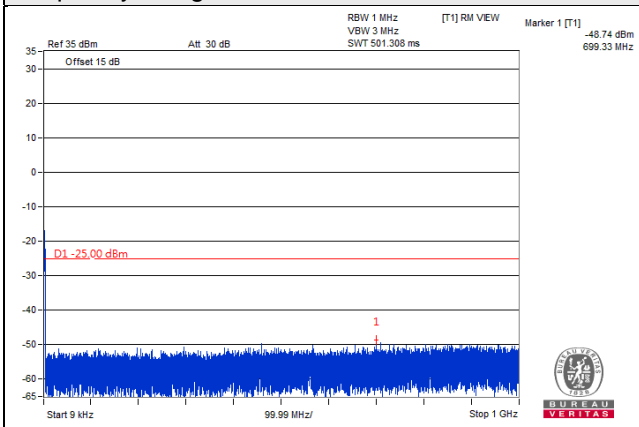

Frequency Range : 1GHz~3GHz

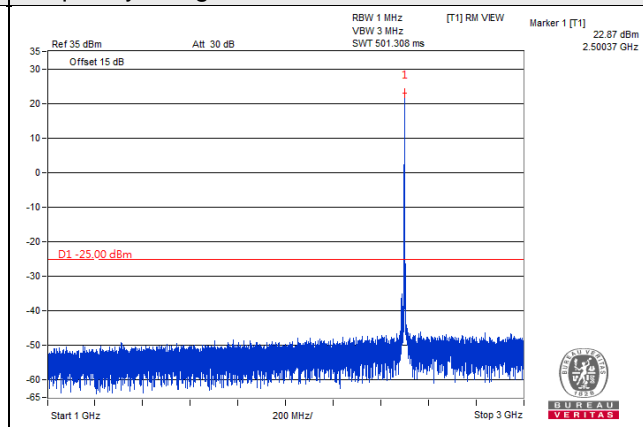

Frequency Range : 3GHz~26GHz

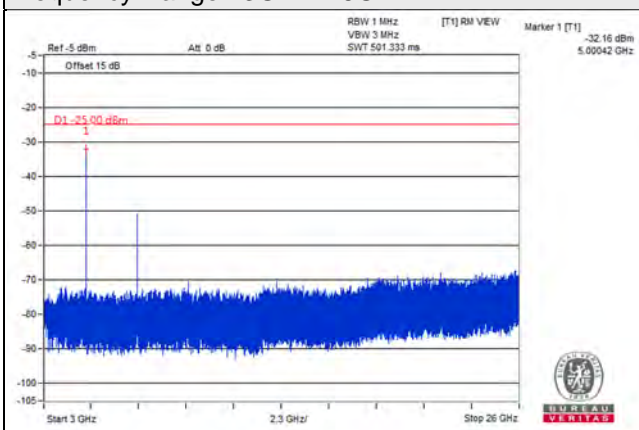

\*The 9kHz signal over the limit is from Spectrum.

Channel Band width: 5MHz

Channel 507000(2535MHz)

Frequency Range : 9kHz~1GHz

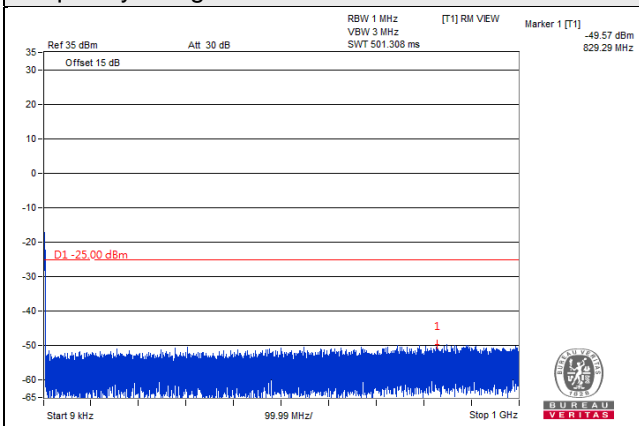

Frequency Range : 1GHz~3GHz

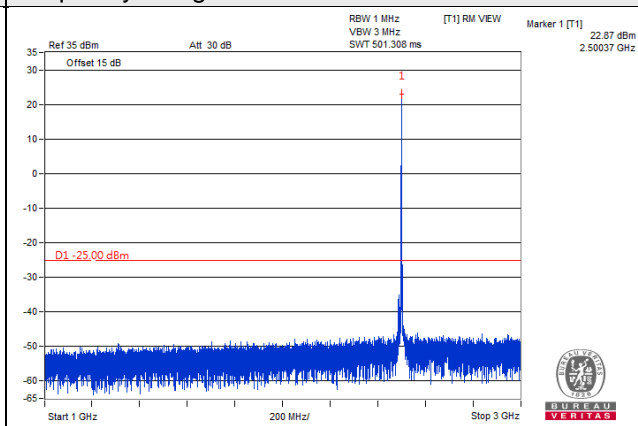

Frequency Range : 3GHz~26GHz

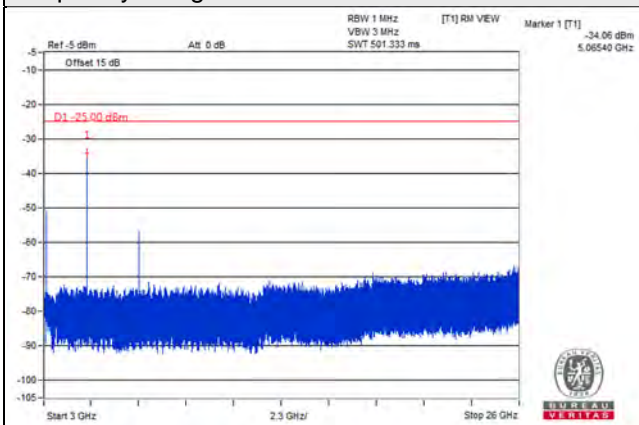

\*The 9kHz signal over the limit is from Spectrum.

Channel Band width: 5MHz

Channel 513500(2567.5MHz)

Frequency Range : 9kHz~1GHz

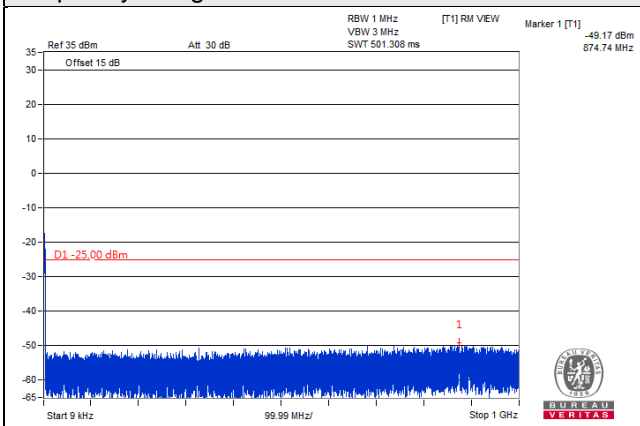

Frequency Range : 1GHz~3GHz

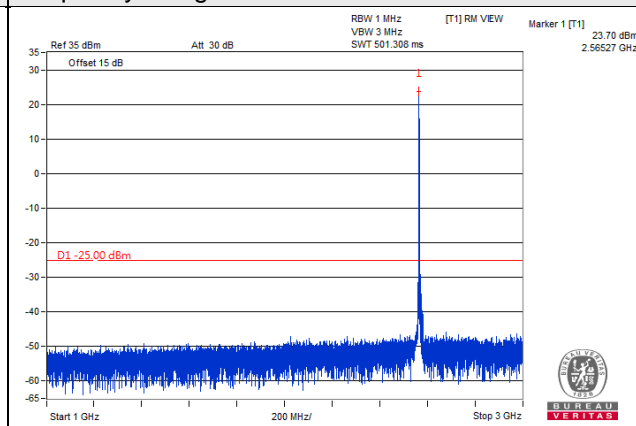

Frequency Range : 3GHz~26GHz

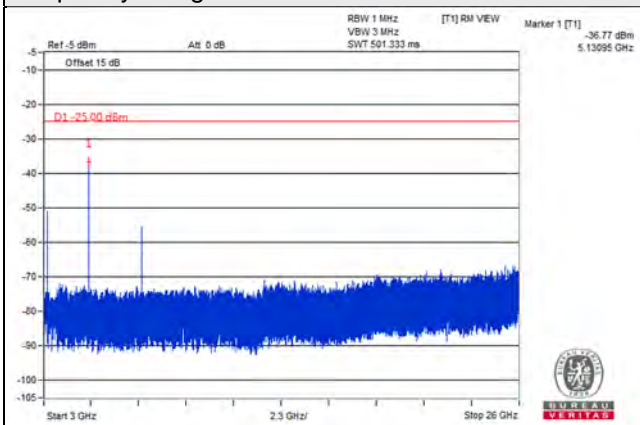

\*The 9kHz signal over the limit is from Spectrum.

Channel Band width: 10MHz

Channel 501000(2505MHz)

Frequency Range : 9kHz~1GHz

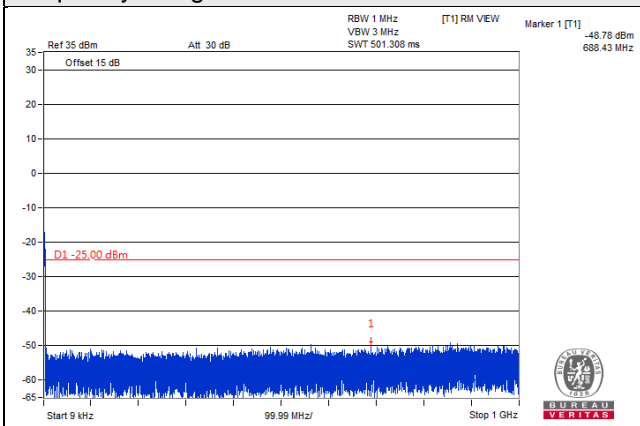

Frequency Range : 1GHz~3GHz

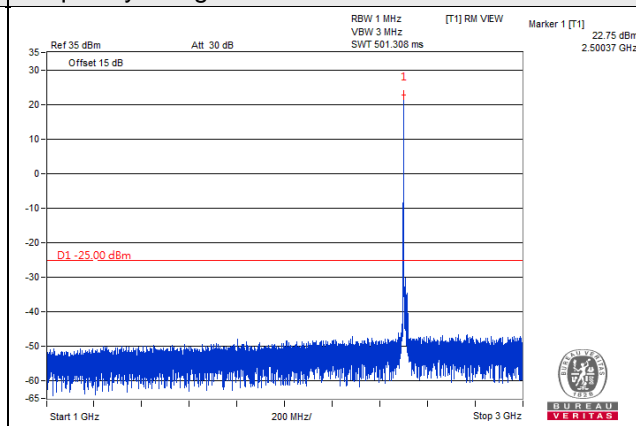

Frequency Range : 3GHz~26GHz

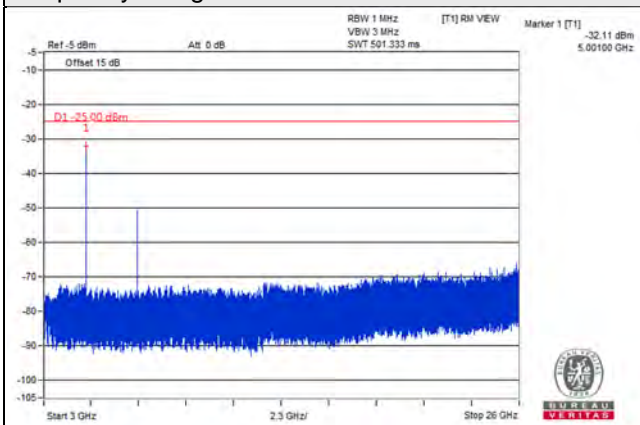

\*The 9kHz signal over the limit is from Spectrum.

Channel Band width: 10MHz

Channel 507000(2535MHz)

Frequency Range : 9kHz~1GHz

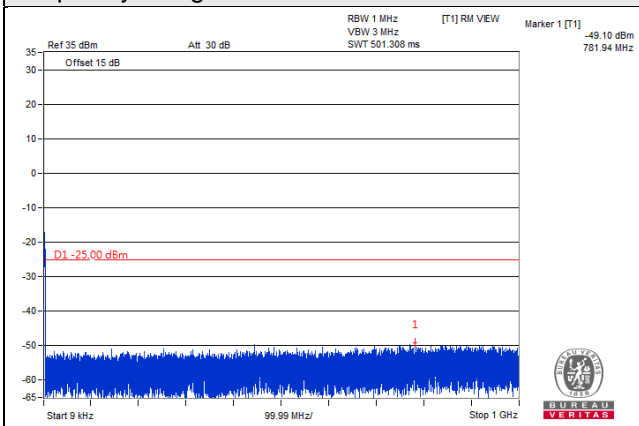

Frequency Range : 1GHz~3GHz

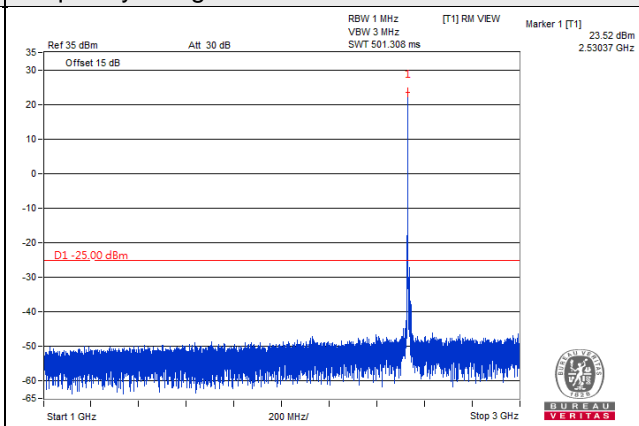

Frequency Range : 3GHz~26GHz

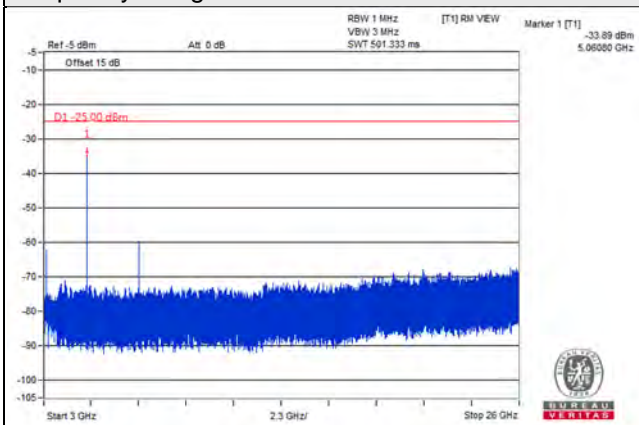

\*The 9kHz signal over the limit is from Spectrum.



Channel Band width: 10MHz

Channel 513000(2565MHz)

Frequency Range : 9kHz~1GHz

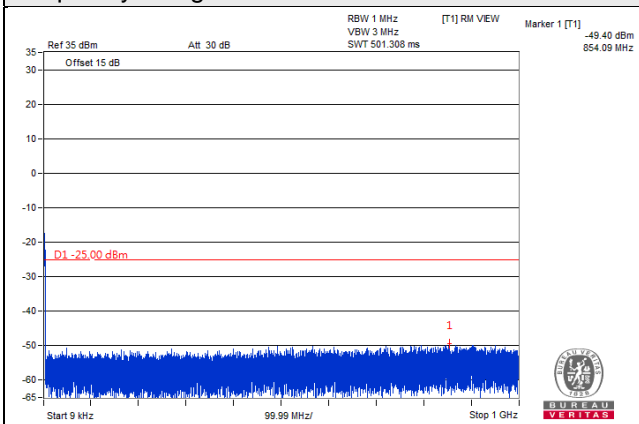

Frequency Range : 1GHz~3GHz

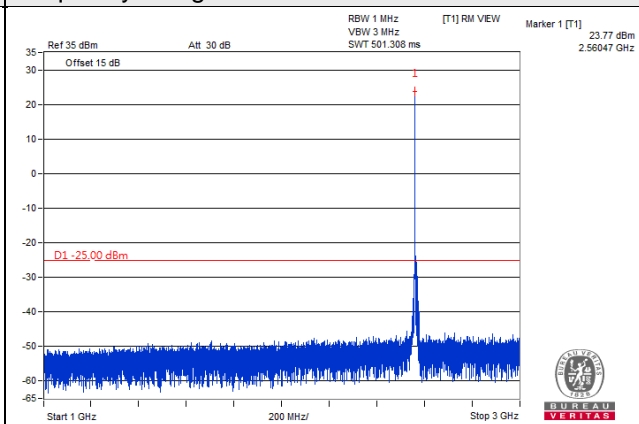

Frequency Range : 3GHz~26GHz

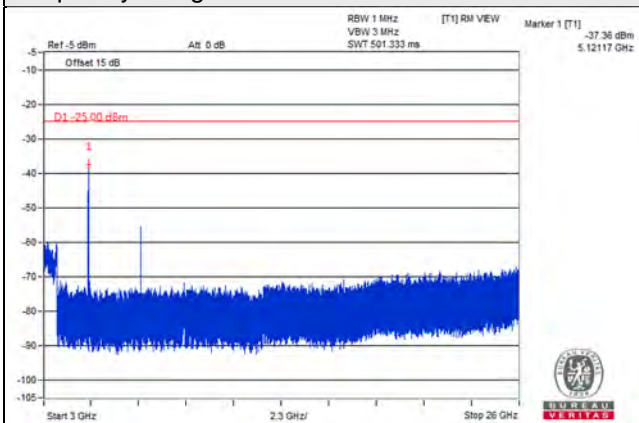

\*The 9kHz signal over the limit is from Spectrum.

Channel Band width: 15MHz

Channel 501500(2507.5MHz)

Frequency Range : 9kHz~1GHz

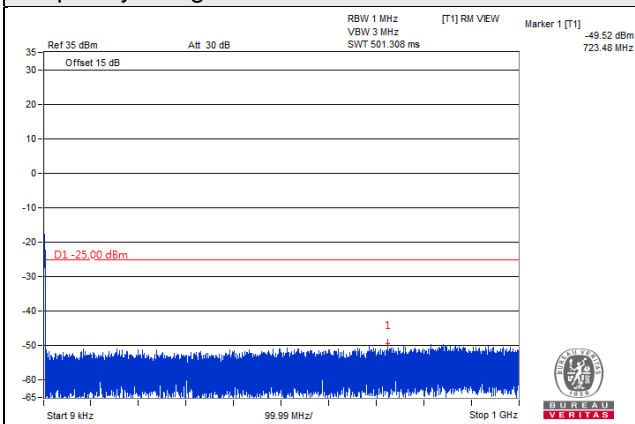

Frequency Range : 1GHz~3GHz

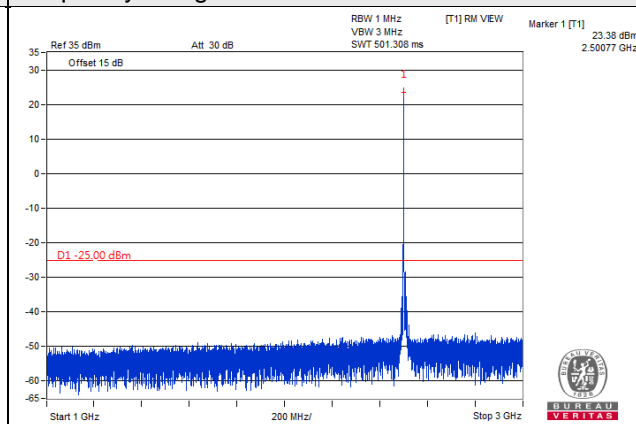

Frequency Range : 3GHz~26GHz

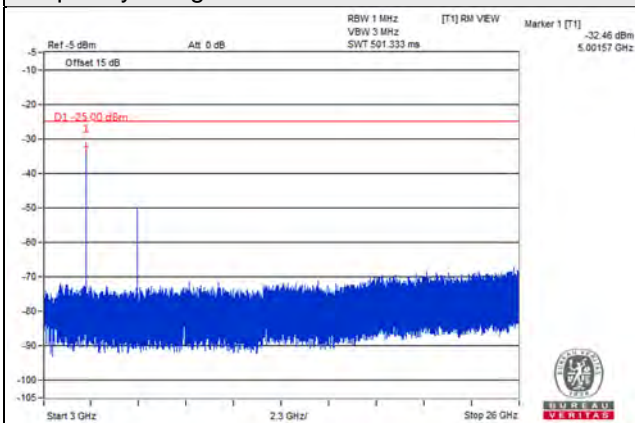

\*The 9kHz signal over the limit is from Spectrum.

Channel Band width: 15MHz

Channel 507000(2535MHz)

Frequency Range : 9kHz~1GHz

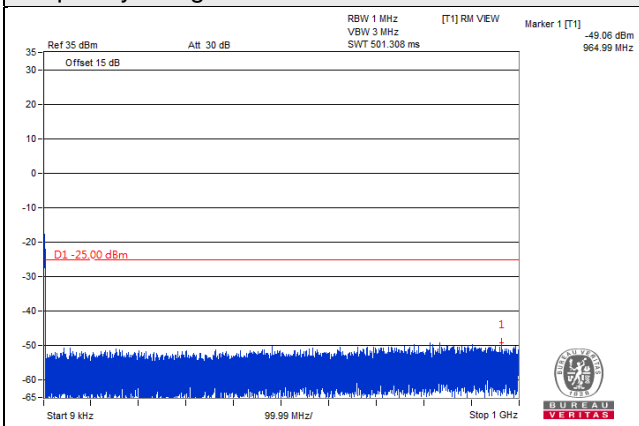

Frequency Range : 1GHz~3GHz

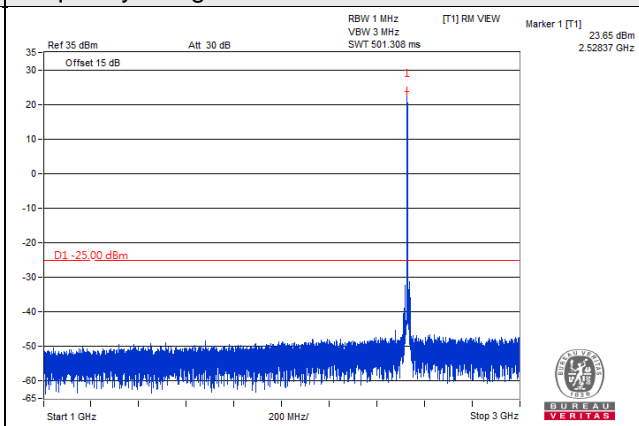

Frequency Range : 3GHz~26GHz

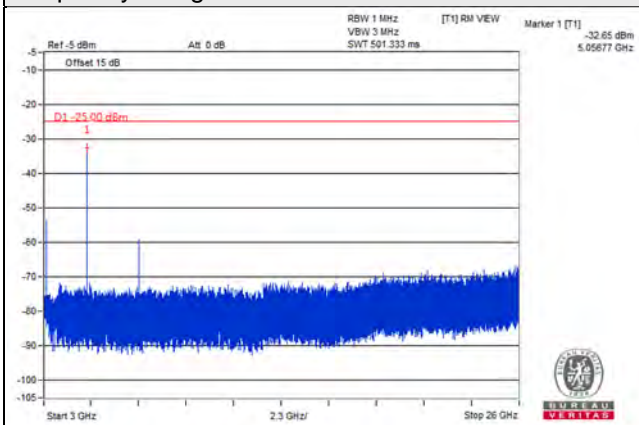

\*The 9kHz signal over the limit is from Spectrum.

Channel Band width: 15MHz

Channel 512500(2562.5MHz)

Frequency Range : 9kHz~1GHz

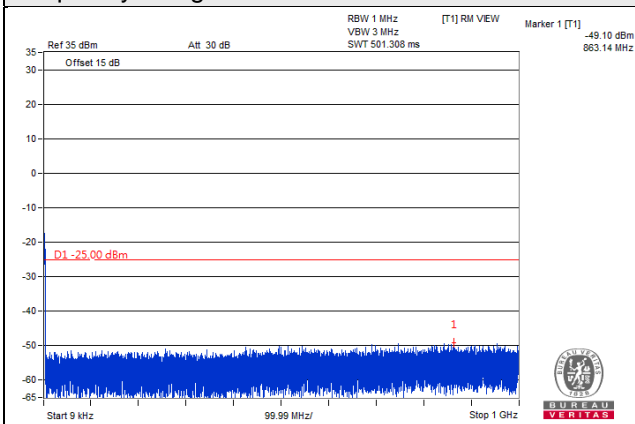

Frequency Range : 1GHz~3GHz

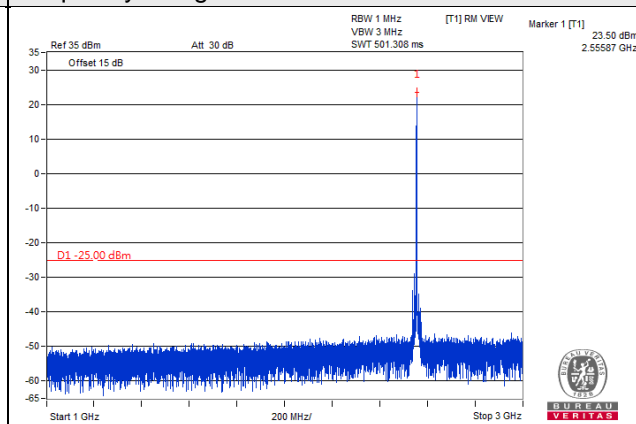

Frequency Range : 3GHz~26GHz

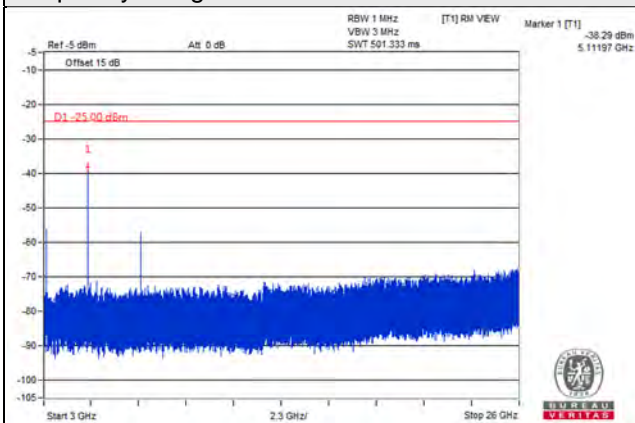

\*The 9kHz signal over the limit is from Spectrum.

Channel Band width: 20MHz

Channel 502000(2510MHz)

Frequency Range : 9kHz~1GHz

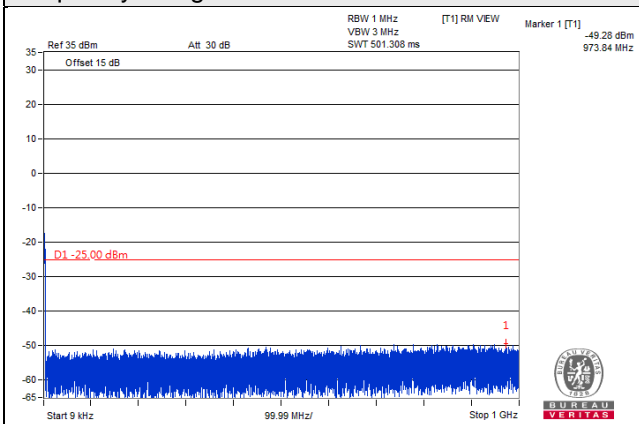

Frequency Range : 1GHz~3GHz

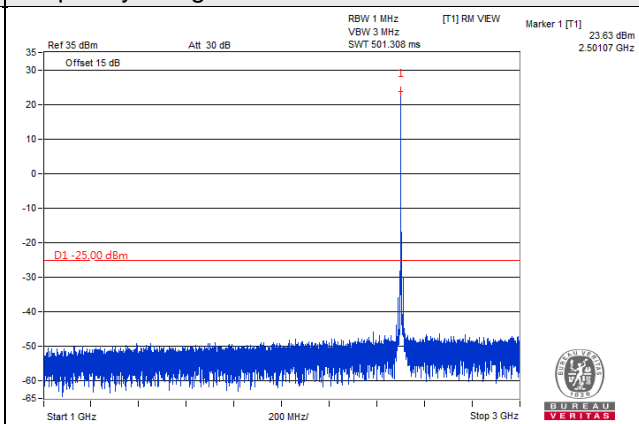

Frequency Range : 3GHz~26GHz

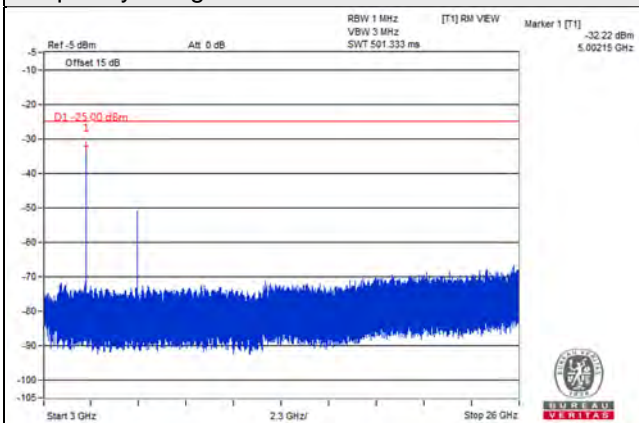

\*The 9kHz signal over the limit is from Spectrum.

Channel Band width: 20MHz

Channel 507000(2535MHz)

Frequency Range : 9kHz~1GHz

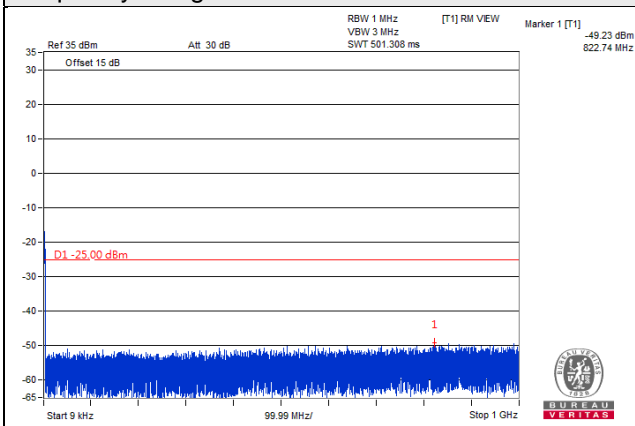

Frequency Range : 1GHz~3GHz

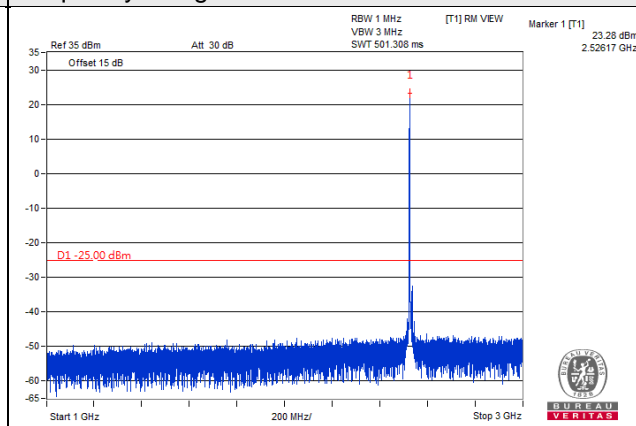

Frequency Range : 3GHz~26GHz

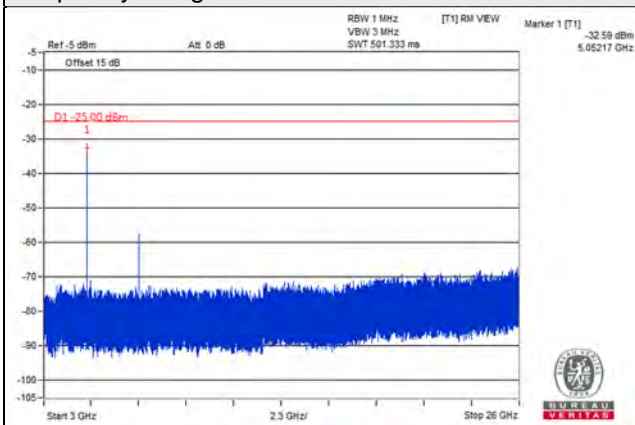

\*The 9kHz signal over the limit is from Spectrum.

Channel Band width: 20MHz

Channel 512000(2560MHz)

Frequency Range : 9kHz~1GHz

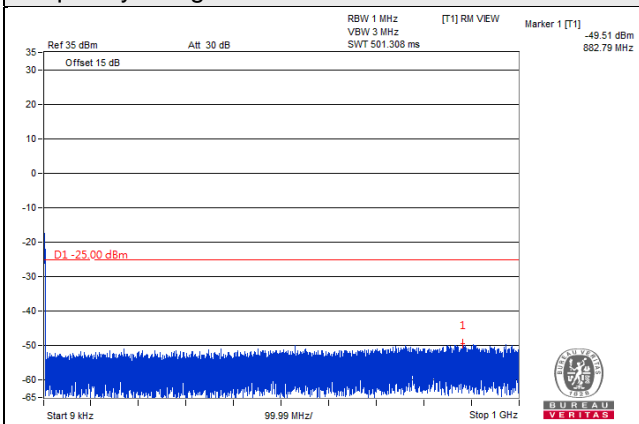

Frequency Range : 1GHz~3GHz

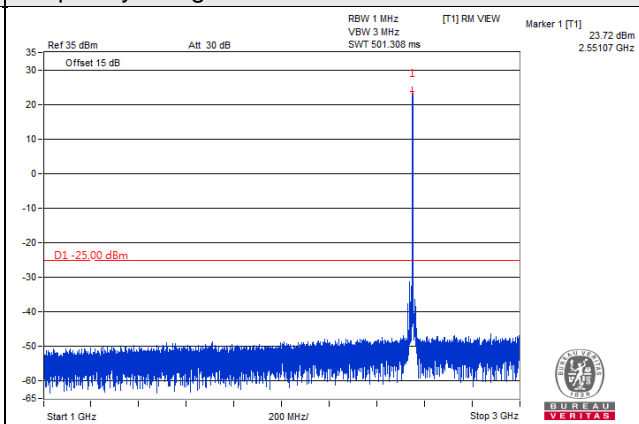

Frequency Range : 3GHz~26GHz

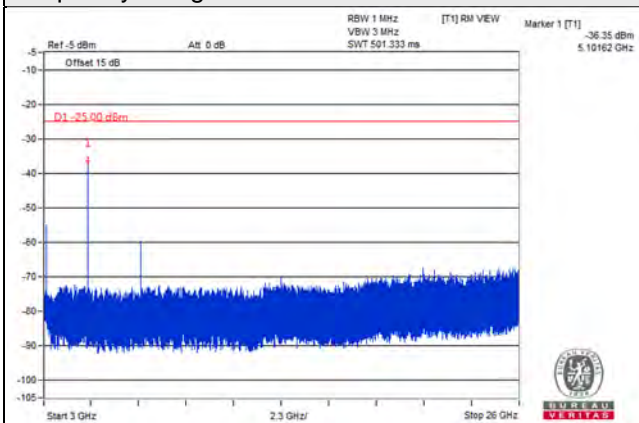

\*The 9kHz signal over the limit is from Spectrum.

LTE Band 5

Channel Bandwidth 1.4MHz

Channel 20407 (824.7MHz)

Frequency Range : 9kHz~1GHz

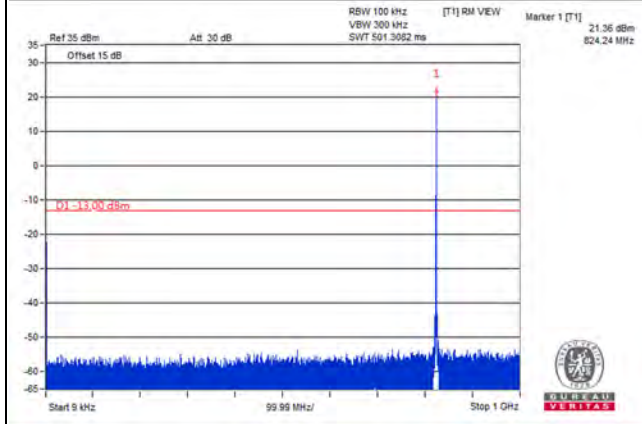

Frequency Range : 1GHz~9GHz

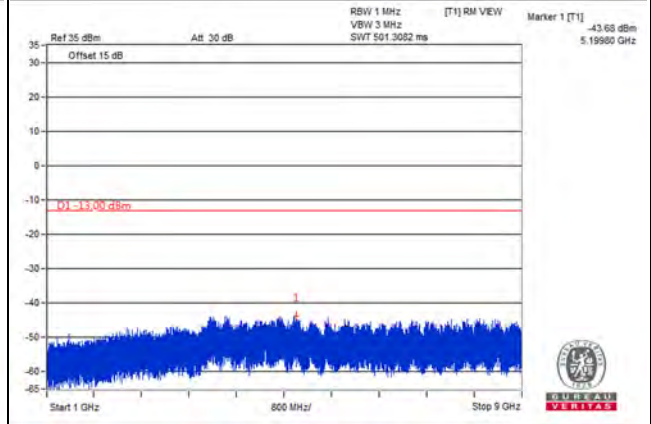

Channel 20525 (836.5MHz)

Frequency Range : 9kHz~1GHz

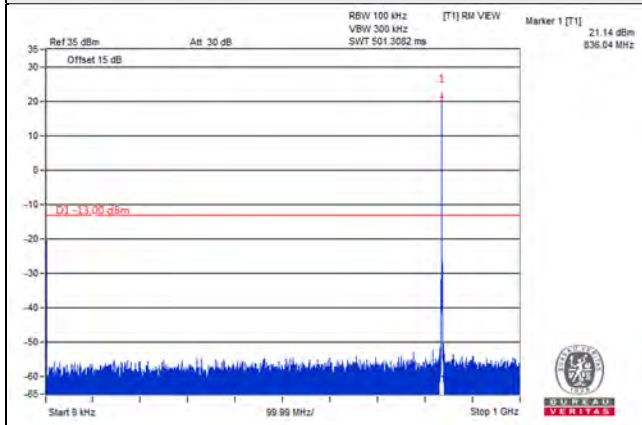

Frequency Range : 1GHz~9GHz

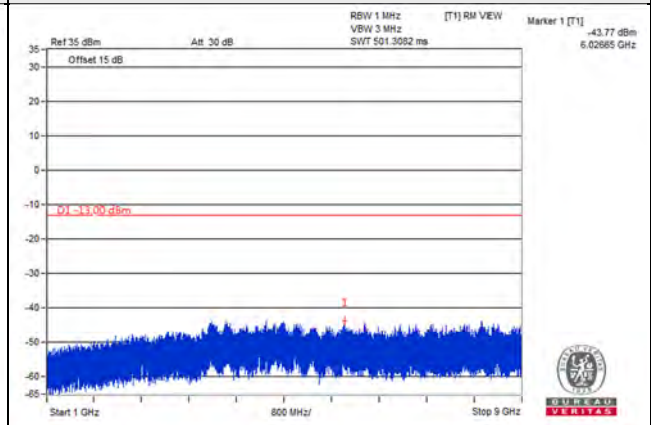

Channel 20643 (848.3MHz)

Frequency Range : 9kHz~1GHz

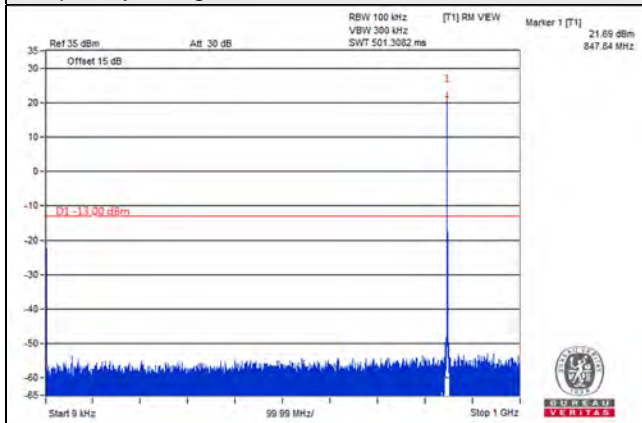

Frequency Range : 1GHz~9GHz

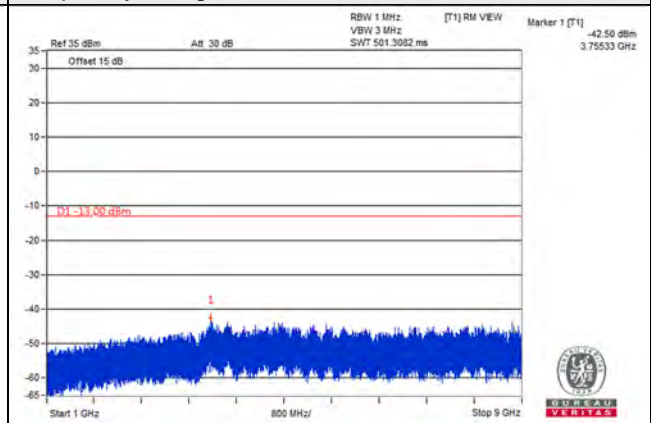

\*The 9kHz signal over the limit is from Spectrum.



Channel Bandwidth 3MHz

Channel 20415 (825.5MHz)

Frequency Range : 9kHz~1GHz      Frequency Range : 1GHz~9GHz

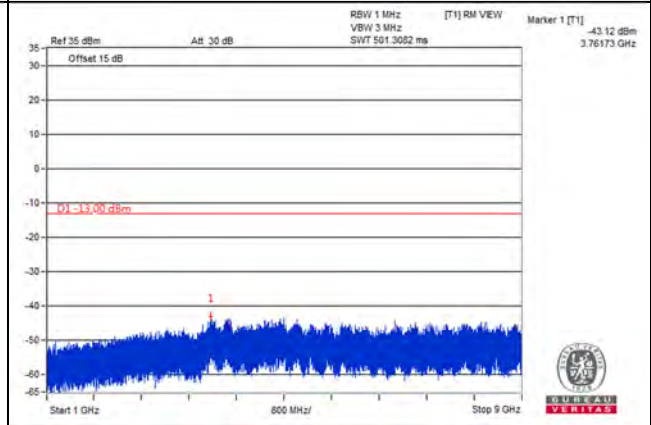
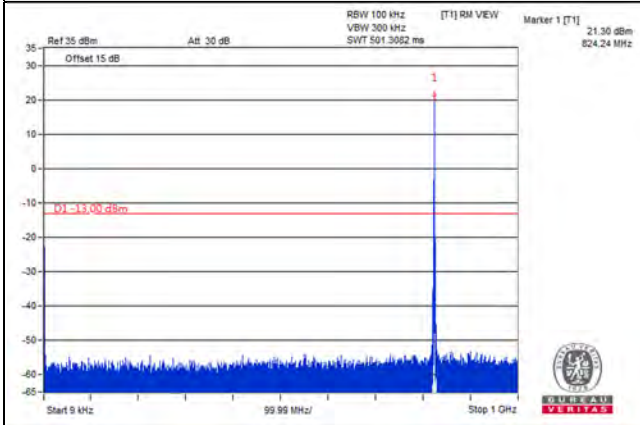

Channel 20525 (836.5MHz)

Frequency Range : 9kHz~1GHz      Frequency Range : 1GHz~9GHz

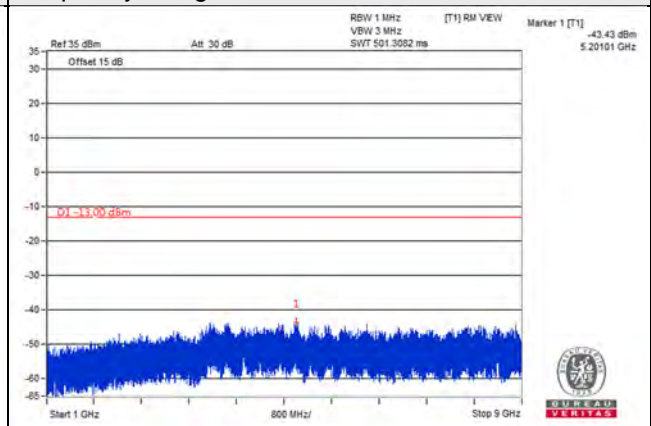
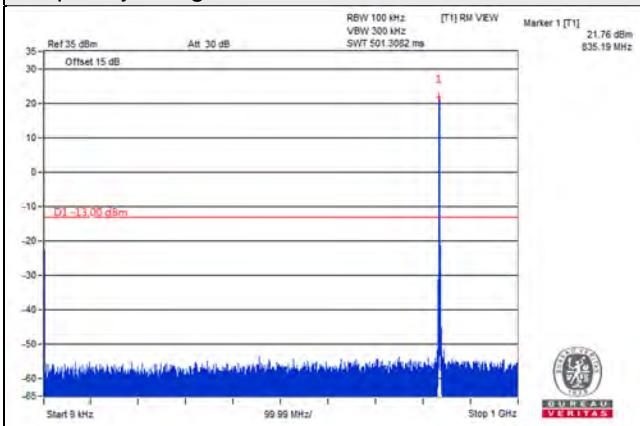

Channel 20635 (847.5MHz)

Frequency Range : 9kHz~1GHz      Frequency Range : 1GHz~9GHz

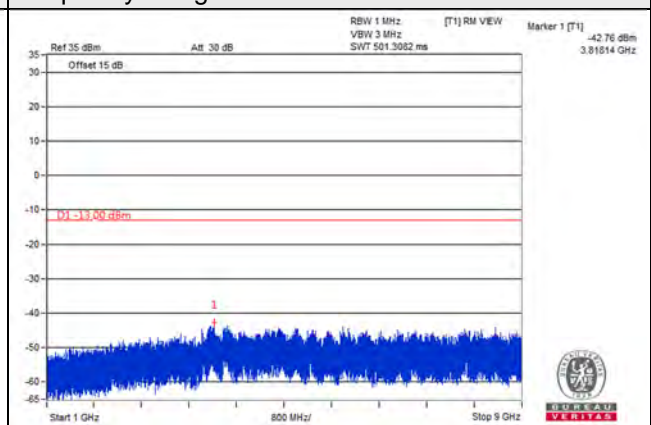
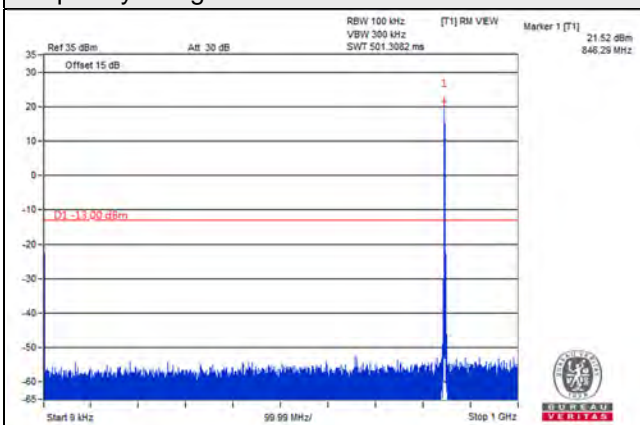

\*The 9kHz signal over the limit is from Spectrum.

Channel Bandwidth 5MHz

Channel 20425 (826.5MHz)

Frequency Range : 9kHz~1GHz      Frequency Range : 1GHz~9GHz

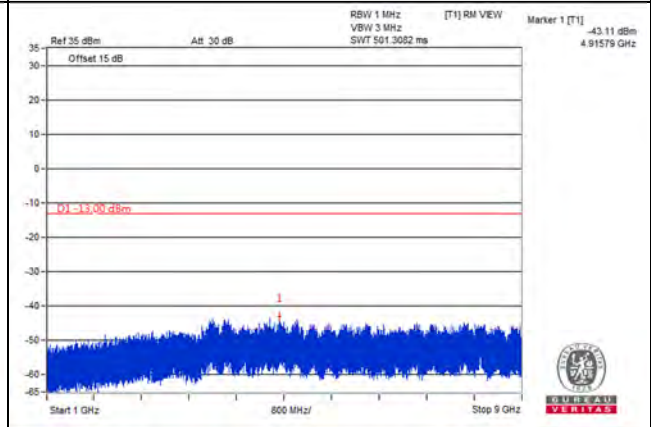
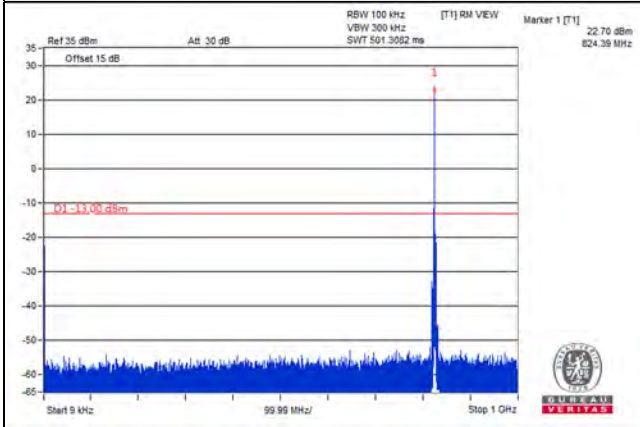

Channel 20525 (836.5MHz)

Frequency Range : 9kHz~1GHz      Frequency Range : 1GHz~9GHz

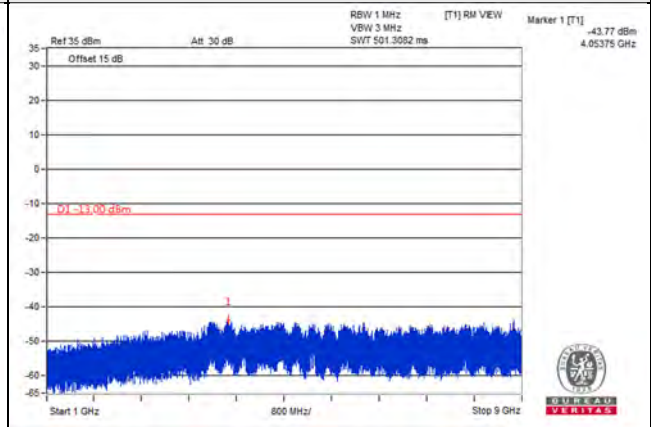
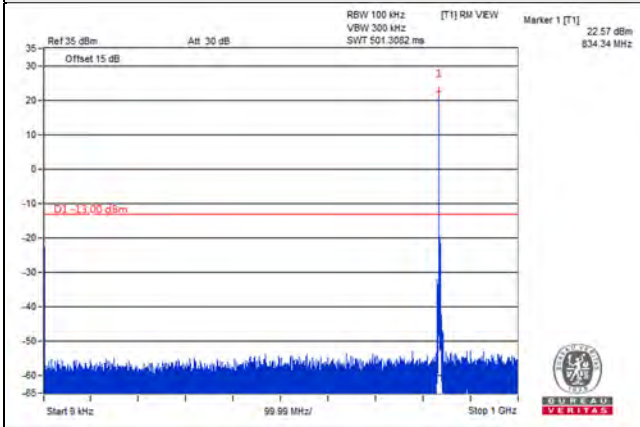

Channel 20625 (846.5MHz)

Frequency Range : 9kHz~1GHz      Frequency Range : 1GHz~9GHz

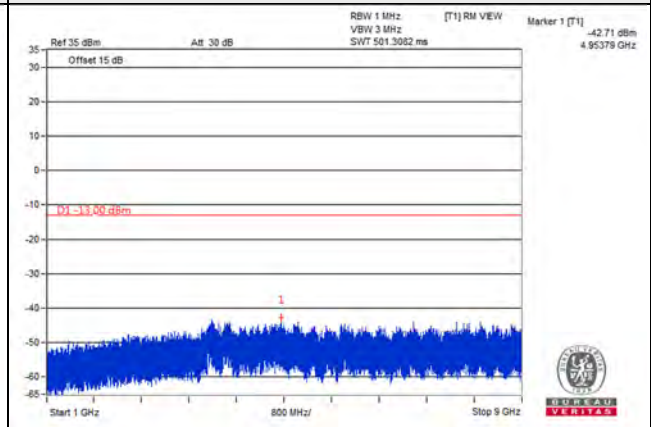
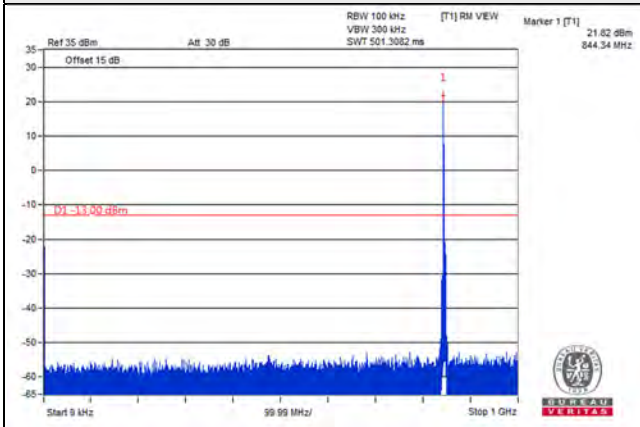

\*The 9kHz signal over the limit is from Spectrum.

Channel Bandwidth 10MHz

Channel 20450 (829.0MHz)

Frequency Range : 9kHz~1GHz

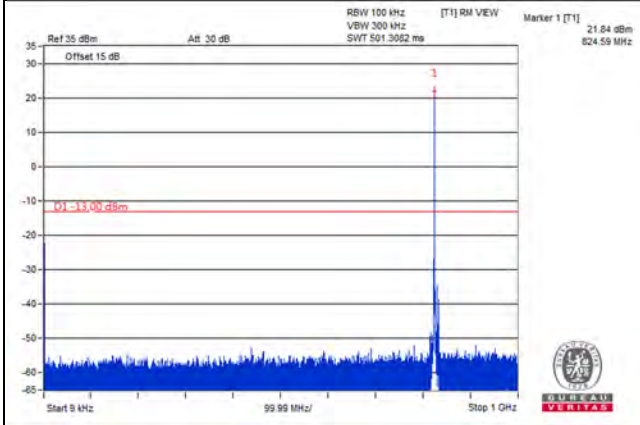

Frequency Range : 1GHz~9GHz

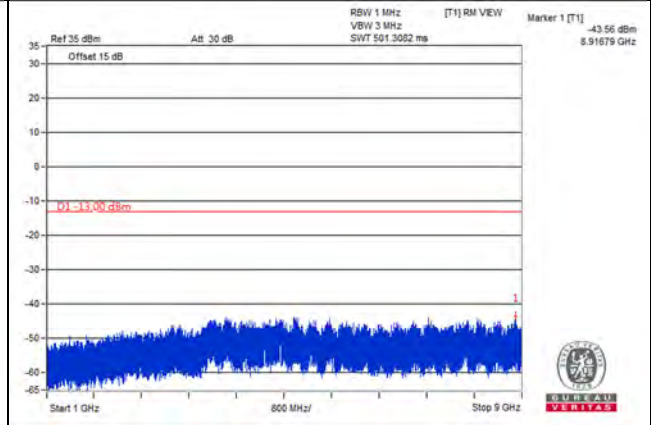

Channel 20525 (836.5MHz)

Frequency Range : 9kHz~1GHz

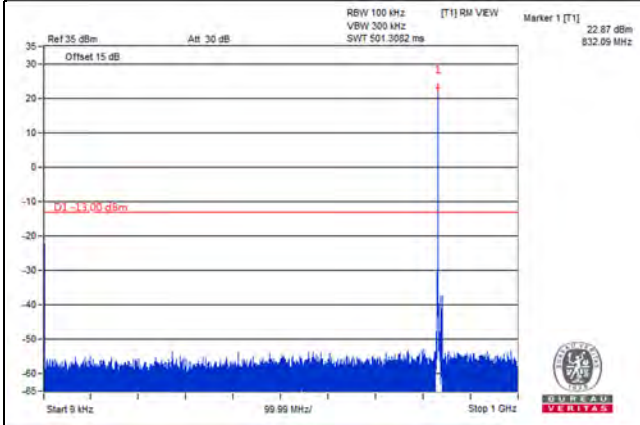

Frequency Range : 1GHz~9GHz

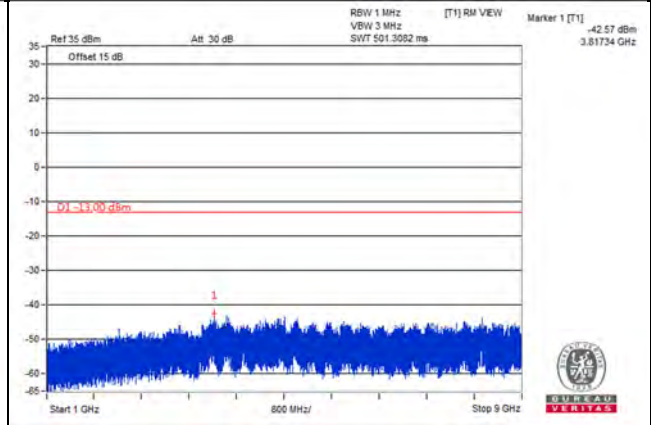

Channel 20600 (844.0MHz)

Frequency Range : 9kHz~1GHz

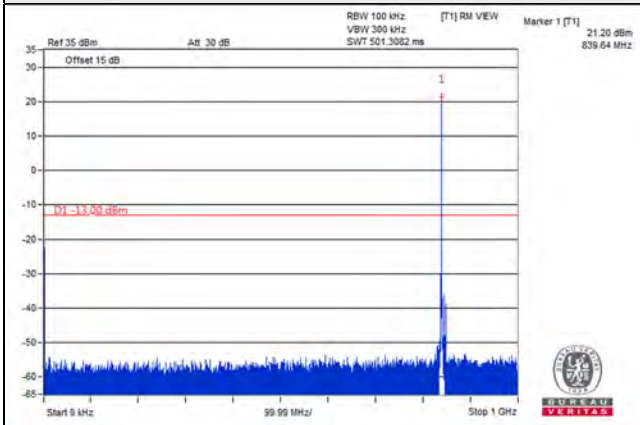

Frequency Range : 1GHz~9GHz

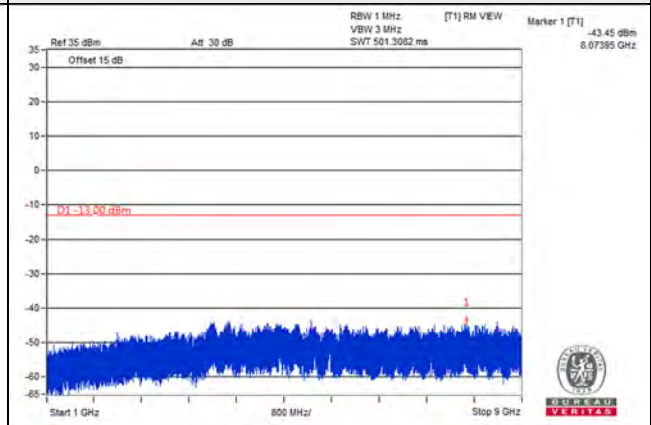

\*The 9kHz signal over the limit is from Spectrum.

LTE Band 12

Channel Band width: 1.4MHz

Channel 23017 (699.7MHz)

Frequency Range : 9kHz~1GHz

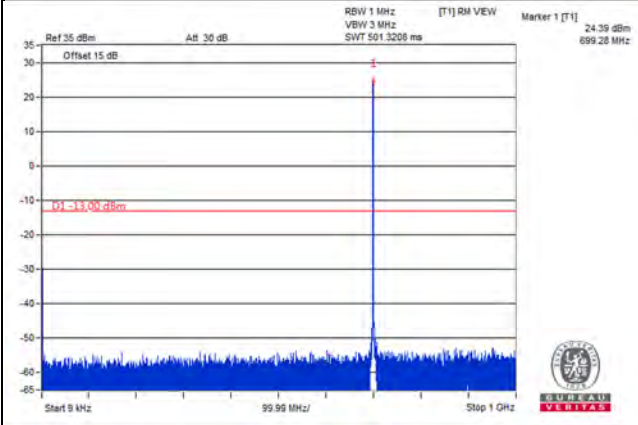

Frequency Range : 1GHz~8GHz

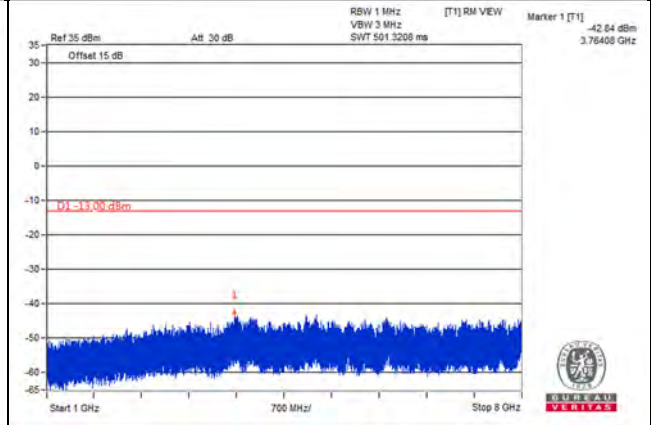

Channel 23095 (707.5MHz)

Frequency Range : 9kHz~1GHz

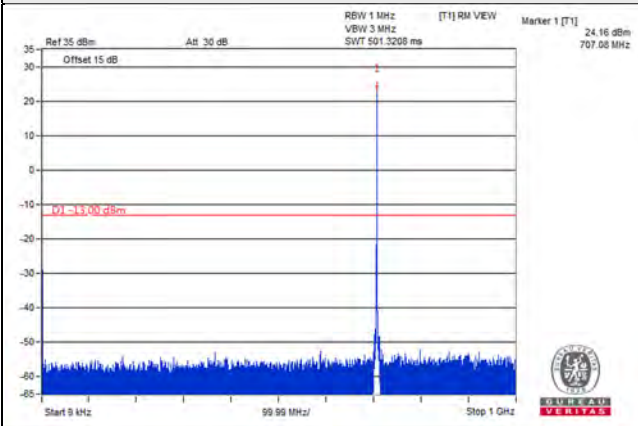

Frequency Range : 1GHz~8GHz

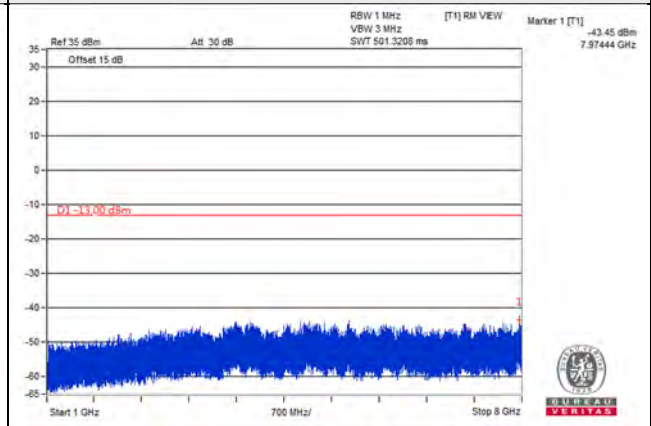

Channel 23173 (715.3MHz)

Frequency Range : 9kHz~1GHz

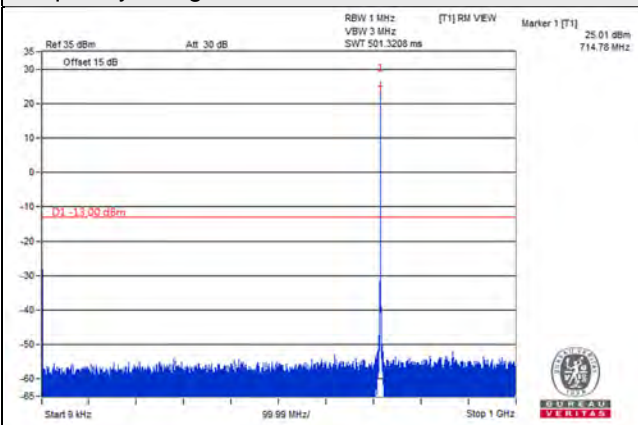

Frequency Range : 1GHz~8GHz

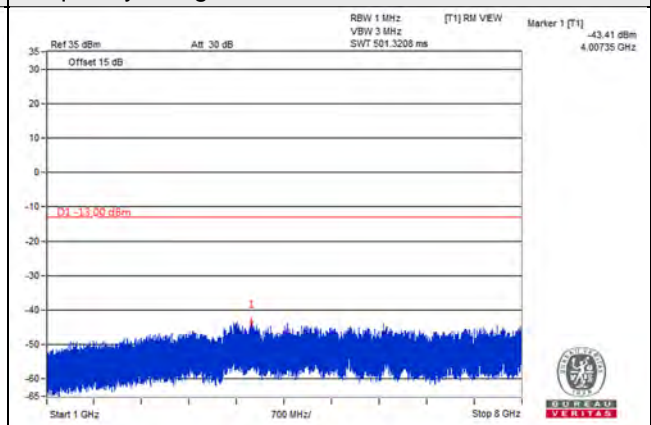

Channel Band width: 3MHz

Channel 23025 (700.5MHz)

Frequency Range : 9kHz~1GHz

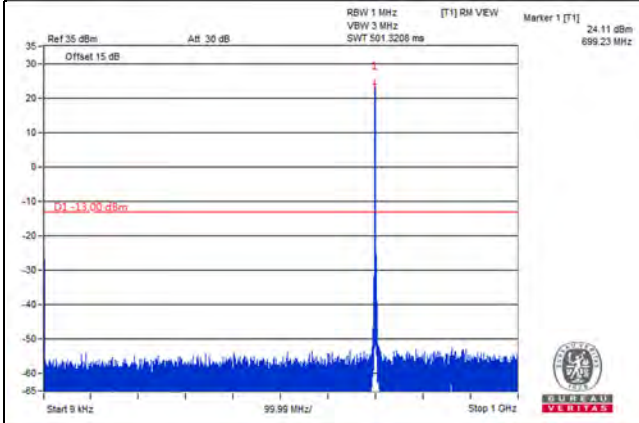

Frequency Range : 1GHz~8GHz

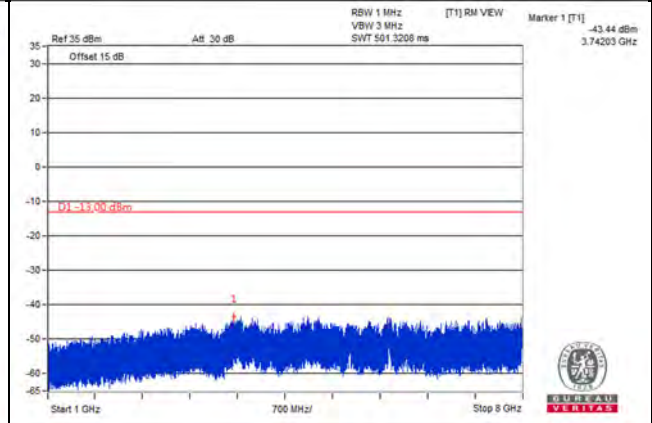

Channel 23095 (707.5MHz)

Frequency Range : 9kHz~1GHz

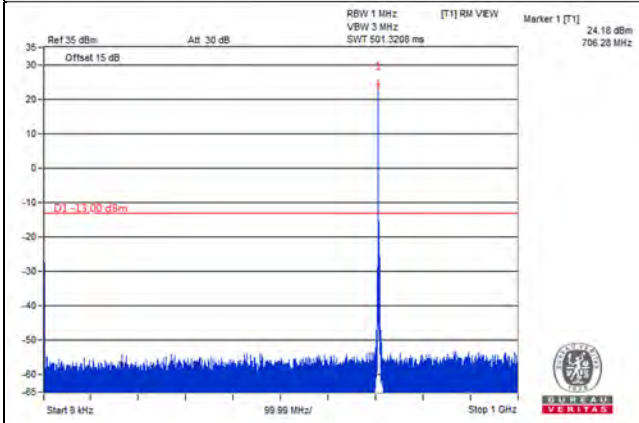

Frequency Range : 1GHz~8GHz

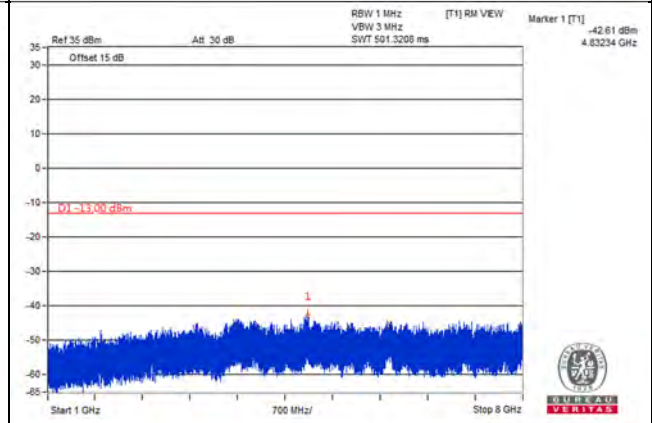

Channel 23165 (714.5MHz)

Frequency Range : 9kHz~1GHz

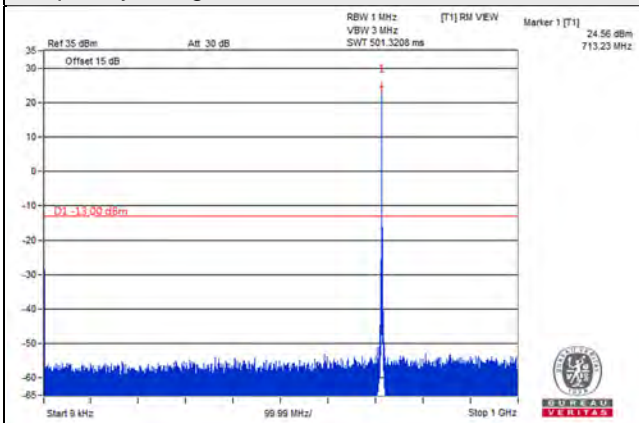

Frequency Range : 1GHz~8GHz

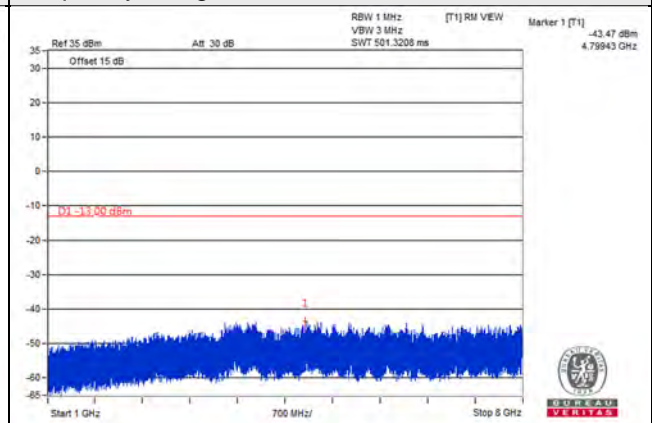

Channel Band width: 5MHz

Channel 23035 (701.5MHz)

Frequency Range : 9kHz~1GHz

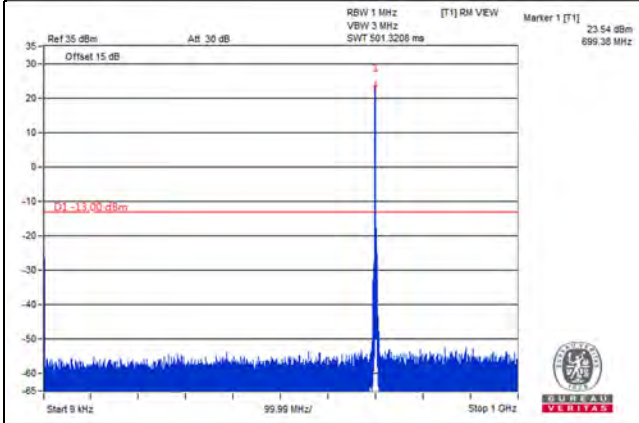

Frequency Range : 1GHz~8GHz

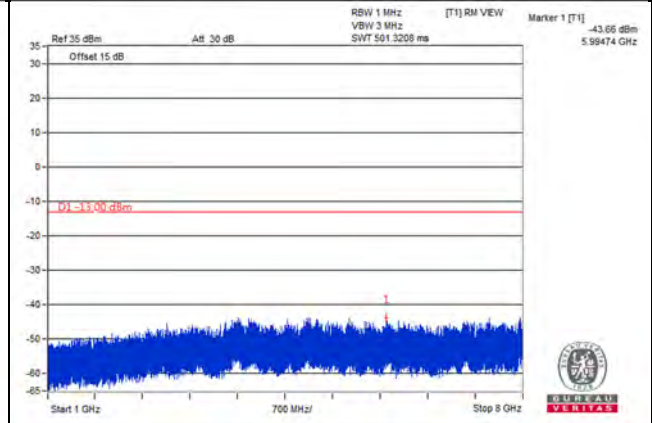

Channel 23095 (707.5MHz)

Frequency Range : 9kHz~1GHz

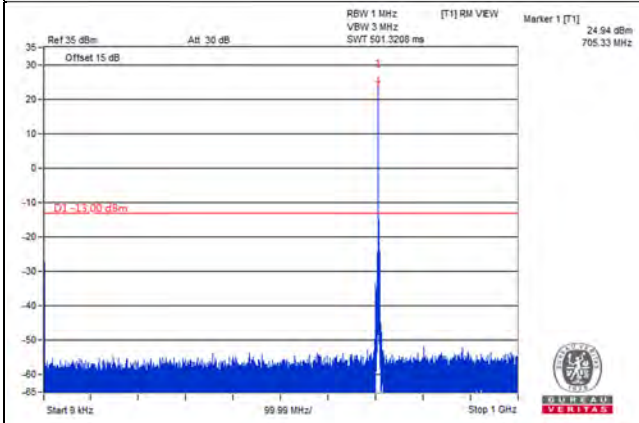

Frequency Range : 1GHz~8GHz

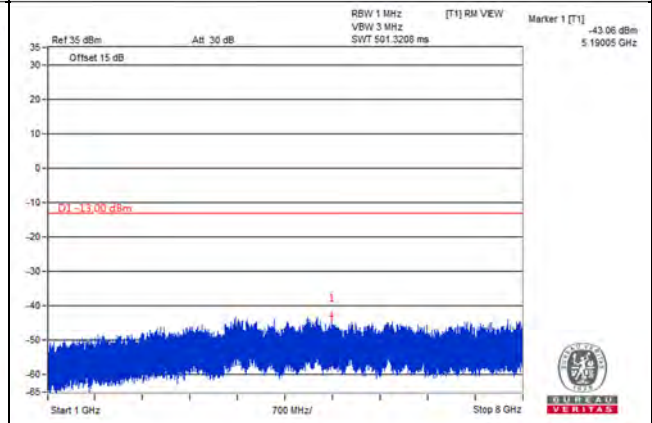

Channel 23155 (713.5MHz)

Frequency Range : 9kHz~1GHz

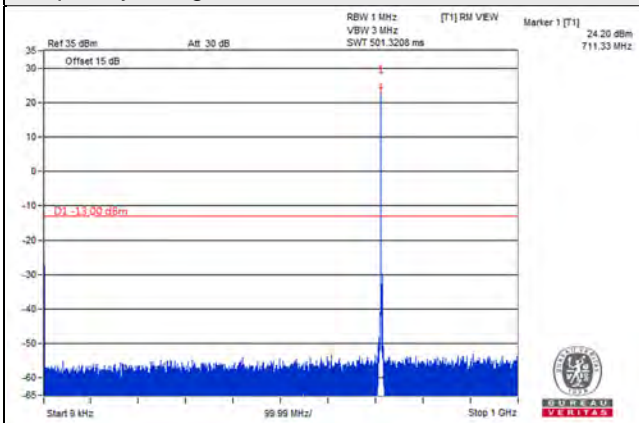

Frequency Range : 1GHz~8GHz

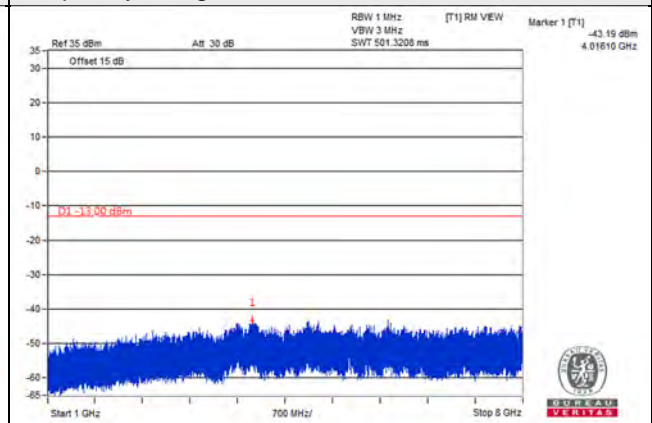

Channel Band width: 10MHz

Channel 23060 (704MHz)

Frequency Range : 9kHz~1GHz

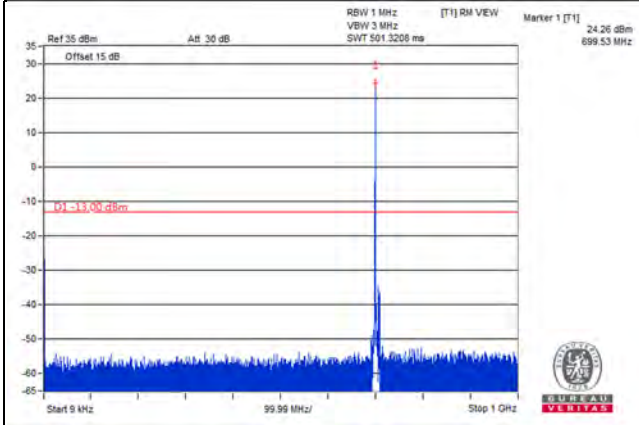

Frequency Range : 1GHz~8GHz

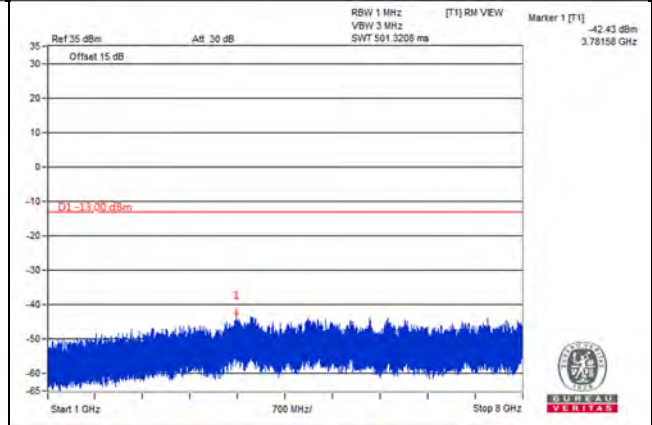

Channel 23095 (707.5MHz)

Frequency Range : 9kHz~1GHz

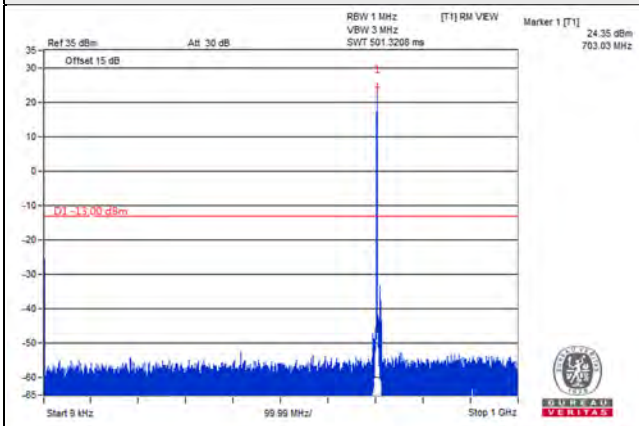

Frequency Range : 1GHz~8GHz

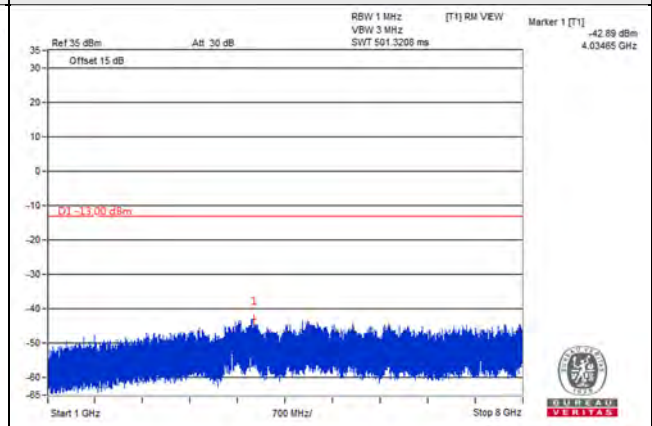

Channel 23130 (711MHz)

Frequency Range : 9kHz~1GHz

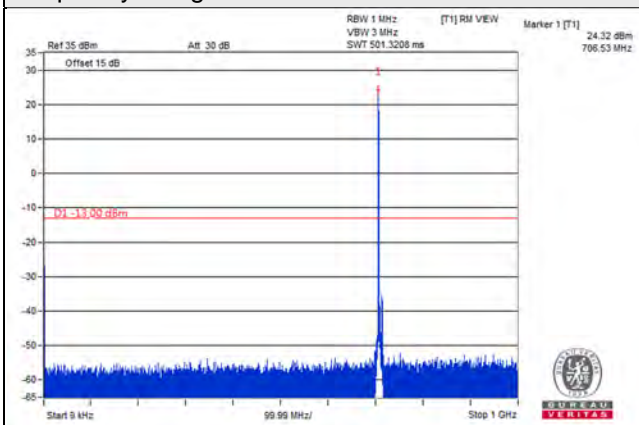

Frequency Range : 1GHz~8GHz

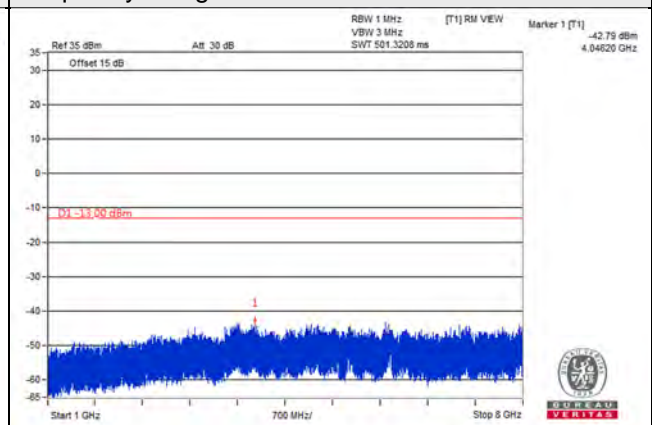

## 4.8 Radiated Emission Measurement

### 4.8.1 Limits of Radiated Emission Measurement

For n7

In the FCC 27.53(m)(4), On any frequency outside a licensee's frequency block, The power of any emission shall be attenuated below the transmitter power (P) by at least  $55 + 10 \log (P)$  dB. The emission limit equal to  $-25\text{dBm}$ .

For LTE Band 5:

The power of any emission outside of the authorized operating frequency ranges must be attenuated below the transmitting power (P) by a factor of at least  $43 + 10 \log(P)$  dB. The emission limit equal to  $-13\text{dBm}$ .

For LTE Band 12:

According to FCC 27.53(g) for operations in the 600 MHz band and the 698-746 MHz band, the power of any emission outside a licensee's frequency band(s) of operation shall be attenuated below the transmitter power (P) within the licensed band(s) of operation, measured in watts, by at least  $43 + 10 \log (P)$  dB. Compliance with this provision is based on the use of measurement instrumentation employing a resolution bandwidth of 100 kilohertz or greater.

### 4.8.2 Test Procedure

- a. Substitution method is used for E.I.R.P measurement. In the semi-anechoic chamber, EUT placed on the 0.8m (below or equal 1 GHz) and/or 1.5 m (above 1 GHz) height of Turn Table, rotated the table around 360 degrees to search the maximum radiation power and receiver antenna shall be rotated vertical and horizontal polarization and moved height from 1m to 4m to find the maximum polar radiated power. The "Read Value" is the spectrum reading the maximum power value.
- b. The substitution horn antenna is substituted for EUT at the same position and signals generator export the CW signal to the substitution antenna via a TX cable. Rotated the Turn Table and moved receiving antenna to find the maximum radiation power. Adjust output power level of S.G to get a Value of spectrum reading equal to "Read Value" of step a. Record the power level of S.G
- c. EIRP = Output power level of S.G – TX cable loss + Antenna gain of substitution horn.
- d. E.R.P power can be calculated form E.I.R.P power by subtracting the gain of dipole, E.R.P power = E.I.R.P power - 2.15dBi.

NOTE: The resolution bandwidth and video bandwidth of test receiver/spectrum analyzer is 1MHz/3MHz.

### 4.8.3 Deviation from Test Standard

No deviation.



#### 4.8.4 Test Setup

For radiated emission 30MHz to 1GHz

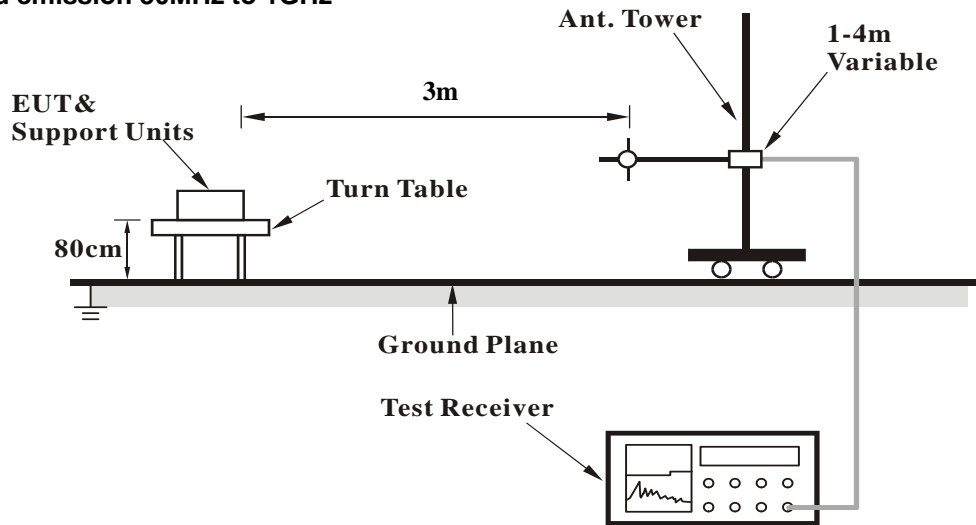

For radiated emission above 1GHz

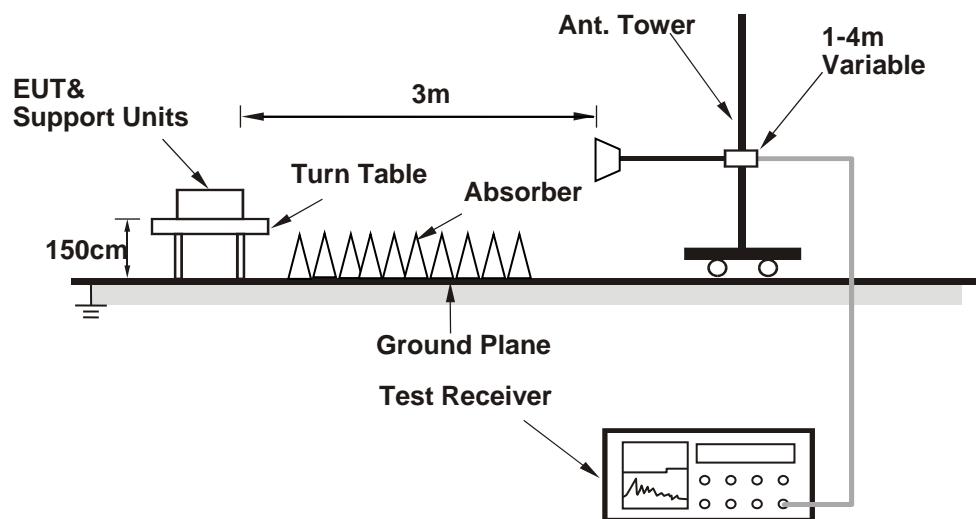

For the actual test configuration, please refer to the attached file (Test Setup Photo).

#### 4.8.5 Test Results

Below 1GHz

n7, Channel Bandwidth: 5MHz

Mode	TX channel 513500 (2567.5MHz)	Frequency Range	Below 1000 MHz
Environmental Conditions	22deg. C, 68%RH	Input Power	120Vac, 60Hz
Tested By	Greg Lin		

Antenna Polarity & Test Distance: Horizontal at 3 M							
No.	Freq. (MHz)	Reading (dBm)	S.G Power Value (dBm)	Correction Factor (dB)	EIRP (dBm)	Limit (dBm)	Margin (dB)
1	30.00	-45.4	-22.0	-19.4	-41.4	-25.0	-16.4
2	81.41	-45.9	-51.5	0.5	-51.0	-25.0	-26.0
3	295.78	-61.6	-62.7	-1.8	-64.5	-25.0	-39.5
4	576.11	-69.2	-71.9	3.7	-68.2	-25.0	-43.2
5	739.07	-69.4	-69.0	3.7	-65.3	-25.0	-40.3
6	994.18	-71.4	-65.8	3.4	-62.4	-25.0	-37.4

Remarks:

1. EIRP (dBm) = S.G Value (dBm) + Correction Factor (dB).
2. Correction Factor (dB) = Substitution Antenna Gain (dB) - Cable Loss (dB).

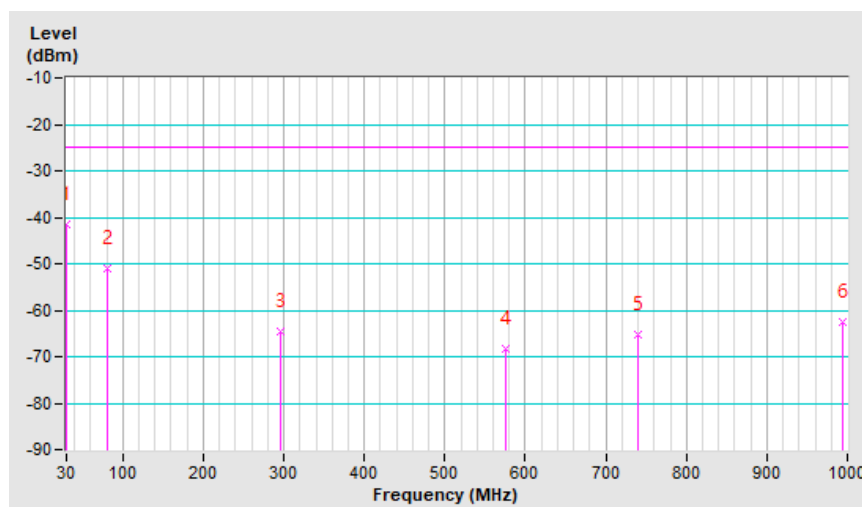

Mode	TX channel 513500 (2567.5MHz)	Frequency Range	Below 1000 MHz
Environmental Conditions	22deg. C, 68%RH	Input Power	120Vac, 60Hz
Tested By	Greg Lin		

Antenna Polarity & Test Distance: Vertical at 3 M							
No.	Freq. (MHz)	Reading (dBm)	S.G Power Value (dBm)	Correction Factor (dB)	EIRP (dBm)	Limit (dBm)	Margin (dB)
1	31.94	-31.2	-23.4	-18.3	-41.7	-25.0	-16.7
2	88.20	-39.7	-45.9	-0.2	-46.1	-25.0	-21.1
3	148.34	-45.5	-44.6	-3.0	-47.6	-25.0	-22.6
4	260.86	-55.8	-53.3	-1.5	-54.8	-25.0	-29.8
5	413.15	-67.2	-70.9	3.3	-67.6	-25.0	-42.6
6	822.49	-70.3	-66.7	3.9	-62.8	-25.0	-37.8

Remarks:

1. EIRP (dBm) = S.G Value (dBm) + Correction Factor (dB).
2. Correction Factor (dB) = Substitution Antenna Gain (dB) - Cable Loss (dB).

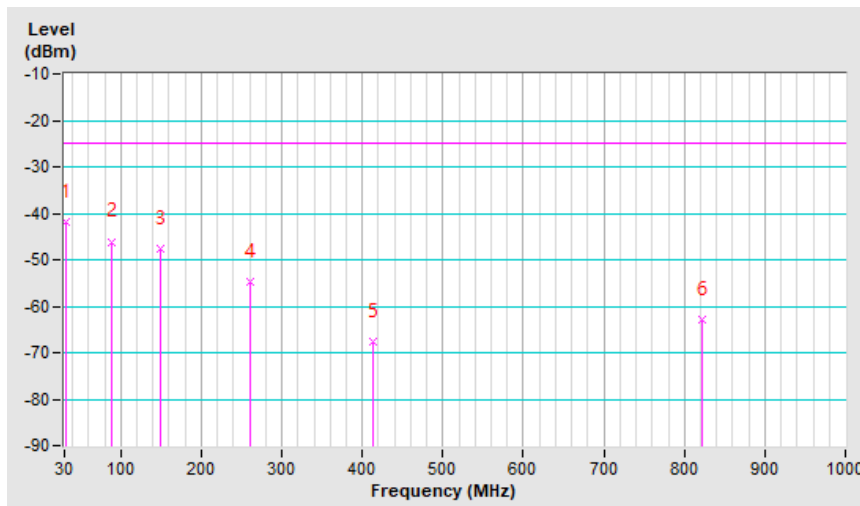

n7, Channel Bandwidth: 20MHz

Mode	TX channel 512000 (2560.0MHz)	Frequency Range	Below 1000 MHz
Environmental Conditions	22deg. C, 68%RH	Input Power	120Vac, 60Hz
Tested By	Greg Lin		

Antenna Polarity & Test Distance: Horizontal at 3 M							
No.	Freq. (MHz)	Reading (dBm)	S.G Power Value (dBm)	Correction Factor (dB)	EIRP (dBm)	Limit (dBm)	Margin (dB)
1	30.00	-45.9	-22.5	-19.4	-41.9	-25.0	-16.9
2	90.14	-39.5	-47.3	-0.2	-47.5	-25.0	-22.5
3	259.89	-59.0	-62.3	-1.5	-63.8	-25.0	-38.8
4	381.14	-52.3	-57.3	3.6	-53.7	-25.0	-28.7
5	729.37	-65.9	-65.8	3.6	-62.2	-25.0	-37.2
6	948.59	-70.5	-65.9	3.7	-62.2	-25.0	-37.2

Remarks:

1. EIRP (dBm) = S.G Value (dBm) + Correction Factor (dB).
2. Correction Factor (dB) = Substitution Antenna Gain (dB) - Cable Loss (dB).

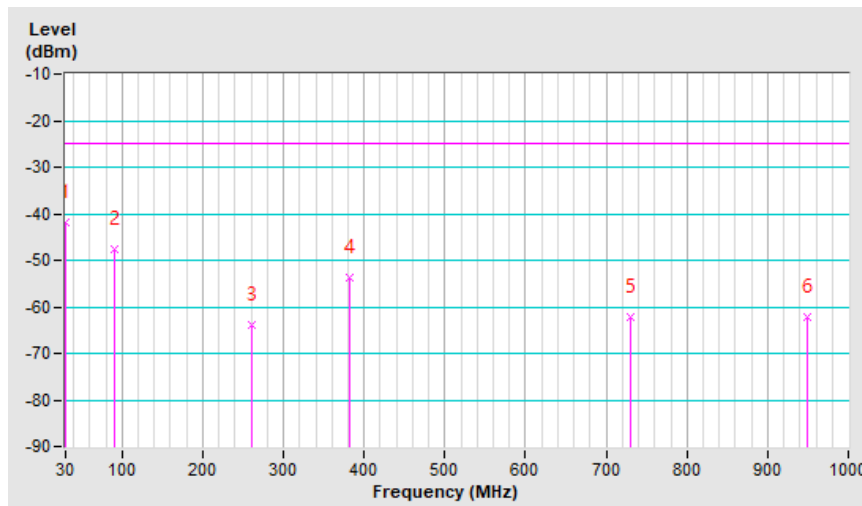

Mode	TX channel 512000 (2560.0MHz)	Frequency Range	Below 1000 MHz
Environmental Conditions	22deg. C, 68%RH	Input Power	120Vac, 60Hz
Tested By	Greg Lin		

Antenna Polarity & Test Distance: Vertical at 3 M							
No.	Freq. (MHz)	Reading (dBm)	S.G Power Value (dBm)	Correction Factor (dB)	EIRP (dBm)	Limit (dBm)	Margin (dB)
1	39.70	-39.9	-35.8	-13.7	-49.5	-25.0	-24.5
2	105.66	-43.6	-49.9	-2.2	-52.1	-25.0	-27.1
3	191.99	-56.2	-55.2	-2.6	-57.8	-25.0	-32.8
4	302.57	-60.6	-64.2	3.7	-60.5	-25.0	-35.5
5	674.08	-69.2	-67.2	3.6	-63.6	-25.0	-38.6
6	993.21	-71.6	-65.0	3.4	-61.6	-25.0	-36.6

Remarks:

1. EIRP (dBm) = S.G Value (dBm) + Correction Factor (dB).
2. Correction Factor (dB) = Substitution Antenna Gain (dB) - Cable Loss (dB).

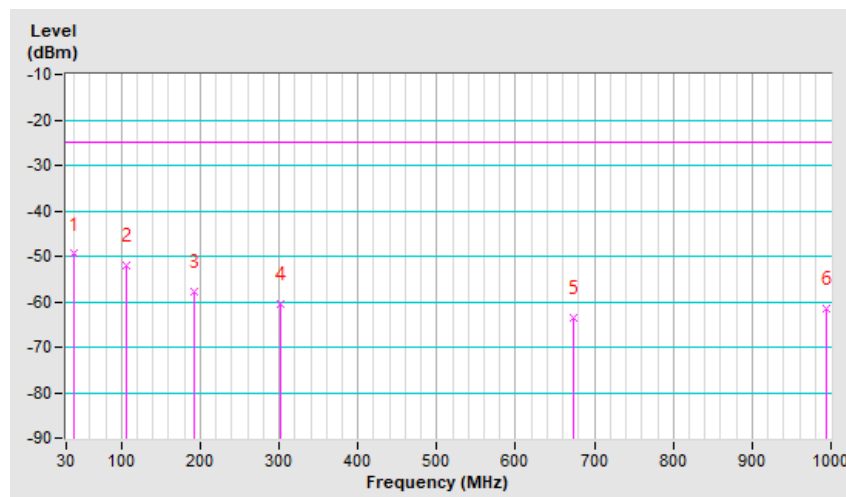

LTE Band 5, Channel Bandwidth: 10MHz

Mode	TX channel 20600 (844.0MHz)	Frequency Range	Below 1000 MHz
Environmental Conditions	22deg. C, 68%RH	Input Power	120Vac, 60Hz
Tested By	Greg Lin		

Antenna Polarity & Test Distance: Horizontal at 3 M							
No.	Freq. (MHz)	Reading (dBm)	S.G Power Value (dBm)	Correction Factor (dB)	ERP (dBm)	Limit (dBm)	Margin (dB)
1	<b>37.76</b>	<b>-51.9</b>	<b>-36.1</b>	<b>-14.7</b>	<b>-50.8</b>	<b>-13.0</b>	<b>-37.8</b>
2	297.72	-64.1	-67.2	-1.7	-68.9	-13.0	-55.9
3	526.64	-60.8	-66.5	3.9	-62.6	-13.0	-49.6
4	664.38	-63.0	-66.3	3.6	-62.7	-13.0	-49.7
5	835.10	-62.5	-61.5	3.8	-57.7	-13.0	-44.7
6	953.44	-63.1	-60.7	3.8	-56.9	-13.0	-43.9

Remarks:

1. ERP (dBm) = S.G Value (dBm) + Correction Factor (dB).
2. Correction Factor (dB) = Substitution Antenna Gain (dB) - Cable Loss (dB) + 2.15dB.

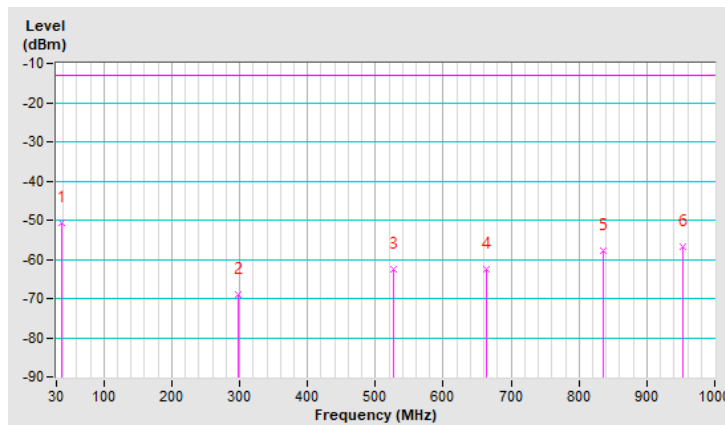

Mode	TX channel 20600 (844.0MHz)	Frequency Range	Below 1000 MHz
Environmental Conditions	22deg. C, 68%RH	Input Power	120Vac, 60Hz
Tested By	Greg Lin		

Antenna Polarity & Test Distance: Vertical at 3 M							
No.	Freq. (MHz)	Reading (dBm)	S.G Power Value (dBm)	Correction Factor (dB)	ERP (dBm)	Limit (dBm)	Margin (dB)
1	64.92	-46.6	-53.9	-1.9	-55.8	-13.0	-42.8
2	101.78	-51.8	-60.7	-1.6	-62.3	-13.0	-49.3
3	278.32	-63.4	-60.6	-1.6	-62.2	-13.0	-49.2
4	590.66	-60.1	-63.3	3.8	-59.5	-13.0	-46.5
5	757.50	-63.0	-61.8	3.8	-58.0	-13.0	-45.0
6	916.58	-63.6	-60.9	3.6	-57.3	-13.0	-44.3

Remarks:

1. ERP (dBm) = S.G Value (dBm) + Correction Factor (dB).
2. Correction Factor (dB) = Substitution Antenna Gain (dB) - Cable Loss (dB) + 2.15dB.

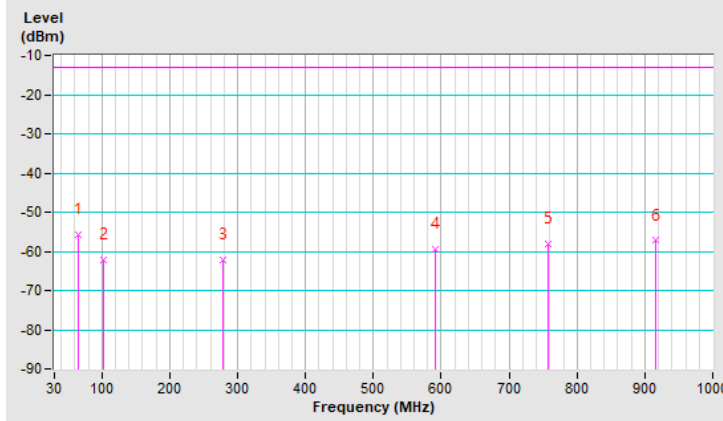

LTE Band 12, Channel Bandwidth: 1.4MHz

Mode	TX channel 23017 (699.7MHz)	Frequency Range	Below 1000 MHz
Environmental Conditions	22deg. C, 68%RH	Input Power	120Vac, 60Hz
Tested By	Greg Lin		

Antenna Polarity & Test Distance: Horizontal at 3 M

No.	Freq. (MHz)	Reading (dBm)	S.G Power Value (dBm)	Correction Factor (dB)	ERP (dBm)	Limit (dBm)	Margin (dB)
1	31.94	-54.4	-34.8	-18.3	-53.1	-13.0	-40.1
2	272.50	-64.5	-69.4	-1.5	-70.9	-13.0	-57.9
3	454.86	-58.8	-64.4	3.5	-60.9	-13.0	-47.9
4	577.08	-62.6	-67.4	3.7	-63.7	-13.0	-50.7
5	788.54	-66.8	-67.6	4.0	-63.6	-13.0	-50.6
6	943.74	-67.7	-65.2	3.7	-61.5	-13.0	-48.5

Remarks:

1. ERP (dBm) = S.G Value (dBm) + Correction Factor (dB).
2. Correction Factor (dB) = Substitution Antenna Gain (dB) - Cable Loss (dB) + 2.15dB.

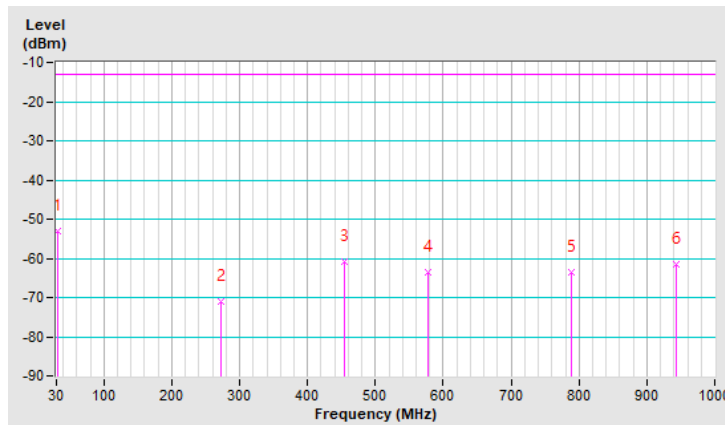



Mode	TX channel 23017 (699.7MHz)	Frequency Range	Below 1000 MHz
Environmental Conditions	22deg. C, 68%RH	Input Power	120Vac, 60Hz
Tested By	Greg Lin		

Antenna Polarity & Test Distance: Vertical at 3 M							
No.	Freq. (MHz)	Reading (dBm)	S.G Power Value (dBm)	Correction Factor (dB)	ERP (dBm)	Limit (dBm)	Margin (dB)
1	68.80	-47.6	-55.6	-0.8	-56.4	-13.0	-43.4
2	169.68	-58.4	-60.9	-2.8	-63.7	-13.0	-50.7
3	262.80	-60.0	-59.5	-1.6	-61.1	-13.0	-48.1
4	383.08	-61.9	-68.0	3.5	-64.5	-13.0	-51.5
5	577.08	-58.4	-62.2	3.7	-58.5	-13.0	-45.5
6	926.28	-66.0	-63.2	3.7	-59.5	-13.0	-46.5

Remarks:

- ERP (dBm) = S.G Value (dBm) + Correction Factor (dB).
- Correction Factor (dB) = Substitution Antenna Gain (dB) - Cable Loss (dB) + 2.15dB.

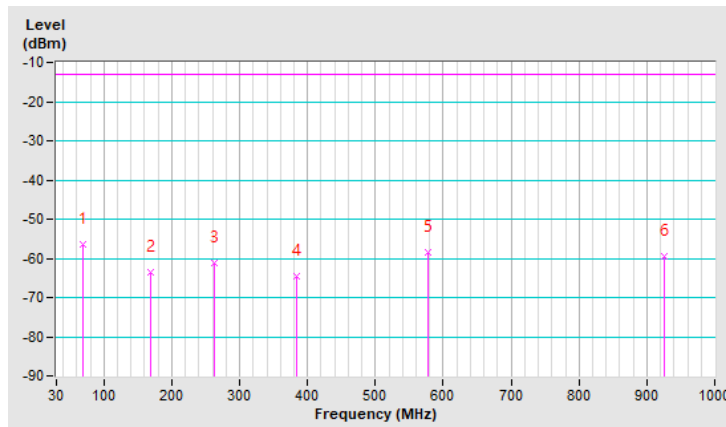

Above 1GHz  
n7, Channel Bandwidth 5MHz

Mode	TX channel 370500 (1852.50MHz)	Frequency Range	1GHz ~ 20GHz
Environmental Conditions	22deg. C, 68%RH	Input Power	120Vac, 60Hz
Tested By	Greg Lin		

Antenna Polarity & Test Distance: Horizontal at 3 M							
No.	Freq. (MHz)	Reading (dBm)	S.G Power Value (dBm)	Correction Factor (dB)	EIRP (dBm)	Limit (dBm)	Margin (dB)
1	3705.00	-61.5	-53.0	1.4	-51.6	-13.0	-38.6
Antenna Polarity & Test Distance: Vertical at 3 M							
No.	Freq. (MHz)	Reading (dBm)	S.G Power Value (dBm)	Correction Factor (dB)	EIRP (dBm)	Limit (dBm)	Margin (dB)
1	3705.00	-58.7	-50.5	1.4	-49.1	-13.0	-36.1

Remarks:

1. EIRP (dBm) = S.G Value (dBm) + Correction Factor (dB).
2. Correction Factor (dB) = Substitution Antenna Gain (dB) - Cable Loss (dB).

Mode	TX channel 376000 (1880.00MHz)	Frequency Range	1GHz ~ 20GHz
Environmental Conditions	22deg. C, 68%RH	Input Power	120Vac, 60Hz
Tested By	Greg Lin		

Antenna Polarity & Test Distance: Horizontal at 3 M							
No.	Freq. (MHz)	Reading (dBm)	S.G Power Value (dBm)	Correction Factor (dB)	EIRP (dBm)	Limit (dBm)	Margin (dB)
1	3760.00	-61.1	-52.6	1.3	-51.3	-13.0	-38.3
Antenna Polarity & Test Distance: Vertical at 3 M							
No.	Freq. (MHz)	Reading (dBm)	S.G Power Value (dBm)	Correction Factor (dB)	EIRP (dBm)	Limit (dBm)	Margin (dB)
1	3760.00	-58.8	-50.5	1.3	-49.2	-13.0	-36.2

Remarks:

1. EIRP (dBm) = S.G Value (dBm) + Correction Factor (dB).
2. Correction Factor (dB) = Substitution Antenna Gain (dB) - Cable Loss (dB).

Mode	TX channel 381500 (1907.50MHz)	Frequency Range	1GHz ~ 20GHz
Environmental Conditions	22deg. C, 68%RH	Input Power	120Vac, 60Hz
Tested By	Greg Lin		

Antenna Polarity & Test Distance: Horizontal at 3 M							
No.	Freq. (MHz)	Reading (dBm)	S.G Power Value (dBm)	Correction Factor (dB)	EIRP (dBm)	Limit (dBm)	Margin (dB)
1	3815.00	-61.7	-53.4	1.4	-52.0	-13.0	-39.0
Antenna Polarity & Test Distance: Vertical at 3 M							
No.	Freq. (MHz)	Reading (dBm)	S.G Power Value (dBm)	Correction Factor (dB)	EIRP (dBm)	Limit (dBm)	Margin (dB)
1	3815.00	-59.3	-51.1	1.4	-49.7	-13.0	-36.7

Remarks:

1. EIRP (dBm) = S.G Value (dBm) + Correction Factor (dB).
2. Correction Factor (dB) = Substitution Antenna Gain (dB) - Cable Loss (dB).

n7, Channel Bandwidth 10MHz

Mode	TX channel 371000 (1855.00MHz)	Frequency Range	1GHz ~ 20GHz
Environmental Conditions	22deg. C, 68%RH	Input Power	120Vac, 60Hz
Tested By	Greg Lin		

Antenna Polarity & Test Distance: Horizontal at 3 M							
No.	Freq. (MHz)	Reading (dBm)	S.G Power Value (dBm)	Correction Factor (dB)	EIRP (dBm)	Limit (dBm)	Margin (dB)
1	3710.00	-61.0	-52.5	1.4	-51.1	-13.0	-38.1
Antenna Polarity & Test Distance: Vertical at 3 M							
No.	Freq. (MHz)	Reading (dBm)	S.G Power Value (dBm)	Correction Factor (dB)	EIRP (dBm)	Limit (dBm)	Margin (dB)
1	3710.00	-58.7	-50.5	1.4	-49.1	-13.0	-36.1

Remarks:

1. EIRP (dBm) = S.G Value (dBm) + Correction Factor (dB).
2. Correction Factor (dB) = Substitution Antenna Gain (dB) - Cable Loss (dB).

Mode	TX channel 376000 (1880.00MHz)	Frequency Range	1GHz ~ 20GHz
Environmental Conditions	22deg. C, 68%RH	Input Power	120Vac, 60Hz
Tested By	Greg Lin		

Antenna Polarity & Test Distance: Horizontal at 3 M							
No.	Freq. (MHz)	Reading (dBm)	S.G Power Value (dBm)	Correction Factor (dB)	EIRP (dBm)	Limit (dBm)	Margin (dB)
1	3760.00	-61.5	-53.0	1.3	-51.7	-13.0	-38.7
Antenna Polarity & Test Distance: Vertical at 3 M							
No.	Freq. (MHz)	Reading (dBm)	S.G Power Value (dBm)	Correction Factor (dB)	EIRP (dBm)	Limit (dBm)	Margin (dB)
1	3760.00	-59.3	-51.0	1.3	-49.7	-13.0	-36.7

Remarks:

1. EIRP (dBm) = S.G Value (dBm) + Correction Factor (dB).
2. Correction Factor (dB) = Substitution Antenna Gain (dB) - Cable Loss (dB).

Mode	TX channel 381000 (1905.00MHz)	Frequency Range	1GHz ~ 20GHz
Environmental Conditions	22deg. C, 68%RH	Input Power	120Vac, 60Hz
Tested By	Greg Lin		

Antenna Polarity & Test Distance: Horizontal at 3 M							
No.	Freq. (MHz)	Reading (dBm)	S.G Power Value (dBm)	Correction Factor (dB)	EIRP (dBm)	Limit (dBm)	Margin (dB)
1	3810.00	-61.6	-53.2	1.3	-51.9	-13.0	-38.9
Antenna Polarity & Test Distance: Vertical at 3 M							
No.	Freq. (MHz)	Reading (dBm)	S.G Power Value (dBm)	Correction Factor (dB)	EIRP (dBm)	Limit (dBm)	Margin (dB)
1	3810.00	-58.8	-50.5	1.3	-49.2	-13.0	-36.2

Remarks:

1. EIRP (dBm) = S.G Value (dBm) + Correction Factor (dB).
2. Correction Factor (dB) = Substitution Antenna Gain (dB) - Cable Loss (dB).

n7, Channel Bandwidth 15MHz

Mode	TX channel 371500 (1857.50MHz)	Frequency Range	1GHz ~ 20GHz
Environmental Conditions	22deg. C, 68%RH	Input Power	120Vac, 60Hz
Tested By	Greg Lin		

Antenna Polarity & Test Distance: Horizontal at 3 M							
No.	Freq. (MHz)	Reading (dBm)	S.G Power Value (dBm)	Correction Factor (dB)	EIRP (dBm)	Limit (dBm)	Margin (dB)
1	3715.00	-61.1	-52.6	1.4	-51.2	-13.0	-38.2
Antenna Polarity & Test Distance: Vertical at 3 M							
No.	Freq. (MHz)	Reading (dBm)	S.G Power Value (dBm)	Correction Factor (dB)	EIRP (dBm)	Limit (dBm)	Margin (dB)
1	3715.00	-59.1	-50.9	1.4	-49.5	-13.0	-36.5

Remarks:

1. EIRP (dBm) = S.G Value (dBm) + Correction Factor (dB).
2. Correction Factor (dB) = Substitution Antenna Gain (dB) - Cable Loss (dB).

Mode	TX channel 376000 (1880.00MHz)	Frequency Range	1GHz ~ 20GHz
Environmental Conditions	22deg. C, 68%RH	Input Power	120Vac, 60Hz
Tested By	Greg Lin		

Antenna Polarity & Test Distance: Horizontal at 3 M							
No.	Freq. (MHz)	Reading (dBm)	S.G Power Value (dBm)	Correction Factor (dB)	EIRP (dBm)	Limit (dBm)	Margin (dB)
1	3760.00	-61.2	-52.7	1.3	-51.4	-13.0	-38.4
Antenna Polarity & Test Distance: Vertical at 3 M							
No.	Freq. (MHz)	Reading (dBm)	S.G Power Value (dBm)	Correction Factor (dB)	EIRP (dBm)	Limit (dBm)	Margin (dB)
1	3760.00	-58.7	-50.4	1.3	-49.1	-13.0	-36.1

Remarks:

1. EIRP (dBm) = S.G Value (dBm) + Correction Factor (dB).
2. Correction Factor (dB) = Substitution Antenna Gain (dB) - Cable Loss (dB).

Mode	TX channel 380500 (1902.50MHz)	Frequency Range	1GHz ~ 20GHz
Environmental Conditions	22deg. C, 68%RH	Input Power	120Vac, 60Hz
Tested By	Greg Lin		

Antenna Polarity & Test Distance: Horizontal at 3 M							
No.	Freq. (MHz)	Reading (dBm)	S.G Power Value (dBm)	Correction Factor (dB)	EIRP (dBm)	Limit (dBm)	Margin (dB)
1	3805.00	-61.4	-53.0	1.3	-51.7	-13.0	-38.7
Antenna Polarity & Test Distance: Vertical at 3 M							
No.	Freq. (MHz)	Reading (dBm)	S.G Power Value (dBm)	Correction Factor (dB)	EIRP (dBm)	Limit (dBm)	Margin (dB)
1	3805.00	-59.0	-50.8	1.3	-49.5	-13.0	-36.5

Remarks:

1. EIRP (dBm) = S.G Value (dBm) + Correction Factor (dB).
2. Correction Factor (dB) = Substitution Antenna Gain (dB) - Cable Loss (dB).

n7, Channel Bandwidth 20MHz

Mode	TX channel 372000 (1860.00MHz)	Frequency Range	1GHz ~ 20GHz
Environmental Conditions	22deg. C, 68%RH	Input Power	120Vac, 60Hz
Tested By	Greg Lin		

Antenna Polarity & Test Distance: Horizontal at 3 M							
No.	Freq. (MHz)	Reading (dBm)	S.G Power Value (dBm)	Correction Factor (dB)	EIRP (dBm)	Limit (dBm)	Margin (dB)
1	3720.00	-61.3	-52.8	1.4	-51.4	-13.0	-38.4
Antenna Polarity & Test Distance: Vertical at 3 M							
No.	Freq. (MHz)	Reading (dBm)	S.G Power Value (dBm)	Correction Factor (dB)	EIRP (dBm)	Limit (dBm)	Margin (dB)
1	3720.00	-59.1	-50.9	1.4	-49.5	-13.0	-36.5

Remarks:

1. EIRP (dBm) = S.G Value (dBm) + Correction Factor (dB).
2. Correction Factor (dB) = Substitution Antenna Gain (dB) - Cable Loss (dB).

Mode	TX channel 376000 (1880.00MHz)	Frequency Range	1GHz ~ 20GHz
Environmental Conditions	22deg. C, 68%RH	Input Power	120Vac, 60Hz
Tested By	Greg Lin		

Antenna Polarity & Test Distance: Horizontal at 3 M							
No.	Freq. (MHz)	Reading (dBm)	S.G Power Value (dBm)	Correction Factor (dB)	EIRP (dBm)	Limit (dBm)	Margin (dB)
1	3760.00	-61.2	-52.7	1.3	-51.4	-13.0	-38.4
Antenna Polarity & Test Distance: Vertical at 3 M							
No.	Freq. (MHz)	Reading (dBm)	S.G Power Value (dBm)	Correction Factor (dB)	EIRP (dBm)	Limit (dBm)	Margin (dB)
1	3760.00	-58.9	-50.6	1.3	-49.3	-13.0	-36.3

Remarks:

1. EIRP (dBm) = S.G Value (dBm) + Correction Factor (dB).
2. Correction Factor (dB) = Substitution Antenna Gain (dB) - Cable Loss (dB).



Mode	TX channel 380000 (1900.00MHz)	Frequency Range	1GHz ~ 20GHz
Environmental Conditions	22deg. C, 68%RH	Input Power	120Vac, 60Hz
Tested By	Greg Lin		

Antenna Polarity & Test Distance: Horizontal at 3 M							
No.	Freq. (MHz)	Reading (dBm)	S.G Power Value (dBm)	Correction Factor (dB)	EIRP (dBm)	Limit (dBm)	Margin (dB)
1	3800.00	-61.0	-52.6	1.3	-51.3	-13.0	-38.3
Antenna Polarity & Test Distance: Vertical at 3 M							
No.	Freq. (MHz)	Reading (dBm)	S.G Power Value (dBm)	Correction Factor (dB)	EIRP (dBm)	Limit (dBm)	Margin (dB)
1	3800.00	-58.9	-50.7	1.3	-49.4	-13.0	-36.4

Remarks:

1. EIRP (dBm) = S.G Value (dBm) + Correction Factor (dB).
2. Correction Factor (dB) = Substitution Antenna Gain (dB) - Cable Loss (dB).

LTE Band 5, Channel Bandwidth: 1.4MHz

Mode	TX channel 20407 (824.7MHz)	Frequency Range	1GHz ~ 10GHz
Environmental Conditions	22deg. C, 68%RH	Input Power	120Vac, 60Hz
Tested By	Greg Lin		

Antenna Polarity & Test Distance: Horizontal at 3 M

No.	Freq. (MHz)	Reading (dBm)	S.G Power Value (dBm)	Correction Factor (dB)	ERP (dBm)	Limit (dBm)	Margin (dB)
1	1649.40	-63.8	-56.0	0.9	-55.1	-13.0	-42.1

Antenna Polarity & Test Distance: Vertical at 3 M

No.	Freq. (MHz)	Reading (dBm)	S.G Power Value (dBm)	Correction Factor (dB)	ERP (dBm)	Limit (dBm)	Margin (dB)
1	1649.40	-62.8	-55.5	0.9	-54.6	-13.0	-41.6

Remarks:

1. ERP (dBm) = S.G Value (dBm) + Correction Factor (dB).
2. Correction Factor (dB) = Substitution Antenna Gain (dB) - Cable Loss (dB) + 2.15dB.

Mode	TX channel 20525 (836.5MHz)	Frequency Range	1GHz ~ 10GHz
Environmental Conditions	22deg. C, 68%RH	Input Power	120Vac, 60Hz
Tested By	Greg Lin		

Antenna Polarity & Test Distance: Horizontal at 3 M

No.	Freq. (MHz)	Reading (dBm)	S.G Power Value (dBm)	Correction Factor (dB)	ERP (dBm)	Limit (dBm)	Margin (dB)
1	1673.00	-64.3	-56.7	0.8	-55.9	-13.0	-42.9

Antenna Polarity & Test Distance: Vertical at 3 M

No.	Freq. (MHz)	Reading (dBm)	S.G Power Value (dBm)	Correction Factor (dB)	ERP (dBm)	Limit (dBm)	Margin (dB)
1	1673.00	-62.9	-55.6	0.8	-54.8	-13.0	-41.8

Remarks:

1. ERP (dBm) = S.G Value (dBm) + Correction Factor (dB).
2. Correction Factor (dB) = Substitution Antenna Gain (dB) - Cable Loss (dB) + 2.15dB.

Mode	TX channel 20643 (848.3MHz)	Frequency Range	1GHz ~ 10GHz
Environmental Conditions	22deg. C, 68%RH	Input Power	120Vac, 60Hz
Tested By	Greg Lin		

Antenna Polarity & Test Distance: Horizontal at 3 M							
No.	Freq. (MHz)	Reading (dBm)	S.G Power Value (dBm)	Correction Factor (dB)	ERP (dBm)	Limit (dBm)	Margin (dB)
1	1696.60	-64.0	-56.5	0.7	-55.8	-13.0	-42.8
Antenna Polarity & Test Distance: Vertical at 3 M							
No.	Freq. (MHz)	Reading (dBm)	S.G Power Value (dBm)	Correction Factor (dB)	ERP (dBm)	Limit (dBm)	Margin (dB)
1	1696.60	-62.6	-55.3	0.7	-54.6	-13.0	-41.6

Remarks:

1. ERP (dBm) = S.G Value (dBm) + Correction Factor (dB).
2. Correction Factor (dB) = Substitution Antenna Gain (dB) - Cable Loss (dB) + 2.15dB.

LTE Band 5, Channel Bandwidth: 5MHz

Mode	TX channel 20425 (826.5MHz)	Frequency Range	1GHz ~ 10GHz
Environmental Conditions	22deg. C, 68%RH	Input Power	120Vac, 60Hz
Tested By	Greg Lin		

Antenna Polarity & Test Distance: Horizontal at 3 M

No.	Freq. (MHz)	Reading (dBm)	S.G Power Value (dBm)	Correction Factor (dB)	ERP (dBm)	Limit (dBm)	Margin (dB)
1	1653.00	-64.0	-56.3	0.9	-55.4	-13.0	-42.4

Antenna Polarity & Test Distance: Vertical at 3 M

No.	Freq. (MHz)	Reading (dBm)	S.G Power Value (dBm)	Correction Factor (dB)	ERP (dBm)	Limit (dBm)	Margin (dB)
1	1653.00	-62.5	-55.3	0.9	-54.4	-13.0	-41.4

Remarks:

1. ERP (dBm) = S.G Value (dBm) + Correction Factor (dB).
2. Correction Factor (dB) = Substitution Antenna Gain (dB) - Cable Loss (dB) + 2.15dB.

Mode	TX channel 20525 (836.5MHz)	Frequency Range	1GHz ~ 10GHz
Environmental Conditions	22deg. C, 68%RH	Input Power	120Vac, 60Hz
Tested By	Greg Lin		

Antenna Polarity & Test Distance: Horizontal at 3 M

No.	Freq. (MHz)	Reading (dBm)	S.G Power Value (dBm)	Correction Factor (dB)	ERP (dBm)	Limit (dBm)	Margin (dB)
1	1673.00	-64.0	-56.4	0.8	-55.6	-13.0	-42.6

Antenna Polarity & Test Distance: Vertical at 3 M

No.	Freq. (MHz)	Reading (dBm)	S.G Power Value (dBm)	Correction Factor (dB)	ERP (dBm)	Limit (dBm)	Margin (dB)
1	1673.00	-62.6	-55.3	0.8	-54.5	-13.0	-41.5

Remarks:

1. ERP (dBm) = S.G Value (dBm) + Correction Factor (dB).
2. Correction Factor (dB) = Substitution Antenna Gain (dB) - Cable Loss (dB) + 2.15dB.

Mode	TX channel 20625 (846.5MHz)	Frequency Range	1GHz ~ 10GHz
Environmental Conditions	22deg. C, 68%RH	Input Power	120Vac, 60Hz
Tested By	Greg Lin		

Antenna Polarity & Test Distance: Horizontal at 3 M							
No.	Freq. (MHz)	Reading (dBm)	S.G Power Value (dBm)	Correction Factor (dB)	ERP (dBm)	Limit (dBm)	Margin (dB)
1	1693.00	-63.6	-56.1	0.7	-55.4	-13.0	-42.4
Antenna Polarity & Test Distance: Vertical at 3 M							
No.	Freq. (MHz)	Reading (dBm)	S.G Power Value (dBm)	Correction Factor (dB)	ERP (dBm)	Limit (dBm)	Margin (dB)
1	1693.00	-62.2	-54.9	0.7	-54.2	-13.0	-41.2

Remarks:

1.  $ERP (dBm) = S.G \text{ Value (dBm)} + \text{Correction Factor (dB)}$ .
2.  $\text{Correction Factor (dB)} = \text{Substitution Antenna Gain (dB)} - \text{Cable Loss (dB)} + 2.15dB$ .

LTE Band 5, Channel Bandwidth: 10MHz

Mode	TX channel 20450 (829.0MHz)	Frequency Range	1GHz ~ 10GHz
Environmental Conditions	22deg. C, 68%RH	Input Power	120Vac, 60Hz
Tested By	Greg Lin		

Antenna Polarity & Test Distance: Horizontal at 3 M

No.	Freq. (MHz)	Reading (dBm)	S.G Power Value (dBm)	Correction Factor (dB)	ERP (dBm)	Limit (dBm)	Margin (dB)
1	1658.00	-63.8	-56.2	0.9	-55.3	-13.0	-42.3

Antenna Polarity & Test Distance: Vertical at 3 M

No.	Freq. (MHz)	Reading (dBm)	S.G Power Value (dBm)	Correction Factor (dB)	ERP (dBm)	Limit (dBm)	Margin (dB)
1	1658.00	-62.4	-55.2	0.9	-54.3	-13.0	-41.3

Remarks:

1. ERP (dBm) = S.G Value (dBm) + Correction Factor (dB).
2. Correction Factor (dB) = Substitution Antenna Gain (dB) - Cable Loss (dB) + 2.15dB.

Mode	TX channel 20525 (836.5MHz)	Frequency Range	1GHz ~ 10GHz
Environmental Conditions	22deg. C, 68%RH	Input Power	120Vac, 60Hz
Tested By	Greg Lin		

Antenna Polarity & Test Distance: Horizontal at 3 M

No.	Freq. (MHz)	Reading (dBm)	S.G Power Value (dBm)	Correction Factor (dB)	ERP (dBm)	Limit (dBm)	Margin (dB)
1	1673.00	-63.8	-56.2	0.8	-55.4	-13.0	-42.4

Antenna Polarity & Test Distance: Vertical at 3 M

No.	Freq. (MHz)	Reading (dBm)	S.G Power Value (dBm)	Correction Factor (dB)	ERP (dBm)	Limit (dBm)	Margin (dB)
1	1673.00	-62.2	-54.9	0.8	-54.1	-13.0	-41.1

Remarks:

1. ERP (dBm) = S.G Value (dBm) + Correction Factor (dB).
2. Correction Factor (dB) = Substitution Antenna Gain (dB) - Cable Loss (dB) + 2.15dB.

Mode	TX channel 20600 (844.0MHz)	Frequency Range	1GHz ~ 10GHz
Environmental Conditions	22deg. C, 68%RH	Input Power	120Vac, 60Hz
Tested By	Greg Lin		

Antenna Polarity & Test Distance: Horizontal at 3 M							
No.	Freq. (MHz)	Reading (dBm)	S.G Power Value (dBm)	Correction Factor (dB)	ERP (dBm)	Limit (dBm)	Margin (dB)
1	1688.00	-63.6	-55.9	0.7	-55.2	-13.0	-42.2
Antenna Polarity & Test Distance: Vertical at 3 M							
No.	Freq. (MHz)	Reading (dBm)	S.G Power Value (dBm)	Correction Factor (dB)	ERP (dBm)	Limit (dBm)	Margin (dB)
1	1688.00	-61.9	-54.6	0.7	-53.9	-13.0	-40.9

Remarks:

1. ERP (dBm) = S.G Value (dBm) + Correction Factor (dB).
2. Correction Factor (dB) = Substitution Antenna Gain (dB) - Cable Loss (dB) + 2.15dB.

LTE Band 12, Channel Bandwidth: 1.4MHz

Mode	TX channel 23017 (699.7MHz)	Frequency Range	1GHz ~ 18GHz
Environmental Conditions	22deg. C, 68%RH	Input Power	120Vac, 60Hz
Tested By	Greg Lin		

Antenna Polarity & Test Distance: Horizontal at 3 M

No.	Freq. (MHz)	Reading (dBm)	S.G Power Value (dBm)	Correction Factor (dB)	ERP (dBm)	Limit (dBm)	Margin (dB)
1	1399.40	-64.7	-58.4	0.9	-57.5	-13.0	-44.5

Antenna Polarity & Test Distance: Vertical at 3 M

No.	Freq. (MHz)	Reading (dBm)	S.G Power Value (dBm)	Correction Factor (dB)	ERP (dBm)	Limit (dBm)	Margin (dB)
1	1399.40	-60.5	-55.4	0.9	-54.5	-13.0	-41.5

Remarks:

1. ERP (dBm) = S.G Value (dBm) + Correction Factor (dB).
2. Correction Factor (dB) = Substitution Antenna Gain (dB) - Cable Loss (dB) + 2.15dB.

Mode	TX channel 23095 (707.5MHz)	Frequency Range	1GHz ~ 18GHz
Environmental Conditions	22deg. C, 68%RH	Input Power	120Vac, 60Hz
Tested By	Greg Lin		

Antenna Polarity & Test Distance: Horizontal at 3 M

No.	Freq. (MHz)	Reading (dBm)	S.G Power Value (dBm)	Correction Factor (dB)	ERP (dBm)	Limit (dBm)	Margin (dB)
1	1415.00	-64.8	-58.2	0.9	-57.3	-13.0	-44.3

Antenna Polarity & Test Distance: Vertical at 3 M

No.	Freq. (MHz)	Reading (dBm)	S.G Power Value (dBm)	Correction Factor (dB)	ERP (dBm)	Limit (dBm)	Margin (dB)
1	1415.00	-61.8	-56.4	0.9	-55.5	-13.0	-42.5

Remarks:

1. ERP (dBm) = S.G Value (dBm) + Correction Factor (dB).
2. Correction Factor (dB) = Substitution Antenna Gain (dB) - Cable Loss (dB) + 2.15dB.



Mode	TX channel 23173 (715.3MHz)	Frequency Range	1GHz ~ 18GHz
Environmental Conditions	22deg. C, 68%RH	Input Power	120Vac, 60Hz
Tested By	Greg Lin		

Antenna Polarity & Test Distance: Horizontal at 3 M							
No.	Freq. (MHz)	Reading (dBm)	S.G Power Value (dBm)	Correction Factor (dB)	ERP (dBm)	Limit (dBm)	Margin (dB)
1	1430.60	-65.3	-58.6	1.0	-57.6	-13.0	-44.6
Antenna Polarity & Test Distance: Vertical at 3 M							
No.	Freq. (MHz)	Reading (dBm)	S.G Power Value (dBm)	Correction Factor (dB)	ERP (dBm)	Limit (dBm)	Margin (dB)
1	1430.60	-62.1	-56.6	1.0	-55.6	-13.0	-42.6

Remarks:

1.  $ERP (dBm) = S.G \text{ Value (dBm)} + \text{Correction Factor (dB)}$ .
2.  $\text{Correction Factor (dB)} = \text{Substitution Antenna Gain (dB)} - \text{Cable Loss (dB)} + 2.15dB$ .

LTE Band 12, Channel Bandwidth: 5MHz

Mode	TX channel 23035 (701.5MHz)	Frequency Range	1GHz ~ 18GHz
Environmental Conditions	22deg. C, 68%RH	Input Power	120Vac, 60Hz
Tested By	Greg Lin		

Antenna Polarity & Test Distance: Horizontal at 3 M

No.	Freq. (MHz)	Reading (dBm)	S.G Power Value (dBm)	Correction Factor (dB)	ERP (dBm)	Limit (dBm)	Margin (dB)
1	1403.00	-64.8	-58.4	0.9	-57.5	-13.0	-44.5

Antenna Polarity & Test Distance: Vertical at 3 M

No.	Freq. (MHz)	Reading (dBm)	S.G Power Value (dBm)	Correction Factor (dB)	ERP (dBm)	Limit (dBm)	Margin (dB)
1	1403.00	-61.5	-56.4	0.9	-55.5	-13.0	-42.5

Remarks:

1. ERP (dBm) = S.G Value (dBm) + Correction Factor (dB).
2. Correction Factor (dB) = Substitution Antenna Gain (dB) - Cable Loss (dB) + 2.15dB.

Mode	TX channel 23095 (707.5MHz)	Frequency Range	1GHz ~ 18GHz
Environmental Conditions	22deg. C, 68%RH	Input Power	120Vac, 60Hz
Tested By	Greg Lin		

Antenna Polarity & Test Distance: Horizontal at 3 M

No.	Freq. (MHz)	Reading (dBm)	S.G Power Value (dBm)	Correction Factor (dB)	ERP (dBm)	Limit (dBm)	Margin (dB)
1	1415.00	-64.8	-58.3	0.9	-57.4	-13.0	-44.4

Antenna Polarity & Test Distance: Vertical at 3 M

No.	Freq. (MHz)	Reading (dBm)	S.G Power Value (dBm)	Correction Factor (dB)	ERP (dBm)	Limit (dBm)	Margin (dB)
1	1415.00	-61.6	-56.3	0.9	-55.4	-13.0	-42.4

Remarks:

1. ERP (dBm) = S.G Value (dBm) + Correction Factor (dB).
2. Correction Factor (dB) = Substitution Antenna Gain (dB) - Cable Loss (dB) + 2.15dB.

Mode	TX channel 23155 (713.5MHz)	Frequency Range	1GHz ~ 18GHz
Environmental Conditions	22deg. C, 68%RH	Input Power	120Vac, 60Hz
Tested By	Greg Lin		

Antenna Polarity & Test Distance: Horizontal at 3 M							
No.	Freq. (MHz)	Reading (dBm)	S.G Power Value (dBm)	Correction Factor (dB)	ERP (dBm)	Limit (dBm)	Margin (dB)
1	1427.00	-65.2	-58.5	1.0	-57.5	-13.0	-44.5
Antenna Polarity & Test Distance: Vertical at 3 M							
No.	Freq. (MHz)	Reading (dBm)	S.G Power Value (dBm)	Correction Factor (dB)	ERP (dBm)	Limit (dBm)	Margin (dB)
1	1427.00	-62.1	-56.6	1.0	-55.6	-13.0	-42.6

Remarks:

1. ERP (dBm) = S.G Value (dBm) + Correction Factor (dB).
2. Correction Factor (dB) = Substitution Antenna Gain (dB) - Cable Loss (dB) + 2.15dB.

LTE Band 12, Channel Bandwidth: 10MHz

Mode	TX channel 23060 (704MHz)	Frequency Range	1GHz ~ 18GHz
Environmental Conditions	22deg. C, 68%RH	Input Power	120Vac, 60Hz
Tested By	Greg Lin		

Antenna Polarity & Test Distance: Horizontal at 3 M

No.	Freq. (MHz)	Reading (dBm)	S.G Power Value (dBm)	Correction Factor (dB)	ERP (dBm)	Limit (dBm)	Margin (dB)
1	1408.00	-64.8	-58.4	0.9	-57.5	-13.0	-44.5

Antenna Polarity & Test Distance: Vertical at 3 M

No.	Freq. (MHz)	Reading (dBm)	S.G Power Value (dBm)	Correction Factor (dB)	ERP (dBm)	Limit (dBm)	Margin (dB)
1	1408.00	-61.4	-56.2	0.9	-55.3	-13.0	-42.3

Remarks:

1. ERP (dBm) = S.G Value (dBm) + Correction Factor (dB).
2. Correction Factor (dB) = Substitution Antenna Gain (dB) - Cable Loss (dB) + 2.15dB.

Mode	TX channel 23095 (707.5MHz)	Frequency Range	1GHz ~ 18GHz
Environmental Conditions	22deg. C, 68%RH	Input Power	120Vac, 60Hz
Tested By	Greg Lin		

Antenna Polarity & Test Distance: Horizontal at 3 M

No.	Freq. (MHz)	Reading (dBm)	S.G Power Value (dBm)	Correction Factor (dB)	ERP (dBm)	Limit (dBm)	Margin (dB)
1	1415.00	-64.7	-58.1	0.9	-57.2	-13.0	-44.2

Antenna Polarity & Test Distance: Vertical at 3 M

No.	Freq. (MHz)	Reading (dBm)	S.G Power Value (dBm)	Correction Factor (dB)	ERP (dBm)	Limit (dBm)	Margin (dB)
1	1415.00	-61.5	-56.1	0.9	-55.2	-13.0	-42.2

Remarks:

1. ERP (dBm) = S.G Value (dBm) + Correction Factor (dB).
2. Correction Factor (dB) = Substitution Antenna Gain (dB) - Cable Loss (dB) + 2.15dB.

Mode	TX channel 23130 (711MHz)	Frequency Range	1GHz ~ 18GHz
Environmental Conditions	22deg. C, 68%RH	Input Power	120Vac, 60Hz
Tested By	Greg Lin		

Antenna Polarity & Test Distance: Horizontal at 3 M							
No.	Freq. (MHz)	Reading (dBm)	S.G Power Value (dBm)	Correction Factor (dB)	ERP (dBm)	Limit (dBm)	Margin (dB)
1	1422.00	-65.0	-58.4	1.0	-57.4	-13.0	-44.4
Antenna Polarity & Test Distance: Vertical at 3 M							
No.	Freq. (MHz)	Reading (dBm)	S.G Power Value (dBm)	Correction Factor (dB)	ERP (dBm)	Limit (dBm)	Margin (dB)
1	1422.00	-61.7	-56.2	1.0	-55.2	-13.0	-42.2

Remarks:

1. ERP (dBm) = S.G Value (dBm) + Correction Factor (dB).
2. Correction Factor (dB) = Substitution Antenna Gain (dB) - Cable Loss (dB) + 2.15dB.

## 5 Pictures of Test Arrangements

Please refer to the attached file (Test Setup Photo).

## Appendix – Information of the Testing Laboratories

We, Bureau Veritas Consumer Products Services (H.K.) Ltd., Taoyuan Branch, were founded in 1988 to provide our best service in EMC, Radio, Telecom and Safety consultation. Our laboratories are FCC recognized accredited test firms and accredited and approved according to ISO/IEC 17025.

If you have any comments, please feel free to contact us at the following:

### Lin Kou EMC/RF Lab

Tel: 886-2-26052180

Fax: 886-2-26051924

### Hsin Chu EMC/RF/Telecom Lab

Tel: 886-3-6668565

Fax: 886-3-6668323

### Hwa Ya EMC/RF/Safety Lab

Tel: 886-3-3183232

Fax: 886-3-3270892

**Email:** [service.adt@tw.bureauveritas.com](mailto:service.adt@tw.bureauveritas.com)

**Web Site:** [www.bureauveritas-adt.com](http://www.bureauveritas-adt.com)

The address and road map of all our labs can be found in our web site also.

--- END ---