

TAS ALGORITHM VALIDATION TEST REPORT

EUT Description	XMM 7560 Cellular Modem embedded in Fibocom M2 L860-GL cellular module
Brand Name	Fibocom M2
Model Name	L860-GL
FCC ID	Generic (see note in Section 6)
Date of Test Start/End	2019-05-20 /2019-05-29
Features	LTE, UMTS (see Section 6)

Applicant	Intel Mobile Communications
Address	100 Center Point Circle, Suite 200 Columbia, South Carolina 29210 USA
Contact Person	Steven Hackett
Telephone/Fax/ Email	steven.c.hackett@intel.com

Test Report identification	180709-01.TR01
Revision Control	Rev. 00 This test report revision replaces any previous test report revision (see Section 1)

Intel Corporation S.A.S – WRF Lab
425 rue de Goa – Le Cargo B6 - 06600, Antibes, France
Tel. +33493001400 / Fax +33493001401

Table of Contents

1. Document Revision History	3
2. Document Scope.....	3
3. General Conditions, Competences and Guarantees.....	3
4. Environmental Conditions	3
5. Test Samples	3
6. EUT Features	4
7. TAS Algorithm Validation Considerations	5
7.1. ALGORITHM VALIDATION USING CONDUCTED POWER MEASUREMENT	6
7.1.1. RANGE OF PARAMETERS CONSIDERED FOR ALGORITHM VALIDATION.....	6
8. Summary of Validation Tests and Results	9
Annex A. Test Setup Description	10
A.1 MEASUREMENT SYSTEM.....	10
A.1.1 Test Setup	10
A.1.2 Test Equipment List.....	11
Annex B. Validation Test Results	12
B.1 VALIDATION USING CONDUCTED POWER MEASUREMENT	12
B.2 TAS VALIDATION TESTS AND RESULTS	13
B.2.1 Fundamental Algorithm Validation for a Range Control Parameters	13
B.2.1.1 Validation for LTE in Band 2	13
B.2.1.2 Validation of UMTS/WCDMA Band 2	17
B.2.2 Algorithm Validation According to Time Varying Power Control Test Sequences	22
B.2.3 Algorithm Validation for Drop Connection and Reboot	25
B.2.3.1 Connection Drop and Reboot Scenario Validation	25
B.2.3.2 Handover Validation from LTE Band 2 to LTE Band 4	27
B.2.3.3 Handover Validation from LTE Band 2 to WCDMA Band 4	28
Annex C. Photographs	29
C.1 TEST SETUP	29
C.2 TEST SAMPLE AND TEST PLATFORM	30

1. Document Revision History

Revision #	Date	Modified by	Revision Details
Rev. 00	2019-09-09	Walid EL HAJJ	First Issue

2. Document Scope

This document describes the Time-Averaging SAR (**TAS**) algorithm validation test setup and measurement results for the XMM 7560 Cellular Modem incorporated in the Fibocom M2 L860-GL cellular module. The implementation details and **TAS** operating characteristics are described in the "Operation Descriptions" document (confidential); therefore, only a brief summary of the **TAS** operating parameters is included in this test report. Therefore, only a brief summary of the **TAS** operating parameters is included in this test report. The validation tests are performed using mainly conducted power measurements. Details of the conducted power measurement test setup, test procedures and validation results are included in Annex A and B. The validation results demonstrate that **TAS** can reliably apply dynamic power control to ensure SAR compliance in real-time

3. General Conditions, Competences and Guarantees

- ✓ Intel Corporation SAS Wireless RF Lab (Intel WRF Lab) is an ISO/IEC 17025:2005 testing laboratory accredited by the American Association for Laboratory Accreditation (A2LA) with the certificate number 3478.01.
- ✓ Intel Corporation SAS Wireless RF Lab (Intel WRF Lab) is an Accredited Test Firm recognized by the FCC, with Designation Number FR0011.
- ✓ Intel WRF Lab only provides testing services and is committed to providing reliable, unbiased test results and interpretations.
- ✓ Intel WRF Lab is liable to its client for maintaining confidentiality of all information and test results relating to the item under test.
- ✓ Intel WRF Lab has developed calibration and proficiency programs to ensure the measurement equipment used are providing correlated and reliable test results to its customers.
- ✓ This report is only relevant to the item that has undergone testing.
- ✓ This report does not imply an approval of the product by the Certification Bodies or competent Authorities.

4. Environmental Conditions

During the tests, the environmental conditions at the site where the measurements were performed are given in the following table:

Temperature	22°C
Humidity	43%

5. Test Samples

Sample	Control #	Description	Model	Serial #	Note
#1	180709-01.S01	Modem Module	L860 GL PR3.0	6A13JM0053	Conducted Power Tests
	180709-01.S07	Extender Board	-	-	

6. EUT Features

Brand Name	Fibocom M2							
Model Name	L860-GL							
FCC ID	Generic*							
Software Version/ Date	+XGENDATA: " XG756ES30S7E10NANNDEFXOC619181063645 M2_7560_XMM7560_REV_1.0_RPC_NAND_ULTRA3 2019-Apr-22 18:56:00 *XG756ES30S7E10NANNDEFXOC619181063645__M2_7560_01.1916.00*"							
Supported Wireless Configurations and Operating Modes	"FAB-CODE:7*SDRAMVendor=0x00 (N/A)"							
	The Fibocom M2 L860-GL module supports only UMTS and LTE, without carrier aggregation. The applicable frequency bands and operating modes are identified in the following table, where North America bands are shown in bold.							
	Mode	Bands	Supported Tx Mode					
			WCDMA	HSDPA	HSUPA	DC-HSDPA		
	WCDMA / HSPA+	FDD I (1920.0 – 1980.0 MHz)	✓	✓	✓	✓		
		FDD II (1850.0 – 1910.0 MHz)	✓	✓	✓	✓		
		FDD IV (1710.0 – 1755.0 MHz)	✓	✓	✓	✓		
		FDD V (824.0 – 849.0 MHz)	✓	✓	✓	✓		
		FDD VIII (880.0 – 915.0 MHz)	✓	✓	✓	✓		
	Mode	Bands	Supported Channel Bandwidth (MHz)					
			1.4	3	5	10	15	20
	LTE FDD	Band 1 (1920.0 – 1980.0 MHz)			✓	✓	✓	✓
		Band 2 (1850.0 – 1910.0 MHz)	✓	✓	✓	✓	✓	✓
		Band 3 (1710.0 – 1785.0 MHz)						
		Band 4 (1710.0 – 1755.0 MHz)	✓	✓	✓	✓	✓	✓
		Band 5 (824.0 – 849.0 MHz)	✓	✓	✓	✓	✓	✓
		Band 7 (2500.0 – 2570.0 MHz)			✓	✓	✓	✓
		Band 8 (880.0 – 915.0 MHz)	✓	✓	✓	✓		
		Band 12 (699.0 – 716.0 MHz)	✓	✓	✓	✓	✓	✓
		Band 13 (777.0 – 787.0 MHz)			✓	✓		
Band 14 (788.0 – 798.0 MHz)				✓	✓			
Band 17 (704.0 – 716.0 MHz)				✓	✓			
Band 18 (815.0 – 830.0 MHz)		✓	✓	✓	✓	✓	✓	
Band 19 (830.0 – 845.0 MHz)		✓	✓	✓	✓	✓	✓	
Band 20 (832.0 – 862.0 MHz)				✓	✓	✓	✓	
Band 25 (1850.0 – 1915.0 MHz)		✓	✓	✓	✓	✓	✓	
Band 26 (814.0 – 849.0 MHz)		✓	✓	✓	✓	✓	✓	
Band 28 (703.0 – 748.0 MHz)		✓	✓	✓	✓	✓	✓	
Band 30 (2305.0 – 2315.0 MHz)	✓	✓	✓	✓	✓	✓		
Band 66 (1710.0 – 1780.0 MHz)	✓	✓	✓	✓	✓	✓		
LTE TDD	Band 38 (2570.0 – 2620.0 MHz)			✓	✓	✓	✓	
	Band 39 (1880.0 – 1920.0 MHz)			✓	✓	✓	✓	
	Band 40 (2300.0 – 2400.0 MHz)			✓	✓	✓	✓	
	Band 41 (2496.0 – 2690.0 MHz)			✓	✓	✓	✓	

*Note: The algorithm validation is host independent. This report can be used for any host with TAS parameters in the validation range.

7. TAS Algorithm Validation Considerations

As described in the “Operation Descriptions” document, **TAS** has 5 parameters that are accessible to host devices incorporating the XMM 7560 Cellular Modem. There are two additional control and operating parameters that are derived from these 5 accessible parameters. The parameters are identified in Table 1 below. An illustration of **TAS** functionality, according to these parameters, is shown in Figure 1. Since **TAS** is fully contained within the XMM 7560 Cellular Modem, other than allowing a host device to select the accessible parameters, **TAS** operation is fully independent of the host product.

Table 1 – XMM 7560 Operating Parameters

Accessible Parameters	Derived Parameters
<i>Avg_SAR_UppThresh</i>	$Avg_SAR_LowThresh = Avg_SAR_UppThresh - DPR_OFF_SAR_Offset$
<i>DPR_ON_SAR_Offset</i>	$Max_Power_DPR_ON = Avg_SAR_UppThresh - DPR_ON_SAR_Offset$
<i>DPR_OFF_SAR_Offset</i>	
<i>Avg_SAR_Check_Period</i>	
<i>Avg_SAR_Roll_Period</i>	

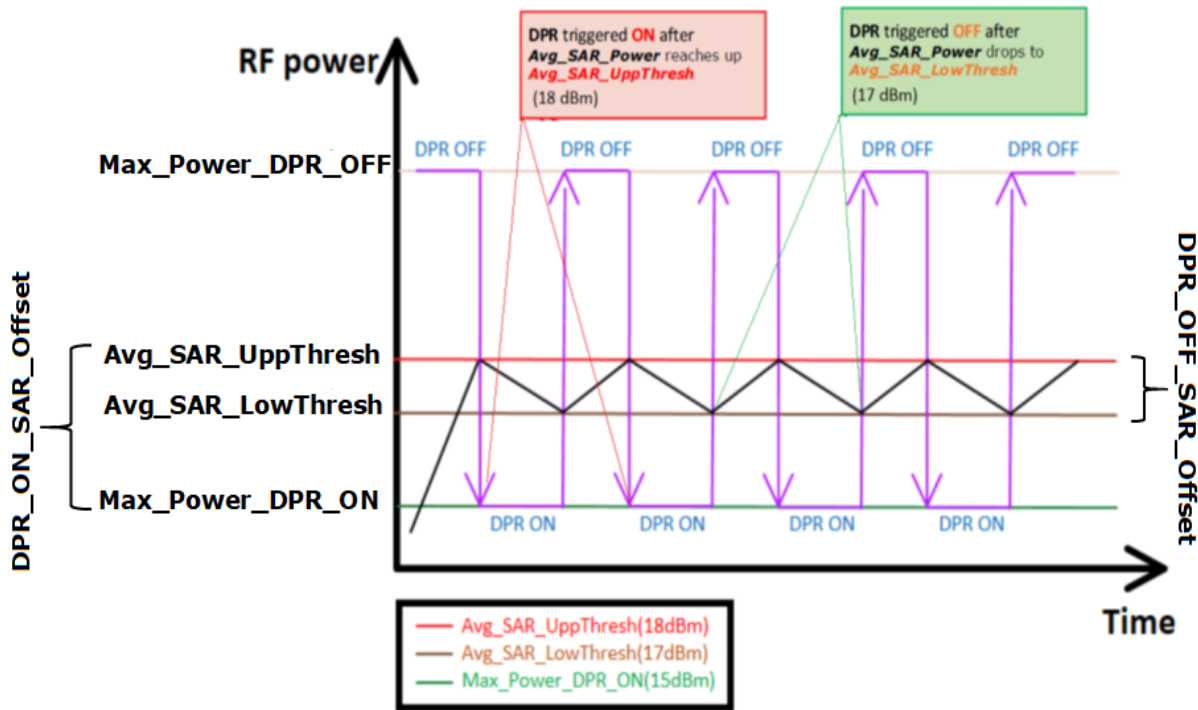

Figure 1 – Power control dynamics of TAS Algorithm for ensuring SAR compliance

When XMM 7560 operates in the end user environment, TAS is always enabled; end users do not have the option to disable TAS. Therefore, the time-averaged power (**Avg_SAR_Power**) is always kept below the specified upper power threshold (**Avg_SAR_UppThresh**) and SAR compliance is determined in real-time at each **Avg_SAR_Check_Period** according to the time-averaging window **Avg_SAR_Roll_Period**. The recommended settings of **Avg_SAR_Roll_Period** and **Avg_SAR_Check_Period** for the XMM 7560 Cellular Modem are 100 sec and below 1 sec, respectively.

7.1. Algorithm Validation using Conducted Power Measurement

TAS operating characteristics and algorithm implementation have been validated using conducted power measurement according to parameters that are applicable to the host products. TAS is fully self-contained within the XMM 7560 and, other than the power recording time interval used for UMTS and LTE, 10 msec vs. 1 msec, the same power control mechanism is applied to both 3G and 4G. Since TAS operations are independent of frequency band and wireless mode, and SAR compliance can be established at the maximum time-averaged power level specified by *Avg_SAR_UppThresh*, validation of the algorithm and implementation using conduct power measurement test configurations is appropriate and acceptable.

The following XMM 7560 operating conditions are used in the conducted power measurement configurations to validate TAS algorithm implementation. The conducted power measurement test setup is described in Annex A.1.

1. under maximum output power conditions for UMTS and LTE, according to a diverse range of operating and control parameters
2. under normal UMTS and LTE operations in Connected states, according to specific power control test sequences
3. when a connection is dropped and re-established
4. when a handover occurs between frequency bands and modes within LTE or UMTS
5. when a handover occurs between LTE and UMTS

7.1.1. Range of Parameters Considered for Algorithm Validation

TAS algorithm validation has been performed for UMTS and LTE according to cases with different combinations of operating parameters listed in Table 2, see details in Tables B.1 and B.2. All attenuations and offsets are accounted for in uplink power measurements at the Main Antenna port. This is described in Annex A.1.1 and illustrated in the test setup photos in Annex A.1.3. The test results are shown in Annex B.2.1.1 for LTE and Annex B.2.1.2 for UMTS.

Table 2 – Range of Parameters

Parameters
<i>Avg_SAR_UppThresh</i>
<i>Avg_SAR_LowThresh</i>
<i>Max_Power_DPR_ON</i>

7.1.2. Time Varying Power Control Test Sequences Considered for Algorithm Validation

Two types of power control test sequences are used in the conducted power measurement test setup for **TAS** algorithm validation in selected mode/band configurations under normal LTE and UMTS operations in Connected State. The first test sequence (#1) is for validating the functionality of **DPR** (Dynamic Power Reduction) according to the values of **Max_Power_DPR_OFF**, **Max_Power_DPR_ON**, **Avg_SAR_UppThresh** and **Avg_SAR_LowThresh** specified for the mode/band. The second test sequence (#2) consists of a pre-determined sequence of random or arbitrary power levels and durations for validating overall **TAS** functionality to ensure SAR compliance through dynamic power control.

1. Sequence #1: Starting at below **Avg_SAR_LowThresh** for a fixed duration, the sequence is followed by a sufficiently long duration of transmission at **Max_Power_DPR_OFF** until **DPR** is turned ON. After it is confirmed that **Avg_SAR_Power** remains between **Avg_SAR_UppThresh** and **Avg_SAR_LowThresh**, the XMM 7560 is commanded to reduce output power to below **Avg_SAR_LowThresh** to ensure **DPR** is subsequently turned OFF.
2. Sequence #2: A power profile consisting of varying levels between **Max_Power_DPR_OFF** and below **Max_Power_DPR_ON**, with varying transmission durations in the range of 1 – 20 seconds, are sent by the Call Box to the XMM 7560. The power levels and intervals used in the tests have been determined according to preliminary test results.

The time durations and power levels used for the two test sequences are listed in Table 3 and Table 4. These sequences are applied to validate TAS in both UMTS and LTE. In Table 3, for sequence #1, the power level is set to an initial level below **Max_Power_DPR_ON** and followed by maximum output power (**Max_Power_DPR_OFF**) requests from the Call Box to verify DPR control and TAS responses. This is then followed by a Call Box output power request of below **Max_Power_DPR_ON** to ensure proper TAS response is observed when DPR is disabled. Table 4 consists of the sequence of power levels and time durations sent from the Call Box to XMM 7560 to validate dynamic power control

under arbitrary/random conditions, similar to those experienced by typical end users, to demonstrate DPR reliability. Both of these sequences are illustrated in Figure 2.

Table 3 – Test Sequence #1

Sequence 1			
Time	Duration	Tx_Power	Notes
150	150	5 dBm	< Low Threshold
350	200	23	Max power
720	370	13	Lower -2 dB

Table 4 – Test Sequence #2

Sequence 2			
Time	Duration	Tx_Power	Notes
150	150	5 dBm	< Lower
165	15	14	Upper-4dB
185	20	18	Upper
205	20	20,5	(Upper+Pmax)/2
215	10	10	Upper-8dB
235	20	23	Pmax
250	15	18	Upper
265	15	11	Upper-7dB
285	20	23	Pmax
305	20	13	Upper -5dB
320	15	18	Upper
330	10	12	Upper-6dB
340	10	20,5	Upper+max/2
360	20	11	Upper -7 dB
380	20	11	Upper - 7dB
390	10	20,5	Upper+max/2
400	10	12	Upper-6dB
415	15	18	Upper
435	20	13	Upper -5dB
455	20	23	Pmax
465	10	11	Upper-7dB
480	15	18	Upper
500	20	23	Pmax
515	15	10	Upper-8dB
535	20	20,5	(Upper+Pmax)/2
555	20	18	Upper
570	15	14	Upper-4dB
720	150	5	< Lower Threshold

Note: Pmax=Max_Power_DPR_OFF (23 dBm),
Upper=Avg_SAR_UppThresh (18 dBm) and Lower = Avg_SAR_LowThresh (15 dBm)

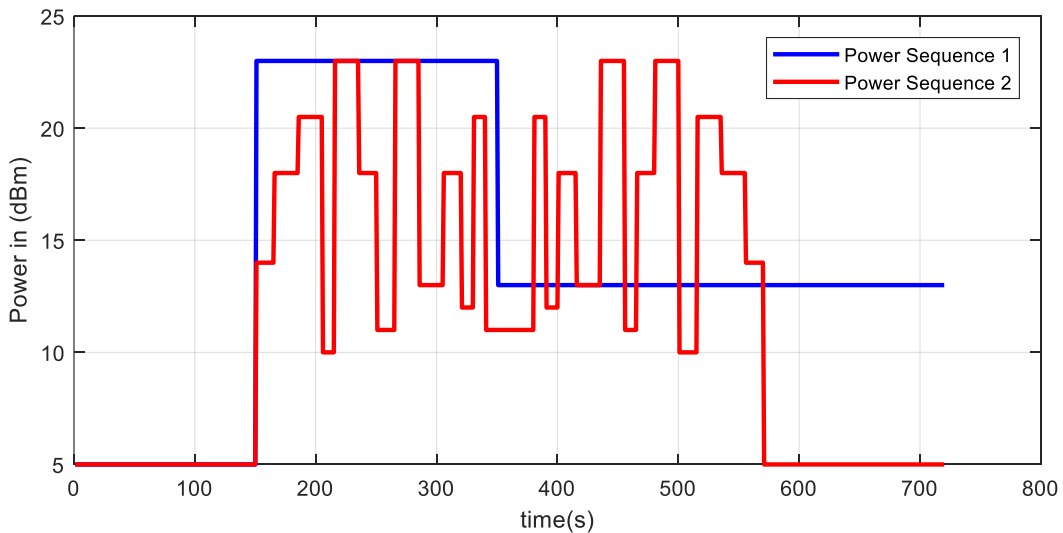

Figure 2 – Plot of Tx power for test sequence #1 and #2

For each test sequence, **TAS** should respond by maintaining **Avg_SAR_Power** at or below **Avg_SAR_UppThresh** according to **DPR** requirements; therefore, SAR measurement at **Avg_SAR_UppThresh** according to normally required SAR procedures is all that would be necessary to determine compliance. These are demonstrated by the supporting test results in Annex B.2.2.

7.1.3. Connection Drop and Technology/Band Handover Validation

In order to demonstrate that **TAS** functions as expected during a drop connection or handover, the first test sequence (#1) in Section 7.2 (Table 2) is adapted for validating algorithm control continuity during such temporarily discontinued transmissions. A connection drop or handover is initiated after **DPR** is turned ON and **Avg_SAR_Power** is maintained between **Avg_SAR_UppThresh** and **Avg_SAR_LowThresh**. When the connection is re-established, maximum output power is requested by the Call Box to ensure **DPR** remains ON and **TAS** response is verified to ensure algorithm control continuity. These are demonstrated by the validation results in Annex B.2.3.

8. Summary of Validation Tests and Results

The following table lists the types of **TAS** algorithm validation tests performed and the corresponding Tables and Annexes describing the test configurations and validation results. Description of the conducted power measurement test setup and photos are included in Annex A.

Validation Type	Test Configurations	Test Results
Range of TAS Parameter	Table B1 Table B2	LTE: Annex B.2.1.1 UMTS: Annex B.2.1.2
Time Varying Test Sequences	Table B3	LTE & UMTS: Annex B.2.2
Connection Drop	Table B4	Drop connection: Annex B.2.3.1
Handover	Table B5 Table B6	LTE B2 to LTE B4 handover: Annex B.2.3.2 LTE B2 to UMTS B4 handover: Annex B.2.3.3

Annex A. Test Setup Description

A.1 Measurement System

A.1.1 Test Setup

The conducted power measurement test setup is described in the following and illustrated in Figure A.

- The Fibocom M2 L860-GL module, which contains the XMM 7560 Cellular Modem, is installed in an Intel Test Platform (DUT) to emulate a generic host device and to provide proper interface for the Call Box and test equipment. Photos of the Fibocom module, XMM 7560 and test equipment are included in included in Annex A.1.3 and A.3.
- A control PC is used to configure the Call Box to send power control test sequences to the XMM 7560, according to those described in Section 7 and Annex B.
- Uplink signal power is monitored by the Spectrum Analyzer and record by the PC with a time resolution of 25 msec, which is substantially less than the power adjustment interval (**Avg_SAR_Check_Period**) of 1 sec used for XMM 7560.
- The values of **Avg_SAR_Power** are read from the XMM 7560 by the PC at each **Avg_SAR_Check_Period**
- In addition to power results, the time sequence of power control commands and power samples are also recorded by the PC to enable results to be correlated and plotted. Uplink signal from the XMM 7560 is fed through a 3 dB Power Splitter, which delivers an equal amount of signal to the Sectrum Analyser and the Call Box. The Splitter has high isolation between the Spectrum Analyser and the Call Box. Due to different Uplink/Downlink frequencies and the zero span time-domain measurement used, interference of Uplink and Downlink sigals is avoided.
- Path loss in the power measurement setup from the XMM 7560 Main Antenna port to either the Call Box or the Spectrum Analyser is 17.58 dB, with less than 0.1 dB difference between Band 2 and Band 4 (used for the tests).

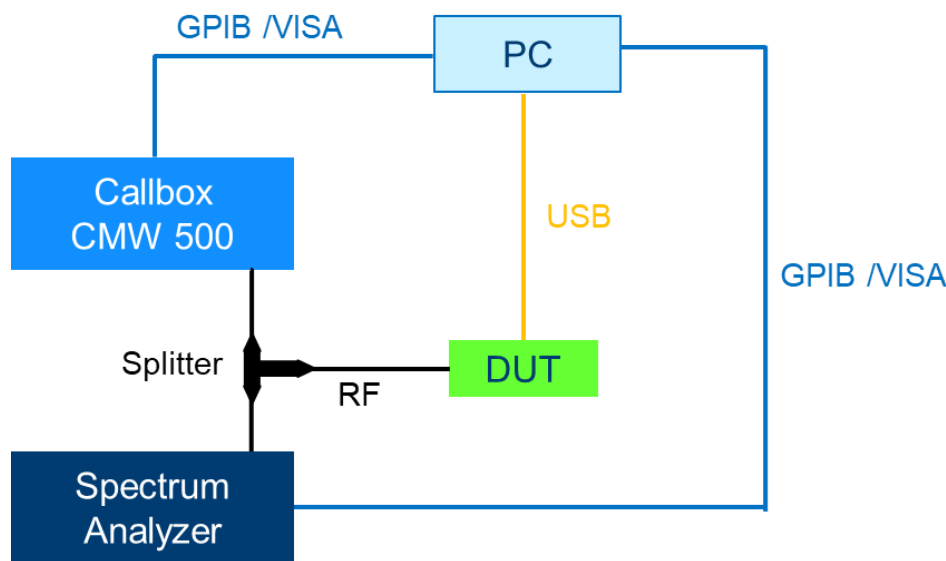

Figure A.1 – Validation using conducted power measurement test setup.

A.1.2 Test Equipment List

The Equipments used for the conducted power measurement test setup are listed below. The Test Platform (DUT), test setup and associated equipment are shown in Annex C.

ID#	Device	Type/Model	Serial #	Manufacturer	Cal. Date	Cal. Due Date
0319	Communication Tester	CMW500	152721	Rohde & Schwarz	2018-04-12	2020-04-12
0322	Spectrum Analyzer	FSL6	102143	Rohde & Schwarz	2018-04-13	2020-04-13
-	Power Divider	PE2083	-	Pasternack	Attenuation and loss verified before use	

Annex B. Validation Test Results

B.1 Validation using Conducted Power Measurement

The **TAS** algorithm and its reliability for ensuring SAR compliance have been validated using conducted power measurements, according to the validation procedures described in Section 7.1 of this test report. The validations include both LTE and UMTS. The test configurations and validation results are shown in the sub-sections of this Annex. The wireless operating modes and transmission configurations used for the algorithm validation tests are described in Tables B1 – B6. Following each Table, **TAS** responses according to **Avg_SAR_Power**, which is time averaged over **Avg_SAR_Roll_Period**, and the corresponding (instantaneous) output power transmitted by the XMM 7560 Cellular Modem, measured by the Spectrum analyzer, are plotted separately for the test configurations after each Table. The results verify that **DPR** is turned ON when **Avg_SAR_Power** reaches **Avg_SAR_UppThresh** and **TAS** is able to maintain **Avg_SAR_Power** between **Avg_SAR_UppThresh** and **Avg_SAR_LowThresh** until **Avg_SAR_Power** falls below **Avg_SAR_LowThresh** and **DPR** is turned OFF.

For the M2 module, XMM 7560 is validated with **Avg_SAR_Check_Period** and **Avg_SAR_Roll_Period** set to 1 sec and 100 sec, respectively. The total duration for each test is 12 minutes (720 sec). The maximum output power available from the specific XMM 7560 Cellular Modem used for the validation tests is about 22 - 23 dBm. The following is a brief description of the test configurations:

- Table B1 and Table B2 – Configurations used to verify **TAS** responses to power control for the operating parameters in Table 2 of Section 7.1.1. The test starts from a reboot condition and is followed by maximum output power requests from the Call Box to the XMM 7560. There are 6 cases each for UMTS and LTE.
- Table B3 – Wireless mode configurations used for testing the test sequences listed in Table 2 and Table 3 of Section 7.2.
- Table B4 – Wireless mode configurations used for testing a drop-connection, which is introduced after **DPR** is turned ON due to maximum power requests from the Call Box. After the connection is reestablished, maximum output power is again requested to demonstrate **DPR** and **TAS** control continuity with respect to power accumulated before and after the drop-connection condition. In addition, instead of a drop-connection, the test is repeated by replacing the drop-connection with a reboot.
- Table B5 – Wireless mode configurations used for testing handover from LTE B2 to LTE B4, similar to configurations used for drop-connection.
- Table B6 – Wireless mode configurations used for testing handover from LTE B2 to UMTS B4, similar to configurations used for drop-connection.

B.2 TAS Validation Tests and Results

B.2.1 Fundamental Algorithm Validation for a Range Control Parameters

B.2.1.1 Validation for LTE in Band 2

Table B1 – Test Cases for LTE Band 2 using 1 RB and QPSK

Test Case #	Band	Max Power	Roll Period	Check Period	Avg_SAR_UppThresh [dBm]	Avg_SAR_LowThresh [dBm]	Max_Power_DPR_ON [dBm]
1	LTE B2	23 dBm	100 sec	1 sec	22	21	20
2					22	19	16
3					20	19	18
4					20	17	14
5					18	17	16
6					18	15	12

Note: Values for **Max Power**, **Avg_SAR_UppThresh**, **Avg_SAR_LowThresh** and **Max_Power_DPR_ON** indicated above are approximated. The exact values for these are set according to the actual **Max Power** at the time of testing, accounting for tolerance, and the range (in dB) for **Avg_SAR_UppThresh**, **Avg_SAR_LowThresh** and **Max_Power_DPR_ON**. These can introduce an apparent shift of the curves relative to **Max Power** shown in the plots. However, they have no impact to **TAS**.

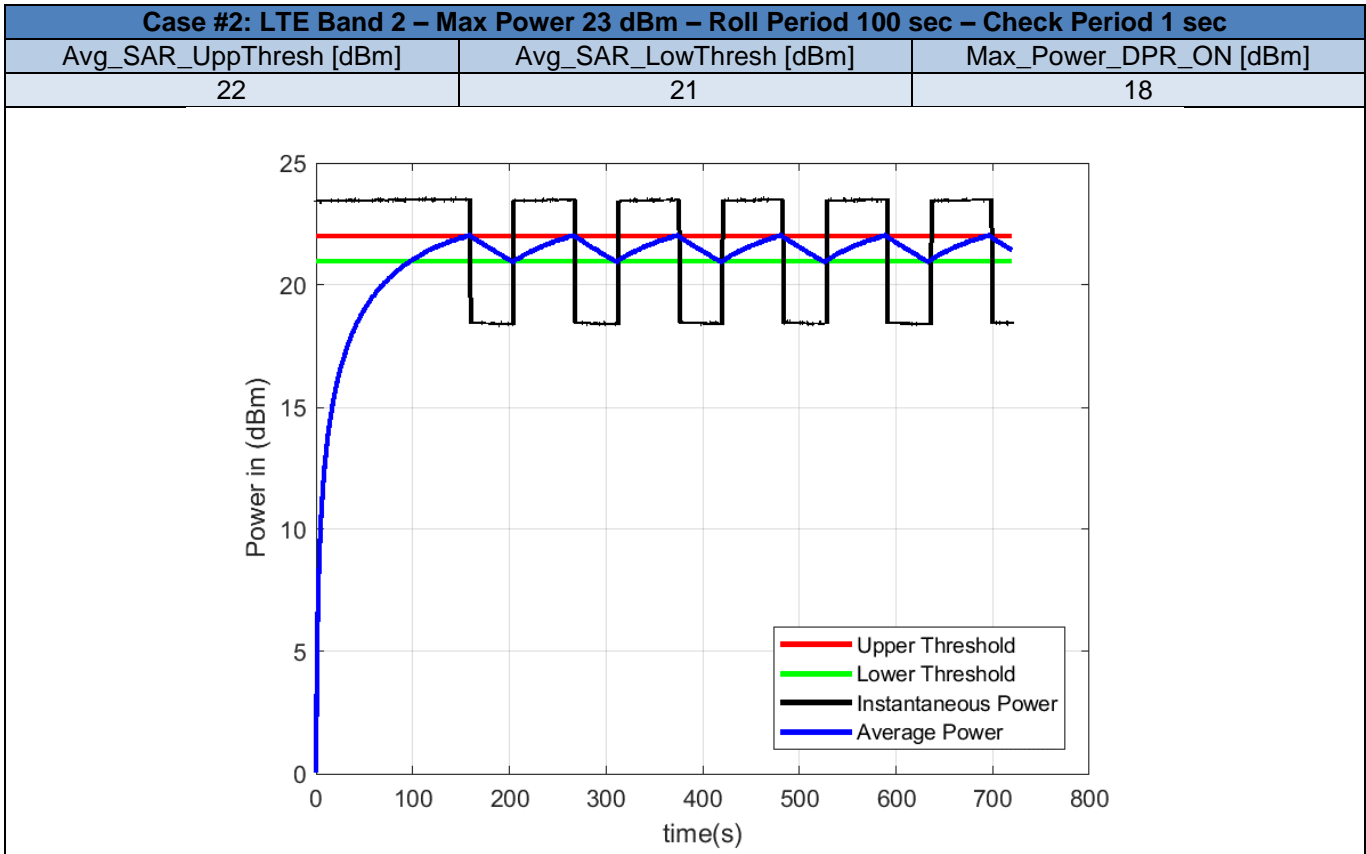
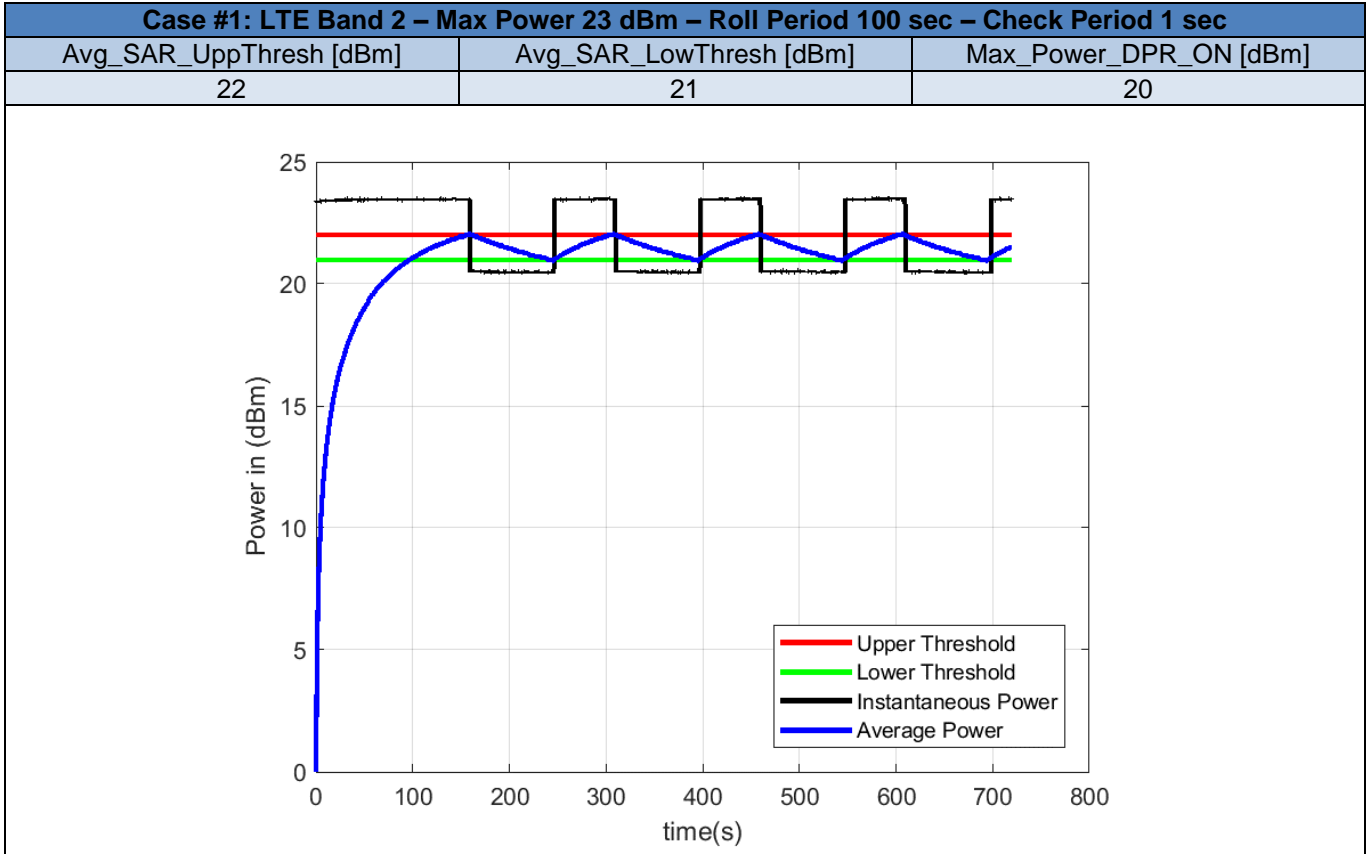

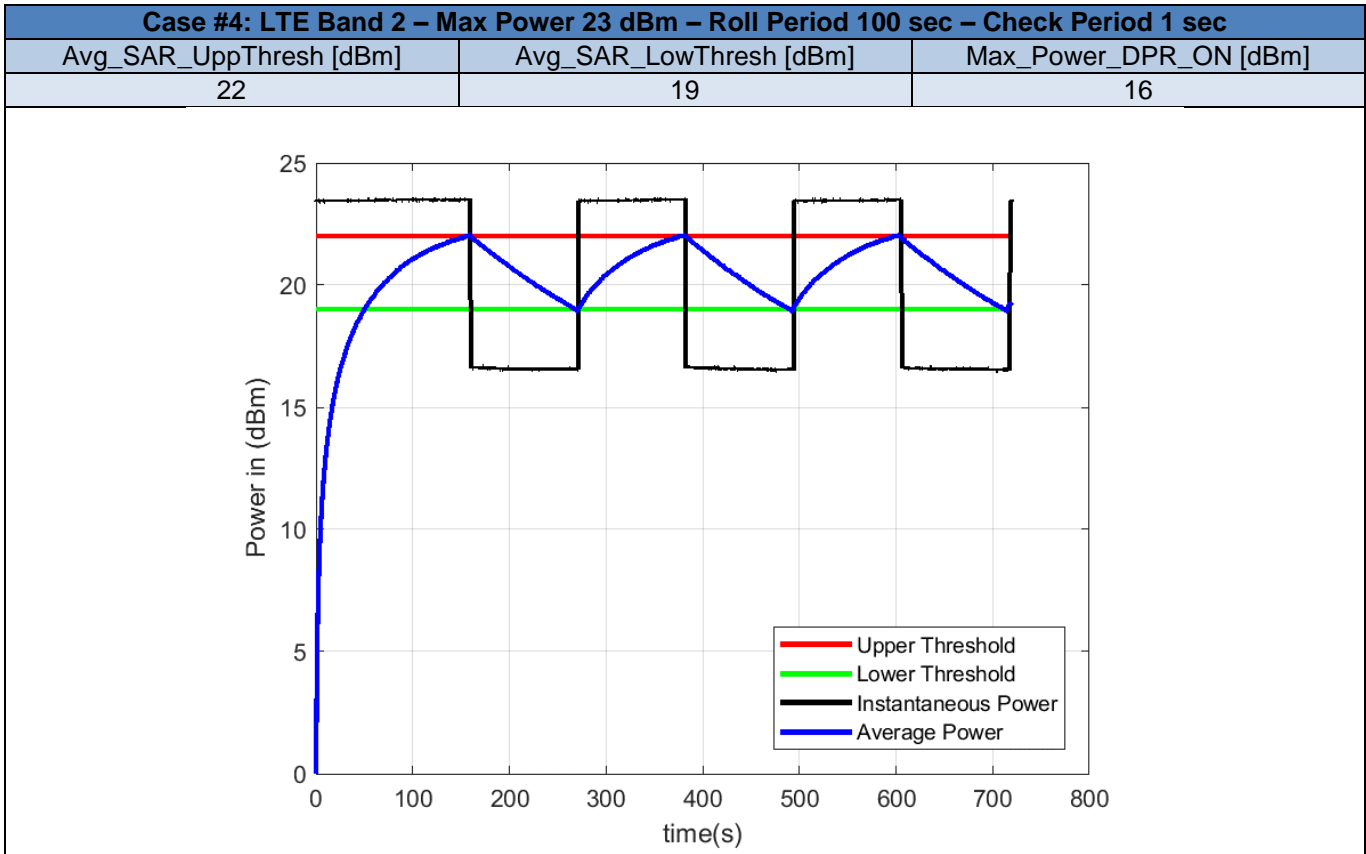
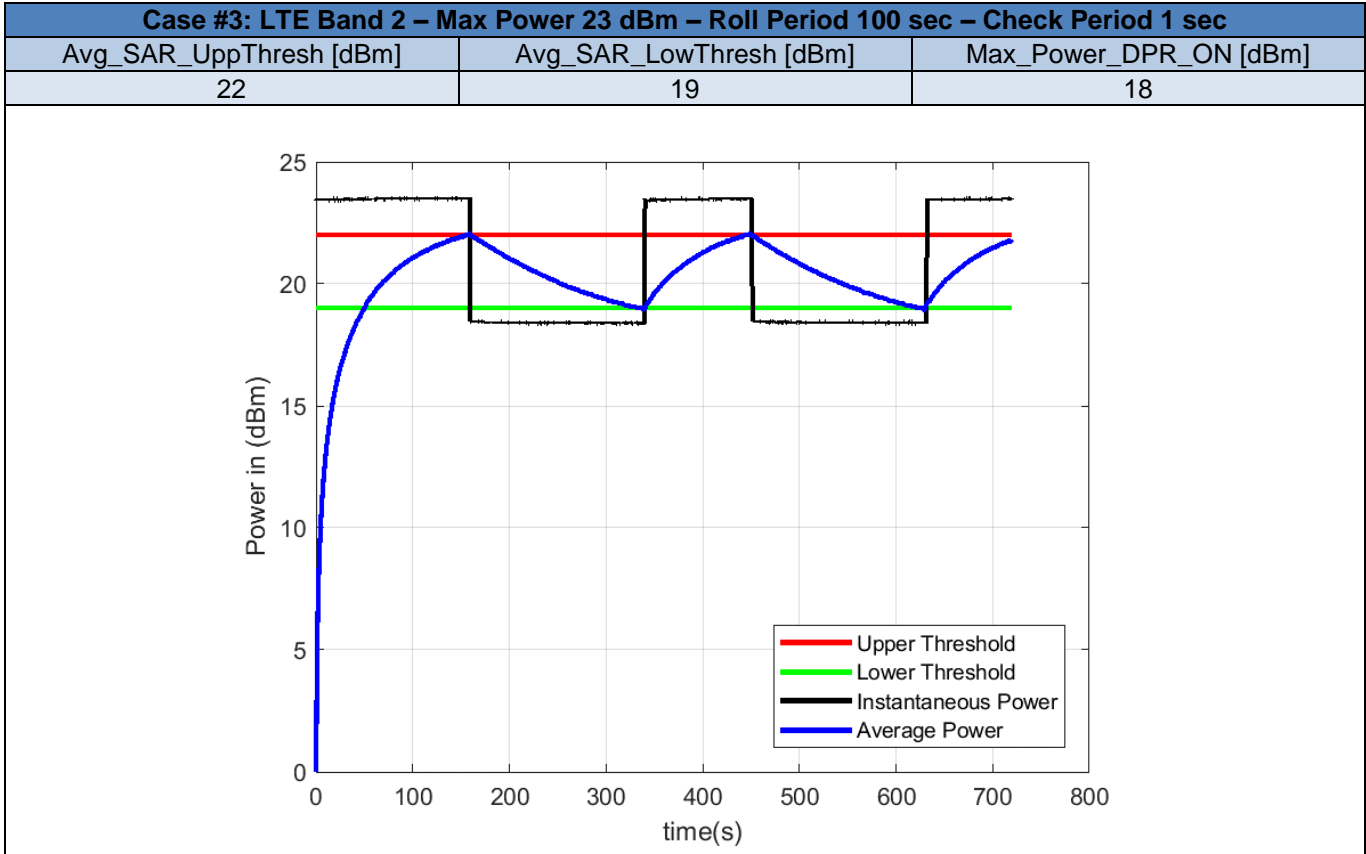

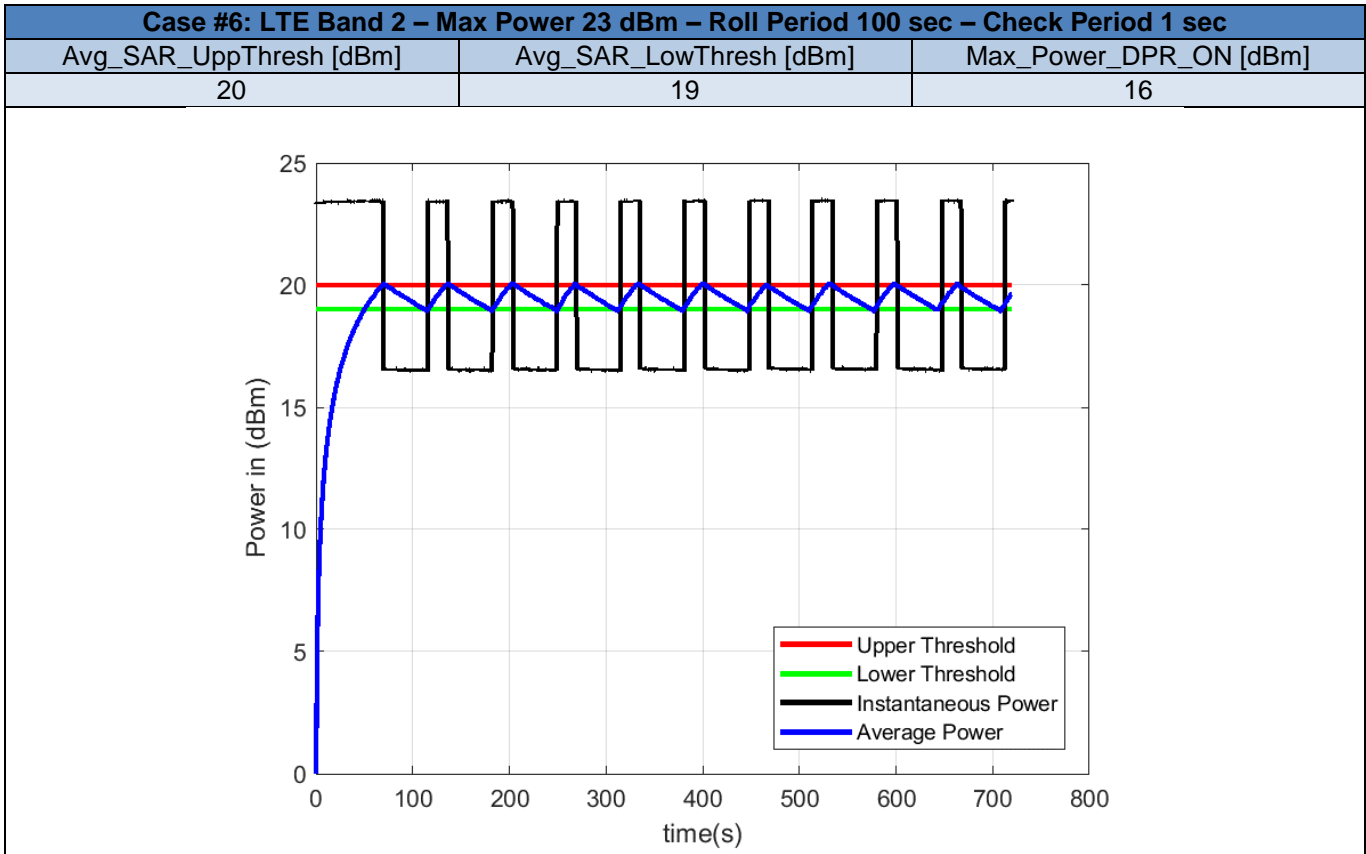
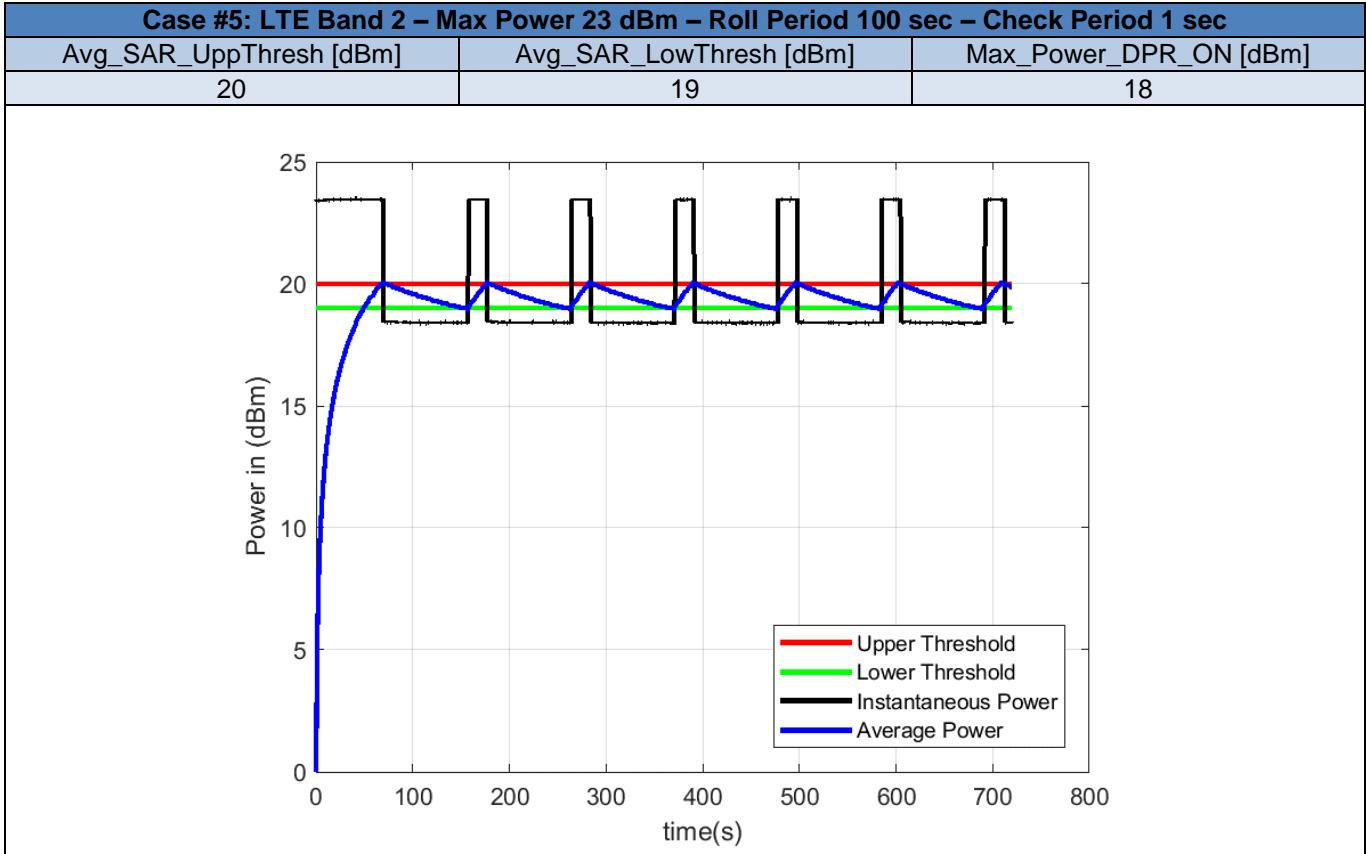

B.2.1.2 Validation of UMTS/WCDMA Band 2
Table B2 – Test Cases for UMTS/WCDMA Band 2 – RMC

Test Case #	Band	Max Power	Roll Period	Check Period	Avg_SAR_UppThresh [dBm]	Avg_SAR_LowThresh [dBm]	Max_Power_DPR_ON [dBm]
1	WCDMA B2	22.5 dBm	100 sec	1 sec	22	21	20
2					22	19	16
3					20	19	18
4					20	17	14
5					18	17	16
6					18	15	12

Note: Values for **Max Power**, **Avg_SAR_UppThresh**, **Avg_SAR_LowThresh** and **Max_Power_DPR_ON** indicated above are approximated. The exact values for these are set according to the actual **Max Power** at the time of testing, accounting for tolerance, and the range (in dB) for **Avg_SAR_UppThresh**, **Avg_SAR_LowThresh** and **Max_Power_DPR_ON**. These can introduce an apparent shift of the curves relative to **Max Power** shown in the plots. However, they have no impact to **TAS**.

Results for the test cases in Table B2 are shown in the following plots.

Note: The maximum output power in WCDMA mode for this test sample was about 22.5 dBm, which was 0.5 dB lower than the 23 dBm specified; therefore, *Max_Power_DPR_ON* and *Max_Power_DPR_OFF* are shifted lower by 0.5 dB in plots for all WCDMA test cases. While *Max_Power_DPR_OFF* was 0.5 dB lower, *Avg_SAR_UppThresh* and *Avg_SAR_LowThresh* were not adjusted. This does not seem to have any noticeable impact to **TAS** control.

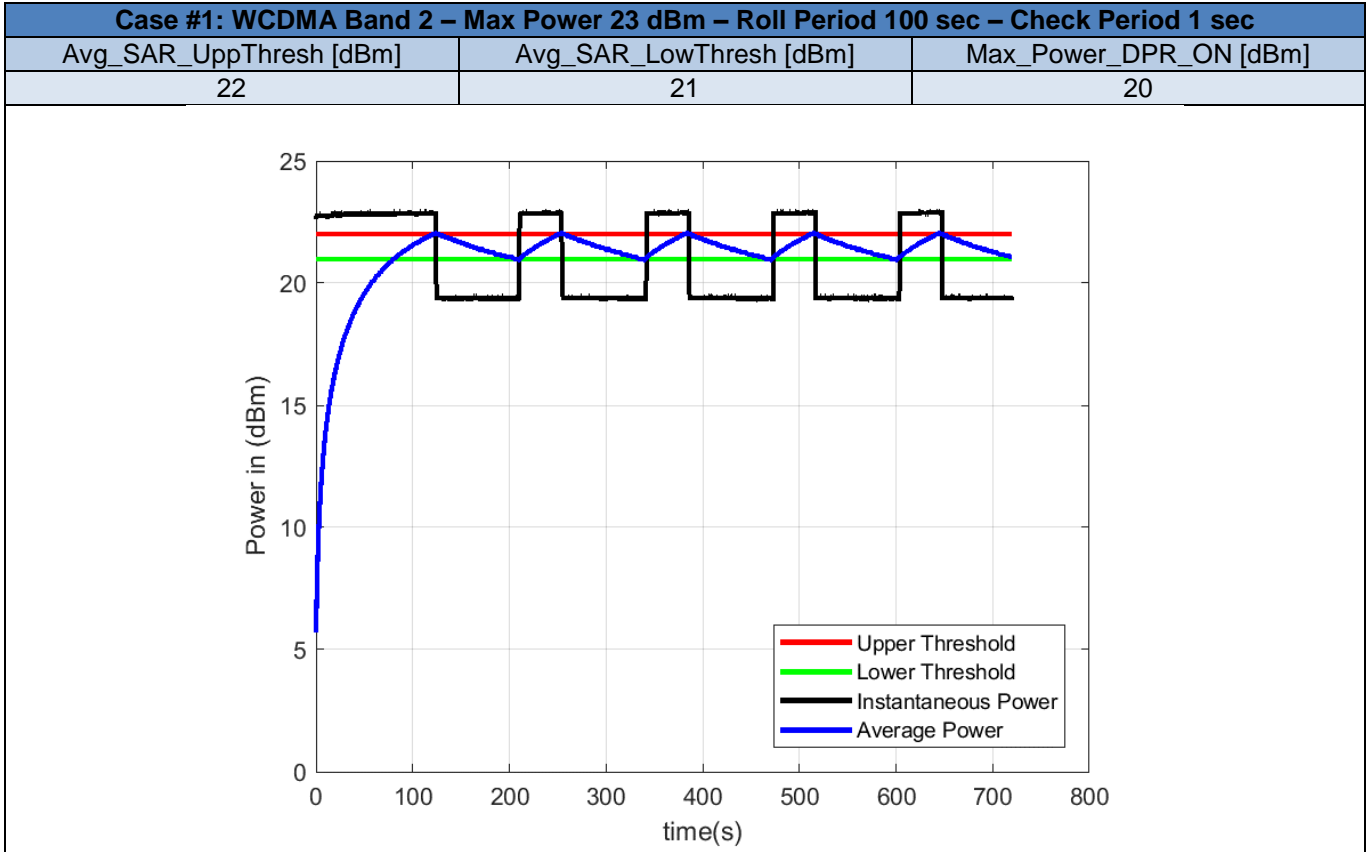

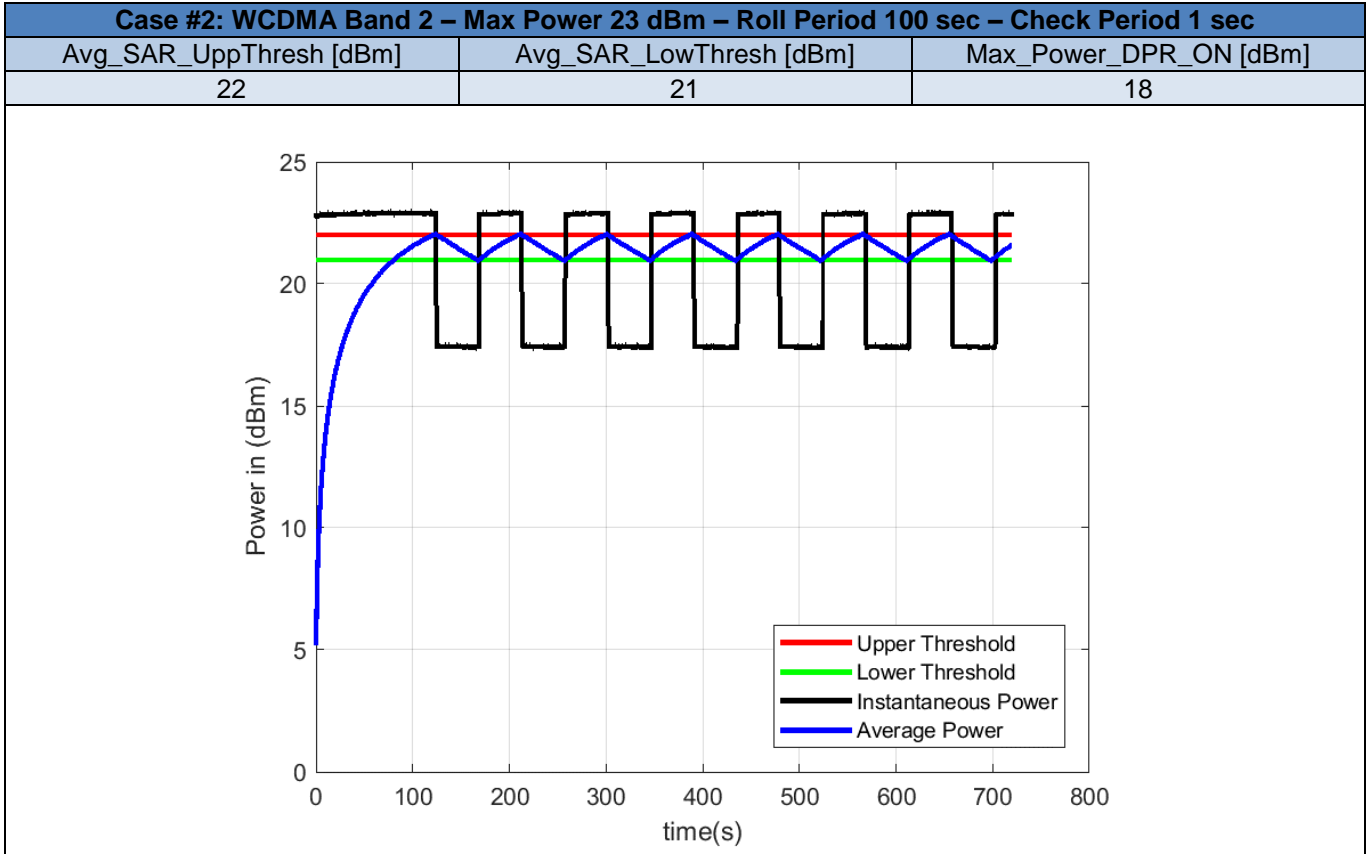

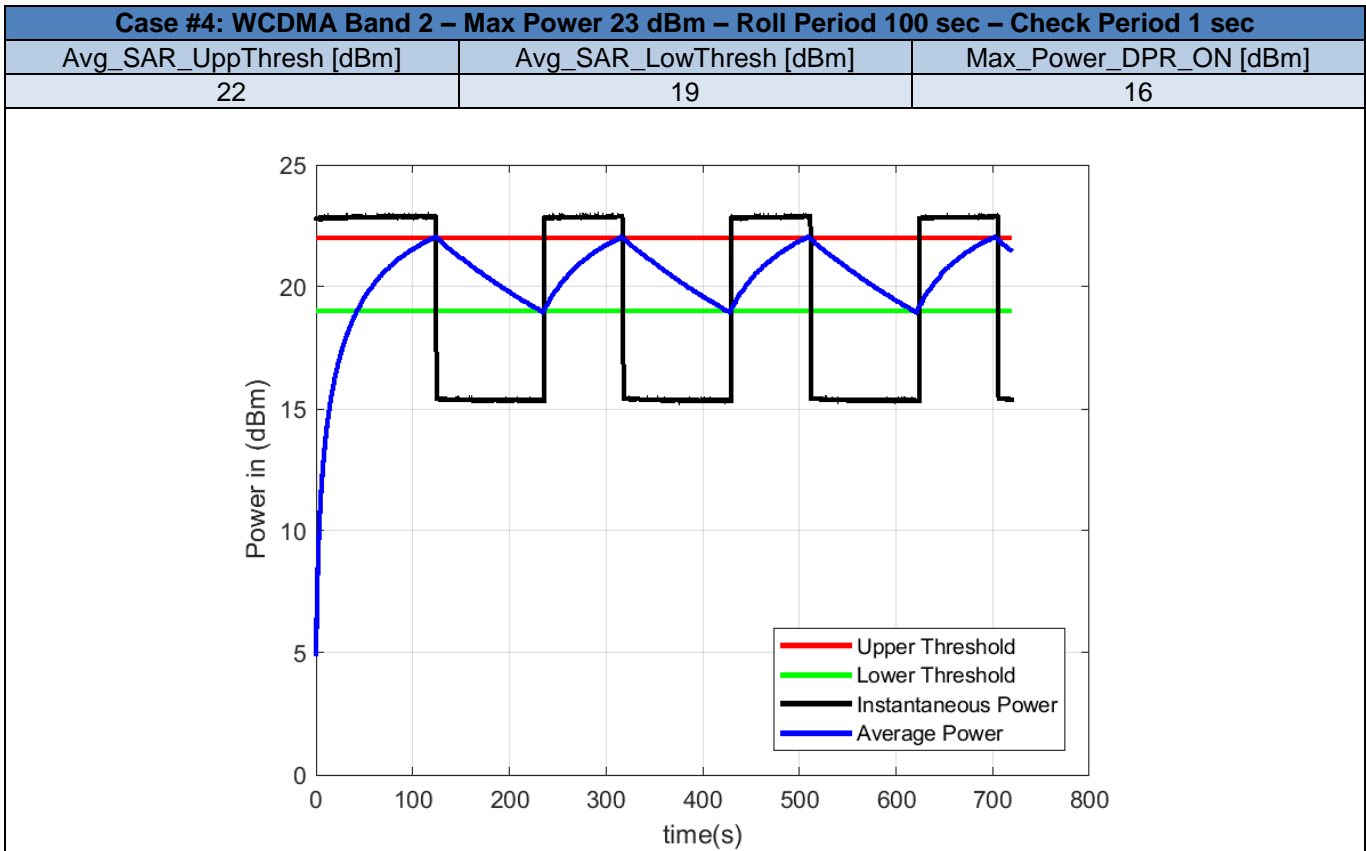
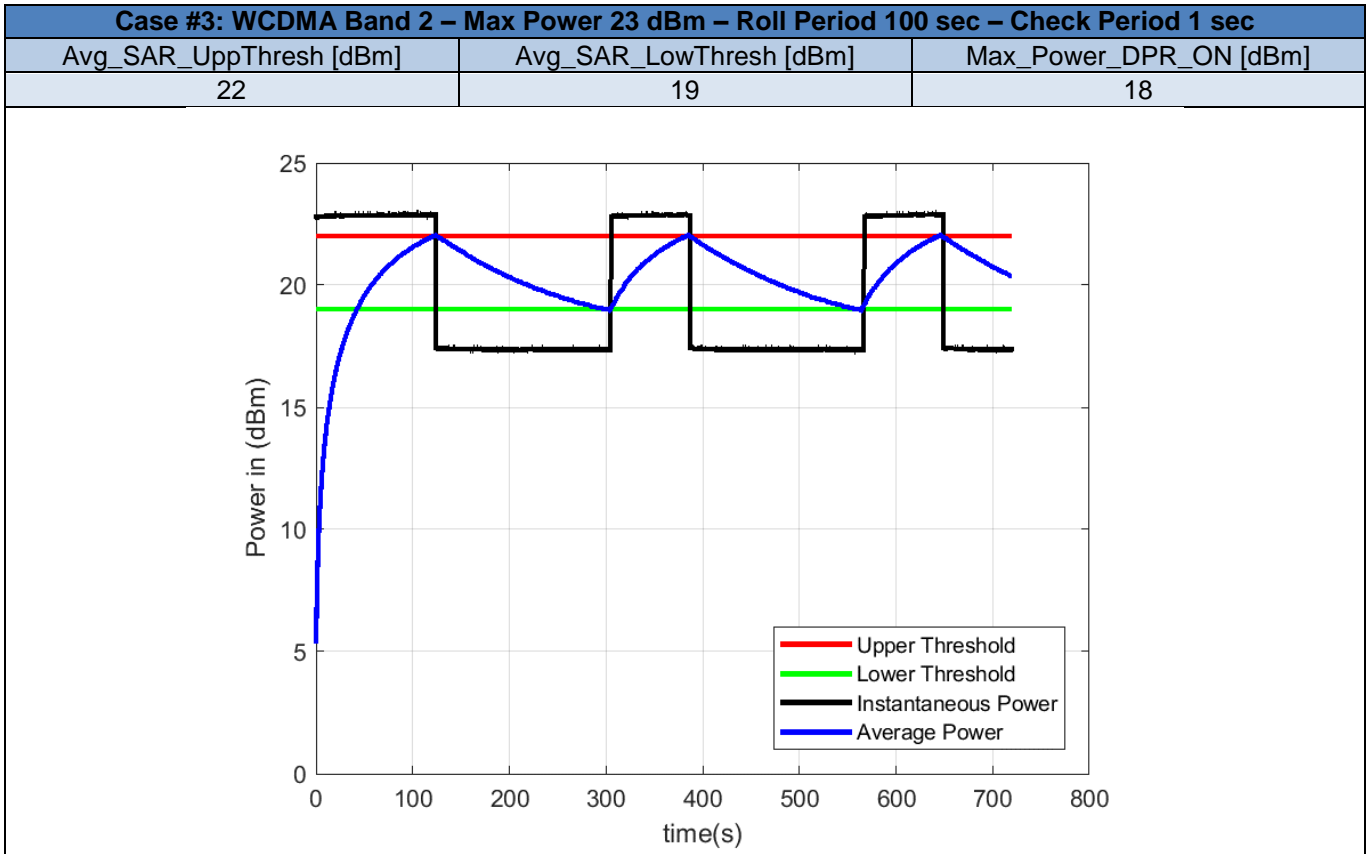

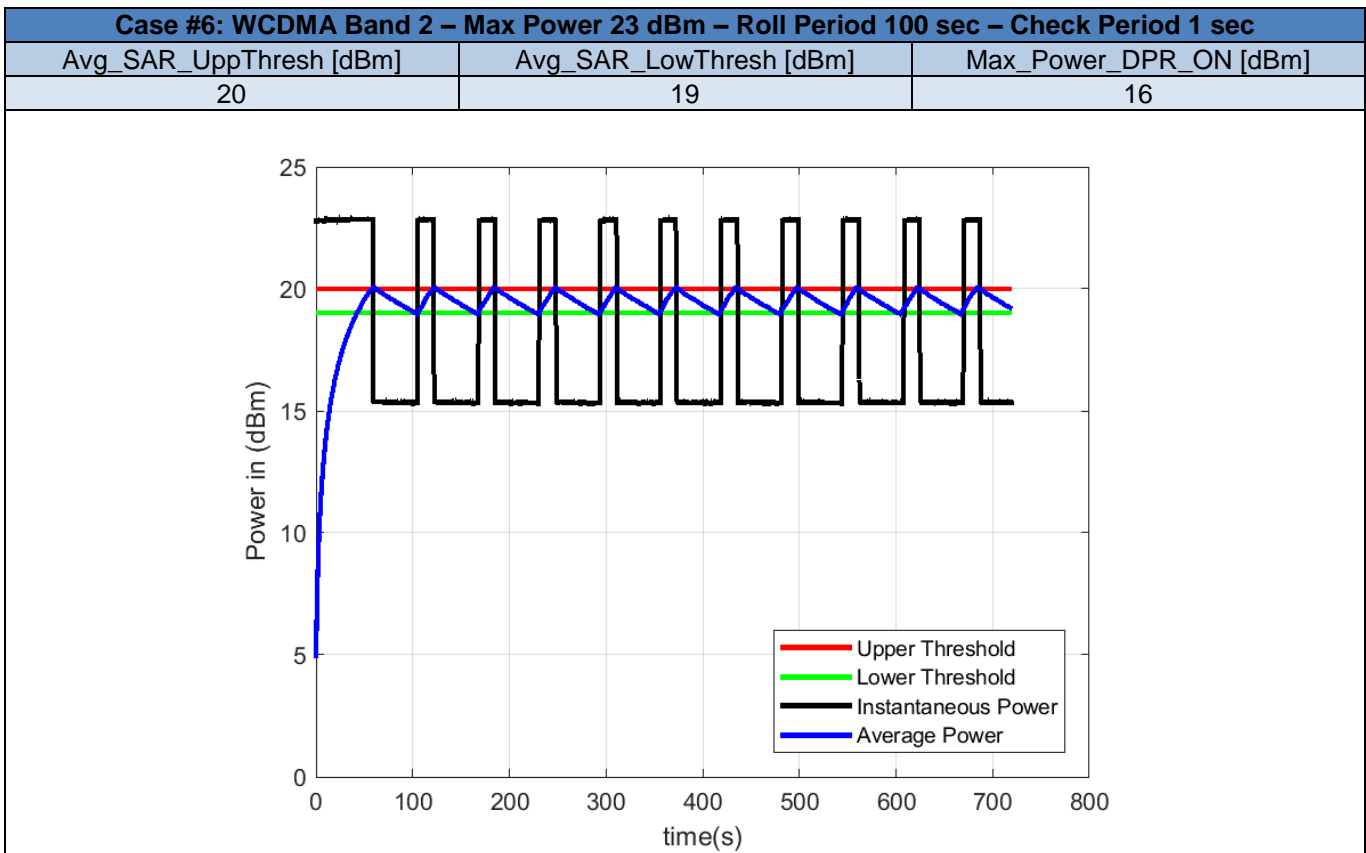
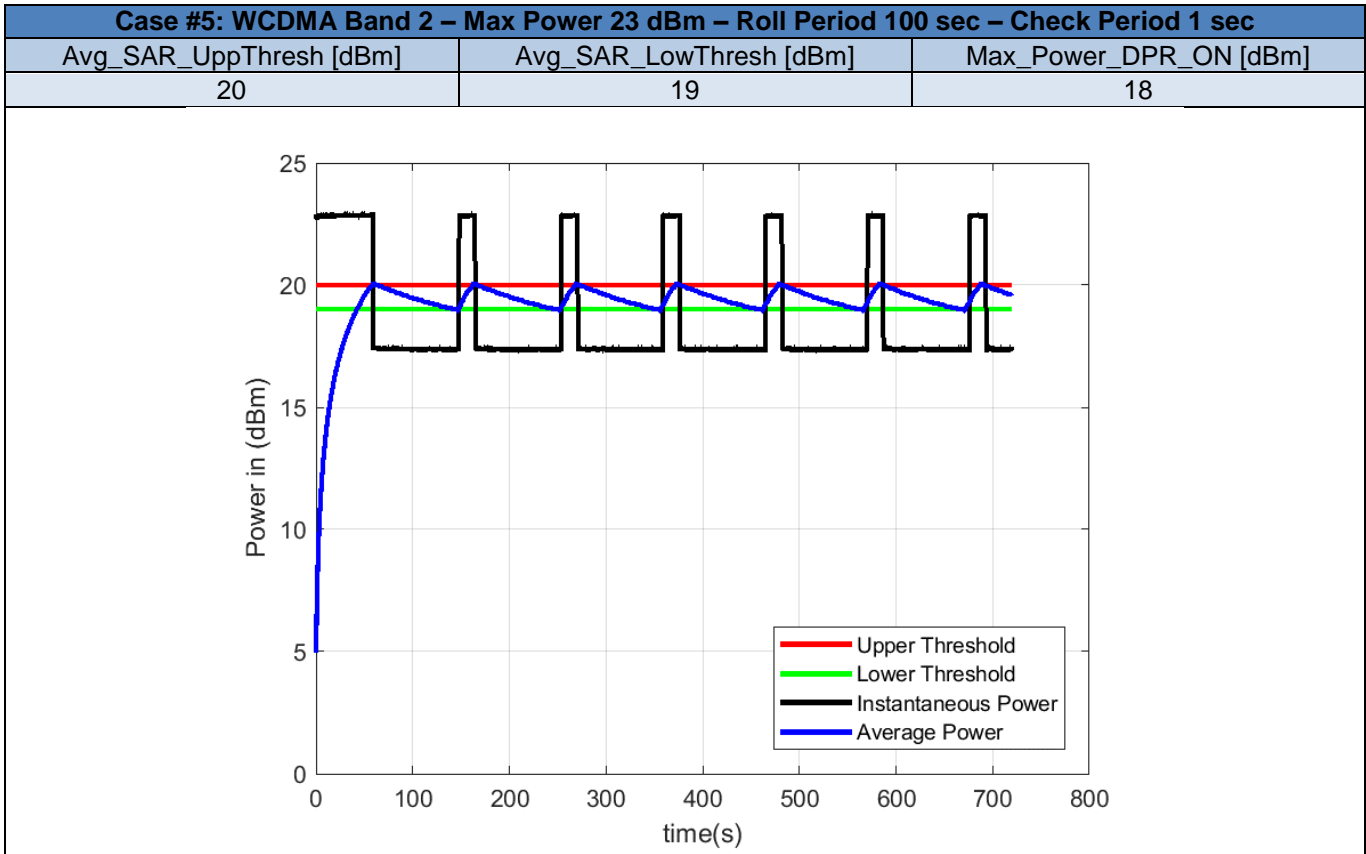

B.2.2 Algorithm Validation According to Time Varying Power Control Test Sequences

Table B3 – Test Cases for Test Sequences in Tables 2 and 3 for LTE and WCDMA - Band 2

Test Case #	Band	Max Power	Roll Period	Check Period	Avg_SAR_UppThresh [dBm]	Avg_SAR_LowThresh [dBm]	Max_Power_DPR_ON [dBm]
1	LTE B2	23 dBm	100 sec	1 sec	18	15	14
2					18	15	14
3	WCDMA B2	22.5 dBm			18	15	14
4					18	15	14

Note: Values for **Max Power**, **Avg_SAR_UppThresh**, **Avg_SAR_LowThresh** and **Max_Power_DPR_ON** indicated above are approximated. The exact values for these are set according to the actual **Max Power** at the time of testing, accounting for tolerance, and the range (in dB) for **Avg_SAR_UppThresh**, **Avg_SAR_LowThresh** and **Max_Power_DPR_ON**. These can introduce an apparent shift of the curves relative to **Max Power** shown in the plots. However, they have no impact to **TAS**.

Results for the test cases in Table B3 are shown in the following plots.

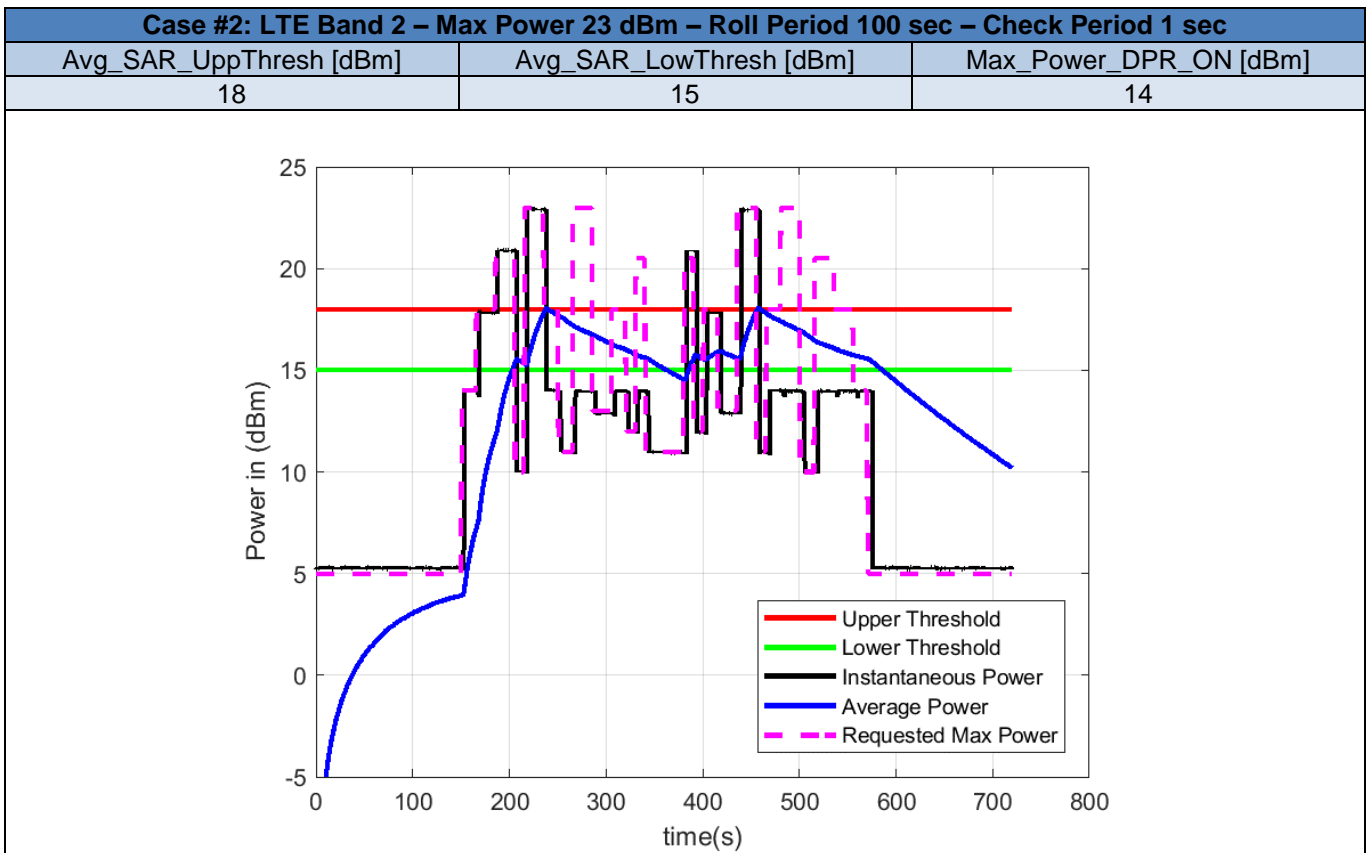
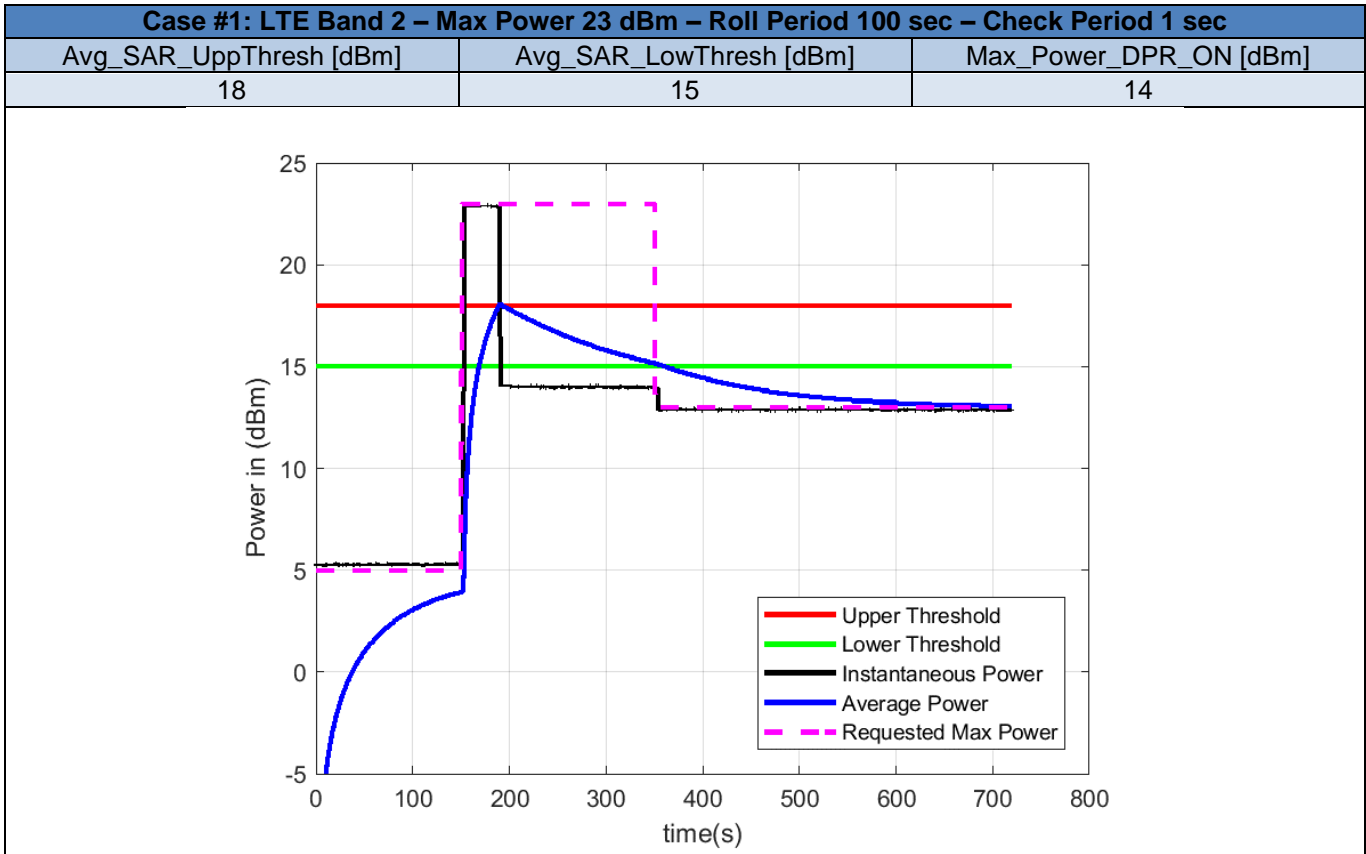

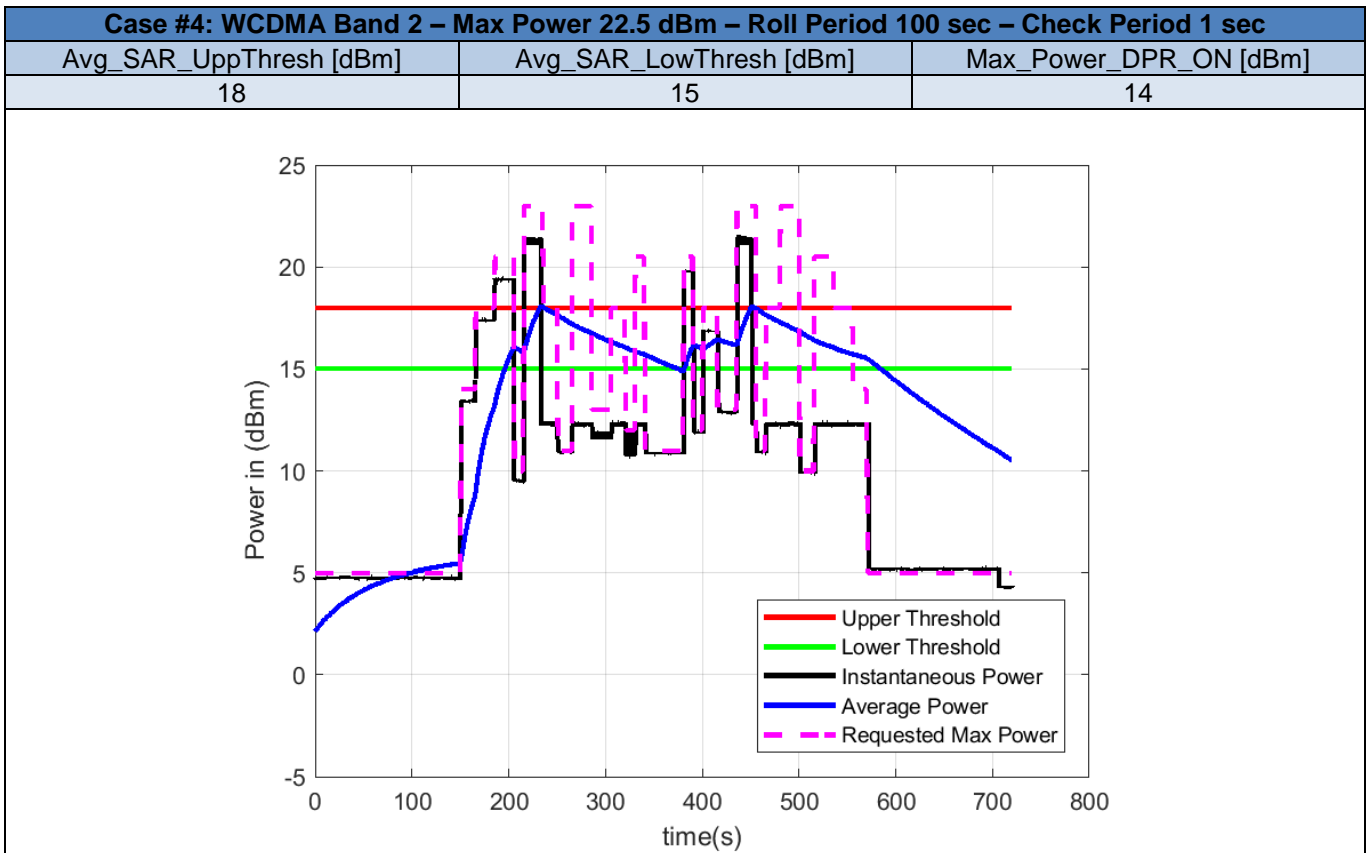
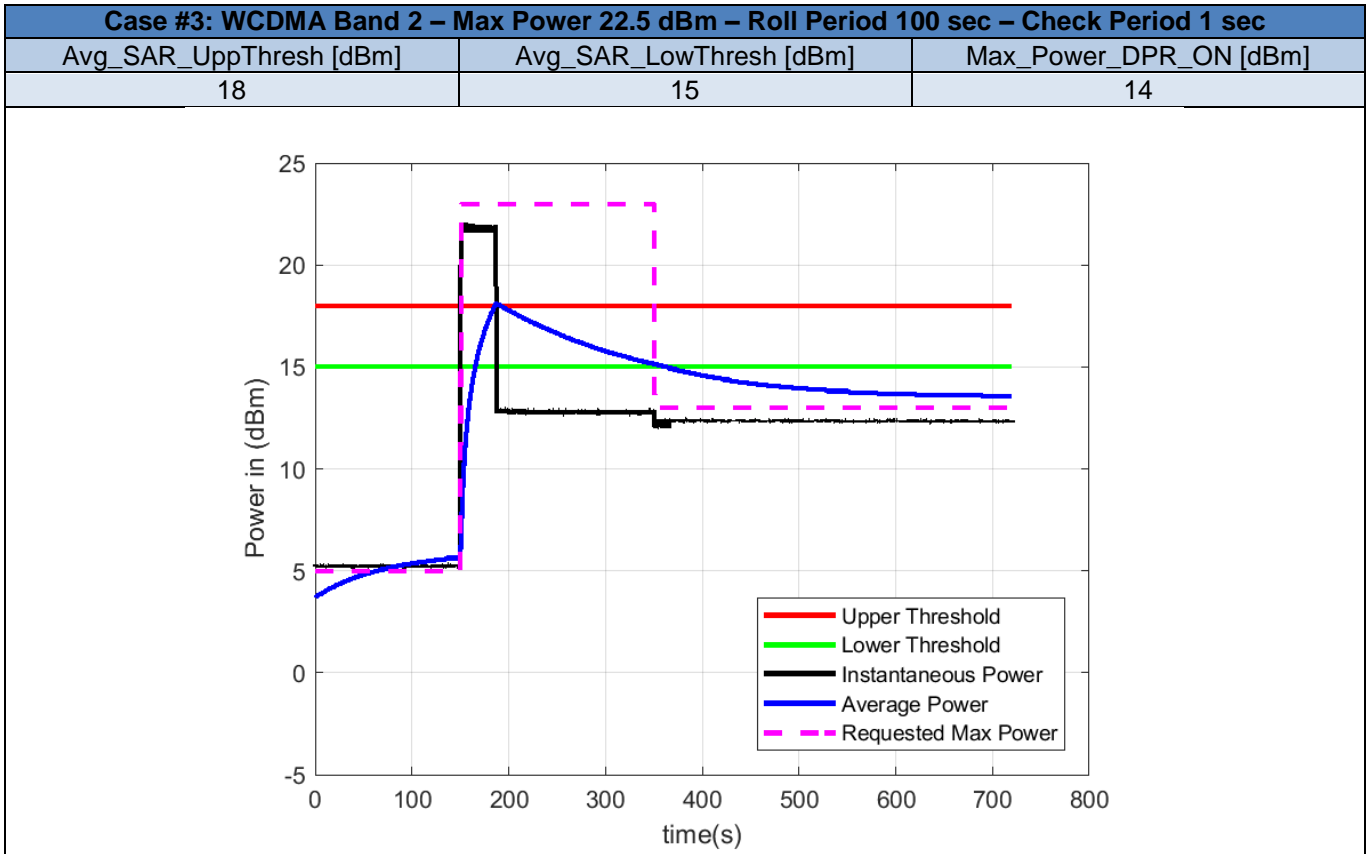

B.2.3 Algorithm Validation for Drop Connection and Reboot

B.2.3.1 Connection Drop and Reboot Scenario Validation

Table B4 – Test Cases for LTE connection drop and reboot

Test Case #	Band	Max Power	Roll Period	Check Period	Avg_SAR_UppT hresh [dBm]	Avg_SAR_LowT hresh [dBm]	Max_Power_DPR_ON [dBm]
1: Drop Connection	LTE B2	23 dBm	100 sec	1 sec	18	17	14
2: Reboot					18	17	14

Results for the test cases in Table **Table B4** are shown in the following plots.

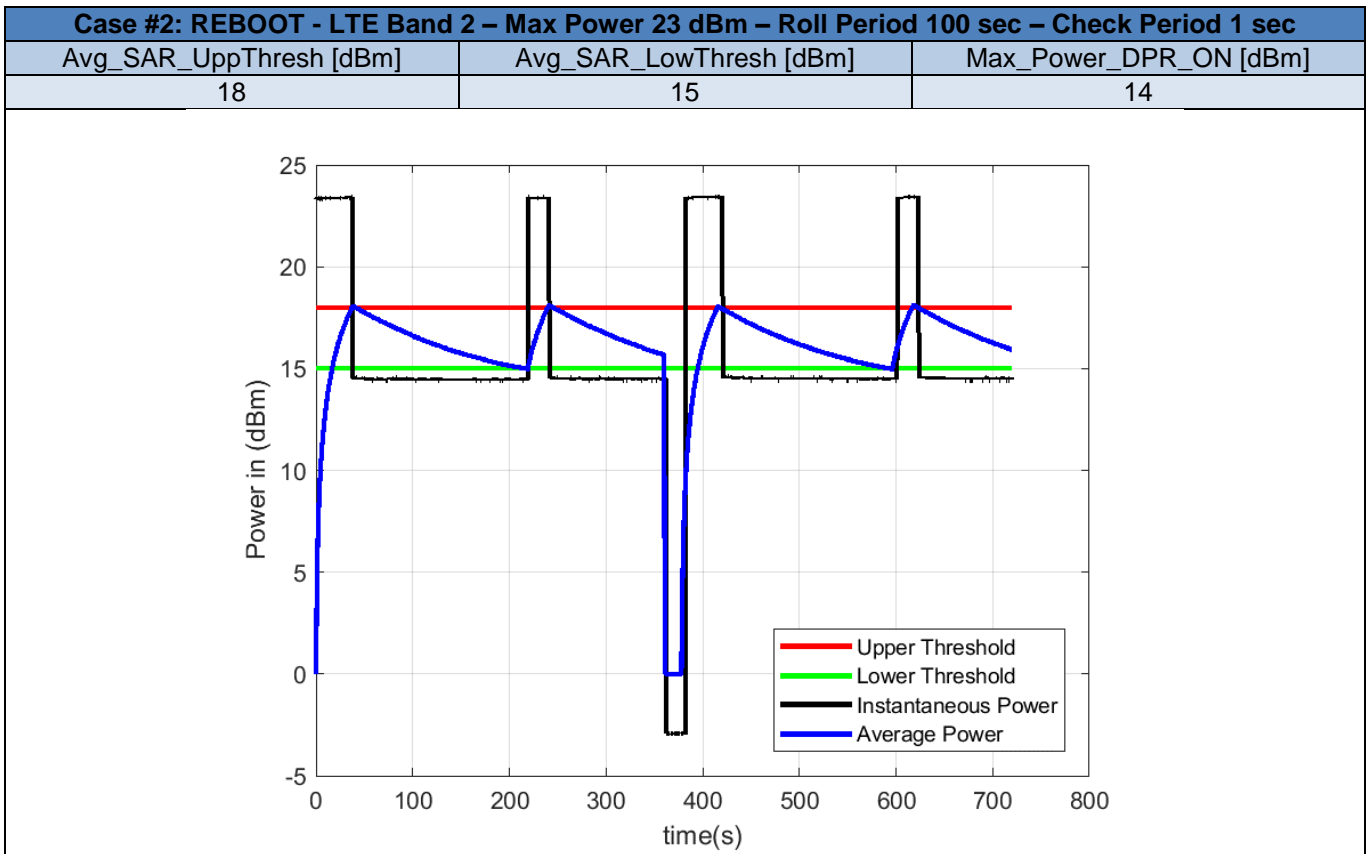
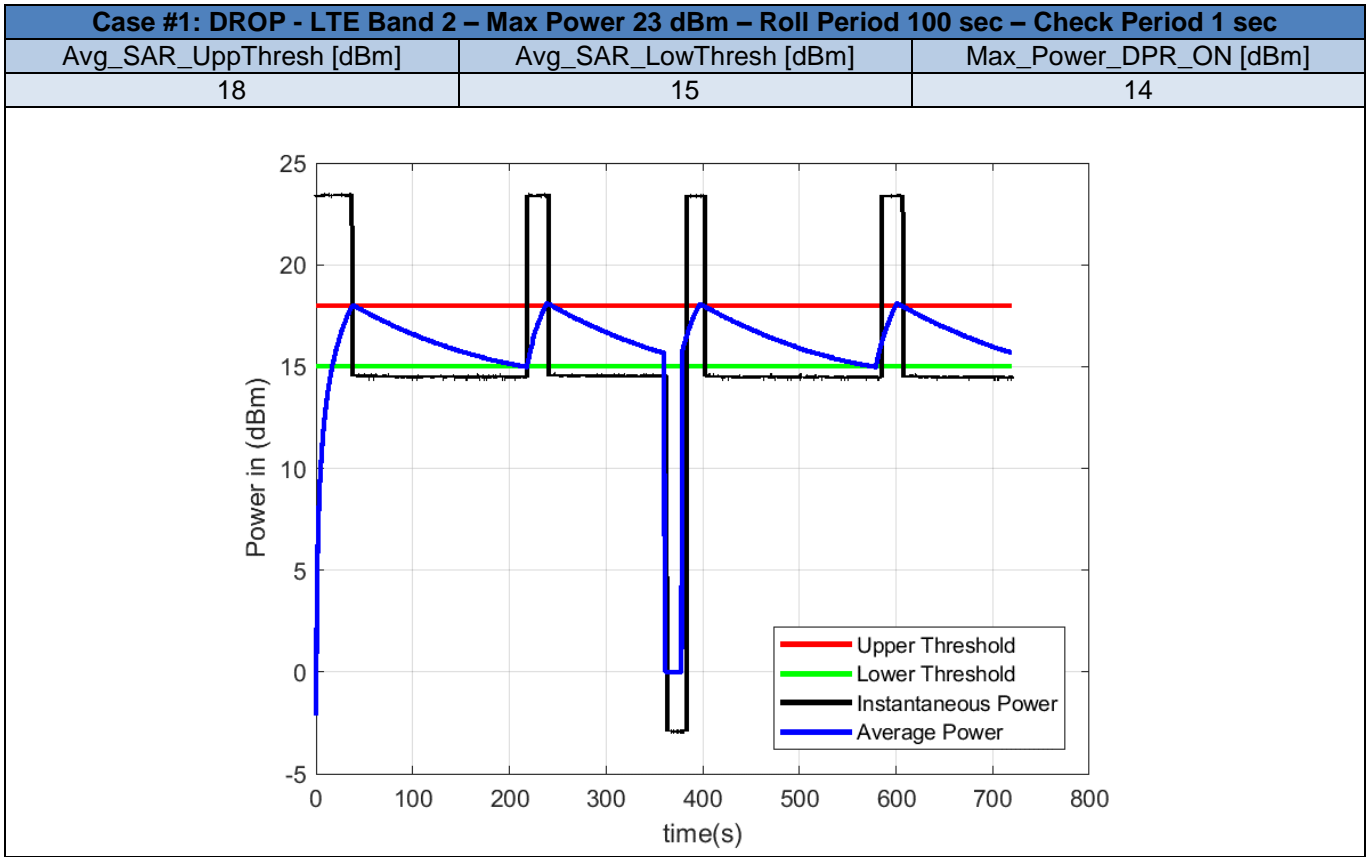

B.2.3.2 Handover Validation from LTE Band 2 to LTE Band 4

Table B5 – Test Case for Handover from LTE Band 2 to LTE Band 4

Test Case #	Band	Max Power	Roll Period	Check Period	Avg_SAR_UppThresh [dBm]	Avg_SAR_LowThresh [dBm]	Max_Power_DPR_ON [dBm]
1	LTE B2	23 dBm	100 sec	1 sec	20	17	16
	LTE B4						

Note: Values for **Max Power**, **Avg_SAR_UppThresh**, **Avg_SAR_LowThresh** and **Max_Power_DPR_ON** indicated above are approximated. The exact values for these are set according to the actual **Max Power** at the time of testing, accounting for tolerance, and the range (in dB) for **Avg_SAR_UppThresh**, **Avg_SAR_LowThresh** and **Max_Power_DPR_ON**. These can introduce an apparent shift of the curves relative to **Max Power** shown in the plots. However, they have no impact to **TAS**.

Results for the test case in Table B5 are shown in the following plot.

Note: This handover test was done at a different time from all of the above tests. The LTE **Max_Power_DPR_ON** and **Max_Power_DPR_OFF** levels were about 0.5 dB lower than specified due to tune-up tolerances (± 1 dB) relating to board temperature introduced power drift. This has no impact on **TAS** operations.

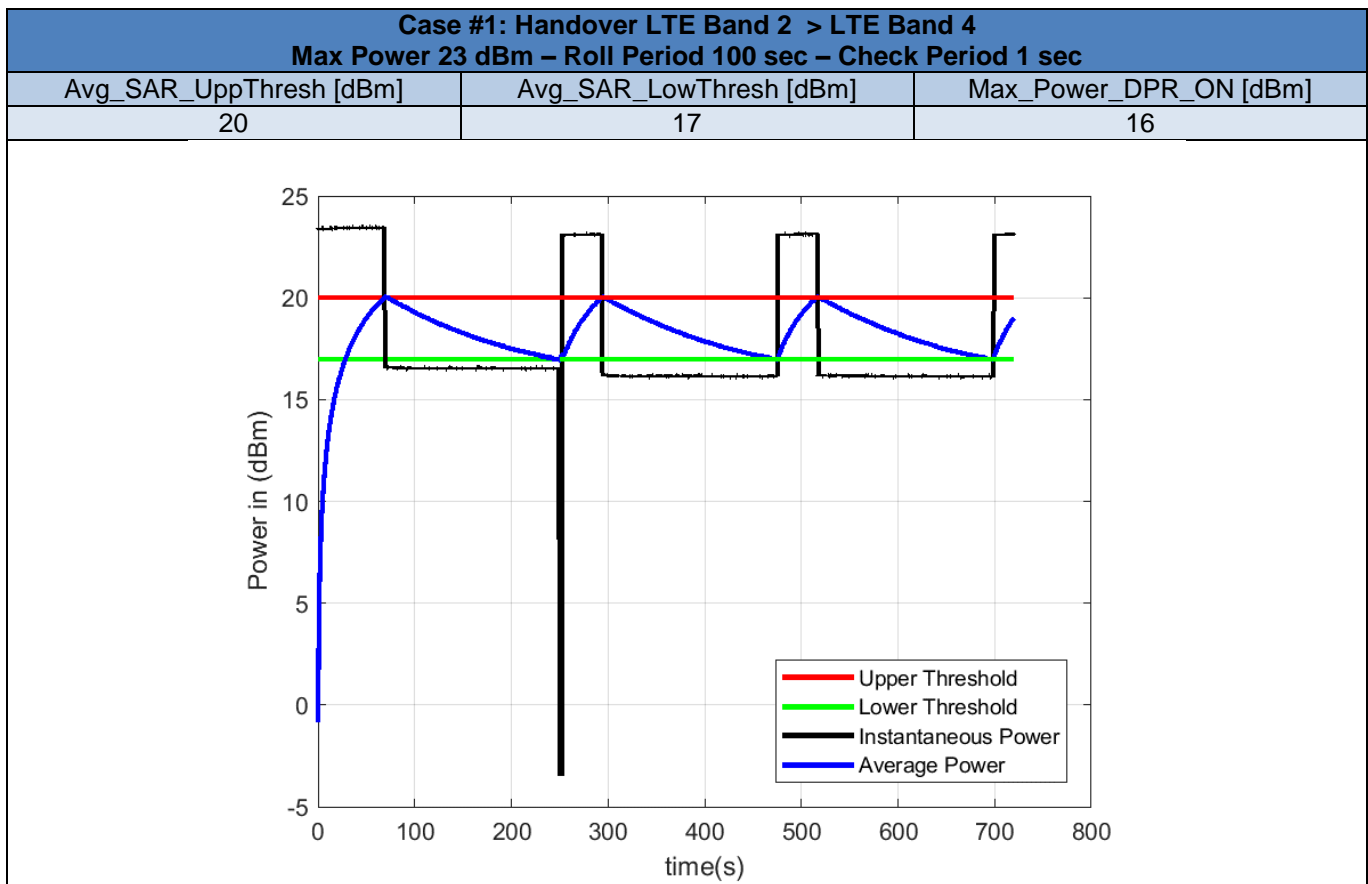

B.2.3.3 Handover Validation from LTE Band 2 to WCDMA Band 4

Table B6 – Test Case for Handover from LTE Band 2 to WCDMA Band 4

Test Case #	Band	Max Power	Roll Period	Check Period	Avg_SAR_UppT hresh [dBm]	Avg_SAR_LowT hresh [dBm]	Max_Power_DPR_ON [dBm]
1	LTE B2	23 dBm	100 sec	1 sec	20	17	16
	WCDMA B4	22.5 dBm			18	15	14

Note: Values for **Max Power**, **Avg_SAR_UppThresh**, **Avg_SAR_LowThresh** and **Max_Power_DPR_ON** indicated above are approximated. The exact values for these are set according to the actual **Max Power** at the time of testing, accounting for tolerance, and the range (in dB) for **Avg_SAR_UppThresh**, **Avg_SAR_LowThresh** and **Max_Power_DPR_ON**. These can introduce an apparent shift of the curves relative to **Max Power** shown in the plots. However, they have no impact to **TAS**.

Results for the test case in Table B6 are shown in the following plot.

Note: This handover test was done at a different time from all of the above tests. The LTE **Max_Power_DPR_ON** and **Max_Power_DPR_OFF** levels were about 0.5 dB lower than specified due to tune-up tolerances (± 1 dB) related to board temperature introduced power drift. This has no impact on **TAS** operations.

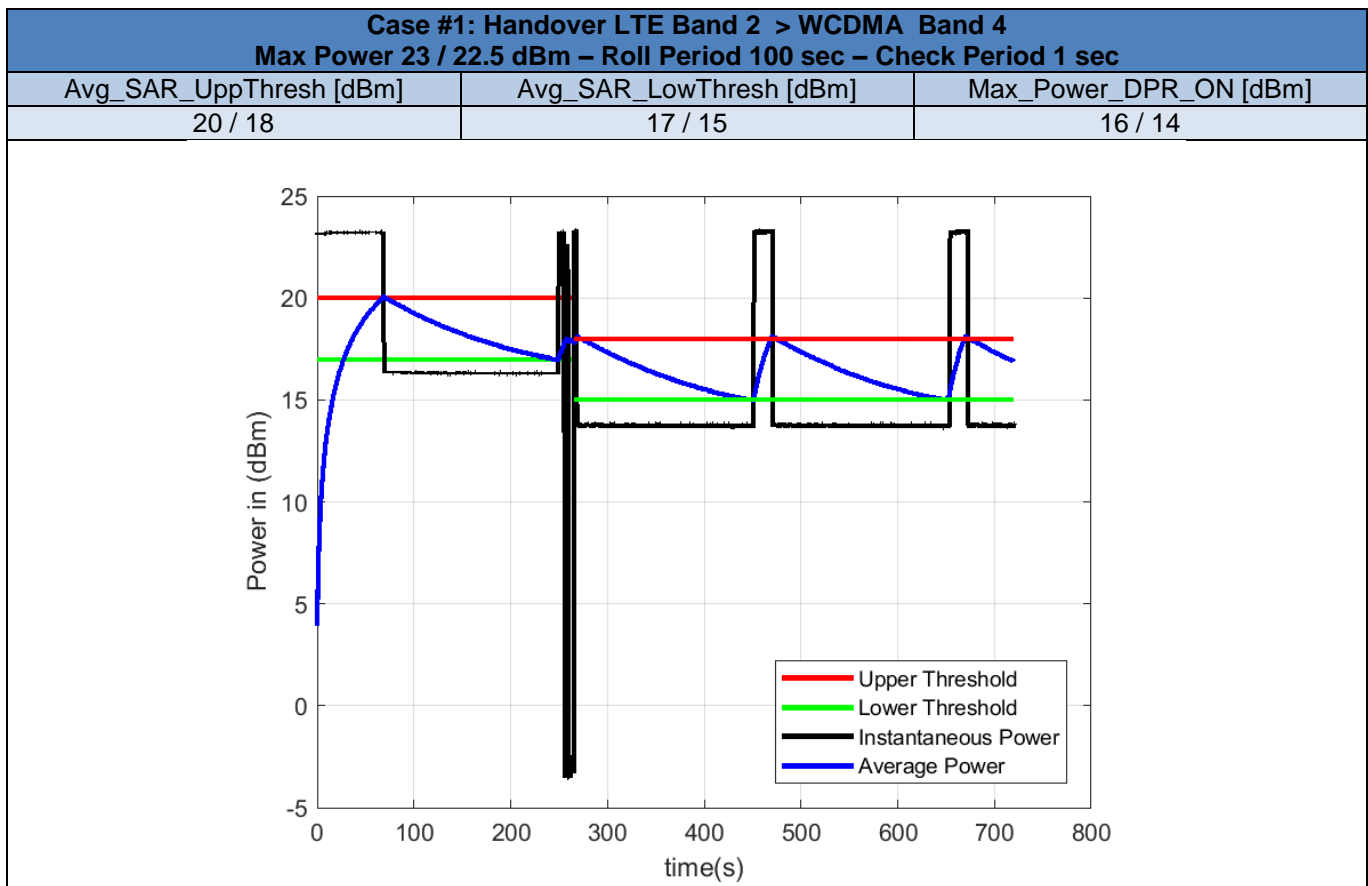

Annex C. Photographs

C.1 Test Setup

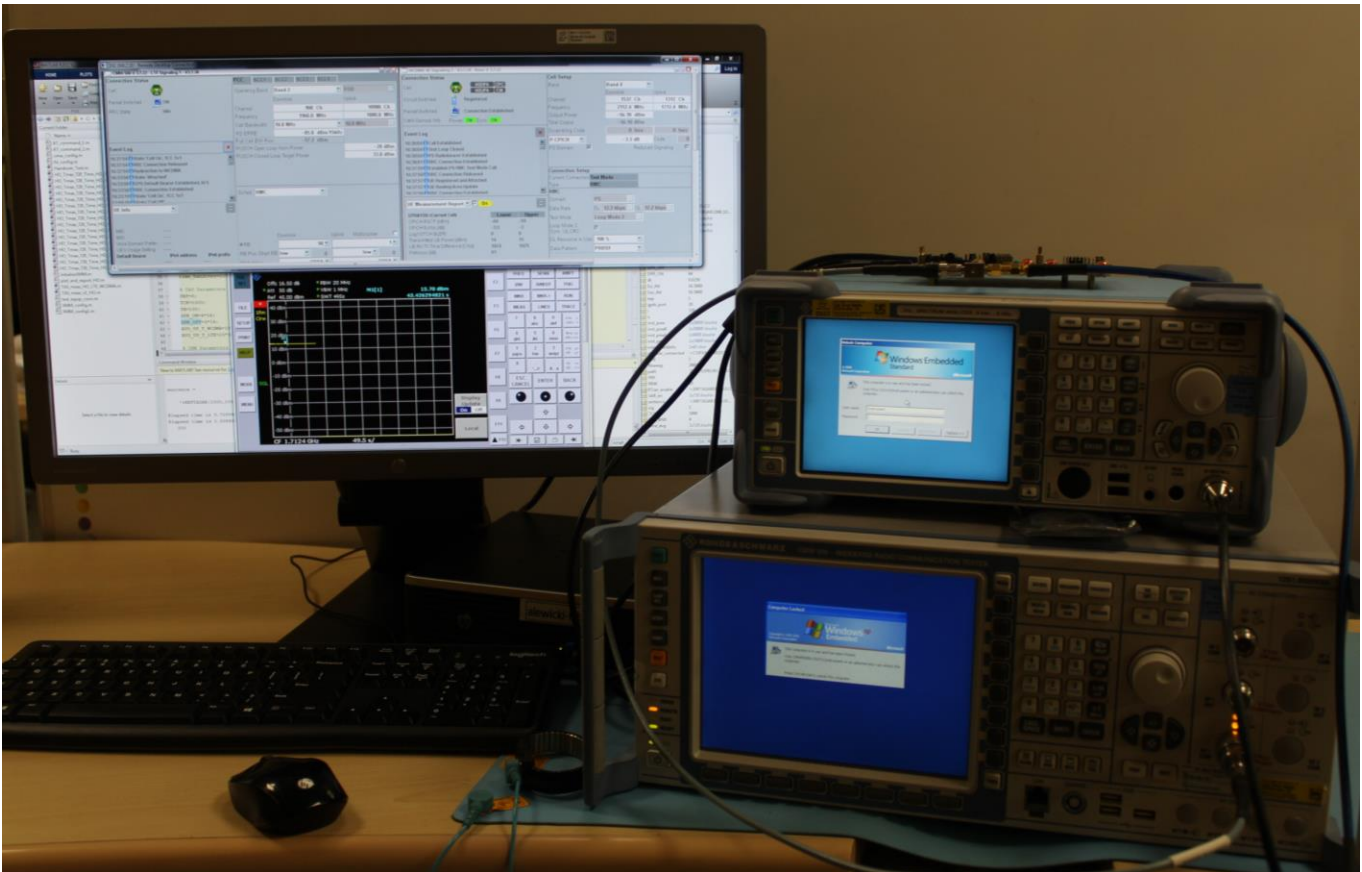

Fibocom Module with XMM 7560 mounted on the Intel Test Platform, placed on top of the Spectrum Analyzer and Call Box CMW 500, which are under GPIB control through the PC (see Annex A).

C.2 Test Sample and Test Platform

Sample #01

Fibocom Module Front

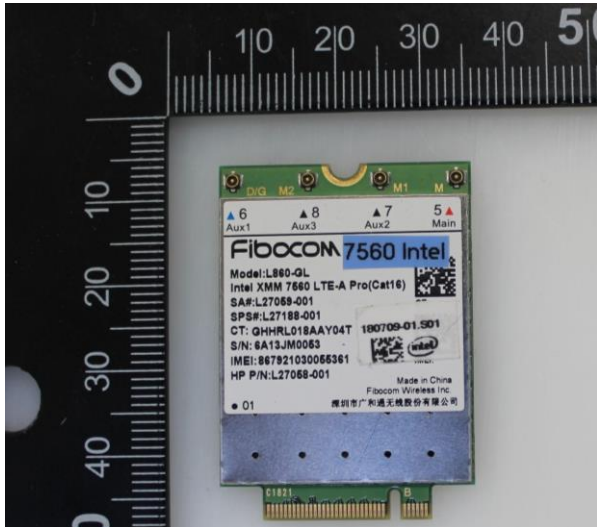

Fibocom Module Back

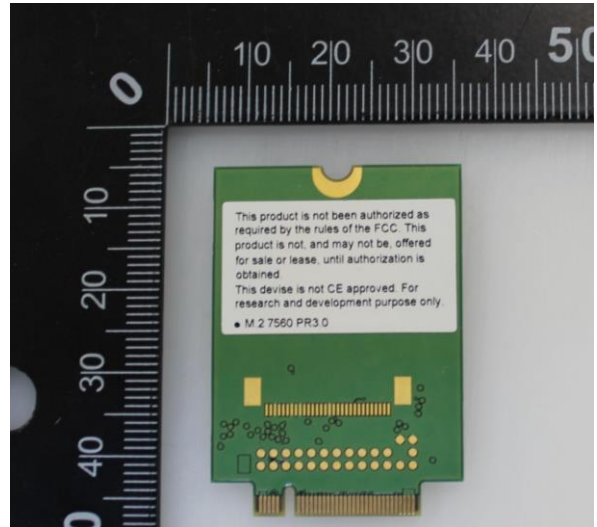

Extender Board – Test Platform

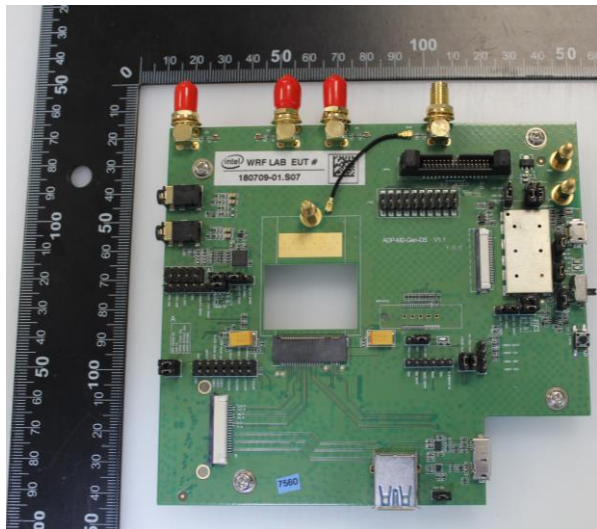

Module monted on the Extender Board

